



**NATIONAL INTELLECTUAL PROPERTY CENTER OF GEORGIA  
SAKPATENTI**

**OFFICIAL BULLETIN  
OF THE INDUSTRIAL PROPERTY**

**15(403)**

**2014  
TBILISI**

# INID CODES FOR IDENTIFICATION OF BIBLIOGRAPHIC DATA

## INVENTIONS, UTILITY MODELS

- (10) Number of publication for application, which has been examined
- (11) Number of patent and kind of document
- (21) Serial number of application
- (22) Date of filing of the application
- (23) Date of exhibition or the date of the earlier filing and the number of application, if any
- (24) Date from which patent may have effect
- (31) Number of priority application
- (32) Date of filing of priority application
- (33) Code of the country or regional organization allotting priority application number
- (44) Date of publication of application not granted, but examined and number of bulletin
- (45) Date of publication of registered document
- (51) International Patent Classification Index
- (54) Title of the invention
- (57) Abstract
- (60) Number of examined patent document granted by foreign patent office, date from which patent has effect and country code
- (62) Number of the earlier application and in case of divided application, date of filing an application
- (71) Name, surname and address of applicant (country code)
- (72) Name, surname of inventor (country code)
- (73) Name, surname and address of patent owner (country code)
- (74) Name, surname of representative or patent attorney
- (85) Date of commencement of the national phase of International Application
- (86) Number and date of filing of international application
- (87) Number and date of publication of international application

## DESIGNS

- (10) Number of publication for application
- (11) Number of patent and kind of document or number of registration
- (15) Date of registration/Date of patent renewal
- (18) Expected expiration date of patent or registration
- (21) Serial number of application
- (22) Date of filing of the application
- (23) Date of exhibition or the date of the earlier filing and the number of application, if any
- (24) Date from which patent may have effect
- (28) Number of designs included in the application
- (30) Data relating to priority (number of application, date of filing of application, two-letter code identifying the authority with whom the priority application was made)
- (31) Number of priority application
- (32) Date of filing of priority application
- (33) Code of the country or regional organization allotting priority application number
- (34) Two-letter code according to WIPO St.3 identifying the authority with which the priority application was made
- (44) Date of publication of design and number of bulletin (the first publication)
- (45) Date of publication of design registered by WIPO and number of bulletin
- (51) International Classification for designs (class and subclass of the Locarno Classification)
- (54) Title of the invention
- (55) Reproduction of the design
- (57) Description of characteristic features of the design including indication of colors
- (58) Date of recording of any kind of amendment in the Register
- (62) Number of the earlier application, registration and document number and if available the date of filing an application in case of divided application
- (71) Name, surname and address of applicant (country code)
- (72) Name, surname of creator (country code)
- (73) Name, surname and address of patent owner (country code)
- (74) Name, surname of representative or patent attorney
- (81) Contracting states concerned
  - II designated contracting states according to the 1960 Act
  - III designated contracting states according to the 1999 Act
- (85) Owner's permanent address
- (86) Owner's nationality
- (87) Owner's residence
- (88) State in which the owner has a real and effective industrial or commercial establishment

## TRADEMARKS

- (111) – Number of registration
- (151) – Date of registration
- (156) – Date of the renewal
- (181) – Expected expiration date of registration
- (186) – Renewal expiration date of registration
- (141) – Date of cancel of duration of the mark
- (210) – Serial number of application
- (220) – Date of filing of the application
- (230) – Data concerning exhibition
- (260) – Number of application, for which favorable decision of examination about registration has been taken (publication number)
- (310) – Number of the first application
- (320) – Date of filing of the first application
- (330) – Code, identifying national or regional Office where the first application was made
- (511) – International Classification of Goods and Services for the purposes of registration of trade marks and/or list of goods and/or services classified according thereto
- (531) – Description of figurative elements of Trade Marks according to the International Classification of the Figurative Elements of Marks
- (540) – Reproduction of Trade Mark
- (550) – Nature and kind of Trade Mark
- (580) – Date of recording of any kind changes in respect of applications or registrations
- (591) – Information concerning colors claimed
- (731) – Name and address of the applicant
- (732) – Name and address of the holder of the registration
- (740) – Name and address of the representative
- (750) – Address for correspondence
- (770) – Name and address of the previous applicant or holder in case of change in ownership
- (771) – Previous name and address of the applicant or holder in case of change in ownership
- (791) – Name and address of the licensee
- (793) – Indication of conditions and/or restrictions under the license (Type of license, number of license agreement, data of license, data of validity of license)
- (800) – Certain data relating to the international registration of Trade Marks under the Protocol Relating to Madrid Agreement (International registration number)

## CODES FOR PUBLICATION IN BULLETIN

- (21) AP 0000 000000 – serial number of application for invention
- (10) AP 0000 0000 A – number of published application for invention (first publication)
- (11) P 0000 0000 B – number of patent for invention (second publication)
- (21) API 0000 000000 – number of application for imported patent
- (11) PI 0000 0000 A – number of imported patent (first publication)
- (21) AU 0000 000000 – serial number of application for utility model
- (10) AU 0000 000 U – number of published application for utility model (first publication)
- (11) U 0000 000 Y – number of patent for utility model (second publication)
- (21) AD 0000 000000 – serial number of application for design
- (10) AD 0000 000 S – number of published application for design (first publication)
- (11) D 0000 000 S – number of patent for design (second publication)

## INTERNATIONAL PATENT CLASSIFICATION FOR INVENTIONS AND UTILITY MODELS

- SECTION A – HUMAN NECESSITIES
- SECTION B – PERFORMING OPERATIONS; TRANSPORTING
- SECTION C – CHEMISTRY; METALLURGY
- SECTION D – TEXTILES; PAPER
- SECTION E – FIXED CONSTRUCTIONS
- SECTION F – MECHANICAL ENGINEERING; LIGHTING; HEATING; WEAPONS; BLASTING
- SECTION G – PHYSICS
- SECTION H – ELECTRICITY

- 
- M – Trade Mark
  - (210) AM 0000 000000 – Serial number of application;
  - (260) AAM 0000 00000 A – Publication number of application;
  - (111) M 0000 00000 R – Number of registration;
  - (111) MMM0000 00000 Rn – Number of renewals, in which n=1,2,3;
  - (111) M 0000 00000 R(P) – Number of registration under partial assignment of rights
-

**LIST OF CODES, IN ALPHABETIC SEQUENCE, AND THE CORRESPONDING (SHORT) NAMES OF STATES, OTHER ENTITIES AND INTERGOVERNMENTAL ORGANIZATIONS**  
(WIPO STANDARD ST.3)

AD	Andorra				
AE	United Arab Emirates				
AF	Afghanistan				
AG	Antigua and Barbuda				
AI	Anguilla				
AL	Albania				
AM	Armenia				
AN	Netherlands Antilles				
AO	Angola				
AP	African Regional Intellectual Property Organization (ARIPO)				
AR	Argentina				
AT	Austria				
AU	Australia				
AW	Aruba				
AZ	Azerbaijan				
BA	Bosnia and Herzegovina				
BB	Barbados				
BD	Bangladesh				
BE	Belgium				
BF	Burkina Faso				
BG	Bulgaria				
BH	Bahrain				
BI	Burundi				
BJ	Benin				
BM	Bermuda				
BN	Brunei Darussalam				
BO	Bolivia				
BR	Brazil				
BS	Bahamas				
BT	Bhutan				
BV	Bouvet Island				
BW	Botswana				
BX	Benelux Office for Intellectual Property (BOIP)				
BY	Belarus				
BZ	Belize				
CA	Canada				
CD	Democratic Republic of the Congo				
CF	Central African Republic				
CG	Congo				
CH	Switzerland				
CI	Cote d'Ivoire				
CK	Cook Islands				
CL	Chile				
CM	Cameroon				
CN	China				
CO	Colombia				
CR	Costa Rica				
CU	Cuba				
CV	Cape Verde				
CY	Cyprus				
CZ	Czech Republic				
DE	Germany				
DJ	Djibouti				
DM	Dominica				
DO	Dominican Republic				
DZ	Algeria				
EA	Eurasian Patent Organization (EAPO)				
EC	Ecuador				
EE	Estonia				
EG	Egypt				
EH	Western Sahara				
EM	Office for Harmonization in the Internal Market (Trademarks and Designs)(OHIM)				
EP	European Patent Office (EPO)				
ER	Eritrea				
ES	Spain				
ET	Ethiopia				
FI	Finland				
FJ	Fiji				
FK	Falkland Islands (Malvinas)				
FO	Faroe Islands				
FR	France				
GA	Gabon				
GB	United Kingdom				
GC	Patent Office of the Cooperation Council for the Arab States of the Gulf (GCC)				
GD	Grenada				
GG	Guernsey				
GH	Ghana				
GI	Gibraltar				
GT	Guatemala				
GW	Guinea- Bissau				
GY	Guyana				
HK	The Hong Kong Special Administrative Region of the People's Republic of China				
HN	Honduras				
HR	Croatia				
HT	Haiti				
HU	Hungary				
IB	International Bureau of the World Intellectual Property Organization (WIPO)				
ID	Indonesia				
IE	Ireland				
IL	Israel				
IM	Isle of Man				
IN	India				
IQ	Iraq				
ID	Indonesia				
IE	Ireland				
IL	Israel				
IM	Isle of Man				
IN	India				
IQ	Iraq				
IR	Iran (Islamic Republic of)				
IS	Iceland				
IT	Italy				
JE	Jersey				
JM	Jamaica				
JO	Jordan				
JP	Japan				
KE	Kenya				
KG	Kyrgyzstan				
KH	Cambodia				
KI	Kiribati				
KM	Saint Kitts and Nevis				
KP	Democratic People's Republic of Korea				
KR	Republic of Korea				
KW	Kuwait				
KY	Cayman Islands				
KZ	Kazakhstan				
LA	Lao People's Democratic Republic				
LB	Lebanon				
LC	Saint Lucia				
LI	Liechtenstein				
LK	Sri Lanka				
LR	Liberia				
LS	Lesotho				
LT	Lithuania				
LU	Luxembourg				
LV	Latvia				
LY	Libyan Arab Jamahiriya				
MA	Morocco				
MC	Monaco				
MD	Republic of Moldova				
ME	Montenegro				
MG	Madagascar				
MK	The former Yugoslav Republic of Macedonia				
ML	Mali				
MM	Myanmar				
MN	Mongolia				
MO	Macao				
MP	Northern Mariana Islands				
MR	Mauritania				
MS	Montserrat				
MT	Malta				
MU	Mauritius				
MV	Maldives				
MW	Malawi				
MX	Mexico				
MY	Malaysia				
MZ	Mozambique				
NA	Namibia				
NE	Niger				
NG	Nigeria				
NI	Nicaragua				
NL	Netherlands				
NO	Norway				
NP	Nepal				
NR	Nauru				
NZ	New Zealand				
OA	African Intellectual Property Organization (OAPI)				
OM	Oman				
PA	Panama				
PE	Peru				
PG	Papua New Guinea				
PH	Philippines				
PK	Pakistan				
PL	Poland				
PT	Portugal				
PW	Palau				
PY	Paraguay				
QA	Qatar				
QZ	Community Plant Variety Office (European Community) (CPVO)				
RO	Romania				
RS	Serbia				
RU	Russian Federation				
RW	Rwanda				
SA	Saudi Arabia				
SB	Solomon Islands				
SC	Seychelles				
SD	Sudan				
SG	Singapore				
SH	Saint Helena				
SI	Slovenia				
SK	Slovakia				
SL	Sierra Leone				
SM	San Marino				
SN	Senegal				
SO	Somalia				
SR	Suriname				
ST	Sao Tome and Principe				
SV	El Salvador				
SY	Syrian Arab Republic				
SZ	Swaziland				
TC	Turks and Caicos Islands				
TD	Chad				
TG	Togo				
TH	Thailand				
TJ	Tajikistan				
TL	Timor-Leste				
TM	Turkmenistan				
TN	Tunisia				
TO	Tonga				
TR	Turkey				
SE	Sweden				
TT	Trinidad and Tobago				
TV	Tuvalu				
TW	Taiwan, Province of China				
TZ	United Republic of Tanzania				
UA	Ukraine				
UG	Uganda				
US	United States of America				
UY	Uruguay				
UZ	Uzbekistan				
VA	Holy See				
VC	Saint Vincent and the Grenadines				
VE	Venezuela				
VG	Virgin Islands (British)				
VN	Viet Nam				
VU	Vanuatu				
WO	World Intellectual Property Organization (WIPO)				
WS	Samoa				
XN	Nordic Patent Institute (NPI)				
YE	Yemen				
ZA	South Africa				
ZM	Zambia				
ZW	Zimbabwe				

**NATIONAL INTELLECTUAL PROPERTY CENTER OF GEORGIA  
SAKPATENTI**

**OFFICIAL BULLETIN  
OF THE INDUSTRIAL PROPERTY**

**15(403)**

**INVENTIONS  
UTILITY MODELS  
DESIGNS  
TRADEMARKS**

**DATE OF PUBLICATION  
2014 08 11**

# CONTENTS

<b>PUBLISHED TITLES OF PROTECTION .....</b>	<b>2</b>
<b>INVENTIONS</b>	
▪ APPLICATIONS APPROVED FOR GRANTING PATENTS .....	4
▪ PATENTED INVENTIONS .....	8
<b>UTILITY MODELS</b>	
▪ APPLICATIONS APPROVED FOR GRANTING PATENTS .....	12
▪ PATENTED UTILITY MODEL .....	13
<b>DESIGNS</b>	
▪ APPLICATIONS APPROVED FOR GRANTING PATENT .....	14
▪ REGISTERED DESIGN .....	17
▪ DESIGN REGISTERED ACCORDING TO THE ACCELERATED PROCEDURE .....	18
<b>TRADEMARKS</b>	
▪ APPLICATIONS FILED UNDER THE NATIONAL PROCEDURE APPROVED FOR REGISTRATION .....	19
▪ REGISTERED TRADEMARKS .....	26
▪ TRADEMARKS REGISTERED ACCORDING TO THE ACCELERATED PROCEDURE .....	31
▪ INTERNATIONAL TRADEMARKS FOR WHICH A DECISION ON GANTING PROTECTION IS TAKEN .....	35
▪ INTERNATIONAL TRADEMARKS PROTECTED IN GEORGIA .....	61
<b>OFFICIAL NOTIFICATIONS</b>	
<b>INVENTIONS</b>	
▪ RENEWAL OF A PATENT .....	66
<b>UTILITY MODELS</b>	
▪ RENEWAL OF A PATENT .....	66
<b>TRADEMARKS</b>	
▪ CORRECTION OF PUBLISHED INFORMATION .....	66
<b>CLASSIFICATION INDEXES</b>	
INVENTIONS .....	67
UTILITY MODELS .....	69
DESIGNS .....	70
TRADEMARKS .....	72

## **PUBLISHED TITLES OF PROTECTION**

### **INVENTIONS**

- **APPLICATIONS APPROVED FOR GRANTING PATENTS:**  
13289; 13124; 12310; 12584; 12784; 12855; 12890; 12671
- **PATENTED INVENTIONS:**  
6128-6142

### **UTILITY MODELS**

- **APPLICATIONS APPROVED FOR GRANTING PATENTS:**  
13297; 13353; 13167
- **PATENTED UTILITY MODELS:**  
1823, 1824

### **DESIGNS**

- **APPLICATIONS APPROVED FOR GRANTING PATENT:**  
794; 796
- **REGISTERED DESIGN:**  
585
- **DESIGN REGISTERED ACCORDING TO THE ACCELERATED PROCEDURE:**  
586

### **TRADEMARKS**

- **APPLICATIONS FILED UNDER THE NATIONAL PROCEDURE APPROVED FOR REGISTRATION:**  
72647; 73113; 73115; 73377; 73511; 73761; 73911, 73912; 73924-73926; 73928; 73929; 73931; 73937; 73939, 73940; 73944; 73964-73967; 74065; 74102; 74104, 74105; 74139; 74163; 74327; 74544; 74545; 74570, 74571; 74720; 74760-74762; 74979; 75102; 73104\*
- **REGISTERED TRADEMARKS:**  
25048-25095; 25100
- **TRADEMARKS REGISTERED ACCORDING TO THE ACCELERATED PROCEDURE:**  
25039-25047; 25096-25099; 25101-25105
- **INTERNATIONAL TRADEMARKS FOR WHICH A DECISION ON GRANTING PROTECTIONS IS TAKEN:**  
71431; 71626; 71869; 72132; 72353, 72354; 72368; 72376; 73030-73034; 73036-73038; 73040-73044; 73046; 73048, 73049; 73051-73067; 73686-73695; 73719; 73720; 73723-73725; 73782, 73783; 73785; 73787-73791; 73793-73803; 73998; 74285, 74286; 74289; 74293; 74308, 74309; 74424; 74431; 74441; 74444; 74446; 74448; 74451; 74457; 74615; 74617, 74618; 74620; 74625
- **INTERNATIONAL TRADEMARKS PROTECTED IN GEORGIA:**  
72198-72202; 72205-72208; 72210; 72213-72215; 72221, 72222; 72225, 72226; 72229-72232; 72234; 72236-72247; 72274; 72428-73430; 72435; 72437-73439; 72441, 72442; 72470; 72475; 72527; 72533, 72534; 72538; 72541-72543; 72547-72549; 72551; 72553-72555; 72711; 72715-72717; 72719; 72725; 72727; 72880, 72881; 72885, 72886; 72888, 72889; 72897; 74180-74182; 74184, 74185; 74187-74189; 70662\*

# INVENTIONS

## APPLICATIONS APPROVED FOR GRANTING PATENTS

The decision can be appealed at the Chamber of Appeal of Sakpatenti within 3 months from the publication or at the Mtskheta District Court Administrative Cases Board (Address: №17, Samkhedro str., Mtskheta), within 1 month following the publication.

### PART A

#### A 01

(10) AP 2014 13289 A (51) Int. Cl. (2006)  
A 01 G 17/00

(21) AP 2013 013289 (22) 2013 11 11

(71) Vahtang Simonia (GE)

Saakadzis q. 84, 0180, Tbilisi (GE);

Jamlet Badagadze (GE)

Khevispiris q. 3, 0107, Tbilisi (GE)

(72) Vahtang Simonia (GE);

Jamlet Badagadze (GE)

(54) VINE TRELLIS POST

(57) There is represented a post consisting of underground 1 and overground 2 parts sectional connected to each other. Underground part is executed with metal whereon angle-shaped in cross-section the element 5 provides resistance. The post is additionally equipped with simplex jack 6 placed in a guide 7 rigid onto post underground part. The guide is installed inclined; at that, inclination angle thereof relative to vertical axis is less than 20°. The holes 8 are executed on various heights of post overground part for passing trellis wires throughout thereof; and crosscut lath 9 is established on the end of underground part.

Claims: 1 independent

3 dependent

Fig.: 1

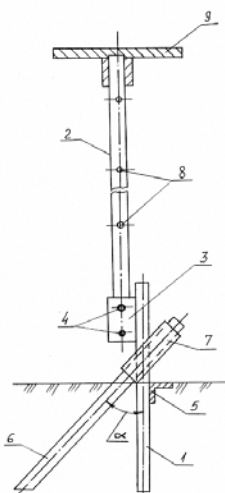

Fig. 1

#### A 23

(10) AP 2014 13124 A (51) Int. Cl. (2006)  
A 23 G 3/00

(21) AP 2013 013124 (22) 2013 06 20

(71) Dodo Tavdidishvili (GE)

Varlamishvilis q. 9/30, 4600, Kutaisi (GE);

Manana Pkhakadze (GE)

9 Aprilis Kheivani 27/30, 4600, Kutaisi (GE);

Tsira Khutsidze (GE)

Chabukianis q. 2, 4600, Kutaisi (GE);

Nino Minadze (GE)

Davit Aghmasheneblis Gamz. 44, 4600,

Kutaisi (GE)

(72) Dodo Tavdidishvili (GE);

Manana Pkhakadze (GE);

Tsira Khutsidze (GE);

Nino Minadze (GE)

(54) DESSERT WITH BEE-FARMING  
PRODUCTS

(57) There is represented a dessert containing in mass%: fruit-berry juices or blend of fruit-berry juices 40-50; water 8-10; tea infusion 10-20; honey 14-16; maize flour 10-12 and farina 4-6.

Claims: 1 independent

#### A 61

(10) AP 2014 12310 A (51) Int. Cl. (2006)  
A 61 K 31/44  
A 01 N 43/42

(21) AP 2009 012310 (22) 2009 12 11

(31) 61/139,536; 61/144,731; 61/205,145

(32) 2008 12 19; 2009 01 14; 2009 01 15

(33) US; US; US

(71) GRACEWAY PHARMACEUTICALS,  
LLC (US)

Suite 500, 340 Martin Luther King Jr.

Boulevard, Bristol, TN 37620 (US).

(72) NORDSIEK, Michael, T. (US);

LEVY, Sharon, F. (US);

LEE, James, H. (US);

KULP, James, H. (US);

BALAJI, Kodumudi, S. (US);

MENG, Tze-Chiang (US).

WU, Jason, J. (US).

BAHM, Valyn, S. (US).

BABILON, Robert; (US)

(74) Shalva Gvaramadze

(85) 2011 07 18

(86) PCT/US2009/067759, 2009 12 11

(54) **LOWER DOSAGE STRENGTH  
IMIQUIMOD FORMULATIONS AND  
SHORT DOSING REGIMENS FOR  
TREATING ACTINIC KERATOSIS**

(57) There is represented composition containing in mass% 2.5 or 3.75 imiquimod and pharmaceutically acceptable carrier containing fatty acid, applied at actinic keratosis treatment.

Claims: 1 independent

25 dependent

Fig.: 69

(10) **AP 2014 12584 A** (51) **Int. Cl. (2006)  
A 61 K 36/00**

(21) AP 2012 012584 (22) 2012 02 20

(71) Eter Kemertelidze (GE)

Pekinis Gamz. 33A, b. 40, 0160, Tbilisi (GE);

Meri Alania (GE)

Dolidzis q. korp. 20, b. 20, 0171, Tbilisi (GE);

Nana Kavtaradze (GE)

Pekinis q. II kvart., korp. 9, b. 31, 0160,

Tbilisi (GE)

(72) Eter Kemertelidze (GE);

Meri Alania (GE);

Nana Kavtaradze (GE)

(54) **HYPOAZOTEMICAL DRUG MADE OF  
PLANT PUERARIA HIRSUTE MATSUM**

(57) There is represented preparation method of hygroscopical extraction of hypoazotemical action from the plant Pueraria hirsute Matsum foliage providing thickening of extract extracted from foliage by means of 70% ethyl alcohol to syrup-like consistence. Application therefor capsule-shapr drug preparation, and application therefor hypoazotemia treatment.

Claims: 3 independent

**PART C****C 07**

(10) **AP 2014 12784 A** (51) **Int. Cl. (2006)  
C 07 D 471/04  
A 61 K 31/4196  
A 61 K 31/437  
A 61 P 25/18  
A 61 P 25/28**

(21) AP 2010 012784 (22) 2010 12 15

(31) PA200901340; 61/287321

(32) 2009 12 17; 2009 12 17

(33) DK; US

(71) H. LUNDBECK A/S (DK)

Ottiliavej 9 DK-2500 Valby (DK)

(72) PÜSCHL, Ask (DK);

NIELSEN, Jacob (DK);

KEHLER, Jan (DK);

KILBURN, John, Paul (GB);

MARIGO, Mauro (IT);

LANGGÅRD, Morten (DK)

(74) Shalva Gvaramadze

(85) 2012 07 12

(86) PCT/DK2010/050344, 2010 12 15

(54) **HETEROAROMATIC ARYL TRIAZOLE  
DERIVATIVES AS PDE10A ENZYME  
INHIBITORS**

(57) There is represented compound of formula (I),

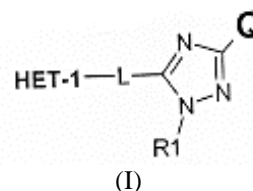

pharmaceutical composition on basis thereof, and application of therapeutically effective amount therefor enzyme PDE10A inhibition.

Claims: 10 independent

24 dependent

(10) **AP 2014 12855 A** (51) **Int. Cl. (2006)  
C 07 D 495/04  
A 61 K 31/519  
A 61 K 31/5377  
A 61 K 31/541  
A 61 P 35/00  
A 61 P 35/02  
A 61 P 35/04  
A 61 P 43/00  
C 07 D 519/00**

(21) AP 2011 012855 (22) 2011 02 16

(31) 2010- 031899; 2010-131950

(32) 2010 02 17; 2010 06 09

(33) JP; JP

(71) TAKEDA PHARMACEUTICAL



COMPANY LIMITED (JP)

1-1, Doshomachi 4-chome, Chuo-ku, Osaka-shi, Osaka 5410045 (JP)

(72) HOMMA, Misaki (JP);

MIYAZAKI, Toru (JP);

OGURO, Yuya (JP);

KURASAWA, Osamu (JP)

(74) Shalva Gvaramadze

(85) 2012 09 12

(86) PCT/JP2011/053303, 2011 02 16

(54) **HETEROCYCLIC COMPOUND**

(57) There is provided application of compound of formula (I),

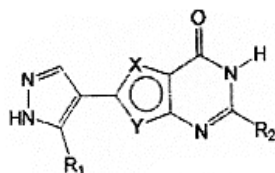

(I)

or effective amount therefor cancer treatment in mammal.

Claims: 12 independent

9 dependent

Table: 6

## C 10

(10) AP 2014 12890 A (51) Int. Cl. (2006)

C 10 G 15/08

B 01 J 19/10

C 02 F 1/36

B 01 F 7/00

(21) AP 2011 012890 (22) 2011 04 14

(31) A 597/2010; A 596/2010

(32) 2010 04 14; 2010 04 14

(33) AT; AT

(71) PRISTEC AG (AT)

Tech Gate Vienna Science and Technology  
Park Donau-City-Strasse 1 A-1220,  
Vienna (AT)

(72) DELGADO CASTILLO, Jose Miquel (ES);

VENECIANO RIVERA, Anibal Luis (CL);

NUERK, Ruediger Uwe (DE);

CHERNIKOV, Fedor (RU)

(74) Shalva Gvaramadze

(85) 2012 11 08

(86) PCT/AT2011/000184, 2011 04 14

(54) **METHOD FOR THE TREATMENT OF LIQUID, IN PARTICULAR MINERAL OIL**

(57) There is disclosed a method for the treatment of liquid, in particular a mineral oil, for increasing the portion of low-boiling fractions. The method provides generating pressure waves having first frequency, subjecting the liquid to said pressure waves in a region of application and feeding so-treated liquid to a tank. At least one pipe flowed

through by treated liquid and immediately following said region of application is excited to oscillations of second frequency, which is the resonance frequency of excited system.

Claims: 3 independent

7 dependent

Fig.: 5

Table: 1

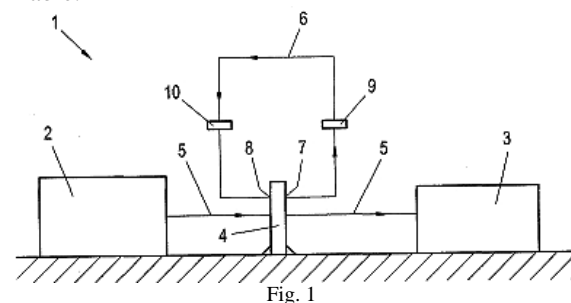

## PART E

### E 21

(10) AP 2014 12671 A (51) Int. Cl. (2006)

E 21 B 43/26

E 21 B 43/25

(21) AP 2010 012671 (22) 2010 08 17

(31) 61/276,950; 61/254,122; 61/297,097;  
12/842,738

(32) 2009 09 18; 2009 10 22; 2010 01 21; 2010 07 23

(33) US; US; US; US

(71) HEAT ON-THE-FLY, LLC (US)

1027 West 11<sup>th</sup> Ave., Covington,  
LA 70433 (US)

(72) HEFLEY, Ransom, Mark (US)

(74) Tamaz Shilakadze

(85) 2012 04 17

(86) PCT/US2010/045791, 2010 08 17

(54) **WATER HEATING APPARATUS FOR CONTINUOUS HEATED WATER FLOW AND METHOD FOR USE IN HYDRAULIC FRACTURING**

(57) There is provided a method of hydraulic fracturing of an oil producing formation includes the provision of a heating apparatus which is transportable and that has a vessel for containing water. The method contemplates heating the water up to a temperature of about 200° F (93.3 °C). A water stream of cool or cold water is transmitted from a source to a mixer, the cool water stream being at ambient temperature. The mixer has an inlet that receives cool or cold water from the source and an outlet that enables a discharge of a mix of cool or cold water and the hot water. After mixing in the mixer, the water assumes a temperature that is suitable for mixing with

chemicals that are used in the fracturing process, such as a temperature of about 40°-120 °F+ (4.4 - 48.9°C+). An outlet discharges a mix of the cool and hot water to surge tanks or to mixing tanks. In the mixing tanks, a proppant and an optional selected chemical or chemicals are added to the water which has been warmed. From the mixing tanks, the water with proppant and optional chemicals is injected into the well for part of the hydraulic fracturing operation. The mixer preferably employs lateral fittings that enable heated water to enter the mixer bore at an acute angle. The mixer can also provide a lateral fitting that exits the mixer bore upstream of the first lateral fitting, the second lateral fitting transmitting water via a conduit such as a hose to the heater.

Claims: 5 independent

17 dependent

Fig.: 12

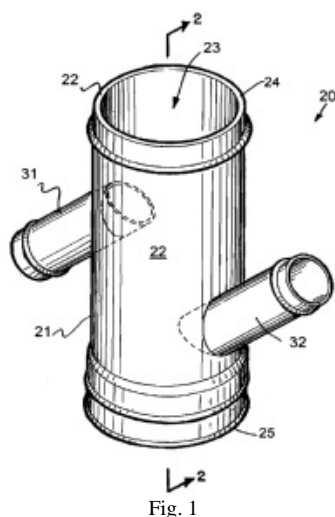

## PATENTED INVENTIONS

### PART A

#### A 61

- (11) **P 2014 6134 B** (51) **Int. Cl. (2006)**  
**A 01 N 37/18**  
**A 01 K 31/16**  
 (10) AP 2014 12428 A (44) 1(389)/2014  
 (21) AP 2010 012428  
 (22) 2010 03 25  
 (24) 2010 03 25  
 (31) 61/163,958; 61/247,318  
 (32) 2009 03 27; 2009 09 30  
 (33) US; US  
 (86) PCT/US2010/028653, 2010 03 25  
 (73) MERCK SHARP & DOHME CORP. (US)  
 126 East Lincoln Ave., Rahway,  
 NJ 07065-0907 (US)  
 (72) COBURN, Craig, A. (US);  
 MCCAULEY, John, A. (US);  
 LUDMERER, Steven, W. (US);  
 LIU, Kun (CN);  
 VACCA, Joseph, P. (US);  
 WU, Hao (CN);  
 HU, Bin (CN);  
 SOLL, Richard (CN);  
 SUN, Fei (CN);  
 WANG, Xinghai (CN);  
 YAN, Man (CN);  
 ZHANG, Chengren (CN);  
 ZHENG, Mingwei (CN);  
 ZHONG, Bin (CN);  
 ZHU, Jian (CN)  
 (74) Tamar Kochlamazashvili  
 (54) **INHIBITORS OF HEPATITIS C VIRUS**  
**REPLICATION**

- (11) **P 2014 6138 B** (51) **Int. Cl. (2006)**  
**A 01 N 43/38**  
**A 61 K 31/40**  
 (10) AP 2014 12711 A (44) 8(396)/2014  
 (21) AP 2010 012711  
 (22) 2010 10 25  
 (24) 2010 10 25  
 (31) 61/254,395  
 (32) 2009 10 23  
 (33) US  
 (86) PCT/US2010/053916, 2010 10 25  
 (73) HEALTH RESEARCH INC (US)  
 Elm and Carlton Streets Buffalo,  
 NY 14263 (US);  
 PANACELA LABS, INC (US)  
 73 High Street Buffalo,  
 New York 14203 (US)

- (72) GUROVA, Katerina (RU);  
 NARIZHEVA, Natalia (RU)  
 (74) Shalva Gvaramadze  
 (54) **METHOD FOR TREATING ANDROGEN**  
**RECEPTOR POSITIVE CANCERS**

#### A 21

- (11) **P 2014 6142 B** (51) **Int. Cl. (2006)**  
**A 21 B 1/22**  
**A 21 B 1/52**  
 (10) AP 2014 13005 A (44) 8(396)/2014  
 (21) AP 2013 013005  
 (22) 2013 02 19  
 (24) 2013 02 19  
 (73) Kartlos Gabarashvili (GE)  
 Nutsubidzis Perd., I I Mkr., I Kv., korp.1, b. 45,  
 0183, Tbilisi (GE)  
 (72) Kartlos Gabarashvili (GE)  
 (54) **"TONE" (GEORGIAN TRADITIONAL**  
**OVEN)**

#### A 61

- (11) **P 2014 6139 B** (51) **Int. Cl. (2006)**  
**A 61 K 9/00**  
**A 61 K 47/14**  
 (10) AP 2014 12712 A (44) 8(396)/2014  
 (21) AP 2010 012712  
 (22) 2010 11 19  
 (24) 2010 11 19  
 (31) 61/262,719; 10164362.5  
 (32) 2009 11 19; 2010 05 28  
 (33) US; EP  
 (86) PCT/EP2010/067844, 2010 11 19  
 (73) SANTEN SAS (FR)  
 Bâtiment Genavenir IV, 1, Rue  
 Pierre Fontaine, F-91000 Evry (FR)  
 (72) GARRIGUE, Jean-Sébastien (FR);  
 LALLEMAND, Frédéric (FR);  
 HEIER, Jeffrey (US)  
 (74) Shalva Gvaramadze  
 (54) **METHOD FOR TREATING RETINAL**  
**CONDITIONS USING AN**  
**INTRAOCULAR TAMPONADE**

- (11) **P 2014 6132 B** (51) **Int. Cl. (2006)**  
**A 61 K 31/4045**  
**A 61 K 31/55**  
**A 61 K 45/06**  
**A 61 P 9/04**  
 (10) AP 2014 12259 A (44) 8(396)/2014

- (21) AP 2011 012259  
 (22) 2011 06 10  
 (24) 2011 06 10  
 (31) 10/02525  
 (32) 2010 06 15  
 (33) FR  
 (73) LES LABORATOIRES SERVIER (FR)  
 35, Rue de Verdun, F-92284 Suresnes Cedex  
 (FR)  
 (72) THUILLEZ, Christian (FR);  
 MULDER, Paulus (FR);  
 VILAINE, Jean-Paul (FR);  
 FRATACCI, Marie-Dominique (FR);  
 LEREBOURS-PIGENNIERE, Guy (FR);  
 FELDMANN, Luc (FR);  
 RUSSEL, Jerome (FR)  
 (74) Tamaz Shilakadze  
 (54) **SINUS NODE IF CURRENT INHIBITOR  
 ASSOCIATION AND ANGIOTENSIN-  
 CONVERTING ENZYME INHIBITOR  
 USAGE AT HEART FAILURE  
 TREATMENT**

---

## PART B

### B 22

- (11) **P 2014 6136 B** (51) **Int. Cl. (2006)  
 B 22 D 41/00**  
 (10) AP 2014 12661 A (44) 8(396)/2014  
 (21) AP 2012 012661  
 (22) 2012 04 10  
 (24) 2012 04 10  
 (73) Otar Barbakadze (GE)  
 Moskovis Gamz., V kv., korp. 7, b. 26,  
 0145, Tbilisi (GE);  
 Vasil Kopaleishvili (GE)  
 I.Abashidzis q. 68, b. 47, 0162, Tbilisi (GE);  
 Lamara Kereselidze (GE)  
 I.Abashidzis q. 68, b. 47, 0162, Tbilisi (GE);  
 Robinzon Lomidze (GE)  
 Rustavelis q. 19, b.18, 3700, Rustavi (GE);  
 Ramaz Bakradze (GE)  
 XII Mkr., korp. 6, b. 176, 3700, Rustavi (GE);  
 Gia Putkaradze (GE)  
 XVII Mkr., korp. 17, b. 17, 3700, Rustavi (GE);  
 Salome Barbakadze (GE)  
 Moskovis Gamz., V kv., korp. 7, b. 26,  
 0145, Tbilisi (GE)  
 (72) Otar Barbakadze (GE);  
 Vasil Kopaleishvili (GE);  
 Lamara Kereselidze (GE);  
 Robinzon Lomidze (GE);  
 Ramaz Bakradze (GE);  
 Gia Putkaradze (GE);  
 Salome Barbakadze (GE)

- (54) **CAST IRON ALLOY CASTING SCOOP**

---

### B 60

- (11) **P 2014 6141 B** (51) **Int. Cl. (2006)  
 B 60 B 19/00  
 B 62 D 57/00**  
 (10) AP 2014 12997 A (44) 8(396)/2014  
 (21) AP 2013 012997  
 (22) 2013 02 12  
 (24) 2013 02 12  
 (73) Amiran Rekhviashvili (GE)  
 V. Chikovanis q. 35, 0177, Tbilisi (GE);  
 Davit Chachanidze (GE)  
 S. Tsintsadzis q. 77 (Saburtalos q. 53), b. 2a  
 0160, Tbilisi (GE);  
 Giorgi Rekhviashvili (GE)  
 V. Chikovanis q. 35, 0177, Tbilisi (GE)  
 (72) Amiran Rekhviashvili (GE);  
 Davit Chachanidze (GE);  
 Giorgi Rekhviashvili (GE)  
 (54) **VEHICLE DRIVE**

---

### B 61

- (11) **P 2014 6130 B** (51) **Int. Cl. (2006)  
 B 61 G 3/10  
 B 61 G 5/06**  
 (10) AP 2014 12145 A (44) 8(396)/2014  
 (21) AP 2011 012145  
 (22) 2011 03 18  
 (24) 2011 03 18  
 (31) EP10 157 092.7; EP10 172 493.8  
 (32) 2010 03 19; 2010 08 11  
 (33) EP; EP  
 (73) VOITH PATENT GMBH (DE)  
 St. Pöltener Straße 43, 89522 Heidenheim (DE)  
 (72) SCHUELER, Martin (DE)  
 (74) Shalva Gvaramadze  
 (54) **COUPLING HEAD OF AUTOMATIC  
 MIDDLE BUFFER**

**PART C****C 07**

- (11) P 2014 6131 B (51) Int. Cl. (2006)  
C 07 D 209/86  
C 07 D 209/88  
C 07 D 401/04  
C 07 D 487/04  
A 61 K 31/403  
A 61 P 33/00  
A 61 P 31/00  
A 61 P 35/00  
A 61 P 29/00
- (10) AP 2014 12213 A (44) 8(396)/2014  
(21) AP 2009 012213  
(22) 2009 10 05  
(24) 2009 10 05  
(31) 61/102,913  
(32) 2008 10 06  
(33) US  
(86) PCT/US2009/059558, 2009 10 05  
(73) INCURON, LLC (RU)  
6 Stolovyi Pereulok, Bld. 2 Moscow,  
121069 (RU)
- (72) TUCKER, John (US);  
SVIRIDOV, Sergey (RU);  
BRODSKY, Leonid (IL);  
BURKHART, Catherine (US);  
PURMAL, Andrei (US);  
GUROVA, Katerina (RU);  
GUDKOV, Andrei (US)
- (74) Tamaz Shilakadze
- (54) **CARBAZOLE COMPOUNDS AND  
THERAPEUTIC USES THEREOF**
- 
- (11) P 2014 6135 B (51) Int. Cl. (2006)  
C 07 J 71/00  
A 61 K 31/58  
A 61 P 5/44
- (10) AP 2014 12612 A (44) 8(396)/2014  
(21) AP 2010 012612  
(22) 2010 09 01  
(24) 2010 09 01  
(31) 09011665.8; PCT/EP2010/005366  
(32) 2009 09 11; 2010 09 01  
(33) EP; WO  
(86) PCT/EP2010/005366, 2010 09 01  
(73) CHIESI FARMACEUTICI S.P.A. (IT)  
Via Palermo, 26/A I-43100 Parma (IT)
- (72) ARMANI, Elisabetta (IT);  
GHIDINI, Eleonora (IT);  
PERETTO, Ilaria (IT);  
VIRDIS, Andrea (IT)
- (74) Shalva Gvaramadze
- (54) **PREGNANE DERIVATIVES  
CONDENSED IN 16, 17 POSITION WITH**

**N-SUBSTITUTED ISOXAZOLIDINE  
RING AS ANTI-INFLAMMATORY  
AGENTS**

- (11) P 2014 6129 B (51) Int. Cl. (2006)  
C 07 K 16/28  
A 61 K 39/395  
A 61 P 37/06  
A 61 P 19/02
- (10) AP 2014 12063 A (44) 8(396)/2014  
(21) AP 2009 012063  
(22) 2009 07 15  
(24) 2009 07 15  
(31) 08160671.7; 09160326.6  
(32) 2008 07 17; 2009 05 15  
(33) EP; EP  
(86) PCT/EP2009/059030, 2009 07 15  
(73) NOVARTIS AG (CH)  
Lichtstrasse 35, CH-4056 Basel (CH)
- (72) HEUSSER, Christoph (CH);  
NEUGEBAUER, Julia (DE);  
SCHAADT, Eveline (DE);  
URLINGER, Stefanie (DE);  
WOISETSCHLAEGER, Maximilian (AT)
- (74) Alexander Kartvelishvili
- (54) **COMPOSITIONS AND METHODS OF  
THERAPEUTIC ANTIBODIES USAGE**
- 
- C 12**

- (11) P 2014 6128 B (51) Int. Cl. (2006)  
C 12 N 15/82  
A 01 H 5/00  
A 01 H 5/10  
C 12 N 9/10  
C 12 N 9/88
- (10) AP 2014 11540 A (44) 8(396)/2014  
(21) AP 2008 011540  
(22) 2008 04 03  
(24) 2008 04 03  
(31) 60/910,008  
(32) 2007 04 04  
(33) US  
(86) PCT/IB2008/002645, 2008 04 03  
(73) BASF SE (DE)  
Carl-Bosch-St. 38, 67056 Ludwigshafen (DE);  
VITERRA, INC (CA)  
2625 Victoria Avenue, Regina, Saskatchewan  
C4T 5T9 (CA)
- (72) YAO, Kening (CA);  
POTTS, Derek (CA);  
MALES, Daryl (CA)
- (74) Tamar Kochlamazashvili
- (54) **HERBICIDE-RESISTANT BRASSICA  
PLANTS AND USAGE METHODS  
THEREOF**
-

**C 21****(11) P 2014 6137 B** (51) **Int. Cl. (2006)**  
**C 21 C 1/00**

(10) AP 2014 12664 A (44) 8(396)/2014

(21) AP 2012 012664

(22) 2012 04 10

(24) 2012 04 10

(73) Otar Barbakadze (GE)

Moskovis Gamz., V kv., korp. 7, b. 26,  
0145 Tbilisi (GE);

Vasil Kopaleishvili (GE)

I.Abashidzis q. 68, b. 47, 0162, Tbilisi (GE);

Lamara Kereselidze (GE)

I.Abashidzis q. 68, b. 47, 0162, Tbilisi (GE);

Robnzon Lomidze (GE)

Rustavelis q. 19, b.18, 3700, Rustavi (GE);

Ramaz Bakradze (GE)

XII Mkr., korp. 6, b. 176, 3700, Rustavi (GE);

Gia Putkaradze (GE)

XVII Mkr., korp. 17, b. 17, 3700, Rustavi (GE);

Salome Barbakadze (GE)

Moskovis Gamz., V kv., korp. 7, b. 26, 0145  
Tbilisi (GE)

(72) Otar Barbakadze (GE);

Vasil Kopaleishvili (GE);

Lamara Kereselidze (GE);

Robnzon Lomidze (GE);

Ramaz Bakradze (GE);

Gia Putkaradze (GE);

Salome Barbakadze (GE)

**(54) SCOOP FOR TREATING ALLOY OUT  
FURNACE AND CASTING THEREOF****PART E****E 04****(11) P 2014 6133 B** (51) **Int. Cl. (2006)**  
**E 04 C 2/26****E 04 B 2/10**

(10) AP 2014 12322 A (44) 8(396)/2014

(21) AP 2011 012322

(22) 2011 08 01

(24) 2011 08 01

(73) Tamaz Mushkudiani (GE)

Bakhtrionis q. 29, b. 76, 0194 Tbilisi (GE);

Levan Mushkudiani (GE)

Bakhtrionis q. 29, b. 76, 0194 Tbilisi (GE);

Lasha Mushkudiani (GE)

Bakhtrionis q. 29, b. 76, 0194 Tbilisi (GE)

(72) Tamaz Mushkudiani (GE);

Levan Mushkudiani (GE);

Lasha Mushkudiani (GE)

**(54) BUILDING BLOCK FOR FRAME WALL  
AND WALL CONSTRUCTION  
THEREWITH****PART F****F 27****(11) P 2014 6140 B** (51) **Int. Cl. (2006)**  
**F 27 D 9/00**

(10) AP 2014 12960 A (44) 8(396)/2014

(21) AP 2013 012960

(22) 2013 01 11

(24) 2013 01 11

(73) Otar Barbakadze (GE)

Moskovis Gamz., V kv., korp. 7, b. 26,  
0145, Tbilisi (GE);

Vasil Kopaleishvili (GE)

I.Abashidzis q. 68, b. 47, 0162, Tbilisi (GE);

Robnzon Lomidze (GE)

Rustavelis q. 19, b.18, 3700, Rustavi (GE);

Nugzar Mumladze (GE)

XVII Mkr., korp.1, b. 18, 3700, Rustavi (GE);

Zaza Tabatadze (GE)

VII Mkr. korp. 22, b. 55, 3700, Rustavi (GE);

Sergo Katsitadze (GE)

Kashakashvilis q. 5, b. 9, 3700, Rustavi (GE);

Salome Barbakadze (GE)

Moskovis Gamz., V kv., korp. 7, b. 26,  
0145 Tbilisi (GE)

(72) Otar Barbakadze (GE);

Vasil Kopaleishvili (GE);

Robnzon Lomidze (GE);

Nugzar Mumladze (GE);

Zaza Tabatadze (GE);

Sergo Katsitadze (GE);

Salome Barbakadze (GE)

**(54) METALLURGICAL FURNACE  
COOLING DEVICE**

# UTILITY MODELS

## APPLICATION APPROVED FOR GRANTING PATENT

The decision can be appealed at the Chamber of Appeal of Sakpatenti within 3 months from the publication or at the Mtskheta District Court Administrative Cases Board (Address: №17, Samkhedro str., Mtskheta), within 1 month following the publication.

### PART A

#### A 47

(10) AU 2014 13297 U (51) Int. Cl. (2006)  
A 47 J 37/00

(21) AU 2013 013297 (22) 2013 11 25

(71) Merab Bagaturia (GE)

I.Chavchavadzis Gamz. 34/3, 4600

Kutaisi (GE)

(72) Merab Bagaturia (GE)

(74) Archil Geguchadze

(54) **DEVICE FOR MEAT FOODS HEATING**

(57) There is represented a device comprising a support 3 fastened into "tone" 1 bottom 2. A roaster 4 is fastened vertically on the support. A support 5 for object 6 liable to be heated is fastened onto the roaster. A bowl 9 forced on the roaster support with a branch 10 outgoing eccentric, disposed radially and inclined down, is hermetically fastened thereon. Said branch is tied to a pipe 13 inclined down, and is passed throughout "tone" 11 wall and thermal protective layer 12 thereof by means of flute 14. Disposed in equal intervals the aerial windows with removable covers 15 are executed in "tone" wall near its base.

Claims: 1 independent

Fig.: 2

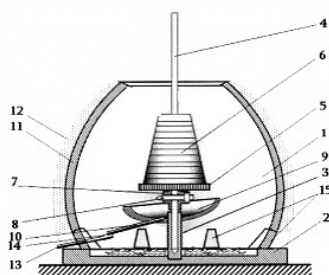

Fig. 1

#### A 61

(10) AU 2014 13353 U (51) Int. Cl. (2006)  
A 61 K 8/368  
A 61 K 7/155

(21) AU 2014 013353 (22) 2014 01 21

(71) Nadezhda Margishvili (GE)

Mtatsmindis q. 12, b. 5, 0108 Tbilisi (GE)

(72) Nadezhda Margishvili

(54) **DEPILATING MEANS**

(57) A utility model belongs to cosmetology, particularly, depilating lotion containing household soda  $\text{NaHCO}_3$ , hydroperit  $\text{CO}(\text{NH}_2)_2$ , ethanol  $\text{C}_2\text{H}_5\text{OH}$ , toilet soap, lavender oil, and water.

Claims: 1 independent

### PART B

#### B 60

(10) AU 2014 13167 U (51) Int. Cl. (2006)  
B 60 P 3/35  
B 60 P 3/32

(21) AU 2013 013167 (22) 2013 07 18

(71) Konstantine Chrelashvili (GE)

Depos q. 68, 4600 Kutaisi (GE);

Vileni Chrelashvili (GE)

Depos q. 68, 4600 Kutaisi (GE)

(72) Konstantine Chrelashvili (GE);

Vileni Chrelashvili (GE)

(54) **TRAILER WITH FOLDED AWNING**

(57) There is represented a trailer with folded awning comprising a body 1 with a chassis 2 and couple of coaxial horizontal hinges 3 on the body frame, and fan-like unfolded awning semi-frames 4 fastened thereon. L-like profile semi-frame 6 is fastened on the chassis under horizontal hinges by means of hinges 5. Front edge 7 of unfolded awning is fastened onto the semi-frame.

Claims: 1 independent

Fig.: 2

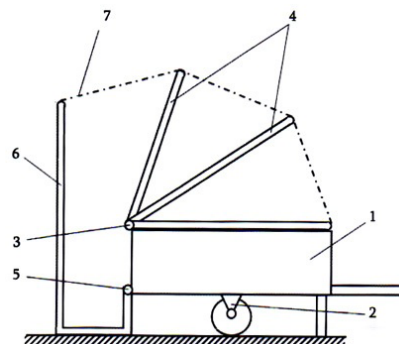

Fig. 1

## PATENTED UTILITY MODELS

### PART F

#### F 16

(11) U 2014 1824 Y (51) Int. Cl. (2006)

F 16 D 9/02

C 09 K 3/14

(10) AU 2014 13287 U (44) 8(396)/2014

(21) AU 2013 013287

(22) 2013 11 11

(24) 2013 11 11

(73) Lia Gventsadze (GE)

Vazha-Pshavelas Gamz. V kvart., korp. 4,

b. 184, 0186, Tbilisi (GE);

Elguja Kutelia (GE)

Dighmis Mas. V kvart., korp. 20, b. 97, 0159,

Tbilisi (GE);

Davit Gventsadze (GE)

Vazha-Pshavelas Gamz. V kvart., korp. 4,

b. 184, 0186, Tbilisi (GE)

(72) Lia Gventsadze (GE);

Elguja Kutelia (GE);

Davit Gventsadze (GE)

(54) **COMPOSITE MATERIAL OF  
FRICTION PLATE**

(72) Otar Barbakadze (GE);

Vasil Kopaleishvili (GE);

Robinzon Lomidze (GE);

Nugzar Mumladze (GE);

Zaza Tabatadze (GE);

Sergo Katsitadze (GE);

Salome Barbakadze (GE)

(54) **THERMOCOUPLE MEASURING  
ALLOY TEMPERATURE**

### PART G

#### G 01

(11) U 2014 1823 Y (51) Int. Cl. (2006)

G 01 K 1/10

(10) AU 2014 12961 U (44) 8(396)/2014

(21) AU 2013 012961

(22) 2013 01 11

(24) 2013 01 11

(73) Otar Barbakadze (GE)

Moskovis Gamz., V kv., korp. 7, b. 26,

0145, Tbilisi (GE);

Vasil Kopaleishvili (GE)

I. Abashidzis q. 68, b. 47, 0162, Tbilisi (GE);

Robinzon Lomidze (GE)

Rustavelis q. 19, b.18, 3700, Rustavi (GE);

Nugzar Mumladze (GE)

XVII Mkr., korp. 1, b. 18, 3700, Rustavi (GE);

Zaza Tabatadze (GE)

VII Mkr., korp. 22, b. 55, 3700, Rustavi (GE);

Sergo Katsitadze (GE)

Kashakashvilis q. 5, b. 9, 3700, Rustavi (GE);

Salome Barbakadze (GE)

Moskovis Gamz., V kv., korp. 7, b. 26,

0145, Tbilisi (GE)



---

# DESIGNS

## APPLICATIONS APPROVED FOR REGISTRATION

The decision can be appealed at the Chamber of Appeal of Sakpatenti within 3 months from the publication or at the Mtskheta District Court Administrative Cases Board (Address: №17, Samkhedro str., Mtskheta), within 1 month following the publication.

(10) AD 2014 794 S (51) 32-00

(21) AD 2014 000794

(22) 2014 04 17

(28) 2

(71) LTD "BORAN SOPKHIMIA" (GE)

Marneulis q. 44, 0165 Tbilisi (GE)

(72) Irakli Dolidze (GE)

(54) GRAPHIC SYMBOL

(55)



(10) AD 2014 796 S (51) 21-01

(21) AD 2014 000796

(22) 2014 04 17

(28) 13

(71) Eter Chkadua (GE)

Tamarashvilis q. 11, b. 64, 0162 Tbilisi (GE);

Gocha Chkadua (GE)

Tamarashvilis q. 11, b. 64, 0162 Tbilisi (GE)

(72) Eter Chkadua (GE);

Gocha Chkadua (GE)

(54) TOY

(55)

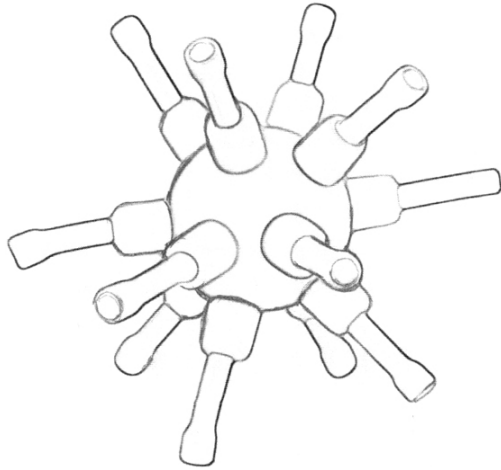

1

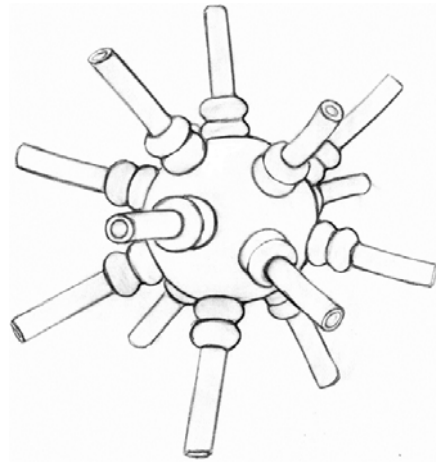

2

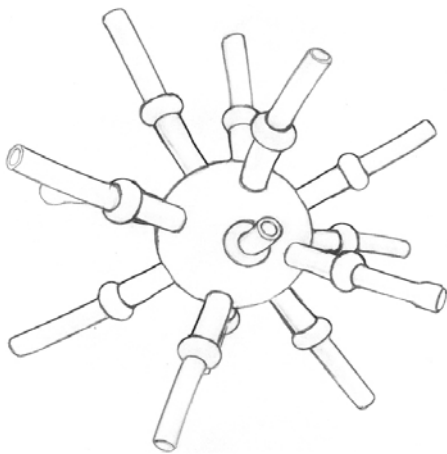

3

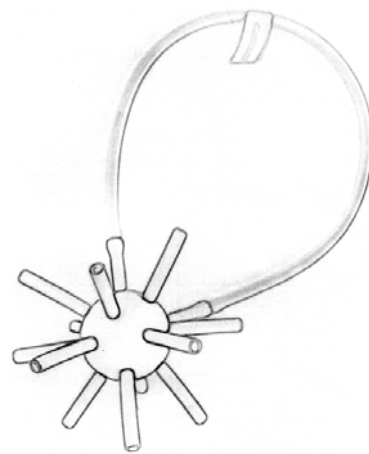

4

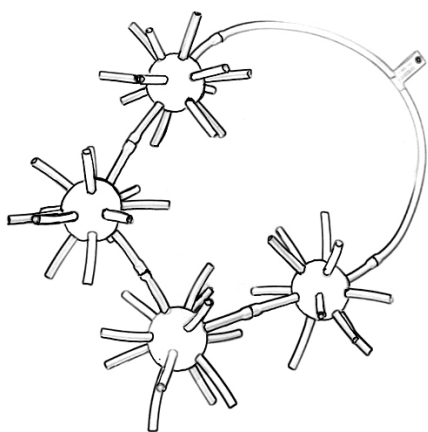

5



6



7

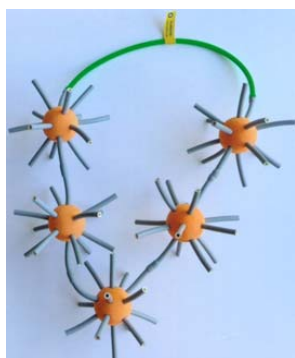

8



9

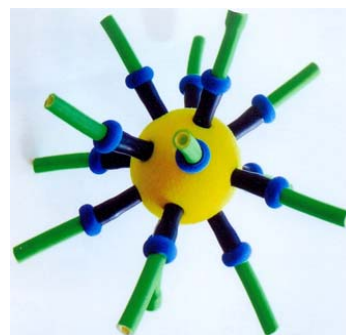

10



11



12



13

## REGISTERED DESIGN

(11) **D 2014 585 S**      (51) **11-01**  
(10) AD 2014 771 S      (44) 8(396) 2014  
(21) AD 2013 000771  
(22) 2013 11 14  
(24) 2013 11 14  
(28) 3  
(18) 2018 11 14  
(73) Ekaterine Dadesheli (GE)  
      Stalinis q. 10/24, 1400, Gori (GE)  
(72) Ekaterine Dadesheli (GE)  
(54) **PENDENT**

---

## DESIGNS REGISTERED ACCORDING TO THE ACCELERATED PROCEDURE

The decision can be appealed at the Chamber of Appeal of Sakpatenti within 3 months from the publication.

- (11) **D 2014 586 S** (51) 06-03  
(21) AD 2014 000809  
(22) 2014 07 14  
(24) 2014 07 14  
(28) 2  
(18) 2019 07 14  
(73) Gari Chapidze (GE)  
Khomlelis q. korp. 4, b. 27, 0182 Tbilisi (GE)  
(72) Gari Chapidze (GE)  
(54) **SCHOOL DESKS WITH LETTER IMAGES**  
(55)

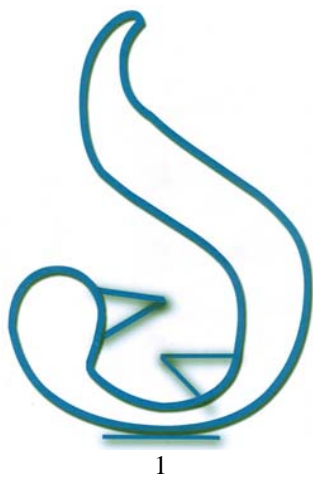

---

# TRADEMARKS

## APPLICATIONS FILED UNDER THE NATIONAL PROCEDURE APPROVED FOR REGISTRATION

The decision can be appealed at the Chamber of Appeal of Sakpatenti within 3 months from the publication or at the Mtskheta District Court Administrative Cases Board (Address: №17, Samkhedro str., Mtskheta), within 1 month following the publication.

(260) AM 2014 72647 A  
(210) AM 072647  
(220) 2013 06 12  
(731) LTD "WINEMAN LTD"  
Gudiashvilis q. 11, 0105, Tbilisi, Georgia  
(740) Shalva Gvaramadze  
(540)

### კახიპარის მარანი KAHIPARI MARANI

(591) Black-white  
(526) **DISCLAIMER** – The trademark is protected as a whole. Word marks „კახიპარი“ and "KAHIPARI" shall not be subject to independent protection.  
(511) 33

---

(260) AM 2014 73113 A  
(210) AM 073113  
(220) 2013 07 15  
(731) LTD "GVMT Group"  
Isani-Samgoris r-ni, Krtsanisis II gas.11,  
0114, Tbilisi, Georgia  
(540)

### Колхидский берег

(591) Black-white  
(526) **DISCLAIMER** – The trademark is protected as a whole. Word mark "Колхидский" shall not be subject to independent protection.  
(511) 33

---

(260) AM 2014 73115 A  
(210) AM 073115  
(220) 2013 07 15  
(731) LTD "GVMT Group"  
Isani-Samgoris r-ni, Krtsanisis II gas.11,  
0114, Tbilisi, Georgia  
(540)

### Солнечный Тифлиς

(591) Black-white  
(526) **DISCLAIMER** – The trademark is protected as a whole. Word mark "Тифлиς" shall not be subject to independent protection.  
(511) 33

---

(260) AM 2014 73377 A  
(210) AM 073377  
(220) 2013 08 02  
(732) Noxell Corporation  
11050 York Road, Hunt Valley, Maryland  
21030-2098, USA  
(740) Shalva Gvaramadze  
(540)

### EYE ENHANCERS

(591) Black-white  
(511) 3

---

(260) AM 2014 73511 A  
(210) AM 073511  
(220) 2013 08 13  
(731) Taco Bell Corp.  
California korporation, 1 Glen Bell Way,  
Irvine, California 92618, USA  
(740) Tamar Kochlamazashvili  
(540)

### LIVE MÁΣ

(591) Black-white  
(511) 29, 30, 43

---

(260) AM 2014 73761 A  
(210) AM 073761  
(220) 2013 08 30  
(731) LTD "MAGTIVINI"  
Agmasheneblis gamz. 119, 0164, Tbilisi,  
Georgia  
(740) Elguja Amozashvili  
(540)

### მაგთივინო Magtiwin

(591) Black-white  
(511) 6, 19, 20, 35, 37, 40

---

(260) AM 2014 73911 A  
(210) AM 073911  
(220) 2013 09 11  
(731) DOMINO'S IP HOLDER LLC  
24 Frank Lloyd Wright Drive, P.O. Box  
485, Ann Arbor, Michigan 48106, USA

(740) Tamar Kochlamazashvili  
(540)

**DOMINO'S PIZZA**

(591) Black-white  
(526) **DISCLAIMER** – The trademark is protected as a whole. Word marks "PIZZA" shall not be subject to independent protection.  
(511) 35

(260) AM 2014 73912 A  
(210) AM 073912  
(220) 2013 09 11  
(731) DOMINO'S IP HOLDER LLC  
24 Frank Lloyd Wright Drive, P.O. Box  
485, Ann Arbor, Michigan 48106, USA  
(740) Tamar Kochlamazashvili  
(540)

**DOMINO'S**

(591) Black-white  
(511) 30, 35, 43

(260) AM 2014 73924 A  
(210) AM 073924  
(220) 2013 09 13  
(731) LTD "Medihelfi"  
P. Meliqishvilis q. 45, 0179, Tbilisi,  
Georgia  
(540)



(591) White, green, dark yellow  
(531) 05.05.04-28.19.00-29.01.13-  
(511) 44

(260) AM 2014 73925 A  
(210) AM 073925  
(220) 2013 09 13  
(731) Amgen Inc.  
One Amgen Center Drive, Thousand Oaks,  
California 91320-1799, USA  
(740) Shalva Gvaramadze  
(540)

**DEPTARGIS**

(591) Black-white  
(511) 5

(260) AM 2014 73926 A  
(210) AM 073926  
(220) 2013 09 13  
(310) 85883070

(320) 2013 03 21  
(330) US  
(731) Amgen Inc.  
One Amgen Center Drive, Thousand Oaks,  
California 91320-1799, USA  
(740) Shalva Gvaramadze  
(540)

**KANJINTI**

(591) Black-white  
(511) 5

(260) AM 2014 73928 A  
(210) AM 073928  
(220) 2013 09 16  
(731) LTD Gvinisa da Alkoholuri Sasmelebis  
Kompania Shaqriani, E. Akhvledianis  
q. 66, 2200, Telavi, Georgia  
(540)

**Shakriani Village**  
**Шакриани Вилледж**  
**შაქრიანი ვილეჯი**

(591) Black-white  
(511) 33

(260) AM 2014 73929 A  
(210) AM 073929  
(220) 2013 09 16  
(731) LTD Gvinisa da Alkoholuri Sasmelebis  
Kompania Shaqriani, E. Akhvledianis  
q. 66, 2200, Telavi, Georgia  
(540)

**Shateau Shakriani**  
**Шато Шакриани**  
**შატო შაქრიანი**

(591) Black-white  
(511) 33

(260) AM 2014 73931 A  
(210) AM 073931  
(220) 2013 09 16  
(731) LTD Gvinisa da Alkoholuri Sasmelebis  
Kompania Shaqriani, E. Akhvledianis  
q. 66, 2200, Telavi, Georgia  
(540)

**Shakriani Vineyards**  
**Шакриани Ваинярдс**  
**შაქრიანი ვაინიარდს**

(591) Black-white  
(511) 33

(260) AM 2014 73937 A  
 (210) AM 073937  
 (220) 2013 09 16  
 (731) LTD PIAZZA MANAGEMENT  
 Chavchavadzis q. N5, 6000, Batumi,  
 Georgia  
 (740) Irakli Kandelaki  
 (540)

Piazza  
Inn

(591) Brown  
 (531) 27.05.01-29.01.07-  
 (511) 43

(260) AM 2014 73939 A  
 (210) AM 073939  
 (220) 2013 09 17  
 (731) Janome Sewing Machine Company  
 Limited. 1463 Hazama-Machi,  
 Hachiojo-Shi, Tokio, Japan  
 (740) Tamar Kochlamazashvili  
 (540)

elna

(591) Black-white  
 (531) 27.05.17-  
 (511) 7, 8

(260) AM 2014 73940 A  
 (210) AM 073940  
 (220) 2013 09 18  
 (731) IE "Gocha Meparishvili"  
 Sop. Tsitelikhevi, 100, Bagdati,  
 Georgia  
 (540)

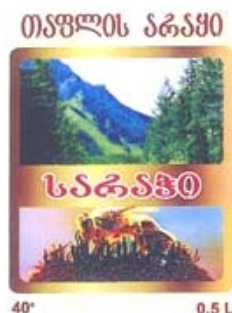

(591) Yellow, green, blue, brown, red  
 (531) 03.13.04-06.01.02-25.01.01-28.19.00-  
 29.01.15-

(526) **DISCLAIMER** – The trademark is protected as a whole. Words and numerical marks „თსვლის არაყი“, „სარაჭი“, "40" and "0,5L" shall not be subject to independent protection.  
 (511) 33

(260) AM 2014 73944 A  
 (210) AM 073944  
 (220) 2013 09 18  
 (731) COLGATE - PALMOLIVE COMPANY  
 A Delaware corporation, 300 Park Avenue,  
 New York, New York 10022, USA  
 (740) Shalva Gvaramadze  
 (540)

**OPTIC WHITE**

(591) Black-white  
 (511) 3, 10, 21

(260) AM 2014 73964 A  
 (210) AM 073964  
 (220) 2013 09 20  
 (731) LTD "TECHNO BUMI"  
 Vazha-Pshavelas gamz. 30a, 0160,  
 Tbilisi, Georgia  
 (740) LTD "TECHNO BUMI"  
 (540)

რინოქსი

**Rinox**

(591) Black-white  
 (531) 27.05.17-28.19.00-  
 (511) 35

(260) AM 2014 73965 A  
 (210) AM 073965  
 (220) 2013 09 20  
 (731) LTD "TECHNO BUMI"  
 Vazha-Pshavelas gamz. 30a, 0160,  
 Tbilisi, Georgia  
 (740) LTD "TECHNO BUMI"  
 (540)

პროზენტა

**Prozenta**

(591) Black-white  
 (531) 27.05.17-28.19.00-  
 (511) 35

(260) AM 2014 73966 A  
 (210) AM 073966  
 (220) 2013 09 20  
 (731) LTD "TECHNO BUMI"  
 Vazha-Pshavelas gamz. 30a, 0160,  
 Tbilisi, Georgia



(740) LTD "TECHNO BUMI"

(540)

რავანელო

**Ravanello**

(591) Black-white

(531) 27.05.17-28.19.00-

(511) 35

(260) AM 2014 73967 A

(210) AM 073967

(220) 2013 09 20

(731) LTD "TECHNO BUMI"

Vazha-Pshavelas gamz. 30a, 0160,  
Tbilisi, Georgia

(740) LTD "TECHNO BUMI"

(540)

რიზერი

**Risser**

(591) Black-white

(531) 27.05.17-28.19.00-

(511) 35

(260) AM 2014 74065 A

(210) AM 074065

(220) 2013 09 30

(731) LTD, "VAZI-1"

Sop. Tserovani, 3318, Mtskheta,  
Georgia

(740) Davit Bichikashvili

(540)

**Mildiani**  
FAMILY WINERY

(591) Black-white

(531) 01.15.23-24.01.03-27.05.04-

(511) 33

(260) AM 2014 74102 A

(210) AM 074102

(220) 2013 09 30

(310) 2013729544

(320) 2013 08 28

(330) RU

(731) Union Tobacco &amp; Cigarette Industries Co.

P.O. Box 851015, Amman 11185, Jordan

(740) Ketevan Tsakadze

(540)

**Mikado**

(591) Black-white

(531) 27.05.17-

(511) 34

(260) AM 2014 74104 A

(210) AM 074104

(220) 2013 09 30

(731) Wang Jianhua

ChengJiaCun, Shangshu Village, An'Ji  
County, Zhejiang Province, China

(740) Shalva Gvaramadze

(540)



(591) Black-white

(531) 03.11.24-26.11.13-

(511) 20

(260) AM 2014 74105 A

(210) AM 074105

(220) 2013 09 30

(731) Wang Jianhua

ChengJiaCun, Shangshu Village, An'Ji  
County, Zhejiang Province, China

(740) Shalva Gvaramadze

(540)



(591) Black-white

(531) 02.01.23-27.05.24-28.03.00-

(511) 20

(260) AM 2014 74139 A

(210) AM 074139

(220) 2013 10 01

(731) Allied Global Tobacco Ltd.

Wey Court West, Union Road, Farnham,  
Surrey GU9 7PT, United Kingdom

(740) Givi Akopashvili

(540)

**ZAFFERANO**

(591) Black-white

(511) 43

(260) AM 2014 74163 A  
 (210) AM 074163  
 (220) 2013 10 02  
 (731) Saqartvelos Arbitrta Asotsiatsia  
 Vake-Saburtalos Raioni, Vazha-Pshavelas  
 Gamz.71, Ofisi N35/1, (Bloko 4), Tbilisi,  
 Georgia  
 (740) Tamar Rogava  
 (540)

**GAA**

(591) Blue  
 (531) 27.05.23-29.01.04-  
 (511) 45

(260) AM 2014 74327 A  
 (210) AM 074327  
 (220) 2013 10 11  
 (731) JOLIDON EXPORT IMPORT SRL  
 Str. Tabacarilor nr.1, Judetul Cluj, CLUJ  
 NAPOCA, 400139, Romania  
 (740) Shalva Gvaramadze  
 (540)

**JOLIDON**

(591) Black-white  
 (531) 27.05.01-  
 (511) 3, 25, 35

(260) AM 2014 74544 A  
 (210) AM 074544  
 (220) 2013 10 30  
 (731) ELJI LAIF SAIENSIZ, LTD.  
 58, Saemunan-ro, Chonogu, Seuli (Koreis  
 respublika), Republic of Korea  
 (740) Tamar Kochlamazashvili  
 (540)

**ROVATITAN**

(591) Black-white  
 (511) 5

(260) AM 2014 74545 A  
 (210) AM 074545  
 (220) 2013 10 30  
 (731) CELGENE CORPORATION  
 86 Morris Avenue, Summit, New Jersey  
 07901, USA  
 (740) Tamaz Shilakadze  
 (540)

**OTE3JA**

(591) Black-white  
 (511) 5

(260) AM 2014 74570 A  
 (210) AM 074570  
 (220) 2013 11 01  
 (731) PHILIP MORRIS PRODUCTS S.A.  
 Quai Jeanrenaud 3, 2000 NEUCHATEL,  
 Switzerland  
 (740) Shalva Gvaramadze  
 (540)

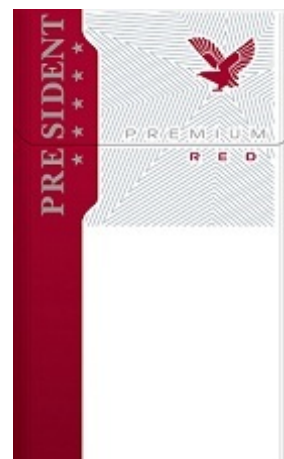

(591) Bordeaux, grey, silver, white  
 (531) 01.01.10-03.07.16-19.03.03-26.11.07-  
 27.05.24-29.01.13-  
 (511) 34

(260) AM 2014 74571 A  
 (210) AM 074571  
 (220) 2013 11 01  
 (731) PHILIP MORRIS PRODUCTS S.A.  
 Quai Jeanrenaud 3, 2000 NEUCHATEL,  
 Switzerland  
 (740) Shalva Gvaramadze  
 (540)



(591) Sky, differnt tones of blue, grey, silver, white  
 (531) 01.01.10-03.07.16-19.03.03-26.11.07-  
 27.05.24-29.01.13-  
 (511) 34

(260) AM 2014 74720 A  
 (210) AM 074720  
 (220) 2013 11 12  
 (731) LTD "Sadazgevo Kompania Unisoni"  
 Budapeshtis q. 15, 0160, Tbilisi, Georgia  
 (740) Nina Javakhishvili  
 (540)

უკვე უფრო დარწმუნებული ხარ

More assured, with Unison

(591) Blue  
 (531) 27.05.01-28.19.00-29.01.04-  
 (511) 36

(260) AM 2014 74760 A  
 (210) AM 074760  
 (220) 2013 11 15  
 (731) Giorgi Pipinashvili  
 Dgebuadzis q. 2, 0102, Tbilisi, Georgia  
 (540)



(591) Red, yellow, orange, blue, black, white  
 (531) 26.01.12-26.01.24-26.04.10-26.11.08-  
 26.11.09-28.19.00-29.01.13-  
 (511) 41

(260) AM 2014 74761 A  
 (210) AM 074761  
 (220) 2013 11 15  
 (731) Western Glove Works  
 555 Logan Avenue Winnipeg, Manitoba  
 R3A 0S4, Canada  
 (740) Tamaz Shilakadze  
 (540)



(591) Black-white  
 (531) 27.05.01-  
 (526) **DISCLAIMER** – The trademark is protected as a whole. Word mark "JEANS" shall not be subject to independent protection.  
 (511) 25, 35

(260) AM 2014 74762 A  
 (210) AM 074762  
 (220) 2013 11 15  
 (310) 85/942, 068  
 (320) 2013 05 24  
 (330) US  
 (731) Tamara Mellon, LLC

660 Madison Avenue, New York,  
 New York 10065, USA

(740) Tamaz Shilakadze  
 (540)



(591) Black-white  
 (531) 27.05.01-27.05.11-  
 (511) 3, 9, 14, 18, 25, 35

(260) AM 2014 74979 A  
 (210) AM 074979  
 (220) 2013 11 29  
 (731) LTD "ARMUNJI"  
 Zurab Chavchavadzis q. 56, 4800, Kvareli,  
 Georgia  
 (540)

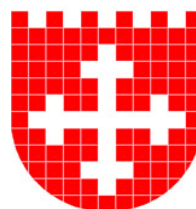

(591) Red, white  
 (531) 24.01.03-24.01.10-24.01.13-24.13.01-  
 29.01.12-  
 (511) 33

(260) AM 2014 75102 A  
 (210) AM 075102  
 (220) 2013 12 10  
 (731) LTD "B.T.B. ELEGANT"  
 Besikis q. 4, Mimdebared (nakveti 46/10),  
 1 sart., 0108, Tbilisi, Georgia;  
 LTD "ELEGANT"  
 Besikis q. 4, b. 64, 0108, Tbilisi, Georgia  
 (540)



(591) Yellow, golden, different tones of brown,  
 red, green, white, blue  
 (531) 24.09.04-27.05.02-29.01.15-  
 (511) 43

(260) AM 73104 A\*

(210) AM 073104

(220) 2013 07 15

(731) Kentucky Fried Chicken International

Holdings, Inc.

1441 Gardiner Lane, Louisville, Kentucky

40213, USA

(740) Tamar Kochlamazashvili

(540)

**iTWISTER**

(591) Black-white

(511) 30

---

**REGISTERED TRADEMARKS**

(111) M 2014 025048 R

(151) 2014 07 28

(181) 2024 07 28

(260) AM 2014 49781 A

(220) 2008 08 20

(732) IDS BORJOMI BEVERAGES CO.N.V.

Toris q. 39, 1200 Borjomi, Georgia

---

(111) M 2014 025049 R

(151) 2014 07 28

(181) 2024 07 28

(260) AM 2014 69694 A

(220) 2012 11 15

(732) JSC "RMG Cooper"

Daba Kazreti, 1100, Bolnisi, Georgia

---

(111) M 2014 025050 R

(151) 2014 07 28

(181) 2024 07 28

(260) AM 2014 69695 A

(220) 2012 11 15

(732) LTD "RMG Cooper"

Daba Kazreti, 1100, Bolnisi, Georgia

---

(111) M 2014 025051 R

(151) 2014 07 28

(181) 2024 07 28

(260) AM 2013 70258 A

(220) 2013 01 09

(732) Pharmaceutical Chemical Cosmetic Industry

ALKALOID AD-Skopje

Bul. Aleksandar Makedonski., 12, 1000

Skopje, MK

---

(111) M 2014 025052 R

(151) 2014 07 28

(181) 2024 07 28

(260) AM 2013 70259 A

(220) 2013 01 09

(732) Pharmaceutical Chemical Cosmetic Industry

ALKALOID AD-Skopje

Bul. Aleksandar Makedonski., 12, 1000

Skopje, MK

---

(111) M 2014 025053 R

(151) 2014 07 28

(181) 2024 07 28

(260) AM 2014 70568 A

(220) 2013 01 25

(732) LTD "GURME"

L. Pasteris q. 7a, 0102, Tbilisi, Georgia

---

(111) M 2014 025054 R

(151) 2014 07 28

(181) 2024 07 28

(260) AM 2014 70700 A

(220) 2013 02 01

(732) MEY ALKOLLU ICKILER SANAYII

VE TICARET ANONIM SIRKETI

Abide-i Hurriyet Cad. №211 Bolkan Center,

B Blok SISLI, 34381, ISTANBUL

---

(111) M 2014 025055 R

(151) 2014 07 28

(181) 2024 07 28

(260) AM 2014 70701 A

(220) 2013 02 01

(732) MEY ALKOLLU ICKILER SANAYII

VE TICARET ANONIM SIRKETI

Abide-i Hurriyet Cad. №211 Bolkan Center,

B Blok SISLI, 34381, ISTANBUL

---

(111) M 2014 025056 R

(151) 2014 07 28

(181) 2024 07 28

(260) AM 2014 70795 A

(220) 2013 02 07

(732) Pernod Ricard Mexico, S.A. de C.V.

Paseo de los Tamarindos №100, Floors 3 & 4,

Col. Bosques de las Lomas, Cuajimalpa de

Morelos 05120, Mexico D.F.

---

(111) M 2014 025057 R

(151) 2014 07 28

(181) 2024 07 28

(260) AM 2014 70926 A

(220) 2013 02 18

(732) Harrington Development Inc.

Elvira Mendez Street, Vallarino bldg., 3rd

Floor, Panama

---

(111) M 2014 025058 R

(151) 2014 07 28

(181) 2024 07 28

(260) AM 2014 70927 A

(220) 2013 02 18

(732) Harrington Development Inc.

Elvira Mendez Street, Vallarino bldg., 3rd

Floor, Panama

---

(111) M 2014 025059 R  
(151) 2014 07 28  
(181) 2024 07 28  
(260) AM 2014 70928 A  
(220) 2013 02 18  
(732) Harrington Development Inc.  
Elvira Mendez Street, Vallarino bldg.,  
3rd Floor, Panama

---

(111) M 2014 025060 R  
(151) 2014 07 28  
(181) 2024 07 28  
(260) AM 2014 70929 A  
(220) 2013 02 19  
(732) IE "Ia Kvaratskhelia"  
Z. Gorgiladzis q., korp. 73, b. 12, 6000,  
Batumi, Georgia

---

(111) M 2014 025061 R  
(151) 2014 07 28  
(181) 2024 07 28  
(260) AM 2014 70932 A  
(220) 2013 02 19  
(732) Harrington Development Inc.  
Elvira Mendez Street, Vallarino bldg.,  
3rd Floor, Panama

---

(111) M 2014 025062 R  
(151) 2014 07 28  
(181) 2024 07 28  
(260) AM 2014 70933 A  
(220) 2013 02 19  
(732) Harrington Development Inc.  
Elvira Mendez Street, Vallarino bldg.,  
3rd Floor, Panama

---

(111) M 2014 025063 R  
(151) 2014 07 28  
(181) 2024 07 28  
(260) AM 2014 71019 A  
(220) 2013 02 22  
(732) Biogen Idec MA Inc.  
a Massachusetts Corporation  
14 Cambridge Center, Cambridge,  
Massachusetts 02142, USA

---

(111) M 2014 025064 R  
(151) 2014 07 28  
(181) 2024 07 28  
(260) AM 2014 71163 A  
(220) 2013 03 01  
(732) Khatuna Dolbaia  
Kostavas q. 4, b. 37, 4400, Poti, Georgia

---

(111) M 2014 025065 R  
(151) 2014 07 28  
(181) 2024 07 28  
(260) AM 2014 71222 A  
(220) 2013 03 05  
(732) JSC "LOMISI"  
Sopeli Natakhtari, 3308, Mtskhetis raioni,  
Georgia

---

(111) M 2014 025066 R  
(151) 2014 07 28  
(181) 2024 07 28  
(260) AM 2014 71223 A  
(220) 2013 03 05  
(732) JSC "LOMISI"  
Sopeli Natakhtari, 3308, Mtskhetis raioni,  
Georgia

---

(111) M 2014 025067 R  
(151) 2014 07 28  
(181) 2024 07 28  
(260) AM 2014 71224 A  
(220) 2013 03 05  
(732) JSC "LOMISI"  
Sopeli Natakhtari, 3308, Mtskhetis raioni,  
Georgia

---

(111) M 2014 025068 R  
(151) 2014 07 28  
(181) 2024 07 28  
(260) AM 2014 71248 A  
(220) 2013 03 07  
(732) Harrington Development Inc.  
Elvira Mendez Street, Vallarino bldg.,  
3rd Floor, Panama

---

(111) M 2014 025069 R  
(151) 2014 07 28  
(181) 2024 07 28  
(260) AM 2014 71261 A  
(220) 2013 03 07  
(732) LTD "VINO GRADI"  
Sh. Nutsubidzis ferd. I m/r, korp. 12,  
b. 45, 0183, Tbilisi, Georgia

---

(111) M 2014 025070 R  
(151) 2014 07 28  
(181) 2024 07 28  
(260) AM 2014 71529 A  
(220) 2013 03 25  
(732) FELLBROOK HOLDINGS LTD  
3rd floor, Iris House, John Kennedy street,  
3106 Limassol, CY

---

(111) M 2014 025071 R  
(151) 2014 07 28  
(181) 2024 07 28  
(260) AM 2014 71569 A  
(220) 2013 03 28  
(732) 24 KITCHEN TELEVISION B.V.  
De Passage 144, Amsterdam zuidoost, 1101  
AX, NL

---

(111) M 2014 025072 R  
(151) 2014 07 28  
(181) 2024 07 28  
(260) AM 2014 71570 A  
(220) 2013 03 28  
(732) 24 KITCHEN TELEVISION B.V.  
De Passage 144, Amsterdam zuidoost, 1101  
AX, NL

---

(111) M 2014 025073 R  
(151) 2014 07 28  
(181) 2024 07 28  
(260) AM 2014 71654 A  
(220) 2013 04 03  
(732) Biogen Idec MA Inc.  
A Massachusetts Corporation  
14 Cambridge Center, Cambridge,  
Massachusetts 02142, USA

---

(111) M 2014 025074 R  
(151) 2014 07 28  
(181) 2024 07 28  
(260) AM 2014 71655 A  
(220) 2013 04 03  
(732) JSC "ASAL DISH TIJARETIS  
tsarmomadgenloba Saqartveloshi"  
Metekhis q. 22, 0103, Tbilisi, Georgia

---

(111) M 2014 025075 R  
(151) 2014 07 28  
(181) 2024 07 28  
(260) AM 2014 71731 A  
(220) 2013 04 08  
(732) LTD "JI-EM-PI"  
Ponichala 65, 0165, Tbilisi, Georgia

---

(111) M 2014 025076 R  
(151) 2014 07 28  
(181) 2024 07 28  
(260) AM 2014 71841 A  
(220) 2013 04 12  
(732) Fretier Sylvie  
5 rue Danielle Casanova, 75001  
PARIS, FR

---

(111) M 2014 025077 R  
(151) 2014 07 28  
(181) 2024 07 28  
(260) AM 2014 71932 A  
(220) 2013 04 17  
(732) SCORPIUS  
55, rue Jouffroy d'Abbans, 75017 Paris, FR

---

(111) M 2014 025078 R  
(151) 2014 07 28  
(181) 2024 07 28  
(260) AM 2014 71937 A  
(220) 2013 04 17  
(732) BRF-Brazil Foods S/A  
R Jorge Tzachel, 475, City of Itajaí, State of  
Santa Catarina, BR

---

(111) M 2014 025079 R  
(151) 2014 07 28  
(181) 2024 07 28  
(260) AM 2014 71961 A  
(220) 2013 04 19  
(732) LTD LTD "Geoseli"  
Gotuas q. 3, mtkvris marjvena sanapiro, 0160,  
Tbilisi, Georgia

---

(111) M 2014 025080 R  
(151) 2014 07 28  
(181) 2024 07 28  
(260) AM 2014 71963 A  
(220) 2013 04 19  
(732) LTD LTD "Geoseli"  
Gotuas q. 3, mtkvris marjvena sanapiro, 0160,  
Tbilisi, Georgia

---

(111) M 2014 025081 R  
(151) 2014 07 28  
(181) 2024 07 28  
(260) AM 2014 71994 A  
(220) 2013 04 23  
(732) LTD "GAMOMCEMLOBA LELO"  
Iosebisdzis q. 49, 0160, Tbilisi, Georgia

---

(111) M 2014 025082 R  
(151) 2014 07 28  
(181) 2024 07 28  
(260) AM 2014 72070 A  
(220) 2013 04 29  
(732) INTEL CORPORATION  
2200 Mission College Boulevard, Santa Clara,  
California 95052-8119, USA

---

(111) M 2014 025083 R  
 (151) 2014 07 28  
 (181) 2024 07 28  
 (260) AM 2014 72190 A  
 (220) 2013 05 10  
 (732) SRS PHARMACEUTICALS Pvt. Ltd.  
 Office №601-605, 6th Floor, Bldg. №2,  
 LBS Marg, Mulund-Goregaon Link Road,  
 Mulund-West, Mumbai-400080, India

(111) M 2014 025084 R  
 (151) 2014 07 28  
 (181) 2024 07 28  
 (260) AM 2014 72316 A  
 (220) 2013 05 22  
 (732) Harrington Development Inc.  
 Elvira Mendez Street, Vallarino bldg.,  
 3rd Floor, Panama

(111) M 2014 025085 R  
 (151) 2014 07 28  
 (181) 2024 07 28  
 (260) AM 2014 72346 A  
 (220) 2013 05 23  
 (732) LTD "UNIMED GRUP KORP"  
 Vake-Saburtalos raioni, Ad. Mitskevichis  
 q. 29, bina 61, Tbilisi, Georgia

(111) M 2014 025086 R  
 (151) 2014 07 28  
 (181) 2024 07 28  
 (260) AM 2014 72506 A  
 (220) 2013 06 04  
 (732) LTD "DOMOQIMI"  
 Isnis bazrobis mopirdapired, nakveti 27/50,  
 Tbilisi, Georgia

(111) M 2014 025087 R  
 (151) 2014 07 28  
 (181) 2024 07 28  
 (260) AM 2014 72507 A  
 (220) 2013 06 04  
 (732) LTD "DOMOQIMI"  
 Isnis bazrobis mopirdapired, nakveti 27/50,  
 Tbilisi, Georgia

(111) M 2014 025088 R  
 (151) 2014 07 28  
 (181) 2024 07 28  
 (260) AM 2014 72509 A  
 (220) 2013 06 04  
 (732) LTD "DOMOQIMI"  
 Isnis bazrobis mopirdapired, nakveti 27/50,  
 Tbilisi, Georgia

(111) M 2014 025089 R  
 (151) 2014 07 28  
 (181) 2024 07 28  
 (260) AM 2014 72874 A  
 (220) 2013 06 28  
 (732) GENERAL MOTORS LLC  
 300 Renaissance Center, City of Detroit, State  
 of Michigan 48265-3000, USA

(111) M 2014 025090 R  
 (151) 2014 07 28  
 (181) 2024 07 28  
 (260) AM 2014 72954 A  
 (220) 2013 07 03  
 (732) Harrington Development Inc.  
 Elvira Mendez Street, Vallarino bldg.,  
 3rd Floor, Panama

(111) M 2014 025091 R  
 (151) 2014 07 28  
 (181) 2024 07 28  
 (260) AM 2014 72972 A  
 (220) 2013 07 05  
 (732) LTD "TECHNO BUMI"  
 Vazha-Pshavelas gamz. 30a, 0160,  
 Tbilisi, Georgia

(111) M 2014 025092 R  
 (151) 2014 07 28  
 (181) 2024 07 28  
 (260) AM 2014 73105 A  
 (220) 2013 07 15  
 (732) Pizza Hut International L.L.C.  
 (a Delaware limited liability company)  
 7100 Corporate Drive, Plano, Texas,  
 75024, USA

(111) M 2014 025093 R  
 (151) 2014 07 28  
 (181) 2024 07 28  
 (260) AM 2014 73181 A  
 (220) 2013 07 25  
 (732) GM KOREA COMPANY  
 199-1 Cheongcheon-2Dong, Bupyung-Gu,  
 Incheon, KR

(111) M 2014 025094 R  
 (151) 2014 07 28  
 (181) 2024 07 28  
 (260) AM 2014 73241 A  
 (220) 2013 07 29  
 (732) LTD "MATRIKSI"  
 E. Takaishvilis q. 80, 6000, Batumi, Georgia



(111) M 2014 025095 R  
(151) 2014 07 28  
(181) 2024 07 28  
(260) AM 2014 73276 A  
(220) 2013 07 30  
(732) British American Tobacco (Brands) Inc.  
(a Delaware corporation)  
2711 Centerville Road, Suite 300,  
Wilmington, Delaware 19808, USA

---

(111) M 2014 025100 R  
(151) 2014 08 01  
(181) 2024 08 01  
(260) AM 2013 72291 A  
(220) 2013 05 20  
(732) Nugzar Shvelidze  
Kipshidzis q. 20, 0162, Tbilisi, Georgia

---

## TRADEMARKS REGISTERED ACCORDING TO THE ACCELERATED PROCEDURE

The decision can be appealed at the Chamber of Appeal of Sakpatenti within 3 months from the publication.

(111) M 2014 25039 R  
(151) 2014 07 15  
(181) 2024 07 15  
(210) AM 077626  
(220) 2014 06 19  
(732) LTD "NEWSTARI"  
Vake-Saburtalos r-ni, Paliashvili-Mosashvilis  
q. 85/24, 0160, Tbilisi, Georgia  
(540)

**გორდა**

(591) Black-white  
(511) 32, 33, 35

(220) 2014 07 04  
(732) LTD "EVROPHARMA GEORGIA"  
Machablis q. 5, 0105, Tbilisi, Georgia  
(740) Nia Masiukovich  
(540)

**ევროფარო**

**Еврофар**

**Eurofar**

(591) Black-white  
(531) 27.05.05-28.05.00-28.19.00-  
(511) 5

(111) M 2014 25040 R  
(151) 2014 07 18  
(181) 2024 07 18  
(210) AM 077710  
(220) 2014 06 26  
(732) GlobalGathering Group Limited  
59-65 Worship Street, London EC2A 2DU,  
United Kingdom  
(740) Giorgi Taktakishvili  
(540)

**GLOBAL GATHERING**

(591) Black-white  
(511) 25, 41

(111) M 2014 25043 R  
(151) 2014 07 07  
(181) 2024 07 07  
(210) AM 077841  
(220) 2014 07 07  
(732) Swiss Pharma International AG  
Waldmannstrasse 8, 8001 Zurich, Switzerland  
(740) Shalva Gvaramadze  
(540)

**Церулин** 

(591) Black-white  
(531) 26.01.12-26.02.07-28.05.00-  
(511) 5

(111) M 2014 25041 R  
(151) 2014 07 18  
(181) 2024 07 18  
(210) AM 077712  
(220) 2014 06 26  
(732) GlobalGathering Group Limited  
59-65 Worship Street, London EC2A 2DU,  
United Kingdom  
(740) Giorgi Taktakishvili  
(540)

 **GLOBAL  
GATHERING**

(591) Black-white  
(531) 26.04.18-26.04.24-27.05.15-27.05.22-  
(511) 25, 41

(111) M 2014 25044 R  
(151) 2014 07 22  
(181) 2024 07 22  
(210) AM 077886  
(220) 2014 07 09  
(732) Megi Vakhtangishvili  
Sopeli Qvemo Khodasheni, 2218, Telavi,  
Georgia  
(740) Sofio Khuchua  
(540)



(591) Cornelian cherry, white

(111) M 2014 25042 R  
(151) 2014 07 18  
(181) 2024 07 18  
(210) AM 077813

(531) 26.04.24-26.11.09-26.13.25-27.05.24-  
28.01.00-29.01.12-  
(511) 27

(111) M 2014 25045 R  
(151) 2014 07 23  
(181) 2024 07 23  
(210) AM 077771  
(220) 2014 07 02  
(732) Blasco Finance Limited  
Road Town, Tortola, British Virgin  
Islands (GB)  
(740) Vasil Sopromadze  
(540)



(591) Black-white  
(531) 26.04.22-26.04.24-27.01.03-27.05.24-  
28.19.00-  
(511) 37

(111) M 2014 25046 R  
(151) 2014 07 23  
(181) 2024 07 23  
(210) AM 077783  
(220) 2014 07 02  
(732) Blasco Finance Limited  
Road Town, Tortola, British Virgin  
Islands (GB)  
(740) Vasil Sopromadze  
(540)



(591) Black-white  
(531) 26.04.22-26.04.24-27.01.03-27.05.24-  
(511) 37

(111) M 2014 25047 R  
(151) 2014 07 23  
(181) 2024 07 23  
(210) AM 077840

(220) 2014 07 07  
(732) Swiss Pharma International AG  
Waldmannstrasse 8, 8001 Zurich, Switzerland  
(740) Shalva Gvaramadze  
(540)

**CERULIN**

(591) Black-white  
(531) 26.01.12-26.02.07-27.05.05-  
(511) 5

(111) M 2014 25096 R  
(151) 2014 07 28  
(181) 2024 07 28  
(210) AM 077808  
(220) 2014 07 03  
(732) LTD "TIFLISSKI VINNI POGREB"  
Iumashevis q.27., 0198, Tbilisi, Georgia  
(740) Shalva Gvaramadze  
(540)



(591) Black-white  
(531) 05.07.10-25.01.19-28.05.00-  
(526) **DISCLAIMER** – The trademark is protected  
as a whole. All verbal records used in the trademark,  
without "MTEBAHI" shall not be subject to  
independent legal protection.  
(511) 33

(111) M 2014 25097 R  
(151) 2014 07 30  
(181) 2024 07 30  
(210) AM 077973  
(220) 2014 07 15  
(732) LTD "APETAIZERI"  
Vake-Saburtalos raioni, Sairmis q. 83, b. 7,  
0194, Tbilisi, Georgia

(540)



(591) Black, grey, light grey  
 (531) 01.15.05-27.05.01-27.05.10-  
 (511) 43

(111) M 2014 25098 R  
 (151) 2014 07 31  
 (181) 2024 07 31  
 (210) AM 077918  
 (220) 2014 07 11  
 (732) LTD "SAQARTVELO BANKIS  
 SASTSAVLO UNIVERSITETI"  
 Mitskevichis q. 29, 0194, Tbilisi, Georgia  
 (740) Giorgi Taktakishvili  
 (540)

მომავალი იწყება აქ

Future Starts Here

Будущее начинается здесь

(591) Black-white  
 (531) 27.05.05-28.05.00-28.19.00-  
 (511) 41

(111) M 2014 25099 R  
 (151) 2014 07 31  
 (181) 2024 07 31  
 (210) AM 077993  
 (220) 2014 07 17  
 (732) LTD "EVROPHARMA GEORGIA"  
 Machablis q. 5, 0105, Tbilisi, Georgia  
 (740) Nia Masiukovichi  
 (540)

კრილომი  
 Крилом  
 Krilom

(591) Black-white  
 (511) 5

(111) M 2014 25101 R  
 (151) 2014 08 01  
 (181) 2024 08 01  
 (210) AM 077949  
 (220) 2014 07 14  
 (732) LTD "VALO-QRISTI"  
 Shavshetis q. 15, 6000, Batumi, Georgia

(540)



(591) Green, red, white  
 (531) 05.03.16-27.05.21-28.05.00-29.01.03-  
 (526) **DISCLAIMER** – The trademark is protected  
 as a whole. Word marks „Для консервации  
 крышки“, „Лучшие качества“ and „ДОМАШ-  
 НИЙ ЗАПАС“ shall not be subject to independent  
 protection.  
 (511) 6

(111) M 2014 25102 R  
 (151) 2014 08 01  
 (181) 2024 08 01  
 (210) AM 077994  
 (220) 2014 07 17  
 (732) Ioseb Kirtskhalia  
 Zemo Vakis (R. Jafaridzis) q. 9, 0179, Tbilisi,  
 Georgia  
 (740) Vakhtang Torotadze  
 (540)



(591) Blue, white, grey  
 (531) 07.01.24-28.19.00-29.01.13-  
 (511) 37

(111) M 2014 25103 R  
 (151) 2014 08 01  
 (181) 2024 08 01  
 (210) AM 077995  
 (220) 2014 07 17  
 (732) Developuri Kompania"MTS KVADRATI"  
 Mazniashvilis q. 4, komertsiuli farti 2, sartuli  
 1, 0102, Tbilisi, Georgia  
 (740) Vakhtang Torotadze  
 (540)



(591) Red, black, white

(531) 07.01.24-07.03.11-24.17.01-27.05.23-  
29.01.13-

(526) **DISCLAIMER** – The trademark is protected as a whole. Word marks "DEVELOPMENT& CONSTRUCTION" shall not be subject to independent protection.

(511) 42

---

(111) M 2014 25104 R

(151) 2014 08 01

(181) 2024 08 01

(210) AM 078065

(220) 2014 07 24

(732) JSC "KAPITAL BANKI"

Vertskhlis q. 1, 0105, Tbilisi, Georgia

(740) Nino Kandelaki

(540)



(591) Grey, silver, golden, black

(531) 24.01.15-27.05.05-28.19.00-29.01.13-

(526) **DISCLAIMER** – The trademark is protected as a whole. Word marks "CAPITAL", „ბანკი“ and "BANK" shall not be subject to independent protection.

(511) 35, 36

---

(111) M 2014 25105 R

(151) 2014 08 01

(181) 2024 08 01

(210) AM 078066

(220) 2014 07 24

(732) JSC "KAPITAL BANKI"

Vertskhlis q. 1, 0105, Tbilisi, Georgia

(740) Nino Kandelaki

(540)



(591) White, blue, sky

(531) 25.07.03-26.04.24-27.05.24-29.01.12-

(511) 35, 36

---

## INTERNATIONAL TRADEMARKS FOR WHICH A DECISION ON GRANTING PROTECTIONS IS TAKEN

The decision can be appealed at the Chamber of Appeal of Sakpatenti within 3 months from the publication or at the Mtskheta District Court Administrative Cases Board (Address: №17, Samkhedro str., Mtskheta), within 1 month following the publication.

(260) AM 2014 71431 A

(800) 1150864

(151) 2012 09 17

(731) İPEK KAĞIT SANAYİ VE TİCARET  
ANONİM ŞİRKETİ

Kanyon Ofis Büyükdere Cad. No:185,  
TR-34394 Levent/Istanbul, Turkey

(540)

# ECO TOUCH

(591) Black, white

(511)

16 – Paper, cardboard and goods made from these materials, not included in other classes; napkins of paper, handkerchiefs of paper, toilet paper, towels of paper, face towels of paper; baby bibs of paper, table cloths of paper, table mats of paper, ornaments made of paper; paper, cardboard and plastic materials for packaging (not included in other classes); plastic sheets, sacks and bags for wrapping and packaging; bookbinding material; printers' type; printing blocks; printed matter; printed publications, calendars, posters, photographs, charts, stickers, stamps; stationery; office requisites, teaching material (except apparatus and furniture), paint brushes.

(260) AM 2014 71626 A

(800) 1152230

(151) 2012 10 15

(731) COTTON CLUB INVESTMENT LTD.

1 st Lipovy, building number 4, Moscow area,  
Balashihinsky area, RU-143985 Sobolikhha,  
Russian Federation

(540)

# AURA

(591) Blue

(511)

21 – Abrasive sponges for scrubbing the skin; sponges for household purposes; toilet sponges; containers for household or kitchen use; kitchen containers; chamois leather for cleaning; toothpicks; brush goods; cleaning instruments, hand-operated; polishing leather; material for brush-making; polishing materials for making shiny, except preparations,

paper and stone; saucepan scourers of metal; gloves for household purposes; polishing gloves; gardening gloves; abrasive pads for kitchen purposes; scouring pads; crumb trays; cups of paper or plastic; drinking glasses; disposable table plates; cloth for washing floors; cloths for cleaning; dusting cloths [rags]; furniture dusters; kitchen utensils; ice cube molds [moulds]; dishwashing brushes; brushes for cleaning tanks and containers; lamp-glass brushes; horse brushes; scrubbing brushes; brushes for footwear; toilet brushes; steel wool; articles for cleaning purposes; steel wool for cleaning; glass [receptacles]; cooking utensils, non-electric; carpet sweepers.

22 – String; tarpaulins; wadding for filtering; clothes lines; textile fibers [fibres]; horsehair; hammocks; jute; wax ends; cord; cocoons; strips for tying-up vines; ladder tapes for Venetian blinds; rope ladders; liber; twine for nets; thread, not of metal, for wrapping or binding; sawdust; straw wrappers for bottles; tow; cotton tow; silk flock; tents; sails; sails for ski sailing; hemp; tarred brattice cloth; feathers for bedding; animal hair; fibrous gaskets for ships; down [feathers]; eiderdown; raffia; hemp bands; fleece wool; nets for camouflage; fishing nets; nets; glass fibers [fibres] for textile use; wood shavings; bags for washing hosiery; raw fibrous textile; network; car towing ropes; wool flock; raw cotton; covers for camouflage; raw silk; carded wool; camel hair; wool wool; combed wool; raw or treated wool; shorn wool; cords for hanging pictures, etc.; sash cords; wadding for padding and stuffing upholstery; kapok; raw linen [flax]; linters; padding materials, not of rubber or plastics; packing [cushioning, stuffing] materials, not of rubber or plastics; bags [sacks] for the transport and storage of materials in bulk; mail bags; binding thread, not of metal, for agricultural purposes; wrapping or binding bands, not of metal; bags [envelopes, pouches] of textile, for packaging; slings, not of metal, for handling loads; snares [nets]; sisal; sheaf-binding yarns; vitreous silica fibers [fibres] for textile use; braces, not of metal, for handling loads; straps, not of metal, for handling loads; cables, not of metal; vehicle covers, not fitted; spa covers, not fitted; unfitted covers for boats and marine vehicles.

41 – Discotheque services; recreation information; entertainment information.

44 – Consultancy in the field of agriculture, horticulture and forestry.

(260) AM 2014 71869 A  
 (800) 1153302  
 (151) 2012 12 19  
 (731) MAN Truck & Bus AG  
 Dachauer Str. 667, 80995 München, Germany  
 (540)



(591) Black, white  
 (511)  
 36 – Insurance; financial affairs; monetary affairs.

(260) AM 2014 72132 A  
 (800) 1155948  
 (151) 2013 02 20  
 (731) Ahava Dead Sea Laboratories Ltd.  
 1 Arava St., P.O.Box 109, 70150 Airport City,  
 Israel

(540) AHAVA  
 (591) Black, white  
 (511)  
 3 – Cosmetics; toiletries; perfumeries; massaging oils; essential oils; non-medical preparations and substances for cleansing, treatment and care of the skin; non-medical preparations and substances for cleansing, treatment and care of the nails; non-medical preparations and substances for cleansing, treatment and care of the hair; non-medical preparations and substances for cleansing, treatment and care of the teeth and the gums; dentifrices; bath salts; soaps; home fragrance products.

35 – Retail sale services in the fields of cosmetics, toiletry, perfumery, massaging oils, essential oils, personal care products, preparations for cleansing, treatment and care of the skin, the nails, the hair, of the teeth and the gums, bath salts, soaps, home fragrance products, scented candles and related products.

44 – Spa services, namely, body treatments, massages, facial treatments, nail treatments, hair treatments, beauty salons, sauna and solarium services, advice and information in the field of health and beauty.

(260) AM 2014 72353 A  
 (800) 1158126  
 (151) 2013 03 18

(731) Henkel AG & Co. KgaA  
 Henkelstr. 67, 40589 Düsseldorf, Germany  
 (540)

## SESSION LABEL

(591) Black, white  
 (511)  
 3 – Soaps, perfumery, ethereal oils, cosmetics, preparations for the conditioning, cleaning, tinting, dyeing, bleaching, fixing and waving of hair, hair lotions and shampoos for cosmetic purposes; dentifrices.

(260) AM 2014 72354 A  
 (800) 1158133  
 (151) 2013 03 29  
 (731) RENAUD COINTREAU SAS  
 25 boulevard Maiesherbes, F-75008 PARIS,  
 France  
 (540)

## SALERS

(591) Black, white  
 (511)  
 33 – Alcoholic beverages (except beers); cognac; eaux-de-vie (brandy); digesters (liqueurs and spirits); liqueurs; wines; spirits.

(260) AM 2014 72368 A  
 (800) 1158331  
 (151) 2013 04 09  
 (731) GRUPPO COIN S.P.A.  
 Via Terraglio, 17, I-30174 MESTRE (VE),  
 Italy  
 (540)

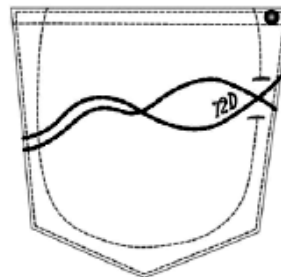

(591) Black, white  
 (511)  
 25 – Clothing articles, namely shirts, t-shirts, polo shirts, blouses, singlets, tank tops, sweat shirts, overalls, gym suits, pullovers, dresses, cardigans, jumpers, knitted wear, jerseys, vests, ponchos, capes, cloaks, parkas, sweaters, blazers, raincoats, anoraks, overcoats, coats, scarves, sports jackets, jerkins, leather jackets, jackets and wind resistant jackets, waistcoats, trousers, slacks, skirts, jeans, jogging pants, bermuda shorts, shorts, pants, babies' pants, underwear, panties, underpants, pantyhose, hosiery, socks,

stockings, tights, leotards, leggings, collars, tunics, petticoats, corsets, brassieres, camisoles, belts, suspenders, ties, neckties, ascots, gloves, fingerless gloves, mittens, foulards, shawls, sweatbands, warm-up suits, nightgowns, pajamas, nightwear, dressing gowns, dance clothes, beachwear, swimwear, bathing suits, bath robes.

(260) AM 2014 72376 A

(800) 1158448

(151) 2013 03 22

(731) Mexon OOD

266 Vasil Levski Str., BG-4003 Plovdiv,  
Bulgaria

(540)



(591) Black, white

(511)

3 – Bleaching preparations and other substances for laundry use; cleaning, polishing, scouring and abrasive preparations; soaps; perfumery, essential oils, cosmetics, hair lotions; dentifrices.

5 – Biocides.

(260) AM 2014 73030 A

(800) 1164332

(151) 2013 03 29

(731) ÇETİN MOBİLYA EKİPMANLARI SAN.  
VE TİC. LTD. ŞTİ.

Yeni Mah. 542, Sk. No:21, Gaziosmanpasa  
Istanbul, Turkey

(540)



(591) Black, white, red

(511)

6 – Common metals and their alloys; metal building materials; transportable buildings of metal; materials of metal for railway tracks; non-electric cables and wires of common metal; ironmongery, small items of metal hardware; pipes and tubes of metal; safes; goods of common metal not included in other classes; ores.

(260) AM 2014 73031 A

(800) 1164348

(151) 2013 04 03

(731) SADE - COMPAGNIE GÉNÉRALE DE  
TRAVAUX D'HYDRAULIQUE

28 rue de la Baume, F-75008 PARIS, France

(540)



(591) Black, white

(511)

37 – All work-related services concerning water supply, water distribution and sanitation and, in particular, drilling, pipes for drinking water, waste water, irrigation water, industrial water, as well as civil engineering structures, special structures, horizontal drilling operations, maintenance and management (installation, repair and maintenance) of networks, pipelines and gas pipelines.

42 – All engineering study services concerning water supply, water distribution and sanitation and, in particular, water catchment and probing services.

(260) AM 2014 73032 A

(800) 1164370

(151) 2013 05 07

(731) Hygiene360 AG

Büelstrasse 17, CH-8330 Pfäffikon ZH,  
Switzerland

(540)



(591) Black, white

(511)

3 – All-purpose cleaners.

5 – All-purpose disinfectants, aseptic antibacterial alcohol-based gel for the skin, antibacterial sprays, disinfectants for sanitary purposes, disinfectants for medical instruments, disinfectants for surfaces; antibacterial cleaning products, antibacterial hand-washing products, disinfectant hand-washing products, disinfectant surface-cleaning products.

(260) AM 2014 73033 A

(800) 1164409

(151) 2013 05 17

(731) Apple Inc.

1 Infinite Loop, Cupertino, CA 95014, USA



(540)



(591) Orange, green, blue, white and gray

(511)

9 – Computer software for creating spreadsheets, tables, graphs, and charts, and for organizing and analyzing data, for home, education, business, and developer use.

(260) AM 2014 73034 A

(800) 1164410

(151) 2013 05 17

(731) Apple Inc.

1 Infinite Loop, Cupertino, CA 95014, USA

(540)



(591) Blue, silver, brown, white and gray

(511) 9 - Computer software for presentation graphics, namely, software for generating, storing, retrieving, manipulating and altering texts and graphics for use in presentations and utility programs for use therewith.

(260) AM 2014 73036 A

(800) 1164430

(151) 2012 12 12

(731) GOLD DROP Sp. z o.o.

Rzeczna 11d, PL-34-600 Limanowa, Poland

(540)

**appi**

(591) Black, white

(511)

2 – reservatives against rust, paints, lacquers, enamels, red lead, zinc oxide, titanium oxide, thinners, varnishes, mordants, pigments, colorants, ground metals being colorants and decorating agents.

3 – Household chemicals in the form of fabric softeners, stain removers, starch glaze for laundry purposes, preparations for removing floor polish, cleaning, bleaching, laundry, washing, rinsing, scouring and polishing preparations, disinfectant soap, cosmetics and personal hygiene preparations for persons and animals, car cosmetics, paint-stripping preparations, rust-removing preparations, abrasive and polishing preparations, agents for removing paint, lacquer, limescale and rust, preparations for cleaning installation pipes, degreasers other than for use in manufacturing processes, floor and furniture polishes, preservatives for furniture, floors, leather, imitation leather and vehicle bodies.

(260) AM 2014 73037 A

(800) 1164532

(151) 2013 05 14

(731) Товариство з обмеженою відповідальністю

"ТОРГОВИЙ ДІМ "ГАДІАХСЬК"

Україна"

вул. Патриса Лумумби, б. 4/6, корп. "В",

кімн. 1308 А, Київ, Печерський район 01042,

Україна

(540)



(591) Yellow, red and brown

(511)

29 – Butter; butter cream; cheese; chocolate nut butter; cocoa butter; coconut butter; condensed milk; curd; kefir [milk beverage]; koumiss [kumiss] [milk beverage]; milk beverages, milk predominating; milk products; milk shakes; milk; peanut butter; rennet; whey.

(260) AM 2014 73038 A

(800) 1164462

(151) 2013 02 06

(731) Zotter Holding GmbH & Co KG

Bergl 56, A-8333 Kornberg bei Riegersburg,

Austria

(540)

**NUTTING HILL**

(591) Black, white

(511)  
30 – Confectionery with nuts; confectionery; chocolate; chocolate based goods; sweets (not included in other classes); cocoa.

(260) AM 2014 73040 A  
(800) 1164471  
(151) 2013 02 05  
(731) SAADET GIDA PAZARLAMA SANAYİ VE TİCARET ANONİM ŞİRKETİ  
Pinar Mahallesi, 19 Mayıs Bulvarı, No: 30,  
Esenyurt, İSTANBUL, Turkey

(540)  
**NAZAR İSTANBUL**  
(591) Black, white  
(511)  
30 – Chewing gum.

(260) AM 2014 73041 A  
(800) 1164511  
(151) 2013 04 10  
(731) Wella GmbH  
Sulzbacher Straße 40, 65824 Schwalbach am  
Taunus, Germany

(540)  
**KOLESTON PERFECT  
INNOSENSE**  
(591) Black, white  
(511)  
3 – Preparations for the care, treatment, beautification and coloring of the hair.

(260) AM 2014 73042 A  
(800) 1164562  
(151) 2013 04 10  
(731) EVER Neuro Pharma GmbH  
Oberburgau 3, A-4866 Unterach am Attersee,  
Austria

(540)  
**PREPALEPAN**  
(591) Black, white  
(511)  
5 – Pharmaceutical and veterinary preparations.

(260) AM 2014 73043 A  
(800) 1164624  
(151) 2013 05 29  
(731) SHAANXI HEAVY-DUTY AUTOMOBILE CO., LTD.  
Jingwei Industrial Park, Xi'An Economic and Technological Development Zone Xi'An  
710200 Shaanxi, China

(540)

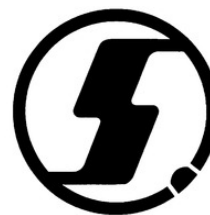

(591) Black, white  
(511)  
35 – Advertising; advertisement planning; commercial administration of the licensing of the goods and services of others; organization of exhibitions for commercial or advertising purposes; import-export agencies; sales promotion for others; business management assistance; relocation services for businesses; systemization of information into computer databases; accounting.

37 – Motor vehicle maintenance and repair; vehicle fueling stations; vehicle wash; vehicle service stations [refuelling and maintenance]; anti-rust treatment for vehicles; retreading of tires; vulcanization of tires [repair]; vehicle lubrication [greasing]; vehicle polishing.

(260) AM 2014 73044 A  
(800) 1164626  
(151) 2013 01 25  
(731) Obschestvo s ogranitshennoi otvetstvennostyuu "TRIUMPH"; 3, bldg. 1,  
Lesteva str. RU-115191 Moscow,  
Russian Federation

(540)

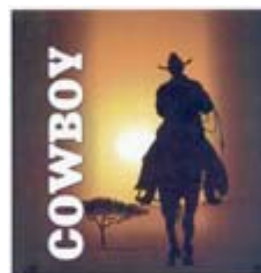

(591) White, black, and gradient shades of yellow, orange, burgundy, brown and beige  
(511)  
3 – Abrasives; amber [perfume]; antistatic preparations for household purposes; aromatics [essential oils]; air fragrancing preparations; flavourings for beverages [essential oils]; breath freshening sprays; balms other than for medical purposes; petroleum jelly for cosmetic purposes; shoe wax; adhesives for cosmetic purposes; scented water; javelle water; lavender water; toilet water; depilatory wax; mustache wax; shoemakers' wax; polishing wax; massage gels other than for medical purposes; dental bleaching gels; geraniol; make-up; deodorants for human beings or for animals; scented wood; perfumes; wind-

screen cleaning liquids; greases for cosmetic purposes; perfumery; decorative transfers for cosmetic purposes; ionone [perfumery]; shaving stones [astringents]; smoothing stones; cosmetics; beard dyes; cosmetic dyes; creams for leather; waxes for leather; polishing creams; cosmetic creams; skin whitening creams; incense; hair lotions; lotions for cosmetic purposes; after-shave lotions; beauty masks; oils for perfumes and scents; oils for cosmetic purposes; oils for toilet purposes; essential oils; essential oils of cedarwood; essential oils of citron; oils for cleaning purposes; bergamot oil; gaultheria oil; jasmine oil; lavender oil; almond oil; rose oil; oil of turpentine for degreasing; almond milk for cosmetic purposes; cleansing milk for toilet purposes; musk [perfumery]; soap; disinfectant soap; deodorant soap; shaving soap; cakes of toilet soap; medicated soap; antiperspirant soap; soap for foot perspiration; almond soap; mint for perfumery; cosmetic kits; emery; eau de cologne; joss sticks; pastes for razor strops; dentifrices; pumice stone; breath freshening strips; shaving preparations; cosmetic preparations for baths; toiletries; hair waving preparations; grinding preparations; douching preparations for personal sanitary or deodorant purposes [toiletries]; color-removing preparations; leather bleaching preparations; polishing preparations; mouth washes, not for medical purposes; refurbishing preparations; laundry bleach; dry-cleaning preparations; paint stripping preparations; lacquer-removing preparations; nail care preparations; cleaning preparations; aloe vera preparations for cosmetic purposes; sunscreen preparations; shining preparations [polish]; make-up powder; diamantine [abrasive]; scouring solutions; false eyelashes; tissues impregnated with cosmetic lotions; saffrol; potpourris [fragrances]; bath salts, not for medical purposes; fumigation preparations [perfumes]; leather preservatives [polishes]; astringents for cosmetic purposes; eyebrow cosmetics; make-up preparations; sun-tanning preparations [cosmetics]; hair colorants; cosmetic preparations for eyelashes; depilatories; depilatory preparations; cosmetic preparations for skin care; shoe and boot cream; shoe polish; cosmetics for animals; mascara; detergents other than for use in manufacturing operations and for medical purposes; antiperspirants [toiletries]; talcum powder, for toilet use; terpenes [essential oils]; emery cloth; shampoos; dry shampoos; glass paper; extracts of flowers [perfumes]; ethereal essences; badian essence; mint essence [essential oil]; sharpening preparations; washing and bleaching preparations; boot polish.

35 – Import-export agencies; commercial information agencies; advertising agencies; demonstration of goods; commercial information and advice for consumers [consumer advice shop]; layout services for advertising purposes; marketing; updating of ad-

vertising material; organization of exhibitions for commercial or advertising purposes; organization of trade fairs for commercial or advertising purposes; shop window dressing; presentation of goods on communication media, for retail purposes; auctioneering; sales promotion for others; rental of advertising time on communication media; publication of publicity texts; bill-posting; outdoor advertising; distribution of samples; dissemination of advertising matter; direct mail advertising; writing of publicity texts; advertising; publicity; on-line advertising on a computer network; advertising by mail order; television commercials; publicity columns preparation; telemarketing services; commercial administration of the licensing of the goods and services of others; administrative processing of purchase orders; modelling for advertising or sales promotion; procurement services for others [purchasing goods and services for other businesses].

(260) AM 2014 73046 A

(800) 1164675

(151) 2013 04 05

(731) SOREMARTEC S.A.

Findel Business Center, Complexe B, Rue de Trèves, L-2632 Findel, Luxembourg

(540)



(591) White, black, light brown, dark brown, beige (511)

30 – Pastry and confectionery; chocolate and products based on chocolate or cocoa, edible ices.

(260) AM 2014 73048 A

(800) 1164708

(151) 2013 04 30

(731) Hygiene360 AG

Büelstrasse 17, CH-8330 Pfäffikon ZH, Switzerland

(540)

## PROSEPTUS

(591) Black, white

(511)

3 – All-purpose cleaners.

5 – All-purpose disinfectants, aseptic antibacterial alcohol-based gel for the skin, antibacterial sprays,

disinfectants for sanitary purposes, disinfectants for medical instruments, disinfectants for surfaces; antibacterial cleaning products, antibacterial hand-washing products, disinfectant hand-washing products, disinfectant surface-cleaning products.

(260) AM 2014 73049 A  
 (800) 1164788  
 (151) 2013 05 23  
 (731) New Art Ltd for Jewels and Objects  
 Gütschstrasse 4, CH-6312 Steinhausen,  
 Switzerland  
 (540)



(591) Brown  
 (511)  
 14 - Precious stones; gold; semi-precious stones; jewelry, precious stones; silver; table clocks; clock dials.  
 16 - Engravings.  
 40 - Gold-plating; silversmithing; gilding.

(260) AM 2014 73051 A  
 (800) 1164822  
 (151) 2012 12 12  
 (731) Mechadyne International Limited  
 Park Farm Technology Centre,  
 Kirtlington/Kidlington, Oxfordshire OX5 3JQ,  
 United Kingdom  
 (540)

**DuoPhase**

(591) Black, white  
 (511)  
 7 - Bearings; mechanical controls; engine noise shields; camshafts; actuators for camshafts; adjustable valve trains; hydraulic cylinders and hydraulic motors; engine mountings; parts for engines and motors; parts for engines and motors for vehicles.  
 9 - Electronic control systems; electronic control systems for motor vehicles; electronic sensors, elec-

tronic processors, electronic measuring instruments; printed circuit boards; electric switches and relays; wiring harnesses; temperature sensors; voltage sensors; transducers; electronic control modules; integrated circuits; and parts and fittings for all the aforesaid goods.

12 - Motor vehicles; parts and fittings for motor land vehicles, namely under bonnet and under vehicle components, assemblies and sub-systems, engines and motors, vehicle axle assemblies, wheel hubs, springs, stabilizer bars, steering linkages, suspensions, torsion bars, brakes, brake pads, brake linings and braking installations, clutches, differential gears, drive gears, drive shafts, gear change selectors, transmissions, couplings, manual and power steering apparatus, steering columns and anti-theft devices; and parts and fittings for all the aforesaid goods.

42 - Research and development of industrial and scientific products; engineering design services; engineering drawing services; engineering testing services; design services, drawing services and testing services relating to automotive engineering; advisory and consultancy services relating to the above.

(260) AM 2014 73052 A  
 (800) 1164848  
 (151) 2013 03 19  
 (731) SOREMARTEC S.A.  
 Findel Business Center, Complexe B, Rue de  
 Trèves, L-2632 Findel, Luxembourg  
 (540)

**KINDER MAXI KING**

(591) Black, white  
 (511)  
 30 - Pastry and confectionery; chocolate and chocolate-based products; edible ices.

(260) AM 2014 73053 A  
 (800) 1164856  
 (151) 2013 05 07  
 (731) XIAMEN ZHENG LIMING  
 METALLURGICAL MACHINERY CO.,  
 LTD.  
 187#, No.2 Zhen Nan Road, Tong'an, Xiamen,  
 361000 Fujian, China  
 (540)



(591) Black, white

(511)  
7 – Colored metal-sheet roll forming machines; machining devices; metal processing machinery.

(260) AM 2014 73054 A  
(800) 1164861  
(151) 2013 04 30  
(731) B.R.  
32 avenue des Champs Elysées, F-75008  
PARIS, France

(540)  
The logo consists of the words "AMBASSADE DE LA BEAUTÉ" in a serif font, with "AMBASSADE" on the top line, "DE LA" in smaller letters in the middle, and "BEAUTÉ" on the bottom line. The text is white and set against a dark blue rectangular background.

(591) Blue  
(511)  
44 – Hygienic and beauty care for human beings; hygienic and beauty care for the face and body including massages; plastic surgery; beauty salons; hairdressing salons; mesotherapy; manicure services; information in the field of cosmetics and hygienic and beauty care.

(260) AM 2014 73055 A  
(800) 1164864  
(151) 2013 03 25  
(731) Toruńskie Zakłady Materiałów  
Opatrunkowych, Spółka Akcyjna;  
Żółkiewskiego 20/26, PL-87-100 Toruń,  
Poland

(540)  
The logo features the word "AIR" in a bold, white, sans-serif font, centered within a blue circle. Two white arrows curve around the circle, one pointing up and the other pointing down. Below the circle, the word "BREATHABLE" is written in a smaller, white, sans-serif font.

(591) Blue, white and dark navy blue  
(511)  
5 – Diaper for incontinents, diaper-pants for incontinents, urological pads for woman, urological pads for men, absorbent incontinents pants, absorbent incontinents liners.

(260) AM 2014 73056 A  
(800) 1164867  
(151) 2013 05 23  
(731) NEW BELLE FOOTWEAR (SHENZHEN)  
CO., LTD.  
No. 99, Huaning West Road, Dalang Street,  
Baoan District, Shenzhen City, Guangdong  
Province, China

(540)  
**STACCATO**

(591) Black, white  
(511)  
18 – Purses; handbags; briefcases; valises; rucksacks; key cases; umbrellas; envelopes, of leather, for packaging; shopping bags; vanity cases, not fitted.  
25 – Shoes; masquerade costumes; raincoats; football shoes.

35 – Dissemination of advertising matter; advertising; advertising agencies; advertising agency specializing in the design and execution of word of mouth, viral, buzz and experiential marketing programs; special event planning for commercial, promotional or advertising purposes; business management and organization consultancy; commercial or industrial management assistance; business management of hotels; import-export agencies; sales promotion for others.

(260) AM 2014 73057 A  
(800) 1164878  
(151) 2013 03 28  
(731) TOPBAŞ KUNDURA SANAYİ VE  
TİCARET LİMİTED ŞİRKETİ;  
Bursa İzmir Sürat Yolu, Selimşahlar Kasabası,  
Selimşahlar, MANİSA, Turkey

(540)  
The logo features the letters "UCS" in a large, bold, red, sans-serif font. To the right of "UCS", the words "UNITED CLUB SPORT" are written in a smaller, black, sans-serif font, stacked in two lines.

(591) Black, white, red  
(511)  
25 – Clothing; underwear, outer clothing, socks, footwear, headgear.

(260) AM 2014 73058 A  
(800) 1164901  
(151) 2013 04 30  
(731) TRICOBİOTOS S.p.A.  
Via di Spicciano, 11, I-59021 Vaiano (PO),  
Italy

(540)  
**COLOREVO**

(591) Black, white  
(511)  
3 – Hair care and treatment preparations; hair cream; hair conditioners; hair lacquers; hair styling waxes; hair colorants; hair color; hair lotions; waving preparations for the hair; preparations for setting hair; hair styling preparations; waving preparations for the hair; hair straightening preparations; bleaching

preparations [decolorants] for hair; hair spray; styling gels for the hair; hair shampoos; soaps and cleansers for the scalp; cosmetics for use on the hair.

(260) AM 2014 73059 A

(800) 1164904

(151) 2013 05 02

(731) ALEXANDRA ALBERTA CHIOLO S.P.A.  
Via Emilio Morosini, 22, I-20135 MILANO  
(MI), Italy

(540)



(591) Black, white

(511)

18 – Leather and imitations of leather, and goods made of these materials and not included in other classes; animal skins, hides; trunks and travelling bags; umbrellas and parasols; walking sticks; whips, harness and saddlery.

25 – Clothing, footwear, headgear.

(260) AM 2014 73060 A

(800) 1164918

(151) 2013 05 21

(731) NOVARTIS AG  
CH-4002 Basel, Switzerland

(540)



(591) Black, white

(511)

10 – Medical and surgical ophthalmic apparatus and equipment.

(260) AM 2014 73061 A

(800) 1164962

(151) 2013 02 04

(731) ITALGOLD KUYUMCULUK SANAYI VE  
TICARET LTD. STI.  
Mimar Hayrettin Mah., Yeniçeriler Cad.  
No:39, BEYAZIT FATİH/İSTANBUL,  
Turkey

(540)



(591) Blue, white

(511)

14 – Jewellery, namely imitation jewellery and jewellery of precious metal and stones; gold thread [jewellery, jewelry (Am.)]; gold, unwrought or beaten; silver thread; silver, unwrought or beaten; bracelets [jewellery, jewelry (Am.)]; rings [jewellery, jewelry (Am.)]; chains [jewellery, jewelry (Am.)]; jewellery; jewelry; medallions [jewellery, jewelry (Am.)]; cuff links; tie pins; pins [jewellery, jewelry (Am.)]; ornamental pins; brooches [jewellery, jewelry (Am.)]; precious stones; ornaments [jewellery, jewelry (Am.)]; trinkets [jewellery, jewelry (Am.)]; statues of precious metal; statuettes of precious metal.

(260) AM 2014 73062 A

(800) 1165005

(151) 2013 02 07

(731) GOLDEN LADY COMPANY S.p.A.  
Via Giacomo Leopardi, 3/5, I-46043  
CASTIGLIONE DELLE STIVIERE (MN),  
Italy

(540)

## GOLDENPOINT

(591) Black, white

(511)

35 – Retail sales services on behalf of third parties that are provided by all means, including Internet, in connection to the following products: clothing, footwear, headgear, soaps, perfumery, essential oils, cosmetics, hair lotions, dentifrices, creams, lotions, gel and balsams for personal use, bath salts.

(260) AM 2014 73063 A

(800) 1165027

(151) 2013 04 29

(731) NOVARTIS AG  
CH-4002 Basel, Switzerland

(540)

## EYEFILE

(591) Black, white

(511)

44 – Provision of information online via a global communication network in the field of ophthalmology; provision of medical informations in the

field of ophthalmology; provision of information in the field of health.

(260) AM 2014 73064 A  
 (800) 1165058  
 (151) 2013 05 21  
 (731) PIERRE FABRE DERMO-COSMETIQUE  
 45 place Abel Gance, F-92100 BOULOGNE,  
 France  
 (540)

## LUNARGAN

(591) Black, white  
 (511)  
 3 – Cosmetic products for skin hygiene, care and beauty; make-up products.  
 5 – Dermo-cosmetic products for skin hygiene and care.

(260) AM 2014 73065 A  
 (800) 1165087  
 (151) 2013 02 14  
 (731) BIOFARMA  
 50 rue Carnot, F-92284 SURESNES CEDEX,  
 France  
 (540)

## INTRICOR

(591) Black, white  
 (511)  
 5 – Pharmaceutical and veterinary products; sanitary products for medical purposes; dietetic food and substances for medical or veterinary use; food for babies; food supplements for humans and animals; plasters, materials for dressings; material for dental fillings and dental impressions; disinfectants; products for destroying vermin; fungicides, herbicides.

(260) AM 2014 73066 A  
 (800) 1165144  
 (151) 2012 12 12  
 (731) Mechadyne International Limited  
 Park Farm Technology Centre,  
 Kirtlington/Kidlington, Oxfordshire OX5 3JQ,  
 United Kingdom  
 (540)

## FlexValve

(591) Black, white  
 (511)  
 7 – Bearings; mechanical controls; engine noise shields; camshafts; actuators for camshafts; adjustable valve trains; hydraulic cylinders and hydraulic

motors; engine mountings; parts for engines and motors; parts for engines and motors for vehicles.

9 – Electronic control systems; electronic control systems for motor vehicles; electronic sensors, electronic processors, electronic measuring instruments; printed circuit boards; electric switches and relays; wiring harnesses; temperature sensors; voltage sensors; transducers; electronic control modules; integrated circuits; and parts and fittings for all the aforesaid goods.

12 – Motor vehicles; parts and fittings for motor land vehicles, namely under bonnet and under vehicle components, assemblies and sub-systems, engines and motors, vehicle axle assemblies, wheel hubs, springs, stabilizer bars, steering linkages, suspensions, torsion bars, brakes, brake pads, brake linings and braking installations, clutches, differential gears, drive gears, drive shafts, gear change selectors, transmissions, couplings, manual and power steering apparatus, steering columns and anti-theft devices; and parts and fittings for all the aforesaid goods.

42 – Research and development of industrial and scientific products; engineering design services; engineering drawing services; engineering testing services; design services, drawing services and testing services relating to automotive engineering; advisory and consultancy services relating to the above.

(260) AM 2014 73067 A  
 (800) 584602  
 (151) 2013 03 31  
 (731) PIVIDAL Joseph-Marie  
 1, avenue Montaigne, F-75008 PARIS, France  
 (540)

## LOLITA LEMPICKA

(591) Black, white  
 (511)  
 3 – Perfumery, cosmetics.

(260) AM 2014 73686 A  
 (800) 1171485  
 (151) 2013 07 08  
 (731) Enterprise Holdings, Inc.  
 600 Corporate Park Drive, St. Louis MO  
 63105, USA  
 (540)



(591) Black, white

(511)  
35 – Customer loyalty services and customer club services, for commercial, promotional and/or advertising purposes.  
39 – Vehicle rental and leasing services, and reservation services for the rental and leasing of vehicles.

(260) AM 2014 73687 A  
(800) 1171488  
(151) 2013 06 28  
(731) SANITANA - FÁBRICA DE SANITÁRIOS DE ANADIA, S.A.  
Zona Industrial de Anadia, P-3781-909  
ANADIA, Portugal

(540)

## SANITANA

(591) Black, white  
(511)  
11 – Sanitary apparatus and installations.

35 – Advertising; dissemination of advertising matter; marketing studies and research; import and export.

39 – Transport, storage, warehousing and distribution services of sanitary ware.

(260) AM 2014 73688 A  
(800) 270493  
(151) 1963 06 12  
(891) 2013 06 13  
(731) Gowan Comércio Internacional e Serviços, Limitada  
Avenida do Infante 50, P-9004-521 Funchal, Madeira, Portugal

(540)

## Dicarzol

(591) Black, white  
(511) 1 - Products for protecting plants, products for preserving foodstuffs.

5 - Pesticides and herbicides, products for protecting plants, products for protecting animals against parasites and insects.

(260) AM 2014 73689 A  
(800) 392322  
(151) 1972 09 13  
(891) 2013 03 12  
(731) EGYT GYÓGYSZERVEGYÉSZETI GYÁR  
30-38, Kereszturi ut, BUDAPEST X, Hungary

(540)

## SENTACURIN

(591) Black, white  
(511)  
5 – Pharmaceutical preparation for human and veterinary use, proprietary medicines.

(260) AM 2014 73690 A  
(800) 479641  
(151) 1983 09 30  
(891) 2013 06 13  
(731) LABORATOIRES OMEGA PHARMA  
FRANCE  
20 rue André Gide, F-92320 Châtillon, France

(540)

## SPREGAL

(591) Black, white  
(511)  
5 – Insecticides and, more specifically, an acaricide product.

(260) AM 2014 73691 A  
(800) 655866  
(151) 1996 05 30  
(891) 2013 05 28  
(731) AUDI AG  
85045 Ingolstadt, Germany

(540)

## S4

(591) Black, white  
(511)  
12 – Motor vehicles and parts for construction thereof (included in this class).

(260) AM 2014 73692 A  
(800) 713914  
(151) 1999 05 31  
(891) 2013 03 12  
(731) GRUPO ANGEL CAMACHO, S.L.  
Avenida del Pilar, 6, E-41530 Morón de la Frontera (Sevilla), Spain

(540)



(591) Black, white  
(511)  
29 – Meat, fish, poultry and game; meat extracts; preserved, frozen, dried and cooked herbs and vegetables; jellies, jams, compotes; eggs, milk and dairy products; edible oils and fats.



(260) AM 2014 73693 A  
 (800) 809586  
 (151) 2003 07 29  
 (891) 2013 07 30  
 (731) Toruńskie Zakłady Materiałów  
 Opatunkowych, Spółka Akcyjna  
 ul. Żółkiewskiego 20/26, PL-87-100, Toruń,  
 Poland

(540)

**plastofilm**

(591) Black, white  
 (511)  
 5 – Sticking plasters.

(260) AM 2014 73694 A  
 (800) 818563  
 (151) 2003 12 27  
 (891) 2013 03 08  
 (731) Messe München GmbH  
 Am Messesee 2, 81829 München, Germany

(540)

**MMI**

(591) Black, white  
 (511)  
 16 – Printed matter except specialist journals and  
 specialized information reports for industry and  
 trade in the field of machines and devices for the  
 treatment and processing of metal, wood, synthetics,  
 ceramics or building material.

35 – Organisation of exhibitions and trade fairs for  
 business and advertising purposes.

41 – Organisation of exhibitions and fairs for  
 cultural and teaching purposes; organisation and  
 arranging of congresses and meetings; publication  
 and issuing of printed matter, except specialist  
 journals and specialized information reports for  
 industry and trade in the field of machines and  
 devices for the treatment and processing of metal,  
 wood, synthetics, ceramics or building material.

(260) AM 2014 73695 A  
 (800) 1114563  
 (151) 2012 04 02  
 (891) 2013 04 29  
 (731) SEXES spol. s r.o.  
 Mileticova 44, SK-821 09 Bratislava, Slovakia

(540)

**SEXES**

(591) Black, white  
 (511)  
 5 – Medicinal drinks.  
 32 – Non-alcoholic beverages.

(260) AM 2014 73719 A  
 (800) 1171765  
 (151) 2013 01 21  
 (891)  
 (731) DR. SERTUS İLAÇ SANAYİ VE TİCARET  
 LİMİTED ŞİRKETİ;  
 Evren Mah. Camiyolu Cad. No.50 K.2,  
 Güneşli, Bağcılar, İstanbul, Turkey

(540)

**SERTOFLEX**

(591) Black, white  
 (511)  
 5 – Medicines for human purposes, medicines for  
 veterinary purposes, chemical preparations for medi-  
 cal purposes, dietetic substances adapted for medical  
 use; dietetic foods adapted for medical purposes;  
 amino acids for medical purposes, nutritional sub-  
 stances, pollen dietary substances, mineral food sub-  
 stances, protein dietary supplements, baby foods, me-  
 dicinal herbs, herbal beverages adapted for medical  
 purposes; medicines for dental purposes, hygienic  
 products for medical purposes including pads,  
 waddings for medical purposes, plasters for medical  
 purposes, dressings for medical purposes, preparati-  
 ons for destroying noxious plants, preparations for  
 destroying noxious animals, fungicides, disinfectants  
 for hygiene purposes, antiseptics, detergents for  
 medical purposes.

(260) AM 2014 73720 A  
 (800) 1171825  
 (151) 2013 05 27  
 (731) İSTİKBAL MOBİLYA SANAYİ VE  
 TİCARET ANONİM ŞİRKETİ  
 1. Organize Sanayi Bölgesi 8., Cadde No:60,  
 MELİKGAZİ, KAYSERİ, Turkey

(540)

**istikbal**

(591) Black, white  
 (511)  
 20 – Furniture; mirrors; picture frames; goods (not  
 included in other classes) of wood, cork, reed, cane,  
 wicker, horn, bone, ivory, whalebone, shell, amber,  
 mother-of-pearl, meerschaum and substitutes for all  
 these materials, or of plastics, metal furniture and  
 furniture for camping; bedding namely mattresses,  
 spring mattresses, pillows and sleeping bags; look-  
 ing glasses and furnishing or toilet mirrors; re-

gistration number plates not of metal; letter boxes not of metal or masonry.

24 – Textiles and textile goods, not included in other classes; bed and table covers.

27 – Carpets, rugs, mats and matting, linoleum and other materials for covering existing floors; non-textile wall hangings.

35 – Advertising; business management; business administration; office functions; the bringing together, for the benefit of others, of a variety of goods excluding the transport thereof, enabling customers to conveniently view and purchase those goods, namely, furniture, mirrors, frames for pictures and paintings, goods of wood, wax, cork, reed, cane, wicker, horn, bone, ivory, whalebone, shell, amber, mother-of-pearl, meerschaum and substitutes for all these materials and of plastics and gypsum, namely, nonmetal connections for furniture, parts for furniture, shelf connecting elements, fitted furniture cover not of fabric, drawer rails, furniture wheels, file cabinets, writing and drawing desks, working benches, bamboo curtains, window shade curtains, roller blind, bamboo band curtains, bead curtains for decorative purposes, curtain rails, curtain rings, curtain hooks, curtain bars, non-textile decorative wall panels, metal furniture and furniture for camping, namely, camping beds, inflatable beds, bedding, namely, mattresses, spring mattresses, pillows, and sleeping bags, looking glasses in the nature of mirrors, textile and textile goods, namely, curtains, shower curtains, household linen, bed sheets, pique fabric, pillowcases, quilts, quilts covers, unfitted armchair covers, unfitted coffee table covers, coverlets, fiber coverlets, bed blankets, textile wall hangings, hand and face towels, bath towels, woven or non-woven fabrics for furniture, bed covers, textile table cloths, carpets, mats, rugs, hall rugs, floor coverings made of synthetic material, namely, oilcloth, artificial grass, linoleum and other materials for covering existing floors, non textile wall hangings, gymnastic mats, wrestling cushions, non-textile wall coverings and wallpaper.

(260) AM 2014 73723 A

(800) 1171849

(151) 2013 07 08

(731) MERCK KGaA

Frankfurter Strasse 250, 64293

DARMSTADT, Germany

(540)

**READYBAG**

(591) Black, white

(511)

1 – Chemicals used in industry, science and photography, as well as in agriculture, horticulture and forestry; unprocessed artificial resins, unprocessed plastics; manures; fire extinguishing compositions; tempering and soldering preparations; chemical substances for preserving foodstuffs; tanning substances; adhesives used in industry; culture media.

(260) AM 2014 73724 A

(800) 1171853

(151) 2013 07 09

(731) KRKA, tovarna zdravil, d.d.

Novo mesto, Šmarješka cesta 6, SI-8501

Novo mesto, Slovenia

(540) LORTENIA

(591) Black, white

(511) 5 - Pharmaceutical preparations.

(260) AM 2014 73725 A

(800) 1171959

(151) 2013 06 14

(731) TURKIYE CUMHURİYETİ ZIRAAT

BANKASI ANONİM ŞİRKETİ

Doganbey M. Ataturk Blv. N:8, ULUS

ALTINDAG ANKARA, Turkey

(540)



(591) Black and red

(511)

9 – Measurement tools, instruments, indicators including the ones for scientific purposes and laboratory-use purposes and materials used in laboratories; apparatus for recording, transmission or reproduction of sound and images including apparatus and computer peripheral equipments for data processing, communication and reproduction; magnetic and optical data carriers and computer programs and software recorded on them, electronic publications which can be downloaded via computer networks and can be recorded on magnetic and optical mediums, cards with magnetic/optical reader; antennas, satellite antennas, amplifiers and parts thereof; ticket dispensers, ATMs; electronic components used at machines and equipments; meters and timers to get consuming amount for a specific period of time; protective clothes, protecting and life saving equipments including ear plugs for divers; glasses, sunglasses, contact lenses and their containers, cases, parts and accessories; controlling instruments and tools for conduction, conversion, storage of electrical energy including cables and power sources

used in electricity and electronics; cells, batteries, anodes and cathodes; instruments the main function of which is warning and alarm except for vehicle alarms, electric bells; tools and instruments of signalization, sign notification to be used in traffic; fire extinguishing apparatus and devices including vehicles for fire extinguishing purposes including fire hoses and valves; radar apparatus, sonars, apparatus and devices for the improvement of night sighting; magnets, decorative magnets.

36 – Insurance services; financial and monetary services; real estate broker and advisor services, real estate management services; customs brokerage services.

(260) AM 2014 73782 A

(800) 1172231

(151) 2013 05 07

(731) Takeda Pharmaceutical Company Limited  
1-1, Doshomachi 4-chome, Chuo-ku,  
Osaka-shi Osaka 540-8645, Japan

(540)

**MELYZEM**

(591) Black, white

(511)

5 – Pharmaceutical preparations.

(260) AM 2014 73783 A

(800) 1172233

(151) 2013 05 07

(731) Takeda Pharmaceutical Company Limited  
1-1, Doshomachi 4-chome, Chuo-ku,  
Osaka-shi Osaka 540-8645, Japan

(540)

**LUCONOG**

(591) Black, white

(511) 5 - Pharmaceutical preparations.

(260) AM 2014 73785 A

(800) 1172256

(151) 2013 05 30

(731) HANGZHOU SUPROR TRANSMISSION  
MACHINERY CO., LTD.  
No.10 Nanzhuang Road, Nanyang Town,  
Xiaoshan District, Hangzhou City,  
ZHEJIANG PROVINCE, China

(540)



(591) Black, white

(511)

7 – Transmissions for machines; bearings [parts of machines]; roller bearings; propulsion mechanisms other than for land vehicles; reduction gears other than for land vehicles; universal joints [cardan joints]; shaft couplings [machines]; bearing brackets for machines; belts for machines; vibrators [machines] for industrial use.

(260) AM 2014 73787 A

(800) 1172268

(151) 2013 01 31

(731) ATAKAN GRUP TEKSTİL SANAYİ VE  
TİCARET LİMİTED ŞİRKETİ  
Meşrutiyet Mahallesi Baytar Ahmet Sokak  
No:9, Şişli İstanbul, Turkey

(540)

**dodona**

(591) Black, white

(511)

25 – Clothing, footwear, headgear.

(260) AM 2014 73788 A

(800) 1172284

(151) 2013 04 24

(731) Nacházel, s.r.o.  
Prumyslová 1472/11, CZ-102 19 Praha  
10 - Hostivar, Czech Republic

(540)

**BIKEWORKX**

(591) Black, white

(511)

3 – Cleaning and maintenance preparations for bicycles, polishing, scouring and abrasive preparations for bicycles.

4 – Fuel, lubricants, industrial and motor (engine) oils and greases, in particular grease and lubricating grease for bicycles.

35 – Wholesale and retail services in the field of cleaning and maintenance preparations for bicycles, of industrial oils and greases, lubricants and fuels, online or by mail order; import, export; representation and exclusive representation relating to the aforesaid products, business brokerage for others.

(260) AM 2014 73789 A  
 (800) 1172289  
 (151) 2013 05 21  
 (731) Brandhouse Limited  
 3rd Floor, Windward House, La Route de la  
 Liberation, St Helier, Jersey JE2 3BQ,  
 United Kingdom

(540)

## OLYBET

(591) Black, white

(511)

41 – Education; providing of training, entertainment; sporting and cultural activities; instruction and training related to facilitating access for users to databases for gaming and gambling; instruction and training in relation to communications for providing access to computer networks, local networks and global networks for players; instruction and training for providing access to databases and allowing users to access databases; gambling; arranging and conducting of games, lotteries and betting on the telephone and on the Internet as well as providing and distributing of information related thereto; gambling services provided on-line also via gambling web sites.

(260) AM 2014 73790 A  
 (800) 1172316  
 (151) 2013 07 08  
 (731) Enterprise Holdings, Inc.  
 600 Corporate Park Drive, St. Louis MO  
 63105, USA

(540)



(591) Black, white

(511)

35 – Customer loyalty services and customer club services, for commercial, promotional and/or advertising purposes.

39 – Vehicle rental and leasing services, and reservation services for the rental and leasing of vehicles.

(260) AM 2014 73791 A  
 (800) 1172326  
 (151) 2013 06 21  
 (731) BIOFARMA  
 50 rue Carnot, F-92284 SURESNES CEDEX,  
 France

(540)

## DETRALEX

(591) Black, white

(511)

3 – Cosmetics, in particular gels, ointments, creams, lotions and sprays; dermatological creams (other than for medical use); essential oils.

5 – Pharmaceutical and veterinary products; dermatological preparations for medical use; sanitary products for medical purposes; medicated bath preparations; dietetic food and substances adapted for medical or veterinary use, food for babies; herbal teas; food supplements for humans and animals; plasters, materials for dressings; material for dental fillings and dental impressions; disinfectants; products for destroying vermin; fungicides, herbicides.

10 – Surgical or medical apparatus and instruments; compression stockings, tights and socks; stockings, tights and socks for varicose veins; bandages for compression dressing.

25 – Clothing; underwear; stockings, tights, socks.

(260) AM 2014 73793 A  
 (800) 1172345  
 (151) 2013 07 23  
 (731) JIANGSU DONGCHENG POWER TOOLS  
 CO., LTD.  
 Industrial Park, Tianfen Town, Qidong City,  
 Jiangsu, China

(540)

## Dongcheng

(591) Black, white

(511)

9 – Tool measuring instruments; carpenters' rules; marking gauges for joinery purposes; angle gauges; verniers; micrometer gauges; measuring apparatus, namely, laser levels, surveyors' levels, line lasers, laser rangefinders, laser direction instruments, bevels, levels, distance measuring apparatus, altimeters, clinometers; probes for scientific purposes, namely, wall scanners, metal detectors, laser detectors, laser scanners for inspection; electric wires; electric cables; printed circuits; armatures for use in electrical apparatus; electric switches; electric connectors; plugs, sockets and other electric connecting attachments; protection devices for personal use against accidents, namely, protective helmets, protective masks, safety belts other than for vehicle seats and sports equipments, dust protective goggles and masks, safety goggles, clothing for protection against accidents, irradiation and fire; sound alarms; eyeglasses; electric batteries; electric accumulators; battery chargers; electrically heated socks.

(260) AM 2014 73794 A

(800) 1172358

(151) 2013 07 31

(731) Avon Products, Inc.

World Headquarters, 777 Third Avenue,  
New York, NY 10017, USA

(540)

## LITTLE PINK DRESS

(591) Black, white

(511)

3 – Non-medicated toilet preparations; toiletries; skin care preparations; skin moisturizers; body and beauty care preparations; powders, creams and lotions, all for the face, hands and body; cosmetic suntan preparations; soaps; shower and bath preparations; beauty masks; talcum powder; nail polish; nail polish remover; enamel for nails; false nails; adhesives for cosmetic purposes; cosmetics; eye makeup remover, eye shadow, eye liner, mascara, lipstick, lip liner, lip gloss; make-up foundation; blusher; tissues impregnated with cosmetic lotions; cotton sticks for cosmetic purposes; cotton wool for cosmetic purposes; preparations for cleaning, moisturising, colouring and styling the hair; preparations for cleaning the teeth; shaving and aftershave preparations; perfumes, fragrances, toilet waters, cologne; deodorants for human beings; anti-perspirants for personal use (toiletries); essential oils (cosmetic).

(260) AM 2014 73795 A

(800) 1172359

(151) 2013 07 31

(731) Avon Products, Inc.

World Headquarters, 777 Third Avenue,  
New York, NY 10017, USA

(540)

## INFINITE LIFT

(591) Black, white

(511)

3 – Non-medicated toilet preparations; toiletries; skin care preparations; skin moisturizers; body and beauty care preparations; powders, creams and lotions, all for the face, hands and body; cosmetic suntan preparations; soaps; shower and bath preparations; beauty masks; talcum powder; nail polish; nail polish remover; enamel for nails; false nails; adhesives for cosmetic purposes; cosmetics; eye makeup remover, eye shadow, eye liner, mascara, lipstick, lip liner, lip gloss; make-up foundation; blusher; tissues impregnated with cosmetic lotions; cotton sticks for cosmetic purposes; cotton wool for cosmetic purposes; preparations for cleaning, moisturising, colouring and styling the hair; preparations for cleaning the teeth; shaving and aftershave pre-

parations; perfumes, fragrances, toilet waters, cologne; deodorants for human beings; anti-perspirants for personal use (toiletries); essential oils (cosmetic).

(260) AM 2014 73796 A

(800) 1172421

(151) 2013 02 28

(731) YETIGEL INTERNATIONAL S.A

220, Rue Des 4 Gendarmes D'Ouvéa - Z.I  
Courtine, F-84000 Avignon, France

(540)

## SCARFACE

(591) Black, white

(511)

25 – Clothing, footwear, headgear; non-slipping devices for footwear; motorists' clothing; bathing caps; swimsuits; bath robes; bath sandals; bath slippers; bandanas [neckerchiefs]; headbands [clothing]; stockings; sweat-absorbent stockings; bibs, not of paper; berets; overalls; boas [necklets]; teddies [undergarments]; hosiery; caps; shower caps; boots; half-boots; tips for footwear; suspenders; lace boots; collar protectors; camisoles; underpants (underwear); bathing trunks; skull caps; bodices; hoods [clothing]; hat frames [skeletons]; belts [clothing]; money belts [clothing]; shawls; footmuffs, not electrically heated; sweaters; hats; paper hats [clothing]; headgear; chasubles; socks; bedroom slippers; footwear; football boots; beach shoes; ski boots; footwear for sports; shirts; short-sleeve shirts; tights; collars (clothing); wet suits for water-skiing; slips [undergarments]; combinations [clothing]; ready-to-wear clothing; corselets; corsets; suits; costumes for fancy dress; ear muffs [clothing]; studs for football boots; neckties; breeches for wear; babies' pants; cycling clothing; dress shields; outer clothing; ready-made linings [parts of clothing]; sashes for wear; footwear uppers; shirt yokes; esparto shoes or sandals; fur stoles; detachable collars; fittings of metal for footwear; sock suspenders; scarves; furs [clothing]; gabardines [clothing]; girdles [underwear]; galoshes; ski gloves; gloves [clothing]; vests; spats; wimples; gymnastics shoes; clothing (garments); top hats; raincoats; leggings [leg warmers]; stocking suspenders; garters; jerseys [clothing]; skirts; skorts; petticoats; ascots; layettes (clothing); leggings [trousers]; liveries; singlets; cuffs; muffs [clothing]; maniples; coats; mantillas; sleep masks; mittens; miters [hats]; top coats; trousers; parkas; dressing gowns; pelerines; pelisses; beachwear; shirt fronts; pockets for clothing; pocket squares; ponchos; pullovers; pajamas; dresses; jumper dresses; wooden shoes; sandals; saris; sarongs; soles for footwear; inner soles; underpants; shoes; trouser straps; underwear; sweat-absorbent underwear; bras-

sieres; sports shoes; aprons [clothing]; heelpieces for footwear; heelpieces for stockings; heels; tee-shirts; boot uppers; togas; welts for footwear; knitwear [clothing]; turbans; uniforms; stuff jackets; jackets; fishing vests; clothing for gymnastics; clothing of leather; clothing of imitations of leather; paper clothing; cap peaks; half veils; shirts; leather or imitation leather clothing; belts (clothing); furs (clothing); gloves (clothing); scarves; neckties; hosiery; socks; bedroom slippers; beach, ski or sports footwear; underwear; bathing caps, caps, hats, beach footwear, masquerade costumes, leotards, singlets, t-shirts, money belts; suspenders; footwear, shirts; clothing of leather; scarves, ties, scarves; gloves; raincoats; underclothing and underwear; trousers; jackets and coats.

32 – Beers; mineral and aerated waters and other non-alcoholic beverages; beverages based on fruit and fruit juices; syrups and other preparations for making beverages; non-alcoholic aperitifs; wort for beer; beers; whey beverages; smoothies; effervescent beverage powders; isotonic beverages; preparations for making beverages; non-alcoholic beverages; non-alcoholic honey-based beverages; non-alcoholic aloe vera beverages; non-alcoholic cocktails; seltzer water; waters [beverages]; table waters; aerated waters; preparations for making aerated water; lithia waters; mineral waters [beverages]; preparations for making mineral water; essences for making beverages; non-alcoholic fruit extracts; fruit beverages (non-alcoholic); ginger beer; hop extracts for making beer; fruit juices; apple juices; vegetable juices [beverages]; kvass [non-alcoholic beverage]; milk of almonds [beverage]; peanut milk [non-alcoholic beverage]; lemonades; syrups for lemonade; preparations for making liqueurs; malt beer; malt wort; must; fruit nectars; orgeat; pastilles for effervescent beverages; grape wort; sarsaparilla [non-alcoholic beverage]; syrups for beverages; soda water; sherbets [beverages]; tomato juice (beverages); fruit juices and fruit-based beverages, frozen or for freezing; beverages with water and syrup, or fruit, or with other ingredients, packaged in flexible bags having the form of a liquid marketed lollipop that the consumer freezes prior to consumption; lemonades; fruit nectars; soda water; aperitifs, non-alcoholic, energy drinks with caffeine, guarana, taurine, glucuronolactone, gingseng; isotonic beverages; energy drinks; fruit nectars, soft drinks, smoothies (mixed fruit or vegetable beverages), sorbets (beverages), tomato juice (beverages); non-alcoholic honey beverages; preparations for making liqueurs; whey beverages; vegetable juices [beverages]; ginger beer; essences for making beverages, non-alcoholic fruit extracts.

(260) AM 2014 73797 A  
(800) 1172394  
(151) 2012 09 07  
(731) ALMERA ELEKTRİK VE ELEKTRONİK  
ÜRÜNLERİ İMALAT SANAYİ TİCARET  
LİMİTED SİRKETİ  
İSTOÇ Töptancılar Çarstst, 9. Ada.  
No: 82/84, Bağçılar - İstanbul, Turkey  
(540)



(591) Green, blue  
(511)  
9 – Apparatus and instruments used for measurement for scientific purposes and used in laboratory, apparatus for recording, transmission or reproduction of sound and images including data processing apparatus, communication devices, computer software and hardware; magnetic and optical data media and exposed camera films; antennas, satellite antennas, amplifiers and parts thereof; ticket automates, cash machines; electronic devices used in machines and devices, electronic semi-conductors, electronic integrated circuits, electronic chips; electric meters, water meters, gas meters, counters and timers used for measuring the consumption in a unit of time; protective clothing, life saving and protecting equipments; apparatus and instruments for transmitting, converting and storing electrical energy including cables and power supplies used in electric and electronic; electric door bells, alarms other than vehicle alarms; traffic signalization equipments; fire-extinguishing apparatus; including radars, submarine radars (sonars), night vision providing and increasing devices and apparatus, namely, night vision goggles; apparatus and machines for electrolysis and galvanization, anodes, cathodes; magnets, decorative magnets.

(260) AM 2014 73798 A  
(800) 1172463  
(151) 2013 07 08  
(731) Monsieur SCHILLER Henri, Numa, Marcel  
6 Avenue Emile Deschanel, F-75007 Paris,  
France  
(540)

## ENDOMETHASONE

(591) Black, white  
(511)  
5 – Pharmaceutical, dental, veterinary and sanitary products, cloths and materials for dressings, materials for dental fillings and dental impressions, disinfectants.

(260) AM 2014 73799 A  
 (800) 1172468  
 (151) 2013 07 09  
 (891)  
 (731) "KYKNOS" GREEK CANNING  
 COMPANY S.A.  
 Sidiras Merarchias 15, GR-211  
 00 NAFPLION, Greece

(540)



(591) Black, white  
 (511)  
 29 - Meat, fish, poultry and game; meat extracts; preserved, frozen, dried and cooked fruits and vegetables; jellies, jams, compotes; eggs, milk and milk products; edible oils and fats.

30 - Coffee, tea, cocoa, sugar, rice, tapioca, sago, artificial coffee; flour and preparations made from cereals, bread, pastry and confectionery, ices; honey, treacle; yeast, baking-powder; salt, mustard; vinegar, sauces (condiments); spices; ice.

31 - Agricultural, horticultural and forestry products and grains not included in other classes; live animals; fresh fruits and vegetables; seeds, natural plants and flowers; foodstuffs for animals, malt.

32 - Beers; mineral and aerated waters and other non-alcoholic drinks; fruit drinks and fruit juices; syrups and other preparations for making beverages.

(260) AM 2014 73800 A  
 (800) 1172474  
 (151) 2013 07 24  
 (731) Igor Moiseyev State academic ensemble of popular dance  
 ul. Tverskaya, 31/4 build. 1, RU-125009  
 Moscow, Russian Federation

(540)



(591) Black, white  
 (511)  
 9 - Audio and video cassettes with recordings; magnetic and optical disks, including DVD with recordings.

16 - Printed materials; teaching materials and visual aids (except equipment).

25 - Clothing; footwear; headgear.

41 - Booking of seats for shows; videotaping; education information; entertainment information; videotape editing; music-halls; organization of balls; organization of exhibitions for cultural or educational purposes; providing recreation facilities; arranging and conducting of workshops (training); organization of competitions (education or entertainment); organization of shows (impresario services); presentation of live performances; videotape film production; rental of videotapes; entertainment; production of shows.

(260) AM 2014 73801 A  
 (800) 1172492  
 (151) 2013 08 09  
 (731) Millennium Pharmaceuticals, Inc.  
 40 Landsdowne Street, Cambridge, MA  
 02139, USA

(540)

**IPLARO**

(591) Black, white  
 (511)  
 5 - Pharmaceutical preparations for human use, namely, for the treatment of hematological malignancies, cancer, auto-immune diseases and disorders and inflammatory diseases and disorders; pharmaceutical preparations for the treatment of cancer.

(260) AM 2014 73802 A  
 (800) 1172493  
 (151) 2013 08 09  
 (731) Millennium Pharmaceuticals, Inc.  
 40 Landsdowne Street, Cambridge,  
 MA 02139, USA

(540)

**NELTEO**

(591) Black, white  
 (511)  
 5 - Pharmaceutical preparations for human use, namely, for the treatment of hematological malignancies, cancer, auto-immune diseases and disorders and inflammatory diseases and disorders; pharmaceutical preparations for the treatment of cancer.

(260) AM 2014 73803 A

(800) 1172494

(151) 2013 08 09

(731) Millennium Pharmaceuticals, Inc.  
40 Landsdowne Street, Cambridge,  
MA 02139, USA

(540)

**NINLARO**

(591) Black, white

(511)

5 – Pharmaceutical preparations for human use, namely, for the treatment of hematological malignancies, cancer, auto-immune diseases and disorders and inflammatory diseases and disorders; pharmaceutical preparations for the treatment of cancer.

(260) AM 2014 73998 A

(800) 1173649

(151) 2012 11 28

(891)

(731) BEIJING XIAOMI TECHNOLOGY CO.,  
LTD.  
2nd Floor, No. 2, Yong Jie North Road,  
Haidian District, Beijing, China

(540)

**MI**

(591) Black, white

(511)

9 – Computer memories; recorded computer programmes; computer keyboards; recorded computer operating programs; computer peripheral devices, recorded computer software; recorded computer software; monitors; mouse; compact discs; printers for use with computers, central processing units; data processing equipment namely readers; scanners; notebook computers; calculators, electronic publications; downloadable software, namely computer programs; mouse pads; wrist rests for use with computers; computer game programs; downloadable mobile phone ringtones, downloadable music files; downloadable image files; universal serial bus flash disks; portable computers; galvanic cells; photocopiers, photographic, electrostatic and thermic, battery chargers; chargers for electric batteries; telephone apparatus; video telephones; portable telephones; mobile phone straps; GPS apparatus; hands free kits for phones; loudspeakers; cabinets for loudspeakers; microphones; television apparatus; compact discs; camcorders; headsets, headphones; DVD players; portable media players; cameras;

stereoscopes; telescopes; wafers; integrated circuits, sunglasses; counters; scales; animated cartoons.

35 – Public relations; economic forecasting; business management of hotels; price comparison services; rental of vending machines; shorthand; advertising; commercial administration of the licensing of the goods and services of others; sales promotion for others; marketing and promotion services; dissemination of advertising matter; demonstration of goods; direct mail advertising; distribution of samples; business investigations; organization of trade fairs for commercial or advertising purposes; layout services for advertising purposes; radio advertising, on-line advertising on a computer network; commercial information and advice for consumers, outsourcing services, television commercials; advertising agencies.

38 – Communications by fiber optic networks; delivery and transmission of greeting cards on-line, transmission of digital documents; radio broadcasting; telephone services; communications by telephone; cellular telephone communication, communications by computer terminals; information about telecommunication.

42 – Graphic arts designing; cloud seeding, digitization of documents, namely scanning; computer system remote monitoring; technical research; computer rental; computer programming; computer software design; updating of computer software; rental of computer software; maintenance of computer software, computer systems analysis; computer system design; installation of computer software; industrial design; packaging design services; conversion of data or documents from physical to electronic media; research and development for others.

(260) AM 2014 74285 A

(800) 1176424

(151) 2013 06 25

(731) Open Joint Stock Company "BELAZ" –  
Management Company of Holding "BELAZ-  
HOLDING"  
40 let Oktyabrya str. 4, 222160 Zhodino,  
Belarus

(540)

**BELAZ**

(591) Black, white

(511)

4 – Fuel; additives, non-chemical, to motor-fuel; cutting fluids; industrial grease; mazut; combustible oil; lubricating oil; industrial oil; motor oil; lubricants; non-slipping preparations for belts; lub-



ricating grease; grease for belts; diesel oil; fuel with an alcoholic base.

(260) AM 2014 74286 A

(800) 1176428

(151) 2013 08 20

(731) TELA BIO, Inc.

1 Great Valley Parkway, Suite 24, Malvern  
PA 19355, USA

(540)

**TELA**

(591) Black, white

(511)

10 – Natural and biocompatible materials comprised of non-living tissue for implantation or application in a surgical site to restore, repair, or treat organ, tissue, and body structures.

(260) AM 2014 74289 A

(800) 1176529

(151) 2013 07 25

(731) PRIVATE JOINT STOCK COMPANY

"INDUSTRIAL ASSOCIATION "KONTI"

Bul. Shevchenko, 6-b, Donetsk 83015,  
Ukraine

(540)

**Сеня**

(591) Black, white

(511)

30 – Coffee, tea, cocoa and artificial coffee; rice; tapioca and sago; flour and preparations made from cereals; bread, pastry and confectionery; ice cream; sugar, honey, treacle; yeast, baking-powder; salt; mustard; vinegar, sauces (condiments); spices; ice; peanut confectionery; high-protein cereal bars; biscuits; farinaceous foods; bakery confectionery products; bread rolls; bread rolls with fillings; waffles; waffle cakes; pasties; products of puff pastry stuffed; glazed and unglazed candies; candied roasted nuts; candied roasted nuts candies; desserts (confectionery); dragee (confectionery); fruit and berry jellies (confectionery); jellied confectionery; jelly candies; frozen kefir and yogurt (frozen confectionery); frozen bakery semi-finished products; marshmallow; marshmallow covered with chocolate; cacao and coffee beverages; coffee beverages with milk; cacao with milk; cacao products; caramels (candies); lozenges (confectionery); cakes; brittle; sugar confectionery; crackers; food starch; croissants; confectionery for decorating Christmas trees;

liquorice (confectionery); candy for food; marzipan; marzipan candies; almond confectionery; dessert mousses (confectionery); chocolate dessert mousses (confectionery); peppermint sweets; chocolate beverages; candy sets; paskha (Easter cake); pastilles; cookies; cookies covered with chocolate; pies (confectionery); quiches; fondants (confectionery); praline; gingerbread; gingerbread covered with chocolate; gingerbread covered with various fillings; puddings; Turkish delight; rice cakes; pastries; crescent rolls; rolls with various fillings (bakery confectionery products); sweets; dessert sauces; souffle (confectionery); chocolate soufflé (confectionery); souffle candies; souffle and jelly candies; tartlet; tarts; petits fours (cakes); chocolate pastries; cakes; fruit, citrus and berry ice; halvah; bakery products; candies; filled candies; waffle candies; toffee candies; chocolate; chocolate desserts; chocolate dragee with raisins or nuts; chocolate paste; chocolate candies; chocolate sticks; chocolate beverages with milk; chocolate figurines.

(260) AM 2014 74293 A

(800) 1176588

(151) 2013 01 22

(731) Rexam Plc

4 Millbank, London SW1P 3XR,  
United Kingdom

(540)

**РЕКСАМ**

(591) Black, white

(511)

6 – Common metals and their alloys; containers of metal; cans of metal; pallets of metal; metal bottles; bottle caps; bottle closures; bottle seals; bottle fasteners; bottles of metal; capsules of metal for bottles; closures and seals of metal for containers, bottles, jars and cans; sheets of aluminium or other metals for the manufacture of containers; foils of metal for wrapping and packaging; metal ends and closures for attachment to cans and other containers; dispensers of metal; pumps of metal for attachment to aerosol cans and other containers; devices of metal for attachment to containers for dispensing the contents of those containers; lids and closures of metal; parts and fittings for all the aforesaid goods.

10 – Surgical, medical, dental and veterinary apparatus and instruments; orthopaedic articles; suture materials; inhalers; metering valves for inhalers; injectors for medical purposes; syringes for injections; syringes for medical or veterinary use; safety devices for medical syringes; nasal, buccal and auricular applicators, valves and pumps; nasal sprays; medical devices; diagnostic disposables for medical

use; infusion pumps; insulin pens; pump systems for spraying medications; eye droppers; dropper bottles for medical purposes; dermal pumps; dermal valves; medicine applicators; receptacles for applying medicines; contraceptive devices to deposit uterine implants; plastic and non-metal dispensers for medical purposes; containers for medical and healthcare purposes; dispensers, namely pumps, tubes, sprayers, nozzles for medical and healthcare purposes; non-metallic dispensers for medical, surgical, pharmaceutical and healthcare purposes and products; parts and fittings for all the aforesaid goods.

20 – Plastic containers; plastic containers for packaging; seals, lids and closures not of metal for containers; non-metallic containers and closures not of metal for containers; plastic and non-metal dispensers; plastic and non-metal pumps for attachment to containers; plastic and non-metal devices for attachment to containers for dispensing the contents of those containers; containers, lids and container closures for medical, surgical, pharmaceutical and healthcare purposes and products; plastic cans; non-metal closures for cans, bottles and jars; corks for bottles and other containers; pallets (not of metal); sealing caps and other devices for sealing; non-metallic lids and closures for containers, bottles and jars; closures for containers for medical and healthcare purposes; parts and fittings for all the aforesaid goods.

42 – Design services; packaging design; container, bottle and can design; information, advisory and consultancy services relating to the aforesaid services.

(260) AM 2014 74308 A  
(800) 1176687  
(151) 2013 04 03  
(731) ROTAPHARM İLAÇLARI LİMİTED  
ŞİRKETİ  
Evren Mah. Camiyolu, Cad. No. 50 K.2,  
GÜNEŞLİ BAĞCILAR İSTANBUL, Turkey

(540)

**Brikeza**  
**Брикеза**

(591) Black, white  
(511)

5 – Medicines for human purposes, medicines for veterinary purposes, chemical preparations for medical purposes, dietetic substances adapted for medical use; dietetic foods adapted for medical purposes; aminoacids for medical purposes, nutria-

tional supplements, pollen dietary substances, mineral food supplements, protein dietary supplements, baby foods, medicinal herbs, herbal beverages adapted for medical purposes; medicines for dental purposes, hygienic products for medical purposes including pads, waddings for medical purposes, plasters for medical purposes, dressings for medical purposes; preparations for destroying noxious plants, preparations for destroying noxious animals, fungicides; deodorants other than for human beings or for animals; disinfectants for hygiene purposes, anti-septics, detergents for medical purposes.

(260) AM 2014 74309 A  
(800) 1176705  
(151) 2013 07 03  
(731) Dongguan HHS Heavy Duty Packaging  
Co.,Ltd.  
No.12-A Pusha South Road, Tangxia Town,  
Dongguan City, Guangdong Province, China

(540)

**HHS**

(591) Black, white  
(511)

16 – Wood pulp paper, advertisement boards of paper or cardboard, cardboard articles, white paperboard, paperboard boxes, brown paperboard, waterproof paperboard, fluting paper, paper for packaging, paper boxes.

(260) AM 2014 74424 A  
(800) 1177684  
(151) 2013 08 05  
(731) Pryvatne aktsionerne tovarystvo "Chumak"  
vul. Kozatska, 3, m. Kakhovka, Khersonska  
obl. 74800, Ukraine

(540)

**ФРУЗИ**

(591) Black, white  
(511)

5 – Lacteal flour for babies; food for babies.

29 – Jams; cream (dairy products); yoghurt; kefir (milk beverage); curd; milk shakes; koumiss (koumiss) (milk beverage); margarine; butter; buttercream; milk beverages, milk predominating; milk and milk products; whey; cheese; soya milk (milk substitute); tofu; fruit puree; fruit, stewed; milk ferments for culinary purposes; low-fat potato chips;

fruit chips; vegetable juices for cooking; vegetable puree; whipped cream.

32 – Non-alcoholic beverages; non-alcoholic honey-based beverages; non-alcoholic fruit extracts; fruit beverages and fruit juices; syrups and other preparations for making beverages; vegetable juices (beverages); fruit nectars, non-alcoholic; smoothies; sherbets (beverages).

33 – Alcoholic beverages, except beers.

---

(260) AM 2014 74431 A

(800) 1067110

(151) 2011 01 04

(891) 2013 08 08

(731) Bestway Inflatables & Material Corp.

3065 Cao An Road, 201812 Shanghai, China

(540)

# Bestway

(591) Black, white

(511)

12 – Inflatable dinghies; rubber boats; canoes; inflatable water scooter; rudders; air pumps.

20 – Inflatable objects in PVC materials, namely: inflatable publicity objects, inflatable sofas and beds, inflatable armchairs and poufs, air mattresses, photo frames; sleeping bags; beds for camping.

28 – Inflatable toys and pleasure facilities in PVC materials, namely: puppets, animals, fishes, birds, trains, planes, utensils; pools; balls; armbands for swimming; ring floats; swimming fins; jet skis; ride-on in the shape on animals and fishes; floating mattresses, armchairs, seats; volley ball frames; jumping tubes and castles; soccer frames; playing houses.

---

(260) AM 2014 74441 A

(800) 1177736

(151) 2013 08 28

(731) CHATEAU CANON

Chateau Canon, F-33330 Saint-Emilion,  
France

(540)

# CROIX CANON

(591) Black, white

(511)

33 – Wines.

---

(260) AM 2014 74444 A

(800) 1177785

(151) 2013 06 22

(731) Zhejiang Aulmo Industrial Co., LTD.

No. 99, Dingxiang Road, Binhaiyuanqu,  
Wenzhou Economic and Technological,  
Development Zone, Zhejiang, China

(540)

# AULMO

(591) Black, white

(511)

9 – Lighting ballasts; time switches, automatic; materials for electricity mains [wires, cables]; switches, electric; junction boxes [electricity]; light regulators [dimmers] [electric]; control panels [electricity]; plugs, sockets and other contacts [electric connections]; low voltage power supply; high & low voltage switchboard.

---

(260) AM 2014 74446 A

(800) 1177823

(151) 2013 04 30

(731) Schaper & Brümmer GmbH & Co. KG

Bahnhofstrasse 35, 38259 Salzgitter, Germany

(540)

# ЦИСТИНОЛ

(591) Black, white

(511)

5 – Pharmaceutical, veterinary and sanitary preparations; hygienic preparations for medical purposes as far as included in this class; dietetic products and substances adapted for medical use; disinfectants; food supplements and nutritional additives for medical purposes; dietetic products and substances for non-medical purposes, mainly consisting of vitamins, vitamin derivatives, enzymes, amino acids, amino acids derivatives, mineral substances and/or trace elements; food supplements and nutritional additives for non-medical purposes, mainly consisting of vitamins, vitamin derivatives, enzymes, amino acids, amino acids derivatives, mineral substances and/or trace elements; food for babies; air deodorising preparations and air purifying preparations for medical purposes, as far as included in this class; mud for baths, oxygen baths, bath salts and bath preparations for medical and therapeutic purposes, as far as included in this class; medicinal teas, herbs teas for medical purposes, slimming tea for medical purposes; sunburn preparations for medical purposes, as far as included in this class; food supplements and nutritional additives for non-medical purposes, mainly consisting of proteins and fats; food supplements and nutritional additives for non-medical purposes, mainly consisting of carbonic hydrates.

29 – Products and substances for non-medical purposes, mainly consisting of protein and/or fats.

30 – Products and substances for non-medical purposes, mainly consisting of sugar; flavourings for beverages other than essential oils and essences for foodstuffs except etheric essences and essential oils.

(260) AM 2014 74448 A

(800) 1177832

(151) 2013 06 13

(731) HONDA MOTOR CO., LTD.

1-1, Minami-Aoyama 2-chome, Minato-ku,  
Tokyo 107-8556, Japan

(540)

## VEZEL

(591) Black, white

(511)

12 – Automobiles and their parts and fittings; vessels and their parts and fittings; aircraft and their parts and fittings; two-wheeled motor vehicles and their parts and fittings; bicycles and their parts and fittings; non-electric prime movers for land vehicles (not including "their parts"), namely, gasoline engines for land vehicles, diesel engines for land vehicles, kerosene engines for land vehicles, steam engines for land vehicles, turbojet engines for land vehicles, turboprop engines for land vehicles, ramjet engines for land vehicles, turbines for land vehicles; mechanical elements for land vehicles, namely, transmission shafts, axles or spindles for land vehicles, bearings for land vehicles, shaft couplings or connectors for land vehicles, power transmissions and gearings for land vehicles, shock absorbers for land vehicles, springs for land vehicles, brakes for land vehicles.

(260) AM 2014 74451 A

(800) 1177919

(151) 2013 08 05

(731) Pryvatne aktsionerne tovarystvo "Chumak"  
vul. Kozatska, 3, m. Kakhovka, Khersonska  
obl. 74800, Ukraine

(540)

## FRUZI

(591) Black, white

(511)

5 – Lactal flour for babies; food for babies.

29 – Jams; cream (dairy products); yoghurt; kefir (milk beverage); curd; milk shakes; koumiss (kumiss) (milk beverage); margarine; butter; buttercream; milk beverages, milk predominating; milk and milk products; whey; cheese; soya milk (milk

substitute); tofu; fruit puree; fruit, stewed; milk ferments for culinary purposes; low-fat potato chips; fruit chips; vegetable juices for cooking; vegetable puree; whipped cream.

32 - Non-alcoholic beverages; non-alcoholic honey-based beverages; non-alcoholic fruit extracts; fruit beverages and fruit juices; syrups and other preparations for making beverages; vegetable juices (beverages); fruit nectars, non-alcoholic; smoothies; sherbets (beverages).

33 - Alcoholic beverages (except beers).

(260) AM 2014 74457 A

(800) 1178007

(151) 2013 02 22

(891)

(731) Open-Type Joint Stock Company "Krasnyj  
Oktyabr"

ul. Malaya Krasnoselskaya, d. 7, RU-107140  
Moscow, Russian Federation

(540)

## Korovka for a green break

(591) Black, white

(511)

30 – Aromatic preparations for food; flavorings [flavourings], other than essential oils, for cakes; flavorings [flavourings], other than essential oils, for beverages; coffee flavorings [flavourings]; flavorrings, other than essential oils; star aniseed; high-protein cereal bars; pancakes; noodle-based prepared meals; buns; bread rolls; vanillin [vanilla substitute]; vanilla [flavoring] [flavouring]; vermicelli [noodles]; natural sweeteners; sausage binding materials; binding agents for ice cream [edible ices]; sea water for cooking; seaweed [condiment]; malt biscuits; cloves [spice]; mustard; gluten additives for culinary purposes; yeast; thickening agents for cooking foodstuffs; leaven; artificial coffee; vegetal preparations for use as coffee substitutes; dressings for salad; fruit jellies [confectionery]; confectionery for decorating christmas trees; cakes; peanut confectionery; almond confectionery; pastries; ginger [spice]; frozen yogurt [confectionery ices]; cocoa; capers; caramels; curry [spice]; gruel, with a milk base, for food; ketchup [sauce]; quiches; gluten prepared as foodstuff; sweetmeats; liquorice [confectionery]; peppermint sweets; cinnamon [spice]; coffee; unroasted coffee; starch for food; crackers; custard; corn, milled; corn, roasted; meat pies; turmeric for food; couscous [semolina]; farinaceous foods; noodles; ice for refreshment; ice, natural or artificial; edible ices; rice cakes; mayonnaise; ma-

caroons [pastry]; macaroni; maltose; hominy; marinades; marzipan; honey; royal jelly; ice cream; dessert mousses [confectionery]; chocolate mousses; muesli; mint for confectionery; cocoa beverages with milk; coffee beverages with milk; coffee-based beverages; tea-based beverages; chocolate beverages with milk; chocolate-based beverages; cocoa-based beverages; infusions, not medicinal; crushed oats; husked oats; nutmegs; stick liquorice [confectionery]; soya bean paste [condiment]; pastilles [confectionery]; molasses for food; pepper; peppers [seasonings]; pesto [sauce]; biscuits; petit-beurre biscuits; pies; pizzas; meat gravies; fondants [confectionery]; popcorn; powders for ice cream; baking powder; mustard meal; pralines; condiments; meat tenderizers, for household purposes; cereal preparations; flour-milling products; oat-based food; propolis; gingerbread; spices; petits fours [cakes]; puddings; cake powder; fruit coulis [sauces]; ravioli; chewing gum; relish [condiment]; rice; wheat germ for human consumption; spring rolls; sago; sugar; aniseed; linseed for human consumption; cake paste; baking soda [bicarbonate of soda for cooking purposes]; malt for human consumption; salt for preserving foodstuffs; cooking salt; celery salt; sorbets [ices]; ham glaze; soya sauce; tomato sauce; sauces [condiments]; spaghetti; seasonings; preparations for stiffening whipped cream; rusks; bread-crumbs; sushi; sandwiches; tabbouleh; tacos; tapioca; tarts; almond paste; tortillas; garden herbs, preserved [seasonings]; vinegar; beer vinegar; ferments for pastes; halvah; bread; unleavened bread; chips [cereal products]; corn flakes; oat flakes; chicory [coffee substitute]; tea; iced tea; chutneys [condiments]; cheeseburgers [sandwiches]; chow-chow [condiment]; saffron [seasoning]; chocolate; malt extract for food; essences for foodstuffs, except etheric essences and essential oils; husked barley; cheese-flavored corn snacks; waffles; cake frosting [icing]; rice-based snack food; cereal-based snack food; pasta; groats for human food; allspice; golden syrup; cream of tartar for culinary purposes.

(260) AM 2014 74615 A

(800) 918102

(151) 2006 11 10

(891) 2013 08 27

(731) Telefonaktiebolaget L M Ericsson

Torshammsgatan 23, Kista, Sweden

(540)

**ERICSSON**

(591) Black, white

(511)

9 – Apparatus and instruments for data communication, satellite communication and telecommunication; apparatus and instruments for weighing,

measuring, signalling, checking (supervision) and teaching; apparatus for recording, transmission or reproduction of sound, images or light; data carriers, data processing equipment, computers, computer programs, peripheral equipment; optical apparatus and instruments; apparatus and instruments for monitoring for telecommunication networks and data communication networks; installation apparatus and instruments for data communication networks and telecommunication networks; batteries; electronic components; electrical and optical cables, electrical wires; base stations; radar equipment, ciphering equipment, crypto-aid equipment, display equipment, scanner equipment; aerials; parts and fittings for all the aforesaid goods.

11 – Apparatus for heating, refrigerating and ventilating.

16 – Printed matter, namely stationery, instructional and teaching material (except apparatus), periodicals, manuals, brochures, business cards, paper, cardboard and goods made from these materials, not included in other classes; bookbinding material; photographs.

35 – Advertising; business management; business administration; office functions.

36 – Leasing.

37 – Installation, maintenance and repair of telecommunication apparatus.

38 – Telecommunication services.

41 – Education within the data communication area, satellite communication area and telecommunication area; providing of training, conferences, seminars, congresses, correspondence courses; providing databases and directories in the fields of music, video, radio, television, news, sports, games, cultural events, entertainment and arts and leisure via communications networks; providing information, audio, video, graphics, text and other multimedia content in the fields of music, video, radio, television, news, sports, games, cultural events, entertainment and arts and leisure via communications networks.

42 – Consultancy services within the data communication area, satellite communication area and telecommunication area; basic research within physics, chemistry and engineering; services relating to data communication technique and satellite communication technique; computer programming, leasing of data processing equipment; customer services, namely technical analysis and consultation, computer diagnostic services, remote and/or on-site monitoring of computer systems, all in the field of data communication area, satellit

(260) AM 2014 74617 A  
 (800) 973254  
 (151) 2008 06 06  
 (891) 2012 09 06  
 (731) Tovarystvo z obmejenouy vidpovidalnostiou  
 "Ukrayinski Djerela"  
 rue Sortouvalna, 20, Kyiv 02081, Ukraine  
 (540)

*Peritkoff*

(591) Black, white  
 (511)

16 – Fountain pens; address stamps; aquarelles; albums; almanacs; architect's models; atlases; forms (printed); drawing pads; writing pads; pamphlets; booklets; signboards of paper or cardboard; printed publications; flags of paper; embroidery designs (patterns); tear-off calendars; viscose sheets for wrapping; greeting cards; newspapers; geographical maps; hygienic paper; terrestrial globes; flowerpot covers of paper; engravings; graphic representations; graphic prints; bibs of paper; babies' napkin-pants (diaper-pants) of paper and cellulose (disposable); babies' napkins of paper and cellulose (disposable); document laminators for office use; document files (stationery); clipboards; printed matter; printers' blankets, not of textile; printing blocks; printing type; printed publications; prints (engravings); labels, not of textile; magazines (periodicals); bookmarks; sealing machines for offices; sealing compounds for stationery purposes; note books; pads (stationery); drawing pads; writing or drawing books; newsletters; calendars; tracing paper; office requisites, except furniture; office perforators; stationery; cards; charts; paintings (pictures) framed or unframed; pictures; cardboard; wood pulp board (stationery); cardboard articles; catalogues; tickets; adhesives (glues) for stationery or household purposes; gums (adhesives) for stationery or household purposes; self-adhesive tapes for stationery or household purposes; books; comic books; envelopes (stationery); copying paper (stationery); boxes of cardboard or paper; drawing instruments; conical paper bags; document laminators for office use; adhesive bands for stationery or household purposes; sheets of reclaimed cellulose for wrapping; modeling materials; lithographs; lithographic works of art; pictures; decalcomanias; bags for microwave cooking; bags (envelopes, pouches) of paper or plastics for packaging; garbage bags of paper or plastics; duplicators; mimeograph apparatus and machines; musical greeting cards; waxed paper; teaching materials (except apparatus); stickers (stationery); handkerchiefs of paper; numbering apparatus; wrappers (stationery); wrapping paper; covers (stationery); passport holders; pencils; pencil lead

holders; packing paper; bookbinding material; etchings; packaging material made of starch; palettes for painters; paper bows; paper ribbons; paper clasps; paper knives (cutters) (office requisites); paper; paper sheets (stationery); paper for recording machines; wood pulp paper; folders for papers; parchment paper; periodicals; seals (stamps); stamp pads; writing materials; writing instruments; manuals (handbooks); stands for pens and pencils; photograph stands; coasters of paper; mats for beer glasses; place mats of paper; song books; posters; plans; plastic cling film, extensible, for palletization; plastic film wrapping; bottle wrappers of cardboard or paper; bottle envelopes of cardboard or paper; paper shredders (for office use); indexes; portraits; postcards; gummed cloth for stationery purposes; prospectuses; ledgers (books); graphic reproductions; hand labeling appliances; towels of paper; luminous paper; face towels of paper; napkins of paper for removing make-up; table napkins of paper; table cloth of paper; loose-leaf binders; paper clips; silver paper; table linen of paper; table napkins of paper; paper ribbons; letter trays; folders for papers; transparencies (stationery); stencils; stencils' plates; toilet paper; figurines (statuettes) of papier-mâché; paper coffee filters; filter paper; filtering materials (paper); school supplies (stationery).

(260) AM 2014 74618 A  
 (800) 1014935  
 (151) 2009 07 08  
 (891) 2013 09 25  
 (731) Limited Liability Company "Kernel-Capital"  
 16 Nemyrovych-Danchenko Str., Kyiv 01133,  
 Ukraine  
 (540)

**KERNEL**

(591) Black, white  
 (511)

29 – Vegetable oils for food; sunflower oil for food.

30 – Flour for food; cereal preparations; bread; salt; mustard; vinegar; sauces in the nature of condiments; condiments; spices; seasonings; ketchup; muesli; pepper; gruel, with a milk base, for food; chips (cereal products).

35 – Advertising; business management; business administration; cost price analysis; accounting; marketing studies; organization of exhibitions for commercial or advertising purposes; business appraisals; demonstration of goods; business information; business inquiries; import-export agencies; export of a variety of goods, namely export of grain and cereal products, sunflower seeds, sunflower oil, oil cake; import of agricultural equipment, plant-

protecting agents, fertilizers, grain and cereal products, sunflower oil; marketing and consultancy; procurement services for others in the nature of purchasing goods and services for other businesses; dissemination of samples; on-line advertising on a computer network; sales promotion for others; the bringing together, for the benefit of others, of a variety of food and non-food products, enabling customers to conveniently view and purchase those goods at retail stores and wholesale outlets; purchasing of agricultural products, grain, cereal products, sunflower seeds for others; assistance in choosing and acquisition of various food and non-food products at retail stores and wholesale outlets; providing business information about various food and non-food products, as well as the services rendered, on the Internet, on web-sites and on web pages that allow customers to inspect and to buy those goods from web-sites and web pages and to get necessary information about these goods and services.

---

(260) AM 2014 74620 A

(800) 1055257

(151) 2010 08 11

(891) 2013 09 10

(731) Vitamin Well AB

Box 2207, SE-104 22 Stockhol, Sweden

(540)

## **VITAMIN WELL**

(591) Black, white

(511)

25 – Clothing, footwear, headgear.

30 – Nutritive preparations made of grain; chocolate.

32 – Mineral and aerated waters and other non-alcoholic drinks.

---

(260) AM 2014 74625 A

(800) 1171168

(151) 2013 06 26

(891) 2013 08 09

(731) JT International S.A.

1, Rue de la Gabelle, CH-1211 Genève 26,  
Switzerland

(540)

## **ALERT**

(591) Black, white

(511)

34 – Raw or manufactured tobacco and manufactured tobacco capsules.

---

---

**INTERNATIONAL TRADEMARKS PROTECTED IN GEORGIA**

(260) AM 2014 72198 A  
(800) 1156364  
(151) 2013 03 25  
(181) 2023 03 25  
(511) 05

---

(260) AM 2014 72208 A  
(800) 1156463  
(151) 2012 10 31  
(181) 2022 10 31  
(511) 09, 10, 11, 35, 37, 42

---

(260) AM 2014 72199 A  
(800) 1156365  
(151) 2013 03 25  
(181) 2023 03 25  
(511) 05

---

(260) AM 2014 72210 A  
(800) 1156472  
(151) 2013 01 15  
(181) 2023 01 15  
(511) 29, 30

---

(260) AM 2014 72200 A  
(800) 1156373  
(151) 2013 03 05  
(181) 2023 03 05  
(511) 09, 35, 37, 38, 39, 42

---

(260) AM 2014 72213 A  
(800) 1156518  
(151) 2013 03 04  
(181) 2023 03 04  
(511) 01

---

(260) AM 2014 72201 A  
(800) 1156380  
(151) 2013 03 21  
(181) 2023 03 21  
(511) 05

---

(260) AM 2014 72214 A  
(800) 1156525  
(151) 2013 03 05  
(181) 2023 03 05  
(511) 09

---

(260) AM 2014 72202 A  
(800) 1156391  
(151) 2013 03 13  
(181) 2023 03 13  
(511) 36

---

(260) AM 2014 72215 A  
(800) 1156543  
(151) 2013 03 06  
(181) 2023 03 06  
(511) 05

---

(260) AM 2014 72205 A  
(800) 1156424  
(151) 2012 09 25  
(181) 2022 09 25  
(511) 05

---

(260) AM 2014 72221 A  
(800) 1156595  
(151) 2013 03 14  
(181) 2023 03 14  
(511) 05, 29

---

(260) AM 2014 72206 A  
(800) 1156431  
(151) 2013 03 26  
(181) 2023 03 26  
(511) 09

---

(260) AM 2014 72222 A  
(800) 1156596  
(151) 2013 03 14  
(181) 2023 03 14  
(511) 29, 30

---

(260) AM 2014 72207 A  
(800) 1156459  
(151) 2012 10 31  
(181) 2022 10 31  
(511) 09, 10, 11, 35, 37, 42

---

(260) AM 2014 72225 A  
(800) 1156632  
(151) 2013 03 14  
(181) 2023 03 14  
(511) 04, 35

---



(260) AM 2014 72226 A  
(800) 1156641  
(151) 2013 03 18  
(181) 2023 03 18  
(511) 20, 35

---

(260) AM 2014 72229 A  
(800) 1156648  
(151) 2012 11 07  
(181) 2022 11 07  
(511) 09, 14

---

(260) AM 2014 72230 A  
(800) 1156652  
(151) 2013 02 14  
(181) 2023 02 14  
(511) 42

---

(260) AM 2014 72231 A  
(800) 1156662  
(151) 2013 03 26  
(181) 2023 03 26  
(511) 09

---

(260) AM 2014 72232 A  
(800) 1156676  
(151) 2013 03 18  
(181) 2023 03 18  
(511) 20, 24, 35

---

(260) AM 2014 72234 A  
(800) 1156721  
(151) 2012 12 06  
(181) 2022 12 06  
(511) 12

---

(260) AM 2014 72236 A  
(800) 1156726  
(151) 2012 11 21  
(181) 2022 11 21  
(511) 01, 03, 05, 41, 42

---

(260) AM 2014 72237 A  
(800) 1156749  
(151) 2013 02 21  
(181) 2023 02 21  
(511) 05

---

(260) AM 2014 72238 A  
(800) 1156762  
(151) 2013 03 06

(181) 2023 03 06  
(511) 05

---

(260) AM 2014 72239 A  
(800) 1156793  
(151) 2013 02 25  
(181) 2023 02 25  
(511) 12

---

(260) AM 2014 72240 A  
(800) 1156800  
(151) 2013 03 26  
(181) 2023 03 26  
(511) 09

---

(260) AM 2014 72241 A  
(800) 1156811  
(151) 2013 03 29  
(181) 2023 03 29  
(511) 07, 11, 12

---

(260) AM 2014 72242 A  
(800) 1156815  
(151) 2013 03 28  
(181) 2023 03 28  
(511) 05

---

(260) AM 2014 72243 A  
(800) 1156816  
(151) 2013 03 28  
(181) 2023 03 28  
(511) 05

---

(260) AM 2014 72244 A  
(800) 1156883  
(151) 2013 03 25  
(181) 2023 03 25  
(511) 05

---

(260) AM 2014 72245 A  
(800) 1156892  
(151) 2013 02 05  
(181) 2023 02 05  
(511) 10

---

(260) AM 2014 72246 A  
(800) 1156900  
(151) 2013 03 13  
(181) 2023 03 13  
(511) 14

---

(260) AM 2014 72247 A  
(800) 1156921  
(151) 2013 02 01  
(181) 2023 02 01  
(511) 29, 30, 35, 43

---

(260) AM 2014 72274 A  
(800) 1157251  
(151) 2012 10 31  
(181) 2022 10 31  
(511) 09, 10, 11, 35, 37, 42

---

(260) AM 2014 72428 A  
(800) 1158985  
(151) 2013 03 20  
(181) 2023 03 20  
(511) 07

---

(260) AM 2014 72429 A  
(800) 1158988  
(151) 2013 03 26  
(181) 2023 03 26  
(511) 41

---

(260) AM 2014 72430 A  
(800) 1159003  
(151) 2012 09 27  
(181) 2022 09 27  
(511) 16, 35, 38, 40, 41, 42

---

(260) AM 2014 72435 A  
(800) 1159017  
(151) 2012 12 24  
(181) 2022 12 24  
(511) 05

---

(260) AM 2014 72437 A  
(800) 1159089  
(151) 2013 03 14  
(181) 2023 03 14  
(511) 21

---

(260) AM 2014 72438 A  
(800) 1159105  
(151) 2013 03 22  
(181) 2023 03 22  
(511) 30, 35

---

(260) AM 2014 72439 A  
(800) 1159191  
(151) 2013 01 22

(181) 2023 01 22  
(511) 12, 39, 41, 43

---

(260) AM 2014 72441 A  
(800) 1159198  
(151) 2013 03 14  
(181) 2023 03 14  
(511) 21

---

(260) AM 2014 72442 A  
(800) 1159213  
(151) 2013 04 05  
(181) 2023 04 05  
(511) 03

---

(260) AM 2014 72470 A  
(800) 1159423  
(151) 2013 03 07  
(181) 2023 03 07  
(511) 37, 42, 43

---

(260) AM 2014 72475 A  
(800) 1159464  
(151) 2013 03 28  
(181) 2023 03 28  
(511) 03, 09, 14, 18, 25, 35, 38, 41, 42, 45

---

(260) AM 2014 72527 A  
(800) 1159633  
(151) 2013 04 25  
(181) 2023 04 25  
(511) 05

---

(260) AM 2014 72533 A  
(800) 1159785  
(151) 2013 04 16  
(181) 2023 04 16  
(511) 03

---

(260) AM 2014 72534 A  
(800) 1159821  
(151) 2013 01 14  
(181) 2023 01 14  
(511) 09, 35, 36, 38, 39, 41, 42, 45

---

(260) AM 2014 72538 A  
(800) 1159825  
(151) 2013 01 14  
(181) 2023 01 14  
(511) 01, 05, 44

---

(260) AM 2014 72541 A  
(800) 1159903  
(151) 2013 04 22  
(181) 2023 04 22  
(511) 01, 30

---

(260) AM 2014 72542 A  
(800) 1159916  
(151) 2013 03 05  
(181) 2023 03 05  
(511) 05, 42

---

(260) AM 2014 72543 A  
(800) 1159934  
(151) 2013 04 06  
(181) 2023 04 06  
(511) 09

---

(260) AM 2014 72547 A  
(800) 1159983  
(151) 2013 02 05  
(181) 2023 02 05  
(511) 09, 14

---

(260) AM 2014 72548 A  
(800) 1159991  
(151) 2013 01 16  
(181) 2023 01 16  
(511) 06, 07, 08, 09, 11, 42

---

(260) AM 2014 72549 A  
(800) 1159993  
(151) 2013 02 13  
(181) 2023 02 13  
(511) 18, 25

---

(260) AM 2014 72551 A  
(800) 1159995  
(151) 2013 03 14  
(181) 2023 03 14  
(511) 03, 05

---

(260) AM 2014 72553 A  
(800) 1160078  
(151) 2013 03 06  
(181) 2023 03 06  
(511) 33

---

(260) AM 2014 72554 A  
(800) 1160040  
(151) 2013 04 03

(181) 2023 04 03  
(511) 30

---

(260) AM 2014 72555 A  
(800) 1160086  
(151) 2013 03 21  
(181) 2023 03 21  
(511) 05

---

(260) AM 2014 72711 A  
(800) 1161306  
(151) 2013 04 16  
(181) 2023 04 16  
(511) 05

---

(260) AM 2014 72715 A  
(800) 813249  
(151) 2003 07 04  
(891) 2013 04 04  
(181) 2013 07 04  
(511) 07

---

(260) AM 2014 72716 A  
(800) 891710  
(151) 2006 05 29  
(891) 2013 03 21  
(181) 2016 05 29  
(511) 26

---

(260) AM 2014 72717 A  
(800) 896314  
(151) 2006 02 24  
(891) 2013 05 09  
(181) 2016 02 24  
(511) 35, 36

---

(260) AM 2014 72719 A  
(800) 956546  
(151) 2008 01 22  
(891) 2013 05 07  
(181) 2018 01 22  
(511) 12

---

(260) AM 2014 72725 A  
(800) 1001129  
(151) 2009 02 05  
(891) 2013 05 10  
(181) 2019 02 05  
(511) 03, 44

---

(260) AM 2014 72727 A

(800) 1015735  
(151) 2009 08 27  
(891) 2013 05 09  
(181) 2019 08 27  
(511) 18, 25

---

(260) AM 2014 72880 A  
(800) 1162630  
(151) 2013 01 29  
(181) 2023 01 29  
(511) 03, 35

---

(260) AM 2014 72881 A  
(800) 1162636  
(151) 2013 03 20  
(181) 2023 03 20  
(511) 07, 08, 11, 21

---

(260) AM 2014 72885 A  
(800) 1162674  
(151) 2013 04 08  
(181) 2023 04 08  
(511) 05

---

(260) AM 2014 72886 A  
(800) 1162720  
(151) 2013 04 03  
(181) 2023 04 03  
(511) 30

---

(260) AM 2014 72888 A  
(800) 1162746  
(151) 2013 04 22  
(181) 2023 04 22  
(511) 05

---

(260) AM 2014 72889 A  
(800) 1162747  
(151) 2013 04 22  
(181) 2023 04 22  
(511) 05

---

(260) AM 2014 72897 A  
(800) 1162830  
(151) 2013 01 23  
(181) 2023 01 23  
(511) 05

---

(260) AM 2014 74180 A  
(800) 1175462  
(151) 2013 07 19

(181) 2023 07 19  
(511) 30

---

(260) AM 2014 74181 A  
(800) 1175496  
(151) 2013 04 18  
(181) 2023 04 18  
(511) 07, 12

---

(260) AM 2014 74182 A  
(800) 1175499  
(151) 2013 03 18  
(181) 2023 03 18  
(511) 24, 35

---

(260) AM 2014 74184 A  
(800) 1175520  
(151) 2013 06 21  
(181) 2023 06 21  
(511) 14

---

(260) AM 2014 74185 A  
(800) 1175522  
(151) 2013 06 28  
(181) 2023 06 28  
(511) 09, 18, 25, 35

---

(260) AM 2014 74187 A  
(800) 1175536  
(151) 2013 07 17  
(181) 2023 07 17  
(511) 30

---

(260) AM 2014 74188 A  
(800) 1175542  
(151) 2013 07 12  
(181) 2023 07 12  
(511) 07, 12, 17, 19, 26

---

(260) AM 2014 74189 A  
(800) 1175577  
(151) 2013 06 28  
(181) 2023 06 28  
(511) 09, 11

---

(260) AM 2014 70662 A\*  
(800) 1043041  
(151) 2010 04 01  
(891) 2012 07 16  
(181) 2020 04 01  
(511) 31

---

---

# OFFICIAL NOTIFICATIONS

## RENEWAL OF A PATENTS

### INVENTION

**(11) P 2002 2661 B**

(73) Roin Nachkebia (GE)

(54) **Plant Medicinal Means and its Use**

DATE OF RENEWAL: 2014 08 11

---

### UTILITY MODEL

**(11) P 2013 1760 B**

(73) Ketevan Imedashvili (GE)

(54) **METHOD OF OBTAINING AVAILABLE SOLUTION FROM GRAPEVINE WASTE**

DATE OF RENEWAL: 2014 08 11

---

## CORRECTION OF PUBLISHED INFORMATION

### TRADEMARK

Bulletin Number	Pg.	Column	PUBLISHED	MUST BE
№13(341) 2014	70	I	(260) AM 71960 A* (210) AM 071960 (220) 2013 04 19 (731) LTD "GEOCELI" Gotuas q. №3, Mtkvris marjvena sanapiro, 0160, Tbilisi, Georgia (540) <b>GEOCREDIT</b> <b>ჯეოკრედიტი</b>  (511) 16, 38	(260) AM 71960 A* (210) AM 071960 (220) 2013 04 19 (731) LTD "GEOCELI" Gotuas q. №3, Mtkvris marjvena sanapiro, 0160, Tbilisi, Georgia (540) <b>GEOCREDIT</b> <b>ჯეოკრედიტი</b>  (591) Black-white (511) 16, 38

---

# CLASSIFICATION INDEXES

## INVENTIONS

### CONCORDANCE TABLE OF INTERNATIONAL CLASSIFICATION INDEX AND PUBLICATION NUMBERS

INTERNATIONAL CLASSIFICATION INDEXES (51)	NUMBER OF PUBLISHED APPLICATION (10)
A 01 G 17/00	AP 2014 13289 A
A 23 G 3/00	AP 2014 13124 A
A 61 K 31/44; A 01 N 43/42	AP 2014 12310 A
A 61 K 36/00	AP 2014 12584 A
C 07 D 471/04; A 61 K 31/4196; A 61 K 31/437; A 61 P 25/18; A 61 P 25/28	AP 2014 12784 A
C 07 D 495/04; A 61 K 31/519; A 61 K 31/5377; A 61 K 31/541; A 61 P 35/00; A 61 P 35/02; A 61 P 35/04; A 61 P 43/00; C 07 D 519/00	AP 2014 12855 A
C 10 G 15/08; B 01 J 19/10; C 02 F 1/36; B 01 F 7/00	AP 2014 12890 A
E 21 B 43/26; E 21 B 43/25	AP 2014 12671 A

### CONCORDANCE TABLE OF PUBLICATION NUMBERS AND INTERNATIONAL CLASSIFICATION INDEX

NUMBER OF PUBLISHED APPLICATION (10)	INTERNATIONAL CLASSIFICATION INDEXES (51)
AP 2014 12310 A	A 61 K 31/44; A 01 N 43/42
AP 2014 12584 A	A 61 K 36/00
AP 2014 12671 A	E 21 B 43/26; E 21 B 43/25
AP 2014 12784 A	C 07 D 471/04; A 61 K 31/4196; A 61 K 31/437; A 61 P 25/18; A 61 P 25/28
AP 2014 12855 A	C 07 D 495/04; A 61 K 31/519; A 61 K 31/5377; A 61 K 31/541; A 61 P 35/00; A 61 P 35/02; A 61 P 35/04; A 61 P 43/00; C 07 D 519/00
AP 2014 12890 A	C 10 G 15/08; B 01 J 19/10; C 02 F 1/36; B 01 F 7/00
AP 2014 13124 A	A 23 G 3/00
AP 2014 13289 A	A 01 G 17/00

**CONCORDANCE TABLE OF INTERNATIONAL CLASSIFICATION INDEX,  
PATENT NUMBERS AND PUBLICATION NUMBERS**

INTERNATIONAL CLASSIFICATION INDEX (51)	NUMBER OF PATENT (11)	NUMBER OF PUBLISHED APPLICATION (10)
A 01 N 37/18; A 01 K 31/16	P 2014 6134 B	AP 2014 12428 A
A 01 N 43/38; A 61 K 31/40	P 2014 6138 B	AP 2014 12711 A
A 21 B 1/22; A 21 B 1/52	P 2014 6142 B	AP 2014 13005 A
A 61 K 9/00; A 61 K 47/14	P 2014 6139 B	AP 2014 12712 A
A 61 K 31/4045, 31/55, 45/06; A 61 P 9/04	P 2014 6132 B	AP 2014 12259 A
B 22 D 41/00	P 2014 6136 B	AP 2014 12661 A
B 60 B 19/00; B 62 D 57/00	P 2014 6141 B	AP 2014 12997 A
B 61 G 3/10, 5/06	P 2014 6130 B	AP 2014 12145 A
C 07 D 209/86; C 07 D 209/88; C 07 D 401/04; C 07 D 487/04; A 61 K 31/403; A 61 P 33/00; A 61 P 31/00; A 61 P 35/00; A 61 P 29/00	P 2014 6131 B	AP 2014 12213 A
C 07 J 71/00; A 61 K 31/58; A 61 P 5/44	P 2014 6135 B	AP 2014 12612 A
C 07 K 16/28; A 61 K 39/395; A 61 P 37/06; A 61 P 19/02	P 2014 6129 B	AP 2014 12063 A
C 12 N 15/82; A 01 H 5/00; A 01 H 5/10; C 12 N 9/10; C 12 N 9/88	P 2014 6128 B	AP 2014 11540 A
C 21 C 1/00	P 2014 6137 B	AP 2014 12664 A
E 04 C 2/26; E 04 B 2/10	P 2014 6133 B	AP 2014 12322 A
F 27 D 9/00	P 2014 6140 B	AP 2014 12960 A

**CONCORDANCE TABLE OF PATENT NUMBERS,  
PUBLICATION NUMBERS AND INTERNATIONAL CLASSIFICATION INDEX**

NUMBER OF PATENT (11)	NUMBER OF PUBLISHED APPLICATION (10)	INTERNATIONAL CLASSIFICATION INDEX (51)
P 2014 6128 B	AP 2014 11540 A	C 12 N 15/82; A 01 H 5/00; A 01 H 5/10; C 12 N 9/10; C 12 N 9/88
P 2014 6129 B	AP 2014 12063 A	C 07 K 16/28; A 61 K 39/395; A 61 P 37/06; A 61 P 19/02
P 2014 6130 B	AP 2014 12145 A	B 61 G 3/10, 5/06
P 2014 6131 B	AP 2014 12213 A	C 07 D 209/86; C 07 D 209/88; C 07 D 401/04; C 07 D 487/04; A 61 K 31/403; A 61 P 33/00; A 61 P 31/00; A 61 P 35/00; A 61 P 29/00
P 2014 6132 B	AP 2014 12259 A	A 61 K 31/4045, 31/55, 45/06; A 61 P 9/04
P 2014 6133 B	AP 2014 12322 A	E 04 C 2/26; E 04 B 2/10
P 2014 6134 B	AP 2014 12428 A	A 01 N 37/18; A 01 K 31/16
P 2014 6135 B	AP 2014 12612 A	C 07 J 71/00; A 61 K 31/58; A 61 P 5/44
P 2014 6136 B	AP 2014 12661 A	B 22 D 41/00
P 2014 6137 B	AP 2014 12664 A	C 21 C 1/00
P 2014 6138 B	AP 2014 12711 A	A 01 N 43/38; A 61 K 31/40
P 2014 6139 B	AP 2014 12712 A	A 61 K 9/00; A 61 K 47/14
P 2014 6140 B	AP 2014 12960 A	F 27 D 9/00
P 2014 6141 B	AP 2014 12997 A	B 60 B 19/00; B 62 D 57/00
P 2014 6142 B	AP 2014 13005 A	A 21 B 1/22; A 21 B 1/52

**CONCORDANCE TABLE OF APPLICATION NUMBERS, PUBLICATION NUMBERS  
AND PATENTS**

NUMBER OF APPLICATION (21)	NUMBER OF PUBLISHED APPLICATION (10)	NUMBER OF PATENT (11)
AP 2008 011540	AP 2014 11540 A	P 2014 6128 B
AP 2009 012063	AP 2014 12063 A	P 2014 6129 B
AP 2009 012213	AP 2014 12213 A	P 2014 6131 B
AP 2010 012428	AP 2014 12428 A	P 2014 6134 B
AP 2010 012612	AP 2014 12612 A	P 2014 6135 B
AP 2010 012711	AP 2014 12711 A	P 2014 6138 B
AP 2010 012712	AP 2014 12712 A	P 2014 6139 B
AP 2011 012145	AP 2014 12145 A	P 2014 6130 B
AP 2011 012259	AP 2014 12259 A	P 2014 6132 B
AP 2011 012322	AP 2014 12322 A	P 2014 6133 B
AP 2012 012661	AP 2014 12661 A	P 2014 6136 B
AP 2012 012664	AP 2014 12664 A	P 2014 6137 B
AP 2013 012960	AP 2014 12960 A	P 2014 6140 B
AP 2013 012997	AP 2014 12997 A	P 2014 6141 B
AP 2013 013005	AP 2014 13005 A	P 2014 6142 B

**UTILITY MODELS**

**CONCORDANCE TABLE OF INTERNATIONAL CLASSIFICATION INDEX  
AND PUBLICATION NUMBERS**

INTERNATIONAL CLASSIFICATION INDEXES (51)	NUMBER OF PUBLISHED APPLICATION (10)
A 47 J 37/00	AU 2014 13297 U
A 61 K 8/368; A 61 K 7/155	AU 2014 13353 U
B 60 P 3/35; B 60 P 3/32	AU 2014 13167 U

**CONCORDANCE TABLE OF PUBLICATION NUMBERS  
AND INTERNATIONAL CLASSIFICATION INDEX**

NUMBER OF PUBLISHED APPLICATION (10)	INTERNATIONAL CLASSIFICATION INDEXES (51)
AU 2014 13167 U	B 60 P 3/35; B 60 P 3/32;
AU 2014 13297 U	A 47 J 37/00; [8]
AU 2014 13353 U	A 61 K 8/368; A 61 K 7/155;

**CONCORDANCE TABLE OF INTERNATIONAL CLASSIFICATION INDEX,  
PATENT NUMBERS AND PUBLICATION NUMBERS**

INTERNATIONAL CLASSIFICATION INDEX (51)	NUMBER OF PATENT (11)	NUMBER OF PUBLISHED APPLICATION (10)
F 16 D 9/02; C 09 K 3/14	U 2014 1824 Y	AU 2014 13287 U
G 01 K 1/10	U 2014 1823 Y	AU 2014 12961 U



**CONCORDANCE TABLE OF PATENT NUMBERS,  
PUBLICATION NUMBERS AND INTERNATIONAL CLASSIFICATION INDEX**

NUMBER OF PATENT (11)	NUMBER OF PUBLISHED APPLICATION (10)	INTERNATIONAL CLASSIFICATION INDEX (51)
U 2014 1823 Y	AU 2014 12961 U	G 01 K 1/10
U 2014 1824 Y	AU 2014 13287 U	F 16 D 9/02; C 09 K 3/14

**CONCORDANCE TABLE OF APPLICATION NUMBERS, PUBLICATION NUMBERS  
AND PATENTS**

NUMBER OF APPLICATION (21)	NUMBER OF PUBLISHED APPLICATION (10)	NUMBER OF PATENT (11)
AU 2013 012961	AU 2014 12961 U	U 2014 1823 Y
AU 2013 013287	AU 2014 13287 U	U 2014 1824 Y

## DESIGNS

**CONCORDANCE TABLE OF INTERNATIONAL CLASSIFICATION INDEX  
AND PUBLICATION NUMBERS**

INTERNATIONAL CLASSIFICATION INDEXES (51)	NUMBER OF PUBLISHED APPLICATION (10)
32-00	AD 2014 794 S
21-01	AD 2014 796 S

**CONCORDANCE TABLE OF PUBLICATION NUMBERS  
AND INTERNATIONAL CLASSIFICATION INDEX**

NUMBER OF PUBLISHED APPLICATION (10)	INTERNATIONAL CLASSIFICATION INDEXES (51)
AD 2014 794 S	32-00
AD 2014 796 S	21-01

**CONCORDANCE TABLE OF INTERNATIONAL CLASSIFICATION INDEX,  
PATENT NUMBERS AND PUBLICATION NUMBERS**

INTERNATIONAL CLASSIFICATION INDEX (51)	NUMBER OF PATENT (11)	NUMBER OF PUBLISHED APPLICATION (10)
11-01	D 2014 585 S	AD 2014 771 S

**CONCORDANCE TABLE OF PATENT NUMBERS,  
PUBLICATION NUMBERS AND INTERNATIONAL CLASSIFICATION INDEX**

NUMBER OF PATENT (11)	NUMBER OF PUBLISHED APPLICATION (10)	INTERNATIONAL CLASSIFICATION INDEX (51)
D 2014 585 S	AD 2014 771 S	11-01

**CONCORDANCE TABLE OF APPLICATION NUMBERS, PUBLICATION NUMBERS  
AND PATENTS**

NUMBER OF APPLICATION (21)	NUMBER OF PUBLISHED APPLICATION (10)	NUMBER OF PATENT (11)
AD 2013 000771 S	AD 2014 771 S	D 2014 585 S

**DESIGN REGISTERED ACCORDING TO THE  
ACCELERATED PROCEDURE**

**CONCORDANCE TABLE OF INTERNATIONAL CLASSIFICATION INDEX  
AND PATENTS NUMBERS**

INTERNATIONAL CLASSIFICATION INDEX (51)	NUMBER OF PATENT (11)
06-03	D 2014 586 S

**CONCORDANCE TABLE OF PATENT NUMBERS AND INTERNATIONAL  
CLASSIFICATION INDEX**

NUMBER OF PATENT (11)	INTERNATIONAL CLASSIFICATION INDEX (51)
D 2014 586 S	06-03

**CONCORDANCE TABLE OF APPLICATION NUMBERS  
AND PATENT NUMBERS**

NUMBER OF APPLICATION (21)	NUMBER OF PATENT (11)
AD 2014 000809	D 2014 586 S

## TRADEMARKS

### CONCORDANCE TABLE OF REGISTRATION NUMBERS, APPLICATION NUMBERS, PUBLICATION NUMBERS AND BULLETIN NUMBERS

NUMBER OF REGISTRATION (111)	NUMBER OF APPLICATION (210)	NUMBER OF PUBLISHED APPLICATION (260)	NUMBER OF BULLETIN
1	2	3	4
M 2014 25039 R	AM 2014 77626	-	15(403) 2014
M 2014 25040 R	AM 2014 77710	-	15(403) 2014
M 2014 25041 R	AM 2014 77712	-	15(403) 2014
M 2014 25042 R	AM 2014 77813	-	15(403) 2014
M 2014 25043 R	AM 2014 77841	-	15(403) 2014
M 2014 25044 R	AM 2014 77886	-	15(403) 2014
M 2014 25045 R	AM 2014 77771	-	15(403) 2014
M 2014 25046 R	AM 2014 77783	-	15(403) 2014
M 2014 25047 R	AM 2014 77840	-	15(403) 2014
M 2014 25048 R	AM 2008 49781	AM 2014 49781 A	6(394) 2014
M 2014 25049 R	AM 2012 69694	AM 2014 69694 A	6(394) 2014
M 2014 25050 R	AM 2012 69695	AM 2014 69695 A	6(394) 2014
M 2014 25051 R	AM 2013 70258	AM 2013 70258 A	24(388) 2013
M 2014 25052 R	AM 2013 70259	AM 2013 70259 A	24(388) 2013
M 2014 25053 R	AM 2013 70568	AM 2014 70568 A	1(389) 2014
M 2014 25054 R	AM 2013 70700	AM 2014 70700 A	1(389) 2014
M 2014 25055 R	AM 2013 70701	AM 2014 70701 A	1(389) 2014
M 2014 25056 R	AM 2013 70795	AM 2014 70795 A	1(389) 2014
M 2014 25057 R	AM 2013 70926	AM 2014 70926 A	4(392) 2014
M 2014 25058 R	AM 2013 70927	AM 2014 70927 A	4(392) 2014
M 2014 25059 R	AM 2013 70928	AM 2014 70928 A	4(392) 2014
M 2014 25060 R	AM 2013 70929	AM 2014 70929 A	1(389) 2014
M 2014 25061 R	AM 2013 70932	AM 2014 70932 A	4(392) 2014
M 2014 25062 R	AM 2013 70933	AM 2014 70933 A	4(392) 2014
M 2014 25063 R	AM 2013 71019	AM 2014 71019 A	2(390) 2014
M 2014 25064 R	AM 2013 71163	AM 2014 71163 A	3(391) 2014
M 2014 25065 R	AM 2013 71222	AM 2014 71222 A	1(389) 2014
M 2014 25066 R	AM 2013 71223	AM 2014 71223 A	1(389) 2014
M 2014 25067 R	AM 2013 71224	AM 2014 71224 A	1(389) 2014
M 2014 25068 R	AM 2013 71248	AM 2014 71248 A	4(392) 2014
M 2014 25069 R	AM 2013 71261	AM 2014 71261 A	4(392) 2014
M 2014 25070 R	AM 2013 71529	AM 2014 71529 A	5(393) 2014
M 2014 25071 R	AM 2013 71569	AM 2014 71569 A	2(390) 2014
M 2014 25072 R	AM 2013 71570	AM 2014 71570 A	2(390) 2014
M 2014 25073 R	AM 2013 71654	AM 2014 71654 A	2(390) 2014
M 2014 25074 R	AM 2013 71655	AM 2014 71655 A	6(394) 2014
M 2014 25075 R	AM 2013 71731	AM 2014 71731 A	7(395) 2014
M 2014 25076 R	AM 2013 71841	AM 2014 71841 A	1(389) 2014
M 2014 25077 R	AM 2013 71932	AM 2014 71932 A	1(389) 2014
M 2014 25078 R	AM 2013 71937	AM 2014 71937 A	1(389) 2014
M 2014 25079 R	AM 2013 71961	AM 2014 71961 A	1(389) 2014
M 2014 25080 R	AM 2013 71963	AM 2014 71963 A	1(389) 2014
M 2014 25081 R	AM 2013 71994	AM 2014 71994 A	5(393) 2014
M 2014 25082 R	AM 2013 72070	AM 2014 72070 A	4(392) 2014
M 2014 25083 R	AM 2013 72190	AM 2014 72190 A	4(392) 2014

1	2	3	4
M 2014 25084 R	AM 2013 72316	AM 2014 72316 A	4(392) 2014
M 2014 25085 R	AM 2013 72346	AM 2014 72346 A	4(392) 2014
M 2014 25086 R	AM 2013 72506	AM 2014 72506 A	6(394) 2014
M 2014 25087 R	AM 2013 72507	AM 2014 72507 A	6(394) 2014
M 2014 25088 R	AM 2013 72509	AM 2014 72509 A	6(394) 2014
M 2014 25089 R	AM 2013 72874	AM 2014 72874 A	5(393) 2014
M 2014 25090 R	AM 2013 72954	AM 2014 72954 A	7(395) 2014
M 2014 25091 R	AM 2013 72972	AM 2014 72972 A	5(393) 2014
M 2014 25092 R	AM 2013 73105	AM 2014 73105 A	5(393) 2014
M 2014 25093 R	AM 2013 73181	AM 2014 73181 A	7(395) 2014
M 2014 25094 R	AM 2013 73241	AM 2014 73241 A	6(394) 2014
M 2014 25095 R	AM 2013 73276	AM 2014 73276 A	6(394) 2014
M 2014 25096 R	AM 2014 77808	-	15(403) 2014
M 2014 25097 R	AM 2014 77973	-	15(403) 2014
M 2014 25098 R	AM 2014 77918	-	15(403) 2014
M 2014 25099 R	AM 2014 77993	-	15(403) 2014
M 2014 25100 R	AM 2013 72291	AM 2013 72291 A	24(388) 2013
M 2014 25101 R	AM 2014 77949	-	15(403) 2014
M 2014 25102 R	AM 2014 77994	-	15(403) 2014
M 2014 25103 R	AM 2014 77995	-	15(403) 2014
M 2014 25104 R	AM 2014 78065	-	15(403) 2014
M 2014 25105 R	AM 2014 78066	-	15(403) 2014

**CONCORDANCE TABLE OF PUBLICATION NUMBERS  
AND APPLICATION NUMBERS**

NUMBER OF PUBLISHED APPLICATION (260)	NUMBER OF APPLICATION (210)	1	2
1	2		
AM 2014 72647 A	AM 2013 72647	AM 2014 73965 A	AM 2013 73965
AM 2014 73113 A	AM 2013 73113	AM 2014 73966 A	AM 2013 73966
AM 2014 73115 A	AM 2013 73115	AM 2014 73967 A	AM 2013 73967
AM 2014 73377 A	AM 2013 73377	AM 2014 74065 A	AM 2013 74065
AM 2014 73511 A	AM 2013 73511	AM 2014 74102 A	AM 2013 74102
AM 2014 73761 A	AM 2013 73761	AM 2014 74104 A	AM 2013 74104
AM 2014 73911 A	AM 2013 73911	AM 2014 74105 A	AM 2013 74105
AM 2014 73912 A	AM 2013 73912	AM 2014 74139 A	AM 2013 74139
AM 2014 73924 A	AM 2013 73924	AM 2014 74163 A	AM 2013 74163
AM 2014 73925 A	AM 2013 73925	AM 2014 74327 A	AM 2013 74327
AM 2014 73926 A	AM 2013 73926	AM 2014 74544 A	AM 2013 74544
AM 2014 73928 A	AM 2013 73928	AM 2014 74545 A	AM 2013 74545
AM 2014 73929 A	AM 2013 73929	AM 2014 74570 A	AM 2013 74570
AM 2014 73931 A	AM 2013 73931	AM 2014 74571 A	AM 2013 74571
AM 2014 73937 A	AM 2013 73937	AM 2014 74720 A	AM 2013 74720
AM 2014 73939 A	AM 2013 73939	AM 2014 74760 A	AM 2013 74760
AM 2014 73940 A	AM 2013 73940	AM 2014 74761 A	AM 2013 74761
AM 2014 73944 A	AM 2013 73944	AM 2014 74762 A	AM 2013 74762
AM 2014 73964 A	AM 2013 73964	AM 2014 74979 A	AM 2013 74979
		AM 2014 75102 A	AM 2013 75102
		AM 2014 73104 A*	AM 2013 73104

**CONCORDANCE TABLE OF INDEX OF GOODS AND/OR SERVICES  
AND APPLICATION NUMBERS**

INDEX OF GOODS AND/OR SERVICES (511)	NUMBER OF PUBLISHED APPLICATION (260)	1	2
1	2	33	AM 2014 73113 A
3	AM 2014 73377 A	33	AM 2014 73115 A
3	AM 2014 73944 A	33	AM 2014 73928 A
3	AM 2014 74327 A	33	AM 2014 73929 A
3	AM 2014 74762 A	33	AM 2014 73931 A
5	AM 2014 73925 A	33	AM 2014 73940 A
5	AM 2014 73926 A	33	AM 2014 74065 A
5	AM 2014 74544 A	33	AM 2014 74979 A
5	AM 2014 74545 A	34	AM 2014 74102 A
6	AM 2014 73761 A	34	AM 2014 74570 A
7	AM 2014 73939 A	34	AM 2014 74571 A
8	AM 2014 73939 A	35	AM 2014 73761 A
9	AM 2014 74762 A	35	AM 2014 73911 A
10	AM 2014 73944 A	35	AM 2014 73912 A
14	AM 2014 74762 A	35	AM 2014 73964 A
18	AM 2014 74762 A	35	AM 2014 73965 A
19	AM 2014 73761 A	35	AM 2014 73966 A
20	AM 2014 73761 A	35	AM 2014 73967 A
20	AM 2014 74104 A	35	AM 2014 74327 A
20	AM 2014 74105 A	35	AM 2014 74761 A
21	AM 2014 73944 A	35	AM 2014 74762 A
25	AM 2014 74327 A	36	AM 2014 74720 A
25	AM 2014 74761 A	37	AM 2014 73761 A
25	AM 2014 74762 A	40	AM 2014 73761 A
29	AM 2014 73511 A	41	AM 2014 74760 A
30	AM 2014 73511 A	43	AM 2014 73511 A
30	AM 2014 73912 A	43	AM 2014 73912 A
30	AM 2014 73104 A*	43	AM 2014 73937 A
33	AM 2014 72647 A	43	AM 2014 74139 A
		43	AM 2014 75102 A
		44	AM 2014 73924 A
		45	AM 2014 74163 A

ONCORDANCE TABLE OF INDEX OF GOODS AND/OR SERVICES  
AND NUMBERS OF TRADEMARKS REGISTERED ACCORDING  
TO THE ACCELERATED PROCEDURE

INDEX OF GOODS AND/OR SERVICES (511)	NUMBER OF REGISTERED ACCORDING TO THE ACCELERATED PROCEDURE (111)
5	M 2014 25042 R
5	M 2014 25043 R
5	M 2014 25047 R
5	M 2014 25099 R
6	M 2014 25101 R
25	M 2014 25040 R
25	M 2014 25041 R
27	M 2014 25044 R
32	M 2014 25039 R
33	M 2014 25039 R
33	M 2014 25096 R
35	M 2014 25039 R
35	M 2014 25037 R
35	M 2014 25104 R
35	M 2014 25105 R
36	M 2014 25104 R
36	M 2014 25105 R
37	M 2014 25045 R
37	M 2014 25046 R
37	M 2014 25102 R
41	M 2014 25040 R
41	M 2014 25041 R
41	M 2014 25098 R
42	M 2014 25103 R
43	M 2014 25097 R

# OFFICIAL BULLETIN OF THE INDUSTRIAL PROPERTY

## 15(403)

EDITOR-IN-CHIEF: N. Bebrishvili

EDITORS-TRANSLATORS: E. Gabunia  
G. Nadareishvili

PROOFREADER: L. Chanturia

COMPUTER LAYOUT: M. Ordenidze

[www.sakpatenti.org.ge](http://www.sakpatenti.org.ge)  
E-mail: [info@sakpatenti.org.ge](mailto:info@sakpatenti.org.ge)