



**NATIONAL INTELLECTUAL PROPERTY CENTER OF GEORGIA  
SAKPATENTI**

**OFFICIAL BULLETIN  
OF THE INDUSTRIAL PROPERTY**

**15(379)**

**2013  
TBILISI**

# INID CODES FOR IDENTIFICATION OF BIBLIOGRAPHIC DATA

## INVENTIONS, UTILITY MODELS

- (10) Number of publication for application, which has been examined
- (11) Number of patent and kind of document
- (21) Serial number of application
- (22) Date of filing of the application
- (23) Date of exhibition or the date of the earlier filing and the number of application, if any
- (24) Date from which patent may have effect
- (31) Number of priority application
- (32) Date of filing of priority application
- (33) Code of the country or regional organization allotting priority application number
- (44) Date of publication of application not granted, but examined and number of bulletin
- (45) Date of publication of registered document
- (51) International Patent Classification Index
- (54) Title of the invention
- (57) Abstract
- (60) Number of examined patent document granted by foreign patent office, date from which patent has effect and country code
- (62) Number of the earlier application and in case of divided application, date of filing an application
- (71) Name, surname and address of applicant (country code)
- (72) Name, surname of inventor (country code)
- (73) Name, surname and address of patent owner (country code)
- (74) Name, surname of representative or patent attorney
- (85) Date of commencement of the national phase of International Application
- (86) Number and date of filing of international application
- (87) Number and date of publication of international application

## DESIGNS

- (10) Number of publication for application
- (11) Number of patent and kind of document or number of registration
- (15) Date of registration/Date of patent renewal
- (18) Expected expiration date of patent or registration
- (21) Serial number of application
- (22) Date of filing of the application
- (23) Date of exhibition or the date of the earlier filing and the number of application, if any
- (24) Date from which patent may have effect
- (28) Number of designs included in the application
- (30) Data relating to priority (number of application, date of filing of application, two-letter code identifying the authority with whom the priority application was made)
- (31) Number of priority application
- (32) Date of filing of priority application
- (33) Code of the country or regional organization allotting priority application number
- (34) Two-letter code according to WIPO St.3 identifying the authority with which the priority application was made
- (44) Date of publication of design and number of bulletin (the first publication)
- (45) Date of publication of design registered by WIPO and number of bulletin
- (51) International Classification for designs (class and subclass of the Locarno Classification)
- (54) Title of the invention
- (55) Reproduction of the design
- (57) Description of characteristic features of the design including indication of colors
- (58) Date of recording of any kind of amendment in the Register
- (62) Number of the earlier application, registration and document number and if available the date of filing an application in case of divided application
- (71) Name, surname and address of applicant (country code)
- (72) Name, surname of creator (country code)
- (73) Name, surname and address of patent owner (country code)
- (74) Name, surname of representative or patent attorney
- (81) Contracting states concerned
  - II designated contracting states according to the 1960 Act
  - III designated contracting states according to the 1999 Act
- (85) Owner's permanent address
- (86) Owner's nationality
- (87) Owner's residence
- (88) State in which the owner has a real and effective industrial or commercial establishment

## TRADEMARKS

- (111) – Number of registration
- (151) – Date of registration
- (156) – Date of the renewal
- (181) – Expected expiration date of registration
- (186) – Renewal expiration date of registration
- (141) – Date of cancel of duration of the mark
- (210) – Serial number of application
- (220) – Date of filing of the application
- (230) – Data concerning exhibition
- (260) – Number of application, for which favorable decision of examination about registration has been taken (publication number)
- (310) – Number of the first application
- (320) – Date of filing of the first application
- (330) – Code, identifying national or regional Office where the first application was made
- (511) – International Classification of Goods and Services for the purposes of registration of trade marks and/or list of goods and/or services classified according thereto
- (531) – Description of figurative elements of Trade Marks according to the International Classification of the Figurative Elements of Marks
- (540) – Reproduction of Trade Mark
- (550) – Nature and kind of Trade Mark
- (580) – Date of recording of any kind changes in respect of applications or registrations
- (591) – Information concerning colors claimed
- (731) – Name and address of the applicant
- (732) – Name and address of the holder of the registration
- (740) – Name and address of the representative
- (750) – Address for correspondence
- (770) – Name and address of the previous applicant or holder in case of change in ownership
- (771) – Previous name and address of the applicant or holder in case of change in ownership
- (791) – Name and address of the licensee
- (793) – Indication of conditions and/or restrictions under the license (Type of license, number of license agreement, data of license, data of validity of license)
- (800) – Certain data relating to the international registration of Trade Marks under the Protocol Relating to Madrid Agreement (International registration number)

## CODES FOR PUBLICATION IN BULLETIN

- (21) AP 0000 000000 – serial number of application for invention
- (10) AP 0000 0000 A – number of published application for invention (first publication)
- (11) P 0000 0000 B – number of patent for invention (second publication)
- (21) API 0000 000000 – number of application for imported patent
- (11) PI 0000 0000 A – number of imported patent (first publication)
- (21) AU 0000 000000 – serial number of application for utility model
- (10) AU 0000 000 U – number of published application for utility model (first publication)
- (11) U 0000 000 Y – number of patent for utility model (second publication)
- (21) AD 0000 000000 – serial number of application for design
- (10) AD 0000 000 S – number of published application for design (first publication)
- (11) D 0000 000 S – number of patent for design (second publication)

## INTERNATIONAL PATENT CLASSIFICATION FOR INVENTIONS AND UTILITY MODELS

- SECTION A – HUMAN NECESSITIES
- SECTION B – PERFORMING OPERATIONS; TRANSPORTING
- SECTION C – CHEMISTRY; METALLURGY
- SECTION D – TEXTILES; PAPER
- SECTION E – FIXED CONSTRUCTIONS
- SECTION F – MECHANICAL ENGINEERING; LIGHTING; HEATING; WEAPONS; BLASTING
- SECTION G – PHYSICS
- SECTION H – ELECTRICITY

- 
- M – Trade Mark
  - (210) AM 0000 000000 – Serial number of application;
  - (260) AAM 0000 00000 A – Publication number of application;
  - (111) M 0000 00000 R – Number of registration;
  - (111) MMM0000 00000 Rn – Number of renewals, in which n=1,2,3;
  - (111) M 0000 00000 R(P) – Number of registration under partial assignment of rights
-

**LIST OF CODES, IN ALPHABETIC SEQUENCE, AND THE CORRESPONDING (SHORT) NAMES OF STATES, OTHER ENTITIES AND INTERGOVERNMENTAL ORGANIZATIONS**  
(WIPO STANDARD ST.3)

AD	Andorra				
AE	United Arab Emirates				
AF	Afghanistan				
AG	Antigua and Barbuda				
AI	Anguilla				
AL	Albania				
AM	Armenia				
AN	Netherlands Antilles				
AO	Angola				
AP	African Regional Intellectual Property Organization (ARIPO)				
AR	Argentina				
AT	Austria				
AU	Australia				
AW	Aruba				
AZ	Azerbaijan				
BA	Bosnia and Herzegovina				
BB	Barbados				
BD	Bangladesh				
BE	Belgium				
BF	Burkina Faso				
BG	Bulgaria				
BH	Bahrain				
BI	Burundi				
BJ	Benin				
BM	Bermuda				
BN	Brunei Darussalam				
BO	Bolivia				
BR	Brazil				
BS	Bahamas				
BT	Bhutan				
BV	Bouvet Island				
BW	Botswana				
BX	Benelux Office for Intellectual Property (BOIP)				
BY	Belarus				
BZ	Belize				
CA	Canada				
CD	Democratic Republic of the Congo				
CF	Central African Republic				
CG	Congo				
CH	Switzerland				
CI	Cote d'Ivoire				
CK	Cook Islands				
CL	Chile				
CM	Cameroon				
CN	China				
CO	Colombia				
CR	Costa Rica				
CU	Cuba				
CV	Cape Verde				
CY	Cyprus				
CZ	Czech Republic				
DE	Germany				
DJ	Djibouti				
DM	Dominica				
DO	Dominican Republic				
DZ	Algeria				
EA	Eurasian Patent Organization (EAPO)				
EC	Ecuador				
EE	Estonia				
EG	Egypt				
EH	Western Sahara				
EM	Office for Harmonization in the Internal Market (Trademarks and Designs)(OHIM)				
EP	European Patent Office (EPO)				
ER	Eritrea				
ES	Spain				
ET	Ethiopia				
FI	Finland				
FJ	Fiji				
FK	Falkland Islands (Malvinas)				
FO	Faroe Islands				
FR	France				
GA	Gabon				
GB	United Kingdom				
GC	Patent Office of the Cooperation Council for the Arab States of the Gulf (GCC)				
GD	Grenada				
GG	Guernsey				
GH	Ghana				
GI	Gibraltar				
GT	Guatemala				
GW	Guinea- Bissau				
GY	Guyana				
HK	The Hong Kong Special Administrative Region of the People's Republic of China				
HN	Honduras				
HR	Croatia				
HT	Haiti				
HU	Hungary				
IB	International Bureau of the World Intellectual Property Organization (WIPO)				
ID	Indonesia				
IE	Ireland				
IL	Israel				
IM	Isle of Man				
IN	India				
IQ	Iraq				
ID	Indonesia				
IE	Ireland				
IL	Israel				
IM	Isle of Man				
IN	India				
IQ	Iraq				
IR	Iran (Islamic Republic of)				
IS	Iceland				
IT	Italy				
JE	Jersey				
JM	Jamaica				
JO	Jordan				
JP	Japan				
KE	Kenya				
KG	Kyrgyzstan				
KH	Cambodia				
KI	Kiribati				
KM	Saint Kitts and Nevis				
KP	Democratic People's Republic of Korea				
KR	Republic of Korea				
KW	Kuwait				
KY	Cayman Islands				
KZ	Kazakhstan				
LA	Lao People's Democratic Republic				
LB	Lebanon				
LC	Saint Lucia				
LI	Liechtenstein				
LK	Sri Lanka				
LR	Liberia				
LS	Lesotho				
LT	Lithuania				
LU	Luxembourg				
LV	Latvia				
LY	Libyan Arab Jamahiriya				
MA	Morocco				
MC	Monaco				
MD	Republic of Moldova				
ME	Montenegro				
MG	Madagascar				
MK	The former Yugoslav Republic of Macedonia				
ML	Mali				
MM	Myanmar				
MN	Mongolia				
MO	Macao				
MP	Northern Mariana Islands				
MR	Mauritania				
MS	Montserrat				
MT	Malta				
MU	Mauritius				
MV	Maldives				
MW	Malawi				
MX	Mexico				
MY	Malaysia				
MZ	Mozambique				
NA	Namibia				
NE	Niger				
NG	Nigeria				
NI	Nicaragua				
NL	Netherlands				
NO	Norway				
NP	Nepal				
NR	Nauru				
NZ	New Zealand				
OA	African Intellectual Property Organization (OAPI)				
OM	Oman				
PA	Panama				
PE	Peru				
PG	Papua New Guinea				
PH	Philippines				
PK	Pakistan				
PL	Poland				
PT	Portugal				
PW	Palau				
PY	Paraguay				
QA	Qatar				
QZ	Community Plant Variety Office (European Community) (CPVO)				
RO	Romania				
RS	Serbia				
RU	Russian Federation				
RW	Rwanda				
SA	Saudi Arabia				
SB	Solomon Islands				
SC	Seychelles				
SD	Sudan				
SG	Singapore				
SH	Saint Helena				
SI	Slovenia				
SK	Slovakia				
SL	Sierra Leone				
SM	San Marino				
SN	Senegal				
SO	Somalia				
SR	Suriname				
ST	Sao Tome and Principe				
SV	El Salvador				
SY	Syrian Arab Republic				
SZ	Swaziland				
TC	Turks and Caicos Islands				
TD	Chad				
TG	Togo				
TH	Thailand				
TJ	Tajikistan				
TL	Timor-Leste				
TM	Turkmenistan				
TN	Tunisia				
TO	Tonga				
TR	Turkey				
SE	Sweden				
TT	Trinidad and Tobago				
TV	Tuvalu				
TW	Taiwan, Province of China				
TZ	United Republic of Tanzania				
UA	Ukraine				
UG	Uganda				
US	United States of America				
UY	Uruguay				
UZ	Uzbekistan				
VA	Holy See				
VC	Saint Vincent and the Grenadines				
VE	Venezuela				
VG	Virgin Islands (British)				
VN	Viet Nam				
VU	Vanuatu				
WO	World Intellectual Property Organization (WIPO)				
WS	Samoa				
XN	Nordic Patent Institute (NPI)				
YE	Yemen				
ZA	South Africa				
ZM	Zambia				
ZW	Zimbabwe				

**NATIONAL INTELLECTUAL PROPERTY CENTER OF GEORGIA  
SAKPATENTI**

**OFFICIAL BULLETIN  
OF THE INDUSTRIAL PROPERTY**

**ОФИЦИАЛЬНЫЙ БЮЛЛЕТЕНЬ  
ПРОМЫШЛЕННОЙ СОБСТВЕННОСТИ**

**15(379)**

**INVENTIONS  
UTILITY MODELS  
DESIGNS  
TRADEMARKS**

**DATE OF PUBLICATION  
2013 08 12**

# CONTENTS

<b>PUBLISHED TITLES OF PROTECTION .....</b>	<b>2</b>
<b>INVENTIONS</b>	
▪ APPLICATIONS APPROVED FOR GRANTING PATENTS .....	4
▪ PATENTED INVENTIONS .....	9
<b>UTILITY MODELS</b>	
▪ APPLICATIONS APPROVED FOR GRANTING PATENTS .....	13
<b>DESIGNS</b>	
▪ APPLICATIONS APPROVED FOR REGISTRATION .....	14
▪ REGISTERED DESIGNS .....	17
▪ DESIGNS REGISTERED WITH THE INTERNATIONAL BUREAU CLAIMING PRIORITY ON THE TERRITORY OF GEORGIA .....	18
<b>TRADEMARKS</b>	
▪ APPLICATIONS FILED UNDER THE NATIONAL PROCEDURE APPROVED FOR REGISTRATION .....	65
▪ TRADEMARKS REGISTERED ACCORDING TO THE ACCELERATED PROCEDURE .....	70
▪ INTERNATIONAL TRADEMARKS FOR WHICH A DECISION ON GANTING PROTECTION IS TAKEN .....	72
▪ INTERNATIONAL TRADEMARKS PROTECTED IN GEORGIA .....	110
<b>OFFICIAL NOTIFICATIONS</b>	
<b>TRADEMARKS</b>	
▪ RENEWAL OF REGISTRATIONS .....	120
▪ CHANGES IN NAMES AND/OR ADDRESSES OF OWNERS.....	121
<b>LIST OF PATENT ATTORNEYS REGISTERED AS A RESULT OF THE CERTIFICATION OF PATENT ATTORNEYS CONDUCTED IN ACCORDANCE WITH THE STATUTE ON PATENT ATTORNEYS OF GEORGIA.....</b>	<b>125</b>
<b>CLASSIFICATION INDEXES</b>	
INVENTIONS .....	127
UTILITY MODELS .....	129
DESIGNS .....	130
TRADEMARKS .....	131

## **PUBLISHED TITLES OF PROTECTION**

### **INVENTIONS**

- **APPLICATIONS APPROVED FOR GRANTING PATENTS:**  
12814; 11983; 11805; 12780; 12825; 12464; 12229; 12534; 11975; 12540; 11978
- **PATENTED INVENTIONS:**  
5896-5910

### **UTILITY MODELS**

- **APPLICATION APPROVED FOR GRANTING PATENT:**  
12778; 12980

### **DESIGNS**

- **APPLICATIONS APPROVED FOR GRANTING PATENTS:**  
753; 742
- **REGISTERED DESIGNS:**  
552
- **DESIGNS REGISTERED WITH THE INTERNATIONAL BUREAU CLAIMING PRIORITY ON THE TERRITORY OF GEORGIA:**  
79610-79613; 79655, 79656; 79658; 80364; 80899; 79650; 79663; 79717; 80997; 81006; 81021; 79783; 79803-79806; 81039; 81051; 81062

### **TRADEMARKS**

- **APPLICATIONS FILED UNDER THE NATIONAL PROCEDURE APPROVED FOR REGISTRATION:**  
68812-68814; 68973; 69091, 69092; 69119-69122; 69149; 69167-69169; 69240; 69327, 69328; 69371; 69387; 69392; 69439, 69440; 69443; 69449, 69450; 69482; 69811; 70112, 70113; 66928\*; 67161\*
- **TRADEMARKS REGISTERED ACCORDING TO THE ACCELERATED PROCEDURE:**  
23866-23876
- **INTERNATIONAL TRADEMARKS FOR WHICH A DECISION ON GRANTING PROTECTIONS IS TAKEN:**  
67803; 67973; 68401; 68558; 68653, 68654; 68657; 68683; 68756-68763; 68836-68845; 68856-68870; 68965; 69000-69004; 69007-69016; 69089; 69093, 69094; 69096; 69103-69106; 69108; 69110-68113; 69266; 69430; 66542\*; 67105\*
- **INTERNATIONAL TRADEMARKS PROTECTED IN GEORGIA:**  
65914; 66032; 66151; 67027-67030; 67032; 67035; 67086; 67112-67114; 67116; 67322; 67400-67404; 67457-67459; 67473; 67491; 67493; 67515-67521; 67524-67526; 67530-67534; 67536; 67541-67547; 67552-67555; 67570-67577; 67620-67623; 67625; 67627; 67632; 67635; 67641; 67714-67721; 67724-67727; 67729-67738; 67741; 67809-67813; 67827-67830; 67833; 67835, 67836

---

# INVENTIONS

## APPLICATIONS APPROVED FOR GRANTING PATENTS

The decision can be appealed at the Chamber of Appeal of Sakpatenti within 3 months from the publication or at the Mtskheta District Court Administrative Cases Board (Address: №17, Samkhedro str., Mtskheta), within 1 month following the publication.

### PART A

#### A 01

(10) AP 2013 12814 A (51) Int. Cl. (2006)  
A 01 G 13/02

(21) AP 2012 012814 (22) 2012 07 31

- (71) Elguja Mezmariashvili (GE)  
M. Burdzglas q. 108, 0194 Tbilisi (GE);  
Nodar Tsignadze (GE)  
Gldanis Mas., III mkr., korp. 17, b. 65,  
0167 Tbilisi (GE);  
Nikoloz Mezmariashvili (GE)  
M. Burdzglas q. 108, 0194 Tbilisi (GE);  
Mamuka Sanikidze (GE)  
Akhalshebis q. 1, b. 28, 0171 Tbilisi (GE);  
Giorgi Mezmariashvili (GE)  
M. Burdzglas q. 108, 0194 Tbilisi (GE)
- (72) Elguja Mezmariashvili (GE)  
Nodar Tsignadze (GE);  
Nikoloz Mezmariashvili (GE);  
Mamuka Sanikidze (GE);  
Giorgi Mezmariashvili (GE)
- (74) Tina Chalauri

(54) **PLANT PROTECTING DEVICE,  
PARTICULARLY VINEYARD FROM  
HAIL**

(57) There is represented device comprising: posts 1 rows with wires 3 to fasten plants 2; longitudinal wires 5 with junction connecting thereto posts encompassing fruits 4 above from one or both sides; twistable protecting surface 6 connected to longitudinal wires; the latches 7 fixing twisted surface; edge componentry 8 existed on surface bottom to open it, executed as stems or conduits locked from one end to be filled with water; and turning arms 9 to twist protecting surface. The latches are hooks able to be open with hands from edge componentry executed as stems fastened to end posts, or flexible hooks able to be open from componentry by weight thereof. Componentry is executed as edge conduits to be filled with water. In the posts parts under latches the transversal curved wires 10 are installed to reach fruits and roll edge componentry on protecting surface at opening thereof. In the posts bottom, transversally, from one

to ground are fixed to hold protecting surface edge componentry.

Claims: 1 independent

Fig.: 3

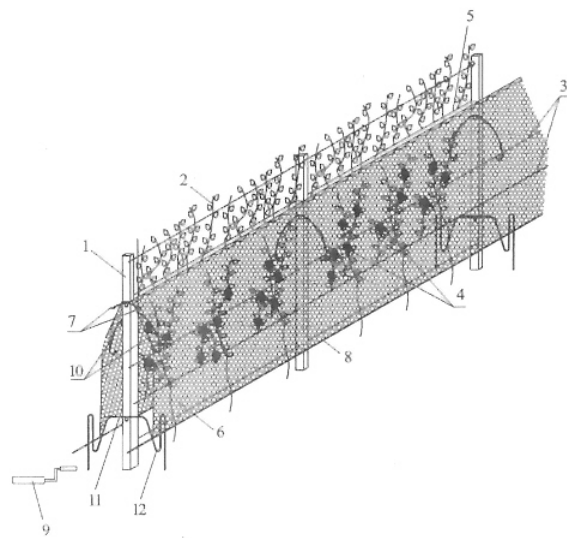

Fig. 1

**PART B****B 42****(10) AP 2013 11983 A (51) Int. Cl. (2006)****B 42 D 15/00****B 42 D 15/10****G 06 K 7/10****G 07 D 7/12****B 41 M 5/00****B 41 M 7/00****G 06 Q 10/00**

(21) AP 2009 011983 (22) 2009 04 02

(31) PCT/IB2008/000785

(32) 2008 04 02

(33) IB

(71) SICPA HOLDING SA (CH)

Avenue de Florissant 41, CH-1008 Prilly (CH)

(72) MARGUERETTAZ, Xavier (CH);

GREMAUD, Frédéric (CH);

COMMEUREUC, Aurélien (FR);

ABOUTANOS, Vickie (AU);

TILLER, Thomas (DE);

ROZUMEK, Olivier (CH)

(74) Alexander Gegechkori

(85) 2010 10 27

(86) PCT/EP2009/002435, 2009 04 02

**(54) IDENTIFICATION AND****AUTHENTICATION BY LIQUID****CRYSTAL MATERIAL MARKINGS****USAGE**

(57) An invention relates to marking with polymeric liquid crystal material having determined optical characteristics allowing authentication and reading thereby machine and authentication thereby human eye. Marking is applied onto item, good or article by variable information printing process. Marking is in the form of indicia, and represents unique code allowing easy authentication by human eye, and secure tracking and tracing of marked item, good or article during usage thereof.

Claims: 5 independent

12 dependent

Fig.: 5

**B 63****(10) AP 2013 11805 A (51) Int. Cl. (2006)****B 63 G 8/00****F 42 B 17/00****F 42 B 19/00**

(21) AP 2010 011805 (22) 2010 05 19

(71) Archil Geguchadze (GE)

Chekhovis q. 25, 4618 Kutaisi (GE);

Eruk Gabunia (GE)

Tavisuplebis q. 5, shes. 11, 4618 Kutaisi (GE)

(72) Archil Geguchadze (GE);

Eruk Gabunia (GE)

**(54) SUBMERSIBLE CRAFT WITH REACTIVE PROPELLER**

(57) There is represented submersible craft comprising case 1, stream maker executed as centrifugal impeller 2 and located in the center; bonnet front side thereof consists of conic and spherical rings 3 placed in each other like a jalousie. The case is covered with polymer elastomer layer 5, whereon the polymer flexible casing 6 is forced from external side. The rudders 8 are allocated in case back side.

Claims: 1 independent

Fig.: 3

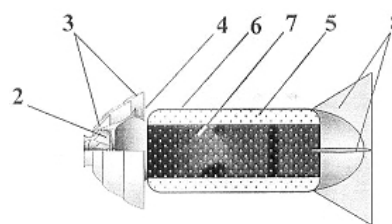

Fig. 2

**B 65****(10) AP 2013 12780 A (51) Int. Cl. (2006)****B 65 D 43/02****B 44 D 3/12**

(21) AP 2010 012780 (22) 2010 10 21

(31) 20 2009 016 507.8

(32) 2009 12 08

(33) DE

(71) ARDAGH MP GROUP NETHERLANDS

B.V. (NL)

Zutphenseweg 51051 NL-7418 AH

Deventer (NL)

(72) KLOSS, Uwe Ernst (DE);

HUBERT, Manfred (DE)

(74) Liliana Darakhvelidze

(85) 2012 07 05

(86) PCT/EP2010/065878, 2010 10 21

**(54) CONTAINER HAVING RELOCKABLE****LID PROVIDED WITH RESILIENT RING**

(57) There is represented container 1 comprising: metal receiving body 2 having peripheral upper edge 6 delimiting upper opening 7, and provided with outward projection 8, and lid 3, which is metallic cover provided with resilient ring 12. Ring comprises locking part 21 having lower free edge 23, and is separated into two annular portions 25, 26 by annular folding line 24. Lower portion 26 is foldable around folding line between two stable positions. Furthermore, ring locking part is provided with locking means engaged with outward projection, it comprises several beads 28 arranged around inner surface of lower portion at distance from each other according



to plan extending at distance from ring lower free edge; also it is provided with several orifices 29 arranged around ring locking part at distance from each other and extending at distance from ring lower free edge; at that, orifices extending through locking part, at least over upper and lower portions height part.

Claims: 3 independent

10 dependent

Fig.: 7

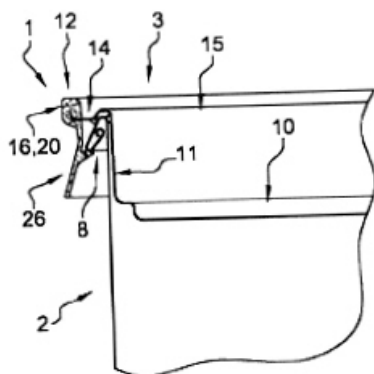

Fig. 6

## PART C

### C 07

(10) AP 2013 12825 A (51) Int. Cl. (2006)  
C 07 B 59/00

(21) AP 2012 012825 (22) 2012 08 10

(71) Zurab Japaridze (GE)  
Vazha-Pshavelas I Shesakh. 3, b. 9, 0186  
Tbilisi (GE);

Guram Maisuradze (GE)

I.Abashidzis q. 22a, b. 2, 0179

Tbilisi (GE);

Irakli Gamkrelidze (GE)

Zakariadzis q. 10, 0177 Tbilisi (GE)

(72) Zurab Japaridze (GE);

Guram Maisuradze (GE);

Irakli Gamkrelidze (GE)

(54) **METHOD OF NATURAL OPIOID  
ALKALOID LABELING**

(57) The method provides labeling alkaloid with isotope 15N, at the condition of plant cultivation containing opioid alkaloid by soil fertilization with nitrogen fertilizers containing isotope 15N.

Claims: 1 independent

1 dependent

(10) AP 2013 12464 A (51) Int. Cl. (2006)  
C 07 C 31/08  
C 07 C 29/76

(21) AP 2011 012464 (22) 2011 11 21

(71) Giga Kasradze (GE)

Pekinis Gamz. 41, "b" korp., b. 321,  
0160 Tbilisi (GE)

(72) Giga Kasradze (GE)

(54) **COMPLEX METHOD OF ALCOHOL  
FILTRATION TO OBTAIN RAW FOR  
HIGH QUALITY ALCOHOLIC  
BEVERAGE PRODUCTION**

(57) The method provides: alcohol refinement with activated carbon; burnt clay powder and potassium permanganate water solution addition on refined alcohol; heating received mix to 50°C with intensive stirring; then, honey addition thereto, and heating to 65-80°C; then, cooling to room temperature; decantation and filtration thereof; at that, components on 100 dal alcohol are taken with following correlation in mass%:

Carbon powder	1-3
Clay powder	10-30
Potassium permanganate water solution	0,1-0,3
Honey	50-100

Claims: 1 independent

## PART F

### F 03

(10) AP 2013 12229 A (51) Int. Cl. (2006)  
F 03 D 3/06

(21) AP 2011 012229 (22) 2011 05 19

(62) 11804 2010 05 19 (GE);

12229/01 2011 05 19 (GE)

(71) Koba Bitsadze (GE)

Varketili-3, I mkr., korp. 32, b. 69,  
0163 Tbilisi (GE)

(72) Koba Bitsadze (GE)

(54) **COMBINED TURBINE**

(57) There is represented turbine comprising: frame 1 having axis, blades 2 fixed circularly thereon and parallel axis, propellers 3 hinged between them perpendicularly on frame axis or on blades. Couple of engaged centrifuge turbines 4 are rigidly amounted on frame axis or on blades between propellers parallel thereof and perpendicularly blades. At that, the propellers are assigned to supply space between propellers on centrifuge turbine blades with air flow, and blades and centrifuge turbine are assigned to start rotation.

Claims: 1 independent

Fig.: 1

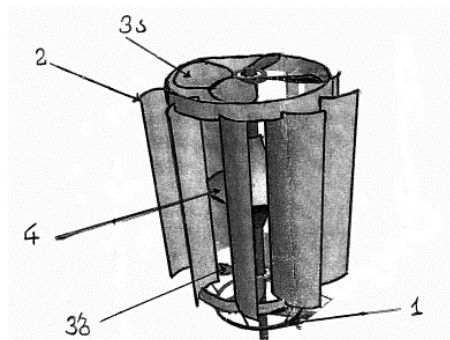

Fig. 1

**F 42**

(10) AP 2013 12534 A (51) Int. Cl. (2006)  
F 42 B 5/02

(21) AP 2012 012534 (22) 2012 01 16

(71) Robert Burchuladze (GE)

Razmadzis q. 68, 0179 Tbilisi (GE)

(72) Robert Burchuladze (GE)

(54) **SCREW-MUZZLE FIREARMS  
CARTRIDGE**

(57) There is represented a cartridge comprising bullet of  $d=8,61$  diameter and cartridge-case; at that, it is executed so, that bullet diameter correlation with those cartridge-case geometrical parameters, such as  $d^1$ -cartridge-case collar diameter at the place of its connection with bullet,  $d^2$ -cartridge-case collar diameter,  $d^3$ -cartridge-case general case diameter at the place of connection therewith cartridge-case collar,  $d^4$ -cartridge-case general case diameter at the place of connection therewith cartridge-case bottom,  $d^5$ -cartridge-case bottom diameter,  $h$ -cartridge-case height,  $h^1$ -cartridge-case conic area height,  $h^2$ -cartridge-case collar height is, appropriately:

$$d/d^1=0.916\pm 0.0137$$

$$d/d^2=0.911\pm 0.0137$$

$$d/d^3=0.561\pm 0.0137$$

$$d/d^4=0.532\pm 0.0137$$

$$d/d^5=0.530\pm 0.0137$$

$$d/h=0.170\pm 0.0137$$

$$d/h^1=1.208\pm 0.0137$$

$$d/h^2=0.957\pm 0.0137$$

Claims: 1 independent

Fig.: 2

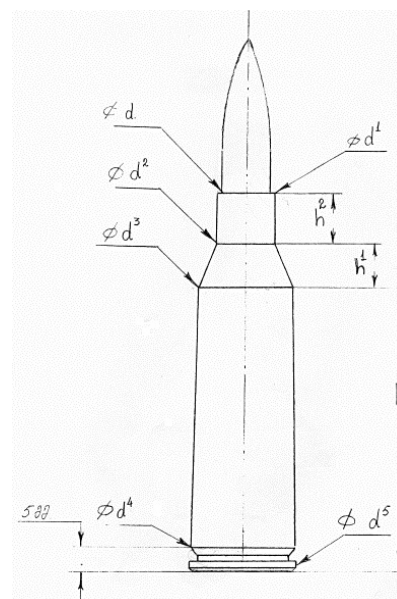

Fig. 2

**PART G****G 07**

(10) AP 2013 11975 A (51) Int. Cl. (2006)  
G 07 D 7/20  
G 06 Q 10/00  
G 06 K 9/64

(21) AP 2008 011975 (22) 2008 10 14

(31) PI 0800754-3

(32) 2008 03 25

(33) BR

(71) SICPA HOLDING SA (CH)

Avenue de Florissant 41, CH-1008 Prilly (CH)

(72) SCHEID BUDZINSKI, João Augusto (BR);

AMON, Philippe (CH);

SETO, Myron (CH)

(74) Alexander Gegechkori

(85) 2010 10 19

(86) PCT/IB2008/002713, 2008 10 14

(54) **METHOD AND SYSTEM CONTROLLING  
ITEM PRODUCTION**

(57) The method provides item production control on production line, wherein each item digital image is processed to obtain, at least identified product type and item data. Identified product type and item data being further used to determine very exactly reliable production volume per product type and per associated item.

Claims: 2 independent

32 dependent

Fig.: 4

**PART H****H 02**

(10) AP 2013 12540 A (51) Int. Cl. (2006)  
H 02 K 33/14

(21) AP 2012 012540 (22) 2012 01 18

(71) Gela Javakhishvili (GE)

Bukhaidzis q. 18, 0102 Tbilisi (GE)

(72) Gela Javakhishvili (GE)

(54) **ELECTROMAGNETIC VIBRATOR**

(57) There is represented a vibrator comprising stator I and armature II. The poles divided on two groups are executed on the stator. The 1-1, 1-2, 1-3 and 1-4 identical scrolls are allocated on stator general poles I-1, I-2, I-3 and I-4, appropriately; at that, the 1-1, 1-3 and 1-2, 1-4 scrolls are switched to each other in sequence. Stator second group poles have two additional poles I-5 and I-6. Adjuster componentry are switched to stator 1-1 and 1-2 scrolls in sequence. The componentry are executed as semiconductor diodes 3-1 and 3-2. Joints of stator scrolls 1-3, 1-4 and semiconductor diodes 3-1 and 3-2 are connected to feeding source clips 7-1, 7-2. The armature is forced onto a shaft 4, whereon lever 5 one side is rigid with dowel 2, and another side is dammed from both sides with springs 6-1 and 6-2. The stator is placed on a case III rigid onto the riser IV. The stator and the armature are symmetrical to vertical Y axis passed on their center and horizontal X axis. Stator additional poles are formed so, that working area instantaneous meaning and air hole size are constant between armature horizontal and stator additional poles at armature angular oscillation.

Claims: 1 independent

Fig.: 1

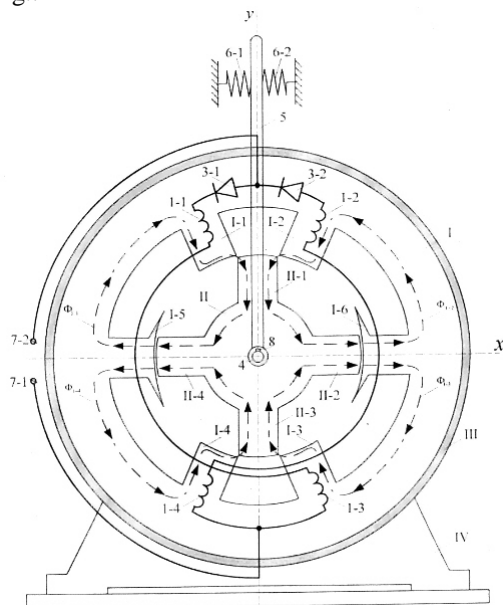

Fig. 1

**H 05**

(10) AP 2013 11978 A (51) Int. Cl. (2006)  
H 05 H 1/00

(21) AP 2010 011978 (22) 2010 10 21

(71) Archil Prangishvili (GE)

Psteris q. 1a, b. 20, 0102 Tbilisi (GE);

Zurab Gasitashvili (GE)

Didi Dighomi, Demetre Tavdadebulis q. 14, b. 7, 0131 Tbilisi (GE);

Giorgi Gelenidze (GE)

Rustavis Gzatk. 40a, b. 32, 0165 Tbilisi (GE);

Davit Gelenidze (GE)

Rustavis Gzatk. 28, b. 57, 0165 Tbilisi (GE);

Guram Gogia (GE)

Oniashvilis q. 13, 0175 Tbilisi (GE);

Medgar Gelenidze (GE)

Rustavis Gzatk. 28, b. 57, 0165 Tbilisi (GE)

(72) Archil Prangishvili (GE);

Zurab Gasitashvili (GE);

Giorgi Gelenidze (GE);

Davit Gelenidze (GE);

Guram Gogia (GE);

Medgar Gelenidze (GE)

(54) **METHOD TO OBTAIN SOLID MATTER  
PLASMA**

(57) The method provides solid matter separately preliminary heating, melting, boiling, evaporating and making vapor current therefrom. Making plasma current is executed by passing of received vapor current throughout plasmatron.

Claims: 1 independent

Fig.: 2

## PATENTED INVENTIONS

### PART A

#### A 61

**(11) P 2013 5900 B**      **(51) Int. Cl. (2006)**  
**A 61 K 31/01**  
**A 61 K 31/047**  
**A 61 P 17/02**  
**A 61 P 17/06**  
**A 61 K 8/30**  
**A 61 K 8/92**

(10) AP 2013 12036 A      (44) 8(372)/2013  
(21) AP 2009 012036  
(22) 2009 05 18  
(24) 2009 05 18  
(31) 0853187  
(32) 2008 05 16  
(33) FR  
(86) PCT/EP2009/056021, 2009 05 18  
(73) PIERRE FABRE DERMO-COSMETIQUE  
(FR)  
45, Place Abel Gance, F-92100 BOULOGNE  
(FR)  
(72) Pierre FABRE (FR);  
Christopher PRZYBYLSKY (FR);  
Jean-François CORDOLIANI (FR);  
Marion COPEC (FR)  
(74) George Meipariani  
(54) **EMOLLIENT COMPOSITION**

---

**(11) P 2013 5901 B**      **(51) Int. Cl. (2006)**  
**A 61 K 35/14**  
**A 61 P 3/10**  
**A 61 P 25/02**

(10) AP 2013 12208 A      (44) 8(372)/2013  
(21) AP 2009 012208  
(22) 2009 09 29  
(24) 2009 09 29  
(31) 08165446.9; 09160858.8  
(32) 2008 09 20; 2009 05 20  
(33) EP; EP  
(86) PCT/DK2009/050251, 2009 09 29  
(73) NYCOMED AUSTRIA GMBH (AT)  
St. Peter Strasse 25, A-4020 Linz (AT)  
(72) Lusine MOVSESYAN (DK)  
(74) Tamaz Shilakadze  
(54) **DEPROTEINISED CALF BLOOD  
PREPARATION USAGE AT DIABETIC  
PERIPHERAL POLYNEUROPATHY  
PREVENTION OR TREATMENT**

**(11) P 2013 5902 B**      **(51) Int. Cl. (2006)**  
**A 61 M 5/32**

(10) AP 2013 12238 A      (44) 8(372)/2013  
(21) AP 2009 012238  
(22) 2009 11 23  
(24) 2009 11 23  
(31) 61/117, 849  
(32) 2008 11 25  
(33) US  
(86) PCT/US2009/065540, 2009 11 23  
(73) RETRACTABLE TECHNOLOGIES, INC  
(US)  
511 Lobo Lane, Little Elm, TX 75068 (US);  
SHAW, Thomas, J (US)  
5310 Buena Vista, Frisco, TX 75034 (US)  
(72) Thomas, J. SHAW (US);  
Ni Zhu (US);  
Steven, R. WISNER (US);  
Mark SMALL (US)  
(74) Alexander Gegechkori  
(54) **INJECTION SYRINGE FOR  
THERAPEUTIC AGENT**

---

**(11) P 2013 5908 B**      **(51) Int. Cl. (2006)**  
**A 61 M 5/178**

(10) AP 2013 12495 A      (44) 8(372)/2013  
(21) AP 2010 012495  
(22) 2010 04 27  
(24) 2010 04 27  
(31) 12/464555  
(32) 2009 05 12  
(33) US  
(86) PCT/US2010/032474, 2010 04 27  
(73) RETRACTABLE TECHNOLOGIES, INC  
(US)  
511 Lobo Lane, Little Elm, TX 75068 (US)  
(72) Thomas J. Shaw (US);  
Kathryn, Margaret DUESMAN (US);  
Ni Zhu (US)  
(74) Alexander Gegechkori  
(54) **IV CATHETER INTRODUCER**

**PART B****B 21**

- (11) P 2013 5899 B (51) Int. Cl. (2006)  
B 21 D 41/02  
B 21 D 51/16
- (10) AP 2013 12009 A (44) 8(372)/2013  
(21) AP 2009 012009  
(22) 2009 04 21  
(24) 2009 04 21  
(31) 08007747.2  
(32) 2008 04 22  
(33) EP  
(86) PCT/EP2009/002988, 2009 04 21  
(73) IMPRESS GROUP B.V. (NL)  
Zutphenseweg 51051, 7400 AH Deventer (NL)  
(72) Johan, Willem ROETERDINK (NL)  
(74) Tamaz Shilakadze  
(54) **METHOD AND APPARATUS  
EXPANDING CONTAINER BODY  
RADIALLY**

**PART C****C 07**

- (11) P 2013 5903 B (51) Int. Cl. (2006)  
C 07 C 231/18  
C 07 C 233/58  
C 07 C 237/20
- (10) AP 2013 12350 A (44) 8(372)/2013  
(21) AP 2010 012350  
(22) 2010 01 29  
(24) 2010 01 29  
(31) 0950552  
(32) 2009 01 29  
(33) FR  
(86) PCT/EP2010/051045, 2010 01 29  
(73) PIERRE FABRE MEDICAMENT (FR)  
45, Place Abel Gance, 92100 Boulogne-  
Billancourt (FR)  
(72) Marc NICOLAS (FR);  
Paul HELLIER (FR);  
Catherine DIARD (FR);  
Laurent SUBRA (FR)  
(74) George Meipariani  
(54) **METHOD OF (1S, 2R)-MILNACIPRAN  
SYNTHESIS**

- (11) P 2013 5897 B (51) Int. Cl. (2006)  
C 07 D 211/90  
A 61 K 31/4422
- (10) AP 2013 12362 A (44) 7(371)/2013  
(21) AP 2010 012362  
(22) 2010 03 11  
(24) 2010 03 11  
(31) 09154872.7; 0915919197.4; 09173816.1  
(32) 2009 03 11; 2009 04 30; 2009 10 22  
(33) EP; EP; EP  
(86) PCT/EP2010/053094, 2010 03 11  
(73) "GRINDEKS", A JOINT STOCK COMPANY  
(LV)  
53, Krustpils Street, 1057 Riga (LV)  
(72) Gunars DUBURS (LV);  
Eglis BISENIEKS (LV);  
Ilmars STONANS (LV);  
Irina SESTAKOVA (LV);  
Ivars KALVINS (LV);  
Brigrita VIGANTE (LV);  
Janis ULDRIKIS (LV);  
Imanta BRUVERE (LV);  
Janis POIKANS (LV);  
Ilona DOMRACEVA (LV);  
Elina JASCENKO (LV)  
(74) Khatuna Imnadze  
(54) **5-FLUOROURACIL AND 1,4-  
DIHYDROPYRIDINE  
PHARMACEUTICAL COMPOUND AND  
APPLICATION THEREAT CANCER  
TREATMENT**

- (11) P 2013 5907 B (51) Int. Cl. (2006)  
C 07 D 401/04  
C 07 D 401/14  
A 61 K 31/454  
A 61 K 31/4545  
A 61 P 3/10
- (10) AP 2013 12490 A (44) 8(372)/2013  
(21) AP 2010 012490  
(22) 2010 05 27  
(24) 2010 05 27  
(31) 61/184355; 61/257621  
(32) 2009 06 05; 2009 11 03  
(33) US; US  
(86) PCT/IB2010/052377, 2010 05 27  
(73) PFIZER INC (US)  
235, East 42nd Street, New York, NY 10017  
(US)  
(72) Michael Pol DENINO (US);  
Kentaro FUTATSUGI (JP);  
Daniel Voi-Cung KUNGI (US);  
Bruce Allen LEFKER (US);  
Vincent MASCITTI (FR);  
Kim Francis MCCLURE (US);  
Michael, John MUNCHHOF(US);  
Ralph Pelton ROBINSON, Jr. (US)

(74) Shalva Gvaramaze  
 (54) **L-(PIPERIDIN-4-YL)-PYRAZOLE  
 DERIVATIVES AS GPR 119  
 MODULATORS**

---

**(11) P 2013 5898 B** (51) **Int. Cl. (2006)  
 C 07 D 498/00**  
 (10) AP 2013 11948 A (44) 8(372)/2013  
 (21) AP 2009 011948  
 (22) 2009 02 25  
 (24) 2009 02 25  
 (31) 61/031,329  
 (32) 2008 02 25  
 (33) US  
 (86) PCT/US2009/035192, 2009 02 25  
 (73) SALIX PHARMACEUTICALS, LTD. (US)  
 1700 Perimeter Park Drive, Morrisville, NC  
 27560 (US)  
 (72) Karen, S. GUSHURST (US);  
 Donglai YANG (US);  
 Melanie ROE (US);  
 Nathan SCHULTHEISS (US);  
 Petinka VLAHOVA (US);  
 Jeffrey, S STULTS (US);  
 Travis, L. HOUSTON (US)  
 (74) Tamaz Shilakadze  
 (54) **RIFAXIMIN FORMS AND USAGE**

---

**C 22**

**(11) P 2013 5906 B** (51) **Int. Cl. (2006)  
 C 22 C 38/00**  
 (10) AP 2013 12479 A (44) 8(372)/2013  
 (21) AP 2011 012479  
 (22) 2011 11 30  
 (24) 2011 11 30  
 (73) LEPL "FERDINAND TAVADZE INSTITUTE  
 OF METALLURGY AND MATERIALS  
 SCIENCE" (GE)  
 Al. Kazbegis Gamz. 15, 0160,  
 Tbilisi (GE)  
 (72) Giorgi Tavadze (GE);  
 Otar Okrostsvardze (GE);  
 Avtandil Khvadagiani (GE);  
 Ioseb Tsintsadze (GE);  
 Anzor Gabisiani (GE);  
 Zangiz Mushkudiani (GE);  
 Neli Gonjilashvili (GE);  
 Londa Tavadze (GE)  
 (54) **LOW-ALLOY STEEL OF HIGH  
 STRENGTH**

---

**PART E****E 04**

**(11) P 2013 5904 B** (51) **Int. Cl. (2006)  
 E 04 B 1/36  
 E 04 B 1/98  
 E 04 H 9/02**  
 (10) AP 2013 12367 A (44) 8(372)/2013  
 (21) AP 2009 012367  
 (22) 2009 02 16  
 (24) 2009 02 16  
 (31) 12367/1-GE  
 (32) 2011 09 12  
 (33) GE  
 (86) PCT/TR2009/000027, 2009 02 16  
 (73) DICLELI (TR)  
 OrtaDoguTeknikUniversitesi,  
 MuhendislikBulimleriBolumu, 06531 Ankara  
 (TR)  
 (72) Ali MILANI SALEM (IR)  
 (74) Givi Akopashvili  
 (54) **MULTI-DIRECTIONAL TORSIONAL  
 HYSTERETIC DAMPER (MTHD)**

---

**PART F****F 02**

**(11) P 2013 5896 B** (51) **Int. Cl. (2006)  
 F 02 C 7/055**  
 (10) AP 2013 11864 A (44) 7(371)/2013  
 (21) AP 2010 011864  
 (22) 2010 06 24  
 (24) 2010 06 24  
 (73) Tamaz Muchiashvili (GE)  
 Galavnis k. 18, 0103, Tbilisi (GE)  
 (72) Tamaz Muchiashvili (GE)  
 (54) **TURBOPROP**

---

**F 03**

**(11) P 2013 5905 B** (51) **Int. Cl. (2006)  
 F 03 D 1/02**  
 (10) AP 2013 12422 A (44) 8(372)/2013  
 (21) AP 2011 012422  
 (22) 2011 10 20  
 (24) 2011 10 20

- (73) Shota Khutsishvili (GE)  
Shkhepis k.3, 0105, Tbilisi (GE)  
(72) Shota Khutsishvili (GE)  
(54) **WIND POWER PLANT WITH ARIABLE  
DIAMATER**
- 

## **F 16**

- (11) P 2013 5910 B (51) Int. Cl. (2006)  
F 16 H 3/00**  
(10) AP 2013 12585 A (44) 8(372)/2013  
(21) AP 2012 012585  
(22) 2012 02 20  
(24) 2012 02 20  
(73) Revaz Varsimashvili (GE)  
Vazha-Pshavela V quartal, build. 4, ap. 82,  
0186, Tbilisi (GE);  
Merab Kakhiani (GE)  
Sulkhan Tsintsadzis q. 56, b. 1, 0160,  
Tbilisi (GE);  
Zurab Varsimashvili (GE)  
Mtskhetis q. 20, b. 34, 0179, Tbilisi (GE);  
Revaz Kakhiani (GE)  
Sulkhan Tsintsadzis q. 56, b. 1, 0160,  
Tbilisi (GE);  
Akaki Kakhiani (GE)  
Sulkhan Tsintsadzis q. 56, b. 1, 0160,  
Tbilisi (GE);  
(72) Revaz Varsimashvili (GE);  
Merab Kakhiani (GE);  
Zurab Varsimashvili (GE);  
Revaz Kakhiani (GE);  
Akaki Kakhiani (GE)  
(54) **ALTERNATE DRIVE RELATIONAL  
GEAR DRIVE**
- 

## **PART H**

### **H 02**

- (11) P 2013 5909 B (51) Int. Cl. (2006)  
H 02 N 11/00**  
(10) AP 2013 12508 A (44) 8(372)/2013  
(21) AP 2011 012508  
(22) 2011 12 20  
(24) 2011 12 20  
(73) Jemal Gogisvanidze (GE)  
Vazisubnis Dasakhleba, korp 2a, b. 43,  
0152, Tbilisi (GE)  
(72) Jemal Gogisvanidze (GE)  
(54) **ELECTROMAGNETIC ENGINE**
-

# UTILITY MODELS

## APPLICATION APPROVED FOR GRANTING PATENT

The decision can be appealed at the Chamber of Appeal of Sakpatenti within 3 months from the publication or at the Mtskheta District Court Administrative Cases Board (Address: №17, Samkhedro str., Mtskheta), within 1 month following the publication.

### PART A

#### A 23

(10) AU 2013 12778 U (51) Int. Cl. (2006)

A 23 K 1/16

A 23 K 1/175

(21) AU 2012 012778 (22) 2012 07 04

(71) Iamze Beshkenadze (GE)

Vazisubani, IV mkr., I kvart., korp. 8,  
b. 99, 0152 Tbilisi (GE)

(72) Iamze Beshkenadze (GE);

Spartak Urotadze (GE);

Nani Zhorzholiani (GE);

Maia Gogaladze (GE);

Givi Begheluri (GE);

Nana Osipova (GE);

Tamar Kvernadze (GE)

(54) **BIRD MEAL CHEMICAL ADDITIVE  
CONTAINING CHELATES**

(57) There is represented chemical additive containing: Ca glutaminat, Mg and Cu methioninat, Mn, Zn, Fe, and Co methionine citrates for g/100kg combined meal with following ratio of components in parts by weight:

Ca•Gl•4H<sub>2</sub>O 37,3-51,62

Mg•(Mt)<sub>2</sub>•4H<sub>2</sub>O 65,94-91,26

Cu•(Mt)<sub>2</sub>•2H<sub>2</sub>O 3,6-4,98

Mn<sub>2</sub>•Mt<sub>2</sub>•L•4H<sub>2</sub>O 30,73-42,53

Zn<sub>2</sub>•Mt<sub>2</sub>•L•2H<sub>2</sub>O 19,86-27,48

Fe<sub>2</sub>•Mt<sub>2</sub>•L•6H<sub>2</sub>O 18,22-25,22

Co<sub>2</sub>•Mt<sub>2</sub>•L•4H<sub>2</sub>O 0,1659-0,2296

Claims: 1 independent

#### A 47

(10) AU 2013 12980 U (51) Int. Cl. (2006)

A 47 J 37/07

(21) AU 2013 012980 (22) 2013 01 28

(71) Iuza Natsvlishvili (GE)

Krtsanisis q. korp. 3a, b. 8, 0114 Tbilisi (GE)

(72) Iuza Natsvlishvili (GE)

(54) **DISPOSABLE TRANSPORTABLE  
DEVICE FOR FOODSTUFFS  
THERMAL PROCESSING**

(57) There is represented device containing cardboard case 1 having bottom 2, walls 3 and 4, and torsion walls 5 and 6. Internal area between case bottom and walls is burning zone. Also, the device comprises skewers and means 7 for their allocation, which is executed as wire-bar carcass. The carcass is tight-fitting in the case so, that surface formed by carcass parts, whereon the skewers are allocated is placed on plane parallel wall edges or above. Also, the device comprises cardboard cap 8, whereon cut 9 is executed, and paper container with solid fuel. The cut is assigned to pass arm 10 fixed on the case.

Claims: 1 independent

5 dependent

Fig.: 4

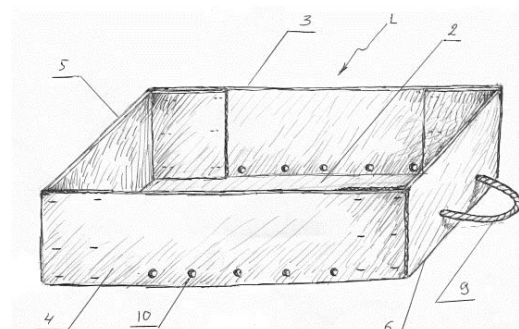

Fig. 2



---

# DESIGNS

## APPLICATION APPROVED FOR REGISTRATION

The decision can be appealed at the Chamber of Appeal of Sakpatenti within 3 months from the publication or at the Mtskheta District Court Administrative Cases Board (Address: №17, Samkhedro str., Mtskheta), within 1 month following the publication.

- (10) AD 2013 753 S (51) 07-01  
(21) AD 2013 000753  
(22) 2013 05 29  
(28) 3  
(71) Davit Donadze (GE)  
Pekinis q. 9, b. 34, 0160 Tbilisi (GE)  
(72) Davit Donadze (GE)  
(54) **DRINKING BOWL**  
(55)



1.1



1.2



1.3



1.4



1.5



1.6



2.1



2.2



2.3



2.4



3

(10) AD 2013 742 S (51) 19-08

(21) AD 2013 000742

(22) 2013 03 26

(28) 5

(71) Irakli Kiria (GE)

G. Dzotsenidzis q. 5, b. 29, 0183 Tbilisi (GE)

(72) Irakli Kiria (GE)

(74) George Taktakishvili

(54) BOTTLE LABEL

(55)



## REGISTERED DESIGNS

- (11) D 2013 552 S**      **(51) 20-03**  
(10) AD 2013 736 S      (44) 8(372)/2013  
(21) AD 2013 000736  
(22) 2013 02 13  
(24) 2013 02 13  
(18) 2018 02 13  
(73) Nugzar Gogua (GE)  
    Tsutskiridze Lane 4, 0103, Tbilisi (GE)  
(72) Nugzar Gogua (GE)  
(54) **FLAG STAND**
-

**DESIGNS, WHICH HAVE BEEN REGISTERED WITH THE INTERNATIONAL  
BUREAU CLAIMING PRIORITY ON THE TERRITORY OF GEORGIA**

(IN ACCORDANCE WITH THE HAGUE ACT OF 1960 AND/OR GENEVA ACT OF THE HAGUE  
AGREEMENT OF 1999)

The decision can be appealed at the Chamber of Appeal of Sakpatenti within 3 months from the publication or at the Mtskheta District Court Administrative Cases Board (Address: №17, Samkhedro Str., Mtskheta), within 1 month following the publication.

(11) DM/079610

(51) 10-02

(15) 2012 11 30

(45) 2013/21 (2013 05 31)

(22) 2012 11 30

(28) 7

(73) SWATCH AG (SWATCH SA) (SWATCH LTD.)

Jakob-Stämpfli-Strasse 94, CH-2502 BIEL/BIENNE (CH)

(85) CH

(86) CH

(87) CH

(88) CH

(89) CH

(81) II. BZ, MA, III. AL, AM, AZ, BA, CH, EM, GE, HR, KG, LI, MC, MD, ME, MK, MN, NO, OM, SG, TJ, TN, TR, UA

(72) N° 1, 2, 3: Patrizio Vita, c/o Swatchlab, Via Archimede 6, IT-20129 Milano; N° 4, 5: Rossana Boffi, c/o Swatchlab, Via Archimede 6, IT-20129 Milano; N° 6, 7: Francesca Errani, c/o Swatchlab, Via Archimede 6, IT-20129 Milano

(54) 1.-7. Wristwatches

(55)



(11) DM/079611

(15) 2012 11 30

(22) 2012 11 30

(28) 2

(73) SWATCH AG (SWATCH SA) (SWATCH LTD.)

Jakob-Stämpfli-Strasse 94, CH-2502 BIEL/BIENNE (CH)

(85) CH

(86) CH

(87) CH

(88) CH

(89) CH

(81) II. BZ, MA. III. AL, AM, AZ, BA, CH, EM, GE, HR, KG, LI, MC, MD, ME, MK, MN, NO, OM, SG, TJ, TN, TR, UA

(72) N° 1, 2: Andrea Arrigoni

c/o Swatchlab, Via Archimede 6, IT-20129 Milano

(54) 1.-2. Wristwatches

(55)

(51) 10-02

(45) 2013/21 (2013 05 31)



**(11) DM/079612**

(15) 2012 11 30

(22) 2012 11 30

(28) 2

(73) SWATCH AG (SWATCH SA) (SWATCH LTD.)

Jakob-Stämpfli-Strasse 94, CH-2502 BIEL/BIENNE (CH)

(85) CH

(86) CH

(87) CH

(88) CH

(89) CH

(81) II. BZ, MA. III. AL, AM, AZ, BA, CH, EM, GE, HR, KG, LI, MC, MD, ME, MK, MN, NO, OM, SG, TJ, TN, TR, UA

(72) N°1: Lorenzo Vallone, c/o Swatchlab, Via Archimede 6, I-20129 Milano; N° 2: Francesca Errani,

c/o Swatchlab, Via Archimede 6, IT-20129 Milano

(54) 1.-2. Wristwatches

(55)

**(51) 10-02**

(45) 2013/21 (2013 05 31)



1

2

---

**(11) DM/079613**

(15) 2012 11 30

(22) 2012 11 30

(28) 1

(73) SWATCH AG (SWATCH SA) (SWATCH LTD.)

Jakob-Stämpfli-Strasse 94, CH-2502 BIEL/BIENNE (CH)

(85) CH

(86) CH

(87) CH

(88) CH

(89) CH

(81) II. BZ, MA. III. AL, AM, AZ, BA, CH, EM, GE, HR, KG, LI, MC, MD, ME, MK, MN, NO, OM, SG,  
TJ, TN, TR, UA

(72) N° 1: Andrea Arrigoni

c/o Swatchlab, Via Archimede 6, IT-20129 Milano

(54) 1. Wristwatch

(55)

**(51) 10-02**

(45) 2013/21 (2013 05 31)



1

---



(11) DM/079655

(51) 10-02

(15) 2012 11 28

(45) 2013/21 (2013 05 31)

(22) 2012 11 28

(28) 3

(73) SWATCH AG (SWATCH SA) (SWATCH LTD)

Jakob-Stämpfli-Strasse 94, CH-2502 Biel/Bienne (CH)

(85) CH

(86) CH

(87) CH

(88) CH

(89) CH

(81) II. BZ, MA, III. AL, AM, AZ, BA, CH, EM, GE, HR, KG, LI, MC, MD, ME, MK, MN, NO, OM, SG, TJ, TN, TR, UA

(72) Damien Goyet

Rue Principale 45, FR-68480 Winkel (France)

(54) 1.-3. Watches

(55)

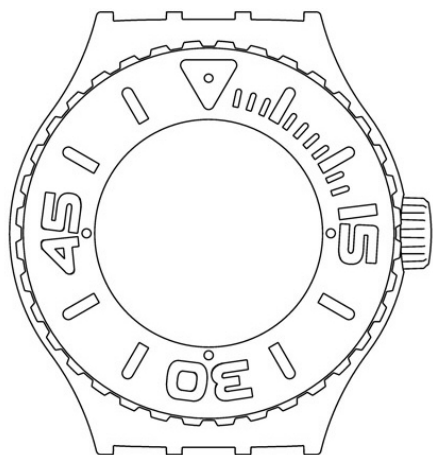

1.1

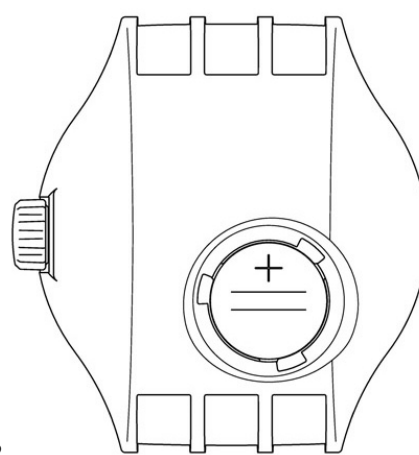

1.2

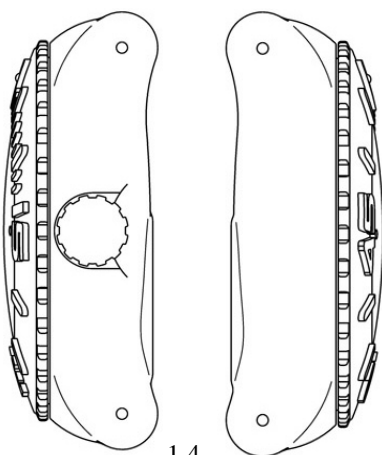

1.3

1.4

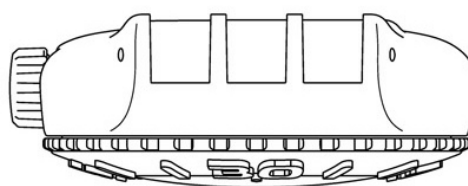

1.5

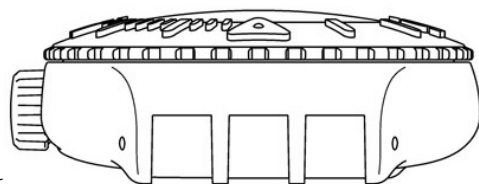

1.6

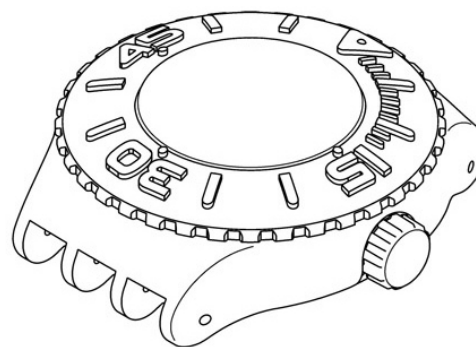

1.7

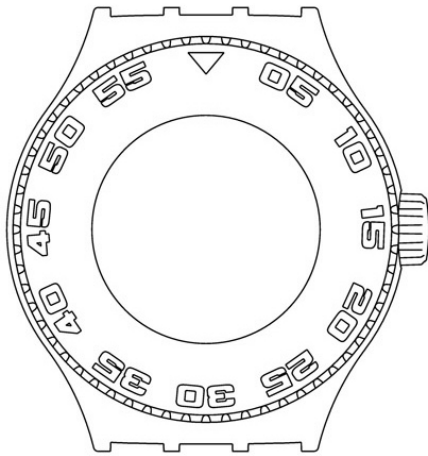

2.1

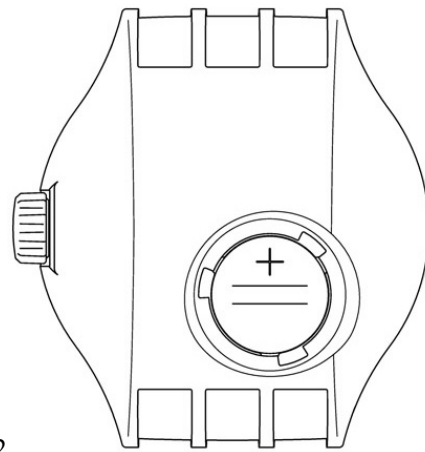

2.2

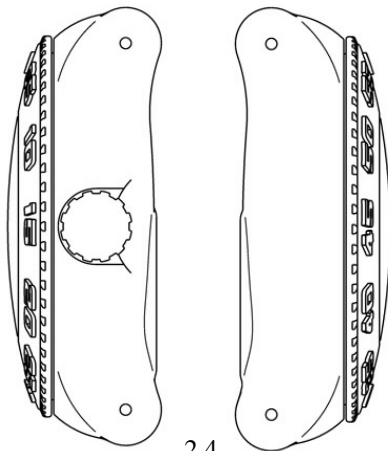

2.3

2.4

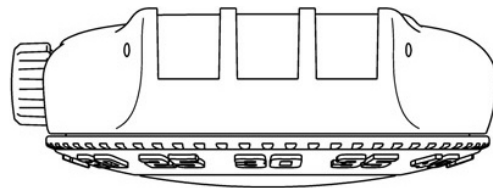

2.5

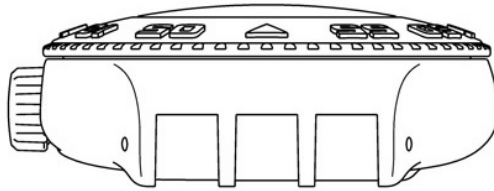

2.6

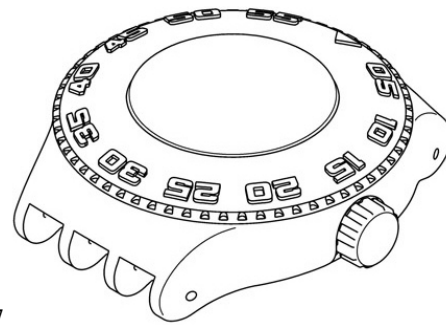

2.7

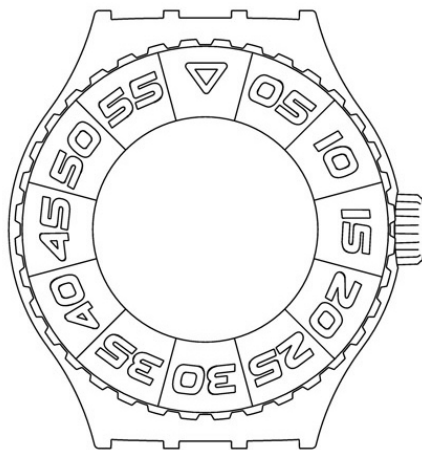

3.1

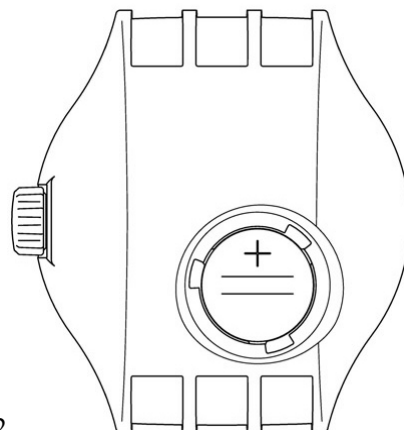

3.2

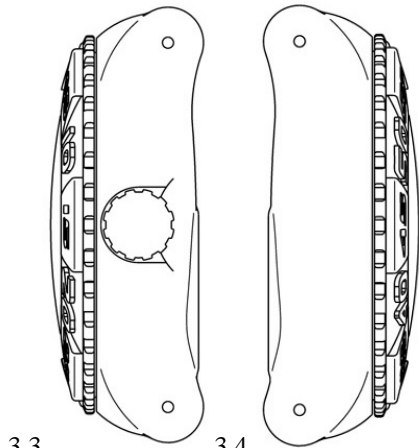

3.3

3.4

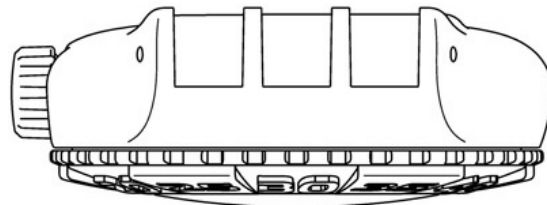

3.5

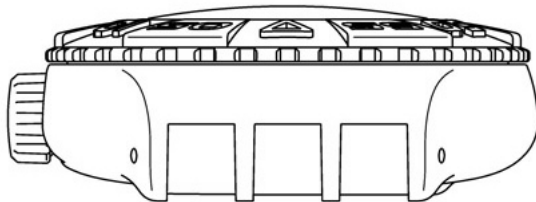

3.6

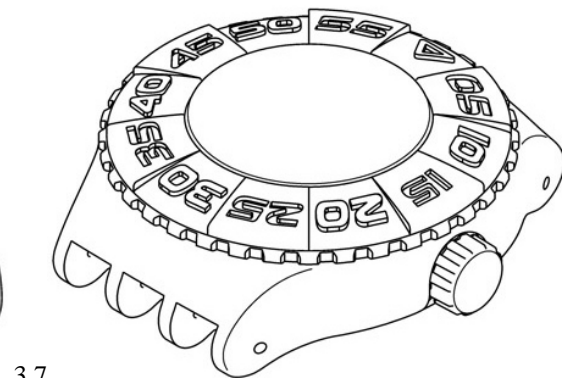

3.7

**(11) DM/079656**

(15) 2012 11 28

(22) 2012 11 28

(28) 2

(73) TISSOT SA (TISSOT AG) (TISSOT LTD)

Chemin des Tourelles 17, CH-2400 Le Locle (CH)

(85) CH

(86) CH

(87) CH

(88) CH

(89) CH

(81) II. BZ, MA. III. AL, AM, AZ, BA, CH, EM, GE, HR, KG, LI, MC, MD, ME, MK, MN, NO, OM, SG, TJ, TN, TR, UA

(72) Mod. No. 1: Damien GOYET, Rue Principale 45, F-68480 Winkel (France); Mod. No. 2: Vianin Benoît, Rue de la Banque 13, CH-2400 LE LOCLE et Scherrer Philippe, Rue des Encrannes 10, CH-2800 DELEMONT

(54) 1.-2. Watch cases with bracelet

(55)



1.1



1.2

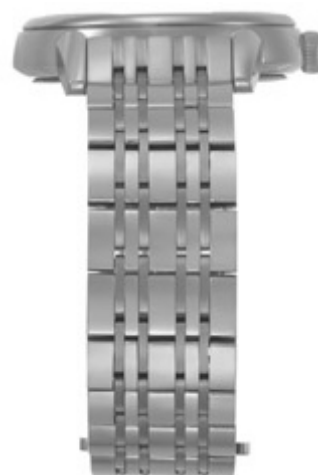

1.3



1.4



1.5



1.6



1.7



1.8



2.1



2.2



2.3



2.4



2.5



2.6



2.7



2.8

---

(11) DM/079658

(51) 10-02

(15) 2012 11 29

(45) 2013/21 (2013 05 31)

(22) 2012 11 29

(28) 1

(73) CERTINA AG (CERTINA SA) (CERTINA LTD.)

17, chemin des Tourelles, CH-2400 LE LOCLE (CH)

(85) CH

(86) CH

(87) CH

(88) CH

(89) CH

(81) II. BZ, MA, III. AL, AM, AZ, BA, CH, EM, GE, HR, KG, LI, MC, MD, ME, MK, MN, NO, OM, SG, TJ, TN, TR, UA

(72) Marco Scarinzi et Renato Scarinzi

SCARINZI S.A., Rue d'Aarberg 107A, 2501 Bienne

(54) 1. Watch case with bracelet

(55)



1.1



1.2



1.3



1.4



1.5



1.6



1.7



1.8



(11) DM/080364

(51) 09-05

(15) 2012 11 28

(45) 2013/21 (2013 05 31)

(22) 2012 11 28

(28) 1

(30) 1: 29.05.2012; 002048819; EM

(73) HAUSBRANDT TRIESTE 1892 S.P.A. Via Foscarini  
52, I-31040 NERVESA DELLA BATTAGLIA (TV) (IT)

(85) EM

(86) IT, EM

(87) IT, EM

(88) IT, EM

(89) EM

(81) II. KP, MA. III. AL, BA, EG, GE, HR, KG, MD, ME, NO, RS, SG, TN, TR, UA

(72) Fabrizio Zanett  
Viale Felissent, 55, I-31020 Villorba (Treviso)

(54) 1. Coffee capsule

(55)

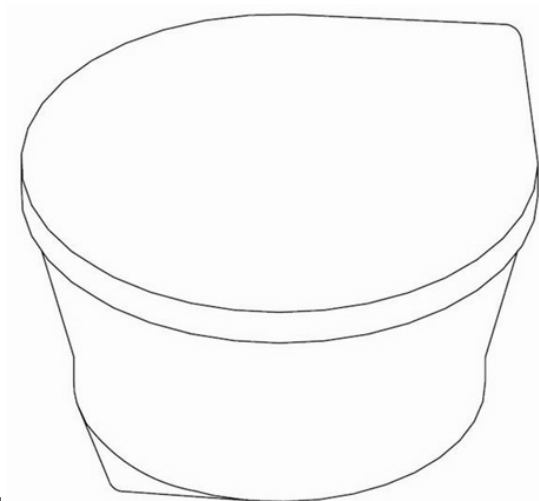

1.1

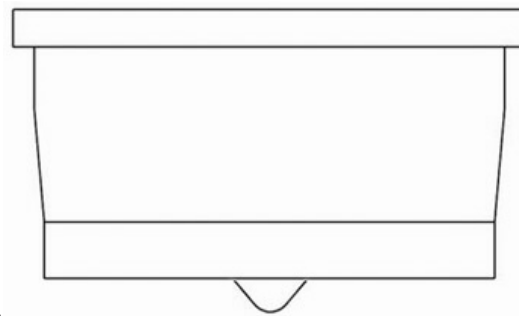

1.2

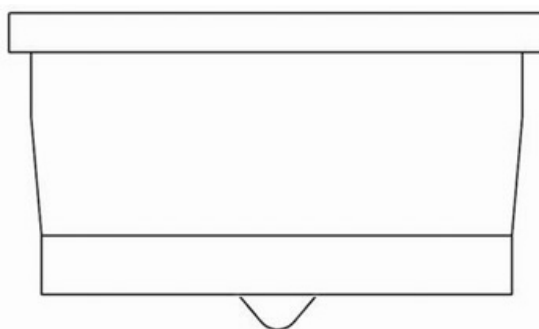

1.3

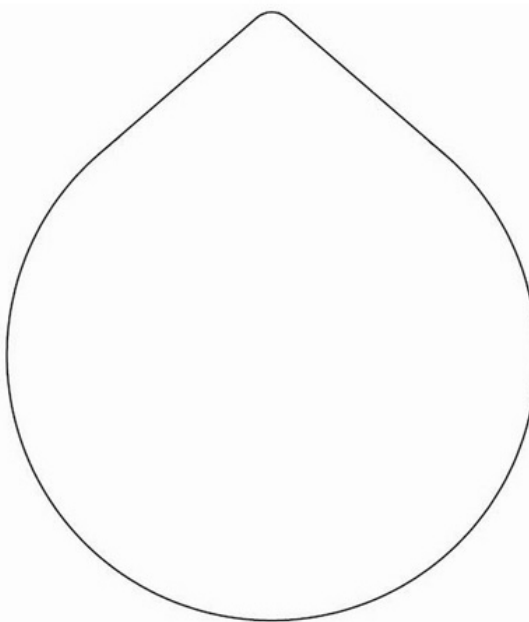

1.4

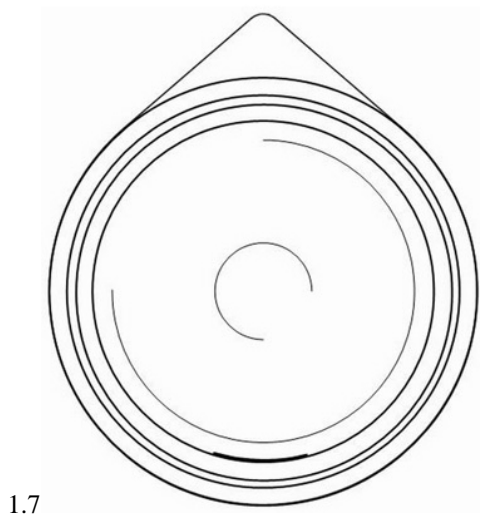
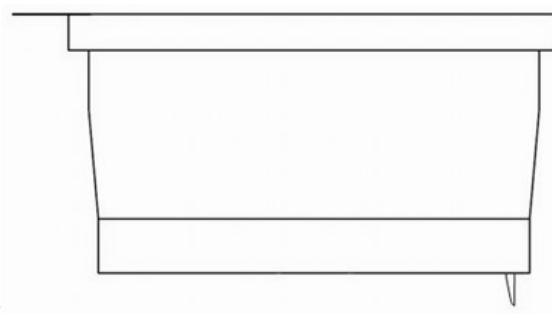
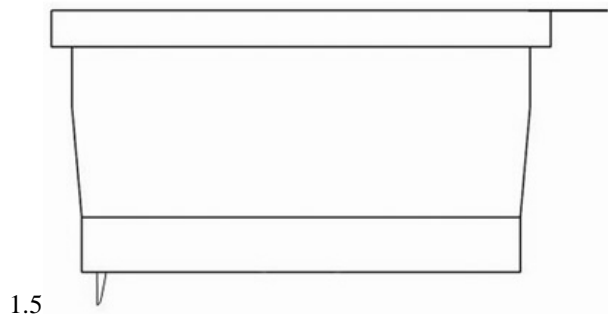

(11) DM/080899

(51) 13-03

(15) 2013 04 29

(45) 2013/21 (2013 05 31)

(22) 2013 04 29

(28) 2

(73) GUNSAN ELEKTRİK MALZEMELERİ SANAYİ VE TİCARET ANONİM ŞİRKETİ

Osmangazi Mahallesi Yıldırım Beyazıt Caddesi No:29, Sancaktepe/Istanbul (TR)

(85) --

(86) TR

(87) TR

(88) TR

(89) TR

(81) III. AM, AZ, BA, EM, GE, HR, KG, MD, MK, RS

(72) MURAT GÜN

Osmangazi Mahallesi Yıldırım Beyazıt Caddesi No:29 Sancaktepe/Istanbul

(54) 1. Grounded socket; 2. Electric switch

(55)



1.1



1.2



1.3



2.1



2.2



2.3

**(11) DM/079650****(51) 23-02**

(15) 2012 12 06

(45) 2013/22 (2013 06 07)

(22) 2012 12 06

(28) 8

(30) 08.06.2012; 002054668-0001-0008; EM

(73) TOMIL S.R.O.

Gen. Svatoně 149/IV, CZ-566 01 Vysoké Mýto (CZ)

(85) EM

(86) EM

(87) EM

(88) EM

(89) EM

(81) III. AZ, BA, CH, EG, GE, HR, IS, MD, ME, NO, RS, TN, TR, UA

(72) Tomáš Müller

Zámecek 443/8, CZ-500 08 Hradec Králové

(54) 1.-8. Fragrance dispensers

(55)

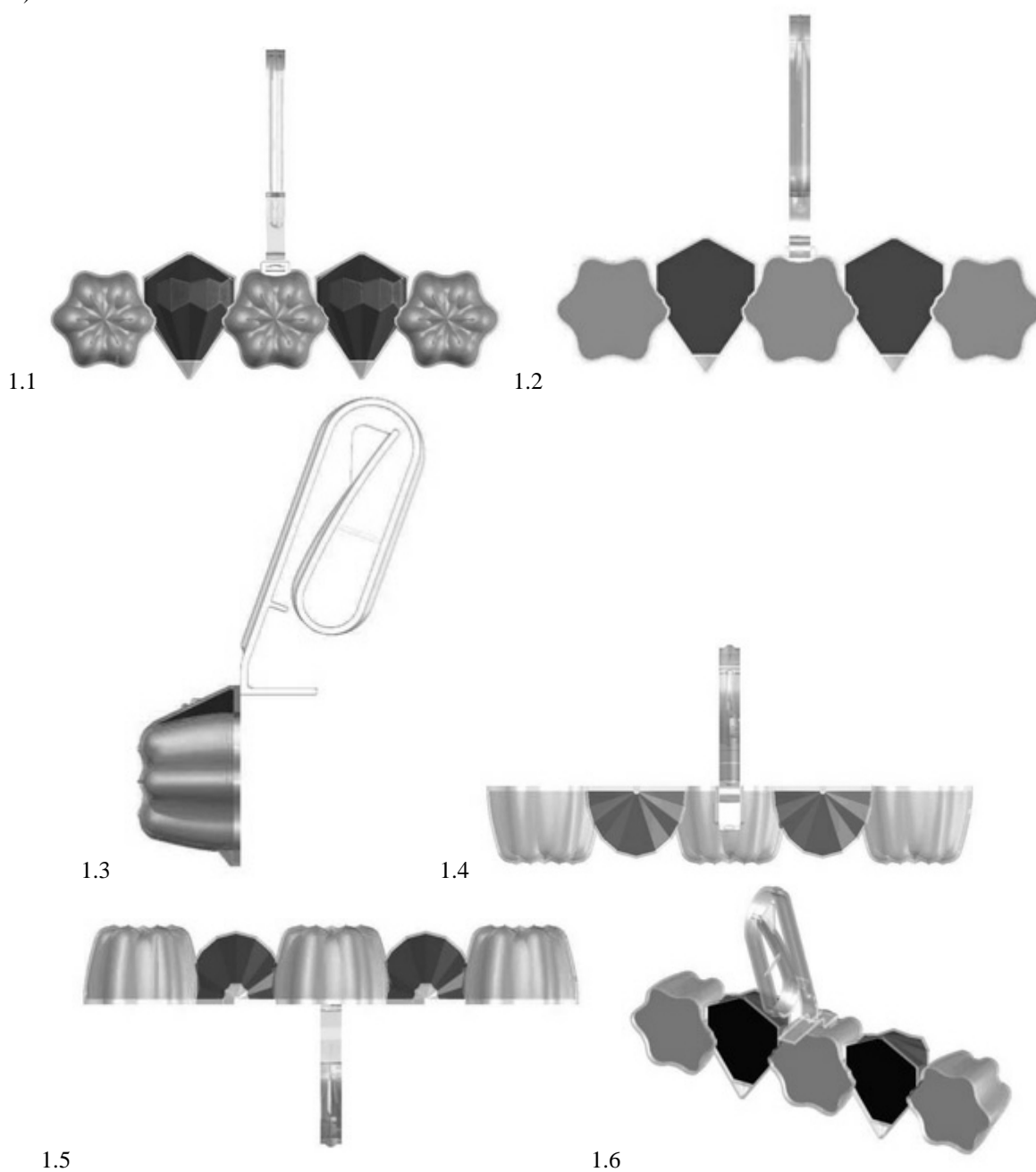



1.7



2.1

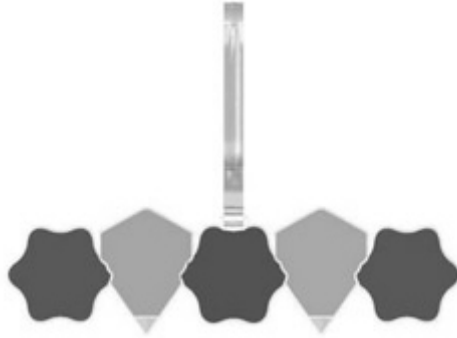

2.2



2.3

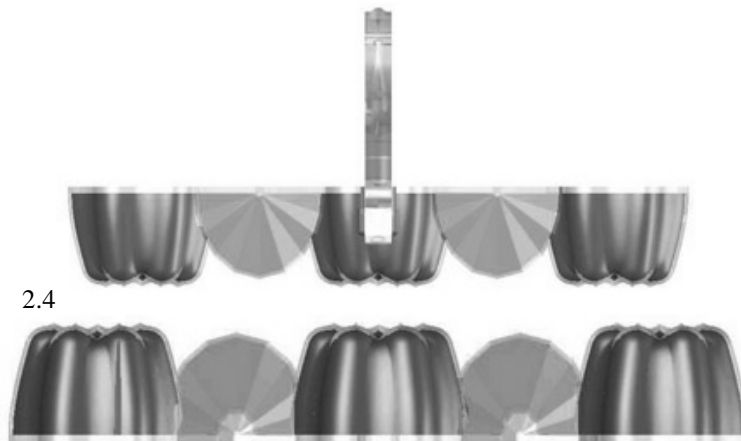

2.4

2.5

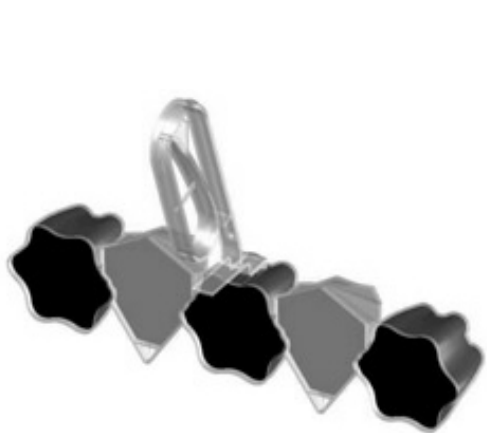

2.6



2.7



3.1

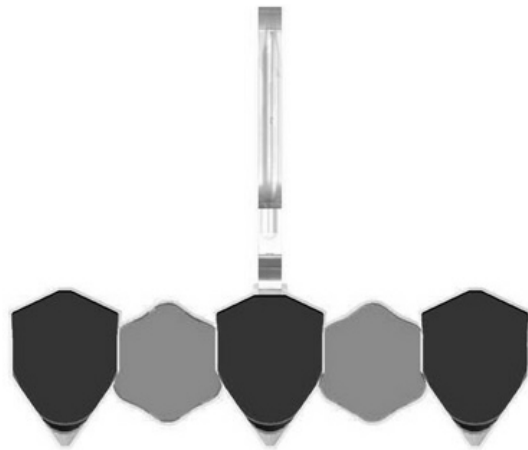

3.2



3.3

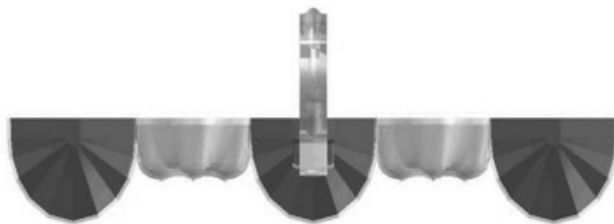

3.4

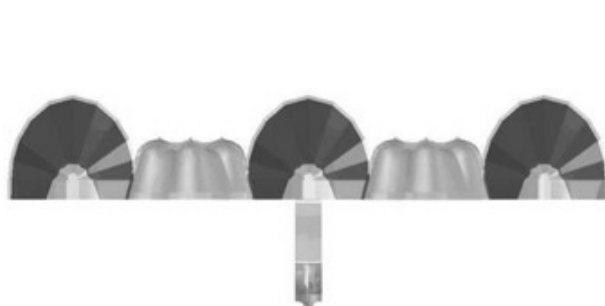

3.5

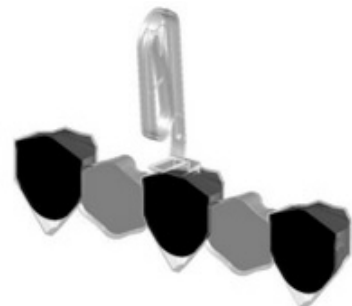

3.6

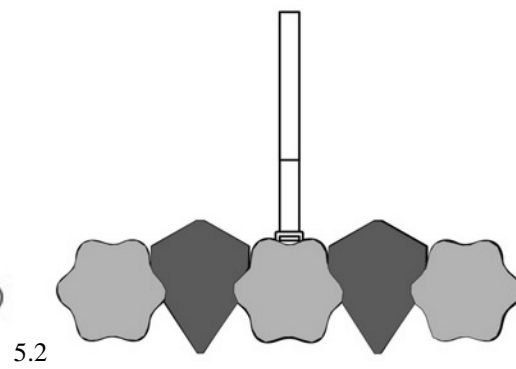
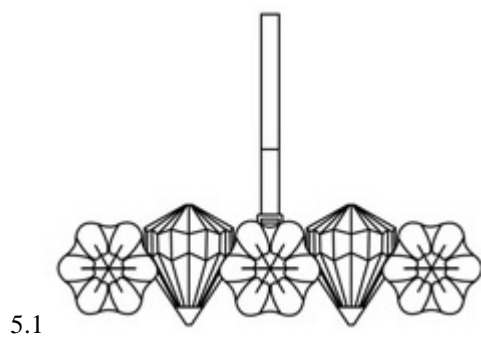
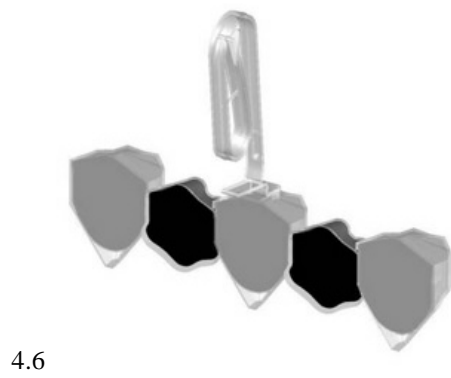
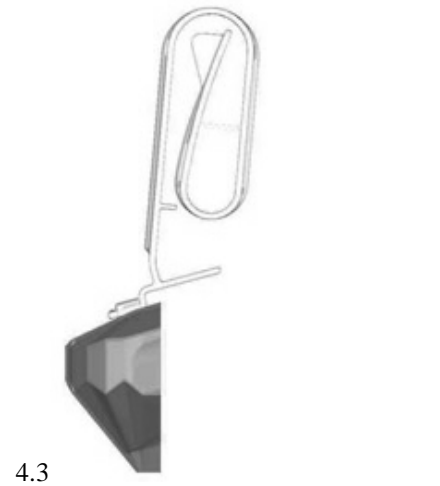
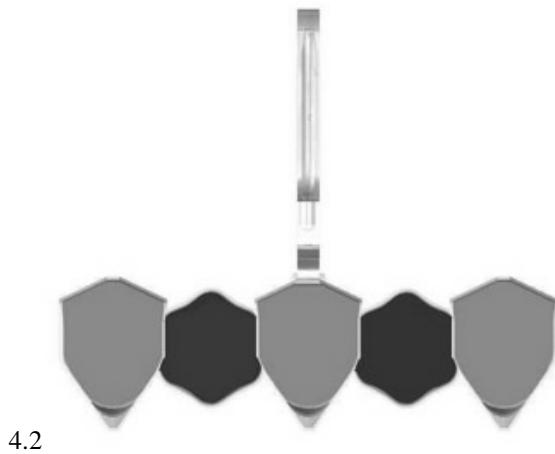

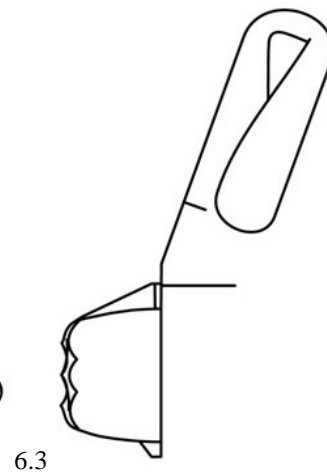
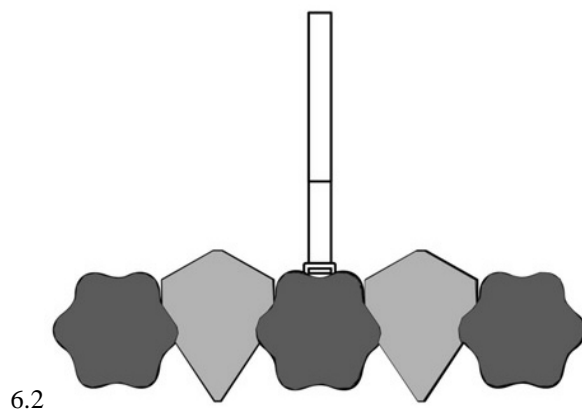
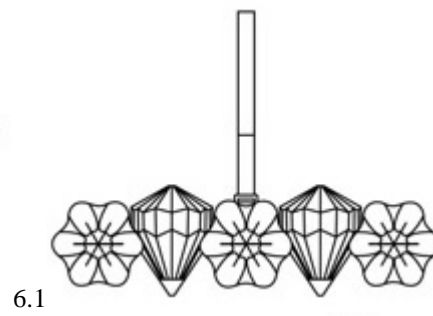
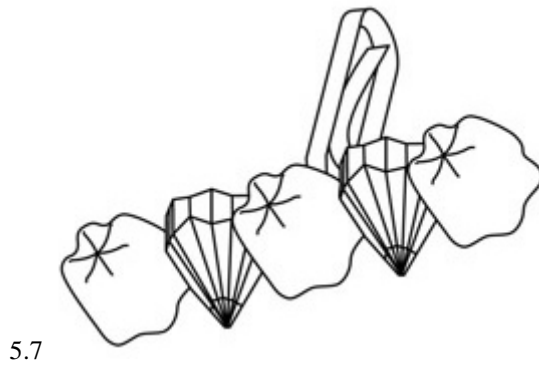
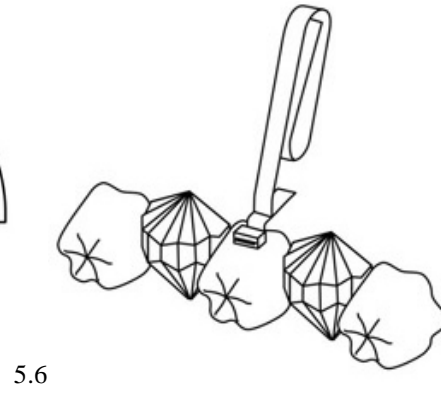
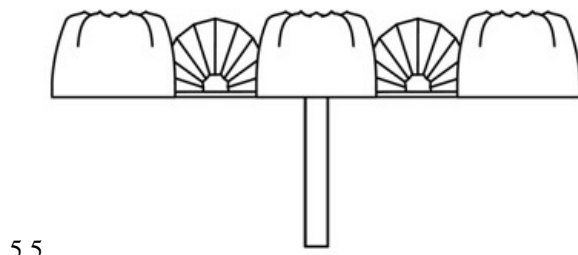
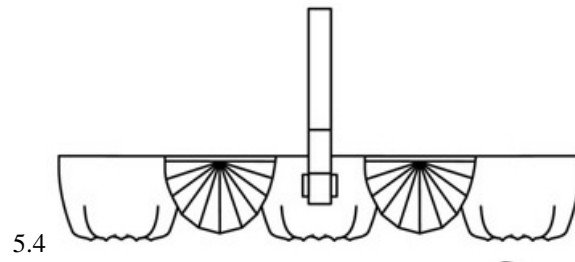
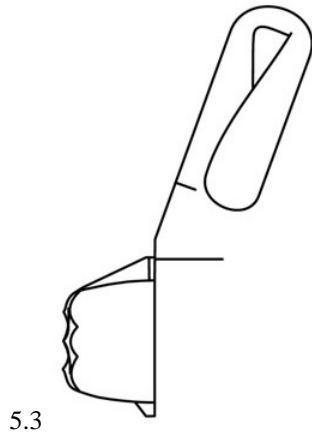



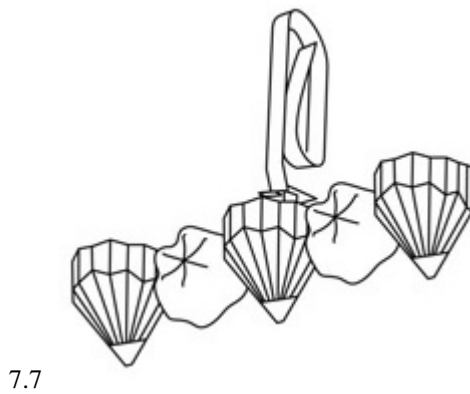
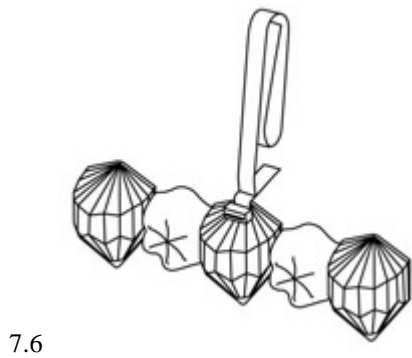
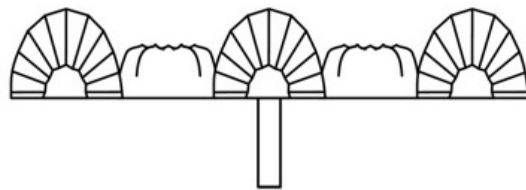
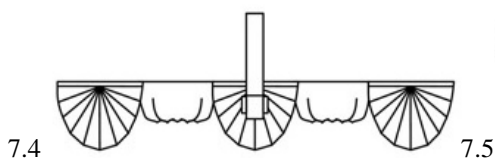
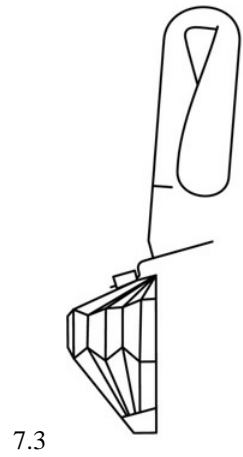
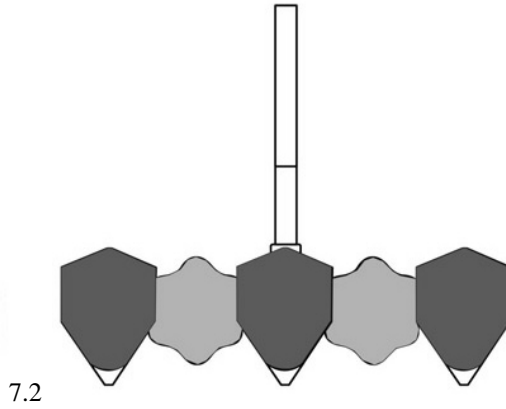
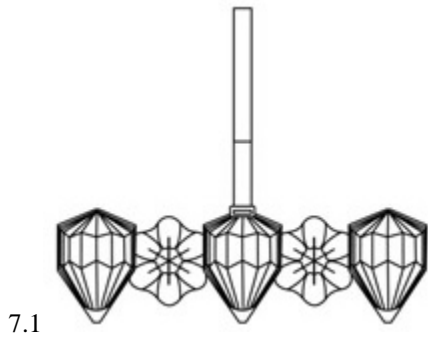
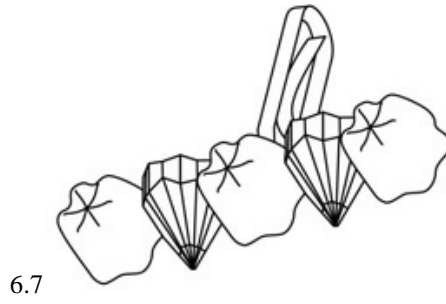
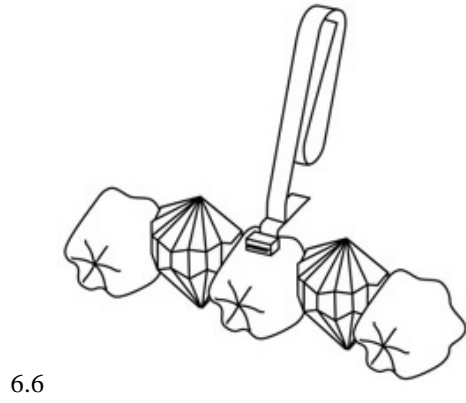
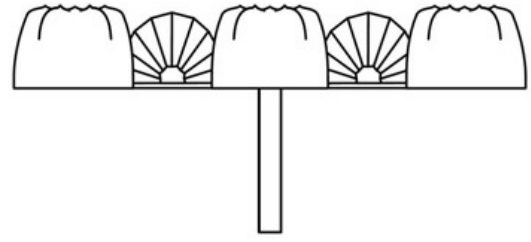
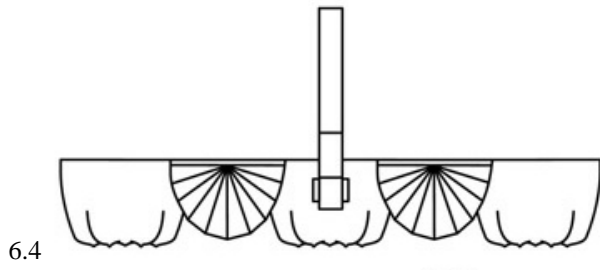

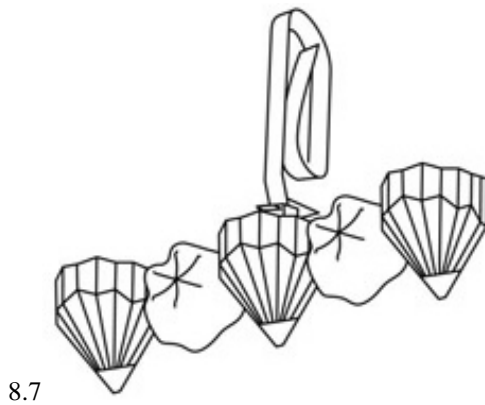
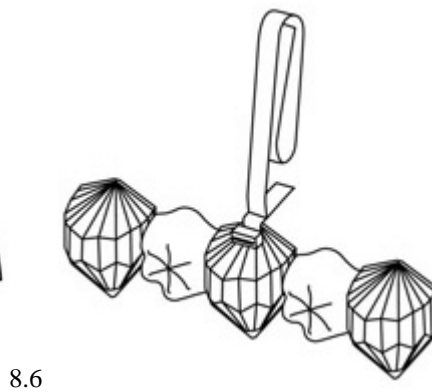
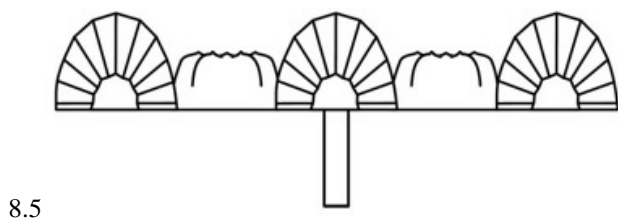
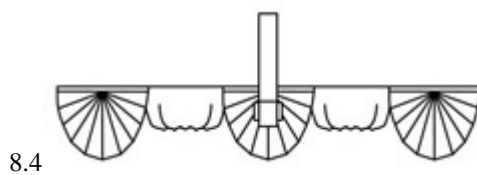
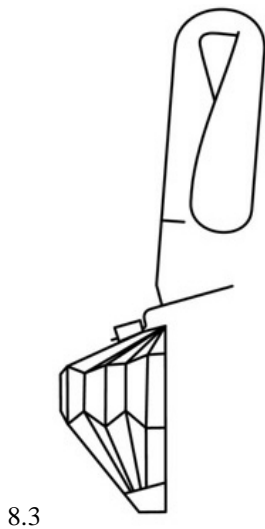
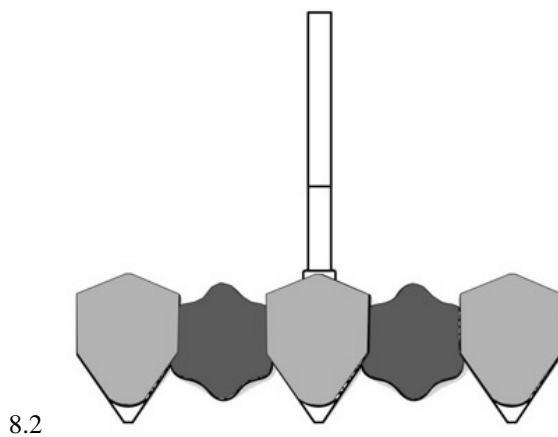
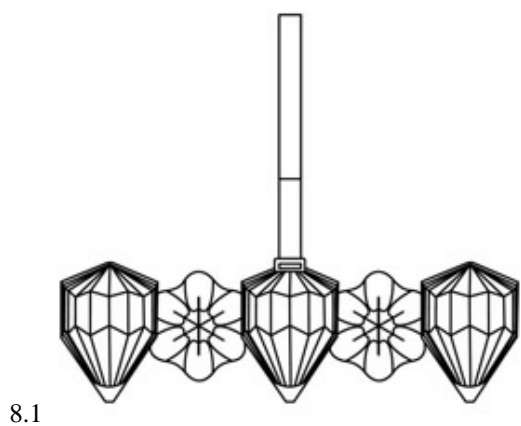

(11) DM/079663

(51) 10-02

(15) 2012 12 03

(45) 2013/22 (2013 06 07)

(22) 2012 12 03

(28) 14

(73) ETA SA MANUFACTURE

HORLOGÈRE SUISSE CH-2540 Grenchen (CH)

(85) CH

(86) CH

(87) CH

(88) CH

(89) CH

(81) II. BZ, MA, III. AL, AM, AZ, BA, CH, EM, GE, HR, KG, LI, MC, MD, ME, MK, MN, NO, OM, SG, TJ, TN, TR, UA

(72) Mod. No.1, 2, 3, 4, 7, 8: Michaela KOCH, Albrecht Achilles-Strasse 2, DE-10709 Berlin (ALLEMAGNE);

Mod. No.5, 6: Véronique STOLL, Chemin de la Marnière 14A, CH-2504 Biel/Bienne (SUISSE);

Mod. No.9, 10, 11: Adele DI MAIUTA, Viaduktstrasse 2, CH-2450 Grenchen (SUISSE) et Charlotte

FABRE, Birkenweg 3, CH-2504 Biel/Bienne (SUISSE) et Véronique STOLL, Chemin de la Marnière 14A,

CH-2504 Biel/Bienne (SUISSE); Mod. No.12, 13, 14: Jérémie Senggen, Chemin du Levant 135, CH-1005

Lausanne (SUISSE)

(54) 1.-14. Wristwatches

(55)





(11) DM/079717

(15) 2012 12 03

(22) 2012 12 03

(28) 12

(73) MÜLLER & MEIRER LEDERWARENFABRIK GMBH

Am Markt 8, 55606 Kirn (DE)

(85) EM

(86) DE, EM

(87) DE, EM

(88) DE, EM

(89) EM

(81) II. BJ, BZ, CI, GA, KP, MA, ML, NE, SN, SR. III. AL, AM, AZ, BA, BW, CH, EG, EM, GE, GH, HR, IS, KG, LI, MC, MD, ME, MK, MN, NA, NO, OA, OM, RS, SG, ST, TR, UA

(72) Steffen Neumann

Albert-Schweitzer-Strasse 10, D-55606 Kirn

(54) 1.-12. Clasps for leather goods

(55)

(51) 08-07

(45) 2013/22 (2013 06 07)



1.1



1.2



1.3



2.1



2.2



2.3



3.1



3.2



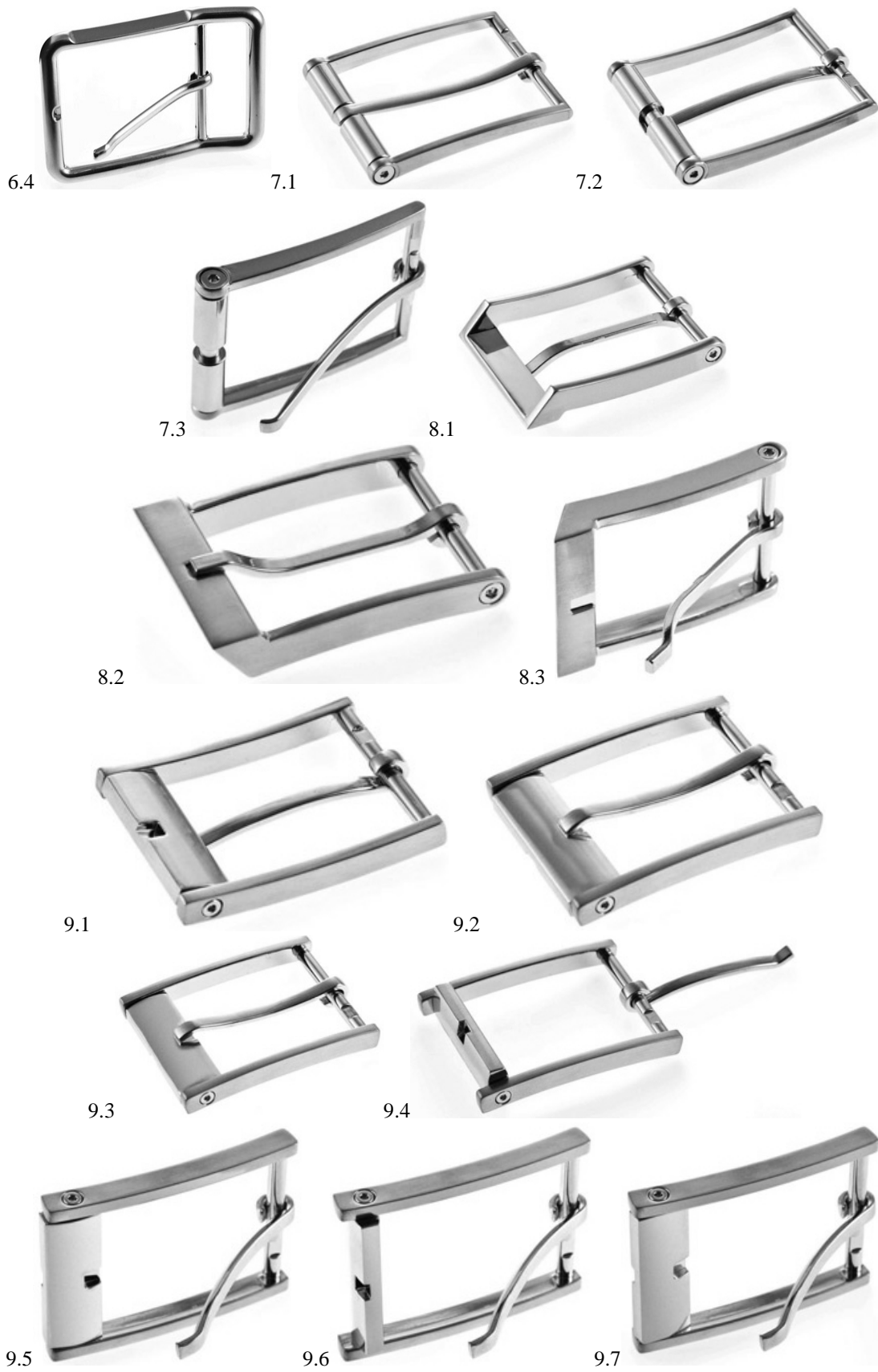

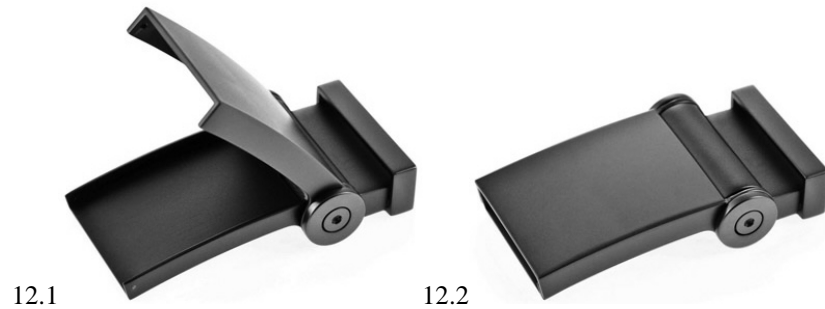



(11) DM/080997 (51) 10-07  
(15) 2013 05 03 (45) 2013/23 (2013 06 14)  
(22) 2013 05 03  
(28) 1  
(73) HERMANN STAIB GMBH  
Grimmigweg 27, 75179 Pforzheim (DE)  
(85) DE, EM  
(86) DE, EM  
(87) DE, EM  
(88) DE, EM  
(89) EM  
(81) III. CH, EM, GE, NO, SG, TR, UA  
(54) 1. Watch bracelet  
(55)

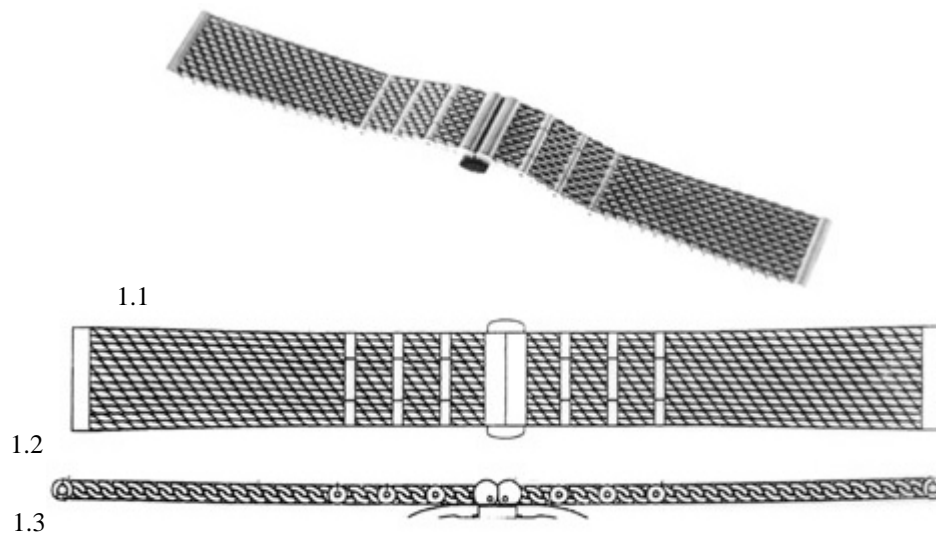

**(11) DM/081006****(51) 11-01**

(15) 2013 05 28

(45) 2013/23 (2013 06 14)

(22) 2013 05 28

(28) 16

(73) "FREY WILLE" GMBH &amp; CO. KG.

Gumpendorferstrasse 81, A-1060 Wien (AT)

(85) EM

(86) EM

(87) EM

(88) EM

(89) EM

(81) III. CH, EG, EM, GE, HR, MD, MK, MN, SG, TR, UA

(54) 1.-2. Bracelets 3. Pendant; 4. Earrings; 5.- 6. Bracelets; 7. Pendant; 8.-9. Bracelets; 10. Pendant;

11.-12. Bracelets; 13. Pendant; 14.-15. Bracelets; 16. Pendant

(55)



1.1



1.2



1.3



1.4



1.5



2.1

2.2



2.3



3



4.1



4.2



4.3



5.1



5.2



5.3



5.4



5.5



6.1



6.2



6.3



7



8.1



8.2



8.3



8.4



8.5



9.1



9.2



9.3



10



11.1



11.2



11.3



11.4



11.5



12.1



12.2



12.3



13



14.1



14.2



14.3



14.4



14.5



15.1



15.2



15.3



16

(11) DM/081021

(51) 25-03

(15) 2012 11 29

(45) 2013/23 (2013 06 14)

(22) 2012 11 29

(28) 2

(73) YORULMAZER, RAFET EREN

Askerocagi Caddesi No:15 Suzer Plaza Kat:30/31, Sisli Istanbul (TR)

(85) --

(86) TR

(87) n/a

(88) n/a

(89) TR

(81) III. AL, AM, AZ, BA, BW, CH, EG, EM, GE, GH, HR, IS, KG, LI, MC, MD, ME, MK, MN, NA, NO, OA, OM, RS, RW, SG, ST, TJ, TN, UA

(72) YORULMAZER

Rafet Eren, Askerocagi Caddesi No:15 Suzer Plaza Kat:30/31 Sisli ISTANBUL

(54) 1.-2. Buildings

(55)

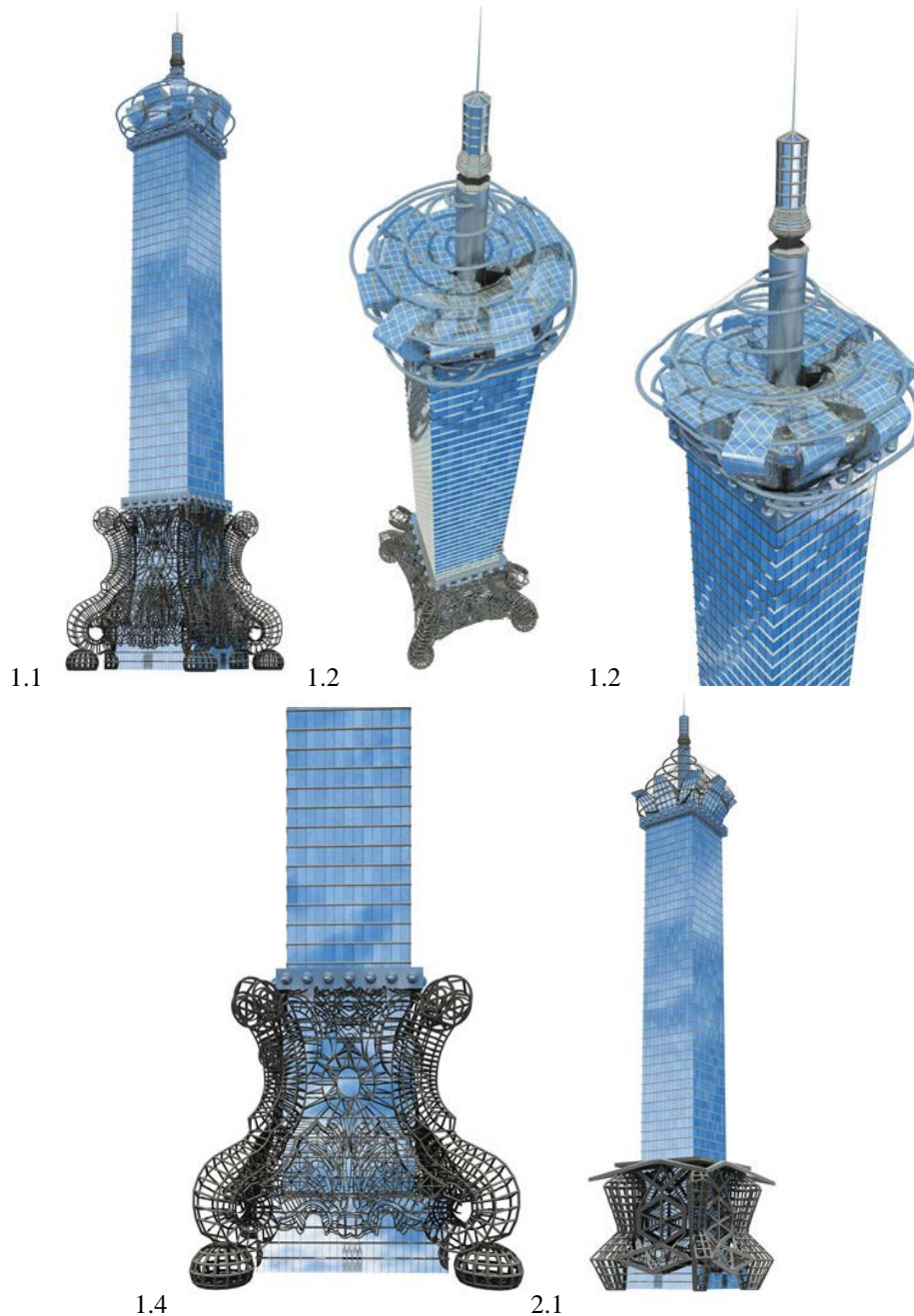



2.2



2.3



2.4



(11) DM/079783

(15) 2012 12 21

(22) 2012 12 21

(28) 8

(73) SWATCH AG (SWATCH SA) (SWATCH LTD.)

Jakob-Stämpfli-Strasse 94, CH-2502 Biel/Bienne (CH)

(85) CH

(86) CH

(87) CH

(88) CH

(89) CH

(81) II. BZ, MA, III. AL, AM, AZ, BA, CH, EM, GE, HR, KG, LI, MC, MD, ME, MK, MN, NO, OM, SG, TJ, TN, TR, UA

(72) Mod. Nos. 1 et 3: Patrizio Vita, Swatchlab, Via Archimede 6, IT-20129 Milano (Italie); Mod. No. 2: Andrea Arrigoni, Swatchlab, Via Archimede 6, IT-20129 Milano (Italie); Mod. No. 4: Rossana Boffi, Swatchlab, Via Archimede 6, IT-20129 Milano (Italie); Mod. Nos. 5 à 7 : Michelangelo Pellegrino, Swatchlab, Via Archimede 6, IT-20129 Milano (Italie); Mod. No. 8: Antonio Fazio, Avenue de Cour 40, CH-1007 Lausanne (Suisse)

(54) 1.-8. Wristwatches

(55)



**(11) DM/079803**

(15) 2012 12 21

(22) 2012 12 21

(28) 2

(73) SWATCH AG (SWATCH SA) (SWATCH LTD.)

Jakob-Stämpfli-Strasse 94, CH-2502 Biel/Bienne (CH)

(85) CH

(86) CH

(87) CH

(88) CH

(89) CH

(81) II. BZ, MA. III. AL, AM, AZ, BA, CH, EM, GE, HR, KG, LI, MC, MD, ME, MK, MN, NO, OM, SG, TJ, TN, TR, UA

(72) Mod. No. 1: Rossana Boffi, Swatchlab, Via Archimede 6, IT-20129 Milano (Italie);

Mod. No. 2: Antonio Fazio, Avenue de Cour 40, CH-1007 Lausanne (Suisse)

(54) 1.-2. Wristwatches

(55)



1.1



1.2



2.1



2.2

(11) DM/079804

(15) 2012 12 21

(22) 2012 12 21

(28) 2

(73) SWATCH AG (SWATCH SA) (SWATCH LTD.)

Jakob-Stämpfli-Strasse 94, CH-2502 Biel/Bienne (CH)

(85) CH

(86) CH

(87) CH

(88) CH

(89) CH

(81) II. BZ, MA. III. AL, AM, AZ, BA, CH, EM, GE, HR, KG, LI, MC, MD, ME, MK, MN, NO, OM, SG, TJ, TN, TR, UA

(72) Mod. No. 1: Patrizio Vita, Swatchlab, Via Archimede 6, IT-20129 Milano (Italie); Mod. No. 2: Francesca Errani, Swatchlab, Via Archimede 6, IT-20129 Milano (Italie)

(54) 1.-2. Wristwatches

(55)

(51) 10-02

(45) 2013/24 (2013 06 21)



**(11) DM/079805**

(15) 2012 12 21

(22) 2012 12 21

(28) 1

(73) SWATCH AG (SWATCH SA) (SWATCH LTD.)

Jakob-Stämpfli-Strasse 94, CH-2502 Biel/Bienne (CH)

(85) CH

(86) CH

(87) CH

(88) CH

(89) CH

(81) II. BZ, MA. III. AL, AM, AZ, BA, CH, EM, GE, HR, KG, LI, MC, MD, ME, MK, MN, NO, OM, SG, TJ, TN, TR, UA

(72) Mod. No. 1: Patrizio Vita, Swatchlab

Via Archimede 6, IT-20129 Milano (Italie)

(54) 1. Wristwatch

(55)

**(51) 10-02**

(45) 2013/24 (2013 06 21)



1

(11) DM/079806

(15) 2012 12 21

(22) 2012 12 21

(28) 1

(73) SWATCH AG (SWATCH SA) (SWATCH LTD.)

Jakob-Stämpfli-Strasse 94, CH-2502 Biel/Bienne (CH)

(85) CH

(86) CH

(87) CH

(88) CH

(89) CH

(81) II. BZ, MA. III. AL, AM, AZ, BA, CH, EM, GE, HR, KG, LI, MC, MD, ME, MK, MN, NO, OM, SG, TJ, TN, TR, UA

(72) Mod. No. 1: Danilo Sala, Swatchlab, Via Archimede 6, IT-20129 Milano (Italie)

(54) 1. Wristwatch

(55)

(51) 10-02

(45) 2013/24 (2013 06 21)



1

---

(11) DM/081039

(51) 25-03

(15) 2012 12 28

(45) 2013/24 (2013 06 21)

(22) 2012 12 28

(28) 1

(73) YORULMAZER, RAFET EREN

Askerocagi Caddesi No:15 Suzer Plaza Kat:30/31, Sisli Istanbul (TR)

(85) –

(86) TR

(87) n/a

(88) n/a

(89) TR

(81) III. AL, AM, AZ, BA, BW, CH, EG, EM, GE, GH, HR, IS, KG, LI, MC, MD, ME, MK, MN, NA, NO, OA, OM, RS, RW, SG, ST, TJ, TN, UA

(72) YORULMAZER, Rafet Eren

Askerocagi Caddesi No:15 Suzer Plaza Kat:30/31 Sisli ISTANBUL

(54) 1. Building

(55)

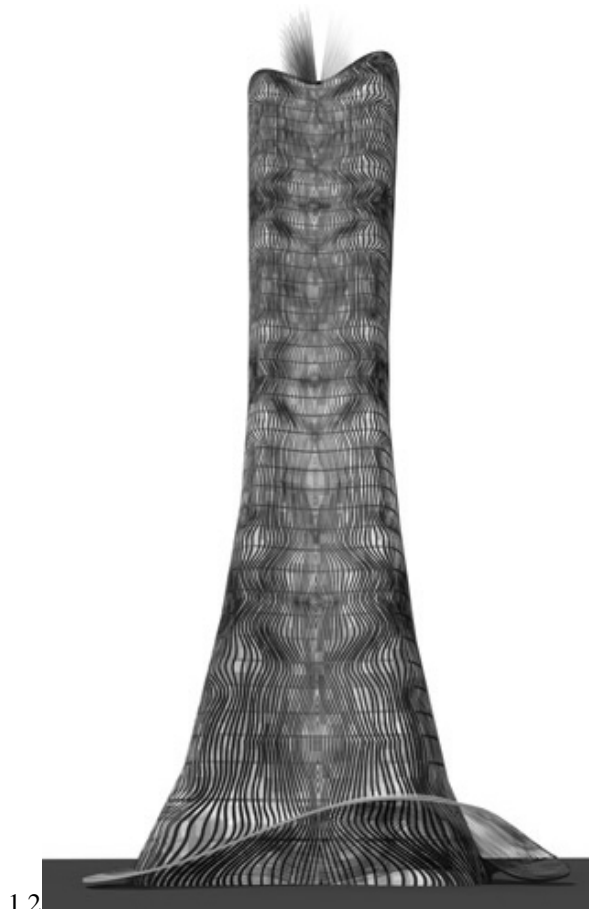
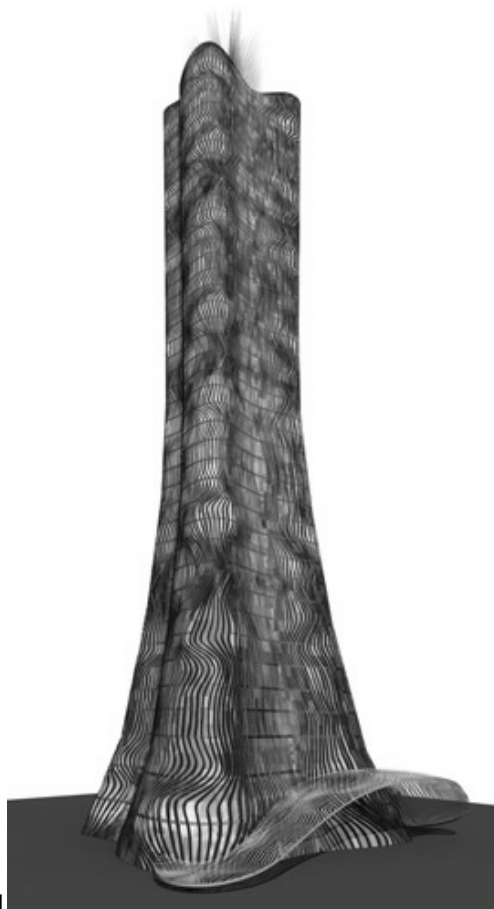

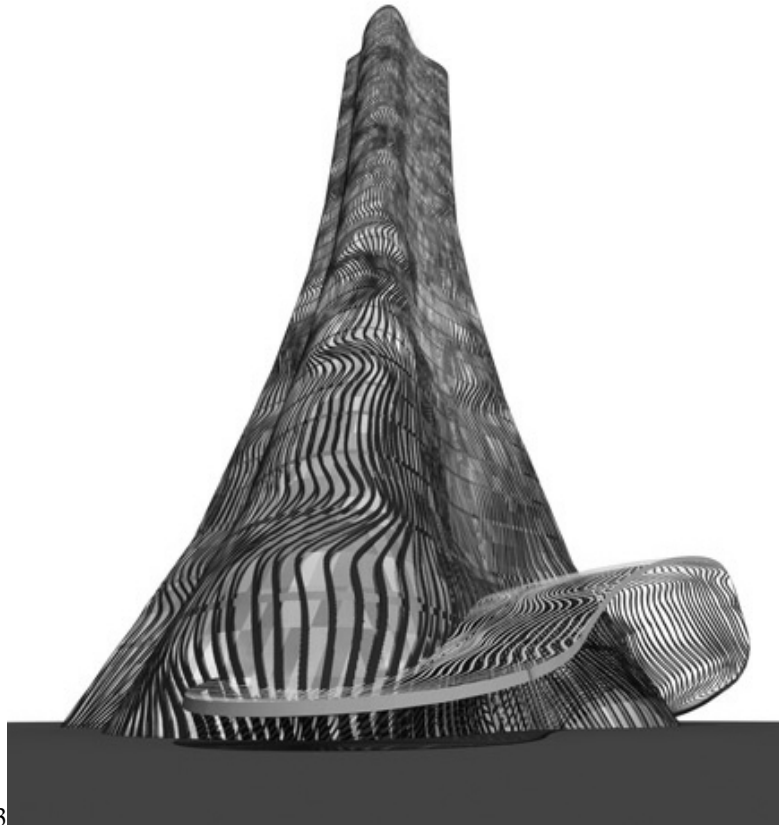

1.3

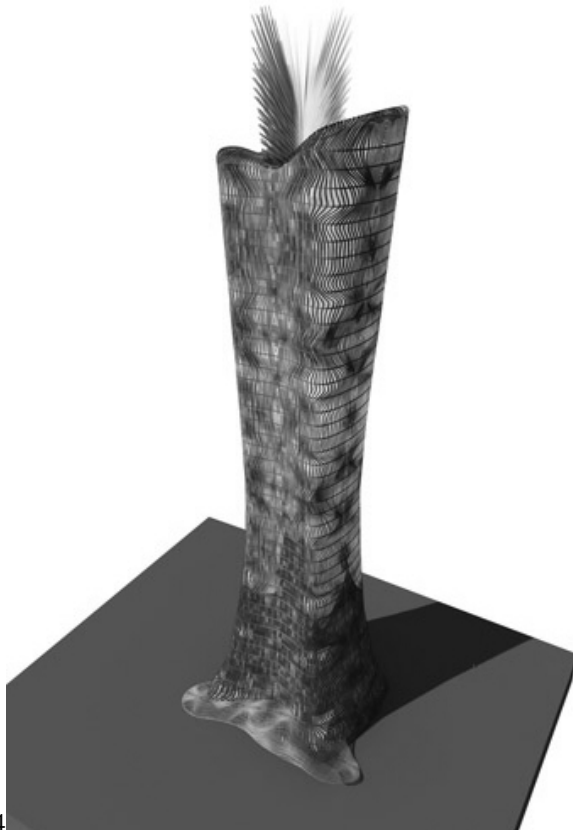

1.4

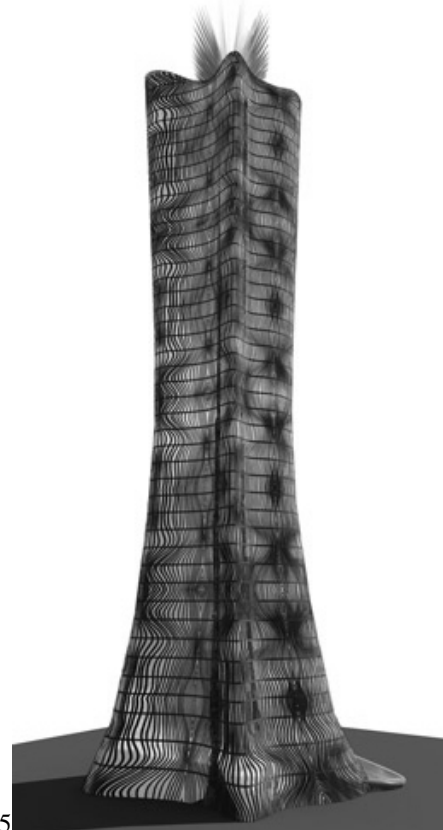

1.5

**(11) DM/081051**

(15) 2013 05 28

(22) 2013 05 28

(28) 1

(73) SAMET KALIP VE MADENI ESYA SANAYI VE TICARET ANONIM SIRKETI

Ataturk Mahallesi Inonu Caddesi No:8-13 Kirac-Esenyurt, TR-34513 Buyukcekmece ISTANBUL (TR)

(85) TR

(86) TR

(87) TR

(88) n/a

(89) TR

(81) III. AZ, EG, EM, GE, KG, OM, SY, TR, UA

(72) Defne Koz Susani, 720 North Franklin, Suite 501, Chicago IL 60654, USA; Marco Susani, 720 North Franklin, Suite 501, Chicago IL 60654, USA

(54) 1. Side panel for drawers

(55)

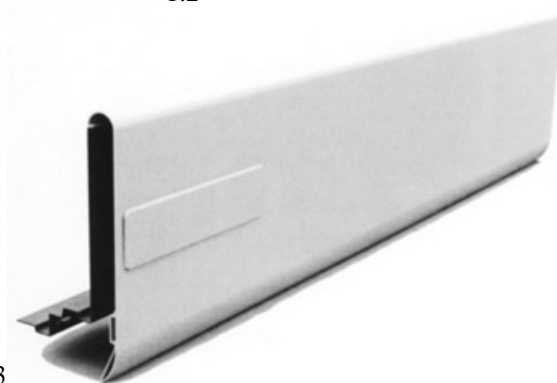
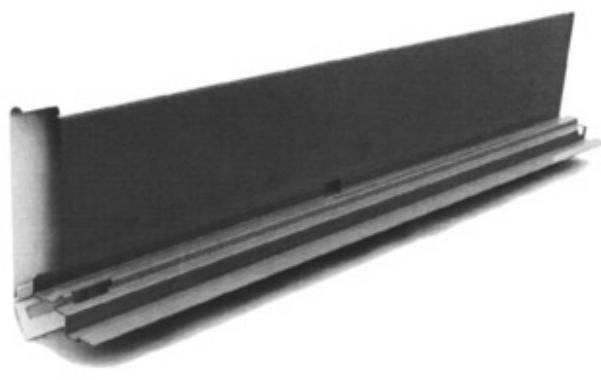
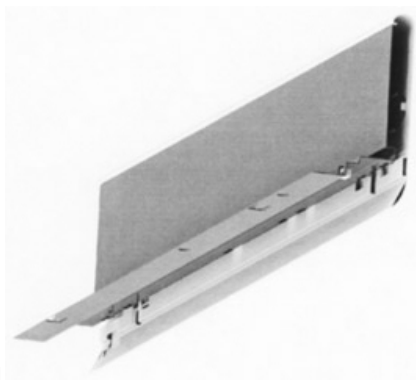



(11) DM/081062

(51) 25-03

(15) 2012 12 28

(45) 2013/24 (2013 06 21)

(22) 2012 12 28

(28) 1

(73) YORULMAZER, RAFET EREN

Askerocagi Caddesi No:15 Suzer Plaza Kat:30/31, Sisli Istanbul (TR)

(85) --

(86) TR

(87) n/a

(88) n/a

(89) TR

(81) III. AL, AM, AZ, BA, BW, CH, EG, EM, GE, GH, HR, IS, KG, LI, MC, MD, ME, MK, MN, NA, NO, OA, OM, RS, RW, SG, ST, TJ, TN, UA

(72) Name: YORULMAZER

Rafet Eren Address: Askerocagi Caddesi No:15 Suzer Plaza Kat:30/31 Sisli ISTANBUL

(54) 1. Hotel building complex

(55)



1.1



1.2



1.3

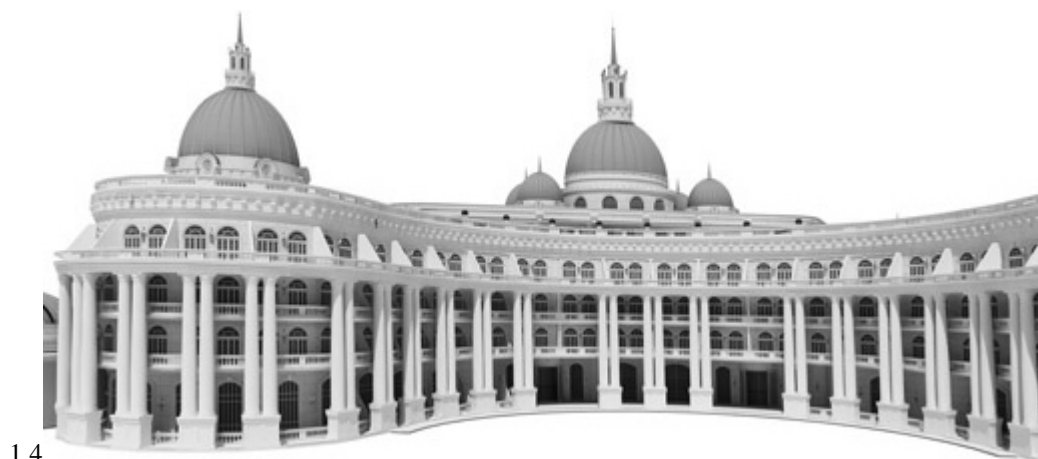

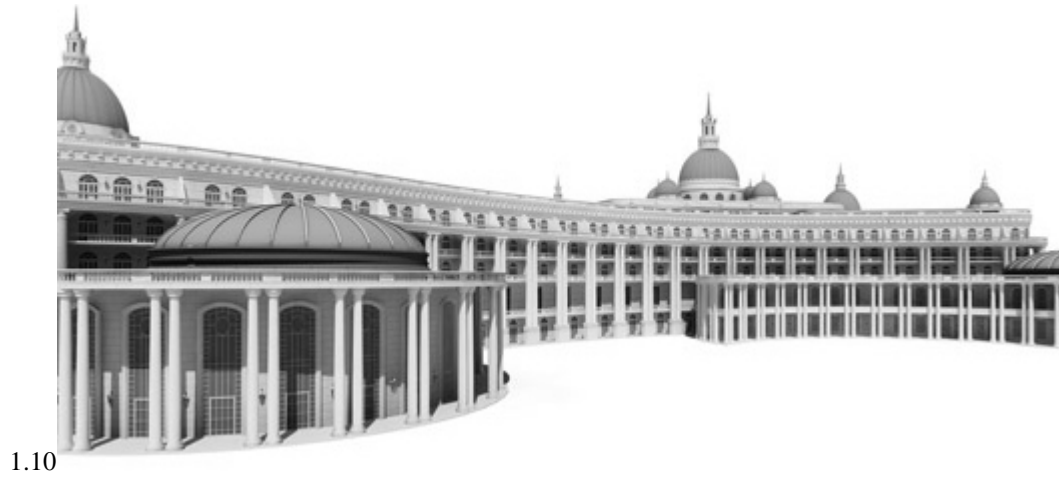

---

# TRADEMARKS

## APPLICATIONS FILED UNDER THE NATIONAL PROCEDURE APPROVED FOR REGISTRATION

The decision can be appealed at the Chamber of Appeal of Sakpatenti within 3 months from the publication or at the Mtskheta District Court Administrative Cases Board (Address: №17, Samkhedro str., Mtskheta), within 1 month following the publication.

(260) AM 2013 68812 A

(210) AM 068812

(220) 2012 09 12

(731) LTD "SMG"

L. Asatianis q. 36a, 0105, Tbilisi, Georgia

(740) Davit Orjonikidze

(540)

ლაქიფეი

**Luckypay**

(591) black, white

(511) 36

---

(260) AM 2013 68813 A

(210) AM 068813

(220) 2012 09 12

(731) LTD "SMG"

L. Asatianis q. 36a, 0105, Tbilisi, Georgia

(740) Davit Orjonikidze

(540)

ლაქი ქარდი

**Lucky card**

(591) black, white

(511) 36

---

(260) AM 2013 68814 A

(210) AM 068814

(220) 2012 09 12

(731) LTD "SMG"

L. Asatianis q. 36a, 0105, Tbilisi, Georgia

(740) Davit Orjonikidze

(540)

ლაქიფეი ფულადი

გზავნილი

**Luckypay money transfer**

(591) black, white

(526) **DISCLAIMER** – the trade mark is protected in its entirety. The word elements „ფულადი გზავნილი“ and “money transfer” shall not be subject to a separate legal protection.

(511) 36

---

(260) AM 2013 68973 A

(210) AM 068973

(220) 2012 09 24

(731) Shalva Gvaramadze

Bakhtrionis q., 1 korp., b. 10, 0160,

Tbilisi, Georgia

(540)

**SHALVINO**

(591) black, white

(511) 33

---

(260) AM 2013 69091 A

(210) AM 069091

(220) 2012 10 02

(310) 85/585,622

(320) 2012 03 30

(330) US

(731) LENOVO (BEIJING) LIMITED

No. 6, Chuengye Road, Shangdi Information

Industry Base, Haidian District, Beijing,

100085, China

(740) Shalva Gvaramadze

(540)

**YOGA**

(591) black, white

(531) 27.05.17-

(511) 9

---

(260) AM 2013 69092 A

(210) AM 069092

(220) 2012 10 03

(731) JOINT-STOCK COMPANY "LIBERTY

CAPITAL"

Ilia Chavchavadzis Gamz. 74, 0162, Tbilisi,

Georgia

(540)

ლიბერთი კაპიტალი

(591) black, white

(511) 36

---

(260) AM 2013 69119 A  
 (210) AM 069119  
 (220) 2012 10 04  
 (310) 201220517  
 (320) 2012 04 17  
 (330) AZ  
 (731) BRITISH AMERICAN TOBACCO  
 (BRANDS) LIMITED  
 Global House, 4 Temple Place, London  
 WC2R 2 PG, United Kingdom  
 (740) Tamara Kochlamazashvili  
 (540)

**STREAMLINED**

(591) black, white  
 (511) 34

(260) AM 2013 69120 A  
 (210) AM 069120  
 (220) 2012 10 04  
 (731) EMILIO PUCCI INTERNATIONAL B.V  
 Oude Utrechtseweg 22-24, 3743 KN BAARN,  
 Netherlands  
 (740) Shalva Gvaramadze  
 (540)

**PUCCI**

(591) black, white  
 (511) 3, 9, 14, 18, 25

(260) AM 2013 69121 A  
 (210) AM 069121  
 (220) 2012 10 04  
 (731) EMILIO PUCCI INTERNATIONAL B.V  
 Oude Utrechtseweg 22-24, 3743 KN BAARN,  
 Netherlands  
 (740) Shalva Gvaramadze  
 (540)

**EMILIO PUCCI**

(591) black, white  
 (511) 3, 9, 14, 18, 25, 35

(260) AM 2013 69122 A  
 (210) AM 069122  
 (220) 2012 10 04  
 (310) FI2012 C000546  
 (320) 2012 04 11  
 (330) IT  
 (731) EMILIO PUCCI INTERNATIONAL B.V  
 Oude Utrechtseweg 22-24, 3743 KN BAARN,  
 Netherlands  
 (740) Shalva Gvaramadze  
 (540)

**PUCCI**

(591) black, white  
 (511) 35

(260) AM 2013 69149 A  
 (210) AM 069149  
 (220) 2012 10 05  
 (310) 20120519  
 (320) 2012 04 17  
 (330) AZ  
 (731) BRITISH AMERICAN TOBACCO  
 (BRANDS) INC.  
 (A delaware corporation)  
 2711 Centerville Road, Suite 300,  
 Wilmington, Delaware 19808, USA  
 (740) Tamara Kochlamazashvili  
 (540)



(591) black, white  
 (531) 27.05.05-27.05.10-27.05.22-  
 (511) 34

(260) AM 2013 69167 A  
 (210) AM 069167  
 (220) 2012 10 09  
 (731) MARRIOTT WORLDWIDE  
 CORPORATION  
 10400 Fernwood Road, Bethesda, Maryland  
 20817, USA  
 (740) Shalva Gvaramadze  
 (540)

**MARRIOTT**

(591) black, white  
 (511) 36

(260) AM 2013 69168 A  
 (210) AM 069168  
 (220) 2012 10 09  
 (731) MARRIOTT WORLDWIDE  
 CORPORATION  
 10400 Fernwood Road, Bethesda, Maryland  
 20817, USA  
 (740) Shalva Gvaramadze  
 (540)



(591) black, white  
 (531) 27.05.01-27.05.17-  
 (511) 36

(260) AM 2013 69169 A  
 (210) AM 069169  
 (220) 2012 10 09  
 (731) MARRIOTT WORLDWIDE  
 CORPORATION  
 10400 Fernwood Road, Bethesda, Maryland  
 20817, USA

(740) Shalva Gvaramadze  
(540)

მარნობა

(591) black, white  
(531) 28.19.00-  
(511) 36

(260) AM 2013 69240 A  
(210) AM 069240  
(220) 2012 10 15  
(731) RAK CERAMICS P.S.K.  
P.O. 4714, Al-Jazeera Al-Hamra Main Road  
Ras-Al-khaimah, United Arab Emirates

(740) Tamaz Shilakadze  
(540)

RAK  
PORCELAIN

(591) red  
(531) 27.05.10-29.01.01-  
(526) **DISCLAIMER** – The trade mark is protected  
in its entirety. The word element "PORCELAIN"  
contained in the mark shall not be subject to a  
separate legal protection.  
(511) 8, 21, 24

(260) AM 2013 69327 A  
(210) AM 069327  
(220) 2012 10 19  
(731) TWENTIETH CENTURY FOX FILM  
CORPORATION  
10201 West Pico Boulevard, Los Angeles,  
California 90035, USA

(740) Tamaz Shilakadze  
(540)

FOX

(591) black, white  
(511) 38,

(260) AM 2013 69328 A  
(210) AM 069328  
(220) 2012 10 19  
(731) SOCIÉTÉ DES PRODUITS NESTLÉ S.A.  
CH-1800 Vevey, Switzerland

(740) Tamaz Shilakadze  
(540)



ნესტლეჯანმრთელი ბავშვები

(591) green, blue, brown, pink

(531) 02.05.01-02.05.23-11.01.04-20.01.03-  
28.19.00-29.01.14-  
(511) 9, 16, 41

(260) AM 2013 69371 A  
(210) AM 069371  
(220) 2012 10 24  
(731) Tamaz Papunashvili  
Mgaloblishvilis q. 3, 0160, Tbilisi,  
Georgia  
(540)



(591) red  
(531) 25.01.01-25.03.03-27.05.03-29.01.01-  
(511) 25

(260) AM 2013 69387 A  
(210) AM 069387  
(220) 2012 10 25  
(310) 010849289  
(320) 2012 04 30  
(330) EM  
(731) JDB INTERNATIONAL GROUP  
COMPANY LIMITED  
Palm Grove House PO Box 438 road Town  
Tortola, British Virgin Islands  
(740) Shalva Gvaramadze  
(540)



(591) brown "pantonine 490c", red "pantonine  
186C", yellow "pantonine 108C", black  
(531) 26.04.22-26.11.08-28.03.00-29.01.12-  
(511) 5, 30, 32

(260) AM 2013 69392 A  
(210) AM 069392  
(220) 2012 10 25  
(731) KOULD STOUN KRIMERI, INC.  
9311 e Via de Ventura, Skotsdeili,  
AZ 852581, USA  
(740) Tamara Kochlamazashvili

(540)



(591) red, dark red, straw-colored, white

(531) 08.01.18-29.01.15-

(511) 30, 32, 43

(260) AM 2013 69439 A

(210) AM 069439

(220) 2012 10 29

(731) Mikheil Tsogoshvili

Temqa me-3 mkr., 4 kv., korp. 53, b. 19,

Tbilisi, Georgia

(540)



(591) raspberry pink, lilac

(531) 26.04.09-27.05.19-29.01.12-

(511) 35, 36, 45

(260) AM 2013 69440 A

(210) AM 069440

(220) 2012 10 29

(731) LTD "MZIURI"

Tseretlis Gamz.117, 0159, Tbilisi,

Georgia

(740) Nugzar Ksovreli

(540)



(591) yellow, green, white

(531) 01.03.16-25.01.05-28.19.00-29.01.14-

(511) 29, 30

(260) AM 2013 69443 A

(210) AM 069443

(220) 2012 10 30

(731) LTD "IMERIONI"

Kavtaradzis 19, 0186, Tbilisi,

Georgia

(540)



(591) red, yellow, white, blue, black

(531) 08.01.06-25.01.01-28.19.00-29.01.14-

(526) **DISCLAIMER** – the trade mark is protected in its entirety. The word elements „ორცხოვლია ვანილი“ shall not be subject to a separate legal protection.

(511) 30

(260) AM 2013 69449 A

(210) AM 069449

(220) 2012 10 30

(731) LTD "NATIONAL INSTITUTE OF ENDOCRINOLOGY"

Lublianas q.2/6, 0159, Tbilisi, Georgia

(740) Mikheil Gotsiridze

(540)



(591) dark green, light green, black, grey

(531) 05.01.16-27.05.11-28.19.00-29.01.12-

(526) **DISCLAIMER** – the trade mark is protected in its entirety. The word elements „ენდოკრინოლოგიის ეროვნული ინსტიტუტი“ and “NATIONAL INSTITUTE OF ENDOCRINOLOGY“ shall not be subject to a separate legal protection.

(511) 44

(260) AM 2013 69450 A

(210) AM 069450

(220) 2012 10 30

(731) LTD "STANDARD TOBACCO INCORPORATED"

Abuseridze-Tbelis q. 13, 0120, Tbilisi,

Georgia

(740) George Meipariani

(540)



(591) white, black, blue, light blue, Marengo, red

(531) 24.01.03-24.01.15-25.01.01-27.05.05-

27.07.02-29.01.14-

(511) 34

(260) AM 2013 69482 A

(210) AM 069482

(220) 2012 10 31

(731) THE RONALD REAGAN PRESIDENTIAL  
FOUNDATION  
40 Presidential Drive, Simi-Valley, California  
93065, USA

(740) George Meipariani

(540)

## RONALD REAGAN

(591) black, white

(511) 9, 16, 25, 35, 36, 41

(260) AM 2013 69811 A

(210) AM 069811

(220) 2012 11 27

(731) MILLER BREWING INTERNATIONAL,  
INC.,  
A DELAWARE CORPORATION  
3939 West Highland Boulevard, Milwaukee,  
Wisconsin 53208, USA

(740) Shalva Gvaramadze

(540)



(591) golden, opalesce blue, light blue, white, red

(531) 26.01.22-26.11.12-27.05.11-27.05.17-  
27.05.19-29.01.13-

(511) 32

(260) AM 2013 70112 A

(210) AM 070112

(220) 2012 12 20

(731) DISNEY ENTERPRISES, INC.  
A DELAWARE CORPORATION  
500 South Buena Vista Street, Burbank,  
California 91521, USA

(740) Shalva Gvaramadze

(540)

## MICKEY MOUSE

(591) black, white

(511) 3, 5, 9, 10, 12, 14, 16, 18, 20, 21, 24, 25, 27,  
28, 29, 30, 32, 38, 41

(260) AM 2013 70113 A

(210) AM 070113

(220) 2012 12 20

(731) DISNEY ENTERPRISES, INC.  
A DELAWARE CORPORATION  
500 South Buena Vista Street, Burbank,  
California 91521, USA

(740) Shalva Gvaramadze

(540)



(591) black, light blue, white, silver, red, dark red

(531) 26.03.23-26.05.22-27.05.01-28.05.00-  
29.01.13-

(511) 3, 5, 9, 10, 12, 14, 16, 18, 20, 21, 24, 25, 27,  
28, 29, 30, 32, 38, 41

(260) AM 66928 A \*

(210) AM 066928

(220) 2012 04 12

(731) AUNTIE ANNE'S INC.  
A PENNSYLVANIA CORPORATION  
Suite 200, 48-50 W. Chestnut Street,  
Lancaster, PA 17603, USA

(740) Shalva Gvaramadze

(540)

## AUNTIE ANNE'S

(591) black, white

(511) 30, 43

(260) AM 67161 A \*

(210) AM 067161

(220) 2012 04 27

(731) LTD MEGATRADE  
Marjanishvilis q., 6, 0102, Tbilisi, Georgia

(740) David Zurabishvili

(540)

## MEGATRADE

(591) black, white

(511) 9, 37, 42



## TRADEMARKS REGISTERED ACCORDING TO THE ACCELERATED PROCEDURE

The decision can be appealed at the Chamber of Appeal of Sakpatenti within 3 months from the publication.

(111) M 2013 23866 R  
(151) 2013 07 29  
(181) 2023 07 29  
(210) AM 072634  
(220) 2013 06 12  
(732) Shorena Razmadze  
Tseronisi q. 6, 0104, Tbilisi, Georgia  
(540)

**Kenwood**

(591) black, white  
(511) 7, 11

(111) M 2013 23867 R  
(151) 2013 07 29  
(181) 2023 07 29  
(210) AM 072804  
(220) 2013 06 21  
(732) LTD "SHERI"  
Didi Lilo, Nakveti 726 (Al. Kartvelishvilis q.),  
0105, Tbilisi, Georgia  
(540)



(591) dark brown, cream-colored  
(531) 05.07.01-11.03.04-27.05.05-29.01.07-  
(511) 30

(111) M 2013 23868 R  
(151) 2013 07 29  
(181) 2023 07 29  
(210) AM 073081  
(220) 2013 07 11  
(732) Badri Bagatelia  
Ir. Abashidzis q. 24, b. 26, 0179, Tbilisi,  
Georgia  
(540)



(591) red, white, yellow  
(531) 26.11.08-28.19.00-29.01.14-  
(511) 43

(111) M 2013 23869 R  
(151) 2013 07 30  
(181) 2023 07 30  
(210) AM 071560  
(732) Joint-Stock Company "SHATO  
MUKHRANI"  
Chavchavadzis gamz. №11, 0179, Tbilisi,  
Georgia  
(740) Shota Metreveli  
(540)

მუხრან-ბატონის რეზერვი

**RESERVE DU PRINCE**

Резерв Князя Мухранского

(591) black, white  
(531) 27.05.05-28.05.00-28.19.00-  
(511) 33

(111) M 2013 23870 R  
(151) 2013 08 01  
(181) 2023 08 01  
(210) AM 073103  
(220) 2013 07 15  
(732) OBSHCHESTVO S OGRANICHENNOI  
OTVETSTVENNOSTYU  
"ALEKSANDROVY POGREBA"  
Altufyevskoe shosse, d. 79a, Str. 25,  
q. Moscow, 127410, Russian Federation  
(740) Shalva Gvaramadze  
(540)

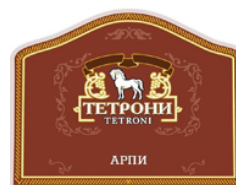

(591) black, white, brown, yellow, various golden  
and chocolate  
(531) 03.03.01-25.01.10-25.01.13-25.03.07-  
28.05.00-29.01.14-  
(511) 33

(111) M 2013 23871 R  
(151) 2013 08 01  
(181) 2023 08 01  
(210) AM 073132  
(220) 2013 07 19

(732) LTD "ALFA"  
Tevdore Mgvdlis, 0154, Tbilisi, Georgia  
(740) Nugzar Ksovreli  
(540)



(591) yellow, light blue, blue and black  
(531) 05.05.04-25.12.03-26.11.08-26.11.09-  
28.19.00-29.01.14-  
(511) 29

(111) M 2013 23872 R  
(151) 2013 08 01  
(181) 2023 08 01  
(210) AM 073169  
(220) 2013 07 23  
(732) Shorena Razmadze  
Tseronisis q. 6, 0104, Tbilisi, Georgia  
(540)

# Bravery

(591) black, white  
(531) 27.05.17-  
(511) 12

(111) M 2013 23873 R  
(151) 2013 08 02  
(181) 2023 08 02  
(210) AM 072802  
(220) 2013 06 21  
(732) LTD "SHERI"  
Didi Lilo, nakveti 726 (Al. Kartvelishvilis q.),  
0105, Tbilisi, Georgia  
(540)



(591) dark brown, cream-colored  
(531) 05.07.01-11.03.04-28.19.00-29.01.07-  
(511) 30

(111) M 2013 23874 R  
(151) 2013 08 02  
(181) 2023 08 02  
(210) AM 071256  
(220) 2013 03 07  
(732) LTD "EVROLUQSI"  
Lilos Das. 5 kv. korp. 2, b. 108, 0198,  
Tbilisi, Georgia

(540)  
**EUROLUX**  
(591) black, white  
(511) 7, 9, 11, 21

(111) M 2013 23875 R  
(151) 2013 08 02  
(181) 2023 08 02  
(210) AM 072812  
(220) 2013 06 24  
(732) LTD "IGRIKA 97"  
Akaki Tseretlis q. 18, b. 19, 1000,  
Baghdati, Georgia  
(740) George Sakvarelidze  
(540)



მინერალური წყალი „ქლიბულა 10“  
მაღალმთიან ხეობიდან

(591) white, blue, green  
(531) 01.15.15-01.15.23-06.01.01-28.19.00-  
29.01.04-  
(526) **DISCLAIMER** – the trade mark is protected  
in its entirety. The word elements „მინერალური  
წყალი მაღალმთიანი ხეობიდან“ shall not be  
subject to a separate legal protection.  
(511) 32

(111) M 2013 23876 R  
(151) 2013 08 02  
(181) 2023 08 02  
(210) AM 073175  
(220) 2013 07 24  
(732) Ketevan Sikharulidze  
Nutsubidzis Perd., I mkr., korp 12, b. 37,  
0183, Georgia

Geor (540)



(591) blue, red, white  
(531) 26.03.23-27.05.04-27.05.10-27.05.23-  
29.01.12-26.03.23-  
(511) 38

## INTERNATIONAL TRADEMARKS FOR WHICH A DECISION ON GRANTING PROTECTIONS IS TAKEN

The decision can be appealed at the Chamber of Appeal of Sakpatenti within 3 months from the publication or at the Mtskheta District Court Administrative Cases Board (Address: №17, Samkhedro str., Mtskheta), within 1 month following the publication.

(260) AM 2013 67803 A  
(800) 1059405  
(731) ABERCROMBIE & FITCH EUROPE SA  
Via Moree, CH – 6850 Mendrisio, Switzerland  
(540)

### HCO

(591) Black, white  
(511)  
25 – Clothing, footwear, headgear.

(260) AM 2013 67973 A  
(800) 1118604  
(731) ASTRO STROBEL  
KOMMUNIKATIONSSYSTEME GMBH  
Olefant 1 – 3, 51427 Bergisch Gladbach,  
Germany  
(540)



(591) Black, white  
(511)  
9 – Aerials for televisions and radios, including receiving aerials and parts therefor; aerial cables; electric cords for aerials; masts for antennae; frequency filters; tube amplifiers; transistor amplifiers; power supply units and inserts for thermionic amplifiers and transistor amplifiers; electric switches; frequency converters; electric installation material; plugs; screw and plug – type couplings and junction boxes; housings for parts for electric circuits, including housings for connections, switches, frequency filters, amplifiers, circuit balancers and junctions; lightning conductors; television and radio aerials, including receiving aerials; distribution boxes; receiving apparatus; apparatus for recording, transmission or reproduction of sounds or images; magnetic data carriers, recording discs; automatic vending machines and mechanisms for coin – operated apparatus; cash registers, calculating machines, data processing equipment and computers; fire – extinguishing apparatus; electronic and high – frequency apparatus and components (including housings) as well as software (included in this class) for receiving aerial installations and distribution installations (individual, communal and cable television installations); aerials for televisions and radios, as well as

parts therefor; elevation pipes, carriers and holders, feeds to be used for the purposes of electric installations/devices; polarisation switches, converters, crossover networks, filters, amplifiers, electric installation material (included in this class), plugs, sockets, attenuators, equalisers, directional couplers, power supply units, modulators, demodulators, receivers, transmitters and control apparatus (all for communications technology apparatus); aerials, apparatus and instruments for cable and wireless and optical message sending and data transmission, including message sending and data transmission by optical fibre technology, apparatus and software for local area networks (LANs) and home bus systems (included in this class), actuators, sensors, monitoring installations, ISDN terminals, gateways and PC cards, parts for the aforesaid goods; cabinets of metal for receiver and distribution installations; cables of metal for electronic purposes.

38 – Telecommunications.

(260) AM 2013 68401 A  
(800) 1121689  
(731) MAGIC PRODUCTION GROUP (M.P.G.)  
SA  
Findel Business Center, Complexe B, Rue de Trèves, L – 2632 FINDEL, Luxembourg  
(540)



(591) Dark yellow, light yellow, light blue, white  
(511)  
28 – Games, toys; gymnastic and sporting articles, not included in other classes; decorations for Christmas trees.  
30 – Coffee, tea, cocoa, sugar, rice, tapioca, sago, artificial coffee; flour and preparations made from cereals, bread, pastry and confectionery, edible ices; honey, treacle; yeast, baking – powder; salt, mustard; vinegar, sauces (condiments); spices; ice for refreshment.  
41 – Educational services; providing of training; entertainment; sporting and cultural activities.

(260) AM 2013 68558 A  
 (800) 1123000  
 (731) CESI S.P.A.  
 Via Raffaele Rubattino, 54 MILANO, Italy  
 (540)

**CESI**

(591) Black, white  
 (511)  
 38 – Telecommunications (services on behalf of third parties).

42 – Scientific and technological services and research and design relating thereto; industrial analysis and research services; design and development of computer hardware and software (services on behalf of third parties).

(260) AM 2013 68653 A  
 (800) 925317  
 (731) COMPAGNIE GENERALE DES  
 ETABLISSEMENTS MICHELIN Société en  
 Commandite par Actions  
 12, cours Sablon, F – 63040 CLERMONT –  
 FERRAND Cedex 09, France  
 (540)

**TYREPLUS**

(591) Black, white  
 (511)  
 16 – Printed matter and publications; technical manuals and guides; printed educational and teaching materials; technical drawings and diagrams; photographs; stationery; calendars; diaries; paperweights; clipboards; packaging materials of cardboard or plastics, namely bags, pouches, films and sheets.

35 – Pneumatic tyre, tyre inner tube retailing and/or wholesaling services; business information services and business advisory services, business management services, all relating to the tyre trade; advertising; sales promotion support services relating to the tyre trade, namely sales promotion services.

37 – Pneumatic tyre and tyre inner tube repair services; tyre and tyre inner tube replacing, fitting, installation and inflation services; tyre retreading and tyre regrooving services; wheel balancing services; services for installation of machines for use in the tyre trade; vehicle repair and maintenance services.

41 – Technical training services relating to the tyre trade; training services in the field of repair and replacement of tyres; training services in the use of machines for mounting, repairing and inflating tyres.

42 – Technical advice services relating to the use, the inspection, the monitoring and the analysis of tyres; services for the design of business premises for the tyre trade; testing and quality control services for tyres and inner tubes.

(260) AM 2013 68654 A  
 (800) 925322  
 (731) COMPAGNIE GENERALE DES  
 ETABLISSEMENTS MICHELIN Société en  
 Commandite par Actions  
 12 cours Sablon, F – 63000 CLERMONT –  
 FERRAND, France  
 (540)



(591) Black, white  
 (511)  
 16 – Printed matter and publications; technical manuals and guides; printed educational and teaching materials; technical drawings and diagrams; photographs; stationery; calendars; diaries; paperweights; clipboards; packaging materials of cardboard or plastics, namely bags, pouches, films and sheets.

35 – Pneumatic tyre, tyre inner tube retailing and/or wholesaling services; business information services and business advisory services, business management services, all such services relating to the tyre trade; advertising; sales promotion support services relating to the tyre trade, namely sales promotion services.

37 – Pneumatic tyre and tyre inner tube repair services; tyre and tyre inner tube replacing, fitting, installation and inflation services; tyre retreading and tyre regrooving services; wheel balancing services; services for installation of machines for use in the tyre trade; vehicle repair and maintenance services.

41 – Technical training services relating to the tyre trade; training services in the field of repair and replacement of tyres; training services in the use of machines for mounting, repairing and inflating tyres.

42 – Technical advice services relating to the use, the inspection, the monitoring and the analysis of tyres; services for the design of business premises for the tyre trade; testing and quality control services for tyres and inner tubes.

(260) AM 2013 68657 A  
 (800) 980172  
 (731) FULYA KOZMETİK ISLAK MENDİL  
 İMALAT VE PAZARLAMA LİMİTED  
 ŞİRKETİ  
 Adnan Kahveci Mahallesi, Gümüşsuyu Sokak  
 No: 1, Gürpınar Büyükçekmece, İSTANBUL,  
 Turkey  
 (540)

**Freshmaker**

(591) Black, white

(511)

3 – Detergents other than for use in manufacturing operations and for medical purposes, laundry starches, laundry bleaches, soaps, softeners, brightening chemicals for household purposes (laundry), perfumes, eau de cologne, lotions for cosmetic purposes, essential oils, deodorants for personal use, rose oils, antiperspirants, after – shave lotions, nail polishes, lipstick, creams, hair dyes, shampoos, hair lotions, hair sprays, hair colorants, hair waving preparations, eyebrow pencils, eyebrow cosmetics, powder, make – up powder, varnish – removing preparations, mascaras, petroleum jelly for cosmetic purposes, jelly for cosmetic purposes, cosmetic preparations for slimming purposes, cosmetic preparations for eyelashes, cosmetic kits, shaving preparations, shaving soaps, cotton wool for cosmetic purposes, tissues impregnated with cosmetic lotions, ear cleaning swabs; wet wipes, disinfectant soap, antiperspirant soap, toothpastes, mouth washes (not for medical purposes), emery cloths, emery paper, polish for furniture and flooring.

(260) AM 2013 68683 A

(800) 1124084

(731) Arcadia Group Brands Limited

Colegrave House, 70 Berners Street, London  
W1T 3NL, United Kingdom

(540)

## EVANS

(591) Black, white

(511)

14 – Precious metals and their alloys and goods in precious metals or coated therewith; semi – precious and precious stones; horological and other chronometric instruments; watches, clocks, jewellery and imitation jewellery; parts and fittings for all the aforesaid goods.

18 – Articles of leather and imitations of leather; trunks and travelling bags; travel cases; luggage; suitcases; holdalls; portmanteaux; valises; bags; handbags; shoulder bags; toilet bags; carrier bags; rucksacks; backpacks; bumbags; sports bags; casual bags; briefcases; attaché cases; music cases; satchels; beauty cases; carriers for suits, for shirts and for dresses; tie cases; notecases; notebook holders; document cases and holders; credit card cases and holders; cheque book holders; wallets; purses; umbrellas; parasols; walking sticks; shooting sticks; belts; parts and fittings for all the aforesaid goods.

(260) AM 2013 68756 A

(800) 586761

(731) B.D.L. S.N.C. DI IVO DONDERO &amp; C.

Località Ciosello, strada per Albareto,  
I – 16047 CORNIA DI MOCONESI  
(Genova), Italy

(540)



(591) Black, white

(511)

19 – Tiling, linings and coverings of stone and ceramic materials for exterior and interior roofs of buildings, for gardens and tiling for pedestrians.

(260) AM 2013 68757 A

(800) 647924A

(731) H. Lundbeck A/S

Ottiliavej 9, DK – 2500 Valby, Denmark

(540)

## CLOPIXOL – ACUPHASE

(591) Black, white

(511)

5 – Pharmaceutical, veterinary and sanitary products; dietetic substances adapted for medical use, food for babies; plasters, materials for dressings; material for stopping teeth, dental wax; disinfectants; products for destroying vermin; fungicides, herbicides.

(260) AM 2013 68758 A

(800) 697480

(731) Lindner Aktiengesellschaft

Bahnhofstrasse 29, 94424 Arnstorf, Germany

(540)

## Lindner

(591) Black, white

(511)

6 – Metal building materials such as metal ceilings, panelled ceilings, air – conditioned ceilings, ceiling panels of metal, fire protection ceilings, illuminated ceilings, metal partitions, mobile partitions, cavity floors, double floors, door systems (metallic), constructional fittings, sound protection elements, fire protection elements; transportable buildings of metal; working cabins.

19 – Building materials of wood and plastic such as panelled ceilings, air – conditioned ceilings, ceiling panels of wooden materials, fire protection ceilings, illuminated ceilings, wooden partitions, mobile partitions, cavity floors, double floors, door systems (non metallic), constructional fittings, sound protection elements, fire protection elements; non - metallic transportable buildings; working cabins.

(260) AM 2013 68759 A

(800) 701168

(731) Lindner Aktiengesellschaft

Bahnhofstrasse 29, 94424 Arnstorf, Germany

(540)

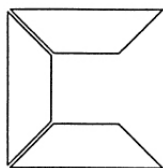

(591) Black, white

(511)

6 – Metal building materials such as metal ceilings, panelled ceilings, air – conditioned ceilings, ceiling panels of metal, fire protection ceilings, illuminated ceilings, metal partitions, mobile partitions, cavity floors, double floors, door systems (metallic), constructional fittings, sound protection elements, fire protection elements; transportable buildings of metal; working cabins.

19 – Building materials of wood and plastic such as panelled ceilings, air – conditioned ceilings, ceiling panels of wooden materials, fire protection ceilings, illuminated ceilings, wooden partitions, mobile partitions, cavity floors, double floors, door systems (non metallic), constructional fittings, sound protection elements, fire protection elements; non – metallic transportable buildings; working cabins.

(260) AM 2013 68760 A

(800) 830239

(731) Toruńskie Zakłady Materiałów  
Opatrunkowych, Spółka Akcyjna  
ul. Żółkiewskiego 20/26, PL – 87 – 100,  
Toruń, Poland

(540)

**plastofix**

(591) Black, white

(511)

5 – Non – woven adhesive tapes for medical purposes.

(260) AM 2013 68761 A

(800) 968815

(731) AstraZeneca AB  
SE – 15185 Södertälje, Sweden

(540)

**BAQISTREL**

(591) Black, white

(511)

5 – Pharmaceutical preparations and substances for the prevention and treatment of diseases and disorders of the metabolism, respiratory system, central nervous system, peripheral nervous system, cardiovascular system, gastro – intestinal system; pharmaceutical preparations and substances for pain control, arthritis, infection, inflammation and diabetes; pharmaceutical preparations and substances for use in the field of anaesthesia, oncology, urology and gynaecology.

(260) AM 2013 68762 A

(800) 997933

(731) Wilh. Wilhelmsen Holding ASA  
Strandveien 20, N – 1366 Lysaker, Norway

(540)



(591) Black, white

(511)

1 – Chemicals used in industry; chemicals and gases for use in the marine and/or maritime industry; industrial gases and refrigerants; cleaning and degreasing chemicals; surface active chemical preparations; chemical products for industrial removal of corrosion and contamination; preparations to break down and decompose oil; chemical products for marine and industrial treatment of bunker oil and heavy fuel oil; water treatment chemicals; combustion improver additives; inert gases; unprocessed artificial resins, unprocessed plastics, fire extinguishing compositions, including fire extinguishing gases, foams and powders; fireproofing and flame resistant preparations; tempering and soldering preparations, including welding preparations, chemicals and gases; adhesives for industrial, marine and/or maritime purposes.

7 – Machines and machine tools; electric welding machines and apparatus; gas operated welding apparatus; compressors for refrigerating apparatus and installations; equipment, apparatus and machines for the preparation/treatment of surfaces; equipment, apparatus and machines for cleaning; equipment, apparatus and machines for sandblasting; equipment, apparatus and machines for sanding; equipment, apparatus and machines for application of paint and coatings to surfaces; equipment, apparatus and machines for spray painting; equipment, apparatus and machines for high pressure washing; compressed air tools, air compressors; hand – held tools, other than hand – operated; bearings, motors (except for land vehicles); machine coupling and transmission components (except for land vehicles); parts and fittings for all the aforementioned goods.

8 – Hand tools and implements (hand – operated), including non – electric apparatus and tools for welding; cutlery; side arms; parts and fittings for all the aforementioned goods.

11 – Apparatus, devices and installations for lighting, heating, steam generating, cooking, refrigerating, drying, ventilating, water supply and sanitary purposes, including air conditioning and ventilation installations; refrigerating storage chambers, containers and installations; freezer storage chambers, containers and installations; parts and fittings for refrigerators and refrigerating plants; parts and fittings for all the aforementioned goods.

12 – Vehicles; apparatus for locomotion by land, air or water; ships; parts and fittings for all the aforementioned goods.

35 – Business management; business administration; professional business consultancy; business evaluations, composition and/or systematization of written communications and registrations as well as utilization or systematization of mathematical or statistical data; compilation and systematization of information into computer databases, preparation of payrolls; personnel management consultancy; employment services and personnel recruitment; accounting and auditing; information and consultancy relating to all the aforementioned services; retail and wholesale services relating to all the aforementioned goods in classes 1, 7, 8 and 11; retail and wholesale services relating to the following goods in class 4: oils and greases for industrial, marine and/or maritime purposes; lubricants; dust adhesive medium; fuels (including motor fuels) and illuminants; retail and wholesale services relating to the following goods in class 7: waste treatment/processing machinery, apparatus and equipment; and their parts and fittings; retail and wholesale services relating to the following goods in class 9: scientific, nautical, electric, photographic, weighing, measuring, signalling, checking (supervision), lifesaving and teaching apparatus and instruments; apparatus for recording transmission or reproduction of sound or images; magnetic data carriers, data processing equipment and computers; fire – extinguishing apparatus and installations; security apparatus, installations and equipment; breathing apparatus, tracking and alarm apparatus, installations and systems; life jackets, life boats and life buoys; apparatus for electric arc welding, electrical installation materials; and their parts and fittings; retail and wholesale services relating to the following goods in class 10; surgical, medical and dental apparatus and instruments; suture materials, beds for medical purposes, custom made furniture for medical purposes; ear muffs, ear plugs, leg protectors, knee protectors, thermometers; oxygen resuscitators; emergency stretchers; and their parts and fittings, retail and wholesale services relating to the following goods in class 12: vehicles; apparatus for locomotion by land, air or water; ships; and their parts and fittings.

37 – Building (construction) services; repair; installation services; shipbuilding; inspection of shipbuilding and shipbuilding projects; building, installation, inspection and repair of fire extinguishing, rescue and safety equipment, products and installations, as well as of refrigerating, heating, ventilating and air conditioning installations; maintenance of insulation; building, installation, inspection and repair of electrical installations and systems, including electro automation installations and systems; building, installation, inspection and repair of gas distribution

systems, and of welding gas and neutral gas installations; building, installation, inspection and repair of inert gas installations and systems; refilling and testing of gas containers; shipbuilding, cleaning and repair of boilers, painting services; building, installation, maintenance and repair of machines; underwater repair; rental of welding machines and equipment; rental of gas cylinders; rental of air compressors; rental of machines, systems and equipment for building, maintenance and repair purposes; rental of cleaning machines and equipment; rental of waste treatment machines and equipment; information and consultancy relating to all the aforementioned services.

39 – Logistics, transport and freight services; packaging and storage of goods; tour operation services; ship brokerage services; bunker broking, transport broking, transport reservation; operating means of transport, including ships; services in connection with the inspection of transport vehicles, including ships, or goods for transport; services in connection with the packaging and packing of goods for dispatch; load handling; services in connection with marine towing, unloading and loading, and operating harbours and docks; rental of means of transport, including boats and ships; rental of containers; rental of warehouse space; information and consultancy relating to all the aforementioned services.

42 – Scientific and technological services and research and design relating thereto; industrial analysis and research services; design and development of computer hardware and software; engineering services (technical expertise); technical project studies, technical project management; consultation and planning related to building (construction); ship design services and ship architectural services, ship engineering services; technical, maritime operation of ships; development, installation, update and maintenance of computer software; rental of computer software; information and consultancy relating to all the aforementioned services.

(260) AM 2013 68763 A

(800) 1022925

(731) BRUNELLO CUCINELLI S.P.A.

Via dell'Industria, 5, Frazione Solomeo,  
I – 06073 CORCIANO (PG), Italy

(540)

**BRUNELLO CUCINELLI**

(591) Black, white

(511)

3 – Bleaching preparations and other substances for laundry use; cleaning, polishing, scouring and abrasive preparations; soaps; perfumery, essential oils, cosmetics, hair lotions; dentifrices.

9 – Scientific, nautical, surveying, photographic, cinematographic, optical, weighing, measuring,

signalling, checking (supervision), life – saving and teaching apparatus and instruments; apparatus and instruments for conducting, switching, transforming, accumulating, regulating or controlling electricity; apparatus for recording, transmission or reproduction of sound or images; magnetic data carriers, recording discs; automatic vending machines and mechanisms for coin – operated apparatus; cash registers, calculating machines, data processing equipment and computers; fire – extinguishing apparatus.

18 – Leather and imitations of leather, and goods made of these materials and not included in other classes; animal skins, hides; trunks and travelling bags; umbrellas, parasols and walking sticks; whips, harness and saddlery.

24 – Textiles and textile goods, not included in other classes; bed and table covers.

25 – Clothing, footwear, headgear.

35 – Advertising; business management; business administration; office functions.

---

(260) AM 2013 68836 A

(800) 1125385

(731) Tovarischestvo s ogranichennoy otvetstvennostyu "Sovmestnoe Predpriyatie "Global Pharm"  
ul. Zhandosova, 184 G, 050042 g. Almaty, Kazakstan

(540)

**Godex®**

**Годекс®**

(591) Black, white

(511)

5 – Pharmaceutical preparations.

---

(260) AM 2013 68837 A

(800) 1125386

(731) Tovarischestvo s ogranichennoy otvetstvennostyu "Sovmestnoe Predpriyatie "Global Pharm"  
ul. Zhandosova, 184 G, 050042 g. Almaty, Kazakstan

(540)

**Непадиф®**

**Гепадиф®**

(591) Black, white

(511)

5 – Pharmaceutical preparations.

(260) AM 2013 68838 A

(800) 1125389

(731) Société des Produits Nestlé S.A.  
CH – 1800 Vevey, Switzerland

(540)

**ГОРЯЧАЯ КРУЖКА**

(591) Black, white

(511)

29 – Vegetables and potatoes (preserved, dried or cooked), fruit (preserved, died or cooked), mushrooms (preserved, died or cooked); meat, poultry, game, fish and seafood, all these goods in the form of extracts, soups, jellies, spreads, preserves, cooked, deep – frozen or dehydrated dishes; jams; eggs; preserved soya beans for human consumption; edible oils and fats; protein preparations for consumption; sausages; charcuterie, peanut butter; soups, concentrated soups, preparations for making soups, thickened soups, bouillon, also in the form of cubes, tablets or powders, bouillon concentrates, preparations for making bouillon, consommés (soups).

30 – Flours, cereal preparations, bread, yeast, pasty; biscuits, cakes, cookies, wafers, caramels, puddings; rice, pasta, noodles; food products made with rice, flour or cereal, also in the form cooked dishes; pizzas, sandwiches; oven – ready preparations of farinaceous paste and cake pastry; powdered mixes for cakes; sauces, soya sauces; tomato ketchup; food flavoring or seasoning products; spices for food, condiments, salad dressings, mayonnaise; mustard; vinegar.

---

(260) AM 2013 68839 A

(800) 1125392

(731) Limited liability company "Arda – Trading"  
29/28 Mira street, Sinelnikovo,  
Dnipropetrovsk region, Ukraine

(540)



(591) Black, white

(511)

33 – Alcoholic beverages (except beers).

---

(260) AM 2013 68840 A

(800) 1125426

(731) Deepflight AG  
Firststrasse 1, CH – 8835 Feusisberg,  
Switzerland

(540)

**DEEPFLIGHT**

(591) Black, white

(511)

9 – CDs, DVDs and other magnetic recording media; apparatus for recording, transmission or reproduction of sound or images.



25 – Clothing, footwear, headgear.

41 – Entertainment; organization and conducting of parties, musical events and dancing events and all related activities; sporting and cultural activities and events.

(260) AM 2013 68841 A

(800) 1125442

(731) Obschestvo s ogranichennoy  
otvetstvennostyu "Proizvodstvenno –  
kommercheskaya firma "Atlantis – Pak"  
72, ul. Onuchkina, kh. Lenina, Aksaisky r- n.  
RU – 346703 Rostovskaya Oblast, Russian  
Federation

(540)



(591) Black, white

(511)

16 – Plastic materials for packaging (not included in other classes); plastic articles for packaging; gummed tape [stationery]; viscose sheets for wrapping; plastic bubble packs [for wrapping or packaging]; sheets of reclaimed cellulose for wrapping; packaging material made of starches; garbage bags [of plastics]; stickers [stationery]; plastic cling film, extensible, for palletization; bags for microwave cooking; plastic film for wrapping; labels, not of textile.

18 – Gut for making sausages; gold beaters' skin.

(260) AM 2013 68842 A

(800) 1125447

(731) Tovarichtchestvo s ogranichennoy  
otvetstvennostyu "Global Beauty"  
oul. Khoussainova, 281, 050060 g. Almaty,  
Kazakstan

(540)



(591) Black, white and pink

(511)

14 – Precious metals and their alloys and goods in precious metals or coated therewith not included in other classes; jewelry, jewelry articles, precious stones; timepieces and chronometric instruments.

16 – Paper, cardboard and goods made from these materials, not included in other classes; printed matter; bookbinding articles; photographs; stationery; adhesives for stationery or household purposes; artists' materials; paintbrushes; typewriters and office requisites (except furniture); instructional or

teaching material (except apparatus); plastic materials for packaging (not included in other classes); printing type; printing blocks.

18 – Leather and imitations of leather, goods made from these materials, not included in other classes; animal skins; trunks and travelling bags; umbrellas, parasols and walking sticks; whips, harness and saddlery.

20 – Furniture, mirrors, picture frames; goods, not included in other classes, of wood, cork, reed, cane, wicker, horn, bone, ivory, whalebone, shell, amber, mother – of – pearl, meerschaum and substitutes for all these materials, or of plastics.

24 – Textiles and textile goods not included in other classes; bed and table covers.

25 – Clothing, footwear, headgear.

28 – Games and toys; gymnastic and sporting articles not included in other classes; decorations for Christmas trees.

35 – Advertising; company management; business administration; office functions.

(260) AM 2013 68843 A

(800) 1125451

(731) Erich Krause Finland Oy  
Henry Fordin katu 5 N, FI – 00150 Helsinki,  
Finland

(540)

**ART BERRY**

(591) Black, white

(511)

9 – Ticket dispensers; coin – operated musical automata [juke boxes]; distribution machines, automatic; motor fire engines; answering machines; accumulators, electric; accumulators, electric, for vehicles; actinometers; alidades; altimeters; ammeters; anemometers; anodes; antennas; anticathodes; apertometers [optics]; divers' apparatus; high – frequency apparatus; testing apparatus not for medical purposes; remote control apparatus; monitoring apparatus, electric; sound recording apparatus; electro – dynamic apparatus for the remote control of railway points; electro – dynamic apparatus for the remote control of signals; distillation apparatus for scientific purposes; diffraction apparatus [microscopy]; air analysis apparatus; apparatus to check franking; sound transmitting apparatus; electrical apparatus for sealing plastics [packaging]; apparatus for fermentation [laboratory apparatus]; electric arc cutting apparatus; electric arc welding apparatus; electric welding apparatus; breathing apparatus, except for artificial respiration; breathing apparatus for underwater swimming; X – rays producing apparatus and installations, not for medical purposes;

cash registers; electric apparatus for commutation; mechanisms for coin – operated apparatus; intercommunication apparatus; stills for laboratory experiments; projection apparatus; Roentgen apparatus not for medical purposes; radiological apparatus for industrial purposes; welding apparatus, electric; blueprint apparatus; flashing lights [luminous signals]; stereoscopic apparatus; telegraphs [apparatus]; telephone apparatus; telephone transmitters; facsimile machines; phototelegraphy apparatus; igniting apparatus, electric, for igniting at a distance; mechanisms for counter – operated apparatus; acidimeters for batteries; acid hydrometers; salinometers; aerometers; beacons, luminous; accumulator jars; barometers; anode batteries; galvanic batteries; batteries for pocketlamps; batteries for lighting; solar batteries; batteries, electric; balances [steelyards]; gasoline pumps for service stations; betatrons; binoculars; electronic tags for goods; magnetic tape units for computers; computer memories; fire hose nozzles; encoded identification bracelets, magnetic; safety tarpaulins; signalling buoys; life buoys; marking buoys; directional compasses; vacuum gauges; electrolyzers; variometers; scales; letter scales; weighbridges; precision balances; levelling staffs [surveying instruments]; camcorders; video cassettes; video telephones; video screens; viewfinders, photographic; sockets, plugs and other contacts [electric connections]; micrometer screws for optical instruments; viscosimeters; circuit closers; wavemeters; voltmeters; coin – operated gates for car parks or parking lots; mechanical signs; switchboxes [electricity]; current rectifiers; jigs [measuring instruments]; gas testing instruments; gasometers; galvanometers; electroplating apparatus; heliographic apparatus; hygrometers; hydrometers; weights; peepholes [magnifying lenses] for doors; holograms; plotters; loudspeakers; sounding leads; plumb bobs; range finders; densimeters; densitometers; optical goods; detectors; galena crystals [detectors]; smoke detectors; counterfeit [false] coin detectors; transparencies [photography]; slide projectors; diaphragms [photography]; dictating machines; dynamometers; floppy disks; phonograph records; disks, magnetic; optical discs; calculating disks; disk drives for computers; juke boxes for computers; DNA chips; electronic notice boards; swimming jackets; bullet – proof waistcoats [vests (Am.)]; life jackets; identification threads for electric wires; nose clips for divers and swimmers; locks, electric; bells [warning devices]; alarm bells, electric; electric door bells; signal bells; acoustic conduits; mirrors for inspecting work; road signs, luminous or mechanical; signs, luminous; marine depth finders; probes for scientific purposes; buzzers; buzzers, electric; needles for record players; measures; pressure measuring apparatus; simulators for the steering and control of vehicles; inverters [electricity]; pressure indicators; indicators [electricity]; temperature indicators; incubators for bacteria

culture; measuring instruments; mathematical instruments; levelling instruments; surveying instruments; azimuth instruments; interfaces for computers; ionisation apparatus, not for the treatment of air; spark – guards; coaxial cables; fibre [fiber (Am.)] optic cables; electrical cabling; calipers; slide calipers; screw – tapping gauges; calculating machines; pocket calculators; decompression chambers; cinematographic cameras; electronic pens [visual display units]; holders for electric coils; identity cards, magnetic; video game cartridges; encoded cards, magnetic; riding helmets; protective helmets; carriers for dark plates [photography]; automated teller machines [ATM]; cathodes; choking coils [impedance]; coils, electric; electromagnetic coils; spools [photography]; cinematographic film, exposed; solenoid valves [electromagnetic switches]; wire connectors [electricity]; electronic agendas; push buttons for bells; mouse pads; magnetic encoders; eyeshades; anti – glare visors; collectors, electric; calibrating rings; protective suits for aviators; commutators; compact discs [audio – video]; compact discs [read – only memory]; comparators; marine compasses; computers; mobile computers; condensers [capacitors]; contacts, electric; contacts, electric, of precious metal; wind socks for indicating wind direction; branch boxes [electricity]; distribution boxes [electricity]; connectors [electricity]; junction boxes [electricity]; battery boxes; cabinets for loudspeakers; diving suits; reflecting discs for wear, for the prevention of traffic accidents; covers for electric outlets; logs [measuring instruments]; lasers, not for medical purposes; lactodensimeters; lactometers; darkroom lamps [photography]; neon signs; thermionic lamps and tubes; thermionic valves [radio]; amplifying tubes; flashlights [photography]; head cleaning tapes [recording]; magnetic tapes; videotapes; surveying chains; fire escapes; rulers [measuring instruments]; slide – rules; contact lenses; correcting lenses [optics]; optical lenses; lens hoods; optical condensers; sounding lines; electricity conduits; measuring spoons; magnifying glasses [optics]; thread counters; magnets; decorative magnets; resuscitation mannequins [teaching apparatus]; mouse [data processing equipment]; pressure gauges; divers' masks; solderers' helmets; protective masks; materials for electricity mains [wires, cables]; accounting machines; voting machines; money counting and sorting machines; material testing instruments and machines; hemline markers; megaphones; diaphragms [acoustics]; diaphragms for scientific apparatus; metal detectors for industrial or military purposes; metronomes; rules [measuring instruments]; carpenters' rules; dressmakers' measures; coin – operated mechanisms for television sets; shutter releases [photography]; micrometers; microprocessors; microscopes; microtomes; microphones; modems; lightning conductors [rods]; monitors [computer hardware]; nautical apparatus and instruments;

animated cartoons; terminals [electricity]; junction sleeves for electric cables; cases fitted with dissecting instruments [microscopy]; navigational instruments; teeth protectors; knee – pads for workers; self – regulating fuel pumps; fuel dispensing pumps for service stations; headsets; surveyors' levels; verniers; sound recording carriers; magnetic data media; optical data media; socks, electrically heated; sheaths for electric cables; identification sheaths for electric wires; weighing machines; punched card machines for offices; furniture especially made for laboratories; shoes for protection against accidents, irradiation and fire; objectives [lenses] [optics]; lenses for astrophotography; egg – candler; clothing for protection against fire; extinguishers; electrified fences; limiters [electricity]; clothing for protection against accidents, irradiation and fire; asbestos clothing for protection against fire; garments for protection against fire; clothing especially made for laboratories; ozonisers [ozonators]; octants; eyepieces; ohmmeters; wrist rests for use with computers; spectacle frames; eyeglass frames; oscillographs; plumb lines; mirrors [optics]; galvanizing apparatus; spectacles [optics]; sunglasses; goggles for sports; signalling panels, luminous or mechanical; radio pagers; pince – nez; electronic pocket translators; transmitters [telecommunication]; transmitters of electronic signals; switches, electric; periscopes; gloves for divers; asbestos gloves for protection against accidents; gloves for protection against accidents; gloves for protection against X – rays for industrial purposes; furnaces for laboratory experiments; pipettes; pyrometers; planimeters; plane tables [surveying instruments]; plates for batteries; wafers [silicon slices]; DVD players; compact disc players; cassette players; sound recording strips; X – ray films, exposed; films, exposed; life – saving rafts; laboratory trays; semi – conductors; polarimeters; fire engines; floats for bathing and swimming; measuring glassware; swimming belts; life belts; circuit breakers; fuses; converters, electric; telerupters; food analysis apparatus; diagnostic apparatus, not for medical purposes; hair – curlers, electrically heated; distance measuring apparatus; speed measuring apparatus [photography]; appliances for measuring the thickness of leather; apparatus for measuring the thickness of skins; speed checking apparatus for vehicles; teaching apparatus; time recording apparatus; make – up removing appliances, electric; distance recording apparatus; apparatus and instruments for astronomy; surveying apparatus and instruments; weighing apparatus and instruments; optical apparatus and instruments; apparatus and instruments for physics; chemistry apparatus and instruments; measuring apparatus; measuring devices, electric; boiler control instruments; meteorological instruments; naval signalling apparatus; observation instruments; navigation apparatus for vehicles [on – board computers];

satellite navigational apparatus; regulating apparatus, electric; precision measuring apparatus; instruments containing eyepieces; audio – receivers and video – receivers; prisms [optics]; cigar lighters for automobiles; printers for use with computers; apparatus for changing record player needles; retorts' stands; drainers for use in photography; cleaning apparatus for phonograph records; fire beaters; sighting telescopes for firearms; test tubes; pressure indicator plugs for valves; magnetic wires; telegraph wires; telephone wires; wires, electric; conductors, electric; copper wire, insulated; fuse wire; computer programmes [programs], recorded; computer game software; computer programs [downloadable software]; computer software, recorded; record players; processors [central processing units]; rods for water diviners; electronic publications, downloadable; distribution consoles [electricity]; control panels [electricity]; radar apparatus; vacuum tubes [radio]; masts for wireless aerials; transmitting sets [telecommunication]; radios; vehicle radios; frames for photographic transparencies; screens for photoengraving; walkie – talkies; voltage surge protectors; voltage regulators for vehicles; light dimmers [regulators], electric; stage lighting regulators; speed regulators for record players; cell switches [electricity]; washing trays [photography]; marking gauges [joinery]; time switches, automatic; relays, electric; safety restraints, other than for vehicle seats and sports equipment; X – ray photographs, other than for medical purposes; rheostats; respiratory masks, other than for artificial respiration; respirators for filtering air; retorts; refractometers; refractors; grids for batteries; speaking tubes; horns for loudspeakers; saccharometers; optical fibers [fibres] [light conducting filaments]; traffic – light apparatus [signalling devices]; dog whistles; sextants; inductors [electricity]; safety nets; nets for protection against accidents; fire alarms; signals, luminous or mechanical; signalling whistles; sirens; scanners [data processing equipment]; integrated circuit cards [smart cards]; connections for electric lines; couplings, electric; sonars; sound locating instruments; lighting ballasts; resistances, electric; spectrograph apparatus; spectroscopes; speed indicators; spirit measures; satellites for scientific purposes; protection devices for personal use against accidents; audiovisual teaching apparatus; radiotelegraphy sets; radiotelephony sets; spectacle glasses; optical glass; glass covered with an electrical conductor; anti – glare glasses; personal stereos; stereoscopes; fire boats; sulphitometers; hands free kits for phones; drying racks [photography]; spherometers; integrated circuits; printed circuits; counters; parking meters; postage stamp meters; milage recorders for vehicles; revolution counters; abacuses; taximeters; ear plugs; ear plugs for divers; tachometers; word processors; television apparatus; telescopes; teleprompters; teleprinters; portable telephones; theodolites; thermometers, not

for medical purposes; thermostats; thermostats for vehicles; crucibles [laboratory]; tone arms for record players; totalizers; transistors [electronic]; protractors [measuring instruments]; battery chargers; transformers [electricity]; whistle alarms; tripods for cameras; vehicle breakdown warning triangles; starter cables for motors; discharge tubes, electric, other than for lighting; capillary tubes; X – rays tubes not for medical purposes; telephone receivers; turnstiles, automatic; quantity indicators; automatic indicators of low pressure in vehicle tires [tyres]; gasoline gauges; water level indicators; electric loss indicators; light – emitting electronic pointers; slope indicators; computer operating programs, recorded; levels [instruments for determining the horizontal]; mercury levels; spirit levels; urinometers; sound power amplifiers; particle accelerators; sprinkler systems for fire protection; electric installations for the remote control of industrial operations; steering apparatus, automatic, for vehicles; balancing apparatus; video recorders; sound reproduction apparatus; invoicing machines; door closers, electric; tape recorders; protection devices against X – rays [Röntgen rays], not for medical purposes; apparatus for games adapted for use with an external display screen or monitor; railway traffic safety appliances; data processing apparatus; door openers, electric; oxygen transvasing apparatus; theft prevention installations, electric; electric devices for attracting and killing insects; amusement apparatus adapted for use with an external display screen or monitor; time clocks [time recording devices]; film cutting apparatus; drying apparatus for photographic prints; optical character readers; elevator operating apparatus; centering apparatus for photographic transparencies; dosage dispensers; chargers for electric batteries; acoustic [sound] alarms; sounding apparatus and machines; life saving apparatus and equipment; editing appliances for cinematographic films; cathodic anti – corrosion apparatus; couplers [data processing equipment]; computer peripheral devices; anti – interference devices [electricity]; demagnetizing apparatus for magnetic tapes; acoustic couplers; anti – theft warning apparatus; alarms; fog signals, non – explosive; adding machines; readers [data processing equipment]; heat regulating apparatus; photocopiers photographic, electrostatic, thermic]; bar code readers; flat irons, electric; filters for respiratory masks; filters for ultraviolet rays, for photography; filters [photography]; magic lanterns; optical lamps; signal lanterns; cameras [photography]; glazing apparatus for photographic prints; shutters [photography]; darkrooms [photography]; photometers; flash – bulbs [photography]; enlarging apparatus [photography]; photovoltaic cells; containers for contact lenses; spectacle cases; pince – nez cases; containers for microscope slides; cases especially made for photographic apparatus and instruments; chromatography apparatus for laboratory use; chro-

nographs [time recording apparatus]; eyeglass chains; cyclotrons; compasses [measuring instruments]; frequency meters; egg timers [sandglasses]; fire blankets; chips [integrated circuits]; gauges; pedometers; meteorological balloons; electrified rails for mounting spot lights; asbestos screens for firemen; protective helmets for sports; eyeglass cords; stands for photographic apparatus; switchboards; distribution boards [electricity]; workmen's protective face – shields; projection screens; radiology screens [photography]; exposure meters [light meters]; welding electrodes; soldering irons, electric; ducts [electricity]; galvanic cells; epidiascopes; ergometers; armatures [electricity]; capacity measures; computer keyboards.

16 – Fountain pens; aquarelles; albums; almanacs; document laminators for office use; atlases; posters; paper bows; table linen of paper; tickets; forms, printed; note books; drawing pads; pads [stationery]; loose – leaf binders; wristbands for the retention of writing instruments; pamphlets; booklets; paper sheets [stationery]; waxed paper; paper for recording machines; paper for radiograms; electrocardiograph paper; drawer liners of paper, perfumed or not; wood pulp paper; copying paper [stationery]; parchment paper; writing paper; luminous paper; toilet paper; wrapping paper; filter paper; Xuan paper for Chinese painting and calligraphy; paper; place mats of paper; writing pads; newsletters; rollers for typewriters; house painters' rollers; obliterating stamps; modelling wax, not for dental purposes; signboards of paper or cardboard; patterns for dressmaking; patterns for making clothes; newspapers; electrotypes; hectographs; shields [paper seals]; modelling clay; terrestrial globes; engravings; slate pencils; pencil leads; pencil holders; chalk holders; holders for stamps [seals]; holders for checkbooks [cheque books]; diagrams; engraving plates; writing slates; blackboards; galley racks [printing]; drawing boards; punches [office requisites]; magazines [periodicals]; paper clasps; money clips; tags for index cards; pen clips; bookmarks; etching needles; tracing needles for drawing purposes; printed publications; bags [envelopes, pouches] of paper or plastics, for packaging; cardboard articles; paper shredders for office use; graphic representations; graining combs; calendars; tear – off calendars; tracing paper; tracing cloth; tracing patterns; gums [adhesives] for stationery or household purposes; lithographic stones; pencils; pencil lead holders; charcoal pencils; pictures; transfers [decalcomanias]; paintings [pictures], framed or unframed; wood pulp board [stationery]; cardboard; hat boxes of cardboard; document files [stationery]; files [office requisites]; index cards [stationery]; credit card imprinters, non – electric; cards; geographical maps; paper tapes and cards for the recordal of computer programmes; perforated cards for Jacquard looms; catalogues; spools for inking ribbons; covers of paper for flower pots;

paintbrushes; painters' brushes; writing brushes; typewriter keys; glue for stationery or household purposes; modelling paste; isinglass for stationery or household purposes; gluten [glue] for stationery or household purposes; starch paste [adhesive] for stationery or household purposes; printing blocks; books; ledgers [books]; manifolds [stationery]; comic books; drawing pins; cigar bands; envelopes [stationery]; duplicators; cases for stamps [seals]; boxes of cardboard or paper; paint boxes [articles for use in school]; correcting fluids [office requisites]; rubber erasers; French curves; paper ribbons; typewriter ribbons; adhesive bands for stationery or household purposes; gummed tape [stationery]; inking ribbons; inking ribbons for computer printers; drawing rulers; square rulers; viscose sheets for wrapping; plastic bubble packs for wrapping or packaging; sheets of reclaimed cellulose for wrapping; steel letters; type [numerals and letters]; numbers [type]; lithographs; lithographic works of art; architects' models; postage stamps; graphic prints; modelling materials; teaching materials [except apparatus]; bookbinding material; sealing compounds for stationery purposes; adhesives [glues] for stationery or household purposes; packaging material made of starches; pencil sharpening machines, electric or non – electric; addressing machines; bookbinding apparatus and machines [office equipment]; typewriters, electric or non – electric; folders [stationery]; franking machines [stamping machines]; chalk for lithography; writing chalk; tailors' chalk; marking chalk; garbage bags of paper or of plastics; mimeograph apparatus and machines; painters' easels; hand – rests for painters; steatite [tailor's chalk]; writing instruments; writing cases [stationery]; printing sets, portable [office requisites]; bibs of paper; stickers [stationery]; finger – stalls [office requisites]; cords for bookbinding; paper knives [cutters] [office requisites]; numbering apparatus; bookbinding cloth; bottle envelopes of cardboard or paper; sealing wafers; covers [stationery]; passport holders; plastic cling film, extensible, for palletization; embroidery designs [patterns]; handwriting specimens for copying; oleographs; musical greeting cards; greeting cards; postcards; etchings; conical paper bags; bags for microwave cooking; palettes for painters; ink sticks; pantographs [drawing instruments]; folders for papers; paper mache; pastels [crayons]; babies' napkins of paper and cellulose, disposable; pen cases; bookbindings; periodicals; pen wipers; office perforators; nibs; nibs of gold; steel pens; drawing pens; song books; seals [stamps]; sealing stamps; announcement cards [stationery]; drawing sets; drawing materials; clipboards; plastics for modelling; address plates for addressing machines; handkerchiefs of paper; plastic film for wrapping; babies' napkin – pants [diaper – pants] of paper and cellulose, disposable; babies' diapers of paper and cellulose, dispo-

sable; letter trays; trays for sorting and counting money; coasters of paper; bookends; stamp stands; mats for beer glasses; stands for pens and pencils; photograph stands; binding strips [bookbinding]; towels of paper; gummed cloth for stationery purposes; printers' blankets, not of textile; inking sheets for document reproducing machines; inking sheets for duplicators; portraits; paperweights; writing cases [sets]; drawing instruments; office requisites, except furniture; writing materials; school supplies [stationery]; adhesive tape dispensers [office requisites]; hand labelling appliances; pencil sharpeners, electric or non – electric; printed matter; blotters; prospectuses; drawing squares; printed timetables; printers' reglets; indexes; elastic bands for offices; graphic reproductions; penholders; pens [office requisites]; table napkins of paper; tissues of paper for removing make – up; face towels of paper; self – adhesive tapes for stationery or household purposes; tablecloths of paper; scrapers [erasers] for offices; paper – clips; staples for offices; erasing products; biological samples for use in microscopy (teaching materials); histological sections for teaching purposes; figurines statuettes of papier mâché; writing board erasers; erasing shields; composing frames [printing]; sealing wax; drawing T – squares; arithmetical tables; placards of paper or cardboard; tablemats of paper; adhesive tapes for stationery or household purposes; writing or drawing books; fabrics for bookbinding; stationery; transparencies [stationery]; stencils [stationery]; stencil plates; stencils; cardboard tubes; Indian inks; moisteners [office requisites]; moisteners for gummed surfaces [office requisites]; carbon paper; chart pointers, non – electronic; bottle wrappers of cardboard or paper; envelope sealing machines, for offices; sealing machines for offices; vignetting apparatus; apparatus for mounting photographs; stapling presses [office requisites]; manuals [handbooks]; filtering materials [paper]; paper coffee filters; flags of paper; silver paper; molds for modelling clays [artists' materials]; photo – engravings; photographs; stencil cases; canvas for painting; chromolithographs [chromos]; compasses for drawing; watercolor [watercolour] saucers for artists; correcting ink [heliography]; ink; inkwells; inking pads; blueprints; rosaries; balls for ball – point pens; cabinets for stationery [office requisites]; printing type; address stamps; stamp pads; stamps [seals]; advertisement boards of paper or cardboard; prints [engravings]; labels, not of textile; cream containers of paper; ink stones [ink reservoirs].

18 – Mountaineering sticks; pocket wallets; card cases [notecases]; reins; harness fittings; parts of rubber for stirrups; chamois leather, other than for cleaning purposes; umbrellas; parasols; briefcases; saddlery; frames for umbrellas or parasols; handbag frames; valves of leather; whips; imitation leather; leather, unworked or semi – worked; leatherboard;

casings, of leather, for springs; umbrella rings; hat boxes of leather; boxes of leather or leather board; boxes of vulcanised fibre; purses; chain mesh purses; fastenings for saddles; butts [parts of hides]; saddle trees; bags [envelopes, pouches] of leather, for packaging; moleskin [imitation of leather]; knee – pads for horses; muzzles; halters; vanity cases, not fitted; leather thread; furniture coverings of leather; gut for making sausages; clothing for pets; trimmings of leather for furniture; collars for animals; dog collars; music cases; slings for carrying infants; gold beaters' skin; cat o' nine tails; pads for horse saddles; horseshoes; bands of leather; coverings of skins [furs]; horse blankets; bandoliers; traces [harness]; fur; haversacks; leather straps; straps for soldiers' equipment; harness straps; straps for skates; straps of leather [saddlery]; chin straps, of leather; stirrup leathers; umbrella handles; walking stick handles; suitcase handles; rucksacks; travelling bags; riding saddles; net bags for shopping; valises; umbrella or parasol ribs; stirrups; bags for climbers; travelling sets [leatherware]; sling bags for carrying infants; garment bags for travel; handbags; tool bags of leather, empty; wheeled shopping bags; beach bags; bags for sports; bags for campers; shopping bags; school bags; travelling trunks; cases, of leather or leatherboard; nose bags [feed bags]; bridoons; walking sticks; umbrella sticks; walking stick seats; bits for animals [harness]; bridles [harness]; harness for animals; key cases [leatherware]; horse collars; trunks [luggage]; suitcases; attaché cases; covers for horse – saddles; umbrella covers; kid; curried skins; animal skins; cattle skins; leather leashes; blinkers [harness]; game bags [hunting accessories].

28 – Amusement machines, automatic and coin – operated; swimming pools [play articles]; novelties for parties, dances [party favors, favours]; baseball gloves; starting blocks for sports; bob – sleighs; body boards; boxing gloves; skating boots with skates attached; dolls' feeding bottles; stationary exercise bicycles; paintballs [ammunition for paintball guns] [sports apparatus]; shuttlecocks; spinning tops [toys]; jigsaw puzzles; punching bags; hang gliders; flying discs [toys]; discuses for sports; dolls' houses; dominoes; surf boards; spring boards [sports articles]; skateboards; sailboards; chessboards; checkerboards; darts; kites; piñatas; toy vehicles; toys; toys for domestic pets; plush toys; mobiles [toys]; practical jokes [novelties]; games other than those adapted for use with an external display screen or monitor; parlor games; board games; ring games; games; bite indicators [fishing tackle]; kaleidoscopes; bladders of balls for games; rosin used by athletes; edges of skis; bingo cards; playing cards; fairground ride apparatus; reels for fishing; rocking horses; swings; skittles; ninepins; billiard cues; golf clubs; hockey sticks; seal skins [coverings for skis]; bells for Christmas trees; dolls' rooms; building games; lines for fishing; confetti; explosive bonbons

[Christmas crackers]; ice skates; roller skates; creels [fishing equipment]; dice; paintball guns [sports apparatus]; ski bindings; dolls' beds; roulette wheels; building blocks [toys]; dolls; flippers for swimming; gut for fishing; gut for rackets; bows for archery; skis; waterskis; surf skis; mah – jong; wax for skis; hunting game calls; puppets; toy masks; theatrical masks; fencing masks; masts for sailboards; teddy bears; chalk for billiard cues; targets; electronic targets; scale model vehicles; playing balls; balls for games; artificial fishing bait; billiard table cushions; knee guards [sports articles]; billiard cue tips; elbow guards [sports articles]; dolls' clothes; in – line roller skates; fencing weapons; twirling batons; paragliders; golf gloves; gloves for games; batting gloves [accessories for games]; toy pistols; air pistols [toys]; percussion caps [toys]; caps for pistols [toys]; rattles [playthings]; horseshoe games; candle holders for Christmas trees; Christmas tree stands; sole coverings for skis; floats for fishing; decoys for hunting or fishing; scent lures for hunting or fishing; archery implements; fishing tackle; kite reels; soap bubbles [toys]; billiard markers; divot repair tools [golf accessories]; protective paddings [parts of sports suits]; rackets; foils for fencing; surfboard leashes; harness for sailboards; weight lifting belts [sports articles]; sling shots [sports articles]; rollers for stationary exercise bicycles; harpoon guns [sports articles]; fencing gauntlets; fish hooks; landing nets for anglers; scooters [toys]; sleighs [sports articles]; butterfly nets; nets for sports; scrapers for skis; appliances for gymnastics; quoits; dumb – bells; climbers' harness; artificial snow for Christmas trees; snowshoes; clay pigeon traps; billiard tables; coin – operated billiard tables; tables for table tennis; tables for indoor football; strings for rackets; cricket bags; golf bags, with or without wheels; clay pigeons [targets]; tennis nets; slides [playthings]; radio – controlled toy vehicles; body – building apparatus; backgammon games; men's athletic supporters [sports articles]; rods for fishing; ornaments for Christmas trees, except illumination articles and confectionery; tennis ball throwing apparatus; conjuring apparatus; apparatus for games other than those adapted for use with an external display screen or monitor; bowling apparatus and machinery; machines for physical exercises; counters [discs] for games; bags especially designed for skis and surfboards; bite sensors [fishing tackle]; marbles for games; billiard balls; play balloons; snow globes; chess games; checkers [games]; shin guards [sports articles]; camouflage screens [sports articles]; chest expanders [exercisers]; Christmas trees of synthetic material; cups for dice.

35 – Import – export agencies; demonstration of goods; marketing studies; organization of exhibitions for commercial or advertising purposes; organization of trade fairs for commercial or advertising purposes; presentation of goods on communication

media, for retail purposes; auctioneering; sales promotion for others; distribution of samples; advertising; on – line advertising on a computer network; advertising by mail order; television advertising; commercial administration of the licensing of the goods and services of others; administrative processing of purchase orders; modelling for advertising or sales promotion; procurement services for others [purchasing goods and services for other businesses].

38 – Electronic mail; telecommunications routing and junction services.

(260) AM 2013 68844 A

(800) 1125452

(731) Erich Krause Finland Oy

Henry Fordin katu 5 N, FI – 00150 Helsinki,  
Finland

(540)

## ARTBERRY

(591) Black, white

(511)

9 – Ticket dispensers; coin – operated musical automata [juke boxes]; distribution machines, automatic; motor fire engines; answering machines; accumulators, electric; accumulators, electric, for vehicles; actinometers; alidades; altimeters; ammeters; anemometers; anodes; antennas; anticathodes; apertometers [optics]; divers' apparatus; high – frequency apparatus; testing apparatus not for medical purposes; remote control apparatus; monitoring apparatus, electric; sound recording apparatus; electro – dynamic apparatus for the remote control of railway points; electro – dynamic apparatus for the remote control of signals; distillation apparatus for scientific purposes; diffraction apparatus [microscopy]; air analysis apparatus; apparatus to check franking; sound transmitting apparatus; electrical apparatus for sealing plastics [packaging]; apparatus for fermentation [laboratory apparatus]; electric arc cutting apparatus; electric arc welding apparatus; electric welding apparatus; breathing apparatus, except for artificial respiration; breathing apparatus for underwater swimming; X – rays producing apparatus and installations, not for medical purposes; cash registers; electric apparatus for commutation; mechanisms for coin – operated apparatus; intercommunication apparatus; stills for laboratory experiments; projection apparatus; Roentgen apparatus not for medical purposes; radiological apparatus for industrial purposes; welding apparatus, electric; blueprint apparatus; flashing lights [luminous signals]; stereoscopic apparatus; telegraphs [apparatus]; telephone apparatus; telephone transmitters; facsimile machines; phototelegraphy apparatus; igniting apparatus, electric, for igniting at a distance; mechanisms for counter – operated apparatus; acidimeters for ba-

teries; acid hydrometers; salinometers; aerometers; beacons, luminous; accumulator jars; barometers; anode batteries; galvanic batteries; batteries for pocketlamps; batteries for lighting; solar batteries; batteries, electric; balances [steelyards]; gasoline pumps for service stations; betatrons; binoculars; electronic tags for goods; magnetic tape units for computers; computer memories; fire hose nozzles; encoded identification bracelets, magnetic; safety tarpaulins; signalling buoys; life buoys; marking buoys; directional compasses; vacuum gauges; electrolyzers; variometers; scales; letter scales; weighbridges; precision balances; levelling staffs [surveying instruments]; camcorders; video cassettes; video telephones; video screens; viewfinders, photographic; sockets, plugs and other contacts [electric connections]; micrometer screws for optical instruments; viscosimeters; circuit closers; wavemeters; voltmeters; coin – operated gates for car parks or parking lots; mechanical signs; switchboxes [electricity]; current rectifiers; jigs [measuring instruments]; gas testing instruments; gasometers; galvanometers; electroplating apparatus; heliographic apparatus; hygrometers; hydrometers; weights; peepholes [magnifying lenses] for doors; holograms; plotters; loudspeakers; sounding leads; plumb bobs; range finders; densimeters; densitometers; optical goods; detectors; galena crystals [detectors]; smoke detectors; counterfeit [false] coin detectors; transparencies [photography]; slide projectors; diaphragms [photography]; dictating machines; dynamometers; floppy disks; phonograph records; disks, magnetic; optical discs; calculating disks; disk drives for computers; juke boxes for computers; DNA chips; electronic notice boards; swimming jackets; bullet – proof waistcoats [vests (Am.)]; life jackets; identification threads for electric wires; nose clips for divers and swimmers; locks, electric; bells [warning devices]; alarm bells, electric; electric door bells; signal bells; acoustic conduits; mirrors for inspecting work; road signs, luminous or mechanical; signs, luminous; marine depth finders; probes for scientific purposes; buzzers; buzzers, electric; needles for record players; measures; pressure measuring apparatus; simulators for the steering and control of vehicles; inverters [electricity]; pressure indicators; indicators [electricity]; temperature indicators; incubators for bacteria culture; measuring instruments; mathematical instruments; levelling instruments; surveying instruments; azimuth instruments; interfaces for computers; ionisation apparatus, not for the treatment of air; spark – guards; coaxial cables; fibre [fiber (Am.)] optic cables; electrical cabling; calipers; slide calipers; screw – tapping gauges; calculating machines; pocket calculators; decompression chambers; cinematographic cameras; electronic pens [visual display units]; holders for electric coils; identity cards, magnetic; video game cartridges; encoded cards, magnetic;

riding helmets; protective helmets; carriers for dark plates [photography]; automated teller machines [ATM]; cathodes; choking coils [impedance]; coils, electric; electromagnetic coils; spools [photography]; cinematographic film, exposed; solenoid valves [electromagnetic switches]; wire connectors [electricity]; electronic agendas; push buttons for bells; mouse pads; magnetic encoders; eyeshades; anti-glare visors; collectors, electric; calibrating rings; protective suits for aviators; commutators; compact discs [audio – video]; compact discs [read – only memory]; comparators; marine compasses; computers; mobile computers; condensers [capacitors]; contacts, electric; contacts, electric, of precious metal; wind socks for indicating wind direction; branch boxes [electricity]; distribution boxes [electricity]; connectors [electricity]; junction boxes [electricity]; battery boxes; cabinets for loudspeakers; diving suits; reflecting discs for wear, for the prevention of traffic accidents; covers for electric outlets; logs [measuring instruments]; lasers, not for medical purposes; lactodensimeters; lactometers; darkroom lamps [photography]; neon signs; thermionic lamps and tubes; thermionic valves [radio]; amplifying tubes; flashlights [photography]; head cleaning tapes [recording]; magnetic tapes; videotapes; surveying chains; fire escapes; rulers [measuring instruments]; slide – rules; contact lenses; correcting lenses [optics]; optical lenses; lens hoods; optical condensers; sounding lines; electricity conduits; measuring spoons; magnifying glasses [optics]; thread counters; magnets; decorative magnets; resuscitation mannequins [teaching apparatus]; mouse [data processing equipment]; pressure gauges; divers' masks; solderers' helmets; protective masks; materials for electricity mains [wires, cables]; accounting machines; voting machines; money counting and sorting machines; material testing instruments and machines; hemline markers; megaphones; diaphragms [acoustics]; diaphragms for scientific apparatus; metal detectors for industrial or military purposes; metronomes; rules [measuring instruments]; carpenters' rules; dressmakers' measures; coin – operated mechanisms for television sets; shutter releases [photography]; micrometers; microprocessors; microscopes; microtomes; microphones; modems; lightning conductors [rods]; monitors [computer hardware]; nautical apparatus and instruments; animated cartoons; terminals [electricity]; junction sleeves for electric cables; cases fitted with dissecting instruments [microscopy]; navigational instruments; teeth protectors; knee – pads for workers; self – regulating fuel pumps; fuel dispensing pumps for service stations; headsets; surveyors' levels; verniers; sound recording carriers; magnetic data media; optical data media; socks, electrically heated; sheaths for electric cables; identification sheaths for electric wires; weighing machines; punched card machines for offices; furniture especially made for laboratories;

shoes for protection against accidents, irradiation and fire; objectives [lenses] [optics]; lenses for astrophotography; egg – candler; clothing for protection against fire; extinguishers; electrified fences; limiters [electricity]; clothing for protection against accidents, irradiation and fire; asbestos clothing for protection against fire; garments for protection against fire; clothing especially made for laboratories; ozonisers [ozonators]; octants; eyepieces; ohmmeters; wrist rests for use with computers; spectacle frames; eyeglass frames; oscillographs; plumb lines; mirrors [optics]; galvanizing apparatus; spectacles [optics]; sunglasses; goggles for sports; signalling panels, luminous or mechanical; radio pagers; pince – nez; electronic pocket translators; transmitters [telecommunication]; transmitters of electronic signals; switches, electric; periscopes; gloves for divers; asbestos gloves for protection against accidents; gloves for protection against accidents; gloves for protection against X – rays for industrial purposes; furnaces for laboratory experiments; pipettes; pyrometers; planimeters; plane tables [surveying instruments]; plates for batteries; wafers [silicon slices]; DVD players; compact disc players; cassette players; sound recording strips; X – ray films, exposed; films, exposed; life – saving rafts; laboratory trays; semi – conductors; polarimeters; fire engines; floats for bathing and swimming; measuring glassware; swimming belts; life belts; circuit breakers; fuses; converters, electric; telerupters; food analysis apparatus; diagnostic apparatus, not for medical purposes; hair – curlers, electrically heated; distance measuring apparatus; speed measuring apparatus [photography]; appliances for measuring the thickness of leather; apparatus for measuring the thickness of skins; speed checking apparatus for vehicles; teaching apparatus; time recording apparatus; make – up removing appliances, electric; distance recording apparatus; apparatus and instruments for astronomy; surveying apparatus and instruments; weighing apparatus and instruments; optical apparatus and instruments; apparatus and instruments for physics; chemistry apparatus and instruments; measuring apparatus; measuring devices, electric; boiler control instruments; meteorological instruments; naval signalling apparatus; observation instruments; navigation apparatus for vehicles [on – board computers]; satellite navigational apparatus; regulating apparatus, electric; precision measuring apparatus; instruments containing eyepieces; audio – receivers and video – receivers; prisms [optics]; cigar lighters for automobiles; printers for use with computers; apparatus for changing record player needles; retorts' stands; drainers for use in photography; cleaning apparatus for phonograph records; fire beaters; sighting telescopes for fire-arms; test tubes; pressure indicator plugs for valves; magnetic wires; telegraph wires; telephone wires; wires, electric; conductors, electric; copper wire,



insulated; fuse wire; computer programmes [programs], recorded; computer game software; computer programs [downloadable software]; computer software, recorded; record players; processors [central processing units]; rods for water diviners; electronic publications, downloadable; distribution consoles [electricity]; control panels [electricity]; radar apparatus; vacuum tubes [radio]; masts for wireless aerials; transmitting sets [telecommunication]; radios; vehicle radios; frames for photographic transparencies; screens for photoengraving; walkie – talkies; voltage surge protectors; voltage regulators for vehicles; light dimmers [regulators], electric; stage lighting regulators; speed regulators for record players; cell switches [electricity]; washing trays [photography]; marking gauges [joinery]; time switches, automatic; relays, electric; safety restraints, other than for vehicle seats and sports equipment; X – ray photographs, other than for medical purposes; rheostats; respiratory masks, other than for artificial respiration; respirators for filtering air; retorts; refractometers; refractors; grids for batteries; speaking tubes; horns for loudspeakers; saccharometers; optical fibers [fibres] [light conducting filaments]; traffic – light apparatus [signalling devices]; dog whistles; sextants; inductors [electricity]; safety nets; nets for protection against accidents; fire alarms; signals, luminous or mechanical; signalling whistles; sirens; scanners [data processing equipment]; integrated circuit cards [smart cards]; connections for electric lines; couplings, electric; sonars; sound locating instruments; lighting ballasts; resistances, electric; spectrograph apparatus; spectrosopes; speed indicators; spirit measures; satellites for scientific purposes; protection devices for personal use against accidents; audiovisual teaching apparatus; radiotelegraphy sets; radiotelephony sets; spectacle glasses; optical glass; glass covered with an electrical conductor; anti – glare glasses; personal stereos; stereoscopes; fire boats; sulphitometers; hands free kits for phones; drying racks [photography]; spherometers; integrated circuits; printed circuits; counters; parking meters; postage stamp meters; milage recorders for vehicles; revolution counters; abacuses; taximeters; ear plugs; ear plugs for divers; tachometers; word processors; television apparatus; telescopes; teleprompters; teleprinters; portable telephones; theodolites; thermometers, not for medical purposes; thermostats; thermostats for vehicles; crucibles [laboratory]; tone arms for record players; totalizers; transistors [electronic]; protractors [measuring instruments]; battery chargers; transformers [electricity]; whistle alarms; tripods for cameras; vehicle breakdown warning triangles; starter cables for motors; discharge tubes, electric, other than for lighting; capillary tubes; X – rays tubes not for medical purposes; telephone receivers; turnstiles, automatic; quantity indicators; automatic indicators of low pressure in vehicle tires [tyres];

gasoline gauges; water level indicators; electric loss indicators; light – emitting electronic pointers; slope indicators; computer operating programs, recorded; levels [instruments for determining the horizontal]; mercury levels; spirit levels; urinometers; sound power amplifiers; particle accelerators; sprinkler systems for fire protection; electric installations for the remote control of industrial operations; steering apparatus, automatic, for vehicles; balancing apparatus; video recorders; sound reproduction apparatus; invoicing machines; door closers, electric; tape recorders; protection devices against X – rays [Roentgen rays], not for medical purposes; apparatus for games adapted for use with an external display screen or monitor; railway traffic safety appliances; data processing apparatus; door openers, electric; oxygen transvasing apparatus; theft prevention installations, electric; electric devices for attracting and killing insects; amusement apparatus adapted for use with an external display screen or monitor; time clocks [time recording devices]; film cutting apparatus; drying apparatus for photographic prints; optical character readers; elevator operating apparatus; centering apparatus for photographic transparencies; dosage dispensers; chargers for electric batteries; acoustic [sound] alarms; sounding apparatus and machines; life saving apparatus and equipment; editing appliances for cinematographic films; cathodic anti – corrosion apparatus; couplers [data processing equipment]; computer peripheral devices; anti – interference devices [electricity]; demagnetizing apparatus for magnetic tapes; acoustic couplers; anti – theft warning apparatus; alarms; fog signals, non – explosive; adding machines; readers [data processing equipment]; heat regulating apparatus; photocopiers photographic, electrostatic, thermic]; bar code readers; flat irons, electric; filters for respiratory masks; filters for ultraviolet rays, for photography; filters [photography]; magic lanterns; optical lamps; signal lanterns; cameras [photography]; glazing apparatus for photographic prints; shutters [photography]; darkrooms [photography]; photometers; flash – bulbs [photography]; enlarging apparatus [photography]; photovoltaic cells; containers for contact lenses; spectacle cases; pince – nez cases; containers for microscope slides; cases especially made for photographic apparatus and instruments; chromatography apparatus for laboratory use; chronographs [time recording apparatus]; eyeglass chains; cyclotrons; compasses [measuring instruments]; frequency meters; egg timers [sandglasses]; fire blankets; chips [integrated circuits]; gauges; pedometers; meteorological balloons; electrified rails for mounting spot lights; asbestos screens for firemen; protective helmets for sports; eyeglass cords; stands for photographic apparatus; switchboards; distribution boards [electricity]; workmen's protective face – shields; projection screens; radiology screens [photography]; exposure meters [light meters]; wel-

ding electrodes; soldering irons, electric; ducts [electricity]; galvanic cells; epidiascopes; ergometers; armatures [electricity]; capacity measures; computer keyboards.

16 – Fountain pens; aquarelles; albums; almanacs; document laminators for office use; atlases; posters; paper bows; table linen of paper; tickets; forms, printed; note books; drawing pads; pads [stationery]; loose – leaf binders; wristbands for the retention of writing instruments; pamphlets; booklets; paper sheets [stationery]; waxed paper; paper for recording machines; paper for radiograms; electrocardiograph paper; drawer liners of paper, perfumed or not; wood pulp paper; copying paper [stationery]; parchment paper; writing paper; luminous paper; toilet paper; wrapping paper; filter paper; Xuan paper for Chinese painting and calligraphy; paper; place mats of paper; writing pads; newsletters; rollers for typewriters; house painters' rollers; obliterating stamps; modelling wax, not for dental purposes; signboards of paper or cardboard; patterns for dressmaking; patterns for making clothes; newspapers; electrotypes; hectographs; shields [paper seals]; modelling clay; terrestrial globes; engravings; slate pencils; pencil leads; pencil holders; chalk holders; holders for stamps [seals]; holders for checkbooks [cheque books]; diagrams; engraving plates; writing slates; blackboards; galley racks [printing]; drawing boards; punches [office requisites]; magazines [periodicals]; paper clasps; money clips; tags for index cards; pen clips; bookmarkers; etching needles; tracing needles for drawing purposes; printed publications; bags [envelopes, pouches] of paper or plastics, for packaging; cardboard articles; paper shredders for office use; graphic representations; graining combs; calendars; tear – off calendars; tracing paper; tracing cloth; tracing patterns; gums [adhesives] for stationery or household purposes; lithographic stones; pencils; pencil lead holders; charcoal pencils; pictures; transfers [decalcomanias]; paintings [pictures], framed or unframed; wood pulp board [stationery]; cardboard; hat boxes of cardboard; document files [stationery]; files [office requisites]; index cards [stationery]; credit card imprints, non – electric; cards; geographical maps; paper tapes and cards for the recordal of computer programmes; perforated cards for Jacquard looms; catalogues; spools for inking ribbons; covers of paper for flower pots; paintbrushes; painters' brushes; writing brushes; typewriter keys; glue for stationery or household purposes; modelling paste; isinglass for stationery or household purposes; gluten [glue] for stationery or household purposes; starch paste [adhesive] for stationery or household purposes; printing blocks; books; ledgers [books]; manifolds [stationery]; comic books; drawing pins; cigar bands; envelopes [stationery]; duplicators; cases for stamps [seals]; boxes of cardboard or paper; paint boxes [articles for use in school]; correcting fluids [office requisites];

rubber erasers; French curves; paper ribbons; typewriter ribbons; adhesive bands for stationery or household purposes; gummed tape [stationery]; inking ribbons; inking ribbons for computer printers; drawing rulers; square rulers; viscose sheets for wrapping; plastic bubble packs for wrapping or packaging; sheets of reclaimed cellulose for wrapping; steel letters; type [numerals and letters]; numbers [type]; lithographs; lithographic works of art; architects' models; postage stamps; graphic prints; modelling materials; teaching materials [except apparatus]; bookbinding material; sealing compounds for stationery purposes; adhesives [glues] for stationery or household purposes; packaging material made of starches; pencil sharpening machines, electric or non – electric; addressing machines; bookbinding apparatus and machines [office equipment]; typewriters, electric or non – electric; folders [stationery]; franking machines [stamping machines]; chalk for lithography; writing chalk; tailors' chalk; marking chalk; garbage bags of paper or of plastics; mimeograph apparatus and machines; painters' easels; hand – rests for painters; steatite [tailor's chalk]; writing instruments; writing cases [stationery]; printing sets, portable [office requisites]; bibs of paper; stickers [stationery]; finger – stalls [office requisites]; cords for bookbinding; paper knives [cutters] [office requisites]; numbering apparatus; bookbinding cloth; bottle envelopes of cardboard or paper; sealing wafers; covers [stationery]; passport holders; plastic cling film, extensible, for palletization; embroidery designs [patterns]; handwriting specimens for copying; oleographs; musical greeting cards; greeting cards; postcards; etchings; conical paper bags; bags for microwave cooking; palettes for painters; ink sticks; pantographs [drawing instruments]; folders for papers; paper mache; pastels [crayons]; babies' napkins of paper and cellulose, disposable; pen cases; bookbindings; periodicals; pen wipers; office perforators; nibs; nibs of gold; steel pens; drawing pens; song books; seals [stamps]; sealing stamps; announcement cards [stationery]; drawing sets; drawing materials; clipboards; plastics for modelling; address plates for addressing machines; handkerchiefs of paper; plastic film for wrapping; babies' napkin – pants [diaper – pants] of paper and cellulose, disposable; babies' diapers of paper and cellulose, disposable; letter trays; trays for sorting and counting money; coasters of paper; bookends; stamp stands; mats for beer glasses; stands for pens and pencils; photograph stands; binding strips [bookbinding]; towels of paper; gummed cloth for stationery purposes; printers' blankets, not of textile; inking sheets for document reproducing machines; inking sheets for duplicators; portraits; paperweights; writing cases [sets]; drawing instruments; office requisites, except furniture; writing materials; school supplies [stationery]; adhesive tape dispensers [office requisites]; hand

labelling appliances; pencil sharpeners, electric or non – electric; printed matter; blotters; prospectuses; drawing squares; printed timetables; printers' reglets; indexes; elastic bands for offices; graphic reproductions; penholders; pens [office requisites]; table napkins of paper; tissues of paper for removing make – up; face towels of paper; self – adhesive tapes for stationery or household purposes; tablecloths of paper; scrapers [erasers] for offices; paper – clips; staples for offices; erasing products; biological samples for use in microscopy (teaching materials); histological sections for teaching purposes; figurines statuettes of papier mâché; writing board erasers; erasing shields; composing frames [printing]; sealing wax; drawing T – squares; arithmetical tables; placards of paper or cardboard; tablemats of paper; adhesive tapes for stationery or household purposes; writing or drawing books; fabrics for bookbinding; stationery; transparencies [stationery]; stencils [stationery]; stencil plates; stencils; cardboard tubes; Indian inks; moisteners [office requisites]; moisteners for gummed surfaces [office requisites]; carbon paper; chart pointers, non – electronic; bottle wrappers of cardboard or paper; envelope sealing machines, for offices; sealing machines for offices; vignetting apparatus; apparatus for mounting photographs; stapling presses [office requisites]; manuals [handbooks]; filtering materials [paper]; paper coffee filters; flags of paper; silver paper; molds for modelling clays [artists' materials]; photo – engravings; photographs; stencil cases; canvas for painting; chromolithographs [chromos]; compasses for drawing; watercolor [watercolour] saucers for artists; correcting ink [heliography]; ink; inkwells; inking pads; blueprints; rosaries; balls for ball – point pens; cabinets for stationery [office requisites]; printing type; address stamps; stamp pads; stamps [seals]; advertisement boards of paper or cardboard; prints [engravings]; labels, not of textile; cream containers of paper; ink stones [ink reservoirs].

18 – Mountaineering sticks; pocket wallets; card cases [notecases]; reins; harness fittings; parts of rubber for stirrups; chamois leather, other than for cleaning purposes; umbrellas; parasols; briefcases; saddlery; frames for umbrellas or parasols; handbag frames; valves of leather; whips; imitation leather; leather, unworked or semi – worked; leatherboard; casings, of leather, for springs; umbrella rings; hat boxes of leather; boxes of leather or leather board; boxes of vulcanised fibre; purses; chain mesh purses; fastenings for saddles; butts [parts of hides]; saddle trees; bags [envelopes, pouches] of leather, for packaging; moleskin [imitation of leather]; knee – pads for horses; muzzles; halters; vanity cases, not fitted; leather thread; furniture coverings of leather; gut for making sausages; clothing for pets; trimmings of leather for furniture; collars for animals; dog collars; music cases; slings for carrying infants; gold beaters' skin; cat o' nine tails; pads for horse

saddles; horseshoes; bands of leather; coverings of skins [furs]; horse blankets; bandoliers; traces [harness]; fur; haversacks; leather straps; straps for soldiers' equipment; harness straps; straps for skates; straps of leather [saddlery]; chin straps, of leather; stirrup leathers; umbrella handles; walking stick handles; suitcase handles; rucksacks; travelling bags; riding saddles; net bags for shopping; valises; umbrella or parasol ribs; stirrups; bags for climbers; travelling sets [leatherware]; sling bags for carrying infants; garment bags for travel; handbags; tool bags of leather, empty; wheeled shopping bags; beach bags; bags for sports; bags for campers; shopping bags; school bags; travelling trunks; cases, of leather or leatherboard; nose bags [feed bags]; bridoons; walking sticks; umbrella sticks; walking stick seats; bits for animals [harness]; bridles [harness]; harness for animals; key cases [leatherware]; horse collars; trunks [luggage]; suitcases; attaché cases; covers for horse – saddles; umbrella covers; kid; curried skins; animal skins; cattle skins; leather leashes; blinkers [harness]; game bags [hunting accessories].

28 – Amusement machines, automatic and coin – operated; swimming pools [play articles]; novelties for parties, dances [party favors, favours]; baseball gloves; starting blocks for sports; bob – sleighs; body boards; boxing gloves; skating boots with skates attached; dolls' feeding bottles; stationary exercise bicycles; paintballs [ammunition for paintball guns] [sports apparatus]; shuttlecocks; spinning tops [toys]; jigsaw puzzles; punching bags; hang gliders; flying discs [toys]; discuses for sports; dolls' houses; dominoes; surf boards; spring boards [sports articles]; skateboards; sailboards; chessboards; checkerboards; darts; kites; piñatas; toy vehicles; toys; toys for domestic pets; plush toys; mobiles [toys]; practical jokes [novelties]; games other than those adapted for use with an external display screen or monitor; parlor games; board games; ring games; games; bite indicators [fishing tackle]; kaleidoscopes; bladders of balls for games; rosin used by athletes; edges of skis; bingo cards; playing cards; fairground ride apparatus; reels for fishing; rocking horses; swings; skittles; ninepins; billiard cues; golf clubs; hockey sticks; seal skins [coverings for skis]; bells for Christmas trees; dolls' rooms; building games; lines for fishing; confetti; explosive bonbons [Christmas crackers]; ice skates; roller skates; creels [fishing equipment]; dice; paintball guns [sports apparatus]; ski bindings; dolls' beds; roulette wheels; building blocks [toys]; dolls; flippers for swimming; gut for fishing; gut for rackets; bows for archery; skis; waterskis; surf skis; mah – jong; wax for skis; hunting game calls; puppets; toy masks; theatrical masks; fencing masks; masts for sailboards; teddy bears; chalk for billiard cues; targets; electronic targets; scale model vehicles; playing balls; balls for games; artificial fishing bait; billiard table cushions; knee guards [sports articles]; billiard cue tips; elbow

guards [sports articles]; dolls' clothes; in – line roller skates; fencing weapons; twirling batons; paragliders; golf gloves; gloves for games; batting gloves [accessories for games]; toy pistols; air pistols [toys]; percussion caps [toys]; caps for pistols [toys]; rattles [playthings]; horseshoe games; candle holders for Christmas trees; Christmas tree stands; sole coverings for skis; floats for fishing; decoys for hunting or fishing; scent lures for hunting or fishing; archery implements; fishing tackle; kite reels; soap bubbles [toys]; billiard markers; divot repair tools [golf accessories]; protective paddings [parts of sports suits]; rackets; foils for fencing; surfboard leashes; harness for sailboards; weight lifting belts [sports articles]; sling shots [sports articles]; rollers for stationary exercise bicycles; harpoon guns [sports articles]; fencing gauntlets; fish hooks; landing nets for anglers; scooters [toys]; sleighs [sports articles]; butterfly nets; nets for sports; scrapers for skis; appliances for gymnastics; quoits; dumb – bells; climbers' harness; artificial snow for Christmas trees; snowshoes; clay pigeon traps; billiard tables; coin – operated billiard tables; tables for table tennis; tables for indoor football; strings for rackets; cricket bags; golf bags, with or without wheels; clay pigeons [targets]; tennis nets; slides [playthings]; radio – controlled toy vehicles; body – building apparatus; backgammon games; men's athletic supporters [sports articles]; rods for fishing; ornaments for Christmas trees, except illumination articles and confectionery; tennis ball throwing apparatus; conjuring apparatus; apparatus for games other than those adapted for use with an external display screen or monitor; bowling apparatus and machinery; machines for physical exercises; counters [discs] for games; bags especially designed for skis and surfboards; bite sensors [fishing tackle]; marbles for games; billiard balls; play balloons; snow globes; chess games; checkers [games]; shin guards [sports articles]; camouflage screens [sports articles]; chest expanders [exercisers]; Christmas trees of synthetic material; cups for dice.

35 – Import – export agencies; demonstration of goods; marketing studies; organization of exhibitions for commercial or advertising purposes; organization of trade fairs for commercial or advertising purposes; presentation of goods on communication media, for retail purposes; auctioneering; sales promotion for others; distribution of samples; advertising; on – line advertising on a computer network; advertising by mail order; television advertising; commercial administration of the licensing of the goods and services of others; administrative processing of purchase orders; modelling for advertising or sales promotion; procurement services for others [purchasing goods and services for other businesses].

38 – Electronic mail; telecommunications routing and junction services.

(260) AM 2013 68845 A

(800) 1125476

(731) KAPCI COATINGS (Mohamed Mohamed Ahmed El Sayed & Partners)  
Port Said Governorate Industrial Zone,  
El Raswa Port Said, Egypt

(540)



(591) Orange, green, blue, black, white and yellow  
(511)

2 – Paints, lacquers, varnishes, preservatives against rust and against deterioration of wood, dyestuffs, mordants, raw natural resins, metals in foil and powder form for painters, decorators, printers and artists.

(260) AM 2013 68856 A

(800) 1125493

(731) MEWAH BRANDS (S) PTE LTD  
5 International Business Park, #05 – 00  
Mewah Building Singapore 609914,  
Singapore

(540)

## AROME

(591) Black, white

(511)

29 – Edible oils and fats and all emulsions thereof; palm oil for food; palm olein; palm stearin; coconut oil; palm kernel oil for food; palm kernel olein; palm kernel stearin; soya bean oil for food; corn oil; cottonseed oil; sunflower oil; rapeseed oil; canola oil; hydrogenated oil for food; hydrogenated palm olein; hydrogenated palm kernel olein; hydrogenated palm kernel stearin; hydrogenated fats; hydrogenated palm stearin; margarine; spreads (jams); butter; confectionery fat; cocoa butter substitute; cocoa butter replacer; cocoa butter equivalent made from palm oil and non – dairy fats; shortening; interesterified fat; butter oil substitutes; blended fats; milk fat substitutes; vegetable oils and fats for food; blended oils and fats; cheese fat; yogurt fat; milk and milk products; peanut butter; coconut – eggs jam; condensed milk; and cocoa butter.

(260) AM 2013 68857 A

(800) 1125504

(731) Honda Motor Co. Ltd.  
1 – 1, Minami – Aoyama 2 – chome,  
Minato – ku, Tokyo 107 – 8556, Japan

(540)

**Crosstour**

(591) Black, white

(511)

12 – Automobiles and their parts and fittings; vessels and their parts and fittings; aircraft and their parts and fittings; two – wheeled motor vehicles and their parts and fittings; bicycles and their parts and fittings; non – electric prime movers for land vehicles (excluding their parts); axles for vehicles; couplings for land vehicles; transmissions for land vehicles; transmission chains for land vehicles; transmission shafts for land vehicles; shock absorbers for automobiles; shock absorbing springs for vehicles; brakes for vehicles.

(260) AM 2013 68858 A

(800) 1125505

(731) Honda Motor Co. Ltd.

1 – 1, Minami – Aoyama 2 – chome,  
Minato – ku, Tokyo 107 – 8556, Japan

(540)

**FCX**

(591) Black, white

(511)

12 – Automobiles and their parts and fittings; two – wheeled motor vehicles, bicycles and their parts and fittings; non – electric prime movers for land vehicles; axles for vehicles; couplings for land vehicles; transmissions for land vehicles; transmission chains for land vehicles; transmission shafts for land vehicles; shock absorbers for automobiles; shock absorbing springs for vehicles; brakes for vehicles; AC motors for land vehicles

(260) AM 2013 68859 A

(800) 1125506

(731) Honda Motor Co., Ltd.

1 – 1, Minami – Aoyama 2 – chome,  
Minato – ku, Tokyo 107 – 8556, Japan

(540)

**ECO ASSIST**

(591) Black, white

(511)

12 – Automobiles and their parts and fittings; two – wheeled motor vehicles, bicycles and their parts and fittings; non – electric prime movers for land vehicles (excluding their parts); axles for vehicles; couplings for land vehicles; transmissions for land vehicles; transmission chains for land vehicles; transmission shafts for land vehicles; shock absorbers for automobiles; shock absorbing springs for vehicles; brakes for vehicles.

(260) AM 2013 68860 A

(800) 1125538

(731) EXAMONE ENTERPRISES LTD.

Arch. Makariou III, 155 PROTEAS HOUSE,  
5th. floor P.C. CY – 3021 Limassol, Cyprus

(540)

**dizao**

(591) Black, white

(511)

5 – Thermal water; wadding for medical purposes; medicinal mud; deodorants, other than for human beings or for animals; mineral food – supplements; cod liver oil; cachets for pharmaceutical purposes; candy, medicated; lotions for pharmaceutical purposes; adhesive plaster; liniments; sunburn ointments; medicinal oils; compresses; pomades for medical purposes; vitamin preparations; therapeutic preparations for the bath; air deodorising preparations; air purifying preparations; pharmaceutical preparations for treating dandruff; pharmaceutical preparations for skin care; medicinal hair growth preparations; preparations of trace elements for human and animal use; eye – wash; panty liners [sanitary]; chewing gum for medical purposes; sanitary napkins; salts for medical purposes; smelling salts; antiseptics; styptic preparations; disinfectants for hygiene purposes; medical preparations for slimming purposes; detergents for medical purposes; remedies for perspiration; serums; medicinal herbs; menstruation knickers; herb teas for medicinal purposes.

14 – Amulets; bracelets; charms; works of art of precious metal; jewellery; figurines [statuettes] of precious metal; ornaments; cases for watches [presentation]; clocks; watches; jewellery cases [cases].

18 – Pocket wallets; umbrellas; boxes of leather or leather board; boxes of vulcanised fibre; purses; vanity cases, not fitted; clothing for pets; leather straps; sling bags for carrying infants; garment bags for travel; handbags; wheeled shopping bags; bags for sports; shopping bags; school bags; travelling trunks; canes; key cases [leatherware]; trunks [luggage]; animal skins.

25 – andanas [neckerchiefs]; underwear; overalls; boas [necklets]; teddies [undergarments]; breeches for wear; trousers; neckties; gaiters; vests; hosiery; collar protectors; tights; suits; bathing suits; masquerade costumes; beach clothes; jackets [clothing]; tee – shirts; sleep masks; furs [clothing]; ear muffs [clothing]; socks; footwear; boots for sports; beach shoes; clothing; outerclothing; jerseys [clothing]; clothing of imitations of leather; clothing of leather; knitwear [clothing]; overcoats; gloves [clothing]; pyjamas; bathing drawers; scarfs; dresses; layettes [clothing]; jumpers [pullovers]; shirts; boots; shoes;

headgear for wear; dressing gowns; stockings; shawls; sashes for wear; pelisses; skirts.

35 – Import – export agencies; advertising agencies; demonstration of goods; organization of trade fairs for commercial or advertising purposes; presentation of goods on communication media, for retail purposes; auctioneering; sales promotion for others; distribution of samples; procurement services for others [purchasing goods and services for other businesses]; dissemination of advertising matter; advertising; business management of hotels.

44 – Manicuring; hairdressing salons; beauty salons; visagists' services; sauna services; solarium services; massage; aromatherapy services; convalescent homes; sanatoriums; health centers; flower arranging; tattooing; health spa services; telemedicine services; landscape design.

(260) AM 2013 68861 A

(800) 1125564

(731) Limited Liability Company "Tosol – Sintez"  
31 A, ul. Vatutina, RU – 606000  
g. Dzerzhinsk, Nizhegorodskaya obl., Russian Federation

(540)

**ROSDOT**

(591) Black, white

(511)

1 – Unprocessed artificial resins, unprocessed plastics; manures; fire extinguishing compositions; tempering and soldering preparations; chemical substances for preserving foodstuffs; tanning substances; adhesives used in industry; agar – agar; nitrogen; actinium; alkaloids; algarovilla [tanning material]; alginates [gelling and inflating preparations] other than for alimentary purposes; crotonic aldehyde; ammonium aldehyde; aldehydes; americium; amyl acetate; ammonia [volatile alkali] for industrial purposes; anhydrous ammonia; ammonia; acetic anhydride; anhydrides; anti – knock substances for internal combustion engines; anti – incrustants; antistatic preparations, other than for household purposes; dressing and finishing preparations for textiles; starch size [chemical preparations]; argon; lead arsenate; astatine; lime acetate; lead acetate; acetate of cellulose, unprocessed; acetylene; acetone; balm of gurjun [gurjon, gurjan] for making varnish; barium; barytes; albumen [animal or vegetable, raw material]; animal albumen [raw material]; iodised albumen; malt albumen; bentonite; berkelium; potassium dioxalate; bichromate of potassium; bichromate of soda; bauxite; albuminized paper; baryta paper; diazo paper; blueprint paper; reagent paper; test paper, chemical; litmus paper; nitrate paper; sensitized paper; photometric paper; borax; agglutinants for concrete; gas purifying preparations; pre-

servatives for pharmaceutical preparations; polish removing substances; preparations for the separation of greases; substances for preventing runs in stockings; water – softening preparations; limestone hardening substances; birdlime; glue for industrial purposes; surface – active chemical agents; tensio – active agents; fissionable material for nuclear energy; foundry binding substances; flower preservatives; seed preserving substances; viscose; bismuth; witherite; distilled water; sea water for industrial purposes; acidulated water for recharging accumulators; heavy water; hydrogen; seaweeds [fertilizers]; gadolinium; protective gases for welding; solidified gases for industrial purposes; gas propellents for aerosols; basic gallate of bismuth; gallium; gambier; helium; aluminium hydrate; hydrates; hyposulphites; ceramic glazings; glycol; china slip; china clay; kaolin; alumina; glycerides; glycerine for industrial purposes; glucose for industrial purposes; glucosides; holmium; hormones for hastening the ripening of fruit; peat pots for horticulture; graphite for industrial purposes; guano; humus; potting soil; detergents for use in manufacturing processes; defoliants; hydrazine; diastase for industrial purposes; kieselgur; manganese dioxide; titanium dioxide for industrial purposes; dry ice [carbon dioxide]; zirconia; oil dispersants; petroleum dispersants; dispersions of plastics; dysprosium; bichloride of tin; detergent additives to petrol [gasoline]; ceramic compositions for sintering [granules and powders]; dolomite for industrial purposes; tan – wood; europium; gelatine for photographic purposes; gelatine for industrial purposes; auxiliary fluids for use with abrasives; liquids for removing sulphates from accumulators; magnetic fluid for industrial purposes; power steering fluid; transmission fluid; grafting wax for trees; tree cavity fillers [forestry]; moderating materials for nuclear reactors; rare earths; metal earths; diatomaceous earth; fuller's earth for use in textile industry; lime chloride; isotopes for industrial purposes; ytterbium; yttrium; iodine for industrial purposes; aluminium iodide; alkaline iodides for industrial purposes; casein for industrial purposes; kainite; potassium; sorrel salt; californium; gum arabic for industrial purposes; tartar other than for pharmaceutical purposes; camphor, for industrial purposes; calcium carbide; carbide; lime carbonate; magnesium carbonate; carbonates; cement [metallurgy]; cassiopium [lutetium]; lutetium [cassiopium]; catalysts; catechu; caustics for industrial purposes; alum; ammonia alum; aluminium alum; chrome alum; quebracho for industrial purposes; ketones; cinematographic film, sensitized but not exposed; oxygen; nitric acid; antranilic acid; benzoic acid; boric acid for industrial purposes; tartaric acid; tungstic acid; gallic acid for the manufacture of ink; gallotannic acid; tannic acid; iodine acid; phenol for industrial purposes; citric acid for industrial purposes; lactic acid; formic acid; persulphuric acid;

oleic acid; picric acid; pyrogallic acid; salicylic acid; sebacic acid; sulphuric acid; sulphurous acid; hydrochloric acid; stearic acid; carbonic acid; spirits of vinegar [dilute acetic acid]; phosphoric acid; hydrofluoric acid; cholic acid; chromic acid; oxalic acid; acids; benzene – based acids; fatty acids; arsenious acid; mineral acids; adhesives for billposting; leather glues; adhesives for wall tiles; adhesives for paperhanging; adhesives for wallpaper; cement for mending broken articles; gums [adhesives], other than for stationery or household purposes; adhesives for industrial purposes; isinglass other than for stationery, household or alimentary purposes; gluten [glue], other than for stationery or household purposes; flocculants; collodion; compost; beer preserving agents; mangrove bark for industrial purposes; tan; starch for industrial purposes; starch paste [adhesive], other than for stationery or household purposes; silicon; krypton; xenon; curium; lanthanum; lecithin [raw material]; lithium; magnesite; manganate; oils for tanning leather; oils for currying leather; oils for preparing leather in the course of manufacture; oils for the preservation of food; carbolineum for the protection of plants; paper pulp; wood pulp; grafting mastic for trees; mastic for leather; cement for pneumatic tires [tyres]; mastic for tires [tyres]; synthetic materials for absorbing oil; ceramic materials in particulate form, for use as filtering media; filtering materials [unprocessed plastics]; filtering materials [mineral substances]; filtering materials [vegetable substances]; copper sulphate [vitriol]; vitriol; metalloids; alkaline – earth metals; alkaline metals; methane; methyl benzene; methyl benzol; flour for industrial purposes; tapioca flour for industrial purposes; potato flour for industrial purposes; soap [metallic] for industrial purposes; arsenic; emollients for industrial purposes; bate for dressing skins; dressing, except oils, for skins; sodium; hypochlorite of soda; naphthalene; sal ammoniac; toxic gas neutralizers; neodymium; neon; neptunium; nitrate of uranium; nitrates; nitric monoxide; nitrous oxide; baryta; uranium oxide; oxalates; lithia [lithium oxide]; lead oxide; antimony oxide; chromium oxide; cobalt oxide for industrial purposes; mercuric oxide; gallnuts; clarification preparations; purification preparations; wine finings; must – fining preparations; textile – brightening chemicals; beer – clarifying and preserving agents; reducing agents for use in photography; wax – bleaching chemicals; fat – bleaching chemicals; organic – bleaching chemicals; pectin [photography]; perborate of soda; humus top dressing; percarbonates; dioxide of hydrogen; hydrogen peroxide; persulphates; perchlorates; foundry sand; plastisols; sensitized plates for offset printing; plasticizers; roentgen films, sensitized but not exposed; x – ray films, sensitized but not exposed; plutonium; substrates for soil – free growing [agriculture]; polonium; potash water; earth for growing; praseodymium; rubber preservatives; bric-

kwork preservatives, except paints and oils; masonry preservatives, except paints and oils; cement preservatives, except paints and oils; preservatives for tiles, except paints and oils; bacterial preparations other than for medical and veterinary use; bacteriological preparations other than for medical and veterinary use; bacteriological preparations for acetification; biological preparations, other than for medical or veterinary purposes; vulcanising preparations; diagnostic preparations, other than for medical or veterinary purposes; renovating preparations for phonograph records; currying preparations for leather; currying preparations for skins; metal hardening preparations; fixing baths [photography]; fixing solutions [photography]; opacifiers for enamel or glass; separating and unsticking [ungluing] preparations; ungluing preparations; unsticking and separating preparations; metal annealing preparations; metal tempering preparations; preparations for preventing the tarnishing of lenses; preparations for preventing the tarnishing of glass; cement – waterproofing preparations, except paints; cement – waterproofing chemicals, except paints; plant growth regulating preparations; fulling preparations for use in textile industry; scale removing preparations, other than for household purposes; flashlight preparations; galvanizing preparations; finishing preparations for use in the manufacture of steel; sizing preparations; animal carbon preparations; cultures of microorganisms other than for medical and veterinary use; preparations of microorganisms other than for medical and veterinary use; corrosive preparations; cryogenic preparations; dehydrating preparations for industrial purposes; degreasing preparations for use in manufacturing processes; grease – removing preparations for use in manufacturing processes; degumming preparations; gum solvents; oil – bleaching chemicals; bleaching preparations [decolorants] for industrial purposes; decolorants for industrial purposes; meat tenderizers for industrial purposes; preparations for stimulating cooking for industrial purposes; preparations of trace elements for plants; moistening [wetting] preparations for use in the textile industry; wetting preparations for use in the textile industry; moistening [wetting] preparations for use in dyeing; moistening [wetting] preparations for use in bleaching; enzyme preparations for industrial purposes; filtering preparations for the beverages industry; fulling preparations; fuel – saving preparations; coal saving preparations; damp proofing preparations, except paints, for masonry; anti – sprouting preparations for vegetables; brazing preparations; preparations of the distillation of wood alcohol; by – products of the processing of cereals for industrial purposes; benzene derivatives; promethium; protactinium; protein [raw material]; mordants for metals; radium for scientific purposes; radon; solvents for varnishes; anti – frothing solutions for accumulators; anti – frothing solutions

for batteries; solutions for cyanotyping; baths for galvanizing; galvanizing baths; silver salt solutions for silvering; toning baths [photography]; drilling muds; rhenium; mercury; rubidium; carbon black for industrial purposes; soot for industrial or agricultural purposes; lamp black for industrial purposes; samarium; saccharin; selenium; salpêtre; saltpeter; sulphur; silver nitrate; carbon sulphide; silicates; aluminium silicate; silicones; scandium; foundry molding [moulding] preparations; acrylic resins, unprocessed; artificial resins, unprocessed; synthetic resins, unprocessed; epoxy resins, unprocessed; calcined soda; soda ash; caustic soda for industrial purposes; barium compounds; fluor spar compounds; salts for industrial purposes; salts [fertilisers]; ammoniacal salts; ammonium salts; salts of precious metals for industrial purposes; salts for galvanic batteries; salts for galvanic cells; salt for preserving, other than for foodstuffs; salts for coloring [colouring] metal; iron salts; gold salts; iodised salts; calcium salts; salt, raw; salts from rare earth metals; mercury salts; toning salts [photography]; chrome salts; chromic salts; salts of alkaline metals; rock salt; mold – release preparations; mould – release preparations; compositions for the manufacture of phonograph records; compositions for the manufacture of technical ceramics; compositions for repairing inner tubes of tires [tyres]; tire repairing compositions; glutinous tree – banding preparations; glutinous tree – grafting preparations; adhesive preparations for surgical bandages; fireproofing preparations; compositions for threading; sauce for preparing tobacco; amyl alcohol; vinic alcohol; wood alcohol; sal ammoniac spirits; spirits of salt; ethyl alcohol; alcohol; cement for boots and shoes; concrete preservatives, except paints and oils; water glass [soluble glass]; strontium; barium sulphate; sulphates; antimony sulphide; sulphides; benzoic sulphide; sulphonic acids; sumac for use in tanning; superphosphates [fertilisers]; antimony; thallium; talc [magnesium silicate]; tannin; cream of tartar, other than for pharmaceutical purposes; tellurium; terbium; tetrachlorides; carbon tetrachloride; acetylene tetrachloride; technetium; thiocarbanilide; titanite; sensitized cloth for photography; blueprint cloth; toluene; toluol; fuel for atomic piles; thorium; peat [fertiliser]; tragacanth gum for use in manufactures; thulium; carbonic hydrates; carbon; activated carbons; carbon for filters; animal carbon; animal charcoal; bone charcoal; blood charcoal; fertilizing preparations; nitrogenous fertilisers; calcium cyanamide [fertilizer]; nitrogenous lime [manure]; fertilizers; manure for agriculture; pyroligneous acid [wood vinegar]; wood vinegar [pyroligneous acid]; uranium; vulcanisation accelerators; enzymes for industrial purposes; fermium; ferrocyanides; soldering fluxes; brazing fluxes; phosphatides; phosphates [fertilisers]; phosphorus; photographic paper; self – toning paper [photography]; photosensitive plates; sensi-

tized photographic plates; ferrotype plates [photography]; sensitized films, unexposed; photographic developers; photographic sensitizers; photographic emulsions; francium; fluorine; refrigerants; refrigerating preparations; chlorine; chlorates; hydrochlorates; aluminium chloride; magnesium chloride; chlorides; palladium chlorides; chromates; caesium; cellulose; cerium; cyanides [prussiates]; prussiates; cymene; loam; slag [fertilisers]; alkalies; caustic alkali; radioactive elements for scientific purposes; emulsifiers; erbium; ethane; methyl ether; sulphuric ether; ethyl ether; glycol ether; ethers; esters; cellulose ethers for industrial purposes; cellulose esters for industrial purposes; electrophoresis gels, other than for medical or veterinary purposes; expanded – clay for hydroponic plant growing [substrate]; glaziers' putty; automobile body fillers; oil cement [putty]; plastics, unprocessed; wallpaper removing preparations.

7 – Machines and machine tools; motors and engines (except for land vehicles); machine coupling and transmission components (except for land vehicles); agricultural implements other than hand – operated; incubators for eggs; welding machines, electric; aerated beverages making machines; soldering apparatus, gas – operated; vulcanisation apparatus; acetylene cleaning apparatus; apparatus for drawing up beer under pressure; aerated water making apparatus; inking apparatus for printing machines; aerators; expansion tanks [parts of machines]; drums [parts of machines]; reels, mechanical, for flexible hoses; concrete mixers [machines]; reels [parts of machines]; bobbins for weaving looms; flues for engine boilers; harrows; bulldozers; hoppers [mechanical discharging]; mine borers; truck lifts; printing rollers for machines; rolling mill cylinders; crank shafts; transmission shafts, other than for land vehicles; valves [parts of machines]; fans for motors and engines; saw benches [parts of machines]; winnowers; bearings [parts of machines]; water heaters [parts of machines]; winches; drilling rigs, floating or non – floating; lawnmowers [machines]; card clothing [parts of carding machines]; emergency power generators; alternators; dynamos; bicycle dynamos; current generators; generators of electricity; exhausts for motors and engines; drilling heads [parts of machines]; drilling bits [parts of machines]; cylinder heads for engines; soldering blow pipes, gas – operated; raking machines; stalk separators [machines]; sieves [machines or parts of machines]; mud catchers and collectors [machines]; tarring machines; engines, other than for land vehicles; hydraulic engines and motors; aeronautical engines; aeroplane engines; engines for air cushion vehicles; compressed air engines; jet engines other than for land vehicles; engines for boats; driving motors other than for land vehicles; de – aerators for feedwater; disintegrators; tympan [parts of printing presses]; holding devices for machine tools; blade



holders [parts of machines]; turf removing ploughs; pressure reducers [parts of machines]; pump diaphragms; chisels for machines; jacks [machines]; rack and pinion jacks; moving pavements [sidewalks]; electric hand drills; grinders/crushers, electric, for household purposes; reapers; reapers and binders; millstones; rakes for raking machines; shredders [machines] for industrial use; injectors for engines; tools [parts of machines]; hand – held tools, other than hand – operated; air condensers; capstans; callenders; rotary steam presses, portable, for fabrics; ditchers [ploughs]; carburetters; carriages for knitting machines; crankcases for machines, motors and engines; road rollers; pressure valves [parts of machines]; clack valves [parts of machines]; can openers, electric; cowlings [parts of machines]; machine wheels; freewheels other than for land vehicles; machine boiler scale collectors; lasts for shoes [parts of machines]; brake shoes other than for vehicles; ball rings for bearings; piston segments; grease rings [parts of machines]; reapers and threshers; coalcutting machines; fittings for engine boilers; compressors [machines]; air pumps [garage installations]; compressors for refrigerators; conveyors [machines]; belt conveyors; converters for steel works; aerocondensers; condensers [steam] [parts of machines]; diggers [machines]; rams [machines]; thermic lances [machines]; mechanized livestock feeders; root slicers [machines]; boxes for matrices [printing]; gear boxes other than for land vehicles; grease boxes [parts of machines]; housings [parts of machines]; harvesting machines; steam engine boilers; coffee grinders, other than hand – operated; taps [parts of machines, engines or motors]; roller bridges; cranes [lifting and hoisting apparatus]; drain cocks; spray guns for paint; cranks [parts of machines]; potters' wheels; grindstones [parts of machines]; cultivators [machines]; motorized cultivators; ploughshares; belts for conveyors; igniting magnetos; igniting magnetos for engines; handling machines, automatic [manipulators]; lubricators [parts of machines]; churns; matrices for use in printing; machine fly – wheels; hair clipping machines for animals; machines for the textile industry; paper machines; vibrators [machines] for industrial use; bellows [machines]; knitting machines; bending machines; ironing machines; mineworking machines; net hauling machines [fishing]; bottle sealing machines; sealing machines for industrial purposes; embossing machines; engraving machines; finishing machines; garbage disposals; blade sharpening [stropping] machines; earth moving machines; cord making machines; lace making machines; butter machines; cigarette machines for industrial purposes; sausage machines; stereotype machines; hosiery looms; crushing machines; dyeing machines; bottle washing machines; dishwashers; bottle filling machines; racket stringing machines; leather – working machines; dairy machines; glass working machines; tobacco processing

machines; corn husking machines; painting machines; oil refining machines; peeling machines; printing machines for use on sheet metal; brewing machines; colour – washing machines; leather paring machines; bitumen making machines; edible pastes making machines; sugar making machines; weeding machines; cinder sifters [machines]; puddling machines; notchers [machine tools]; bread cutting machines; blowing machines for the compression, exhaustion and transport of gases; road making machines; railroad constructing machines; rail – laying machines; bottle capping machines; bottle stopping machines; trash compacting machines; blowing machines for the compression, sucking and carrying of grain; die – stamping machines; stamping machines; darning machines; drainage machines; wrapping machines; grain separators; bookbinding apparatus and machines for industrial purposes; machines and apparatus for cleaning, electric; machines and apparatus for carpet shampooing, electric; machines and apparatus for polishing [electric]; sizing machines; punching machines; riveting machines; kitchen machines, electric; foundry machines; smoothing presses; fleshing machines; rinsing machines; flour mill machines; hemming machines; braiding machines; wringing machines for laundry; steam engines; printing machines; rotary printing presses; typographic machines; compressed air machines; type – setting machines [printing]; trimming machines; spinning frames; heel – making machines; filling machines; friezing machines; cutters [machines]; road sweeping machines [self – propelled]; pressing machines to make satin – like; agricultural machines; sorting machines for industry; stitching machines; washing machines; washing machines [laundry]; coin – operated washing machines; clippers [machines]; drying machines; looms [machines]; kneading machines; beating machines; beaters, electric; packaging machines; molding machines; type – setting machines [photocomposition]; carding machines; sewing machines; typesetting machines; electromechanical machines for chemical industry; labellers [machines]; ore treating machines; milking machines; mills [machines]; mills for household purposes, other than hand – operated; pepper mills other than hand – operated; flour mills; centrifugal mills; hydraulic controls for machines, motors and engines; machine wheelwork; pneumatic controls for machines, motors and engines; feeders [parts of machines]; forge bellows; mixers [machines]; agitators; vacuum cleaner bags; threshing machines; pneumatic hammers; hammers [parts of machines]; tilt hammers; power hammers; reeling apparatus, mechanical; motors for boats; clutches other than for land vehicles; meat choppers [machines]; superchargers; guides for machines; vacuum cleaner attachments for disseminating perfumes and disinfectants; pumps [machines]; pumps [parts of machines, engines or motors]; aerating pumps for aquaria;

vacuum pumps [machines]; compressed air pumps; pumps for heating installations; beer pumps; lubricating pumps; centrifugal pumps; blades [parts of machines]; knives for mowing machines; chaff cutter blades; knives, electric; scissors, electric; bearing brackets for machines; atomisers [machines]; axles for machines; steam traps; chucks [parts of machines]; drill chucks [parts of machines]; exhaust manifold for engines; soldering irons, gas – operated; superheaters; gears, other than for land vehicles; reduction gears other than for land vehicles; propulsion mechanisms other than for land vehicles; drilling machines; saws [machines]; chain saws; guns [tools using explosives]; glue guns, electric; compressed air guns for the extrusion of mastics; carburetter feeders; feeding apparatus for engine boilers; loading ramps; ploughs; pneumatic transporters; hangers [parts of machines]; anti – friction bearings for machines; roller bearings; self – oiling bearings; bearings for transmission shafts; ball – bearings; journal boxes [parts of machines]; elevators [lifts]; lifts, other than ski – lifts; hoists; pulleys; saw blades [parts of machines]; pistons [parts of machines or engines]; dashpot plungers [parts of machines]; pistons for engines; pistons for cylinders; catalytic converters; torque converters other than for land vehicles; fuel conversion apparatus for internal combustion engines; presses [machines for industrial purposes]; wine presses; fodder presses; printing presses; typographic presses; swaging machines; transmissions for machines; elevator belts; pedal drives for sewing machines; high pressure washers; cleaning appliances utilizing steam; food processors, electric; springs [parts of machines]; spinning wheels; punches for punching machines; kick starters for motorcycles; vacuum cleaners; tambours for embroidery machines; radiators [cooling] for motors and engines; sewage pulverizers; air brushes for applying colour; regulators [parts of machines]; pressure regulators [parts of machines]; feedwater regulators; speed governors for machines, engines and motors; knives [parts of machines]; cutting blow pipes, gas – operated; loom shafts; gears for weaving looms; belts for machines; fan belts for motors and engines; dynamo belts; belts for motors and engines; adhesive bands for pulleys; sifters; robots [machines]; stuffing boxes [parts of machines]; paper feeders [printing]; whisks, electric, for household purposes; sparking plugs for internal combustion engines; glow plugs for diesel engines; tedding machines; separators; steam/oil separators; cream/milk separators; sowers [machines]; mixing machines; snow ploughs; sheaf – binding machines; joints [parts of engines]; shaft couplings [machines]; fruit presses, electric, for household purposes; chaff cutters; suction cups for milking machines; stands for machines; machine tools; woodworking machines; sharpening machines; die – cutting and tapping machines; trueing machines; bicycle assembling

machines; mortising machines; stone working machines; metalworking machines; threading machines; planing machines; looms; lathes [machine tools]; milling machines; metal drawing machines; rolling mills; starters for motors and engines; stators [parts of machines]; glaziers' diamonds [parts of machines]; tables for machines; derricks; slide rests [parts of machines]; couplings other than for land vehicles; heat exchangers [parts of machines]; grating machines for vegetables; transmissions, other than for land vehicles; control cables for machines, engines or motors; boiler tubes [parts of machines]; turbines other than for land vehicles; hydraulic turbines; turbocompressors; connecting rods for machines, motors and engines; central vacuum cleaning installations; suction machines for industrial purposes; vehicle washing installations; degreasers [machines]; dust exhausting installations for cleaning purposes; mineral water making machines; sifting installations; pneumatic tube conveyors; dust removing installations for cleaning purposes; condensing installations; air suction machines; dividing machines; igniting devices for internal combustion engines; washing apparatus; binding apparatus for hay; extractors for mines; hydraulic door openers and closers [parts of machines]; pneumatic door openers and closers [parts of machines]; anti – pollution devices for motors and engines; curtain drawing devices, electrically operated; adhesive tape dispensers [machines]; beverage preparation machines, electromechanical; food preparation machines, electromechanical; control mechanisms for machines, engines or motors; shoe polishers, electric; machines and apparatus for wax – polishing, electric; air cushion devices for moving loads; handling apparatus for loading and unloading; elevating apparatus; aprons [parts of machines]; filter presses; filters [parts of machines or engines]; filtering machines; filters for cleaning cooling air, for engines; molds [parts of machines]; printing plates; brake linings other than for vehicles; journals [parts of machines]; centrifugal machines; elevator chains [parts of machines]; driving chains other than for land vehicles; cylinders for motors and engines; cylinders for machines; printing cylinders; shuttles [parts of machines]; universal joints [cardan joints]; pulleys [parts of machines]; vacuum cleaner hoses; brushes [parts of machines]; dynamo brushes; brushes, electrically operated; carbon brushes [electricity]; ejectors; fuel economisers for motors and engines; excavators; shovels, mechanical; agricultural elevators; motors, electric, other than for land vehicles; electric hammers; parquet wax – polishers, electric; cartridges for filtering machines; escalators; automatic grappels for marine purposes.

12 – Vehicles; apparatus for locomotion by land, air or water; motor buses; automobiles; sports cars; concrete mixing vehicles; refrigerated vehicles; casing for pneumatic tires [tyres]; caravans; camping

cars; shock absorbers for automobiles; suspension shock absorbers for vehicles; space vehicles; aircraft; aeronautical apparatus, machines and appliances; snowmobiles; air balloons; luggage carriers for vehicles; ski carriers for cars; vehicle bumpers; bumpers for automobiles; barges; buffers for railway rolling stock; dining cars [carriages]; waggons; carriages [railways]; sleeping cars; dining cars; refrigerated waggons [railroad vehicles]; transmission shafts for land vehicles; bicycles; valves for vehicle tires [tyres]; automobile hoods; hoods for baby carriages; hoods for vehicles; oars; sculls; paddles for canoes; screws [propellers] for ships; hydroplanes; air cushion vehicles; flanges for railway wheel tires [tyres]; lorries; horns for vehicles; treads for vehicles [roller belts]; doors for vehicles; driving motors for land vehicles; motors for cycles; jet engines for land vehicles; screw – propellers; screw – propellers for boats; airships; cable cars; dredgers [boats]; hand cars; bells for bicycles, cycles; rear-view mirrors; portholes; rolling stock for funicular railways; cars for cable transport installations; inner tubes for bicycles, cycles; inner tubes for pneumatic tires [tyres]; hoods for vehicle engines; crankcases for land vehicle components, other than for engines; boats; wheels for bicycles, cycles; mine cart wheels; casters for trolleys [vehicles] [carts (am.)]; hub caps; baby carriages; side cars; baskets adapted for cycles; panniers adapted for cycles; gear boxes for land vehicles; ships' hulls; fenders for ships; bands for wheel hubs; ejector seats for aircraft; wheelchairs; caps for vehicle petrol [gas] tanks; boat hooks; bodies for vehicles; automobile bodies; tipping bodies for lorries [trucks]; traction engines; locomotives; masts for boats; sprinkling trucks; elevating tailgates (am.) [parts of land vehicles]; propulsion mechanisms for land vehicles; motorcycles; freewheels for land vehicles; clutches for land vehicles; repair outfits for inner tubes; adhesive rubber patches for repairing inner tubes; air pumps [vehicle accessories]; bicycle pumps; upholstery for vehicles; rims for vehicle wheels; bicycle rims; windows for vehicles; omnibuses; axles for vehicles; parachutes; ferry boats; pedals for cycles; gearing for land vehicles; treads for retreading tires [tyres]; carts; head – rests for vehicle seats; vehicle running boards; air bags [safety devices for automobiles]; ski lifts; chairlifts; vehicle covers [shaped]; sleeping berths for vehicles; pontoons; torque converters for land vehicles; anti – dazzle devices for vehicles; anti – theft devices for vehicles; sun – blinds adapted for automobiles; non – skid devices for vehicle tires [tyres]; balance weights for vehicle wheels; shock absorbing springs for vehicles; bicycle frames; spars for ships; reduction gears for land vehicles; safety belts for vehicle seats; vehicle suspension springs; rudders; bicycle handle bars; cranks for cycles; aeroplanes; amphibious airplanes; sleighs [vehicles]; kick sledges; bicycle saddles; luggage nets for

vehicles; dress guards for bicycles, cycles; anti – theft alarms for vehicles; reversing alarms for vehicles; vehicle seats; safety seats for children, for vehicles; hydraulic circuits for vehicles; scooters [vehicles]; rolling stock for railways; bicycle spokes; vehicle wheel spokes; inclined ways for boats; undercarriages for vehicles; water vehicles; military vehicles for transport; air vehicles; cycle cars; vehicles for locomotion by land, air, water or rail; electric vehicles; ambulances; remote control vehicles, other than toys; tricycles; carrier tricycles; wind-screens; windscreen wipers; cycle stands; hubs for vehicle wheels; cycle hubs; railway couplings; trailer hitches for vehicles; couplings for land vehicles; wheelbarrows; hose carts; luggage trucks; golf carts; shopping trolleys [carts (am.)]; bogies for railway cars; casting carriages; tilting – carts; goods handling carts; fork lift trucks; cleaning trolleys; torsion bars for vehicles; tramcars; transmissions, for land vehicles; aerial conveyors; trailers [vehicles]; funnels for locomotives; funnels for ships; cleats [nautical]; turbines for land vehicles; direction indicators for bicycles, cycles, etc.; rowlocks; bicycle stands; disengaging gear for boats; ships' steering gears; cable transport apparatus and installations; spoke clips for wheels; funiculars; vans [vehicles]; caissons [vehicles]; automobile chains; bicycle chains; driving chains for land vehicles; anti – skid chains; tipping apparatus, parts of trucks and waggons; covers for baby carriages; covers for vehicle steering wheels; saddle covers for bicycles or motorcycles; seat covers for vehicles; vehicle chassis; automobile chassis; connecting rods for land vehicles, other than parts of motors and engines; axle journals; gears for cycles; tubeless tires [tyres] for bicycles, cycles; bicycle tires [tyres]; automobile tires [tyres]; tires for vehicle wheels; vehicle wheel tires [tyres]; pneumatic tires [tyres]; spikes for tires [tyres]; davits for boats; launches; timbers [frames] for ships; mudguards; cycle mudguards; motors, electric, for land vehicles; yachts.

(260) AM 2013 68862 A  
 (800) 1125571  
 (731) Robert Bosch GmbH  
 70469 Stuttgart, Germany  
 (540)



(591) Black, white  
 (511)  
 7 – Electric machine tools; drilling and boring machines, hammer drills, bench drill presses, drill chucks, drilling hammers and chisel hammers;

screwdrivers; groove – milling cutters; grinding, cutting and roughing equipment such as superfinish devices, angle grinders, triangular grinders, eccentric grinders, belt grinders, vibrating grinders, right angle polishers, straight grinders; metal cutting snips (electric); nibbling apparatus; glue guns; hot – air guns; tackers; circular saws; jigsaws; compound miter saws; curved saws; band saw machines; planing machines; milling machines; bench belt sanding machines; suction apparatus and dust removal apparatus for the aforesaid goods; universal suction equipment; the aforesaid goods also being battery – powered hand – held tool equipment; parts, tools and accessories for the aforesaid goods, included in this class; motorised agricultural implements and garden implements; garden machinery; blowers, compressors and high – pressure cleaners being machines; suction devices (being machines); lawnmowers and motorised apparatus for aerating lawns, mechanical soil and lawn treatment apparatus and lawn trimmers; power operated saws; mechanical cutting apparatus; power shears; motor mower; pumps (included in this class), in particular water pumps; mechanical care and cleaning apparatus; filters (parts of machines or engines); parts, tools and accessories for the aforesaid goods, included in this class.

8 – Hand – operated agricultural implements and garden implements; grippers; hand – operated lawnmowers; hand – operated apparatus for aerating lawns; hand – operated lawn treatment apparatus; hand tools for gardening, saws (hand tools), hand – operated cutting apparatus, shears for garden and household use, tongs, shovels, snow shovels; parts, tools and accessories for the aforesaid goods, included in this class.

9 – Measuring apparatus (electric), batteries, accumulators, chargers for batteries

---

(260) AM 2013 68863 A

(800) 1125582

(731) SUN MARK LIMITED

428 Long Drive, Greenford, Middlesex  
UB6 8UH, United Kingdom

(540)

**GOLDEN COUNTRY**

(591) Black, white

(511)

5 – Pharmaceutical and veterinary preparations; sanitary preparations for medical purposes; dietetic substances adapted for medical use, food for babies; plasters, materials for dressings; material for stopping teeth, dental wax; disinfectants; preparations for destroying vermin; fungicides, herbicides; baby food; baby foods; dietetic substances adapted for medical use, baby food; milk powder for babies; milk powder for foodstuffs for

babies; milk powder for nutritional purposes for babies; milk powders [foodstuff for babies]; powdered milk foods for infants; powdered milk for babies; substitutes for mothers milk; dried milk being food for infants; dried milk powder being food for babies; dried milk preparations being food for babies; dried milk products being food for babies.

29 – Meat, fish, poultry and game; meat extracts; preserved, frozen, dried and cooked fruits and vegetables; jellies, jams, compotes; eggs, milk and milk products; edible oils and fats; dried milk for food; dried milk powder; dried milk preparations; dried milk products; milk powder for nutritional purposes; powdered milk; powdered milk for food; powdered milk for food purposes; margarine, edible oils and fats.

30 – Coffee, tea, sugar, rice, tapioca, sago, artificial coffee; flour and preparations made from cereals, bread, ices; honey, treacle; yeast, baking – powder; salt, mustard; vinegar, sauces (condiments); spices; breakfast cereals; cereal bars (excluding chocolate coated cereal bars); cereal breakfast foods; cereal breakfast products; cereal products; food products consisting of cereals; honey; honeys; natural honey; salad dressings; dressings for salad.

---

(260) AM 2013 68864 A

(800) 1125589

(731) Honda Motor Co., Ltd.

1 – 1, Minami – Aoyama 2 – chome,  
Minato – ku, Tokyo 107 – 8556, Japan

(540)



(591) Black, white

(511)

12 – Automobiles and their parts and fittings; vessels and their parts and fittings; aircraft and their parts and fittings; two – wheeled motor vehicles and their parts and fittings; bicycles and their parts and fittings; non – electric prime movers for land vehicles (excluding their parts); axles for vehicles; couplings for land vehicles; transmissions for land vehicles; transmission chains for land vehicles; transmission shafts for land vehicles; shock absorbers for automobiles; shock absorbing springs for vehicles; brakes for vehicles.

---

(260) AM 2013 68865 A

(800) 200179A

(731) H. Lundbeck A/S

Ottiliavej 9, DK – 2500 Valby, Denmark

(540)

## TRUXAL

(591) Black, white

(511)

5 – Pharmaceutical preparations.

(260) AM 2013 68866 A

(800) 668513

(731) Paul Hartmann AG

Paul – Hartmann – Strasse 12,  
D – 89522, Heidenheim, Germany

(540)

## Hydroclean

(591) Black, white

(511)

5 – Plasters, material for dressings, compresses, swabs, sanitary tampons, medical cotton, dressings impregnated with ointment; wound dressing material with an absorbing pad, with or without a swelling agent and packed with a vapour – pervious cover; granulated material for wounds; bandages and bands for medical use.

(260) AM 2013 68867 A

(800) 892836

(731) BIOFARMA

50 rue Carnot, F – 92284 SURESNES  
CEDEX, France

(540)

## EUVASTOR

(591) Black, white

(511)

5 – Pharmaceutical and veterinary preparations; sanitary preparations for medical purposes; dietetic substances adapted for medical use.

(260) AM 2013 68868 A

(800) 934798

(731) Otkrytoe aktsionernoe obshchestvo

"Konditerskaya fabrika "Slodych"  
ul. Radialnaya 54 220046 Minsk, Belarus

(540)



(591) Black, white

(511)

30 – Bread, pastry and confectionery, spices, crackers, waffles including waffle chips, biscuits, flour – milling products (not included in other classes), cereal preparations, rusks, corn flakes.

35 – Sales promotion for others.

(260) AM 2013 68869 A

(800) 961530

(731) FIORANGELO S.R.L.

Via Molino Vecchio, 1/C – Frazione Piane,  
I – 63022 FALERONE (FM), Italy

(540)



(591) Black, white

(511)

18 – Travelling trunks, purses, travelling sets (leather goods), linings of leather for boots and shoes, furs (animal skins and hides), wallets, valises.

25 – Clothing; footwear, belts (clothing).

(260) AM 2013 68870 A

(800) 975039

(731) FOREST LABORATORIES, Inc

909 Third Avenue, New York, NY 10022,  
USA

(540)

## ZINFORO

(591) Black, white

(511)

5 – Pharmaceutical preparations and substances for the prevention and treatment of diseases and disorders of the metabolism, respiratory system, central nervous system, peripheral nervous system, cardiovascular system, gastro – intestinal system; pharmaceutical preparations and substances for pain control, arthritis, infection, inflammation and diabetes; pharmaceutical preparations and substances for use in the field of anaesthesia, oncology, urology and gynaecology.

(260) AM 2013 68965 A

(800) 1057280

(731) Bakhchevan Yuliia Volodymyrivna

vul. Preobrazhenska, 11, kv. 14 m. Odessa  
65026, Ukraine

(540)



(591) Black, white

(511)

7 – Tin openers, electric; coffee grinders, other than hand – operated; food processors, electric; kitchen machines, electric; edible pastes making machines; labellers (machines); churns; machines for the

textile industry; trash compacting machines; waste compacting machines; washing apparatus; high pressure washers; washing machines; mixers (machines); mixing machines; agitators; mills for household purposes, other than hand – operated; meat choppers (machines); knives, electric; hemming machines; pepper mills other than hand – operated; vacuum cleaners; knitting machines; air suction machines; grinders/crushers, electric, for household purposes; dishwashers; washing machines (laundry); coin – operated washing machines; ironing machines; smoothing presses; vacuum cleaner attachments for disseminating perfumes and disinfectants; spinning machines; fruit presses, electric, for household purposes; beaters, electric; centrifugal machines; spin driers; sifting machines.

8 – Razors, electric or non – electric; depilation appliances, electric and non – electric; table forks; hand implements for hair curling non – electric; edge tools (hand tools); can openers, non – electric; sharpening instruments; blade sharpening instruments; spoons; manicure sets; manicure sets, electric; fleshing knives (hand tools); nail clippers, electric or non – electric; shearers (hand instruments); scissors; scaling knives; pizza cutters, non – electric; penknives; knives; cutlery; nail drawers (hand tools); vegetable slicers; vegetable choppers; vegetable knives; pedicure sets; tweezers; hair – removing tweezers; cheese slicers, non – electric; choppers (knives); oyster openers; ladles (hand tools); nutcrackers; egg slicers, non – electric.

9 – Answering machines; flat irons, electric; apparatus for games adapted for use with an external display screen or monitor; measuring spoons; headphones; radios; television apparatus; portable telephones; telephone apparatus; telephone transmitters; cameras (photography).

21 – Bottles; crockery; vases; fruit cups; epergnes; tankards; containers for household or kitchen use; boxes of metal, for dispensing paper towels; lunch boxes; jugs; pitchers; pottery; pots; decanters; coffeepots, non – electric; cauldrons; cruets; stew – pans; goblets; ceramics for household purposes; crystal (glassware); cooking utensils, non – electric; kitchen utensils; cooking pot sets; kitchen containers; cooking pots; liqueur sets; butter dishes; basins (bowls); spice sets; services (dishes); heaters for feeding bottles, non – electric; carboys; coffee services; basting spoons, for kitchen use; pepper pots; beer mugs; egg cups; flasks; bottles; ice buckets; porcelain ware; dishes; drinking vessels; glass jars (carboys); refrigerating bottles; vessels of metal for making ices and iced drinks; oil cruets; cabarets (trays); shakers; salad bowls; siphons for carbonated water; glass (receptacles); painted glassware; glass flasks (containers); glass bulbs (receptacles); glass bulbs (receptacles); drinking glasses; frying pans; tableware, other than knives, forks and

spoons; table plates; soup bowls; saucers; trays for domestic purposes; heat – insulated containers; heat insulated containers for beverages; thermally insulated containers for food; insulating flasks; vacuum bottles; drinking flasks for travellers; ice cube molds (moulds); bread bins; candy boxes; sugar bowls; hot pots, not electrically heated; tea balls; teapots; kettles, non – electric; tea caddies; tea services; cups.

(260) AM 2013 69000 A

(800) 1126933

(731) Bayer Aktiengesellschaft

Kaiser – Wilhelm – Allee, 51373 Leverkusen,  
Germany

(540)

## VIVERTY

(591) Black, white

(511)

5 – Pharmaceutical preparations; hormonal preparations.

(260) AM 2013 69001 A

(800) 1126939

(731) VALENTINO S.P.A.

Via Turati, 16/18, I – 20121 MILANO, Italy

(540)



(591) Pink, gold, black and grey

(511)

3 – Cosmetics, including night and day creams; cleaning preparations for care of the face and body, bath foam; shaving foam, aftershaves; foundation makeup; nail polish; deodorants for men and women; hand and body soaps; hair shampoos and rinses; hair spray; toothpaste; fragrances, namely perfume, toilet water and essential oils for personal use for men and women.

(260) AM 2013 69002 A

(800) 1126964

(731) Beiersdorf AG

Unnastrasse 48, 20253 Hamburg, Germany

(540)

## NIVEA POWER REFRESH

(591) Black, white  
 (511)  
 3 – Soaps; perfumery, preparations for body and beauty care.

(260) AM 2013 69003 A  
 (800) 1126967  
 (731) EGIS GYOGYSZERGYÁR Nyilvánosan  
 Működő Részvénytársaság  
 Kereszturi ut 30 – 38, H – 1106 Budapest,  
 Hungary

(540)

## ALTFORALLE

(591) Black, white  
 (511)  
 5 – Pharmaceutical preparations for human use.

(260) AM 2013 69004 A  
 (800) 1126968  
 (731) EGIS GYOGYSZERGYÁR Nyilvánosan  
 Működő Részvénytársaság  
 Kereszturi ut 30 – 38, H – 1106 Budapest,  
 Hungary

(540)

## EGIDESSA

(591) Black, white  
 (511)  
 5 – Pharmaceutical preparations for human use.

(260) AM 2013 69007 A  
 (800) 1127011  
 (731) Comité International Olympique  
 Château de Vidy, CH – 1007 Lausanne,  
 Switzerland

(540)

## ISTANBUL 2020

(591) Black, white  
 (511)  
 35 – Advertising; dissemination of advertisements by all media, particularly in the form of themed messages focused on human values; advertising by sponsorship (sponsoring); business management; business administration; office functions; promotion of the goods and services of others, by means of contractual agreements, particularly partnership (sponsorship) and licensing agreements, affording them with increased notoriety and/or enhanced image and/or sympathy derived from the notoriety and/or enhanced image resulting from cultural and sporting events, particularly international events and/or sympathy generated by the above; promotion of the goods and services of others by means of what is referred to as the initial interest factor driving the public to consider, from among many competitors,

goods or services presented with signs, emblems or messages so as to capture its attention; promotion of the goods and services of others by means of the so – called image transfer; rental of advertising space of all type and on all media, whether digital or not; business administration of the participation of national teams to an international sports competition, and promotion intended for the public and bodies interested in providing support to the aforesaid teams; inventory management services; advice relating to stock monitoring services; advertising by means of direct marketing for others relating to marketing of databases; advice for advertising by means of direct marketing for others relating to marketing of databases; advisory services in connection with business reorganization; automobile and truck fleet management services, namely billing and advice in connection with the administrative management of automobile and truck fleets; business administration consultancy; administrative management of power plants of others; business advice in connection with the management of power plants, commercial services, namely administration of contracts for repair and servicing, supply chain management services and advice relating to the purchase and supply in terms of chemicals and chemical services, product inventory and supply services, limitation of costs; advice, marketing, analysis of prices and costs concerning devices for electrochemical purification of liquids for industrial use; administrative, commercial and technical management of computer files; data input and processing services; retail sale of electric and electronic machines and apparatus (grouping, for others, of a range of goods so as to enable customers to view and purchase said goods at their convenience in a retail store carrying electrical goods), information concerning the sale of raw materials, commercial information, commercial information agencies, rental of photocopiers; promotion of the sale of goods and services of others including by means of advertisements, promotional competitions, awarding of prizes and bonuses in the form of promotional lotteries, discounts, reduction tokens and value – added offers in connection with the use of payment cards; promotion of sporting events and competitions for use by others; promotion of concerts and of cultural events for others, organization of exhibitions for commercial or advertising purposes; provision of documentation, namely direct mail advertising, distribution of advertising material, distribution of samples, reproduction of documents; advertising concerning the promotion of commercial sales of goods and services for retail sale purposes; provision of information in connection with e – commerce and electronic retail sale; provision of information concerning the purchase of goods and services on line via the Internet and other computer networks; tourist documentation services, namely advertising concerning transport, travel, hotels, accommodation, food

and meals, sports, entertainment and sightseeing tours, tourist agency services; maintenance of computerized databases.

41 – Educational services; providing of training; entertainment; sporting and cultural activities, televised sporting and cultural entertainment; organization of exhibitions for cultural and educational purposes; organization of competitions and lotteries; betting and gambling services in connection with or relating to sports; entertainment services provided during sporting events or concerning sporting events; organization of sporting and cultural events and activities; organization of real or virtual sporting competitions; operation of sports facilities; rental of audio and video equipment, production of films, other than advertising films; production of sound and video recordings; presentation and distribution of films and of sound and video recordings; rental of sound and video recordings; rental and/or provision via a computer network of interactive entertainment and education products, namely interactive compact discs, CD – ROMs, computer games; entertainment, namely presentation of interactive entertainment and education products, namely interactive compact discs, CD – ROMs, computer games; covering televised and broadcast sporting events; production of television and radio programs and of videotapes; production of cartoons; production of cartoons for television; reservation of tickets for sporting events and shows; timing of sports events; organization of beauty contests; interactive entertainment; on – line betting services; provision of games on the Internet; provision of raffle services; information concerning entertainment or education, provided on line from a data bank or the Internet; electronic game services provided by means of the Internet; provision of electronic publications on line; publication of books, magazines, texts (other than publicity texts) and periodicals; publication of books, magazines, texts (other than publicity texts) and of electronic periodicals on line; provision of digital music from the Internet; provision of digital music from MP3 web sites; provision of sporting results; information services concerning sports and sporting events; rental of recorded sounds and images; audio production services; information services concerning sporting events provided on line from a computer database or the Internet; editing and publishing services; provision of digital music (non – downloadable); offering digital music by means of telecommunications; publication of statistics regarding sporting results and audience ratings for sporting competitions; training in the use and operation of systems for signaling and notification of crossings for the railway and transit industries; education services in the field of medical imaging and diagnosis, namely conducting of seminars, conferences, symposiums or workshops concerning the pharmaceutical industry, intended for medical doctors and employees of phar-

maceutical companies; education services, namely conducting of seminars, conferences, symposiums or workshops in the field of life sciences and biotechnology for scientists and researchers; conducting of seminars on problems in connection with industrial water treatment; training services in all the aforesaid fields; training services in the field of management and medicine by means of the use of instructions and demonstrations provided on line, via the Internet, intranets and extranets; education services, namely conducting of practical training workshops, courses and seminars including demonstrations in the field of medicine and management; design, conducting and hosting of courses, seminars and all training activities in the field of information technology; organization and performance of concerts; booking of seats for shows; movie presentations; entertainment information; film production; show production; theater production services; operation of golf facilities; health club services (fitness training); sports camp services; presentation of live performances; film projection; organization of shows (impresario services); holiday camp services [entertainment]; movie studios; news reporter services; provision of on – line electronic publications, not downloadable; music hall services; education services, namely conducting of courses, seminars, presentations, video presentations; provision of educational material, namely dissemination of material in the field of financial knowledge; education services in the field of tourism; information services in the field of tourism, namely information services regarding reservation of tickets for recreational events; information services in the field of tourism, namely information services regarding entertainment; information services in the field of tourism, namely information services regarding planned sporting, cultural and recreational activities; services in connection with entertainment for tourist assistance; tourist reservation services, namely activity and entertainment reservation services; assistance services for tourists concerning reservation of tickets for recreational events; assistance services for tourists concerning planned sporting, cultural and recreational activities.

(260) AM 2013 69008 A

(800) 1127013

(731) Comité International Olympique  
Château de Vidy, CH – 1007 Lausanne,  
Switzerland

(540)

The logo for the 2020 Summer Olympics in Madrid, featuring the Olympic rings symbol to the left of the text "MADRID 2020".

(591) Black, white

(511)

35 – Advertising; dissemination of advertisements by all media, particularly in the form of themed



messages focused on human values; advertising by sponsorship (sponsoring); business management; business administration; office functions; promotion of the goods and services of others, by means of contractual agreements, particularly partnership (sponsorship) and licensing agreements, affording them with increased notoriety and/or enhanced image and/or sympathy derived from the notoriety and/or enhanced image resulting from cultural and sporting events, particularly international events and/or sympathy generated by the above; promotion of the goods and services of others by means of what is referred to as the initial interest factor driving the public to consider, from among many competitors, goods or services presented with signs, emblems or messages so as to capture its attention; promotion of the goods and services of others by means of the so – called image transfer; rental of advertising space of all type and on all media, whether digital or not; business administration of the participation of national teams to an international sports competition, and promotion intended for the public and bodies interested in providing support to the aforesaid teams; inventory management services; advice relating to stock monitoring services; advertising by means of direct marketing for others relating to marketing of databases; advice for advertising by means of direct marketing for others relating to marketing of databases; advisory services in connection with business reorganization; automobile and truck fleet management services, namely billing and advice in connection with the administrative management of automobile and truck fleets; business administration consultancy; administrative management of power plants of others; business advice in connection with the management of power plants, commercial services, namely administration of contracts for repair and servicing, supply chain management services and advice relating to the purchase and supply in terms of chemicals and chemical services, product inventory and supply services, limitation of costs; advice, marketing, analysis of prices and costs concerning devices for electrochemical purification of liquids for industrial use; administrative, commercial and technical management of computer files; data input and processing services; retail sale of electric and electronic machines and apparatus (grouping, for others, of a range of goods so as to enable customers to view and purchase said goods at their convenience in a retail store carrying electrical goods), information concerning the sale of raw materials, commercial information, commercial information agencies, rental of photocopiers; promotion of the sale of goods and services of others including by means of advertisements, promotional competitions, awarding of prizes and bonuses in the form of promotional lotteries, discounts, reduction tokens and value – added offers in connection with the use of payment

cards; promotion of sporting events and competitions for use by others; promotion of concerts and of cultural events for others, organization of exhibitions for commercial or advertising purposes; provision of documentation, namely direct mail advertising, distribution of advertising material, distribution of samples, reproduction of documents; advertising concerning the promotion of commercial sales of goods and services for retail sale purposes; provision of information in connection with e – commerce and electronic retail sale; provision of information concerning the purchase of goods and services on line via the Internet and other computer networks; tourist documentation services, namely advertising concerning transport, travel, hotels, accommodation, food and meals, sports, entertainment and sightseeing tours, tourist agency services; maintenance of computerized databases.

41 – Educational services; providing of training; entertainment; sporting and cultural activities, televised sporting and cultural entertainment; organization of exhibitions for cultural and educational purposes; organization of competitions and lotteries; betting and gambling services in connection with or relating to sports; entertainment services provided during sporting events or concerning sporting events; organization of sporting and cultural events and activities; organization of real or virtual sporting competitions; operation of sports facilities; rental of audio and video equipment, production of films, other than advertising films; production of sound and video recordings; presentation and distribution of films and of sound and video recordings; rental of sound and video recordings; rental and/or provision via a computer network of interactive entertainment and education products, namely interactive compact discs, CD – ROMs, computer games; entertainment, namely presentation of interactive entertainment and education products, namely interactive compact discs, CD – ROMs, computer games; covering televised and broadcast sporting events; production of television and radio programs and of videotapes; production of cartoons; production of cartoons for television; reservation of tickets for sporting events and shows; timing of sports events; organization of beauty contests; interactive entertainment; on – line betting services; provision of games on the Internet; provision of raffle services; information concerning entertainment or education, provided on line from a data bank or the Internet; electronic game services provided by means of the Internet; provision of electronic publications on line; publication of books, magazines, texts (other than publicity texts) and periodicals; publication of books, magazines, texts (other than publicity texts) and of electronic periodicals on line; provision of digital music from the Internet; provision of digital music from MP3 web sites; provision of sporting results; information services concerning sports and sporting events; rental of recorded sounds and images; audio production

services; information services concerning sporting events provided on line from a computer database or the Internet; editing and publishing services; provision of digital music (non – downloadable); offering digital music by means of telecommunications; publication of statistics regarding sporting results and audience ratings for sporting competitions; training in the use and operation of systems for signaling and notification of crossings for the railway and transit industries; education services in the field of medical imaging and diagnosis, namely conducting of seminars, conferences, symposiums or workshops concerning the pharmaceutical industry, intended for medical doctors and employees of pharmaceutical companies; education services, namely conducting of seminars, conferences, symposiums or workshops in the field of life sciences and biotechnology for scientists and researchers; conducting of seminars on problems in connection with industrial water treatment; training services in all the aforesaid fields; training services in the field of management and medicine by means of the use of instructions and demonstrations provided on line, via the Internet, intranets and extranets; education services, namely conducting of practical training workshops, courses and seminars including demonstrations in the field of medicine and management; design, conducting and hosting of courses, seminars and all training activities in the field of information technology; organization and performance of concerts; booking of seats for shows; movie presentations; entertainment information; film production; show production; theater production services; operation of golf facilities; health club services (fitness training); sports camp services; presentation of live performances; film projection; organization of shows (impresario services); holiday camp services [entertainment]; movie studios; news reporter services; provision of on – line electronic publications, not downloadable; music hall services; education services, namely conducting of courses, seminars, presentations, video presentations; provision of educational material, namely dissemination of material in the field of financial knowledge; education services in the field of tourism; information services in the field of tourism, namely information services regarding reservation of tickets for recreational events; information services in the field of tourism, namely information services regarding entertainment; information services in the field of tourism, namely information services regarding planned sporting, cultural and recreational activities; services in connection with entertainment for tourist assistance; tourist reservation services, namely activity and entertainment reservation services; assistance services for tourists concerning reservation of tickets for recreational events; assistance services for tourists concerning planned sporting, cultural and recreational activities.

(260) AM 2013 69009 A

(800) 1127014

(731) Comité International Olympique  
Château de Vidy, CH – 1007 Lausanne,  
Switzerland

(540)

 TOKYO 2020

(591) Black, white

(511)

35 – Advertising; dissemination of advertisements by all media, particularly in the form of themed messages focused on human values; advertising by sponsorship (sponsoring); business management; business administration; office functions; promotion of the goods and services of others, by means of contractual agreements, particularly partnership (sponsorship) and licensing agreements, affording them with increased notoriety and/or enhanced image and/or sympathy derived from the notoriety and/or enhanced image resulting from cultural and sporting events, particularly international events and/or sympathy generated by the above; promotion of the goods and services of others by means of what is referred to as the initial interest factor driving the public to consider, from among many competitors, goods or services presented with signs, emblems or messages so as to capture its attention; promotion of the goods and services of others by means of the so – called image transfer; rental of advertising space of all type and on all media, whether digital or not; business administration of the participation of national teams to an international sports competition, and promotion intended for the public and bodies interested in providing support to the aforesaid teams; inventory management services; advice relating to stock monitoring services; advertising by means of direct marketing for others relating to marketing of databases; advice for advertising by means of direct marketing for others relating to marketing of databases; advisory services in connection with business reorganization; automobile and truck fleet management services, namely billing and advice in connection with the administrative management of automobile and truck fleets; business administration consultancy; administrative management of power plants of others; business advice in connection with the management of power plants, commercial services, namely administration of contracts for repair and servicing, supply chain management services and advice relating to the purchase and supply in terms of chemicals and chemical services, product inventory and supply services, limitation of costs; advice, marketing, analysis of prices and costs concerning devices for electrochemical purification of liquids for industrial use; administrative, commercial and technical management of computer files; data input and processing

services; retail sale of electric and electronic machines and apparatus (grouping, for others, of a range of goods so as to enable customers to view and purchase said goods at their convenience in a retail store carrying electrical goods), information concerning the sale of raw materials, commercial information, commercial information agencies, rental of photocopiers; promotion of the sale of goods and services of others including by means of advertisements, promotional competitions, awarding of prizes and bonuses in the form of promotional lotteries, discounts, reduction tokens and value – added offers in connection with the use of payment cards; promotion of sporting events and competitions for use by others; promotion of concerts and of cultural events for others, organization of exhibitions for commercial or advertising purposes; provision of documentation, namely direct mail advertising, distribution of advertising material, distribution of samples, reproduction of documents; advertising concerning the promotion of commercial sales of goods and services for retail sale purposes; provision of information in connection with e – commerce and electronic retail sale; provision of information concerning the purchase of goods and services on line via the Internet and other computer networks; tourist documentation services, namely advertising concerning transport, travel, hotels, accommodation, food and meals, sports, entertainment and sightseeing tours, tourist agency services; maintenance of computerized databases.

41 – Educational services; providing of training; entertainment; sporting and cultural activities, televised sporting and cultural entertainment; organization of exhibitions for cultural and educational purposes; organization of competitions and lotteries; betting and gambling services in connection with or relating to sports; entertainment services provided during sporting events or concerning sporting events; organization of sporting and cultural events and activities; organization of real or virtual sporting competitions; operation of sports facilities; rental of audio and video equipment, production of films, other than advertising films; production of sound and video recordings; presentation and distribution of films and of sound and video recordings; rental of sound and video recordings; rental and/or provision via a computer network of interactive entertainment and education products, namely interactive compact discs, CD – ROMs, computer games; entertainment, namely presentation of interactive entertainment and education products, namely interactive compact discs, CD – ROMs, computer games; covering televised and broadcast sporting events; production of television and radio programs and of videotapes; production of cartoons; production of cartoons for television; reservation of tickets for sporting events and shows; timing of sports events; organization of beauty contests; interactive entertainment; on – line

betting services; provision of games on the Internet; provision of raffle services; information concerning entertainment or education, provided on line from a data bank or the Internet; electronic game services provided by means of the Internet; provision of electronic publications on line; publication of books, magazines, texts (other than publicity texts) and periodicals; publication of books, magazines, texts (other than publicity texts) and of electronic periodicals on line; provision of digital music from the Internet; provision of digital music from MP3 web sites; provision of sporting results; information services concerning sports and sporting events; rental of recorded sounds and images; audio production services; information services concerning sporting events provided on line from a computer database or the Internet; editing and publishing services; provision of digital music (non – downloadable); offering digital music by means of telecommunications; publication of statistics regarding sporting results and audience ratings for sporting competitions; training in the use and operation of systems for signaling and notification of crossings for the railway and transit industries; education services in the field of medical imaging and diagnosis, namely conducting of seminars, conferences, symposiums or workshops concerning the pharmaceutical industry, intended for medical doctors and employees of pharmaceutical companies; education services, namely conducting of seminars, conferences, symposiums or workshops in the field of life sciences and biotechnology for scientists and researchers; conducting of seminars on problems in connection with industrial water treatment; training services in all the aforesaid fields; training services in the field of management and medicine by means of the use of instructions and demonstrations provided on line, via the Internet, intranets and extranets; education services, namely conducting of practical training workshops, courses and seminars including demonstrations in the field of medicine and management; design, conducting and hosting of courses, seminars and all training activities in the field of information technology; organization and performance of concerts; booking of seats for shows; movie presentations; entertainment information; film production; show production; theater production services; operation of golf facilities; health club services (fitness training); sports camp services; presentation of live performances; film projection; organization of shows (impresario services); holiday camp services [entertainment]; movie studios; news reporter services; provision of on – line electronic publications, not downloadable; music hall services; education services, namely conducting of courses, seminars, presentations, video presentations; provision of educational material, namely dissemination of material in the field of financial knowledge; education services in the field of tourism; information ser-

vices in the field of tourism, namely information services regarding reservation of tickets for recreational events; information services in the field of tourism, namely information services regarding entertainment; information services in the field of tourism, namely information services regarding planned sporting, cultural and recreational activities; services in connection with entertainment for tourist assistance; tourist reservation services, namely activity and entertainment reservation services; assistance services for tourists concerning reservation of tickets for recreational events; assistance services for tourists concerning planned sporting, cultural and recreational activities.

(260) AM 2013 69010 A

(800) 1127068

(731) Abercrombie & Fitch Europe SA  
Via Moree, CH – 6850 Mendrisio,  
Switzerland

(540)



(591) Black, white

(511)

3 – Bleaching preparations and other substances for laundry use; cleaning, polishing, degreasing and abrasive preparations; soap; perfumery, essential oils, cosmetics, hair lotions; dentifrices.

35 Advertising; business management; business administration; office functions; retail store services for clothing, footwear, headgear, soap, perfumes, essential oils, cosmetics, hair lotions, candles, jewelry and bags; on – line retail store services for clothing, footwear, headgear, soap, perfumes, essential oils, cosmetics, hair lotions, candles, jewelry and bags; customer loyalty scheme services for commercial, promotional and/or advertising purposes.

(260) AM 2013 69011 A

(800) 850246

(731) Landgenossenschaft Ennstal – "Ennstal  
Milch" KG  
A – 8950 Stainach, Austria

(540)

**LANDESSA**

(591) Black, white

(511)

29 – Meat, fish, poultry and game; meat extracts; preserved, dried and cooked fruit and vegetables; jellies, jams, compotes; eggs, milk and milk products; cheese; edible oils and fats.

30 – Coffee, tea, cocoa, sugar, rice, tapioca, sago, artificial coffee; flour and preparations made from

cereals, bread, pastry and confectionery, ices; honey, treacle; yeast, baking – powder; salt, mustard; vinegar, sauces (condiments); spices, ice for refreshment.

32 – Beer; mineral and aerated waters and other non – alcoholic drinks; fruit drinks and fruit juices; syrups and other preparations for making beverages.

(260) AM 2013 69012 A

(800) 1066377

(731) MIRATO S.P.A.

Strada Provinciale Est Sesia, I – 28064  
LANDIONA (NO), Italy

(540)



(591) Black, white

(511)

3 – Bleaching preparations and other substances for laundry use; cleaning, polishing, scouring and abrasive preparations; soaps; perfumery, essential oils, cosmetics, hair lotions; dentifrices.

(260) AM 2013 69013 A

(800) 1077701

(731) YUYAO VISTAR ELECTRONIC SCIENCE  
& TECHNOLOGY CO., LTD.

Qunli Village, Xibei Road, Yuyao City,  
Zhejiang Province, China

(540)



(591) Black, white

(511)

9 – Objectives (lenses) (optics); cameras (photography); flash – bulbs (photography); photographic racks; filters (photography); stands for photographic apparatus; filters for ultraviolet rays, for photography; tripods for cameras; flashlights (photography); cases especially made for photographic apparatus and instruments.

(260) AM 2013 69014 A

(800) 1106461

(731) Rotkäppchen – Mumm Sektkellereien GmbH  
Sektkellereistrasse 5, 06632 Freyburg/Unstrut,  
Germany

(540)

*Rotkäppchen*

(591) Black, white  
(511)  
32 – Beers; mineral waters and aerated waters and other non – alcoholic beverages; de – alcoholised beverages, fruit drinks and fruit juices; syrups and other preparations for making beverages.

33 – Alcoholic beverages (except beers).

(260) AM 2013 69015 A  
(800) 1115057  
(731) Geldermann Privatsektellerei GmbH  
Am Schlossberg 1, 79206 Breisach am Rhein,  
Germany

(540)

*Geldermann*

(591) Black, white  
(511)  
32 – Beers; mineral waters and aerated waters and other non – alcoholic beverages; de – alcoholized beverages, fruit beverages and fruit juices; syrups and other preparations for making beverages.

33 – Alcoholic beverages (except beers).

(260) AM 2013 69016 A  
(800) 1116135  
(731) F. Hoffmann – La Roche AG  
Grenzacherstrasse 124, CH – 4070 Basel,  
Switzerland

(540)

**PEGFERON**

(591) Black, white  
(511)  
5 – Pharmaceutical preparations.

(260) AM 2013 69089 A  
(800) 1092856  
(731) "Caspian Energy" Magazine Edition  
S. Rustam str., 59 ap. 64, AZ – 1007 Baku,  
Azerbaijan

(540)



(591) White and dark blue  
(511)  
35 – Market research and analysis of the industry.  
41 – Cultural activities and education.

(260) AM 2013 69093 A  
(800) 1127858  
(731) KRKA, tovarna zdravil, d.d., Novo mesto  
Šmarješka cesta 6, SI – 8501 Novo mesto,  
Slovenia

(540)

**YCOMVIA**

(591) Black, white  
(511)  
5 – Pharmaceutical preparations.

(260) AM 2013 69094 A  
(800) 1127859  
(731) Toruńskie Zakłady Materiałów  
Opatrunkowych, Spółka Akcyjna  
Żółkiewskiego 20/26, PL – 87 – 100 Toruń,  
Poland

(540)

**surgilex**

(591) Black, white  
(511)  
10 – Gloves for medical purposes.

(260) AM 2013 69096 A  
(800) 1127870  
(731) ALTUNIS – TRADING, GESTÃO E  
SERVIÇOS, LDA.  
RUA DE SÃO FRANCISCO, N° 3, 1°  
ANDAR, SALA D, P – 9000 – 050  
FUNCHAL, Portugal

(540)

**CIPRIANI**

(591) Black, white  
(511)  
32 – Beers; mineral and aerated waters and other non – alcoholic drinks; fruit beverages and fruit juices; syrups and other preparations for making beverages.

(260) AM 2013 69103 A  
(800) 1127951  
(731) Sovmestnoe predpriyatie otkrytoe  
aktsionernoe obshchestvo "Spartak"  
d.63, ul. Sovetskaya, 246655 Gomel, Belarus

(540)

**СПАПТАК**

(591) Black, white  
(511)  
30 – Pastry and confectionery.

(260) AM 2013 69104 A  
(800) 1127959  
(731) OJSC SIBUR Holding  
liter A, 5, ul. Galernaya, RU – 190000  
St. Petersburg, Russian Federation

(540)

**NITROLAST**

(591) Black, white

(511)

1 – Adhesives for industrial purposes; chemical preparations for the manufacture of paints; emollients for industrial purposes; tire repairing compositions; industrial chemicals.

17 – Liquid rubber; synthetic rubber; rubber, raw or semi – worked; latex [rubber]; weatherstripping compositions; insulating materials; rubber material for recapping tires [tyres]; rubber solutions.

35 – Commercial information and advice for consumers [consumer advice shop]; distribution of samples; commercial administration of the licensing of the goods and services of others.

42 – Chemical analysis; technical project studies; engineering; material testing; mechanical research; chemical research; research and development for others; technical research; quality control; chemistry services; scientific laboratory services; surveying.

(260) AM 2013 69105 A

(800) 1127974

(731) SCORPIUS

55, Rue Jouffroy d'Abbans, F – 75017 PARIS, France

(540)

**INIPSANE**

(591) Black, white

(511)

5 – Medicines for controlling stomach acidity in humans.

(260) AM 2013 69106 A

(800) 1128013

(731) JIANGSU GUOQIANG TOOLS CO., LTD

Qidong Tianfen Hardware, Technical Park, Jiangsu Province, China

(540)



(591) Black, white

(511)

7 – Cutting machines; pneumatic hand – held tools, namely, pneumatic bolt – guns, pneumatic drills, pneumatic grinders, pneumatic screwdrivers, pneumatic sanders, pneumatic polishers; electric rotary

hammers; electric demolition hammers; engraving machines; electric motors for power tools; metalworking machines; machine tools, namely, powered machines for cutting or shaping or finishing metals or other materials; electric metal cutting machines; electric mould finishing grinders; electric die grinders; electric weld joint bevellers; electric angle cutting tools; electric polishing machines and apparatus for metalworking; electric knives for metalworking; bits for mining machines; hand – held tools other than hand – operated, namely, electric marble cutters, electric planers, electric wood routers, electric sanders, electric wood trimmers, electric jig saws, electric circular saws, electric angle grinders, electric wrenches, electric screwdrivers, electric hand drills, electric groove cutters, cordless power drills; stators being parts of motors; rotors being parts of motors; carbon brushes (electricity).

(260) AM 2013 69108 A

(800) 1128016

(731) FORTRUST GLOBAL SA

25 c, Boulevard Royal, L – 2449 Luxembourg, Luxembourg

(540)

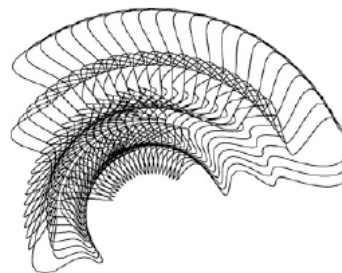

(591) Black, white

(511)

35 – Advertising; business management; business administration; office functions; accounting; business management assistance; business management and organization consultancy; professional business consultancy; efficiency experts; business investigations; business inquiries; business appraisal services; commercial or industrial management assistance; projects [business management assistance]; cost price analysis; marketing studies; marketing research; economic forecasting; procurement services for others [purchasing goods and services for other businesses]; tax preparation; book – keeping; drawing up of statements of accounts; auditing; collection and systemization of information into computer databases; computerized file management; administrative management of companies for others; administrative services as regards corporate domiciliation; data search in computer files for others; compilation of statistics.

36 – Insurance underwriting; financial affairs; monetary affairs; real estate affairs; real – estate brokers; real estate agencies; real estate management;

securities brokerage, stock exchange quotations; capital investment; financial management; mutual funds; investment of funds, including investment funds; financial appraisals (insurance, banking, real estate); fiscal valuations; real estate appraisals; real property appraisals; fiscal assessments; trusteeship services; financial consultancy; financial information; exchanging money; financial operations, financial transactions; monetary operations; financial sponsorship.

41 – Educational services; providing of training; entertainment; sporting and cultural activities; arranging and conducting of training workshops, colloquiums, conferences, congresses, seminars and/or symposiums; arranging and conducting of training workshops, colloquiums, conferences, congresses, seminars and/or symposiums in the fields of company creation and life; providing online electronic publications, not downloadable; publication of electronic books and journals on – line; publication of books, booklets and brochures; publication of texts other than publicity texts.

45 – Legal services; legal research; legal services relating to company domiciliation and financial management; legal analyses for others.

---

(260) AM 2013 69110 A

(800) 1128117

(731) Liu Yang

4A23 Ritan International Mantion, Yabao  
Road, Chaoyang District Beijing, China

(540)

**D.A.MLYGY**

(591) Black, white

(511)

25 – Clothing; shoes; bathing suits; gloves (clothing); football boots; wedding dresses; caps and hats; hosiery; neckties; leather belts for clothing.

---

(260) AM 2013 69111 A

(800) 1128168

(731) WHAT WATCH AG

Löwenstrasse 2, CH – 8001 Zürich,  
Switzerland

(540)

**WHAT?**

(591) Black, white

(511)

14 – Clock hands [clock and watchmaking]; anchors [clock and watch making]; pendulums (clock and watch making); barrels [clock and watch making]; clock cases; boxes of precious metal; watch cases; earrings; watch straps; wristwatches; clock cases; dials [clock and watch making]; sundials; clockworks; watch chains; chronographs [watches]; chronometers; stopwatches; chronometric instru-

ments; chronoscopes; key rings [trinkets or fobs]; control clocks [master clocks]; tie pins; tie clips; jewelry cases [caskets]; presentation cases for timepieces; cases for timepieces; movements for clocks and watches; clocks; atomic clocks; electric clocks; watches; watch springs; watch glasses; wall clocks; alarm clocks.

---

(260) AM 2013 69112 A

(800) 1128185

(731) Bayer Aktiengesellschaft

Kaiser – Willhelm – Allee, 51373  
Leverkusen, Germany

(540)

**YBERTESSE**

(591) Black, white

(511)

5 – Pharmaceutical preparations; hormonal preparations.

---

(260) AM 2013 69113 A

(800) 1128186

(731) Bayer Aktiengesellschaft

Kaiser – Willhelm – Allee, 51373  
Leverkusen, Germany

(540)

**YBRITY**

(591) Black, white

(511)

5 – Pharmaceutical preparations; hormonal preparations.

---

(260) AM 2013 69266 A

(800) 1129867

(731) KRKA, tovarna zdravil, d.d., Novo mesto

Šmarješka cesta 6, SI – 8501 Novo mesto,  
Slovenia

(540)

**YCOMWYA**

(591) Black, white

(511)

5 – Pharmaceutical preparations.

---

(260) AM 2013 69430 A

(800) 1070832

(731) Carlson, Inc.

Carlson Parkway, P.O. Box 59159,  
Minneapolis MN 55459 – 8249, USA

(540)

**CARLSON**

(591) Black, white

(511)

35 – Management of hotels, motels, and resorts for others; customer loyalty services and customer club

---

services, for commercial, promotional and/or advertising purposes; fulfillment of travel rewards in connection with loyalty programs and incentive award programs; providing and managing frequent traveler benefit programs for others.

43 – Hotel, resort and temporary lodging services; making hotel, resort and lodging reservations for others; providing hotel, resort and lodging information and reservation services by means of a computer information network; restaurant, catering and banquet services.

---

(260) AM 66542 A \*

(800) 1107399

(731) CHINALUX SA

26 rue des Gaulois, L – 1618 Luxembourg,  
Luxembourg

(540)

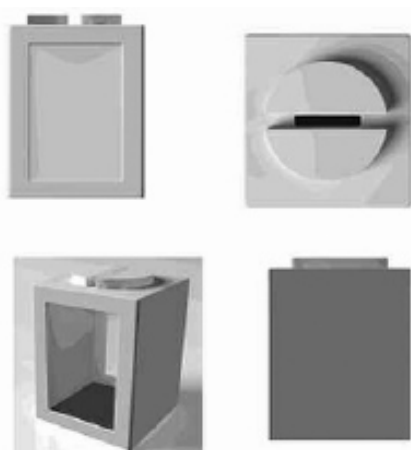

(591) Black, white

(511)

20 – Packaging boxes of plastic.

---

(260) AM 67105 A \*

(800) 916843

(731) DEBENHAMS RETAIL PLC

1 Welbeck Street, London W1G 0AA,  
United Kingdom

(540)



(591) Black, white

(511)

25 – Articles of clothing, footwear and headgear; leisurewear.



**INTERNATIONAL TRADEMARKS PROTECTED IN GEORGIA**

(260) AM 2013 65914 A  
(800) 1102735  
(151) 2011 11 22  
(181) 2021 11 22  
(511) 05, 10, 41, 42, 44

---

(260) AM 2013 66032 A  
(800) 1103492  
(151) 2011 12 13  
(181) 2021 12 13  
(511) 43

---

(260) AM 2013 66151 A  
(800) 1104301  
(151) 2011 10 19  
(181) 2021 10 19  
(511) 32

---

(260) AM 2013 67027 A  
(800) 1111013  
(151) 2012 02 01  
(181) 2022 02 01  
(511) 01, 03, 05

---

(260) AM 2013 67028 A  
(800) 1111044  
(151) 2011 11 25  
(181) 2021 11 25  
(511) 05, 10

---

(260) AM 2013 67029 A  
(800) 1111054  
(151) 2012 01 27  
(181) 2022 01 27  
(511) 04, 07, 09, 11, 21, 24

---

(260) AM 2013 67030 A  
(800) 1111081  
(151) 2011 12 13  
(181) 2021 12 13  
(511) 07

---

(260) AM 2013 67032 A  
(800) 1111125  
(151) 2011 12 13

(181) 2021 12 13  
(511) 07

---

(260) AM 2013 67035 A  
(800) 269592  
(151) 2003 05 20  
(181) 2013 05 20  
(511) 01

---

(260) AM 2013 67086 A  
(800) 1111619  
(151) 2012 01 31  
(181) 2022 01 31  
(511) 28

---

(260) AM 2013 67112 A  
(800) 1065866  
(151) 2010 12 27  
(181) 2020 12 27  
(511) 05

---

(260) AM 2013 67113 A  
(800) 1077773  
(151) 2011 04 05  
(181) 2021 04 05  
(511) 05

---

(260) AM 2013 67114 A  
(800) 1077774  
(151) 2011 04 05  
(181) 2021 04 05  
(511) 05

---

(260) AM 2013 67116 A  
(800) 1082085  
(151) 2011 05 19  
(181) 2021 05 19  
(511) 05

---

(260) AM 2013 67322 A  
(800) 814222  
(151) 2003 06 27  
(181) 2013 06 27  
(511) 09, 18

---

(260) AM 2013 67400 A  
(800) 1013496  
(151) 2009 07 28  
(181) 2019 07 28  
(511) 34

---

(260) AM 2013 67401 A  
(800) 1023200  
(151) 2009 11 26  
(181) 2019 11 26  
(511) 06

---

(260) AM 2013 67402 A  
(800) 1027317  
(151) 2009 11 13  
(181) 2019 11 13  
(511) 36

---

(260) AM 2013 67403 A  
(800) 1088834  
(151) 2011 08 05  
(181) 2021 08 05  
(511) 30

---

(260) AM 2013 67404 A  
(800) 1110627  
(151) 2012 01 31  
(181) 2022 01 31  
(511) 05

---

(260) AM 2013 67457 A  
(800) 963627  
(151) 2007 04 16  
(181) 2017 04 16  
(511) 03, 09, 14, 16, 18, 24, 25, 35

---

(260) AM 2013 67458 A  
(800) 973801  
(151) 2008 05 21  
(181) 2018 05 21  
(511) 29

---

(260) AM 2013 67459 A  
(800) 1078011  
(151) 2011 01 26  
(181) 2021 01 26  
(511) 01, 04

---

(260) AM 2013 67473 A  
(800) 1114761  
(151) 2011 07 18  
(181) 2021 07 18  
(511) 09

---

(260) AM 2013 67491 A  
(800) 1114878  
(151) 2011 12 30  
(181) 2021 12 30  
(511) 16, 31, 44

---

(260) AM 2013 67493 A  
(800) 1114920  
(151) 2012 03 30  
(181) 2022 03 30  
(511) 30

---

(260) AM 2013 67515 A  
(800) 1115319  
(151) 2012 04 12  
(181) 2022 04 12  
(511) 34

---

(260) AM 2013 67516 A  
(800) 1027696  
(151) 2009 11 16  
(181) 2019 11 16  
(511) 25

---

(260) AM 2013 67517 A  
(800) 1027794  
(151) 2009 12 22  
(181) 2019 12 22  
(511) 12

---

(260) AM 2013 67518 A  
(800) 1057209  
(151) 2010 10 15  
(181) 2020 10 15  
(511) 14, 18, 25

---

(260) AM 2013 67519 A  
(800) 1060515  
(151) 2010 11 03  
(181) 2020 11 03  
(511) 25

---

(260) AM 2013 67520 A  
(800) 1065979  
(151) 2010 11 17  
(181) 2020 11 17  
(511) 03

---

(260) AM 2013 67521 A  
(800) 1074035  
(151) 2010 12 20  
(181) 2020 12 20  
(511) 19

---

(260) AM 2013 67524 A  
(800) 1085648  
(151) 2011 06 01  
(181) 2021 06 01  
(511) 05

---

(260) AM 2013 67525 A  
(800) 1096774  
(151) 2011 10 13  
(181) 2021 10 13  
(511) 34

---

(260) AM 2013 67526 A  
(800) 1097355  
(151) 2011 10 31  
(181) 2021 10 31  
(511) 05

---

(260) AM 2013 67530 A  
(800) 1097356  
(151) 2011 10 31  
(181) 2021 10 31  
(511) 05

---

(260) AM 2013 67531 A  
(800) 1100292  
(151) 2011 09 27  
(181) 2021 09 27  
(511) 03

---

(260) AM 2013 67532 A  
(800) 1110048  
(151) 2011 11 04  
(181) 2021 11 04  
(511) 35

---

(260) AM 2013 67533 A  
(800) 581187  
(151) 2011 12 24  
(181) 2021 12 24  
(511) 30

---

(260) AM 2013 67534 A  
(800) 699045A  
(151) 2008 07 23  
(181) 2018 07 23  
(511) 10

---

(260) AM 2013 67536 A  
(800) 705950  
(151) 2008 11 30  
(181) 2018 11 30  
(511) 05

---

(260) AM 2013 67541 A  
(800) 850634  
(151) 2005 02 23  
(181) 2015 02 23  
(511) 16

---

(260) AM 2013 67542 A  
(800) 862947  
(151) 2004 12 28  
(181) 2014 12 28  
(511) 03, 05, 10

---

(260) AM 2013 67543 A  
(800) 886725  
(151) 2006 05 12  
(181) 2016 05 12  
(511) 14

---

(260) AM 2013 67544 A  
(800) 887867  
(151) 2006 06 14  
(181) 2016 06 14  
(511) 14

---

(260) AM 2013 67545 A  
(800) 907873  
(151) 2006 10 18  
(181) 2016 10 18  
(511) 05, 31, 35

---

(260) AM 2013 67546 A  
(800) 955564  
(151) 2008 02 01  
(181) 2018 02 01  
(511) 05

---

(260) AM 2013 67547 A  
(800) 970448  
(151) 2008 07 03  
(181) 2018 07 03  
(511) 02

---

(260) AM 2013 67552 A  
(800) 1115360  
(151) 2011 12 06  
(181) 2021 12 06  
(511) 05, 29, 30

---

(260) AM 2013 67553 A  
(800) 1115364  
(151) 2012 01 30  
(181) 2022 01 30  
(511) 09, 16, 35, 38, 41, 45

---

(260) AM 2013 67554 A  
(800) 1115369  
(151) 2012 02 10  
(181) 2022 02 10  
(511) 41

---

(260) AM 2013 67555 A  
(800) 1115386  
(151) 2012 03 23  
(181) 2022 03 23  
(511) 04

---

(260) AM 2013 67570 A  
(800) 1115418  
(151) 2012 02 21  
(181) 2022 02 21  
(511) 07, 12

---

(260) AM 2013 67571 A  
(800) 1115432  
(151) 2011 10 27  
(181) 2021 10 27  
(511) 30, 32, 43

---

(260) AM 2013 67572 A  
(800) 1115435  
(151) 2011 10 21  
(181) 2021 10 21  
(511) 01, 03, 19, 35, 36, 37, 38, 39, 40, 41, 42, 43

---

(260) AM 2013 67573 A  
(800) 1115438  
(151) 2012 01 19  
(181) 2022 01 19  
(511) 09

---

(260) AM 2013 67574 A  
(800) 1115439  
(151) 2012 01 31  
(181) 2022 01 31  
(511) 25

---

(260) AM 2013 67575 A  
(800) 1115457  
(151) 2012 02 21  
(181) 2022 02 21  
(511) 09, 37, 41, 42

---

(260) AM 2013 67576 A  
(800) 1115474  
(151) 2012 03 14  
(181) 2022 03 14  
(511) 07

---

(260) AM 2013 67577 A  
(800) 1115513  
(151) 2012 01 26  
(181) 2022 01 26  
(511) 09, 16, 38, 42, 45

---

(260) AM 2013 67620 A  
(800) 1115718  
(151) 2012 04 24  
(181) 2022 04 24  
(511) 03, 25, 35

---

(260) AM 2013 67621 A  
(800) 1115761  
(151) 2011 04 04  
(181) 2021 04 04  
(511) 29, 30, 35

---

(260) AM 2013 67622 A  
 (800) 1115767  
 (151) 2012 03 16  
 (181) 2022 03 16  
 (511) 30

---

(260) AM 2013 67715 A  
 (800) 1116938  
 (151) 2012 03 12  
 (181) 2022 03 12  
 (511) 05, 16

---

(260) AM 2013 67623 A  
 (800) 1115791  
 (151) 2012 01 05  
 (181) 2022 01 05  
 (511) 35, 42

---

(260) AM 2013 67716 A  
 (800) 1116949  
 (151) 2012 04 04  
 (181) 2022 04 04  
 (511) 05

---

(260) AM 2013 67625 A  
 (800) 1115869  
 (151) 2012 04 06  
 (181) 2022 04 06  
 (511) 03

---

(260) AM 2013 67717 A  
 (800) 1116959  
 (151) 2012 04 05  
 (181) 2022 04 05  
 (511) 12

---

(260) AM 2013 67627 A  
 (800) 1115887  
 (151) 2012 04 27  
 (181) 2022 04 27  
 (511) 25, 38, 41

---

(260) AM 2013 67718 A  
 (800) 1116964  
 (151) 2012 03 28  
 (181) 2022 03 28  
 (511) 35, 38, 42, 45

---

(260) AM 2013 67632 A  
 (800) 1116022  
 (151) 2012 01 19  
 (181) 2022 01 19  
 (511) 07, 11, 37

---

(260) AM 2013 67719 A  
 (800) 1116976  
 (151) 2012 03 28  
 (181) 2022 03 28  
 (511) 33

---

(260) AM 2013 67635 A  
 (800) 1116068  
 (151) 2011 04 27  
 (181) 2021 04 27  
 (511) 01, 02, 03, 05, 07, 09, 11, 12, 14, 32, 35, 36,  
 37, 38, 41, 42, 43

---

(260) AM 2013 67720 A  
 (800) 1116977  
 (151) 2012 03 28  
 (181) 2022 03 28  
 (511) 33

---

(260) AM 2013 67641 A  
 (800) 1116126  
 (151) 2012 03 23  
 (181) 2022 03 23  
 (511) 05

---

(260) AM 2013 67721 A  
 (800) 1116995  
 (151) 2012 01 31  
 (181) 2022 01 31  
 (511) 05

---

(260) AM 2013 67714 A  
 (800) 1116935  
 (151) 2011 12 22  
 (181) 2021 12 22  
 (511) 09, 35, 36, 41

---

(260) AM 2013 67724 A  
 (800) 1117006  
 (151) 2012 02 07  
 (181) 2022 02 07  
 (511) 09, 14, 18

---

(260) AM 2013 67725 A  
(800) 1117020  
(151) 2012 03 15  
(181) 2022 03 15  
(511) 05

---

(260) AM 2013 67726 A  
(800) 1117031  
(151) 2012 04 04  
(181) 2022 04 04  
(511) 05

---

(260) AM 2013 67727 A  
(800) 1117039  
(151) 2012 03 19  
(181) 2022 03 19  
(511) 05

---

(260) AM 2013 67729 A  
(800) 1117040  
(151) 2012 03 19  
(181) 2022 03 19  
(511) 05

---

(260) AM 2013 67730 A  
(800) 1117041  
(151) 2012 03 19  
(181) 2022 03 19  
(511) 05

---

(260) AM 2013 67731 A  
(800) 1117042  
(151) 2012 03 19  
(181) 2022 03 19  
(511) 05

---

(260) AM 2013 67732 A  
(800) 1117043  
(151) 2012 03 19  
(181) 2022 03 19  
(511) 05

---

(260) AM 2013 67733 A  
(800) 1117044  
(151) 2012 03 19  
(181) 2022 03 19  
(511) 05

---

(260) AM 2013 67734 A  
(800) 1117045  
(151) 2012 03 19  
(181) 2022 03 19  
(511) 05

---

(260) AM 2013 67735 A  
(800) 1117046  
(151) 2012 03 19  
(181) 2022 03 19  
(511) 05

---

(260) AM 2013 67736 A  
(800) 1117047  
(151) 2012 03 19  
(181) 2022 03 19  
(511) 05

---

(260) AM 2013 67737 A  
(800) 1117048  
(151) 2012 03 19  
(181) 2022 03 19  
(511) 05

---

(260) AM 2013 67738 A  
(800) 1117050  
(151) 2012 03 19  
(181) 2022 03 19  
(511) 05

---

(260) AM 2013 67741 A  
(800) 1117091  
(151) 2012 03 13  
(181) 2022 03 13  
(511) 09, 35, 36, 38, 41, 42

---

(260) AM 2013 67809 A  
(800) 1116428  
(151) 2012 02 10  
(181) 2022 02 10  
(511) 41

---

(260) AM 2013 67810 A  
(800) 1116430  
(151) 2012 01 10  
(181) 2022 01 10  
(511) 05

---

(260) AM 2013 67811 A  
(800) 1116481  
(151) 2012 04 11  
(181) 2022 04 11  
(511) 21

---

(260) AM 2013 67835 A  
(800) 1116669  
(151) 2012 04 17  
(181) 2022 04 17  
(511) 09

---

(260) AM 2013 67812 A  
(800) 1116501  
(151) 2012 03 12  
(181) 2022 03 12  
(511) 21, 35

---

(260) AM 2013 67836 A  
(800) 1116676  
(151) 2012 03 21  
(181) 2022 03 21  
(511) 32

---

(260) AM 2013 67813 A  
(800) 1116509  
(151) 2012 04 27  
(181) 2022 04 27  
(511) 09, 38, 42

---

(260) AM 2013 67827 A  
(800) 1116515  
(151) 2012 04 24  
(181) 2022 04 24  
(511) 03, 05

---

(260) AM 2013 67828 A  
(800) 1116524  
(151) 2012 03 29  
(181) 2022 03 29  
(511) 11, 35

---

(260) AM 2013 67829 A  
(800) 1116527  
(151) 2012 03 22  
(181) 2022 03 22  
(511) 34

---

(260) AM 2013 67830 A  
(800) 1116533  
(151) 2012 04 12  
(181) 2022 04 12  
(511) 10, 12, 18, 20

---

(260) AM 2013 67833 A  
(800) 1116641  
(151) 2012 01 19  
(181) 2022 01 19  
(511) 39, 41

---

---

# OFFICIAL NOTIFICATIONS

## INVENTIONS

TRANSFER OF RIGHTS  
(III and IV quarters, 2012)

Patent No.	Former Patent Owner (Assignor)	New Patent Owner (Assignee)	Date of Transfer
5333/1	Rinat Neuroscience Korp. 230 East Grand Ave., South San Francisco, California 94080, US	Labrys Biologics, Inc. 1700 Owens Str., Suite 595, San Francisco, California 94158, US	6/5/2013
5181/1	Zaur Kacharava Gldanis Mas., VIII mkr., korp. 12, b. 141, 0107 Tbilisi, GE; Irakli Kacharava Gldanis Mas., VIII mkr., korp. 12, b. 141, 0107 Tbilisi, GE	Zaur Kacharava Gldanis Mas., VIII mkr., korp. 12, b. 141, 0107 Tbilisi, GE; Irakli Kacharava Gldanis Mas., VIII mkr., korp. 12, b. 141, 0107 Tbilisi, GE; Vakhtang Simonia Saakadzis q. 84, 0180 Tbilisi, GE	6/12/2013
5377/1	Erna Lekveishvili D. Uznadzis q. 4, b. 46, 0102 Tbilisi, GE; Vladimir Tsitsishvili D. Uznadzis q. 2, b. 14, 0102 Tbilisi, GE; Nugzar Jogleadze Miminoshvilis q. 6, 0108 Tbilisi, GE	LTD "Laboratory Kolkhika" Sanapiros q. 10, 0105 Tbilisi, GE	7/18/2013



## PATENT REINSTATEMENT INVENTIONS

**(11) P 2009 4659 B**

(73) Avtandil Balanchivadze (GE)

**(54) SHEETING-DOUGH MACHINE**

Date of Patent Reinstatement: 2013 08 12

---

**(11) P 2006 3912 B**

(73) Darejan Gvelesiani (GE)

**(54) METHOD "Gvelesiani" FOR OBTAINING GRAFTED SAPLINGS OF THE GRAPEVINE**

Date of Patent Reinstatement: 2013 08 12

---

**(11) P 2003 3064 B**

(73) Ermile Tortladze (GE)

**(54) PROCESS AND SYSTEM FOR PARTICIPATION IN A LOTTO TYPE GAME USING  
COMMUNICATION SYSTEM**

Date of Patent Reinstatement: 2013 08 12

---

**(11) P 2003 3060 B**

(73) Davit Gzirishvili (GE);  
Teimuraz Dadiani (GE);  
Tengiz Kukava (GE)

**(54) SOUND CUP**

Date of Patent Reinstatement: 2013 08 12

---

## UTILITY MODELS

**(11) U 2012 1734 Y**

(73) Roin Mosashvili (GE)

**(54) BACKGAMMON BOARD**

Date of Patent Reinstatement: 2013 08 12

---

**(11) U 2012 1750 Y**

(73) Robinzon Khetaguri (GE)

**(54) METHOD FOR LEAD-FLOAT BABBITT PRODUCTION**

Date of Patent Reinstatement: 2013 08 12

---

## REGISTERED LISENCE AGREEMENTS

(11) D 2012 510 S

(54) **CAKE PACKAGE**

(73) Licensor: Zakritoe aqtsionernoe obshchestvo "EXPERIMENTAL CONFECTIONERY ASSOCIATION  
"VOLOGDA" (RU)

Vologodskaia oblast, q. vologda, ul. promishlenaia 12, 160012 (RU)

Licensee: Zakritoe aqtsionernoe obshchestvo "RUSKIY BISKWIT" (RU)

Vologodskaia oblast, g. Cherepovez, ul. Karla Marksa 25, 162622 (RU)

License Agreement Register No: 114 NE

Date: 2013 06 12

License Agreement Duration: from 2013 06 12 to duration expiration

License Form: private no exclusive

---

(11) D 2012 524 S

(54) **CONFECTIONERY PACKAGE**

(73) Licensor: Zakritoe aqtsionernoe obshchestvo "EXPERIMENTAL CONFECTIONERY ASSOCIATION  
"VOLOGDA" (RU)

Vologodskaia oblast, q. vologda, ul. promishlenaia 12, 160012 (RU)

Licensee: Zakritoe aqtsionernoe obshchestvo "RUSKIY BISKWIT" (RU)

Vologodskaia oblast, g. Cherepovez, ul. Karla Marksa 25, 162622 (RU)

License Agreement Register No: 115 NE

Date: 2013 06 12

License Agreement Duration: from 2013 06 12 to duration expiration

License Form: private no exclusive

---

---

# OFFICIAL NOTIFICATIONS

## TRADEMARKS

### RENEWAL OF REGISTRATIONS

(111) M 2003 14911 R1  
(156) 2013 07 24  
(186) 2023 01 30  
(732) LTD "Nina Ananiashvili & Wine Art"  
Sof. Tsinandali, 2217, Telavi, Georgia

---

(111) M 2003 14914 R1  
(156) 2013 07 24  
(186) 2023 01 30  
(732) LTD "Nina Ananiashvili & Wine Art"  
Sof. Tsinandali, 2217, Telavi, Georgia

---

(111) M 2003 14915 R1  
(156) 2013 07 24  
(186) 2023 01 30  
(732) LTD "Nina Ananiashvili & Wine Art"  
Sof. Tsinandali, 2217, Telavi, Georgia

---

(111) M 2003 14917 R1  
(156) 2013 07 24  
(186) 2023 01 30  
(732) LTD "Nina Ananiashvili & Wine Art"  
Sof. Tsinandali, 2217, Telavi, Georgia

---

(111) M 2003 15067 R1  
(156) 2013 07 11  
(186) 2023 03 28  
(732) Joint-Stock Company "Lomisi"  
Sanapiros q.1, 0600, Daba Akhlagori, Georgia

---

(111) M 2003 15068 R1  
(156) 2013 07 11  
(186) 2023 03 28  
(732) Joint-Stock Company "Lomisi"  
Sanapiros q.1, 0600, Daba Akhlagori, Georgia

---

(111) M 2003 15069 R1  
(156) 2013 07 11  
(186) 2023 03 28  
(732) Joint-Stock Company "Lomisi"  
Sanapiros q.1, 0600, Daba Akhlagori, Georgia

---

(111) M 2003 15264 R1  
(156) 2013 09 29  
(186) 2023 09 29  
(732) Walton International Limited  
P.O. Box 1586, George Town, Grand Cayman  
KY1-1110, Cayman Islands

---

(111) M 2003 15278 R1  
(156) 2013 10 15  
(186) 2023 10 15  
(732) Nintendo Co., Ltd  
11-1, Hokotate-cho, Kamitoba, Minami-ku,  
Kyoto-shi, Kyoto, Japan

---

## CHANGES IN NAMES AND/OR ADDRESSES OF OWNERS

(111) M 1995 001026 R1  
 (732) Glaxo Grroup Limited  
 980 Great West Road, Brentford, Middlesex  
 TW8 9GS, United Kingdom  
 (770) Glaxo Group Limited  
 Glaxo Wellcome House, Berkeley Avenue,  
 Greenford, Middlesex UB6 0NN, United  
 Kingdom  
 (580) 2013 07 29

(111) M 1999 012081 R1  
 (732) Glaxo Grroup Limited  
 980 Great West Road, Brentford, Middlesex  
 TW8 9GS, United Kingdom  
 (770) Glaxo Group Limited  
 Glaxo Wellcome House, Berkeley Avenue,  
 Greenford, Middlesex UB6 0NN, United  
 Kingdom  
 (580) 2013 07 29

(111) M 1995 001027 R1  
 (732) Glaxo Grroup Limited  
 980 Great West Road, Brentford, Middlesex  
 TW8 9GS, United Kingdom  
 (770) Glaxo Group Limited  
 Glaxo Wellcome House, Berkeley Avenue,  
 Greenford, Middlesex UB6 0NN, United  
 Kingdom  
 (580) 2013 07 29

(111) M 1999 012085 R1  
 (732) Glaxo Grroup Limited  
 980 Great West Road, Brentford, Middlesex  
 TW8 9GS, United Kingdom  
 (770) Glaxo Group Limited  
 Glaxo Wellcome House, Berkeley Avenue,  
 Greenford, Middlesex UB6 0NN, United  
 Kingdom  
 (580) 2013 07 29

(111) M 1995 001028 R1  
 (732) Glaxo Grroup Limited  
 980 Great West Road, Brentford, Middlesex  
 TW8 9GS, United Kingdom  
 (770) Glaxo Group Limited  
 Glaxo Wellcome House, Berkeley Avenue,  
 Greenford, Middlesex UB6 0NN, United  
 Kingdom  
 (580) 2013 07 29

(111) M 1999 012086 R1  
 (732) Glaxo Grroup Limited  
 980 Great West Road, Brentford, Middlesex  
 TW8 9GS, United Kingdom  
 (770) Glaxo Group Limited  
 Glaxo Wellcome House, Berkeley Avenue,  
 Greenford, Middlesex UB6 0NN, United  
 Kingdom  
 (580) 2013 07 29

(111) M 1995 001033 R1  
 (732) Glaxo Grroup Limited  
 980 Great West Road, Brentford, Middlesex  
 TW8 9GS, United Kingdom  
 (770) Glaxo Group Limited  
 Glaxo Wellcome House, Berkeley Avenue,  
 Greenford, Middlesex UB6 0NN, United  
 Kingdom  
 (580) 2013 07 29

(111) M 2003 014911 R1  
 (732) LTD "Nina Ananiashvili & Wine Art"  
 Sof. Tsinandali, 2217, Telavi, Georgia  
 (770) LTD "Gv & Dzm"  
 Sof. Tsinandali, 383333 , Telavi, Georgia  
 (580) 2013 08 01

(111) M 1999 012077 R1  
 (732) Glaxo Grroup Limited  
 980 Great West Road, Brentford, Middlesex  
 TW8 9GS, United Kingdom  
 (770) Glaxo Group Limited  
 Glaxo Wellcome House, Berkeley Avenue,  
 Greenford, Middlesex UB6 0NN, United  
 Kingdom  
 (580) 2013 07 29

(111) M 2003 014914 R1  
 (732) LTD "Nina Ananiashvili & Wine Art"  
 Sof. Tsinandali, 2217, Telavi, Georgia  
 (770) LTD "Gv & Dzm"  
 Sof. Tsinandali, 383333 , Telavi, Georgia  
 (580) 2013 08 01

(111) M 2003 014915 R1  
 (732) LTD "Nina Ananiashvili & Wine Art"  
 Sof. Tsinandali, 2217, Telavi, Georgia  
 (770) LTD "Gv & Dzm"  
 Sof. Tsinandali, 383333 , Telavi, Georgia

(580) 2013 08 01

---

(111) M 2003 014917 R1  
 (732) LTD "Nina Ananiashvili & Wine Art"  
 Sof. Tsinandali, 2217, Telavi, Georgia  
 (770) LTD "Gv & Dzm"  
 Sof. Tsinandali, 383333, Telavi, Georgia  
 (580) 2013 08 01

---

(111) M 2003 015264 R1  
 (732) Walton International Limited  
 P.O. Box 1586, George Town, Grand Cayman  
 KY1-1110, Cayman Islands  
 (770) Walton International Limited  
 P.O. Box 1586, Royal Bank Building,  
 Cardinal Avenue, George Town, Grand  
 Cayman, Cayman Islands  
 (580) 2013 08 02

---

(111) M 1996 004082 R1  
 (732) Glaxo Grroup Limited  
 980 Great West Road, Brentford, Middlesex  
 TW8 9GS, United Kingdom  
 (770) Glaxo Group Limited  
 Glaxo Wellcome House, Berkeley Avenue,  
 Greenford, Middlesex UB6 0NN, United  
 Kingdom  
 (580) 2013 07 29

---

(111) M 1997 004446 R1  
 (732) Glaxo Grroup Limited  
 980 Great West Road, Brentford, Middlesex  
 TW8 9GS, United Kingdom  
 (770) Glaxo Group Limited  
 Glaxo Wellcome House, Berkeley Avenue,  
 Greenford, Middlesex UB6 0NN, United  
 Kingdom  
 (580) 2013 07 29

---

(111) M 1997 004448 R1  
 (732) Glaxo Grroup Limited  
 980 Great West Road, Brentford, Middlesex  
 TW8 9GS, United Kingdom  
 (770) Glaxo Group Limited  
 Glaxo Wellcome House, Berkeley Avenue,  
 Greenford, Middlesex UB6 0NN, United  
 Kingdom  
 (580) 2013 07 29

---

(111) M 1997 004449 R1  
 (732) Glaxo Grroup Limited  
 980 Great West Road, Brentford, Middlesex  
 TW8 9GS, United Kingdom  
 (770) Glaxo Group Limited  
 Glaxo Wellcome House, Berkeley Avenue,  
 Greenford, Middlesex UB6 0NN, United  
 Kingdom  
 (580) 2013 07 29

---

(111) M 1997 004450 R1  
 (732) Glaxo Grroup Limited  
 980 Great West Road, Brentford, Middlesex  
 TW8 9GS, United Kingdom  
 (770) Glaxo Group Limited  
 Glaxo Wellcome House, Berkeley Avenue,  
 Greenford, Middlesex UB6 0NN, United  
 Kingdom  
 (580) 2013 07 29

---

(111) M 1997 004451 R1  
 (732) Glaxo Grroup Limited  
 980 Great West Road, Brentford, Middlesex  
 TW8 9GS, United Kingdom  
 (770) Glaxo Group Limited  
 Glaxo Wellcome House, Berkeley Avenue,  
 Greenford, Middlesex UB6 0NN, United  
 Kingdom  
 (580) 2013 07 29

---

(111) M 1997 004452 R1  
 (732) Glaxo Grroup Limited  
 980 Great West Road, Brentford, Middlesex  
 TW8 9GS, United Kingdom  
 (770) Glaxo Group Limited  
 Glaxo Wellcome House, Berkeley Avenue,  
 Greenford, Middlesex UB6 0NN, United  
 Kingdom  
 (580) 2013 07 29

---

(111) M 1997 005481 R1  
 (732) Glaxo Grroup Limited  
 980 Great West Road, Brentford, Middlesex  
 TW8 9GS, United Kingdom  
 (770) Glaxo Group Limited  
 Glaxo Wellcome House, Berkeley Avenue,  
 Greenford, Middlesex UB6 0NN, United  
 Kingdom  
 (580) 2013 07 29

---

(111) M 1995 000646 R1  
(732) Glaxo Grroup Limited  
980 Great West Road, Brentford, Middlesex  
TW8 9GS, United Kingdom  
(770) Glaxo Group Limited  
Glaxo Wellcome House, Berkeley Avenue,  
Greenford, Middlesex UB6 0NN, United  
Kingdom  
(580) 2013 07 29

---

(111) M 1995 000648 R1  
(732) Glaxo Grroup Limited  
980 Great West Road, Brentford, Middlesex  
TW8 9GS, United Kingdom  
(770) Glaxo Group Limited  
Glaxo Wellcome House, Berkeley Avenue,  
Greenford, Middlesex UB6 0NN, United  
Kingdom  
(580) 2013 07 29

---

(111) M 1997 006491 R1  
(732) Glaxo Grroup Limited  
980 Great West Road, Brentford, Middlesex  
TW8 9GS, United Kingdom  
(770) Glaxo Group Limited  
Glaxo Wellcome House, Berkeley Avenue,  
Greenford, Middlesex UB6 0NN, United  
Kingdom  
(580) 2013 07 29

---

(111) M 1997 006493 R1  
(732) Glaxo Grroup Limited  
980 Great West Road, Brentford, Middlesex  
TW8 9GS, United Kingdom  
(770) GLAXO GROUP LIMITED  
Berkeley Avenue, Greenford, Middlesex  
WB6 0NN, United Kingdom  
(580) 2013 08 01

---

(111) M 1997 007309 R1  
(732) Glaxo Grroup Limited  
980 Great West Road, Brentford, Middlesex  
TW8 9GS, United Kingdom  
(770) Glaxo Group Limited  
Glaxo Wellcome House, Berkeley Avenue,  
Greenford, Middlesex UB6 0NN, United  
Kingdom  
(580) 2013 07 29

---

(111) M 1997 007854 R1  
(732) Glaxo Grroup Limited  
980 Great West Road, Brentford, Middlesex  
TW8 9GS, United Kingdom

(770) Glaxo Group Limited,  
Glaxo Wellcome House, Berkeley Avenue,  
Greenford, Middlesex UB6 0NN, United  
Kingdom  
(580) 2013 07 29

---

(111) M 1997 007856 R1  
(732) Glaxo Grroup Limited  
980 Great West Road, Brentford, Middlesex  
TW8 9GS, United Kingdom  
(770) Glaxo Group Limited  
Glaxo Wellcome House, Berkeley Avenue,  
Greenford, Middlesex UB6 0NN, United  
Kingdom  
(580) 2013 07 29

---

(111) M 1997 007857 R1  
(732) Glaxo Grroup Limited  
980 Great West Road, Brentford, Middlesex  
TW8 9GS, United Kingdom  
(770) Glaxo Group Limited  
Glaxo Wellcome House, Berkeley Avenue,  
Greenford, Middlesex UB6 0NN, United  
Kingdom  
(580) 2013 07 29

---

(111) M 1997 007858 R1  
(732) Glaxo Grroup Limited  
980 Great West Road, Brentford, Middlesex  
TW8 9GS, United Kingdom  
(770) Glaxo Group Limited  
Glaxo Wellcome House, Berkeley Avenue,  
Greenford, Middlesex UB6 0NN, United  
Kingdom  
(580) 2013 07 29

---

(111) M 1997 007859 R1  
(732) Glaxo Grroup Limited  
980 Great West Road, Brentford, Middlesex  
TW8 9GS, United Kingdom  
(770) Glaxo Group Limited  
Glaxo Wellcome House, Berkeley Avenue,  
Greenford, Middlesex UB6 0NN, United  
Kingdom  
(580) 2013 07 29

---

(111) M 1997 007860 R1  
(732) Glaxo Grroup Limited  
980 Great West Road, Brentford, Middlesex  
TW8 9GS, United Kingdom  
(770) Glaxo Group Limited  
Glaxo Wellcome House, Berkeley Avenue,  
Greenford, Middlesex UB6 0NN, United  
Kingdom

(580) 2013 07 29

---

(111) M 1997 007862 R1  
(732) Glaxo Grroup Limited  
980 Great West Road, Brentford,  
Middlesex TW8 9GS, United Kingdom  
(770) Glaxo Group Limited  
Glaxo Wellcome House, Berkeley Avenue,  
Greenford, Middlesex UB6 0NN, United  
Kingdom  
(580) 2013 07 29

---

(111) M 1995 000942 R1  
(732) Glaxo Group Limited  
Glaxo Wellcome House, Berkeley Avenue,  
Greenford, Middlesex UB6 0NN,  
United Kingdom  
(770) GLAXO GROUP LIMITED  
GLAXO HAUSE, Berkeley Avenue,  
Greenford, Middlesex UB6 0NN, United  
Kingdom  
(580) 20130731

---

(111) M 1995 000942 R1  
(732) Glaxo Grroup Limited  
980 Great West Road, Brentford, Middlesex  
TW8 9GS, United Kingdom  
(770) Glaxo Group Limited  
Glaxo Wellcome House, Berkeley Avenue,  
Greenford, Middlesex UB6 0NN, United  
Kingdom  
(580) 2013 0731

---

(111) M 1995 000944 R1  
(732) Glaxo Grroup Limited  
980 Great West Road, Brentford, Middlesex  
TW8 9GS, United Kingdom  
(770) Glaxo Group Limited  
Glaxo Wellcome House, Berkeley Avenue,  
Greenford, Middlesex UB6 0NN, United  
Kingdom  
(580) 2013 07 29

---

### List of Patent Attorneys Registered

as a result of the certification of patent attorneys conducted in accordance with the "Statute on Patent Attorneys of Georgia" approved by Order №1 of the Chairman of LEPL National Intellectual Property Center of Georgia "Sakpatenti" of January 12, 2011

<b>Certification No.</b>	<b>Name, last Name</b>	<b>Registration No.</b>	<b>Registration Date</b>
001	Levan Nanobashvili	040	13.06.2011
002	Vakhtang Torotadze	023	13.06.2011
003	David Lanchava	041	13.06.2011
004	Merab Kvimsadze	042	13.06.2011
005	George Batlidze	043	13.06.2011
006	George Kartvelishvili	044	13.06.2011
007	Archil Lezhava	045	13.06.2011
008	Levan Nikoladze	046	13.06.2011
009	Sopio Mujiri	047	13.06.2011
010	George Taktakishvili	035	13.06.2011
011	Nikoloz Gogilidze	048	13.06.2011
012	Teona Kakhidze	049	25.04.2012
013	Khatuna Imnadze	008	25.04.2012
014	Nino Bakhtadze	028	25.04.2012
015	Shota Metreveli	050	25.04.2012
016	Natalia Babikashvili	051	25.04.2012
017	Zurab Lomsadze	052	25.04.2012
018	Ekaterine Nemsadze	053	25.04.2012
019	Irine Pilauri	054	25.04.2012
020	Nino Mgaloblishvili	055	25.04.2012
021	Irma Kavtaradze	056	25.04.2012
022	Tamar Kochlamazashvili	031	25.04.2012
023	Givi Akopashvili	012	25.04.2012
024	George Meipariani	018	25.04.2012
025	Pavle Meipariani	034	25.04.2012
026	Shalva Gvaramadze	001	25.04.2012
027	David Dzamukashvili	057	25.04.2012
028	Dimitri Dzamukashvili	030	25.04.2012
029	Irakli Gvilia	058	25.07.2013
030	Miranda Gurgenidze	059	25.07.2013
031	Nino Eloshvili	060	25.07.2013
032	Zaal Varsimashvili	061	25.07.2013
033	Alexander Kvernadze	038	25.07.2013
034	Merab Kutsia	062	25.07.2013
035	Tamar Machavariani	063	25.07.2013
036	Tamar Surmava	064	25.07.2013
037	Tamaz Urtmelidze	065	25.07.2013
038	Sopio Panjikidze	066	25.07.2013



039	Nugzar Ksovreli	025	25.07.2013
040	George Ghvinjilia	029	25.07.2013
041	Tina Chalauri	013	25.07.2013
042	Ketevan Tsakadze	067	25.07.2013
043	Tamar Kharazishvili	068	25.07.2013

In accordance with Order №1 of the Chairman of LEPL National Intellectual Property Center of Georgia "Sakpatenti" of January 12, 2011 on the approval of the "Statute on Patent Attorneys of Georgia", patent attorneys registered on the basis of the statute "On Patent Attorneys of Georgia" approved by Decree of the President of Georgia № 223 of May 8, 2002 are entitled to pass certification in accordance with the rule established by the "Statute on Patent Attorneys of Georgia" before January 1, 2015.

---

# CLASSIFICATION INDEXES

## INVENTIONS

### CONCORDANCE TABLE OF INTERNATIONAL CLASSIFICATION INDEX AND PUBLICATION NUMBERS

INTERNATIONAL CLASSIFICATION INDEXES (51)	NUMBER OF PUBLISHED APPLICATION (10)
A 01 G 13/02	AP 2013 12814 A
B 42 D 15/00; B 42 D 15/10; G 06 K 7/10; G 07 D 7/12; B 41 M 5/00; B 41 M 7/00; G 06 Q 10/00	AP 2013 11983 A
B 63 G 8/00; F 42 B 17/00; F 42 B 19/00	AP 2013 11805 A
B 65 D 43/02; B 44 D 3/12	AP 2013 12780 A
C 07 B 59/00	AP 2013 12825 A
C 07 C 31/08; C 07 C 29/76	AP 2013 12464 A
F 03 D 3/06	AP 2013 12229 A
F 42 B 5/02	AP 2013 12534 A
G 07 D 7/20; G 06 Q 10/00; G 06 K 9/64	AP 2013 11975 A
H 02 K 33/14	AP 2013 12540 A
H 05 H 1/00	AP 2013 11978 A

### CONCORDANCE TABLE OF APPLICATION APPLICATION PUBLICATION NUMBERS AND INTERNATIONAL CLASSIFICATION INDEXES

NUMBER OF PUBLISHED APPLICATION (10)	INTERNATIONAL CLASSIFICATION INDEXES (51)
AP 2013 11805 A	B 63 G 8/00; F 42 B 17/00; F 42 B 19/00
AP 2013 11975 A	G 07 D 7/20; G 06 Q 10/00; G 06 K 9/64
AP 2013 11978 A	H 05 H 1/00
AP 2013 11983 A	B 42 D 15/00; B 42 D 15/10; G 06 K 7/10; G 07 D 7/12; B 41 M 5/00; B 41 M 7/00; G 06 Q 10/00
AP 2013 12229 A	F 03 D 3/06
AP 2013 12464 A	C 07 C 31/08; C 07 C 29/76
AP 2013 12534 A	F 42 B 5/02
AP 2013 12540 A	H 02 K 33/14
AP 2013 12780 A	B 65 D 43/02; B 44 D 3/12
AP 2013 12814 A	A 01 G 13/02
AP 2013 12825 A	C 07 B 59/00

**CONCORDANCE TABLE OF INTERNATIONAL CLASSIFICATION INDEXES,  
PATENT NUMBERS AND PUBLICATION NUMBERS**

INTERNATIONAL CLASSIFICATION INDEX (51)	NUMBER OF PATENT (11)	NUMBER OF PUBLISHED APPLICATION (10)
A 61 K 31/01; A 61 K 31/047; A 61 P 17/02; A 61 P 17/06; A 61 K 8/30; A 61 K 8/92	P 2013 5900 B	AP 2013 12036 A
A 61 K 35/14; A 61 P 3/10; A 61 P 25/02	P 2013 5901 B	AP 2013 12208 A
A 61 M 5/32	P 2013 5902 B	AP 2013 12238 A
A 61 M 5/178	P 2013 5908 B	AP 2013 12495 A
B 21 D 41/02; B 21 D 51/16	P 2013 5899 B	AP 2013 12009 A
C 07 C 231/18; C 07 C 233/58; C 07 C 237/20	P 2013 5903 B	AP 2013 12350 A
C 07 D 211/90; A 61 K 31/4422	P 2013 5897 B	AP 2013 12362 A
C 07 D 401/04; C 07 D 401/14; A 61 K 31/454; A 61 K 31/4545; A 61 P 3/10	P 2013 5907 B	AP 2013 12490 A
C 07 D 498/00	P 2013 5898 B	AP 2013 11948 A
C 22 C 38/00	P 2013 5906 B	AP 2013 12479 A
E 04 B 1/36; E 04 B 1/98; E 04 H 9/02	P 2013 5904 B	AP 2013 12367 A
F 02 C 7/055	P 2013 5896 B	AP 2013 11864 A
F 03 D 1/02	P 2013 5905 B	AP 2013 12422 A
F 16 H 3/00	P 2013 5910 B	AP 2013 12585 A
H 02 N 11/00	P 2013 5909 B	AP 2013 12508 A

**CONCORDANCE TABLE OF PATENT NUMBERS,  
PUBLICATION NUMBERS AND INTERNATIONAL CLASSIFICATION INDEXES**

NUMBER OF PATENT (11)	NUMBER OF PUBLISHED APPLICATION (10)	INTERNATIONAL CLASSIFICATION INDEX (51)
P 2013 5896 B	AP 2013 11864 A	F 02 C 7/055
P 2013 5898 B	AP 2013 11948 A	C 07 D 498/00
P 2013 5899 B	AP 2013 12009 A	B 21 D 41/02; B 21 D 51/16
P 2013 5900 B	AP 2013 12036 A	A 61 K 31/01; A 61 K 31/047; A 61 P 17/02; A 61 P 17/06; A 61 K 8/30; A 61 K 8/92
P 2013 5901 B	AP 2013 12208 A	A 61 K 35/14; A 61 P 3/10; A 61 P 25/02
P 2013 5902 B	AP 2013 12238 A	A 61 M 5/32
P 2013 5903 B	AP 2013 12350 A	C 07 C 231/18; C 07 C 233/58; C 07 C 237/20
P 2013 5897 B	AP 2013 12362 A	C 07 D 211/90; A 61 K 31/4422
P 2013 5904 B	AP 2013 12367 A	E 04 B 1/36; E 04 B 1/98; E 04 H 9/02
P 2013 5905 B	AP 2013 12422 A	F 03 D 1/02
P 2013 5906 B	AP 2013 12479 A	C 22 C 38/00
P 2013 5907 B	AP 2013 12490 A	C 07 D 401/04; C 07 D 401/14; A 61 K 31/454; A 61 K 31/4545; A 61 P 3/10
P 2013 5908 B	AP 2013 12495 A	A 61 M 5/178
P 2013 5909 B	AP 2013 12508 A	H 02 N 11/00
P 2013 5910 B	AP 2013 12585 A	F 16 H 3/00

**CONCORDANCE TABLE OF APPLICATION NUMBERS, APPLICATION  
PUBLICATION NUMBERS AND PATENT NUMBERS**

NUMBER OF APPLICATION (21)	NUMBER OF PUBLISHED APPLICATION (10)	NUMBER OF PATENT (11)
AP 2009 011948	AP 2013 11948 A	P 2013 5898 B
AP 2009 012009	AP 2013 12009 A	P 2013 5899 B
AP 2009 012036	AP 2013 12036 A	P 2013 5900 B
AP 2009 012208	AP 2013 12208 A	P 2013 5901 B
AP 2009 012238	AP 2013 12238 A	P 2013 5902 B
AP 2009 012367	AP 2013 12367 A	P 2013 5904 B
AP 2010 011864	AP 2013 11864 A	P 2013 5896 B
AP 2010 012350	AP 2013 12350 A	P 2013 5903 B
AP 2010 012362	AP 2013 12362 A	P 2013 5897 B
AP 2010 012490	AP 2013 12490 A	P 2013 5907 B
AP 2010 012495	AP 2013 12495 A	P 2013 5908 B
AP 2011 012422	AP 2013 12422 A	P 2013 5905 B
AP 2011 012479	AP 2013 12479 A	P 2013 5906 B
AP 2011 012508	AP 2013 12508 A	P 2013 5909 B
AP 2012 012585	AP 2013 12585 A	P 2013 5910 B

**UTILITY MODELS**

**CONCORDANCE TABLE OF INTERNATIONAL CLASSIFICATION INDEXES  
AND PUBLICATION NUMBERS**

INTERNATIONAL CLASSIFICATION INDEXES (51)	NUMBER OF PUBLISHED APPLICATION (10)
A 23 K 1/16; A 23 K 1/175	AU 2013 12778 U
A 47 J 37/07	AU 2013 12980 U

**CONCORDANCE TABLE OF PUBLICATION NUMBERS  
AND INTERNATIONAL CLASSIFICATION INDEXES**

NUMBER OF PUBLISHED APPLICATION (10)	INTERNATIONAL CLASSIFICATION INDEXES (51)
AU 2013 12778 U	A 23 K 1/16; A 23 K 1/175
AU 2013 12980 U	A 47 J 37/07

**DESIGNS****CONCORDANCE TABLE OF INTERNATIONAL CLASSIFICATION INDEXES  
AND PUBLICATION NUMBERS**

INTERNATIONAL CLASSIFICATION INDEX (51)	NUMBER OF PUBLISHED APPLICATION (10)
07-01	AD 2013 753 S
19-08	AD 2013 742 S

**CONCORDANCE TABLE OF PUBLICATION NUMBERS  
AND INTERNATIONAL CLASSIFICATION INDEX**

NUMBER OF PUBLISHED APPLICATION (10)	INTERNATIONAL CLASSIFICATION INDEXES (51)
AD 2013 742 S	19-08
AD 2013 753 S	07-01

**CONCORDANCE TABLE OF INTERNATIONAL CLASSIFICATION INDEX,  
PATENT NUMBERS AND PUBLICATION NUMBERS**

INTERNATIONAL CLASSIFICATION INDEX (51)	NUMBER OF PATENT (11)	NUMBER OF PUBLISHED APPLICATION (10)
20-03	D 2013 552 S	AD 2013 736 S

**CONCORDANCE TABLE OF PATENT NUMBERS,  
PUBLICATION NUMBERS AND INTERNATIONAL CLASSIFICATION INDEXES**

NUMBER OF PATENT (11)	NUMBER OF PUBLISHED APPLICATION (10)	INTERNATIONAL CLASSIFICATION INDEX (51)
D 2013 552 S	AD 2013 736 S	20-03

**CONCORDANCE TABLE OF APPLICATION NUMBERS, PUBLICATION NUMBERS  
AND PATENT NUMBERS**

NUMBER OF APPLICATION (21)	NUMBER OF PUBLISHED APPLICATION (10)	NUMBER OF PATENT (11)
AD 2013 000736	AD 2013 736 S	D 2013 552 S

## TRADEMARKS

### CONCORDANCE TABLE OF PUBLICATION NUMBERS AND APPLICATION NUMBERS

NUMBER OF PUBLISHED APPLICATION (260)	NUMBER OF APPLICATION (210)	1	2
1	2		
AM 2013 68812 A	AM 2012 68812	AM 2013 69240 A	AM 2012 69240
AM 2013 68813 A	AM 2012 68813	AM 2013 69327 A	AM 2012 69327
AM 2013 68814 A	AM 2012 68814	AM 2013 69328 A	AM 2012 69328
AM 2013 68973 A	AM 2012 68973	AM 2013 69371 A	AM 2012 69371
AM 2013 69091 A	AM 2012 69091	AM 2013 69387 A	AM 2012 69387
AM 2013 69092 A	AM 2012 69092	AM 2013 69392 A	AM 2012 69392
AM 2013 69119 A	AM 2012 69119	AM 2013 69439 A	AM 2012 69439
AM 2013 69120 A	AM 2012 69120	AM 2013 69440 A	AM 2012 69440
AM 2013 69121 A	AM 2012 69121	AM 2013 69443 A	AM 2012 69443
AM 2013 69122 A	AM 2012 69122	AM 2013 69449 A	AM 2012 69449
AM 2013 69149 A	AM 2012 69149	AM 2013 69450 A	AM 2012 69450
AM 2013 69167 A	AM 2012 69167	AM 2013 69482 A	AM 2012 69482
AM 2013 69168 A	AM 2012 69168	AM 2013 69811 A	AM 2012 69811
AM 2013 69169 A	AM 2012 69169	AM 2013 70112 A	AM 2012 70112
		AM 2013 70113 A	AM 2012 70113
		AM 2013 66928 A*	AM 2012 66928
		AM 2013 67161 A*	AM 2012 67161

### CONCORDANCE TABLE OF INDEX OF GOODS AND/OR SERVICES AND APPLICATION NUMBERS

INDEX OF GOODS AND/OR SERVICES (511)	NUMBER OF PUBLISHED APPLICATION (260)	1	2
1	2		
3	AM 2013 69120 A	12	AM 2013 70112 A
3	AM 2013 69121 A	12	AM 2013 70113 A
3	AM 2013 70112 A	14	AM 2013 69120 A
3	AM 2013 70113 A	14	AM 2013 69121 A
5	AM 2013 69387 A	14	AM 2013 70112 A
5	AM 2013 70112 A	14	AM 2013 70113 A
5	AM 2013 70113 A	16	AM 2013 69328 A
8	AM 2013 69240 A	16	AM 2013 69482 A
9	AM 2013 67161 A*	16	AM 2013 70112 A
9	AM 2013 69091 A	16	AM 2013 70113 A
9	AM 2013 69120 A	18	AM 2013 69120 A
9	AM 2013 69121 A	18	AM 2013 69121 A
9	AM 2013 69328 A	18	AM 2013 70112 A
9	AM 2013 69482 A	18	AM 2013 70113 A
9	AM 2013 70112 A	20	AM 2013 70112 A
9	AM 2013 70113 A	20	AM 2013 70113 A
10	AM 2013 70112 A	21	AM 2013 69240 A
10	AM 2013 70113 A	21	AM 2013 70112 A
		21	AM 2013 70113 A
		24	AM 2013 70112 A
		24	AM 2013 70113 A
		24	AM 2013 69240 A
		25	AM 2013 69120 A

1	2
25	AM 2013 69121 A
25	AM 2013 69240 A
25	AM 2013 69371 A
25	AM 2013 69482 A
25	AM 2013 70112 A
25	AM 2013 70113 A
27	AM 2013 70112 A
27	AM 2013 70113 A
28	AM 2013 70112 A
28	AM 2013 70113 A
29	AM 2013 69440 A
29	AM 2013 70112 A
29	AM 2013 70113 A
30	AM 2013 66928 A*
30	AM 2013 69387 A
30	AM 2013 69392 A
30	AM 2013 69440 A
30	AM 2013 69443 A
30	AM 2013 70112 A
30	AM 2013 70113 A
32	AM 2013 69387 A
32	AM 2013 69392 A
32	AM 2013 69811 A
32	AM 2013 70112 A
32	AM 2013 70113 A
33	AM 2013 68973 A
34	AM 2013 69119 A
34	AM 2013 69149 A

1	2
34	AM 2013 69450 A
35	AM 2013 69121 A
35	AM 2013 69122 A
35	AM 2013 69439 A
35	AM 2013 69482 A
36	AM 2013 68812 A
36	AM 2013 68813 A
36	AM 2013 68814 A
36	AM 2013 69092 A
36	AM 2013 69167 A
36	AM 2013 69168 A
36	AM 2013 69169 A
36	AM 2013 69439 A
36	AM 2013 69482 A
37	AM 2013 67161 A*
38	AM 2013 69327 A
38	AM 2013 70112 A
38	AM 2013 70113 A
41	AM 2013 69328 A
41	AM 2013 69482 A
41	AM 2013 70112 A
41	AM 2013 70113 A
42	AM 2013 67161 A*
43	AM 2013 66928 A*
43	AM 2013 69392 A
44	AM 2013 69449 A
45	AM 2013 69439 A

CONCORDANCE TABLE OF INDEX OF GOODS AND/OR SERVICES  
AND NUMBERS OF TRADEMARKS REGISTERED ACCORDING  
TO THE ACCELERATED PROCEDURE

INDEX OF GOODS AND/OR SERVICES (511)	NUMBER OF MARK REGISTERED ACCORDING TO THE ACCELERATED PROCEDURE (111)
7	M 2013 23866 R
7	M 2013 23874 R
9	M 2013 23874 R
11	M 201323866 R
11	M 2013 23874 R
12	M 2013 23872 R
21	M 2013 23874 R
29	M 2013 23871 R
30	M 2013 23867 R
30	M 2013 23873 R
32	M 2013 23875 R
33	M 2013 23869 R
33	M 2013 23870 R
38	M 2013 23876 R
43	M 2013 23863 R
43	M 2013 23868 R

## Remedy of Irregularities

Bulletin No.	Page	Application No (260)	International Code	Was Published	Will be Published
6(370)	7	AP 2013 12171 A	(72)	Nikoloz Enukidze (GE); Zaira Simonia (GE); Nodar Chkheidze (GE); Eter Nadirashvili (GE); Gulnara Pavliashvili (GE); Giorgi Burjanadze (GE)	Tsitsino Kurtskhalia (GE); Nikoloz Enukidze (GE); Zaira Simonia (GE); Nodar Chkheidze (GE); Eter Nadirashvili (GE); Gulnara Pavliashvili (GE); Giorgi Burjanadze (GE)
14(376)	14	P 2013 5887 B	(72)	Nikoloz Enukidze (GE); Zaira Simonia (GE); Nodar Chkheidze (GE); Eter Nadirashvili (GE); Gulnara Pavliashvili (GE); Giorgi Burjanadze (GE)	Tsitsino Kurtskhalia (GE); Nikoloz Enukidze (GE); Zaira Simonia (GE); Nodar Chkheidze (GE); Eter Nadirashvili (GE); Gulnara Pavliashvili (GE); Giorgi Burjanadze (GE)



# OFFICIAL BULLETIN OF THE INDUSTRIAL PROPERTY

## 15(379)

EDITOR-IN-CHIEF: N. Bebrishvili

EDITORS-TRANSLATORS: E. Gabunia  
G. Nadareishvili

PROOFREADER: L. Chanturia

COMPUTER LAYOUT: K. Svanidze

[www.sakpatenti.org.ge](http://www.sakpatenti.org.ge)

E-mail: [info@sakpatenti.org.ge](mailto:info@sakpatenti.org.ge)