



**NATIONAL INTELLECTUAL PROPERTY CENTER OF GEORGIA
SAKPATENTI**

**OFFICIAL BULLETIN
OF THE INDUSTRIAL PROPERTY**

18(406)

**2014
TBILISI**

INID CODES FOR IDENTIFICATION OF BIBLIOGRAPHIC DATA

INVENTIONS, UTILITY MODELS

- (10) Number of publication for application, which has been examined
- (11) Number of patent and kind of document
- (21) Serial number of application
- (22) Date of filing of the application
- (23) Date of exhibition or the date of the earlier filing and the number of application, if any
- (24) Date from which patent may have effect
- (31) Number of priority application
- (32) Date of filing of priority application
- (33) Code of the country or regional organization allotting priority application number
- (44) Date of publication of application not granted, but examined and number of bulletin
- (45) Date of publication of registered document
- (51) International Patent Classification Index
- (54) Title of the invention
- (57) Abstract
- (60) Number of examined patent document granted by foreign patent office, date from which patent has effect and country code
- (62) Number of the earlier application and in case of divided application, date of filing an application
- (71) Name, surname and address of applicant (country code)
- (72) Name, surname of inventor (country code)
- (73) Name, surname and address of patent owner (country code)
- (74) Name, surname of representative or patent attorney
- (85) Date of commencement of the national phase of International Application
- (86) Number and date of filing of international application
- (87) Number and date of publication of international application

DESIGNS

- (10) Number of publication for application
- (11) Number of patent and kind of document or number of registration
- (15) Date of registration/Date of patent renewal
- (18) Expected expiration date of patent or registration
- (21) Serial number of application
- (22) Date of filing of the application
- (23) Date of exhibition or the date of the earlier filing and the number of application, if any
- (24) Date from which patent may have effect
- (28) Number of designs included in the application
- (30) Data relating to priority (number of application, date of filing of application, two-letter code identifying the authority with whom the priority application was made)
- (31) Number of priority application
- (32) Date of filing of priority application
- (33) Code of the country or regional organization allotting priority application number
- (34) Two-letter code according to WIPO St.3 identifying the authority with which the priority application was made
- (44) Date of publication of design and number of bulletin (the first publication)
- (45) Date of publication of design registered by WIPO and number of bulletin
- (51) International Classification for designs (class and subclass of the Locarno Classification)
- (54) Title of the invention
- (55) Reproduction of the design
- (57) Description of characteristic features of the design including indication of colors
- (58) Date of recording of any kind of amendment in the Register
- (62) Number of the earlier application, registration and document number and if available the date of filing an application in case of divided application
- (71) Name, surname and address of applicant (country code)
- (72) Name, surname of creator (country code)
- (73) Name, surname and address of patent owner (country code)
- (74) Name, surname of representative or patent attorney
- (81) Contracting states concerned
 - II designated contracting states according to the 1960 Act
 - III designated contracting states according to the 1999 Act
- (85) Owner's permanent address
- (86) Owner's nationality
- (87) Owner's residence
- (88) State in which the owner has a real and effective industrial or commercial establishment

TRADEMARKS

- (111) – Number of registration
- (151) – Date of registration
- (156) – Date of the renewal
- (181) – Expected expiration date of registration
- (186) – Renewal expiration date of registration
- (141) – Date of cancel of duration of the mark
- (210) – Serial number of application
- (220) – Date of filing of the application
- (230) – Data concerning exhibition
- (260) – Number of application, for which favorable decision of examination about registration has been taken (publication number)
- (310) – Number of the first application
- (320) – Date of filing of the first application
- (330) – Code, identifying national or regional Office where the first application was made
- (511) – International Classification of Goods and Services for the purposes of registration of trade marks and/or list of goods and/or services classified according thereto
- (531) – Description of figurative elements of Trade Marks according to the International Classification of the Figurative Elements of Marks
- (540) – Reproduction of Trade Mark
- (550) – Nature and kind of Trade Mark
- (580) – Date of recording of any kind changes in respect of applications or registrations
- (591) – Information concerning colors claimed
- (731) – Name and address of the applicant
- (732) – Name and address of the holder of the registration
- (740) – Name and address of the representative
- (750) – Address for correspondence
- (770) – Name and address of the previous applicant or holder in case of change in ownership
- (771) – Previous name and address of the applicant or holder in case of change in ownership
- (791) – Name and address of the licensee
- (793) – Indication of conditions and/or restrictions under the license (Type of license, number of license agreement, data of license, data of validity of license)
- (800) – Certain data relating to the international registration of Trade Marks under the Protocol Relating to Madrid Agreement (International registration number)

CODES FOR PUBLICATION IN BULLETIN

- (21) AP 0000 000000 – serial number of application for invention
- (10) AP 0000 0000 A – number of published application for invention (first publication)
- (11) P 0000 0000 B – number of patent for invention (second publication)
- (21) API 0000 000000 – number of application for imported patent
- (11) PI 0000 0000 A – number of imported patent (first publication)
- (21) AU 0000 000000 – serial number of application for utility model
- (10) AU 0000 000 U – number of published application for utility model (first publication)
- (11) U 0000 000 Y – number of patent for utility model (second publication)
- (21) AD 0000 000000 – serial number of application for design
- (10) AD 0000 000 S – number of published application for design (first publication)
- (11) D 0000 000 S – number of patent for design (second publication)

INTERNATIONAL PATENT CLASSIFICATION FOR INVENTIONS AND UTILITY MODELS

- SECTION A – HUMAN NECESSITIES
- SECTION B – PERFORMING OPERATIONS; TRANSPORTING
- SECTION C – CHEMISTRY; METALLURGY
- SECTION D – TEXTILES; PAPER
- SECTION E – FIXED CONSTRUCTIONS
- SECTION F – MECHANICAL ENGINEERING; LIGHTING; HEATING; WEAPONS; BLASTING
- SECTION G – PHYSICS
- SECTION H – ELECTRICITY

-
- M – Trade Mark
 - (210) AM 0000 000000 – Serial number of application;
 - (260) AAM 0000 00000 A – Publication number of application;
 - (111) M 0000 00000 R – Number of registration;
 - (111) MMM0000 00000 Rn – Number of renewals, in which n=1,2,3;
 - (111) M 0000 00000 R(P) – Number of registration under partial assignment of rights
-

LIST OF CODES, IN ALPHABETIC SEQUENCE, AND THE CORRESPONDING (SHORT) NAMES OF STATES, OTHER ENTITIES AND INTERGOVERNMENTAL ORGANIZATIONS
(WIPO STANDARD ST.3)

AD	Andorra				
AE	United Arab Emirates				
AF	Afghanistan				
AG	Antigua and Barbuda				
AI	Anguilla				
AL	Albania				
AM	Armenia				
AN	Netherlands Antilles				
AO	Angola				
AP	African Regional Intellectual Property Organization (ARIPO)				
AR	Argentina				
AT	Austria				
AU	Australia				
AW	Aruba				
AZ	Azerbaijan				
BA	Bosnia and Herzegovina				
BB	Barbados				
BD	Bangladesh				
BE	Belgium				
BF	Burkina Faso				
BG	Bulgaria				
BH	Bahrain				
BI	Burundi				
BJ	Benin				
BM	Bermuda				
BN	Brunei Darussalam				
BO	Bolivia				
BR	Brazil				
BS	Bahamas				
BT	Bhutan				
BV	Bouvet Island				
BW	Botswana				
BX	Benelux Office for Intellectual Property (BOIP)				
BY	Belarus				
BZ	Belize				
CA	Canada				
CD	Democratic Republic of the Congo				
CF	Central African Republic				
CG	Congo				
CH	Switzerland				
CI	Cote d'Ivoire				
CK	Cook Islands				
CL	Chile				
CM	Cameroon				
CN	China				
CO	Colombia				
CR	Costa Rica				
CU	Cuba				
CV	Cape Verde				
CY	Cyprus				
CZ	Czech Republic				
DE	Germany				
DJ	Djibouti				
DM	Dominica				
DO	Dominican Republic				
DZ	Algeria				
EA	Eurasian Patent Organization (EAPO)				
EC	Ecuador				
EE	Estonia				
EG	Egypt				
EH	Western Sahara				
EM	Office for Harmonization in the Internal Market (Trademarks and Designs)(OHIM)				
EP	European Patent Office (EPO)				
ER	Eritrea				
ES	Spain				
ET	Ethiopia				
FI	Finland				
FJ	Fiji				
FK	Falkland Islands (Malvinas)				
FO	Faroe Islands				
FR	France				
GA	Gabon				
GB	United Kingdom				
GC	Patent Office of the Cooperation Council for the Arab States of the Gulf (GCC)				
GD	Grenada				
GG	Guernsey				
GH	Ghana				
GI	Gibraltar				
GT	Guatemala				
GW	Guinea- Bissau				
GY	Guyana				
HK	The Hong Kong Special Administrative Region of the People's Republic of China				
HN	Honduras				
HR	Croatia				
HT	Haiti				
HU	Hungary				
IB	International Bureau of the World Intellectual Property Organization (WIPO)				
ID	Indonesia				
IE	Ireland				
IL	Israel				
IM	Isle of Man				
IN	India				
IQ	Iraq				
ID	Indonesia				
IE	Ireland				
IL	Israel				
IM	Isle of Man				
IN	India				
IQ	Iraq				
IR	Iran (Islamic Republic of)				
IS	Iceland				
IT	Italy				
JE	Jersey				
JM	Jamaica				
JO	Jordan				
JP	Japan				
KE	Kenya				
KG	Kyrgyzstan				
KH	Cambodia				
KI	Kiribati				
KM	Saint Kitts and Nevis				
KP	Democratic People's Republic of Korea				
KR	Republic of Korea				
KW	Kuwait				
KY	Cayman Islands				
KZ	Kazakhstan				
LA	Lao People's Democratic Republic				
LB	Lebanon				
LC	Saint Lucia				
LI	Liechtenstein				
LK	Sri Lanka				
LR	Liberia				
LS	Lesotho				
LT	Lithuania				
LU	Luxembourg				
LV	Latvia				
LY	Libyan Arab Jamahiriya				
MA	Morocco				
MC	Monaco				
MD	Republic of Moldova				
ME	Montenegro				
MG	Madagascar				
MK	The former Yugoslav Republic of Macedonia				
ML	Mali				
MM	Myanmar				
MN	Mongolia				
MO	Macao				
MP	Northern Mariana Islands				
MR	Mauritania				
MS	Montserrat				
MT	Malta				
MU	Mauritius				
MV	Maldives				
MW	Malawi				
MX	Mexico				
MY	Malaysia				
MZ	Mozambique				
NA	Namibia				
NE	Niger				
NG	Nigeria				
NI	Nicaragua				
NL	Netherlands				
NO	Norway				
NP	Nepal				
NR	Nauru				
NZ	New Zealand				
OA	African Intellectual Property Organization (OAPI)				
OM	Oman				
PA	Panama				
PE	Peru				
PG	Papua New Guinea				
PH	Philippines				
PK	Pakistan				
PL	Poland				
PT	Portugal				
PW	Palau				
PY	Paraguay				
QA	Qatar				
QZ	Community Plant Variety Office (European Community) (CPVO)				
RO	Romania				
RS	Serbia				
RU	Russian Federation				
RW	Rwanda				
SA	Saudi Arabia				
SB	Solomon Islands				
SC	Seychelles				
SD	Sudan				
SG	Singapore				
SH	Saint Helena				
SI	Slovenia				
SK	Slovakia				
SL	Sierra Leone				
SM	San Marino				
SN	Senegal				
SO	Somalia				
SR	Suriname				
ST	Sao Tome and Principe				
SV	El Salvador				
SY	Syrian Arab Republic				
SZ	Swaziland				
TC	Turks and Caicos Islands				
TD	Chad				
TG	Togo				
TH	Thailand				
TJ	Tajikistan				
TL	Timor-Leste				
TM	Turkmenistan				
TN	Tunisia				
TO	Tonga				
TR	Turkey				
SE	Sweden				
TT	Trinidad and Tobago				
TV	Tuvalu				
TW	Taiwan, Province of China				
TZ	United Republic of Tanzania				
UA	Ukraine				
UG	Uganda				
US	United States of America				
UY	Uruguay				
UZ	Uzbekistan				
VA	Holy See				
VC	Saint Vincent and the Grenadines				
VE	Venezuela				
VG	Virgin Islands (British)				
VN	Viet Nam				
VU	Vanuatu				
WO	World Intellectual Property Organization (WIPO)				
WS	Samoa				
XN	Nordic Patent Institute (NPI)				
YE	Yemen				
ZA	South Africa				
ZM	Zambia				
ZW	Zimbabwe				

**NATIONAL INTELLECTUAL PROPERTY CENTER OF GEORGIA
SAKPATENTI**

**OFFICIAL BULLETIN
OF THE INDUSTRIAL PROPERTY**

18(406)

**INVENTIONS
UTILITY MODELS
DESIGNS
TRADEMARKS**

**DATE OF PUBLICATION
2014 09 25**

CONTENTS

PUBLISHED TITLES OF PROTECTION	2
INVENTIONS	
▪ APPLICATIONS APPROVED FOR GRANTING PATENTS	4
▪ PATENTED INVENTIONS	9
UTILITY MODELS	
▪ APPLICATION APPROVED FOR GRANTING PATENT	11
▪ PATENTED UTILITY MODELS	12
DESIGNS	
▪ REGISTERED DESIGN	13
TRADEMARKS	
▪ APPLICATIONS FILED UNDER THE NATIONAL PROCEDURE APPROVED FOR REGISTRATION	14
▪ REGISTERED TRADEMARKS	22
▪ TRADEMARKS REGISTERED ACCORDING TO THE ACCELERATED PROCEDURE	27
▪ INTERNATIONAL TRADEMARKS FOR WHICH A DECISION ON GANTING PROTECTION IS TAKEN	28
▪ INTERNATIONAL TRADEMARKS PROTECTED IN GEORGIA	60
OFFICIAL NOTIFICATIONS	
TRADEMARKS	
▪ RENEWAL OF REGISTRATIONS	69
▪ COMPLETE TRANSFER OF RIGHTS	71
▪ CHANGES IN NAMES AND/OR ADDRESSES OF OWNERS	73
▪ INVALIDATION OF TRADEMARKS REGISTRATION	75
▪ CANSSELLING OF INTERNATIONAL TRADEMARK REGISTRATION	75
▪ CORRECTION OF PUBLISHED INFORMATION	75
CLASSIFICATION INDEXES	
INVENTIONS	76
UTILITY MODELS	78
DESIGNS	79
TRADEMARKS	80

PUBLISHED TITLES OF PROTECTION

INVENTIONS

- **APPLICATIONS APPROVED FOR GRANTING PATENTS:**
1366; 12142; 12328; 12393; 12861; 13077; 13025; 13021; 12676; 12415
- **PATENTED INVENTIONS:**
6166-6174

UTILITY MODELS

- **APPLICATION APPROVED FOR GRANTING PATENT:**
13430
- **PATENTED UTILITY MODELS:**
1833-1835

DESIGNS

- **REGISTERED DESIGN:**
590

TRADEMARKS

- **APPLICATIONS FILED UNDER THE NATIONAL PROCEDURE APPROVED FOR REGISTRATION:**
71680; 71924*; 72524; 73633; 73877; 73934; 73968-73972; 74059, 74060; 74169; 74249; 74303; 74328-74332; 74340; 74345, 74346; 74484-74486; 74546; 74711; 74754; 74757; 74770; 74802; 74810; 74868, 74869; 74903-74905; 74920; 74994, 74995; 75002; 75009; 75076-75079; 75097; 75104; 75118, 75119; 75121; 75134; 75219
- **REGISTERED TRADEMARKS:**
25158-25207
- **TRADEMARKS REGISTERED ACCORDING TO THE ACCELERATED PROCEDURE:**
25157; 25208
- **INTERNATIONAL TRADEMARKS FOR WHICH A DECISION ON GRANTING PROTECTIONS IS TAKEN:**
70827*; 72283*; 71404; 73045; 73071; 73073-73076; 73079, 73080; 73191; 73194, 73195; 73199, 73200; 73350; 74202; 74223-74226; 74228-74231; 74235-74241; 74251-74255; 74257-74261; 74279, 74280; 74460; 74462-74588; 74590; 74603; 74605-74612; 74662-74669; 74671; 74686, 74687; 74794-74798; 74803; 74812, 74813; 74817-74819
- **INTERNATIONAL TRADEMARKS PROTECTED IN GEORGIA:**
70584; 65404; 70448; 71390; 71394; 71902, 71903; 71905-71907; 71913, 71314; 71916; 71919-71923; 71938-71940; 71943; 71945-71957; 71972, 71973; 71996-71999; 72001, 72002; 72004, 7 2005; 72009-72011; 72050; 72057-72068; 72175; 72177-72179; 72182-72184; 72187, 72188; 72562; 72584-72597; 72602-72606; 72740; 72758-72772; 72818; 72820-72822; 72824, 72825; 72827-72831; 72833, 72834; 72838-72845; 72847; 73139; 73148-73150; 73318; 73335

INVENTIONS

APPLICATIONS APPROVED FOR GRANTING PATENTS

The decision can be appealed at the Chamber of Appeal of Sakpatenti within 3 months from the publication or at the Mtskheta District Court Administrative Cases Board (Address: №17, Samkhedro str., Mtskheta), within 1 month following the publication.

PART A

A 01

(10) AP 2014 13166 A (51) Int. Cl. (2006)

A 01 N 29/04

A 61 K 31/025

(21) AP 2011 013166 (22) 2011 12 22

(31) 61/426379

(32) 2010 12 22

(33) US

(71) H. LUNDBECK A/S (DK)

Ottiliavej 9, DK-2500 Valby (DK)

(72) LI, Guiying (US);

ZHOU, Hao (US);

WEISS, Jesse (US);

DOLLER, Dario (US);

FORD, James (US)

(74) Shalva Gvaramadze

(85) 2013 07 18

(86) PCT/US2011/066690, 2011 12 22

(54) **BICYCLO [3.2.1] OCTYL AMIDE**

DERIVATIVES AND USAGE THEREOF

(57) There are represented bicycle [3.2.1] octyl amide derivatives of common formula (I),

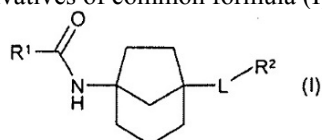

and pharmaceutical compositions containing thereof, which are metabotropic allosteric modifiers of mGluR5 glutamate receptor, applied at cognitive, neurodegenerative, psychical or neurologic diseases treatment.

Claims: 3 independent

13 dependent

A 61

(10) AP 2014 12142 A (51) Int. Cl. (2006)

A 61 K 38/00

A 61 K 9/50

A 61 K 9/16

A 61 K 9/20

A 61 K 9/48

(21) AP 2009 012142 (22) 2009 08 14

(31) 61/089,422; 61/273,332; 61/231,725

(32) 2008 08 15; 2009 08 03; 2009 08 06

(33) US; US; US

(71) IRONWOOD PHARMACEUTICALS, INC. (US)

301 Binney Street Cambridge, MA 02142 (US)

(72) FRETZEN, Angelika (US);

WITOWSKI, Steven (US);

GROSSI, Alfredo (US);

ZHAO, Hong (US);

DEDHIYA, Mahendra (US);

MO, Yun (US)

(74) Shalva Gvaramadze

(85) 2011 03 15

(86) PCT/US2009/004675, 2009 08 14

(54) **LINACLOTIDE-CONTAINING FORMULATIONS FOR ORAL ADMINISTRATION**

(57) There are represented: composition containing pharmaceutically acceptable carrier linaclotide, cations selected from Mg^{2+} , Ca^{2+} , Zn^{2+} , Mn^{2+} , K^+ , Na^+ or Ae^{3+} , and steric slow primary amine selected from following: amino acid polymeric amine or compound of formula



wherein values R^1 , R^2 and R^3 are provided in the claims, application thereat the treatment of disorders of gastrointestinal tract, such as intestine functional disorder, syndrome of intestine irritation, etc.

Claims: 6 independent

44 dependent

Fig.: 1

Table: 17

PART B**B 01**

(10) AP 2014 12328 A (51) Int. Cl. (2006)

B 01 D 53/14

B 01 D 53/58

C 01 C 1/10

C 01 C 1/12

B 01 D 61/36

(21) AP 2010 012328 (22) 2010 01 11

(31) MI2009A 000025

(32) 2009 01 13

(33) IT

(71) SAIPEM S.P.A. (IT)

Via Martiri di Cefalonia 67, San Donato

Milanese, I-20097 (IT)

(72) CASARA, Paolo (IT);

GIANAZZA, Alessandro (IT);

MIRACCA, Ivano (IT)

(74) Shalva Gvaramadze

(85) 2011 08 05

(86) PCT/EP2010/000189, 2010 01 11

(54) **PROCESS FOR RECOVERY OF****AMMONIA FROM GASEOUS STREAM**

(57) There is represented a process for recovery of ammonia comprising following phases: a) subjecting the gaseous stream containing ammonia to washing with an aqueous washing solution having pH lower than 7, with the formation of a purified gaseous stream and an aqueous solution containing an ammonium salt; b) subjecting the aqueous solution containing the ammonium salt coming from phase to distillation process with a hydrophobic microporous membrane at a temperature ranging from 50 to 250°C and a pressure ranging from 50 KPa to 4 MPa absolute with the formation of a regenerated washing solution and a gaseous stream comprising NH₃ and H₂O; c) recycling said generated washing solution to phase (a).

Claims: 2 independent

16 dependent

Fig.: 1

PART C**C 07**

(10) AP 2014 12393 A (51) Int. Cl. (2006)

C 07 D 231/12

C 07 D 231/20

C 07 D 231/38

C 07 D 401/04

C 07 D 401/12

C 07 D 401/14

C 07 D 403/12

C 07 D 407/12

C 07 D 409/04

C 07 D 417/12

A 61 K 31/4155

(21) AP 2010 012393 (22) 2010 03 03

(31) 61/157, 046; 61/304,053

(32) 2009 03 03; 2010 02 12

(33) US; US

(71) E. I. DU PONT DE NEMOURS AND COMPANY (US)

1007 Market Street, Wilmington, DE-19898 (US)

(72) LONG, Jeffrey, Keith (US);

HONG, Wonpyo (KR);

TAGGI, Andrew, Edmund (US)

(74) Tamaz Shilakadze

(85) 2011 09 26

(86) PCT/US2010/026003, 2010 03 03

(54) **FUNGICIDAL PYRAZOLES**

(57) Present invention relates to novel derivatives of pyrazole of formulas (1) and (2):

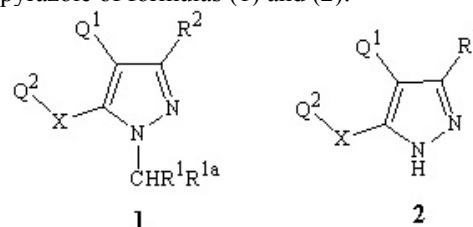

as well as compositions containing compounds of formula (1), and methods to control plant diseases caused by fungicidal pathogens providing application of effective amount of compound or composition, accordingly present invention.

Claims: 6 independent

11 dependent

(10) AP 2014 12861 A (51) Int. Cl. (2006)

C 07 D 307/20

C 07 D 307/28

C 07 D 307/30

C 07 D 307/32

C 07 D 307/58

C 07 D 405/04

C 07 D 405/10

C 07 D 407/12

C 07 D 409/12

C 07 D 409/14**C 07 D 413/12****A 01 N 43/08**

- (21) AP 2011 012861 (22) 2011 01 31
 (31) 10154297.5; 10154301.5
 (32) 2010 02 22; 2010 02 22
 (33) EP; EP
 (71) SYNGENTA PARTICIPATIONS AG (CH)
 Schwarzwaldallee 215, CH-4058, Basel (CH)
 (72) EL QACEMI, Myriem (FR);
 CASSAYRE, Jérôme Yves (FR);
 TOUEG, Julie Clementine (FR);
 RENOLD, Peter (CH);
 PITTERNA, Thomas (AT)

(74) Tamar Kochlamazashvili

(85) 2012 09 21

(86) PCT/EP2011/051284, 2011 01 31

**(54) DIHYDROFURAN DERIVATIVES
AS INSECTICIDAL COMPOUNDS**

(57) There are represented dihydrofuran derivatives of common formula (I),

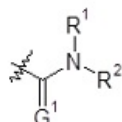
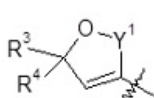
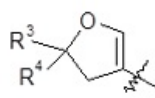
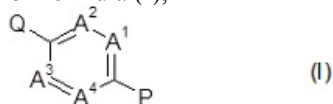

preparation method thereof, and insecticidal, acaricide, nematocidal and molluscocidal compositions containing them applied to control vermin – insect, mite, nematode and mulluscs.

Claims: 4 independent

11 dependent

(10) AP 2014 13077 A (51) Int. Cl. (2006)**C 07 D 471/04****A 61 K 31/519****A 61 P 3/10****A 61 P 3/04**

(21) AP 2011 013077 (22) 2011 10 31

(31) 10-2010-0107868

(32) 2010 11 01

(33) KR

(71) LG LIFE SCIENCES LTD. (KR)

LG Gwanghwamun Bldg. 92, Sinmunno 2-ga,
 Jongno-gu Seoul 110-062 (KR)

(72) PARK, Ki Sook (KR);

YUN, Jung Min (KR);

KIM, Bong Chan (KR);

KIM, Kyu Young (KR);

LEE, Ji Hye (KR)

(74) Shalva Gvaramadze

(85) 2013 05 01

(86) PCT/KR2011/008186, 2011 10 31

(54) HYDRATE OF 1-((2S)-2-AMINO-4-[2,4-BIS(TRIFLUOROMETHYL)-5,8-DIHYDROPYRIDO[3,4-D]PYRIMIDIN-7(6H)-YL]-4-OXOBUTYL)-5,5-DIFLUORO-PIPERIDIN-2-ONE TARTRATE

(57) There are represented hydrate of 1-((2s)-2-amino-4-[2,4-bis(trifluoromethyl)-5,8-dihydropyrido[3,4-d]pyrimidin-7(6h)-yl]-4-oxobutyl)-5,5-difluoro-piperidin-2-one tartrate of formula I,

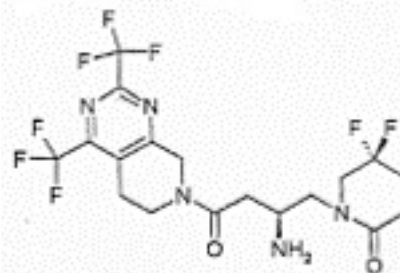

pharmaceutical composition containing them, preparation method thereof, and application thereof the treatment of diabetes or obesity.

Claims: 3 independent

3 dependent

(10) AP 2014 13025 A (51) Int. Cl. (2006)**C 07 D 487/04****A 61 K 31/519****A 61 P 25/28**

(21) AP 2011 013025 (22) 2011 08 09

(31) 10172597.6; 11154397.1

(32) 2010 08 12; 2011 02 14

(33) EP; EP

(71) BOEHRINGER INGELHEIM

INTERNATIONAL GMBH (DE)

Binger Straße 173, 55216 Ingelheim Am
 Rhein (DE)

(72) HEINE, Niklas (DE);

EICKMEIER, Christian (DE);

FERRARA, Marco (IT);

GIOVANNINI, Riccardo (IT);

ROSENBROCK, Holger (DE);

SCHAENZLE, Gerhard (DE)

(74) Tamar Kochlamazashvili

(85) 2013 03 11

(86) PCT/EP2011/063705, 2011 08 09

(54) 6-CYCLOALKYL-1, 5-DIHYDRO-PYRAZOLO [3, 4-D] PYRIMIDIN-4-ONE DERIVATIVES AND THEIR USE AS PDE9A INHIBITORS

(57) There are represented 6-cycloalkyl-1,5-dihydro-pyrazolo [3,4-D] pyrimidin-4-one derivatives of formula (I),

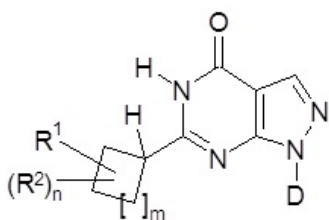

pharmaceutical compositions containing them, which are PDE9A inhibitors and used at pathological conditions, particularly, Alzheimer and schizophrenia treatment.

Claims: 9 independent

9 dependent

(10) AP 2014 13021 A (51) **Int. Cl. (2006)**
C 07 D 513/04
A 61 K 31/542
A 61 P 25/00

(21) AP 2011 013021 (22) 2011 08 09

(31) 2010-179577

(32) 2010 08 10

(33) JP

(71) TAKEDA PHARMACEUTICAL
COMPANY LIMITED (JP)

1-1, Doshomachi 4-chome, Chuo-ku, Osaka-
shi, Osaka 5410045 (JP)

(72) KORI, Masakuni (JP);
IMAEDA, Toshihiro (JP);
NAKAMURA, Shinji (JP);
TOYOFUKU, Masashi (JP);
HONDA, Eiji (JP);
ASANO, Yasutomi (JP);
UJIKAWA, Osamu (JP);
MOCHIZUKI, Michiyo (JP)

(74) Shalva Gvaramadze

(85) 2013 03 04

(86) PCT/JP2011/068497, 2011 08 09

(54) **HETEROCYCLIC COMPOUND AND
USAGE THEREOF**

(57) There are represented heterocyclic compounds of
common formula (I)

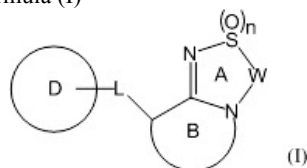

Characterized with strengthening effect of AMPA
receptor (α -amino-3-hydroxy-5-methyl-4-isoxasole pro-
pionic acid) applied at the treatment of depression,
schizophrenia, and Alzheimer's disease.

Claims: 8 independent

13 dependent

C 12

(10) AP 2014 12676 A (51) **Int. Cl. (2006)**
C 12 P 21/08
A 61 K 35/14
G 01 N 33/35

(21) AP 2010 012676 (22) 2010 09 30

(31) 61/248,014

(32) 2009 10 02

(33) US

(71) THE REGENTS OF THE UNIVERSITY OF
CALIFORNIA (US)

1111 Franklin Street 5th Floor Oakland, CA
94607-5200 (US)

(72) AKASSOGLU, Katerina (US)

(74) Alexander Gegechkori

(85) 2012 04 23

(86) PCT/US2010/050873, 2010 09 30

(54) **MONOCLONAL ANTIBODIES**

(57) The present invention provides an isolated
antibody that binds a fibrin or fibrinogen γ C
domain. In various aspects, the antibody inhibits
microglial adhesion to the fibrin or fibrinogen γ C
domain, inhibits Mac-1 binding to the fibrin or
fibrinogen γ C domain, and/or suppresses clinical
symptoms, wherein pathology is selected from
following group: disseminated sclerosis, rheuma-
toid arthritis and cancer.

Claims: 3 independent

3 dependent

Fig.: 4

PART E

E 02

(10) AP 2014 12415 A (51) **Int. Cl. (2006)**
E 02 F 7/06
B 03 B 9/00

(21) AP 2010 012415 (22) 2010 03 15

(31) 2009/0158

(32) 2009 03 16

(33) BE

(71) DREDGING INTERNATIONAL N.V. (BE)
Schelvedijk 30 B-2070 Zwijndrecht (BE)

(72) VANDYCKE, Stefaan (BE)

(74) Tamaz Shilakadze

(85) 2011 10 12

(86) PCT/US2010/053288, 2010 03 15

(54) **METHOD AND DEVICE FOR
TREATING DREDGED MATERIAL
EXTRACTED BY MEANS OF
DREDGING VESSEL**

(57) The invention relates to a method and device
for treating dredged material 50 extracted by means
of dredging vessel 30, and the dredged material 50
is fed from the dredging vessel to at least one
centrifugal separator 10, which centrifugal
separator separates the dredged material into a wet
fraction 51 and a dry fraction 52; at least collection
of wet fraction and feeding thereto gravity separator
20, additional separation of collected wet fraction

into dry 53 and wet 54 fractions, and at least feeding of dry fraction onto seagoing transport vessel 49 capable receive and transportation of at least 50000 ton of dry fraction of extracted dredged material. The method also provides a system comprising equipment 1 treating extracted dredged material and seagoing transport vessel 40 for collecting dry fraction and transportation.

Claims: 3 independent
13 dependent

Fig.: 2

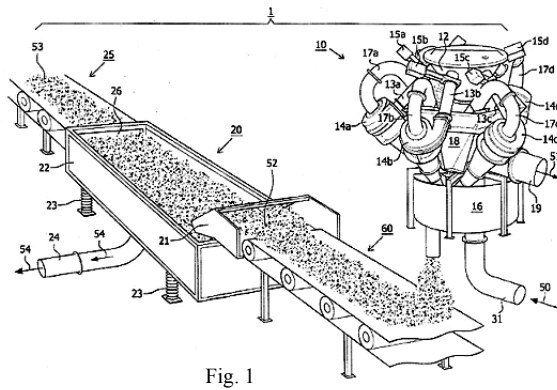

PATENTED INVENTIONS

PART A

A 61

(11) P 2014 6172 B **(51) Int. Cl. (2006)**
A 61 F 2/16
 (10) AP 2014 13245 A (44) 11(399)/2014
 (21) AP 2013 013245
 (22) 2013 09 26
 (24) 2013 09 26
 (73) Merab Dvali (GE)
 I. Abashidzis q. 31, 0179, Tbilisi (GE)
 (72) Merab Dvali (GE)
 (54) **PHACO INTRAOCULAR CRYSTALLINE LENS**

(11) P 2014 6173 B **(51) Int. Cl. (2006)**
A 61 F 2/16
 (10) AP 2014 13246 A (44) 11(399)/2014
 (21) AP 2013 013246
 (22) 2013 09 26
 (24) 2013 09 26
 (73) Merab Dvali (GE)
 I. Abashidzis q. 31, 0179, Tbilisi (GE)
 (72) Merab Dvali (GE)
 (54) **ACCOMMODATIVE INTRAOCULAR CRYSTALLINE LENS**

(11) P 2014 6170 B **(51) Int. Cl. (2006)**
A 61 K 8/37
A 61 Q 19/00
 (10) AP 2014 12797 A (44) 11(399)/2014
 (21) AP 2010 012797
 (22) 2010 12 17
 (24) 2010 12 17
 (31) 0959165
 (32) 2009 12 18
 (33) FR
 (86) PCT/EP2010/070028, 2010 12 17
 (73) PIERRE FABRE DERMO-COSMETIQUE (FR)
 45, Place Abel Gance, F-92100 Boulogne-Billancourt (FR)
 (72) DECHELETTE, Corinne (FR);
 REDOULES, Daniel (FR)
 (74) Shalva Gvaramadze
 (54) **USAGE OF 2,3-DIHYDROXYPROPYL DODECANOATE FOR TREATING SEBOREA**

(11) P 2014 6166 B **(51) Int. Cl. (2006)**
A 61 K 9/14
A 61 K 9/16
A 61 K 9/20
A 61 K 9/48
A 61 K 47/12
A 61 K 47/36
A 61 K 47/38
 (10) AP 2014 12120 A (44) 11(399)/2014
 (21) AP 2009 012120
 (22) 2009 07 27
 (24) 2009 07 27
 (31) 2008-194219
 (32) 2008 07 28
 (33) JP
 (86) PCT/JP2009/063708, 2009 07 27

(73) TAKEDA PHARMACEUTICAL COMPANY LIMITED (JP)
 1-1, Doshomaci 4-chome, Chuo-ku, Osaka-shi, Osaka 541-0045 (JP)
 (72) HIRAISHI, Yasuhiro (JP);
 NONOMURA, Muneo (JP)
 (74) Shalva Gvaramadze
 (54) **PHARMACEUTICAL COMPOSITION**

(11) P 2014 6168 B **(51) Int. Cl. (2006)**
A 61 P 13/02
C 07 D 498/04
A 61 P 21/00
A 61 P 3/00
A 61 P 15/00
A 61 P 43/00
 (10) AP 2014 12529 A (44) 11(399)/2014
 (21) AP 2010 012529
 (22) 2010 06 14
 (24) 2010 06 14
 (31) 2009-142673; 2010-147226
 (32) 2009 06 15; 2010 06 14
 (33) JP; JP
 (86) PCT/JP2010/060408, 2010 06 14

(73) TAKEDA PHARMACEUTICAL COMPANY LIMITED (JP)
 1-1, Doshomaci 4-chome, Chuo-ku, Osaka-shi, Osaka 541-0045 (JP)
 (72) SASAKI, Shigekazu (JP);
 KUSUMOTO, Tomokazu (JP);
 NOMURA, Izumi (JP);
 MAEZAKI, Hironobu (JP)
 (74) Shalva Gvaramadze
 (54) **PYRAZINOOXAZEPINE DERIVATIVES**

PART B**B 23**

- (11) P 2014 6174 B** (51) **Int. Cl. (2006)**
B 23 P 6/04
- (10) AP 2014 13374 A (44) 11(399)/2014
(21) AP 2014 013374
(22) 2014 02 03
(24) 2014 02 03
(73) Ioseb Maisuradze (GE)
Zakariadzis q. 9, b. 12, 0177, Tbilisi (GE)
(72) Ioseb Maisuradze (GE)
(54) **METHOD TO REPAIR RAILWAY
AND/OR UNDERGROUND CARRIAGE
FRAME CROSS BEAM CRACK**

PART C**C 07**

- (11) P 2014 6169 B** (51) **Int. Cl. (2006)**
C 07 D 471/10
A 61 K 31/438
A 61 P 3/10
A 61 P 1/16
- (10) AP 2014 12700 A (44) 11(399)/2014
(21) AP 2010 012700
(22) 2010 10 29
(24) 2010 10 29
(31) 61/259,823
(32) 2009 11 10
(33) US
(86) PCT/IB2010/054908, 2010 10 29
(73) PFIZER INC. (US)
235 East 42nd Street, New York,
NY 10017 (US)
(72) BAGLEY, Scott, William (US);
GRIFFITH, David, Andrew (US);
KUNG, Daniel, Wei-Shung (US)
(74) Shalva Gvaramadze
(54) **N1-PYRAZOLOSPIROKETONE
ACETYL-COA CARBOXYLASE
INHIBITORS**

- (11) P 2014 6171 B** (51) **Int. Cl. (2006)**
C 07 D 495/04
- (10) AP 2014 12804 A (44) 11(399)/2014
(21) AP 2010 012804
(22) 2010 12 21
(24) 2010 12 21
(31) P0900795
(32) 2009 12 21
(33) HU

- (86) PCT/HU2010/000148, 2010 12 21
(73) EGIS GYÓGYSZERGYÁR
NYILVÁNOSAN MŰKÖDŐ
RÉSZVÉNYTÁRSASÁG (HU)
Keresztúri út 30-38 H-1106 Budapest (HU)
(72) PORCS-MAKKAY, Márta (HU);
GREGOR, Tamás (HU);
VOLK, Balázs (HU);
NÉMETH, Gábor (HU);
BARKÓCZY, József (HU);
NYULASI, Bálint (HU);
MEZEI, Tibor (HU);
RUZSICS, György (HU);
PANDUR, Angéla (HU);
SZILÁGYI, Erika (HU);
NAGY, Kálmán (HU);
SLÉGEL, Péter (HU);
MOLNÁR, Enikő (HU);
DEBRECZENI, József (HU)
(74) Liliana Darakhvelidze
(54) **IMPROVED PROCESS FOR
PHARMACEUTICAL COMPOUND
PREPARATION**

C 10

- (11) P 2014 6167 B** (51) **Int. Cl. (2006)**
C 10 G 29/04
C 10 G 29/16
C 10 G 9/00
C 10 G 1/04
E 21 B 43/00
- (10) AP 2014 12380 A (44) 11(399)/2014
(21) AP 2010 012380
(22) 2010 02 10
(24) 2010 02 10
(31) 61/152,220
(32) 2009 02 12
(33) US
(86) PCT/US2010/023740, 2010 02 10
(73) RED LEAF RESOURCES, INC. (US)
200 W. Civic Center Drive, Suite 190 Sandy,
UT 84070 (US)
(72) PATTEN, James, W. (US);
DANA, Todd (US)
(74) Shalva Gvaramadze
(54) **CARBON MANAGEMENT AND
SEQUESTRATION FROM
ENCAPSULATED CONTROL
INFRASTRUCTURES**

UTILITY MODELS

APPLICATION APPROVED FOR GRANTING PATENT

The decision can be appealed at the Chamber of Appeal of Sakpatenti within 3 months from the publication or at the Mtskheta District Court Administrative Cases Board (Address: №17, Samkhedro str., Mtskheta), within 1 month following the publication.

PART B

B 65

(10) AU 2014 13430 U (51) Int. Cl. (2006)
B 65 D 5/30

(21) AU 2014 013430 (22) 2014 03 27

(71) TASTE BRAKE, JSC (GE)

Varketili 3, I mkr., korp. 32, b. 10,
0163, Tbilisi (GE)

(72) Devid Endeladze (GE)

(54) **CARTON CUTOUT**

(57) There is represented carton cutout comprising four or more bend longitudinal lines 2 with allocated between them the sections – double walls 3, bottom 4 and top 5, section edges are weakened in bended part and are connected to leaves 6, 7 and 8 for carton assembly. The leaf 8 has a catch 9 for carton fixation. Package carton cutout has two or more even crosswise lines 10 with weakened cross-section to create detachable belt 11 or belts.

Claims: 1 independent

Fig.: 2

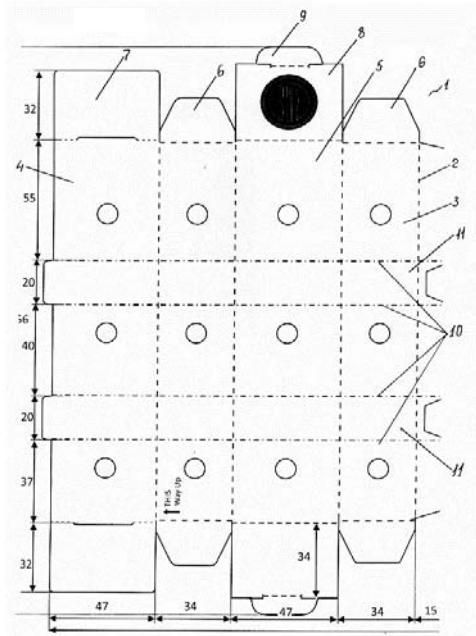

Fig. 1

PATENTED UTILITY MODELS**PART E****E 04**

**(11) U 2014 1834 Y (51) Int. Cl. (2006)
E 04 B 2/08**
(10) AU 2014 13288 U (44) 11(399)/2014
(21) AU 2013 013288
(22) 2013 11 11
(24) 2013 11 11
(73) Zaur Khomeriki (GE)
Al. Kazbegis Gamz. 34, b. 52, 0186,
Tbilisi (GE)
(72) Zaur Khomeriki (GE)
(54) **HEAT-INSULATING WALL**

PART G**G 01**

**(11) U 2014 1833 Y (51) Int. Cl. (2006)
G 01 G 3/00**
(10) AU 2014 13283 U (44) 11(399)/2014
(21) AU 2013 013283
(22) 2013 11 05
(24) 2013 11 05
(73) Pridon Gvajaia (GE)
Tsminda Giorgis q. 142, 4400, Poti (GE)
(72) Pridon Gvajaia (GE)
(54) **METHOD OF HEAVY-LOAD SCALES
CALIBRATION, GRADUATION AND
CHECKING**

PART F**F 25**

**(11) U 2014 1835 Y (51) Int. Cl. (2006)
F 25 B 30/00
H 02 N 10/00
H 01 L 37/02**
(10) AU 2014 13340 U (44) 11(399)/2014
(21) AU 2013 013340
(22) 2013 12 25
(24) 2013 12 25
(73) Mikheil Zviadadze (GE)
Dighmis Mas., III kvart., korp. 35, b. 19,
0159 Tbilisi (GE);
Anzor Berdzenishvili (GE)
Dighmis Mas., III kvart., korp. 35, b. 19,
0159 Tbilisi (GE)
(72) Mikheil Zviadadze (GE);
Anzor Berdzenishvili (GE)
(54) **FERROELECTRIC HEAT PUMP**

REGISTERED DESIGN

- (11) D 2014 590 S** **(51) 19-08**
(10) AD 2014 784 S (44) 11(399)/2014
(21) AD 2014 000784
(22) 2014 03 04
(24) 2014 03 04
(18) 2019 03 04
(28) 1
(73) LTD "MITANA" (GE)
 G. Chkondidelis q. 26, 0180, Tbilisi (GE)
(72) Zaur Morbedadze (GE)
(54) **SAUSAGE LABEL**
-

TRADEMARKS

APPLICATIONS FILED UNDER THE NATIONAL PROCEDURE APPROVED FOR REGISTRATION

The decision can be appealed at the Chamber of Appeal of Sakpatenti within 3 months from the publication or at the Mtskheta District Court Administrative Cases Board (Address: №17, Samkhedro str., Mtskheta), within 1 month following the publication.

(260) AM 2014 71680 A
(210) AM 071680
(220) 2014 01 21
(731) LTD "ADAMIUMI"
Rubiniantsis q. 21/3, b. 19, Erevani, Armenia
(740) Nerses Mkrtishiani
(540)



(591) Red, white
(531) 26.01.20-27.05.24-28.19.00-29.01.12-
(526) The trademark is protected as a whole. The words „ხორცის პროდუქტები“ included therein shall not be subject to independent legal protection.
(511) 29

(260) AM 71924 A*
(210) AM 071924
(220) 2013 04 17
(731) STAFFORD-MILLER (IRELAND) LIMITED
Clocherane, Youghal Road, Dungarvan, Co.
Waterford, Ireland
(740) Shalva Gvaramadze
(540)

SENSODYNE

(591) Black, white
(511) 3, 5, 10, 21

(260) AM 2014 72524 A
(210) AM 072524
(220) 2013 06 06
(731) LTD "KAKHURI"
Tbilisis gzatketsili №1, 2200, Telavi, Georgia
(540)

ნაფარეული ველი НАПАРЕУЛИ ВЕЛИ Napareuli Velley

(591) Black, white
(511) 33

(260) AM 2014 73633 A
(210) AM 073633
(220) 2013 08 22
(731) FASHION ONE TELEVISION LLC.
820 Meridian Ave, Suite 100, 33139 Miami
Beach, Florida, USA
(740) Khatuna Imnadze
(540)



(591) Black, white
(531) 26.04.09-26.11.03-27.05.10-27.05.21-
(511) 38

(260) AM 2014 73877 A
(210) AM 073877
(220) 2013 09 09
(731) LTD "AKHALI NATEBA"
Al. Kazbegis 25a, 0160, Tbilisi, Georgia
(740) Khatuna Imnadze
(540)



(591) Black, white, yellow
(531) 26.04.12-26.11.09-27.05.17-28.19.00-
29.01.12-
(511) 11

(260) AM 2014 73934 A
(210) AM 073934
(220) 2013 09 16
(731) HANKOOK TIRE WORLDWIDE CO., LTD
647-15, Yoksam-dong, Kangnam-gu, seoul,
Republic of Korea
(740) Larisa Amirxaniani
(540)

HANKOOK

(591) Black, white
(511) 12

(260) AM 2014 73968 A
(210) AM 073968
(220) 2013 09 20

(731) LTD "TEQNO BUMI"
Vazha-Pshavelas gamz. 30a, 0160, Tbilisi,
Georgia

(740) LTD "TEQNO BUMI"
(540)

ვინუსი

Vinus

(591) Black, white
(531) 27.05.17-28.19.00-
(511) 35

(260) AM 2014 73969 A
(210) AM 073969
(220) 2013 09 20
(731) LTD "TEQNO BUMI"
Vazha-Pshavelas gamz. 30a, 0160, Tbilisi,
Georgia

(740) LTD "TEQNO BUMI"
(540)

ვიზერი

Visser

(591) Black, white
(531) 27.05.17-28.19.00-
(511) 35

(260) AM 2014 73970 A
(210) AM 073970
(220) 2013 09 20
(731) LTD "TEQNO BUMI"
Vazha-Pshavelas gamz. 30a, 0160, Tbilisi,
Georgia

(740) LTD "TEQNO BUMI"
(540)

ვერბერი

Werber

(591) Black, white
(531) 27.05.17-28.19.00-
(511) 35

(260) AM 2014 73971 A
(210) AM 073971
(220) 2013 09 20
(731) LTD "TEQNO BUMI"
Vazha-Pshavelas gamz. 30a, 0160, Tbilisi,
Georgia

(740) LTD "TEQNO BUMI"

(540)

ვიზნერი

Wiesner

(591) Black, white
(531) 27.05.17-28.19.00-
(511) 35

(260) AM 2014 73972 A
(210) AM 073972
(220) 2013 09 20
(731) LTD "TEQNO BUMI"
Vazha-Pshavelas gamz. 30a, 0160, Tbilisi,
Georgia
(740) LTD "TEQNO BUMI"
(540)

ვორლდლაინი

Worldline

(591) Black, white
(531) 27.05.17-28.19.00-
(511) 35

(260) AM 2014 74059 A
(210) AM 074059
(220) 2013 09 27
(731) ZHEJIANG TIANLI TOOLS CO., LTD
YUEQINGSHI CITY FURONG SPECIAL
INDUSTRIAL ZONE, ZHEJIANG, China
(740) Alexander Kvernadze
(540)

SKOLE

(591) Black, white
(531) 27.05.17-
(511) 8

(260) AM 2014 74060 A
(210) AM 074060
(220) 2013 09 27
(731) DIAGEO BRANDS B.V.
10-12 Molenwerf, 1014 BG Amsterdam,
Netherlands
(740) Tamar Kochlamazashvili
(540)

DOUBLE BLACK

(591) Black, white
(511) 33

(260) AM 2014 74169 A
 (210) AM 074169
 (220) 2013 10 02
 (731) LTD "BARAMBO"
 Sof. Natakhtari, 3308, Mtskheta, Georgia
 (540)

ბარამბო
Barambo
 Барамбо

(591) Black, white
 (511) 25, 28, 38, 41

(260) AM 2014 74249 A
 (210) AM 074249
 (220) 2013 10 08
 (731) "THE GILLETTE COMPANY"
 One Gillette Park, Boston, Massachusetts
 02127, USA

(740) Shalva Gvaramadze
 (540)

SWIRL

(591) Black, white
 (511) 8

(260) AM 2014 74303 A
 (210) AM 074303
 (220) 2013 10 10
 (731) LTD "EMEDICA"
 Griboedovis q. №3, 0108, Tbilisi, Georgia
 (540)

The logo for EMEDICA features a stylized blue '@' symbol followed by the word 'medica' in a lowercase, blue, sans-serif font.

(591) Blue, sky-blue
 (531) 26.01.18-29.01.04-
 (511) 9, 35, 36, 38, 39, 42

(260) AM 2014 74328 A
 (210) AM 074328
 (220) 2013 10 11
 (731) LTD "QARTULI GVINIS SAKHLI"
 Sof. Zegaani, 1514, Gurjaanis raioni, Georgia
 (740) Zurab Batsanadze
 (540)

აზნაური
AZNAURI
 АЗНАУРИ

(591) Black, white
 (511) 33

(260) AM 2014 74329 A
 (210) AM 074329
 (220) 2013 10 11
 (731) LTD "QARTULI GVINIS SAKHLI"
 Sof. Zegaani, 1514, Gurjaanis raioni, Georgia
 (740) Zurab Bacanadze
 (540)



(591) Red and beige
 (531) 05.07.10-26.01.21-26.04.22-28.05.00-
 29.01.13-
 (526) The trademark is protected as a whole. The
 word "TBILISOBA" included therein shall not be
 subject to independent legal protection.
 (511) 33

(260) AM 2014 74330 A
 (210) AM 074330
 (220) 2013 10 11
 (731) LTD "QARTULI GVINIS SAKHLI"
 Sof. Zegaani, 1514, Gurjaanis raioni, Georgia
 (740) Zurab Bacanadze
 (540)



(591) Red and beige
 (531) 05.07.10-26.01.21-26.04.22-28.19.00-
 29.01.13-
 (526) The trademark is protected as a whole. The
 word „თბილისობა“ included therein shall not be
 subject to independent legal protection.
 (511) 33

(260) AM 2014 74331 A
 (210) AM 074331
 (220) 2013 10 11
 (731) LTD "QARTULI GVINIS SAKHLI"
 Sof. Zegaani, 1514, Gurjaanis raioni, Georgia
 (740) Zurab Bacanadze
 (540)



(591) Red and beige
 (531) 05.07.10-26.01.21-26.04.22-27.05.24-
 29.01.13-

(526) The trademark is protected as a whole. The word "TBILISOBA" included therein shall not be subject to independent legal protection.
(511) 33

(260) AM 2014 74332 A
(210) AM 074332
(220) 2013 10 11
(731) JSC "QARTULI LUDIS KOMPANIA"
Sof. saguramo, 3311, Mtskheta, Georgia
(740) Edisher Khimshiashvili
(540)



(591) Golden, blue and green color combination
(531) 05.07.10-06.07.01-24.01.10-24.01.11-28.19.00-29.01.15-

(526) The trademark is protected as a whole. The word "Грузинский" included therein shall not be subject to independent legal protection.
(511) 32

(260) AM 2014 74340 A
(210) AM 074340
(220) 2013 10 15
(731) LTD "EMBRIONI"
S. Karatakla, 4703, Gardabani, Georgia
(740) Tea Kereselidze
(540)

V-DRUF
ვი-დრუფი

(591) Black, white
(511) 5

(260) AM 2014 74345 A
(210) AM 074345
(220) 2013 10 15
(731) "MASTERCARD INTERNATIONAL INCORPORATED", a Delaware Corporation
2000 Purchase Street, Purchase, New York 10577, USA
(740) Tamar Kochlamazashvili
(540)

WORLD MASTERCARD

(591) Black, white
(511) 36

(260) AM 2014 74346 A
(210) AM 074346
(220) 2013 10 15
(731) "THE YOKOHAMA RUBBER CO., LTD"
36-11, 5-chome Shimbashi, Minato-ku, Tokyo, Japan
(740) Shalva Gvaramadze
(540)

ice GUARD

(591) Black, white
(531) 27.05.17-
(511) 12

(260) AM 2014 74484 A
(210) AM 074484
(220) 2013 10 25
(731) MEGAINPHARM GMBH
Wörthersee-Süduferstr. 163 c. 5, 9082 Maria Wörth, Austria
(740) Shalva Gvaramadze
(540)

MYRAMISTIN

(591) Black, white
(511) 3, 5

(260) AM 2014 74485 A
(210) AM 074485
(220) 2013 10 25
(731) MEGAINPHARM GMBH
Wörthersee-Süduferstr. 163 c. 5, 9082 Maria Wörth, Austria
(740) Shalva Gvaramadze
(540)

МИРАМИСТИН

(591) Black, white
(511) 3, 5

(260) AM 2014 74486 A
(210) AM 074486
(220) 2013 10 25
(731) JSC „IERIA“
Gudautis q. №7, didubis raioni, 0119, Tbilisi, Georgia
(540)

ბუბო
Нუნი
Nuni

(591) Black, white
(511) 3, 5

(260) AM 2014 74546 A
 (210) AM 074546
 (220) 2013 10 30
 (731) FISHER CONTROLS INTERNATIONAL LLC
 205 South Center St., Marshalltown, Iowa
 50158, USA
 (740) Tamaz Shilakadze
 (540)

DELTA V

(591) Black, white
 (511) 9

(260) AM 2014 74711 A
 (210) AM 074711
 (220) 2013 11 11
 (731) KAREN VARDANYAN
 Ap. 36, 3 Bairon Str., Yerevan, Armenia
 (740) Davit Zurabishvili
 (540)

ORIENT

(591) Black, white
 (511) 30

(260) AM 2014 74754 A
 (210) AM 074754
 (220) 2013 11 15
 (731) LTD "GEO-ALKO"
 Lilos 51, 0103, Tbilisi, Georgia
 (540)



(591) Swampy, brown and/or bordeaux
 (531) 25.01.10-25.01.19-25.03.07-27.05.24-
 29.01.12-
 (511) 33

(260) AM 2014 74757 A
 (210) AM 074757
 (220) 2013 11 15
 (731) LTD "GEO-ALKO"
 Lilos 51, 0103, Tbilisi, Georgia
 (540)

ძველი კახეთი СТАРАЯ КАХЕТИЯ

(591) Black, white
 (526) The trademark is protected as a whole. The words „კახეთი“ and "КАХЕТИЯ" included therein shall not be subject to independent legal protection.
 (511) 33

(260) AM 2014 74770 A
 (210) AM 074770
 (220) 2013 11 18
 (731) VISA INTERNATIONAL SERVICE
 ASSOCIATION
 900 Metro Center Boulevard, Foster City,
 California 94404, USA
 (740) George Meipariani
 (540)

EVERYWHERE YOU WANT TO BY

(591) Black, white
 (511) 36

(260) AM 2014 74802 A
 (210) AM 074802
 (220) 2013 11 20
 (731) PHILIP MORRIS BRANDS SÀRL.
 Quai Jeanrenaud 3, 2000 Neuchâtel,
 Switzerland
 (740) Shalva Gvaramadze
 (540)



(591) White, black, different tone grey, sky-blue
 and blue
 (531) 01.05.01-19.03.03-24.09.07-25.01.01-
 27.05.10-29.01.12-

(526) The trademark is protected as a whole. The words "SUPER SLIMS" included therein shall not be subject to independent legal protection.
(511) 34

(260) AM 2014 74810 A
(210) AM 074810
(220) 2013 11 21
(731) "DIVAN TURIZM İŞLETMELERİ ANONİM ŞİRKETİ"
Saray Mahalessi. Dr. Fazil Küçük Cad. Üntel Sok. No:15 Ümraniye, Istanbul, Turkey
(740) George Meipariani
(540)

divan
suits

(591) Black, white
(531) 27.05.11-
(511) 35, 36, 43

(260) AM 2014 74868 A
(210) AM 074868
(220) 2013 11 25
(731) JSC "TELAVIS GVINIS MARANI"
sof. Kurdgelauri, 2200, Telavi, Georgia
(740) Alexander Kvernadze
(540)

MZIANI

(591) Black, white
(511) 33

(260) AM 2014 74869 A
(210) AM 074869
(220) 2013 11 25
(731) JSC "TELAVIS GVINIS MARANI"
sof. Kurdgelauri, 2200, Telavi, Georgia
(740) Alexander Kvernadze
(540)

MZIANETI

(591) Black, white
(511) 33

(260) AM 2014 74903 A
(210) AM 074903
(220) 2013 11 26
(731) LTD "ABC"
Khosharaulis q.25 (nak. 5/35), korp.3, 0119, Tbilisi, Georgia
(540)

STYLER

(591) Black, white
(511) 19, 35

(260) AM 2014 74904 A
(210) AM 074904
(220) 2013 11 26
(731) LTD "ABC"
Khosharaulis q.25 (nak. 5/35), korp.3, 0119, Tbilisi, Georgia
(540)

Gensin

(591) Black, white
(531) 27.05.01-
(511) 19, 35

(260) AM 2014 74905 A
(210) AM 074905
(220) 2013 11 26
(310) 2013737871
(320) 2013 11 01
(330) RU
(731) LOEWE SA
Calle Goya 4, Madrid 28001, Spain
(740) Shalva Gvaramadze
(540)

AURA LOEWE MAGNETICA

(591) Black, white
(511) 3

(260) AM 2014 74920 A
(210) AM 074920
(220) 2013 11 27
(731) LTD "JANSAGI PRODUQTI-DISTRIBUTSIA"
Kostavas q. № 75, me-9 korp., b. №2, 0171, Tbilisi, Georgia
(740) Ketevan Dolidze
(540)

წიქსა

(591) Black, white
(511) 29, 30

(260) AM 2014 74994 A
(210) AM 074994
(220) 2013 12 02
(731) SWISS PHARMA INTERNATIONAL AG
Waldmannstrasse 8, 8001 Zurich, Switzerland
(740) Shalva Gvaramadze
(540)

MOMESAL

(591) Black, white
(511) 5

(260) AM 2014 74995 A
(210) AM 074995
(220) 2013 12 02

(731) SWISS PHARMA INTERNATIONAL AG
 Waldmannstrasse 8, 8001 Zurich, Switzerland
 (740) Shalva Gvaramadze
 (540)

MOMESTER

(591) Black, white
 (511) 5

(260) AM 2014 75002 A
 (210) AM 075002
 (220) 2013 12 03
 (731) LTD "QARTULI BROILER"
 Ak. Shanidzis q.21, 0179, Tbilisi, Georgia
 (740) George Taktakishvili
 (540)



(591) White, red
 (531) 26.04.04-26.04.12-26.04.22-26.04.24-
 29.01.12-
 (511) 29, 35

(260) AM 2014 75009 A
 (210) AM 075009
 (220) 2013 12 03
 (731) MEDA AB
 Box 906, SE-170 09 Solna, Sweden
 (740) Shalva Gvaramadze
 (540)

СОЛКОСЕРИЛ

(591) Black, white
 (511) 5

(260) AM 2014 75076 A
 (210) AM 075076
 (220) 2013 12 06
 (731) LTD "KARTLIS MENEJMENTI"
 Kostavas q. 75g, I sartuli, 0160, Tbilisi,
 Georgia
 (540)



(591) Black, white
 (531) 01.15.23-05.05.20-26.01.06-27.05.01-
 29.01.13-
 (511) 1, 5, 6, 7, 11, 12, 17, 21, 29, 31, 35, 37, 42, 44

(260) AM 2014 75077 A
 (210) AM 075077
 (220) 2013 12 06
 (731) LTD "KARTLIS MENEJMENTI"
 Kostavas q. 75g, I sartuli, 0160, Tbilisi,
 Georgia
 (540)



(591) Black, white
 (531) 01.15.23-05.05.20-26.01.06-28.19.00-
 (511) 1, 5, 6, 7, 11, 12, 17, 21, 29, 31, 35, 37, 42, 44

(260) AM 2014 75078 A
 (210) AM 075078
 (220) 2013 12 06
 (731) LTD "KARTLIS MENEJMENTI"
 Kostavas q. 75g, I sartuli, 0160, Tbilisi,
 Georgia
 (540)



(591) Different tone red, yellow, green
 (531) 01.15.23-05.05.20-26.01.06-27.05.01-
 29.01.13-
 (511) 1, 5, 6, 7, 11, 12, 17, 21, 29, 31, 35, 37, 42, 44

(260) AM 2014 75079 A
 (210) AM 075079
 (220) 2013 12 06
 (731) LTD "KARTLIS MENEJMENTI"
 Kostavas q. 75g, I sartuli, 0160, Tbilisi,
 Georgia
 (540)



(591) Different tone red, yellow, green
 (531) 01.15.23-05.05.20-26.01.06-28.19.00-
 29.01.13-
 (511) 1, 5, 6, 7, 11, 12, 17, 21, 29, 31, 35, 37, 42, 44

(260) AM 2014 75097 A
 (210) AM 075097
 (220) 2013 12 09
 (731) ASUSTEK COMPUTER INCORPORATION
 4F. No:150, Li-Te Rd., Peitou, Taipei, Taiwan,
 China
 (740) Khatuna Imnadze
 (540)

IN SEARCH OF INCREDIBLE

(591) Black, white
 (511) 9

(260) AM 2014 75104 A
 (210) AM 075104
 (220) 2013 12 11
 (731) HOLMARK QARDS PI EL SI
 Bingli roud, bredfordi, uest iorkshiri, bd9 6sd,
 United Kingdom
 (740) George Meipariani
 (540)



(591) Black, white
 (531) 03.01.14-26.04.22-27.05.05-
 (511) 24, 25

(260) AM 2014 75118 A
 (210) AM 075118
 (220) 2013 12 13
 (310) 1,631,204
 (320) 2013 06 14
 (330) CA
 (731) FIT FOODS LTD.
 101-1551 Broadway Street, Port-Coquitlam,
 British Columbia V3c 6N9, Canada
 (740) George Meipariani
 (540)

MUTANT

(591) Black, white
 (511) 5

(260) AM 2014 75119 A
 (210) AM 075119
 (220) 2013 12 13
 (310) UK00003011391
 (320) 2013 06 25
 (330) GB
 (731) BRITISH AMERICAN TOBACCO
 (BRANDS) INC.
 (a Delaware corporation)
 2711 Centerville Road, Suite 300,

Wilmington, Delaware 19808, USA
 (740) Tamar Kochlamazashvili
 (540)

AHE>D

(591) Black, white
 (511) 34

(260) AM 2014 75121 A
 (210) AM 075121
 (220) 2013 12 13
 (731) TERUMO CORPORATION
 44-1, 2-Chome, Hatagaya Shibuya-ku, Tokyo,
 Japan
 (740) Shalva Gvaramadze
 (540)



(591) Black, white
 (531) 26.01.18-27.05.17-
 (511) 10

(260) AM 2014 75134 A
 (210) AM 075134
 (220) 2013 12 16
 (731) LTD "JEOTREIDI"
 Agladzis q.№26, korp. 4, b. 33, 0102,
 Tbilisi, Georgia
 (740) George Taktakishvili
 (540)

Масляна

(591) Black, white
 (511) 29

(260) AM 2014 75219 A
 (210) AM 075219
 (220) 2013 09 09
 (310) 73877/3-GE
 (320) 2013 09 09
 (330) GE
 (731) LTD "Akhali Nateba"
 Al. Kazbegis 25a, 0160, Tbilisi, Georgia
 (740) Khatuna Imnadze
 (540)



(591) Black, white, yellow
 (531) 26.04.12-26.11.09-27.05.17-28.19.00-
 29.01.12-
 (511) 11

REGISTERED TRADEMARKS

(111) M 2014 025158 R
(151) 2014 09 10
(181) 2024 09 10
(260) AM 2013 68256 A
(220) 2013 04 12

(732) LTD "UNIMED GROUP CORP."
Ad. Mitskevichis q. 29, b. 61, 0194, Tbilisi,
Georgia

(111) M 2014 025159 R
(151) 2014 09 10
(181) 2024 09 10
(260) AM 2013 71033 A
(220) 2013 02 25

(732) LTD "UNIMED GROUP CORP."
Ad. Mitskevichis q. 29, b. 61, 0194, Tbilisi,
Georgia

(111) M 2014 025160 R
(151) 2014 09 10
(181) 2024 09 10
(260) AM 2013 71036 A
(220) 2013 02 25

(732) LTD "UNIMED GROUP CORP."
Ad. Mitskevichis q. 29, b. 61, 0194, Tbilisi,
Georgia

(111) M 2014 025161 R
(151) 2014 09 10
(181) 2024 09 10
(260) AM 2014 71119 A
(220) 2013 02 27

(732) JSC "TELAVIS GVINIS MARANI"
Sof. Kurdgelauri, 2200, Telavi, Georgia

(111) M 2014 025162 R
(151) 2014 09 10
(181) 2024 09 10
(260) AM 2014 71360 A
(220) 2013 03 14

(732) STARBUCKS CORPORATION d/b/a
STARBUCKS COFFEE COMPANY
(a Washington corporation), 2401 Utah
Avenue South, Seattle, Washington
98134, USA

(111) M 2014 025163 R
(151) 2014 09 10
(181) 2024 09 10
(260) AM 2014 71369 A
(220) 2013 03 15

(732) EVOLUTION FRESH, INC.
a Delaware corporation
1055 Cooley Avenue, San Bernardino,
California 92408, USA

(111) M 2014 025164 R
(151) 2014 09 10
(181) 2024 09 10
(260) AM 2014 71442 A
(220) 2013 03 20

(732) STARBUCKS CORPORATION D/B/A
STARBUCKS COFFEE COMPANY
(a Washington Corporation)
2401 Utah Avenue South, Seattle, Washington
98134, USA

(111) M 2014 025165 R
(151) 2014 09 10
(181) 2024 09 10
(260) AM 2014 71445 A
(220) 2013 03 20

(732) ARCOR S.A.I.C.
Av. Fulvio Pagani 487, Arroyito, Province of
Cordoba, Argentina

(111) M 2014 025166 R
(151) 2014 09 10
(181) 2024 09 10
(260) AM 2014 71447 A
(220) 2013 03 20

(732) SHULTON, INC.
One Procter & Gamble Plaza, Cincinnati
Ohio 45202, USA

(111) M 2014 025167 R
(151) 2014 09 10
(181) 2024 09 10
(260) AM 2014 71497 A
(220) 2013 03 22

(732) LTD "BI EM SI GORGIA"
Sokhumis q.10, 6000, Batumi, Georgia

(111) M 2014 025168 R
(151) 2014 09 10
(181) 2024 09 10
(260) AM 2014 71498 A
(220) 2013 03 22

(732) LTD "BI EM SI GORGIA"
Sokhumis q.10, 6000, Batumi, Georgia

(111) M 2014 025169 R (151) 2014 09 10 (181) 2024 09 10 (260) AM 2014 71621 A (220) 2013 04 02 (732) COLGATE-PALMOLIVE COMPANY, a Delaware corporation 300 Park Avenue, New York, New York 10022, USA	6001 Bollinger Canyon Road, San Ramon, CA 94583, USA
<hr/>	
(111) M 2014 025170 R (151) 2014 09 10 (181) 2024 09 10 (260) AM 2014 71641 A (220) 2013 04 02 (732) CLAAS KGaA mbH Münsterstraße 33, 33428 Harsewinkel, Germany	(111) M 2014 025175 R (151) 2014 09 10 (181) 2024 09 10 (260) AM 2014 71809 A (220) 2013 04 12 (732) CHEVRON INTELLECTUAL PROPERTY LLC 6001 Bollinger Canyon Road, San Ramon, CA 94583, USA
<hr/>	
(111) M 2014 025171 R (151) 2014 09 10 (181) 2024 09 10 (260) AM 2014 71728 A (220) 2013 04 08 (732) CLAAS KGaA mbH Münsterstraße 33, 33428 Harsewinkel, Germany	(111) M 2014 025176 R (151) 2014 09 10 (181) 2024 09 10 (260) AM 2014 71810 A (220) 2013 04 12 (732) CHEVRON INTELLECTUAL PROPERTY LLC 6001 Bollinger Canyon Road, San Ramon, CA 94583, USA
<hr/>	
(111) M 2014 025172 R (151) 2014 09 10 (181) 2024 09 10 (260) AM 2014 71765 A (220) 2013 04 10 (732) STIEFEL LABORATORIES, INC., Corporation Service Company 2711 Centerville Road, Suite 400, 19808 Wilmington, Delaware, USA	(111) M 2014 025177 R (151) 2014 09 10 (181) 2024 09 10 (260) AM 2014 71811 A (220) 2013 04 12 (732) CHEVRON INTELLECTUAL PROPERTY LLC 6001 Bollinger Canyon Road, San Ramon, CA 94583, USA
<hr/>	
(111) M 2014 025173 R (151) 2014 09 10 (181) 2024 09 10 (260) AM 2014 71806 A (220) 2013 04 12 (732) CHEVRON INTELLECTUAL PROPERTY LLC 6001 Bollinger Canyon Road, San Ramon, CA 94583, USA	(111) M 2014 025178 R (151) 2014 09 10 (181) 2024 09 10 (260) AM 2014 71812 A (220) 2013 04 12 (732) CHEVRON INTELLECTUAL PROPERTY LLC 6001 Bollinger Canyon Road, San Ramon, CA 94583, USA
<hr/>	
(111) M 2014 025174 R (151) 2014 09 10 (181) 2024 09 10 (260) AM 2014 71807 A (220) 2013 04 12 (732) CHEVRON INTELLECTUAL PROPERTY LLC	(111) M 2014 025179 R (151) 2014 09 10 (181) 2024 09 10 (260) AM 2014 71813 A (220) 2013 04 12 (732) CHEVRON INTELLECTUAL PROPERTY LLC 6001 Bollinger Canyon Road, San Ramon, CA 94583, USA
<hr/>	

(111) M 2014 025180 R
(151) 2014 09 10
(181) 2024 09 10
(260) AM 2014 71814 A
(220) 2013 04 12
(732) CHEVRON INTELLECTUAL
PROPERTY LLC6001 Bollinger Canyon
Road, San Ramon, CA 94583, USA

(111) M 2014 025181 R
(151) 2014 09 10
(181) 2024 09 10
(260) AM 2014 71815 A
(220) 2013 04 12
(732) CHEVRON INTELLECTUAL
PROPERTY LLC6001 Bollinger Canyon
Road, San Ramon, CA 94583, USA

(111) M 2014 025182 R
(151) 2014 09 10
(181) 2024 09 10
(260) AM 2014 71816 A
(220) 2013 04 12
(732) CHEVRON INTELLECTUAL
PROPERTY LLC6001 Bollinger Canyon
Road, San Ramon, CA 94583, USA

(111) M 2014 025183 R
(151) 2014 09 10
(181) 2024 09 10
(260) AM 2014 71817 A
(220) 2013 04 12
(732) CHEVRON INTELLECTUAL
PROPERTY LLC6001 Bollinger Canyon
Road, San Ramon, CA 94583, USA

(111) M 2014 025184 R
(151) 2014 09 10
(181) 2024 09 10
(260) AM 2014 71818 A
(220) 2013 04 12
(732) CHEVRON INTELLECTUAL
PROPERTY LLC6001 Bollinger Canyon
Road, San Ramon, CA 94583, USA

(111) M 2014 025185 R
(151) 2014 09 10
(181) 2024 09 10
(260) AM 2014 71819 A
(220) 2013 04 12
(732) CHEVRON INTELLECTUAL
PROPERTY LLC
6001 Bollinger Canyon Road, San Ramon,
CA 94583, USA

(111) M 2014 025186 R
(151) 2014 09 10
(181) 2024 09 10
(260) AM 2014 71820 A
(220) 2013 04 12
(732) CHEVRON INTELLECTUAL
PROPERTY LLC
6001 Bollinger Canyon Road, San Ramon,
CA 94583, USA

(111) M 2014 025187 R
(151) 2014 09 10
(181) 2024 09 10
(260) AM 2014 71821 A
(220) 2013 04 12
(732) CHEVRON INTELLECTUAL
PROPERTY LLC
6001 Bollinger Canyon Road, San Ramon,
CA 94583, USA

(111) M 2014 025188 R
(151) 2014 09 10
(181) 2024 09 10
(260) AM 2014 71822 A
(220) 2013 04 12
(732) CHEVRON INTELLECTUAL
PROPERTY LLC6001 Bollinger Canyon
Road, San Ramon, CA 94583, USA

(111) M 2014 025189 R
(151) 2014 09 10
(181) 2024 09 10
(260) AM 2014 71823 A
(220) 2013 04 12
(732) CHEVRON INTELLECTUAL
PROPERTY LLC6001 Bollinger Canyon
Road, San Ramon, CA 94583, USA

(111) M 2014 025190 R
(151) 2014 09 10
(181) 2024 09 10
(260) AM 2014 71824 A
(220) 2013 04 12
(732) CHEVRON INTELLECTUAL
PROPERTY LLC6001 Bollinger Canyon
Road, San Ramon, CA 94583, USA

(111) M 2014 025191 R
(151) 2014 09 10
(181) 2024 09 10
(260) AM 2014 71825 A
(220) 2013 04 12
(732) CHEVRON INTELLECTUAL
PROPERTY LLC
6001 Bollinger Canyon Road, San Ramon,
CA 94583, USA

(111) M 2014 025192 R
(151) 2014 09 10
(181) 2024 09 10
(260) AM 2014 71826 A
(220) 2013 04 12
(732) CHEVRON INTELLECTUAL
PROPERTY LLC6001 Bollinger Canyon
Road, San Ramon, CA 94583, USA

(111) M 2014 025193 R
(151) 2014 09 10
(181) 2024 09 10
(260) AM 2014 71827 A
(220) 2013 04 12
(732) CHEVRON INTELLECTUAL
PROPERTY LLC6001 Bollinger Canyon
Road, San Ramon, CA 94583, USA

(111) M 2014 025194 R
(151) 2014 09 10
(181) 2024 09 10
(260) AM 2014 71828 A
(220) 2013 04 12
(732) CHEVRON INTELLECTUAL
PROPERTY LLC6001 Bollinger Canyon
Road, San Ramon, CA 94583, USA

(111) M 2014 025195 R
(151) 2014 09 10
(181) 2024 09 10
(260) AM 2014 71829 A
(220) 2013 04 12
(732) CHEVRON INTELLECTUAL
PROPERTY LLC6001 Bollinger Canyon
Road, San Ramon, CA 94583, USA

(111) M 2014 025196 R
(151) 2014 09 10
(181) 2024 09 10
(260) AM 2014 71831 A
(220) 2013 04 12
(732) CHEVRON INTELLECTUAL
PROPERTY LLC6001 Bollinger Canyon
Road, San Ramon, CA 94583, USA

(111) M 2014 025197 R
(151) 2014 09 10
(181) 2024 09 10
(260) AM 2014 71832 A
(220) 2013 04 12
(732) CHEVRON INTELLECTUAL
PROPERTY LLC
6001 Bollinger Canyon Road, San Ramon,
CA 94583, USA

(111) M 2014 025198 R
(151) 2014 09 10
(181) 2024 09 10
(260) AM 2014 72145 A
(220) 2013 05 07
(732) DAVIT DOLIDZE
Khoshtaria-barnovis q.27/42a, b. 5, 0108,
Tbilisi, Georgia

(111) M 2014 025199 R
(151) 2014 09 10
(181) 2024 09 10
(260) AM 2014 72561 A
(220) 2013 06 07
(732) LTD "JEOPASTI"
Saburtalos q. №43, b. 13, 0102, Tbilisi,
Georgia

(111) M 2014 025200 R
(151) 2014 09 10
(181) 2024 09 10
(260) AM 2014 72567 A
(220) 2013 06 10
(732) INTERNATIONAL COFFEE & TEA, LLC
1945 South La Cienega Boulevard, Los
Angeles, California 90034, USA

(111) M 2014 025201 R
(151) 2014 09 10
(181) 2024 09 10
(260) AM 2014 72774 A
(220) 2013 06 19
(732) LTD "ENONI"
Marabdis q.23, b. 11, 0179, Tbilisi, Georgia

(111) M 2014 025202 R
(151) 2014 09 10
(181) 2024 09 10
(260) AM 2014 72869 A
(220) 2013 06 27
(732) BRIDGESTONE CORPORATION
1-1, Kyobashi 3-chome, Chuo-ku, Tokyo,
Japan.

(111) M 2014 025203 R
(151) 2014 09 10
(181) 2024 09 10
(260) AM 2014 72870 A
(220) 2013 06 27
(732) BRIDGESTONE CORPORATION
1-1, Kyobashi 3-chome, Chuo-ku, Tokyo,
Japan.

(111) M 2014 025204 R
(151) 2014 09 10
(181) 2024 09 10
(260) AM 2014 72871 A
(220) 2013 06 27
(732) S.C. JOHNSON & SON, INC.
a Wisconsin corporation
1525 Howe Street, Racine, Wisconsin
53403-2236, USA

(111) M 2014 025205 R
(151) 2014 09 10
(181) 2024 09 10
(260) AM 2014 72882 A
(220) 2013 06 28
(732) ANDELI GROUP CO., LTD.
No:208 Weiqi Road, Yueqing Economic
Development Zone, Yueqing, Zhejiang
325600, China

(111) M 2014 025206 R
(151) 2014 09 10
(181) 2024 09 10
(260) AM 2014 72931 A
(220) 2013 07 02
(732) MARRIOTT INTERNATIONAL, INC.
10400 Fernwood Road, Bethesda, Maryland
20817, USA

(111) M 2014 025207 R
(151) 2014 09 10
(181) 2024 09 10
(260) AM 2014 73100 A
(220) 2013 07 12
(732) LTD "JEO-TREIDINGI" "GEO-TRADING LTD"
Varketilis me-4 m/r, me-3 kv. 7-19, 0163,
Tbilisi, Georgia

TRADEMARKS REGISTERED ACCORDING TO THE ACCELERATED PROCEDURE

The decision can be appealed at the Chamber of Appeal of Sakpatenti within 3 months from the publication.

(111) M 2014 25157 R
(151) 2014 09 03
(181) 2024 09 03
(210) AM 078334
(220) 2014 08 20
(732) LTD "VELINGTONI"
Stanislavskis 5, 0119, Tbilisi, Georgia
(540)

ფრიქს ჩიპს
Frixx chips
Фрикс чипс

(591) Black, white
(526) The trademark is protected as a whole. Word combinations „ჩიპს“, "chips" and "чипс" in the trademark, shall not be subject to independent legal protection.
(511) 29, 35

(111) M 2014 25208 R
(151) 2014 09 11
(181) 2024 09 11
(210) AM 078451
(220) 2014 09 02
(732) OOO "FIRMA "DISNA"
Ul. Lavrskaia, 16, 01015, q. Kievi, Ukraine
(740) Davit Zurabishvili
(540)



(591) Black, white
(531) 01.03.07-
(511) 33

INTERNATIONAL TRADEMARKS FOR WHICH A DECISION ON GRANTING PROTECTIONS IS TAKEN

The decision can be appealed at the Chamber of Appeal of Sakpatenti within 3 months from the publication or at the Mtskheta District Court Administrative Cases Board (Address: №17, Samkhedro str., Mtskheta), within 1 month following the publication.

(260) AM 70827 A*

(800) 1145951

(731) SAMSUNG ELECTRONICS CO., LTD.
129, Samsung-ro, Yeongtong-gu, Suwon-si,
Gyeonggi-do, Republic of Korea

(540)

Samsung ATIV Tab

(591) Black, white

(511)

9 – Mobile telephones; smart phones; tablet computers; notebook computers.

(260) AM 72283 A*

(800) 1025706

(731) Ukrainsko-shveytsarske spilne pidpnyemstvo u formi tovarystva z obmezhenoyu vidpovidalnistyu "Ukrwermut+Co"
Sums'ka str., 73, Kharkiv 61023, Ukraine

(540)

АОМ КФЕ

(591) Black, white

(511)

30 – Coffee; coffee-based beverages; coffee beverages with milk; cocoa; cocoa beverages with milk; cocoa-based beverages; cocoa products; chocolate; chocolate-based beverages; chocolate beverages with milk; sugar.

43 – Bar services; cafes; cafeterias; restaurants; self-service restaurants; food and drink catering; snack-bars.

(260) AM 2014 71404 A

(800) 1073665

(151) 2011 03 15

(891) 2013 01 09

(731) NUFARM
28, boulevard Camélinat, F-92230
GENNEVILLIERS, France

(540)

IKANOS

(591) Black, white

(511)

5 – Herbicides.

(260) AM 2014 73045 A

(800) 1164666

(151) 2013 03 27

(731) Limited Liability Company "DiS PLUS"
16 Park street, 26, RU-105484 Moscow,
Russian Federation

(540)

MAGISTRAL

(591) Black, white

(511)

11 – LED lamps for highways.

(260) AM 2014 73071 A

(800) 790476

(151) 2002 10 29

(891) 2013 02 25

(731) "VIPERA COSMETICS" WRZESIŃSKI
RYSZARD
ul. Armii Krajowej 10, PL-05-500
PIASECZNO, Poland

(540)

vipera

(591) Black, white

(511)

3 – Cosmetics, perfumery products.

(260) AM 2014 73073 A

(800) 1030086

(151) 2009 12 01

(891) 2013 05 30

(731) Skyscanner Limited
c/o Pinsent Masons LLP, 5 Old Bailey,
London EC4M 7BA, United Kingdom

(540)

SKYSCANNER

(591) Black, white

(511)

35 – Advertising services provided via the Internet, opinion polling, data processing, provision of business information, data feeds, auctioneering, all relating to travel.

39 – Travel information and arrangement services provided from an Internet website providing information via means of a global computer network; travel information provided online from a computer

database; travel information accessible via a mobile phone utilising wireless application protocol technology.

42 – Operating of a search engine relating to travel.

(260) AM 2014 73074 A

(800) 1091363

(151) 2011 06 10

(891) 2013 04 08

(731) Obchtchestvo s ogranichennoi otvetstvennostiou "Laboratoria sovremennogo zdorovia"
ul. Khimzavodskaya, 11/20, RU-633004
Berds, Novosibirskaya obl., Russian
Federation

(540)

CHRONOLONG

(591) Black, white

(511)

3 – Bath salts, not for medical purposes; beauty masks; cleansing milk for toilet purposes; cosmetics; cosmetic creams; cosmetic dyes; cosmetic kits; cosmetic preparations for baths; cosmetic preparations for skin care; dentifrices; hair colorants; hair waving preparations; greases for cosmetic purposes; lipsticks; lotions for cosmetic purposes; nail care preparations; oils for cosmetic purposes; perfumery; pomades for cosmetic purposes; shampoos; shaving preparations; soap; tissues impregnated with cosmetic lotions; toiletries.

5 – Albuminous foodstuffs for medical purposes; albuminous preparations for medical purposes; antiseptics; bacterial preparations for medical and veterinary use; balms for medical purposes; biocides; biological preparations for medical purposes [including bioactive food additives]; dietetic beverages adapted for medical purposes; dietetic foods adapted for medical purposes; dietetic substances adapted for medical use; digestives for pharmaceutical purposes; elixirs [pharmaceutical preparations]; ferments for pharmaceutical purposes; food for babies; germicides; herbs teas for medicinal purposes; lacteal flour for babies; liniments; lotions for pharmaceutical purposes; medicinal herbs; medicinal infusions; medicinal oils; medicinal roots; mineral food-supplements [including bioactive food additives]; nervines; nutritional additives for medical purposes [including bioactive food additives]; opotherapy preparations; preparations of trace elements for human use [including bioactive food additives]; sea water for medicinal bathing; serums; styptic preparations; therapeutic preparations for the bath; tonics [medicines]; vitamin preparations.

(260) AM 2014 73075 A

(800) 1102595

(151) 2011 11 11

(891) 2013 04 08

(731) Obchtchestvo s Ogranichennoy Otvetstvennostyu "Laboratoriya Sovremennogo Zdorovya"
ul. Khimzavodskaya, 11/20, Berdsk,
RU-633004 Novosibirskaya oblast,
Russian Federation

(540)

TETRARDIOL

(591) Black, white

(511)

5 – Albuminous foodstuffs for medical purposes; albuminous preparations for medical purposes; antiparasitic preparations; antiseptics; bacterial preparations for medical and veterinary use; balms for medical purposes; biocides; biological preparations for medical purposes [namely, bioactive food additives]; diabetic bread; dietetic beverages adapted for medical purposes; dietetic foods adapted for medical purposes; dietetic substances adapted for medical use; digestives for pharmaceutical purposes; ferments for pharmaceutical purposes; germicides; herbs teas for medicinal purposes; food for babies; lacteal flour for babies; liniments; lotions for pharmaceutical purposes; medicinal herbs; medicinal infusions; medicinal oils; medicinal roots; mineral food-supplements [namely, bioactive food additives]; nervines; nutritional additives for medical purposes [namely, bioactive food additives]; opotherapy preparations; preparations of trace elements for human use [namely, bioactive food additives]; sea water for medicinal bathing; serums; styptic preparations; therapeutic preparations for the bath; tonics [medicines]; vitamin preparations.

(260) AM 2014 73076 A

(800) 1106840

(151) 2011 12 20

(891) 2013 04 17

(731) Joseph-Marie PIVIDAL
1 avenue Montaigne, F-75008 PARIS, France

(540)

LOLITA LEMPICKA

(591) Black, white

(511)

9 – Spectacles.

14 – Precious metals and their alloys and goods in precious metals or coated therewith, not included in other classes; jewelry, precious stones; horological and chronometric instruments.

18 – Leather and imitations of leather, and goods made of these materials and not included in other classes; bags, card cases, purses, briefcases, clutch bags made of leather or imitation leather; trunks and traveling bags; umbrellas, parasols and walking sticks.

(260) AM 2014 73079 A
 (800) 1137668
 (151) 2012 09 06
 (891) 2013 05 24
 (731) KWH Mirka Ltd
 FI-66850 Jepua, Finland
 (540)

АБРАЛОН

(591) Black, white
 (511)
 3 – Abrasives, coated abrasives, non-woven abrasives, flexible abrasives, abrasive net, abrasive film, abrasive cloth, abrasive paper, abrasive discs, abrasive sheets, abrasive strips, abrasive belts, abrasive rolls.

(260) AM 2014 73080 A
 (800) 1140449
 (151) 2012 10 11
 (891) 2013 05 24
 (731) KWH Mirka Ltd
 FI-66850 JEPUA, Finland
 (540)

КБЮ.СИЛВЕР

(591) Black, white
 (511)
 3 – Abrasives, coated abrasives, flexible abrasives, abrasive paper, abrasive discs, abrasive sheets, abrasive strips, abrasive rolls, abrasive belts.

(260) AM 2014 73191 A
 (800) 1165862
 (151) 2013 05 16
 (731) VANHECKE Peter
 Bogdana Khmel'nitskogo Street 80 app. 14,
 KIEV 01030, Ukraine
 (540)

CANNONIERE

(591) Black, white
 (511)
 3 – Bleaching preparations and other substances for laundry use; cleaning, polishing, scouring and abrasive preparations; soaps; perfumery, essential oils, cosmetics, hair lotions; dentifrices.

18 – Leather and imitation leather, and goods made of these materials and not included in other classes; animal skins; trunks and suitcases; umbrellas and parasols; walking sticks; whips, harness and saddlery.

25 – Clothing, footwear, headgear.

35 – Advertising; business management; business administration; administrative services; retail services in the field of clothing, footwear and headgear; commercial mediation for wholesale trade in clothing, footwear and headgear; commercial mediation for sale (by electronic means, such as the Internet) of clothing, footwear and headgear.

(260) AM 2014 73194 A
 (800) 1165905
 (151) 2013 06 07
 (731) Aegerion Pharmaceuticals, Inc.
 101 Main Street, STE 1850, Cambridge,
 Massachusetts 02142, USA
 (540)

LOJUXTA

(591) Black, white
 (511)
 5 – Pharmaceuticals for the treatment of cardiovascular disorders, in particular, hyperlipidemia.
 42 – Pharmaceutical research and development in the field of cardiovascular disease, in particular, hyperlipidemia.

(260) AM 2014 73195 A
 (800) 1165920
 (151) 2011 11 24
 (731) BEIQI FOTON MOTOR CO., LTD.
 Laoniawan Village North, Shayang Road,
 Shahe Town, Changping District, 102206
 Beijing, China
 (540)

AUV

(591) Black, white
 (511)
 12 – Automobiles; trucks; vehicles for transport for agricultural use; tractors; engines for motor land vehicles; motorcycles; cars; fork lift trucks; lifting cars; coaches.

(260) AM 2014 73199 A
 (800) 1165958
 (151) 2012 11 22
 (731) BERTEKS TEKSTİL SANAYİ VE TİCARET
 ANONİM ŞİRKETİ
 Dosab Karanfil Sokak No:5, Osmangazi-
 Bursa, Turkey
 (540)

IODSIGN

(591) Black, white
 (511)
 24 – Woven textiles, namely, fabrics for use in the manufacture of clothing, towels, table linen, bed linen, household linen; non-woven textiles, namely, fabrics for use in the manufacture of clothing, towels, table linen, bed linen, household linen; fiberglass fabrics for textile use; fabric impervious to gases for aeronautical balloons; waterproof fabrics, namely, waterproof fabric for manufacturing clothing, furniture, luggage and automobile upholstery; gummed waterproof cloth; fabric of imitation animal skins; textile linings, namely, linen lining fabric for shoes, unfinished textile for the manufacture of li-

nings for garments, textile used as lining for clothing; buckram; filtering materials of textile, namely, chemical fiber fabrics, synthetic fiber fabrics, inorganic fiber mixed fabrics all for use in filtering liquids and powders; quilts of textile, blankets; washing mitts, bath linen, hand towels, face towels of textile, bathing towels; tapestries of textile, handkerchiefs of textile, banners of textile, namely, cloth banners; flags not of paper, namely, cloth flags, fabric flags; cloth labels; traveling rugs, namely, lap rugs; curtains of textile, shower curtains of textile, shower curtains of plastics; oilcloth for use as table cloths; bed covers, namely, bed blankets, bed sheets, bedspreads, bed linen, diapered linen, pillowcases, quilt covers; furniture coverings of textile, namely, unfitted fabric furniture covers; upholstery fabrics; table napkins of textile; bed covers of paper.

25 – Clothing, namely, trousers, jackets, overcoats, coats, skirts, suits, jerseys, waistcoats, shirts, ready-made leather linings (parts of clothing), T-shirts, sweatshirts, dresses, bermuda shorts, shorts, pajamas, pullovers, jeans, tracksuits, rainwear, beachwear, bathing suits, swimming suits; clothing for sports (for exclusive use for sports), clothing for babies, namely, shirts, pants, coats, dresses; underclothing, namely, boxer shorts, brassieres, briefs, pants, socks; footwear, namely shoes excluding orthopedic shoes, sandals, waterproof boots, walking boots, booties, sporting shoes, slippers; shoe parts namely heelpieces, insoles for footwear, footwear uppers; headgear, namely caps, skull caps, sports caps, hats, berets; gloves (clothing), stockings, belts (clothing), camisoles, sarongs, scarves, neck scarves, shawls, collars, neckties, ties, suspender belts.

35 – Advertising agencies services, marketing and publicity bureaus services including commercial or advertisement exhibition and trade fair organization services; providing office functions; business management; business administration; import and export agencies; business investigations, evaluations, expert business appraisals; auctioneering; the bringing together, for the benefit of others, of woven textiles, namely, fabrics for use in the manufacture of clothing, towels, table linen, bed linen, household linen, clothing, footwear, headgear (excluding the transport thereof), enabling customers to conveniently view and purchase those goods; all of the aforementioned services may be provided by retail stores, wholesale outlets, through mail order catalogues or by means of electronic media, for example, through web sites or television shopping programmes.

(260) AM 2014 73200 A
(800) 1165969
(151) 2013 01 10
(731) JOEONE CO.,LTD.

Qingmengyuan Zone, Quanzhou Economy & Technology, Development Area, Fujian Province, China

(540)

Calliprimo
格利派蒙

(591) Black, white

(511)

25 – Clothing; shirts; suits, trousers; knitwear (clothing); top coats; jackets (clothing); clothing of imitations of leather; clothing of leather; clothing of leather; tee-shirts; underwear, dust coats; waistcoats; layettes (clothing); bathing suits; shoes; hats; hosiery; gloves; neckties; straps (Terms Too Vague in the opinion of the International Bureau – Rule 13(2)(b) of the Common Regulations); wedding clothes.

(260) AM 2014 73350 A

(800) 1168012

(151) 2013 06 17

(731) DENK PHARMA GmbH & Co. KG
Prinzregentenstr. 79, 81675 München,
Germany

(540)

DENK

(591) Black, white

(511)

5 – Pharmaceutical preparations and chemical preparations for medical purposes; healthcare preparations; dietetic preparations for medical purposes on the basis of vitamins, mineral nutrients, trace elements, proteins and carbohydrates; food supplements for medical and non-medical purposes.

35 – Wholesale and retail trade with pharmaceutical and chemical preparations used in industry, science, agriculture, horticulture and forestry, especially for use in the foodstuff, food supplement, pharmaceutical and cosmetics industries, artificial sweeteners, paints and dyes, plant extracts and plant oils for cosmetic purposes, chemical preparations for pharmaceutical and medical purposes, animal oils and plant oils as well as plant extracts for pharmaceutical and medical purposes, proteins for pharmaceutical and medical purposes, food supplements for pharmaceutical and medical purposes, minerals and vitamins.

(260) AM 2014 74202 A

(800) 1175707

(151) 2013 08 02

(731) Messe München GmbH
Am Messesee 2, 81829 München,
Germany

(540)



(591) Green, orange, grey and black

(511)

35 – Advertising, marketing and promotion; arranging and conducting of trade fairs and shows, events, displays, conferences, conventions, presentations, talks and exhibitions for business and advertising purposes; business networking services; provision, reservation and rental of exhibition stands, booths and equipment, advertising hoardings and advertising space; provision of trade information relating to the ceramics industry; business advice, assistance and information; business services relating to the provision of sponsorship; information, advice and consultancy in relation to all the aforesaid services.

(260) AM 2014 74223 A

(800) 1175875

(151) 2013 04 17

(731) Zentiva Group, a.s.

U Kabelovny 130, CZ-102 37 Praha

10 – Dolní Měcholupy, Czech Republic

(540)

MANTEXIN

(591) Black, white

(511)

5 – Medicines, pharmaceutical preparations for human use.

(260) AM 2014 74224 A

(800) 1175876

(151) 2013 04 17

(731) Zentiva Group, a.s.

U Kabelovny 130, CZ-102 37 Praha

10 – Dolní Měcholupy, Czech Republic

(540)

SEGOSANA

(591) Black, white

(511)

5 – Medicines, pharmaceutical preparations for human use.

(260) AM 2014 74225 A

(800) 1175927

(151) 2013 08 20

(731) Becton, Dickinson and Company

1 Becton Drive, MC 090 Franklin Lakes,

NJ 07417, USA

(540)

BD FACSFREE

(591) Black, white

(511)

1 – Chemicals for flow cytometry.

(260) AM 2014 74226 A

(800) 1175929

(151) 2013 08 20

(731) Apple Inc.

1 Infinite Loop, Cupertino, CA 95014, USA

(540)

AIRPORT TIME CAPSULE

(591) Black, white

(511)

9 – Computer hardware and peripherals; computer hardware and computer software for communication between multiple computers and between computers and local and global computer networks; computer hardware for data backup; computer memory hardware.

(260) AM 2014 74228 A

(800) 1175937

(151) 2013 06 10

(731) COMPANY FOREX CLUB LTD.

Apartment No 3 Beau Bios, Castle Comfort, Roseau, Dominica

(540)

LIBERTEX

(591) Black, white

(511)

9 – Identity cards, magnetic; encoded magnetic cards; optical data media; magnetic data media; electronic publications, downloadable; smart cards [integrated circuit cards]; audiovisual teaching apparatus; computer programmes [programs], recorded; computer game programs; computer programs [downloadable software].

36 – Financial analysis; lease-purchase financing; capital investments; financial information; financial consultancy; stock exchange quotations; brokerage; financial management; exchanging money; home banking; electronic funds transfer; stocks and bonds brokerage; loans [financing]; instalment loans; provident fund services; mutual funds; financing services.

42 – Computer system analysis; recovery of computer data; computer virus protection services; installation of computer software; computer software consultancy; updating of computer software; monitoring of computer systems by remote access; maintenance of computer software; providing search engines for the internet; data conversion of computer programs and data [not physical conversion];

computer system design; rental of web servers; rental of computer software; hosting computer sites [web sites]; duplication of computer programs; computer software design; creating and maintaining web sites for others; computer programming; surveying.

(260) AM 2014 74229 A

(800) 1175961

(151) 2013 03 01

(731) DIZAYN TEKNIK BORU VE
ELEMENLARI SANAYI VE TICARET
ANONIM SIRKETI

Ataturk Mah. Inonu Cad. No:6 Kirac,
TR-34522 Esenyurt/Istanbul, Turkey

(540)



(591) Blue, red and white

(511)

6 – Pipes and tubes of metal; water-pipes of metal; gas-pipes of metal; junctions of metal for pipes; drilling pipes of metal; flanges of metal; nipples; stop collars of metal; collars of metal for fastening pipes; elbows of metal for pipes; tees of metal.

19 – Non-metallic rigid plastic pipes for building and their fittings; water pipes, not of metal; drain pipes, not of metal; branching pipes, not of metal.

(260) AM 2014 74230 A

(800) 1175973

(151) 2013 04 05

(731) MAZZA GRAZIANO
Lungomare Gramsci, 19, I-63822 PORTO
SAN GIORGIO (FM), Italy

(540)



(591) Black, white

(511)

18 – Leather and imitations of leather, and goods made of these materials and not included in other classes; animal skins, hides; trunks and travelling bags; bags of leather, eco-leather, imitation leather, plastic or textile, including bags, handbags, shoulder bags, overnight bags, key cases, chain mail purses, not of precious metal, holdalls, gentlemen's handbags, make-up bags, travelling bags, shopping bags, wheeled shopping bags, travelling sets (leather ware), vanity cases (not fitted); bags for footwear and multi-purpose sports bags, waist packs, rucksacks, vanity cases, all of leather, imitation leather and/or textile; garment bags for travel of leather and eco-leather, key cases, key cases of leather; purses, briefcases, pocket wallets, card cases (notecases),

business card holders, pocket wallets and accessories, all of leather, imitation leather, eco-leather and/or textile, not included in other classes; hat boxes of leather, cases of leather or leather board; leather lining for boots and shoes; umbrellas, parasols and walking sticks; whips, harness and saddlery.

25 – Clothing for men, women and children of any kind of textile or material, including skirts, trousers, shorts, jeans, shirts, blouses, jerseys, sweaters, t-shirts, vests, suits, tracksuits, coats, overcoats, coats, bomber jackets, jackets, wind-resistant jackets, waterproof clothing, parkas, stockings, tights, socks, tights, shawls, sashes for wear, scarves, gloves, ties, underwear, nightshirts, pyjamas, bath robes and bathing costumes; footwear for men, women and children of textile, leather, imitation leather or any other material, including sandals, bath sandals, bath slippers, boots and booties, moccasins and slippers, slippers, gymnastic shoes, beach shoes, sports shoes, dance shoes, leisure footwear, overshoes, soles for footwear, parts of footwear, not included in other classes, components for footwear, not included in other classes; hats and berets, caps, sun visors; belts; clothing accessories of leather and imitation leather included in this class.

35 – Commercial consultancy, advertising, advertising services provided over the Internet; presentation of goods and services on the Internet; business management; marketing; retailing and wholesaling, including via the Internet, of leather and imitations of leather, and goods made of these materials and not included in other classes, animal skins, hides; trunks and travelling bags, bags of leather, eco-leather, imitations of leather, plastic or textile material, including handbags, everyday bags, shoulder bags, overnight bags, key cases, chain mail purses, not of precious metal, holdalls, gentlemen's handbags, make-up bags, duffel bags and travel bags, bags for shopping, wheeled shopping bags, travelling sets (leather ware), vanity cases (not fitted), shoe bags and multipurpose bags for sport, bum bags, rucksacks, beauty cases, all being of leather, imitations of leather and/or textile, garment bags for travel of leather and eco-leather, cases for keys, key cases of leather, purses, document holders, pocket wallets, card cases, business card holders, pocket wallets and accessories, not included in other classes, all of leather, imitations of leather, eco-leather and/or textiles, hat boxes of leather, cases of leather or leather board, covers of leather for boots and shoes, umbrellas, parasols and walking sticks, whips, harness and saddlery; retailing and wholesaling, including via the Internet, of clothing for men, women and children, in textile or material of all kinds, including skirts, trousers, shorts, jeans, shirts, chemisettes, sports jerseys, sweaters, T-shirts, vests, overalls, tracksuits, coats, overcoats, sports jackets, top coats, waistcoats, hoodies, jackets, wind-

cheaters, raincoats, parkas, stockings, tights, socks, body stockings, shawls, sashes for wear, scarves, gloves, ties, underclothing, baby-doll nightdresses, nightdresses, pyjamas, bathrobes and swimsuits, footwear for men, women and children of textile, leather, imitations of leather and material of any other kind, including sandals, bath sandals, bath slippers, boots, walking boots and shoes, moccasins and slippers, mules, gym shoes, beach shoes, footwear for sport, ballet shoes, footwear for leisure, overshoes, soles for footwear, parts of footwear not included in other classes, components for footwear not included in other classes, hats and berets, headgear, sun visors, belts, clothing accessories of leather and imitations of leather included in this class; marketing services provided via the Internet; auctioneering, in particular in the Internet; business administration; business advisory services relating to franchising; commercial management assistance in relation to franchises, office functions (provided by others).

(260) AM 2014 74231 A

(800) 1175975

(151) 2013 05 02

(731) GIANVITO ROSSI S.R.L.

UNIPERSONALE

Via Gramsci, 9, I-47030 SAN MAURO

PASCOLI (FC), Italy

(540)

Gianvito Rossi

MILANO

(591) Black, white

(511)

3 – Soaps; perfumery; essential oils; cosmetics; hair lotions; dentifrices; eau de Cologne (cologne water); cosmetic creams; sachets for perfuming linen; air fragrancing preparations; talcum powder, for toilet use.

9 – Spectacle cases; pince-nez chains; spectacle lenses; spectacle frames; sunglasses; goggles for sports; spectacles (optics).

14 – Precious metals and their alloys and goods in precious metals and their alloys or coated therewith, not included in other classes; jewellery, precious stones; horological and chronometric instruments; rings (jewellery, jewelry (Am.)); cuff links; bracelets (jewellery, jewelry (Am.)); watch bracelets (bands); necklaces (jewellery, jewelry (Am.)); earrings; hat ornaments of precious metal.

18 – Trunks (luggage); vanity cases, not fitted; suit bags; hiking bags; travelling sets (leatherware); shopping bags; shoe bags; school satchels; key cases; umbrellas; wallets; pouch baby carriers; purses; leather briefcases.

25 – Footwear; gloves; belts.

35 – Wholesale, retailing and online sale of soaps, perfumery, essential oils, cosmetics, hair lotions, dentifrices, eau de cologne (cologne water), cosmetic creams, sachets for perfuming linen, air fragrancing preparations, talcum powder, for toilet use, spectacle cases, pince-nez chains, spectacle lenses, spectacle frames, sunglasses, goggles for sports, spectacles (optics), precious metals and their alloys and goods in precious metals and their alloys or coated therewith, not included in other classes, jewellery, precious stones, horological and chronometric instruments, rings (jewellery, jewelry (Am.)), cufflinks, bracelets (jewellery, jewelry (Am.)), watch bracelets (bands), necklaces (jewellery, jewelry (Am.)), earrings, hat ornaments of precious metal, trunks (luggage), vanity cases, not fitted, suit bags, hiking bags, travelling sets (leatherware), shopping bags, shoe bags, school satchels, key cases, umbrellas, wallets, pouch baby carriers, purses, leather briefcases, footwear, gloves, belts.

(260) AM 2014 74235 A

(800) 1176006

(151) 2013 05 28

(731) ROTA SEYAHAT ACENTALIGI VE

TURİZM LTD.STİ.

Soğucaksu Mahallesi Susam Sokağı No:3,

Aksu Antalya, Turkey

(540)

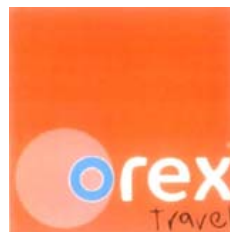

(591) Orange, blue, white, black, pink.

(511)

39 – Transport; packaging and storage of goods; travel arrangement; arranging and booking tourist travel and sightseeing tours, arranging booking and travel for package holidays.

41 – Education; providing of training; entertainment; sporting and cultural activities, arranging and conducting of seminars, congresses, conferences and symposiums.

43 – Services for providing food and drink; temporary accommodation, agency services for booking hotel accommodation.

(260) AM 2014 74236 A

(800) 1176015

(151) 2013 06 12

(731) BRUPHARMEXPORT SPRL

Rue de la Grotte 14, B-1020 Bruxelles,

Belgium

(540)



(591) Black, white

(511)

5 – Pharmaceutical and veterinary products; sanitary products for medicine; dietetic food and substances for medical or veterinary use; food for babies; food supplements for humans and animals; plasters; materials for dressings; material for dental fillings and dental impressions; disinfectants; products for destroying vermin; fungicides; herbicides.

16 – Paper, cardboard and goods made of these materials not included in other classes; printed matter (printing products); bookbinding material; photographs; stationery; adhesives for stationery or household purposes; artists' materials; paintbrushes; typewriters and office requisites (except furniture); instructional or teaching material (except apparatus); plastic materials for packaging (not included in other classes); printing type; printing blocks.

42 – Scientific and technological services and research and design relating thereto; industrial analysis and research services; design and development of computers and software.

44 – Medical services; veterinary services; hygienic and beauty care for human beings or animals; agriculture, horticulture and forestry services.

(260) AM 2014 74237 A

(800) 1176016

(151) 2013 06 04

(731) Europäische Patentorganisation
80331 München, Germany

(540)

Espacenet

(591) Black, white

(511)

38 – Providing access to computer databases; online services, namely providing and transmitting data, especially publications, texts, information, legal status, drawings and pictures concerning patents and utility models; transfer and transmission of data through the Internet by means of telecommunication (telecommunication); online services, namely providing access to an automated translation system and transmitting the automated translations; providing access to an Internet system and to computer network systems for machine translations; leasing of access time to computer databases.

42 – Providing search engines for computer databases and for the internet.

45 – Online services in the field of patent information.

(260) AM 2014 74238 A

(800) 1176027

(151) 2013 08 08

(731) Tovarishchestvo s ogranichennoi
otvetstvennostyu "Hamle Company Ltd"
ul. Abylai Khana, d. 3-A, g. Kaskelen,
040900 Almalinskaya obl., Kazakstan

(540)

XAMJIE

(591) Black, white

(511)

30 – Pastry and confectionery including biscuits, sweetmeats [candy], waffles, chocolate, chewing gum.

(260) AM 2014 74239 A

(800) 1176031

(151) 2013 08 01

(731) ATLAS COPCO AIRPOWER, NV
Boomsesteenweg 957, B-2610 Wilrijk,
Belgium

(540)



(591) Blue

(511)

7 – Machines and machine tools; motors and engines (except for land vehicles); machine coupling and transmission components (except for land vehicles); compressors; air compressors; piston compressors; air/water separators; compressed air guns; power-operated spray guns; hand-held electric grinders; pneumatic hammers; couplings (other than for land vehicles); valves (parts of machines); power stapler guns; vacuum cleaners; lubricators (parts of machines); chisels for machines; filters (parts of machines); grinders, grinding machines; drain cocks; drive systems for operating the motor within a compressor in a variable speed; driving motors other than for land vehicles.

(260) AM 2014 74240 A

(800) 1176064

(151) 2013 07 02

(731) Jakobi Import + Export GmbH
Robert-Perthel Straße 3, 50739 Köln,
Germany

(540)

Riksamin

(591) Black, white

(511)

5 – Food for babies, dietetic beverages adapted for medical purposes, infusions for medical purposes, medicinal infusions.

30 – Coffee, coffee-based beverages and coffee beverages with milk, artificial coffee and vegetal preparations for use as coffee substitutes, tea, tea-based beverages, iced tea and herbal teas, not medicinal infusions, cocoa and cocoa-based beverages, cocoa beverages with milk, chocolate beverages with milk and chocolate-based beverages, ice for refreshment.

32 – Beers and non-alcoholic beverages, mineral water (beverages and carbonated water, fruit juices, fruit juice beverages, non-alcoholic fruit juice beverages and fruit nectars, lemonades and syrups for lemonade, syrups for beverages, preparations and essences for making beverages, non-alcoholic fruit extracts, non-alcoholic honey-based beverages, powders for effervescing beverages and pastilles for effervescing beverages, vegetable juices (beverages), isotonic beverages, milk of almonds (beverage), whey beverages, sherbets (beverages).

(260) AM 2014 74241 A

(800) 1176098

(151) 2013 07 25

(731) CHIESI FARMACEUTICI S.P.A.

26/A, via Palermo, I-43122 PARMA (PR),
Italy

(540)

SABACOMB

(591) Black, white

(511)

5 – Pharmaceutical preparations and medicinal preparations; pharmaceutical preparations for treating respiratory disorders.

(260) AM 2014 74251 A

(800) 1176103

(151) 2013 07 29

(731) "Group of companies "Accent"

Limited Liability Company
5, lit. Zh, Samoilovoy str., RU-192102
Saint Petersburg, Russian Federation

(540)



(591) Blue, green, orange, black and lilac

(511)

6 – Aluminium foil; foils of metal for wrapping and packaging.

16 – Garbage bags of paper or of plastics; plastic film for wrapping; viscose sheets for wrapping; plastic bubble packs for wrapping or packaging; sheets of reclaimed cellulose for wrapping; silver paper; paper napkins.

21 – Sponges for household purposes; sponge holders; buckskin for cleaning; saucepan scourers of metal; gloves for household purposes; polishing gloves; gardening gloves; pads for cleaning; cloths for washing floors; cloths for cleaning; dusting cloths [rags]; articles for cleaning purposes including nail brushes, rolls with adhesive layers for cleaning clothes, toilet brushes, dishwashing brushes, devices for cleaning windows, long handled tar brushes, mops, mop wringers.

22 – Bags, and namely bags of textile for washing linen and clothes; bags for washing hosiery.

24 – Textile goods, and namely napkins of textile.

(260) AM 2014 74252 A

(800) 1176108

(151) 2013 07 09

(731) Astellas Pharma Europe B.V.

Sylviusweg 62, NL-2333 BE Leiden,
Netherlands

(540)

OMNIC OCAS

(591) Black, white

(511)

5 – Pharmaceutical and medical preparations and substances.

(260) AM 2014 74253 A

(800) 1176118

(151) 2013 07 31

(731) BIOFARMA

50 rue Carnot, F-92284 SURESNES CEDEX,
France

(540)

ПРЕСТАЛИА

(591) Black, white

(511)

5 – Pharmaceutical and veterinary products; sanitary products for medicine; dietetic food and substances adapted for medical or veterinary use, food for babies; food supplements for humans and animals; materials for dressings; material for dental fillings and dental impressions; disinfectants; products for destroying vermin; fungicides, herbicides.

(260) AM 2014 74254 A
 (800) 1176119
 (151) 2013 07 31
 (731) BIOFARMA
 50 rue Carnot, F-92284 SURESNES CEDEX,
 France

(540)

ВИАКОРАМ

(591) Black, white

(511)

5 – Pharmaceutical and veterinary products; sanitary products for medicine; dietetic food and substances adapted for medical or veterinary use, food for babies; food supplements for humans and animals; materials for dressings; material for dental fillings and dental impressions; disinfectants; products for destroying vermin; fungicides, herbicides.

(260) AM 2014 74255 A

(800) 1176123

(151) 2013 08 07

(731) BIOFARMA

50 rue Carnot, F-92284 SURESNES CEDEX,
 France

(540)

IVADILOL

(591) Black, white

(511)

5 – Pharmaceutical and veterinary products; sanitary products for medicine; dietetic food and substances for medical or veterinary use; food for babies; food supplements for humans and animals; materials for dressings; material for dental fillings and dental impressions; disinfectants; products for destroying pests; fungicides, herbicides.

(260) AM 2014 74257 A

(800) 1176134

(151) 2013 05 03

(731) Svenska Cellulosa Aktiebolaget SCA

Box 200, SE-101 23 Stockholm, Sweden

(540)



(591) Black, white

(511)

4 – Fuels; fuels from biological sources; wood heating pellets; renewable fuels; briquettes of wood; wind energy; electrical energy.

35 – Business information services provided on-line from a computer database or the internet; distribution of samples; systematization of data in databases.

38 – Providing access to a compilation of information from computer databases matter in relation to health care, hygienic care and geriatric care; provi-

ding access to a global computer network for the transfer and dissemination of information.

39 – Transport; transportation logistics, including stevedoring; arrangement of transport including forwarding; transport services, including information and advice relating to customs clearance in relation to import and export; shipping services; packaging and storage of goods; warehouse storage services; energy distribution; fuel distribution services; delivery of fuel; arrangement of the storage of fuels; information and consultation of all aforementioned services.

41 – Education; education services relating to personal care, health care and geriatric care; arranging and conducting of educational seminars in relation to personal care, health care and geriatric care; provision of preserve facilities for hunting and fishing; arranging parties for hunting and fishing.

42 – Industrial analysis and research services in the field of the paper industry including paper pulp area, area of paper and cotton products for household, hygienic, sanitary and cosmetic purposes, forest industry and energy; provision of technical information relating to the manufacture of paper; design of stationery.

44 – Healthcare; consulting services relating to health; services for planning, organizing and monitoring for individualised healthcare, including such services provided online or via the internet; hygienic and beauty care for human beings; forestry services including management, administration, planning, manuring, losing the topsoil, planting, clearing and thinning.

(260) AM 2014 74258 A

(800) 1176139

(151) 2013 07 23

(731) C.F.E.B. SISLEY

16, avenue George V, F-75008 PARIS, France

(540)



sisley

(591) White, green, dark blue, light blue, grey, brown, pink, green, purple.

(511)

3 – Soaps, perfumery, essential oils, cosmetics, hair lotions, dentifrices.

(260) AM 2014 74259 A

(800) 1176207

(151) 2013 07 22

(731) REVOLUTION INTERNATIONAL LIMITED

10th Floor, Raffles Tower, 19 Cybercity, Ebene, Mauritania

(540)

THE RAKE

(591) Black, white

(511)

16 – Magazines [printed publications] relating to art markets; magazines [printed publications] relating to watches; magazines [printed publications] relating to auctions; magazines [printed publications] relating to the motor car trade; periodic publications; periodical publications relating to cars; periodical publications relating to consumer financial services; periodical publications relating to health care; periodical publications relating to medical research; periodical publications relating to travel; printed monthly publications; printed publications; printed publications relating to leisure activities; printed publications relating to motor boats; printed publications relating to wine; publications relating to high-fidelity systems; all included in this class.

(260) AM 2014 74260 A

(800) 1176211

(151) 2013 07 11

(731) Metamar Mermer Granit Madencilik Sanayi Ticaret Anonim Şirketi
Antalya Yolu Üzeri 6. Km., Sav Kasabasi Isparta, Turkey

(540)



(591) Dark blue, light blue

(511)

19 – Marble.

(260) AM 2014 74261 A

(800) 1176219

(151) 2013 08 06

(731) It Luggage Limited

Riverside House, River Way, Harlow, Essex CM20 2DQ, United Kingdom

(540)



(591) Black and white.

(511)

18 – Attaché cases; backpacks; beach bags, briefcases; cosmetic bags; game bags; garments bags for travel; holdalls; rucksacks; school bags; school satchels; shopping bags; sports bags; trolley suitcases; vanity cases; wheeled shopping bags; handbags; purses; pocket wallets; key cases; travelling sets; trunks.

(260) AM 2014 74279 A

(800) 1176271

(151) 2012 11 15

(731) BAŞALAN PATENT VE TRADE MARK SINAİ MÜLKİYET HİZMETLERİ MÜŞAVİRLİK LİMİTED ŞİRKETİ
Giz 2000 Plaza, Ayazağa Yolu No:7 Kat.12 Maslak, Şişli, İSTANBUL, Turkey

(540)



(591) Green, white, orange, black

(511)

41 – Education; providing of training; publication of books, publication of electronic books and journals on-line and hard copy; publication of texts, other than publicity texts.

45 – Legal services; intellectual property consultancy, licensing of intellectual property, intellectual property watching services, intellectual property management services, consultancy services regarding with trademark, patent and industrial design, all kind of services for intellectual property, search, consultancy and representation services about the protection of intellectual property rights, management consultancy search and representation services about copyrights.

(260) AM 2014 74280 A

(800) 1176331

(151) 2012 12 18

(731) RAM DIS TICARET ANONİM SİRKETİ
Ruzgarlibahce Mahallesi Cumhuriyet, Caddesi Energy Plaza, Kat:2, Beykoz Istanbul, Turkey

(540)

RAM

(591) Black, white

(511)

7 – Construction machines and apparatus; rolling mills; power hammers; molding machines; rolling mill cylinders; elevators (lifts); elevator operating apparatus; mobile elevating work platforms; lifting work platforms; loading ramps; cranes (lifting and hoisting apparatus); escalators; hoists; belt conveyors; agricultural implements other than hand-operated; agricultural machines; motors and engines (except for land vehicles); machine coupling and transmission components (except for land vehicles); brake linings other than for vehicles; brake pads other than for vehicles; brake segments other than for vehicles; brake shoes other than for vehicles; starters for motors and engines; dynamos; bicycle dynamos; sparking plugs for internal combustion engines; igniting devices for internal combustion engines; injectors for engines; exhaust silencers for engines; silencers for motors and engines; silencers as part of vehicle exhaust systems; belts for motors and engines; timing belts for engines and motors; dynamo belts; belts for conveyors; roller bearings; ball-bearings; bearings; carburettors; carburettor feeders; fuel economisers for motors and engines; fuel conversion apparatus for internal combustion engines; radiators (cooling) for motors and engines; fans for motors and engines; cylinder heads for engines; pistons for cylinders; cylinders for motors and engines; motors, electric, other than for land vehicles; alternators; current generators; emergency power generators; generators of electricity; industrial robots; shearing machines for animals; compressors (machines); electric welding apparatus; welding machines, electric; printing machines; crushing machines; wrapping machines; filling machines; labellers (machines); sorting machines for industry; sewing machines; embroidery machines; machines for the textile industry; pumps for heating installations; pumps (parts of machines, engines or motors); self-regulating fuel pumps; electrical water pumps; kitchen machines, electric namely mixers, blenders, electric, for household purposes, electric food processors; electric knives; electric meat grinders; garbage disposals; dishwashers; washing machines; machines and apparatus for wax-polishing, electric; electric vacuum cleaners; electric machines and apparatus for carpet shampooing; brushes for vacuum cleaners; hoses for vacuum cleaners; dust bags for vacuum cleaners; dust filters for vacuum cleaners; suction nozzles for vacuum cleaners; vacuum cleaner attachments for disseminating perfumes and disinfectants; electric fan units for vacuum cleaners; vacuum cleaner bags; vacuum cleaner hoses; foundry machines; converters for steelworks; vehicle washing machines; kneading machines; dough maturing machines; dough cutting machines; grain humidifying machines; grain separators; sifters; winnowers; air suction machines; hoppers; milling machines;

machines for processing grain; grinding machines; sieve machines; grain husking machines; galvanizing machines; galvanizing apparatus.

9 – Laboratory apparatus and instruments, ovens for laboratory use, furnaces for laboratory use, furniture especially made for laboratories; illuminated advertising signs, luminous signs; apparatus and instruments for conducting, switching, transforming, accumulating, regulating or controlling electricity; photocopying machines, blueprint apparatus; apparatus for recording, transmission or reproduction of sound or images; magnetic data carriers, recording discs; compact discs, DVDs and other digital recording media; mechanisms for coin-operated apparatus; cash registers, calculating machines, data processing equipment, computers; computer software; weighing apparatus and instruments; detectors, electronic imaging devices, roentgen apparatus not for medical purposes; life jackets; life buoys; swim floats for safety purposes; breathing apparatus for underwater swimming; diving suits; divers' masks; ear plugs for divers; gloves for divers; nose clips for divers and swimmers; diving goggles; life belts; safety nets; protective helmets; protective helmets for sports; protective masks; protective suits for aviators; workmen's protective face-shields; gloves for protection against accidents; asbestos gloves for protection against accidents; gloves for protection against X-rays for industrial purposes; protective goggles; signalling buoys; signalling whistles; signal lanterns; optical glass; eyeglasses; spectacle glasses; anti-glare glasses; welding goggles; sunglasses; contact lenses; optical lenses; containers for contact lenses; cases for spectacles and sunglasses; cases for eyeglasses; parts and accessories for eyeglasses; parts and accessories for spectacles; alarms; electric alarm bells; sirens; speed checking apparatus for vehicles; gasoline gauges; oil level sensors; temperature indicators; tachometers; taximeters; balancing apparatus; vehicle breakdown warning triangles; reflectors for traffic signals; road signs, luminous or mechanical; blinkers (signalling lights); traffic-light apparatus; railway traffic safety appliances; fire-extinguishing apparatus; rules (measuring instruments); bubble levels; measuring tapes; folding rules; plumb lines; magnets; decorative magnets.

11 – Apparatus for lighting, heating, steam generating, cooking, refrigerating, drying, ventilating, water supply and sanitary purposes.

35 – Advertising; business management; business administration; office functions; import-export agencies; the bringing together, for the benefit of others, of a variety of goods (excluding the transport thereof), enabling customers to conveniently view and purchase those goods (such services may be provided by retail stores, wholesale outlets, means of

electronic media, through mail order catalogues or other similar services).

36 – Insurance; banking services, financial management services, financial analysis services, financial sponsorship, providing financial information, factoring, lease-purchase financing services, hire-purchase financing, exchanging money; real estate affairs; customs brokerage.

37 – Building and construction services; rental of construction equipment; cleaning of building interiors, cleaning of building exteriors, window cleaning, street cleaning, chimney sweeping, rental of cleaning machines; disinfecting, vermin exterminating, other than for agriculture, rat exterminating; vehicle maintenance and repair; repair or maintenance of vessels, shipbuilding; maintenance and repair of air vehicles; repair and maintenance of furniture, furniture restoration; installation, maintenance and repair of heating equipment, installation, maintenance and repair of air conditioning apparatus, installation of plumbing, maintenance of plumbing, repair of plumbing; renovation of clothing, clothing repair; leather care, cleaning and repair; laundry services, pressing of clothing, cleaning of clothing; artificial snow-making services; film projector repair and maintenance, photographic apparatus repair; repair of industrial machinery, repair of electrical equipment, repair or maintenance of office machines and apparatus, repair or maintenance of computers, maintenance and repair of computer hardware; maintenance and repair of security and safety equipment; telephone installation and repair; elevator installation and repair; clock and watch repair or maintenance; wallpapering; mining extraction; sanding; retinning; knife sharpening; safe maintenance and repair; umbrella repair, parasol repair; shoe repair.

39 – Transport; packaging and storage of goods; travel arrangement.

40 – Metal treatment services, namely, galvanizing, metal plating, metal casting, cadmium plating, chromium plating, gold-plating, tin-plating, silver-plating, nickel plating, coppersmithing, electroplating, soldering, magnetization, metal tempering, metal casting, boiler-making, providing material treatment information; photocomposing services, photographic printing, photogravure, processing of photographic and cinematographic films, photographic processing; processing of raw materials for the manufacture of food and beverages, food canning, food smoking, food and drink preservation, millworking, flour milling, fruit crushing; slaughtering of animals; working of leather and furs, namely, fur dyeing, fur glossing, fur mothproofing, fur staining, custom fashioning of fur, leather staining, leather tanning, leather dyeing; taxidermy; preparation and treatment of fabric, namely, warping (looms), textile mothproofing, cloth edging, cloth cutting, fabric blea-

ching, cloth dyeing, printing of patterns on textiles, fabric fireproofing, fabric waterproofing, pre-shrinking of fabric, crease-resistant treatment of fabric; wool treating; tailoring; dressmaking, cloth cutting, clothing alteration, embroidery services; woodworking, timber felling and processing, sawmill planing; engraving, framing of works of art; water treating, processing of chemicals, processing of gas, air purification, air freshening, air deodorizing, recycling of waste materials, sorting of waste and recyclable material (transformation), refining services, processing of oil, water purification, water treating; glass-blowing, glass tinting, glass polishing; custom assembling of materials; dental technician services; pottery firing; production of energy; rental of generators; paper treating; bookbinding; laser scribing; laminating; saddlery working; shoe staining and dyeing; quilting.

43 – Services for providing food and drink; temporary accommodation.

(260) AM 2014 74460 A

(800) 1178053

(151) 2013 06 18

(731) UNICREDIT LEASING S.p.A.

Via Rivani, 5, I-40138 BOLOGNA (BO),
Italy; LEASINT S.p.A. Via Montebello, 18,
I-20121 MILANO, Italy

(540)

ALCOTT

(591) Black, white

(511)

25 – Men's, women's and children's clothing, namely, trousers, pants, evening dresses, suits, skirts, miniskirts, coats, pullovers, jumpers, sweaters, jackets, blazers, blouses, shorts, shirts, T-shirts, robes, swimwear, beach robes, beachwear, belts, neckties, bandanas, foulards, scarves, wristbands, waistcoats, hats, caps, gloves, scarfs, jeans, underwear, pyjamas, track suites, socks, shoes, boots, slippers.

35 – Selling services, wholesale and retail commercial distribution, shop selling services; shop management services; mail order, Internet shopping; import and export services; assistance in business management and product commercialization, within the framework of a franchise contract; franchise-issuing services in relation to commercial management assistance, including a chain of shops; information and consultancy services in relation to retailing; commercial consultancy and business management assistance; shop window dressing; office machines and equipment rental; advertisement services, including those related to distribution of advertising and commercial charts and fliers, directly or by mail; public relations, commercial consultancy; assistance for the operation of store chains.

(260) AM 2014 74462 A
 (800) 1178074
 (151) 2013 07 17
 (731) CLAAS KGaA mbH
 Münsterstraße 33, 33428 Harsewinkel,
 Germany
 (540)



(591) Yellow, orange, red, pink, violet, dark blue,
 light blue, turquoise, light green, dark green,
 light brown, dark brown, beige and grey

(511)
 7 – Agricultural machines and implements, in particular reapers and threshers, forage harvesters (choppers), baling presses, mowers, turners and swathers, soil cultivation machines and implements, sowers (machines) implements for releasing fertilisers and plant protection substances, and parts and fittings therefor, included in this class.

9 – Scientific, surveying, photographic, cinematographic, optical, weighing, measuring, signalling, checking (supervision) apparatus and instruments; apparatus for recording, transmission and reproduction of data, sound or images, communications apparatus such as transmitters, receivers, antennae, modems, magnetic data carriers, calculating machines, data processing equipment, computers, ancillary devices for data processing installations such as data readers, data storage devices, printers, monitors, scanners, data carriers including floppy disks, CD-ROMs, DVDs, with and without programs, algorithms or batches of data recorded thereon, parts therefor and apparatus and systems constructed therefrom, instructional material, software, video tapes, magnetic, optical or other data carriers, data processing equipment including computers, testers and testing instruments, cables, wires, pipes, switches, pressure switches, fuses, ports, plugs, thermostats, meters, sensors, transformers, tachometers, diagnostic equipment, indicators and controls, fittings, servicing boxes with electrical, electronic or mechanical controls, computer programs, computer software, and parts and components therefor, electronic data processing equipment for optimising the functioning of agricultural machines; parts thereof included in this class.

12 – Vehicles, apparatus for locomotion by land or water, in particular tractors, agricultural transport equipment and loading wagons for conveying agricultural goods, and components and parts therefor, included in this class.

35 – Creating marketing concepts for private contractors and inter-enterprise machine use, marketing concepts for comparing the efficiency of agricultural machines, professional business consultancy with regard to the methods and systems for planning, organising, managing and supervising agricultural enterprises and private contractors, professional business consultancy and optimisation of agricultural machine systems and transport chains for optimising logistics processes.

44 – Agricultural, horticultural and forestry services.

(260) AM 2014 74463 A
 (800) 1178077
 (151) 2013 08 08
 (731) Harry Winston SA
 Chemin du Tourbillon 8, CH-1228 Plan-
 les-Ouates, Switzerland

(540)



(591) Black, white

(511)

14 – Precious metals and their alloys and goods made of these materials or coated therewith included in this class, namely figurines, trophies; jewelry, namely rings, earrings, cuff links, bracelets, charms, brooches, chains, necklaces, tie pins, tie clips, jewelry caskets (cases), cases; precious stones, semi-precious stones; timepieces and chronometric instruments, namely chronometers, chronographs, clocks, watches, wristwatches, wall clocks, alarm clocks as well as parts and accessories for the aforesaid goods, namely hands, anchors, pendulums, barrels, watch cases, watch straps, watch dials, clockworks, watch chains, movements for timepieces, watch springs, watch glasses, presentation cases for timepieces, cases for timepieces.

(260) AM 2014 74464 A
 (800) 1178085
 (151) 2013 08 14
 (731) Baxter International Inc.
 One Baxter Parkway, Deerfield
 (IL 60015-4634), USA

(540)

HOMECHOICE CLARIA

(591) Black, white

(511)

10 – Medical apparatus and instruments; dialysis apparatus (dialyzers) and accessories therefor included in this class.

(260) AM 2014 74465 A
 (800) 1178116
 (151) 2013 08 29
 (731) SONG WEN MING
 R.701, 5# BeiYuan-Shangmaoqu, Yiwu city,
 322001 Zhejiang Province, China
 (540)



(591) Black, white
 (511)
 18 – Animal leather, imitation leather, purses, backpacks, handbags, travelling bags, leatherware travelling sets, shopping bags, leather trimmings, umbrellas.
 25 – Clothing, child cloth, shoes, hats, hosiery, clothing gloves, strap, wedding cloth.

(260) AM 2014 74466 A
 (800) 1178127
 (151) 2013 08 26
 (731) Beiersdorf AG
 Unnastrasse 48, 20253 Hamburg, Germany
 (540)



(591) Yellow, silver and white
 (511)
 3 – Soaps; perfumery, essential oils, cosmetics, hair lotions; dentifrices.

(260) AM 2014 74467 A
 (800) 1178152
 (151) 2013 08 23
 (731) PRIVATE JOINT STOCK COMPANY
 "INDUSTRIAL ASSOCIATION "KONTI"
 Bul. Shevchenko, 6-b, Donetsk 83015,
 Ukraine
 (540)

Ришелье

(591) Black, white
 (511)
 30 – Confectionery including candies; chocolate; glazed and unglazed candies; roasted candied nuts (candies); dragee (confectionery); jelly candies; sweetmeats; marzipan candies; sets of candies; fondants (confectionery); souffle candies; souffle and jelly candies; candies; candies with fillings; waffle can-

dies; toffee candies; chocolate; chocolate dragee with raisins or nuts; chocolate candies; chocolate bars; chocolate figurines.

(260) AM 2014 74468 A
 (800) 1178174
 (151) 2013 07 26
 (731) Farco-Pharma GmbH Pharmazeutische
 Präparate
 Gereonsmühlengasse 1-11, 50670 Köln,
 Germany
 (540)

Endosgel

(591) Black, white
 (511)
 5 – Pharmaceutical and veterinary preparations; sanitary preparations for medical purposes; dietetic food and substances adapted for medical or veterinary use, food for babies; dietary supplements for humans and animals; plasters, materials for dressings; material for stopping teeth, dental wax; disinfectants; preparations for destroying vermin; fungicides, herbicides; dental impression materials; evacuants; medical preparations for slimming purposes; slimming pills; adjuvants for medical purposes; acaricides; aconitine; aldehydes for pharmaceutical purposes; algicides; alginates for pharmaceutical purposes; alkaline iodides for pharmaceutical purposes; alkaloids for medical purposes; medicinal alcohol; alcohol for pharmaceutical purposes; aloe vera preparations for pharmaceutical purposes; dental amalgams; amino acids for medical purposes; amino acids for veterinary purposes; analgesics; anaesthetics; angostura bark for medical purposes; antibiotics; anti-rheumatism bracelets; anti-rheumatism rings; antiseptics; antiseptic cotton; appetite suppressants for medical purposes; appetite suppressant pills; bracelets for medical purposes; medicines for human purposes; medicines for veterinary purposes; medicines for dental purposes; medicines for alleviating constipation; aseptic cotton; asthmatic tea; ethers for pharmaceutical purposes; caustics for pharmaceutical purposes; caustic pencils; eye-washes; eyepatches for medical purposes; acetates for pharmaceutical purposes; babies' diaper-pants; food for babies; babies' napkins [diapers]; bath salts for medical purposes; bath preparations, medicated; therapeutic preparations for the bath; bacterial poisons; bacterial preparations for medical and veterinary use; bacteriological preparations for medical and veterinary use; dietary fiber; balms for medical purposes; balsamic preparations for medical purposes; bandages for dressings; barks for pharmaceutical purposes; cotton for medical purposes; sedatives; biological tissue cultures for medical purposes; biological tissue cultures for veterinary purposes; biological preparations for medical purposes; biological preparations for

veterinary purposes; biocides; lead water; blood for medical purposes; hematogen; leeches for medical purposes; blood plasma; depuratives; candy, medicated; tanning pills; bromine for pharmaceutical purposes; powder of cantharides; chemical preparations to treat wheat smut; chemical preparations for treating phylloxera; vine disease treating chemicals; chemico-pharmaceutical preparations; chemical contraceptives; chemical conductors for electrocardiograph electrodes; chemical preparations to treat mildew; chemical preparations for the diagnosis of pregnancy; chemical preparations for medical purposes; chemical preparations for pharmaceutical purposes; chemical preparations for veterinary purposes; chemical reagents for medical or veterinary purposes; cinchona for medical purposes; quinine for medical purposes; chinoline for medical purposes; surgical tissues; surgical implants [living tissues]; hydrated chloral for pharmaceutical purposes; chloroform; condurango bark for medical purposes; curare; sanitary towels; decoctions for pharmaceutical purposes; dental cements; deodorants, other than for human beings or for animals; deodorants for clothing and textiles; disinfectants for chemical toilets; disinfectants for hygiene purposes; detergents for medical purposes; diabetic bread adapted for medical use; diagnostic preparations for medical purposes; diastase for medical purposes; dietetic beverages adapted for medical purposes; dietetic substances adapted for medical use; dietetic foods adapted for medical purposes; digitalin; dill oil for medical purposes; drugs for medical purposes; alloys of precious metals for dental purposes; albuminous preparations for medical purposes; elixirs [pharmaceutical preparations]; gentian for pharmaceutical purposes; enzymes for medical purposes; enzymes for veterinary purposes; enzyme preparations for medical purposes; enzyme preparations for veterinary purposes; aluminium acetate for pharmaceutical purposes; esters for pharmaceutical purposes; eucalyptol for pharmaceutical purposes; eucalyptus for pharmaceutical purposes; fennel for medical purposes; ferments for pharmaceutical purposes; greases for medical purposes; greases for veterinary purposes; febrifuges; fish meal for pharmaceutical purposes; fly catching paper; fly glue; fly destroying preparations; formic aldehyde for pharmaceutical purposes; chilblain preparations; frostbite salve for pharmaceutical purposes; fungicides; gallic acid for pharmaceutical purposes; gases for medical purposes; gelatine for medical purposes; royal jelly for pharmaceutical purposes; poisons; glycerine for medical purposes; glycerophosphates; dental amalgams of gold; guaiacol for pharmaceutical purposes; gum for medical purposes; gamboge for medical purposes; gurjun [gurjon, gurjan] balsam for medical purposes; belts for sanitary napkins [towels]; hemostatic pencils; adhesives for dentures; hemoglobin; hemorrhoid preparations; preparations for destroying dry

rot fungus; yeast for pharmaceutical purposes; adhesive plasters; remedies for foot perspiration; remedies for perspiration; charcoal for pharmaceutical purposes; extracts of hops for pharmaceutical purposes; hormones for medical purposes; cement for animal hooves; corn remedies; corn rings for the feet; repellents for dogs; dog lotions; dog washes; hydrastine; hydrastinine; vaccines; pants, absorbent, for incontinents; insecticides; insect repellents; personal sexual lubricants; irish moss for medical purposes; isotopes for medical purposes; jalap; iodine for pharmaceutical purposes; iodides for pharmaceutical purposes; iodoform; tincture of iodine; jujube, medicated; potassium salts for medical purposes; preparations of lime for pharmaceutical purposes; calomel; cooling sprays for medical purposes; camphor for medical purposes; camphor oil for medical purposes; candy for medical purposes; capsules for medicines; cachets for pharmaceutical purposes; carbolineum [parasiticide]; poultices; cachou for pharmaceutical purposes; chewing gum for medical purposes; rubber for dental purposes; germicides; adhesive bands for medical purposes; bone cement for surgical and orthopaedic purposes; cocaine; colloidion for pharmaceutical purposes; collyrium; compresses; headache pencils; smoking herbs for medical purposes; herbal teas for medicinal purposes; creosote for pharmaceutical purposes; croton bark; cultures of microorganisms for medical and veterinary use; liquorice for pharmaceutical purposes; stick liquorice for pharmaceutical purposes; larvae exterminating preparations; laxatives; cod liver oil; linseed for pharmaceutical purposes; linseed meal for pharmaceutical purposes; lecithin for medical purposes; liniments; solutions for contact lenses; solvents for removing adhesive plasters; lotions for pharmaceutical purposes; lotions for veterinary purposes; air purifying preparations; lupulin for pharmaceutical purposes; magnesia for pharmaceutical purposes; malt for pharmaceutical purposes; malted milk beverages for medical purposes; milk of almonds for pharmaceutical purposes; mangrove bark for pharmaceutical purposes; preparations for destroying mice; medicinal drinks; medicinal herbs; medicinal infusions; medicinal hair growth preparations; medicinal tea; sea water for medicinal bathing; meal for pharmaceutical purposes; melissa water for pharmaceutical purposes; milking grease; menthol; articles for headache; milk ferments for pharmaceutical purposes; lactose for pharmaceutical purposes; mineral food supplements; mineral waters for medical purposes; mineral water salts; preparations for the treatment of burns; soil-sterilising preparations; anti-uric preparations; preparations for callouses; air deodorising preparations; preparations to facilitate teething; douching preparations for medical purposes; preparations for reducing sexual activity; preparations for destroying vermin; molding wax for dentists; moleskin for medical purposes; sanitary pads;

sanitary pants; mud for baths; medicinal mud; mothproofing preparations; mothproof paper; mouthwashes for medical purposes; ergot for pharmaceutical purposes; myrobalan bark for pharmaceutical purposes; bacteriological culture mediums; lacteal flour for babies; albuminous foodstuffs for medical purposes; nutritive substances for microorganisms; nutritional supplements; albumin dietary supplements; alginate dietary supplements; enzyme dietary supplements; royal jelly dietary supplements; glucose dietary supplements; yeast dietary supplements; casein dietary supplements; linseed dietary supplements; linseed oil dietary supplements; lecithin dietary supplements; pollen dietary supplements; propolis dietary supplements; protein dietary supplements; wheat germ dietary supplements; dietary supplements for animals; narcotics; bicarbonate of soda for pharmaceutical purposes; sodium salts for medical purposes; by-products of the processing of cereals for dietetic or medical purposes; nervines; medicinal oils; opiates; opium; opodeldoc; opotherapy preparations; antioxidant pills; paper for mustard plasters; antiparasitic collars for animals; antiparasitic preparations; parasiticides; lozenges for pharmaceutical purposes; pectin for pharmaceutical purposes; pepsins for pharmaceutical purposes; peptones for pharmaceutical purposes; pearl powder for medical purposes; pesticides; mint for pharmaceutical purposes; bunion pads; pharmaceutical preparations; pharmaceutical preparations for treating dandruff; pharmaceutical preparations for skin care; phenol for pharmaceutical purposes; phosphates for pharmaceutical purposes; anticryptogamic preparations; pomades for medical purposes; porcelain for dental prostheses; bronchodilating preparations; preparations of trace elements for human and animal use; sterilising preparations; propolis for pharmaceutical purposes; protein supplements for animals; pyrethrum powder; quassia for medical purposes; quebracho for medical purposes; mercurial ointments; radioactive substances for medical purposes; radium for medical purposes; rat poison; fumigating sticks; fumigation preparations for medical purposes; reagent paper for medical or veterinary purposes; contact lens cleaning preparations; medicine cases, portable, filled; rhubarb roots for pharmaceutical purposes; smelling salts; castor oil for medical purposes; radiological contrast substances for medical purposes; ointments for pharmaceutical purposes; salts for medical purposes; salts for mineral water baths; sarsaparilla for medical purposes; oxygen for medical purposes; oxygen baths; acids for pharmaceutical purposes; lint for medical purposes; soporifics; dental abrasives; slug exterminating preparations; flowers of sulphur for pharmaceutical purposes; sulphur sticks [disinfectants]; mustard for pharmaceutical purposes; mustard oil for medical purposes; mustard plasters; serums; serotherapeutic medicines; siccatives [drying agents] for medical

purposes; syrups for pharmaceutical purposes; scapulars for surgical purposes; panty liners [sanitary]; sunburn ointments; sunburn preparations for pharmaceutical purposes; semen for artificial insemination; stem cells for medical purposes; stem cells for veterinary purposes; starch for dietetic or pharmaceutical purposes; steroids; breast-nursing pads; strychnine; styptic preparations; sulphonamides [medicines]; suppositories; tobacco extracts [insecticides]; tobacco-free cigarettes for medical purposes; sanitary tampons; turpentine for pharmaceutical purposes; oil of turpentine for pharmaceutical purposes; thermal water; thymol for pharmaceutical purposes; animal washes; tinctures for medical purposes; tonics [medicines]; glucose for medical purposes; tissues impregnated with pharmaceutical lotions; vermin destroying preparations; herbicides; vaginal washes; petroleum jelly for medical purposes; gauze for dressings; first-aid boxes, filled; dressings, medical; surgical dressings; absorbent cotton; digestives for pharmaceutical purposes; vesicants; veterinary preparations; cattle washes; vitamin preparations; wart pencils; hydrogen peroxide for medical purposes; wadding for medical purposes; insect repellent incense; tartar for pharmaceutical purposes; cream of tartar for pharmaceutical purposes; diapers for pets; napkins for incontinents; bismuth preparations for pharmaceutical purposes; bismuth subnitrate for pharmaceutical purposes; vulnerary sponges; vermifuges; medicinal roots; teeth filling material; dental mastics; dental lacquer; cedar wood for use as an insect repellent; cellulose ethers for pharmaceutical purposes; cellulose esters for pharmaceutical purposes; sugar for medical purposes.

(260) AM 2014 74469 A

(800) 1178190

(151) 2013 07 02

(731) PEGAS S.R.L.

firmă comercială de producție; Str. Petricani nr. 174, MD-2059 Chișinău, Republic of Moldova

(540)



(591) Red, green and white

(511)

29 – Meat, fish, poultry and game; meat extracts; preserved, frozen, dried and cooked fruit and vegetables; jellies, jams, compotes; eggs; milk and dairy products; edible oils and fats.

35 – Advertising; business management; business administration; office functions.

- (260) AM 2014 74470 A
 (800) 1178215
 (151) 2013 06 04
 (731) Hankook Tire Worldwide Co.
 Ltd.; #647-15 Yoksam-dong, Kangnam-gu,
 Seoul, Republic of Korea

(540)
Hankook Smart Control

- (591) Black, white
 (511)
 12 – Pneumatic tires; casings for pneumatic tires; inner tubes for pneumatic tires; tires, solid, for vehicle wheels; tires for vehicle wheels; valves for vehicle tires; motorcycle tires; inner tubes for automobile tires; automobile tires; bicycle tires; inner tubes for bicycles, motorcycles; tubeless tires for bicycles, motorcycles; studs for tires; spikes for tires; adhesive rubber patches for repairing inner tubes; repair outfits for inner tubes.

- (260) AM 2014 74471 A
 (800) 1178233
 (151) 2013 01 19
 (731) Wikimedia Foundation, Inc.
 149 New Montgomery Street, 3rd Floor,
 San Francisco CA 94105, USA

(540)
WIKIPEDIA

- (591) Black, white
 (511)
 9 – Software for powering websites, the creation and editing of web pages via a web browser for use by community websites, corporate intranets, knowledge management systems and note services; software for downloading, transmitting, receiving, providing, publishing, extracting, encoding, decoding, reading, storing, and organizing audiovisual, videographic, and written data, all in conjunction with a global computer network.

35 – Information relating to business administration provided online or via the internet; business administration in the nature of providing information through online website in the field of general encyclopedic knowledge to third parties.

41 – Providing online publications in the form of encyclopedias and encyclopedia articles; providing training in the use of software and multimedia products, and in the editing of and collaboration on articles; educational services, namely, conferences, workshops, and seminars concerning the administration of an encyclopedia project and the use and administration of encyclopedia article entries; providing information on educational or entertainment events; publication of books; arranging and conducting of colloquia, conferences, and conventions in the fields of software and multimedia product use and in the editing of and collaboration on articles;

educational services, namely arranging and conducting educational conferences; conducting classes, seminars, conferences, workshops, and training organizing community cultural events; arranging and conducting educational colloquiums, conferences, conventions and seminars; publishing of books and magazines; electronic publishing services, namely publication of books, periodicals, and texts of others online; providing text, images, moving images, audio visual images, quotations, news, definitions via the internet; providing information in the field of encyclopedic knowledge, quotations, news, definitions, images, moving images, audiovisual works via the internet; providing online publications in the form of encyclopedias and encyclopedia articles; providing of training, namely, courses and seminars in the use of software and multimedia products, and in the editing of and collaboration on articles; educational services, namely, conferences, workshops, and seminars concerning the administration of an encyclopedia project and the use and administration of encyclopedia article entries; providing information on educational or entertainment events; arranging and conducting of colloquia, conferences, and conventions in the fields of software and multimedia product use and in the editing of and collaboration on articles.

42 – Providing a website featuring technology that enables internet users to create, bookmark, annotate, and publicly share quotations, news, definitions, images, moving images, and audiovisual images (Terms Too Vague in the opinion of the International Bureau – Rule 13(2)(b) of the Common Regulations); computer services, namely maintaining a website for others featuring information and links relating to other online resources for encyclopedic knowledge, quotations, news, definitions, images, moving images, audio visual images (Terms Too Vague in the opinion of the International Bureau – Rule 13(2)(b) of the Common Regulations).

- (260) AM 2014 74472 A
 (800) 1178240
 (151) 2013 04 10
 (731) AKTSIONERNO DROUJESTVO
 "BULGARTABAC-HOLDING"
 "Graf Ignatiev" Str. 62, BG-1000 SOFIA,
 Bulgaria

(540)



(591) Black, white
(511)

16 – Paper, cardboard and goods made from these materials, not included in other classes; printed matter; photographs; plastic materials for packaging (not included in other classes); paper and cardboard packages, especially cigarette packages; boxes of cardboard; wrappings and packages (stationery); packing paper, cigar bands; stationery; forms (printed); pamphlets; writing pads; placards of paper or cardboard; posters; decalcomanias; labels, not of textile; calendars; catalogues; folders (stationery); files (office requisites); bags (envelopes, pouches) of paper or plastics, for packaging.

34 – Tobacco; smokers' articles; matches; cigarettes, cigars; cigarillos; lighters for smokers; tobacco- raw, manipulated or processed; tobacco products; cigarette filters; cigarette paper; ashtrays for smokers.

35 – Advertising; business management; business administration; office functions; publication of publicity texts; radio advertising; advertising through posters; distribution of samples, models, patterns; dissemination of advertising matters; sales advertising; advertising agencies; TV advertisements; administrative activities and services for management of domestic and international commercial transactions; consultations connected with the business management; marketing surveys and researches; consulting services for business management; management of business or industrial enterprises assistance, support in business management; organization of exhibitions and fairs with commercial and advertising purposes; outdoor advertising with bill boards; advertising services using outdoor posters, advertising panel and wall surfaces; demonstration of goods; preparation and publishing of advertisements through printed, audio, video, radio, television and electronic media; advertising through the global computer network; actualization of advertisement matters' import-export agencies.

(260) AM 2014 74473 A

(800) 1178255

(151) 2013 06 04

(731) Hankook Tire Worldwide Co., Ltd.
#647-15 Yoksam-dong, Kangnam-gu,
Seoul, Republic of Korea

(540)

Hankook Smart Flex

(591) Black, white

(511)

12 – Pneumatic tires; casings for pneumatic tires; inner tubes for pneumatic tires; tires, solid, for vehicle wheels; tires for vehicle wheels; valves for vehicle tires; motorcycle tires; inner tubes for automobile tires; automobile tires; bicycle tires; inner tubes for bicycles, motorcycles; tubeless tires for bicycles, motorcycles; studs for tires; spikes for tires; adhesive rubber patches for repairing inner tubes; repair

outfits for inner tubes;

(260) AM 2014 74474 A

(800) 1178256

(151) 2013 06 04

(731) Hankook Tire Worldwide Co. Ltd.
#647-15 Yoksam-dong, Kangnam-gu,
Seoul, Republic of Korea

(540)

Hankook Smart Work

(591) Black, white

(511)

12 – Pneumatic tires; casings for pneumatic tires; inner tubes for pneumatic tires; tires, solid, for vehicle wheels; tires for vehicle wheels; valves for vehicle tires; motorcycle tires; inner tubes for automobile tires; automobile tires; bicycle tires; inner tubes for bicycles, motorcycles; tubeless tires for bicycles, motorcycles; studs for tires; spikes for tires; adhesive rubber patches for repairing inner tubes; repair outfits for inner tubes.

(260) AM 2014 74475 A

(800) 1178259

(151) 2013 06 04

(731) Hankook Tire Worldwide Co., Ltd.
#647-15 Yoksam-dong, Kangnam-gu,
Seoul, Republic of Korea

(540)

Hankook Smart Touring

(591) Black, white

(511)

12 – Pneumatic tires; casings for pneumatic tires; inner tubes for pneumatic tires; tires, solid, for vehicle wheels; tires for vehicle wheels; valves for vehicle tires; motorcycle tires; inner tubes for automobile tires; automobile tires; bicycle tires; inner tubes for bicycles, motorcycles; tubeless tires for bicycles, motorcycles; studs for tires; spikes for tires; adhesive rubber patches for repairing inner tubes; repair outfits for inner tubes.

(260) AM 2014 74476 A

(800) 1178260

(151) 2013 06 04

(731) Hankook Tire Worldwide Co., Ltd.
#647-15 Yoksam-dong, Kangnam-gu,
Seoul, Republic of Korea

(540)

Hankook Smart City

(591) Black, white

(511)

12 – Pneumatic tires; casings for pneumatic tires; inner tubes for pneumatic tires; tires, solid, for vehicle

wheels; tires for vehicle wheels; valves for vehicle tires; motorcycle tires; inner tubes for automobile tires; automobile tires; bicycle tires; inner tubes for bicycles, motorcycles; tubeless tires for bicycles, motorcycles; studs for tires; spikes for tires; adhesive rubber patches for repairing inner tubes; repair outfits for inner tubes.

(260) AM 2014 74477 A

(800) 1178268

(151) 2013 07 05

(731) BIOFARMA

50 rue Carnot, F-92284 SURESNES CEDEX,
France

(540)

EVOMODUL

(591) Black, white

(511)

5 – Pharmaceutical and veterinary products; sanitary products for medicine; dietetic food and substances for medical or veterinary use; food for babies; food supplements for humans and animals; materials for dressings; material for dental fillings and dental impressions; disinfectants; products for destroying pests; fungicides, herbicides.

(260) AM 2014 74478 A

(800) 1178369

(151) 2013 08 26

(731) SANOFI

54 rue La Boétie, F-75008 Paris, France

(540)



The logo for AUBAGIO features a stylized blue wave above the word "AUBAGIO" in a bold, blue, sans-serif font.

(591) Blue, light blue.

(511)

5 – Pharmaceutical products for the treatment of multiple sclerosis, excluding dermatological pharmaceutical products and pharmaceutical products for skin treatment.

(260) AM 2014 74479 A

(800) 1178406

(151) 2013 09 20

(731) John Player & Sons Limited

21 Beckett Way, Park West, Nangor Road,
Dublin 12, Ireland

(540)



(591) Black, white

(511)

34 – Tobacco, whether manufactured or unmanufactured; tobacco products; tobacco substitutes, none being for medicinal or curative purposes; cigarettes; hand rolling tobacco; matches and smokers' articles; cigarette tubes; cigarette filters; cigarette papers.

(260) AM 2014 74480 A

(800) 1178408

(151) 2013 08 07

(731) ORIFLAME COSMETICS S.A.

24, avenue Emile Reuter, L-2420
LUXEMBOURG, Luxembourg

(540)

ORIFLAME MY RED

(591) Black, white

(511)

3 – Soaps; perfumery, essential oils, cosmetics, hair lotions; dentifrices.

(260) AM 2014 74581 A

(800) 1179128

(151) 2013 07 29

(731) Institute Hyalual GmbH

Birkenstrasse 47, CH-6343 Rotkreuz,
Switzerland

(540)

PREDERMAL

(591) Black, white

(511)

5 – Pharmaceutical preparations for esthetic medicine, plastic surgery, dermatology and cosmetology; pharmacological preparations for skin care; injectable dermal filler.

(260) AM 2014 74582 A

(800) 1179176

(151) 2013 09 13

(731) Shenzhen Miracle Laptop Bags Co., Limited

RM 1412 & 1413, 4F, Building 1,
YuanZheng Technology Park, North
of Wuhe Avenue, Bantian Street, Longgang
District, Shenzhen City, Guangdong Province,
China

(540)

miracase

(591) Black, white

(511)

18 – Imitation leather; school bags; backpacks; attaché cases; handbags; travelling bags; moleskin (imitation of leather); umbrellas; walking sticks; saddle cloths for horses.

(260) AM 2014 74583 A
 (800) 1179211
 (151) 2013 09 16
 (731) Recordati Pharma GmbH
 Eberhard-Finckh-Strasse 55, 89075 Ulm,
 Germany
 (540)

Mirfulan

(591) Black, white
 (511)
 3 – Essential oils; cosmetics.
 5 – Pharmaceutical preparations.

(260) AM 2014 74584 A
 (800) 1179224
 (151) 2013 08 08
 (731) Chipita Industrial and Commercial Company
 S.A. with the distinctive title Chipita S.A.
 12th km National Road, Athens-Lamia,
 GR-144 52 Metamorphosis, Greece
 (540)



(591) Black, white
 (511)
 29 – Vegetables, cooked, namely potato products of all types, including potato chips, potato crisps, low-fat potato chips, potato flakes and potato sticks, potato fritters; cheese; edible oils; edible fats.
 30 – Flour for food; wheat flour; flour and preparations made from cereals (except foodstuff for animals); flour-milling products; pop corn; cereal-based snack food; dough based snacks; farinaceous foods; baking powder, namely prepared baking mixtures for bread; bread; bread rolls; breadcrumbs; bread products of all types (chips, crisps, sticks); sandwiches; rusks; cereal preparations, namely bread preparations being snacks and crisp bread; pizzas, including half-finished preserved foods; crackers; spices; cakes; croissants; pastries; pastry; confectionery; biscuits.

(260) AM 2014 74585 A
 (800) 1179225
 (151) 2013 08 08
 (731) Chipita Industrial and Commercial Company
 S.A. with the distinctive title Chipita S.A.
 12th km National Road, Athens-Lamia,
 GR-144 52 Metamorphosis, Greece

(540)



(591) Red, dark-red, light-red, orange, black, white
 (511)
 29 – Vegetables, cooked, namely potato products of all types, including potato chips, potato crisps, low-fat potato chips, potato flakes and potato sticks, potato fritters; cheese; edible oils; edible fats.
 30 – Flour for food; wheat flour; flour and preparations made from cereals (except foodstuff for animals); flour-milling products; pop corn; cereal-based snack food; dough based snacks; farinaceous foods; baking powder, namely prepared baking mixtures for bread; bread; bread rolls; breadcrumbs; bread products of all types (chips, crisps, sticks); sandwiches; rusks; cereal preparations, namely bread preparations being snacks and crisp bread; pizzas, including half-finished preserved foods; crackers; spices; cakes; croissants; pastries; pastry; confectionery; biscuits.

(260) AM 2014 74586 A
 (800) 1179238
 (151) 2013 08 16
 (731) Japan Tobacco Inc.
 2-2-1 Toranomom, Minato-ku, Tokyo, Japan
 (540)



(591) Orange and blue
 (511)
 34 – Tobacco, raw or manufactured; smoking tobacco, pipe tobacco, rolling tobacco, chewing tobacco, moist tobacco powder called "snus"; cigarettes, cigars, cigarillos; substances for smoking sold separately or mixed with tobacco for non-medical and non-therapeutic purposes; snuff; smokers' articles included in this class; cigarette paper, cigarette tubes and matches.

(260) AM 2014 74587 A
 (800) 1179250
 (151) 2013 03 01
 (731) Solvay
 Rue de Ransbeek 310, B-1120 Bruxelles,
 Belgium

(540)



(591) Blue

(511)

1 – Chemicals used in industry, science, as well as in agriculture, horticulture and forestry, in particular, solvents, barium, strontium, calcium chloride, caustic soda, chlorine products, peroxide products, polyglycerol products, calcium (aforementioned) carbonate, carbonate and sodium bicarbonate, cellulose acetate, amino acids, sulfuric acid, surfactants, dyp-henils and derivatives, fluorochemicals, hexanedioic acid, polyamide intermediates, phosphorus derivatives, silica, rare earth elements, mixed oxides and alumina; biological products used in industry and science; unprocessed artificial resins, unprocessed plastic components and plastics, in particular vinyl polymers and specialty monomers, polyamide resins; fire extinguishing compositions; manure for agriculture; tempering and soldering preparations; chemical substances for preserving foodstuffs; chemicals for use as additives for foodstuffs; tanning substances; agents for leather treatment (not included in other classes); chemicals for water, air and soil treatment; adhesives for use in industry; luminescent chemicals for industrial use; chemicals used in industry for the manufacture of phosphors; chemicals for flame-retardant treatments; polyamides; catalysts.

2 – Paints, varnishes, lacquers, coatings (paints); inks (not included in other classes); preservatives against rust and against deterioration of wood; dyestuffs; mordants; raw natural resins; protective coatings.

3 – Bleaching preparations and other substances for laundry use; cleaning, polishing, scouring and abrasive preparations; chemicals for household use, not included in other classes; soaps, perfumery, essential oils, cosmetics; non-medicinal bath salts; hair lotions; dentifrices; preservatives for leather.

5 – Pharmaceutical and veterinary products; therapeutic products relating to genes and cells; sanitary products for medical purposes; dietetic substances for medical use; food supplements for humans and animals; disinfectants; products for destroying vermin; fungicides, herbicides.

9 – Scientific, optical, measuring and checking (supervision) apparatus and instruments; apparatus and instruments for conducting, switching, transforming, accumulating, regulating or controlling electricity; apparatus for recording, transmission or reproduction of sound or images; magnetic data carriers, recording discs; apparatus and instruments for monitoring and automated regulation for tanks, tubing,

valves, housings, boxes, filters and pumping units as well as for installations for filling, storing and feeding of fuel, gas and other fluids; calculating machines; data processing equipment; computers; software; fire-extinguishing apparatus; clothing for protection against fire, heat, radiation and/or chemical reactions; protection devices for personal use against accidents; spectacles (optics); optical goods; diagnostic apparatus not for medical use; memory cards or microprocessor cards.

12 – Vehicles; motorcycles; cycles, bicycles; apparatus for locomotion by land, air or water; motors and engines for land vehicles; structural parts for vehicles, not included in other classes; spare parts of plastic for vehicles, not included in other classes, in particular any technical parts, fuel tanks for vehicles and filling systems thereof, bodies, bumpers, spoilers, dashboards, glove compartments, storage consoles, vehicle roofs and interior side panels, door panels and handles, shock absorbers, frames, kickstands, brakes, handlebars, wheel rims, pedals, tires and wheels.

17 – Rubber, gum and goods made from these materials, not included in other classes; plastics in extruded form for use in manufacture; plastic composites and other semi-finished goods of plastic, also in the form of fluids, mousses, foils, sheets, membranes, plates or tubes; fibres and yarns not for textile use; sealing, packing and insulating material; flexible tubes, not of metal; insulating resin; insulating fluids; electric insulating fluids; semi-processed cellulose acetate, in particular for the manufacture of filters for cigarettes; connecting hose for vehicle radiators; filtering materials (semi-processed foams or plastics).

19 – Building materials, not of metal; rigid panels assemblies and panels made of plastic for building; door and window frames of plastic; non-metallic rigid pipes for building; road building products; non-metallic transportable buildings.

22 – Ropes, string, thread, nets, tents, tarpaulins, sails, bags (not included in other classes); padding and stuffing materials (except of rubber or plastics); raw fibrous textile materials; synthetic and/or artificial fibers (for textile use); cables, not of metal; packing (cushioning, stuffing) materials, not of rubber or plastics; textile fibers; bags or sacks (bags) of textile, for packaging; glass fibers [fibres] for textile use.

23 – Yarns and threads for textile use; elastic thread and yarn for textile use; fiberglass thread for textile use; spun wool; spun silk.

30 – Flour; pastry and confectionery; edible ices; yeast, baking-powder; salt; condiments; spices; aromatic preparations for food; vanillin.

31 – Animal foodstuffs.

37 – Construction, installation, maintenance and repair of industrial equipment; construction, installation, maintenance and repair of installations for recycling and the treatment of materials; construction, installation, maintenance and repair of installations for the treatment of water, soils, gas and air; construction, installation, maintenance and repair of co-generation installations; construction, installation, maintenance and repair of installations for producing and distributing electrical, thermal, calorific and refrigerating energy; maintenance services for thermal equipment; maintenance operations on equipment and installations pertaining to environmental engineering; maintenance of equipment, also on the basis of technical reports on installations, measurements and condition reports; the aforesaid services, also on the basis of diagnostics or in the context of visual and functional undertaking of installations; installation, repair and maintenance of technical equipment in the field of electrical, thermal, calorific and refrigerating energy, also in connection with the management of such apparatus.

39 – Transport; packaging and storage of goods; water distribution; distribution of energy, such as electricity, gas, oil, heat, cold and air.

40 – Recycling and treatment of materials; water, soil, gas and air treatment; surface treatment; treatment of waste; the aforementioned services also in the framework of pollution control; processing of energy; production of energy; advice concerning the aforesaid services.

42 – Scientific and technological services, and research and design relating thereto; industrial analysis and research services; technical project studies; surveying (engineering work); testing of materials; design and development of computers and software; engineering services in environmental engineering; technical measurements and research with a view to establishing technical reports and installation condition reports.

(260) AM 2014 74588 A

(800) 1179256

(151) 2013 09 13

(731) Recordati Rare Diseases Inc.

100 Corporate Drive, Lebanon, New Jersey
08833, USA

(540)

NEOPROFEN

(591) Black, white

(511)

5 – Pharmaceutical preparations, namely anti-inflammatories and analgesics in the form of injections for babies/infants.

(260) AM 2014 74590 A

(800) 1179506

(151) 2013 04 30

(731) ROTAPHARM İLAÇLARI LİMİTED
ŞİRKETİ

Evren Mah. Camiyolu, Cad. No: 50 K.2,
GÜNEŞLİ BAĞCILAR İSTANBUL, Turkey

(540)

DYNAMIX ENERGY

(591) Black, white

(511)

5 – Medicines for human purposes, medicines for veterinary purposes, chemical preparations for medical purposes, dietetic substances adapted for medical use; dietetic foods adapted for medical purposes; amino acids for medical purposes, nutritional supplements, pollen dietary substances, mineral food supplements, protein dietary supplements, baby foods, medicinal herbs, herbal beverages adapted for medical purposes; medicines for dental purposes, hygienic products for medical purposes including pads, wadding for medical purposes, plasters for medical purposes, dressings for medical purposes, preparations for destroying noxious plants, preparations for destroying noxious animals, fungicides, deodorants other than for human beings or for animals, disinfectants for hygiene purposes, antiseptics, detergents for medical purposes.

(260) AM 2014 74603 A

(800) 1179544

(151) 2013 07 29

(731) Institute Hyalual GmbH

Birkenstrasse 47, CH-6343 Rotkreuz,
Switzerland

(540)

DECASAN

(591) Black, white

(511)

5 – Pharmaceutical and veterinary products; sanitary products for medicine; dietetic food and substances adapted for medical or veterinary use, food for babies; food supplements for humans and animals; plasters, materials for dressings; material for dental fillings and dental impressions; disinfectants; products for destroying vermin; fungicides, herbicides; deodorants other than for personal use; tobacco-free cigarettes for medical use; antibiotics; vaccines; wadding for medical use; dietetic substances for medical use; sea water for medicinal bathing; mineral waters for medical use; thermal water; hematogen; mustard plasters; mud for baths; medicinal mud; cod liver oil; iodine for pharmaceutical use; wart pencils; cachou for pharmaceutical use; bunion pads; products for calluses; corn remedies; anti-rheumatism rings; candy for pharmaceutical use; adhesive plaster; constipation remedies; ointments for pharmaceutical use; sunburn ointments; frostbite salve for

pharmaceutical use; gauze for dressings; anti-horsefly oils; oils for medical use; medical dressings; medicines for human medicine; medicines; medicines for dental use; filled first-aid boxes; medicinal drinks; malted milk beverages for medical use; narcotics; medicinal infusions; tincture of iodine; tinctures for medical use; sanitary panties; absorbent underpants for incontinence; sanitary napkins for incontinence; hydrogen peroxide for medical use; plasters; eye patches for medical use; compresses; surgical dressings; breast-nursing pads; pomades for medical use; belts for sanitary towels; sanitary tampons; bacterial preparations for medical or veterinary use; bacteriological preparations for medical or veterinary use; balms for medical use; albuminous preparations for medical use; biological preparations for medical use; bismuth preparations for pharmaceutical use; vitamin preparations; diagnostic products for medical use; hemorrhoid products; preparations to facilitate teething; products for the treatment of burns; sterilizing products; pharmaceutical products for treating dandruff; pharmaceutical products for skin care; contact lens cleaning preparations; therapeutic preparations for the bath; medicinal hair growth preparations; preparations of trace elements for human and animal consumption; sulfonamides (medicines); pharmaceutical products; sunburn products for pharmaceutical use; enzyme preparations for medical use; chemo-pharmaceuticals; chemical preparations for the diagnosis of pregnancy; chemical preparations for medical use; chemical preparations for pharmaceutical use; chilblain products; dietetic foods for medical use; sanitary pads; vaginal washes; solutions for contact lenses; sanitary towels; hygienic bandages; suppositories; soporifics; mineral water salts; salts for mineral water baths; salts for medical use; anesthetics; antiseptics; analgesics; vermifuges; appetite suppressants for medical purposes; medical preparations for slimming purposes; febrifuges; depuratives; migraine treatment articles; remedies for perspiration; chemical contraceptives; anti-parasitic products; purgatives; nervines; tranquilizers; digestives for pharmaceutical use; sanitary tampons; medicinal herbs; enzymes for medical use; ferments for pharmaceutical use; herbal teas; elixirs (pharmaceutical remedies).

(260) AM 2014 74605 A

(800) 1179560

(151) 2013 08 08

(731) Burlington Fashion GmbH

Oststraße 5, 57392 Schmallenberg, Germany

(540)



(591) Black, white

(511)

3 – Soaps for cosmetic purposes, perfumery goods, essential oils; products for personal hygiene and beauty care; cosmetic products to clean, care for and beautify the skin, the scalp and the hair; toilet articles, included in this class, deodorants for personal use, pre shave and after shave products.

14 – Jewellery, watches.

18 – Goods made of leather and imitations of leather (included in this class), bags, suitcases, backpacks; small leather articles (included in this class), especially purses, wallets, key cases; umbrellas and parasols.

25 – All kind of shoes; clothing, especially all kind of hosiery, knitwear, outerwear, sportswear; underwear; headwear, belts.

(260) AM 2014 74606 A

(800) 1179564

(151) 2013 08 21

(731) VDM Metals GmbH

Plettenberger Strasse 2, 58791 Werdohl,
Germany

(540)

VDM alloy 31 plus

(591) Black, white

(511)

6 – Sheet metals, bands, ingots, poles, rods, rings, plates, foils, wires (not for electric purposes), soldering wires, round plates, blanks, punched, deep-drawn, rolled and bent parts, riveted and cold-formed parts, billets, iron slabs, blocks, pipes (weldless and welded), forged, continuously cast and cast parts, all goods made of common metals and metal alloys or stainless steels, in particular of special steels, especially containing nickel, chromium, iron, copper, zirconium, titanium, niobium, tantalum, manganese, cobalt, aluminum, magnesium, zinc, tin, lead, molybdenum and alloys thereof, in particular usable as components in gas and steam turbines, as boiler construction parts, as structural parts in the furnace and power station construction, in the chemical and petrochemical industry as well as in the field of the nuclear energy technique, electronics, electro-technics, in the offshore field, in the automobile and aeronautical industry, in the medical technique and architecture; crude and partially worked common metals and metal alloys; semi-finished products and metal goods, especially made of nickel, chromium, iron, copper, zirconium, titanium, cobalt, molybdenum, aluminum, magnesium, niobium, tantalum, manganese, zinc, tin, lead and alloys thereof; semi-finished products made of brass; semi-finished products made of magnetic materials, especially in form of bands, sheet metals, foils, wires, poles, pro-

files; crude and partially worked non-iron alloys in form of blocks, slabs, plates, sheet metals, rods, poles, tubes (seamlessly welded), round plates, billets, disks, cast, drawn, rolled, pressed, forged; formed metal parts, slide bearings; bronzes in form of poles, tubes, bands and pressed parts, parts made of bronze for highly stressed bearing bushes, bronze tubes for pipes; composite metals (in which the core metal and the cover metal are welded or soldered to each other); filler metals on the base of iron chrome nickel alloys; components as well as finished structural parts made of metal and alloys thereof for the electrolytic extraction of zinc.

9 – Resistance-normals, measuring, precision and slide resistors; series resistors for measuring instruments, shunt resistors for ampere meters, starter resistors, load resistors, adjustment and control resistors, heating resistors; anodes; boards; wires made of common metals and alloys thereof, especially made of nickel, chromium, cobalt, iron and alloys thereof for electric purposes; electric heating conductors and electric resistors made of metallic materials in form of wires, bands, foils and coils; structural parts as parts of fuel cells made of common metals, especially iron and chromium.

(260) AM 2014 74607 A
(800) 1179606
(151) 2013 08 13
(731) Krewel Meuselbach GmbH; Krewelstraße 2, 53783 Eitorf, Germany
(540)



(591) HKS 14 red, black and white
(511)
5 – Medicines; pharmaceutical products and preparations for health care; dietetic substances adapted for medical use; dietetic substances for non-medical use and supplements for non-medical use on the basis of plant fibers, vitamins, minerals, trace elements and amino acids.

35 – Advertising and marketing.

44 – Health and beauty care.

(260) AM 2014 74608 A
(800) 1179618
(151) 2013 09 10
(731) SILVANOLS, SIA
Kurbada iela 2a, LV-1009 Rīga, Latvia

(540)
СИЛВАНОЛС

(591) Black, white
(511)
5 – Pharmaceutical preparations; non-prescription drugs; natural medicines and drugs; personal hygiene preparations for medical use; dietetic products for medical use; food for babies; vitamins; dietary supplements for medical use; food additives for medical use.

(260) AM 2014 74609 A
(800) 1179648
(151) 2013 09 23
(731) ARTE REGAL IMPORT, S.L.
Calle Comtat, s/n Pol. Ind. La Cova, E-46940 Manises (Valencia), Spain



(591) Black, white
(511)
4 – Candles and wicks for lighting; candles; nightlights [candles]; lamp wicks; wicks for candles; Christmas tree candles; perfumed candles.

6 – Common metals and their alloys; non-electric cables and wires of common metal; ironmongery and small items of metal hardware; pipes and tubes of metal; safes; goods of common metal not included in other classes; ores of metal.

9 – Scientific, nautical, surveying, photographic, cinematographic, optical, weighing, measuring, signaling, checking (supervision), life-saving and teaching apparatus and instruments; apparatus and instruments for conducting, switching, transforming, accumulating, regulating or controlling electricity; apparatus for recording, transmission or reproduction of sound or images; magnetic data carriers, sound recording disks; compact disks, DVDs and other digital recording media; mechanisms for coin-operated apparatus; cash registers, calculating machines, data processing equipment, computers; software; extinguishers.

(260) AM 2014 74610 A
(800) 1179653
(151) 2013 09 26
(731) TELA BIO, Inc.
1 Great Valley Parkway, Suite 24, Malvern PA 19355, USA

(540)
TELAGEN

(591) Black, white

(511)
10 – Natural and biocompatible materials comprised of non-living tissue with native regenerative properties of extracellular matrix (ECM) for hernia and soft-tissue repair.

(260) AM 2014 74611 A
(800) 431445
(151) 1977 06 29
(891) 2013 07 30
(731) Novartis AG
CH-4002 Basel, Switzerland

(540)

LEPONEX

(591) Black, white
(511)
5 – Pharmaceutical products, chemical products for medical and sanitary use, pharmaceutical drugs, medicines.

(260) AM 2014 74612 A
(800) 452281
(151) 1980 03 28
(891) 2013 07 30
(731) Novartis AG
CH-4002 Basel, Switzerland

(540)

SIRDALUD

(591) Black, white
(511)
5 – Pharmaceutical preparations.

(260) AM 2014 74662 A
(800) 1180204
(151) 2013 08 23
(731) EGIS GYÓGYSZERGYÁR NYILVÁNO-
SAN MŰKÖDŐ RÉSZVÉNYTÁRSASÁG
Keresztúri út 30-38, H-1106 Budapest,
Hungary

(540)

ANDAKON

(591) Black, white
(511)
5 – Pharmaceutical preparations for human use.

(260) AM 2014 74663 A
(800) 1180205
(151) 2013 08 23
(731) EGIS GYÓGYSZERGYÁR NYILVÁNO-
SAN MŰKÖDŐ RÉSZVÉNYTÁRSASÁG
Keresztúri út 30-38, H-1106 Budapest,
Hungary

(540)

TRIPRESS

(591) Black, white
(511)
5 – Pharmaceutical preparations for human use.

(260) AM 2014 74664 A
(800) 1180206
(151) 2013 08 23
(731) EGIS GYÓGYSZERGYÁR NYILVÁNO-
SAN MŰKÖDŐ RÉSZVÉNYTÁRSASÁG
Keresztúri út 30-38, H-1106 Budapest,
Hungary

(540)

ZULLABO

(591) Black, white
(511)
5 – Pharmaceutical preparations for human use.

(260) AM 2014 74665 A
(800) 1180207
(151) 2013 08 23
(731) EGIS GYÓGYSZERGYÁR NYILVÁNO-
SAN MŰKÖDŐ RÉSZVÉNYTÁRSASÁG
Keresztúri út 30-38, H-1106 Budapest,
Hungary

(540)

EGIRAN

(591) Black, white
(511)
5 – Pharmaceutical preparations for human use.

(260) AM 2014 74666 A
(800) 1180215
(151) 2013 08 16
(731) Omega SA (Omega AG) (Omega Ltd.)
Jakob-Stämpfli-Strasse 96, CH-2502
Biel/Bienne, Switzerland

(540)

MOONWATCH

(591) Black, white
(511)
14 – Precious metals and their alloys and goods made thereof or coated therewith included in this class, jewelry, jewelry cases, cases (caskets), precious stones, timepieces and chronometric instruments, watch chains, presentation cases for timepieces, cases for timepieces.

(260) AM 2014 74667 A
(800) 1180220
(151) 2013 09 09

(731) Sturm, Ruger & Company, Inc.
1 Lacey Place, Southport CT 06890, USA
(540)



(591) Black, white
(511)
13 - Firearms.

(260) AM 2014 74668 A
(800) 1180223
(151) 2013 08 28
(731) EGIS GYOGYSZERGYÁR Nyilvánosan
Működő Részvénytársaság
Kereszturi ut 30-38, H-1106 Budapest,
Hungary
(540)

EGIROS

(591) Black, white
(511)
5 - Pharmaceutical preparations for human use.

(260) AM 2014 74669 A
(800) 1180224
(151) 2013 08 28
(731) EGIS GYOGYSZERGYÁR Nyilvánosan
Működő Részvénytársaság
Kereszturi ut 30-38, H-1106 Budapest,
Hungary
(540)

EGICOMPLEX

(591) Black, white
(511)
5 - Pharmaceutical preparations for human use.

(260) AM 2014 74671 A
(800) 1180234
(151) 2013 03 18
(731) MBK IP UK LIMITED
c/o Pitmans SK Sport & Entertainment LLP,
1 Crown Court, 66 Cheapside, London
EC2V 6LR, United Kingdom
(540)

ХОДОРКОВСКИЙ

(591) Black, white
(511)
9 - Scientific, nautical, surveying, photographic, cinematographic, optical, weighing, measuring, signalling, checking (supervision), life-saving and teaching apparatus and instruments; apparatus and instruments for conducting, switching, transforming,

accumulating, regulating or controlling electricity; apparatus for recording, transmission or reproduction of sound or images; magnetic data carriers, recording discs; compact discs, DVDs and other digital recording media; mechanisms for coin-operated apparatus; cash registers, calculating machines, data processing equipment, computers; computer software; fire extinguishing apparatus; computer games; computer game programs; video game software; videos; MP3s; MP4s; CD5s; audio and/or visual tapes; cassettes; records; digital music (downloadable from the Internet); podcasts; film, sound and video recordings; sound and video recordings and publications in electronic form supplied online, from databases or from facilities provided on the Internet; downloadable electronic publications; telephone ring tones (downloadable); computer databases; sunglasses; eyeglasses; holographic images; parts and fittings for the aforesaid goods.

16 - Paper, cardboard and goods made from these materials, not included in other classes; printed matter; bookbinding material; photographs; stationery; adhesives for stationery or household purposes; artists' materials; paint brushes; typewriters and office requisites (except furniture); instructional and teaching material (except apparatus); plastic materials for packaging (not included in other classes); printers' type; printing blocks; printed publications; books, song books, magazines, leaflets, brochures, journals and event programmes; flyers; greeting cards; post cards; pens; document cases, card holders, photograph holders, albums of all kinds; stickers; souvenir programmes.

25 - Clothing, footwear, headgear.

35 - Advertising; business management; business administration; office functions; organisation, operation and supervision of loyalty schemes and incentive schemes; advertising and marketing; accountancy; auctioneering; organisation of trade fairs; opinion polling; data processing; provision of business information; business management and organization consultancy; acquisition and merger consultation; business expertise services; analyses and appraisals of enterprises; retail services connected with the sale of scientific, nautical, surveying, photographic, cinematographic, optical, weighing, measuring, signalling, checking (supervision), life-saving and teaching apparatus and instruments, apparatus and instruments for conducting, switching, transforming, accumulating, regulating or controlling electricity, apparatus for recording, transmission or reproduction of sound or images, magnetic data carriers, recording discs, compact discs, DVDs and other digital recording media, mechanisms for coin-operated apparatus, cash registers, calculating machines, data processing equipment, computers, computer software, fire-extinguishing apparatus, recording discs, computer programs, computer games, compu-

ter game programs, video games, videos, MP3s, MP4s, CDs, audio and/or visual tapes, cassettes, discs, records, digital music (downloadable from the Internet), podcasts, film, sound and video recordings, sound and video recordings and publications in electronic form supplied on-line, from databases or from facilities provided on the Internet, downloadable electronic publications, digital music (downloadable) from the Internet, telephone ring tones (downloadable), databases, sunglasses, eyeglasses, holographic images, paper, cardboard and goods made from these materials, not included in other classes, printed matter, bookbinding material, photographs, stationery, adhesives for stationery or household purposes, artists' materials, paint brushes, typewriters and office requisites (except furniture), instructional and teaching material (except apparatus), plastic materials for packaging (not included in other classes), printers' type, printing blocks, printed publications, books, song books, magazines, leaflets, brochures, journals and event programmes, flyers, greeting cards, post cards, pens, document cases, card holders, photograph holders, albums of all kinds, stickers, souvenir programmes, clothing, footwear, headgear; consultancy, advisory and information services relating to the aforesaid services.

36 – Insurance; financial affairs; monetary affairs; real estate affairs; charitable services, namely financial services; charitable fund raising; charitable collections; political fund-raising services; management of funds; financial grant services; consultancy, advisory and information services relating to the aforesaid services.

38 – Telecommunications; chat room services for social networking; providing access to an Internet portal; e-mail services; providing user access to the Internet; radio and television broadcasting; distribution of data or audio visual images via a global computer network or the Internet; consultancy, advisory and information services relating to the aforesaid services.

41 – Education; providing of training; entertainment; sporting and cultural activities; electronic games services provided by means of the Internet; organisation of competitions for education or entertainment; production of radio and television programmes; providing on-line electronic publications (not downloadable); publication of texts (other than publicity texts); provision of on-line electronic publications (not downloadable) from the Internet; provision of recreational and entertainment facilities; recording of music onto a variety of media; production of sound recordings; production of musical recordings; production of audio recordings; organising, arranging, managing and staging musical events, shows, concerts, festivals, gigs and live band performances; arranging of award ceremonies; production of television, film, radio and music program-

mes and recordings; composition of music; video taping; digital music (not downloadable) provided from the Internet; theatrical booking services, concert booking services; ticket reservation and ticket agency services for concerts and other events; ticket agency services provided online, by telephone, mobile telephone, and through ticket outlets; the provision of on-line electronic publications and digital music (not downloadable) from the Internet in the form of podcasts; management of music venues; information relating to all the foregoing provided by telephone, mobile telephone, on-line from a computer database or via the Internet; personal mentoring; consultancy, advisory and information services relating to the aforesaid services.

45 – Legal services; security services for the protection of property and individuals; personal and social services rendered by others to meet the needs of individuals; legal information and research services; advisory services relating to the law, alternative dispute resolution and arbitration services; arranging for the provision of legal services; provision of information relating to legal services; court reporting; providing information on issues concerning human rights; charitable services, namely spiritual mentoring; spiritual mentoring; civil defence and civil protection; compilation of legal and regulatory information; preparation of regulations; political lobbying services; consultancy, advisory and information services relating to the aforesaid services.

(260) AM 2014 74686 A

(800) 1180273

(151) 2013 04 09

(731) Tkachenko Yurii Volodymyrovych
vul. Literaturna, 14A, m. Irmino, Luhanska
obl. 94091, Ukraine

(540)

Ероза

(591) Black, white

(511)

6 – Aluminium wire; fittings of metal for building; reinforcing materials of metal for building; framework of metal for building; building materials of metal; door stops of metal; gates of metal; bindings of metal; hooks (metal hardware); latticework of metal; latticework of metal; doors of metal; turnstiles; door bells, non-electric; door stops of metal; protecting fences of metal; wire stretchers (tension links); base metal wire; wire cloth; outdoor blinds of metal; iron wire; crash barriers of metal for roads; common metals, unwrought or semi-wrought; couplings of metal for chains; signs, non-luminous and non-mechanical, of metal, for roads; signs, non-luminous and non-mechanical, of metal; rope thimbles of metal; ropes of metal; cables of metal,

non-electric; pillars of metal for buildings and structures; barbed wire; brackets of metal for building; buildings of metal; chains of metal; number plates, of metal; fences of metal; poles of metal; bands of metal for tying-up purposes; safes (strong boxes); signalling panels, non-luminous and non-mechanical, of metal; buckles of common metal (hardware); buildings, transportable, of metal; steel wire; steel buildings; steel masts; (posts of metal; advertisement columns of metal; stops of metal; boarding stairs of metal, mobile, for passengers; stair treads (steps) of metal; staircases of metal; palings of metal; metal barbed tape; metal barbed reinforced tape; metal barbed razor wire fences; metal mesh; metal mesh for fence; safety barriers, metal; metal safety barriers, installed on board of ships, to protect people or goods; metal barbed razor wire fence for protection against penetration of sea pirates; metal buckles for connecting turns of wire; buckles for fixing of protective safety barriers; not automatic metal turnstiles; transportable metal fences; metal limiters; metal fixtures; metal brackets.

9 – Alarm instruments and tools; detectors; electric signal bells; bells (warning devices); acoustic (sound) alarms; magnetic code cards; magnetic encoders; metal detectors for industrial or military purposes; electrified fences; electronic perimeter security systems; electrical security devices; anti-theft warning devices; control panels (electricity); whistle alarms; light or mechanical alarm; light or mechanical alarm panels; sirens; blinkers (signalling lights); electrical warning devices; electronic video control systems; electronic components of alarm systems, except vehicle security systems; access control systems; electronic components of perimeter security systems; electrical shock systems of perimeter security; warning devices.

19 – Non-metal barbed tape for protecting structures; non-metal tape for protecting structures; non-metal reinforced barbed tape for protecting structures; barbed razor wire fences, not of metal; fences for perimeter security, not of metal; mesh for fencing, not of metal; safety barriers, not of metal; building structures, not of metal; fences, not of metal; palings, not of metal; gates, not of metal; doors, not of metal; turnpikes, not of metal and not automatic; turnstiles, not of metal and not automatic; hanging barriers, not of metal, not of textile; transportable constructions, not of metal; chains for protecting structures, not of metal; posts, not of metal; framework for building, not of metal; pipes, not of metal; plastic profiles; non-metallic transportable constructions for security systems and perimeter security; reflective road posts, not of metal; siding, not of metal; building materials, not of metal; non-metallic transportable constructions; prefabricated houses, hangars, summer houses, pavilions, piers, not of metal; floors, roofs, ceilings, not of metal; quick-mounting structures, not of metal; plastic barbed wire for protecting structures;

barbed tape of plastic and non-metal composite materials for protecting structures; tape of non-metal composite materials for protecting structures; reinforced tape of non-metal composite materials for protecting structures; reinforced barbed tape of plastic and non-metal composite materials for protecting structures; barbed razor wire fence of plastic or polymer materials; guarding for perimeter security of plastic and non-metal composite materials; plastic meshes for protecting structures; plastic crash barriers; protective fence of plastic; buildings (structures) of plastic or non-metallic composite materials; plastic fences; plastic palings; plastic gates; plastic doors; turnstiles, turnpikes of plastic, not automatic; hanging barriers of plastic; plastic transportable structures; plastic posts; plastic poles; frameworks for building, of plastic and non-metal composite materials; building materials of plastic and non-metal composite materials; plastic building materials; plastic reflective road posts; plastic siding; props, not of metal.

35 – Subscription to telecommunication services for third parties; import-export agencies; commercial information agencies; advertising agencies; cost price analysis; rental of advertising space; auditing; employment agencies; maintenance of automated databases; book-keeping (accounting); invoicing; demonstration of goods; transcription; public opinion polling; market research; business information; commercial information and advice for consumers; business research; research in the field of marketing; personnel recruitment; business organization and business management consultancy; personnel management consultancy; professional business consultancy; layout services for advertising purposes; management in creative businesses; news clipping services; updating of advertising material; text processing; secretarial services; shorthand; organization of exhibitions for commercial or advertising purposes; arranging newspaper subscriptions for third parties; organization of trade fairs for commercial or advertising purposes; shop window dressing; commercial activity appraisals; payroll preparation; data search in computer files (for third parties); sponsorship search; business management assistance; commercial or industrial management assistance; presentation of goods on communication media, for retail purposes; economic forecasting; auctioneering; sales promotion (for third parties); rental of office equipment; rental of advertising time on communication media; publicity material rental; rental of vending machines; rental of photocopying machines; publication of publicity texts; typing; radio advertising; bill-posting; distribution of samples; dissemination of advertising matter; writing of publicity texts; advertising; on-line advertising in computer network; advertising by mail order; television advertising; document reproduction; compilation and provision of statistics; compilation of information into computer databases; information on business operations;

systemization of information into computer databases; tax preparation; drawing up of statements of accounts; preparation of advertisement rubrics in newspapers; psychological testing for the selection of personnel; business management of hotels; commercial administration of the licensing of the goods and services (of third parties); administrative processing of purchase orders; services in the field of public relations; modelling for advertising or sales promotion; relocation services for businesses; price comparison services; procurement services for third parties (purchasing and supply of goods for other businesses); outsourcing services (business assistance); commercial management; telephone answering for unavailable subscribers; photocopying services; efficiency experts.

37 – Well drilling; vulcanization of tires (tyres) (repair); building sealing; building insulating; repair information; construction information; bricklaying; riveting; construction consultation; varnishing; car wash; vehicle wash; roofing services; painting work; carpentry; vehicle maintenance; safe maintenance and repair; vehicle service stations (refuelling and maintenance); construction of fair stalls and pavilions; construction of quick-mounting structures, including houses, hangars, sheds; installation of doors and windows; installation and adjusting of irrigation equipment; installation and adjusting of heating equipment; installation and adjusting of security alarm; installation and adjusting of fire protection equipment; installation, adjusting and maintenance of perimeter security; installation of concertina razor wire; installation of barbed wire fencing; installation of barbed razor wire barriers; installation of guard rails.

42 – Maintenance and updating of computer software; recovery of computer data; installation of computer software; duplication of computer software; computer system design, including systems of technical protection of information; design of systems of monitoring and control of access to information; conversion of computer programmes and data (not physical conversion).

(260) AM 2014 74687 A

(800) 1180302

(151) 2013 05 27

(731) ITT ITALIA S.r.l.

Corso Europa, 41/43, I-20020 LAINATE
(MI), Italy

(540)



(591) Black, white

(511)

7 – Mechanical devices for the manufacture of vehicle parts; electrically driven tools for assembling and disassembling of vehicle parts; brakes, other than for vehicles, and parts thereof.

9 – Mechanical devices for measuring vehicle parts.

12 – Vehicle parts, including brake blocks, brake shoes, chocks, and parts thereof, such as back plates, brake pads; brakes for vehicles and parts thereof.

16 – Instruction manuals, books for describing said vehicle parts.

(260) AM 2014 74794 A

(800) 1180894

(151) 2013 08 26

(731) Hyundai Motor Company

231, Yangjae-Dong, Seocho-Gu, Seoul,
137-938, Republic of Korea

(540)

SANTA FE

(591) Black, white

(511)

28 – Tricycles for children [playthings]; rocking horses; toy musical instruments; playing balls; toy blocks; scooters [toys]; flying discs [toys]; dolls' rooms; dolls' feeding bottles; clothes for dolls; dolls' houses; dolls' beds; teddy bears; toy pistols; paper toys; plush toys; plastic toys; toy masks; rubber toys; metallic toys; practical jokes [novelties]; marionettes; rattan toys; rattles [playthings]; remote controlled toys [other than those adapted for use with television receivers]; mannequin dolls; mascot dolls; mobiles [toys]; wooden toys; toy sets; puppets; infant walkers [playthings]; model vehicles for children.

(260) AM 2014 74795 A

(800) 1180917

(151) 2013 08 09

(731) Limited Liability Company "Tosol-Sintez"

31 A, ul. Vatutina, RU-606000 g. Dzerzhinsk,
Nizhegorodskaya obl., Russian Federation

(540)

DEF BLUE

(591) Black, white

(511)

1 – Fertilizing preparations; nitrogenous fertilizers; manure for agriculture.

(260) AM 2014 74796 A

(800) 1180922

(151) 2013 09 18

(731) KRKA, tovarna zdravil, d.d., Novo mesto

Šmarješka cesta, SI-8501 Novo Mesto,
Slovenia

(540)

FLEBAVEN

(591) Black, white

(511)

5 – Pharmaceutical preparations.

(260) AM 2014 74797 A

(800) 1180923

(151) 2013 09 18

(731) KRKA, tovarna zdravil, d.d., Novo mesto
Šmarješka cesta, SI-8501 Novo Mesto,
Slovenia

(540)

FLADIOS

(591) Black, white

(511)

5 – Pharmaceutical preparations.

(260) AM 2014 74798 A

(800) 1180934

(151) 2013 08 21

(731) OTKRYTOE AKTSIONERNOE
OBCHTCHESTVO "NEFTYANAYA
KOMPANIYA "LUKOIL"
Sretensky bouvar 11, RU-101000 MOSKVA,
Russian Federation

(540)

КАРВИНИЛ

(591) Black, white

(511)

1 – Chemical products for use in industry and science; unprocessed plastics.

(260) AM 2014 74803 A

(800) 1180975

(151) 2013 02 12

(731) Inbloom, Inc.
P.O. Box 23350, Seattle WA 98102, USA

(540)

INBLOOM

(591) Black, white

(511)

41 – Consultation in the field of K-12 education systems and/or creating educational standards in the field of K-12 education.

42 – Providing temporary use of online non-downloadable software for accessing and using a cloud-based multi-tenant data store that creates interoperability of data from many source systems and formats and makes it available to authorized users and application developers; providing temporary use of software that facilitates linkages from data records to courseware, and assessment tools from many providers; application service provider (ASP) services,

namely, hosting application programming interface (API) software that enables application developers, courseware designers, educators, researchers and others to share academic information and resources; application service provider (ASP) services, namely, hosting computer software applications of others; all of the foregoing in the field of K-12 education; providing computer application programming interfaces that enable application developers, courseware designers, educators, researchers and others to share information and resources in the field of K-12 education.

(260) AM 2014 74812 A

(800) 1181087

(151) 2013 09 26

(731) VANGUARD TRADEMARK HOLDINGS
USA LLC
600 Coporate Park Drive, St. Louis MO
63105, USA

(540)

EMERALD CLUB

(591) Black, white

(511)

39 – Automobile rental services; reservation services for the rental and leasing of vehicles.

(260) AM 2014 74813 A

(800) 1181110

(151) 2013 08 02

(731) BACARDI & COMPANY LIMITED
Aeulestrasse 5, FL-9490 VADUZ,
Liechtenstein

(540)

GRAN LUSSO

(591) Black, white

(511)

33 – Alcoholic beverages, except beers.

(260) AM 2014 74817 A

(800) 1181122

(151) 2013 09 06

(731) Trove Limited
3rd floor, Heritage House, 235 Main Street,
Gibraltar, Gibraltar

(540)

SEVENS

(591) Black, white

(511)

33 – Alcoholic beverages, except beer; distilled beverages; alcoholic beverages containing fruit; anisette [liqueur]; aperitifs; arak [arrack]; brandy; wine; whisky; kirsch; vodka; gin; bitters; perry; cocktails; curacao; liqueurs; hydromel [mead]; spirits [beverages]; peppermint liqueurs; piquette; rice alcohol;

rum; sake; cider; alcoholic extracts; alcoholic essences; fruit extracts, alcoholic.

(260) AM 2014 74818 A

(800) 1181147

(151) 2013 09 03

(731) EGIS GYÓGYSZERGYÁR NYILVÁNO-
SAN MŰKÖDŐ RÉSZVÉNYTÁRSASÁG
Keresztúri út 30-38, H-1106 Budapest,
Hungary

(540)

CORDAPRED

(591) Black, white

(511)

5 – Pharmaceutical preparations for human use.

(260) AM 2014 74819 A

(800) 1181148

(151) 2013 09 30

(731) Richter Gedeon Nyrt.
Gyömrői út 19-21, H-1103 Budapest,
Hungary

(540)

КЛАМАВИРТ

(591) Black, white

(511)

5 – Pharmaceutical preparations.

INTERNATIONAL TRADEMARKS PROTECTED IN GEORGIA

(260) AM 2013 70584 A
(800) 1144404
(151) 2012 10 08
(181) 2022 10 08
(511) 09, 37, 42

(260) AM 2014 71906 A
(800) 1153806
(151) 2013 02 07
(181) 2023 02 07
(511) 07

(260) AM 2014 65404 A
(800) 1098167
(151) 2011 10 27
(181) 2021 10 27
(511) 21

(260) AM 2014 71907 A
(800) 1153807
(151) 2013 02 07
(181) 2023 02 07
(511) 07

(260) AM 2014 70448 A
(800) 1142448
(151) 2012 09 20
(181) 2022 09 20
(511) 03, 25

(260) AM 2014 71913 A
(800) 710929
(151) 1999 03 19
(891) 2012 12 26
(181) 2019 03 19
(511) 32

(260) AM 2014 71390 A
(800) 1150594
(151) 2012 08 15
(181) 2022 08 15
(511) 14, 24, 28, 30

(260) AM 2014 71914 A
(800) 798696
(151) 2003 03 06
(891) 2013 03 07
(181) 2023 03 06
(511) 05

(260) AM 2014 71394 A
(800) 1150605
(151) 2012 11 05
(181) 2022 11 05
(511) 12

(260) AM 2014 71916 A
(800) 908772
(151) 2005 12 16
(891) 2013 01 28
(181) 2015 12 16
(511) 13

(260) AM 2014 71902 A
(800) 1153774
(151) 2012 11 21
(181) 2022 11 21
(511) 09, 35, 42

(260) AM 2014 71919 A
(800) 1053879
(151) 2010 08 31
(891) 2013 02 18
(181) 2020 08 31
(511) 14

(260) AM 2014 71903 A
(800) 1153783
(151) 2012 11 12
(181) 2022 11 12
(511) 05

(260) AM 2014 71920 A
(800) 1070660
(151) 2011 01 14
(891) 2012 12 31
(181) 2021 01 14
(511) 03, 35

(260) AM 2014 71905 A
(800) 1153805
(151) 2013 02 07
(181) 2023 02 07
(511) 07

(260) AM 2014 71921 A
(800) 1103867
(151) 2011 07 05
(891) 2013 02 14
(181) 2021 07 05
(511) 05, 10

(260) AM 2014 71922 A
(800) 1141101
(151) 2012 10 16
(891) 2013 01 25
(181) 2022 10 16
(511) 05

(260) AM 2014 71923 A
(800) 1139739
(151) 2012 09 25
(891) 2013 01 21
(181) 2022 09 25
(511) 01, 03, 05

(260) AM 2014 71938 A
(800) 1153861
(151) 2012 07 24
(181) 2022 07 24
(511) 06, 20, 35

(260) AM 2014 71939 A
(800) 1153878
(151) 2013 02 01
(181) 2023 02 01
(511) 09, 38, 41

(260) AM 2014 71940 A
(800) 1153931
(151) 2012 10 11
(181) 2022 10 11
(511) 29, 30, 32

(260) AM 2014 71943 A
(800) 1153982
(151) 2013 02 01
(181) 2023 02 01
(511) 35, 37

(260) AM 2014 71945 A
(800) 1153994
(151) 2013 01 04
(181) 2023 01 04
(511) 05

(260) AM 2014 71946 A
(800) 1154063
(151) 2012 12 20
(181) 2022 12 20
(511) 02

(260) AM 2014 71947 A
(800) 1154072
(151) 2012 11 27
(181) 2022 11 27
(511) 35, 39, 41, 44, 45

(260) AM 2014 71948 A
(800) 1154087
(151) 2012 05 18
(181) 2022 05 18
(511) 03, 09, 14, 16, 18, 25, 28, 35, 41

(260) AM 2014 71949 A
(800) 1154145
(151) 2012 11 22
(181) 2022 11 22
(511) 34

(260) AM 2014 71950 A
(800) 1154147
(151) 2012 11 22
(181) 2022 11 22
(511) 34

(260) AM 2014 71951 A
(800) 1154236
(151) 2013 02 04
(181) 2023 02 04
(511) 34

(260) AM 2014 71952 A
(800) 1154237
(151) 2013 02 05
(181) 2023 02 05
(511) 34

(260) AM 2014 71953 A
(800) 1154263
(151) 2013 02 18
(181) 2023 02 18
(511) 05

(260) AM 2014 71954 A
(800) 1154334
(151) 2012 09 28

(181) 2022 09 28
(511) 12, 35

(260) AM 2014 71955 A
(800) 1154378
(151) 2013 01 10
(181) 2023 01 10
(511) 33

(260) AM 2014 71956 A
(800) 1154462
(151) 2012 09 20
(181) 2022 09 20
(511) 29, 30, 32, 35

(260) AM 2014 71957 A
(800) 1154491
(151) 2012 09 07
(181) 2022 09 07
(511) 09, 16, 25, 28, 41

(260) AM 2014 71972 A
(800) 1154568
(151) 2012 04 10
(891) 2013 04 11
(181) 2022 04 10
(511) 29, 30

(260) AM 2014 71973 A
(800) 1154605
(151) 2013 01 24
(181) 2023 01 24
(511) 05

(260) AM 2014 71996 A
(800) 1154606
(151) 2013 01 22
(181) 2023 01 22
(511) 05

(260) AM 2014 71997 A
(800) 1154607
(151) 2013 01 22
(181) 2023 01 22
(511) 05

(260) AM 2014 71998 A
(800) 1154619
(151) 2013 01 21
(181) 2023 01 21
(511) 05

(260) AM 2014 71999 A
(800) 1154629
(151) 2013 03 14
(181) 2023 03 14
(511) 06

(260) AM 2014 72001 A
(800) 1154631
(151) 2013 01 30
(181) 2023 01 30
(511) 30

(260) AM 2014 72002 A
(800) 801996
(151) 2003 03 07
(891) 2013 03 08
(181) 2023 03 07
(511) 27

(260) AM 2014 72004 A
(800) 807028
(151) 2003 03 25
(891) 2013 03 26
(181) 2023 03 25
(511) 30

(260) AM 2014 72005 A
(800) 1097276
(151) 2011 05 05
(891) 2013 03 07
(181) 2021 05 05
(511) 25, 28, 30, 32, 33, 34, 41, 43

(260) AM 2014 72009 A
(800) 1099717
(151) 2011 10 21
(891) 2013 02 20
(181) 2021 10 21
(511) 05

(260) AM 2014 72010 A
(800) 1131962
(151) 2012 06 06
(891) 2013 02 20
(181) 2022 06 06
(511) 05

(260) AM 2014 72011 A
(800) 1141211
(151) 2012 07 09
(891) 2013 02 19
(181) 2022 07 09
(511) 07, 09, 11

(260) AM 2014 72050 A
(800) 1155199
(151) 2012 12 07
(181) 2022 12 07
(511) 03, 20, 25, 27, 28, 35, 41

(260) AM 2014 72057 A
(800) 1155298
(151) 2013 02 05
(181) 2023 02 05
(511) 19, 20, 27

(260) AM 2014 72058 A
(800) 1155303
(151) 2013 02 08
(181) 2023 02 08
(511) 28, 30

(260) AM 2014 72059 A
(800) 1155312
(151) 2013 02 22
(181) 2023 02 22
(511) 05

(260) AM 2014 72060 A
(800) 1155313
(151) 2013 02 22
(181) 2023 02 22
(511) 05

(260) AM 2014 72061 A
(800) 1155314
(151) 2013 02 22
(181) 2023 02 22
(511) 05

(260) AM 2014 72062 A
(800) 1155339
(151) 2012 12 31
(181) 2022 12 31
(511) 25

(260) AM 2014 72063 A
(800) 1155346
(151) 2013 02 22
(181) 2023 02 22
(511) 05

(260) AM 2014 72064 A
(800) 1155364
(151) 2013 02 26

(181) 2023 02 26
(511) 25

(260) AM 2014 72065 A
(800) 597896
(151) 1993 01 28
(891) 2013 02 25
(181) 2023 01 28
(511) 05

(260) AM 2014 72066 A
(800) 788491
(151) 2002 09 06
(891) 2013 02 04
(181) 2022 09 06
(511) 25

(260) AM 2014 72067 A
(800) 822003
(151) 2003 11 10
(891) 2013 03 11
(181) 2013 11 10
(511) 09, 16, 20

(260) AM 2014 72068 A
(800) 1093859
(151) 2011 08 25
(891) 2013 03 14
(181) 2021 08 25
(511) 30

(260) AM 2014 72175 A
(800) 915058
(151) 2006 12 28
(891) 2013 01 23
(181) 2016 12 28
(511) 39

(260) AM 2014 72177 A
(800) 981362
(151) 2008 09 17
(891) 2013 03 04
(181) 2018 09 17
(511) 09, 14, 18, 25

(260) AM 2014 72178 A
(800) 1039066
(151) 2010 03 29
(891) 2013 02 28
(181) 2020 03 29
(511) 07, 16, 39

(260) AM 2014 72179 A
(800) 1055571
(151) 2010 03 04
(891) 2013 01 30
(181) 2020 03 04
(511) 06, 07, 37, 42

(260) AM 2014 72182 A
(800) 1068726
(151) 2011 01 05
(891) 2013 02 11
(181) 2021 01 05
(511) 29, 30, 31

(260) AM 2014 72183 A
(800) 1078181
(151) 2011 01 07
(891) 2013 02 27
(181) 2021 01 07
(511) 03, 14, 16, 18, 22, 24, 25, 28, 29, 30, 32, 35,
36, 37, 38, 39, 41, 45

(260) AM 2014 72184 A
(800) 1091960
(151) 2011 08 16
(891) 2013 02 27
(181) 2021 08 16
(511) 12

(260) AM 2014 72187 A
(800) 1132103
(151) 2012 08 30
(891) 2013 03 18
(181) 2022 08 30
(511) 32, 33

(260) AM 2014 72188 A
(800) 1133635
(151) 2012 08 31
(891) 2013 03 07
(181) 2022 08 31
(511) 05

(260) AM 2014 72562 A
(800) 1160184
(151) 2013 03 20
(181) 2023 03 20
(511) 09, 11

(260) AM 2014 72584 A
(800) 1160202
(151) 2013 01 28

(181) 2023 01 28
(511) 16, 17, 21

(260) AM 2014 72585 A
(800) 1160212
(151) 2013 03 19
(181) 2023 03 19
(511) 12

(260) AM 2014 72586 A
(800) 1160442
(151) 2013 03 28
(181) 2023 03 28
(511) 37

(260) AM 2014 72587 A
(800) 1160272
(151) 2013 05 02
(181) 2023 05 02
(511) 05

(260) AM 2014 72588 A
(800) 1160273
(151) 2012 11 12
(181) 2022 11 12
(511) 05

(260) AM 2014 72589 A
(800) 1160288
(151) 2013 01 07
(181) 2023 01 07
(511) 10

(260) AM 2014 72590 A
(800) 1160329
(151) 2012 10 10
(181) 2022 10 10
(511) 09, 35, 38, 41

(260) AM 2014 72591 A
(800) 1160338
(151) 2012 11 19
(181) 2022 11 19
(511) 05

(260) AM 2014 72592 A
(800) 1160373
(151) 2013 03 21
(181) 2023 03 21
(511) 09, 11, 41

(260) AM 2014 72593 A
(800) 1160390
(151) 2013 04 05
(181) 2023 04 05
(511) 05

(260) AM 2014 72594 A
(800) 1160391
(151) 2013 04 05
(181) 2023 04 05
(511) 05

(260) AM 2014 72595 A
(800) 1160392
(151) 2013 04 05
(181) 2023 04 05
(511) 05

(260) AM 2014 72596 A
(800) 1160393
(151) 2013 04 05
(181) 2023 04 05
(511) 05

(260) AM 2014 72597 A
(800) 1160394
(151) 2013 04 05
(181) 2023 04 05
(511) 05

(260) AM 2014 72602 A
(800) 1160395
(151) 2013 04 05
(181) 2023 04 05
(511) 05

(260) AM 2014 72603 A
(800) 1160396
(151) 2013 04 05
(181) 2023 04 05
(511) 05

(260) AM 2014 72604 A
(800) 1160397
(151) 2013 04 05
(181) 2023 04 05
(511) 05

(260) AM 2014 72605 A
(800) 1160398
(151) 2013 04 05

(181) 2023 04 05
(511) 05

(260) AM 2014 72606 A
(800) 1160452
(151) 2013 04 24
(181) 2023 04 24
(511) 25

(260) AM 2014 72740 A
(800) 1161360
(151) 2013 01 30
(181) 2023 01 30
(511) 05

(260) AM 2014 72758 A
(800) 1161532
(151) 2013 01 11
(181) 2023 01 11
(511) 29

(260) AM 2014 72759 A
(800) 1161539
(151) 2013 03 12
(181) 2023 03 12
(511) 05, 42

(260) AM 2014 72760 A
(800) 1161543
(151) 2013 02 15
(181) 2023 02 15
(511) 29, 30

(260) AM 2014 72761 A
(800) 1161554
(151) 2013 02 07
(181) 2023 02 07
(511) 30

(260) AM 2014 72762 A
(800) 1161576
(151) 2013 04 04
(181) 2023 04 04
(511) 01, 02, 17, 20

(260) AM 2014 72763 A
(800) 1161593
(151) 2013 04 05
(181) 2023 04 05
(511) 03, 05, 10

(260) AM 2014 72764 A
(800) 1161656
(151) 2013 05 07
(181) 2023 05 07
(511) 12

(260) AM 2014 72765 A
(800) 1161664
(151) 2013 04 10
(181) 2023 04 10
(511) 19

(260) AM 2014 72766 A
(800) 1161688
(151) 2013 01 11
(181) 2023 01 11
(511) 10

(260) AM 2014 72767 A
(800) 1161741
(151) 2013 03 27
(181) 2023 03 27
(511) 18, 25

(260) AM 2014 72768 A
(800) 1161760
(151) 2013 04 12
(181) 2023 04 12
(511) 05

(260) AM 2014 72769 A
(800) 1161761
(151) 2013 04 12
(181) 2023 04 12
(511) 05

(260) AM 2014 72770 A
(800) 1161762
(151) 2013 04 12
(181) 2023 04 12
(511) 05

(260) AM 2014 72771 A
(800) 1161812
(151) 2013 02 01
(181) 2023 02 01
(511) 07, 11

(260) AM 2014 72772 A
(800) 1161823
(151) 2012 05 30

(181) 2022 05 30
(511) 35

(260) AM 2014 72818 A
(800) 1162108
(151) 2013 01 25
(181) 2023 01 25
(511) 05

(260) AM 2014 72820 A
(800) 1162110
(151) 2013 01 25
(181) 2023 01 25
(511) 05

(260) AM 2014 72821 A
(800) 1162114
(151) 2013 04 12
(181) 2023 04 12
(511) 33

(260) AM 2014 72822 A
(800) 1162115
(151) 2012 08 15
(181) 2022 08 15
(511) 14, 24, 28, 30

(260) AM 2014 72824 A
(800) 1162118
(151) 2013 03 20
(181) 2023 03 20
(511) 01, 02, 03, 05

(260) AM 2014 72825 A
(800) 1162133
(151) 2013 03 19
(181) 2023 03 19
(511) 30

(260) AM 2014 72827 A
(800) 1162158
(151) 2013 04 24
(181) 2023 04 24
(511) 14

(260) AM 2014 72828 A
(800) 1162171
(151) 2013 03 04
(181) 2023 03 04
(511) 13

(260) AM 2014 72829 A
(800) 1162185
(151) 2013 04 02
(181) 2023 04 02
(511) 34

(260) AM 2014 72830 A
(800) 1162196
(151) 2012 12 18
(181) 2022 12 18
(511) 12, 17

(260) AM 2014 72831 A
(800) 1162204
(151) 2012 07 18
(181) 2022 07 18
(511) 07, 12, 35

(260) AM 2014 72833 A
(800) 1162206
(151) 2012 08 13
(181) 2022 08 13
(511) 16, 35, 41

(260) AM 2014 72834 A
(800) 1162235
(151) 2013 03 15
(181) 2023 03 15
(511) 06, 09, 11, 37, 42

(260) AM 2014 72838 A
(800) 1162245
(151) 2013 03 29
(181) 2023 03 29
(511) 09, 38, 41

(260) AM 2014 72839 A
(800) 1162268
(151) 2013 04 02
(181) 2023 04 02
(511) 03, 05

(260) AM 2014 72840 A
(800) 1162272
(151) 2013 03 04
(181) 2023 03 04
(511) 07, 11, 17, 21

(260) AM 2014 72841 A
(800) 1162286
(151) 2013 03 19

(181) 2023 03 19
(511) 01

(260) AM 2014 72842 A
(800) 1162329
(151) 2013 04 24
(181) 2023 04 24
(511) 33

(260) AM 2014 72843 A
(800) 1162330
(151) 2013 03 20
(181) 2023 03 20
(511) 01, 02, 03, 05

(260) AM 2014 72844 A
(800) 1162331
(151) 2013 04 01
(181) 2023 04 01
(511) 07

(260) AM 2014 72845 A
(800) 1162338
(151) 2013 03 23
(181) 2023 03 23
(511) 09, 35, 38, 41, 42

(260) AM 2014 72847 A
(800) 1162388
(151) 2012 05 09
(181) 2022 05 09
(511) 09, 36

(260) AM 2014 73139 A
(800) 1165354
(151) 2012 10 19
(181) 2022 10 19
(511) 35, 37, 39, 41, 42, 45

(260) AM 2014 73148 A
(800) 1165488
(151) 2013 03 27
(181) 2023 03 27
(511) 12, 16, 17

(260) AM 2014 73149 A
(800) 1165501
(151) 2013 03 26
(181) 2023 03 26
(511) 03, 35

(260) AM 2014 73150 A
(800) 1165510
(151) 2013 03 25
(181) 2023 03 25
(511) 05

(260) AM 2014 73318 A
(800) 1127949
(151) 2012 05 24
(891) 2013 06 01
(181) 2022 05 24
(511) 25

(260) AM 2014 73335 A
(800) 1167777
(151) 2013 05 18
(181) 2023 05 18
(511) 33

OFFICIAL NOTIFICATIONS

TRADEMARKS

RENEWAL OF REGISTRATIONS

(111) M 1994 54 R2

(156) 2014 10 25

(186) 2024 10 25

(732) KABUSHIKI KAISHA PILOT
CORPORATION

(also trading Pilot Corporation)

6-21, Kyobashi 2-Chome, Chuo-Ku, Tokyo,
Japan

388 Greenwich Street, New York,

New York 10013, USA

(111) M 1994 117 R2

(156) 2014 10 27

(186) 2024 10 27

(732) CITIGROUP GLOBAL MARKETS INC.

388 Greenwich Street, New York, New York
10013, USA

(111) M 1994 84 R2

(156) 2014 10 26

(186) 2024 10 26

(732) FUJI JUKOGYO KABUSHIKI KAISHA

(also trading as Fuji Heavy Industries LTD.)

7-2, Nishi-Shinjuku 1-Chome, Shinjuku-ku,
Tokyo, Japan

(111) M 1994 121 R2

(156) 2014 10 27

(186) 2024 10 27

(732) PROCTER & GAMBLE HOLDING GmbH

Sulzbacher Strasse 40, 65824 Schwalbach am
Tanus, Germany

(111) M 1994 91 R2

(156) 2014 10 26

(186) 2024 10 26

(732) KABUSHIKI KAISHA PILOT
CORPORATION

(also trading Pilot Corporation)

6-21, Kyobashi 2-Chome, Chuo-Ku,
Tokyo, Japan

(111) M 1994 122 R2

(156) 2014 10 28

(186) 2024 10 28

(732) PROCTER & GAMBLE HOLDING GmbH

Sulzbacher Strasse 40, 65824 Schwalbach am
Tanus, Germany

(111) M 1994 92 R2

(156) 2014 10 26

(186) 2024 10 26

(732) PROCTER & GAMBLE HOLDING GmbH

Sulzbacher Strasse 40, 65824 Schwalbach
am Tanus, Germany

(111) M 1994 123 R2

(156) 2014 10 28

(186) 2024 10 28

(732) PROCTER & GAMBLE HOLDING GmbH

Sulzbacher Strasse 40, 65824 Schwalbach am
Tanus, Germany

(111) M 1994 93 R2

(156) 2014 10 26

(186) 2024 10 26

(732) FUJI JUKOGYO KABUSHIKI KAISHA

(also trading as Fuji Heavy Industries LTD.)

7-2, Nishi-Shinjuku 1-Chome, Shinjuku,
Tokyo, Japan

(111) M 1994 142 R2

(156) 2014 10 28

(186) 2024 10 28

(732) PROCTER & GAMBLE HOLDING GmbH

Sulzbacher Strasse 40, 65824 Schwalbach am
Tanus, Germany

(111) M 1994 116 R2

(156) 2014 10 27

(186) 2024 10 27

(732) CITIGROUP GLOBAL MARKETS INC

(111) M 1994 149 R2

(156) 2014 10 28

(186) 2024 10 28

(732) PROCTER & GAMBLE HOLDING GmbH

Sulzbacher Strasse 40, 65824 Schwalbach am
Tanus, Germany

(111) M 1994 171 R2
(156) 2014 10 28
(186) 2024 10 28
(732) PROCTER & GAMBLE HOLDING GmbH
Sulzbacher Strasse 40, 65824 Schwalbach am
Taunus, Germany

(111) M 1994 223 R2
(156) 2014 11 01
(186) 2024 11 01
(732) PROCTER & GAMBLE HOLDING GmbH
Sulzbacher Strasse 40, 65824 Schwalbach am
Taunus, Germany

(111) M 1994 233 R2
(156) 2014 11 02
(186) 2024 11 02
(732) UNITED PARCEL SERVICE OF
AMERICA, INC
400 Perimeter Center- Terraces North
ATLANTA, Georgia 30346, USA

(111) M 1994 234 R2
(156) 2014 11 02
(186) 2024 11 02
(732) UNITED PARCEL SERVICE OF
AMERICA, INC
400 Perimeter Center- Terraces North
ATLANTA, Georgia 30346, USA

(111) M 1994 334 R2
(156) 2014 11 08
(186) 2024 11 08
(732) CABLE NEWS NETWORK, INC.
One CNN Center, Atlanta, GA 30303, USA

(111) M 1994 444 R2
(156) 2014 11 11
(186) 2024 11 11
(732) UNITED PARCEL SERVICE OF
AMERICA, INC.
55 Glenlake Parkway, NE Atlanta, Georgia,
USA

(111) M 2004 15600 R1
(156) 2014 07 25
(186) 2024 07 19
(732) LTD "GEOFUDI"
Chubinashvilis q.39, 0164, Tbilisi, Georgia

(111) M 2004 15626 R1
(156) 2014 08 13
(186) 2024 08 13
(732) THE CONCENTRATE MANUFACTU-
RING COMPANY OF IRELAND
(also trading as Seven-Up International),
an Irish Corporation
Corner Hause, 20 Parlament Street, Hamilton,
Bermuda

(111) M 2004 15628 R1
(156) 2014 08 13
(186) 2024 08 13
(732) THE CONCENTRATE MANUFACTU-
RING COMPANY OF IRELAND
(also trading as Seven-Up International)
an Irish Corporation;
Corner Hause, 20 Parlament Street, Hamilton,
Bermuda

(111) M 2004 15676 R1
(156) 2014 10 18
(186) 2024 10 18
(732) TOYOTA JIDOSHA KABUSHIKI KAISHA
(also trading as TOYOTA MOTOR
CORPORATION)
1, Toyota-Cho, Toyota-Shi, Aichi-Ken, Japan

(111) M 2004 15678 R1
(156) 2014 10 18
(186) 2024 10 18
(732) TOYOTA JIDOSHA KABUSHIKI KAISHA
(also trading as TOYOTA MOTOR
CORPORATION)
1, Toyota-Cho, Toyota-Shi, Aichi-Ken, Japan

(111) M 2004 15732 R1
(156) 2014 11 11
(186) 2024 11 11
(732) ACTAVIS EAD
29 Atanas Dukov Str., Lozenets district,
Sofia, Bulgaria

COMPLETE TRANSFER OF RIGHTS

(111) M 1999 011444 R1 (732) BAYER INTELLECTUAL PROPERTY GMBH Alfred-Nobel-Strasse 10, 40789 Monheim am Rhein, Germany (770) BAYER AG D-51368 Leverkusen, Germany (580) 2014 09 11	2-1, Kasumigaseki 3-chome, Chiyoda-ku, Tokyo, Japan (580) 2014 09 12
(111) M 1999 011445 R1 (732) BAYER INTELLECTUAL PROPERTY GMBH Alfred-Nobel-Strasse 10, 40789 Monheim am Rhein, Germany (770) BAYER AG D-51368 Leverkusen, Germany (580) 2014 09 11	(111) M 2013 023586 R (732) TEIJIN LIMITED 6-7, Minamihommachi 1-chome, Chuo-ku, Osaka, Japan (770) TEIJIN PHARMA LIMITED 2-1, Kasumigaseki 3-chome, Chiyoda-ku, Tokyo, Japan (580) 2014 09 12
(111) M 1996 001484 R1 (732) BAYER INTELLECTUAL PROPERTY GMBH Alfred-Nobel-Strasse 10, 40789 Monheim am Rhein, Germany (770) BAYER AG D-51368 Leverkusen, Germany (580) 2014 09 11	(111) M 2013 023587 R (732) TEIJIN LIMITED 6-7, Minamihommachi 1-chome, Chuo-ku, Osaka, Japan (770) TEIJIN PHARMA LIMITED 2-1, Kasumigaseki 3-chome, Chiyoda-ku, Tokyo, Japan (580) 2014 09 12
(111) M 2012 022403 R (732) Nikoloz Beniaidze Sof. Arkhiloskalo, 1603, Dedoflistskaro, Georgia (770) LTD "SHIRAQIS PRODUQTEBI" Vake-saburtalos raioni, Nutsbidzis me-4 m/r, korp. 24, b. 32, 0183, Tbilisi, Georgia (580) 2014 09 04	(111) M 2013 023816 R (732) TEIJIN LIMITED 6-7, Minamihommachi 1-chome, Chuo-ku, Osaka, Japan (770) TEIJIN PHARMA LIMITED 2-1, Kasumigaseki 3-chome, Chiyoda-ku, Tokyo, Japan (580) 2014 09 12
(111) M 2012 022760 R (732) TEIJIN LIMITED 6-7, Minamihommachi 1-chome, Chuo-ku, Osaka, Japan (770) TEIJIN PHARMA LIMITED 2-1, Kasumigaseki 3-chome, Chiyda-ku, Tokyo, Japan (580) 2014 09 12	(111) M 2014 024647 R (732) LTD "IANTARI" Sif. Podolino, Angari 3, Silnechnogorskis raioni, 141420, Moskovis olqi, Russian Federation (770) LTD "FDT" Panfilovis qucha 12 (Rusetis Federatsia q. Khimki, Moskovis olqi 141400), Russian Federation (580) 2014 09 11
(111) M 2013 023538 R (732) TEIJIN LIMITED 6-7, Minamihommachi 1-chome, Chuo-ku, Osaka, Japan (770) TEIJIN PHARMA LIMITED	(111) M 2014 024648 R (732) LTD "IANTARI" Sif. Podolino, Angari 3, Silnechnogorskis raioni, 141420, Moskovis olqi, Russian Federation (770) LTD "FDT" Panfilovis qucha 12 (Rusetis Federatsia q. Khimki, Moskovis olqi 141400), Russian Federation (580) 2014 09 11

(111) M 2014 024651 R
 (732) LTD "IANTARI"
 Sif. Podolino, Angari 3, Silnechnogorskis
 raioni, 141420, Moskovis olqi, Russian
 Federation
 (770) LTD "FDT"
 Panfilovis qucha 12 (Rusetis Federatsia
 q. Khimki, Moskovis olqi 141400),
 Russian Federation
 (580) 2014 09 11

(111) M 2014 024652 R
 (732) LTD "IANTARI"
 Sif. Podolino, Angari 3, Silnechnogorskis
 raioni, 141420, Moskovis olqi, Russian
 Federation
 (770) LTD "FDT"
 Panfilovis qucha 12 (Rusetis Federatsia
 q. Khimki, Moskovis olqi 141400),
 Russian Federation
 (580) 2014 09 11

(111) M 1996 003242 R1
 (732) DEVRO PLC
 Moodiesburn, Chryston, Glasgow G69 0JE,
 United Kingdom
 (770) DEVRO S.R.O.
 Jilemnice, Victorská 830, 514 19, Czech
 Republic
 (580) 2014 09 11

(111) M 1996 003733 R1
 (732) BAYER INTELLECTUAL PROPERTY
 GMBH
 Alfred-Nobel-Strasse 10, 40789 Monheim am
 Rhein, Germany
 (770) BAYER AG
 D-51368 Leverkusen, Germany
 (580) 2014 09 11

(111) M 1995 000545 R1
 (732) BAYER INTELLECTUAL PROPERTY
 GMBH
 Alfred-Nobel-Strasse 10, 40789 Monheim am
 Rhein, Germany
 (770) BAYER AG
 D-51368 Leverkusen, Germany
 (580) 2014 09 11

(111) M 1997 007252 R1
 (732) BAYER INTELLECTUAL PROPERTY
 GMBH
 Alfred-Nobel-Strasse 10, 40789 Monheim am
 Rhein, Germany
 (770) BAYER AG

D-51368 Leverkusen, Germany
 (580) 2014 09 11

(111) M 1997 007253 R1
 (732) BAYER INTELLECTUAL PROPERTY
 GMBH
 Alfred-Nobel-Strasse 10, 40789 Monheim am
 Rhein, Germany
 (770) BAYER AG
 D-51368 Leverkusen, Germany
 (580) 2014 09 11

(111) M 1998 008914 R1
 (732) BAYER INTELLECTUAL PROPERTY
 GMBH
 Alfred-Nobel-Strasse 10, 40789 Monheim am
 Rhein, Germany
 (770) BAYER AKTIENGESELLSCHAFT
 D-51368 Leverkusen, Germany
 (580) 2014 09 11

(111) M 1995 000958 R1
 (732) BAYER INTELLECTUAL PROPERTY
 GMBH
 Alfred-Nobel-Strasse 10, 40789 Monheim am
 Rhein, Germany
 (770) BAYER AG
 D-51368 Leverkusen, Germany
 (580) 2014 09 11

(111) M 1995 000959 R1
 (732) BAYER INTELLECTUAL PROPERTY
 GMBH
 Alfred-Nobel-Strasse 10, 40789 Monheim am
 Rhein, Germany
 (770) BAYER AG
 D-51368 Leverkusen, Germany
 (580) 2014 09 11

CHANGES IN NAMES AND/OR ADDRESSES OF OWNERS

(111) M 2002 014768 R1
 (732) OSI PHARMACEUTICALS, LLC
 1 Astellas Way, Northbrook, Illinois,
 60062, USA
 (770) OSI PHARMACEUTICALS, LLC
 1 Bioscience Park Drive, Farmingdale,
 NY 11735, USA
 (580) 2014 09 04

(111) M 2004 015732 R1
 (732) ACTAVIS EAD
 29 Atanas Dukov Str., Lozenets district,
 Sofia, Bulgaria
 (770) ACTAVIS AD
 Kniaginia Maria Louisa Blvd..2, Business
 Centre "TSUM", 1000 Sofia, Bulgaria
 (580) 2014 09 05

(111) M 2005 016083 R
 (732) OSI PHARMACEUTICALS, LLC
 1 Astellas Way, Northbrook, Illinois, 60062,
 USA
 (770) OSI PHARMACEUTICALS, LLC
 1 Bioscience Park Drive, Farmingdale,
 NY 11735, USA
 (580) 2014 09 04

(111) M 2005 016392 R
 (732) Publichne Aktsionerne Tovarystvo
 "KRAFT FOODS UKRAINA"
 vul. Naberezhna, 28A, Trostyanets, Sumska
 obl., 42600, Ukraine
 (770) KRAFT FOODS UKRAINA CLOSED
 JOINT STOCK COMPANY
 28-A, Naberezhna Str., TROSTYANETS
 42600, Sumy Region, Ukraine
 (580) 2014 09 04

(111) M 2005 016392 R
 (732) Publichne aktsionerne Tovarystvo
 "MONDELEZ UKRAINA"
 vul. Naberezhna, 28A, Trostyanets, Sumska
 obl., 42600, Ukraine
 (770) Publichne aktsionerne Tovarystvo
 "KRAFT FOODS UKRAINA"
 vul. Naberezhna, 28A, Trostyanets, Sumska
 obl., 42600, Ukraine
 (580) 2014 09 04

(111) M 2007 018109 R
 (732) Publichne Aktsionerne Tovaristvo
 "KRAFT FOODS UKRAINA"
 vul. Naberezhna, 28A, Trostyanets, Sumska
 obl., 42600, Ukraine
 (770) Закрите Акціонерне Товариство
 "КРАФТ ФУДЗ УКРАЇНА"
 42600, Сумська область, г. Тростянець,
 Набережна ул. 28-А, Ukraine
 (580) 2014 09 04

(111) M 2007 018109 R
 (732) Publichne Aktsionerne Tovaristvo
 "MONDELEZ UKRAINA"
 vul. Naberezhna, 28A, Trostyanets, Sumska
 obl., 42600, Ukraine
 (770) Publichne Aktsionerne Tovaristvo
 "KRAFT FOODS UKRAINA"
 vul. Naberezhna, 28A, Trostyanets, Sumska
 obl., 42600, Ukraine
 (580) 2014 09 04

(111) M 2008 018840 R
 (732) Otkritoe Aktsionernoe Obshchestvo
 "SINERGIA CAPITAL"
 Ul. pobedi, d.26, 143090 krasnoznamenski,
 moskovskaia obl., Russian Federation
 (770) Открытое Акционерное Общество
 "СИНЕРГИЯ КАПИТАЛ"
 Хлебников переулок, д. 7, стр. 2, 107020
 Москва, Russian Federation
 (580) 2014 09 03

(111) M 2009 019503 R
 (732) NINE WEST DEVELOPMENT LLC
 1411 Broadway, New York, NY 10018, USA
 (770) NINE WEST DEVELOPMENT
 CORPORATION
 1007 Orange Street, Suite 225, Wilmington,
 Delaware 19801, USA
 (580) 2014 09 04

(111) M 2009 019504 R
 (732) NINE WEST DEVELOPMENT LLC
 1411 Broadway, New York, NY 10018, USA
 (770) NINE WEST DEVELOPMENT
 CORPORATION
 1007 Orange Street, Suite 225, Wilmington,
 Delaware 19801, USA
 (580) 2014 09 04

(111) M 2012 022367 R
 (732) NINE WEST DEVELOPMENT LLC
 1411 Broadway, New York, NY 10018, USA
 (770) NINE WEST DEVELOPMENT
 CORPORATION
 1007 Orange Street, Suite 225, Wilmington,
 Delaware 19801, USA
 (580) 2014 09 04

(111) M 2012 022403 R
 (732) LTD "SHIRAQIS PRODUQTEBI"
 Vake-Saburtalos raioni, Nutsubidzis me-4
 m/r, korp. 24, b. 32, 0183, Tbilisi, Georgia
 (770) LTD "SHIRAQIS EKO PROPDUQTEBI"
 Vake-saburtalos raioni, Nutsubidzis me-4
 m/r, korp. 24, b. 32, 0183, Tbilisi, Georgia
 (580) 2014 09 04

(111) M 2012 022587 R
 (732) Publichne Aktsionerne Tovaristvo
 "KRAFT FOODS UKRAINA"
 vul. Naberezhna, 28A, Trostyanets, Sumaska
 obl., 42600, Ukraine
 (770) CJSC "KRAFT FOODS UKRAINA"
 42600, Sumskaya obl., M. Trostyanets, vul.
 Naberejna 28a, Ukraine
 (580) 2014 09 04

(111) M 2012 022587 R
 (732) Publichne Aktsionerne Tovaristvo
 "MONDELEZ UKRAINA"
 vul. Naberezhna, 28A, Trostyanets, Sumaska
 obl., 42600, Ukraine
 (770) Publichne Aktsionerne Tovaristvo
 "KRAFT FOODS UKRAINA"
 vul. Naberezhna, 28A, Trostyanets, Sumaska
 obl., 42600, Ukraine
 (580) 2014 09 04

(111) M 2012 022829 R
 (732) NINE WEST DEVELOPMENT LLC
 1411 Broadway, New York, NY 10018, USA
 (770) NINE WEST DEVELOPMENT
 CORPORATION
 1007 Orange Street, Suite 225, Wilmington,
 Delaware 19801, USA
 (580) 2014 09 04

(111) M 2013 023388 R
 (732) NINE WEST DEVELOPMENT LLC
 1411 Broadway, New York, NY 10018, USA
 (770) NINE WEST DEVELOPMENT
 CORPORATION
 1007 Orange Street, Suite 225, Wilmington,

Delaware 19801, USA
 (580) 2014 09 04

(111) M 1996 003242 R1
 (732) DEVRO S.R.O.
 Prague 1, Platněřská 4, 110 00, Czech
 Republic
 (770) CUTISIN SRO
 51419 Jilemnice, Vichovska 830, Czech
 Republic
 (580) 2014 09 11

(111) M 1996 003242 R1
 (732) DEVRO S.R.O.
 Jilemnice, Victorská 830, 514 19, Czech
 Republic
 (770) DEVRO S.R.O.
 Prague 1, Platněřská 4, 110 00, Czech
 Republic
 (580) 2014 09 11

(111) M 1998 009564 R1
 (732) NINE WEST DEVELOPMENT LLC
 1411 Broadway, New York, NY 10018, USA
 (770) NINE WEST DEVELOPMENT
 CORPORATION
 1007 Orange Street, Suite 225, Wilmington,
 Delaware 19801, USA
 (580) 2014 09 04

INVALIDATION OF TRADEMARK REGISTRATION

(111) M 2003 15387 R

(141) 2014 06 29, Not payment for prolongation of registration on the following of 10 years

(732) BEVERAGE TRADE MARK COMPANY LIMITED

Trident Chambers, Wickhams Cay, P.O.Box 146, Road Town, Tortola, Virginia Island (Griat Britain)

CANCELLING OF INTERNATIONAL TRADEMARK REGISTRATION

(800) 831679

(731) Mepha AG

Kirschgartenstrasse 14, CH-4051 Basel, Switzerland

(540)

LORAXINE

(591) Black-white

(511) 05

(141) 2014 09 11

GROUND: Order №46 of Sakpatenti Chairman of 2014 08 14 for enforcement of the decision of June 10, 2014, of Tbilisi City Court Civil Cases Board (Case №2/4651-14).

CORRECTION OF PUBLISHED INFORMATION

BULLETIN №	Pg.	NUMBER OF APPLICATION (260)	INTER. INDEX	PUBLISHED	MUST BE
14(402)	21 (II)	AM 2014 A 74304 R	(526)		(526) The trademark is protected as a whole. Word combinations "КЕТЧУП" in the trademark, shall not be subject to independent legal protection.
14(402)	22 (I)	AM 2014 A 74305 R	(591)	(591) White, red, green, yellow, orange	(591) White, red, green, yellow, orange, blue, black, brown
14(402)	22 (I)	AM 2014 A 74306 R	(526)	(526) The trademark is protected as a whole. The verbal signs "ОЛИВКОВЫЙ МАЙОНЕЗ" included therein, shall not be subject to independent legal protection.	(526) The trademark is protected as a whole. The verbal sign "МАЙОНЕЗ" included therein, shall not be subject to independent legal protection.

CLASSIFICATION INDEXES

INVENTIONS

CONCORDANCE TABLE OF INTERNATIONAL CLASSIFICATION INDEX AND PUBLICATION NUMBERS

INTERNATIONAL CLASSIFICATION INDEXES (51)	NUMBER OF PUBLISHED APPLICATION (10)
A 01 N 29/04; A 61 K 31/025	AP 2014 13166 A
A 61 K 38/00; A 61 K 9/50; A 61 K 9/16; A 61 K 9/20; A 61 K 9/48	AP 2014 12142 A
B 01 D 53/14; B 01 D 53/58; C 01 C 1/10; C 01 C 1/12; B 01 D 61/36	AP 2014 12328 A
C 07 D 231/12; C 07 D 231/20; C 07 D 231/38; C 07 D 401/04; C 07 D 401/12; C 07 D 401/14; C 07 D 403/12; C 07 D 407/12; C 07 D 409/04; C 07 D 417/12; A 61 K 31/4155	AP 2014 12393 A
C 07 D 307/20; C 07 D 307/28; C 07 D 307/30; C 07 D 307/32; C 07 D 307/58; C 07 D 405/04; C 07 D 405/10; C 07 D 407/12; C 07 D 409/12; C 07 D 409/14; C 07 D 413/12; A 01 N 43/08	AP 2014 12861 A
C 07 D 471/04; A 61 K 31/519; A 61 P 3/10; A 61 P 3/04	AP 2014 13077 A
C 07 D 487/04; A 61 K 31/519; A 61 P 25/28	AP 2014 13025 A
C 07 D 513/04; A 61 K 31/542; A 61 P 25/00	AP 2014 13021 A
C 12 P 21/08; A 61 K 35/14; G 01 N 33/35	AP 2014 12676 A
E 02 F 7/06; B 03 B 9/00	AP 2014 12415 A

CONCORDANCE TABLE OF PUBLICATION NUMBERS AND INTERNATIONAL CLASSIFICATION INDEX

NUMBER OF PUBLISHED APPLICATION (10)	INTERNATIONAL CLASSIFICATION INDEXES (51)
AP 2014 12142 A	A 61 K 38/00; A 61 K 9/50; A 61 K 9/16; A 61 K 9/20; A 61 K 9/48
AP 2014 12328 A	B 01 D 53/14; B 01 D 53/58; C 01 C 1/10; C 01 C 1/12; B 01 D 61/36
AP 2014 12393 A	C 07 D 231/12; C 07 D 231/20; C 07 D 231/38; C 07 D 401/04; C 07 D 401/12; C 07 D 401/14; C 07 D 403/12; C 07 D 407/12; C 07 D 409/04; C 07 D 417/12; A 61 K 31/4155
AP 2014 12415 A	E 02 F 7/06; B 03 B 9/00
AP 2014 12676 A	C 12 P 21/08; A 61 K 35/14; G 01 N 33/35
AP 2014 12861 A	C 07 D 307/20; C 07 D 307/28; C 07 D 307/30; C 07 D 307/32; C 07 D 307/58; C 07 D 405/04; C 07 D 405/10; C 07 D 407/12; C 07 D 409/12; C 07 D 409/14; C 07 D 413/12; A 01 N 43/08
AP 2014 13021 A	C 07 D 513/04; A 61 K 31/542; A 61 P 25/00
AP 2014 13025 A	C 07 D 487/04; A 61 K 31/519; A 61 P 25/28
AP 2014 13077 A	C 07 D 471/04; A 61 K 31/519; A 61 P 3/10; A 61 P 3/04
AP 2014 13166 A	A 01 N 29/04; A 61 K 31/025

**CONCORDANCE TABLE OF INTERNATIONAL CLASSIFICATION INDEX,
PATENT NUMBERS AND PUBLICATION NUMBERS**

INTERNATIONAL CLASSIFICATION INDEX (51)	NUMBER OF PATENT (11)	NUMBER OF PUBLISHED APPLICATION (10)
A 61 F 2/16	P 2014 6172 B	AP 2014 13245 A
A 61 F 2/16	P 2014 6173 B	AP 2014 13246 A
A 61 K 8/37; A 61 Q 19/00	P 2014 6170 B	AP 2014 12797 A
A 61 K 9/14; A 61 K 9/16; A 61 K 9/20; A 61 K 9/48; A 61 K 47/12; A 61 K 47/36; A 61 K 47/38	P 2014 6166 B	AP 2014 12120 A
A 61 P 13/02; C 07 D 498/04; A 61 P 21/00; A 61 P 3/00; A 61 P 15/00; A 61 P 43/00	P 2014 6168 B	AP 2014 12529 A
B 23 P 6/04	P 2014 6174 B	AP 2014 13374 A
C 07 D 471/10; A 61 K 31/438; A 61 P 3/10; A 61 P 1/16	P 2014 6169 B	AP 2014 12700 A
C 07 D 495/04	P 2014 6171 B	AP 2014 12804 A
C 10 G 29/04; C 10 G 29/16; C 10 G 9/00; C 10 G 1/04; E 21 B 43/00	P 2014 6167 B	AP 2014 12380 A

**CONCORDANCE TABLE OF PATENT NUMBERS,
PUBLICATION NUMBERS AND INTERNATIONAL CLASSIFICATION INDEX**

NUMBER OF PATENT (11)	NUMBER OF PUBLISHED APPLICATION (10)	INTERNATIONAL CLASSIFICATION INDEX (51)
P 2014 6166 B	AP 2014 12120 A	A 61 K 9/14; A 61 K 9/16; A 61 K 9/20; A 61 K 9/48; A 61 K 47/12; A 61 K 47/36; A 61 K 47/38
P 2014 6167 B	AP 2014 12380 A	C 10 G 29/04; C 10 G 29/16; C 10 G 9/00; C 10 G 1/04; E 21 B 43/00
P 2014 6168 B	AP 2014 12529 A	A 61 P 13/02; C 07 D 498/04; A 61 P 21/00; A 61 P 3/00; A 61 P 15/00; A 61 P 43/00
P 2014 6169 B	AP 2014 12700 A	C 07 D 471/10; A 61 K 31/438; A 61 P 3/10; A 61 P 1/16
P 2014 6170 B	AP 2014 12797 A	A 61 K 8/37; A 61 Q 19/00
P 2014 6171 B	AP 2014 12804 A	C 07 D 495/04
P 2014 6172 B	AP 2014 13245 A	A 61 F 2/16
P 2014 6173 B	AP 2014 13246 A	A 61 F 2/16
P 2014 6174 B	AP 2014 13374 A	B 23 P 6/04

**CONCORDANCE TABLE OF APPLICATION NUMBERS, PUBLICATION NUMBERS
AND PATENTS**

NUMBER OF APPLICATION (21)	NUMBER OF PUBLISHED APPLICATION (10)	NUMBER OF PATENT (11)
AP 2009 012120	AP 2014 12120 A	P 2014 6166 B
AP 2010 012380	AP 2014 12380 A	P 2014 6167 B
AP 2010 012529	AP 2014 12529 A	P 2014 6168 B
AP 2010 012700	AP 2014 12700 A	P 2014 6169 B
AP 2010 012797	AP 2014 12797 A	P 2014 6170 B
AP 2010 012804	AP 2014 12804 A	P 2014 6171 B
AP 2013 013245	AP 2014 13245 A	P 2014 6172 B
AP 2013 013246	AP 2014 13246 A	P 2014 6173 B
AP 2014 013374	AP 2014 13374 A	P 2014 6174 B

UTILITY MODELS

CONCORDANCE TABLE OF INTERNATIONAL CLASSIFICATION INDEX AND PUBLICATION NUMBERS

INTERNATIONAL CLASSIFICATION INDEXES (51)	NUMBER OF PUBLISHED APPLICATION (10)
B 65 D 5/30	AU 2014 13430 U

CONCORDANCE TABLE OF PUBLICATION NUMBERS AND INTERNATIONAL CLASSIFICATION INDEX

NUMBER OF PUBLISHED APPLICATION (10)	INTERNATIONAL CLASSIFICATION INDEXES (51)
AU 2014 13430 U	B 65 D 5/30

CONCORDANCE TABLE OF INTERNATIONAL CLASSIFICATION INDEX, PATENT NUMBERS AND PUBLICATION NUMBERS

INTERNATIONAL CLASSIFICATION INDEX (51)	NUMBER OF PATENT (11)	NUMBER OF PUBLISHED APPLICATION (10)
E 04 B 2/08	U 2014 1834 Y	AU 2014 13288 U
F 25 B 30/00; H 02 N 10/00; H 01 L 37/02	U 2014 1835 Y	AU 2014 13340 U
G 01 G 3/00	U 2014 1833 Y	AU 2014 13283 U

CONCORDANCE TABLE OF PATENT NUMBERS, PUBLICATION NUMBERS AND INTERNATIONAL CLASSIFICATION INDEX

NUMBER OF PATENT (11)	NUMBER OF PUBLISHED APPLICATION (10)	INTERNATIONAL CLASSIFICATION INDEX (51)
U 2014 1833 Y	AU 2014 13283 U	G 01 G 3/00
U 2014 1834 Y	AU 2014 13288 U	E 04 B 2/08
U 2014 1835 Y	AU 2014 13340 U	F 25 B 30/00; H 02 N 10/00; H 01 L 37/02

CONCORDANCE TABLE OF APPLICATION NUMBERS, PUBLICATION NUMBERS AND PATENTS

NUMBER OF APPLICATION (21)	NUMBER OF PUBLISHED APPLICATION (10)	NUMBER OF PATENT (11)
AU 2013 013283	AU 2014 13283 U	U 2014 1833 Y
AU 2013 013288	AU 2014 13288 U	U 2014 1834 Y
AU 2013 013340	AU 2014 13340 U	U 2014 1835 Y

DESIGNS**CONCORDANCE TABLE OF INTERNATIONAL CLASSIFICATION INDEX,
PATENT NUMBERS AND PUBLICATION NUMBERS**

INTERNATIONAL CLASSIFICATION INDEX (51)	NUMBER OF PATENT (11)	NUMBER OF PUBLISHED APPLICATION (10)
19-08	D 21014 590 S	AD 2014 784 S

**CONCORDANCE TABLE OF PATENT NUMBERS,
PUBLICATION NUMBERS AND INTERNATIONAL CLASSIFICATION INDEX**

NUMBER OF PATENT (11)	NUMBER OF PUBLISHED APPLICATION (10)	INTERNATIONAL CLASSIFICATION INDEX (51)
D 21014 590 S	AD 2014 784 S	19-08

**CONCORDANCE TABLE OF APPLICATION NUMBERS, PUBLICATION NUMBERS
AND PATENTS**

NUMBER OF APPLICATION (21)	NUMBER OF PUBLISHED APPLICATION (10)	NUMBER OF PATENT (11)
AD 2014 000784	AD 2014 784 S	D 21014 590 S

TRADEMARKS

CONCORDANCE TABLE OF REGISTRATION NUMBERS, APPLICATION NUMBERS, PUBLICATION NUMBERS AND BULLETIN NUMBERS

NUMBER OF REGISTRATION (111)	NUMBER OF APPLICATION (210)	NUMBER OF PUBLISHED APPLICATION (260)	NUMBER OF BULLETIN
M 2014 25157 R	AM 2014 78334	-	18(406) 2014
M 2014 25158 R	AM 2012 68256	AM 2013 68256 A	24(388) 2013
M 2014 25159 R	AM 2013 71033	AM 2013 71033 A	24(388) 2013
M 2014 25160 R	AM 2013 71036	AM 2013 71036 A	24(388) 2013
M 2014 25161 R	AM 2013 71119	AM 2014 71119 A	3(391) 2014
M 2014 25162 R	AM 2013 71360	AM 2014 71360 A	3(391) 2014
M 2014 25163 R	AM 2013 71369	AM 2014 71369 A	3(391) 2014
M 2014 25164 R	AM 2013 71442	AM 2014 71442 A	3(391) 2014
M 2014 25165 R	AM 2013 71445	AM 2014 71445 A	8(396) 2014
M 2014 25166 R	AM 2013 71447	AM 2014 71447 A	8(396) 2014
M 2014 25167 R	AM 2013 71497	AM 2014 71497 A	3(391) 2014
M 2014 25168 R	AM 2013 71498	AM 2014 71498 A	3(391) 2014
M 2014 25169 R	AM 2013 71621	AM 2014 71621 A	8(396) 2014
M 2014 25170 R	AM 2013 71641	AM 2014 71641 A	8(396) 2014
M 2014 25171 R	AM 2013 71728	AM 2014 71728 A	8(396) 2014
M 2014 25172 R	AM 2013 71765	AM 2014 71765 A	8(396) 2014
M 2014 25173 R	AM 2013 71806	AM 2014 71806 A	8(396) 2014
M 2014 25174 R	AM 2013 71807	AM 2014 71807 A	8(396) 2014
M 2014 25175 R	AM 2013 71809	AM 2014 71809 A	8(396) 2014
M 2014 25176 R	AM 2013 71810	AM 2014 71810 A	8(396) 2014
M 2014 25177 R	AM 2013 71811	AM 2014 71811 A	8(396) 2014
M 2014 25178 R	AM 2013 71812	AM 2014 71812 A	8(396) 2014
M 2014 25179 R	AM 2013 71813	AM 2014 71813 A	8(396) 2014
M 2014 25180 R	AM 2013 71814	AM 2014 71814 A	8(396) 2014
M 2014 25181 R	AM 2013 71815	AM 2014 71815 A	8(396) 2014
M 2014 25182 R	AM 2013 71816	AM 2014 71816 A	8(396) 2014
M 2014 25183 R	AM 2013 71817	AM 2014 71817 A	8(396) 2014
M 2014 25184 R	AM 2013 71818	AM 2014 71818 A	8(396) 2014
M 2014 25185 R	AM 2013 71819	AM 2014 71819 A	8(396) 2014
M 2014 25186 R	AM 2013 71820	AM 2014 71820 A	8(396) 2014
M 2014 25187 R	AM 2013 71821	AM 2014 71821 A	8(396) 2014
M 2014 25188 R	AM 2013 71822	AM 2014 71822 A	8(396) 2014
M 2014 25189 R	AM 2013 71823	AM 2014 71823 A	8(396) 2014
M 2014 25190 R	AM 2013 71824	AM 2014 71824 A	8(396) 2014
M 2014 25191 R	AM 2013 71825	AM 2014 71825 A	8(396) 2014
M 2014 25192 R	AM 2013 71826	AM 2014 71826 A	8(396) 2014
M 2014 25193 R	AM 2013 71827	AM 2014 71827 A	8(396) 2014
M 2014 25194 R	AM 2013 71828	AM 2014 71828 A	8(396) 2014
M 2014 25195 R	AM 2013 71829	AM 2014 71829 A	8(396) 2014
M 2014 25196 R	AM 2013 71831	AM 2014 71831 A	8(396) 2014
M 2014 25197 R	AM 2013 71832	AM 2014 71832 A	8(396) 2014
M 2014 25198 R	AM 2013 72145	AM 2014 72145 A	4(392) 2014
M 2014 25199 R	AM 2013 72561	AM 2014 72561 A	3(391) 2014
M 2014 25200 R	AM 2013 72567	AM 2014 72567 A	6(394) 2014
M 2014 25201 R	AM 2013 72774	AM 2014 72774 A	7(395) 2014

1	2	3	4
M 2014 25202 R	AM 2013 72869	AM 2014 72869 A	8(396) 2014
M 2014 25203 R	AM 2013 72870	AM 2014 72870 A	8(396) 2014
M 2014 25204 R	AM 2013 72871	AM 2014 72871 A	8(396) 2014
M 2014 25205 R	AM 2013 72882	AM 2014 72882 A	8(396) 2014
M 2014 25206 R	AM 2013 72931	AM 2014 72931 A	7(395) 2014
M 2014 25207 R	AM 2013 73100	AM 2014 73100 A	5(393) 2014
M 2014 25208 R	AM 2014 78451	-	18(406) 2014

**CONCORDANCE TABLE OF PUBLICATION NUMBERS
AND APPLICATION NUMBERS**

NUMBER OF PUBLISHED APPLICATION (260)	NUMBER OF APPLICATION (210)	1	2
AM 2014 71680 A	AM 2013 71680	AM 2014 74485 A	AM 2013 74485
AM 2014 71924 A*	AM 2013 71924	AM 2014 74486 A	AM 2013 74486
AM 2014 72524 A	AM 2013 72524	AM 2014 74546 A	AM 2013 74546
AM 2014 73633 A	AM 2013 73633	AM 2014 74711 A	AM 2013 74711
AM 2014 73877 A	AM 2013 73877	AM 2014 74754 A	AM 2013 74754
AM 2014 73934 A	AM 2013 73934	AM 2014 74757 A	AM 2013 74757
AM 2014 73968 A	AM 2013 73968	AM 2014 74770 A	AM 2013 74770
AM 2014 73969 A	AM 2013 73969	AM 2014 74802 A	AM 2013 74802
AM 2014 73970 A	AM 2013 73970	AM 2014 74810 A	AM 2013 74810
AM 2014 73971 A	AM 2013 73971	AM 2014 74868 A	AM 2013 74868
AM 2014 73972 A	AM 2013 73972	AM 2014 74869 A	AM 2013 74869
AM 2014 74059 A	AM 2013 74059	AM 2014 74903 A	AM 2013 74903
AM 2014 74060 A	AM 2013 74060	AM 2014 74904 A	AM 2013 74904
AM 2014 74169 A	AM 2013 74169	AM 2014 74905 A	AM 2013 74905
AM 2014 74249 A	AM 2013 74249	AM 2014 74920 A	AM 2013 74920
AM 2014 74303 A	AM 2013 74303	AM 2014 74994 A	AM 2013 74994
AM 2014 74328 A	AM 2013 74328	AM 2014 74995 A	AM 2013 74995
AM 2014 74329 A	AM 2013 74329	AM 2014 75002 A	AM 2013 75002
AM 2014 74330 A	AM 2013 74330	AM 2014 75009 A	AM 2013 75009
AM 2014 74331 A	AM 2013 74331	AM 2014 75076 A	AM 2013 75076
AM 2014 74332 A	AM 2013 74332	AM 2014 75077 A	AM 2013 75077
AM 2014 74340 A	AM 2013 74340	AM 2014 75078 A	AM 2013 75078
AM 2014 74345 A	AM 2013 74345	AM 2014 75079 A	AM 2013 75079
AM 2014 74346 A	AM 2013 74346	AM 2014 75097 A	AM 2013 75097
AM 2014 74484 A	AM 2013 74484	AM 2014 75097 A	AM 2013 75097
		AM 2014 75104 A	AM 2013 75104
		AM 2014 75118 A	AM 2013 75118
		AM 2014 75119 A	AM 2013 75119
		AM 2014 75121 A	AM 2013 75121
		AM 2014 75134 A	AM 2013 75134
		AM 2014 75219 A	AM 2013 75219

CONCORDANCE TABLE OF INDEX OF GOODS AND/OR SERVICES
AND APPLICATION NUMBERS

INDEX OF GOODS AND/OR SERVICES (511)	NUMBER OF PUBLISHED APPLICATION (260)	1	2
1	2	12	AM 2014 75077 A
1	AM 2014 75076 A	12	AM 2014 75078 A
1	AM 2014 75077 A	12	AM 2014 75079 A
1	AM 2014 75078 A	17	AM 2014 75076 A
1	AM 2014 75079 A	17	AM 2014 75077 A
3	AM 2014 71924 A*	17	AM 2014 75078 A
3	AM 2014 74484 A	17	AM 2014 75079 A
3	AM 2014 74485 A	19	AM 2014 74903 A
3	AM 2014 74486 A	19	AM 2014 74904 A
3	AM 2014 74905 A	21	AM 2014 71924 A*
5	AM 2014 71924 A*	21	AM 2014 75076 A
5	AM 2014 74340 A	21	AM 2014 75077 A
5	AM 2014 74484 A	21	AM 2014 75078 A
5	AM 2014 74485 A	21	AM 2014 75079 A
5	AM 2014 74486 A	21	AM 2014 75076 A
5	AM 2014 74994 A	24	AM 2014 75104 A
5	AM 2014 74995 A	25	AM 2014 74169 A
5	AM 2014 75009 A	25	AM 2014 75104 A
5	AM 2014 75076 A	28	AM 2014 74169 A
5	AM 2014 75077 A	29	AM 2014 71680 A
5	AM 2014 75078 A	29	AM 2014 74920 A
5	AM 2014 75079 A	29	AM 2014 75002 A
5	AM 2014 75118 A	29	AM 2014 75076 A
6	AM 2014 75076 A	29	AM 2014 75077 A
6	AM 2014 75077 A	29	AM 2014 75078 A
6	AM 2014 75078 A	29	AM 2014 75079 A
6	AM 2014 75079 A	29	AM 2014 75134 A
7	AM 2014 75076 A	30	AM 2014 74711 A
7	AM 2014 75077 A	30	AM 2014 74920 A
7	AM 2014 75078 A	31	AM 2014 75076 A
7	AM 2014 75079 A	31	AM 2014 75077 A
8	AM 2014 74059 A	31	AM 2014 75078 A
8	AM 2014 74249 A	31	AM 2014 75079 A
9	AM 2014 74303 A	32	AM 2014 74332 A
9	AM 2014 74546 A	33	AM 2014 72524 A
9	AM 2014 75097 A	33	AM 2014 74060 A
10	AM 2014 71924 A*	33	AM 2014 74328 A
10	AM 2014 75121 A	33	AM 2014 74329 A
11	AM 2014 73877 A	33	AM 2014 74330 A
11	AM 2014 75076 A	33	AM 2014 74331 A
11	AM 2014 75077 A	33	AM 2014 74754 A
11	AM 2014 75078 A	33	AM 2014 74757 A
11	AM 2014 75079 A	33	AM 2014 74868 A
11	AM 2014 75219 A	33	AM 2014 74869 A
12	AM 2014 73934 A	34	AM 2014 74802 A
12	AM 2014 74346 A	34	AM 2014 75119 A
12	AM 2014 75076 A	35	AM 2014 73968 A
		35	AM 2014 73969 A
		35	AM 2014 73970 A
		35	AM 2014 73971 A
		35	AM 2014 73972 A
		35	AM 2014 74303 A

1	2
35	AM 2014 74810 A
35	AM 2014 74903 A
35	AM 2014 74904 A
35	AM 2014 75002 A
35	AM 2014 75076 A
35	AM 2014 75077 A
35	AM 2014 75078 A
35	AM 2014 75079 A
36	AM 2014 74303 A
36	AM 2014 74345 A
36	AM 2014 74770 A
36	AM 2014 74810 A
37	AM 2014 75076 A
37	AM 2014 75077 A
37	AM 2014 75078 A
37	AM 2014 75079 A

1	2
38	AM 2014 73633 A
38	AM 2014 74169 A
38	AM 2014 74303 A
39	AM 2014 74303 A
41	AM 2014 74169 A
42	AM 2014 74303 A
42	AM 2014 75076 A
42	AM 2014 75077 A
42	AM 2014 75078 A
42	AM 2014 75079 A
43	AM 2014 74810 A
44	AM 2014 75076 A
44	AM 2014 75077 A
44	AM 2014 75078 A
44	AM 2014 75079 A

**CONCORDANCE TABLE OF INDEX OF GOODS AND/OR SERVICES
AND NUMBERS OF TRADEMARKS REGISTERED ACCORDING
TO THE ACCELERATED PROCEDURE**

INDEX OF GOODS AND/OR SERVICES (511)	NUMBER OF REGISTERED ACCORDING TO THE ACCELERATED PROCEDURE (111)
29	M 2014 25157 R
33	M 2014 25208 R
35	M 2014 25157 R

OFFICIAL BULLETIN OF THE INDUSTRIAL PROPERTY

18(406)

EDITOR-IN-CHIEF: N. Bebrishvili

EDITORS-TRANSLATORS: E. Gabunia
G. Nadareishvili

PROOFREADER: L. Chanturia

COMPUTER LAYOUT: M. Ordenidze
K. Svanidze

www.sakpatenti.org.ge

E-mail: info@sakpatenti.org.ge