



**NATIONAL INTELLECTUAL PROPERTY CENTER OF GEORGIA
SAKPATENTI**

**OFFICIAL BULLETIN
OF THE INDUSTRIAL PROPERTY**

18(382)

**2013
TBILISI**

**NATIONAL INTELLECTUAL PROPERTY CENTER OF GEORGIA
SAKPATENTI**

**OFFICIAL BULLETIN
OF THE INDUSTRIAL PROPERTY**

**ОФИЦИАЛЬНЫЙ БЮЛЛЕТЕНЬ
ПРОМЫШЛЕННОЙ СОБСТВЕННОСТИ**

18(382)

**INVENTIONS
UTILITY MODELS
DESIGNS
TRADEMARKS**

**DATE OF PUBLICATION
2013 09 25**

INID CODES FOR IDENTIFICATION OF BIBLIOGRAPHIC DATA

INVENTIONS, UTILITY MODELS

- (10) Number of publication for application, which has been examined
- (11) Number of patent and kind of document
- (21) Serial number of application
- (22) Date of filing of the application
- (23) Date of exhibition or the date of the earlier filing and the number of application, if any
- (24) Date from which patent may have effect
- (31) Number of priority application
- (32) Date of filing of priority application
- (33) Code of the country or regional organization allotting priority application number
- (44) Date of publication of application not granted, but examined and number of bulletin
- (45) Date of publication of registered document
- (51) International Patent Classification Index
- (54) Title of the invention
- (57) Abstract
- (60) Number of examined patent document granted by foreign patent office, date from which patent has effect and country code
- (62) Number of the earlier application and in case of divided application, date of filing an application
- (71) Name, surname and address of applicant (country code)
- (72) Name, surname of inventor (country code)
- (73) Name, surname and address of patent owner (country code)
- (74) Name, surname of representative or patent attorney
- (85) Date of commencement of the national phase of International Application
- (86) Number and date of filing of international application
- (87) Number and date of publication of international application

DESIGNS

- (10) Number of publication for application
- (11) Number of patent and kind of document or number of registration
- (15) Date of registration/Date of patent renewal
- (18) Expected expiration date of patent or registration
- (21) Serial number of application
- (22) Date of filing of the application
- (23) Date of exhibition or the date of the earlier filing and the number of application, if any
- (24) Date from which patent may have effect
- (28) Number of designs included in the application
- (30) Data relating to priority (number of application, date of filing of application, two-letter code identifying the authority with whom the priority application was made)
- (31) Number of priority application
- (32) Date of filing of priority application
- (33) Code of the country or regional organization allotting priority application number
- (34) Two-letter code according to WIPO St.3 identifying the authority with which the priority application was made
- (44) Date of publication of design and number of bulletin (the first publication)
- (45) Date of publication of design registered by WIPO and number of bulletin
- (51) International Classification for designs (class and subclass of the Locarno Classification)
- (54) Title of the invention
- (55) Reproduction of the design
- (57) Description of characteristic features of the design including indication of colors
- (62) Number of the earlier application, registration and document number and if available the date of filing an application in case of divided application
- (71) Name, surname and address of applicant (country code)
- (72) Name, surname of creator (country code)
- (73) Name, surname and address of patent owner (country code)
- (74) Name, surname of representative or patent attorney
- (81) Contracting states concerned
 - II designated contracting states according to the 1960 Act
 - III designated contracting states according to the 1999 Act
- (85) Owner's permanent address
- (86) Owner's nationality
- (87) Owner's residence
- (88) State in which the owner has a real and effective industrial or commercial establishment

TRADEMARKS

- (111) - Number of registration
- (151) - Date of registration
- (156) - Date of the renewal
- (181) - Expected expiration date of registration
- (186) - Renewal expiration date of registration
- (141) - Date of cancel of duration of the mark
- (210) - Serial number of application
- (220) - Date of filing of the application
- (230) - Data concerning exhibition
- (260) - Number of application, for which favorable decision of examination about registration has been taken (publication number)
- (310) - Number of the first application
- (320) - Date of filing of the first application
- (330) - Code, identifying national or regional Office where the first application was made
- (511) - International Classification of Goods and Services for the purposes of registration of trade marks and/or list of goods and/or services classified according thereto
- (526) - Disclaimer
- (531) - Description of figurative elements of Trade Marks according to the International Classification of the Figurative Elements of Marks
- (540) - Reproduction of Trade Mark
- (550) - Nature and kind of Trade Mark
- (580) - Date of recording of any kind changes in respect of applications or registrations
- (591) - Information concerning colors claimed
- (731) - Name and address of the applicant
- (732) - Name and address of the holder of the registration
- (740) - Name and address of the representative
- (750) - Address for correspondence
- (770) - Name and address of the previous applicant or holder in case of change in ownership
- (771) - Previous name and address of the applicant or holder in case of change in ownership
- (791) - Name and address of the licensee
- (793) - Indication of conditions and/or restrictions under the license (Type of license, number of license agreement, data of license, data of validity of license)
- (800) - Certain data relating to the international registration of Trade Marks under the Protocol Relating to Madrid Agreement (International registration number
- (891) - Date of subsequent designation

CODES FOR PUBLICATION IN BULLETIN

- (21) AP 0000 000000 - serial number of application for invention
- (10) AP 0000 0000 A - number of published application for invention (first publication)
- (11) P 0000 0000 B - number of patent for invention (second publication)
- (21) API 0000 000000 - number of application for imported patent
- (11) PI 0000 0000 A - number of imported patent (first publication)
- (21) AU 0000 000000 - serial number of application for utility model
- (10) AU 0000 000 U - number of published application for utility model (first publication)
- (11) U 0000 000 Y - number of patent for utility model (second publication)
- (21) AD 0000 000000 - serial number of application for design
- (10) AD 0000 000 S - number of published application for design (first publication)
- (11) D 0000 000 S - number of patent for design (second publication)

INTERNATIONAL PATENT CLASSIFICATION FOR INVENTIONS AND UTILITY MODELS

- SECTION A - HUMAN NECESSITIES
- SECTION B - PERFORMING OPERATIONS; TRANSPORTING
- SECTION C - CHEMISTRY; METALLURGY
- SECTION D - TEXTILES; PAPER
- SECTION E - FIXED CONSTRUCTIONS
- SECTION F - MECHANICAL ENGINEERING; LIGHTING; HEATING; WEAPONS; BLASTING
- SECTION G - PHYSICS
- SECTION H - ELECTRICITY

-
- M - Trade Mark
 - (210) AM 0000 000000 - Serial number of application;
 - (260) AAM 0000 00000 A - Publication number of application;
 - (111) M 0000 00000 R - Number of registration;
 - (111) MMM0000 00000 Rn - Number of renewals, in which n=1,2,3;
 - (111) M 0000 00000 R(P) - Number of registration under partial assignment of rights
-

CONTENTS

PUBLISHED TITLES OF PROTECTION	2
INVENTIONS	
▪ APPLICATIONS APPROVED FOR GRANTING PATENTS	4
▪ PATENTED INVENTIONS	10
UTILITY MODELS	
▪ PATENTED UTILITY MODEL	11
DESIGNS	
▪ REGISTERED DESIGN	12
TRADEMARKS	
▪ APPLICATIONS FILED UNDER THE NATIONAL PROCEDURE APPROVED FOR REGISTRATION	13
▪ REGISTERED TRADEMARKS	18
▪ TRADEMARKS REGISTERED ACCORDING TO THE ACCELERATED PROCEDURE	22
▪ INTERNATIONAL TRADEMARKS FOR WHICH A DECISION ON GANTING PROTECTION IS TAKEN	24
▪ INTERNATIONAL TRADEMARKS PROTECTED IN GEORGIA	73
OFFICIAL NOTIFICATIONS	
TRADEMARKS	
▪ RENEWAL OF REGISTRATIONS	77
▪ COMPLETE TRANSFER OF RIGHTS	79
▪ CHANGES IN NAMES AND/OR ADDRESSES OF OWNERS	82
▪ REFUSAL TO GRANT INTERNATIONAL TRADEMARK PROTECTION.....	101
▪ CANCELLATION OF INTERNATIONAL TRADEMARK PROTECTION FOR SOME GOODS LISTED IN APPLICATION.....	101
▪ ANNULMENT OF INTERNATIONAL TRADEMARK PROTECTION.....	102
CLASSIFICATION INDEXES	
INVENTIONS	103
UTILITY MODELS	104
DESIGNS	105
TRADEMARKS	106

PUBLISHED TITLES OF PROTECTION

INVENTIONS

- **APPLICATIONS APPROVED FOR GRANTING PATENTS:**
12363; 12275; 11515; 12760; 12709; 12557; 12253; 12278; 12498; 12556; 12617; 12696; 12524; 12276
- **PATENTED INVENTIONS:**
5920-5923

UTILITY MODELS

- **PATENTED UTILITY MODEL:**
1780

DESIGNS

- **REGISTERED DESIGN:**
555

TRADEMARKS

- **APPLICATIONS FILED UNDER THE NATIONAL PROCEDURE APPROVED FOR REGISTRATION:**
64997; 69542; 69552, 69553; 69655; 69719, 69720; 69785, 69786; 69878, 69879; 69930; 70015; 70041, 70071, 70072; 70114; 70118; 70188; 70191; 70208; 70220; 70730; 70790; 67866*; 69239*
- **REGISTERED TRADEMARKS:**
24018-24061
- **TRADEMARKS REGISTERED ACCORDING TO THE ACCELERATED PROCEDURE:**
24012-24017; 24062-24065
- **INTERNATIONAL TRADEMARKS FOR WHICH A DECISION ON GRANTING PROTECTIONS IS TAKEN:**
68278; 68393; 68485; 68488; 68490; 68492-68494; 68587-68590; 68592-68596; 68663; 68665-68667; 68710, 68711; 68713, 68714; 68716-68721; 68723-68727; 68729, 68730; 68916-68920; 68923-68926; 68935-68937; 68939-68942; 69006; 69076; 69080-69082; 69109; 69155, 69156; 69158-69161; 69255; 69257; 69261; 69263-69265; 69267; 69269-69273; 69281, 69282; 69332-69334; 69336--69338; 69340; 69343, 69344; 69346; 69349; 69352-69355; 69357; 69360-69363; 69365; 69367-69370; 69372, 69373; 69375-69378; 69380-69384; 69386; 69446, 69447; 69455; 69457-69460; 69462; 69464--69468; 69470; 69472; 69474-69478; 69480, 69481; 69483-69493; 69495-69501; 69662; 69815, 69816; 69818-69821; 69829; 69833-69837; 69844; 69847, 69848; 69852, 69854, 69855; 69860-69862; 69933; 66677*; 67739*
- **INTERNATIONAL TRADEMARKS PROTECTED IN GEORGIA:**
66668; 67309; 67380; 67388; 67391; 67679, 67680; 67682-67685; 67687; 67808; 67967; 67990; 68013, 68014; 68072; 68074; 68076, 68077; 68079-68081; 68087-68091; 68093; 68097-68100; 68121; 68123-68130; 68201-68211; 68214-68217; 68219-68221; 68728; 69580

INVENTIONS

APPLICATIONS APPROVED FOR GRANTING PATENTS

The decision can be appealed at the Chamber of Appeal of Sakpatenti within 3 months from the publication or at the Mtskheta District Court Administrative Cases Board (Address: №17, Samkhedro str., Mtskheta), within 1 month following the publication.

PART A

A 01

- (10) AP 2013 12363 A (51) Int. Cl. (2006)
A 01 N 43/58
A 61 K 31/50
- (21) AP 2010 012363 (22) 2010 02 04
(31) 61/202,207; 61/213,927
(32) 2009 02 05; 2009 07 30
(33) US; US
(71) TAKEDA PHARMACEUTICAL COMPANY LIMITED (JP)
1-1, Doshomachi 4-chome, Chuo-ku Osaka-shi, Osaka 541-0045 (JP)
(72) TANIGUCHI, Takahiko (JP);
KAWADA, Akira (JP);
KONDO, Mitsuyo (JP);
QUINN, John, F. (US);
KUNITOMO, Jun (JP);
YOSHIKAWA, Masato (JP);
FUSHIMI, Makoto (JP)
(74) Shalva Gvaramadze
(85) 2011 09 05
(86) PCT/US2010/000307, 2010 02 04
(54) **PYRIDAZINONE COMPOUNDS**
(57) There are represented: compound of formula (I),

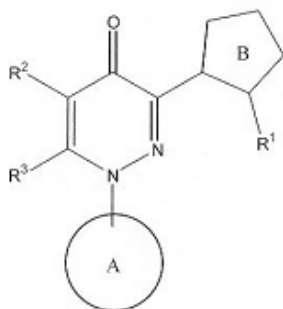

which is phosphodiesterase 10A inhibiting agent, and application thereof for schizophrenia prevention and treatment in mammalian.
Claims: 17 independent
12 dependent
Fig.: 1

A 61

- (10) AP 2013 12275 A (51) Int. Cl. (2006)
A 61 K 9/00
A 61 K 38/00
A 61 K 38/08
A 61 K 38/17
A 61 P 35/00
- (21) AP 2009 012275 (22) 2009 12 28
(31) 61/203,887
(32) 2008 12 29
(33) US
(71) TAKEDA PHARMACEUTICAL COMPANY LIMITED (JP)
1-1, Doshomachi 4-chome, Chuo-ku Osaka-shi, Osaka 541-0045 (JP)
(72) MATSUI, Hisanori (JP)
(74) Shalva Gvaramadze
(85) 2011 06 28
(86) PCT/JP2009/071919, 2009 12 28
(54) **CANCER PROPHYLACTIC/THERAPEUTIC AGENT**
(57) There is represented androgen-independent cancer prophylactic/therapeutic agent, which includes metastatin derivative, and is applied at the treatment.
Claims: 1 independent
2 dependent
Fig.: 2

- (10) AP 2013 11515 A (51) Int. Cl. (2006)
A 61 K 31/167
A 61 K 31/57
A 61 P 11/06
- (21) AP 2008 011515 (22) 2008 04 16
(31) 07007930.6
(32) 2007 04 19
(33) EP
(71) CHIESI FARMACEUTICI S.P.A. (IT)
Via Palermo, 26/A, I-43100 Parma (IT)
(72) CHIESI, Paolo (IT);
RONDELLI, Ivano (IT);
ACERBI, Daniela (IT);
POLI, Gianluigi (IT)
(74) Shalva Gvaramadze
(85) 2009 10 19
(86) PCT/EP2008/003012, 2008 04 16

(54) **USAGE OF COMPOSITION
COMPRISING FORMOTEROL AND
BECLOMETASONE
DIPROPIONATE FOR PREVENTION
AND/OR TREATMENT OF ASTHMA
EXACERBATION**

(57) The present invention relates to: a) formoterol, pharmaceutically acceptable salt or solvate or solvate of salt thereof; and b) application of composition comprising beclometasone dipropionate for inhalation medicament preparation to remove acute asthma episodes by application of same composition during maintenance therapy of asthma.

Claims: 1 independent
25 dependent

(10) **AP 2013 12760 A** (51) **Int. Cl. (2006)**

A 61P 35/00
A 61K 31/495
C 07 D 401/04
C 07 D 401/10
C 07 D 401/12
C 07 D 401/14
C 07 D 405/04
C 07 D 405/12
C 07 D 409/12
C 07 D 413/10
C 07 D 413/12
C 07 D 417/12
C 07 D 405/14
C 07 D 413/14
C 07 D 217/24

(21) AP 2010 012760 (22) 2010 12 21
(31) 61/288992; PCT/CN2010/078927
(32) 2009 12 22; 2010 11 19
(33) US; CN
(71) NOVARTIS AG (CH)
Lichtstrasse 35 CH-4056 Basel (CH)
(72) BERGHAUSEN, Joerg (DE);
BUSCHMANN, Nicole (DE);
FURET, Pascal (FR);
GESSIER, François (FR);
HERGOVICH LISZTAN, Joanna (CA);
HOLZER, Philipp (CH);
JACOBY, Edgar (BE);
KALLEN, Joerg (CH);
MASUYA, Keiichi (JP);
PISSOT SOLDERMANN, Carole (FR);
REN, Haixia (CN);
STUTZ, Stefan (CH)
(74) Alexander Kartvelishvili
(85) 2012 06 22
(86) PCT/EP2010/070364, 2010 12 21

(54) **SUBSTITUTED ISOQUINOLINONES
AND QUINAZOLINONES**

(57) There are represented bicyclic heterocycles containing nitrogen of formula (I),

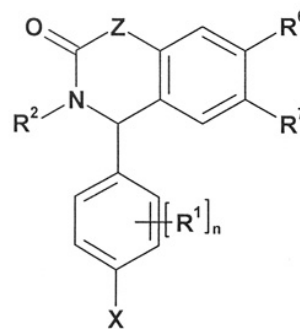

and pharmaceutical compositions containing them applicable at the treatment of diseases caused by MDM2 and MDM4 activity.

Claims: 9 independent
19 dependent

PART B

B 01

(10) **AP 2013 12709 A** (51) **Int. Cl. (2006)**
B 01 D 47/06

(21) AP 2012 012709 (22) 2012 05 14
(71) Gigo Jandieri (GE)
Vazisubani, I mkr., korp. 3, b. 36,
0152 Tbilisi (GE);
Guranda Jishkariani (GE)
Dolidzis q. korp. 26, b. 20, 0171 Tbilisi (GE);
Mimoza Baghishvili (GE)
Panaskertelis q. korp. 19, b. 138,
0194 Tbilisi (GE);
Marika Kapanadze (GE)
Sop. Sviri, 2015 Zesataponi (GE)
(72) Gigo Jandieri (GE);
Guranda Jishkariani (GE);
Mimoza Baghishvili (GE);
Marika Kapanadze (GE)

(54) **DEVICE PURIFYING INDUSTRIAL
EXHAUSTING**

(57) There is represented device comprising: cylindrical case 1 closed from ends and inclined relative to vertical plane forming acute angle, exhausting gas inlet pipe 2, purified gas outlet pipe 3 having coal block. The chokes 4 are allocated in the case and are reverse-advanced movable, and water sprays 5 are allocated between periphery chokes and inlet-outlet pipes in case internal cylindrical surface arched sector; furthermore, spray supplement pipe 6 is connected through to end surface lower sector from outlet pipe and is located parallel to said surface. At that,

case is filled with water 7 on inlet pipe level and has dirt outlet valve 8.

Claims: 1 independent

Fig.: 1

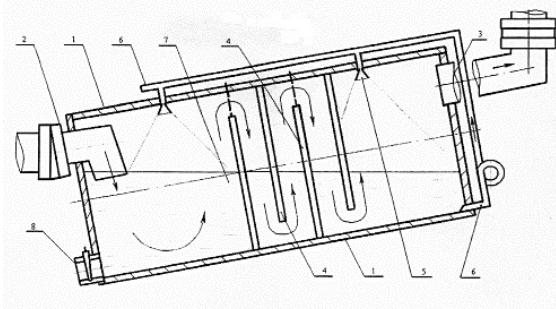

B 60

(10) AP 2013 12557 A (51) Int. Cl. (2006)
B 60 T 1/14

(21) AP 2012 012557 (22) 2012 02 06

(71) Isak Jugashvili (GE)

Rustavis Gzatk. 42, b. 51, 0165 Tbilisi (GE)

(72) Isak Jugashvili (GE)

(54) **VEHICLE ADDITIONAL BRAKE DEVICE**

(57) There is represented brake device comprising brake pedal 1, main hydrocylinder 2 and additional hydrocylinder 4 connected thereby pipe, brake leg 11 with brake block 14 fixed in the bottom thereof. By means of hydrocylinder and draft 17 the brake leg is hinged to vehicle back axle on tire 12 back side so, that place of draft hinged connection with leg is located in leg longitudinal symmetrical axis front end, and place of additional hydrocylinder rod 13 hinged 19 connection with leg is located on same longitudinal symmetrical axis on front end from leg transversal symmetrical axis; at that, by means of additional draft 18 each leg is hingedly connected to vehicle differential or body bottom.

Claims: 1 independent

Fig.: 4

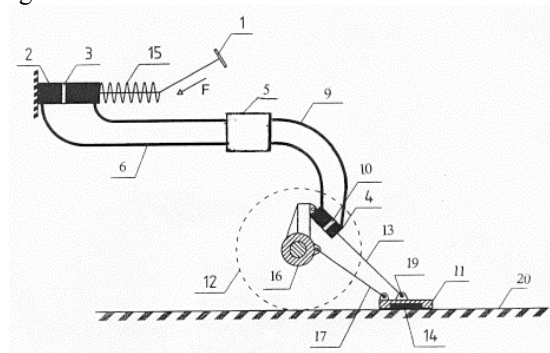

Fig. 3

PART C

C 07

(10) AP 2013 12253 A (51) Int. Cl. (2006)
C 07 D 311/08

(21) AP 2009 012253 (22) 2009 11 06

(31) 2420/MUM/2008; 61/138,456;
664/MUM/2009; 61/171,265

(32) 2011 11 17; 2008 12 17; 2009 03 23;
2009 04 21

(33) IN; US; IN; US

(71) GLENMARK PHARMACEUTICALS
S.A. (CH)

Chemin de Combetta, 5 CH-2300 La Chaux-
de-Fonds (CH)

(72) CHAUDHARI, Sachin, Sundarlal (IN);
THOMAS, Abraham (IN);

KADAM, Ashok, Bhausahab (IN);

DHONE, Sachin, Vasantrao (IN);

ADIK, Bharat, Gangadhar (IN);

KHAIRATKAR-JOSHI, Neelima (IN);

KATTIGE, Vidya, Ganapati (IN)

(74) Alexander Kvernadze

(85) 2011 06 06

(86) PCT/IB2009/007353, 2009 11 06

(54) **CHROMENONE DERIVATIVES AS
TRPV3 ANTAGONISTS**

(57) There are represented compound of formula
(II),

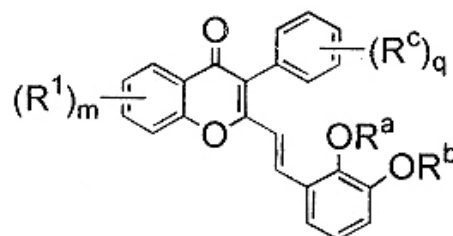

(II)

pharmaceutical composition on basis thereof, and
application thereof the treatment of diseases caused
by vanilloid receptor.

Claims: 4 independent

11 dependent

Table: 1

(10) AP 2013 12278 A (51) Int. Cl. (2006)
C 07 D 277/82
C 07 D 417/12
A 61 K 31/428
A 61 K 31/496
A 61 P 35/00

- (21) AP 2009 012278 (22) 2009 12 01
(31) 2008-307581; 2009-125256
(32) 2008 12 02; 2009 05 25
(33) JP; JP
(71) TAKEDA PHARMACEUTICAL COMPANY LIMITED (JP)
1-1, Doshomachi 4-chome, Chuo-ku Osaka-shi, Osaka 541-0045 (JP)
(72) OKANIWA, Masanori (JP);
TAKAGI, Terufumi (JP);
HIROSE, Masaaki (JP)
(74) Shalva Gvaramadze
(85) 2011 07 01
(86) PCT/JP2009/070447, 2009 12 01
(54) **BENZOTHAZOLE DERIVATIVES AS ANTICANCER AGENTS**
(57) An invention relates to benzothiazole derivatives of formula (I)

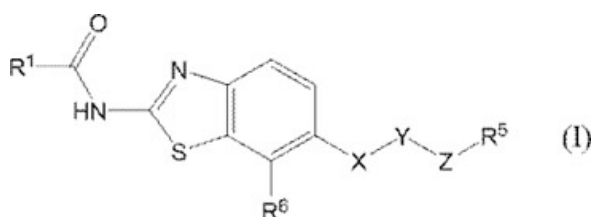

having strong Raf inhibitory activity, which are applied at cancer treatment.

Claims: 16 independent
9 dependent

(10) AP 2013 12498 A (51) Int. Cl. (2006)
C 07 D 295/135

- (21) AP 2010 012498 (22) 2010 05 11
(31) PA200900597
(32) 2009 05 11
(33) DK
(71) H. LUNDBECK A/S (DK)
Ottiliavej 9, DK-2500 Valby (DK)
(72) TREPPENDAHL, Svend (DK);
LILTORP, Karin (DK);
LOPEZ DE DIEGO, Heidi (DK)
(74) Shalva Gvaramadze
(85) 2011 12 09
(86) PCT/DK2010/050101, 2010 05 11
(54) **STABLE FORMS OF N-(2,6-DIMETHYL-4-MORPHOLIN-4-YL-PHENYL)-3,3-DIMETHYL-BUTYRAMIDE**
(57) An invention relates to N-(2,6-dimethyl-4-morpholin-4-yl-phenyl)-3,3-dimethyl-butyramide and preparation method thereof.

Claims: 6 independent
3 dependent

(10) AP 2013 12556 A (51) Int. Cl. (2006)
C 07 D 213/69
A 61 K 31/4422
A 61 P 11/00
A 61 P 13/12
A 61 P 25/28
A 61 P 35/00

- (21) AP 2010 012556 (22) 2010 07 05
(31) 61/222,979
(32) 2009 07 03
(33) US
(71) APOTEX TECHNOLOGIES INC. (CA)
150 Signet Drive Toronto, Ontario M9L 1T9 (CA)
(72) TAM, Tim Fat (CA);
LEUNG-TOUNG, Regis (CA);
WANG, Yingsheng (CA);
ZHAO, Yanqing (CA);
XIN, Tao (CA);
SHAH, Birenkumar (CA);
N'ZEMBA, Blaise (CA);
WODZINSKA, Jolanta Maria (CA);
PREMYSLOVA, Marina (CA)
(74) Shalva Gvaramadze
(85) 2012 02 02
(86) PCT/CA2010/001027, 2010 07 05
(54) **FLUORINATED DERIVATIVES OF 3-HYDROXYPYRIDIN-4-ONES**
(57) There is represented compound of formula (I)

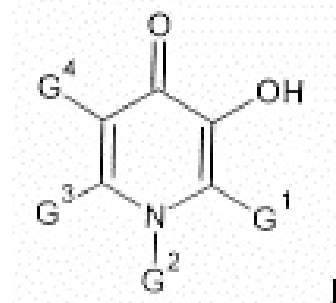

applicable at the treatment of medical condition caused by toxic concentration of iron.

Claims: 4 independent
83 dependent

Fig.: 13

(10) AP 2013 12617 A

(51) Int. Cl. (2006)

C 07 C 251/44

C 07 D 231/14

C 07 C 45/62

C 07 C 45/64

C 07 C 45/66

C 07 C 45/69

C 07 C 49/693

C 07 C 49/743

(21) AP 2010 012617

(22) 2010 07 07

(31) 09167363.2; 09169501.5

(32) 2009 08 06; 2009 09 04

(33) EP; EP

(71) SYNGENTA PARTICIPATIONS AG (CH)
Schwarzwaldallee 215 CH-4058 Basel (CH)

(72) GRIBKOV, Denis (RU);

MÜLLER, Adrian (CH);

LAGGER, Martin (CH);

GIORDANO, Fanny (FR)

(74) Tamar Kochlamazashvili

(85) 2012 03 06

(86) PCT/EP2010/059703, 2010 07 07

(54) **METHOD OF PYRAZOLE CARBOXYLIC ACID AMIDES PREPARATION**

(57) There is represented preparation method of 3-difluoromethyl-1-methyl-1H-pyrazole-4-carboxylic acid (9-dichloromethylene-1,2,3,4-tetrahydro-1,4-methano-naphthalen-5-yl)-amide.

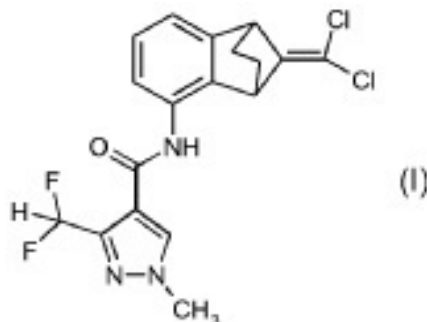

Claims: 6 independent

2 dependent

(10) AP 2013 12696 A

(51) Int. Cl. (2006)

C 07 D 471/04

C 07 D 498/04

C 07 D 513/04

A 61 K 31/4355

A 61 K 31/4365

A 61 K 31/437

A 61 P 29/00

A 61 P 35/00

(21) AP 2010 012696

(22) 2010 11 02

(31) 2678/CHE/2009

(32) 2009 11 04

(33) IN

(71) NOVARTIS AG (CH)

Lichtstrasse 35 CH-4056 Basel (CH)

(72) BOCK, Mark G. (US);
CHIKKANNA, Dinesh (IN);
MCCARTHY, Clive (GB);
MOEBITZ, Henrik (DE);
PANDIT, Chetan (CA)

(74) Alexander Kartvelishvili

(85) 2012 05 04

(86) PCT/EP2010/066659, 2010 11 02

(54) **HETEROCYCLIC SULFONAMIDE DERIVATIVES USEFUL AS MEK INHIBITORS**

(57) Present invention relates to heterocyclic sulfonamide compounds of formula (IA),

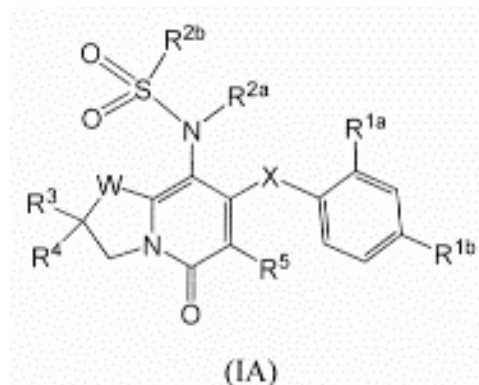
wherein R^{1a}, R^{1b}, X, R^{2a}, R^{2b}, W, R³, R⁴, and R⁵ are defined therein. Said compounds are MEK inhibitors and are applicable at the treatment of hyperproliferative diseases, such as cancer and inflammation.

Claims: 10 independent

6 dependent

PART E

E 02

- (10) AP 2013 12524 A (51) Int. Cl. (2006)
E 02 F 3/43
(21) AP 2011 012524 (22) 2011 12 29
(71) Vazha Gogadze (GE)
9 Aprilis Kheivani 15/60, 4400 Poti (GE);
Giorgi Gogadze (GE)
9 Aprilis Kheivani 15/60, 4400 Poti (GE);
Mamuka Gogadze (GE)
9 Aprilis Kheivani 15/60, 4400 Poti (GE)
(72) Vazha Gogadze (GE);
Giorgi Gogadze (GE);
Mamuka Gogadze (GE)

**(54) SINGLE BUCKET EXCAVATOR
WORKING EQUIPMENT**

(57) There is represented an equipment comprising: boom bottom 1 and top 2 parts, arm 3 managed with hydrocylinders 4 and 5 and connected to bucket 6 by means of two parallel hydrocylinders 8 and 9; at that, bucket and arm hinged connection is executed as longitudinal cylindrical hinge 10 connected to transversal cylindrical hinge 7.

Claims: 1 independent

Fig.: 2

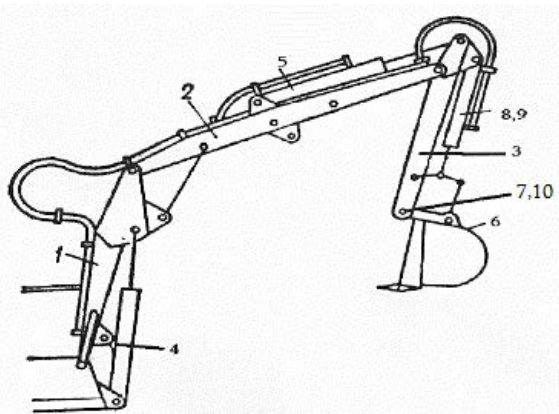

Fig. 1

PART F

F 01

- (10) AP 2013 12276 A (51) Int. Cl. (2006)
F 01 C 1/00
(21) AP 2011 012276 (22) 2011 06 29
(71) Givi Kumsiashvili (GE)
Tmekis Das. III mkr., III kvart., korp. 41, b. 28,
0197 Tbilisi (GE)
(72) Givi Kumsiashvili (GE)
(54) **CAR ENGINE**

(57) There is represented an engine, which rotor is executed on an axle 3 as at least three pistons 12, 13 and 14 placed there by means of rims 5-10; at that, the rims corresponding each piston are placed on the axle by means of advance clutch 15, and are rotatable independent of each other. By means of distribute element 26 a compressor 23 is connected to pressure I and depression II areas corresponding rotor internal capacity.

Claims: 1 independent

2 dependent

Fig.: 4

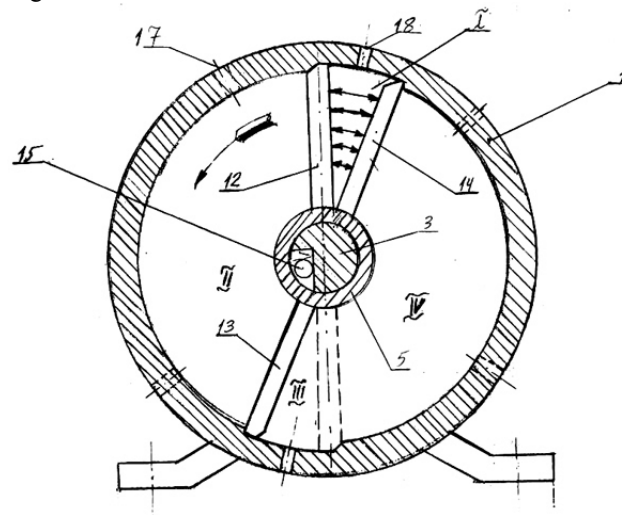

Fig. 2

PATENTED INVENTIONS

PART A

A 61

- (11) **P 2013 5920 B** (51) **Int. Cl. (2006)**
A 61 F 13/10
 (10) AP 2013 12122 A (44) 11(375)/2013
 (21) AP 2009 012122
 (22) 2009 07 31
 (24) 2009 07 31
 (31) 0855350; PCT/EP2009/059933
 (32) 2008 08 01; 2009 07 31
 (33) FR; FR
 (86) PCT/EP2009/059933, 2009 07 31
 (73) PIERRE FABRE DERMO-
 COSMETIQUE (FR)
 45, place Abel Gance,
 92100 Boulogne-billancourt (FR)
 (72) COUBETERGUES, H ela (FR);
 VOISARD, Jean-Jacques (FR)
 (74) George Meipariani
 (54) **KIT FOR ONYCHOMYCOSIS**
TREATMENT
-

PART C

C 04

- (11) **P 2013 5922 B** (51) **Int. Cl. (2006)**
C 04 B 28/00
 (10) AP 2013 12741 A (44) 11(375)/2013
 (21) AP 2012 012741
 (22) 2012 06 06
 (24) 2012 06 06
 (73) Silva Kemertelidze (GE)
 Saburtalos q. 30a, b. 46, 0160 Tbilisi (GE)
 (72) Silva Kemertelidze (GE)
 (54) **POLYSTYRENE CONCRETE MIX FOR**
MAKING WALL BLOCKS
-

PART E

E 02

- (11) **P 2013 5921 B** (51) **Int. Cl. (2006)**
E 02 D 27/32
 (10) AP 2013 12740 A (44) 11(375)/2013
 (21) AP 2012 012740
 (22) 2012 06 06
 (24) 2012 06 06
 (73) Silva Kemertelidze (GE)
 Saburtalos q. 30a, b. 46, 0160 Tbilisi (GE)
 (72) Silva Kemertelidze (GE)
 (54) **CONCRETE MIX FOR CONTINUOUS**
FOOTING ESTABLISHMENT
-

PART H

H 01

- (11) **P 2013 5923 B** (51) **Int. Cl. (2006)**
H 01 S 3/20
 (10) AP 2013 12246 A (44) 6(370)/2013
 (21) AP 2011 012246
 (22) 2011 06 01
 (24) 2011 06 01
 (73) Merab Jibladze (GE)
 I.Chavchavadzis Gamz. 16, b. 23, 0128,
 Tbilisi (GE);
 Guram Dgebuadze (GE)
 Tsinamdzghvrishvilis q. 121, b. 94, 0164,
 Tbilisi (GE);
 Alexandre Mikaberidze (GE)
 Tamarashvilis q. 11, b. 114, 0162,
 Tbilisi (GE);
 Zurab Razmadze (GE)
 Barnovis q. 26, 0108, Tbilisi (GE);
 Giorgi Mumladze (GE)
 Bogdan Khmelnitiskis q. 8, b. 35, 0113,
 Tbilisi (GE)
 (72) Merab Jibladze (GE);
 Guram Dgebuadze (GE);
 Alexandre Mikaberidze (GE);
 Zurab Razmadze (GE);
 Giorgi Mumladze (GE)
 (54) **LASER ON MICRO AND/OR**
NANOPARTICLES POWDER
SUSPENSION
-

REGISTERED DESIGN

- (11) **D 2013 555 S** (51) **09-01**
(10) AD 2013 741 S (44) 11(375)/2013
(21) AD 2013 000741 (22) 2013 03 19
(24) 2013 03 19
(28) 1
(18) 2018 03 19
(31) DM/079130
(32) 2012 09 19
(33) IB
(73) MOLSON COORS BREWING COMPANY
 (UK) LIMITED (GB)
 High Street, Burton Upon Trent, Staffordshire,
 DE14 1JZ (GB)
(72) Andrew Capper (GB);
 Niall McRiner (GB)
(74) Alexander Gegechkori
(54) **BOTTLE**
-

TRADEMARKS

APPLICATIONS FILED UNDER THE NATIONAL PROCEDURE APPROVED FOR REGISTRATION

The decision can be appealed at the Chamber of Appeal of Sakpatenti within 3 months from the publication or at the Mtskheta District Court Administrative Cases Board (Address: №17, Samkhedro str., Mtskheta), within 1 month following the publication.

(260) AM 2013 64997 A

(210) AM 064997

(220) 2012 12 07

(731) LTD "IVERIULI"

Voroninis q. 11, 0112 Tbilisi, Georgia

(540)

აპიპური, Apipurri, Апипури



(591) Black, yellow, blue, brown

(531) 01.05.06-03.13.05-05.07.02-26.01.21-
27.05.05-28.05.00-28.19.00-29.01.15-

(526) **DISCLAIMER** – The trademark is protected as a whole, verbal signs „ამინომჟაეები, ვიტამინები, მინერალები“ and "AMINO ACIDS, VITAMINS, MINERALS" in the trademark shall not be subject of independent legal protection.

(511) 30

(260) AM 2013 69542 A

(210) AM 069542

(220) 2012 11 05

(731) LTD "SAVACHRO SAKHLI A DA R
AFRIKOVEBI"

(Trade House A and Rafrikovs)

Iv. Javakhishvilis q. №85, 0164 Tbilisi,
Georgia

(540)



(591) Pink, black, white

(531) 05.03.13-05.05.20-27.05.05-29.01.12-

(526) **DISCLAIMER** – The trademark is protected as a whole, verbal sign "taxi" in the trademark shall not be subject of independent legal protection.

(511) 39

(260) AM 2013 69552 A

(210) AM 069552

(220) 2012 11 06

(731) LTD "AGROFIRM KOBULETI"

S. Kvirike, 6206 Kobuleti R-ni,
Georgia

(740) Irakli Saparidze

(540)

პონტო
Pontus

(591) Black, white

(511) 30, 32

(260) AM 2013 69553 A

(210) AM 069553

(220) 2012 11 06

(731) LTD "AGROFIRM KOBULETI"

S. Kvirike, 6206 Kobuleti R-ni, Georgia

(740) Irakli Saparidze

(540)



(591) Green, red, golden

(531) 05.03.14-26.04.18-27.05.21-29.01.13-

(511) 30, 32

(260) AM 2013 69655 A
 (210) AM 069655
 (220) 2012 11 12
 (731) Avtandil Ksovreli
 Titsian Tabidzis q. 15, 0179 Tbilisi, Georgia
 (540)



(591) Brown, light brown, red
 (531) 19.09.02-28.19.00-29.01.13-
 (511) 33

(260) AM 2013 69719 A
 (210) AM 069719
 (220) 2012 11 16
 (731) LTD "HEIDELBERGCEMENT
 CAUCASUS"
 Lermontovis q. 18, 0105 Tbilisi, Georgia
 (740) Giorgi Taktakishvili
 (540)



(591) Green, grey
 (531) 02.01.23-07.01.06-07.01.08-27.05.05-
 28.19.00-29.01.12-
 (511) 41

(260) AM 2013 69720 A
 (210) AM 069720
 (220) 2012 11 16
 (731) LTD "HEIDELBERGCEMENT
 CAUCASUS"
 Lermontovis q. 18, 0105 Tbilisi, Georgia
 (740) Giorgi Taktakishvili
 (540)



(591) Green, grey
 (531) 02.01.23-07.01.06-07.01.08-27.05.05-
 28.19.00-29.01.12-
 (511) 19, 37, 41

(260) AM 2013 69785 A
 (210) AM 069785
 (220) 2012 11 26
 (731) LTD "TM-SERVICE"
 125047 Moscow, Ul. 2-ja Bretskaja d. 8,
 Russian Federation
 (740) Liliana Darakhvelidze
 (540)

VERI

(591) Black, white
 (531) 27.05.01-
 (511) 33

(260) AM 2013 69786 A
 (210) AM 069786
 (220) 2012 11 26
 (731) LTD "TM-SERVICE"
 125047 Moscow, Ul. 2-ja Bretskaja d. 8,
 Russian Federation
 (740) Liliana Darakhvelidze
 (540)

BEPH

(591) Black, white
 (531) 28.05.00-
 (511) 33

(260) AM 2013 69878 A
 (210) AM 069878
 (220) 2012 12 03
 (731) LTD "ENJOY & JOY"
 Savanelis q. 20, 0105 Tbilisi, Georgia
 (740) Giorgi Taktakishvili
 (540)

ENJOY&JOY

(591) Blue
 (531) 24.17.09-29.01.04-
 (511) 3

(260) AM 2013 69879 A
 (210) AM 069879
 (220) 2012 12 03
 (731) LTD "ENJOY & JOY"
 Savanelis q. 20, 0105 Tbilisi, Georgia
 (740) Giorgi Taktakishvili
 (540)



(591) White, red, blue
 (531) 24.17.09-26.04.03-29.01.13-
 (511) 3

(260) AM 2013 69930 A
 (210) AM 069930
 (220) 2012 12 05
 (731) LTD "KVESI JGUPI" (Kvesi Group)
 Nutsubidzis III mkr., I kvart., korp. 1, b. 11,
 0183 Tbilisi, Georgia

(540)



(591) Black, white
 (531) 20.07.01-27.07.17-28.19.00-
 (526) **DISCLAIMER** – The trademark is protected
 as a whole, verbal sign „საინფორმაციო ცენტრი“
 in the trademark shall not be subject of independent
 legal protection.
 (511) 35, 38

(260) AM 2013 70015 A
 (210) AM 070015
 (220) 2012 12 11
 (731) HOLDING LE DUFF "HLD"
 (French Corporation)
 105 A, Avenue Henri Freville, 35200
 RENNES, France
 (740) Shalva Gvaramadze
 (540)

ბრიომ დორე

(591) Black, white
 (531) 28.19.00-
 (511) 29, 30, 43

(260) AM 2013 70041 A
 (210) AM 070041
 (220) 2012 12 13
 (731) VALIO LTD
 Meijeritie 6, 00370 Helsinki,
 Finland
 (740) Giorgi Taktakishvili
 (540)

FIN

(591) Black, white
 (511) 29, 32

(260) AM 2013 70071 A
 (210) AM 070071
 (220) 2012 12 14
 (731) LTD "AVERSI-PHARMA"
 Davit Aghmasheneblis Gamz., 148/2, 0112
 Tbilisi, Georgia
 (540)

**პამირეო
 Памирей
 Pamiray**

(591) Black, white
 (511) 5

(260) AM 2013 70072 A
 (210) AM 070072
 (220) 2012 12 14
 (731) LTD "AVERSI-PHARMA"
 Davit Aghmasheneblis Gamz., 148/2, 0112
 Tbilisi, Georgia
 (540)

**მეგარეო
 Мегарей
 Megaray**

(591) Black, white
 (511) 5

(260) AM 2013 70114 A
 (210) AM 070114
 (220) 2012 12 20
 (731) LTD "TIFLISSKIJ VINNIJ POGREB"
 Iumashevis q. 27, 0198 Tbilisi, Georgia
 (740) Shalva Gvaramadze
 (540)

**ქართული ვაზი
 КАРТУЛИ ВАЗИ
 KARTULI VAZI**

(591) Black, white
 (511) 33

(260) AM 2013 70118 A
 (210) AM 070118
 (220) 2012 12 21
 (731) HARRINGTON DEVELOPMENT INC.
 Elvira Mendez Street, Vallari Bldg., 3-rd
 Floor, Panama, Panama
 (740) Givi Akopashvili
 (540)

WISH

(591) Black, white
 (511) 34

(260) AM 2013 70188 A
 (210) AM 070188
 (220) 2012 12 28
 (731) JOINT STOCK CO. "LIBERTY BANK"
 I.Chavchavadzis Gamz. 74, 0162 Tbilisi,
 Georgia

(540)
The business of payments

(591) Black, white
 (511) 36

(260) AM 2013 70191 A
 (210) AM 070191
 (220) 2012 12 31
 (731) Gela Mikadze
 Lalionis Shes. 5, 0101 Tbilisi, Georgia

(540)
MAC'S KHACHAPURI

(591) Black, white
 (526) **DISCLAIMER** – The trademark is protected as a whole, verbal sign "KHACHAPURI" in the trademark shall not be subject of independent legal protection.
 (511) 30, 35, 43

(260) AM 2013 70208 A
 (210) AM 070208
 (220) 2013 01 03
 (731) Gogita Sozashvili
 Simon Chikovanis q. 35, b. 7, 0171 Tbilisi,
 Georgia

(740) Sopio Sozashvili
 (540)

სათავადო
SATAVADO
САТАВАДО

(591) Black, white
 (511) 29, 30, 32

(260) AM 2013 70220 A
 (210) AM 070220
 (220) 2013 01 08
 (731) ZENTIVA GROUP A.S.
 U Kabelovny 130, 10237 Praha 10, Dolni
 Mecholupy, Czech Republic

(740) Giorgi Ghvinjilia
 (540)

ZENTIVA

(591) Black, white
 (511) 10

(260) AM 2013 70730 A
 (210) AM 070730
 (220) 2013 02 04
 (731) ZENTIVA SAĞLIC ÜRÜNLERİ SANAYI
 VE TICARET A.Ş.
 Büyükdere Cad: 193 Kat: 4 Levent, Istanbul,
 Turkey

(740) Giorgi Meipariani
 (540)

ZAMIKAN
ЗАМИКАН
ზამიკანი

(591) Black, white
 (511) 5

(260) AM 2013 70790 A
 (210) AM 070790
 (220) 2013 02 07
 (731) LTD "GMT MTATSMINDA"
 Tavisuplebis Moedani 4, me-7 sart., 0105
 Tbilisi, Georgia

(740) Vakhtang Tsirekidze
 (540)

პური გულიანი
PURI GULIANI

(591) Black, white
 (526) **DISCLAIMER** – The trademark is protected as a whole, verbal sign „პური“ "PURI" in the trademark shall not be subject of independent legal protection.
 (511) 30, 43

(260) AM 67866 A *
 (210) AM 067866
 (220) 2012 07 04
 (731) Irakli Kiria
 G. Dzotsenidzis q. 5, b. 29, 0183 Tbilisi,
 Georgia

(740) Giorgi Taktakishvili
 (540)



(591) White, red, grey, black
 (531) 25.07.25-28.19.00-29.01.14-
 (526) **DISCLAIMER** – The trademark is protected as a whole, verbal sign „ოჯახის ღვინო“ in the trademark shall not be subject of independent legal protection.
 (511) 33

(260) AM 69239 A *

(210) AM 069239

(220) 2012 10 12

(731) LTD "ARCHI"

Gamrekeli q. 19, 0160 Tbilisi, Georgia

(740) Shalva Kokhreidze

(540)

archi
არქი

(591) Black, white

(511) 36, 37

REGISTERED TRADEMARKS

(111) M 2013 024018 R
(151) 2013 09 17
(181) 2023 09 17
(260) AM 2013 66278 A
(220) 2012 02 21
(732) ÖZMAYA SANAYI A.Ş.
Eski Adana Yolu Uzeri P.K. 50, 01960
Ceyhan-Adana, Turkey

(111) M 2013 024023 R
(151) 2013 09 17
(181) 2023 09 17
(260) AM 2013 67180 A
(220) 2012 04 30
(732) SPIRITS PRODUCT INTERNATIONAL
IP B.V.
7, Rue Nicolas Bove, 1253 Luxembourg, LU

(111) M 2013 024019 R
(151) 2013 09 17
(181) 2023 09 17
(260) AM 2013 66549 A
(220) 2012 03 16
(732) GENENTECH INC.
1 D N A Way, South San-Francisco CA
94080-4990, USA

(111) M 2013 024024 R
(151) 2013 09 17
(181) 2023 09 17
(260) AM 2013 67181 A
(220) 2012 04 30
(732) SPIRITS PRODUCT INTERNATIONAL
IP B.V.
7, Rue Nicolas Bove, 1253 Luxembourg, LU

(111) M 2013 024020 R
(151) 2013 09 17
(181) 2023 09 17
(260) AM 2013 66560 A
(220) 2012 03 19
(732) TAKEDA PHARMACEUTICAL COMPANY
LIMITED
1-1, Doshomachi 4-chome, Chuo-ku, Osaka,
Japan

(111) M 2013 024025 R
(151) 2013 09 17
(181) 2023 09 17
(260) AM 2013 67263 A
(220) 2012 05 08
(732) GERDA 2 SP. Z O O
Ul. 1-go Maja 12, PL-27-200 Starachowice,
Poland

(111) M 2013 024021 R
(151) 2013 09 17
(181) 2023 09 17
(260) AM 2013 67026 A
(220) 2012 04 23
(732) LTD "LISIPO"
Vakis R-ni, Lisis Tbis Mimdebare
(Nakveti 1/5), 0102 Tbilisi, Georgia

(111) M 2013 024026 R
(151) 2013 09 17
(181) 2023 09 17
(260) AM 2013 67297 A
(220) 2012 05 11
(732) MEDICOVER HOLDING S.A
24 Ave. Emile Reuter, L-2420 Luxembourg,
LU

(111) M 2013 024022 R
(151) 2013 09 17
(181) 2023 09 17
(260) AM 2013 67162 A
(220) 2012 04 27
(732) LTD "MEGATRADE"
Marjanishvilis q. 6, 0102 Tbilisi, Georgia

(111) M 2013 024027 R
(151) 2013 09 17
(181) 2023 09 17
(260) AM 2013 67338 A
(220) 2012 05 16
(732) OLD NEW (ITM) INC.
2 Folsom Str., San-Francisco, CA 94105,
USA

(111) M 2013 024028 R
(151) 2013 09 17
(181) 2023 09 17
(260) AM 2013 67339 A
(220) 2012 05 16
(732) OLD NEW (ITM) INC.
2 Folsom Str., San-Francisco, CA 94105,
USA

(111) M 2013 024029 R
(151) 2013 09 17
(181) 2023 09 17
(260) AM 2013 67427 A
(220) 2012 05 25
(732) ZELMER MARKETS SP. Z O O
Ul. Hoffmanowej 19, 35-016 Rzeszów,
Poland

(111) M 2013 024030 R
(151) 2013 09 17
(181) 2023 09 17
(260) AM 2013 67467 A
(220) 2012 05 29
(732) LTD "NEOPHARM"
Davit Aghmashebelis Kheivani 12 km.,
0131 Tbilisi, Georgia

(111) M 2013 024031 R
(151) 2013 09 17
(181) 2023 09 17
(260) AM 2013 67496 A
(220) 2012 05 30
(732) LTD "EDENA"
Rustavelis q. 1, 2400 Terjola,
Georgia

(111) M 2013 024032 R
(151) 2013 09 17
(181) 2023 09 17
(260) AM 2013 67579 A
(220) 2012 06 07
(732) LTD "MEGATRADE"
Marjanishvilis q. 6, 0102 Tbilisi,
Georgia

(111) M 2013 024033 R
(151) 2013 09 17
(181) 2023 09 17
(260) AM 2013 67585 A
(220) 2012 06 07
(732) LTD "NOBLEX"
Shanidzis q. 8, 0179 Tbilisi,
Georgia

(111) M 2013 024034 R
(151) 2013 09 17
(181) 2023 09 17
(260) AM 2013 67616 A
(220) 2012 06 12
(732) LTD "KVARLIS MARANI 2011"
Rustavelis q.3, 4800 Kvareli, Georgia

(111) M 2013 024035 R
(151) 2013 09 17
(181) 2023 09 17
(260) AM 2013 67617 A
(220) 2012 06 12
(732) LTD "KVARLIS MARANI 2011"
Rustavelis q. 3, 4800 Kvareli, Georgia

(111) M 2013 024036 R
(151) 2013 09 17
(181) 2023 09 17
(260) AM 2013 67701 A
(220) 2012 06 20
(732) COSMETICS LIMITED
Suite 104A, Sepri Square, Nassau, Bahamas
Islands

(111) M 2013 024037 R
(151) 2013 09 17
(181) 2023 09 17
(260) AM 2013 67864 A
(220) 2012 07 04
(732) ALMIRALL, S.A.
Ronda General Mitre 151, 08022 Barcelona,
Spain

(111) M 2013 024038 R
(151) 2013 09 17
(181) 2023 09 17
(260) AM 2013 67865 A
(220) 2012 07 04
(732) ALMIRALL, S.A.
Ronda General Mitre 151, 08022 Barcelona,
Spain

(111) M 2013 024039 R
(151) 2013 09 17
(181) 2023 09 17
(260) AM 2013 68027 A
(220) 2012 07 11
(732) BRITISH AMERICAN TOBACCO
(BRANDS) INC.
(DELAWARE CORPORATION)
2711 2711 Centerville Road, Suite 300,
Wilmington, DE 19808, USA

(111) M 2013 024040 R
(151) 2013 09 17
(181) 2023 09 17
(260) AM 2013 68028 A
(220) 2012 07 11

(732) BRITISH AMERICAN TOBACCO
(BRANDS) INC.
(DELAWARE CORPORATION)
2711 Centerville Road, Suite 300,
Wilmington, DE 19808, USA

(111) M 2013 024041 R
(151) 2013 09 17
(181) 2023 09 17
(260) AM 2013 68053 A
(220) 2012 07 13

(732) NON-PROFIT LEGAL ENTITY "OZHIOS
MARANI"
Sop. Ozhio, 0906 Akhmetis R-ni, Georgia

(111) M 2013 024042 R
(151) 2013 09 17
(181) 2023 09 17
(260) AM 2013 68056 A
(220) 2012 07 13

(732) MILLENNIUM & COPTHORNE
INTERNATIONAL LIMITED
36 Robinson Road, No.04-01 City House,
Singapore 068877, Singapore

(111) M 2013 024043 R
(151) 2013 09 17
(181) 2023 09 17
(260) AM 2013 68057 A
(220) 2012 07 13

(732) MILLENNIUM & COPTHORNE
INTERNATIONAL LIMITED
36 Robinson Road, No.04-01 City House,
Singapore 068877, Singapore

(111) M 2013 024044 R
(151) 2013 09 17
(181) 2023 09 17
(260) AM 2013 68058 A
(220) 2012 07 13

(732) MILLENNIUM & COPTHORNE
INTERNATIONAL LIMITED
36 Robinson Road, No.04-01 City House,
Singapore 068877, Singapore

(111) M 2013 024045 R
(151) 2013 09 17
(181) 2023 09 17
(260) AM 2013 68059 A
(220) 2012 07 13

(732) MILLENNIUM & COPTHORNE
INTERNATIONAL LIMITED
36 Robinson Road, No.04-01 City House,
Singapore 068877, Singapore

(111) M 2013 024046 R
(151) 2013 09 17
(181) 2023 09 17
(260) AM 2013 68060 A
(220) 2012 07 13

(732) MILLENNIUM & COPTHORNE
INTERNATIONAL LIMITED
36 Robinson Road, No.04-01 City House,
Singapore 068877, Singapore

(111) M 2013 024047 R
(151) 2013 09 17
(181) 2023 09 17
(260) AM 2013 68061 A
(220) 2012 07 13

(732) MILLENNIUM & COPTHORNE
INTERNATIONAL LIMITED
36 Robinson Road, No.04-01 City House,
Singapore 068877, Singapore

(111) M 2013 024048 R
(151) 2013 09 17
(181) 2023 09 17
(260) AM 2013 68062 A
(220) 2012 07 13

(732) MILLENNIUM & COPTHORNE
INTERNATIONAL LIMITED
36 Robinson Road, No.04-01 City House,
Singapore 068877, Singapore

(111) M 2013 024049 R
(151) 2013 09 17
(181) 2023 09 17
(260) AM 2013 68150 A
(220) 2012 07 23

(732) LTD "RAIMBEK BOTTLERS"
Nurmakov Str. 160, 050008 Almaty,
Kazakhstan

(111) M 2013 024050 R
(151) 2013 09 17
(181) 2023 09 17
(260) AM 2013 68157 A
(220) 2012 07 25

(732) BAUSCH & LOMB INCORPORATED
One Bausch & Lomb, Rochester, NY 14604,
USA

(111) M 2013 024051 R
 (151) 2013 09 17
 (181) 2023 09 17
 (260) AM 2013 68194 A
 (220) 2012 08 02
 (732) LTD "CHIRINA"
 L. Gudiashvilis q. 9, 0105 Tbilisi, Georgia

(111) M 2013 024052 R
 (151) 2013 09 17
 (181) 2023 09 17
 (260) AM 2013 68195 A
 (220) 2012 08 03
 (732) LTD "SAMOSELI PIRVELI"
 Zubalashvilebis q. 7, 0108 Tbilisi, Georgia

(111) M 2013 024053 R
 (151) 2013 09 17
 (181) 2023 09 17
 (260) AM 2013 68199 A
 (220) 2012 08 03
 (732) GENERAL MOTORS LLC
 300 Renaissance Center, City of Detroit,
 State of Michigan 48265-3000, USA

(111) M 2013 024054 R
 (151) 2013 09 17
 (181) 2023 09 17
 (260) AM 2013 68247 A
 (220) 2012 08 08
 (732) LTD "GURJAANIS NAYINI 2012"
 (Ice-cream Gurjaani 2012)
 Gldanis Mas., IV mkr., korp. 1, b. 45, 0167
 Tbilisi, Georgia

(111) M 2013 024055 R
 (151) 2013 09 17
 (181) 2023 09 17
 (260) AM 2013 68249 A
 (220) 2012 08 08
 (732) LTD "GURJAANIS NAYINI 2012"
 (Ice-cream Gurjaani 2012)
 Gldanis Mas., IV mkr., korp. 1, b. 45, 0167
 Tbilisi, Georgia

(111) M 2013 024056 R
 (151) 2013 09 17
 (181) 2023 09 17
 (260) AM 2013 68261 A
 (220) 2012 08 10
 (732) AS "GRINDEKS"
 (JOINT STOCK CO. "GRINDEKS")
 Krustpils Str. 53. Riga, 1057 Latvia

(111) M 2013 024057 R
 (151) 2013 09 17
 (181) 2023 09 17
 (260) AM 2013 68262 A
 (220) 2012 08 10
 (732) JOINT STOCK CO. "LIBERTY BANK"
 Ilia Chavchavadzis Gamz. 74, 0162 Tbilisi,
 Georgia

(111) M 2013 024058 R
 (151) 2013 09 17
 (181) 2023 09 17
 (260) AM 2013 68398 A
 (220) 2012 08 16
 (732) LTD "AVERSI PHARMA"
 Davit Aghmasheneblis Gamz., 148/2, 0112
 Tbilisi, Georgia

(111) M 2013 024059 R
 (151) 2013 09 17
 (181) 2023 09 17
 (260) AM 2013 68478 A
 (220) 2012 08 21
 (732) SOCIÉTÉ AIR FRANCE
 45, Rue de Paris 95747 Roissy Charles de
 Gaulle, France

(111) M 2013 024060 R
 (151) 2013 09 17
 (181) 2023 09 17
 (260) AM 2013 68522 A
 (220) 2012 08 23
 (732) JOINT STOCK CO. "SMALL AND
 AVERAGE BUSINESS
 INVESTIGATION FUND "MTSVANE
 KAPITALI" (Green Capital)
 Davit Aghmasheneblis Gamz. 154, 0102
 Tbilisi, Georgia

(111) M 2013 024061 R
 (151) 2013 09 17
 (181) 2023 09 17
 (260) AM 2013 68673 A
 (220) 2012 08 31
 (732) Zurab Bubuteishvili
 Paliashvilis q. 62, 0179 Tbilisi, Georgia

TRADEMARKS REGISTERED ACCORDING TO THE ACCELERATED PROCEDURE

The decision can be appealed at the Chamber of Appeal of Sakpatenti within 3 months from the publication.

(111) M 2013 24012 R
(151) 2013 09 20
(181) 2023 09 20
(210) AM 073569
(732) LTD "TAM GEO"
Gudiashvilis Moedani 4, 0105 Tbilisi,
Georgia
(740) Irakli Gvilia
(540)



(591) Blue, ink-colored, grey, opalesce pink, orange,
white
(531) 26.11.12-26.15.01-27.05.19-29.01.15-
(511) 43

(111) M 2013 24013 R
(151) 2013 09 09
(181) 2023 09 09
(210) AM 073696
(220) 2013 08 26
(732) LTD "FIRM DISNA"
Ul. Lavrskaia 16, 01015 Kiev, Ukraine
(740) Davit Zurabishvili
(540)

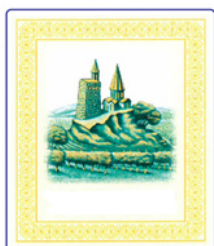

(591) White, yellow, green
(531) 07.01.01-07.01.03-07.05.06-06.01.01-
05.01.08-
(511) 33

(111) M 2013 24014 R
(151) 2013 09 13
(181) 2023 09 13
(210) AM 073491
(220) 2013 08 12
(732) Aleksandre Kamushadze
Tseretlis Gamz. 77, korp. 5, b. 41, 0119
Tbilisi, Georgia

(540)

მითანა

MEATANA

(591) Black, white
(531) 27.05.05-28.19.00-
(511) 29, 35

(111) M 2013 24015 R
(151) 2013 09 13
(181) 2023 09 13
(210) AM 073664
(220) 2013 08 23
(732) HARRINGTON DEVELOPMENT INC.
Elvira Mendez Street, Vallari Bldg.,
3-rd Floor, Panama
(740) Givi Akopashvili
(540)



(591) Blue, white, cream-colored, grey
(531) 03.03.01-19.03.24-28.19.00-29.01.14-
(526) **DISCLAIMER** – Maximum permissible
norms, measuring and regulation thereof, as well as
medical warning records of tobacco goods for rea-
lization in Georgia used in the trademark shall not be
subject of independent legal protection.
(511) 34

(111) M 2013 24016 R
(151) 2013 09 13
(181) 2023 09 13
(210) AM 073665
(220) 2013 08 23
(732) HARRINGTON DEVELOPMENT INC.
Elvira Mendez Street, Vallari Bldg.,
3-rd Floor, Panama
(740) Givi Akopashvili
(540)



(591) Red, white, cream-colored, grey
 (531) 03.03.01-19.03.24-28.19.00-29.01.14-
 (526) **DISCLAIMER** – Maximum permissible norms, measuring and regulation thereof, as well as medical warning records of tobacco goods for realization in Georgia used in the trademark shall not be subject of independent legal protection.
 (511) 34

(111) M 2013 24017 R
 (151) 2013 09 13
 (181) 2023 09 13
 (210) AM 072813
 (220) 2013 06 24
 (732) LTD "IGRIKA 97"
 Akaki Tseretlis q. 18, b. 19, 1000 Baghdati, Georgia
 (740) Giorgi Sakvarelidze
 (540)



წყაროს წყალი „ხედა დიმი“ მალაღმთიან ხეობიდან

(591) White, blue, sky blue, green
 (531) 01.15.15-01.15.23-06.01.01-28.19.00-29.01.04-
 (526) **DISCLAIMER** – The trademark is protected as a whole, verbal signs „წყაროს წყალი“, „ხედა დიმი“ and „მალაღმთიან ხეობიდან“ in the trademark shall not be subject of independent legal protection.
 (511) 32

(111) M 2013 24062 R
 (151) 2013 09 20
 (181) 2023 09 20
 (210) AM 073881
 (220) 2013 09 09
 (732) LTD "ALFA"
 Tevdore Mghvdlis q. 53, 0154 Tbilisi, Georgia
 (740) Nugzar Ksovreli
 (540)



(591) Green, blue, yellow, brown, black, white
 (531) 05.05.04-06.07.05-28.19.00-29.01.15-
 (526) **DISCLAIMER** – The trademark is protected as a whole, verbal sign „თბილისი“ in the trademark shall not be subject of independent legal protection.
 (511) 29

(111) M 2013 24063 R
 (151) 2013 09 20
 (181) 2023 09 20
 (210) AM 073875
 (220) 2013 09 06
 (732) SAMSUNG ELECTRONICS CO., LTD.
 416, Maetan-dong, Yeongtong-gu, Suwon-si, Gyeonggi-do, Republic of Korea
 (740) Giorgi Taktakishvili
 (540)

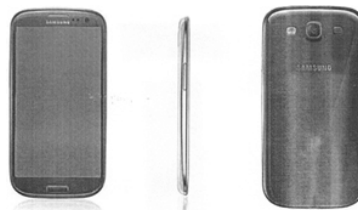

(591) Black, white
 (531) 16.01.11-
 (511) 9

(111) M 2013 24064 R
 (151) 2013 09 20
 (181) 2023 09 20
 (210) AM 073874
 (732) Davit Buadze
 L. Kavsadzis 7a, 0162 Tbilisi, Georgia

(540)

ხვენი

(591) Black, white
 (531) 28.19.00-
 (511) 32

(111) M 2013 24065 R
 (151) 2013 09 20
 (181) 2023 09 20
 (210) AM 073865
 (220) 2013 09 05
 (732) LTD "RUSTAVIS AZOTI"
 Mshvidobis q. 2, 3702 Rustavi, Georgia
 (740) Nairi Gergaia
 (540)



(591) Green, blue
 (531) 26.01.06-26.15.01-29.01.12-
 (511) 1, 35, 44

INTERNATIONAL TRADEMARKS FOR WHICH A DECISION ON GRANTING PROTECTIONS IS TAKEN

The decision can be appealed at the Chamber of Appeal of Sakpatenti within 3 months from the publication or at the Mtskheta District Court Administrative Cases Board (Address: №17, Samkhedro str., Mtskheta), within 1 month following the publication.

(260) AM 2013 68278 A

(800) 846996

(151) 2004 12 15

(891) 2012 04 25

(731) MEMİŞOĞLU TARIM ÜRÜNLERİ
TİCARET LİMİTED ŞİRKETİ
Mücahitler Caddesi, Vardarli İşhane 5/6,
İÇEL-MERSİN, Turkey

(540)

TAT

(591) Black, white

(511)

29 – Peas, beans, broad beans, kidney beans, lentils, soup and soup preparations, okra.

30 – Rice, boiled and pounded wheat; cereal preparations.

(260) AM 2013 68393 A

(800) 1051241

(151) 2010 09 10

(891) 2012 05 25

(731) Hilding Anders International AB
Östra Varvsgatan 4, SE-211 19 Malmö,
Sweden

(540)

HILDING ANDERS

(591) Black, white

(511)

20 – Furniture, beds, bedding (except linen), pillows; mattresses; mirrors; picture frames; settees; divans.

22 – Hammocks; padding and stuffing materials (except of rubber or plastics), feathers for bedding, stuffing beds and upholstery.

24 – Bed clothes, sheets (textile), pillowcases, bed blankets, quilts, bedspreads, textiles, upholstery fabrics, mattress covers, loose covers for furniture, pillow shams, bed covers of paper.

(260) AM 2013 68485 A

(800) 1031941

(151) 2010 02 24

(891) 2012 06 28

(731) The Whistler Group, Inc.
3604 NW Frontage Road, Bentonville,
AZ 72712, USA

(540)

WHISTLER

(591) Black, white

(511)

9 – Communications headsets for use with communication radios, intercom systems, or other communications network transceivers; converters; Global positioning system GPS); inverters; laser speed detectors; Power inverters; radar detectors; receivers for navigation systems; voltage regulators; radar navigation aids; radar Systems, namely, speed radar detectors.

(260) AM 2013 68488 A

(800) 1084039

(151) 2011 06 27

(891) 2012 06 08

(731) Actelion Pharmaceuticals Ltd.
Gewerbstrasse 16, CH-4123 Allschwil,
Switzerland

(540)

TURLEBO

(591) Black, white

(511)

5 – Pharmaceutical preparations.

(260) AM 2013 68490 A

(800) 1090234

(151) 2011 08 16

(891) 2012 06 21

(731) Novo Nordisk A/S
Novo Allé, DK-2880 Bagsvaerd, Denmark

(540)

Ryzodeg

(591) Black, white

(511)

5 – Pharmaceutical preparations for the treatment of diabetes.

(260) AM 2013 68492 A
 (800) 1095374
 (151) 2011 08 12
 (891) 2012 07 03
 (731) Public Joint Stock Company "Pharmstandard"
 Likhachevsky proezd
 d. 5 "B", g. Dolgoprudny, RU-141700
 Moscow Region, Russian Federation

(540)

ЦИНОКАП

(591) Black, white

(511)

5 – Mineral food-supplements; Nutritional additives for medical purposes; Pharmaceutical preparations.

(260) AM 2013 68493 A
 (800) 1096616
 (151) 2011 08 12
 (891) 2012 07 03
 (731) Public Joint Stock Company "Pharmstandard"
 Likhachevsky proezd
 d. 5 "B", g. Dolgoprudny, RU-141700
 Moscow Region, Russian Federation

(540)

АКОПТА

(591) Black, white

(511)

5 – Mineral food-supplements; Nutritional additives for medical purposes; Pharmaceutical preparations.

(260) AM 2013 68494 A
 (800) 1105500
 (151) 2011 08 12
 (891) 2012 04 02
 (731) ESTA İNŞAAT SANAYİ LOJİSTİK VE DIŞ
 TİCARET A.Ş.
 Vali Konağı Caddesi Akkavak Sok. Karahan
 Apt.No: 19-21 K:1 D:5, Nişantaşı Şişli,
 İSTANBUL, Turkey

(540)

Hello

(591) Black, white

(511)

5 – Pharmaceutical and veterinary preparations; sanitary preparations for medical purposes; dietetic substances adapted for medical use, food for babies; medicinal, herb teas, teas for slimming purposes, ginseng tea for medicinal use; products for dental purposes other than dental tools and equipment, hygienic bandages, pads, pants, absorbent, for incontinence; plasters, materials for dressings; material for stopping teeth, dental wax; deodorants other than for personal purposes; disinfectants; preparations for destroying vermin; fungicides, herbicides.

21 – Home and kitchen goods made of glass, porcelain, ceramics, ordinary metal, plastic and synthetic and other materials, namely, buckets, waste baskets, sauce pots, plates, paper plates and glasses, trays, coffee pots, strainers, kitchen ladles, basting spoons, spatulas, washtubs, bowls, egg cups, cake molds, pitchers, food keeping boxes, coasters not of paper and not being table linen, toilet paper holders, baby baths, ice molds and ice buckets; heat insulated containers for beverages, flasks, fitted picnic baskets (including dishes), sports cups, bread boxes, bread baskets, bread cutting boards (including of, synthetic materials); non-electric heating and cooking utensils, namely, cookers, heaters, grills; metal cooking skewers, bottles, jars, demijohns, corkscrews, shoe horns, toothpicks, pipettes, ironing boards, ironing board covers, clothes racks for drying, clothes drying hanger, cages for pets, under bed boxes for storage, toilet storage boxes, watering cans, water boxes and boxes for household use, bird baths, bird rings, indoor terrariums for animal and plant cultivation, ornaments made of glass, porcelain, ceramics or terra-cotta; sculptures and works of art, included in this class; mouse traps, insect traps, fly catchers, fly swatters, toilet utensils, perfume burners, perfume censers, perfume sprays and vaporizers, cosmetic utensils (non-electric), appliances for removing make-up (non-electric), powder puffs, toilet cases, nozzles for sprinkler hose, nozzles for watering cans, watering devices, roses for watering cans, glass, unworked or semi-worked (except building glass), mosaics of and powdered glass for decoration, not for building; glass wool other than for insulation and textile.

35 – Advertising; business management; business administration; office functions, bringing together, for the benefit of others, of a variety of goods (excluding the transport thereof), enabling customers to conveniently view and purchase those goods.

(260) AM 2013 68587 A
 (800) 252325
 (151) 1962 02 08
 (891) 2012 06 01
 (731) Melitta Haushaltsprodukte GmbH & Co. KG
 Ringstrasse 99, 32427 Minden, Germany

(540)

Melitta

(591) Black, white

(511)

16 – Paper for drawing and writing paper, cardboard, paper and cardboard goods (excluding paper, cardboard, paper and cardboard goods for the office equipment industry).

21 – Household and kitchen utensils, objects of porcelain and of glass.

(260) AM 2013 68588 A

(800) 471179

(151) 1982 08 24

(891) 2012 07 04

(731) Astellas Pharma Europe B.V.

Sylviusweg 62, NL-2333 BE Leiden,

Netherlands

(540)

ZINERYT

(591) Black, white

(511)

5 – Pharmaceutical products and remedies for human use.

(260) AM 2013 68590 A

(800) 651134

(151) 1996 02 06

(891) 2012 07 04

(731) Astellas Pharma Europe B.V.

Sylviusweg 62, NL-2333 BE Leiden,

Netherlands

(540)

ЗИНЕПИТ

(591) Black, white

(511)

5 – Pharmaceutical preparations and medicines for human use.

(260) AM 2013 68592 A

(800) 749780

(151) 2000 12 11

(891) 2012 06 07

(731) INDUSTRIA DE DISEÑO TEXTIL, S.A.

(INDITEX, S.A.)

Avenida de la Diputación, Edificio Inditex

E-15142 ARTEIXO, A CORUÑA, Spain

(540)

TEXTURES ZARA

(591) Black, white

(511)

3 – Bleaching preparations and other substances for laundry use; cleaning, polishing, scouring and abrasive preparations; soaps; perfumery, essential oils, cosmetics, hair lotions; dentifrices.

(260) AM 2013 68593 A

(800) 781198

(151) 2002 04 26

(891) 2012 05 03

(731) Palfinger AG

24-28, F.W. Scherer-Straße, A-5101

BERGHEIM/SALZBURG, Austria

(540)

EPSILON

(591) Black, white

(511)

7 – Lifting apparatus, in particular loading cranes for vehicles; spare parts for loading cranes, in particular hydraulic drives.

(260) AM 2013 68594 A

(800) 908925

(151) 2006 11 03

(891) 2012 06 05

(731) Intrum Justitia Licensing AG

Industriestrasse 13c, CH-6300 Zug,

Switzerland

(540)

INTRUM

(591) Black, white

(511)

35 – Advertising; business management; business administration; office functions.

36 – Insurance; financial affairs; monetary affairs; real estate affairs.

42 – Legal services in the field of debt collection.

(260) AM 2013 68595 A

(800) 916210

(151) 2007 02 08

(891) 2012 06 22

(731) Zakrytoe Aktsionernoe Obschestvo "Nauchno-

proizvodstvenny Tsentr "ELFA"

komnata pravlenia, d. 14, Volgogradsky pr-t,

RU-109316 Moskva, Russian Federation

(540)

ЭЛЬФАСЕПТ

ELFASEPT

(591) Black, white

(511)

5 – Pharmaceuticals.

(260) AM 2013 68596 A

(800) 934606

(151) 2007 07 23

(891) 2012 06 18

(731) Nordic Spirit AB

Nybrokajen 7, SE-111 48 Stockholm, Sweden

(540)

DQ Vodka

(591) Black, white

(511)

33 – Alcoholic beverages (except beers).

(260) AM 2013 68663 A
 (800) 1000869
 (151) 2008 11 28
 (891) 2012 07 09
 (731) NIHON SHOKKEN HOLDINGS CO., LTD.
 3, Tomitashinkou 1-chome, Imabari-shi,
 Ehime 799-1582, Japan

(540)

日本食研

(591) Black, white

(511)

29 – Fish and crustaceans (not live); frozen vegetables; frozen fruits; processed meat products; processed marine products; processed vegetables and fruits; soup mixes.

30 – Seasonings; sauces (condiments); salad dressings; spices; cereal preparations; Chinese stuffed dumplings (gyoza); sandwiches; Chinese-style steamed meat buns; sushi; fried balls of batter mix with small pieces of octopus (Takoyaki); steamed buns stuffed with minced meat (Niku-manjuh); hamburgers; pizzas; boxed lunches consisting of cooked rice with added cooked vegetables, or cooked rice with added cooked meat, or cooked rice with added cooked meat and cooked vegetables, or cooked rice with added cooked chicken, or cooked rice with added cooked chicken and cooked vegetables, or cooked rice with added cooked fish, or cooked rice with added cooked fish and cooked vegetables, all the aforementioned being prepared for immediate consumption; hotdogs; meat pies; ravioli; instant confectionery mixes, namely instant doughnut mixes, instant pudding mixes, and instant pancake mixes; flour for food.

(260) AM 2013 68665 A
 (800) 1102885
 (151) 2011 11 30
 (891) 2012 06 13
 (731) NOVARTIS AG
 CH-4002 Basel, Switzerland

(540)



(591) Blue, white and gray

(511)

5 – Pharmaceutical products for human use.

(260) AM 2013 68666 A
 (800) 1117620
 (151) 2012 05 10
 (891) 2012 06 15
 (731) Glaxosmithkline Biologicals S.A.
 Rue de l'Institut 89, B-1330 Rixensart,
 Belgium

(540)

ROTARIX

(591) Black, white

(511)

5 – Vaccines for human use.

(260) AM 2013 68667 A
 (800) 1123932
 (151) 2012 05 24
 (731) AMOCARAT S.A.
 ul. Królewska 1, PL-43-354 Czaniec, Poland

(540)

obsessive

(591) Black and red

(511)

25 – Underclothing.

(260) AM 2013 68710 A
 (800) 1124404
 (151) 2012 05 30
 (731) Plzeňský Prazdroj, a.s.
 U Prazdroje 7, CZ-304 97 Plzeň,
 Czech Republic

(540)



(591) Black, white

(511)

32 – Beer and beverages based on beer, fermented malt beverages; mineral and aerated waters and other non-alcoholic drinks; fruit drinks and fruit juices; syrups and other preparations for making beverages.

(260) AM 2013 68711 A
 (800) 1124423
 (151) 2012 06 04
 (731) KRKA, tovarna zdravil, d.d., Novo mesto
 Šmarješka cesta 6, SI-8501 Novo mesto,
 Slovenia

(540)
TOLUCOMBI

(591) Black, white
 (511)
 5 – Pharmaceutical preparations.

(260) AM 2013 68713 A
 (800) 1124442
 (151) 2012 06 20
 (731) BENELLI ARMI S.P.A.
 Via della Stazione, 50, I-61029 URBINO
 (PU), Italy

(540)

(591) Black, white
 (511)
 13 – Firearms; ammunition and projectiles; explosives; fireworks.

(260) AM 2013 68714 A
 (800) 1124443
 (151) 2012 06 20
 (731) Boehringer Ingelheim International GmbH
 55218 Ingelheim, Germany

(540)
Тундрион

(591) Black, white
 (511)
 5 – Pharmaceutical preparations.

(260) AM 2013 68716 A
 (800) 1124448
 (151) 2012 06 06
 (731) EGIS GYÓGYSZERGYÁR Nyilvánosan
 Működő Részvénytársaság
 Keresztúri út 30-38 H-1106 Budapest,
 Hungary

(540)
ZOTENIR

(591) Black, white
 (511)
 5 – Pharmaceutical preparations for human use.

(260) AM 2013 68717 A
 (800) 1124454
 (151) 2012 06 06
 (731) EGIS GYÓGYSZERGYÁR Nyilvánosan
 Működő Részvénytársaság
 Keresztúri út 30-38 H-1106 Budapest,
 Hungary

(540)
ZEGOMIB

(591) Black, white
 (511)
 5 – Pharmaceutical preparations for human use.

(260) AM 2013 68718 A
 (800) 1124455
 (151) 2012 06 05
 (731) EGIS GYÓGYSZERGYÁR Nyilvánosan
 Működő Részvénytársaság
 Keresztúri út 30-38 H-1106 Budapest,
 Hungary

(540)
DROSEGIS

(591) Black, white
 (511)
 5 – Pharmaceutical preparations for human use.

(260) AM 2013 68719 A
 (800) 1124456
 (151) 2012 06 05
 (731) EGIS GYÓGYSZERGYÁR Nyilvánosan
 Működő Részvénytársaság
 Keresztúri út 30-38 H-1106 Budapest,
 Hungary

(540)
FORSMAJOR

(591) Black, white
 (511)
 5 – Pharmaceutical preparations for human use.

(260) AM 2013 68720 A
 (800) 1124457
 (151) 2012 06 06
 (731) EGIS GYÓGYSZERGYÁR Nyilvánosan
 Működő Részvénytársaság
 Keresztúri út 30-38 H-1106 Budapest,
 Hungary

(540)
SUZANA

(591) Black, white
 (511)
 5 – Pharmaceutical preparations for human use.

(260) AM 2013 68721 A
 (800) 1124466
 (151) 2012 07 06
 (731) Akzo Nobel Coatings International B.V.
 Velperweg 76, NL-6824 BM Arnhem,
 Netherlands
 (540)

WEATHERSHIELD

(591) Black, white
 (511)
 2 – Paints, varnishes, lacquers; thinners, colouring matters, all being additives for paints, varnishes or lacquers; preservatives against rust and against deterioration of wood; priming preparations (in the nature of paints); wood stains.

(260) AM 2013 68723 A
 (800) 1124487
 (151) 2011 11 18
 (731) Zakrytoe aktsionernoe obshchestvo "I-Teco"
 Street Bolshaya Nikitskaya, 24, bldg. 5, floor
 2, RU-103009 Moscow, Russian Federation
 (540)



(591) White, black, green
 (511)
 9 – Computers, computer memories for them; compact discs [read-only memory]; interfaces [for computers]; microprocessors; modems; hardware for monitors; data processing apparatus; computer peripheral devices and printers for use with computers; magnetic data media; optical data media; disks [magnetic]; optical discs; disk drives [for computers]; magnetic tapes; readers including scanners [data processing equipment]; electronic pens [visual display units]; audiovisual teaching apparatus; video recorders; high-frequency apparatus; calculating machines; laptop computers.

38 – Leasing access time to a computer database; consultancy services in the field of telecommunication equipment.

39 – Freight forwarding; wrapping of goods; packing of goods; storage of goods; storage; storage rental; garage rental; rental of covered parking for transport; rental of storage containers; information storage.

41 – Arranging and conducting of conferences; arranging and conducting of seminars; arranging and conducting of symposiums.

42 – Computer rental; rental of computer software; technical project studies; design of artwork; technical advice relating to computers; consultancy services in the field of information technology.

(260) AM 2013 68724 A
 (800) 1124488
 (151) 2011 11 17
 (731) Closed Joint Stock Company "Barnaul
 Cartridge Plant"
 28, Kulagina Str., Barnaul, RU-656002 Altai
 Territory, Russian Federation
 (540)



(591) Golden, dark cherry
 (511)
 13 – Cartridges; cartridge cases; ammunition for firearms.

(260) AM 2013 68725 A
 (800) 1124494
 (151) 2011 12 09
 (731) Joint Stock Company "TVEL"
 24, ul. Bolshaya Ordynka, RU-119017
 Moscow, Russian Federation
 (540)



(591) Black, white
 (511)
 1 – Agar-agar; nitrogen; actinium; alkaloids; algovilla [tanning material]; alginates [gelling and inflating preparations] other than for alimentary purposes; crotonic aldehyde; ammonium aldehyde; aldehydes; americium; amyl acetate; ammonia [volatile alkali] for industrial purposes; anhydrous ammonia; ammonia; acetic anhydride; anhydrides; anti-knock substances for internal combustion engines; anti-incrustants; disincrustants; antistatic preparations, other than for household purposes; antifreeze; dextrine size; dressing and finishing preparations for textiles; size for finishing and priming; argon; lead arsenate; astatine; aluminium acetate; lime acetate; lead acetate; acetate of cellulose, unprocessed; acetates [chemicals]; acetylene; acetone; oenological bactericides [chemical preparations used in wine making]; balm of gurjun [gurjon, gurjan] for making varnish; barium; barytes; albumen [animal or vegetable, raw material]; animal albumen [raw material]; iodised albumen; malt albumen; bentonite; berkelium; bicarbonate of soda for chemical purposes;

potassium dioxalate; bichromate of potassium; bichromate of soda; bauxite; bromine for chemical purposes; albuminized paper; baryta paper; diazo paper; blueprint paper; reagent paper; test paper, chemical; litmus paper; nitrate paper; sensitized paper; photometric paper; borax; agglutinants for concrete; gas purifying preparations; preservatives for pharmaceutical preparations; polish removing substances; preparations for the separation of greases; substances for preventing runs in stockings; water-softening preparations; limestone hardening substances; tanning substances; birdlime; glue for industrial purposes; surface-active chemical agents; artificial sweeteners [chemical preparations]; fissionable material for nuclear energy; foundry binding substances; concrete-aeration chemicals; leather-dressing chemicals; chemical preparations for the manufacture of paints; chemical substances for preserving foodstuffs; starch-liquifying chemicals [ungluing agents]; flower preservatives; seed preserving substances; viscose; bismuth; bismuth nitrite for chemical purposes; witherite; distilled water; sea water for industrial purposes; acidulated water for recharging accumulators; heavy water; hydrogen; seaweeds [fertilizers]; gadolinium; getters [chemically active substances]; protective gases for welding; solidified gases for industrial purposes; gas propellents for aerosols; basic gallate of bismuth; gallium; gambier; helium; electrophoresis gels, other than for medical or veterinary purposes; aluminium hydrate; hydrates; hyposulphites; ceramic glazings; glycol; expanded-clay for hydroponic plant growing [substrate]; china slip; kaolin; alumina; glycerides; glycerine for industrial purposes; glucose for industrial purposes; glucosides; holmium; hormones for hastening the ripening of fruit; peat pots for horticulture; graphite for industrial purposes; guano; humus; potting soil; detergents for use in manufacturing processes; defoliant; hydrazine; diastase for industrial purposes; kieselgur; manganese dioxide; titanium dioxide for industrial purposes; dry ice [carbon dioxide]; zirconia; oil dispersants; petroleum dispersants; dysprosium; bichloride of tin; detergent additives to petrol [gasoline]; ceramic compositions for sintering [granules and powders]; additives, chemical, to drilling muds; additives, chemical, to insecticides; chemical additives for oils; additives, chemical, to motor fuel; additives, chemical, to fungicides; dolomite for industrial purposes; tan-wood; europium; gelatine for photographic purposes; gelatine for industrial purposes; auxiliary fluids for use with abrasives; fluids for hydraulic circuits; liquids for removing sulphates from accumulators; brake fluid; magnetic fluid for industrial purposes; power steering fluid; transmission fluid; grafting wax for trees; tree cavity fillers [forestry]; glaziers' putty; moderating materials for nuclear reactors; rare earths; metal earths; diatomaceous earth; fuller's earth for use in textile industry; lime

chloride; isotopes for industrial purposes; ion exchangers [chemical preparations]; ytterbium; yttrium; iodine for industrial purposes; iodine for chemical purposes; aluminium iodide; alkaline iodides for industrial purposes; casein for industrial purposes; kainite; potassium; sorrel salt; californium; gum arabic for industrial purposes; tartar other than for pharmaceutical purposes; camphor, for industrial purposes; calcium carbide; carbide; lime carbonate; magnesium carbonate; carbonates; cement [metallurgy]; cassiopium [lutetium]; catalysts; biochemical catalysts; catechu; caustics for industrial purposes; alum; ammonia alum; aluminium alum; chrome alum; quebracho for industrial purposes; ketones; cinematographic film, sensitized but not exposed; oxygen; nitric acid; antranilic acid; benzoic acid; boric acid for industrial purposes; tartaric acid; tungstic acid; gallic acid for the manufacture of ink; gallotannic acid; tannic acid; iodic acid; phenol for industrial purposes; citric acid for industrial purposes; lactic acid; formic acid; persulphuric acid; oleic acid; picric acid; pyrogallic acid; salicylic acid; sebacic acid; sulphuric acid; sulphurous acid; hydrochloric acid; stearic acid; carbonic acid; spirits of vinegar [dilute acetic acid]; phosphoric acid; hydrofluoric acid; cholic acid; chromic acid; oxalic acid; acids; benzene-based acids; fatty acids; arsenious acid; mineral acids; adhesives for billposting; leather glues; adhesives for wall tiles; adhesives for paperhanging; cement for mending broken articles; gums [adhesives], other than for stationery or household purposes; adhesives for industrial purposes; isinglass other than for stationery, household or alimentary purposes; gluten [glue], other than for stationery or household purposes; flocculants; collodion; compost; beer preserving agents; mangrove bark for industrial purposes; tan; starch for industrial purposes; starch paste [adhesive], other than for stationery or household purposes; silicon; creosote for chemical purposes; krypton; xenon; curium; lanthanum; lecithin [raw material]; lithium; magnesite; manganate; oils for tanning leather; oils for currying leather; oils for preparing leather in the course of manufacture; oils for the preservation of food; carbolium for the protection of plants; paper pulp; wood pulp; grafting mastic for trees; mastic for leather; mastic for tires [tyres]; synthetic materials for absorbing oil; ceramic materials in particulate form, for use as filtering media; filtering materials [mineral substances]; filtering materials [vegetable substances]; filtering materials [chemical preparations]; copper sulphate [vitriol]; metalloids; alkaline-earth metals; alkaline metals; methane; methyl benzene; methyl benzol; flour for industrial purposes; tapioca flour for industrial purposes; potato flour for industrial purposes; soap [metallic] for industrial purposes; arsenic; emollients for industrial purposes; dressing, except oils, for skins; sodium; hypochlorite of soda; naphthalene; sal ammoniac; toxic gas neut-

ralizers; neodymium; neon; neptunium; nitrate of uranium; nitrates; combusting preparations [chemical additives to motor fuel]; nitrous oxide; baryta; uranium oxide; oxalates; lithia [lithium oxide]; lead oxide; antimony oxide; chromium oxide; cobalt oxide for industrial purposes; mercuric oxide; olive-ne [chemical preparations]; gallnuts; clarification preparations; wine finings; must-finishing preparations; textile-brightening chemicals; beer-clarifying and preserving agents; reducing agents for use in photography; bases [chemical preparations]; wax-bleaching chemicals; fat-bleaching chemicals; organic-bleaching chemicals; pectin [photography]; perborate of soda; humus top dressing; percarbonates; hydrogen peroxide; persulphates; perchlorates; foundry sand; sensitized plates for offset printing; plasticizers; roentgen films, sensitized but not exposed; plutonium; substrates for soil-free growing [agriculture]; polonium; potash; potash water; earth for growing; praseodymium; rubber preservatives; brickwork preservatives, except paints and oils; masonry preservatives, except paints and oils; cement preservatives, except paints and oils; preservatives for tiles, except paints and oils; bacterial preparations other than for medical and veterinary use; bacteriological preparations other than for medical and veterinary use; bacteriological preparations for acetification; biological preparations, other than for medical or veterinary purposes; vulcanising preparations; diagnostic preparations, other than for medical or veterinary purposes; renovating preparations for phonograph records; currying preparations for leather; currying preparations for skins; metal hardening preparations; fixing baths [photography]; fixing solutions [photography]; opacifiers for enamel or glass; separating and unsticking [ungluing] preparations; metal annealing preparations; preparations for preventing the tarnishing of lenses; preparations for preventing the tarnishing of glass; cement-waterproofing preparations, except paints; plant growth regulating preparations; anti-boil preparations for engine coolants; fulling preparations for use in textile industry; scale removing preparations, other than for household purposes; flashlight preparations; galvanizing preparations; finishing preparations for use in the manufacture of steel; sizing preparations; animal carbon preparations; cultures of microorganisms other than for medical and veterinary use; corrosive preparations; cryogenic preparations; dehydrating preparations for industrial purposes; degreasing preparations for use in manufacturing processes; degumming preparations; gum solvents; oil-bleaching chemicals; bleaching preparations [decolorants] for industrial purposes; meat tenderizers for industrial purposes; preparations for stimulating cooking for industrial purposes; preparations of trace elements for plants; moistening [wetting] preparations for use in the textile industry; moistening [wetting] preparations for use in dyeing;

moistening [wetting] preparations for use in bleaching; enzyme preparations for industrial purposes; filtering preparations for the beverages industry; chemical preparations to prevent mildew; vine disease preventing chemicals; chemical preparations for protection against wheat blight [smut]; chemical condensation preparations; chemical preparations for smoking meat; chemical substances for analyses in laboratories, other than for medical or veterinary purposes; chemical preparations for scientific purposes, other than for medical or veterinary use; chemical preparations for facilitating the alloying of metals; engine-decarbonising chemicals; fulling preparations; fuel-saving preparations; coal saving preparations; damp proofing preparations, except paints, for masonry; anti-sprouting preparations for vegetables; brazing preparations; preparations of the distillation of wood alcohol; by-products of the processing of cereals for industrial purposes; benzene derivatives; cellulose derivatives [chemicals]; promethium; protactinium; protein [raw material]; mordants for metals; radium for scientific purposes; radon; solvents for varnishes; anti-frothing solutions for accumulators; solutions for cyanotyping; baths for galvanizing; silver salt solutions for silvering; toning baths [photography]; drilling muds; fissionable chemical elements; chemical reagents, other than for medical or veterinary purposes; rhenium; mercury; rubidium; carbon black for industrial purposes; soot for industrial or agricultural purposes; lamp black for industrial purposes; samarium; saccharin; selenium; salpetre; sulphur; silver nitrate; carbon sulphide; silicates; aluminium silicate; silicones; scandium; foundry molding preparations; acrylic resins, unprocessed; artificial resins, unprocessed; synthetic resins, unprocessed; epoxy resins, unprocessed; calcined soda; caustic soda for Industrial purposes; barium compounds; fluorspar compounds; salts for industrial purposes; salts [fertilisers]; salts [chemical preparations]; ammoniacal salts; ammonium salts; salts of precious metals for industrial purposes; salts for galvanic cells; salt for preserving, other than for foodstuffs; salts for coloring metal; iron salts; gold salts; iodised salts; calcium salts; sodium salts [chemical preparations]; salt, raw; salts from rare earth metals; mercury salts; toning salts [photography]; chrome salts; chromic salts; salts of alkaline metals; rock salt; mold-release preparations; fire extinguishing compositions; coolants for vehicle engines; compositions for the manufacture of phonograph records; compositions for the manufacture of technical ceramics; compositions for repairing inner tubes of tires; tire repairing compositions; acid proof chemical compositions; glutinous tree-banding preparations; adhesive preparations for surgical bandages; fireproofing preparations; compositions for threading; sauce for preparing tobacco; amyl alcohol; vinic alcohol; wood alcohol; sal ammoniac spirits; ethyl alcohol;

alcohol; cement for boots and shoes; concrete preservatives, except paints and oils; water glass [soluble glass]; strontium; barium sulphate; sulphates; antimony sulphide; sulphides; benzoic sulphide; sulphonic acids; sumac for use in tanning; superphosphates [fertilisers]; antimony; thallium; talc [magnesium silicate]; tannin; cream of tartar, other than for pharmaceutical purposes; tellurium; terbium; tetrachlorides; carbon tetrachloride; acetylene tetrachloride; technetium; thiocarbanilide; titanite; sensitized cloth for photography; blueprint cloth; toluol; fuel for atomic piles; thorium; peat [fertiliser]; tragacanth gum for use in manufactures; thulium; carbonic hydrates; carbon; activated carbons; carbon for filters; animal carbon; animal charcoal; bone charcoal; blood charcoal; fertilizing preparations; nitrogenous fertilisers; calcium cyanamide [fertilizer]; nitrogenous lime [manure]; fertilizers; manure for agriculture; pyroligneous acid [wood vinegar]; uranium; chemical intensifiers for paper; chemical intensifiers for rubber; vulcanisation accelerators; enzymes for industrial purposes; ferments for chemical purposes; milk ferments for chemical purposes; fermium; ferrocyanides; soldering fluxes; brazing fluxes; formic aldehyde for chemical purposes; phosphatides; phosphates [fertilisers]; phosphorus; photographic paper; self-toning paper [photography]; photosensitive plates; sensitized photographic plates; ferrotype plates [photography]; sensitized films, unexposed; photographic developers; photographic sensitizers; chemical preparations for use in photography; photographic emulsions; francium; fluorine; industrial chemicals; chemicals for forestry, except fungicides, herbicides, insecticides and parasiticides; glass-frosting chemicals; leather-renovating chemicals; glass-staining chemicals; enamel and glass-staining chemicals; enamel-staining chemicals; oil-separating chemicals; water purifying chemicals; oil-purifying chemicals; radiator flushing chemicals; soldering chemicals; welding chemicals; condensation-preventing chemicals; stain-preventing chemicals for use on fabrics; anti-tarnishing chemicals for windows; leather-waterproofing chemicals; textile-waterproofing chemicals; chemical preparations, except pigments, for the manufacture of enamel; leather-impregnating chemicals; textile-impregnating chemicals; horticulture chemicals, except fungicides, herbicides, insecticides and parasiticides; agricultural chemicals, except fungicides, weedkillers, herbicides, insecticides and parasiticides; soil conditioning preparations; chimney cleaners, chemical; color-brightening chemicals for industrial purposes; refrigerants; chlorine; chlorates; hydrochlorates; aluminium chloride; magnesium chloride; chlorides; palladium chlorides; chromates; flowers of sulphur for chemical purposes; caesium; cellulose; cerium; cyanides [prussiates]; cymene; loam; slag caustic alkali; radioactive elements for scientific purposes; emulsifiers; erbium; ethane; methyl ether;

sulphuric ether; ethyl ether; glycol ether; ethers; esters; cellulose ethers for industrial purposes; cellulose esters for industrial purposes.

6 – Aluminium; anchors; fittings of metal for building; white metal; beacons of metal, non-luminous; vats of metal; girders of metal; joists of metal; bottles [metal containers] for compressed gas or liquid air; preserve tins; preserving boxes of metal; swimming pools [metal structures]; beryllium [glucium]; blooms [metallurgy]; ingots of common metal; bolts of metal; eye bolts; casks of metal; mooring buoys of metal; barrels of metal; identification bracelets of metal, for hospitals; bronze; bells; bells for animals; letters and numerals of common metal, except type; silos of metal; busts of common metal; vanadium; bird baths [structures of metal]; vice benches of metal; screws of metal; aviaries of metal [structures]; tungsten; hoppers of metal, non-mechanical; gates of metal; sleeves [metal hardware]; signboards of metal; diving boards of metal; loading gauge rods, of metal, for railway waggons; nuts of metal; galena [ore]; celtium [hafnium]; nails; brads; tacks [nails]; horseshoe nails; germanium; tombs of metal; vice claws of metal; doors of metal; memorial plaques, of metal; tombstone plaques of metal; packaging containers of metal; containers of metal for storing acids; jealousies of metal; iron, unwrought or semi-wrought; gutters of metal; tinplate; bungs of metal; plugs of metal; bolts, flat; latch bars of metal; window fasteners of metal; crampons of metal [cramps]; binding screws of metal for cables; wheel clamps [boots]; rivets of metal; padlocks; locks of metal for vehicles; locks of metal, other than electric; locks of metal for bags; spring locks; box fasteners of metal; machine belt fasteners of metal; door bolts; bottle closures of metal; closures of metal for containers; bolts; wall plugs of metal; latches of metal; tension links; stretchers for metal bands [tension links]; wire stretchers [tension links]; stretchers for iron bands [tension links]; couplings of metal for chains; door bells, non-electric; signs, non-luminous and non-mechanical, of metal, for roads; signs, non-luminous and non-mechanical, of metal; numberplates, of metal; registration plates, of metal; bronzes [works of art]; works of art of common metal; hardware of metal, small; ironmongery; indium; cabanas of metal; telephone booths of metal; cadmium; paint spraying booths, of metal; ropes of metal; telpher cables; greenhouse frames of metal; framework of metal for building; cornices of metal; skating rinks [structures of metal]; cermets; metal cages for wild animals; keys; knobs of metal; cobalt, raw; chill-molds [foundry]; bed casters of metal; furniture casters of metal; pillars of metal for buildings; sealing caps of metal; bottle caps of metal; capsules of metal for bottles; sealing caps of metal for bottles; tent pegs of metal; rings of common metal for keys; copper rings; ferrules of metal; ferrules of metal for handles; rings of metal; stop

collars of metal; door fittings, of metal; fittings of metal for windows; buildings, transportable, of metal; buildings of metal; steel buildings; guard rails of metal; baskets of metal; money boxes of metal; door cases of metal; door frames of metal; stringers [parts of staircases] of metal; taps for casks, of metal; tubing of metal; casings of metal for oilwells; roofing of metal; brackets of metal for building; turntables [railways]; manhole covers of metal; pitons of metal [mountaineering equipment]; hooks [metal hardware]; pot hooks of metal; hooks for slate [metal hardware]; hooks of metal for clothes rails; clothes hooks of metal; chicken-houses, of metal; brass, unwrought or semi-wrought; bands of metal for tying-up purposes; scaffolding of metal; staircases of metal; ladders of metal; limonite; steel sheets; cast steel; traps for wild animals; magnesium; manganese; reinforcing materials, of metal, for concrete; reinforcing materials of metal for machine belts; reinforcing materials of metal for pipes; reinforcing materials of metal for building; materials of metal for funicular railway permanent ways; railway material of metal; building materials of metal; refractory construction materials of metal; masts of metal; steel masts; copper, unwrought or semi-wrought; sheets and plates of metal; common metals, unwrought or semi-wrought; pyrophoric metals; metals in powder form; molybdenum; door knockers; monuments of metal; porches of metal [building]; monuments of metal for tombs; bronzes for tombstones; roof flashing of metal; fish plates [rails]; flashing of metal, for building; anvils; anvils [portable]; beak-irons [bick-irons]; ferrules of metal for walking sticks; rope thimbles of metal; handcuffs; duckboards of metal; german silver; nickel; niobium; grease nipples; thread of metal for tying-up purposes; binding thread of metal for agricultural purposes; house numbers of metal, non-luminous; braces of metal for handling loads; wall claddings of metal [building]; wall linings of metal [building]; cladding of metal for construction and building; moldings of metal for cornices; laths of metal; barrel hoops of metal; fences of metal; palings of metal; tree protectors of metal; crash barriers of metal for roads; latticework of metal; trellis of metal; ironwork for doors; ironwork for windows; windows of metal; casement windows of metal; tin; shuttering of metal for concrete; filings of metal; cask stands of metal; poles of metal, for electric lines; props of metal; wainscotting of metal; signalling panels, non-luminous and non-mechanical, of metal; partitions of metal; lintels of metal; strap-hinges of metal; shims; rocket launching platforms of metal; platforms, pre-fabricated, of metal; transport pallets of metal; floor tiles, of metal; tiles of metal for building; anchor plates; tie plates; armour plate; gravestone slabs of metal; tile floorings of metal; iron slabs; lead seals; loading pallets, of metal; handling pallets of metal; firedogs [andirons]; armour plating; paving blocks

of metal; roof coverings of metal; floors of metal; sills of metal; ceilings of metal; gold solder; silver solder; door closers, non-electric; door openers, non-electric; door springs, non-electric; valves of metal, other than parts of machines; clips of metal for cables and pipes; wall hooks of metal for pipes; floating docks of metal for mooring boats; iron wire; aluminium wire; wire for aerials; soldering wire of metal; wire of common metal; wire of common metal alloys, except fuse wire; barbed wire; copper wire, not insulated; steel wire; washers of metal; springs [metal hardware]; rods of metal for welding; rods of metal for brazing; rods of metal for brazing and welding; enclosures of metal for tombs; window frames of metal; frames of metal for building; tanks of metal; containers of metal [storage, transport]; containers of metal for liquid fuel; containers of metal for compressed gas or liquid air; floating containers of metal; rails of metal; belts of metal for handling loads; gratings of metal; furnace fireguards; pulleys of metal, other than for machines; runners of metal for sliding doors; window pulleys; iron ores; ores of metal; chrome ores; tool handles of metal; door handles of metal; scythe handles of metal; broom handles of metal; knife handles of metal; pilings of metal; lead, unwrought or semi-wrought; safes [strong boxes]; vaults of metal [burial]; buckles of common metal [hardware]; door scrapers; cable joints of metal, non-electric; jets of metal; nozzles of metal; anti-friction metal; silver plated tin alloy; alloys of common metal; nickel-silver; bindings of metal; sheaf binders of metal; shutters of metal; outdoor blinds of metal; steel alloys; iron strip; steel strip; steel, unwrought or semi-wrought; tinfoil; statues of common metal; figurines [statuettes] of common metal; tombstone stelae of metal; pegs of metal; pins [hardware]; bars for metal railings; posts of metal; advertisement columns of metal; telegraph posts of metal; railway switches; steps [ladders] of metal; slings of metal for handling loads; stair treads [steps] of metal; identity plates of metal; tantalum [metal]; troughs of metal for mixing mortar; greenhouses of metal, transportable; titanium; wire cloth; tombac; boarding stairs of metal, mobile, for passengers; cables of metal, non-electric; wire rope; mooring bollards of metal; turnstiles, non-automatic; angle irons; tinplate packings; stops of metal; door stops of metal; gate stops of metal; sash fasteners of metal for windows; bicycle parking installations of metal; towel dispensers, fixed, of metal; wind-driven bird-repelling devices made of metal; tungsten iron; molybdenum iron; silicon iron; ferrotitanium; chrome iron; door panels of metal; weather vanes of metal; wind vanes of metal; aluminium foil; foils of metal for wrapping and packaging; ice moulds of metal; foundry molds of metal; fittings of metal for coffins; fittings of metal for beds; fittings of metal for furniture; building or furniture fittings of nickel-silver; chromium; cattle

chains; chains for dogs; safety chains of metal; chains of metal; zinc; zirconium; tiles of metal; cast iron, unwrought or semi-wrought; balls of steel; hinges of metal; poles of metal; crampons [climbing irons]; cashboxes of metal; safety cashboxes; belt stretchers of metal; railroad ties of metal; window casement bolts; cotter pins; spurs; roller blinds of steel; building boards of metal; insect screens of metal; furnace fire screens; badges of metal for vehicles; lock bolts; bins of metal; chests of metal; tool boxes of metal, empty; tool chests of metal, empty; chests of metal for food; meat safes of metal; boxes of common metal; letter boxes of metal.

11 – Lamp shades; steam accumulators; heat accumulators; defrosters for vehicles; water heaters [apparatus]; distillation apparatus; desiccating apparatus; disinfectant apparatus; air deodorising apparatus; tanning apparatus [sun beds]; ionisation apparatus for the treatment of air; coffee roasters; beverages cooling apparatus; hand drying apparatus for washrooms; water purifying apparatus and machines; refrigerating apparatus and machines; drying apparatus and installations; freezers; drying apparatus; fruit roasters; framework of metal for ovens; coolers for furnaces; expansion tanks for central heating installations; refining towers for distillation; bidets; boilers, other than parts of machines; bath tubs; spa baths [vessels]; bath tubs for sitz baths; waffle irons, electric; fans [air-conditioning]; fans [parts of air-conditioning installations]; electric fans for personal use; roasting spits; refrigerating display cabinets [display cases]; water heaters; flushing apparatus; air reheaters; extractor hoods for kitchens; gas generators [installations]; gas condensers, other than parts of machines; acetylene generators; hydrants; burners; acetylene burners; petrol burners; gas burners; burners for lamps; germicidal burners; incandescent burners; oxhydrogen burners; laboratory burners; oil burners; alcohol burners; hot water bottles; warming pans; footwarmers, electric or non-electric; bedwarmers; pocket warmers; lampshade holders; stills; showers; chimney flues; refrigerating containers; gas lighters; lighters; friction lighters for igniting gas; chimney blowers; coils [parts of distilling, heating or cooling installations]; ash pits for furnaces; evaporators; flares; shower cubicles; turkish bath cabinets, portable; heating apparatus; refrigerating chambers; fireplaces, domestic; autoclaves [electric pressure cookers]; pressure cooking saucepans, electric; air valves for steam heating installations; level controlling valves in tanks; thermostatic valves [parts of heating installations]; electrically heated carpets; light bulbs; light bulbs, electric; solar collectors [heating]; distillation columns; lamp globes; air conditioning apparatus; gas boilers; laundry room boilers; washing coppers; heating boilers; coffee machines, electric; taps [cocks, spigots] for pipes; taps [faucets]; mixer taps for water pipes; forges, portable; lava rocks for use in barbecue

grills; lights, electric, for christmas trees; acetylene flares; safety lamps; gas lamps; curling lamps; germicidal lamps for purifying air; projector lamps; lamps for directional signals of automobiles; light bulbs for directional signals for vehicles; arc lamps; laboratory lamps; oil lamps; soldering lamps; ultraviolet ray lamps, not for medical purposes; miners' lamps; electric lamps; chandeliers; barbecues; bread baking machines; watering machines for agricultural purposes; disposable sterilization pouches; foot-muffs, electrically heated; heaters, electric, for feeding bottles; heaters for baths; heaters for heating irons; immersion heaters; brackets for gas burners; anti-splash tap nozzles; heat pumps; filaments for electric lamps; heating filaments, electric; magnesium filaments for lighting; luminous house numbers; bath linings; heating apparatus for defrosting windows of vehicles; hot air bath fittings; bath fittings; loading apparatus for furnaces; kiln furniture [supports]; sauna bath installations; refrigerating appliances and installations; blankets, electric, not for medical purposes; lamp reflectors; vehicle reflectors; clean chambers [sanitary installations]; steam boilers, other than parts of machines; pasteurisers; lamp casings; sockets for electric lights; coffee percolators, electric; furnaces, other than for experimental purposes; stoves [heating apparatus]; bakers' ovens; hot air ovens; microwave ovens [cooking apparatus]; microwave ovens for industrial purposes; incinerators; kilns; solar furnaces; urinals [sanitary fixtures]; feeding apparatus for heating boilers; heating plates; cookers; kitchen ranges [ovens]; aquarium heaters; aquarium lights; heating cushions [pads], electric, not for medical purposes; cooking utensils, electric; water intake apparatus; deodorising apparatus, not for personal use; apparatus for dehydrating foodstuffs organic materials; griddles [cooking appliances]; grills [cooking appliances]; roasting apparatus; fumigation apparatus, not for medical purposes; gas scrubbing apparatus; oil-scrubbing apparatus; glue-heating appliances; drying apparatus for fodder and forage; water filtering apparatus; air purifying apparatus and machines; ice machines and apparatus; cooling appliances and installations; cooking apparatus and installations; lighting apparatus and installations; sanitary apparatus and installations; cooking rings; lighting apparatus for vehicles; heating apparatus, electric; hot air apparatus; heating apparatus for solid, liquid or gaseous fuels; steam facial apparatus [saunas]; safety accessories for water or gas apparatus and pipes; regulating and safety accessories for gas apparatus; regulating accessories for water or gas apparatus and pipes; regulating and safety accessories for water apparatus; regulating and safety accessories for gas pipes; roasting jacks; anti-dazzle devices for automobiles [lamp fittings]; plate warmers; electric appliances for making yogurt; rotisseries; radiator caps; diving lights; flashlights [torches]; searchlight

hts; washers for water taps; anti-glare devices for vehicles [lamp fittings]; radiators [heating]; central heating radiators; radiators, electric; sinks; disinfectant dispensers for toilets; drip irrigation emitters [irrigation fittings]; light diffusers; atomic piles; nuclear reactors; heat regenerators; flushing tanks; pressure water tanks; furnace grates; roasters; lamps; standard lamps; street lamps; ceiling lights; toilet seats; lighting installations for air vehicles; gas scrubbers [parts of gas installations]; lamp glasses; sterilizers; water sterilizers; air sterilisers; air driers [dryers]; laundry dryers, electric; hair driers [dryers]; malt roasters; tobacco roasters; heat exchangers, not parts of machines; bread toasters; discharge tubes, electric, for lighting; lamp chimneys; luminous tubes for lighting; flues for heating boilers; boiler pipes [tubes] for heating installations; pipes [parts of sanitary installations]; toilets [water-closets]; toilets, portable; humidifiers for central heating radiators; wash-hand basins [parts of sanitary installations]; toilet bowls; water conduits installations; bath installations; bath plumbing fixtures; air conditioning installations; ventilation [air-conditioning] installations for vehicles; desalination plants; processing installations for fuel and nuclear moderating material; watering installations, automatic; cooling installations for water; cooling installations for liquids; milk cooling installations; cooling installations for tobacco; water purification installations; purification installations for sewage; steam generating installations; water distribution installations; air filtering installations; swimming pool chlorinating units; ventilation [air-conditioning] installations and apparatus; water softening apparatus and installations; cooling installations and machines; heating installations; heaters for vehicles; heating installations [water]; polymerisation installations; water supply installations; ash conveyor installations, automatic; whirlpool-jet apparatus; air cooling apparatus; furnaces; hearths; stoves; aquarium filtration apparatus; flare stacks for use in the oil industry; headlights for automobiles; vehicle headlights; filters [parts of household or industrial installations]; filters for air conditioning; coffee filters, electric; filters for drinking water; lanterns; automobile lights; bicycle lights; lights for vehicles; pocket searchlights; pocket torches, electric; lanterns for lighting; chinese lanterns; fairy lights for festive decoration; fountains; ornamental fountains; deep fryers, electric; oven fittings made of fireclay; fittings, shaped, for furnaces; refrigerators; chromatography apparatus for industrial purposes; kettles, electric; dampers [heating]; ventilation hoods; ventilation hoods for laboratories; dental ovens; refrigerating cabinets; ice boxes; fuel economisers; carbon for arc lamps; heating elements.

42 – Computer systems analysis; chemical analysis; authenticating works of art; recovery of computer data; graphic arts designing; computer virus protection services; installation of computer software; me-

teorological information; weather forecasting; material testing; textile testing; bacteriological research; biological research; geological research; research in the field of environmental protection; cosmetic research; mechanical research; physics [research]; chemical research; analysis for oil-field exploitation; underwater exploration; calibration [measuring]; oil-well testing; quality control; vehicle roadworthiness testing; land surveying; dress designing; updating of computer software; geological surveys; oil-field surveys; maintenance of computer software; design of interior decor; conversion of data or documents from physical to electronic media; providing search engines for the internet; data conversion of computer programs and data [not physical conversion]; computer system design; rental of web servers; computer rental; rental of computer software; geological prospecting; oil prospecting; hosting computer sites [web sites]; duplication of computer programs; computer software design; cloud seeding; consultancy in the field of energy-saving; creating and maintaining web sites for others; computer programming; industrial design; styling [industrial design]; chemistry services; packaging design.

(260) AM 2013 68726 A

(800) 1124501

(151) 2012 02 09

(731) Zakritoe aktsionernoe obshchestvo "Edim Doma"

stroenie 1, 15, Naprudny pereulok,
RU-129110 Moskva, Russian Federation

(540)



(591) Red and white

(511)

29 – Charcuterie; caviar; meat; meat, preserved; liver pastes; liver; milk products; food products made from fish; poultry, not live; fish [not live]; fish, preserved; salted fish; vegetable salads; fruit salads; herrings; sausages in batter; cheese; potato flakes; potato chips.

30 – Bread; pastry and confectionery; ice-cream; mustard; vinegar; condiments.

35 – Advertising; television advertising; advertising agencies; sales promotion for others; organization of exhibitions for commercial or advertising purposes; procurement services for others [purchasing goods and services for other businesses].

41 – Entertainment; organization of sports competitions; videotaping; dubbing; movie studios; micro-filming; videotape editing; production of radio and television programmes; music-halls; organization of exhibitions for cultural or educational purposes; arranging and conducting of workshops [training]; arranging of beauty contests; operating lotteries; television entertainment; presentation of live performances; theatre productions; rental of videotapes; film production; rental of sound recordings; rental of videotapes; rental of cine-films; news reporters services; providing casino facilities [gambling].

43 – Food and drink catering.

(260) AM 2013 68727 A

(800) 1124503

(151) 2012 01 24

(731) ANFA AYAKKABI DERI TEKSTIL
TURIZM GIDA INSAAT SANAYI VE
TICARET LIMITED SIRKETI
Tiyatro Cad. Yahyapasa Sk. Azak Bigcenter
No.19/77, Eminönü-Istanbul, Turkey

(540)



T I F L A N I

(591) Blue, light blue, white

(511)

25 – Clothing, not being protective clothing, incorporating reflective or fluorescent elements or material underwear outdoor clothing knitted clothing cotton or other textile fibers denims leather clothing paper clothing clothing for sports beach clothes shirts jackets (clothing) pants skirts blouses bathing costumes underclothing gloves (clothing) socks footwear shoes boots slippers booties fitting for shoes, sports shoes, iron fittings for shoes, heels and heel-pieces for boots and shoes, tap shoes, leg warmers, footwear uppers; headgear; hats, berets, caps; clothing for babies, babies' diapers of textile, swaddling clothes, wraps, babies' nappies of textile, briefs, baby bibs, not of paper; combinations (clothing) pareos, detachable collars, collars (clothing), bandanas, neckties, bow ties, scarfs, cuffs, shawls, arm warmers (clothing), head sweatbands, head scarves, wrist bands, belts for clothing, braces, garters.

35 – The bringing together, for the benefit of others, of a variety of goods, excluding the transport thereof, enabling customers to conveniently view and purchase those goods.

(260) AM 2013 68729 A

(800) 1124566

(151) 2012 01 12

(731) Weekday Brands AB

Box 336, SE-573 24 Tranås, Sweden

(540)



(591) Black, white

(511)

25 – Clothing, footwear, headgear.

35 – Advertising and business advertising; business management; business administration; office functions; online consumer information; retailer services regarding soaps, perfumery, essential oils, cosmetics, hair lotions, dentifrices, eyewear cases, spectacles, sunglasses, eye-glass frames, glasses cases, spectacle chains, precious metals and their alloys, and goods in precious metals or coated therewith, jewellery, precious stones, horological and chronometric instruments, paper, cardboard and goods made from these materials, printed matter, book-binding material, photographs, stationery, adhesives for stationery or household purposes, artists' materials, paint brushes, typewriters and office requisites (except furniture), instructional and teaching material (except apparatus), plastic materials for packaging, printers' type, printing blocks, printed publications, loaders and books, leather and imitations of leather, and all goods made of these materials, skins, hides, trunks and travelling bags; umbrellas, parasols and walking sticks, whips, harness and saddlery, clothing, footwear, headwear.

(260) AM 2013 68730 A

(800) 1124574

(151) 2012 06 06

(731) Smith. James Todd

6311 Romaine Street, Suite 7219, c/o LL Cool
J, Inc. Los Angeles CA 90038, USA

(540)

A SWEET TOUCH OF HOPE

(591) Black, white

(511)

14 – Jewelry.

(260) AM 2013 68916 A

(800) 1125910

(151) 2012 02 03

(731) Combitec AB

Svärdvägen 11, SE-182 33 DANDERYD,
Sweden

(540)

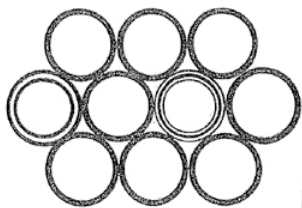
(591) Black, white
(511)

7 – Machines; blowing machines for the compression, exhaustion and transport of gases; lubricating pumps; lifting apparatus; machine tools; handling apparatus for loading and unloading; propulsion mechanisms other than for land vehicles; transmissions, other than for land vehicles; mine borers; speed governors for machines, engines and motors; valves (parts of machines); axles for machines; connecting rods for machines, motors and engines; guards (parts of machines); couplings other than for land vehicles; handling machines, automatic (manipulators); robots (machines); motors, other than for land vehicles; control cables for machines, engines or motors; control mechanisms for machines, engines or motors; drilling bits (parts of machines); centrifugal pumps; drilling heads (parts of machines); bearings (parts of machines); cylinders for machines; separators; sorting machines for industry; clutches other than for land vehicles; pumps (parts of machines, engines or motors); suction machines for industrial purposes; tools (parts of machines); holding devices for machine tools; bearings for transmission shafts; pneumatic transporters; pumps (machines); pressure regulators (parts of machines); pressure valves (parts of machines); machine wheels; superheaters; superchargers; conveyors (machines); drilling rigs (floating or non-floating); hydraulic controls for machines, motors and engines; pneumatic controls for machines, motors and engines; crankcases for machines, motors and engines; electromechanical machines for chemical industry; oil refining machines; mufflers for motors and engines; machines, engines and motors used in power stations; generators, compressors, pumps, regulators, turbines, current generators and superheaters and superchargers for power stations; self-regulating fuel pumps; fuel dispensing pumps for service stations.

9 – Material testing instruments and machines; testing apparatus not for medical purposes; gas testing instruments; gas meters; pressure gauges; sprinkler systems for fire protection; chemistry apparatus and instruments; electric installations for the remote control of industrial operations; apparatus and instruments for checking (supervision).

11 – Gas scrubbing apparatus; filters (parts of household or industrial installations); gas scrubbers (parts of gas installations); cooling installations for liquids; level controlling valves in tanks; oil burners; refining towers for distillation; cooling installations and

machines; regulating accessories for water or gas apparatus and pipes; safety accessories for water or gas apparatus and pipes; coils (parts of distilling, heating or cooling installations); regulating and safety accessories for gas pipes; regulating and safety accessories for water apparatus; regulating and safety accessories for gas apparatus; oil-scrubbing apparatus; industrial purifying installations for the handling of waste, air, water and energy products including nuclear waste reactors; flare stacks for use in the oil industry; heating apparatus for solid, liquid or gaseous fuels; solar thermal collectors (heating); fuel economizers.

37 – Drilling for oil, gas, coal, water or other natural resources for the production of power and energy products; vehicle service stations; rebuilding machines that have been worn or partially destroyed; rental of construction equipment; construction; underwater construction; building construction supervision; machinery installation, maintenance and repair; pipeline construction and maintenance.

(260) AM 2013 68917 A

(800) 1125953

(151) 2012 07 10

(731) Sovmestnoe predpriyatie otkrytoe
aktsionernoe obshchestvo "Spartak"
d.63, ul. Sovetskaya, 246655 Gomel,
Belarus

(540)

SPARTAK

(591) Black, white

(511)

30 – Pastry and confectionery.

(260) AM 2013 68918 A

(800) 1125954

(151) 2012 07 19

(731) BIOFARMA
50 rue Carnot, F-92284 SURESNES CEDEX,
France

(540)

VIALIBRAM

(591) Black, white

(511)

5 – Pharmaceutical and veterinary preparations; sanitary preparations for medical purposes; dietetic preparations adapted for medical use.

(260) AM 2013 68919 A

(800) 1125957

(151) 2012 07 31

(731) Philip Morris Products S.A.
Quai Jeanrenaud 3, CH-2000 Neuchâtel,
Switzerland

(540)



(591) Black, white

(511)

34 – Tobacco, raw or manufactured; tobacco products, including cigars, cigarettes, cigarillos, tobacco for roll-your-own cigarettes, pipe tobacco, chewing tobacco, snuff tobacco, kretek; snus; tobacco substitutes (not for medical purposes); smokers' articles, including cigarette paper and tubes, cigarette filters, tobacco tins, cigarette cases and ashtrays, pipes, pocket apparatus for rolling cigarettes, lighters; matches.

(260) AM 2013 68920 A

(800) 1125991

(151) 2012 07 18

(731) Chocoladefabriken Lindt & Sprüngli AG
Seestrasse 204, CH-8802 Kilchberg,
Switzerland

(540)



(591) Black, white

(511)

30 – Cocoa and chocolate powder; hollow and filled chocolate; chocolate cakes, namely small assorted chocolates (pralines); hollow and filled chocolate shapes.

(260) AM 2013 68923 A

(800) 1126011

(151) 2011 12 16

(731) Federal State Unitary Company "Microgen Scientific Industrial Company for Immunobiological Medicines" of the Ministry of Health and Social Department of the Russian Federation
15, 1st Dubrovskaya, RU-115088 Moscow,
Russian Federation

(540)



(591) Black, white

(511)

1 – Alginates [gelling and inflating preparations] other than for alimentary purposes; aldehydes; acetates [chemicals]; oenological bactericides [chemical preparations used in wine making]; protein [raw material]; litmus paper; preservatives for pharmaceutical preparations; surface-active chemical agents; chemical substances for preserving foodstuffs; distilled water; hydrates; glycerides; detergents for use in manufacturing processes; ion exchangers [chemical preparations]; casein for industrial purposes; catalysts; biochemical catalysts; salicylic acid; spirits of vinegar [dilute acetic acid]; oxalic acid; acids; flocculants; bases [chemical preparations]; bacterial preparations other than for medical and veterinary use; bacteriological preparations other than for medical and veterinary use; biological preparations, other than for medical or veterinary purposes; diagnostic preparations, other than for medical or veterinary purposes; plant growth regulating preparations; preparations of microorganisms other than for medical and veterinary use; enzyme preparations for Industrial purposes; chemical substances for analyses in laboratories, other than for medical or veterinary purposes; chemical preparations for scientific purposes, other than for medical or veterinary use; chemical reagents other than for medical or veterinary purposes; salts; salts [chemical preparations]; alcohol; carbonic hydrates; enzymes for industrial purposes; water purifying chemicals.

3 – Breath freshening sprays; petroleum jelly for cosmetic purposes; aromatics [essential oils]; flavorings for beverages [essential oils]; eau de cologne; deodorants for personal use; perfumes; alum stones [antiseptic]; cosmetic creams; skin whitening creams; beauty masks; oils for cosmetic purposes; ethereal oils; mint for perfumery; bases for flower perfumes; hydrogen peroxide for cosmetic purposes; toiletries; mouth washes; potpourris [fragrances]; cosmetics; extracts of flowers.

5 – Alkaloids for medical purposes; aldehydes for pharmaceutical purposes; amino acids for veterinary purposes; amino acids for medical purposes; antibiotics; germicides; vaccines; cotton for medical purposes; dietetic substances adapted for medical use; edible plant fibers, non-nutritive; gases for medical purposes; hemoglobin; glycerin for medical purposes; glucose for medical purposes; mineral food-supplements; nutritional additives for medical purposes; yeast for pharmaceutical purposes; gelatin for

medical purposes; iodine for pharmaceutical purposes; iodides for pharmaceutical purposes; capsules for medicines; capsules for pharmaceutical purposes; caustics for pharmaceutical purposes; adhesive bands for medical purposes; candy for medical purposes; barks for pharmaceutical purposes; medicinal roots; blood for medical purposes; cultures of microorganisms for medical and veterinary purposes; lactose; adhesive plaster; lotions for pharmaceutical purposes; ointments for pharmaceutical purposes; medicinal oils; dressings, medical; medicines; medicines for veterinary purposes; serotherapeutic medicines; medicines for human purposes; medicinal drinks; milk ferments for pharmaceutical purposes; fishmeal for pharmaceutical purposes; dietetic beverages adapted for medical purposes; narcotics; medicinal infusions; tinctures for medical purposes; pectin for pharmaceutical purposes; pepsins for pharmaceutical purposes; peptones for pharmaceutical purposes; hydrogen peroxide for medical purposes; pills for pharmaceutical purposes; blood plasma; plasters for medical purposes; bacterial preparations for medical and veterinary use; bacteriological preparations for medical and veterinary use; balsamic preparations for medical purposes; albuminous preparations for medical purposes; biological preparations for veterinary purposes; biological preparations for medical purposes; veterinary preparations; vitamin preparations; diagnostic preparations for medical purposes; sterilising preparations; pharmaceutical preparations for skin care; contact lens cleaning preparations; preparations of trace elements for human and animal use; pharmaceutical preparations; enzyme preparations for medical purposes; chemico-pharmaceutical preparations; chemical preparations for the diagnosis of pregnancy; albuminous foodstuffs for medical purposes; hydrated chloral for pharmaceutical purposes; solutions for contact lenses; chemical solutions for medical and veterinary purposes; chemical reagents for medical or veterinary purposes; gum for medical purposes; rubber for dental purposes; sugar for medical purposes; asthmatic tea; suppositories; syrups for pharmaceutical purposes; greases for veterinary purposes; salts for medical purposes; sodium salts for medical purposes; mineral water salts; medicinal alcohol; disinfectants for hygiene purposes; mouthwashes for medical purposes; febrifuges; depuratives; detergents for medical purposes; antiparasitic preparations; purgatives; tonics [medicines]; nervines; digestives for pharmaceutical purposes; bacteriological culture mediums; serums; vulnerary sponges; thymol for pharmaceutical purposes; medicinal herbs; surgical tissues; enzymes for medical purposes; ferments for pharmaceutical purposes; formic aldehyde for pharmaceutical purposes.

9 – Distillation apparatus for scientific purposes; apparatus for fermentation [laboratory apparatus]; measures; diaphragms for scientific apparatus; mea-

suring instruments; test tubes; refractometers; chromatography apparatus for laboratory use.

10 – Surgical apparatus and instruments; apparatus for use in medical analysis; blood testing apparatus; physical exercise apparatus, for medical purposes; resuscitation apparatus; diagnostic apparatus for medical purposes; needles for medical purposes; injectors for medical purposes; ultraviolet ray lamps for medical purposes; aerosol dispensers for medical purposes; massage apparatus; medical apparatus and instruments; receptacles for applying medicines; spirometers; syringes for medical purposes; syringes for injections; hypodermic syringes.

16 – Albums; booklets; wrappers [stationery]; cardboard articles; calendars; pencils; wood pulp board; cardboard; document files [stationery]; office requisites except furniture; writing materials; prospectuses; chromolithographs [chromos]; labels, not of textile.

31 – Algae for human or animal consumption; additives to fodder, not for medical purposes.

35 – Cost price analysis; professional business consultancy; demonstration of goods; opinion polling; marketing research; business information; business investigations; updating of advertising material; word processing; organization of trade fairs for commercial and advertising purposes; business appraisals; payroll preparation; business management assistance; commercial or industrial management assistance; economic forecasting; sales promotion for others; publication of publicity texts; distribution of samples; dissemination of advertising matter; publicity; drawing up of statements of accounts.

36 – Financial analysis; capital investment; financial consultancy; financial management; exchanging money; financial evaluation [insurance; banking; real estate]; loans; leasing of real estate; leasing of farms; financial sponsorship; financing services; fiscal assessments.

39 – Transport reservation; parcel delivery; delivery of goods; hauling; transportation; freight; transport brokerage; freight brokerage; vehicle rental; light-rage; packaging of goods; chauffeur services; physical storage of electronically-stored data or documents; storage of goods; warehousing.

42 – Computer system analysis; chemical analysis; technical project studies; engineering; bacteriological research; biological research; physics [research]; chemical research; calibration [measuring]; consultancy in the field of computer hardware; quality control; hosting computer sites; computer software design; styling [industrial design]; packaging design.

44 – Medical services; veterinary services; pharmacy advice; veterinary assistance; medical assistance; blood bank services; animal grooming.

45 – Intellectual property consultancy; intellectual property watching services; licensing of intellectual property; legal services.

(260) AM 2013 68924 A

(800) 1126016

(151) 2012 06 21

(731) Henkel AG & Co. KGaA
Henkelstrasse 67, 40589 Düsseldorf,
Germany

(540)

**Schwarzkopf
COLOR
ULTIMATE**

(591) Black, white

(511)

3 – Preparations for caring, cleaning, tinting, coloring, bleaching, fixing and waving hair.

(260) AM 2013 68925 A

(800) 1126031

(151) 2012 06 22

(731) Sodrugestvo Group S.A.
36-38 Grand Rue, L-1660 LUXEMBOURG,
Luxembourg

(540)



(591) White, green, violet

(511)

29 – Meat, fish, poultry and game; meat extracts; preserved, frozen, dried and cooked fruits and vegetables; jellies, jams, compotes; eggs; milk and milk products; edible oils and fats.

31 – Grains and agricultural, horticultural and forestry products not included in other classes; live animals; fresh fruits and vegetables; seeds; natural plants and flowers; foodstuffs for animals; malt.

39 – Transport; packaging and storage of goods; travel arrangement.

(260) AM 2013 68926 A

(800) 1126032

(151) 2012 06 22

(731) Sodrugestvo Group S.A.
36-38 Grand Rue, L-1660 LUXEMBOURG,
Luxembourg

(540)

**GROUP OF COMPANIES
SODRUGESTVO**

(591) White, green, violet

(511)

29 – Meat, fish, poultry and game; meat extracts; preserved, frozen, dried and cooked fruits and vegetables; jellies, jams, compotes; eggs; milk and milk products; edible oils and fats.

31 – Grains and agricultural, horticultural and forestry products not included in other classes; live animals; fresh fruits and vegetables; seeds; natural plants and flowers; foodstuffs for animals; malt.

39 – Transport; packaging and storage of goods; travel arrangement.

(260) AM 2013 68935 A

(800) 1126095

(151) 2011 12 02

(731) OKYANUS KİMYA HIRDAVAT
ELEKTRİKLİ EL ALETLERİ VE
ELEKTRONİK MALZEMELERİ İTHALAT
İHRACAT SANAYİ TİCARET LİMİTED
ŞİRKETİ
Hadımköy Mahallesi, Arpaslan Sokak No: 10,
Arnavutköy-İstanbul, Turkey

(540)

silverhill

(591) Black, white

(511)

1 – Industrial chemicals; chemicals for use in textile and tanning (except paints), unprocessed synthetic materials; unprocessed plastic, unprocessed artificial resins for specific use and industry, oil-separating chemicals, distilled water, industrial gases, substances for maintaining fresh foodstuffs namely chemical products, food preservative compositions; chemical compositions for use in the refrigeration; salts for industrial purposes; chemical preparations for scientific purposes; chemical substances for analyses in laboratories, other than for medical or veterinary purposes; chemical test papers; radioactive elements for scientific purposes; chemical reagents; chemical preparations for use in photography, namely, photosensitive papers, foils, and films; unexposed cinematographic and photographic films, unexposed roentgen films, chemical preparations used in film processing; chemicals for agriculture, horticulture, and forestry, namely, fertilizers, seaweeds (fertilizers), humus, culture soil, soil-conditioning chemicals, plant growth regulating preparations, grafting mastic for trees and tree cavity fillers, fertilizing peat, chemical preparations to prevent mildew and fungus; fire extinguishing compositions, agglutinants for concrete and cement, waterproofing chemicals; adhesives for wall tiles, glues, other than for stationery or household purposes; chemical additives to motor fuel, brake fluids, antifreeze, engine-decar-

bonising chemicals, coolants for vehicle engines and anti-boil preparations thereof; chemical filtering materials; preparations for lime and alga prevention, lime and alga removing preparations; chemical chimney cleaners; drilling muds for drilling machines; glaziers' putty.

17 – Insulating materials for sound, heat and electricity; fibers (glass) for insulation, semi-processed foams for insulation, non-conducting materials for retaining heat; insulators for electric mains; insulating fabrics; foils of metal for insulating; insulating paints; insulating paper; asbestos paper; asbestos cloth; asbestos fabrics; adhesive bands other than stationery and not for medical or household purposes; insulating tape and band; asbestos coverings; asbestos sheets; asbestos felt; rubber stoppers; expansion joint fillers; chemical compositions for repairing leaks; flexible plumbing pipes of plastic, rubber or natural rubber, canvas hose pipes, fire hoses, flexible compressed air pipe fittings, not of metal, pipe fittings, vehicle radiator connecting hoses, synthetic plastic as semi-finished products in form of foils, plates, rods, profiles, hoses, tubes, blocks, foam rubber, natural rubber, synthetic resins, rubber, cellulose acetate film, plastic film other than for wrapping, semi-processed brake lining material, clutch linings, rubber thread not for textile use, plastic fibers, natural rubber threads not for textile use, natural rubber and rubber bags for merchandise packaging, goods made of rubber, natural rubber, plastic and similar materials, namely, rubber and natural rubber pads (shock absorber), expansion bellows, rubber stoppers, sealing plugs made primarily from rubber, billets from rubber, sleeves and brackets of rubber, foam rubber for protecting parts of machinery, rings of rubber for use as pipe connection seals, gasket sealer for use in plumbing, gasket rings, padding materials of rubber or plastics.

(260) AM 2013 68936 A

(800) 1126104

(151) 2012 02 28

(731) OBSHESTVO S OGRANICHENNOY
OTVETSTVENNOSTJU "UK "Dom"
pom. 11H, lit. A 29/28 ul. Rubinshteina,
RU-191002 Saint-Petersburg, Russian
Federation

(540)



(591) Black, white

(511)

16 – Aquarelles; albums; posters; tickets; forms, printed; note books; pamphlets; booklets; packing paper; paper; blotters; newsletters; signboards of paper or cardboard; newspapers; engravings; printed publications; cardboard articles; graphic representations; calendars; pictures; catalogues; books; envelopes [stationery]; lithographs; architects' models; graphic prints; teaching materials [except apparatus]; adhesives [glues] for stationery or household purposes; writing cases [stationery]; stickers [stationery]; covers [stationery]; musical greeting cards; greeting cards; postcards; conical paper bags; folders for papers; bookbindings; seals [stamps]; portraits; writing cases [sets]; writing materials; printed matter; prospectuses; graphic reproductions; placards of paper or cardboard; photographs [printed]; labels, not of textile.

28 – Amusement machines, automatic and coin-operated; swimming pools [play articles]; hang gliders; surf boards; skateboards; toys; board games; games; fairground ride apparatus; swings; skittles; toy masks; balls for games; sleighs [sports articles]; appliances for gymnastics; billiard tables; tables for table tennis; tables for indoor football; machines for physical exercises; bowling apparatus and machinery.

35 – Import-export agencies; commercial information agencies; advertising agencies; rental of advertising space; auditing; employment agencies; computerized file management; accounting; demonstration of goods; opinion polling; marketing studies; business information; commercial information and advice for consumers [consumer advice shop]; business investigations; marketing research; personnel recruitment; business management and organization consultancy; business organization consultancy; personnel management consultancy; professional business consultancy; layout services for advertising purposes; business management of performing artists; news clipping services; updating of advertising material; organization of exhibitions for commercial or advertising purposes; organization of trade fairs for commercial or advertising purposes; shop window dressing; business appraisals; payroll preparation; data search in computer files for others; business management assistance; commercial or Industrial management assistance; economic forecasting; auctioneering; sales promotion for others; office machines and equipment rental; rental of advertising time on communication media; publicity material rental; rental of vending machines; rental of photocopying machines; publication of publicity texts; radio advertising; bill-posting; distribution of samples; dissemination of advertising matter; writing of publicity texts; advertising; on-line advertising on a computer network; advertising by mail order; television commercials; document reproduction; compila-

tion of statistics; compilation of information into computer databases; business inquiries; tax preparation; drawing up of statements of accounts; publicity columns preparation; psychological testing for the selection of personnel; business management of hotels; commercial administration of the licensing of the goods and services of others; administrative processing of purchase orders; public relations; modelling for advertising or sales promotion; relocation services for businesses; price comparison services; procurement services for others [purchasing goods and services for other businesses]; outsourcing services [business assistance].

36 – Real estate agencies; accommodation bureaux [apartments]; issue of tokens of value; housing agents; real estate management; banking; fiduciary; financing services.

41 – Academies [education]; rental of tennis courts; booking of seats for shows; videotaping; physical education; discotheque services; gaming; publication of books; education information; recreation information; entertainment information; movie studios; health club services [health and fitness training]; night clubs; videotape editing; production of radio and television programmes; music-halls; game services provided on-line from a computer network; gymnastic instruction; practical training [demonstration]; organization of balls; organization of exhibitions for cultural or educational purposes; providing recreation facilities; arranging and conducting of colloquiums; arranging and conducting of congresses; arranging and conducting of conferences; arranging and conducting of concerts; arranging and conducting of workshops [training]; arranging and conducting of seminars; arranging and conducting of symposiums; organization of competitions [education or entertainment]; arranging of beauty contests; operating lotteries; organization of shows [impresario services]; organization of sports competitions; vocational guidance [education or training advice]; amusement parks; television entertainment; providing karaoke services; providing golf facilities; providing sports facilities; providing amusement arcade services; cinema presentations; presentation of live performances; theatre productions; timing of sports events; videotape film production; film production, other than advertising films; rental of audio equipment; rental of camcorders; rental of video cassette recorders; rental of videotapes; rental of show scenery; rental of movie projectors and accessories; rental of cine-films; rental of stadium facilities; rental of lighting apparatus for theatrical sets or television studios; rental of radio and television sets; rental of skin diving equipment; rental of sports equipment, except vehicles; electronic desktop publishing; publication of electronic books and journals on-line; radio entertainment; entertainer services; amusements; zoological garden services; news

reporters services; party planning [entertainment]; providing museum facilities [presentation, exhibitions]; educational services; recording studio services; photography; photographic reporting; production of shows.

43 – Accommodation bureaux [hotels, boarding houses]; rental of temporary accommodation; tourist homes; hotel reservations; boarding house bookings; temporary accommodation reservations; hotels; snack-bars; cafés; cafeterias; motels; boarding houses; boarding for animals; restaurants; self-service restaurants; canteens; holiday camp services [lodging]; bar services; providing campground facilities; food and drink catering; day-nurseries [crèches].

44 – Public baths for hygiene purposes; Turkish baths; landscape design; convalescent homes; manicuring; massage; hairdressing salons; medical assistance; animal breeding; gardening; landscape gardening; beauty salons; sanatoriums; flower arranging; health spa services; visagists' services; plant nurseries; services of a psychologist; sauna services; solarium services; telemedicine services; nursing, medical; lawn care; animal grooming; physical therapy; plastic surgery.

(260) AM 2013 68937 A

(800) 1126105

(151) 2012 02 28

(731) OBSHESTVO S OGRANICHENNOY OTVETSTVENNOSTJU "UK "Dom" pom. 11H, lit. A 29/28 ul. Rubinshteina, RU-191002 Saint-Petersburg, Russian Federation

(540)



(591) Black, white

(511)

16 – Aquarelles; albums; posters; tickets; forms, printed; note books; pamphlets; booklets; packing paper; paper; blotters; newsletters; signboards of paper or cardboard; newspapers; engravings; printed publications; cardboard articles; graphic representations; calendars; pictures; catalogues; books; envelopes [stationery]; lithographs; architects' models; graphic prints; teaching materials [except apparatus]; adhesives [glues] for stationery or household purposes; writing cases [stationery]; stickers [stationery]; covers [stationery]; musical greeting cards; greeting cards; postcards; conical paper bags; folders for

papers; bookbindings; seals [stamps]; portraits; writing cases [sets]; writing materials; printed matter; prospectuses; graphic reproductions; placards of paper or cardboard; photographs [printed]; labels, not of textile.

28 – Amusement machines, automatic and coin-operated; swimming pools [play articles]; hang gliders; surf boards; skateboards; toys; board games; games; fairground ride apparatus; swings; skittles; toy masks; balls for games; sleighs [sports articles]; appliances for gymnastics; billiard tables; tables for table tennis; tables for indoor football; machines for physical exercises; bowling apparatus and machinery.

35 – Import-export agencies; commercial information agencies; advertising agencies; rental of advertising space; auditing; employment agencies; computerized file management; accounting; demonstration of goods; opinion polling; marketing studies; business information; commercial information and advice for consumers [consumer advice shop]; business investigations; marketing research; personnel recruitment; business management and organization consultancy; business organization consultancy; personnel management consultancy; professional business consultancy; layout services for advertising purposes; business management of performing artists; news clipping services; updating of advertising material; organization of exhibitions for commercial or advertising purposes; organization of trade fairs for commercial or advertising purposes; shop window dressing; business appraisals; payroll preparation; data search in computer files for others; business management assistance; commercial or Industrial management assistance; economic forecasting; auctioneering; sales promotion for others; office machines and equipment rental; rental of advertising time on communication media; publicity material rental; rental of vending machines; rental of photocopying machines; publication of publicity texts; radio advertising; bill-posting; distribution of samples; dissemination of advertising matter; writing of publicity texts; advertising; on-line advertising on a computer network; advertising by mail order; television commercials; document reproduction; compilation of statistics; compilation of information into computer databases; business inquiries; tax preparation; drawing up of statements of accounts; publicity columns preparation; psychological testing for the selection of personnel; business management of hotels; commercial administration of the licensing of the goods and services of others; administrative processing of purchase orders; public relations; modelling for advertising or sales promotion; relocation services for businesses; price comparison services; procurement services for others [purchasing goods and services for other businesses]; outsourcing services [business assistance].

36 – Real estate agencies; accommodation bureaux [apartments]; issue of tokens of value; housing agents; real estate management; banking; fiduciary; financing services.

41 – Academies [education]; rental of tennis courts; booking of seats for shows; videotaping; physical education; discotheque services; gaming; publication of books; education information; recreation information; entertainment information; movie studios; health club services [health and fitness training]; night clubs; videotape editing; production of radio and television programmes; music-halls; game services provided on-line from a computer network; gymnastic instruction; practical training [demonstration]; organization of balls; organization of exhibitions for cultural or educational purposes; providing recreation facilities; arranging and conducting of colloquiums; arranging and conducting of congresses; arranging and conducting of conferences; arranging and conducting of concerts; arranging and conducting of workshops [training]; arranging and conducting of seminars; arranging and conducting of symposiums; organization of competitions [education or entertainment]; arranging of beauty contests; operating lotteries; organization of shows [impresario services]; organization of sports competitions; vocational guidance [education or training advice]; amusement parks; television entertainment; providing karaoke services; providing golf facilities; providing sports facilities; providing amusement arcade services; cinema presentations; presentation of live performances; theatre productions; timing of sports events; videotape film production; film production, other than advertising films; rental of audio equipment; rental of camcorders; rental of video cassette recorders; rental of videotapes; rental of show scenery; rental of movie projectors and accessories; rental of cine-films; rental of stadium facilities; rental of lighting apparatus for theatrical sets or television studios; rental of radio and television sets; rental of skin diving equipment; rental of sports equipment, except vehicles; electronic desktop publishing; publication of electronic books and journals on-line; radio entertainment; entertainer services; amusements; zoological garden services; news reporters services; party planning [entertainment]; providing museum facilities [presentation, exhibitions]; educational services; recording studio services; photography; photographic reporting; production of shows.

43 – Accommodation bureaux [hotels, boarding houses]; rental of temporary accommodation; tourist homes; hotel reservations; boarding house bookings; temporary accommodation reservations; hotels; snack-bars; cafés; cafeterias; motels; boarding houses; boarding for animals; restaurants; self-service restaurants; canteens; holiday camp services [lodging]; bar services; providing campground facilities.

ties; food and drink catering; day-nurseries [crèches].

44 – Public baths for hygiene purposes; Turkish baths; landscape design; convalescent homes; manicuring; massage; hairdressing salons; medical assistance; animal breeding; gardening; landscape gardening; beauty salons; sanatoriums; flower arranging; health spa services; visagists' services; plant nurseries; services of a psychologist; sauna services; solarium services; telemedicine services; nursing, medical; lawn care; animal grooming; physical therapy; plastic surgery.

(260) AM 2013 68939 A

(800) 1126127

(151) 2012 05 24

(731) INDUSTRIAS QUIMICAS DEL VALLES, S.A.

Avda. Rafael Casanova, 81, E-08100 Mollet del Valles (Barcelona), Spain

(540)

Curenox

(591) Black, white

(511)

5 – Pharmaceutical, veterinary and sanitary preparations; dietetic substances adapted for medical use, food for babies; plasters, materials for dressings; material for dental fillings and dental impressions; disinfectants; pesticides; fungicides, herbicides.

(260) AM 2013 68940 A

(800) 1126136

(151) 2012 05 30

(731) CrossFit, Inc.

1500 Green Hill Road, Suite 201, Scotts Valley CA 95066, USA

(540)

FORGING ELITE FITNESS

(591) Black, white

(511)

25 – Shirts.

41 – Physical fitness training.

(260) AM 2013 68941 A

(800) 1126141

(151) 2012 04 13

(731) DOSSODOSSİ TEKSTİL SANAYİ TURİZM VE ORGANİZASYON LİMİTED ŞİRKETİ
Mesihpaşa Cad. Kızıltaş Sokak No.13, Kat 1-2-3, Eminönü İstanbul, Turkey

(540)



(591) Dark green, white

(511)

25 – Clothing (inner and outer clothing) made from all kinds of material except clothing for protective purposes; socks, footwear, headgear.

(260) AM 2013 68942 A

(800) 1126142

(151) 2012 04 18

(731) BRISA BRIDGESTONE SABANCI LASTIK SANAYI VE TICARET ANONIM SİRKETİ
Sabanci Center, Kule 2, Kat: 7-8-9, 4.

Levent İSTANBUL, Turkey

(540)

LASSA ICEWAYS

(591) Black, white

(511)

12 – Inner and outer tyres for vehicles, tubeless tyres.

(260) AM 2013 69006 A

(800) 1126972

(151) 2012 06 05

(731) EGİS GYÓGYSZERGYÁR Nyilvánosan Működő Részvénytársaság
Keresztúri út 30-38 H-1106 Budapest, Hungary

(540)

FEMISTOP

(591) Black, white

(511)

5 – Pharmaceutical preparations for human use.

(260) AM 2013 69076 A

(800) 551676

(151) 1989 11 13

(891) 2012 06 15

(731) IGOL FRANCE

614 rue de Cagny, F-80090 AMIENS, France

(540)

IGOL

(591) Black, white

(511)

4 – Non-edible mineral, animal, vegetable, synthetic oils and greases of all types, gasoline, petroleum, motor fuel and derivatives of all types and petroleum by-products.

(260) AM 2013 69080 A
 (800) 561972
 (151) 1990 11 02
 (891) 2011 10 05
 (731) Eschenbach Optik GmbH
 Schopenhauerstrasse 10, 90409 Nürnberg,
 Germany

(540)

HUMPHREY'S

(591) Black, white
 (511)
 9 – Frames for spectacles, sunglasses.

(260) AM 2013 69081 A
 (800) 576812
 (151) 1991 11 01
 (891) 2012 07 02
 (731) GUERBET
 15, rue des Vanesses, F-93420 VILLEPINTE,
 France

(540)

ORIODOL

(591) Black, white
 (511)
 5 – Pharmaceuticals, veterinary and sanitary preparations; dietetic substances for medical use; food for babies; plasters, materials for dressings; material for dental fillings and dental impressions; disinfectants.

(260) AM 2013 69082 A
 (800) 780426
 (151) 2002 05 04
 (891) 2012 06 22
 (731) Takeda GmbH
 Byk- Gulden-Str. 2, 78467 Konstanz,
 Germany

(540)

FREATHE

(591) Black, white
 (511)
 5 – Medicines.

(260) AM 2013 69109 A
 (800) 1128035
 (151) 2012 07 10
 (731) ICE IP S.A.
 Rue des Tilleuls 3, L-8832 Rombach,
 Luxembourg

(540)

ICE

(591) Black, white
 (511)
 14 – Precious metals and their alloys and goods made of these materials not included in other classes; jewelry, precious stones; timepieces and chronometric instruments.

(260) AM 2013 69155 A
 (800) 1027972
 (151) 2010 01 20
 (891) 2012 08 23
 (731) EXACTTARGET, INC.
 20 North Meridian Street, Suite 200,
 INDIANAPOLIS, IN 46204,
 USA

(540)

EXACTTARGET

(591) Black, white
 (511)
 35 – Marketing services, namely, promoting the goods and services of others by distributing over the Internet their commercial and promotional information in the form of electronic mail, brochures, and advertisements.

(260) AM 2013 69156 A
 (800) 1030204
 (151) 2009 10 01
 (891) 2012 05 15
 (731) TRUSTING SPA
 Via Guido Rossa 11, I-50032 Borgo San
 Lorenzo (Firenze), Italy

(540)



(591) Black, white
 (511)
 7 – Machines and machine tools, brake shoes, not for land vehicles, brake seals, not for land vehicles, brake segments, not for land vehicles.

12 – Land vehicles, brakes for land vehicles, rings, shoes and seals for brakes for land vehicles.

17 – Brake sealing materials of rubber, semi-processed.

(260) AM 2013 69158 A
 (800) 1060806
 (151) 2010 10 25
 (891) 2012 07 25
 (731) ÖZBEKTAŞ SPOR GİYİM SANAYİ VE DIŞ
 TİCARET LİMİTED ŞİRKETİ
 Büyük Reşitpaşa Caddesi, Kurultay Sokak
 No. 16/A, Laleli-İstanbul, Turkey

(540)

LORRENDO

(591) Black, white
 (511)
 25 – Clothing, namely, trousers, jackets, overcoats, coats, skirts, suits, jerseys, waistcoats, shirts, t-shirts, sweatshirts, dresses, bermuda shorts, shorts, paja-

mas, pullovers, jeans, tracksuits, rainwear, beachwear, bathing suits, swimming suits; clothing for sportswear (for exclusive use for sports), clothing for babies; underclothing, namely, boxer shorts, brassieres, briefs, pants, socks; footwear, namely shoes excluding orthopedic shoes, sandals, waterproof boots, walking boots, bootees, sporting shoes, slippers; shoe parts namely heelpieces, insoles for footwear, footwear uppers; headgear, namely caps, skull caps, sports caps, hats, berets; gloves (clothing), stockings, belts (clothing), camisoles, sarongs, scarves, neck scarves, shawls, collars, neckties, ties, suspender belts.

35 – The bringing together, for the benefit of others, underclothing and outer clothing, socks, footwear, headgear (excluding the transport thereof), enabling customers to conveniently view and purchase those goods; such services may be provided by retail stores, wholesale outlets, through mail order catalogues or by means of electronic media, for example, through web sites or television shopping programmes.

(260) AM 2013 69159 A

(800) 1089797

(151) 2011 07 19

(891) 2012 08 20

(731) Fresenius Medical Care Deutschland GmbH
Else-Kröner-Strasse 1, 61352 Bad Homburg,
Germany

(540)

CorDiax

(591) Black, white

(511)

10 – Medical instruments and apparatus for extracorporeal purification of blood; blood filters.

(260) AM 2013 69160 A

(800) 1117802

(151) 2012 05 09

(891) 2012 07 26

(731) Davidoff & Cie SA
2, rue de Rive, CH-1200 Genève, Switzerland

(540)

id

(591) Black, white

(511)

34 – Tobacco, whether manufactured or unmanufactured; tobacco products; tobacco substitutes, for non-medical and non-curative use; cigarettes; smokers' articles, cigarette lighters; ashtrays; matches.

(260) AM 2013 69161 A

(800) 1123031

(151) 2012 03 28

(731) Sundek, LLC

3950 Executive Park Blvd., SE Southport
NC 28461, USA

(540)

SUNDEK

(591) Black, white

(511)

25 – Clothing, namely, swimsuits, boardshorts, sweatshirts, knit shirts, t-shirts, tank tops, jackets, coats, dresses, dress shirts, pants, capri pants, and shorts; footwear; headgear.

(260) AM 2013 69255 A

(800) 1129727

(151) 2012 08 10

(731) Obschestvo s ogranichennoi otvetstvennostyu
"V Kontakte"

Letter B, 8 Tverskaya St., RU-191015
Saint Petersburg, Russian Federation

(540)

v kontakte

(591) Black, white

(511)

9 – Computer game programs; computer programs [downloadable software]; voltage regulators for vehicles; data processing apparatus.

35 – Computer file management; marketing research; updating of advertising material; data search in computer files for others; publication of publicity texts; systemization of information into computer databases; on-line advertising on a computer network; compilation of information into computer Databases.

38 – Message sending; computer aided transmission of messages and images; teleconferencing services.

41 – Education information; recreation information; entertainment information; providing recreation facilities; game services provided on-line from a computer network; publication of electronic books and journals online; club services [entertainment or education].

42 – Hosting computer sites [web sites]; providing search engines for the internet; creating and maintaining web sites for others.

(260) AM 2013 69257 A

(800) 1129731

(151) 2012 08 14

(731) Janssen Pharmaceutica NV

Turnhoutseweg 30, B-2340 Beerse, Belgium

(540)

EVADURE

(591) Black, white

(511)

5 – Human pharmaceutical preparations.

(260) AM 2013 69261 A

(800) 1129765

(151) 2012 08 09

(731) Abercrombie & Fitch Europe SA
Via Moree, CH-6850 Mendrisio, Switzerland

(540)

ABERCROMBIE

(591) Black, white

(511)

25 – Clothing, footwear, headgear, belts for clothing.

35 – Advertising; business management; business administration; office functions; retail store services for clothing, footwear, headgear, soap, perfumes, essential oils, cosmetics, hair lotions, candles, jewelry and bags; on-line retail store services for clothing, footwear, headgear, soap, perfumes, essential oils, cosmetics, hair lotions, candles, jewelry and bags; customer loyalty scheme services for commercial, promotional and/or advertising purposes.

(260) AM 2013 69263 A

(800) 1129863

(151) 2012 08 06

(731) KRKA, tovarna zdravil, d.d., Novo mesto
Šmarješka cesta 6, SI-8501 Novo mesto,
Slovenia

(540)

OTOXOLAN

(591) Black, white

(511)

5 – Veterinary preparations.

(260) AM 2013 69264 A

(800) 1129865

(151) 2012 08 06

(731) KRKA, tovarna zdravil, d.d., Novo mesto
Šmarješka cesta 6, SI-8501 Novo mesto,
Slovenia

(540)

OTONAZYL

(591) Black, white

(511)

5 – Veterinary preparations.

(260) AM 2013 69265 A

(800) 1129866

(151) 2012 07 11

(731) KRKA, tovarna zdravil, d.d., Novo mesto
Šmarješka cesta 6, SI-8501 Novo mesto,
Slovenia

(540)

ECANSYA

(591) Black, white

(511)

5 – Pharmaceutical preparations.

(260) AM 2013 69267 A

(800) 1129868

(151) 2012 07 11

(731) KRKA, tovarna zdravil, d.d., Novo mesto
Šmarješka cesta 6, SI-8501 Novo mesto,
Slovenia

(540)

REWISCA

(591) Black, white

(511)

5 – Pharmaceutical preparations.

(260) AM 2013 69269 A

(800) 1129870

(151) 2012 07 11

(731) KRKA, tovarna zdravil, d.d., Novo mesto
Šmarješka cesta 6, SI-8501 Novo mesto,
Slovenia

(540)

МОДИТЕН

(591) Black, white

(511)

5 – Pharmaceutical preparations.

(260) AM 2013 69270 A

(800) 1129871

(151) 2012 07 11

(731) KRKA, tovarna zdravil, d.d., Novo mesto
Šmarješka cesta 6, SI-8501 Novo mesto,
Slovenia

(540)

КЕНАЛОГ

(591) Black, white

(511)

5 – Pharmaceutical preparations.

(260) AM 2013 69271 A

(800) 1129872

(151) 2012 07 11

(731) KRKA, tovarna zdravil, d.d., Novo mesto
Šmarješka cesta 6, SI-8501 Novo mesto,
Slovenia

(540)

YWASCA

(591) Black, white
 (511)
 5 – Pharmaceutical preparations.

(260) AM 2013 69272 A
 (800) 1129873
 (151) 2011 07 25
 (731) KRKA, tovarna zdravil, d.d., Novo mesto
 Šmarješka cesta 6, SI-8501 Novo mesto,
 Slovenia
 (540)

OHAUS

(591) Black, white
 (511)
 9 – Gravimetric measuring instruments, weighing devices and weighing scales of all types; mechanical, electrical and electronic parts (including fastening means, weighing pans, draft shields, protection covers, transport cases, weights, load cells (measuring instruments), displays and computer software) for gravimetric measuring instruments, weighing devices and weighing scales included in this class; devices for measuring, testing and control as well as parts thereof, namely transducers for weight, force or pressure, vibration, acceleration and thereof derivable values; load cells (measuring instruments), weighing cells, and weigh modules as well as parts thereof; mass comparators; pipettes, automated pipetting machines, pipette tips and pipette accessories; printed circuit boards; transmitters; electrodes, detecting elements; devices, systems as well as parts thereof for the measurement of the volume, the dimension, the placing and the weight of objects; barcode scanners, hand scanners, electromagnetic scanners, optical scanners, image scanners and scanners for industrial inspection; devices, systems, as well as parts thereof (including computer programmes, data processing devices, electronic controls, displays, sensors, holders, housings) for measuring, testing, and control of physical, chemical and analytical properties, especially for the measurement of moisture content analysis, dry content analysis, thermal analysis (including thermogravimetry, thermo-mechanical analysis, dynamic-mechanical analysis, dielectrical analysis, detection of boiling, melting and dripping point), calorimetry, chromatography, rheology, photometry, colorimetry, coulometry, refractometry, titration, measurement of density, specific weight and concentration, particle characterization, crystallization, flow measurement, vortex flow measurement, infrared spectroscopy, potentiometric measurement, conductometry, amperometric measurement, pH measurement, redox measurement, measurement of ions, ion selective measurement, turbidity measurement, oxygen measurement, ozone measurement, carbon dioxide measurement, measurement of dissolved gases, conductivity measurement, total-organic-content measurement, tenside measurement;

computers, data storage, computer software, data processing devices, electronic controls, electronic evaluation devices for weighing, measuring, testing and control devices and systems as well as for industrial process control; computers, data storage, computer software, data processing devices, weighing scales and weighing devices for recording, statistical analysis, output and visualisation of gravimetric, physical, chemical and analytical measurement values and non-physical product criteria for quality and charge control; computers, data storage, computer software, data processing devices, weighing scales and weighing devices for safe-guarding the undertaking of instructions, the back traceability and the compliance with legal requirements; computers, data storage, computer software, data processing devices for unit price management, for inventory management, for merchandising, for promotion, for management of grocery retail department business processes and for operator control; computers, data storage, computer software, data processing devices for function control and diagnosis of devices, systems as well as parts thereof; computers, data storage, data, computer software, data processing devices, computer networks for workflow management, for device integration, for information sharing and for documentation of work processes; interfaces based on source codes for data communication (for software installation, data exchange, remote diagnosis, assistance) with programmable client/server functions for the connection of sensors, measuring devices, laboratory devices and operating terminals to a network; manuals, catalogues and magazines on data media for displaying on viewing screens; periphery devices used in connection with aforementioned devices and systems for weighing, measuring, testing and control contained in this list of goods, namely devices for transport and data saving, foot pedals, tweezers, weighing forks, weighing grips, dosing spatulas, driers, remote displays, printers, digital-to-analog converters, devices for data reading, for data input, for data display, for data selection, for data transfer, devices for control, including computers and computer programs for saving and processing of weighing, measuring, testing and control data, especially for inventory management, for quality control, for laboratory automation, for recognition of probes, for process testing, control and automation; devices and shieldings for securing electromagnetic compatibility; electrical devices, systems as well as parts thereof for the prevention of electrostatic effects; devices, systems as well as parts thereof included in this class; coupon issue devices, price calculating devices.

37 – Installation, servicing and repair of measuring instruments for carrying out gravimetric, physical, chemical, analytical measurements and dosings, including performance of function tests on measuring instruments for carrying out gravimetric, physical,

chemical, analytical measurements and dosings; provision of information regarding maintenance of measuring instruments for carrying out gravimetric, physical, chemical, analytical measurements and dosings.

(260) AM 2013 69273 A
(800) 1129874
(151) 2012 08 06
(731) KRKA, tovarna zdravil, d.d., Novo mesto
Šmarješka cesta 6, SI-8501 Novo mesto,
Slovenia

(540)

OTOXAZOL

(591) Black, white
(511)
5 – Veterinary preparations.

(260) AM 2013 69281 A
(800) 1130026
(151) 2012 08 24
(731) APPLE INC.
1 Infinite Loop, Cupertino, CA 95014, USA

(540)

FAIRPLAY

(591) Black, white
(511)
9 – Digital rights management software.

(260) AM 2013 69282 A
(800) 1130064
(151) 2012 07 12
(731) MCB Finance AS
Lõõtsa 8, EE-11415 Tallinn, Estonia

(540)



(591) Green and yellow
(511)
36 – Insurance; financial affairs, monetary affairs and real estate affairs; loans and debit card services; credit card services; monetary affairs; banks (banking).

(260) AM 2013 69332 A
(800) 1130628
(151) 2012 07 31
(731) VALENTINO S.P.A.
Via Turati, 16/18, I-20121 MILANO, Italy

(540)

ROCKSTUD

(591) Black, white
(511)
25 – Clothing, overalls, underwear, sweaters, shirts, jumpers, suits, ready-made clothing, trousers, outer clothing, knitwear, coats, skirts, petticoats, pullovers, overcoats, jackets, stuff jackets, ski jackets, ski pants, parkas, clothing of leather, T-shirts, blouses, pants, dressing gowns, formal dresses, vests, jerseys, pajamas, bathrobes, brassieres, camisoles, corselets, slippers, children's clothing, layettes, bathing caps, bathing suits, clothing for gymnastic, waterproof clothing, raincoats, masquerade costumes; footwear, slippers, bath slippers, boots, sport boots, horse-riding boots, galoshes, shoes, beach shoes, sandals, sport shoes, gymnastic shoes, overshoes; headgear, hats, caps, cap peaks; socks, sock suspenders, stockings, garters, gloves, mittens, muffs, shawls, ties, neckties, scarves and foulards (clothing article), veils, bandanas, fur stoles, belts; wedding dresses.

(260) AM 2013 69333 A
(800) 1130632
(151) 2012 08 30
(731) Limited Liability Company "PEPTOS
PHARMA"
korp. 74-82, d. 16/10, ul. Miklukho-Maklaya,
RU-117997 Moscow, Russian Federation

(540)

stemokine

(591) Black, white
(511)
5 – Pharmaceutical and veterinary preparations; sanitary preparations for medical purposes.

(260) AM 2013 69334 A
(800) 1130692
(151) 2012 08 31
(731) Shenzhen Basicom Electronic Company
Limited
No. 41-1, Guangda Road, 189 Industry Park,
Henggang Town, Longgang District,
Shenzhen, 518000 Guangdong, China

(540)



(591) Black, white
(511)
9 – Battery chargers; batteries; camcorders; electronic apparatus and devices for controlling access to pay-television services; cards with integrated circuits; notebook computers; printers for use with computers; computers.

(260) AM 2013 69336 A
 (800) 1130695
 (151) 2012 03 16
 (731) GRAMELLINI ANNALISA
 Via Roma, 374M, I-31043 FONTANELLE
 (TV), Italy

(540)
WORLD OF BEAUTY

(591) Black, white
 (511)
 3 – Bleaching preparations and other substances for laundry use; cleaning, polishing, scouring and abrasive preparations; soaps; perfumery, essential oils, cosmetics, hair lotions; dentifrices.

10 – Surgical, medical, dental and veterinary apparatus and instruments, artificial limbs, eyes and teeth; orthopedic articles; suture materials.

(260) AM 2013 69337 A
 (800) 1130700
 (151) 2012 07 30
 (731) WARRE & C.^a, S.A.
 Travessa Barão de Forrester, n°86,
 P-4400-034 Vila Nova de Gaia, Portugal

(540)
WARRE'S

(591) Black, white
 (511)
 33 – Alcoholic beverages (except beers), namely Port wines.

(260) AM 2013 69338 A
 (800) 1130701
 (151) 2012 07 30
 (731) W. & J. GRAHAM & COMPANHIA, S.A.
 Rua Rei Ramiro, n°514, P-4400-034 Vila
 Nova de Gaia, Portugal

(540)
GRAHAM'S

(591) Black, white
 (511)
 33 – Alcoholic beverages (except beers), namely Port wines.

(260) AM 2013 69340 A
 (800) 1130729
 (151) 2012 08 07
 (731) Merck KGaA
 Frankfurter Strasse 250, 64293 Darmstadt,
 Germany

(540)
STIMUVAY

(591) Black, white

(511)
 5 – Pharmaceutical preparations for human use in the field of oncology.

(260) AM 2013 69343 A
 (800) 1130730
 (151) 2012 08 07
 (731) Merck KGaA
 Frankfurter Strasse 250, 64293 Darmstadt,
 Germany

(540)
STIMUVAM

(591) Black, white
 (511)
 5 – Pharmaceutical preparations for human use in the field of oncology.

(260) AM 2013 69344 A
 (800) 1130751
 (151) 2012 03 21
 (731) GREINER PURTEC GmbH
 Greiner Strasse 70, A-4550 Kremsmünster,
 Austria

(540)
GREINER AEROSPACE

(591) Black, white
 (511)
 12 – Vehicle seats and/or aero plane seats, as well as their components and spare parts; seats and seat upholstery for public transport.

17 – Foils, plates and poles of plastics (semi-finished products); caulking, packaging and insulating materials; none of the aforementioned goods in form of firm and flexible conducts, hoses and tubes.

20 – Seats of metal; furniture of plastics, mattresses and/or overlay mattresses of plastics or other materials mixed with plastics; upholstery of foam; mattresses of foam; parts of upholstery of foamed material, in particular for vehicles and/or aero plane seats; seat covers of foam or plastics, in particular vehicle and/or aero plane seats; linings of foam and/or plastics for tanks.

(260) AM 2013 69346 A
 (800) 1130778
 (151) 2012 03 07
 (731) Dikovskiy Vladimir Anatolievich
 42, ul. Novaja, derevnja Shulgino,
 Odintsovskiy rajon, RU-143083 Moskovskaja
 oblast , Russian Federation

(540)
УРСОЛИВ

(591) Black, white

(511)

5 – Pharmaceutical and veterinary preparations; sanitary preparations for medical purposes; nutritional supplements for medical purposes; bacterial preparations for medical and veterinary use; nutritive substances for microorganisms; chemical reagents for medical or veterinary purposes; bacterial preparations for medical and veterinary use; chemical preparations for medical, pharmaceutical, veterinary purposes.

(260) AM 2013 69349 A

(800) 1130801

(151) 2012 05 30

(731) ISOLINE, s.r.o.

Koží 915/7, CZ-110 00 Praha 1 – Staré město,
Czech Republic

(540)

ISOLINE

(591) Black, white

(511)

5 – Concentrates and syrups for preventive and medical purposes, energy gels for preventive and medical purposes, tablets and pills for preventive and medical purposes, energy bars for preventive and medical purposes, vitamin and enhancing nutritional preparations, dietetic foodstuffs.

29 – Milk products, namely yogurt and other products made from milk, dietetic preparations based on milk, milk-based products for a good condition and slim figure, milk beverages.

32 – Non-alcoholic beverages, non-alcoholic, refreshing, invigorating and energy beverages, preparations for making beverages including instant (powders for effervescing beverages), syrups and concentrates, lemonade, beverages for sportsmen, powders for effervescing beverages, isotonic beverages, hypotonic beverages, ion beverages, slimming beverages.

(260) AM 2013 69352 A

(800) 1130833

(151) 2012 07 12

(731) Integration Point, Inc.

11016 Rushmore Drive, Suite 200,
Charlotte NC 28277, USA

(540)

INTEGRATION POINT

(591) Black, white

(511)

9 – Computer software for use in managing imports, exports and global trade.

42 – Software as a service "SAAS" services, namely, providing hosted software for use by others in managing imports, exports and global trade.

(260) AM 2013 69353 A

(800) 1130857

(151) 2012 10 18

(731) Guangzhou Bathone Industrial Co., LTD

No.6, Avenue 2, Fuping Road, Xiaoping
Industrial Park, Shiqiao Town, Panyu District,
Guangzhou, China

(540)

BRAVAT

(591) Black, white

(511)

11 – Bidets; bath tubs for sitz baths; toilet bowls; water closets; toilet seats; urinals (sanitary fixtures); sanitary apparatus and installations; taps (faucets); wash-hand basins (parts of sanitary installations); wash-hand bowls (parts of sanitary installations).

(260) AM 2013 69354 A

(800) 1130860

(151) 2012 08 02

(731) GUANGDONG PISEN ELECTRIC CO.,
LTD.

No. 9, Qinfu 1st Street, Jintang Industrial
Park, Niushipu Village, Liuyue, Henggang
Town, Longgang District, Shenzhen City,
Guangdong Province, China

(540)

WOCOL

(591) Black, white

(511)

9 – Batteries for lighting; chargers for electric batteries; galvanic cells; galvanic batteries; accumulators, electric; solar batteries; batteries, electric.

(260) AM 2013 69355 A

(800) 1130876

(151) 2012 06 18

(731) TESAN İLETİŞİM ANONİM ŞİRKETİ

Çobançeşme Mahallesi Bilge Sokak No:17,
Yenibosna Bahçelievler-İstanbul, Turkey

(540)

Ttec

(591) Black, white

(511)

9 – Apparatus and instruments for conducting, switching, transforming, accumulating, regulating or controlling electricity; apparatus for recording, transmission or reproduction of sound or images; magnetic data carriers, recording discs; compact

discs, dvds and other digital recording media; mechanisms for coin-operated apparatus; cash registers, calculating machines, data processing equipment, computers; computer software; fire-extinguishing apparatus.

(260) AM 2013 69357 A
 (800) 1130904
 (151) 2012 06 29
 (731) DORYA DEKORASYON INSAAT
 TEKSTIL SANAYI VE TICARET A.S.
 Plevne Bulvari, No:15/A, TR-35220 Alsancak
 Izmir, Turkey

(540)

The logo for Dorya Interiors features the word "dorya" in a lowercase, blue, cursive script font. Below it, the word "INTERIORS" is written in a smaller, blue, uppercase, sans-serif font.

(591) Blue
 (511)
 20 – Furniture.

(260) AM 2013 69360 A
 (800) 1130933
 (151) 2012 08 13
 (731) Joint Belarusian-German Venture "Santa
 Bremor" Limited Liability Company
 ul. Katin Bor 106, 224025 Brest, Belarus

(540)

The logo for Iokki consists of the word "IOKKI" in a bold, black, uppercase, serif font.

(591) Black, white
 (511)
 30 – Coffee, tea, cocoa, sugar, rice, tapioca, sago, artificial coffee; flour and preparations made from cereals; bread, pastry and confectionery, ice cream; honey, treacle; yeast, baking-powder; salt; mustard; vinegar, condiments; spices; edible ice.

(260) AM 2013 69361 A
 (800) 1130957
 (151) 2012 08 24
 (731) BIOFARMA
 50 rue Carnot, F-92284 SURESNES CEDEX,
 France

(540)

The logo for Prestilol features the word "PRESTILOL" in a bold, black, uppercase, serif font.

(591) Black, white
 (511)
 5 – Pharmaceutical and veterinary preparations; sanitary preparations for medical purposes; dietetic food and substances adapted for medical or veterinary use; food for babies; dietary supplements for humans and animals; plasters, materials for dressings; material for dental fillings and dental impressions; disinfectants; pesticides; fungicides, herbicides; medicated bath preparations; chemical

preparations for medical or pharmaceutical use; medicinal herbs; herbal teas; parasiticides; alloys of precious metals for dental purposes.

(260) AM 2013 69362 A
 (800) 1130958
 (151) 2012 08 23
 (731) BIOFARMA
 50 rue Carnot, F-92284 SURESNES CEDEX,
 France

(540)

The logo for Biserval features the word "BISERVAL" in a bold, black, uppercase, serif font.

(591) Black, white
 (511)
 5 – Pharmaceutical and veterinary preparations; sanitary preparations for medical purposes; dietetic food and substances adapted for medical or veterinary use; food for babies; dietary supplements for humans and animals; plasters, materials for dressings; material for dental fillings and dental impressions; disinfectants; pesticides; fungicides, herbicides; medicated bath preparations; chemical preparations for medical or pharmaceutical use; medicinal herbs; herbal teas; parasiticides; alloys of precious metals for dental purposes.

(260) AM 2013 69363 A
 (800) 1130985
 (151) 2012 07 22
 (891) 2012 07 12
 (731) HangZhou Rebon Cabinets Co., Ltd.
 No. 188 Trade Street, Jingjiang, Xiaoshan,
 Hangzhou, Zhejiang Province,
 China

(540)

The logo for Rebon features the word "Rebon" in a bold, black, uppercase, serif font.

(591) Black, white
 (511)
 11 – Lamps; gas lighters; regulating and safety accessories for gas apparatus; refrigerators; water heaters; bakers' ovens; gas burners; hot plates; microwave ovens (cooking apparatus); extractor hoods for kitchens; hydrants; sinks; multifunctional heaters for use in bathroom; sterilized cupboard; radiators, electric; lighters.
 20 – Cupboards; benches (furniture); sideboards; furniture; cabinets; beds; sofas; plate racks; tea tables; furniture fittings, not of metal.

(260) AM 2013 69365 A
 (800) 1131023
 (151) 2012 03 31
 (731) Dr. Willmar Schwabe GmbH & Co. KG

Willmar-Schwabe-Strasse 4, 76227 Karlsruhe,
Germany

(540)

ВИТАНГО

(591) Black, white

(511)

5 – Pharmaceutical and veterinary preparations; sanitary preparations for medical purposes; dietetic substances adapted for medical use; dietary supplement for non medical use on the basis of proteins, fat, fatty acids; dietary supplement for non medical use on the basis of carbohydrates.

29 – Food, namely dietetic food for non medical use on the basis of proteins, fat, fatty acids, included in this class.

30 – Food, namely dietetic food for non medical use on the basis of carbohydrates, included in this class.

(260) AM 2013 69367 A

(800) 1131035

(151) 2012 05 14

(731) Proizvodstvennoe respublikanskoe unitarnoe predpriyatie "Minskintercaps"
ul. Inzhenernaya 26, 220075 Minsk, Belarus

(540)

УНОПРОСТ

(591) Black, white

(511)

5 – Drugs for medical purposes; medicines for human purposes; pharmaceutical and veterinary preparations; capsules for medicines; capsules for pharmaceutical purposes; dietetic substances adapted for medical use; nutritional additives for medical purposes; vitamin preparations; sanitary preparations for personal hygiene other than toiletries; enzyme preparations for medical and veterinary purposes; fodder supplements for veterinary purposes; biologically active food supplements; chemical preparations for medical and veterinary purposes; medicinal preparations for medical and veterinary purposes including those of vegetable or animal origin; adjuvants for medical purposes; tonics (medicines); chemical preparations for pharmaceutical purposes; medicinal oils; biological preparations for medical and veterinary purposes; preparations of trace elements for human and animal use; salts for medical purposes.

(260) AM 2013 69368 A

(800) 1131036

(151) 2012 05 14

(731) Proizvodstvennoe respublikanskoe unitarnoe predpriyatie "Minskintercaps"
ul. Inzhenernaya 26, 220075 Minsk, Belarus

(540)

АНГРИМАКС

(591) Black, white

(511)

5 – Drugs for medical purposes; medicines for human purposes; pharmaceutical and veterinary preparations; capsules for medicines, capsules for pharmaceutical purposes; dietetic substances adapted for medical use; nutritional additives for medical purposes; vitamin preparations; sanitary preparations for personal hygiene other than toiletries; enzyme preparations for medical and veterinary purposes; fodder supplements for veterinary purposes; biologically active food supplements; chemical preparations for medical and veterinary purposes; medicinal preparations for medical and veterinary purposes including those of vegetable or animal origin; adjuvants for medical purposes; tonics (medicines); chemical preparations for pharmaceutical purposes; medicinal oils; biological preparations for medical and veterinary purposes; preparations of trace elements for human and animal use; salts for medical purposes.

(260) AM 2013 69369 A

(800) 1131038

(151) 2012 06 20

(731) Honda Motor Co., Ltd.

1-1, Minami-Aoyama 2-chome, Minato-ku,
Tokyo 107-8556, Japan

(540)

VSA

(591) Black, white

(511)

12 – Automobiles and their parts and fittings; two-wheeled motor vehicles and their parts and fittings; bicycles and their parts and fittings; electric tricycles and their parts and fittings; non-electric prime movers for land vehicles; axles for vehicles; couplings for land vehicles; transmissions for land vehicles; transmission chains for land vehicles; transmission shafts for land vehicles; shock absorbers for automobiles; shock absorbing springs for vehicles; brakes for vehicles; AC motors or DC motors for land vehicles; anti-theft alarms for vehicles.

(260) AM 2013 69370 A

(800) 1131093

(151) 2012 08 01

(731) OJSC SIBUR Holding

liter A, 5, ul. Galernaya, RU-190000
St. Petersburg, Russian Federation

(540)

VERSOTEP

(591) Black, white

(511)

1 – Adhesives for industrial purposes; chemical preparations for the manufacture of paints; emollients for industrial purposes; tire repairing compositions; industrial chemicals.

17- Liquid rubber; synthetic rubber; rubber, raw or semi-worked; latex [rubber]; weatherstripping compositions; insulating materials; rubber material for recapping tires [tyres]; rubber solutions.

19 – Binding material for road repair; bituminous products for building; road coating materials; materials for making and coating roads; pitch.

35 – Commercial information and advice for consumers [consumer advice shop]; distribution of samples; commercial administration of the licensing of the goods and services of others.

42 – Chemical analysis; technical project studies; engineering; material testing; mechanical research; chemical research; research and development for others; technical research; quality control; chemistry services; scientific laboratory services; surveying

(260) AM 2013 69372 A

(800) 1131097

(151) 2012 06 15

(731) TMC ITALIA SPA

Viale dell'industria, 65, I-21052 Busto
Arsizio (VA), Italy

(540)



(591) Black, white and red

(511)

7 – Machinery and machine tools.

9 – Equipment and instruments for conduction, switching, transformation accumulation, regulation and electricity control.

(260) AM 2013 69373 A

(800) 1131119

(151) 2012 03 30

(731) FINMECCANICA – Società per azioni

Piazza Monte Grappa, 4, I-00195 Roma, Italy

(540)

ALENIA AERMACCHI

(591) Black, white

(511)

9 – Scientific, nautical, surveying, photographic, cinematographic, optical, weighing, measuring, signalling, checking (supervision), life-saving and teaching apparatus and instruments; apparatus and instruments for conducting, switching, transforming, accumulating, regulating or controlling electricity; apparatus for recording, transmission or reproduction of sound or images; magnetic data carriers, recording discs; mechanisms for coin-operated apparatus; cash registers, calculating machines, data processing equipment and computers; fire-extinguishing apparatus.

12 – Vehicles; apparatus for locomotion by land, air or water.

25 – Clothing, footwear, headgear.

37 – Building construction; repair; installation services.

41 – Education; providing of training; entertainment; sporting and cultural activities.

42 – Scientific and technological services and research and design relating thereto; industrial analysis and research services; design and development of computer hardware and software.

(260) AM 2013 69375 A

(800) 1131144

(151) 2012 08 21

(731) Société des Produits Nestlé S.A.

CH-1800 Vevey, Switzerland

(540)



(591) Red, blue, dark gray, light gray, yellow, dark purple, pink, black and white

(511)

30 – Coffee, coffee extracts, coffee-based beverages and preparations; iced coffee; artificial coffee, artificial coffee extracts, artificial coffee-based beverages and preparations; chicory [coffee substitute]; tea, tea extracts, tea-based beverages and preparations; iced tea; malt-based preparations for human consumption; cocoa and cocoa-based beverages and preparations; chocolate, chocolate products, chocolate-based beverages and preparations; confectionery, sugar confectionery, candy; sugar; chewing gum not for medical purposes; natural sweeteners;

bakery products, bread, yeast, pastries; biscuits, cakes, cookies, wafers, caramels, desserts (included in this class), puddings; edible ices, water ices, sherbets, frozen confectionery, frozen cakes, ice cream, frozen desserts, frozen yogurts, powders and binding agents (included in this class) for making edible ices and/or water ices and/or sherbets and/or frozen confectionery and/or frozen cakes and/or ice cream and/or frozen desserts and/or frozen yogurts; honey and artificial honey; breakfast cereals, muesli, corn flakes, cereal bars, ready-to-eat cereals; cereal preparations; rice, pasta, noodles; food products made from rice, flour or cereals, also in the form of cooked dishes; pizzas; sandwiches; ready-to-bake cake paste and food paste preparations; sauces, soya sauce; tomato ketchup; food flavoring or seasoning products; spices for food, condiments, salad dressings, mayonnaise; mustard; vinegar.

(260) AM 2013 69376 A
(800) 1131158
(151) 2012 03 05
(731) Henkel AG & Co. KGaA
Henkelstraße 67, 40589 Düsseldorf,
Germany
(540)

AERO 360°

(591) Black, white
(511)
1 – Chemical preparation for absorbing humidity; chemical preparations for neutralizing and refreshing air.
3 – Essential oils; essential oils for scenting; preparations for perfuming, all of the previous not for personal use.
5 – Agents for refreshing air; deodorants other than for human beings or for animals; agents for neutralizing and refreshing air.

(260) AM 2013 69377 A
(800) 1131166
(151) 2012 05 17
(731) Dochirne pidpryemstvo "Kondyterska korporatsiia "Roshen"
vul. Elektrykiv, 26/9, Kyiv 04176,
Ukraine
(540)



(591) Green, yellow and white
(511)
30 – Sweetmeats (candy), chocolate candies.

(260) AM 2013 69378 A
(800) 1131170
(151) 2012 05 30
(731) CrossFit, Inc.
1500 Green Hill Road, Suite 201, Scotts
Valley CA 95066, USA
(540)

CROSSFIT

(591) Black, white
(511)
16 – Paper goods and printed matter, namely, a series of books, written articles, handouts and worksheets in the fields of fitness, nutrition, sports and exercise; printed instructional, educational, and teaching materials in the fields of fitness, nutrition, sports and exercise; magazines in the fields of fitness, nutrition, sports and exercise; general feature magazines; exercise books; posters, bumper stickers.
25 – Clothing, namely, shirts, pants, shorts, jackets, sweatshirts, sweatpants, headwear, socks; footwear.
28 – Exercising equipment, namely, weight lifting bars, dumbbells, medicine balls, nets for sports, exercise bars; fitness machines and equipment, namely, rowing machines; exercise weights; gymnastic apparatus.
41 – Entertainment services, namely, an on-going series featuring fitness, nutrition, sports and exercise provided through television, internet; providing information in the fields of fitness training, sports and exercise via a website; online publication of journals in the fields of fitness, nutrition, sports and exercise; entertainment services, namely, providing information in the fields of fitness training, sports, and exercise via a podcast; educational services, namely, conducting lectures, seminars and workshops in the fields of fitness, nutrition, sports and exercise; entertainment in the nature of competitions in the field of fitness; entertainment in the nature of sports competitions; fitness training.

(260) AM 2013 69380 A
(800) 1131178
(151) 2012 04 27
(731) D.A.S. KAUCUK VE PLASTİK SANAYİ
TİCARET LİMİTED ŞİRKETİ
Nosab 115. Sokak No:8, Nilüfer – Bursa,
Turkey
(540)

ONEFLEX

(591) Black, white

(511)

17 – Rubber; gutta-percha; gum; asbestos; mica and goods made from these materials; insulating materials; non-conducting materials for retaining heat; insulators for electric mains; insulating fabrics; foils of metal for insulating; insulating paints; insulating paper; asbestos paper; asbestos cloth; asbestos fabrics; adhesive bands other than stationery and not for medical or household purposes; insulating tape and band; asbestos coverings; asbestos sheets; asbestos felt; rubber stoppers; fillers for expansion joints; chemical compositions for repairing leaks; flexible plumbing pipes of plastic, rubber or natural rubber, canvas hose pipes, flexible compressed air pipe fittings, not of metal; non-metal hose fittings; vehicle radiator connecting hoses; synthetic plastic as semi-finished products in form of foils, plates, rods, profiles, hoses, tubes, blocks, foam rubber, natural rubber, synthetic elastomer resin blended with additives and colorants sold in a pellet form, rubber, cellulose acetate film, plastic films not used for packing padding, semi-processed brake lining material, clutch linings, rubber thread not for textile use, plastic fibers, natural rubber threads, not for textile use, natural rubber and rubber bags for merchandise packaging; goods made of rubber, natural rubber, plastic and similar materials, namely, rubber and natural rubber pads (shock absorber), expansion joint fillers, rubber stoppers, sealing plugs made primarily from rubber, billets from rubber, rubber sleeves for protecting parts of machinery, foam rubber for protecting parts of machinery, rings of rubber for use as pipe connection seals, gasket sealer for use in plumbing, gasket rings.

(260) AM 2013 69381 A

(800) 1131189

(151) 2012 06 06

(731) Blagotvoritelnyy fond imeni Davida Saradjeva ul. Pobedy, d.89, kv.12, Kizlyar, RU-368870 Dagestan, Russian Federation

(540)



(591) Black, white

(511)

32 – Beer, mineral and aerated waters and other non-alcoholic beverages; fruit beverages and fruit juices; syrups and other preparations for making beverages.

33 – Alcoholic beverages, except beer, aperitifs; aperitifs; arrack, brandy; wine; whisky; vodka; hydromel; gin; bitters; cocktails; liqueurs; piquette; rum; cider; alcoholic extracts; fruit extracts, alcoholic;

alcoholic essences; peppermint liqueurs; rice alcohol; sake; distilled beverages.

(260) AM 2013 69382 A

(800) 1131201

(151) 2012 07 18

(731) SUZHOU COMESI IMP. & EXP. CO., LTD
16 Gold River, 35 Shishan Road, Suzhou,
China

(540)



(591) Black, white

(511)

6 – Signboards of metal, cattle chains, roller blinds of steel, pegs of metal, door handles of metal, rings of common metal for keys, locks of metal, other than electric, bins of metal, safes (strong boxes), springs (metal hardware).

(260) AM 2013 69383 A

(800) 1131205

(151) 2012 07 18

(731) Shandong Sacred Sun Power Sources Co.
Ltd.; No. 1 Shengyang Road, Qufu, 273100
Shandong, China

(540)

**SACRED SUN**

(591) Black, white

(511)

9 – Electric accumulators; electric accumulators for vehicles; batteries, electric; batteries, electric, for vehicles; accumulator boxes; solar batteries; batteries for lighting; battery boxes; plates for batteries; chargers for electric batteries.

(260) AM 2013 69384 A

(800) 1131210

(151) 2012 06 15

(731) ARNEST S.P.A.

Nogarole Rocca (VR), Italy

(540)



(591) Black, white
(511)
3 – Bleaching preparations and other substances for laundry use; cleaning, polishing, scouring and abrasive preparations.

5 – Pharmaceutical and veterinary preparations; sanitary preparations for medical purposes; dietetic food and substances adapted for medical or veterinary use, food for babies; dietary supplements for humans and animals; plasters, materials for dressings; material for stopping teeth, dental wax; disinfectants; preparations for destroying vermin; fungicides, herbicides.

(260) AM 2013 69386 A
(800) 1131227
(151) 2012 03 14
(731) Dr. Willmar Schwabe GmbH & Co. KG
Willmar-Schwabe-Strasse 4, 76227 Karlsruhe,
Germany
(540)

Umckalor

(591) Black, white
(511)
5 – Pharmaceutical and veterinary preparations; sanitary preparations for medical purposes; dietetic substances adapted for medical use; dietary supplement for non-medical use on the basis of proteins, fat, fatty acids dietary supplement for non-medical use on the basis of carbohydrates.

29 – Food, namely dietetic food or in so far as included in this class.

30 – Food, namely dietetic food or in so far as included in this class.

(260) AM 2013 69446 A
(800) 1131711
(151) 2012 03 22
(731) METREX RESEARCH, LLC
1717 West Collins Avenue, Orange CA
92867, USA
(540)

METREX

(591) Black, white
(511)
3 – Cleaning solutions for medical and dental instruments, equipment and surfaces.

5 – Sterilizing and disinfecting solutions for medical and dental instruments, equipment and surfaces; antimicrobial skin care products, namely, liquid surgical scrub, liquid soap, no rinse gel, no rinse gel towelettes and skin lotion.

(260) AM 2013 69447 A
(800) 1131732
(151) 2012 09 12
(731) Société des Produits Nestlé S.A.
CH-1800 Vevey, Switzerland
(540)

LINIZIO

(591) Black, white
(511) 30 – Coffee, coffee extracts, coffee-based beverages and preparations; iced coffee; artificial coffee, artificial coffee extracts, artificial coffee-based beverages and preparations; chicory (coffee substitute); tea, tea extracts, tea-based beverages and preparations; iced tea; malt-based preparations for human consumption; cocoa and cocoa-based beverages and preparations; chocolate, chocolate products, chocolate-based beverages and preparations; sugar; confectionery, bakery goods, pastries; biscuits, cakes, cookies, wafers, caramels, edible ices, water ices, sherbets, iced confectionery, iced cakes, ice cream, iced desserts, iced yogurts; breakfast cereals, muesli, corn flakes, cereal bars, ready-to-eat cereals; cereal preparations.

(260) AM 2013 69455 A
(800) 1131805
(151) 2012 08 28
(731) L'OREAL
14 rue Royale, F-75008 PARIS, France
(540)

NEOGENIC

(591) Black, white
(511)
3 – Shampoos; gels, mousses, balms and aerosol products for hair care and hair styling; hair spray; hair dyes and bleaching products; hair waving and setting products.

(260) AM 2013 69457 A
(800) 1131815
(151) 2012 08 14
(731) Zentiva Group, a.s.
U kabelovny 130, CZ-102 37 Praha 10 – dolní
Měcholupy, Czech Republic
(540)

ZOLENDROS

(591) Black, white
(511)
5 – Medicines, pharmaceutical preparations for human use.

(260) AM 2013 69458 A
(800) 1131823
(151) 2012 08 14

(731) Zentiva Group, a.s.
U kabelovny 130, CZ-102 37 Praha 10 – dolní
Měcholupy, Czech Republic

(540)

ALGOXIB

(591) Black, white

(511)

5 – Medicines, pharmaceutical preparations for human use.

(260) AM 2013 69459 A

(800) 1131833

(151) 2012 09 10

(731) LUCKY SPIRITS LTD
THIRD FLOOR 24, CHISWELL STREET,
London EC1Y 4YX, United Kingdom

(540)

The Gild

(591) Black, white

(511)

33 – Alcoholic beverages (except beers).

(260) AM 2013 69460 A

(800) 1131863

(151) 2012 09 07

(731) Vivus, Inc. 1172 Castro Street, Mountain
View, CA 94040, USA

(540)

STENDRA

(591) Black, white

(511)

5 – Pharmaceutical preparations.

(260) AM 2013 69462 A

(800) 1131914

(151) 2012 08 13

(731) Omega SA (Omega AG) (Omega Ltd.)
Jakob-Stämpfli-Strasse 96, CH-2502
Biel/Bienne, Switzerland

(540)

SPEEDMASTER '57

(591) Black, white

(511)

14 – Precious metals and their alloys and goods in precious metals or coated therewith, included in this class; jewelry, precious stones; timepieces and chronometric instruments.

(260) AM 2013 69464 A

(800) 1131941

(151) 2012 03 16

(731) ZENTIVA SAGLIK URUNLERI SANAYI

VE TICARET ANONIM SIRKETI

Buyukdere Cad. Ali Kaya, Sk. No: 7, Levent
Istanbul, Turkey

(540)

ALGOGESIC

(591) Black, white

(511)

5 – Pharmaceutical and veterinary preparations; sanitary preparations for medical purposes; chemical preparations for medical purposes; dietetic substances adapted for medical use; dietetic foods adapted for medical purposes; food for babies; material for stopping teeth; dental wax; gases for medical purposes; sanitary knickers; sanitary napkins; sanitary pads; sanitary panties; sanitary towels; sanitary tampons; medicinal herbs and herb teas for medicinal purposes; teas for medicinal purposes; medical preparations for slimming purposes; deodorants, other than for human beings or for animals; air purifying preparations; air deodorising preparations; air deodorising preparations; air purifying preparations; room deodorants; disinfectants; antiseptics; detergents for medical purposes; preparations for destroying vermin; fungicides; herbicides; chemical preparations for medical purposes; chemical preparations for pharmaceutical purposes; chemical preparations for veterinary purposes.

(260) AM 2013 69465 A

(800) 1131946

(151) 2012 05 08

(731) Nicoventures Limited
1 Water Street, London WC2R 3LA,
United Kingdom

(540)

VOKE

(591) Black, white

(511)

5 – Pharmaceutical preparations, namely preparations for human use including, but not limited to, transdermal patches, lozenges and microtablets; mouth sprays and nasal sprays for medical purposes.

10 – Medical devices, namely medical devices for human use including, but not limited to inhalators.

34 – Tobacco substitutes, cigarettes containing tobacco substitutes, cigarettes containing nicotine, not for medical purposes; cigarettes, tobacco, tobacco products, lighters for smokers, matches, smokers' articles.

(260) AM 2013 69466 A

(800) 1131973

(151) 2012 07 27

(731) Zentiva Group, a.s.

U kabelovny 130, CZ-102 37 Praha 10 – dolní
Měcholupy, Czech Republic
(540)

ESTMAR

(591) Black, white
(511)
5 – Medicines, pharmaceutical preparations for human use.

(260) AM 2013 69467 A
(800) 1131974
(151) 2012 07 27
(731) Zentiva Group, a.s.
U kabelovny 130, CZ-102 37 Praha 10 – dolní
Měcholupy, Czech Republic
(540)

MINING

(591) Black, white
(511)
5 – Medicines, pharmaceutical preparations for human use.

(260) AM 2013 69468 A
(800) 1131975
(151) 2012 07 27
(731) Zentiva Group, a.s.
U kabelovny 130, CZ-102 37 Praha 10 – dolní
Měcholupy, Czech Republic
(540)

LETHE

(591) Black, white
(511)
5 – Medicines, pharmaceutical preparations for human use.

(260) AM 2013 69470 A
(800) 1131999
(151) 2012 08 01
(731) OJSC SIBUR Holding
liter A, 5, ul. Galernaya, RU-190000 St.
Petersburg, Russian Federation
(540)

VERSOTEC

(591) Black, white
(511)
1 – Adhesives for industrial purposes; chemical preparations for the manufacture of paints; emollients for industrial purposes; tire repairing compositions; industrial chemicals.

17 – Liquid rubber; synthetic rubber; rubber, raw or semi-worked; latex [rubber]; weatherstripping compositions; insulating materials; rubber material for recapping tires [tyres]; rubber solutions.

19 – Binding material for road repair; bituminous products for building; road coating materials; materials for making and coating roads; pitch.

35 – Commercial information and advice for consumers [consumer advice shop]; distribution of samples; commercial administration of the licensing of the goods and services of others.

42 – Chemical analysis; technical project studies; engineering; material testing; mechanical research; chemical research; research and development for others; technical research; quality control; chemistry services; scientific laboratory services; surveying.

(260) AM 2013 69472 A
(800) 1132020
(151) 2012 08 14
(731) ETAM
57-59, rue Henri Barbusse, F-92110 Clichy,
France
(540)

Glam
by *Etam*

(591) Black, white
(511)
3 – Cosmetics, cosmetic creams, make-up powder, cosmetic lotions, milks and lotions for removing make-up; make-up preparations, foundation, blush, lipstick, mascara, pencils for the eyes and eyelids, nail polish, nail polish remover; cosmetic preparations for toiletry use and for bath and shower use, shower gels, bubble baths, cosmetic milk, body care oil and lotions for cosmetic use, body glitter, deodorants for personal use, toilet water, perfumes, scented water; tanning and after-sun milks, gels and oils (cosmetics), sun-protection preparations (cosmetic sun-tanning preparations); cosmetic sun-tanning preparations; decorative transfers for cosmetic use.

18 – Leather and imitation leather; animal skins, trunks and suitcases, travel chests; boxes of leather, boxes of leatherboard, small leather bags (envelopes, pouches) for packaging, handbags, travel bags, backpacks, beach bags, wheeled bags, school bags, belt bags, garment bags, travel and make-up sets sold empty, leather bands, small suitcases; purses, briefcases, wallets, coin purses, card cases (wallets), key cases (leatherware), umbrellas, parasols and walking sticks.

25 – Clothing, footwear, headgear; clothing for men, women and children, dresses, skirts, underskirts, pant skirts, suits, trousers, shorts, Bermuda shorts, undershorts, shirts, blouses, bodices, tee-shirts, sweatshirts, vests, coats, gabardines, raincoats, furs,

stoles, sashes for wear, shawls, scarves, gloves (clothing), neckties, belts (clothing), socks, stockings, tights, underclothing, pajamas, dressing gowns, bathing suits, bathrobes; shoes, sandals, boots, ankle boots, booties, slippers; headgear, hats, berets, caps.

(260) AM 2013 69474 A

(800) 1132055

(151) 2012 08 28

(731) Melnikov Pavel Eduardovich

Apt. 99, 7 Badaeva Street, RU-193318

St. Petersburg, Russian Federation

(540)



(591) Black, white

(511)

6 – Common metals and their alloys; metal building materials; transportable buildings of metal; materials of metal for railway tracks; non-electric cables and wires of common metal; ironmongery, small items of metal hardware; pipes and tubes of metal; safes; goods of common metal not included in other classes; ores; fittings of metal for building; bottles [metal containers] for compressed gas or liquid air; reels of metal, non-mechanical, for flexible hoses; swimming pools [metal structures]; bolts of metal; bird baths [structures of metal]; letters and numerals of common metal, except type; silos of metal; screws of metal; nuts of metal; nails; doors of metal; packaging containers of metal; tinplate; crampons of metal [cramps]; rivets of metal; locks of metal, other than electric; closures of metal for containers; bungs of metal; tension links; door bells, non-electric; works of art of common metal; greenhouse frames of metal; framework of metal for building; cornices of metal; drain traps [valves] of metal; elbows of metal for pipes; manifolds of metal for pipelines; sealing caps of metal; bottle caps of metal; rings of common metal for keys; buildings of metal; steel buildings; taps for casks, of metal; brackets of metal for building; clothes hooks of metal; ladders of metal; steel sheets; reinforcing materials of metal for pipes; reinforcing materials of metal for building; building materials of metal; wall claddings of metal [building]; wall linings of metal [building]; moldings of metal for cornices; laths of metal; barrel hoops of metal; casement windows of metal; wainscotting of metal; penstock pipes of metal; water-pipes of metal; gutter pipes of metal; ducts of metal for ventilating and air conditioning installations; drain pipes of metal; pipes of metal; angle irons; clips of metal for cables and pipes; tool chests of metal, empty; meat safes of metal; boxes of common metal; letter boxes of metal.

37 – Building construction; repair; installation services; repair information; construction information;

bricklaying; riveting; rustproofing; plumbing; masonry; roofing services; painting, interior and exterior; underwater repair; cabinet making [repair]; plastering; repair of security locks; pump repair; demolition of buildings; warehouse construction and repair; vehicle service stations [refueling and maintenance]; washing; artificial snow-making services; irrigation devices installation and repair; elevator installation and repair; heating equipment installation and repair; burglar alarm installation and repair; furnace installation and repair; telephone installation and repair; air conditioning apparatus installation and repair; fire alarm installation and repair; freezing equipment installation and repair; electric appliance installation and repair; kitchen equipment installation; machinery installation, maintenance and repair.

(260) AM 2013 69475 A

(800) 1132076

(151) 2012 09 05

(731) Private Joint Stock Company

"ALEF-VINAL"

Sobinova street, 1, Dnipropetrovsk 49083,

Ukraine

(540)

Green Day

(591) Black, white

(511)

33 – Rice alcohol; alcoholic beverages, except beer; alcoholic essences; alcoholic extracts; anise [liqueur]; anisette [liqueur]; aperitifs; arak [arrack]; arrack [arak]; alcoholic beverages, except beer; alcoholic beverages containing fruit; distilled beverages; bitters; brandy; cider; cocktails; curacao; digesters [liqueurs and spirits]; distilled beverages; alcoholic beverages containing fruit; fruit extracts, alcoholic; gin; hydromel [mead]; kirsch; liqueurs; mead [hydromel]; peppermint liqueurs; perry; piquette; rice alcohol; rum; sake; spirits [beverages]; vodka; whisky; wine.

(260) AM 2013 69476 A

(800) 1132080

(151) 2012 08 21

(731) Merck KGaA

Frankfurter Strasse 250, 64293 Darmstadt,

Germany

(540)



(591) Black, white

(511)

5 – Pharmaceutical and veterinary preparations; sanitary preparations for medical purposes; dietetic substances adapted for medical use.

41 – Education and providing of training in the medical field.

44 – Medical services.

(260) AM 2013 69477 A

(800) 1132098

(151) 2012 08 27

(731) SANTEN PHARMACEUTICAL CO., LTD.
9-19, Shimoshinjo 3-chome,
Higashiyodogawa-ku, Osaka-shi, Osaka-fu
533-8651, Japan

(540)

COMVEO

(591) Black, white

(511)

5 – Ophthalmic preparations.

(260) AM 2013 69478 A

(800) 1132100

(151) 2012 09 07

(731) Société des Produits Nestlé S.A.
CH-1800 Vevey, Switzerland

(540)

ПОЧЕМУЧКА

(591) Black, white

(511)

30 – Coffee, coffee-based beverages and preparations; iced coffee; tea, tea-based beverages and preparations; iced tea; malt-based preparations for human consumption; cocoa and cocoa-based beverages and preparations; chocolate, chocolate products, chocolate-based beverages and preparations; confectionery, sugar confectionery, candy; sugar; chewing gum not for medical purposes; baked goods, bread, pastries; biscuits, cakes, cookies, wafers, caramels; ice cream, water ices, sherbets, frozen confectionery, frozen cakes, frozen yogurts; powders and binding agents (included in this class) for making ice cream, water ices, sherbets, frozen confectionery, frozen cakes, frozen yogurts; breakfast cereals, muesli, corn flakes, cereal bars, ready-to-eat cereals; cereal preparations; pizzas; sandwiches.

(260) AM 2013 69480 A

(800) 1132123

(151) 2012 06 29

(731) "YURI GAGARIN" AD
ul. "Rogoshko shosse" 1, BG-4003 Plovdiv,
Bulgaria

(540)



(591) Combination of red, white, gray, dark gray, yellow and black

(511)

16 – Packages and boxes of paper or paperboard; printed materials; plastic film for wrapping; labels not of textile; all the mentioned goods are related to cigarettes, cigarette filters, cigarette paper and tubes for making cigarettes.

34 – Cigarettes; smokers' articles, including cigarette paper and tubes for making cigarettes; cigarette filters; cigarette cases.

(260) AM 2013 69481 A

(800) 1132133

(151) 2012 08 17

(731) Giorgio ARMANI S.P.A.
Milan, Swiss Branch Mendrisio; Via Penate
4, CH-6850 Mendrisio, Switzerland

(540)

EMPORIO ARMANI EYEWEAR

(591) Black, white

(511)

9 – Sunglasses, eyeglasses; spectacle frames; parts and accessories for spectacles, namely spectacle lenses (for sunglasses, corrective spectacles and esthetic spectacles), spectacle arms and other spare parts, cases and stands for spectacles; spectacle chains; contact lenses and contact lens cases; scientific, nautical, surveying, photographic, cinematographic, optical, weighing, measuring, signaling, checking (supervision), life-saving and teaching apparatus and instruments; apparatus and instruments for conducting, switching, transforming, accumulating, regulating or controlling electricity; apparatus for recording, transmission or reproduction of sound or images; magnetic recording media, sound recording disks; compact disks, DVDs and other digital recording media; mechanisms for coin-operated apparatus; cash registers, calculating machines, data processing equipment; computers; software.

35 – Advertising through store signs; advertising; business management; business administration; office functions, wholesale and retail sale (excluding transportation) in stores, via global computer networks, of spectacles, spectacle lenses, spectacle fra-

mes, spectacle cases and stands, spectacle arms, spectacle chains, contact lenses and cases for contact lenses.

(260) AM 2013 69483 A

(800) 1132154

(151) 2012 06 04

(731) Zentiva Group, a.s.

U kabelovny 130, CZ-102 37 Praha 10 – dolní Měcholupy, Czech Republic

(540)



(591) Blue, green, brown and white

(511)

5 – Medicaments, pharmaceutical preparations for human use.

16 – Printed advertising materials.

35 – Advertising, publicity, marketing.

(260) AM 2013 69484 A

(800) 1132172

(151) 2012 03 22

(731) Nuplex Industries (Aust) Pty Limited

49-61 Stephen Road, BOTANY NSW 2019, Australia

(540)

nuplex

(591) Black, white

(511)

1 – Chemical products including artificial resins, emulsions and polymers in this class.

2 – Surface coatings in this class including various types of paints and natural resins.

19 – Building materials (non metallic).

27 – Floor coverings excluding wooden and metal floors.

35 – Wholesale and retailing services relating to the sale of chemical products including artificial resins, emulsions, polymers, surface coatings including various types of paints and natural resins, floor

coverings including floor insulation, building materials.

37 – Construction and repair services being services relating to the construction of buildings, installation and repair of manufactured products including floor coverings, flooring systems, plaster cladding systems; construction and repair services undertaken by painters, roofers and boat builders including services in this class auxiliary to such services.

(260) AM 2013 69485 A

(800) 1132175

(151) 2012 03 29

(731) INDUSTRIA DE DISEÑO TEXTIL, S.A.

(INDITEX, S.A.)

Avda. de la Diputación, Edificio Inditex, E-15142 ARTEIXO (A CORUÑA), Spain

(540)

XDYE

(591) Black, white

(511)

26 – Lace and embroidery, ribbons and braid; buttons, hooks and eyes, pins and needles; artificial flowers; boxes for needles; pin and needle cushions; ornaments for footwear and hats (not of precious metal); haberdashery (except thread); hair bands; armbands; reins for guiding children; brooches (clothing accessories); sewing boxes; belt clasps; shoe laces; wreaths of artificial flowers; ornamental novelty badges; thimbles (for sewing); tiaras; needle cases; buckles (clothing accessories); buckles (for footwear); shoulder pads for clothing; hair pins; badges for wear not of precious metal; tinsels (trimmings for clothing); numbers or letters for marking linen; bodkins; barrettes (hair slides); lace trimmings; feathers (clothing accessories); top-knots (pompoms); picot (lace); zip fasteners; competitors' numbers; heat adhesive patches for decoration of textile articles (haberdashery); rug hooks; snap fasteners; ostrich feathers (clothing accessories); corset busks; prize ribbons; rimming cords for clothing; tassels (haberdashery); expanding bands for holding sleeves; hair ornaments; false hair; hair nets; shoe eyelets; chenille (passementerie); frills (lacework); pant clips for cyclists; fastenings for clothing; hook-and-pile fastening tapes; elastic ribbons; tapes for curtain headings; cords for clothing; collar supports; false hems; rosettes (passementerie); festoons (embroidery); fringes; artificial fruit; braids; hair coloring caps; artificial garlands; darning eggs; trimmings for clothing; tresses of hair; wigs; silver embroidery; edgings for clothing; rosettes (haberdashery); suspenders (for clothing); suspender fasteners; skirt flounces; braids; toupees; shoe hooks.

- (260) AM 2013 69486 A
 (800) 1132176
 (151) 2012 05 30
 (731) GUANGDONG HAoyIKANG HOTEL
 MANAGEMENT CO., LTD.
 Danshui Donghua Avenue, Huiyang District,
 Guangdong Province, China
 (540)



- (591) Black, white
 (511)
 43 – Hotels; rental of meeting rooms; retirement homes; day-nurseries (crèches); boarding for animals; rental of chairs, tables, table linen, glassware; accommodation bureaux (hotels, boarding houses); restaurants; tea houses; bars.

- (260) AM 2013 69487 A
 (800) 1132191
 (151) 2012 06 05
 (731) Industria de Diseño Textil, S.A.
 (Inditex, S.A.)
 Avenida de la Diputación, Edificio Inditex,
 E-15142 Arteixo (A Coruña), Spain
 (540)

TRF

- (591) Black, white
 (511)
 3 – Bleaching preparations and other substances for laundry use; cleaning, polishing, degreasing and abrasive preparations; soaps; perfumery, essential oils, cosmetics, hair lotions; dentifrices, shaving preparations; toilet water; blueing for laundry; starch for laundry purposes; color-brightening chemicals for household use (laundry washing); cotton sticks for cosmetic use; beauty masks; cosmetic preparations for skin tanning; cosmetic preparations for skin care; hair colorants and dyes; shoe creams and polishes; wax; cobblers' wax, non-slipping wax for floors, wax for parquet floors, polishing wax, tailors' wax, wax for leather; shampoos; cosmetic kits; depilatory preparations; make-up removing preparations, deodorants for personal use (perfumery); lipstick; cosmetic pencils; hair spray and nail polish; nail polish removing agents; tissues impregnated with cosmetic lotions; pre-moistened or impregnated cleaning wipes or towelettes; after-shave lotions; lotions for cosmetic use; make-up preparations; pomades for cosmetic use; stain removers; sachets for perfuming linen; nail care preparations; cobblers' wax and pitch; creams for footwear, bleaching preparations (decolorants) for cosmetic use; flower extracts (perfumery); incense; scented wood; decorative patterns for cosmetic use; false eyelashes and nails; pumice stone; fragrant potpourris; cosmetic

preparations for slimming; cosmetic preparations for baths; hair-waving preparations; washing agents; toiletries; mouth care products not for medical use; bath salts other than for medical use; sanitary preparations which are personal hygiene preparations; oils for toiletry purposes; sunscreen products (cosmetic skin-tanning preparations); eau de cologne; deodorant soaps; talcum powder for toiletry purposes; abrasives; mustache wax; hair colorants; eyebrow cosmetics; hair removal wax; cleaning chalk; shampoos for pets; cosmetics for animals; cosmetic creams; bars of soap; soap for preventing foot perspiration; detergents other than for use during manufacturing processes and those for medical use; cleansing milks; Javelle water; dry-cleaning preparations; scented water; perfumes; cosmetics for eyelashes; make-up powder; adhesives for affixing hairpieces; softeners; cosmetic dyes; dye-removing agents; cleaning cloths impregnated with detergents.

18 – Leather and imitation leather, goods made of these materials not included in other classes; animal skins; trunks and traveling bags; umbrellas, parasols and walking sticks; whips, harness and saddlery; climbing, camping and beach bags; handbag frames; frames for umbrellas or parasols; alpenstocks; bags; bags; travel bags; travel and key cases (leatherware); attache cases; coin purses not of precious metal; school bags; garment bags (for travel); hat boxes of leather; leather (or cloth) bags for carrying infants; wheeled shopping bags; boxes and cases of leather or leather board; boxes of vulcanized fiber; wallets (document folders); pocket wallets; wallets (leatherware); toiletry cases; collars for animals; dog leashes; leather laces; umbrella covers; covers for horse-saddles; haversacks; horse blankets; backpacks; backpacks for school; reins for horses; small bags (envelopes, pouches) for packaging (of leather); horse riding saddles; pads for horse saddles; umbrella rings; blinders (harness); harness fittings of iron; harnesses (teams) for animals; harness fittings; walking-stick seats; bandoliers of leather; tool bags of leather (empty); chain mesh purses (not of precious metal); beach bags; muzzles; bridles (harnesses); bridle straps or halters; leatherboard; bands of leather; travel trunks; shopping bags; leather equipment; harness straps; leather straps (harnesses); straps for skates; trimmings of leather for furniture; leather straps; butts [parts of hides]; curried skins; cat o' nine tails; coverings of skins (furs for clothing or ornaments); stirrup leathers; parts of rubber for stirrups; bits for animals (harness); guide reins; attaché-cases; moleskin (imitation leather); fur skins; chamois leather other than for cleaning; nose bags (feed bags); net bags; casings of leather for springs; knee-pads for horses; fastenings for saddles; card cases (document holders); straps (harnesses); valves of leather; stirrups; musical instrument cases (trunks and carrying cases for transporting musical instruments).

25 – Ready-to-wear clothing for men, women and children, footwear (except orthopedic footwear), headgear; clothing for motorists and cyclists; bibs not of paper; headbands (clothing); bath robes; bathing suits; bathing caps and sandals; boas (necklets); underwear; babies' diaper pants; scarves; footwear for sports and beach shoes; hoods (clothing); shawls; belts (clothing); money belts (clothing); water skiing suits; neckties; corsets (girdles); mufflers; fur stoles; girdles (underwear); scarves; caps [headwear]; caps; gloves (clothing); raincoats; underwear, mantillas; stockings; socks; Ascots; babies' diapers of textile; pocket squares; furs (clothing); pajamas; soles for footwear; heels; veils (clothing); suspenders; paper clothing; clothing for gymnastics and sports; layettes; collars (clothing), jerseys, mittens; ear muffs (clothing); inner soles; bow ties; pareus; cuffs for clothing; dress shields; beach clothes; beach wear; cap peaks; overalls; pockets for clothing; sock suspenders; stocking suspenders; petticoats; tights or leotards; aprons (clothing); head dresses (headgear); wooden shoes; caps; garters; coats; esparto shoes or sandals; non-slipping devices for footwear; bath gowns (bathrobes); bath slippers; birettas; blouses; body suits (underwear); berets; footmuffs, not electrically heated; lace boots; boots; boot uppers; studs for football boots; half-boots; fittings of metal for footwear; tips for footwear; welts for footwear; heelpieces for footwear; pants; shirts; shirt yokes; shirt fronts; tee-shirts; bodices; vests; jackets; fishing vests; stuff jackets; combinations (clothing); slips (underwear); detachable collars; collars; clothing of leather; clothing of imitation leather; shower caps; slippers; skirts; ready-made linings (parts of clothing); top coats (clothing); gabardines (clothing); gymnastic shoes; jerseys (clothing); jerseys (pullovers); jerseys (sweaters); liveries; muffs (for clothing); footwear uppers; trousers; parkas; pelerines; pelisses; spats; spats (leg protectors); knitwear; knitwear [clothing]; clothing for gymnastics; outerclothing; sandals; saris; underpants; hats; bras (brassieres); toques; togas; trouser straps; suits; turbans; dresses; slippers, footwear for sports.

(260) AM 2013 69488 A

(800) 1132234

(151) 2012 08 14

(731) FOSHAN CITY NANHAI POPULA FAN CO., LTD.

Xiaotang Shishan, Xincheng Industrial Zone
Nanhai Foshan, Guangdong, China

(540)



(591) Black, white

(511)

11 – Air conditioners; air filtering installations; fans (air-conditioning); gas scrubbing apparatus; fans (parts of air-conditioning installations); ventilation (air-conditioning) installations and apparatus; electric fans for personal use; exhaust fan; electric blowers; air purifying apparatus and machines.

(260) AM 2013 69489 A

(800) 1132239

(151) 2012 07 13

(731) voestalpine Tubulars GmbH & Co KG

Alpinestraße 17, A-8652 Kindberg-Aumühl,
Austria

(540)

VAroroughneck

(591) Black, white

(511)

6 – Pressure pipes of steel for the transport of oil and/or natural gas; pipe junctions of metal such as steel, in particular for oil pipelines or natural gas pipelines; gastight threaded connecting pieces of metal such as steel, in particular for oil pipelines or natural gas pipelines; pipe muffs of metal, in particular steel; threaded pipes of metal, in particular steel.

37 – Repair oil pipeline construction and maintenance; installation of threaded pipes and/or gastight threaded connecting pieces of metal; repair of threaded pipes and/or gastight threaded connecting pieces of metal.

(260) AM 2013 69490 A

(800) 1132266

(151) 2012 06 20

(731) Dariusz Wasikiewicz "Aseptia"

ul. Cieszyńska 365, PL-43-382 Bielsko-Biala,
Poland

(540)

OregaseptH97

(591) Black, white

(511)

5 – Pharmaceutical preparations; dietetic substances adapted for medical use, supplements of diet; mineral food-supplements; medicinal oils; medicinal herbs.

(260) AM 2013 69491 A

(800) 1132273

(151) 2012 06 20

(731) OCP S.A.

2 Rue Al Abtai, Hay Erraha, Casablanca,
Morocco

(540)



(591) Green and yellow

(511)

1 – Industrial chemicals.

6 – Ores.

41 – Organization of events.

42 – Industrial research and development.

(260) AM 2013 69492 A

(800) 1132274

(151) 2012 08 02

(731) Guillemot Corporation S.A.

Place du Granier, B.P. 97143, F-35135

Chantepie, France

(540)

THRUSTMASTER

(591) Black, white

(511)

9 – Scientific, nautical, surveying, photographic, cinematographic, optical, weighing, measuring, signaling, checking (supervision), life-saving and teaching apparatus and instruments; apparatus and instruments for conducting, switching, transforming, accumulating, regulating or controlling electricity; apparatus for recording, transmission or reproduction of sound or images; magnetic recording media, sound recording or optical discs; compact disks, DVDs and other digital recording media; mechanisms for coin-operated apparatus; cash registers; calculating machines; data processing equipment and computers; fire-extinguishing apparatus; computer game software; software (recorded programs); computer peripheral devices; electric batteries; detectors; electric wires; electric relays; diving suits, gloves or masks; clothing for protection against accidents, irradiation and fire; protection devices for personal use against accidents; spectacles (optics); optical goods; spectacle cases; diagnostic apparatus, not for medical purposes; integrated circuit cards (smart cards); safety tarpaulins; recorded computer programs; simulation controllers, manual controllers, control levers and rudder controllers used for video games and/or pre-paid games machines; input signal switches on computers for controlling software for video games, electronic games, games on computers; video games; apparatus and instruments for electronic games, pre-paid games machines.

28 – Games, toys; Christmas tree decorations (excluding lighting and confectionery); Christmas trees of synthetic material; apparatus for physical education or gymnastics; fishing tackle; balls for games or play balloons; billiard tables, cues or balls; playing cards or board games; ice or roller skates; scooters (toys); sailboards or surf boards; rackets; snowshoes; skis; protective paddings (parts of sports suits).

(260) AM 2013 69493 A

(800) 1132278

(151) 2012 08 31

(731) ARCHOS S.A.

12 rue Ampère, F-91430 IGNY, France

(540)

FAMILY PAD

(591) Black, white

(511)

9 – Photographic, cinematographic and teaching apparatus and instruments; apparatus for recording, transmission, reproduction or processing of sound or images; magnetic recording media, calculating machines; data processing equipment; computers; portable digital tablets; software (recorded programs); computer game software; computer peripheral devices; integrated circuit cards [smart cards].

(260) AM 2013 69495 A

(800) 1132279

(151) 2012 09 03

(731) Davidoff & Cie SA

2, rue de Rive, CH-1200 Genève,

Switzerland

(540)



(591) Black, white and orange

(511)

34 – Cigarettes; smokers' articles.

(260) AM 2013 69496 A

(800) 1132280

(151) 2012 09 03

(731) Davidoff & Cie SA

2, rue de Rive, CH-1200 Genève,

Switzerland

(540)



(591) White, black and orange

(511)

34 – Cigarettes; smokers' articles.

(260) AM 2013 69497 A

(800) 1132281

(151) 2012 09 03

(731) Davidoff & Cie SA

2, rue de Rive, CH-1200 Genève, Switzerland

(540)



(591) White, black and blue

(511)

34 – Cigarettes; smokers' articles.

(260) AM 2013 69498 A

(800) 1132318

(151) 2012 06 01

(731) VOXLAND

208 Bd de Plombières, Les Rizeries,

F-13003 MARSEILLE, France

(540)

BEEWI

(591) Black, white

(511)

9 – Apparatus for recording, transmission or reproduction of sound or images; magnetic data carriers, recording disks; audio and video compact disks, data processing equipment and computers; facsimile machines, automatic answering machines, dictating apparatus, alarms, games adapted for use only with a television set, electronic games on disks

or compact disks, walkie talkies, personal stereos, spectacles and spectacle cases; software for providing access to wireless local area networks; software for access to a computer network or data transmission network, especially to a global communication network (such as the Internet) or to a private or restricted network (such as an intranet); equipment for electricity transmission and distribution installations; electrical protection devices, including remote-control, control and monitoring devices, namely switches, changeover switches, pressure switches, light signalling devices, socket outlets, bells (warning devices), transformers; measuring instruments, smoke, wind, rain, temperature, brightness and motion detectors; electrical/electronic display and monitoring devices for multiple applications; automatic circuit controllers, namely relays, contactors, time switches, switching clocks, programmable switching devices and controllers, dimmers, remote controls, remote-controlled switches, remotely controlled circuit breakers, thermostats; equipment intended for electrical installations for individuals, namely wall switches, ceiling switches (pull-switches), data transfer sockets, telephone sockets, power sockets, connectors, intruder alarms and fire alarms, smoke and heat detectors, transmission devices for telephone apparatus, video surveillance apparatus, transmitters and receivers, as well as cables for transmitting data, images and sounds, electrical/electronic apparatus for automatic control of building installations; recorded software, particularly on a central server and/or control interfaces for displaying and/or for controlling, automating and operating electrical and electronic installations, as well as data processing installations, namely lighting installations, heating devices, air conditioning installations, ventilating installations, drying installations, protection installations, installations incorporating audio and video devices or information technology devices; guard devices for lighting.

11 – Apparatus and installations for lighting, heating, refrigerating, ventilating, aerating, air conditioning, water and fluid distribution; electric lamps and tubes, especially for electrical installation, control, signaling, marking and lighting apparatus and equipment; halogen lamps; lamps; electric light bulbs; light bulbs; independent lighting units, including lighting for security, marking and atmospheric purposes; modular emergency lighting units; security lighting plates; lighting fixtures; incandescent and fluorescent lighting fixtures; portable lighting apparatus; lighting apparatus and installations.

28 – Games, toys; ornaments for Christmas trees (except illumination articles); gymnastic or sporting articles not included in other classes, robots (toys) for entertainment; electronic toys, electronic toys other than those adapted for use only with an external display screen or monitor, electronic games

apparatus other than those adapted for use only with an external display screen or monitor.

38 – Electronic mail and dissemination (transmission) of information via electronic means, especially for global communication networks; communication (transmission) between computer terminals, transmission of information accessible by access code and held in databases by computer or data-communications database server centers; communication (transmission) of information via computer terminals on national, international and global communication networks, by cable, via satellite; services for transmitting and receiving electronic messages, sounds, images and music by wireless network; services for transmitting photographs, images, music and sounds by wireless telephone; providing access to wireless, telephone, radiotelephone, data communication, global communication (such as the Internet) or private or restricted access (such as intranets) networks, to a global (such as on the Internet) communication server center or private or restricted access (such as on an intranet) network; telecommunication network services for home automation applications, especially for control and management of electrical and electronic circuits for lighting, heating, air conditioning, ventilation, blinds, shutters and curtains, for the remote control of electrical apparatus, for dealing with breakdowns, leaks or faults, for managing temperature levels and fluid consumption levels, for controlling and managing systems for security, alarm, fire protection, surveillance, access control, intruder defense, recording and/or dissemination of sounds and/or images, intercoms, telephones, television, telecommunications and/or computing; providing access to computer and/or telecommunications sites and portals relating to the field of electrical equipment for installations, of electrical installations, of apparatus, equipment, installations and systems for lighting, electric control, signalling, monitoring, alarms, access control, home automation and information networks; rental of access time to the aforesaid databases and to sites on electronic communications networks relating to electrical equipment for installations.

42 – Technical installations relating to electrical equipment for installations, to electrical installations, to apparatus, equipment and installations for lighting, electric control, signalling, surveillance, alarms, access control and/or home automation; design, adjustment, installation, maintenance, duplication, hiring out and rental of computer programs, software and databases, in the field of electrical equipment for installations or intended for electricians and installers of electrical equipment or for technical training and teaching purposes; updating of the aforesaid computer programs and software; computer programming; computer system design; data conversion of computer programs and

data (not physical conversion); conversion of data or documents from physical to electronic media; creating and maintaining websites for others; hosting of computer sites (websites); engineering, expert assessments, professional advice and consulting, drafting, technical consulting, technical research; all the aforesaid services being in relation to the field of electrical equipment for installations, of electrical installations, of apparatus, equipment, installations and systems for lighting, electric control, signalling, surveillance, alarms, access control, home automation; and information networks; the aforesaid services being consultable or accessible also on-line or on telecommunications and/or computer networks; computer network services for home automation applications, especially for the control and management of electric and electronic circuits, lighting, heating, air conditioning, ventilation, blinds, shutters and curtains, for the remote control of electrical apparatus, for management of breakdowns, leaks or faults, for management of temperature levels and fluid consumption levels, for control and management of systems for security, alarms, fire protection, monitoring, access control, intruder defense, recording and/or dissemination of sounds and/or images, intercoms, telephones, television, telecommunications and/or computing.

45 – Security services for protection and for monitoring of people in their homes, of buildings, of goods, of apparatus and of equipment for aid, assistance and care for persons and provided by people; operation of an alarm and intervention center (security services)

(260) AM 2013 69499 A
 (800) 1132352
 (151) 2012 07 31
 (731) Erchonia Corporation
 2021 Commerce Drive, McKinney, TX
 75069, USA
 (540)



(591) Black, white
 (511)
 10 – Lasers for medical use.

(260) AM 2013 69500 A
 (800) 1132400
 (151) 2012 08 16
 (731) TKS SA, société anonyme
 37 Avenue Mathieu, B-6600 Bastogne,
 Belgium

(540)

CHANGE YOU CAN

(591) Black, white

(511)

9 – Apparatus for recording, transmission and reproduction of sound or images; magnetic data carriers; magnetic cards; software; telephone apparatus; telephone receivers; telephone transmitters; cameras [photography]; radio receivers; radio transmitters; computer hardware; parts and component parts for portable and handheld digital electronic devices; parts and component parts for mobile telephones; mobile telephone cases; covers for mobile telephones; all kinds of batteries; battery chargers; earphones; loudspeakers; microphones; apparatus for connecting and charging portable and handheld digital electronic devices; parts and component parts for the aforementioned goods; spectacles; goggles for sports; sunglasses; spectacle cases; spectacle glasses; spectacle frames.

14 – Precious metals and their alloys and goods in precious metals or coated therewith, not included in other classes; jewelry, precious stones; timepieces and chronometric instruments; watches and watchbands.

28 – Computer games apparatus.

35 – Advertising; business management; business administration; retail sale of soap, perfumery, essential oils, cosmetics, hair lotions, apparatus for recording, transmission, reproduction of sound or images, magnetic recording media, magnetic cards, software, telephone apparatus, telephone receivers, telephone transmitters, computer games apparatus, photographic apparatus, radio receivers, radio transmitters, computer hardware, parts and accessories for portable and handheld digital electronic devices, parts and accessories for mobile telephones, mobile telephone cases, covers for mobile telephones, all kinds of batteries, battery chargers, earphones, loudspeakers, microphones, apparatus for connecting and charging portable and handheld digital electronic devices, parts and component parts for the aforementioned goods, spectacles, goggles for sports, sunglasses, spectacle cases, spectacle glasses, spectacle frames, vehicles, apparatus for locomotion by land, air or water, timepieces and chronometric instruments, watches and watchbands, leather and imitation leather, goods made from these materials, animal skins, trunks and traveling bags, umbrellas, parasols and walking sticks, clothing, headgear, footwear and plastic bags for packaging.

(260) AM 2013 69501 A

(800) 1132437

(151) 2012 07 03

(731) Sungrow Power Supply Co., Ltd.

No. 2 Tianhu Road, New & High Technology Industrial, Development Zone, Hefei, Anhui, China

(540)

SolarInfo

(591) Black, white

(511)

9 – Computer software, recorded; computer programs (downloadable software); data processing apparatus; electro-dynamic apparatus for the remote control of signals; inverters (electricity); current rectifiers; distribution boxes (electricity); electric apparatus for commutation.

(260) AM 2013 69662 A

(800) 1134051

(151) 2012 08 23

(731) N.V. Nutricia

Eerste Stationsstraat 186, NL-2712 HM
ZOETERMEER, Netherlands

(540)

3-я СТУПЕНЬ

(591) Black, white

(511)

5 – Babyfood.

29 – Milk and milk products.

(260) AM 2013 69815 A

(800) 1135151

(151) 2012 09 06

(731) Bayer Intellectual Property GmbH

40789 Monheim am Rhein, Germany

(540)

CANESORAL

(591) Black, white

(511)

5 – Pharmaceutical preparations.

(260) AM 2013 69816 A

(800) 1135154

(151) 2012 09 26

(731) Recordati Ireland Limited

Raheens East, Ringaskiddy, Co. Cork, Ireland

(540)

REGOLDIA

(591) Black, white

(511)

5 – Pharmaceutical products and preparations.

(260) AM 2013 69818 A

(800) 1135156

(151) 2012 09 04

(731) MABXIENCE, S.A.

Yagaron 1407, 11100 Montevideo,
Uruguay

(540)

MABXIENCE

(591) Black, white

(511)

5 – Pharmaceutical, veterinary and sanitary preparations, dietetic substances for medical use and vitamins.

42 Chemical, biological and pharmaceutical research services.

(260) AM 2013 69819 A

(800) 1135167

(151) 2012 09 05

(731) Deutsche Amphibolin-Werke von Robert Murjahn Stiftung & Co KG
Rossoerfer Strasse 50, 64372 Ober-Ramstadt, Germany

(540)

Alpina Expert

(591) Black, white

(511)

1 – Chemicals used in industry; preservative and damp-proofing preparations for masonry, roofing tiles, cement and concrete, except paints and oils; unprocessed artificial resins, unprocessed synthetic resins and unprocessed plastics (in the form of powders, granules, liquids or pastes); solvents for paints, varnishes and lacquers; adhesives used in industry; adhesives for wallpaper; adhesives used in building; fillers for subsurface treatment for paints (not included in other classes).

2 – Paints, varnishes, lacquers, glazes (included in this class), preservatives against rust; primers; colorants, dyes, dye pastes, mordants; thickeners for paints; fixatives, siccatives (drying agents) for paints; natural resins (included in this class); thinning and binding preparations for paints and lacquers; preservatives against deterioration of wood, wood stains, oils for the preservation of wood; paints (included in this class), including structuring paints; bactericidal and/or fungicidal paints; anti-corrosive preparations; protective preparations for metals; metals in foil and powder form for painters, decorators, printers and artists.

19 – Building materials (non-metallic); profile rails and brackets, not of metal, for building, in particular edging profiles; aligning and equalising parts, not of metal, for building; spacers, not of metal, for building; window ledges, not of metal; natural and artificial stones; mortar and quartz (building materials); plaster, included in this class; coatings (building materials); wall and ceiling panels (not of metal, for building); fabric embedding mortar for building purposes; fillers (building materials).

(260) AM 2013 69820 A

(800) 1135172

(151) 2012 10 18

(731) Beiersdorf AG
Unnastrasse 48, 20253 Hamburg, Germany

(540)

NIVEA ORIGINALS

(591) Black, white

(511)

3 – Soaps, perfumery, essential oils, cosmetics.

(260) AM 2013 69821 A

(800) 1135195

(151) 2012 07 11

(731) ORIFLAME COSMETICS S.A.
24, avenue Emile Reuter, L-2420
LUXEMBOURG, Luxembourg

(540)

ifresh & nature!
BY ORIFLAME

(591) Pink

(511)

3 – Soaps, perfumery, essential oils, cosmetics, hair lotions; dentifrices.

(260) AM 2013 69829 A

(800) 1135218

(151) 2012 09 24

(731) Takeda Pharmaceutical Company Limited
1-1, Doshomachi 4-chome, Chuo-ku,
Osaka-shi Osaka 540-8645, Japan

(540)

NESINA PIO

(591) Black, white

(511)

5 – Pharmaceutical preparations.

(260) AM 2013 69833 A

(800) 1135219

(151) 2012 08 24

(731) Takeda Pharmaceutical Company Limited
1-1, Doshomachi 4-chome, Chuo-ku,
Osaka-shi Osaka 540-8645, Japan

(540)

NESINA MET

(591) Black, white

(511)

5 – Pharmaceutical preparations.

(260) AM 2013 69834 A
 (800) 1135226
 (151) 2012 08 23
 (731) N.V. Nutricia
 Eerste Stationsstraat 186, NL-2712 HM
 Zoetermeer, Netherlands

(540)
2-ая СТУПЕНЬ

(591) Black, white
 (511)
 5 – Baby food.
 29 – Milk and milk products.

(260) AM 2013 69835 A
 (800) 1135227
 (151) 2012 08 23
 (731) N.V. Nutricia
 Eerste Stationsstraat 186, NL-2712 HM
 Zoetermeer, Netherlands

(540)
1-ая СТУПЕНЬ

(591) Black, white
 (511)
 5 – Baby food.
 29 – Milk and milk products.

(260) AM 2013 69836 A
 (800) 1135229
 (151) 2012 09 14
 (731) Publichne aktsionerne tovarystvo
 "Kharkivska biskvitna fabryka"
 vul. Lozivska, 8, Kharkiv 61017, Ukraine

(540)
ЯСОЧКА

(591) Black, white
 (511)
 30 – Sponge cakes; cookies; buns; waffles; confectionery; pastries; confectionery for decorating Christmas trees; fruit jellies (confectionery); cakes; peanut confectionery; almond confectionery; pies; cocoa; cocoa products; caramels (candy); sweetmeats (candy); liquorice (confectionery); peppermint sweets; crackers; candy; marzipan; custard; pastilles (confectionery); lozenges (confectionery); petits fours (cakes); biscuits; fondants (confectionery); popcorn; pralines; gingerbread; puddings; cake powder; sugar; sweet paste for cakes, pies, cookies, buns, gingerbread, puddings; sweets (confectionery); rusks; sandwiches; tarts; candy decorations for cakes; chocolate decorations for cakes; halvah; chips from cereal products; chocolate.

(260) AM 2013 69837 A
 (800) 1135254
 (151) 2012 06 22
 (731) Tovarystvo z obmegoju vidpovidalnistu
 "Promyslovo-torgovelnna Kompanija SHABO"
 Vul. Dzergynskogo, 10, S. Shabo,
 Bilgorod-Dnistovskiy r-n, Odeska obl. 67770,
 Ukraine

(540)
MASTER TARDAN

(591) Black, white
 (511)
 33 – Alcoholic beverages, except beer; aperitifs; arak (arrack); brandy; wine; sparkling wine; whisky; vermouth; anisette (liqueur); anise (liqueur); hydromel (mead); vodka; kirsch; grape vodka; perry; gin; cocktails; curacao; liqueurs; peppermint liqueurs; mixed alcoholic beverages, except beer-based beverages; distilled beverages; alcoholic beverages containing fruit; bitters; piquette; rice alcohol; rum; sake; cider; spirits (beverages); alcoholic extracts; alcoholic essences; digesters (liqueurs and spirits); fruit extracts (alcoholic).

(260) AM 2013 69844 A
 (800) 1135257
 (151) 2012 09 27
 (731) KRKA, tovarna zdravil, d.d., Novo mesto
 Šmarješka cesta 6, SI-8501 Novo mesto,
 Slovenia

(540)
СЕПТАНАЗАЛ

(591) Black, white
 (511)
 5 – Pharmaceutical preparations.

(260) AM 2013 69847 A
 (800) 1135319
 (151) 2012 04 17
 (731) HUAWEI TECHNOLOGIES CO., LTD.
 Administration Building Huawei
 Technologies Co., Ltd. Bantian, Longgang
 District, Shenzhen, China

(540)
Ascend

(591) Black, white
 (511)
 9 – Mobile phones; USB modems / wireless modems; data cards; gateways; video telephones; modems; computers; set-top boxes; household network communication terminal devices and equipments for accessing Internet, making phone calls, viewing videos and playing games; digital readers; ADSL broadband accessing terminal devices and equipments; routers; ebook devices; communi-

cation modules; PDAs (personal digital assistants); telephones for remote telephone conferencing; digital photo frames; apparatus for remote video conference; apparatus for network video conference; intelligent control apparatus for video conference; batteries; battery chargers; mouse; headphones; software in communication field; microphones; tablet computers.

(260) AM 2013 69848 A

(800) 1135367

(151) 2012 05 31

(731) GÜCEL TEKSTİL SANAYİ PAZARLAMA
VE TİCARET LİMİTED SİRKETİ

M. Nezihi Özmen Mahallesi, Mehmet Akif
Caddesi, Kestane Sokak No:12/5 Merter –
GÜNGÖREN – İSTANBUL, Turkey

(540)

NANANIA

(591) Black, white

(511)

18 – Leather and imitation leather, animal skins; animal hides, artificial leathers, stout leathers, lining leather; goods made of leather, imitation leather or synthetic materials, namely, travel bags, valises, wallets, handbags, backpacks for carrying babies, leather and stout leather boxes for storing greeting cards, leather hat boxes for travel; make-up cases sold empty, toiletry bags sold empty, vanity cases sold empty, tool bags sold empty; book bags; carrying cases for documents, briefcases, backpacks, school bags, leather shopping bags, leather cases for banknotes; umbrellas, sun umbrellas, namely, parasols and canes; whips, harnesses and saddlery, stirrups, horse bridles.

25 – Clothing, namely, trousers, jackets, overcoats, coats, skirts, suits, jerseys, waistcoats, shirts, T-shirts, sweatshirts, dresses, Bermuda shorts, shorts, pajamas, pullovers, jeans, tracksuits, rainwear, beachwear, bathing suits, swimming suits; clothing for sports (for exclusive use for sports), clothing for babies, namely, shirts, pants, coats, dresses; underclothing, namely, boxer shorts, brassieres, briefs, pants, socks; footwear, namely shoes excluding orthopedic shoes, sandals, waterproof boots, walking boots, booties, sporting shoes, slippers; shoe parts namely heelpieces, insoles for footwear, footwear uppers; headgear, namely caps, skull caps, sports caps, hats, berets; gloves (clothing), stockings, belts (clothing), camisoles, sarongs, scarves, neck scarves, shawls, collars, neckties, ties, suspender belts.

35 – Advertising agency services, marketing and publicity bureau services including commercial or advertisement exhibition and trade fair organization services; providing office functions; business management; business administration; import and export agencies; business investigations, evaluations, expert

business appraisals; auctioneering; the bringing together, for the benefit of others, of leather and imitation leather, animal skins, goods made of leather, imitation leather or synthetic materials, clothing, footwear, headgear (excluding the transport thereof), enabling customers to conveniently view and purchase those goods; all the aforementioned services may be provided by retail stores, wholesale outlets, through mail order catalogues or by means of electronic media, for example, through Web sites or television shopping programmes.

(260) AM 2013 69852 A

(800) 1135373

(151) 2012 03 10

(731) MICROSOFT CORPORATION

One Microsoft W, Redmond, WA
98052-6399, USA

(540)

SURFACE

(591) Black, white

(511)

9 – Computers; tablet computers; laptop computers; mobile computers; reader for e-books and other electronic publications; computer peripherals; wireless computer peripherals; mobile communications modules for use with tablet computers; headphones; audio speakers; computer keyboards; computer mouse; webcams; digital pens; power cords; battery chargers; electrical cables and cord sets; electronic docking stations; computer docking stations; adapters for use with computers and computer peripherals; usb hardware devices; carrying cases and holders for electronic equipment, namely, tablet computers, laptop computers, mobile computers, computer peripherals, readers for e-books and other electronic publications, and computer accessories.

15 – Electronic musical keyboards.

(260) AM 2013 69854 A

(800) 1135431

(151) 2012 07 18

(731) Ravensberger Schmierstoffvertrieb GmbH

Jöllenecker Straße 2, 33824 Werther,
Germany

(540)

CleanSynto

(591) Black, white

(511)

4 – Industrial oils and greases; lubricants; motor oils, gear oils, hydraulic oils; sliding lacquers; solid, liquid and gaseous fuels (including motor spirit); waxes for industrial use; metal processing fluids in the form of technical oils and fats; petroleum (raw or refined).

(260) AM 2013 69855 A
 (800) 1135445
 (151) 2012 09 14
 (731) Celgene Corporation
 86 Morris Avenue Summit, NJ 17901, USA

(540)

POMALYST

(591) Black, white
 (511)
 5 – Pharmaceutical preparations, namely, cytokine inhibitory drugs; pharmaceutical preparations that modulate the immune system; pharmaceutical preparations for the treatment of certain cancers and blood diseases.

(260) AM 2013 69860 A
 (800) 1135451
 (151) 2012 09 14
 (731) The Innocence Project, Inc.
 40 Worth Street, Suite 701, New York NY
 10013, USA

(540)

INNOCENCE PROJECT

(591) Black, white
 (511)
 41 – Educational services, namely, conducting classes, seminars, conferences, clinics, and workshops in the field of criminal justice.
 45 – Legal services; promoting the interests of criminal defendants in the field of politics.

(260) AM 2013 69861 A
 (800) 1135467
 (151) 2012 08 21
 (731) ORIFLAME COSMETICS S.A.
 24, avenue Emile Reuter, L-2420
 LUXEMBOURG, Luxembourg

(540)

ORIFLAME PRETTY SWAN

(591) Black, white
 (511)
 3 – Soaps, perfumery, essentials oils, cosmetics, hair lotions; dentifrices.

(260) AM 2013 69862 A
 (800) 1135498
 (151) 2012 08 23
 (731) PETRONAS LUBRICANTS ITALY S.P.A.
 Via Santena, 1, I-10029 VILLASTELLONE
 (TO), Italy

(540)

POWERICE

(591) Black, white

(511)
 4 – Refrigerating oil.

(260) AM 2013 69933 A
 (800) 1136618
 (151) 2012 09 27
 (731) KRKA, tovarna zdravil, d.d., Novo mesto
 Šmarješka cesta 6, SI-8501 Novo mesto,
 Slovenia

(540)

СЕПТАНАЗ

(591) Black, white
 (511)
 5 – Pharmaceutical preparations.

(260) AM 66677 A *
 (800) 1108545
 (731) RHODIA CHIMIE
 40, rue de la Haie Coq, F-93300
 AUBERVILLIERS, France

(540)

RHODIAROME

(591) Black, white
 (511)
 1 – Chemicals used in industry; chemicals for use in the perfume, additives, cosmetic, pharmaceutical, food and plastics industries; active material and synthesis intermediate for use in the perfume, additives, cosmetic, pharmaceutical, food and plastics industries; chemicals containing vanillin used in the perfume, cosmetic, additives, pharmaceutical, food and plastics industries.

(260) AM 67739 A *
 (800) 1117051
 (731) Richter Gedeon Nyrt.
 Gyömrői út 19-21, H-1103 Budapest, Hungary

(540)

ЕСМИЯ

(591) Black, white
 (511)
 5 – Pharmaceutical preparations.

INTERNATIONAL TRADEMARKS PROTECTED IN GEORGIA

(260) AM 2013 66668 A
(800) 1108416
(151) 2012 01 02
(181) 2022 01 02
(511) 40, 42

(260) AM 2013 67309 A
(800) 1113342
(151) 2011 11 18
(181) 2021 11 18
(511) 18, 25

(260) AM 2013 67380 A
(800) 1113874
(151) 2011 11 29
(181) 2021 11 29
(511) 01, 03, 04

(260) AM 2013 67388 A
(800) 1089770
(151) 2011 05 03
(891) 2012 03 06
(181) 2021 05 03
(511) 03

(260) AM 2013 67391 A
(800) 817546A
(151) 2003 09 16
(891) 2012 03 16
(181) 2013 09 16
(511) 05

(260) AM 2013 67679 A
(800) 1089326
(151) 2011 04 28
(891) 2012 04 26
(181) 2021 04 28
(511) 09, 25, 41

(260) AM 2013 67680 A
(800) 1095492
(151) 2011 10 07
(891) 2012 05 11
(181) 2021 10 07
(511) 05

(260) AM 2013 67682 A
(800) 1095493
(151) 2011 10 07
(891) 2012 05 11
(181) 2021 10 07
(511) 05

(260) AM 2013 67683 A
(800) 1096801
(151) 2011 10 20
(891) 2012 05 11
(181) 2021 10 20
(511) 05

(260) AM 2013 67684 A
(800) 1105657
(151) 2012 01 02
(891) 2012 04 23
(181) 2022 01 02
(511) 03, 18, 25

(260) AM 2013 67685 A
(800) 1107343
(151) 2011 12 20
(891) 2012 04 26
(181) 2021 12 20
(511) 25

(260) AM 2013 67687 A
(800) 1109867
(151) 2012 02 01
(891) 2012 04 25
(181) 2022 02 01
(511) 32

(260) AM 2013 67808 A
(800) 1116418
(151) 2011 11 22
(181) 2021 11 22
(511) 25

(260) AM 2013 67967 A
(800) 1118500
(151) 2012 02 15
(181) 2022 02 15
(511) 16

(260) AM 2013 67990 A
(800) 807503
(151) 2003 07 09
(891) 2012 05 30
(181) 2013 07 09
(511) 05

(260) AM 2013 68013 A
(800) 1118723
(151) 2012 03 30
(181) 2022 03 30
(511) 30

(260) AM 2013 68014 A
(800) 1118746
(151) 2011 12 13
(181) 2021 12 13
(511) 08, 09, 11, 16, 20, 21

(260) AM 2013 68072 A
(800) 1119120
(151) 2012 03 03
(181) 2022 03 03
(511) 14

(260) AM 2013 68074 A
(800) 1119224
(151) 2011 12 29
(181) 2021 12 29
(511) 03

(260) AM 2013 68076 A
(800) 1119229
(151) 2011 12 09
(181) 2021 12 09
(511) 05, 29

(260) AM 2013 68077 A
(800) 1119232
(151) 2011 12 20
(181) 2021 12 20
(511) 05, 29

(260) AM 2013 68079 A
(800) 1119261
(151) 2012 02 02
(181) 2022 02 02
(511) 12, 37, 39, 42

(260) AM 2013 68080 A
(800) 1119300
(151) 2012 04 24
(181) 2022 04 24

(511) 12, 28

(260) AM 2013 68081 A
(800) 1119308
(151) 2012 05 15
(181) 2022 05 15
(511) 31

(260) AM 2013 68087 A
(800) 1119376
(151) 2012 02 20
(181) 2022 02 20
(511) 43

(260) AM 2013 68088 A
(800) 1119381
(151) 2012 03 15
(181) 2022 03 15
(511) 26

(260) AM 2013 68089 A
(800) 1119419
(151) 2012 02 29
(181) 2022 02 28
(511) 07, 11

(260) AM 2013 68090 A
(800) 1119429
(151) 2012 05 31
(181) 2022 05 31
(511) 09

(260) AM 2013 68091 A
(800) 1119465
(151) 2012 03 09
(181) 2022 03 09
(511) 09, 12, 37

(260) AM 2013 68093 A
(800) 1119502
(151) 2012 01 19
(181) 2022 01 19
(511) 36

(260) AM 2013 68097 A
(800) 1119562
(151) 2011 08 26
(181) 2021 08 26
(511) 05, 30, 32

(260) AM 2013 68098 A
(800) 1119568
(151) 2011 10 28
(181) 2021 10 28
(511) 33

(260) AM 2013 68099 A
(800) 1119577
(151) 2011 12 29
(181) 2021 12 29
(511) 03

(260) AM 2013 68100 A
(800) 1119597
(151) 2012 02 20
(181) 2022 02 20
(511) 18, 25, 28

(260) AM 2013 68121 A
(800) 1104585
(151) 2011 10 26
(181) 2021 10 26
(511) 30, 32

(260) AM 2013 68123 A
(800) 888701
(151) 2006 03 15
(891) 2012 05 11
(181) 2016 03 15
(511) 25

(260) AM 2013 68124 A
(800) 912723
(151) 2006 11 30
(891) 2012 06 05
(181) 2016 11 30
(511) 35, 36

(260) AM 2013 68125 A
(800) 933422
(151) 2007 07 20
(891) 2012 05 11
(181) 2017 07 20
(511) 39, 43

(260) AM 2013 68126 A
(800) 935579
(151) 2007 07 20
(891) 2012 05 11
(181) 2017 07 20
(511) 39, 43

(260) AM 2013 68127 A
(800) 942536
(151) 2007 06 06
(891) 2012 05 11
(181) 2017 06 06
(511) 39, 43

(260) AM 2013 68128 A
(800) 968319
(151) 2008 06 04
(891) 2012 05 28
(181) 2018 06 04
(511) 03

(260) AM 2013 68129 A
(800) 979792
(151) 2008 05 01
(891) 2012 05 03
(181) 2018 05 01
(511) 01, 19

(260) AM 2013 68130 A
(800) 1119742
(151) 2012 04 19
(181) 2022 04 19
(511) 31

(260) AM 2013 68201 A
(800) 1119984
(151) 2012 05 23
(181) 2022 05 23
(511) 14

(260) AM 2013 68202 A
(800) 1120031
(151) 2012 04 12
(181) 2022 04 12
(511) 01, 02, 04

(260) AM 2013 68203 A
(800) 1120043
(151) 2011 10 10
(181) 2021 10 10
(511) 03, 07, 08

(260) AM 2013 68204 A
(800) 1120065
(151) 2012 01 10
(181) 2022 01 10
(511) 32

(260) AM 2013 68205 A
(800) 1120110
(151) 2012 05 08
(181) 2022 05 08
(511) 30

(260) AM 2013 68206 A
(800) 1120117
(151) 2012 04 23
(181) 2022 04 23
(511) 32

(260) AM 2013 68207 A
(800) 1120192
(151) 2012 01 30
(181) 2022 01 30
(511) 14

(260) AM 2013 68208 A
(800) 1120203
(151) 2012 05 14
(181) 2022 05 14
(511) 09, 14

(260) AM 2013 68209 A
(800) 1120230
(151) 2011 12 09
(181) 2021 12 09
(511) 05, 29

(260) AM 2013 68210 A
(800) 1120231
(151) 2011 12 09
(181) 2021 12 09
(511) 05, 29

(260) AM 2013 68211 A
(800) 1120232
(151) 2011 12 09
(181) 2021 12 09
(511) 05, 29

(260) AM 2013 68214 A
(800) 1120238
(151) 2012 02 07
(181) 2022 02 07
(511) 32, 33, 34

(260) AM 2013 68215 A
(800) 1120253
(151) 2012 03 28
(181) 2022 03 28

(511) 33

(260) AM 2013 68216 A
(800) 1120289
(151) 2012 02 21
(181) 2022 02 21
(511) 11, 21

(260) AM 2013 68217 A
(800) 1120290
(151) 2012 04 26
(181) 2022 04 26
(511) 11

(260) AM 2013 68219 A
(800) 1120339
(151) 2011 11 14
(181) 2021 11 14
(511) 01, 02, 19

(260) AM 2013 68220 A
(800) 1120346
(151) 2012 03 27
(181) 2022 03 27
(511) 25

(260) AM 2013 68221 A
(800) 1120357
(151) 2012 04 05
(181) 2022 04 05
(511) 25

(260) AM 2013 68728 A
(800) 1124504
(151) 2012 02 28
(181) 2022 02 28
(511) 05, 31

(260) AM 2013 69580 A
(800) 1133115
(151) 2012 09 12
(181) 2022 09 12
(511) 36

OFFICIAL NOTIFICATIONS
TRADEMARKS
RENEWAL OF REGISTRATIONS

(111) M 2003 14991 R1
(156) 2013 07 23
(186) 2023 02 12
(732) LTD "Tiflisski Vinni Pogreb"
Iumashevis q.27, 0198, Tbilisi, Georgia

(111) M 2003 15158 R1
(156) 2013 07 23
(186) 2023 06 11
(732) LTD "Tiflisski Vinni Pogreb"
Iumashevis q.27, 0198, Tbilisi, Georgia

(111) M 2003 15005 R1
(156) 2013 08 12
(186) 2023 03 04
(732) Johnson & Johnson
One Johnson & Johnson Plaza, New
Brunswick, New Jersey 08933, USA

(111) M 2003 15159 R1
(156) 2013 07 23
(186) 2023 06 11
(732) LTD "Tiflisski Vinni Pogreb"
Iumashevis q.27, 0198, Tbilisi, Georgia

(111) M 2003 15006 R1
(156) 2013 08 12
(186) 2023 03 04
(732) Johnson & Johnson
One Johnson & Johnson Plaza, New
Brunswick, New Jersey 08933, USA

(111) M 2003 15160 R1
(156) 2013 08 12
(186) 2023 06 11
(732) Johnson & Johnson
One Johnson & Johnson Plaza, New
Brunswick, New Jersey 08933, USA

(111) M 2003 15110 R1
(156) 2013 08 12
(186) 2023 04 30
(732) Johnson & Johnson
One Johnson & Johnson Plaza, New
Brunswick, New Jersey 08933, USA

(111) M 2003 15170 R1
(156) 2013 08 01
(186) 2023 06 27
(732) LTD „Haidelbergtsement jorjia"
Lermontovis q. №18, 0105, Tbilisi,
Georgia

(111) M 2003 15111 R1
(156) 2013 08 12
(186) 2023 04 30
(732) Johnson & Johnson
One Johnson & Johnson Plaza, New
Brunswick, New Jersey 08933, USA

(111) M 2003 15203 R1
(156) 2013 07 16
(186) 2023 07 16
(732) LTD "Matriqsi"
E. Takaishvilis q., 80, 6000, Batumi,
Georgia

(111) M 2003 15157 R1
(156) 2013 07 23
(186) 2023 06 11
(732) LTD "Tiflisski Vinni Pogreb"
Iumashevis q.27, 0198, Tbilisi, Georgia

(111) M 2003 15209 R1
(156) 2013 08 09
(186) 2023 07 16
(732) LTD samautskeblo kompania "Rustavi 2"
Vazha-Pshavelas gamz. 45, 0177, Tbilisi,
Georgia

(111) M 2003 15212 R1
(156) 2013 08 06
(186) 2023 07 16
(732) LTD "GPC"
Marjanishvilis q. 26, 0102, Tbilisi, Georgia

(111) M 2003 15213 R1
(156) 2013 08 12
(186) 2023 07 16
(732) Johnson & Johnson
One Johnson & Johnson Plaza, New
Brunswick, New Jersey 08933, USA

(111) M 2003 15263 R1
(156) 2013 09 29
(186) 2023 09 29
(732) Oracle International Corporation
500 Oracle Parkway, Redwood City,
CA 94065, USA

(111) M 2003 15269 R1
(156) 2013 10 15
(186) 2023 10 15
(732) Cilag GmbH International
Landis+Gyr-Strasse 1, CH-6300 Zug,
Switzerland

(111) M 2003 15293 R1
(156) 2013 10 15
(186) 2023 10 15
(732) MITSUBISHI JIDOSHA KOGYO
KABUSHIKI KAISHA
33-8, Shiba 5-chome, Minato-ku, Tokyo,
Japan

(111) M 2003 15295 R1
(156) 2013 10 15
(186) 2023 10 15
(732) WARSTEINER BRAUEREI HAUS
CRAMER KG
Domring, 59581 WARSTEIN, Germany

(111) M 2003 15303 R1
(156) 2013 10 29
(186) 2023 10 29
(732) Merck Sharp & Dohme Corp.
One Merck Drive, Whitehouse Station,
New Jersey 08889, USA

(111) M 2003 15318 R1
(156) 2013 11 14
(186) 2023 11 14
(732) Johnson & Johnson
One Johnson & Johnson Plaza,
New Brunswick, New Jersey 08933, USA

(111) M 2003 15319 R1
(156) 2013 11 14
(186) 2023 11 14
(732) Alza Corporation (a wholly owner subsidiary
of Jonson & Johnson manufacturers and
merchants)
1900 Charleston Road, Mountain View,
CA 94039-7210, USA

COMPLETE TRANSFER OF RIGHTS

(111) M 1998 010998 R1
 (732) Grundig Multimedia AG
 Rotzbergsstrasse 1, CH-6362 Stansstad,
 Switzerland
 (770) GRUNDIG Multimedia B.V.
 Strawinskyalaan 3105, NL-1077ZX
 Amsterdam, Netherlands
 (580) 2013 08 14

(111) M 2000 013322 R1
 (732) Opel Special Vehicles GmbH
 Mainzer Strasse (Adam Opel AG - M55),
 65428, Ruesselsheim, Germany
 (770) Opel Eisenach GmbH
 Adam-Opel-Strasse 100, 99817 Eisenach,
 Germany
 (580) 2013 08 12

(111) M 1998 011231 R1
 (732) Grundig Multimedia AG
 Rotzbergsstrasse 1, CH-6362 Stansstad,
 Switzerland
 (770) GRUNDIG Multimedia B.V.
 Strawinskyalaan 3105, NL-1077ZX
 Amsterdam, Netherlands
 (580) 2013 08 14

(111) M 2000 013324 R1
 (732) Opel Special Vehicles GmbH
 Mainzer Strasse (Adam Opel AG - M55),
 65428, Ruesselsheim, Germany
 (770) Opel Eisenach GmbH
 Adam-Opel-Strasse 100, 99817 Eisenach,
 Germany
 (580) 2013 08 12

(111) M 1999 012285 R1
 (732) Opel Special Vehicles GmbH
 Mainzer Strasse (Adam Opel AG - M55),
 65428, Ruesselsheim, Germany
 (770) Opel Eisenach GmbH
 Adam-Opel-Strasse 100, 99817 Eisenach,
 Germany
 (580) 2013 08 12

(111) M 2000 013325 R1
 (732) Opel Special Vehicles GmbH
 Mainzer Strasse (Adam Opel AG - M55),
 65428, Ruesselsheim, Germany
 (770) Opel Eisenach GmbH
 Adam-Opel-Strasse 100, 99817 Eisenach,
 Germany
 (580) 2013 08 12

(111) M 1999 012674 R1
 (732) Opel Special Vehicles GmbH
 Mainzer Strasse (Adam Opel AG - M55),
 65428, Ruesselsheim, Germany
 (770) Opel Eisenach GmbH
 Adam-Opel-Strasse 100, 99817 Eisenach,
 Germany
 (580) 2013 08 12

(111) M 2003 014991 R1
 (732) LTD "Tiflisski Vinni Pogreb"
 Iumashevis q.27, 0198, Tbilisi, Georgia
 (770) Shezguduli pasukhismgeblobis sazogadoeba
 "gvinis qarkhana AKHASHENI"
 Iumashevis q. 27, 0198, Tbilisi, Georgia;
 LTD "Tiflisski Vinni Pogreb"
 Iumashevis q.27, 0198, Tbilisi, Georgia
 (580) 2013 09 05

(111) M 1999 012677 R1
 (732) Opel Special Vehicles GmbH
 Mainzer Strasse (Adam Opel AG - M55),
 65428, Ruesselsheim, Germany
 (770) Opel Eisenach GmbH
 Adam-Opel-Strasse 100, 99817 Eisenach,
 Germany
 (580) 2013 08 12

(111) M 2003 015157 R1
 (732) LTD "Tiflisski Vinni Pogreb"
 Iumashevis q.27, 0198, Tbilisi, Georgia
 (770) Shezguduli pasukhismgeblobis sazogadoeba
 "gvinis qarkhana AKHASHENI"
 Iumashevis q. 27, 0198, Tbilisi, Georgia;
 LTD "Tiflisski Vinni Pogreb"
 Iumashevis q.27, 0198, Tbilisi, Georgia
 (580) 2013 09 05

(111) M 2003 015158 R1
(732) LTD "Tiflisski Vinni Pogreb"
Iumashevis q.27, 0198, Tbilisi, Georgia
(770) LTD gvinis qarkhana "AKHASHENI"
Iumashevis q. 27, 0151, Tbilisi, Georgia
(580) 2013 09 05

(111) M 2003 015159 R1
(732) LTD "Tiflisski Vinni Pogreb"
Iumashevis q.27, 0198, Tbilisi, Georgia
(770) Sh.P.S. gvinis qarkhana "AKHASHENI"
Iumashevis q. 27, 0151, Tbilisi, Georgia
(580) 2013 09 05

(111) M 2012 022403 R
(732) LTD "shiraqis eko propduqtebi"
Vake-saburtalos raioni, Nutsubidzis me-4 m/r,
korp.24, bina 32, 0183, Tbilisi, Georgia
(770) Nikoloz Beniaidze
Sof. Arkhiloskalo, 1603, Dedoflistskaro,
Georgia
(580) 2013 08 16

(111) M 1997 004726 R1
(732) Opel Special Vehicles GmbH
Mainzer Strasse (Adam Opel AG - M55),
65428, Ruesselsheim, Germany
(770) Opel Eisenach GmbH
Adam-Opel-Strasse 100, 99817 Eisenach,
Germany
(580) 2013 08 12

(111) M 1997 005192 R1
(732) Opel Special Vehicles GmbH
Mainzer Strasse (Adam Opel AG - M55),
65428, Ruesselsheim, Germany
(770) Opel Eisenach GmbH
Adam-Opel-Strasse 100, 99817 Eisenach,
Germany
(580) 2013 08 12

(111) M 1997 005195 R1
(732) Opel Special Vehicles GmbH
Mainzer Strasse (Adam Opel AG - M55),
65428, Ruesselsheim, Germany
(770) Opel Eisenach GmbH
Adam-Opel-Strasse 100, 99817 Eisenach,
Germany
(580) 2013 08 12

(111) M 1997 007016 R1
(732) Opel Special Vehicles GmbH
Mainzer Strasse (Adam Opel AG - M55),
65428, Ruesselsheim, Germany
(770) Opel Eisenach GmbH
Adam-Opel-Strasse 100, 99817 Eisenach,
Germany
(580) 2013 08 12

(111) M 1997 007928 R1
(732) Opel Special Vehicles GmbH
Mainzer Strasse (Adam Opel AG - M55),
65428, Ruesselsheim, Germany
(770) Opel Eisenach GmbH
Adam-Opel-Strasse 100, 99817 Eisenach,
Germany
(580) 2013 08 12

(111) M 1997 007930 R1
(732) Opel Special Vehicles GmbH,
Mainzer Strasse (Adam Opel AG - M55),
65428, Ruesselsheim, Germany
(770) Opel Eisenach GmbH
Adam-Opel-Strasse 100, 99817 Eisenach,
Germany
(580) 2013 08 12

(111) M 1997 007936 R1
(732) Opel Special Vehicles GmbH
Mainzer Strasse (Adam Opel AG - M55),
65428, Ruesselsheim, Germany
(770) Opel Eisenach GmbH
Adam-Opel-Strasse 100, 99817 Eisenach,
Germany
(580) 2013 08 12

(111) M 1997 007961 R1
(732) DEQUEST AG
Bundesplatz 1, 6300 Zug, Switzerland
(770) Thermphos Trading GmbH
Bundesplatz 1, 6300 Zug, Switzerland
(580) 2010 06 02

(111) M 1997 007961 R1
(732) Italmatch Chemicals S.P.A.
Via Pietro Chiesa 7/13, Torri Piane,
San-Beningo, 16149 Genova, Italy
(770) DEQUEST AG
Bundesplatz 1, 6300 Zug, Switzerland
(580) 2013 08 14

(111) M 1998 009161 R1
(732) Tresmontes Lucchetti S.A.
Los Conquistadores 2345, Providencia,
Santiago, Chile
(770) COMPANIA DE PRODUCTOS
ALIMENTOS Y SERVICIOS "CORPORA
S.A."
General Baquedano 1278, Santiago, Chile
(580) 2013 08 12

(111) M 1998 009164 R1
(732) Tresmontes Lucchetti S.A.
Los Conquistadores 2345, Providencia,
Santiago, Chile
(770) COMPANIA DE PRODUCTOS
ALIMENTOS Y SERVICIOS "CORPORA
S.A."
General Baquedano 1278, Santiago, Chile
(580) 2013 08 12

(111) M 1998 009168 R1
(732) Tresmontes Lucchetti S.A.
Los Conquistadores 2345, Providencia,
Santiago, Chile
(770) COMPANIA DE PRODUCTOS
ALIMENTOS Y SERVICIOS "CORPORA
S.A."
General Baquedano 1278, Santiago, Chile
(580) 2013 08 12

(111) M 1998 009810 R1
(732) Tresmontes Lucchetti S.A.
Los Conquistadores 2345, Providencia,
Santiago, Chile
(770) CORPORA TRES MONTES S.A.,
Los Conquistadores 1700, Santiago, Chile
(580) 2013 08 12

CHANGES IN NAMES AND/OR ADDRESSES OF OWNERS

(111) M 1998 010389 R1
(732) Glaxo Grroup Limited
980 Great West Road, Brentford, Middlesex
TW8 9GS, United Kingdom
(770) Glaxo Group Limited
Glaxo Wellcome House, Berkeley Avenue,
Greenford, Middlesex UB6 0NN,
United Kingdom
(580) 2013 07 29

(111) M 1998 010556 R1
(732) Intercontinental Great Brands LLC.
100 Deforest Ave, East Hanover, NJ,
07936, USA
(770) KRAFT FOODS GLOBAL BRANDS LLC
Three Lakes Drive, Northfield, Illinois
60093, USA
(580) 2013 09 06

(111) M 1998 010985 R1
(732) Glaxo Grroup Limited
980 Great West Road, Brentford, Middlesex
TW8 9GS, United Kingdom
(770) Glaxo Group Limited
Glaxo Wellcome House, Berkeley Avenue,
Greenford, Middlesex UB6 0NN,
United Kingdom
(580) 2013 07 29

(111) M 1998 010986 R1
(732) Glaxo Grroup Limited
980 Great West Road, Brentford, Middlesex
TW8 9GS, United Kingdom
(770) Glaxo Group Limited
Glaxo Wellcome House, Berkeley Avenue,
Greenford, Middlesex UB6 0NN,
United Kingdom
(580) 2013 07 29

(111) M 1998 010987 R1
(732) Glaxo Grroup Limited
980 Great West Road, Brentford, Middlesex
TW8 9GS, United Kingdom
(770) Glaxo Group Limited
Glaxo Wellcome House, Berkeley Avenue,
Greenford, Middlesex UB6 0NN,
United Kingdom
(580) 2013 07 29

(111) M 1998 010988 R1
(732) Glaxo Grroup Limited
980 Great West Road, Brentford, Middlesex
TW8 9GS, United Kingdom
(770) Glaxo Group Limited
Glaxo Wellcome House, Berkeley Avenue,
Greenford, Middlesex UB6 0NN,
United Kingdom
(580) 2013 07 29

(111) M 1998 011019 R1
(732) Glaxo Grroup Limited
980 Great West Road, Brentford, Middlesex
TW8 9GS, United Kingdom
(770) Glaxo Group Limited
Glaxo Wellcome House, Berkeley Avenue,
Greenford, Middlesex UB6 0NN,
United Kingdom
(580) 2013 07 29

(111) M 1998 011313 R1
(732) Glaxo Grroup Limited
980 Great West Road, Brentford, Middlesex
TW8 9GS, United Kingdom
(770) Glaxo Group Limited
Glaxo Wellcome House, Berkeley Avenue,
Greenford, Middlesex UB6 0NN,
United Kingdom
(580) 2013 07 29

(111) M 1999 011507 R1
(732) Glaxo Grroup Limited
980 Great West Road, Brentford, Middlesex
TW8 9GS, United Kingdom
(770) Glaxo Group Limited
Glaxo Wellcome House, Berkeley Avenue,
Greenford, Middlesex UB6 0NN,
United Kingdom
(580) 2013 07 29

(111) M 1999 011751 R1
(732) Glaxo Grroup Limited
980 Great West Road, Brentford, Middlesex
TW8 9GS, United Kingdom
(770) Glaxo Group Limited
Glaxo Wellcome House, Berkeley Avenue,
Greenford, Middlesex UB6 0NN,
United Kingdom
(580) 2013 07 29

(111) M 1999 011857 R1
(732) Glaxo Grroup Limited
980 Great West Road, Brentford, Middlesex
TW8 9GS, United Kingdom
(770) Glaxo Group Limited
Glaxo Wellcome House, Berkeley Avenue,
Greenford, Middlesex UB6 0NN,
United Kingdom
(580) 2013 07 29

(111) M 1999 011943 R1
(732) Glaxo Grroup Limited
980 Great West Road, Brentford, Middlesex
TW8 9GS, United Kingdom
(770) Glaxo Group Limited
Glaxo Wellcome House, Berkeley Avenue,
Greenford, Middlesex UB6 0NN,
United Kingdom
(580) 2013 07 29

(111) M 1999 011944 R1
(732) Glaxo Grroup Limited
980 Great West Road, Brentford, Middlesex
TW8 9GS, United Kingdom
(770) Glaxo Group Limited
Glaxo Wellcome House, Berkeley Avenue,
Greenford, Middlesex UB6 0NN,
United Kingdom
(580) 2013 07 29

(111) M 1999 011946 R1
(732) Glaxo Grroup Limited
980 Great West Road, Brentford, Middlesex
TW8 9GS, United Kingdom
(770) Glaxo Group Limited
Glaxo Wellcome House, Berkeley Avenue,
Greenford, Middlesex UB6 0NN,
United Kingdom
(580) 2013 07 29

(111) M 1999 011952 R1
(732) Glaxo Grroup Limited
980 Great West Road, Brentford, Middlesex
TW8 9GS, United Kingdom
(770) Glaxo Group Limited
Glaxo Wellcome House, Berkeley Avenue,
Greenford, Middlesex UB6 0NN,
United Kingdom
(580) 2013 07 29

(111) M 1999 011953 R1
(732) Glaxo Grroup Limited
980 Great West Road, Brentford, Middlesex
TW8 9GS, United Kingdom
(770) Glaxo Group Limited
Glaxo Wellcome House, Berkeley Avenue,
Greenford, Middlesex UB6 0NN,
United Kingdom
(580) 2013 07 29

(111) M 1999 011976 R1
(732) Glaxo Grroup Limited
980 Great West Road, Brentford, Middlesex
TW8 9GS, United Kingdom
(770) Glaxo Group Limited
Glaxo Wellcome House, Berkeley Avenue,
Greenford, Middlesex UB6 0NN,
United Kingdom
(580) 2013 07 29

(111) M 1999 012189 R1
(732) Intercontinental Great Brands LLC.
100 Deforest Ave, East Hanover, NJ,
07936, USA
(770) KRAFT FOODS GLOBAL BRANDS LLC
Three Lakes Drive, Northfield, Illinois
60093, USA
(580) 2013 09 06

(111) M 1999 012190 R1
(732) Glaxo Grroup Limited
980 Great West Road, Brentford, Middlesex
TW8 9GS, United Kingdom
(770) Glaxo Group Limited
Glaxo Wellcome House, Berkeley Avenue,
Greenford, Middlesex UB6 0NN,
United Kingdom
(580) 2013 07 29

(111) M 1999 012191 R1
(732) Glaxo Grroup Limited
980 Great West Road, Brentford, Middlesex
TW8 9GS, United Kingdom
(770) Glaxo Group Limited
Glaxo Wellcome House, Berkeley Avenue,
Greenford, Middlesex UB6 0NN,
United Kingdom
(580) 2013 07 29

(111) M 1999 012234 R1
 (732) Glaxo Grroup Limited
 980 Great West Road, Brentford, Middlesex
 TW8 9GS, United Kingdom
 (770) Glaxo Group Limited
 Glaxo Wellcome House, Berkeley Avenue,
 Greenford, Middlesex UB6 0NN,
 United Kingdom
 (580) 2013 07 29

(111) M 1995 001245 R1
 (732) Intercontinental Great Brands LLC.
 100 Deforest Ave, East Hanover, NJ,
 07936, USA
 (770) KRAFT FOODS GLOBAL BRANDS LLC
 Three Lakes Drive, Northfield, Illinois
 60093, USA
 (580) 2013 09 06

(111) M 1995 001250 R1
 (732) Intercontinental Great Brands LLC.
 100 Deforest Ave, East Hanover, NJ,
 07936, USA
 (770) KRAFT FOODS GLOBAL BRANDS LLC
 Three Lakes Drive, Northfield, Illinois
 60093, USA
 (580) 2013 09 06

(111) M 1995 001251 R1
 (732) Intercontinental Great Brands LLC.
 100 Deforest Ave, East Hanover, NJ,
 07936, USA
 (770) KRAFT FOODS GLOBAL BRANDS LLC
 Three Lakes Drive, Northfield, Illinois
 60093, USA
 (580) 2013 09 06

(111) M 1995 001252 R1
 (732) Intercontinental Great Brands LLC.
 100 Deforest Ave, East Hanover, NJ,
 07936, USA
 (770) KRAFT FOODS GLOBAL BRANDS LLC
 Three Lakes Drive, Northfield, Illinois
 60093, USA
 (580) 2013 09 06

(111) M 1995 001266 R1
 (732) Intercontinental Great Brands LLC.
 100 Deforest Ave, East Hanover, NJ,
 07936, USA
 (770) KRAFT FOODS GLOBAL BRANDS LLC
 Three Lakes Drive, Northfield, Illinois
 60093, USA

(580) 2013 09 06

(111) M 1995 001271 R1
 (732) Intercontinental Great Brands LLC.
 100 Deforest Ave, East Hanover, NJ,
 07936, USA
 (770) KRAFT FOODS GLOBAL BRANDS LLC
 Three Lakes Drive, Northfield, Illinois
 60093, USA
 (580) 2013 09 06

(111) M 1995 001273 R1
 (732) Intercontinental Great Brands LLC.
 100 Deforest Ave, East Hanover, NJ,
 07936, USA
 (770) KRAFT FOODS GLOBAL BRANDS LLC
 Three Lakes Drive, Northfield, Illinois
 60093, USA
 (580) 2013 09 06

(111) M 1999 012743 R1
 (732) Intercontinental Great Brands LLC.
 100 Deforest Ave, East Hanover, NJ,
 07936, USA
 (770) KRAFT FOODS GLOBAL BRANDS LLC
 Three Lakes Drive, Northfield, Illinois
 60093, USA
 (580) 2013 09 06

(111) M 1995 001278 R1
 (732) Intercontinental Great Brands LLC.
 100 Deforest Ave, East Hanover, NJ,
 07936, USA
 (770) KRAFT FOODS GLOBAL BRANDS LLC
 Three Lakes Drive, Northfield, Illinois
 60093, USA
 (580) 2013 09 06

(111) M 1999 012981 R1
 (732) Glaxo Grroup Limited
 980 Great West Road, Brentford, Middlesex
 TW8 9GS, United Kingdom
 (770) Glaxo Group Limited
 Glaxo Wellcome House, Berkeley Avenue,
 Greenford, Middlesex UB6 0NN,
 United Kingdom
 (580) 2013 07 29

(111) M 1999 012982 R1
(732) Glaxo Grroup Limited
980 Great West Road, Brentford, Middlesex
TW8 9GS, United Kingdom
(770) Glaxo Group Limited
Glaxo Wellcome House, Berkeley Avenue,
Greenford, Middlesex UB6 0NN,
United Kingdom
(580) 2013 07 29

(111) M 2000 013149 R1
(732) Glaxo Grroup Limited
980 Great West Road, Brentford, Middlesex
TW8 9GS, United Kingdom
(770) Glaxo Group Limited
Glaxo Wellcome House, Berkeley Avenue,
Greenford, Middlesex UB6 0NN,
United Kingdom
(580) 2013 07 29

(111) M 2000 013244 R1
(732) Glaxo Grroup Limited
980 Great West Road, Brentford, Middlesex
TW8 9GS, United Kingdom
(770) Glaxo Group Limited
Glaxo Wellcome House, Berkeley Avenue,
Greenford, Middlesex UB6 0NN,
United Kingdom
(580) 2013 07 29

(111) M 2000 013436 R1
(732) Joint-Stock Co. "sadazgvevo kompania
aldagi"
Dzveli tbilisis raioni, pushkinis q. №3, Tbilisi,
Georgia
(770) Joint-Stock Co. sadazgvevo kompania "Aldagi
BCI"
Kazbegis q. 3-5, 0179, Tbilisi, Georgia
(580) 2013 09 05

(111) M 2000 013437 R1
(732) Joint-Stock Co. "sadazgvevo kompania
aldagi"
Dzveli tbilisis raioni, pushkinis q. №3, Tbilisi,
Georgia
(770) Joint-Stock Co. sadazgvevo kompania "Aldagi
BCI"
Kazbegis q. 3-5, 0179, Tbilisi, Georgia
(580) 2013 09 05

(111) M 2000 013438 R1
(732) Joint-Stock Co. "sadazgvevo kompania
aldagi"
Dzveli tbilisis raioni, pushkinis q. №3, Tbilisi,
Georgia
(770) Saaqtsio sazogadoeba sadazgvevo kompania
"Aldagi BCI"
Kazbegis q. 3-5, 0179, Tbilisi, Georgia
(580) 2013 09 05

(111) M 2000 013439 R1
(732) Joint-Stock Co. "sadazgvevo kompania
aldagi"
Dzveli tbilisis raioni, pushkinis q. №3, Tbilisi,
Georgia
(770) Joint-Stock Co. sadazgvevo kompania "Aldagi
BCI"
Kazbegis q. 3-5, 0179, Tbilisi, Georgia
(580) 2013 09 05

(111) M 2000 013493 R1
(732) Glaxo Grroup Limited
980 Great West Road, Brentford, Middlesex
TW8 9GS, United Kingdom
(770) Glaxo Group Limited
Glaxo Wellcome House, Berkeley Avenue,
Greenford, Middlesex UB6 0NN,
United Kingdom
(580) 2013 07 29

(111) M 2000 013497 R1
(732) Glaxo Grroup Limited
980 Great West Road, Brentford, Middlesex
TW8 9GS, United Kingdom
(770) Glaxo Group Limited
Glaxo Wellcome House, Berkeley Avenue,
Greenford, Middlesex UB6 0NN
United Kingdom
(580) 2013 07 29

(111) M 2000 013540 R1
(732) The American Society of Mechanical
Engeneering,
Two Park Avenue, New York, New York
10016-5990, USA
(770) The American Society of Mechanical
Engeneering,
Three Park Avenue, New York, New York
10016-5990, USA
(580) 2013 09 05

(111) M 2000 013541 R1
 (732) The American Society of Mechanical
 Engeneering
 Two Park Avenue, New York, New York
 10016-5990, USA
 (770) The American Society of Mechanical
 Engeneering
 Three Park Avenue, New York, New York
 10016-5990, USA
 (580) 2013 09 05

(111) M 2000 013605 R1
 (732) Glaxo Grroup Limited
 980 Great West Road, Brentford, Middlesex
 TW8 9GS, United Kingdom
 (770) Glaxo Group Limited
 Glaxo Wellcome House, Berkeley Avenue,
 Greenford, Middlesex UB6 0NN,
 United Kingdom
 (580) 2013 07 29

(111) M 2000 013666 R1
 (732) Glaxo Grroup Limited
 980 Great West Road, Brentford, Middlesex
 TW8 9GS, United Kingdom
 (770) Glaxo Group Limited
 Glaxo Wellcome House, Berkeley Avenue,
 Greenford, Middlesex UB6 0NN,
 United Kingdom
 (580) 2013 07 29

(111) M 2001 014106 R1
 (732) Glaxo Grroup Limited
 980 Great West Road, Brentford, Middlesex
 TW8 9GS, United Kingdom
 (770) Glaxo Group Limited
 Glaxo Wellcome House, Berkeley Avenue,
 Greenford, Middlesex UB6 0NN,
 United Kingdom
 (580) 2013 07 29

(111) M 2001 014129 R1
 (732) Glaxo Grroup Limited
 980 Great West Road, Brentford, Middlesex
 TW8 9GS, United Kingdom
 (770) Glaxo Group Limited
 Glaxo Wellcome House, Berkeley Avenue,
 Greenford, Middlesex UB6 0NN,
 United Kingdom
 (580) 2013 07 29

(111) M 2001 014151 R1
 (732) Intercontinental Great Brands LLC.
 100 Deforest Ave, East Hanover, NJ,
 07936, USA
 (770) KRAFT FOODS GLOBAL BRANDS LLC
 Three Lakes Drive, Northfield, Illinois
 60093, USA
 (580) 2013 09 06

(111) M 2001 014188 R1
 (732) Glaxo Grroup Limited
 980 Great West Road, Brentford, Middlesex
 TW8 9GS, United Kingdom
 (770) Glaxo Group Limited
 Glaxo Wellcome House, Berkeley Avenue,
 Greenford, Middlesex UB6 0NN,
 United Kingdom
 (580) 2013 07 29

(111) M 2002 014266 R1
 (732) Intercontinental Great Brands LLC.
 100 Deforest Ave, East Hanover, NJ,
 07936, USA
 (770) KRAFT FOODS GLOBAL BRANDS
 LLC Three Lakes Drive, Northfield, Illinois
 60093, USA
 (580) 2013 09 06

(111) M 2002 014394 R1
 (732) Cerveceria Modelo, S. de R.L. de C.V.
 Lago Alberto N156, Colonia Anahuac,
 11320 Mexico, D.F., Mexico
 (770) Cerveceria Modelo, S.A. de C.V.
 Lago Alberto N156, Colonia Anahuac,
 11320 Mexico, D.F., Mexico
 (580) 2013 08 14

(111) M 2002 014395 R1
 (732) Cerveceria Modelo, S. de R.L. de C.V.
 Lago Alberto N156, Colonia Anahuac,
 11320 Mexico, D.F., Mexico
 (770) Cerveceria Modelo, S.A. de C.V.,
 Lago Alberto N156, Colonia Anahuac, 11320
 Mexico, D.F., Mexico
 (580) 2013 08 14

(111) M 2002 014766 R1
 (732) The American Society of Mechanical
 Engeneering
 Two Park Avenue, New York, New York
 10016-5990, USA

(770) The American Society of Mechanical
Engineering
Three Park Avenue, New York, New York
10016-5990, USA
(580) 2013 09 05

(111) M 2003 015061 R1
(732) Intercontinental Great Brands LLC.
100 Deforest Ave, East Hanover, NJ, 07936,
USA
(770) KRAFT FOODS GLOBAL BRANDS LLC
Three Lakes Drive, Northfield, Illinois 60093,
USA
(580) 2013 09 06

(111) M 2003 015255 R1
(732) Glaxo Grroup Limited
980 Great West Road, Brentford, Middlesex
TW8 9GS, United Kingdom
(770) Glaxo Group Limited
Glaxo Wellcome House, Berkeley Avenue,
Greenford, Middlesex UB6 0NN,
United Kingdom
(580) 2013 07 29

(111) M 2004 015437 R
(732) Glaxo Grroup Limited
980 Great West Road, Brentford, Middlesex
TW8 9GS, United Kingdom
(770) Glaxo Group Limited
Glaxo Wellcome House, Berkeley Avenue,
Greenford, Middlesex UB6 0NN,
United Kingdom
(580) 2013 07 29

(111) M 2004 015503 R
(732) Glaxo Grroup Limited
980 Great West Road, Brentford, Middlesex
TW8 9GS, United Kingdom
(770) Glaxo Group Limited
Glaxo Wellcome House, Berkeley Avenue,
Greenford, Middlesex UB6 0NN,
United Kingdom
(580) 2013 07 29

(111) M 2004 015596 R
(732) Glaxo Grroup Limited
980 Great West Road, Brentford, Middlesex
TW8 9GS, United Kingdom
(770) Glaxo Group Limited
Glaxo Wellcome House, Berkeley Avenue,
Greenford, Middlesex UB6 0NN,
United Kingdom

(580) 2013 07 29

(111) M 2004 015679 R
(732) Glaxo Grroup Limited
980 Great West Road, Brentford, Middlesex
TW8 9GS, United Kingdom
(770) Glaxo Group Limited
Glaxo Wellcome House, Berkeley Avenue,
Greenford, Middlesex UB6 0NN,
United Kingdom
(580) 2013 07 29

(111) M 2005 015820 R
(732) Glaxo Grroup Limited
980 Great West Road, Brentford, Middlesex
TW8 9GS, United Kingdom
(770) Glaxo Group Limited
Glaxo Wellcome House, Berkeley Avenue,
Greenford, Middlesex UB6 0NN,
United Kingdom
(580) 2013 07 29

(111) M 2005 015894 R
(732) Glaxo Grroup Limited
980 Great West Road, Brentford, Middlesex
TW8 9GS, United Kingdom
(770) GLAXO GROUP LIMITED
Glaxo Wellcome House, Berkeley Avenue,
Greenford, Middlesex UB6 0NN,
United Kingdom
(580) 2013 07 29

(111) M 2005 015895 R
(732) Glaxo Grroup Limited,
980 Great West Road, Brentford, Middlesex
TW8 9GS, United Kingdom
(770) GLAXO GROUP LIMITED
Glaxo Wellcome House, Berkeley Avenue,
Greenford, Middlesex UB6 0NN,
United Kingdom
(580) 2013 07 29

(111) M 2005 015913 R
(732) Glaxo Grroup Limited
980 Great West Road, Brentford, Middlesex
TW8 9GS, United Kingdom
(770) GLAXO GROUP LIMITED
Glaxo Wellcome House, Berkeley Avenue,
Greenford, Middlesex UB6 0NN,
United Kingdom
(580) 2013 07 29

(111) M 2005 015914 R
(732) Glaxo Grroup Limited,
980 Great West Road, Brentford, Middlesex
TW8 9GS, United Kingdom
(770) GLAXO GROUP LIMITED
Glaxo Wellcome House, Berkeley Avenue,
Greenford, Middlesex UB6 0NN,
United Kingdom
(580) 2013 07 29

(111) M 2005 016356 R
(732) Glaxo Grroup Limited
980 Great West Road, Brentford, Middlesex
TW8 9GS, United Kingdom
(770) GLAXO GROUP LIMITED
Glaxo Wellcome House, Berkeley Avenue,
Greenford, Middlesex UB6 0NN,
United Kingdom
(580) 2013 07 29

(111) M 2005 016073 R
(732) Glaxo Grroup Limited
980 Great West Road, Brentford, Middlesex
TW8 9GS, United Kingdom
(770) GLAXO GROUP LIMITED
Glaxo Wellcome House, Berkeley Avenue,
Greenford, Middlesex UB6 0NN,
United Kingdom
(580) 2013 07 29

(111) M 2005 016402 R
(732) Glaxo Grroup Limited
980 Great West Road, Brentford, Middlesex
TW8 9GS, United Kingdom
(770) Glaxo Group Limited
Glaxo Wellcome House, Berkeley Avenue,
Greenford, Middlesex UB6 0NN,
United Kingdom
(580) 2013 07 29

(111) M 2005 016074 R
(732) Glaxo Grroup Limited
980 Great West Road, Brentford, Middlesex
TW8 9GS, United Kingdom
(770) GLAXO GROUP LIMITED
Glaxo Wellcome House, Berkeley Avenue,
Greenford, Middlesex UB6 0NN,
United Kingdom
(580) 2013 07 29

(111) M 2005 016403 R
(732) Glaxo Grroup Limited
980 Great West Road, Brentford, Middlesex
TW8 9GS, United Kingdom
(770) Glaxo Group Limited
Glaxo Wellcome House, Berkeley Avenue,
Greenford, Middlesex UB6 0NN,
United Kingdom
(580) 2013 07 29

(111) M 2005 016214 R
(732) Glaxo Grroup Limited
980 Great West Road, Brentford, Middlesex
TW8 9GS, United Kingdom
(770) Glaxo Group Limited
Glaxo Wellcome House, Berkeley Avenue,
Greenford, Middlesex UB6 0NN,
United Kingdom
(580) 2013 07 29

(111) M 2005 016404 R
(732) Glaxo Grroup Limited
980 Great West Road, Brentford, Middlesex
TW8 9GS, United Kingdom
(770) Glaxo Group Limited
Glaxo Wellcome House, Berkeley Avenue,
Greenford, Middlesex UB6 0NN,
United Kingdom
(580) 2013 07 29

(111) M 2005 016217 R
(732) Glaxo Grroup Limited
980 Great West Road, Brentford, Middlesex
TW8 9GS, United Kingdom
(770) GLAXO GROUP LIMITED
Glaxo Wellcome House, Berkeley Avenue,
Greenford, Middlesex UB6 0NN,
United Kingdom
(580) 2013 07 29

(111) M 2005 016405 R
(732) Glaxo Grroup Limited
980 Great West Road, Brentford, Middlesex
TW8 9GS, United Kingdom
(770) Glaxo Group Limited
Glaxo Wellcome House, Berkeley Avenue,
Greenford, Middlesex UB6 0NN,
United Kingdom
(580) 2013 07 29

(111) M 2005 016406 R
(732) Glaxo Group Limited
980 Great West Road, Brentford, Middlesex
TW8 9GS, United Kingdom
(770) Glaxo Group Limited
Glaxo Wellcome House, Berkeley Avenue,
Greenford, Middlesex UB6 0NN,
United Kingdom
(580) 2013 07 29

(111) M 2006 016667 R
(732) Intercontinental Great Brands LLC.
100 Deforest Ave, East Hanover, NJ, 07936,
USA
(770) KRAFT FOODS GLOBAL BRANDS LLC
Three Lakes Drive, Northfield, Illinois 60093,
USA
(580) 2013 09 06

(111) M 2007 017664 R
(732) Glaxo Group Limited
980 Great West Road, Brentford, Middlesex
TW8 9GS, United Kingdom
(770) Glaxo Group Limited
Glaxo Wellcome House, Berkeley Avenue,
Greenford, Middlesex UB6 0NN,
United Kingdom
(580) 2013 07 29

(111) M 2007 017726 R
(732) Tibotec Pharmaceuticals
Eastgate Village, Eastgate, Little Island,
County Cork, Ireland
(770) TIBOTEC PHARMACEUTICALS LTD.
Little Island, County Cork, Ireland
(580) 2013 08 01

(111) M 2007 017726 R
(732) JANSSEN R&D IRELAND
Eastgate Village, Eastgate, Little Island,
County Cork, Ireland
(770) Tibotec Pharmaceuticals
Eastgate Village, Eastgate, Little Island,
County Cork, Ireland
(580) 2013 08 01

(111) M 2007 017727 R
(732) Tibotec Pharmaceuticals
Eastgate Village, Eastgate, Little Island,
County Cork, Ireland
(770) TIBOTEC PHARMACEUTICALS LTD.
Little Island, County Cork, Ireland

(580) 2013 08 01

(111) M 2007 017727 R
(732) JANSSEN R&D IRELAND
Eastgate Village, Eastgate, Little Island,
County Cork, Ireland
(770) Tibotec Pharmaceuticals
Eastgate Village, Eastgate, Little Island,
County Cork, Ireland
(580) 2013 08 01

(111) M 2007 017728 R
(732) Tibotec Pharmaceuticals
Eastgate Village, Eastgate, Little Island,
County Cork, Ireland
(770) TIBOTEC PHARMACEUTICALS LTD.
Little Island, County Cork, Ireland
(580) 2013 08 01

(111) M 2007 017728 R
(732) JANSSEN R&D IRELAND
Eastgate Village, Eastgate, Little Island,
County Cork, Ireland
(770) Tibotec Pharmaceuticals
Eastgate Village, Eastgate, Little Island,
County Cork, Ireland
(580) 2013 08 01

(111) M 2007 018105 R
(732) Glaxo Group Limited
980 Great West Road, Brentford, Middlesex
TW8 9GS, United Kingdom
(770) Glaxo Group Limited
Glaxo Wellcome House, Berkeley Avenue,
Greenford, Middlesex UB6 0NN,
United Kingdom
(580) 2013 07 29

(111) M 2008 018508 R
(732) Glaxo Group Limited
980 Great West Road, Brentford, Middlesex
TW8 9GS, United Kingdom
(770) Glaxo Group Limited
Glaxo Wellcome House, Berkeley Avenue,
Greenford, Middlesex UB6 0NN,
United Kingdom
(580) 2013 07 29

(111) M 2008 018977 R
(732) Glaxo Grroup Limited
980 Great West Road, Brentford, Middlesex
TW8 9GS, United Kingdom
(770) Glaxo Group Limited
Glaxo Wellcome House, Berkeley Avenue,
Greenford, Middlesex UB6 0NN,
United Kingdom
(580) 2013 07 29

(111) M 2008 018978 R
(732) Glaxo Grroup Limited
980 Great West Road, Brentford, Middlesex
TW8 9GS, United Kingdom
(770) Glaxo Group Limited
Glaxo Wellcome House, Berkeley Avenue,
Greenford, Middlesex UB6 0NN,
United Kingdom
(580) 2013 07 29

(111) M 2008 019015 R
(732) China Kweichow Moutai Distillery (Group)
Co., Ltd
No.4 East Mountain Lane, East Road of
Outside Loop, Guiyang City, Guizhou
Province, China
(770) China Kweichow Moutai Distillery Co., Ltd
No.4 East Mountain Lane, East Road of
Outside Loop, Guiyang City, Guizhou
Province, China
(580) 2013 08 14

(111) M 2009 019931 R
(732) Glaxo Grroup Limited
980 Great West Road, Brentford, Middlesex
TW8 9GS, United Kingdom
(770) Glaxo Group Limited
Glaxo Wellcome House, Berkeley Avenue,
Greenford, Middlesex UB6 0NN,
United Kingdom
(580) 2013 07 29

(111) M 2010 020255 R
(732) Glaxo Grroup Limited
980 Great West Road, Brentford, Middlesex
TW8 9GS, United Kingdom
(770) Glaxo Group Limited
Glaxo Wellcome House, Berkeley Avenue,
Greenford, Middlesex UB6 0NN,
United Kingdom
(580) 2013 07 29

(111) M 2010 020256 R
(732) Glaxo Grroup Limited
980 Great West Road, Brentford, Middlesex
TW8 9GS, United Kingdom
(770) Glaxo Group Limited
Glaxo Wellcome House, Berkeley Avenue,
Greenford, Middlesex UB6 0NN,
United Kingdom
(580) 2013 07 29

(111) M 2010 020309 R
(732) Glaxo Grroup Limited
980 Great West Road, Brentford, Middlesex
TW8 9GS, United Kingdom
(770) GLAXO GROUP LIMITED
Glaxo Wellcome House, Berkeley Avenue,
Greenford, Middlesex UB6 0NN,
United Kingdom
(580) 2013 07 29

(111) M 2010 020310 R
(732) Glaxo Grroup Limited
980 Great West Road, Brentford, Middlesex
TW8 9GS, United Kingdom
(770) GLAXO GROUP LIMITED
Glaxo Wellcome House, Berkeley Avenue,
Greenford, Middlesex UB6 0NN,
United Kingdom
(580) 2013 07 29

(111) M 2010 020587 R
(732) Glaxo Grroup Limited
980 Great West Road, Brentford, Middlesex
TW8 9GS, United Kingdom
(770) Glaxo Group Limited
Glaxo Wellcome House, Berkeley Avenue,
Greenford, Middlesex UB6 0NN,
United Kingdom
(580) 2013 07 29

(111) M 2010 020588 R
(732) Glaxo Grroup Limited
980 Great West Road, Brentford, Middlesex
TW8 9GS, United Kingdom
(770) Glaxo Group Limited
Glaxo Wellcome House, Berkeley Avenue,
Greenford, Middlesex UB6 0NN,
United Kingdom
(580) 2013 07 29

(111) M 2010 020589 R
 (732) Glaxo Group Limited
 980 Great West Road, Brentford, Middlesex
 TW8 9GS, United Kingdom
 (770) Glaxo Group Limited
 Glaxo Wellcome House, Berkeley Avenue,
 Greenford, Middlesex UB6 0NN,
 United Kingdom
 (580) 2013 07 29

(111) M 2010 020689 R
 (732) Harrington Development Inc.
 Mossfon Building. second Floor, East
 54 th street, Panama, Panama
 (770) Harrington Development Inc.,
 Arango-Orillac Bldg. East 54 th street,
 Panama, Panama
 (580) 2013 09 05

(111) M 2010 020689 R
 (732) Harrington Development Inc.
 Elvira Mendez Street, Vallarino bldg.,
 3rd Floor, Panama, Panama
 (770) Harrington Development Inc.
 Mossfon Building. second Floor, East
 54 th street, Panama, Panama
 (580) 2013 09 05

(111) M 2010 020835 R
 (732) Glaxo Group Limited
 980 Great West Road, Brentford, Middlesex
 TW8 9GS, United Kingdom
 (770) Glaxo Group Limited
 Glaxo Wellcome House, Berkeley Avenue,
 Greenford, Middlesex UB6 0NN,
 United Kingdom
 (580) 2013 07 29

(111) M 2011 021115 R
 (732) Harrington Development Inc.
 Mossfon Building. second Floor, East
 54 th street, Panama, Panama
 (770) Harrington Development Inc.
 Arango-Orillac Bldg. East 54 th street,
 Panama
 (580) 2013 09 05

(111) M 2011 021115 R
 (732) Harrington Development Inc.
 Elvira Mendez Street, Vallarino bldg.,
 3rd Floor, Panama, Panama

(770) Harrington Development Inc.
 Mossfon Building. second Floor, East
 54 th street, Panama, Panama
 (580) 2013 09 05

(111) M 2011 021300 R
 (732) Harrington Development Inc.
 Mossfon Building. second Floor, East
 54 th street, Panama, Panama
 (770) Harrington Development Inc.
 Arango-Orillac Bldg., East 54th street,
 Panama
 (580) 2013 09 05

(111) M 2011 021300 R
 (732) Harrington Development Inc.
 Elvira Mendez Street, Vallarino bldg.,
 3rd Floor, Panama, Panama
 (770) Harrington Development Inc.
 Mossfon Building. second Floor, East
 54 th street, Panama, Panama
 (580) 2013 09 05

(111) M 2011 021356 R
 (732) Harrington Development Inc.
 Mossfon Building. second Floor, East
 54 th street, Panama, Panama
 (770) Harrington Development Inc.
 Arango-Orillac Bldg. East 54 th street,
 Panama, Panama
 (580) 2013 09 05

(111) M 2011 021356 R
 (732) Harrington Development Inc.
 Elvira Mendez Street, Vallarino bldg.,
 3rd Floor, Panama, Panama
 (770) Harrington Development Inc.
 Mossfon Building. second Floor, East
 54 th street, Panama, Panama
 (580) 2013 09 05

(111) M 1996 002142 R1
 (732) Intercontinental Great Brands LLC.
 100 Deforest Ave, East Hanover, NJ, 07936,
 USA
 (770) KRAFT FOODS GLOBAL BRANDS LLC
 Three Lakes Drive, Northfield, Illinois 60093,
 USA
 (580) 2013 09 06

(111) M 1996 002147 R1
 (732) Intercontinental Great Brands LLC.
 100 Deforest Ave, East Hanover, NJ, 07936,
 USA
 (770) KRAFT FOODS GLOBAL BRANDS LLC
 Three Lakes Drive, Northfield, Illinois 60093,
 USA
 (580) 2013 09 06

(111) M 2011 021857 R
 (732) Harrington Development Inc.
 Mossfon Building. second Floor, East
 54 th street, Panama, Panama
 (770) Harrington Development Inc.
 Arango-Orillac Bldg. East 54 th street,
 Panama
 (580) 2013 09 05

(111) M 2011 021857 R
 (732) Harrington Development Inc.
 Elvira Mendez Street, Vallarino bldg.,
 3rd Floor, Panama, Panama
 (770) Harrington Development Inc.
 Mossfon Building. second Floor, East
 54 th street, Panama, Panama
 (580) 2013 09 05

(111) M 2011 021997 R
 (732) Harrington Development Inc.
 Mossfon Building. second Floor, East
 54 th street, Panama, Panama
 (770) Harrington Development Inc.
 Arango-Orillac Bldg. East 54 th street,
 Panama
 (580) 2013 09 05

(111) M 2011 021997 R
 (732) Harrington Development Inc.
 Elvira Mendez Street, Vallarino bldg.,
 3rd Floor, Panama, Panama
 (770) Harrington Development Inc.
 Mossfon Building. second Floor, East
 54 th street, Panama, Panama
 (580) 2013 09 05

(111) M 2011 022053 R
 (732) Harrington Development Inc.
 Mossfon Building. second Floor, East
 54 th street, Panama, Panama
 (770) Harrington Development Inc.
 Arango-Orillac Bldg. East 54 th street,
 Panama

(580) 2013 09 05

(111) M 2011 022053 R
 (732) Harrington Development Inc.
 Elvira Mendez Street, Vallarino bldg.,
 3rd Floor, Panama, Panama
 (770) Harrington Development Inc.
 Mossfon Building. second Floor, East
 54 th street, Panama, Panama
 (580) 2013 09 05

(111) M 2012 022427 R
 (732) Intercontinental Great Brands LLC.
 100 Deforest Ave, East Hanover, NJ, 07936,
 USA
 (770) Kraft Foods Global Brands LLC.
 Three Lakes Drive, Northfield, Illinois 60093,
 USA
 (580) 2013 09 06

(111) M 2012 022428 R
 (732) Intercontinental Great Brands LLC.
 100 Deforest Ave, East Hanover, NJ, 07936,
 USA
 (770) Kraft Foods Global Brands LLC.
 Three Lakes Drive, Northfield, Illinois 60093,
 USA
 (580) 2013 09 06

(111) M 2012 022429 R
 (732) Intercontinental Great Brands LLC.,
 100 Deforest Ave, East Hanover, NJ, 07936,
 USA
 (770) Kraft Foods Global Brands LLC.,
 Three Lakes Drive, Northfield, Illinois 60093,
 USA
 (580) 2013 09 06

(111) M 2012 022458 R
 (732) Intercontinental Great Brands LLC.
 100 Deforest Ave, East Hanover, NJ, 07936,
 USA
 (770) KRAFT FOODS GLOBAL BRANDS LLC
 Three Lakes Drive, Northfield, Illinois 60093,
 USA
 (580) 2013 09 06

(111) M 2012 022459 R
 (732) Intercontinental Great Brands LLC.
 100 Deforest Ave, East Hanover, NJ, 07936,
 USA

(770) KRAFT FOODS GLOBAL BRANDS LLC
Three Lakes Drive, Northfield, Illinois 60093,
USA
(580) 2013 09 06

(111) M 2012 022460 R
(732) Intercontinental Great Brands LLC.,
100 Deforest Ave, East Hanover, NJ, 07936,
USA
(770) KRAFT FOODS GLOBAL BRANDS LLC
Three Lakes Drive, Northfield, Illinois 60093,
USA
(580) 2013 09 06

(111) M 2012 022561 R
(732) Intercontinental Great Brands LLC.
100 Deforest Ave, East Hanover, NJ, 07936,
USA
(770) Kraft Foods Global Brands LLC
Three Lakes Drive, Northfield, Illinois 60093,
USA
(580) 2013 09 06

(111) M 2012 022607 R
(732) Intercontinental Great Brands LLC.
100 Deforest Ave, East Hanover, NJ, 07936,
USA
(770) Kraft Foods Global Brands LLC.
Three Lakes Drive, Northfield, Illinois 60093,
USA
(580) 2013 09 06

(111) M 2012 022689 R
(732) Harrington Development Inc.
Mossfon Building. second Floor, East
54 th street, Panama, Panama
(770) Harrington Development Inc.
Arango-Orillac Bldg. East 54 th street,
Panama
(580) 2013 09 05

(111) M 2012 022689 R
(732) Harrington Development Inc.
Elvira Mendez Street, Vallarino bldg.,
3rd Floor, Panama, Panama
(770) Harrington Development Inc.
Mossfon Building. second Floor, East
54 th street, Panama, Panama
(580) 2013 09 05

(111) M 2012 022690 R
(732) Harrington Development Inc.
Mossfon Building. second Floor, East
54 th street, Panama, Panama
(770) Harrington Development Inc.
Arango-Orillac Bldg. East 54 th street,
Panama
(580) 2013 09 05

(111) M 2012 022690 R
(732) Harrington Development Inc.
Elvira Mendez Street, Vallarino bldg.,
3rd Floor, Panama, Panama
(770) Harrington Development Inc.
Mossfon Building. second Floor, East
54 th street, Panama, Panama
(580) 2013 09 05

(111) M 2013 023488 R
(732) Harrington Development Inc.
Mossfon Building. second Floor, East
54 th street, Panama, Panama
(770) Harrington Development Inc.
Arango-Orillac Bldg. East 54 th street,
Panama
(580) 2013 09 05

(111) M 2013 023488 R
(732) Harrington Development Inc.
Elvira Mendez Street, Vallarino bldg.,
3rd Floor, Panama, Panama
(770) Harrington Development Inc.
Mossfon Building. second Floor, East
54 th street, Panama, Panama
(580) 2013 09 05

(111) M 2013 023496 R
(732) Harrington Development Inc.
Mossfon Building. second Floor, East
54 th street, Panama, Panama
(770) Harrington Development Inc.
Arango-Orillac Bldg. East 54 th street,
Panama
(580) 2013 09 05

(111) M 2013 023496 R
(732) Harrington Development Inc.
Elvira Mendez Street, Vallarino bldg.,
3rd Floor, Panama, Panama

(770) Harrington Development Inc.
Mossfon Building. second Floor, East
54 th street, Panama, Panama
(580) 2013 09 05

(111) M 2013 023562 R
(732) Tibotec Pharmaceuticals
Eastgate Village, Eastgate, Little Island,
County Cork, Ireland
(770) Tibotec Pharmaceuticals,
Eastgate Village, Eastgate, Little Island,
County Cork, Ireland
(580) 2013 08 01

(111) M 1996 002799 R1
(732) Intercontinental Great Brands LLC.
100 Deforest Ave, East Hanover, NJ, 07936,
USA
(770) KRAFT FOODS GLOBAL BRANDS LLC
Three Lakes Drive, Northfield, Illinois 60093,
USA
(580) 2013 09 06

(111) M 1996 003138 R1
(732) Intercontinental Great Brands LLC.
100 Deforest Ave, East Hanover, NJ, 07936,
USA
(770) KRAFT FOODS GLOBAL BRANDS LLC
Three Lakes Drive, Northfield, Illinois 60093,
USA
(580) 2013 09 06

(111) M 1996 003440 R1
(732) Intercontinental Great Brands LLC.
100 Deforest Ave, East Hanover, NJ, 07936,
USA
(770) KRAFT FOODS GLOBAL BRANDS LLC
Three Lakes Drive, Northfield, Illinois 60093,
USA
(580) 2013 09 06

(111) M 1996 003441 R1
(732) Intercontinental Great Brands LLC.
100 Deforest Ave, East Hanover, NJ, 07936,
USA
(770) KRAFT FOODS GLOBAL BRANDS LLC
Three Lakes Drive, Northfield, Illinois 60093,
USA
(580) 2013 09 06

(111) M 1996 003477 R1
(732) Boehringer Ingelheim Pharma GmbH & Co.
KG
55218 Ingelheim, (DE), Germany
(770) BOEHRINGER INGELHEIM PHARMA
GMBH & CO. KG
Binger Strasse 173, 55216 Ingelheim am
Rhein, Germany, Germany
(580) 2013 09 05

(111) M 1996 003503 R1
(732) Intercontinental Great Brands LLC.
100 Deforest Ave, East Hanover, NJ, 07936,
USA
(770) KRAFT FOODS GLOBAL BRANDS LLC
Three Lakes Drive, Northfield, Illinois 60093,
USA
(580) 2013 09 06

(111) M 1996 004169 R1
(732) NIKON CORPORATION
12-1, Yurakucho 1-chome, Chiyoda-ku,
Tokyo 100-8331, Japan
(770) NIKON CORPORATION
2-3, Marunouchi 3-chome, Chiyoda-ku,
Tokyo, Japan
(580) 2013 08 14

(111) M 1996 004279 R1
(732) Glaxo Group Limited
980 Great West Road, Brentford, Middlesex
TW8 9GS, United Kingdom
(770) Glaxo Group Limited
Glaxo Wellcome House, Berkeley Avenue,
Greenford, Middlesex UB6 0NN,
United Kingdom
(580) 2013 07 29

(111) M 1997 005157 R1
(732) Cerveceria Modelo, S.A. de C.V.
Lago Alberto N156, Colonia Anahauac, 11320
Mexico, D.F., Mexico
(770) Cerveceria Modelo, S.A. de C.V.
Lago Alberto N156, Colonia Anahuac, Miguel
Hidalgo, 11320 Mexico, D.F., Mexico
(580) 2013 08 14

(111) M 1997 005158 R1
(732) Cerveceria Modelo, S.A. de C.V.
Lago Alberto N156, Colonia Anahauac, 11320
Mexico, D.F., Mexico

(770) Cerveceria Modelo, S.A. de C.V.
Lago Alberto N156, Colonia Anahuac, Miguel
Hidalgo, 11320 Mexico, D.F., Mexico
(580) 2013 08 14

(111) M 1997 005159 R1
(732) Cerveceria Modelo, S.A. de C.V.
Lago Alberto N156, Colonia Anahuac, 11320
Mexico, D.F., Mexico
(770) Cerveceria Modelo, S.A. de C.V.
Lago Alberto N156, Colonia Anahuac, Miguel
Hidalgo, 11320 Mexico, D.F., Mexico
(580) 2013 08 14

(111) M 1997 005414 R1
(732) Glaxo Group Limited,
980 Great West Road, Brentford, Middlesex
TW8 9GS, United Kingdom
(770) Glaxo Group Limited
Glaxo Wellcome House, Berkeley Avenue,
Greenford, Middlesex UB6 0NN,
United Kingdom
(580) 2013 07 29

(111) M 1997 005924 R1
(732) Glaxo Group Limited
980 Great West Road, Brentford, Middlesex
TW8 9GS, United Kingdom
(770) Glaxo Group Limited
Glaxo Wellcome House, Berkeley Avenue,
Greenford, Middlesex UB6 0NN,
United Kingdom
(580) 2013 07 29

(111) M 1997 005925 R1
(732) Glaxo Group Limited
980 Great West Road, Brentford, Middlesex
TW8 9GS, United Kingdom
(770) Glaxo Group Limited
Glaxo Wellcome House, Berkeley Avenue,
Greenford, Middlesex UB6 0NN,
United Kingdom
(580) 2013 07 29

(111) M 1995 000608 R1
(732) Intercontinental Great Brands LLC.
100 Deforest Ave, East Hanover, NJ, 07936,
USA
(770) KRAFT FOODS GLOBAL BRANDS LLC
Three Lakes Drive, Northfield, Illinois 60093,
USA
(580) 2013 09 06

(111) M 1995 000609 R1
(732) Intercontinental Great Brands LLC.
100 Deforest Ave, East Hanover, NJ, 07936,
USA
(770) KRAFT FOODS GLOBAL BRANDS LLC
Three Lakes Drive, Northfield, Illinois 60093,
USA
(580) 2013 09 06

(111) M 1997 006257 R1
(732) Glaxo Group Limited
980 Great West Road, Brentford, Middlesex
TW8 9GS, United Kingdom
(770) Glaxo Group Limited
Glaxo Wellcome House, Berkeley Avenue,
Greenford, Middlesex UB6 0NN,
United Kingdom
(580) 2013 07 29

(111) M 1997 006258 R1
(732) Glaxo Group Limited
980 Great West Road, Brentford, Middlesex
TW8 9GS, United Kingdom
(770) Glaxo Group Limited
Glaxo Wellcome House, Berkeley Avenue,
Greenford, Middlesex UB6 0NN,
United Kingdom
(580) 2013 07 29

(111) M 1997 006259 R1
(732) Glaxo Group Limited
980 Great West Road, Brentford, Middlesex
TW8 9GS, United Kingdom
(770) Glaxo Group Limited
Glaxo Wellcome House, Berkeley Avenue,
Greenford, Middlesex UB6 0NN,
United Kingdom
(580) 2013 07 29

(111) M 1997 006260 R1
(732) Glaxo Group Limited
980 Great West Road, Brentford, Middlesex
TW8 9GS, United Kingdom
(770) Glaxo Group Limited
Glaxo Wellcome House, Berkeley Avenue,
Greenford, Middlesex UB6 0NN,
United Kingdom
(580) 2013 07 29

(111) M 1997 006779 R1
(732) Glaxo Grroup Limited
980 Great West Road, Brentford, Middlesex
TW8 9GS, United Kingdom
(770) Glaxo Group Limited
Glaxo Wellcome House, Berkeley Avenue,
Greenford, Middlesex UB6 0NN,
United Kingdom
(580) 2013 07 29

(111) M 1997 006946 R1
(732) Glaxo Grroup Limited
980 Great West Road, Brentford, Middlesex
TW8 9GS, United Kingdom
(770) Glaxo Group Limited
Glaxo Wellcome House, Berkeley Avenue,
Greenford, Middlesex UB6 0NN,
United Kingdom
(580) 2013 07 29

(111) M 1997 006983 R1
(732) Glaxo Grroup Limited
980 Great West Road, Brentford, Middlesex
TW8 9GS, United Kingdom
(770) Glaxo Group Limited
Glaxo Wellcome House, Berkeley Avenue,
Greenford, Middlesex UB6 0NN,
United Kingdom
(580) 2013 07 29

(111) M 1997 007060 R1
(732) Intercontinental Great Brands LLC.
100 Deforest Ave, East Hanover, NJ, 07936,
USA
(770) KRAFT FOODS GLOBAL BRANDS LLC
Three Lakes Drive, Northfield, Illinois 60093,
USA
(580) 2013 09 06

(111) M 1997 007204 R1
(732) Intercontinental Great Brands LLC.
100 Deforest Ave, East Hanover, NJ, 07936,
USA
(770) KRAFT FOODS GLOBAL BRANDS LLC
Three Lakes Drive, Northfield, Illinois 60093,
USA
(580) 2013 09 06

(111) M 1997 007208 R1
(732) Intercontinental Great Brands LLC.
100 Deforest Ave, East Hanover, NJ, 07936,
USA

(770) KRAFT FOODS GLOBAL BRANDS LLC
Three Lakes Drive, Northfield, Illinois 60093,
USA
(580) 2013 09 06

(111) M 1997 007266 R1
(732) Intercontinental Great Brands LLC.
100 Deforest Ave, East Hanover, NJ, 07936,
USA
(770) KRAFT FOODS GLOBAL BRANDS LLC
Three Lakes Drive, Northfield, Illinois 60093,
USA
(580) 2013 09 06

(111) M 1997 007268 R1
(732) Intercontinental Great Brands LLC.
100 Deforest Ave, East Hanover, NJ, 07936,
USA
(770) KRAFT FOODS GLOBAL BRANDS LLC
Three Lakes Drive, Northfield, Illinois 60093,
USA
(580) 2013 09 06

(111) M 1997 007664 R1
(732) Glaxo Grroup Limited
980 Great West Road, Brentford, Middlesex
TW8 9GS, United Kingdom
(770) Glaxo Group Limited
Glaxo Wellcome House, Berkeley Avenue,
Greenford, Middlesex UB6 0NN,
United Kingdom
(580) 2013 07 29

(111) M 1997 007665 R1
(732) Glaxo Grroup Limited
980 Great West Road, Brentford, Middlesex
TW8 9GS, United Kingdom
(770) Glaxo Group Limited
Glaxo Wellcome House, Berkeley Avenue,
Greenford, Middlesex UB6 0NN,
United Kingdom
(580) 2013 07 29

(111) M 1997 007666 R1
(732) Glaxo Grroup Limited
980 Great West Road, Brentford, Middlesex
TW8 9GS, United Kingdom
(770) Glaxo Group Limited
Glaxo Wellcome House, Berkeley Avenue,
Greenford, Middlesex UB6 0NN,
United Kingdom
(580) 2013 07 29

(111) M 1997 007678 R1
(732) Glaxo Grroup Limited
980 Great West Road, Brentford, Middlesex
TW8 9GS, United Kingdom
(770) Glaxo Group Limited
Glaxo Wellcome House, Berkeley Avenue,
Greenford, Middlesex UB6 0NN,
United Kingdom
(580) 2013 07 29

(111) M 1997 007680 R1
 (732) Glaxo Grroup Limited
 980 Great West Road, Brentford, Middlesex
 TW8 9GS, United Kingdom
 (770) Glaxo Group Limited
 Glaxo Wellcome House, Berkeley Avenue,
 Greenford, Middlesex UB6 0NN,
 United Kingdom
 (580) 2013 07 29

(111) M 1997 007681 R1
 (732) Glaxo Grroup Limited,
 980 Great West Road, Brentford, Middlesex
 TW8 9GS, United Kingdom
 (770) Glaxo Group Limited
 Glaxo Wellcome House, Berkeley Avenue,
 Greenford, Middlesex UB6 0NN,
 United Kingdom
 (580) 2013 07 29

(111) M 1997 007682 R1
 (732) Glaxo Grroup Limited
 980 Great West Road, Brentford, Middlesex
 TW8 9GS, United Kingdom
 (770) Glaxo Group Limited
 Glaxo Wellcome House, Berkeley Avenue,
 Greenford, Middlesex UB6 0NN,
 United Kingdom
 (580) 2013 07 29

(111) M 1997 007684 R1
 (732) Glaxo Grroup Limited
 980 Great West Road, Brentford, Middlesex
 TW8 9GS, United Kingdom
 (770) Glaxo Group Limited
 Glaxo Wellcome House, Berkeley Avenue,
 Greenford, Middlesex UB6 0NN,
 United Kingdom
 (580) 2013 07 29

(111) M 1997 007685 R1
 (732) Glaxo Grroup Limited
 980 Great West Road, Brentford, Middlesex
 TW8 9GS, United Kingdom
 (770) Glaxo Group Limited
 Glaxo Wellcome House, Berkeley Avenue,
 Greenford, Middlesex UB6 0NN,
 United Kingdom
 (580) 2013 07 29

(111) M 1997 007686 R1
 (732) Glaxo Grroup Limited
 980 Great West Road, Brentford, Middlesex
 TW8 9GS, United Kingdom
 (770) Glaxo Group Limited
 Glaxo Wellcome House, Berkeley Avenue,
 Greenford, Middlesex UB6 0NN,
 United Kingdom
 (580) 2013 07 29

(111) M 1997 007798 R1
 (732) Glaxo Grroup Limited
 980 Great West Road, Brentford, Middlesex
 TW8 9GS, United Kingdom
 (770) Glaxo Group Limited
 Glaxo Wellcome House, Berkeley Avenue,
 Greenford, Middlesex UB6 0NN,
 United Kingdom
 (580) 2013 07 29

(111) M 1997 007824 R1
 (732) CERVECERIA DEL PACIFICO, S. DE R.L.
 DE C.V.
 Calzada Gabriel Leyva y Melchor Ocampo
 s/n, Colonia Centro, 82000 Mazatlan,
 Sinaloa, Mexico
 (770) CERVECERIA DEL PACIFICO, S.A. DE
 C.V.
 Calzada Gabriel Leyva y Melchor Ocampo
 s/n, Colonia Centro, 82000 Mazatlan, Sinaloa,
 Mexico
 (580) 2013 08 14

(111) M 1997 007825 R1
 (732) Cerveceria Modelo, S.A. de C.V.
 Lago Alberto N156, Colonia Anahuac,
 11320 Mexico, D.F., Mexico
 (770) Cerveceria Modelo, S.A. de C.V.
 Lago Alberto N156, Colonia Anahuac, Miguel
 Hidalgo, 11320 Mexico, D.F., Mexico
 (580) 2013 08 14

(111) M 1998 008101 R1
 (732) Glaxo Grroup Limited
 980 Great West Road, Brentford, Middlesex
 TW8 9GS, United Kingdom
 (770) Glaxo Group Limited
 Glaxo Wellcome House, Berkeley Avenue,
 Greenford, Middlesex UB6 0NN,
 United Kingdom
 (580) 2013 07 29

(111) M 1998 008173 R1
(732) Glaxo Grroup Limited
980 Great West Road, Brentford, Middlesex
TW8 9GS, United Kingdom
(770) Glaxo Group Limited
Glaxo Wellcome House, Berkeley Avenue,
Greenford, Middlesex UB6 0NN,
United Kingdom
(580) 2013 07 29

(111) M 1998 008174 R1
(732) Glaxo Grroup Limited
980 Great West Road, Brentford, Middlesex
TW8 9GS, United Kingdom
(770) Glaxo Group Limited
Glaxo Wellcome House, Berkeley Avenue,
Greenford, Middlesex UB6 0NN,
United Kingdom
(580) 2013 07 29

(111) M 1998 008207 R1
(732) Glaxo Grroup Limited
980 Great West Road, Brentford, Middlesex
TW8 9GS, United Kingdom
(770) Glaxo Group Limited
Glaxo Wellcome House, Berkeley Avenue,
Greenford, Middlesex UB6 0NN,
United Kingdom
(580) 2013 07 29

(111) M 1998 008210 R1
(732) Glaxo Grroup Limited
980 Great West Road, Brentford, Middlesex
TW8 9GS, United Kingdom
(770) Glaxo Group Limited
Glaxo Wellcome House, Berkeley Avenue,
Greenford, Middlesex UB6 0NN,
United Kingdom
(580) 2013 07 29

(111) M 1998 008211 R1
(732) Glaxo Grroup Limited
980 Great West Road, Brentford, Middlesex
TW8 9GS, United Kingdom
(770) Glaxo Group Limited
Glaxo Wellcome House, Berkeley Avenue,
Greenford, Middlesex UB6 0NN,
United Kingdom
(580) 2013 07 29

(111) M 1998 008218 R1
(732) Glaxo Grroup Limited
980 Great West Road, Brentford, Middlesex
TW8 9GS, United Kingdom
(770) Glaxo Group Limited
Glaxo Wellcome House, Berkeley Avenue,
Greenford, Middlesex UB6 0NN,
United Kingdom
(580) 2013 07 29

(111) M 1998 008363 R1
(732) Intercontinental Great Brands LLC.
100 Deforest Ave, East Hanover, NJ, 07936,
USA
(770) KRAFT FOODS GLOBAL BRANDS LLC
Three Lakes Drive, Northfield, Illinois 60093,
USA
(580) 2013 09 06

(111) M 1998 008367 R1
(732) Intercontinental Great Brands LLC.
100 Deforest Ave, East Hanover, NJ, 07936,
USA
(770) KRAFT FOODS GLOBAL BRANDS LLC
Three Lakes Drive, Northfield, Illinois 60093,
USA
(580) 2013 09 06

(111) M 1998 008500 R1
(732) Intercontinental Great Brands LLC.
100 Deforest Ave, East Hanover, NJ, 07936,
USA
(770) KRAFT FOODS GLOBAL BRANDS LLC
Three Lakes Drive, Northfield, Illinois 60093,
USA
(580) 2013 09 06

(111) M 1998 008541 R1
(732) Glaxo Grroup Limited
980 Great West Road, Brentford, Middlesex
TW8 9GS, United Kingdom
(770) Glaxo Group Limited
Glaxo Wellcome House, Berkeley Avenue,
Greenford, Middlesex UB6 0NN,
United Kingdom
(580) 2013 07 29

(111) M 1998 008542 R1
(732) Glaxo Grroup Limited
980 Great West Road, Brentford, Middlesex
TW8 9GS, United Kingdom
(770) Glaxo Group Limited
Glaxo Wellcome House, Berkeley Avenue,
Greenford, Middlesex UB6 0NN,
United Kingdom
(580) 2013 07 29

(111) M 1998 008544 R1
(732) Glaxo Grroup Limited
980 Great West Road, Brentford, Middlesex
TW8 9GS, United Kingdom
(770) Glaxo Group Limited
Glaxo Wellcome House, Berkeley Avenue,
Greenford, Middlesex UB6 0NN,
United Kingdom
(580) 2013 07 29

(111) M 1998 008546 R1
(732) Glaxo Grroup Limited
980 Great West Road, Brentford, Middlesex
TW8 9GS, United Kingdom
(770) Glaxo Group Limited
Glaxo Wellcome House, Berkeley Avenue,
Greenford, Middlesex UB6 0NN,
United Kingdom
(580) 2013 07 29

(111) M 1998 009082 R1
(732) Glaxo Grroup Limited
980 Great West Road, Brentford, Middlesex
TW8 9GS, United Kingdom
(770) Glaxo Group Limited
Glaxo Wellcome House, Berkeley Avenue,
Greenford, Middlesex UB6 0NN,
United Kingdom
(580) 2013 07 29

(111) M 1998 009597 R1
(732) Glaxo Grroup Limited
980 Great West Road, Brentford, Middlesex
TW8 9GS, United Kingdom
(770) Glaxo Group Limited
Glaxo Wellcome House, Berkeley Avenue,
Greenford, Middlesex UB6 0NN,
United Kingdom
(580) 2013 07 29

(111) M 1998 009602 R1
(732) Cerveceria Modelo, S.A. de C.V.
Lago Alberto N156, Colonia Anahauac, 11320
Mexico, D.F., Mexico
(770) Cerveceria Modelo, S.A. de C.V.
Lago Alberto N156, Colonia Anahauac, 11320
Mexico, D.F., Mexico
(580) 2013 08 14

(111) M 1998 009603 R1
(732) Cerveceria Modelo, S.A. de C.V.
Lago Alberto N156, Colonia Anahauac, 11320
Mexico, D.F., Mexico
(770) Cerveceria Modelo, S.A. de C.V.
Lago Alberto N156, Colonia Anahauac, 11320
Mexico, D.F., Mexico
(580) 2013 08 14

(111) M 1998 009833 R1
(732) Glaxo Grroup Limited
980 Great West Road, Brentford, Middlesex
TW8 9GS, United Kingdom
(770) Glaxo Group Limited
Glaxo Wellcome House, Berkeley Avenue,
Greenford, Middlesex UB6 0NN,
United Kingdom
(580) 2013 07 29

(111) M 1998 009834 R1
(732) Glaxo Grroup Limited
980 Great West Road, Brentford, Middlesex
TW8 9GS, United Kingdom
(770) Glaxo Group Limited
Glaxo Wellcome House, Berkeley Avenue,
Greenford, Middlesex UB6 0NN,
United Kingdom
(580) 2013 07 29

(111) M 1998 009835 R1
(732) Glaxo Grroup Limited
980 Great West Road, Brentford, Middlesex
TW8 9GS, United Kingdom
(770) Glaxo Group Limited
Glaxo Wellcome House, Berkeley Avenue,
Greenford, Middlesex UB6 0NN,
United Kingdom
(580) 2013 07 29

(111) M 1998 009937 R1
(732) Intercontinental Great Brands LLC.
100 Deforest Ave, East Hanover, NJ, 07936,
USA
(770) KRAFT FOODS GLOBAL BRANDS LLC
Three Lakes Drive, Northfield, Illinois 60093,
USA
(580) 2013 09 06

(111) M 1998 009938 R1
(732) Intercontinental Great Brands LLC.
100 Deforest Ave, East Hanover, NJ, 07936,
USA
(770) KRAFT FOODS GLOBAL BRANDS LLC
Three Lakes Drive, Northfield, Illinois 60093,
USA
(580) 2013 09 06

(111) M 1998 009976 R1
(732) Glaxo Group Limited
980 Great West Road, Brentford, Middlesex
TW8 9GS, United Kingdom
(770) Glaxo Group Limited
Glaxo Wellcome House, Berkeley Avenue,
Greenford, Middlesex UB6 0NN,
United Kingdom
(580) 2013 07 29

(111) M 1998 009979 R1
(732) Glaxo Group Limited
980 Great West Road, Brentford, Middlesex
TW8 9GS, United Kingdom
(770) Glaxo Group Limited
Glaxo Wellcome House, Berkeley Avenue,
Greenford, Middlesex UB6 0NN,
United Kingdom
(580) 2013 07 29

REFUSAL TO GRANT INTERNATIONAL
TRADEMARK PROTECTION

(800) 1076327
(151) 2011 03 09
(181) 2021 03 09
(511) 01, 03, 04
(731) UAB "SCT Lubricants"
Silutes pl. 119, LT-95112 Klaipeda, Lithuania
(540)

CHEMPIOIL

(141) 2013 08 22
Grounds: Decree No.64 of 22.09.2013 of the Chairman of SAKPATENTI for the purpose of enforcement of the Decision (Case No.3/111-12) rendered on 11.04.2013 by Mtskheta Regional Court Administrative Cases Board.

CANCELLATION OF INTERNATIONAL TRADEMARK PROTECTION
FOR SOME GOODS LISTED IN APPLICATION

(800) 911443
(151) 2006 05 03
(181) 2016 05 03
(511) 09, 35, 36, 38, 39, 41
(731) TÜRKİYE GARANTİ BANKASI ANONİM ŞİRKET
Levent Nispetiye Mahallesi, Aytar Caddesi No. 2, Beşiktaş, İSTANBUL, Turkey
(540)

Flexi

(141) 2013 09 23
Protection of whole list of 9 class goods is cancelled.
Grounds: Decree No.71 of 20.09.2013 of the Chairman of SAKPATENTI for the purpose of enforcement of the Decision (Case No.2/4479-13) rendered on 24.06.2013 of Tbilisi City Court Civil Cases Board.

ANNULMENT OF INTERNATIONAL TRADEMARK PROTECTION

(800) 1033185

(151) 2010 01 07

(181) 2020 01 07

(731) LIMITED LIABILITY COMPANY AVTOTRANSPORTNOE ENTERPRISE "BYTOVIK"

3 Garazhnaya Street, Malakhovka, Lyuberetsky District, RU-140032 Moscow Region, Russian Federation

(540)

MONSTER

(141) 2013 09 23

Grounds: Decree No.72 of 20.09.2012 of the Chairman of SAKPATENTI for the purpose of enforcement of the Decision (Case No.2/4051-12) rendered on 18.09.2012 of Tbilisi City Court Civil Cases Board.

CLASSIFICATION INDEXES

INVENTIONS

CONCORDANCE TABLE OF INTERNATIONAL CLASSIFICATION INDEX AND PUBLICATION NUMBERS

INTERNATIONAL CLASSIFICATION INDEXES (51)	NUMBER OF PUBLISHED APPLICATION (10)
A 01 N 43/58; A 61 K 31/50	AP 2013 12363 A
A 61 K 9/00; A 61 K 38/00; A 61 K 38/08; A 61 K 38/17; A 61 P 35/00	AP 2013 12275 A
A 61 K 31/167; A 61 K 31/57; A 61 P 11/06	AP 2013 11515 A
A 61 P 35/00; A 61 K 31/495; C 07 D 401/04; C 07 D 401/10; C 07 D 401/12; C 07 D 401/14; C 07 D 405/04; C 07 D 405/12; C 07 D 409/12; C 07 D 413/10; C 07 D 413/12; C 07 D 417/12; C 07 D 405/14; C 07 D 413/14; C 07 D 217/24	AP 2013 12760 A
B 01 D 47/06	AP 2013 12709 A
B 60 T 1/14	AP 2013 12557 A
C 07 D 311/08	AP 2013 12253 A
C 07 D 277/82; C 07 D 417/12; A 61 K 31/428; A 61 K 31/496; A 61 P 35/00	AP 2013 12278 A
C 07 D 295/135	AP 2013 12498 A
C 07 D 213/69; A 61 K 31/4422; A 61 P 11/00; A 61 P 13/12; A 61 P 25/28; A 61 P 35/00	AP 2013 12556 A
C 07 C 251/44; C 07 D 231/14; C 07 C 45/62; C 07 C 45/64; C 07 C 45/66; C 07 C 45/69; C 07 C 49/693; C 07 C 49/743	AP 2013 12617 A
C 07 D 471/04; C 07 D 498/04; C 07 D 513/04; A 61 K 31/4355; A 61 K 31/4365; A 61 K 31/437; A 61 P 29/00; A 61 P 35/00	AP 2013 12696 A
E 02 F 3/43	AP 2013 12524 A
F 01 C 1/00	AP 2013 12276 A

CONCORDANCE TABLE OF APPLICATION APPLICATION PUBLICATION NUMBERS AND INTERNATIONAL CLASSIFICATION INDEXES

NUMBER OF PUBLISHED APPLICATION (10)	INTERNATIONAL CLASSIFICATION INDEXES (51)
AP 2013 12363 A	A 01 N 43/58; A 61 K 31/50
AP 2013 12275 A	A 61 K 9/00; A 61 K 38/00; A 61 K 38/08; A 61 K 38/17; A 61 P 35/00
AP 2013 11515 A	A 61 K 31/167; A 61 K 31/57; A 61 P 11/06
AP 2013 12760 A	A 61 P 35/00; A 61 K 31/495; C 07 D 401/04; C 07 D 401/10; C 07 D 401/12; C 07 D 401/14; C 07 D 405/04; C 07 D 405/12; C 07 D 409/12; C 07 D 413/10; C 07 D 413/12; C 07 D 417/12; C 07 D 405/14; C 07 D 413/14; C 07 D 217/24
AP 2013 12709 A	B 01 D 47/06
AP 2013 12557 A	B 60 T 1/14
AP 2013 12253 A	C 07 D 311/08
AP 2013 12278 A	C 07 D 277/82; C 07 D 417/12; A 61 K 31/428; A 61 K 31/496; A 61 P 35/00
AP 2013 12498 A	C 07 D 295/135
AP 2013 12556 A	C 07 D 213/69; A 61 K 31/4422; A 61 P 11/00; A 61 P 13/12; A 61 P 25/28; A 61 P 35/00
AP 2013 12617 A	C 07 C 251/44; C 07 D 231/14; C 07 C 45/62; C 07 C 45/64; C 07 C 45/66; C 07 C 45/69; C 07 C 49/693; C 07 C 49/743
AP 2013 12696 A	C 07 D 471/04; C 07 D 498/04; C 07 D 513/04; A 61 K 31/4355; A 61 K 31/4365; A 61 K 31/437; A 61 P 29/00; A 61 P 35/00
AP 2013 12524 A	E 02 F 3/43
AP 2013 12276 A	F 01 C 1/00

**CONCORDANCE TABLE OF INTERNATIONAL CLASSIFICATION INDEXES,
PATENT NUMBERS AND PUBLICATION NUMBERS**

INTERNATIONAL CLASSIFICATION INDEX (51)	NUMBER OF PATENT (11)	NUMBER OF PUBLISHED APPLICATION (10)
A 61 F 13/10	P 2013 5920 B	AP 2013 12122 A
C 04 B 28/00	P 2013 5922 B	AP 2013 12741 A
E 02 D 27/32	P 2013 5921 B	AP 2013 12740 A
H 01 S 3/20	P 2013 5923 B	AP 2013 12246 A

**CONCORDANCE TABLE OF PATENT NUMBERS,
PUBLICATION NUMBERS AND INTERNATIONAL CLASSIFICATION INDEXES**

NUMBER OF PATENT (11)	NUMBER OF PUBLISHED APPLICATION (10)	INTERNATIONAL CLASSIFICATION INDEX (51)
P 2013 5920 B	AP 2013 12122 A	A 61 F 13/10
P 2013 5923 B	AP 2013 12246 A	H 01 S 3/20
P 2013 5921 B	AP 2013 12740 A	E 02 D 27/32
P 2013 5922 B	AP 2013 12741 A	C 04 B 28/00

**CONCORDANCE TABLE OF APPLICATION NUMBERS, APPLICATION
PUBLICATION NUMBERS AND PATENT NUMBERS**

NUMBER OF APPLICATION (21)	NUMBER OF PUBLISHED APPLICATION (10)	NUMBER OF PATENT (11)
AP 2009 012122	AP 2013 12122 A	P 2013 5920 B
AP 2011 012246	AP 2013 12246 A	P 2013 5923 B
AP 2012 012740	AP 2013 12740 A	P 2013 5921 B
AP 2012 012741	AP 2013 12741 A	P 2013 5922 B

UTILITY MODELS

**CONCORDANCE TABLE OF INTERNATIONAL CLASSIFICATION INDEX,
PATENT NUMBERS AND PUBLICATION NUMBERS**

INTERNATIONAL CLASSIFICATION INDEX (51)	NUMBER OF PATENT (11)	NUMBER OF PUBLISHED APPLICATION (10)
F 24 C 3/00	U 2013 1780 Y	AU 2013 12938 U

CONCORDANCE TABLE OF PATENT NUMBERS,
PUBLICATION NUMBERS AND INTERNATIONAL CLASSIFICATION INDEX

NUMBER OF PATENT (11)	NUMBER OF PUBLISHED APPLICATION (10)	INTERNATIONAL CLASSIFICATION INDEX (51)
U 2013 1780 Y	AU 2013 12938 U	F 24 C 3/00

CONCORDANCE TABLE OF APPLICATION NUMBERS, PUBLICATION NUMBERS AND PATENTS

NUMBER OF APPLICATION (21)	NUMBER OF PUBLISHED APPLICATION (10)	NUMBER OF PATENT (11)
AU 2012 012938	AU 2013 12938 U	U 2013 1780 Y

DESIGNS

CONCORDANCE TABLE OF INTERNATIONAL CLASSIFICATION INDEX,
PATENT NUMBERS AND PUBLICATION NUMBERS

INTERNATIONAL CLASSIFICATION INDEX (51)	NUMBER OF PATENT (11)	NUMBER OF PUBLISHED APPLICATION (10)
09-01	D 2013 555 S	AD 2013 741 S

CONCORDANCE TABLE OF PATENT NUMBERS,
PUBLICATION NUMBERS AND INTERNATIONAL CLASSIFICATION INDEXES

NUMBER OF PATENT (11)	NUMBER OF PUBLISHED APPLICATION (10)	INTERNATIONAL CLASSIFICATION INDEX (51)
D 2013 555 S	AD 2013 741 S	09-01

CONCORDANCE TABLE OF APPLICATION NUMBERS, PUBLICATION NUMBERS AND PATENT NUMBERS

NUMBER OF APPLICATION (21)	NUMBER OF PUBLISHED APPLICATION (10)	NUMBER OF PATENT (11)
AD 2013 000741	AD 2013 741 S	D 2013 555 S

TRADEMARKS

CONCORDANCE TABLE OF REGISTRATION NUMBERS, APPLICATION NUMBERS, PUBLICATION NUMBERS AND BULLETIN NUMBERS

NUMBER OF REGISTRATION (111)	NUMBER OF APPLICATION (210)	NUMBER OF PUBLISHED APPLICATION (260)	NUMBER OF BULLETIN
1	2	3	4
M 2013 24012 R	AM 2013 73569	-	18(382) 2013
M 2013 24013 R	AM 2013 73696	-	18(382) 2013
M 2013 24014 R	AM 2013 73491	-	18(382) 2013
M 2013 24015 R	AM 2013 73664	-	18(382) 2013
M 2013 24016 R	AM 2013 73665	-	18(382) 2013
M 2013 24017 R	AM 2013 72813	-	18(382) 2013
M 2013 24018 R	AM 2012 66278	AM 2013 66278 A	6(370) 2013
M 2013 24019 R	AM 2012 66549	AM 2013 66549 A	9(373) 2013
M 2013 24020 R	AM 2012 66560	AM 2013 66560 A	5(369) 2013
M 2013 24021 R	AM 2012 67026	AM 2013 67026 A	10(374) 2013
M 2013 24022 R	AM 2012 67162	AM 2013 67162 A	7(371) 2013
M 2013 24023 R	AM 2012 67180	AM 2013 67180 A	6(370) 2013
M 2013 24024 R	AM 2012 67181	AM 2013 67181 A	6(370) 2013
M 2013 24025 R	AM 2012 67263	AM 2013 67263 A	5(369) 2013
M 2013 24026 R	AM 2012 67297	AM 2013 67297 A	7(371) 2013
M 2013 24027 R	AM 2012 67338	AM 2013 67338 A	5(369) 2013
M 2013 24028 R	AM 2012 67339	AM 2013 67339 A	5(369) 2013
M 2013 24029 R	AM 2012 67427	AM 2013 67427 A	6(370) 2013
M 2013 24030 R	AM 2012 67467	AM 2013 67467 A	10(374) 2013
M 2013 24031 R	AM 2012 67496	AM 2013 67496 A	5(369) 2013
M 2013 24032 R	AM 2012 67579	AM 2013 67579 A	8(372) 2013
M 2013 24033 R	AM 2012 67585	AM 2013 67585 A	9(373) 2013
M 2013 24034 R	AM 2012 67616	AM 2013 67616 A	8(372) 2013
M 2013 24035 R	AM 2012 67617	AM 2013 67617 A	8(372) 2013
M 2013 24036 R	AM 2012 67701	AM 2013 67701 A	7(371) 2013
M 2013 24037 R	AM 2012 67864	AM 2013 67864 A	8(372) 2013
M 2013 24038 R	AM 2012 67865	AM 2013 67865 A	8(372) 2013
M 2013 24039 R	AM 2012 68027	AM 2013 68027 A	8(372) 2013
M 2013 24040 R	AM 2012 68028	AM 2013 68028 A	8(372) 2013
M 2013 24041 R	AM 2012 68053	AM 2013 68053 A	7(371) 2013
M 2013 24042 R	AM 2012 68056	AM 2013 68056 A	7(371) 2013
M 2013 24043 R	AM 2012 68057	AM 2013 68057 A	8(372) 2013
M 2013 24044 R	AM 2012 68058	AM 2013 68058 A	8(372) 2013
M 2013 24045 R	AM 2012 68059	AM 2013 68059 A	7(371) 2013
M 2013 24046 R	AM 2012 68060	AM 2013 68060 A	7(371) 2013
M 2013 24047 R	AM 2012 68061	AM 2013 68061 A	8(372) 2013
M 2013 24048 R	AM 2012 68062	AM 2013 68062 A	8(372) 2013
M 2013 24049 R	AM 2012 68150	AM 2013 68150 A	8(372) 2013
M 2013 24050 R	AM 2012 68157	AM 2013 68157 A	8(372) 2013
M 2013 24051 R	AM 2012 68194	AM 2013 68194 A	10(374) 2013
M 2013 24052 R	AM 2012 68195	AM 2013 68195 A	10(374) 2013
M 2013 24053 R	AM 2012 68199	AM 2013 68199 A	10(374) 2013
M 2013 24054 R	AM 2012 68247	AM 2013 68247 A	10(374) 2013
M 2013 24055 R	AM 2012 68249	AM 2013 68249 A	10(374) 2013
M 2013 24056 R	AM 2012 68261	AM 2013 68261 A	10(374) 2013
M 2013 24057 R	AM 2012 68262	AM 2013 68262 A	10(374) 2013

1	2	3	4
M 2013 24058 R	AM 2012 68398	AM 2013 68398 A	10(374) 2013
M 2013 24059 R	AM 2012 68478	AM 2013 68478 A	9(373) 2013
M 2013 24060 R	AM 2012 68522	AM 2013 68522 A	10(374) 2013
M 2013 24061 R	AM 2012 68673	AM 2013 68673 A	10(374) 2013
M 2013 24062 R	AM 2013 73881	-	18(382) 2013
M 2013 24063 R	AM 2013 73875	-	18(382) 2013
M 2013 24064 R	AM 2013 73874	-	18(382) 2013
M 2013 24065 R	AM 2013 73865	-	18(382) 2013

**CONCORDANCE TABLE OF PUBLICATION NUMBERS
AND APPLICATION NUMBERS**

NUMBER OF PUBLISHED APPLICATION (260)	NUMBER OF APPLICATION (210)	1	2
1	2		
AM 2013 64997 A	AM 2011 64997	AM 2013 70015 A	AM 2012 70015
AM 2013 69542 A	AM 2012 69542	AM 2013 70041 A	AM 2012 70041
AM 2013 69552 A	AM 2012 69552	AM 2013 70071 A	AM 2012 70071
AM 2013 69553 A	AM 2012 69553	AM 2013 70072 A	AM 2012 70072
AM 2013 69655 A	AM 2012 69655	AM 2013 70114 A	AM 2012 70114
AM 2013 69719 A	AM 2012 69719	AM 2013 70118 A	AM 2012 70118
AM 2013 69720 A	AM 2012 69720	AM 2013 70188 A	AM 2012 70188
AM 2013 69785 A	AM 2012 69785	AM 2013 70191 A	AM 2012 70191
AM 2013 69786 A	AM 2012 69786	AM 2013 70208 A	AM 2013 70208
AM 2013 69878 A	AM 2012 69878	AM 2013 70220 A	AM 2013 70220
AM 2013 69879 A	AM 2012 69879	AM 2013 70730 A	AM 2013 70730
AM 2013 69930 A	AM 2012 69930	AM 2013 70790 A	AM 2013 70790
		AM 2013 67866* A	AM 2012 67866
		AM 2013 69239* A	AM 2012 69239

**CONCORDANCE TABLE OF INDEX OF GOODS AND/OR SERVICES
AND APPLICATION NUMBERS**

INDEX OF GOODS AND/OR SERVICES (511)	NUMBER OF PUBLISHED APPLICATION (260)	1	2
1	2		
3	AM 2013 69878 A	30	AM 2013 70191 A
3	AM 2013 69879 A	30	AM 2013 70208 A
5	AM 2013 70071 A	30	AM 2013 70790 A
5	AM 2013 70072 A	32	AM 2013 69552 A
5	AM 2013 70730 A	32	AM 2013 69553 A
10	AM 2013 70220 A	32	AM 2013 70041 A
19	AM 2013 69720 A	32	AM 2013 70208 A
29	AM 2013 70015 A	33	AM 2013 69655 A
29	AM 2013 70041 A	33	AM 2013 69785 A
29	AM 2013 70208 A	33	AM 2013 69786 A
30	AM 2013 64997 A	33	AM 2013 70114 A
30	AM 2013 69552 A	33	AM 2013 67866 A*
30	AM 2013 69553 A	34	AM 2013 70118 A
30	AM 2013 70015 A	35	AM 2013 69930 A
		35	AM 2013 70191 A
		36	AM 2013 70188 A
		36	AM 2013 69239 A*
		37	AM 2013 69720 A
		37	AM 2013 69239 A*

1	2
38	AM 2013 69930 A
39	AM 2013 69542 A
41	AM 2013 69719 A
41	AM 2013 69720 A

1	2
43	AM 2013 70015 A
43	AM 2013 70191 A
43	AM 2013 70790 A

CONCORDANCE TABLE OF INDEX OF GOODS AND/OR SERVICES
AND NUMBERS OF TRADEMARKS REGISTERED ACCORDING
TO THE ACCELERATED PROCEDURE

INDEX OF GOODS AND/OR SERVICES (511)	NUMBER OF REGISTERED ACCORDING TO THE ACCELERATED PROCEDURE (111)
1	M 2013 24065 R
2	M 2013 24064 R
9	M 2013 24063 R
29	M 2013 24014 R
29	M 2013 24062 R
32	M 2013 24017 R
33	M 2013 24013 R
34	M 2013 24015 R
34	M 2013 24016 R
35	M 2013 24014 R
35	M 2013 24065 R
43	M 2013 24012 R
44	M 2013 24065 R

OFFICIAL BULLETIN OF THE INDUSTRIAL PROPERTY

18(382)

EDITOR-IN-CHIEF: N. Bebrishvili

EDITORS-TRANSLATORS: E. Gabunia
G. Nadareishvili

PROOFREADER: L. Chanturia

COMPUTER LAYOUT: K. Svanidze

www.sakpatenti.org.ge

E-mail: info@sakpatenti.org.ge