



**NATIONAL INTELLECTUAL PROPERTY CENTER OF GEORGIA
SAKPATENTI**

**OFFICIAL BULLETIN
OF THE INDUSTRIAL PROPERTY**

19(359)

**2012
TBILISI**

INID CODES FOR IDENTIFICATION OF BIBLIOGRAPHIC DATA

INVENTIONS, UTILITY MODELS

- (10) Number of publication for application, which has been examined
- (11) Number of patent and kind of document
- (21) Serial number of application
- (22) Date of filing of the application
- (23) Date of exhibition or the date of the earlier filing and the number of application, if any
- (24) Date from which patent may have effect
- (31) Number of priority application
- (32) Date of filing of priority application
- (33) Code of the country or regional organization allotting priority application number
- (44) Date of publication of application not granted, but examined and number of bulletin
- (45) Date of publication of registered document
- (51) International Patent Classification Index
- (54) Title of the invention
- (57) Abstract
- (60) Number of examined patent document granted by foreign patent office, date from which patent has effect and country code
- (62) Number of the earlier application and in case of divided application, date of filing an application
- (71) Name, surname and address of applicant (country code)
- (72) Name, surname of inventor (country code)
- (73) Name, surname and address of patent owner (country code)
- (74) Name, surname of representative or patent attorney
- (85) Date of commencement of the national phase of International Application
- (86) Number and date of filing of international application
- (87) Number and date of publication of international application

DESIGNS

- (10) Number of publication for application
- (11) Number of patent and kind of document or number of registration
- (15) Date of registration/Date of patent renewal
- (18) Expected expiration date of patent or registration
- (21) Serial number of application
- (22) Date of filing of the application
- (23) Date of exhibition or the date of the earlier filing and the number of application, if any
- (24) Date from which patent may have effect
- (28) Number of designs included in the application
- (30) Data relating to priority (number of application, date of filing of application, two-letter code identifying the authority with whom the priority application was made)
- (31) Number of priority application
- (32) Date of filing of priority application
- (33) Code of the country or regional organization allotting priority application number
- (34) Two-letter code according to WIPO St.3 identifying the authority with which the priority application was made
- (44) Date of publication of design and number of bulletin (the first publication)
- (45) Date of publication of design registered by WIPO and number of bulletin
- (51) International Classification for designs (class and subclass of the Locarno Classification)
- (54) Title of the invention
- (55) Reproduction of the design
- (57) Description of characteristic features of the design including indication of colors
- (58) Date of recording of any kind of amendment in the Register
- (62) Number of the earlier application, registration and document number and if available the date of filing an application in case of divided application
- (71) Name, surname and address of applicant (country code)
- (72) Name, surname of creator (country code)
- (73) Name, surname and address of patent owner (country code)
- (74) Name, surname of representative or patent attorney
- (81) Contracting states concerned
 - II designated contracting states according to the 1960 Act
 - III designated contracting states according to the 1999 Act
- (85) Owner's permanent address
- (86) Owner's nationality
- (87) Owner's residence
- (88) State in which the owner has a real and effective industrial or commercial establishment

TRADEMARKS

- (111) – Number of registration
- (151) – Date of registration
- (156) – Date of the renewal
- (181) – Expected expiration date of registration
- (186) – Renewal expiration date of registration
- (141) – Date of cancel of duration of the mark
- (210) – Serial number of application
- (220) – Date of filing of the application
- (230) – Data concerning exhibition
- (260) – Number of application, for which favorable decision of examination about registration has been taken (publication number)
- (310) – Number of the first application
- (320) – Date of filing of the first application
- (330) – Code, identifying national or regional Office where the first application was made
- (511) – International Classification of Goods and Services for the purposes of registration of trade marks and/or list of goods and/or services classified according thereto
- (531) – Description of figurative elements of Trade Marks according to the International Classification of the Figurative Elements of Marks
- (540) – Reproduction of Trade Mark
- (550) – Nature and kind of Trade Mark
- (580) – Date of recording of any kind changes in respect of applications or registrations
- (591) – Information concerning colors claimed
- (731) – Name and address of the applicant
- (732) – Name and address of the holder of the registration
- (740) – Name and address of the representative
- (750) – Address for correspondence
- (770) – Name and address of the previous applicant or holder in case of change in ownership
- (771) – Previous name and address of the applicant or holder in case of change in ownership
- (791) – Name and address of the licensee
- (793) – Indication of conditions and/or restrictions under the license (Type of license, number of license agreement, data of license, data of validity of license)
- (800) – Certain data relating to the international registration of Trade Marks under the Protocol Relating to Madrid Agreement (International registration number)

CODES FOR PUBLICATION IN BULLETIN

- (21) AP 0000 000000 – serial number of application for invention
- (10) AP 0000 0000 A – number of published application for invention (first publication)
- (11) P 0000 0000 B – number of patent for invention (second publication)
- (21) API 0000 000000 – number of application for imported patent
- (11) PI 0000 0000 A – number of imported patent (first publication)
- (21) AU 0000 000000 – serial number of application for utility model
- (10) AU 0000 000 U – number of published application for utility model (first publication)
- (11) U 0000 000 Y – number of patent for utility model (second publication)
- (21) AD 0000 000000 – serial number of application for design
- (10) AD 0000 000 S – number of published application for design (first publication)
- (11) D 0000 000 S – number of patent for design (second publication)

INTERNATIONAL PATENT CLASSIFICATION FOR INVENTIONS AND UTILITY MODELS

- SECTION A – HUMAN NECESSITIES
- SECTION B – PERFORMING OPERATIONS; TRANSPORTING
- SECTION C – CHEMISTRY; METALLURGY
- SECTION D – TEXTILES; PAPER
- SECTION E – FIXED CONSTRUCTIONS
- SECTION F – MECHANICAL ENGINEERING; LIGHTING; HEATING; WEAPONS; BLASTING
- SECTION G – PHYSICS
- SECTION H – ELECTRICITY

-
- M – Trade Mark
 - (210) AM 0000 000000 – Serial number of application;
 - (260) AAM 0000 00000 A – Publication number of application;
 - (111) M 0000 00000 R – Number of registration;
 - (111) MMM0000 00000 Rn – Number of renewals, in which n=1,2,3;
 - (111) M 0000 00000 R(P) – Number of registration under partial assignment of rights
-

LIST OF CODES, IN ALPHABETIC SEQUENCE, AND THE CORRESPONDING (SHORT) NAMES OF STATES, OTHER ENTITIES AND INTERGOVERNMENTAL ORGANIZATIONS
(WIPO STANDARD ST.3)

AD	Andorra				
AE	United Arab Emirates				
AF	Afghanistan				
AG	Antigua and Barbuda				
AI	Anguilla				
AL	Albania				
AM	Armenia				
AN	Netherlands Antilles				
AO	Angola				
AP	African Regional Intellectual Property Organization (ARIPO)				
AR	Argentina				
AT	Austria				
AU	Australia				
AW	Aruba				
AZ	Azerbaijan				
BA	Bosnia and Herzegovina				
BB	Barbados				
BD	Bangladesh				
BE	Belgium				
BF	Burkina Faso				
BG	Bulgaria				
BH	Bahrain				
BI	Burundi				
BJ	Benin				
BM	Bermuda				
BN	Brunei Darussalam				
BO	Bolivia				
BR	Brazil				
BS	Bahamas				
BT	Bhutan				
BV	Bouvet Island				
BW	Botswana				
BX	Benelux Office for Intellectual Property (BOIP)				
BY	Belarus				
BZ	Belize				
CA	Canada				
CD	Democratic Republic of the Congo				
CF	Central African Republic				
CG	Congo				
CH	Switzerland				
CI	Cote d'Ivoire				
CK	Cook Islands				
CL	Chile				
CM	Cameroon				
CN	China				
CO	Colombia				
CR	Costa Rica				
CU	Cuba				
CV	Cape Verde				
CY	Cyprus				
CZ	Czech Republic				
DE	Germany				
DJ	Djibouti				
DM	Dominica				
DO	Dominican Republic				
DZ	Algeria				
EA	Eurasian Patent Organization (EAPO)				
EC	Ecuador				
EE	Estonia				
EG	Egypt				
EH	Western Sahara				
EM	Office for Harmonization in the Internal Market (Trademarks and Designs)(OHIM)				
EP	European Patent Office (EPO)				
ER	Eritrea				
ES	Spain				
ET	Ethiopia				
FI	Finland				
FJ	Fiji				
FK	Falkland Islands (Malvinas)				
FO	Faroe Islands				
FR	France				
GA	Gabon				
GB	United Kingdom				
GC	Patent Office of the Cooperation Council for the Arab States of the Gulf (GCC)				
GD	Grenada				
GG	Guernsey				
GH	Ghana				
GI	Gibraltar				
GT	Guatemala				
GW	Guinea- Bissau				
GY	Guyana				
HK	The Hong Kong Special Administrative Region of the People's Republic of China				
HN	Honduras				
HR	Croatia				
HT	Haiti				
HU	Hungary				
IB	International Bureau of the World Intellectual Property Organization (WIPO)				
ID	Indonesia				
IE	Ireland				
IL	Israel				
IM	Isle of Man				
IN	India				
IQ	Iraq				
ID	Indonesia				
IE	Ireland				
IL	Israel				
IM	Isle of Man				
IN	India				
IQ	Iraq				
IR	Iran (Islamic Republic of)				
IS	Iceland				
IT	Italy				
JE	Jersey				
JM	Jamaica				
JO	Jordan				
JP	Japan				
KE	Kenya				
KG	Kyrgyzstan				
KH	Cambodia				
KI	Kiribati				
KM	Saint Kitts and Nevis				
KP	Democratic People's Republic of Korea				
KR	Republic of Korea				
KW	Kuwait				
KY	Cayman Islands				
KZ	Kazakhstan				
LA	Lao People's Democratic Republic				
LB	Lebanon				
LC	Saint Lucia				
LI	Liechtenstein				
LK	Sri Lanka				
LR	Liberia				
LS	Lesotho				
LT	Lithuania				
LU	Luxembourg				
LV	Latvia				
LY	Libyan Arab Jamahiriya				
MA	Morocco				
MC	Monaco				
MD	Republic of Moldova				
ME	Montenegro				
MG	Madagascar				
MK	The former Yugoslav Republic of Macedonia				
ML	Mali				
MM	Myanmar				
MN	Mongolia				
MO	Macao				
MP	Northern Mariana Islands				
MR	Mauritania				
MS	Montserrat				
MT	Malta				
MU	Mauritius				
MV	Maldives				
MW	Malawi				
MX	Mexico				
MY	Malaysia				
MZ	Mozambique				
NA	Namibia				
NE	Niger				
NG	Nigeria				
NI	Nicaragua				
NL	Netherlands				
NO	Norway				
NP	Nepal				
NR	Nauru				
NZ	New Zealand				
OA	African Intellectual Property Organization (OAPI)				
OM	Oman				
PA	Panama				
PE	Peru				
PG	Papua New Guinea				
PH	Philippines				
PK	Pakistan				
PL	Poland				
PT	Portugal				
PW	Palau				
PY	Paraguay				
QA	Qatar				
QZ	Community Plant Variety Office (European Community) (CPVO)				
RO	Romania				
RS	Serbia				
RU	Russian Federation				
RW	Rwanda				
SA	Saudi Arabia				
SB	Solomon Islands				
SC	Seychelles				
SD	Sudan				
SG	Singapore				
SH	Saint Helena				
SI	Slovenia				
SK	Slovakia				
SL	Sierra Leone				
SM	San Marino				
SN	Senegal				
SO	Somalia				
SR	Suriname				
ST	Sao Tome and Principe				
SV	El Salvador				
SY	Syrian Arab Republic				
SZ	Swaziland				
TC	Turks and Caicos Islands				
TD	Chad				
TG	Togo				
TH	Thailand				
TJ	Tajikistan				
TL	Timor-Leste				
TM	Turkmenistan				
TN	Tunisia				
TO	Tonga				
TR	Turkey				
SE	Sweden				
TT	Trinidad and Tobago				
TV	Tuvalu				
TW	Taiwan, Province of China				
TZ	United Republic of Tanzania				
UA	Ukraine				
UG	Uganda				
US	United States of America				
UY	Uruguay				
UZ	Uzbekistan				
VA	Holy See				
VC	Saint Vincent and the Grenadines				
VE	Venezuela				
VG	Virgin Islands (British)				
VN	Viet Nam				
VU	Vanuatu				
WO	World Intellectual Property Organization (WIPO)				
WS	Samoa				
XN	Nordic Patent Institute (NPI)				
YE	Yemen				
ZA	South Africa				
ZM	Zambia				
ZW	Zimbabwe				

**NATIONAL INTELLECTUAL PROPERTY CENTER OF GEORGIA
SAKPATENTI**

**OFFICIAL BULLETIN
OF THE INDUSTRIAL PROPERTY**

19(359)

**INVENTIONS
UTILITY MODELS
DESIGNS
TRADEMARKS**

**DATE OF PUBLICATION
2012 10 10**

CONTENTS

PUBLISHED TITLES OF PROTECTION	2
INVENTIONS	
▪ APPLICATIONS APPROVED FOR GRANTING PATENTS	3
▪ PATENTED INVENTIONS	9
UTILITY MODELS	
▪ APPLICATION APPROVED FOR GRANTING PATENT	13
▪ PATENTED UTILITY MODEL	14
DESIGNS	
▪ APPLICATION APPROVED FOR GRANTING PATENT	15
▪ REGISTERED DESIGNS	16
▪ DESIGN ACCORDING TO THE ACCELERATED PROCEDURE	17
TRADEMARKS	
▪ APPLICATIONS FILED UNDER THE NATIONAL PROCEDURE APPROVED FOR REGISTRATION	20
▪ REGISTERED TRADEMARKS	21
▪ TRADEMARKS REGISTERED ACCORDING TO THE ACCELERATED PROCEDURE	25
▪ INTERNATIONAL TRADEMARKS FOR WHICH A DECISION ON GANTING PROTECTION IS TAKEN	27
▪ INTERNATIONAL TRADEMARKS PROTECTED IN GEORGIA	41
OFFICIAL NOTIFICATIONS	
TRADEMARKS	
▪ RENEWAL OF REGISTRATIONS	50
▪ COMPLETE TRANSFER OF RIGHTS	52
▪ CHANGES IN NAMES AND/OR ADDRESSES OF OWNERS	55
CLASSIFICATION INDEXES	
INVENTIONS	58
UTILITY MODELS	60
DESIGNS	61
TRADEMARKS	63

PUBLISHED TITLES OF PROTECTION

INVENTIONS

- **APPLICATIONS APPROVED FOR GRANTING PATENTS:**
12424; 12071; 11545; 11451; 11618; 12014; 11619; 12025; 11874; 11249; 12105; 12107; 12083; 11206; 11733; 12277
- **PATENTED INVENTIONS:**
5655-5667

UTILITY MODELS

- **APPLICATION APPROVED FOR GRANTING PATENT:**
12318
- **PATENTED UTILITY MODEL:**
1739

DESIGNS

- **APPLICATION APPROVED FOR GRANTING PATENT:**
702
- **REGISTERED DESIGN:**
508
- **DESIGN REGISTERED ACCORDING TO THE ACCELERATED PROCEDURE:**
509

TRADEMARKS

- **APPLICATIONS FILED UNDER THE NATIONAL PROCEDURE APPROVED FOR REGISTRATION:**
65455; 65662-65666; 65822
- **REGISTERED TRADEMARKS:**
22928-22971
- **TRADEMARKS REGISTERED ACCORDING TO THE ACCELERATED PROCEDURE:**
22972-22978
- **INTERNATIONAL TRADEMARKS FOR WHICH A DECISION ON GRANTING PROTECTIONS IS TAKEN:**
64408-64410; 64412-64415; 64713; 65034; 65038; 65040; 65042; 65044; 65056; 65060, 65061; 65113-65116; 65118, 65119; 65141-65143; 65368, 65370-65376; 65396-65401; 65403; 65405, 65406; 65408-65411; 65413-65417; 66134
- **INTERNATIONAL TRADEMARKS PROTECTED IN GEORGIA:**
62458; 62576-62578; 62581; 62584-62587; 62589; 62664-62671; 62675, 62676; 62679; 62849; 63108; 63271; 63308; 63311; 63361, 63362; 63364; 63413,63414; 63416, 63417; 63423, 63424; 63431; 63488, 63489; 63492; 63514-63524; 63526-63528; 63596, 63597; 63677; 63689; 63714; 63749; 63752-63756; 63759-63761; 63848; 63850-63853; 63879-63882; 63884; 63887-63898; 63919; 63944-63953; 63992-64001; 64004, 64005; 64088; 64090-64097; 64194; 64196-64202

INVENTIONS

APPLICATIONS APPROVED FOR GRANTING PATENTS

The decision can be appealed at the Chamber of Appeal of Sakpatenti within 3 months from the publication or at the Administrative Chamber of the Tbilisi City Court (Address: №6, David Aghmashenebeli Kheivani 12 km., Tbilisi) within 1 month following the publication.

PART A

A 24

(10) AP 2012 12424 A (51) Int. Cl. (2006)

A 24 D 1/04

(21) AP 2011 012424 (22) 2011 10 24

(71) ALLIED GLOBAL TOBACCO LTD (GB)

Wey Court West, Union Road, Farnham,
Surrey GU9 7PT (GB)

(72) Mariam Gurgenzidze (GE)

(74) Givi Akopashvili

(54) **CIGARETTE WITHOUT FILTER**

(57) A cigarette without filter comprises a bar 1 located in a cigarette paper 2 and a paper cigarette holder 3 connected with a tobacco bar by ring paper 5. Three plastic segments 4 having longitudinal clappers are inserted into the paper cigarette holder with a particular interval. Plastic segment length correlation with a distance between two adjacent segments is 2.33. In one version of invention embodiment the plastic segment is performed as a tube 6 having a core 7 formed with two S-shaped surfaces crossing each other under 90° and having lengths of tube to which they are connected. In another version the plastic segment is performed with two annular tubes 9 and 10, and with connecting thereof three parabolic surfaces 11 located in a distance of 120° from each other and having lengths of said tubes. The narrow parts of parabolic surfaces are oriented to an internal tube, and the open parts thereof are oriented to an external tube.

Claims: 1 independent

2 dependent

Fig.: 3

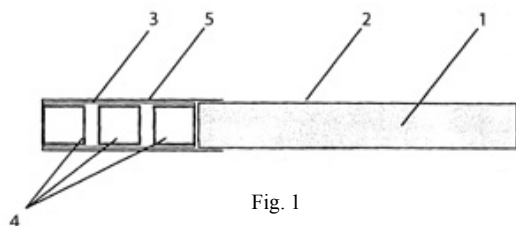

A 61

(10) AP 2012 12071 A (51) Int. Cl. (2006)

A 61 K 9/20

A 61 K 31/505

A 61 P 3/06

(21) AP 2008 012071 (22) 2008 06 27

(31) PCT/IB2008/052595

(33) IB

(71) ABDI IBRAHIM ILAC SANAYI VE
TICARET ANONIM SIRKETI (TR)
Sanayi Mahallesi, Tunç Caddesi No 3,
Esenyurt-İstanbul (TR)

(72) FARSHI, Farhad Sayyad (TR);

AVCI, Recep (TR);

APARI, Serdar (TR)

(74) Liliana Darakhvelidze

(85) 2011 01 25

(86) PCT/IB2008/052595, 2008 06 27

(54) **PHARMACEUTICAL COMPOSITIONS
OF ROSUVASTATIN CALCIUM**

(57) An invention relates to pharmaceutical composition in oral dosed form containing mix of rosuvastatin calcium and alkali-earth metals carbonates or bicarbonates, wherein mix molar ratio is in the range of 1:0.43-1.75, which provides composition dissolution profile improvement in 0.1N HCl medium.

Claims: 1 independent

7 dependent

Fig.: 4

(10) AP 2012 11545 A (51) Int. Cl. (2006)

A 61 K 31/55

A 61 K 49/00

(21) AP 2009 011545 (22) 2009 11 05

(31) 08.06225

(32) 2008 11 07

(33) FR

(71) LES LABORATOIRES SERVIER (FR)

35, Rue de Verdun, F-92284

Suresnes Cedex (FR)

(72) LEREBOURS-PIGEONNIERE,

Guy (FR);

DUBOST-BRAMA, Ariane (FR);

FLEURINCK, Carmen (BE)

(74) Tamaz Shilakadze
 (54) **USAGE OF IVABRADINE AS
 DIAGNOSTIC AGENT IN
 CORONARY ANGIOGRAPHY
 METHOD BY MULTISLICE
 COMPUTED TOMOGRAPHY**
 (57) There is represented usage of ivabradine, or 3-
 {3-[[{(7S)-3,4-dimethoxybicyclo-[4.2.0]octa-1,3,5-
 trien-7-yl]-methyl}(methyl) amino]propyl}-7,8-
 dimethoxy-1,3,4,5tetrahy-dro-2H-3-benzazepin-2-
 one, pharmaceutically acceptable acid-additive
 salts thereof or hydrates of said salts as diagnosti-
 c agents in coronary angiography method carried out
 by multislice computed tomography.
 Claims: 2 independent
 1 dependent

(10) AP 2012 11451 A (51) Int. Cl. (2006)
 A 61 K 31/57
 A 61 K 45/06
 A 61 P 15/06

(21) AP 2008 011451 (22) 2008 02 05
 (31) 60/888,480; 60/973,667
 (32) 2007 02 06; 2007 09 19
 (33) US; US

(71) COLUMBIA LABORATORIES
 (BERMUDA) LIMITED (BM)
 Canon's Court, 22 Victoria Street, PO
 Box HM1179, Hamilton HM12 (BM)

(72) CREASY, George (US)

(74) Tamaz Shilakadze

(85) 2009 09 04

(86) PCT/GB2008/000397, 2008 02 05

(54) **PROGESTERONE FOR PRETERM
 BIRTH PREVENTION**

(57) There is represented progesterone application
 at the treatment or spontaneous preterm birth
 prevention for pregnant women having shorted
 cervix.

Claims: 1 independent

24 dependent

Fig.: 14

(10) AP 2012 11618 A (51) Int. Cl. (2006)
 A 61 K 31/495
 A 61 K 31/551
 A 61 P 25/18

(21) AP 2008 011618 (22) 2008 05 19

(31) P0700369

(32) 2007 05 24

(33) HU

(71) RICHTER GEDEON NYRT. (HU)

Gyömrői út 19-21, H-1103

Budapest (HU)

(72) LASZLOVSZKY, István (HU);

NÉMETH, György (HU);

ANDOR, György (HU)

(74) Liliana Darakhvelidze

(85) 2009 12 24

(86) PCT/HU2008/000051, 2008 05 19

(54) **TRANS-4-{2-[4-(2,3-DICHLOROPHE-NYL)-
 PIPERAZIN-1-YL]-ETHYL}-N,N-DIME-
 THYL-CARBAMOYL-CYCLOHEXYL-
 AMINE FOR SCHIZOPHRENIA
 TREATMENT**

(57) The present invention relates to (thio)-
 carbamoyl-cyclohexane derivatives, particularly, to
 trans-4- {2-[4-(2,3-dichlorophenyl)-piperazin-1-yl]-
 ethyl}-N,N- dimethylcarbamoyl-cyclohexylamine
 and pharmaceutically acceptable salts thereat
 medicament preparation for schizophrenia
 treatment. Furthermore, the present invention
 relates to schizophrenia treatment by (thio)-
 carbamoyl-cyclohexane derivatives, particularly,
 trans-4- {2-[4-(2,3-dichlorophenyl)-piperazin-1-yl]-
 ethyl}-N,N-imethylcarbamoyl-cyclohexylamine
 and their pharmaceutically acceptable salts
 application.

Claims: 1 independent

16 dependent

(10) AP 2012 12014 A (51) Int. Cl. (2006)

A 61 K 31/593

A 61 K 33/24

A 61 K 47/40

A 61 K 45/06

A 61 P 19/00

(21) AP 2010 012014 (22) 2010 11 25

(31) 09.05706

(32) 2009 11 27

(33) FR

(71) LES LABORATOIRES SERVIER (FR)

35, Rue de Verdun, F-92284 Suresnes Cedex (FR)

(72) BRIAULT, Gilles (FR);

QUENAULT, Xavier (FR);

POIRIER, Cécile (FR);

PEAN, Jean-Manuel (FR)

(74) Tamaz Shilakadze

(54) **PHARMACEUTICAL COMPOSITION
 CONTAINING SALT OF STRONTIUM,
 VITAMIN D AND CYCLODEXTRIN**

(57) There are represented: pharmaceutical
 composition containing salt of strontium, vitamin
 D, cyclodextrin and one or more nontoxic
 pharmaceutically acceptable excipient or carrier,
 wherein mass ratio is 1/40-1/80; and application
 thereat bone diseases or arthrosis treatment.

Claims: 2 independent

10 dependent

Table: 2

(10) AP 2012 11619 A (51) Int. Cl. (2006)

A 61 P 25/18

A 61 K 31/4965

(21) AP 2008 011619 (22) 2008 05 19

(31) P0700370

(32) 2007 05 24

(33) HU

(71) RICHTER GEDEON NYRT. (HU)

Gyömrői út 19-21, H-1103

Budapest (HU)

(72) LASZLOVSZKY, István (HU);

NÉMETH, György (HU);

ANDOR, György (HU)

(74) Liliana Darakhvelidze

(85) 2009 12 24

(86) PCT/HU2008/000052, 2008 05 19

(54) **TRANS-4-{2-[4-(2,3-DICHLOROPHENYL)-PIPERAZIN-1-YL]-ETHYL}-N,N-DIMETHYL CARBAMOYL-CYCLOHEXYLAMINE FOR ACUTE MANIA TREATMENT**

(57) The present invention relates to (thio)-carbamoyl-cyclohexane derivatives, particularly, to trans-4-{2-[4-(2,3-dichlorophenyl)-piperazin-1-yl]-ethyl}-N,N-dimethylcarbamoyl-cyclohexylamine and pharmaceutically acceptable salts thereof for medicament preparation for acute mania treatment. Furthermore, the present invention relates to acute mania treatment by trans-4-{2-[4-(2,3-dichlorophenyl)-piperazin-1-yl]-ethyl}-N,N-dimethylcarbamoyl-cyclohexylamine and their pharmaceutically acceptable salts application.

Claims: 1 independent

15 dependent

PART C

C 04

(10) AP 2012 12025 A (51) Int. Cl. (2006)

C 04 B 28/04

C 04 B 111/20

(21) AP 2010 012025 (22) 2010 12 06

(71) Paata Gogoladze (GE)

Kutuzovs q. 3, 0194, Tbilisi (GE)

(72) Paata Gogoladze (GE);

Vazha Chagelishvili (GE);

Marc Baitsel (DE);

Giorgi Lomidze (GE)

(54) **COMPOSITION FOR SHOTCRETE PREPARATION**

(57) There are represented composition for shotcrete preparation containing cement; at that, a fiber is lubricated with glycerol.

Claims: 1 independent

Fig.: 1

C 07

(10) AP 2012 11874 A (51) Int. Cl. (2006)

C 07 D 209/08

A 61 K 31/404

(21) AP 2008 011874 (22) 2008 12 10

(31) 07.08604

(32) 2007 12 11

(33) FR

(71) LES LABORATOIRES SERVIER (FR)

35, Rue de Verdun, F-92284

Suresnes Cedex (FR)

(72) CORDI Alexis (BE);

HABERKORN Laure (FR);

VERBEUREN Tony (BE);

COURCHAY Christine (FR);

SIMONET Serge (FR)

(74) Tamaz Shilakadze

(85) 2010 07 05

(86) PCT/FR2008/001716, 2008 12 10

(54) **NOVEL DIAZENIUMDIOLATE DERIVATIVES, THEIR PREPARATION METHOD AND PHARMACEUTICAL COMPOSITIONS CONTAINING THEREOF**

(57) An invention relates to: diazeniumdiolate compounds of formula (I),

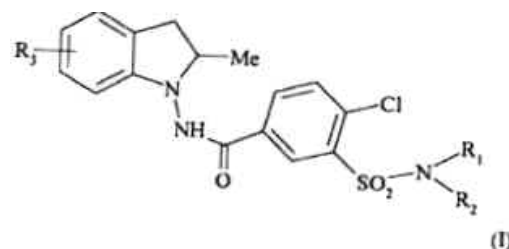

wherein derivatives have values provided in the description, their preparation method and pharmaceutical compositions thereof. Said compounds are applied at the treatment of hypertension and cardiovascular diseases.

Claims: 4 independent

11 dependent

(10) AP 2012 11249 A (51) Int. Cl. (2006)

C 07 D 213/61

C 07 D 471/04

A 61 K 31/437

(21) AP 2007 011249 (22) 2007 10 08

(31) 11/539,857; PCT/US2006/039667;

60/912,629

(32) 2006 10 09; 2006 10 10; 2007 04 18

(33) US; US; US

(71) TAKEDA PHARMACEUTICAL COMPANY LIMITED (JP)

1-1, Doshomachi 4-chome, Chuo-ku, Osaka-shi, Osaka 541-0045 (JP)

- (72) BROWN, Jason, W. (US);
- DONG, Qing (US);
- PARASELLI, Bheema, R. (US);
- STAFFORD, Jeffrey, Alan (US);
- WALLACE, Michael, B. (US);
- WIJESEKERA, Hasanthi (AU)

(74) Tamara Kochlamazashvili
 (85) 2009 05 08
 (86) PCT/US2007/080714, 2007 10 08

(54) KINASE INHIBITORS

(57) The present invention relates to: compound inhibiting kinase – 5-(3-(ethylsulfonyl)phenyl)-3,8-dimethyl-N-(1-methyl-4-piperidinyl)-9H-pyrido[2,3-b]indole-7-carboxamide – one of concrete embodiment of compound of formula (I),

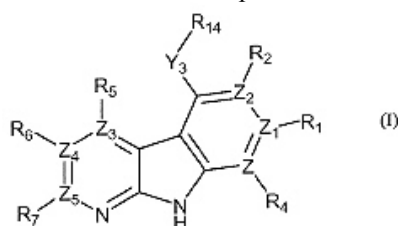

and application thereof.

Claims: 4 independent
 3 dependent

Fig.: 1

(10) AP 2012 12105 A (51) Int. Cl. (2006) C 07 D 223/16

- (21) AP 2011 012105 (22) 2011 02 15
- (31) 10,00657
- (32) 2010 02 17
- (33) FR
- (71) LES LABORATOIRES SERVIER (FR)

35, Rue de Verdun, F-92284 Suresnes Cedex (FR)

- (72) PEGLION, Jean-Loui (FR);
- CAIGNARD, Pascal (FR)

(74) Tamaz Shilakadze

(54) NEW METHOD FOR IVABRADINE AND THEIR ACID-ADDITIVE SALTS SYNTHESIS

(57) There is represented a new method for ivabradine of formula (I),

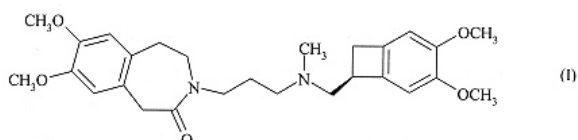

and their pharmaceutically acceptable acid-additive salts synthesis.

Claims: 3 independent
 8 dependent

C 10

(10) AP 2012 12107 A (51) Int. Cl. (2006) C 10 L 5/00

- (21) AP 2009 012107 (22) 2009 07 14
- (31) 61/134,991
- (32) 2008 07 16
- (33) US
- (71) BRUSO, Bruce, L. (US)

57 Park Lane, Hegins, Pennsylvania 17938 (US)

- (72) BRUSO, Bruce, L. (US)

(74) Tamara Kochlamazashvili

(85) 2011 02 16
 (86) PCT/US2009/004102, 2009 07 14

(54) METHOD AND APPARATUS REFINING COAL

(57) There is represented refining coal method for sulphur and other contamination removal. The method provides coal mixing with ammonia water solution having selected range of concentration preferentially consisting of 3%-5% ammonia in water. By mixing the solution contacts with coal surfaces and pores. Also, the method provides monitoring refinement for this moment determination, when water ammonia concentration, which is in selected range, will be reduced to the level lower of this range; and water ammonia having ammonia concentration in selected range or upper thereof is supplied into reaction vessel for the purpose to return solution in determined scopes. Refined coal can be washed and dried or dried without washing with ammonia coverage formation on coal surfaces and in pores. There is suggested apparatus performing variations for this method embodiment.

Claims: 2 independent
 11 dependent

Fig.: 3

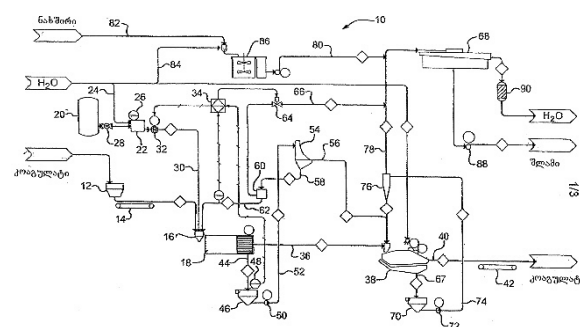

Fig. 1

PART E**E 02**

(10) AP 2012 12083 A (51) Int. Cl. (2006)

E 02 F 1/00

E 02 F 3/88

E 02 F 5/28

(21) AP 2009 012083 (22) 2009 07 02

(31) 08159701.5

(32) 2008 07 04

(33) EP

(71) DREDGING INTERNATIONAL ASIA
PACIFIC PTE. LTD (SG)

371 Beach Road, No 24-08 KeyPoint,

Singapore 199597 (SG)

OLDENDORFF CARRIERS GMBH &
CO. KG (DE)

Willy-Brandt-Allee 6, 23554

Luebeck (DE)

(72) VAN WELLEN, Erik (BE);
ROSENSTOCK, Mark (DE)

(74) Tamara Kochlamazashvili

(85) 2011 02 03

(86) PCT/EP2009/058348, 2009 07 02

(54) **METHOD FOR DELIVERING
LARGE QUANTITIES OF UNDER
WATER SOIL TO RECLAMATION
AREA**

(57) A method provides the following stages: mooring at least of one seagoing transport vessel having size considerably larger of dredging vessel and adapted to receive a large quantity of soil in the vicinity at least of one borrow area, providing at least one dredging vessel for dredging soil at least in one borrow area, and its transportatoin into the transport vessel, loading the soil into buffering vessel or directly into the transport vessel, soil transportatoin to the long distance reclamation site in a transportable state, mooring the transport vessel on the reclamation site, and unloading the soil from the transport vessel on the reclamation site.

Claims: 1 independent

9 dependent

Fig.: 11

PART F**F 41**

(10) AP 2012 11206 A (51) Int. Cl. (2006)

F 41 H 1/02

(21) AP 2009 011206 (22) 2009 04 07

(71) Teimuraz Kikvadze (GE)

Tkabladzis q. 19, 4616, Kutaisi (GE)

(72) Teimuraz Kikvadze (GE)

(54) **LAYERED ARMATURE**

(57) An armature comprises high-modular and high-oriented rigid armature panels 3 and 4 forming two layers of pressed polyethylene performed so, that they are forming quadrangular truncated pyramids, and are located in aramid fabric casings 1 and 2; at that, the pyramids of various layers are directed to each other by small bases thereof and are adjoined to each other by their sides.

Claims: 1 independent

Fig.: 2

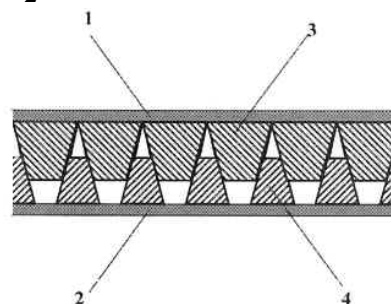

Fig. 1

PART G**G 07**

(10) AP 2012 11773 A (51) Int. Cl. (2006)

G 07 D 7/00

G 07 D 7/12

(21) AP 2007 011773 (22) 2007 10 09

(71) SICPA HOLDING SA (CH)

Avenue de Florissant 41, CH-1008

Prilly (CH)

(72) DECOUX, Eric (FR);

CALLEGARI, Andrea (IT)

(74) Alexander Gegechkori

(85) 2010 04 27

(86) PCT/IB2007/003002, 2007 10 09

(54) **DEVICE FOR SECURITY MARKING
AUTHENTICATION**

(57) There is represented an authentication device for visual authentication of document or item comprising circular polarizing security marking. The device comprises a light source and the

polarization filters for parallel or alternate illumination of said marking on document with left or right circular polarized light. Also, there are disclosed corresponding methods for visual and automated marking authentication.

Claims: 3 independent
5 dependent

Fig.: 13

PART H

H 01

**(10) AP 2012 12277 A (51) Int. Cl. (2006)
H 01 L 21/00**

(21) AP 2011 012277 (22) 2011 06 30

(71) Tinatin Laperashvili (GE)
Mukhianis Das., III mkr., korp. 10,
b. 131, 380072, Tbilisi (GE)

(72) Tinatin Laperashvili (GE)

**(54) METHOD OF SEMICONDUCTOR
DEVICE PRODUCTION**

(57) A method provides III-V group semiconductor surface electrocleaning and III group metal electrochemical application on refined surface in unique technological process. Received metal-semiconductor structure is thermally treated in an atmosphere of high purity restored or inert gas.

Claims: 1 independent

Fig.: 14

PATENTED INVENTIONS

PART A

A 61

- (11) P 2012 5660 B** (51) Int. Cl. (2006)
A 01 N 25/02
(10) AP 2012 11737 A (44) 12(352)/2012
(21) AP 2008 011737
(22) 2008 08 12
(24) 2008 08 12
(31) 0716593.9
(32) 2007 08 24
(33) GB
(73) SYNGENTA LIMITED (GB)
European Regional Centre, Priestley Road,
Surrey Research Park, Guildford, Surrey
GU2 7YH (GB)
(72) BELL, Gordon, Alastair (GB);
HARRIS, Clair, Louise (GB);
TOVEY, Ian, David (GB)
(74) Tamaz Shilakadze
(85) 2010 03 23
(86) PCT/GB2008/002738, 2008 08 12
(54) **IMPROVED ORGANIC COMPOUNDS**
-

A 61

- (11) P 2012 5658 B** (51) Int. Cl. (2006)
A 61 K 31/198
A 61 K 31/519
C 07 D 487/04
(10) AP 2012 11325 A (44) 12(352)/2012
(21) AP 2007 011325
(22) 2007 11 19
(24) 2007 11 19
(31) 60/860,840; 60/861,459; 60/957,236
(32) 2006 11 22; 2006 11 29; 2007 08 22
(33) US; US; US
(73) INCYTE CORPORATION (US)
Experimental Station, Route 141&Henry Clay
Road, Building E336, Wilmington,
DE 19880 (US)
(72) ZHUO, Jincong (US);
XU, Meizhong (US);
HE, Chunhong (US);
ZHANG, Colin (CN);
QIAN, Ding-quan (CN);
BURNS, David M. (CN);
LI, Yunlong (US);
METCALF, Brian (US);
YAO, Wenqing (US)
(74) Shalva Gvaramadze

- (85) 2009 06 22
(86) PCT/US2007/085100, 2007 11 19
(54) **IMIDAZOTRIAZINES AND IMIDAZO-
PYRIMIDINES AS KINASE INHIBITORS**
-

- (11) P 2012 5656 B** (51) Int. Cl. (2006)
A 61 K 36/00
(10) AP 2012 11156 A (44) 11(351)/2012
(21) AP 2009 011156
(22) 2009 03 11
(24) 2009 03 11
(72) TSMU TBILISI STATE MEDICAL
UNIVERSITY (GE)
Vazha-Pshavelas gamz. 33, 0177,
Tbilisi (GE)
(72) Lili Zviadadze (GE);
Nino Tabatadze (GE);
Margarita Gabelaia (GE);
Henry Dekanosidze (GE);
Valentina Vachnadze (GE);
Evelyna Jakeli (GE);
Michael Gedevanishvili (GE);
Iza Sikharulidze (GE);
Natela Gogitidze (GE)
(74) Zurab Kemoklidze
(54) **METHOD OF OBTAINING
ANTICONVULSANT DRY HERBAL
EXTRACT**
-

- (11) P 2012 5659 B** (51) Int. Cl. (2006)
A 61 K 38/00
A 61 K 31/70
(10) AP 2012 11391 A (44) 12(352)/2012
(21) AP 2007 011391
(22) 2007 12 31
(24) 2007 12 31
(31) 61/196,711; 61/066,151
(32) 2006 12 29; 2007 09 12
(33) US; US
(73) IPSEN PHARMA S.A.S. (FR)
65, Quai Georges Gorse, F-92100
Boulogne-Billancourt (FR)
(72) DONG, Zheng, Xin (US);
CHERIF-CHEIKH, Roland (FR);
CORDERO RIGOL, Jose-antonio (ES);
ALLOZA, Miravete, Resurreccion (ES);
LACOMBE, Frederic (FR);
TOBALINA MAESTRE, Maria, Dolores (ES)
(74) Shalva Gvaramadze
(85) 2009 07 29
(86) PCT/US2007/026490, 2007 12 31

(54) **PHARMACEUTICAL COMPOSITIONS
CONTAINING GLUCAGON-LIKE
PEPTIDE-1 (GLP-1)**

(11) **P 2012 5661 B** (51) **Int. Cl. (2006)
A 61 L 15/22
A 61 L 15/60
C 08 L 83/04**

(10) AP 2012 11781 A (44) 12(352)/2012

(21) AP 2008 011781

(22) 2008 09 30

(24) 2008 09 30

(31) 60/997,166

(32) 2007 09 30

(33) US

(73) MEDA AB (SE)

Pipers Väg 2 A/Box 906, S-170 09,
Solna (SE)

(72) PALEFSKY, Irwin (US);

WILSON, Ni'kita (US)

(74) Shalva Gvaramadze

(85) 2010 04 30

(86) PCT/US2008/078340, 2008 09 30

(54) **SILICONE GEL-BASED COMPOSITI-
ONS FOR WOUND HEALING AND
SCAR REMOVAL**

PART B

B 64

(11) **P 2012 5655 B** (51) **Int. Cl. (2006)
B 64 C 1/32**

(10) AP 2012 10655 A (44) 12(352)/2012

(21) AP 2008 010655

(22) 2008 04 21

(24) 2008 04 21

(73) David Nadaraia (GE)

Panaskertelis q. korp. 1, b. 188, 0194,
Tbilisi (GE)

(72) David Nadaraia (GE)

(54) **NADARAIA PLAN**

(11) **P 2012 5657 B** (51) **Int. Cl. (2006)
B 64 C 17/06
F 03 G 3/08
G 01 C19/00**

(10) AP 2012 11216 A (44) 12(352)/2012

(21) AP 2006 011216

(22) 2006 11 13

(24) 2006 11 13

(31) 2006/05622

(32) 2006 10 10

(33) TR

(73) ERKE ERKE ARASTIRMALARI VE
MUHENDISLIK A.S. (TR)

Halkali Merkez Mah. Basin Ekspres Yolu,
No. 5/A Kat 5, Kucukcekmece,

(72) ÖZTÜRK, Mustafa Naci; (TR)

(74) Shalva Gvaramadze

(85) 2009 04 10

(86) PCT/IB2006/054206, 2006 11 13

(54) **GYROSCOPIC APPARATUS**

PART C

C 07

(11) **P 2012 5666 B** (51) **Int. Cl. (2006)**

C 07 D 401/12

C 07 D 403/12

C 07 D 417/12

C 07 D 471/04

C 07 D 487/04

A 61 P 13/00

A 61 K 31/4178

A 61 K 31/506

(10) AP 2012 11992 A (44) 12(352)/2012

(21) AP 2009 011992

(22) 2009 04 02

(24) 2009 04 02

(31) 61/123,063; 61/206,043

(32) 2008 04 04; 2009 01 27

(33) US; US

(71) MERCK SHARP & DOHME CORP. (US)

126 East Lincoln Avenue, Rahway,
NJ 07065-0907 (US)

(72) BERGER, Richard (US);

CHANG, Lehua (CN);

EDMONDSON, Scott, D. (US);

GOBLE, Stephen, D. (US);

HA, Sookhee, Nicole (US);

KAR, Nam, Fung (US);

KOPKA, Ihor, E. (US);

LI, Bing (US);

MORRIELLO, Gregori, J. (US);

MOYES, Chris, R. (GB);

SHEN, Dong-Ming (US);

WANG, Liping (US);

ZHU, Cheng (CN)

(74) Shalva Gvaramadze

(85) 2010 11 04

(86) PCT/US2009/039249, 2009 04 02

(54) **HYDROXYMETHYL PYRROLIDINES
AS β 3 ADRENERGIC RECEPTOR
AGONISTS**

- (11) P 2012 5664 B (51) Int. Cl. (2006)
C 07 D 471/04
C 07 D 498/04
C 07 D 513/04
A 61 P 35/00
A 61 K 31/4355
A 61 K 31/4365
A 61 K 31/437
- (10) AP 2012 11952 A (44) 12(352)/2012
(21) AP 2009 011952
(22) 2009 02 25
(24) 2009 02 25
(31) 2008-045134; 2008-256755
(32) 2008 02 26; 2008 10 01
(33) JP; JP
(73) TAKEDA PHARMACEUTICAL COMPANY LIMITED (JP)
1-1, Doshomachi 4-chome, Chuo-ku, Osaka-shi, Osaka 5410045 (JP)
(72) FUJII, Nobuhiro (JP);
OGURO, Yuya (JP);
SASAKI, Satoshi (JP)
KONDO, Shigeru (JP)
(74) Shalva Gvaramadze
(85) 2010 09 24
(86) PCT/JP2009/054007, 2009 02 25
(54) **CONDENSED HETEROCYCLIC DERIVATIVES AND APPLICATION THEREOF**

PART F

F 02

- (11) P 2012 5662 B (51) Int. Cl. (2006)
F 02 B 51/00
- (10) AP 2012 11838 A (44) 12(352)/2012
(21) AP 2010 011838
(22) 2010 06 09
(24) 2010 06 09
(73) Alexi Nozadze (GE)
Ak. Tseretlis gamz. 69, b. 3, 0119, Tbilisi (GE)
(72) Alexi Nozadze (GE)
(54) **INTERNAL-COMBUSTION ENGINE FEED SYSTEM**

F 04

- (11) P 2012 5663 B (51) Int. Cl. (2006)
F 04 C 21/00
- (10) AP 2012 11840 A (44) 12(352)/2012
(21) AP 2010 011840
(22) 2010 06 11

- (24) 2010 06 11
(73) Tamaz Megrelidze (GE)
M. Zandukelis q. 12, b.11, 0108, Tbilisi (GE);
Vitalij Ghvachliani (GE)
Didi Lilos das., 0198, Tbilisi (GE);
David Gugulashvili (GE)
Dighmis mas., III kvart., korp. 20, b. 10, 0119, Tbilisi (GE);
George Megrelidze (GE)
M. Zandukelis q. 12, b.11, 0108, Tbilisi (GE);
Levan Gugulashvili (GE)
Dighmis mas., III kvart., korp. 20, b. 10, 0159, Tbilisi (GE);
Givi Gugulashvili (GE)
Gldanis mas., III mkr., korp. 77, b. 31, 0167, Tbilisi (GE)
(72) Tamaz Megrelidze (GE);
Vitalij Ghvachliani (GE);
David Gugulashvili (GE);
George Megrelidze (GE);
Levan Gugulashvili (GE);
Givi Gugulashvili (GE)
(54) **COMPRESSOR**

F 16

- (11) P 2012 5665 B (51) Int. Cl. (2006)
F 16 H 21/16
- (10) AP 2012 11985 A (44) 12(352)/2012
(21) AP 2010 011985
(22) 2010 11 01
(24) 2010 11 01
(73) Jumber Uplisashvili (GE)
Didgoris q. 201, 0113, Tbilisi (GE);
Nia Natbiladze (GE)
Kazbegis gamz. 1, b. 12, 0160, Tbilisi (GE);
Tea Baramashvili (GE)
Varketilis 3, III mkr., korp. 319, b. 32, 0163, Tbilisi (GE);
Lali Mdzevashvili (GE)
Moskovis gamz., V kvart., korp. 10, b. 9, 0145, Tbilisi (GE);
Amiran Gogitidze (GE)
Chaisubnis q. 3, 0102, Tbilisi (GE)
(72) Jumber Uplisashvili (GE);
Nia Natbiladze (GE);
Tea Baramashvili (GE);
Lali Mdzevashvili (GE);
Amiran Gogitidze (GE)
(54) **COUPLED SPACE INVERSOR**

PART G

G 01

- (11) P 2012 5667 B (51) Int. Cl. (2006)
G 01 N 33/10
- (10) AP 2012 12160 A (44) 12(352)/2012
- (21) AP 2011 012160
- (22) 2011 03 30
- (24) 2011 03 30
- (73) Elizabeth Tsereteli (GE)
Mtskhety q. 8, b. 93, 0179, Tbilisi (GE);
Shalva Gogoladze (GE)
Mtskhety q. 8, b. 93, 0179, Tbilisi (GE)
- (72) Elizabeth Tsereteli (GE);
Shalva Gogoladze (GE)
- (54) **METHOD OF GLUTEN AND STARCH
PREPARATION FROM FLOUR, AND
DEVICE CARRYING OUT THEREOF**
-

UTILITY MODELS

APPLICATION APPROVED FOR GRANTING PATENT

The decision can be appealed at the Chamber of Appeal of Sakpatenti within 3 months from the publication or at the Administrative Chamber of the Tbilisi City Court (Address: №6, David Aghmashenebeli Kheivani 12 km., Tbilisi) within 1 month following the publication.

PART A

A 61

(10) AU 2012 12318 U (51) Int. Cl. (2006)

A 61 K 33/00

A 61 K 33/34

(21) AU 2011 012318 (22) 2011 07 25

(71) Eliso Khatiashvili (GE)

Ipolite Khvichias q. 14, b. 28, 0160,

Tbilisi (GE);

Michael Khatiashvili (GE)

Ipolite Khvichias q. 14, b. 28, 0160,

Tbilisi (GE);

Tinatin Khatiashvili (GE)

Ipolite Khvichias q. 14, b. 28, 0160,

Tbilisi (GE);

Giorgi Khatiashvili (GE)

Ipolite Khvichias q. 14, b. 28, 0160,

Tbilisi (GE)

(72) Eliso Khatiashvili (GE);

Michael Khatiashvili (GE);

Tinatin Khatiashvili (GE);

Giorgi Khatiashvili (GE)

(54) **METHOD OF "KHATIASHVILI
MIXTURE" PREPARATION AGAINST
BENIGN SKIN FORMATIONS**

(57) There are used 1000 volume portion of 65% nitric acid mixed with 5-10 mass. portion of copper, and then, 15-22 mass. portion of household soda is added therefor a mixture preparation against benign skin formations.

Claims: 1 independent

PATENTED UTILITY MODEL

PART A

A 61

- (11) U 2012 1739 Y (51) Int. Cl. (2006)
A 61 N 5/06
- (10) AU 2012 12357 U (44) 12(352)/2012
(21) AU 2011 012357
(22) 2011 08 29
(24) 2011 08 29
(73) Merab Jibladze (GE)
I. Chavchavadzis gamz. 16, b. 23, 0179,
Tbilisi (GE)
(72) Merab Jibladze (GE)
(54) **PHOTOTHERAPEUTIC DEVICE "AISI"**
-

DESIGN

APPLICATION APPROVED FOR REGISTRATION

The decision can be appealed at the Chamber of Appeal of Sakpatenti within 3 months from the publication or at the Administrative Chamber of the Tbilisi City Court (Address: №6, David Aghmashenebeli Kheivani 12 km., Tbilisi) within 1 month following the publication.

(10) AD 2012 702 S (51) 21-01

(21) AD 2012 000702

(22) 2012 05 14

(28) 1

(71) Rostom Zhordania (GE)

Nakashidzis q. 25, 0105, Tbilisi (GE)

(72) Rostom Zhordania (GE)

(54) CHESSBOARD TABLE WITH BACKGAMMON BUILT-IN

(55)



1.1



1.2



1.3

REGISTERED DESIGN

- (11) **D 2012 508 S** (51) **02-02**
(10) AD 2012 690 S (44) 12(352)/2012
(21) AD 2012 000690
(22) 2012 03 06
(24) 2012 03 06
(28) 2
(18) 2017 03 06
(73) Archil Gavashelishvili (GE)
 Stalinis q. 39, 3600, Oni (GE)
(72) Archil Gavashelishvili (GE)
(54) **1. GEORGIAN MILITARY UNIFORM;**
 2. HUNTER UNIFORM
-

DESIGN REGISTERED ACCORDING TO THE ACCELERATED PROCEDURE

The decision can be appealed at the Chamber of Appeal of Sakpatenti within 3 months from the publication.

(11) D 2012 509 S

(51) 02-02

(21) AD 2012 000701

(22) 2012 05 11

(24) 2012 05 11

(28) 10

(18) 2017 05 11

(73) LTD "ELIF TEXTILE" (GE)

Lilo Moli, Sabitumo Bazroba, Sabitumo Bazrobis Tsis Setis Rigi, Maghazia 12, Tbilisi (GE)

(72) Ali Gochen (GE)

(74) Levan Nikoladze

Besikis q. 4, Biznes Tsentri Besikze, Ofisi 203, 0108, Tbilisi (GE)

(54) SLEEVELESS SPORTS JERSEY

(55)







8.1



8.2



8.3



9.1



9.2



9.3



10.1



10.2



10.3

TRADEMARKS

APPLICATIONS FILED UNDER THE NATIONAL PROCEDURE APPROVED FOR REGISTRATION

The decision can be appealed at the Chamber of Appeal of Sakpatenti within 3 months from the publication or at the Administrative Chamber of the Tbilisi City Court (Address: №6, David Aghmashenebeli Kheivani 12 km., Tbilisi) within 1 month following the publication.

(260) AM 2012 65455 A

(210) AM 065455

(220) 2011 12 20

(731) LTD "AVERSI-FARMA"

Davit Agmasheneblis gamz., 148/2, 0112,
Tbilisi, Georgia

(540)

ფორტიმილი

Фортимил

Fortimil

(591) Black, white

(511) 5

(260) AM 2012 65662 A

(210) AM 065662

(220) 2011 12 29

(731) RANBAXY LABORATORIES LIMITED

Plot N 90, Sector-32, Gurgaon-122001,
Haryana, India

(740) Tamar Kochlamazashvili

(540)

AEROLER

(591) Black, white

(511) 5

(260) AM 2012 65663 A

(210) AM 065663

(220) 2011 12 29

(731) RANBAXY LABORATORIES LIMITED

Plot N 90, Sector-32, Gurgaon-122001,
Haryana, India

(740) Tamar Kochlamazashvili

(540)

УЛЬТРАВИРИН

(591) Black, white

(511) 5

(260) AM 2012 65664 A

(210) AM 065664

(220) 2011 12 29

(731) RANBAXY LABORATORIES LIMITED

Plot N 90, Sector-32, Gurgaon-122001,
Haryana, India

(740) Tamar Kochlamazashvili

(540)

RHEORAN SF

(591) Black, white

(511) 5

(260) AM 2012 65665 A

(210) AM 065665

(220) 2011 12 29

(731) RANBAXY LABORATORIES LIMITED

Plot N 90, Sector-32, Gurgaon-122001,
Haryana, India

(740) Tamar Kochlamazashvili

(540)

DONERUM

(591) Black, white

(511) 5

(260) AM 2012 65666 A

(210) AM 065666

(220) 2011 12 29

(731) RANBAXY LABORATORIES LIMITED

Plot N 90, Sector-32, Gurgaon-122001,
Haryana, India

(740) Tamar Kochlamazashvili

(540)

SYNERPEN

(591) Black, white

(511) 5

(260) AM 2012 65822 A

(210) AM 065822

(220) 2012 01 11

(731) TOYOTA JIDOSHA KABUSHIKI KAISHA

(also trading as TOYOTA MOTOR
CORPORATION)

1, Toyota-Cho, Toyota-Shi, Aichi-Ken, Japan

(740) Tamar Kochlamazashvili

(540)

ES250

(591) Black, white

(511) 12

REGISTERED TRADEMARKS

(111) M 2012 022928 R

(151) 2012 09 24

(181) 2022 09 24

(260) AM 2011 56920 A

(220) 2010 02 05

(732) LTD "KASTEЛИ-SAQARTVELO"

Kakhetis gzatketsili, Lilos ludis qarkhana,,
0151, Tbilisi, Georgia

(111) M 2012 022929 R

(151) 2012 09 24

(181) 2022 09 24

(260) AM 2012 59111 A

(220) 2010 08 12

(732) Reckitt Benckiser (Switzerland) AG

Richtistr. 5, Postfach CH-8304 Wallisellen,
Zurich, Switzerland

(111) M 2012 022930 R

(151) 2012 09 24

(181) 2022 09 24

(260) AM 2011 61156 A

(220) 2011 02 04

(732) RENAULT s.a.s.;

92100 BOULOGNE-BILLAN COURT,
France

(111) M 2012 022931 R

(151) 2012 09 24

(181) 2022 09 24

(260) AM 2012 61198 A

(220) 2011 02 07

(732) GULF INTERNATIONAL LUBRICANTS,
LTD.

Canon's Court, 22 Victoria street, Hamilton,
HM12, Bermuda

(111) M 2012 022932 R

(151) 2012 09 24

(181) 2022 09 24

(260) AM 2012 64144 A

(220) 2011 09 20

(732) LTD "BTM TEXTILE"

Meliqishvilis q. 25, bina 3, 6000, Batumi,
Georgia

(111) M 2012 022933 R

(151) 2012 09 24

(181) 2022 09 24

(260) AM 2011 61833 A

(220) 2011 03 24

(732) COSTA LIMITED

Whitbread Court, Houghton Hall Business
Park, Porz Avenue, Dunstable, Bedfordshire
LU5 5XE, United Kingdom

(111) M 2012 022934 R

(151) 2012 09 24

(181) 2022 09 24

(260) AM 2012 62056 A

(220) 2011 09 05

(732) Joint Stock Company BANKI "RESPUBLIKA"

Grigol Abashidzis q. N2, 0179, Tbilisi,
Georgia

(111) M 2012 022935 R

(151) 2012 09 24

(181) 2022 09 24

(260) AM 2012 62387 A

(220) 2011 05 10

(732) AVANTHA HOLDINGS LIMITED

First India Plase, Tower-C, Mehrauli-
Gurgaon Road, Gurgaon, Haryana-122002,
India

(111) M 2012 022936 R

(151) 2012 09 24

(181) 2022 09 24

(260) AM 2012 62605 A

(220) 2011 05 27

(732) GENERAL MOTORS LLC

300 Renaissance Center, City of Detroit,
State of Michigan 48265-3000, USA

(111) M 2012 022937 R

(151) 2012 09 24

(181) 2022 09 24

(260) AM 2012 62629 A

(220) 2011 05 31

(732) Joint Stock Company "NOBEL ILAC

SANAYII VE TICARET ANONIM
SIRKETI" TSARM. SAQARTVELOSHI
Tavisuflebis moedani N4, 0105, Tbilisi,
Georgia

(111) M 2012 022938 R

(151) 2012 09 24

(181) 2022 09 24

(260) AM 2012 62630 A

(220) 2011 05 31

(732) Joint Stock Company "NOBEL ILAC
SANAYII VE TICARET ANONIM
SIRKETI" TSARM. SAQARTVELOSHI
Tavisuflebis moedani N4, 0105, Tbilisi,
Georgia

(260) AM 2012 62709 A
(220) 2011 06 03
(732) LTD AGROGANVITAREBA
Isnis raioni, samgoris chikhi 4, 0120, Tbilisi,
Georgia

(111) M 2012 022939 R
(151) 2012 09 24
(181) 2022 09 24
(260) AM 2012 62641 A
(220) 2011 06 01
(732) LTD "ALTA"
Saburtalos q. N35, 0194 , Tbilisi, Georgia

(111) M 2012 022945 R
(151) 2012 09 24
(181) 2022 09 24
(260) AM 2012 62714 A
(220) 2011 06 03
(732) LTD "VIA TREVETI"
Abashidzis q.24, 0179, Tbilisi, Georgia

(111) M 2012 022940 R
(151) 2012 09 24
(181) 2022 09 24
(260) AM 2012 62643 A
(220) 2011 06 01
(732) LTD "SHUMERI"
Mtkvris martskhena sanapiro, Agladzis 34,
0119, Tbilisi, Georgia

(111) M 2012 022946 R
(151) 2012 09 24
(181) 2022 09 24
(260) AM 2012 62716 A
(220) 2011 06 03
(732) DAVIT ASATIANI
Shartavas q. 35, korp.1, bina 40, 0160,
Tbilisi, Georgia

(111) M 2012 022941 R
(151) 2012 09 24
(181) 2022 09 24
(260) AM 2012 62646 A
(220) 2011 06 01
(732) IMAX CORPORATION
2525 Speakman Drive, Misissauga,
ON L5K 1B1, Canada

(111) M 2012 022947 R
(151) 2012 09 24
(181) 2022 09 24
(260) AM 2012 62718 A
(220) 2011 06 06
(732) ALEQSANDR SLOBODIAN
ul. Radunskaaia, d. 26, kv. 55, 02097 Kiev,
Ukraine

(111) M 2012 022942 R
(151) 2012 09 24
(181) 2022 09 24
(260) AM 2012 62684 A
(220) 2011 06 03
(732) LTD "BERTA"
Tserovani, 3318, Mtskheta, Georgia

(111) M 2012 022948 R
(151) 2012 09 24
(181) 2022 09 24
(260) AM 2012 62719 A
(220) 2011 06 06
(732) SHEZGUDULI PASUKHISMGEBLOBIS
SAZOGADOEBA IBERIELI
Nutsubidzis ferdobi, me-3 m/r, me-2 kvartali,
me-3 korpusi, 0183, Tbilisi, Georgia

(111) M 2012 022943 R
(151) 2012 09 24
(181) 2022 09 24
(260) AM 2012 62708 A
(220) 2011 06 03
(732) LTD AGROGANVITAREBA
Isnis raioni, samgoris chikhi 4, 0120, Tbilisi,
Georgia

(111) M 2012 022949 R
(151) 2012 09 24
(181) 2022 09 24
(260) AM 2012 62720 A
(220) 2011 06 06
(732) SHEZGUDULI PASUKHISMGEBLOBIS
SAZOGADOEBA IBERIELI
Nutsubidzis ferdobi, me-3 m/r, me-2 kvartali,
me-3 korpusi, 0183, Tbilisi, Georgia

(111) M 2012 022944 R
(151) 2012 09 24
(181) 2022 09 24

(111) M 2012 022950 R
(151) 2012 09 24
(181) 2022 09 24
(260) AM 2012 62880 A
(220) 2011 06 16
(732) THE GILLETTE COMPANY
One Gillete Park, Boston, Massachusetts
02127, USA

(111) M 2012 022951 R
(151) 2012 09 24
(181) 2022 09 24
(260) AM 2112 62908 A
(220) 2011 06 20
(732) AAIP "AGROBIZNESTSENTRI-
LANCHKHUTI"
Kostavas 37, 2800, Lanchkhuti, Georgia

(111) M 2012 022952 R
(151) 2012 09 24
(181) 2022 09 24
(260) AM 2012 62979 A
(220) 2011 06 28
(732) General Motors LLC
300 Renaissance Center, City of Detroit,
State of Michigan 48265-3000, USA

(111) M 2012 022953 R
(151) 2012 09 24
(181) 2022 09 24
(260) AM 2012 63017 A
(220) 2011 07 01
(732) BRAUN-FORMAN POLSKA SP. Z.O.O.
E POLISH LIMITED KOMPANI
Ul. Postepu 21 d, 02-645 Warshava, Poloneti,
Poland

(111) M 2012 022954 R
(151) 2012 09 24
(181) 2022 09 24
(260) AM 2012 63018 A
(220) 2011 07 01
(732) JOHNSON & JOHNSON
(a corporation the state of New Jersey)
One Johnson & Johnson Plaza,
New Brunswick, New Jersey, USA

(111) M 2012 022955 R
(151) 2012 09 24
(181) 2022 09 24
(260) AM 2012 63055 A
(220) 2011 07 04

(732) LTD IDS Borjomi Beverages Co. N.V.
45, Pareraweg, Curacao, Netherlands
Antilles

(111) M 2012 022956 R
(151) 2012 09 24
(181) 2022 09 24
(260) AM 2012 63121 A
(220) 2011 07 07
(732) LTD "RADIO IMEDI"
Aleqsidzis q.3, 0193, Tbilisi, Georgia

(111) M 2012 022957 R
(151) 2012 09 24
(181) 2022 09 24
(260) AM 2012 63221 A
(220) 2011 07 14
(732) LTD "BARAMBO"
Sopeli Natakharti., 3308, Mtskheta, Georgia

(111) M 2012 022958 R
(151) 2012 09 24
(181) 2022 09 24
(260) AM 2012 63227 A
(220) 2011 07 15
(732) WORLD MEDICINE LIMITED
Commonwealth Trust Limited, Drake
Chambers, Tortola, British Virgin Islands

(111) M 2012 022959 R
(151) 2012 09 24
(181) 2022 09 24
(260) AM 2012 63228 A
(220) 2011 07 15
(732) WORLD MEDICINE LIMITED
Commonwealth Trust Limited, Drake
Chambers, Tortola, British Virgin Islands

(111) M 2012 022960 R
(151) 2012 09 24
(181) 2022 09 24
(260) AM 2012 63239 A
(220) 2011 07 15
(732) LTD "BALLIS"
Davit Agmasheneblis 115-d, 0170,
Akhalqalaqi, Georgia

(111) M 2012 022961 R
(151) 2012 09 24
(181) 2022 09 24
(260) AM 2012 63240 A

TRADEMARKS

(220) 2011 07 15
(732) LTD "BALLIS"
Davit Agmasheneblis 115-d, 0170,
Akhalqalaqi, Georgia

(111) M 2012 022962 R
(151) 2012 09 24
(181) 2022 09 24
(260) AM 2012 63322 A
(220) 2011 07 21
(732) SOCIETE NATIONALE
D'EXPLOITATION INDUSTRIELLE
DES TABACS ET ALLUMETTES, SA
143 boulevard Romain Rolland, Cedex 14,
Paris 75685 , France

(111) M 2012 022963 R
(151) 2012 09 24
(181) 2022 09 24
(260) AM 2012 63377 A
(220) 2011 07 25
(732) INOVATSIURI TEQNOLOGIEBIS
SAERTASHORISO FONDI
Jiqias q. N8, 0186, Tbilisi, Georgia

(111) M 2012 022964 R
(151) 2012 09 24
(181) 2022 09 24
(260) AM 2012 63479 A
(220) 2011 07 29
(732) QATAR OLYMPIC COMMITTEE
P.O. Box: 7494, Doha, Qatar

(111) M 2012 022965 R
(151) 2012 09 24
(181) 2022 09 24
(260) AM 2012 63575 A
(220) 2011 08 04
(732) BASF Agro B.V., Arnhem (NL),
Zweigniederlassung Wädenswil;
Moosacherstrasse 2, Au, Switzerland

(111) M 2012 022966 R
(151) 2012 09 24
(181) 2022 09 24
(260) AM 2012 63618 A
(220) 2011 08 10
(732) TOYOTA JIDOSHA KABUSHIKI KAISHA
(also trading as TOYOTA MOTOR
CORPORATION)
1, Toyota-Cho, Toyota-Shi, Aichi-Ken,
Japan

(111) M 2012 022967 R
(151) 2012 09 24
(181) 2022 09 24
(260) AM 2012 63652 A
(220) 2011 08 10
(732) PEPSICO, INC. A NORTH CAROLINA
CORPORATION
700 Anderson Hill Road, Purchase,
New York 10577, USA

(111) M 2012 022968 R
(151) 2012 09 24
(181) 2022 09 24
(260) AM 2012 63692 A
(220) 2011 08 12
(732) SOSO MAMULADZE
Tsulukidzis 23 b, bina 91, 0154, Tbilisi,
Georgia

(111) M 2012 022969 R
(151) 2012 09 24
(181) 2022 09 24
(260) AM 2012 63856 A
(220) 2011 08 25
(732) JAPAN TOBACCO INC.
2-2-1 Toranomom Minato-ku, Tokyo, Japan

(111) M 2012 022970 R
(151) 2012 09 24
(181) 2022 09 24
(260) AM 2012 63877 A
(220) 2011 09 01
(732) WORLD VISION INTERNATIONAL
800 West Chestnut Avenue, 91016
Monrovia, California, USA

(111) M 2012 022971 R
(151) 2012 09 24
(181) 2022 09 24
(260) AM 2012 63883 A
(220) 2011 09 02
(732) CASPIAN HOUSEHOLD APPLIANCES
TRADING (L.L.C)
P.O. Box: 16579, Dubai, United Arab
Emirates

TRADEMARKS REGISTERED ACCORDING TO THE ACCELERATED PROCEDURE

The decision can be appealed at the Chamber of Appeal of Sakpatenti within 3 months from the publication.

(111) M 2012 22972 R

(151) 2012 09 25

(181) 2022 09 25

(210) AM 068815

(220) 2012 09 12

(732) LTD "Maknatuna"

Ninoshvilis Ishes., N6, 4600, Qutaisi,
Georgia

(540)



(591) Red, yellow, black, blue, grey, golden, white

(531) 01.03.07-05.05.04-05.07.06-25.01.01-
28.19.00-29.01.15-

(511) 30

(111) M 2012 22973 R

(151) 2012 09 25

(181) 2022 09 25

(210) AM 068764

(220) 2012 09 06

(732) KOBACHKHIDZE

V. Sarajishvilis q. 26, 0108, Tbilisi, Georgia

(740) Davit Zurabishvili

(540)



(591) Golden, black, white

(531) 03.03.01-25.01.19-25.03.07-27.05.11-
28.19.00-29.01.14-

(526) **Disclaimer** – Word combinations "BAZALETI", „საზაღვრო“, "SPARKLING WINE" in the trademark shall not be subject to independent protection.

(511) 33

(111) M 2012 22974 R

(151) 2012 09 27

(181) 2022 09 27

(210) AM 068250

(220) 2012 08 08

(310) UA-M201211794

(320) 2012 07 11

(330) UA

(732) JAPAN TOBACCO INC.

2-2-1, Toranomom, Minato-ku, Tokyo, Japan

(740) Shalva Gvaramadze

(540)

SLIDE UP

(591) Black, white

(511) 34

(111) M 2012 22975 R

(151) 2012 09 28

(181) 2022 09 28

(210) AM 068585

(220) 2012 08 27

(732) LTD "KONIAKISA DA GVINIS

QARKHANA VAZIANI"

Sopeli Martkopi, dasakhleba Vaziani,

Gardabnis munitsipaliteti, 1320, Georgia

(540)



(591) Dark oxra, black, white

(531) 07.01.01-28.05.00-29.01.14-

(526) **Disclaimer** – The trademark is protected as a whole, word combination "Кახети", shall not be subject to independent protection.

(511) 33

(111) M 2012 22976 R

(151) 2012 09 28

(181) 2022 09 28

(210) AM 068662

(220) 2012 08 30

(732) LTD "KONIAKISA DA GVINIS

QARKHANA VAZIANI"

Sopeli Martkopi, dasakhleba Vaziani,

Gardabnis munitsipaliteti, 1320, Georgia

(540)



(591) Grey, black

(531) 07.01.01-27.05.11-27.05.19-

(526) **Disclaimer** – The trademark is protected as a whole, word combination "Kakheti", shall not be subject to independent protection.

(511) 33

(111) M 2012 22977 R

(151) 2012 09 28

(181) 2022 09 28

(210) AM 068668

(220) 2012 08 31

(732) LTD "CAPITAL GEORGIA & ROUTEH"

Sopeli Sabirqendi, 3002, Marneulis raioni,

Georgia

(740) Lali Sudadze

(540)



(591) Black, yellow, orange, green, red

(531) 05.03.14-26.01.18-27.05.03-27.05.07-
29.01.15-

(526) **Disclaimer** – The trademark is protected as a whole, word combination "Georgia", shall not be subject to independent protection.

(511) 29, 35

(111) M 2012 22978 R

(151) 2012 09 28

(181) 2022 09 28

(210) AM 068689

(220) 2012 09 03

(732) LTD "DZRAVA"

Sopeli Khutsubani, 6219, Kobuleti, Georgia

(540)



The choice of pro

(591) Blue, black

(531) 26.01.02-26.01.20-26.11.12-29.01.12-

(511) 7

INTERNATIONAL TRADEMARKS FOR WHICH A DECISION ON GRANTING PROTECTIONS IS TAKEN

The decision can be appealed at the Chamber of Appeal of Sakpatenti within 3 months from the publication or at the Administrative Chamber of the Tbilisi City Court (Address: №6, David Aghmashenebeli Kheivani 12 km., Tbilisi) within 1 month following the publication.

(260) AM 2012 64408 A
(800) 1090753
(731) CITY OF GLENDALE
950 Birch Street Glendale CO 80246, USA
(540)

RUGBYTOWN USA

(591) Black, white
(511)
41 – Providing a website containing information relating to the sport of rugby, including team information, player statistics and news; educational services, namely, conducting programs in the field of rugby; educational services, namely, conducting on-line exhibitions and displays and interactive exhibits in the field of rugby; entertainment, namely, production of rugby football games and tournaments; entertainment services in the nature of rugby games, namely, hosting events; entertainment services, namely, the organization, promotion, production, and presentation of rugby football competitions and a rugby football team, and the teaching of rugby football; conducting educational exhibitions in the nature of rugby; conducting entertainment exhibitions in the nature of rugby; museums.

(260) AM 2012 64409 A
(800) 1090764
(731) LIST TRADE-MARK
Via Cerchiara, 67, I-00131 ROMA, Italy
(540)

LIST

(591) Black, white
(511)
14 – Precious metals and their alloys and goods in precious metals or coated therewith, not included in other classes; jewellery, precious stones; horological and chronometric instruments.

(260) AM 2012 64410 A
(800) 1063574
(731) DELTAKOM ELECTRONICS Ltd.
26, "Rajko Aleksiev" Str., entr. B, fl. 4, apt. 7,
BG-1000 Sofia, Bulgaria
(540)



(591) Black, white
(511)
9 – Apparatus for recording, transmission or reproduction of sound or images; audiovisual teaching apparatus; electronic publications (downloadable); cinematographic cameras; teaching apparatus and instruments; sound recording apparatus; magnetic data media; optical data media; video screens; computer programs (downloadable software); computer programmes (programs), recorded; sound recording discs; compact discs (audio-video); computer software (recorded).

35 – Business management; business administration; office functions; systemization of information into computer databases; compilation of information into computer databases.

38 – Telecommunications.

42 – Scientific and technological services and research and design relating thereto; design and development of computer hardware and software.

(260) AM 2012 64412 A
(800) 838766
(731) RĪGAS PIENA KOMBINĀTS
A/S Bauskas Iela 180, LV-1004 Rīga,
Latvia
(540)

RASA

(591) Black, white
(511)
29 – Milk and milk products, including milk based desserts; edible oils and fats; eggs; preserved, dried and cooked fruits and vegetables; jellies, jams, compotes.
30 – Ice cream; ice cream based desserts, ice; pastry and confectionery.

(260) AM 2012 64413 A
(800) 904493
(731) EZINC METAL SANAYI VE TICARET
ANONIM SIRKETI
Organize Sanayi Bolgesi 11., Cad. No: 12,
TR-38070 Kayseri, Turkey

(540)



(591) Black, white

(511)

11 – Apparatus for heating and steam generating, namely stoves, part of heating installations, boilers for central heating and natural gas installations (boilers), steam boilers, exchangers, burners, equipment for heating systems, water heaters used also as heating system, water heaters, thermosiphon, namely refers to a method of passive heat exchange based on natural convection which circulates liquid in a vertical closed-loop circuit without requiring a conventional pump, radiators, heat pumps, electrical water boilers used for parts of installation, solar energy collectors and apparatus, water heating unit with solar energy and parts thereof, water heaters used for parts of installation with electrical, solid, household, gas fuels, combination boiler, boilers and central heating boilers, bathroom heaters.

(260) AM 2012 64414 A

(800) 941784

(731) IWI AG

Industriestrasse 13-C, CH-6304 Zug,
Switzerland

(540)

SPLAT

(591) Black, white

(511)

3 – Bleaching preparations and other substances for laundry use; cleaning, polishing, scouring and abrasive preparations; soaps; perfumery, essential oils, cosmetics, hair lotions; dentifrices.

5 – Pharmaceutical and veterinary preparations; sanitary preparations for medical purposes; dietetic substances adapted for medical use, food for babies; plasters, materials for dressings; material for stopping teeth, dental wax; disinfectants; vitamin preparations.

(260) AM 2012 64415 A

(800) 963950

(731) Acino Holding AG

Erlenstrasse 1, CH-4058 Basel, Switzerland

(540)



(591) Orange, magenta, Coolgrey

(511)

1 – Chemical products used in industry and science.

3 – Bleaching preparations and other substances for laundry use; cleaning, polishing, scouring and abrasive preparations; soaps; perfumery, essential oils, cosmetics, hair lotions; dentifrices.

5 – Pharmaceutical and veterinary preparations; sanitary preparations for medical purposes; dietetic substances adapted for medical use, food for babies; plasters, materials for dressings; material for stopping teeth, dental wax; disinfectants; preparations for destroying vermin; fungicides, herbicides.

42 – Scientific and technological services as well as research services in pharmacy, medicine and chemistry; advice on science, especially in pharmacy, medicine and chemistry.

(260) AM 2012 64713 A

(800) 761316

(731) LABORATOIRES D'ANJOU

(Société par actions simplifiée)

16 rue de l'Exposition, F-75007 PARIS,
France

(540)

CEBELIA

(591) Black, white

(511)

3 – Soap, perfumery, essential oils, cosmetics, hair lotions, dentifrices.

(260) AM 2012 65034 A

(800) 1095735

(731) Barilla G. e R.

Fratelli – Società per Azioni; Via Mantova,
166, I-43100 PARMA, Italy

(540)



(591) Yellow, light blue, green, red, brown, white

(511)

32 – Beers; mineral and aerated waters and other non-alcoholic drinks; fruit drinks and fruit juices; syrups and other preparations for making beverages; isotonic beverages.

(260) AM 2012 65038 A

(800) 1095781

(731) DKV EURO SERVICE GmbH & Co. KG

Balcke-Dürr-Allee 3, 40882 Ratingen,
Germany

(540)



(591) Dark silver, light silver, dark grey and light grey

(511)

16 – Paper, cardboard (paperboard) and goods made from these materials, not included in other classes; printed matter; book-binding materials; photographs; stationery; instructional and teaching materials (except apparatus); plastic packaging material not included in other classes; printers' type; printing blocks.

35 – Advertising, particularly updating of advertising material and brochures for advertising purposes; development of advertising and marketing concepts; television advertising; publication of advertising copy; customer acquisition and care through direct mailing; marketing; market research; opinion research; online advertising on a computer network; organisation and conduct of advertising events; organisation of exhibitions and fairs for commercial and advertising purposes; planning of advertising activities; presentation of companies on the Internet and in other media; presentation of goods by means of communication media for the retail trade; collection and compilation of theme-based press articles; dissemination of advertisements; preparation of advertising copy; (sales promotion) (for third parties); advertising by written advertisements; advertising on the internet for third parties; business management; business administration; preparation of cost-price analyses; information for business purposes; consultancy for the organisation and management of companies; consultancy services, assistance and planning in the area of company management; procurement services for third parties; business consultancy and advisory services; bookkeeping; checking of accounts; office functions; administration of expendable material inventories; management and issue of office supplies; correspondence course; computerized file management; advertising agency services; tax consultancy services, namely, preparation of tax declarations; auditing services; outsourcing services, especially conduct of auctions and compulsory sales; conduct of company transfers; transcriptions services; business management of real property (facility management); enquiries in the business field; billing (office functions); preparation of expert business management reports; preparation of export business reports; preparation of account statements; compilation of statistics; preparation of tax declarations; preparation of economic forecasts; commercial and business information and consultancy services for consumers; provision

of information with regard to commercial and business matters; Billing of account on behalf of third parties; business consultancy in the area of billing services, namely, business consultancy for billing (office functions) which are based mainly on customer-orientedly developed software programs; settlement in the field of software-aided services in the area of billing services, namely, billing (office functions) based mainly on customer-orientedly developed software programs; provision of services for other companies in connection with billing for commercial and service transactions, namely, billing (office functions) for third parties; submission of refund applications via electronic portals of individual credit finance authorities (office functions); monitoring and booking of refund amounts (office functions); Preparation of mineral tax refunds in various countries (office functions); computer-aided billing for fuels, ferry fees, motorway tolls, tolls and/or value-added tax (office functions); Sales and sales services provided at service stations related to computer aided billing services, namely, clearance fees (office functions); computer-aided billing for freight and freight brokerage charges (office functions); compilation of data for toll roads and tunnels; computer-aided billing for tunnel fees; computer-aided billing (office functions) for repair services; recording of personal and vehicle-related data (office functions); systematisation of motor vehicle master data, tank data, motor vehicle costs and revenues in computer data bases for statistical purposes; business organization and planning of order and coordination of motor vehicle operations; updating of data in computer data bases for order planning; provision for third parties of contracts for mobile phone services; invoicing services; company management for third parties; photocopying services; aid in the management of industrial or commercial businesses; information with regard to business matters; commercial administration of goods and services licensing for third parties; payroll preparation services; enquiries in computer files for third parties; enquiries with regard to business matters; public relations; organisational consultancy with regard to business matters; organisational consultancy; out-sourcing services (aid in the business field); human resource management; personnel recruitment; human resource selection with the aid of psychological aptitude tests; planning and monitoring of corporate developments in an organisational respect; planning (aid) for company management, namely, preparation of annual planning, including planning/advance planning of budgets; writing services (word processing); typing services; secretarial services; finding sponsors; shorthand services; systematisation of data in computer data bases; telephone answering services for unavailable subscribers; business consultancy; consumer advisory services; brokerage of comm-

rcial and business contacts, including via the internet; brokerage of commercial transactions for third parties, including those within the framework of e-commerce; industrial asset management; organisational project management in the data processing sector; compilation of data on computer data bases; organisation project management in the field of data processing, namely development and further-development of new products for third parties and for agencies, including analysis of market development, product controlling, namely, investment appraisals before new product development and continuous budget monitoring (accounting); organisational business planning; human resource management consultancy; company management consultancy; human resource administration, namely, qualitative and quantitative human resource planning (office functions); international human resource management planning when setting up branches; analysis of sales markets; cost controller services; conduct of marketing campaigns; conduct of market analyses; creditor accounting (suppliers), debtor accounting (customers), material/overhead cost accounting, fixed asset accounting; control of costs; sales and marketing controlling; administration, processing and dispatch of payment reminders (office functions); vehicle fleet management, namely, organisational vehicle fleet administration.

36 – Insurance; finance; monetary transactions; real property; banking transactions; clearing transactions; safety deposit services; estate agent services; stockbroker services; securities brokerage; debt collection; logging, settlement and securing of forward transactions; provision of financial information; factoring; financial analyses; financial consultancy; financial estimates (in the field of insurance, banking and land); financing services; financing consultancy (loan consultancy); business liquidations (financial services); grant of installment loans; real estate administration; real estate administration and brokerage of real estate and office space, discussion and conference areas (facility management); investment transactions; credit brokerage; leasing; life-assurance services; merger and acquisition transactions, namely, financial consultancy for the purchase or sale of companies, and company participations; savings-bank transactions; provision of sureties and bails; grant of loans; productive-fund investment brokerage; brokerage of insurance contracts; asset administration; insurance consultancy; financial-audit services; corporate financing; provision of information on company creditworthiness; collection services, particularly the collection of debts outstanding (collection transactions) and the administration of accounts receivable (asset administration), particularly searches, enquiries into financial circumstances for the classification of accounts receivable and risks to ac-

counts receivable and the monitoring of payment targets; broking of credit insurance contracts; asset administration; issue of magnetic and/or chip cards with payment function; settlement of monetary transactions with magnetic and/or chip cards; financial consultancy in the area of insurance, health, real property and finance; sponsoring (financial support) of scientific functions and other financial furtherance of technical innovations; rental, lease and broking of flats, houses, residential home places and similar premises (real property) included in this class; issue to industrial freight and passenger transport businesses of service cards with payment functions for third parties for the cashless in-transit supplying of lorries and buses and their drivers; computer-aided settlement of financial and monetary transactions with service cards with payment functions; electronic settlement of foreign value-added tax refunds; freight forwarding services, in particular, payment for third parties of duty on goods; border clearance and ferry services, namely, provision of access authorisation for toll lanes and tunnels (customs clearance for third parties); collection of use fees by the issue of vignettes; damage description by the preparation of expert financial damage reports; cashless billing, namely, settlement of invoices in the field of the cashless in-transit supplying of national and internationally operating industrial goods and passenger transport companies and of national and internationally industrially operated motor car and/or lorry fleets, in the area of transport and in the area of the afore-mentioned activities; broking of financial participating interests in industrial, trading and service companies and the management and administration of other assets, it is permissible without express permission (asset administration); rental and leasing of real estate and office areas.

37 – Services of a motor vehicle repair workshop, namely, the maintenance and repair of motor vehicles, including those in industrial freight transport; service station services and sales and services relating thereto, namely, cleaning of motor vehicles, repair of motor vehicles; breakdown assistance, namely, repair of motor vehicles on site and at motor vehicle repair workshops; rental service, namely, the rental of construction vehicles; motor-vehicle maintenance; repair and maintenance of tyres and motor vehicle cooling systems; installation services; installation and maintenance of toll logging and toll billing equipment; exterior and interior cleaning of buildings; facility management or infrastructural building management, namely, repair, upkeep and maintenance of real property, including the utility systems integrated with them, particularly heating and electrical systems; installation and repair of burglar alarms, electrical equipment and fire alarm, heating and air-conditioning systems; construction of fair stands

and shops; painting and bricklaying services, wallpapering services; furniture care services; cleaning of motor vehicles, window cleaning, rust prevention services, street cleaning; rental of cleaning and roadsweeping machinery; installation, maintenance, cleaning and repair of machines and automatic systems, particularly fork lift and lifting trucks; installation, maintenance and repair of computer hardware; maintenance of data processing equipment; building maintenance, repair and cleaning (caretaker services).

38 – Telecommunications, including radio services, particularly, radio guidance of motor vehicles in industrial freight transport; telecommunication services for nationally and internationally operating industrial freight and passenger transport services, namely, the transmission of information about the state of roads, the traffic situation, the location of service stations, the location of vehicles, and technical vehicle matters and transmission via the Internet and radio services of information relating to the price of fuel at home and abroad; multi-language emergency breakdown services, namely, the transmission by telecommunication lines of motor vehicle experts' specialist technical knowledge (telephone services through call centres).

39 – Transport services, particularly freight forwarding services, except payment of duty on goods; breakdown assistance, namely, the towing away and recovery of motor vehicles; rental services, namely, rental of buses and motor vehicles for the freight-for-warding sector; transport of motor vehicles by rail; accident services, namely, broking of replacement motor vehicles and towing vehicles and the towing away of motor vehicles; packaging and storage of goods; travel arrangement; transshipment of transport goods; logistics, namely, customer-specific picking of goods in the area of transport logistics, parcel dispatch processing; courier and forwarding agent planning, freight shipments; preparation of dispatch documents as part of transport services; storage of furniture and goods, removal services; location of broken-down vehicles through computer-aided map systems; route guidance by radio, namely, motor vehicle fleet management by means of electronic navigation and locating equipment and by means of radio.

41 – Education and training, particularly lecture programmes and workshops; entertainment; sports and cultural activities; development of training and further-training concepts, including training and further-training events; organisation of leisure-time activities; organisation and conduct of conferences; organisation and conduct of congresses; organisation and conduct of symposia; organisation and conduct of colloquies; organisation and conduct of further-training events in connection with fran-

chising concepts; training and further-training in the field of franchising; publication and editing of books, brochures (except for advertising purposes) and training materials; provision of multilingual breakdown services, namely, interpreting services, included in this class; information services for nationally and internationally operating industrial freight and passenger transport services, namely, publication of printed matter (except that for advertising purposes) relating to the state of roads, the traffic situation, the location of service stations and the location of vehicles, relating to technical vehicle matters and relating to the price of fuel at home and abroad; human resource support and development by training and further-training.

42 – Scientific and technological services and research work and designer services relating to these, particularly the compilation of computer software and programs for data processing, particularly in the area of financial, insurance and real property services; enquiries and searches in data bases for science and research; technical development of magnetic and chip cards and other computer-aided insurance and financial verification; electronic data storage, industrial analysis and research services; updating of computer software; updating of Web pages; building construction consultancy (architectural consultancy); consultancy in the field of homepage and Web page design; preparation of Internet presentations; computer consultancy services; computer system analyses; computer system design; design and preparation of home pages and Websites; computer software design; graphic design services; graphic art services; engineering services; digital image processing (graphic art services); compilation of programs for data processing; preparation of expert technical reports; design and maintenance of Websites for third parties; installation of computer programs; conversion of computer programs and data, excepting physical changes; conversion of data or documents from material to electronic media; copying of computer programs; rental of computer software; rental of data processing equipment; rental and maintenance of storage space for use as Websites for third parties (hosting); maintenance of computer software; restoration of computer data; development services with regard to new products for third parties; product quality control; maintenance of computer software; design and development of computer hardware and computer software, particularly compilation of computer software and programs; installation and maintenance of software for toll logging and toll billing equipment; technical development of IT systems; data processing consultancy for IT systems; rental of computer hardware for IT systems; layout design for advertising purposes; provision of forms and updating, namely, development and design of forms for third parties.

43 – Catering and accommodation services for guests; rental and lease of discussion and conference areas.

45 – Legal services; security services for the protection of assets or persons; personal and social services provided by third parties with regard to individual needs; issue of licences for franchise concepts; issue of licences for industrial property rights and copyrights; administration of copyrights and industrial property rights, particularly patents, utility models and registered designs, including trademark rights; lawyer's services, namely, legal action as part of accounts receivable management; legal consultancy for the drawing up and maintenance of contracts (customer contracts, supplier contracts, standard contracts, purchasing, service contracts, specific-work contracts, work contracts, company contracts); consultancy with regard to escape plans, emergency treatment and fire prevention in the field of occupational health and safety; electrical system inspections for safety purposes, regular inspection of equipment and work equipment for safety purposes; consultancy with regard to intellectual property and industrial property rights; licensing with regard to intellectual property and industrial property rights, including those in the field of copyright; trade in intellectual property (rights) and industrial property rights; legal representation in tax matters; consultancy with regard to security, namely, data protection, data security, data access and data archiving, certification and attestation (security strategies).

(260) AM 2012 65040 A

(800) 1095789

(731) X-Trade Brokers Dom Maklerski S.A.
ul. Ogrodowa 58, PL-00-876 Warszawa,
Poland

(540)



(591) Red, white and black

(511)

36 – Brokerage.

(260) AM 2012 65042 A

(800) 1095814

(731) DONGGUAN COOMO FURNITURE
CO., LTD

Furniture Road, Shuanggang Village, Houjie
Town, Dongguan City, Guangdong Province,
China

(540)



(591) Black, white

(511)

20 – Furniture; chairs (seats); mattresses; beds; sofas; furniture shelves; mirrors (looking glasses); works of art, of wood, wax, plaster or plastic; doors for furniture; bolsters.

(260) AM 2012 65044 A

(800) 1095854

(731) OTKRYTOE AKTSIONERNOE
OBSHCHESTVO "STROITELNAYA
KOMPANIA "MOST"
korp.4, d.9, Michurinsky prospect,
RU-119192 Moskva, Russian Federation

(540)



(591) White and blue

(511)

37 – Asphaltting; drilling of wells; rebuilding engines that have been worn or partially destroyed; rebuilding machines that have been worn or partially destroyed; retreading of tires [tyres]; building sealing; mining extraction; knife sharpening; building insulating; repair information; construction information; bricklaying; riveting; varnishing; retinning; scaffolding; road paving; car wash; vehicle wash; building construction supervision; rustproofing; anti-rust treatment for vehicles; strong-room maintenance and repair; vehicle maintenance; painting or repair of signs; cleaning of buildings [exterior surface]; vehicle polishing; rental of road sweeping machines; rental of cleaning machines; rental of construction equipment; rental of bulldozers, rental of excavators, rental of cranes [construction equipment]; plumbing; masonry; roofing services; painting, interior and exterior; underwater repair; cabinet making [repair]; plastering; quarrying services; repair of security locks; motor vehicle maintenance and repair; burner maintenance and repair; airplane maintenance and repair; safe maintenance and repair; pump repair; vehicle repair; vehicle greasing; demolition of buildings; warehouse construction and repair; vehicle service

stations [refuelling and maintenance]; pipeline construction and maintenance; pier breakwater building; underwater construction; harbour construction; factory construction; construction; shipbuilding; artificial snow-making services; irrigation devices installation and repair; elevator installation and repair; heating equipment installation and repair; burglar alarm installation and repair; furnace installation and repair; air conditioning apparatus installation and repair; fire alarm installation and repair; freezing equipment installation and repair; electric appliance installation and repair; installation, maintenance and repair of computer hardware; machinery installation, maintenance and repair; interference suppression in electrical apparatus; boiler cleaning and repair; vehicle cleaning; pumicing, sanding.

(260) AM 2012 65056 A

(800) 1095855

(731) Vidkryte akcionerne tovarystvo

"KYIVMEDPREPARAT"

vul. Saksaganskogo, 139, Kyiv 01032,

Ukraine

(540)

ИНСПИРОН

(591) Black, white

(511)

5 – Analgesics; anesthetics; antibiotics; first-aid boxes, filled; bacterial preparations for medical and veterinary use, bacteriological preparations for medical and veterinary use, balms for medical purposes; balsamic preparations for medical purposes; biological preparations for veterinary purposes; biological preparations for medical purposes, vaginal washes, vaccines, therapeutic preparations for the bath; bath preparations, medicated; bath salts for medical purposes; veterinary preparations; vitamin preparations; haemorrhoid preparations; sanitary panties; hygienic bandages; sanitary pads; hormones for medical purposes; disinfectants for hygiene purposes; diagnostic preparations for medical purposes; dietetic substances adapted for medical use; eucalyptus for pharmaceutical purposes; elixirs (pharmaceutical preparations); nervines; sedatives; adjuvants for medical purposes; camphor for medical purposes; camphor oil for medical purposes; cachets for pharmaceutical purposes; capsules for medicines; castor oil for medical purposes; barks for pharmaceutical purposes; medicinal roots; additives to fodder for medical purposes; depuratives; styptic preparations; medicines for veterinary purposes; medicines for human purposes; medicinal roots; medicinal tea; medicinal herbs; medicinal drinks; medicinal infusions; medicinal oils; liniments; lotions for veterinary purposes; lotions for pharmaceutical purposes; ointments

for pharmaceutical purposes; menthol; mint for pharmaceutical purposes; tinctures for medical purposes; medicinal oils; opotherapy preparations; napkins for incontinents; pills for pharmaceutical purposes; laxatives; purgatives; febrifuges; anti-uric preparations; syrups for pharmaceutical purposes; soporifics; medicinal alcohol; sterilising preparations; pastilles for pharmaceutical purposes; digestives for pharmaceutical purposes; herbs teas for medicinal purposes; pharmaceutical preparations; enzymes for veterinary purposes; enzymes for medical purposes; ferments for pharmaceutical purposes; enzyme preparations for veterinary purposes; enzyme preparations for medical purposes; dietetic foods adapted for medical purposes; pants, absorbent, for incontinents; napkins for incontinents; chemico-pharmaceutical preparations; chemical preparations for veterinary purposes; chemical preparations for medical purposes; chemical preparations for pharmaceutical purposes.

(260) AM 2012 65060 A

(800) 1095935

(731) AR KAGIT SANAYI ve TICARET

LIMITED SIRKETI

Turgut Reis Mah. Demokrasi, Cad.

No: 189/A, Sultanbeyli / Istanbul, Turkey

(540)



(591) Tones of blue and purple; white and grey

(511)

3 – Bleaching preparations and other substances for laundry use; cleaning, polishing scouring and abrasive preparations; soaps; perfumery, essential oils, cosmetics, hair lotions; dentifrices, tissues impregnated with cosmetic lotions; cotton wool for cosmetic purposes, cotton buds; dental bleaching gels; dentifrices; denture polishes.

16 – Paper, cardboard and goods made from these materials, not included in other classes; printed matter; bookbinding material; photographs; stationery; adhesives for stationery or household purposes; artists' materials; paint brushes; typewriters and office requisites (except furniture); instructional and teaching material (except apparatus); plastic materials for packaging (not included in other classes); wrappers; printers' type; printing blocks; toilet paper; towels of paper; napkins of paper; babies' napkins of paper and cellulose, disposable; babies' diapers of paper and cellulose, disposable.

- (260) AM 2012 65061 A
 (800) 1095943
 (731) VIDKRYTE AKTSIONERNE
 TOVARYSTVO "KOBLEVO"
 vul. Odeska, 6, s. Kobleve, Berezanskyj
 rajon, Mykolajivska oblast 57453, Ukraine
 (540)



- (591) Red, light brown, blue and white
 (511)
 33 – Alcoholic beverages, except beer; aperitifs; arak (arrack); brandy; whisky; vermouths, wine; beverages containing wine, white wines, table wines; dessert wine; sparkling wines; liqueur wine; fortified wine; muscat wine; sweet wine; semi-dry wine; wine foam, including carbonated, pink wine; dry wines; red wine; fruit and berry wines; anisette (liqueur); anise (liqueur); hydromel (mead); vodka; kirsch; perry; gin; cocktails; curacao; liqueurs; peppermint liqueurs; distilled beverages; alcoholic beverages containing fruit; bitters; piquette; rice alcohol; rum; sake; cider; spirits (beverages); alcoholic extracts; alcoholic essences; digesters (liqueurs and spirits); fruit extracts, alcoholic, soft (light) alcoholic beverages.

- (260) AM 2012 65113 A
 (800) 840866
 (731) SIGMA-TAU INDUSTRIE
 FARMACEUTICHE RIUNITE S.P.A.
 Viale Shakespeare, 47, I-00144 Roma, Italy
 (540)

CARNITENE

- (591) Black, white
 (511)
 5 – Pharmaceutical and veterinary products; sanitary products for medical purposes; dietetic substances adapted for medical use, food for babies; plasters, materials for dressings; material for dental fillings and dental impressions; disinfectants; pesticides; fungicides, herbicides.

- (260) AM 2012 65114 A
 (800) 850341
 (731) CONCRETE COMPANY FOR READY
 MADE GARMENTS S.A.E.
 6th October City 2nd Industrial Zone, Piece
 10/11 GIZA, Egypt
 (540)



- (591) Black, white
 (511)
 25 – Clothing (ready-to-wear clothing for children).

- (260) AM 2012 65115 A
 (800) 872585
 (731) Bionorica SE
 Kerschensteinerstrasse 11-15, 92318
 Neumarkt, Germany
 (540)

ТОНЗИЛГОН

- (591) Black, white
 (511)
 5 – Pharmaceutical and veterinary preparations as well as preparations for health care; dietetic products for medical use, plasters, dressings; disinfectants; plant extracts; dyes and flavorings in the form of liquids, solids or gases for pharmaceutical products and for dietetic products for medical use; nutritional supplements included in this class.

- (260) AM 2012 65116 A
 (800) 874246
 (731) BASF SE
 Carl-Bosch-Strasse 38, 67056 Ludwigshafen,
 Germany
 (540)

ТЕРСЕЛ

- (591) Black, white
 (511)
 5 – Pesticides, particularly preparations for destroying vermin, fungicides, herbicides, insecticides.

- (260) AM 2012 65118 A
 (800) 961722
 (731) SANTINI SRL
 Via Romagna, 23, I-62010 MORROVALLE
 (MACERATA), Italy

(540)



(591) Black, white

(511)

18 – Leather and imitation leather, goods made of these materials not included in other classes; suitcases.

25 – Clothing, footwear.

(260) AM 2012 65119 A

(800) 902703

(731) CELTEX S.P.A.

Via Marlianese, 43, I-51030 SERRAVALLE
PISTOIESE (PT), Italy

(540)



(591) Black, white

(511)

16 – Paper goods for hygienic, sanitary and domestic purposes.

(260) AM 2012 65141 A

(800) 1096428

(731) ORIFLAME COSMETICS S.A.

24, avenue Emile Reuter, L-2420
LUXEMBURG, Luxembourg

(540)

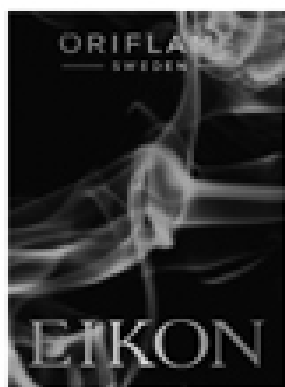

(591) Black, white

(511)

3 – Soaps; perfumery; essential oils; cosmetics; hair lotions; dentifrices.

(260) AM 2012 65142 A

(800) 1096429

(731) ORIFLAME COSMETICS S.A.

24, avenue Emile Reuter, L-2420
LUXEMBURG, Luxembourg

(540)

ORIFLAME LOVELY GARDEN

(591) Black, white

(511)

3 – Soaps, perfumery, essential oils, cosmetics, hair lotions, dentifrices.

(260) AM 2012 65143 A

(800) 1096430

(731) ORIFLAME COSMETICS S.A.

24, avenue Emile Reuter, L-2420
LUXEMBURG, Luxembourg

(540)

ORIFLAME FUSE

(591) Black, white

(511)

3 – Soaps, perfumery, essential oils, cosmetics, hair lotions, dentifrices.

(260) AM 2012 65368 A

(800) 1098017

(731) BRUEL S.P.A.

Via G.B. Verci, 40, I-36061 Bassano del
Grappa (VI), Italy

(540)

BRUNO PREMI

(591) Black, white

(511)

14 – Precious metals and their alloys and goods in precious metals or coated therewith, not included in other classes; jewellery, precious stones; horological and chronometric instruments.

18 – Leather and imitations of leather, and goods made of these materials and not included in other classes; animal skins, hides; trunks and travelling bags; umbrellas, parasols and walking sticks; whips, harness, and saddlery.

25 – Clothing, footwear, headgear.

35 – The bringing together, for the benefit of others, of a variety of goods (excluding the transport thereof) enabling customers to conveniently view and purchase those goods; such services may be provided by retail stores, wholesale outlets, through mail order catalogues or by means of electronic media, for example, through web sites or television shopping programmes.

(260) AM 2012 65370 A
 (800) 1098080
 (731) Limited Liability Company "RANGOLI"
 Street Central, 21, Kiev Region, v. Gora,
 Borispol 08324, Ukraine

(540)

RANGOLI

(591) Black, white
 (511)
 5 – Pharmaceutical and veterinary preparations;
 sanitary preparations for medical purposes;
 dietetic substances adapted for medical use,
 food for babies; plasters, materials for dressings;
 material for stopping, teeth, dental wax;
 disinfectants; preparations for destroying vermin;
 fungicides, herbicides.

(260) AM 2012 65371 A
 (800) 1098081
 (731) CHANEL SARL
 Burgstrasse 26, CH-8750 Glaris, Switzerland

(540)

**LIGNE GRAPHIQUE DE
 CHANEL**

(591) Black, white
 (511)
 3 – Cosmetics, make-up products.

(260) AM 2012 65372 A
 (800) 1098085
 (731) HANGZHOU YUHANG YUANDA
 INDUSTRIAL CO., LTD.
 Xingwang Industry Area, Yunhe County,
 Yuhang, Hangzhou City, Zhejiang Province,
 China

(540)

CROSSKNIFE

(591) Black, white
 (511)
 18 – Purses; travelling trunks; rucksacks;
 attaché cases; handbags; travelling bags;
 briefcases; valises; trunks (luggage);
 suitcases.

(260) AM 2012 65373 A
 (800) 1098086
 (731) PROCTER & GAMBLE INTERNATIONAL
 OPERATIONS SA
 47, route de Saint-Georges, CH-1213 Petit-
 Lancy, Switzerland

(540)

RED SIN

(591) Black, white

(511)
 3 – Soaps, perfumery, essential oils,
 cosmetics, hair lotions, dentifrices.

(260) AM 2012 65374 A
 (800) 1098092
 (731) BAYER CONSUMER CARE AG
 Peter Merian-Strasse 84, CH-4052 Basel,
 Switzerland

(540)

ЭЛЕВИТ

(591) Black, white
 (511)
 5 – Pharmaceutical products; dietetic substances
 adapted for medical use.

(260) AM 2012 65375 A
 (800) 1098093
 (731) PHILIP MORRIS BRANDS SÀRL
 Quai Jeanrenaud 3, CH-2000 Neuchâtel,
 Switzerland

(540)



(591) Black, white
 (511)
 34 – Tobacco, raw or manufactured; tobacco products,
 including cigars, cigarettes, cigarillos, tobacco for
 roll-your-own cigarettes, pipe tobacco, chewing tobacco,
 snuff tobacco, kretek; snus; tobacco substitutes (not for
 medical purposes); smokers' articles, including cigarette
 paper and tubes, cigarette filters, tobacco tins, cigarette
 cases and ashtrays, pipes, pocket apparatus for rolling
 cigarettes, lighters; matches.

(260) AM 2012 65376 A
 (800) 1098108
 (731) PHILIP MORRIS BRANDS SÀRL
 Quai Jeanrenaud 3, CH-2000 Neuchâtel,
 Switzerland

(540)

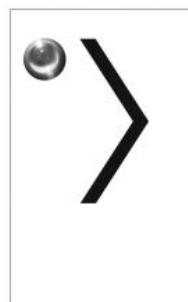

(591) Black, white

(511)

34 – Tobacco, raw or manufactured; tobacco products, including cigars, cigarettes, cigarillos, tobacco for roll-your-own cigarettes, pipe tobacco, chewing tobacco, snuff tobacco, kretek; snus; tobacco substitutes (not for medical purposes); smokers' articles, including cigarette paper and tubes, cigarette filters, tobacco tins, cigarette cases and ashtrays, pipes, pocket apparatus for rolling cigarettes, lighters; matches.

(260) AM 2012 65396 A

(800) 1098111

(731) PHILIP MORRIS BRANDS SÀRL
Quai Jeanrenaud 3, CH-2000 Neuchâtel,
Switzerland

(540)



(591) Black, white

(511)

34 – Tobacco, raw or manufactured; tobacco products, including cigars, cigarettes, cigarillos, tobacco for roll-your-own cigarettes, pipe tobacco, chewing tobacco, snuff tobacco, kretek; snus; tobacco substitutes (not for medical purposes); smokers' articles, including cigarette paper and tubes, cigarette filters, tobacco tins, cigarette cases and ashtrays, pipes, pocket apparatus for rolling cigarettes, lighters; matches.

(260) AM 2012 65397 A

(800) 1098112

(731) PHILIP MORRIS BRANDS SÀRL
Quai Jeanrenaud 3, CH-2000 Neuchâtel,
Switzerland

(540)



(591) Black, white

(511)

34 – Tobacco, raw or manufactured; tobacco products, including cigars, cigarettes, cigarillos, tobacco for roll-your-own cigarettes, pipe tobacco, chewing tobacco, snuff tobacco, kretek; snus; tobacco substitutes (not for medical purposes); smokers' articles, including cigarette paper and tubes, cigarette filters, tobacco tins, cigarette cases and ashtrays, pipes, pocket apparatus for rolling cigarettes, lighters; matches.

(260) AM 2012 65398 A

(800) 1098123

(731) Bayer Consumer Care AG
Peter Merian Str. 84, CH-4052 Basel,
Switzerland

(540)

BEPANPRO

(591) Black, white

(511)

3 – Cosmetics.

5 – Pharmaceutical products.

(260) AM 2012 65399 A

(800) 1098128

(731) Bayer Consumer Care AG
Peter Merian Str. 84, CH-4052 Basel,
Switzerland

(540)

BEPANCARE

(591) Black, white

(511)

3 – Cosmetics.

5 – Pharmaceutical products.

(260) AM 2012 65400 A

(800) 1098146

(731) Bayer Consumer Care AG
Peter Merian Str. 84, CH-4052 Basel,
Switzerland

(540)

БЕПАНТЕН

(591) Black, white

(511)

3 – Body care and beauty products (for topical and oral administration and in the form of eye drops) for treating the skin, nose and eyes, including products for skin care during pregnancy and breastfeeding and for babies, for dry skin irritations, except hair care products and hair styling products of all kinds, depilatory preparations and hair coloring preparations.

(260) AM 2012 65401 A
 (800) 1098155
 (731) TRIENT AS
 Skaganeset, N-5382 Skogsvag, Norway
 (540)

SEKKINGSTAD

(591) Black, white
 (511)
 29 – Meat, fish, poultry and game; meat extracts; preserved, frozen, dried and cooked fruits and vegetables; jellies, jams, compotes; eggs, milk and milk products; edible oils and fats.

31 – Agricultural, horticultural and forestry products and grains not included in other classes; live animals; live fish and shellfish; fresh fruits and vegetables; seeds, natural plants and flowers; food-stuffs for animals; malt.

40 – Fish processing, namely, slaughtering, carving, filleting, freezing, cooling, smoking, drying, salting, lye treatment and canning of fish.

(260) AM 2012 65403 A
 (800) 1098162
 (731) CHANGSHU TONGRUN AUTO
 ACCESSORY CO., LTD.
 New Longteng Industrial Park, Changshu
 Economic Development Zone, Jiangsu
 Province, China

(540)

BLACK JACK

(591) Black, white
 (511)
 7 – Lifts (other than ski-lifts); elevators (lifts); elevating apparatus; escalators; moving staircases (escalators); truck lifts; waggon lifts; electric portable drills; hydraulic hand tools; hand operated hydraulic presses; machines for the textile industry.

(260) AM 2012 65405 A
 (800) 1098170
 (731) PHILIP MORRIS BRANDS SÀRL
 Quai Jeanrenaud 3, CH-2000 Neuchâtel,
 Switzerland

(540)

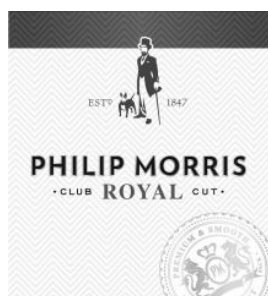

(591) Black, white
 (511)
 34 – Tobacco, raw or manufactured; tobacco products, including cigars, cigarettes, cigarillos, tobacco for roll-your-own cigarettes, pipe tobacco, chewing tobacco, snuff tobacco, kretek; snus; tobacco substitutes (not for medical purposes); smokers' articles, including cigarette paper and tubes, cigarette filters, tobacco tins, cigarette cases and ashtrays, pipes, pocket apparatus for rolling cigarettes, lighters; matches.

(260) AM 2012 65406 A
 (800) 1098182
 (731) EGIS Gyógyszergyár Nyilvánosan Működő
 Részvénytársaság
 Kereszturi ut. 30-38, H-1106 Budapest,
 Hungary

(540)

CADELTA

(591) Black, white
 (511)
 5 – Pharmaceutical preparations for human purposes.

(260) AM 2012 65408 A
 (800) 1098184
 (731) EGIS GYOGYSZERGYÁR Nyilvánosan
 Működő Részvénytársaság
 Kereszturi ut 30-38, H-1106 Budapest,
 Hungary

(540)

ERLEGIN

(591) Black, white
 (511)
 5 – Pharmaceutical preparations for human purposes.

(260) AM 2012 65409 A
 (800) 1098185
 (731) EGIS GYOGYSZERGYÁR Nyilvánosan
 Működő Részvénytársaság
 Kereszturi ut 30-38, H-1106 Budapest,
 Hungary

(540)

FLAXITERAN

(591) Black, white
 (511)
 5 – Pharmaceutical preparations for human purposes.

(260) AM 2012 65410 A
 (800) 1098191
 (731) AR-YILDIZ MADENI ESYA SANAYI VE

TICARET ANONIM SIRKETI
Istoç Toptancılar Çarşısı Z Blok No:11/13,
Mahmutbey-Bagcilar, Turkey

(540)



(591) Black, white

(511)

8 – Cutlery in precious metals or coated therewith; cutlery; forks; spoons; knives; cutters; choppers and peelers (non-electric); cutting tools.

21 – Household or kitchen utensils (non-electric); glassware, porcelain and earthenware not included in other classes; ornaments of porcelain, terra-cotta or glass; household and kitchen utensils of glass, porcelain, base metal, plastic, synthetic material or other materials; bottles; jars; carboys; cosmetic utensils; appliances for removing make-up, non-electric; powder puffs; boxes for toilet utensils; bottle openers; shoe horns; toothpicks; pipettes.

24 – Textiles and textile goods, not included in other classes; bed and table covers.

35 – Import-export agencies; the bringing together, for the benefit of others, of a variety of goods (excluding the transport thereof), enabling customers to conveniently view and purchase those goods.

(260) AM 2012 65411 A

(800) 1098249

(731) METAL FORM W.L.L.

Building 1959, Road 5146, Block 951, Askar,
Bahrain

(540)



(591) Purple, grey and white

(511)

6 – Alloys of common metals; aluminium; aluminium wire; cable joints of metal, non-electric; clips of metal for cables and pipes; cables of metal (non-electric).

9 – Co-axial cables; cables, electric; cables (fibre optic); junction sleeves for electric cables; conductors (electric).

(260) AM 2012 65413 A

(800) 1098277

(731) EGIS GYÓGYSZERGYÁR Nyilvánosan

Működő Részvénytársaság
Kereszturi út 30-38, H-1106 Budapest,
Hungary

(540)

ZOMBULAN

(591) Black, white

(511)

5 – Pharmaceutical preparations for human purposes.

(260) AM 2012 65414 A

(800) 1098282

(731) PUBLICHNE AKTSIONERNE

TOVARYSTVO "KHARKIVSKA
BISKVITNA FABRYKA"

vul. Lozivska, 8, Kharkiv 61017, Ukraine

(540)

ЧАІР
ЧАІР

(591) Black, white

(511)

30 – Coffee, tea, cocoa, sugar, rice, tapioca, sago, artificial coffee; flour for food and cereal preparations, bread; confectionery (sweets), ice cream, honey, golden syrup; yeast, baking-powder; salt, mustard; vinegar, condiments; spices; edible ices; peanut confectionery; farinaceous foods; pastries; bread rolls; buns; waffles; biscuits; fruit jellies (confectionery); custard; cocoa products; caramels (candy); lozenges (confectionery); confectionery for decorating Christmas trees; liquorice (confectionery); candy for food; marzipan; macaroons (pastry); almond confectionery; peppermint sweets; stick liquorice (confectionery); cookies; pies (confectionery); fondants (confectionery); pralines; edible decorations for cakes; gingerbread; puddings; rice cakes; sandwiches; malt biscuits; rusks; petit-beurre biscuits; cakes; petits fours (cakes); crackers; tarts; halvah; sweetmeats (candy); sugar confectionery; chocolate.

(260) AM 2012 65415 A

(800) 1098308

(731) KALISTO BUSINESS CORP.

P.O. Box 3321, Drake Chambers, Road
Town, Tortola, British Virgin Islands

(540)

Centro •

(591) White and dark pink

(511)

9 – Calculating machines; decorative magnets; spectacles [optics]; sunglasses; goggles for sports; eyeglasses; spectacle cases; eyeglass chains; eyeglass cords.

20 – Busts of wood, wax, plaster or plastic; fans for personal use, non-electric; coat hangers; mirrors [looking glasses]; hand-held mirrors [toilet mirrors]; bamboo; animal claws; animal hooves; coral; meerschaum; whalebone, unworked or semi-worked; stag antlers; tortoiseshell; shells; horn, unworked or semi-worked; animal horns; rattan; wickerwork; works of art of wood, wax, plaster or plastic; cabinet work; baskets, not of metal; mobiles [decoration]; picture frames; statuettes of wood, wax, plaster or plastic.

28 – Novelties for parties, dances [party favors, favours]; starting blocks for sports; spinning tops [toys]; jigsaw puzzles; dominoes; christmas trees of synthetic material; kites; toys; plush toys; mobiles [toys]; board games; kaleidoscopes; playing cards; confetti; dolls; marionettes; toy masks; candle holders for christmas trees; ornaments for christmas trees, except illumination articles and confectionery; chess games; checkers [games].

(260) AM 2012 65416 A

(800) 1098395

(731) JAKUSZ Systemy Zabezpieczen Bankowych
Bogdan Jakusz
ul. Przemyslowa 40, PL-83-400 Koscierzyna,
Poland

(540)

JAKUSZ 

(591) Blue and black

(511)

6 – Transportable metal building constructions, cash boxes and safes (strong-boxes), doors to strong-rooms, armour plating, containers and boxes of metal, strong-rooms, devices of metal for detonation of ammunition and explosives, containers of metal for transport and storage of ammunition and explosives, detonation chambers of metal.

9 – Signalling, supervision and alarm apparatus and instruments, apparatus for recording, transmitting or reproduction of sound or images, alarms, including anti-theft warning apparatus, electrical apparatus for door opening, electrical apparatus for access control, close-circuit television with monitoring, monitoring apparatus, electric, warning devices.

13 – Apparatus and containers for detonation of ammunition and explosives.

37 – Renovation of strong-rooms, strong-room doors, safes (strong boxes) and safe locks, safes and strong-boxes installation, burglar alarms installation and repair, installation, repair and maintenance of apparatus for detonation of ammunition and explosives.

(260) AM 2012 65417 A

(800) 1098407

(731) PAVLIACHVILI IOSIF RAMINOVITCH
kv.24, 8B, rue Roustavelli, RU-127254
Moscou, Russian Federation

(540)

СОСО ПАВЛИАШВИЛИ

(591) Black, white

(511)

41 – Teaching; providing of training; entertainment; sporting and cultural activities.

(260) AM 2012 66134 A

(800) 1104101

(731) OBSHESTVO S OGRANICHENNOY
OTVETSTVENNOSTYU "SPLAT-
COSMETICA"

ul. Stromynka, dom 19, korp. 2, RU-107076
Moscow, Russian Federation

(540)

SPLAT

(591) Black, white

(511)

21 – Abrasive sponges for scrubbing the skin; sponges for household purposes; deodorising apparatus for personal use; brush goods; shaving brushes; polishing materials for making shiny, except preparations, paper and stone; floss for dental purposes; cosmetic utensils; toilet utensils; appliances for removing make-up, non-electric; combs; electric combs; aerosol dispensers, not for medical purposes; water apparatus for cleaning teeth and gums; scrubbing brushes; toothbrushes; toothbrushes, electric; electric brushes, except parts of machines; brushes; eyebrow brushes; nail brushes.

INTERNATIONAL TRADEMARKS PROTECTED IN GEORGIA

(260) AM 2012 62458 A
(800) 1073504
(151) 2010 12 02
(181) 2020 12 02
(511) 33

(260) AM 2012 62576 A
(800) 1074969
(151) 2011 04 06
(181) 2021 04 06
(511) 05

(260) AM 2012 62577 A
(800) 1074970
(151) 2011 04 07
(181) 2021 04 07
(511) 05

(260) AM 2012 62578 A
(800) 1074971
(151) 2011 04 06
(181) 2021 04 06
(511) 09

(260) AM 2012 62581 A
(800) 1075025
(151) 2010 08 11
(181) 2020 08 11
(511) 32

(260) AM 2012 62584 A
(800) 1075036
(151) 2010 12 06
(181) 2020 12 06
(511) 09, 35, 38, 41

(260) AM 2012 62585 A
(800) 1075037
(151) 2011 01 14
(181) 2021 01 14
(511) 06, 07, 09, 11, 37

(260) AM 2012 62586 A
(800) 1075079
(151) 2011 03 18
(181) 2021 03 18

(511) 29, 39

(260) AM 2012 62587 A
(800) 1075094
(151) 2010 07 16
(181) 2020 07 16
(511) 09, 35, 36, 38, 41, 42, 45

(260) AM 2012 62589 A
(800) 1075128
(151) 2010 09 10
(181) 2020 09 10
(511) 03, 05, 25, 29, 30, 31, 32, 33, 34, 43

(260) AM 2012 62664 A
(800) 1075804
(151) 2010 08 24
(181) 2020 08 24
(511) 09, 16, 35, 36, 41, 42, 44, 45

(260) AM 2012 62665 A
(800) 1075807
(151) 2010 07 16
(181) 2020 07 16
(511) 09, 35, 36, 38, 41, 42, 45

(260) AM 2012 62666 A
(800) 1075820
(151) 2011 04 06
(181) 2021 04 06
(511) 11

(260) AM 2012 62667 A
(800) 1075821
(151) 2011 03 22
(181) 2021 03 22
(511) 11

(260) AM 2012 62668 A
(800) 1075835
(151) 2011 03 24
(181) 2021 03 24
(511) 18, 25

TRADEMARKS

(260) AM 2012 62669 A
(800) 1075847
(151) 2010 06 14
(181) 2020 06 14
(511) 12

(260) AM 2012 63271 A
(800) 1080863
(151) 2011 03 24
(181) 2021 03 24
(511) 34, 35

(260) AM 2012 62670 A
(800) 1075867
(151) 2011 03 14
(181) 2021 03 14
(511) 05

(260) AM 2012 63308 A
(800) 1081347
(151) 2011 02 09
(181) 2021 02 09
(511) 38

(260) AM 2012 62671 A
(800) 1075883
(151) 2011 04 11
(181) 2021 04 11
(511) 06, 19

(260) AM 2012 63311 A
(800) 1081394
(151) 2011 05 04
(181) 2021 05 04
(511) 03, 05

(260) AM 2012 62675 A
(800) 435016B
(151) 2007 12 29
(181) 2017 12 29
(511) 05

(260) AM 2012 63361 A
(800) 1082059
(151) 2011 05 04
(181) 2021 05 04
(511) 10

(260) AM 2012 62676 A
(800) 795981
(151) 2002 11 21
(181) 2012 11 21
(511) 25

(260) AM 2012 63362 A
(800) 1082065
(151) 2011 04 28
(181) 2021 04 28
(511) 21

(260) AM 2012 62679 A
(800) 1031863
(151) 2009 12 31
(181) 2019 12 31
(511) 25

(260) AM 2012 63364 A
(800) 1082094
(151) 2011 05 27
(181) 2021 05 27
(511) 30

(260) AM 2012 62849 A
(800) 1076989
(151) 2011 04 22
(181) 2021 04 22
(511) 33

(260) AM 2012 63413 A
(800) 1082280
(151) 2011 03 18
(181) 2021 03 18
(511) 07, 11

(260) AM 2012 63108 A
(800) 1079467
(151) 2011 04 28
(181) 2021 04 28
(511) 05, 30, 32

(260) AM 2012 63414 A
(800) 1082284
(151) 2011 06 14
(181) 2021 06 14
(511) 30

(260) AM 2012 63416 A
(800) 1082330
(151) 2011 05 19
(181) 2021 05 19
(511) 29, 30, 35

(260) AM 2012 63514 A
(800) 1083615
(151) 2011 05 11
(181) 2021 05 11
(511) 30

(260) AM 2012 63417 A
(800) 1082383
(151) 2011 05 20
(181) 2021 05 20
(511) 16

(260) AM 2012 63515 A
(800) 1083616
(151) 2011 05 17
(181) 2021 05 17
(511) 05

(260) AM 2012 63423 A
(800) 1082423
(151) 2011 06 06
(181) 2021 06 06
(511) 07, 42

(260) AM 2012 63516 A
(800) 1083617
(151) 2011 05 17
(181) 2021 05 17
(511) 05

(260) AM 2012 63424 A
(800) 1082438
(151) 2011 05 13
(181) 2021 05 13
(511) 03, 17, 21

(260) AM 2012 63517 A
(800) 1083618
(151) 2011 05 17
(181) 2021 05 17
(511) 05

(260) AM 2012 63431 A
(800) 1082512
(151) 2010 09 29
(181) 2020 09 29
(511) 02, 03, 05, 10, 16, 21, 25, 35

(260) AM 2012 63518 A
(800) 1083623
(151) 2011 05 20
(181) 2021 05 20
(511) 05

(260) AM 2012 63488 A
(800) 810874
(151) 2003 09 24
(181) 2013 09 24
(511) 03, 05

(260) AM 2012 63519 A
(800) 1083657
(151) 2011 03 01
(181) 2021 03 01
(511) 05, 09, 10

(260) AM 2012 63489 A
(800) 840558
(151) 2004 07 16
(181) 2014 07 16
(511) 29

(260) AM 2012 63520 A
(800) 1083659
(151) 2011 03 23
(181) 2021 03 23
(511) 06, 17, 19, 20, 35, 40, 42

(260) AM 2012 63492 A
(800) 919810
(151) 2007 02 19
(181) 2017 02 19
(511) 05, 29, 30

(260) AM 2012 63521 A
(800) 1083667
(151) 2011 04 29
(181) 2021 04 29
(511) 18, 25

TRADEMARKS

(260) AM 2012 63522 A
(800) 1083671
(151) 2011 05 10
(181) 2021 05 10
(511) 33

(260) AM 2012 63677 A
(800) 1084531
(151) 2011 05 13
(181) 2021 05 13
(511) 09

(260) AM 2012 63523 A
(800) 1083674
(151) 2011 06 09
(181) 2021 06 09
(511) 05

(260) AM 2012 63689 A
(800) 1084632
(151) 2011 06 03
(181) 2021 06 03
(511) 30

(260) AM 2012 63524 A
(800) 1083675
(151) 2011 05 26
(181) 2021 05 26
(511) 16, 41

(260) AM 2012 63714 A
(800) 1084844
(151) 2011 03 24
(181) 2021 03 24
(511) 16, 35, 36

(260) AM 2012 63526 A
(800) 1083699
(151) 2010 10 25
(181) 2020 10 25
(511) 03, 09, 14, 18, 25, 35

(260) AM 2012 63749 A
(800) 1084923
(151) 2011 04 21
(181) 2021 04 21
(511) 19

(260) AM 2012 63527 A
(800) 1083714
(151) 2011 06 30
(181) 2021 06 30
(511) 33

(260) AM 2012 63752 A
(800) 1084955
(151) 2011 04 20
(181) 2021 04 20
(511) 30, 35, 39

(260) AM 2012 63528 A
(800) 1083722
(151) 2011 01 06
(181) 2021 01 06
(511) 16, 35, 36, 41, 42, 45

(260) AM 2012 63753 A
(800) 1085018
(151) 2011 06 22
(181) 2021 06 22
(511) 09

(260) AM 2012 63596 A
(800) 1084016
(151) 2010 07 15
(181) 2020 07 15
(511) 06, 09, 14, 16, 18, 20, 21, 25, 28

(260) AM 2012 63754 A
(800) 1085024
(151) 2011 06 21
(181) 2021 06 21
(511) 25

(260) AM 2012 63597 A
(800) 1084030
(151) 2011 06 01
(181) 2021 06 01
(511) 29, 31

(260) AM 2012 63755 A
(800) 1085078
(151) 2011 06 27
(181) 2021 06 27
(511) 09

(260) AM 2012 63756 A
(800) 1085095
(151) 2011 06 10
(181) 2021 06 10
(511) 39

(260) AM 2012 63853 A
(800) 870708
(151) 2005 11 21
(181) 2015 11 21
(511) 12

(260) AM 2012 63759 A
(800) 1085152
(151) 2011 05 31
(181) 2021 05 31
(511) 29, 30, 32

(260) AM 2012 63879 A
(800) 1086236
(151) 2011 01 06
(181) 2021 01 06
(511) 36

(260) AM 2012 63760 A
(800) 1085153
(151) 2011 05 31
(181) 2021 05 31
(511) 29, 30, 32

(260) AM 2012 63880 A
(800) 1086239
(151) 2011 07 01
(181) 2021 07 01
(511) 14

(260) AM 2012 63761 A
(800) 1085154
(151) 2011 05 31
(181) 2021 05 31
(511) 29, 30, 32

(260) AM 2012 63881 A
(800) 1086272
(151) 2011 03 07
(181) 2021 03 07
(511) 35, 38, 41

(260) AM 2012 63848 A
(800) 1086176
(151) 2011 07 22
(181) 2021 07 22
(511) 01

(260) AM 2012 63882 A
(800) 1086282
(151) 2011 05 09
(181) 2021 05 09
(511) 09, 09

(260) AM 2012 63850 A
(800) 790769
(151) 2002 09 16
(181) 2012 09 16
(511) 12

(260) AM 2012 63884 A
(800) 1086315
(151) 2011 07 07
(181) 2021 07 07
(511) 35, 36, 37, 42, 43

(260) AM 2012 63851 A
(800) 837361
(151) 2004 08 18
(181) 2014 08 18
(511) 03, 05

(260) AM 2012 63887 A
(800) 1086390
(151) 2011 03 09
(181) 2021 03 09
(511) 30

(260) AM 2012 63852 A
(800) 838377
(151) 2004 11 05
(181) 2014 11 05
(511) 05

(260) AM 2012 63888 A
(800) 1086407
(151) 2011 06 30
(181) 2021 06 30
(511) 03, 05

TRADEMARKS

(260) AM 2012 63889 A
(800) 1086408
(151) 2011 07 12
(181) 2021 07 12
(511) 09, 35, 42

(260) AM 2012 63897 A
(800) 1086433
(151) 2011 04 01
(181) 2021 04 01
(511) 03

(260) AM 2012 63890 A
(800) 1086416
(151) 2011 07 15
(181) 2021 07 15
(511) 09, 42

(260) AM 2012 63898 A
(800) 1086439
(151) 2011 06 06
(181) 2021 06 06
(511) 09, 36, 45

(260) AM 2012 63891 A
(800) 1086421
(151) 2011 06 23
(181) 2021 06 23
(511) 12

(260) AM 2012 63919 A
(800) 1086919
(151) 2011 03 24
(181) 2021 03 24
(511) 16, 35, 36

(260) AM 2012 63892 A
(800) 1086422
(151) 2011 07 14
(181) 2021 07 14
(511) 05

(260) AM 2012 63944 A
(800) 968901
(151) 2008 02 21
(181) 2018 02 21
(511) 04

(260) AM 2012 63893 A
(800) 1086426
(151) 2011 05 30
(181) 2021 05 30
(511) 05

(260) AM 2012 63945 A
(800) 973599
(151) 2008 03 06
(181) 2018 03 06
(511) 09, 16, 38, 41

(260) AM 2012 63894 A
(800) 1086427
(151) 2011 07 07
(181) 2021 07 07
(511) 05

(260) AM 2012 63946 A
(800) 1008031
(151) 2009 06 16
(181) 2019 06 16
(511) 28

(260) AM 2012 63895 A
(800) 1086428
(151) 2011 07 07
(181) 2021 07 07
(511) 05

(260) AM 2012 63947 A
(800) 1019074
(151) 2009 10 22
(181) 2019 10 22
(511) 05

(260) AM 2012 63896 A
(800) 1086429
(151) 2011 07 07
(181) 2021 07 07
(511) 05

(260) AM 2012 63948 A
(800) 1038693
(151) 2010 04 21
(181) 2020 04 21
(511) 34

(260) AM 2012 63949 A
(800) 1051861
(151) 2010 09 01
(181) 2020 09 01
(511) 32

(260) AM 2012 63995 A
(800) 1087477
(151) 2011 03 16
(181) 2021 03 16
(511) 09, 12, 25, 28, 32, 36, 38, 41

(260) AM 2012 63950 A
(800) 1059793
(151) 2010 11 02
(181) 2020 11 02
(511) 07, 08, 42

(260) AM 2012 63996 A
(800) 1087485
(151) 2011 04 11
(181) 2021 04 11
(511) 21

(260) AM 2012 63951 A
(800) 1074273
(151) 2011 03 11
(181) 2021 03 11
(511) 06, 17, 19

(260) AM 2012 63997 A
(800) 1087487
(151) 2011 03 16
(181) 2021 03 16
(511) 01, 09, 11, 17, 19

(260) AM 2012 63952 A
(800) 1077048
(151) 2011 03 31
(181) 2021 03 31
(511) 25, 35

(260) AM 2012 63998 A
(800) 1087530
(151) 2011 06 06
(181) 2021 06 06
(511) 05

(260) AM 2012 63953 A
(800) 1077453
(151) 2011 04 20
(181) 2021 04 20
(511) 25

(260) AM 2012 63999 A
(800) 1087602
(151) 2011 05 26
(181) 2021 05 26
(511) 25, 35

(260) AM 2012 63992 A
(800) 1087422
(151) 2011 07 05
(181) 2021 07 05
(511) 14

(260) AM 2012 64000 A
(800) 1087620
(151) 2011 05 10
(181) 2021 05 10
(511) 16, 35

(260) AM 2012 63993 A
(800) 1087436
(151) 2011 07 02
(181) 2021 07 02
(511) 30

(260) AM 2012 64001 A
(800) 1087622
(151) 2009 06 02
(181) 2019 06 02
(511) 36

(260) AM 2012 63994 A
(800) 1087473
(151) 2011 07 19
(181) 2021 07 19
(511) 03, 16

(260) AM 2012 64004 A
(800) 1087674
(151) 2011 07 27
(181) 2021 07 27
(511) 03

TRADEMARKS

(260) AM 2012 64005 A
(800) 1087688
(151) 2011 06 30
(181) 2021 06 30
(511) 30

(260) AM 2012 64096 A
(800) 1088565
(151) 2011 06 10
(181) 2021 06 10
(511) 03

(260) AM 2012 64088 A
(800) 1088492
(151) 2011 07 22
(181) 2021 07 22
(511) 19

(260) AM 2012 64097 A
(800) 1088591
(151) 2011 07 22
(181) 2021 07 22
(511) 06, 17, 19

(260) AM 2012 64090 A
(800) 1088514
(151) 2010 10 05
(181) 2020 10 05
(511) 03, 05

(260) AM 2012 64194 A
(800) 1089043
(151) 2011 08 05
(181) 2021 08 05
(511) 10

(260) AM 2012 64091 A
(800) 1088529
(151) 2011 04 07
(181) 2021 04 07
(511) 03, 14, 16, 18, 25, 35

(260) AM 2012 64196 A
(800) 1089070
(151) 2011 07 06
(181) 2021 07 06
(511) 03

(260) AM 2012 64092 A
(800) 1088530
(151) 2011 04 07
(181) 2021 04 07
(511) 03, 05, 08, 10, 16, 21, 24, 25, 27, 28, 44

(260) AM 2012 64197 A
(800) 1089135
(151) 2011 07 06
(181) 2021 07 06
(511) 25

(260) AM 2012 64093 A
(800) 1088531
(151) 2011 04 07
(181) 2021 04 07
(511) 07, 11, 12, 17

(260) AM 2012 64198 A
(800) 1089141
(151) 2011 07 12
(181) 2021 07 12
(511) 09

(260) AM 2012 64094 A
(800) 1088532
(151) 2011 03 31
(181) 2021 03 31
(511) 03, 09, 16, 24, 35, 41, 42

(260) AM 2012 64199 A
(800) 1089177
(151) 2011 06 24
(181) 2021 06 24
(511) 31

(260) AM 2012 64095 A
(800) 1088544
(151) 2011 04 04
(181) 2021 04 04
(511) 09

(260) AM 2012 64200 A
(800) 1000211
(151) 2009 04 06
(181) 2019 04 06
(511) 25

(260) AM 2012 64201 A
(800) 1028986
(151) 2009 12 03
(181) 2019 12 03
(511) 10

(260) AM 2012 64202 A
(800) 1047619
(151) 2010 06 15
(181) 2020 06 15
(511) 03

OFFICIAL NOTIFICATIONS

TRADEMARKS

RENEWAL OF REGISTRATIONS

(111) M 2002 14265 R1 (156) 2012 07 24 (186) 2022 01 18 (732) SOPHARMA AD 16, Iliensko Shaussee Str., 1220 Sofia, Bulgaria	c/o General Partners, Pfizer Manufacturing LLC and Pfizer Production LLC, 235 East 42nd Street, New York, NY 10017, USA
(111) M 2002 14348 R1 (156) 2012 07 10 (186) 2022 02 18 (732) QINGDAO HAIER INVESTMENT DEVELOPMENT CO., LTD Haier Industrial Zone, Qingdao Hi-Tech Industrial Area, Qingdao 266101, Shandong Province, China	(111) M 2002 14654 R1 (156) 2012 09 13 (186) 2022 09 13 (732) H-D MICHIGAN, LLC 315 West Huron Street, Suite 400, Ann Arbor, MI 48103, USA
(111) M 2002 14553 R1 (156) 2012 07 11 (186) 2022 07 11 (732) BioMarin/Genzyme LLC One Kendall Square, Cambridge, Massachusetts 02139-1562, USA	(111) M 2002 14655 R1 (156) 2012 09 13 (186) 2022 09 13 (732) H-D MICHIGAN, LLC 315 West Huron Street, Suite 400, Ann Arbor, MI 48103, USA
(111) M 2002 14569 R1 (156) 2012 07 29 (186) 2022 07 29 (732) ALSTOM 3, Avenue Andre Malraux, F-92300 Levallois-Perret, France	(111) M 2002 14661 R1 (156) 2012 09 13 (186) 2022 09 13 (732) FORD MOTOR COMPANY The American Road, Dearborn, Michigan 48121, USA
(111) M 2002 14638 R1 (156) 2012 09 13 (186) 2022 09 13 (732) C.P.PHARMACEUTICALS INTERNATIONAL C.V. c/o General Partners, Pfizer Manufacturing LLC and Pfizer Production LLC, 235 East 42nd Street, New York, NY 10017, USA	(111) M 2002 14662 R1 (156) 2012 09 13 (186) 2022 09 13 (732) FORD MOTOR COMPANY The American Road, Dearborn, Michigan 48121, USA
(111) M 2002 14641 R1 (156) 2012 09 13 (186) 2022 09 13 (732) C.P.PHARMACEUTICALS INTERNATIONAL C.V.	(111) M 2002 14663 R1 (156) 2012 09 13 (186) 2022 09 13 (732) ALLIED DOMEQ LIMITED Chivas House, 72 Chancellors Road, London W6 9RS, United Kingdom
(111) M 2002 14672 R1 (156) 2012 09 13 (186) 2022 09 13	(111) M 2002 14672 R1 (156) 2012 09 13 (186) 2022 09 13

(732) ZIPPO MANUFACTURING COMPANY
33 Barber Street, Bradford, Pennsylvania
16701, USA

(111) M 2002 14697 R1
(156) 2012 09 30
(186) 2022 09 30
(732) ZENTIVA A.S.

Nitrianska 100, 920 27 Hlohovec, Slovakia

(111) M 2002 14708 R1
(156) 2012 10 15
(186) 2022 10 15

(732) MITSUBISHI JIDOSHA KOGYO
KABUSHIKI KAISHA
33-8, Shiba 5-chome, Minato-ku, Tokyo,
Japan

(111) M 2002 14734 R1
(156) 2012 10 15
(186) 2022 10 15

(732) GABRIELLE STUDIO, INC. (A NEW
YORK CORPORATION)
87 Mayfield Avenue, Edison, New Jersey
08837, USA

(111) M 2002 14759 R1
(156) 2012 10 15
(186) 2022 10 15

(732) KABUSHIKI KAISHA MAKITA,
TRADING AS MAKITA CORPORATION
11-8, 3-CHOME, SUMIYOSHI-CHO,
ANJO-SHI, AICHI-KEN, Japan

(111) M 2002 14760 R1
(156) 2012 10 15
(186) 2022 10 15

(732) SOUTHERN COMFORT PROPERTIES,
INC.
4040 Civic Center Drive, Suite 528, San
Rafael, CA 94903, USA

(111) M 2002 14790 R1
(156) 2012 11 15
(186) 2022 11 15

(732) EMINENCE SPEAKER, LLC
P.O. Box 360, 838 Mulberry Pike, Eminence,
KY 40019-0360, USA

(111) M 2002 14795 R1
(156) 2012 11 15
(186) 2022 11 15

(732) ACCENTURE GLOBAL SERVICES
LIMITED
3 Grand Canal Plaza, Upper Grande canal
Street, Dublin 4, Ireland

(111) M 2003 14867 R1
(156) 2013 01 14
(186) 2023 01 14

(732) CHURCH & DWIGHT CO., INC.
469 North Harrison Street, Princeton,
New Jersey 08543, USA

(111) M 2003 14880 R1
(156) 2013 01 14
(186) 2023 01 14

(732) ACCENTURE GLOBAL SERVICES
LIMITED
3 Grand Canal Plaza, Upper Grande canal
Street, Dublin 4, Ireland

(111) M 2003 14922 R1
(156) 2013 01 30
(186) 2023 01 30

(732) G.G. PROPERTIES, LTD
Dorchester House, 7 Church Street,
Hamilton, Bermuda HM 11, United Kingdom

(111) M 2003 14984 R1
(156) 2013 02 12
(186) 2023 02 12

(732) ABBOTT MEDICAL OPTICS, INC.
1700 E. St. Andrew Place, Santa Ana,
California 92799-5162, USA

COMPLETE TRANSFER OF RIGHTS

(111) M 1999 012189 R1
(732) CADBURY SCHWEPPE'S TREASURY
INTERNATIONAL
c/o Cadbury Ireland Limited, Coolock,
Dublin 5, Ireland
(770) CADBURY IRELAND LIMITED
Malahide Road, Coolock, Dublin 5, Ireland,
(580) 2012 09 18

(111) M 1999 012189 R1
(732) KRAFT FOODS GLOBAL BRADNDS
LLC
Three Lakes Drive, Northfield, Illinois
60093, USA
(770) CADBURY SCHWEPPE'S TREASURY
INTERNATIONAL
c/o Cadbury Ireland Limited, Coolock,
Dublin 5, Ireland
(580) 2012 09 18

(111) M 1999 012739 R1
(732) TULIP FOOD COMPANY GMBH
Kokkolastrasse 2, 40882, Ratingen,
Denmark
(770) TULIP FOOD COMPANY A/S
Tulipvej 1, 8940 Randers SV, Denmark
(580) 2012 09 20

(111) M 2000 013577 R1
(732) TULIP FOOD COMPANY GMBH,
Kokkolastrasse 2, 40882, Ratingen,
Denmark
(770) TULIP FOOD COMPANY A/S
Tulipvej 1, 8940 Randers SV, Denmark
(580) 2012 09 18

(111) M 2001 014151 R1
(732) CADBURY SCHWEPPE'S TREASURY
INTERNATIONAL
c/o Cadbury Ireland Limited, Coolock,
Dublin
(770) CADBURY IRELAND LIMITED
Malahide Road, Coolock, Dublin 5, Ireland
(580) 2012 09 18

(111) M 2001 014151 R1
(732) KRAFT FOODS GLOBAL BRADNDS LLC
Three Lakes Drive, Northfield, Illinois
60093, USA

(770) CADBURY SCHWEPPE'S TREASURY
INTERNATIONAL
c/o Cadbury Ireland Limited, Coolock,
Dublin 5, Ireland
(580) 2012 09 18

(111) M 2002 014596 R
(732) BUSHNELL INC.
9200 Cody, Overland Park, Kansas 66214,
USA
(770) BUSHNELL HOLDINGS, INC.
9200 Cody, Overland Park, Kansas 66214,
USA
(580) 2012 09 17

(111) M 2002 014790 R1
(732) Eminence Speaker Acquisition, LLC
P.O. Box 360, 838 Mulberry Pike, Eminence,
KY 40019-0360, USA
(770) EMINENCE SPEAKER CORPORATION
P.O. Box 360, 838 Mulberry Pike,
40019-0360 Eminence, KY, USA
(580) 2012 09 20

(111) M 2004 015545 R
(732) LEILA JANASHIA
Aragvispirelis q. 42, Tbilisi, Georgia;
MAMUKA MAISURADZE
Chkondidelis q. 20, korp. 1, bina 21, Tbilisi,
Georgia;
TEIMURAZ FSUTURI
Sop. Varketilis dasakhleba, Gardabani,
Georgia
(770) EMZAR BALADZE
Vazha-Pshavela 7, ap.14, 6000, Batumi,
Georgia
(580) 2012 09 03

(111) M 2007 017348 R
(732) AIP International Ltd
PO Box 3483, Road Town, Tortola, British
Virgin Islands
(770) Oriani Consultadoria e Servicos LDA
77, Avenue Arriaga, Edificio Marina Forum,
Se Funchal, Madeira, Portugal
(580) 2012 09 17

(111) M 2007 017476 R
 (732) LTD "SHKHEFI"
 M. Kavtaradzis 11, 0180, Tbilisi, Georgia
 (770) Ss "Nikora"
 M. Kavtaradzis 11, 0180, Tbilisi, Georgia
 (580) 2012 09 13

(111) M 2009 019116 R
 (732) NOVARTIS AG,
 CH-4002 Basel, Switzerland
 (770) ALCON, INC.,
 Bosch 69, CH-6331 Hunenberg, Switzerland
 (580) 2012 09 17

(111) M 2011 021205 R
 (732) BARNES & NOBLE BOOKSELLERS, INC
 122 Fifth Avenue, New York,
 New York 10011, USA
 (770) BARNES & NOBLE COLLEGE
 BOOKSELLERS, LLC
 120 Mountain View Boulevard, Basking
 Ridge, New Jersey 07920, USA
 (580) 2012 09 17

(111) M 2011 021461 R
 (732) MAKA METREVELI
 Larsis shes. 3, b. 29, 0179, Tbilisi, Georgia
 (770) LTD "FESHEN GRUPI"
 Pekinis q. N14, 0171, Tbilisi, Georgia
 (580) 2012 09 20

(111) M 2011 021464 R
 (732) MAKA METREVELI
 Larsis shes. 3, b. 29, 0179, Tbilisi, Georgia
 (770) LTD "FESHEN GRUPI"
 Pekinis q. N14, 0171, Tbilisi, Georgia
 (580) 2012 09 20

(111) M 2011 021475 R
 (732) MAKA METREVELI
 Larsis shes. 3, b. 29, 0179, Tbilisi, Georgia
 (770) LTD "FESHEN GRUPI"
 Pekinis q. N14, 0171, Tbilisi, Georgia
 (580) 2012 09 20

(111) M 2011 021476 R
 (732) MAKA METREVELI
 Larsis shes. 3, b. 29, 0179, Tbilisi, Georgia
 (770) LTD "FESHEN GRUPI"
 Pekinis q. N14, 0171, Tbilisi, Georgia
 (580) 2012 09 20

(111) M 2012 022458 R
 (732) CADBURY SCHWEPPE'S TREASURY
 INTERNATIONAL
 c/o Cadbury Ireland Limited, Coolock,
 Dublin 5, Ireland
 (770) CADBURY IRELAND LIMITED
 Malahide Road, Coolock, Dublin 5, Ireland
 (580) 2012 09 18

(111) M 2012 022458 R
 (732) KRAFT FOODS GLOBAL BRADNDS LLC
 Three Lakes Drive, Northfield, Illinois
 60093, USA
 (770) CADBURY SCHWEPPE'S TREASURY
 INTERNATIONAL
 c/o Cadbury Ireland Limited, Coolock,
 Dublin 5, Ireland
 (580) 2012 09 18

(111) M 2012 022459 R
 (732) CADBURY SCHWEPPE'S TREASURY
 INTERNATIONAL
 c/o Cadbury Ireland Limited, Coolock,
 Dublin 5, Ireland
 (770) CADBURY IRELAND LIMITED
 Malahide Road, Coolock, Dublin 5, Ireland
 (580) 2012 09 18

(111) M 2012 022459 R
 (732) KRAFT FOODS GLOBAL BRADNDS LL
 Three Lakes Drive, Northfield, Illinois 60093,
 USA
 (770) CADBURY SCHWEPPE'S TREASURY
 INTERNATIONAL
 c/o Cadbury Ireland Limited, Coolock,
 Dublin 5, Ireland
 (580) 2012 09 18

(111) M 2012 022460 R
 (732) CADBURY SCHWEPPE'S TREASURY
 INTERNATIONAL
 c/o Cadbury Ireland Limited, Coolock,
 Dublin 5, Ireland
 (770) CADBURY IRELAND LIMITED
 Malahide Road, Coolock, Dublin 5, Ireland
 (580) 2012 09 18

(111) M 2012 022460 R
 (732) KRAFT FOODS GLOBAL BRADNDS
 LLC
 Three Lakes Drive, Northfield, Illinois 60093,
 USA
 (770) CADBURY SCHWEPPE'S TREASURY
 INTERNATIONAL

c/o Cadbury Ireland Limited, Coolock,
Dublin 5, Ireland
(580) 2012 09 18

(111) M 1997 006291 R1
(732) DIAVIA S.r.L.
Via Efrem Nobili 2, Molinella (BO), Italy
(770) DELPHI Italia Automotive Systems S.R.L.
Via Torino 166, 10097 Borgata Paradiso-
Collegno (TO), Italy
(580) 2012 09 03

(111) M 1998 009225 R1
(732) WD-40 Manufacturing Company
1061 Cudahy Place, San Diego, California
92110, USA
(770) WD-40 COMPANY
1061 Cudahy Place, San Diego, California
92110, USA
(580) 2012 09 14

(111) M 1998 009357 R1
(732) KONINKLIJKE DOUWE EGBERTS B.V.
Oosterdoksstraat 80, 1011 DK Amsterdam,
Netherlands
(770) SARA LEE/DE N.V.
P.O. Box 2, 3500 CA Utrecht, Netherlands
(580) 2012 09 03

(111) M 1998 009419 R1
(732) KONINKLIJKE DOUWE EGBERTS B.V.
Oosterdoksstraat 80, 1011 DK Amsterdam,
Netherlands
(770) SARA LEE/DE N.V.
P.O. Box 2, 3500 CA Utrecht, Netherlands
(580) 2012 09 03

(111) M 1998 009579 R1
(732) TULIP FOOD COMPANY GMBH
Kokkolastrasse 2, 40882, Ratingen, Denmark
(770) TULIP FOOD COMPANY A/S
Tulipvej 1, 8940 Randers SV, Denmark
(580) 2012 09 18

(111) M 1998 009937 R1
(732) CADBURY SCHWEPPE'S TREASURY
INTERNATIONAL
c/o Cadbury Ireland Limited, Coolock,
Dublin 5, Ireland
(770) CADBURY IRELAND LIMITED
Malahide Road, Coolock, Dublin 5, Ireland,
Ireland
(580) 2012 09 18

(111) M 1998 009937 R1
(732) KRAFT FOODS GLOBAL BRANDS LLC
Three Lakes Drive, Northfield, Illinois 60093,
USA
(770) CADBURY SCHWEPPE'S TREASURY
INTERNATIONAL
c/o Cadbury Ireland Limited, Coolock,
Dublin 5, Ireland
(580) 2012 09 18

CHANGES IN NAMES AND/OR ADDRESSES OF OWNERS

(111) M 1999 012739 R1
 (732) TULIP FOOD COMPANY A/S
 Tulipvej 1, 8940 Randers SV, Denmark
 (770) TULIP FOOD COMPANY P/S
 Tulipvej 1, 8940 Randers SV, Denmark
 (580) 2012 09 20

(111) M 2000 013577 R1
 (732) TULIP FOOD COMPANY A/S
 Tulipvej 1, 8940 Randers SV, Denmark
 (770) TULIP FOOD COMPANY P/S
 Tulipvej 1, 8940 Randers SV, Denmark
 (580) 2012 09 18

(111) M 1996 001436 R1
 (732) POST FOODS, LLC, DELAWARE
 LIMITED LIABILITY COMPANY
 1 Upper Pond Road, Porsippamy, NJ 07054,
 USA
 (770) POST FOODS, LLC, DELAWARE
 LIMITED LIABILITY COMPANY
 800 Market Street, St. Louis, Missouri 63101,
 USA
 (580) 2012 09 14

(111) M 2002 014554 R1
 (732) GENZYME CORPORATION
 500 Kendall St., Cambridge, MA 02142, USA
 (770) GENZYME CORPORATION
 One Kendall Square, Cambridge,
 Massachusetts 02139-1562, USA
 (580) 2012 09 20

(111) M 2002 014555 R1
 (732) GENZYME CORPORATION
 500 Kendall St., Cambridge, MA 02142, USA
 (770) GENZYME CORPORATION
 One Kendall Square, Cambridge,
 Massachusetts 02139-1562, USA
 (580) 2012 09 20

(111) M 2002 014596 R
 (732) BUSHNELL HOLDINGS, INC.
 9200 Cody, Overland Park, Kansas 66214,
 USA
 (770) BUSHNELL CORPORATION
 9200 Cody, Overland Park, Kansas 66214,
 USA
 (580) 2012 09 17

(111) M 1996 001462 R1
 (732) POST FOODS, LLC, DELAWARE
 LIMITED LIABILITY COMPANY
 1 Upper Pond Road, Porsippamy, NJ 07054,
 USA
 (770) POST FOODS, LLC, DELAWARE
 LIMITED LIABILITY COMPANY
 800 Market Street, St. Louis, Missouri 63101,
 USA
 (580) 2012 09 14

(111) M 2002 014663 R1
 (732) ALLIED DOMEQC LIMITED
 Chivas House, 72 Chancellors Road, London
 W6 9RS, United Kingdom
 (770) ALLIED DOMEQC P.L.C.
 The Pavillions, Bridgwater Road, Bedminster
 Down, Bristol BS13 8AR, United Kingdom
 (580) 2012 09 13

(111) M 2002 014790 R1
 (732) EMINENCE SPEAKER, LLC
 P.O. Box 360, 838 Mulberry Pike, Eminence,
 KY 40019-0360 , USA
 (770) EMINENCE SPEAKER ACQUISITION,
 LLC
 P.O. Box 360, 838 Mulberry Pike, Eminence,
 KY 40019-0360 , USA
 (580) 2012 09 20

(111) M 2004 015545 R
 (732) EMZAR BALADZE
 Vazha-Pshavela 7, ap.14, 6000, Batumi,
 Georgia
 (770) EMZAR BALADZE
 Panaskertelis q., korp. 11, bina 4, 0194,
 Tbilisi, Georgia
 (580) 2012 09 03

(111) M 2004 015723 R
 (732) DANDY A/S
 Hjulmagervej 4B, DK-7100 Vejle, Denmark
 (770) DANDY A/S
 Dandyvej, 7100 Vejle, Denmark
 (580) 2012 09 14

(111) M 2004 015723 R
 (732) KRAFT FUDS DANMARK
 INTELLECTUAL PROPERTY APS

Roskildevej 161, DK-2620 Albertslund,
Denmark
(770) DANDY A/S
Hjulmagervej 4B, DK-7100 Vejle, Denmark
(580) 2012 09 14

(111) M 2005 015993 R
(732) AUJAN INDUSTRIES Co (S.J.C)
P.O. box 990, Dammam, 31421,
Saudi Arabia
(770) AUJAN INDUSTRIES CO.
P.O. Box 990, DAMMAM, 31421,
Saudi Arabia
(580) 2012 09 03

(111) M 2007 017476 R
(732) Ss "NIKORA"
M. Kavtaradzis 11, 0180, Tbilisi, Georgia
(770) LTD "NIKORA"
M. Kavtaradzis q. 11, 0180 , Tbilisi, Georgia
(580) 2012 09 13

(111) M 2009 019722 R
(732) AUJAN INDUSTRIES CO (S.J.C)
P.O. box 990, Dammam, 31421,
Saudi Arabia
(770) AUJAN INDUSTRIES CO.
P.O. Box 990, DAMMAM, 31421,
Saudi Arabia
(580) 2012 09 03

(111) M 2009 019723 R
(732) AUJAN INDUSTRIES CO (S.J.C)
P.O. box 990, Dammam, 31421, Saudi Arabia
(770) AUJAN INDUSTRIES CO.
P.O. Box 990, DAMMAM, 31421, Saudi
Arabia
(580) 2012 09 03

(111) M 2009 019724 R
(732) AUJAN INDUSTRIES CO (S.J.C)
P.O. box 990, Dammam, 31421,
Saudi Arabia
(770) AUJAN INDUSTRIES CO.
P.O. Box 990, DAMMAM, 31421,
Saudi Arabia
(580) 2012 09 03

(111) M 2009 019725 R
(732) AUJAN INDUSTRIES CO (S.J.C)
P.O. box 990, Dammam, 31421,
Saudi Arabia

(770) AUJAN INDUSTRIES CO.
P.O. Box 990, DAMMAM, 31421, Saudi
Arabia
(580) 2012 09 03

(111) M 2009 019726 R
(732) AUJAN INDUSTRIES CO (S.J.C)
P.O. box 990, Dammam, 31421, Saudi Arabia
(770) AUJAN INDUSTRIES CO.
P.O. Box 990, DAMMAM, 31421, Saudi
Arabia
(580) 2012 09 03

(111) M 2009 019727 R
(732) AUJAN INDUSTRIES CO (S.J.C)
P.O. box 990, Dammam, 31421, Saudi Arabia
(770) AUJAN INDUSTRIES CO.
P.O. Box 990, DAMMAM, 31421, Saudi
Arabia
(580) 2012 09 03

(111) M 2012 022797 R
(732) Obshestvo s ogranichenoi otvetstvenostiu
"United beikers" (OOO „Iunaited beikers")
Ul. Vitruka 4, 394033 g. Voronezhi, Russian
Federation
(770) Obshestvo s ogranichenoi otvetstvenostiu
"United beikers" (OOO „Iunaited beikers")
Ul. Vitruka 4, 394033 g. Voronezhi, Russian
Federation
(580) 2012 05 18

(111) M 2012 022797 R
(732) Obshestvo s ogranichenoi otvetstvenostiu
"Kellogg Rus" (OOO „Kellogg Rus")
Ul. Vitruka 4, 394033 g. Voronezhi, Russian
Federation
(770) Obshestvo s ogranichenoi otvetstvenostiu
"United beikers" (OOO „Iunaited beikers")
Ul. Vitruka 4, 394033 g. Voronezhi, Russian
Federation
(580) 2012 09 14

(111) M 1996 003802 R1
(732) SALVATORE FERRAGAMO S.P.A.
Via dei Tornabuoni 2, Florence, Italy
(770) SALVATORE FERRAGAMO ITALIA
S.P.A.
Via dei Tornabuoni 2, Florence, Italy
(580) 2012 09 03

(111) M 1997 005710 R1
(732) BASF Coating GmbH
1, Glasuritstrasse, D-48165 Munster,
Germany
(770) BASF Coating AG
1, Glasuritstrasse, D-48165 Munster,
Germany
(580) 2012 09 03

(111) M 1998 009569 R1
(732) DANDY A/S
Hjulgagervej 4B, DK-7100 Vejle, Denmark
(770) DANDY A/S
Dandyvej DK-7100 Vejle, Denmark,
Denmark
(580) 2012 09 14

(111) M 1998 009569 R1
(732) Kraft Fuds Danmark Intellectual Property
ApS
Roskildevej 161, DK-2620 Albertslund,
Denmark
(770) DANDY A/S
Hjulgagervej 4B, DK-7100 Vejle, Denmark
(580) 2012 09 14

(111) M 1998 009579 R1
(732) TULIP FOOD COMPANY A/S
Tulipvej 1, 8940 Randers SV, Denmark
(770) TULIP FOOD COMPANY P/S
Tulipvej 1, 8940 Randers SV, Denmark
(580) 2012 09 18

(111) M 1998 009975 R1
(732) Kraft Fuds Danmark Intellectual Property
ApS
Roskildevej 161, DK-2620 Albertslund,
Denmark
(770) DANDY A/S
Dandyvej, 7100 Vejle, Denmark
(580) 2012 09 14

(111) M 1998 009975 R1
(732) Kraft Fuds Danmark Intellectual Property
ApS
Roskildevej 161, DK-2620 Albertslund,
Denmark
(770) DANDY A/S
Hjulgagervej 4B, DK-7100 Vejle, Denmark
(580) 2012 09 14

CLASSIFICATION INDEXES

INVENTIONS

CONCORDANCE TABLE OF INTERNATIONAL CLASSIFICATION INDEX AND PUBLICATION NUMBERS

INTERNATIONAL CLASSIFICATION INDEXES (51)	NUMBER OF PUBLISHED APPLICATION (10)
A 24 D 1/04	AP 2012 12424 A
A 61 K 9/20; A 61 K 31/505; A 61 P 3/06	AP 2012 12071 A
A 61 K 31/55; A 61 K 49/00	AP 2012 11545 A
A 61 K 31/57; A 61 K 45/06; A 61 P 15/06	AP 2012 11451 A
A 61 K 31/495; A 61 K 31/551; A 61 P 25/18	AP 2012 11618 A
A 61 K 31/593; A 61 K 33/24; A 61 K 47/40; A 61 K 45/06; A 61 P 19/00	AP 2012 12014 A
A 61 P 25/18; A 61 K 31/4965	AP 2012 11619 A
C 04 B 28/04, 111/20	AP 2012 12025 A
C 07 D 209/08; A 61 K 31/404	AP 2012 11874 A
C 07 D 213/61; C 07 D 471/04; A 61 K 31/437	AP 2012 11249 A
C 07 D 223/16	AP 2012 12105 A
C 10 L 5/00	AP 2012 12107 A
E 02 F 1/00; E 02 F 3/88; E 02 F 5/28	AP 2012 12083 A
F 41 H 1/02	AP 2012 11206 A
G 07 D 7/00; G 07 D 7/12	AP 2012 11773 A
H 01 L 21/00	AP 2012 12277 A

CONCORDANCE TABLE OF PUBLICATION NUMBERS AND INTERNATIONAL CLASSIFICATION INDEX

NUMBER OF PUBLISHED APPLICATION (10)	INTERNATIONAL CLASSIFICATION INDEXES (51)
AP 2012 11206 A	F 41 H 1/02
AP 2012 11249 A	C 07 D 213/61; C 07 D 471/04; A 61 K 31/437
AP 2012 11451 A	A 61 K 31/57; A 61 K 45/06; A 61 P 15/06
AP 2012 11545 A	A 61 K 31/55; A 61 K 49/00
AP 2012 11618 A	A 61 K 31/495; A 61 K 31/551; A 61 P 25/18
AP 2012 11619 A	A 61 P 25/18; A 61 K 31/4965
AP 2012 11773 A	G 07 D 7/00; G 07 D 7/12
AP 2012 11874 A	C 07 D 209/08; A 61 K 31/404
AP 2012 12014 A	A 61 K 31/593; A 61 K 33/24; A 61 K 47/40; A 61 K 45/06; A 61 P 19/00
AP 2012 12025 A	C 04 B 28/04, 111/20
AP 2012 12071 A	A 61 K 9/20; A 61 K 31/505; A 61 P 3/06
AP 2012 12083 A	E 02 F 1/00; E 02 F 3/88; E 02 F 5/28
AP 2012 12105 A	C 07 D 223/16
AP 2012 12107 A	C 10 L 5/00
AP 2012 12277 A	H 01 L 21/00
AP 2012 12424 A	A 24 D 1/04

CONCORDANCE TABLE OF INTERNATIONAL CLASSIFICATION INDEX,
PATENT NUMBERS AND PUBLICATION NUMBERS

INTERNATIONAL CLASSIFICATION INDEX (51)	NUMBER OF PATENT (11)	NUMBER OF PUBLISHED APPLICATION (10)
A 01 N 25/02	P 2012 5660 B	AP 2012 11737 A
A 61 K 31/198; A 61 K 31/519; C 07 D 487/04	P 2012 5658 B	AP 2012 11325 A
A 61 K 36/00	P 2012 5656 B	AP 2012 11156 A
A 61 K 38/00; A 61 K 31/70	P 2012 5659 B	AP 2012 11391 A
A 61 L 15/22; A 61 L 15/60; C 08 L 83/04	P 2012 5661 B	AP 2012 11781 A
B 64 C 1/32	P 2012 5655 B	AP 2012 10655 A
B 64 C 17/06; F 03 G 3/08; G 01 C 19/00	P 2012 5657 B	AP 2012 11216 A
C 07 D 401/12; C 07 D 403/12; C 07 D 417/12; C 07 D 471/04; C 07 D 487/04; A 61 P 13/00; A 61 K 31/4178; A 61 K 31/506	P 2012 5666 B	AP 2012 11992 A
C 07 D 471/04; C 07 D 498/04; C 07 D 513/04; A 61 P 35/00; A 61 K 31/4355; A 61 K 31/4365; A 61 K 31/437	P 2012 5664 B	AP 2012 11952 A
F 02 B 51/00	P 2012 5662 B	AP 2012 11838 A
F 04 C 21/00	P 2012 5663 B	AP 2012 11840 A
F 16 H 21/16	P 2012 5665 B	AP 2012 11985 A
G 01 N 33/10	P 2012 5667 B	AP 2012 12160 A

CONCORDANCE TABLE OF PATENT NUMBERS,
PUBLICATION NUMBERS AND INTERNATIONAL CLASSIFICATION INDEX

NUMBER OF PATENT (11)	NUMBER OF PUBLISHED APPLICATION (10)	INTERNATIONAL CLASSIFICATION INDEX (51)
P 2012 5655 B	AP 2012 10655 A	B 64 C 1/32
P 2012 5656 B	AP 2012 11156 A	A 61 K 36/00
P 2012 5657 B	AP 2012 11216 A	B 64 C 17/06; F 03 G 3/08; G 01 C 19/00
P 2012 5658 B	AP 2012 11325 A	A 61 K 31/198; A 61 K 31/519; C 07 D 487/04
P 2012 5659 B	AP 2012 11391 A	A 61 K 38/00; A 61 K 31/70
P 2012 5660 B	AP 2012 11737 A	A 01 N 25/02
P 2012 5661 B	AP 2012 11781 A	A 61 L 15/22; A 61 L 15/60; C 08 L 83/04
P 2012 5662 B	AP 2012 11838 A	F 02 B 51/00
P 2012 5663 B	AP 2012 11840 A	F 04 C 21/00
P 2012 5664 B	AP 2012 11952 A	C 07 D 471/04; C 07 D 498/04; C 07 D 513/04; A 61 P 35/00; A 61 K 31/4355; A 61 K 31/4365; A 61 K 31/437
P 2012 5665 B	AP 2012 11985 A	F 16 H 21/16
P 2012 5666 B	AP 2012 11992 A	C 07 D 401/12; C 07 D 403/12; C 07 D 417/12; C 07 D 471/04; C 07 D 487/04; A 61 P 13/00; A 61 K 31/4178; A 61 K 31/506
P 2012 5667 B	AP 2012 12160 A	G 01 N 33/10

CONCORDANCE TABLE OF APPLICATION NUMBERS, PUBLICATION NUMBERS AND PATENTS

NUMBER OF APPLICATION (21)	NUMBER OF PUBLISHED APPLICATION (10)	NUMBER OF PATENT (11)
AP 2008 010655	AP 2012 10655 A	P 2012 5655 B
AP 2009 011156	AP 2012 11156 A	P 2012 5656 B
AP 2006 011216	AP 2012 11216 A	P 2012 5657 B
AP 2007 011325	AP 2012 11325 A	P 2012 5658 B
AP 2007 011391	AP 2012 11391 A	P 2012 5659 B
AP 2008 011737	AP 2012 11737 A	P 2012 5660 B
AP 2008 011781	AP 2012 11781 A	P 2012 5661 B
AP 2010 011838	AP 2012 11838 A	P 2012 5662 B
AP 2010 011840	AP 2012 11840 A	P 2012 5663 B
AP 2009 011952	AP 2012 11952 A	P 2012 5664 B
AP 2010 011985	AP 2012 11985 A	P 2012 5665 B
AP 2009 011992	AP 2012 11992 A	P 2012 5666 B
AP 2011 012160	AP 2012 12160 A	P 2012 5667 B

UTILITY MODELS

CONCORDANCE TABLE OF INTERNATIONAL CLASSIFICATION INDEX AND PUBLICATION NUMBERS

INTERNATIONAL CLASSIFICATION INDEXES (51)	NUMBER OF PUBLISHED APPLICATION (10)
A 61 K 33/00, 33/34	AU 2012 12318 U

CONCORDANCE TABLE OF PUBLICATION NUMBERS AND INTERNATIONAL CLASSIFICATION INDEX

NUMBER OF PUBLISHED APPLICATION (10)	INTERNATIONAL CLASSIFICATION INDEXES (51)
AU 2012 12318 U	A 61 K 33/00, 33/34

CONCORDANCE TABLE OF INTERNATIONAL CLASSIFICATION INDEX, PATENT NUMBERS AND PUBLICATION NUMBERS

INTERNATIONAL CLASSIFICATION INDEX (51)	NUMBER OF PATENT (11)	NUMBER OF PUBLISHED APPLICATION (10)
A 61 N 5/06	U 2012 1739 Y	AU 2012 12357 U

**CONCORDANCE TABLE OF PATENT NUMBERS,
PUBLICATION NUMBERS AND INTERNATIONAL CLASSIFICATION INDEX**

NUMBER OF PATENT (11)	NUMBER OF PUBLISHED APPLICATION (10)	INTERNATIONAL CLASSIFICATION INDEX (51)
U 2012 1739 Y	AU 2012 12357 U	A 61 N 5/06

**CONCORDANCE TABLE OF APPLICATION NUMBERS, PUBLICATION NUMBERS
AND PATENTS**

NUMBER OF APPLICATION (21)	NUMBER OF PUBLISHED APPLICATION (10)	NUMBER OF PATENT (11)
AU 2011 012357	AU 2012 12357 U	U 2012 1739 Y

DESIGNS

**CONCORDANCE TABLE OF INTERNATIONAL CLASSIFICATION INDEX
AND PUBLICATION NUMBERS**

INTERNATIONAL CLASSIFICATION INDEXES (51)	NUMBER OF PUBLISHED APPLICATION (10)
21-01	AD 2012 702 S

**CONCORDANCE TABLE OF PUBLICATION NUMBERS
AND INTERNATIONAL CLASSIFICATION INDEX**

NUMBER OF PUBLISHED APPLICATION (10)	INTERNATIONAL CLASSIFICATION INDEXES (51)
AD 2012 702 S	21-01

**CONCORDANCE TABLE OF INTERNATIONAL CLASSIFICATION INDEX,
PATENT NUMBERS AND PUBLICATION NUMBERS**

INTERNATIONAL CLASSIFICATION INDEX (51)	NUMBER OF PATENT (11)	NUMBER OF PUBLISHED APPLICATION (10)
02-02	D 2012 508 S	AD 2012 690 S

CONCORDANCE TABLE OF PATENT NUMBERS,
PUBLICATION NUMBERS AND INTERNATIONAL CLASSIFICATION INDEX

NUMBER OF PATENT (11)	NUMBER OF PUBLISHED APPLICATION (10)	INTERNATIONAL CLASSIFICATION INDEX (51)
D 2012 508 S	AD 2012 690 S	02-02

CONCORDANCE TABLE OF APPLICATION NUMBERS, PUBLICATION NUMBERS AND PATENTS

NUMBER OF APPLICATION (21)	NUMBER OF PUBLISHED APPLICATION (10)	NUMBER OF PATENT (11)
AD 2012 000690	AD 2012 690 S	D 2012 508 S

**DESIGN REGISTERED ACCORDING TO THE
ACCELERATED PROCEDURE**

CONCORDANCE TABLE OF INTERNATIONAL CLASSIFICATION INDEX
AND PATENTS NUMBERS

INTERNATIONAL CLASSIFICATION INDEX (51)	NUMBER OF PATENT (11)
02-02	D 2012 509 S

CONCORDANCE TABLE OF PATENT NUMBERS AND INTERNATIONAL
CLASSIFICATION INDEX

NUMBER OF PATENT (11)	INTERNATIONAL CLASSIFICATION INDEX (51)
D 2012 509 S	02-02

CONCORDANCE TABLE OF APPLICATION NUMBERS
AND PATENT NUMBERS

NUMBER OF APPLICATION (21)	NUMBER OF PATENT (11)
AD 2012 000701	D 2012 509 S

TRADEMARKS

CONCORDANCE TABLE OF REGISTRATION NUMBERS, APPLICATION NUMBERS, PUBLICATION NUMBERS AND BULLETIN NUMBERS

NUMBER OF REGISTRATION (111)	NUMBER OF APPLICATION (210)	NUMBER OF PUBLISHED APPLICATION (260)	NUMBER OF BULLETIN
M 2012 22928 R	AM 2010 56920	AM 2011 56920 A	16(332) 2011
M 2012 22929 R	AM 2010 59111	AM 2012 59111 A	10(350) 2012
M 2012 22930 R	AM 2011 61156	AM 2011 61156 A	9(349) 2012
M 2012 22931 R	AM 2011 61198	AM 2012 61198 A	10(350) 2012
M 2012 22932 R	AM 2011 64144	AM 2012 64144 A	8(348) 2012
M 2012 22933 R	AM 2011 61833	AM 2011 61833 A	9(349) 2012
M 2012 22934 R	AM 2011 62056	AM 2012 62056 A	8(348) 2012
M 2012 22935 R	AM 2011 62387	AM 2012 62387 A	6(346) 2012
M 2012 22936 R	AM 2011 62605	AM 2012 62605 A	6(346) 2012
M 2012 22937 R	AM 2011 62629	AM 2012 62629 A	6(346) 2012
M 2012 22938 R	AM 2011 62630	AM 2012 62630 A	6(346) 2012
M 2012 22939 R	AM 2011 62641	AM 2012 62641 A	10(350) 2012
M 2012 22940 R	AM 2011 62643	AM 2012 62643 A	10(350) 2012
M 2012 22941 R	AM 2011 62646	AM 2012 62646 A	10(350) 2012
M 2012 22942 R	AM 2011 62684	AM 2012 62684 A	10(350) 2012
M 2012 22943 R	AM 2011 62708	AM 2012 62708 A	10(350) 2012
M 2012 22944 R	AM 2011 62709	AM 2012 62709 A	10(350) 2012
M 2012 22945 R	AM 2011 62714	AM 2012 62714 A	5(345) 2012
M 2012 22946 R	AM 2011 62716	AM 2012 62716 A	10(350) 2012
M 2012 22947 R	AM 2011 62718	AM 2012 62718 A	6(346) 2012
M 2012 22948 R	AM 2011 62719	AM 2012 62719 A	6(346) 2012
M 2012 22949 R	AM 2011 62720	AM 2012 62720 A	6(346) 2012
M 2012 22950 R	AM 2011 62880	AM 2012 62880 A	6(346) 2012
M 2012 22951 R	AM 2011 62908	AM 2112 62908 A	1(341) 2012
M 2012 22952 R	AM 2011 62979	AM 2012 62979 A	5(345) 2012
M 2012 22953 R	AM 2011 63017	AM 2012 63017 A	5(345) 2012
M 2012 22954 R	AM 2011 63018	AM 2012 63018 A	5(345) 2012
M 2012 22955 R	AM 2011 63055	AM 2012 63055 A	4(344) 2012
M 2012 22956 R	AM 2011 63121	AM 2012 63121 A	4(344) 2012
M 2012 22957 R	AM 2011 63221	AM 2012 63221 A	6(346) 2012
M 2012 22958 R	AM 2011 63227	AM 2012 63227 A	5(345) 2012
M 2012 22959 R	AM 2011 63228	AM 2012 63228 A	5(345) 2012
M 2012 22960 R	AM 2011 63239	AM 2012 63239 A	9(349) 2012
M 2012 22961 R	AM 2011 63240	AM 2012 63240 A	9(349) 2012
M 2012 22962 R	AM 2011 63322	AM 2012 63322 A	9(349) 2012
M 2012 22963 R	AM 2011 63377	AM 2012 63377 A	5(345) 2012
M 2012 22964 R	AM 2011 63479	AM 2012 63479 A	6(346) 2012
M 2012 22965 R	AM 2011 63575	AM 2012 63575 A	9(349) 2012
M 2012 22966 R	AM 2011 63618	AM 2012 63618 A	6(346) 2012
M 2012 22967 R	AM 2011 63652	AM 2012 63652 A	6(346) 2012
M 2012 22968 R	AM 2011 63692	AM 2012 63692 A	7(347) 2012
M 2012 22969 R	AM 2011 63856	AM 2012 63856 A	9(349) 2012
M 2012 22970 R	AM 2011 63877	AM 2012 63877 A	10(350) 2012
M 2012 22971 R	AM 2011 63883	AM 2012 63883 A	8(348) 2012

1	2	3	4
M 2012 22972 R	AM 2012 68815	–	19(359) 2012
M 2012 22973 R	AM 2012 68764	–	19(359) 2012
M 2012 22974 R	AM 2012 68250	–	19(359) 2012
M 2012 22975 R	AM 2012 68585	–	19(359) 2012
M 2012 22976 R	AM 2012 68662	–	19(359) 2012
M 2012 22977 R	AM 2012 68668	–	19(359) 2012
M 2012 22978 R	AM 2012 68689	–	19(359) 2012

CONCORDANCE TABLE OF PUBLICATION NUMBERS
AND APPLICATION NUMBERS

NUMBER OF PUBLISHED APPLICATION (260)	NUMBER OF APPLICATION (210)
AM 2012 65455 A	AM 2011 65455
AM 2012 65662 A	AM 2011 65662
AM 2012 65663 A	AM 2011 65663
AM 2012 65664 A	AM 2011 65664
AM 2012 65665 A	AM 2011 65665
AM 2012 65666 A	AM 2011 65666
AM 2012 65822 A	AM 2012 65822

CONCORDANCE TABLE OF INDEX OF GOODS AND/OR SERVICES
AND APPLICATION NUMBERS

INDEX OF GOODS AND/OR SERVICES (511)	NUMBER OF PUBLISHED APPLICATION (260)
5	AM 2012 65455 A
5	AM 2012 65662 A
5	AM 2012 65663 A
5	AM 2012 65664 A
5	AM 2012 65665 A
5	AM 2012 65666 A
12	AM 2012 65822 A

CONCORDANCE TABLE OF INDEX OF GOODS AND/OR SERVICES
AND NUMBERS OF TRADEMARKS REGISTERED ACCORDING
TO THE ACCELERATED PROCEDURE

INDEX OF GOODS AND/OR SERVICES (511)	NUMBER OF REGISTERED ACCORDING TO THE ACCELERATED PROCEDURE (111)
7	M 2012 22978 R
29	M 2012 22977 R
30	M 2012 22972 R
33	M 2012 22973 R
33	M 2012 22975 R
33	M 2012 22976R
34	M 2012 22974 R
35	M 2012 22977 R

OFFICIAL BULLETIN OF THE INDUSTRIAL PROPERTY

19(359)

EDITOR-IN-CHIEF: N. Bebrishvili

EDITORS-TRANSLATORS: E. Gabunia

PROOFREADER: L. Chanturia

COMPUTER LAYOUT: M. Ordenidze
K. Svanidze

www.sakpatenti.org.ge
E-mail: info@sakpatenti.org.ge