



**NATIONAL INTELLECTUAL PROPERTY CENTER OF GEORGIA
SAKPATENTI**

**OFFICIAL BULLETIN
OF THE INDUSTRIAL PROPERTY**

20(360)

**2012
TBILISI**

INID CODES FOR IDENTIFICATION OF BIBLIOGRAPHIC DATA

INVENTIONS, UTILITY MODELS

- (10) Number of publication for application, which has been examined
- (11) Number of patent and kind of document
- (21) Serial number of application
- (22) Date of filing of the application
- (23) Date of exhibition or the date of the earlier filing and the number of application, if any
- (24) Date from which patent may have effect
- (31) Number of priority application
- (32) Date of filing of priority application
- (33) Code of the country or regional organization allotting priority application number
- (44) Date of publication of application not granted, but examined and number of bulletin
- (45) Date of publication of registered document
- (51) International Patent Classification Index
- (54) Title of the invention
- (57) Abstract
- (60) Number of examined patent document granted by foreign patent office, date from which patent has effect and country code
- (62) Number of the earlier application and in case of divided application, date of filing an application
- (71) Name, surname and address of applicant (country code)
- (72) Name, surname of inventor (country code)
- (73) Name, surname and address of patent owner (country code)
- (74) Name, surname of representative or patent attorney
- (85) Date of commencement of the national phase of International Application
- (86) Number and date of filing of international application
- (87) Number and date of publication of international application

DESIGNS

- (10) Number of publication for application
- (11) Number of patent and kind of document or number of registration
- (15) Date of registration/Date of patent renewal
- (18) Expected expiration date of patent or registration
- (21) Serial number of application
- (22) Date of filing of the application
- (23) Date of exhibition or the date of the earlier filing and the number of application, if any
- (24) Date from which patent may have effect
- (28) Number of designs included in the application
- (30) Data relating to priority (number of application, date of filing of application, two-letter code identifying the authority with whom the priority application was made)
- (31) Number of priority application
- (32) Date of filing of priority application
- (33) Code of the country or regional organization allotting priority application number
- (34) Two-letter code according to WIPO St.3 identifying the authority with which the priority application was made
- (44) Date of publication of design and number of bulletin (the first publication)
- (45) Date of publication of design registered by WIPO and number of bulletin
- (51) International Classification for designs (class and subclass of the Locarno Classification)
- (54) Title of the invention
- (55) Reproduction of the design
- (57) Description of characteristic features of the design including indication of colors
- (58) Date of recording of any kind of amendment in the Register
- (62) Number of the earlier application, registration and document number and if available the date of filing an application in case of divided application
- (71) Name, surname and address of applicant (country code)
- (72) Name, surname of creator (country code)
- (73) Name, surname and address of patent owner (country code)
- (74) Name, surname of representative or patent attorney
- (81) Contracting states concerned
 - II designated contracting states according to the 1960 Act
 - III designated contracting states according to the 1999 Act
- (85) Owner's permanent address
- (86) Owner's nationality
- (87) Owner's residence
- (88) State in which the owner has a real and effective industrial or commercial establishment

TRADEMARKS

- (111) – Number of registration
- (151) – Date of registration
- (156) – Date of the renewal
- (181) – Expected expiration date of registration
- (186) – Renewal expiration date of registration
- (141) – Date of cancel of duration of the mark
- (210) – Serial number of application
- (220) – Date of filing of the application
- (230) – Date concerning exhibition
- (260) – Number of application, for which favorable decision of examination about registration has been taken (publication number)
- (310) – Number of the first application
- (320) – Date of filing of the first application
- (330) – Code, identifying national or regional Office where the first application was made
- (511) – International Classification of Goods and Services for the purposes of registration of trade marks and/or list of goods and/or services classified according thereto
- (531) – Description of figurative elements of Trade Marks according to the International Classification of the Figurative Elements of Marks
- (540) – Reproduction of Trade Mark
- (550) – Nature and kind of Trade Mark
- (580) – Date of recording of any kind changes in respect of applications or registrations
- (591) – Information concerning colors claimed
- (731) – Name and address of the applicant
- (732) – Name and address of the holder of the registration
- (740) – Name and address of the representative
- (750) – Address for correspondence
- (770) – Name and address of the previous applicant or holder in case of change in ownership
- (771) – Previous name and address of the applicant or holder in case of change in ownership
- (791) – Name and address of the licensee
- (793) – Indication of conditions and/or restrictions under the license (Type of license, number of license agreement, data of license, data of validity of license)
- (800) – Certain data relating to the international registration of Trade Marks under the Protocol Relating to Madrid Agreement (International registration number)

CODES FOR PUBLICATION IN BULLETIN

- (21) AP 0000 000000 – serial number of application for invention
- (10) AP 0000 0000 A – number of published application for invention (first publication)
- (11) P 0000 0000 B – number of patent for invention (second publication)
- (21) API 0000 000000 – number of application for imported patent
- (11) PI 0000 0000 A – number of imported patent (first publication)
- (21) AU 0000 000000 – serial number of application for utility model
- (10) AU 0000 000 U – number of published application for utility model (first publication)
- (11) U 0000 000 Y – number of patent for utility model (second publication)
- (21) AD 0000 000000 – serial number of application for design
- (10) AD 0000 000 S – number of published application for design (first publication)
- (11) D 0000 000 S – number of patent for design (second publication)

INTERNATIONAL PATENT CLASSIFICATION FOR INVENTIONS AND UTILITY MODELS

- SECTION A – HUMAN NECESSITIES
- SECTION B – PERFORMING OPERATIONS; TRANSPORTING
- SECTION C – CHEMISTRY; METALLURGY
- SECTION D – TEXTILES; PAPER
- SECTION E – FIXED CONSTRUCTIONS
- SECTION F – MECHANICAL ENGINEERING; LIGHTING; HEATING; WEAPONS; BLASTING
- SECTION G – PHYSICS
- SECTION H – ELECTRICITY

-
- M – Trade Mark
 - (210) AM 0000 000000 – Serial number of application;
 - (260) AAM 0000 00000 A – Publication number of application;
 - (111) M 0000 00000 R – Number of registration;
 - (111) MMM0000 00000 Rn – Number of renewals, in which n=1,2,3;
 - (111) M 0000 00000 R(P) – Number of registration under partial assignment of rights
-

LIST OF CODES, IN ALPHABETIC SEQUENCE, AND THE CORRESPONDING (SHORT) NAMES OF STATES, OTHER ENTITIES AND INTERGOVERNMENTAL ORGANIZATIONS
(WIPO STANDARD ST.3)

AD	Andorra				
AE	United Arab Emirates				
AF	Afghanistan				
AG	Antigua and Barbuda				
AI	Anguilla				
AL	Albania				
AM	Armenia				
AN	Netherlands Antilles				
AO	Angola				
AP	African Regional Intellectual Property Organization (ARIPO)				
AR	Argentina				
AT	Austria				
AU	Australia				
AW	Aruba				
AZ	Azerbaijan				
BA	Bosnia and Herzegovina				
BB	Barbados				
BD	Bangladesh				
BE	Belgium				
BF	Burkina Faso				
BG	Bulgaria				
BH	Bahrain				
BI	Burundi				
BJ	Benin				
BM	Bermuda				
BN	Brunei Darussalam				
BO	Bolivia				
BR	Brazil				
BS	Bahamas				
BT	Bhutan				
BV	Bouvet Island				
BW	Botswana				
BX	Benelux Office for Intellectual Property (BOIP)				
BY	Belarus				
BZ	Belize				
CA	Canada				
CD	Democratic Republic of the Congo				
CF	Central African Republic				
CG	Congo				
CH	Switzerland				
CI	Cote d'Ivoire				
CK	Cook Islands				
CL	Chile				
CM	Cameroon				
CN	China				
CO	Colombia				
CR	Costa Rica				
CU	Cuba				
CV	Cape Verde				
CY	Cyprus				
CZ	Czech Republic				
DE	Germany				
DJ	Djibouti				
DM	Dominica				
DO	Dominican Republic				
DZ	Algeria				
EA	Eurasian Patent Organization (EAPO)				
EC	Ecuador				
EE	Estonia				
EG	Egypt				
EH	Western Sahara				
EM	Office for Harmonization in the Internal Market (Trademarks and Designs)(OHIM)				
EP	European Patent Office (EPO)				
ER	Eritrea				
ES	Spain				
ET	Ethiopia				
FI	Finland				
FJ	Fiji				
FK	Falkland Islands (Malvinas)				
FO	Faroe Islands				
FR	France				
GA	Gabon				
GB	United Kingdom				
GC	Patent Office of the Cooperation Council for the Arab States of the Gulf (GCC)				
GD	Grenada				
GG	Guernsey				
GH	Ghana				
GI	Gibraltar				
GT	Guatemala				
GW	Guinea- Bissau				
GY	Guyana				
HK	The Hong Kong Special Administrative Region of the People's Republic of China				
HN	Honduras				
HR	Croatia				
HT	Haiti				
HU	Hungary				
IB	International Bureau of the World Intellectual Property Organization (WIPO)				
ID	Indonesia				
IE	Ireland				
IL	Israel				
IM	Isle of Man				
IN	India				
IQ	Iraq				
ID	Indonesia				
IE	Ireland				
IL	Israel				
IM	Isle of Man				
IN	India				
IQ	Iraq				
IR	Iran (Islamic Republic of)				
IS	Iceland				
IT	Italy				
JE	Jersey				
JM	Jamaica				
JO	Jordan				
JP	Japan				
KE	Kenya				
KG	Kyrgyzstan				
KH	Cambodia				
KI	Kiribati				
KM	Saint Kitts and Nevis				
KP	Democratic People's Republic of Korea				
KR	Republic of Korea				
KW	Kuwait				
KY	Cayman Islands				
KZ	Kazakhstan				
LA	Lao People's Democratic Republic				
LB	Lebanon				
LC	Saint Lucia				
LI	Liechtenstein				
LK	Sri Lanka				
LR	Liberia				
LS	Lesotho				
LT	Lithuania				
LU	Luxembourg				
LV	Latvia				
LY	Libyan Arab Jamahiriya				
MA	Morocco				
MC	Monaco				
MD	Republic of Moldova				
ME	Montenegro				
MG	Madagascar				
MK	The former Yugoslav Republic of Macedonia				
ML	Mali				
MM	Myanmar				
MN	Mongolia				
MO	Macao				
MP	Northern Mariana Islands				
MR	Mauritania				
MS	Montserrat				
MT	Malta				
MU	Mauritius				
MV	Maldives				
MW	Malawi				
MX	Mexico				
MY	Malaysia				
MZ	Mozambique				
NA	Namibia				
NE	Niger				
NG	Nigeria				
NI	Nicaragua				
NL	Netherlands				
NO	Norway				
NP	Nepal				
NR	Nauru				
NZ	New Zealand				
OA	African Intellectual Property Organization (OAPI)				
OM	Oman				
PA	Panama				
PE	Peru				
PG	Papua New Guinea				
PH	Philippines				
PK	Pakistan				
PL	Poland				
PT	Portugal				
PW	Palau				
PY	Paraguay				
QA	Qatar				
QZ	Community Plant Variety Office (European Community) (CPVO)				
RO	Romania				
RS	Serbia				
RU	Russian Federation				
RW	Rwanda				
SA	Saudi Arabia				
SB	Solomon Islands				
SC	Seychelles				
SD	Sudan				
SG	Singapore				
SH	Saint Helena				
SI	Slovenia				
SK	Slovakia				
SL	Sierra Leone				
SM	San Marino				
SN	Senegal				
SO	Somalia				
SR	Suriname				
ST	Sao Tome and Principe				
SV	El Salvador				
SY	Syrian Arab Republic				
SZ	Swaziland				
TC	Turks and Caicos Islands				
TD	Chad				
TG	Togo				
TH	Thailand				
TJ	Tajikistan				
TL	Timor-Leste				
TM	Turkmenistan				
TN	Tunisia				
TO	Tonga				
TR	Turkey				
SE	Sweden				
TT	Trinidad and Tobago				
TV	Tuvalu				
TW	Taiwan, Province of China				
TZ	United Republic of Tanzania				
UA	Ukraine				
UG	Uganda				
US	United States of America				
UY	Uruguay				
UZ	Uzbekistan				
VA	Holy See				
VC	Saint Vincent and the Grenadines				
VE	Venezuela				
VG	Virgin Islands (British)				
VN	Viet Nam				
VU	Vanuatu				
WO	World Intellectual Property Organization (WIPO)				
WS	Samoa				
XN	Nordic Patent Institute (NPI)				
YE	Yemen				
ZA	South Africa				
ZM	Zambia				
ZW	Zimbabwe				

**NATIONAL INTELLECTUAL PROPERTY CENTER OF GEORGIA
SAKPATENTI**

**OFFICIAL BULLETIN
OF THE INDUSTRIAL PROPERTY**

20(360)

INVENTIONS

UTILITY MODELS

DESIGNS

TRADEMARKS

**APPELLATIONS OF ORIGIN AND GEOGRAPHICAL
INDICATIONS OF GOODS**

DATE OF PUBLICATION

2012 10 25

CONTENTS

PUBLISHED TITLES OF PROTECTION	2
INVENTIONS	
▪ APPLICATIONS APPROVED FOR GRANTING PATENTS	4
▪ PATENTED INVENTIONS	8
UTILITY MODELS	
▪ APPLICATIONS APPROVED FOR GRANTING PATENTS	12
▪ PATENTED UTILITY MODEL	14
DESIGNS	
▪ APPLICATION APPROVED FOR GRANTING PATENTS	15
▪ REGISTERED DESIGN	17
▪ DESIGN REGISTERED ACCORDING TO THE ACCELERATED PROCEDURE	18
▪ DESIGNS, REGISTERED WITH THE INTERNATIONAL BUREAU CLAIMING PRIORITY ON THE TERRITORY OF GEORGIA	19
TRADEMARKS	
▪ APPLICATIONS FILED UNDER THE NATIONAL PROCEDURE APPROVED FOR REGISTRATION	71
▪ REGISTERED TRADEMARKS	76
▪ TRADEMARKS REGISTERED ACCORDING TO THE ACCELERATED PROCEDURE	80
▪ INTERNATIONAL TRADEMARKS FOR WHICH A DECISION ON GRANTING PROTECTION IS TAKEN	82
▪ INTERNATIONAL TRADEMARKS PROTECTED IN GEORGIA	120
APPELLATIONS OF ORIGIN AND GEOGRAPHICAL INDICATIONS OF GOODS	
▪ THE RIGHT TO USE OF REGISTERED APPELLATIONS OF ORIGIN OF GOODS	129
OFFICIAL NOTIFICATIONS	
TRADEMARKS	
▪ RENEWAL OF REGISTRATIONS	143
▪ CHANGES IN NAMES AND/OR ADDRESSES OF OWNERS	144
▪ INVALIDATION OF TRADEMARKS REGISTRATIONS	145
▪ CORRECTION OF MISTAKES	145
CLASSIFICATION INDEXES	
INVENTIONS	146
UTILITY MODELS	148
DESIGNS	149
TRADEMARKS	151

PUBLISHED TITLES OF PROTECTION

INVENTIONS

- **APPLICATIONS APPROVED FOR GRANTING PATENTS:**
12681; 12129; 12228; 11845; 12046; 12237; 11705; 12093; 11945; 12069
- **PATENTED INVENTIONS:**
5668-5681

UTILITY MODELS

- **APPLICATIONS APPROVED FOR GRANTING PATENTS:**
12420; 12541; 12187
- **PATENTED UTILITY MODEL:**
1740

DESIGNS

- **APPLICATIONS APPROVED FOR GRANTING PATENTS:**
707; 711
- **REGISTERED DESIGN:**
510
- **DESIGN REGISTERED ACCORDING TO THE ACCELERATED PROCEDURE:**
511
- **DESIGNS REGISTERED WITH THE INTERNATIONAL BUREAU CLAIMING PRIORITY ON THE TERRITORY OF GEORGIA:**
78609; 78615; 78627; 77535; 77788; 78640; 78658; 77876; 78698; 78705; 78715; 78721

TRADEMARKS

- **APPLICATIONS FILED UNDER THE NATIONAL PROCEDURE APPROVED FOR REGISTRATION:**
64664, 64665; 64686; 64695; 64698; 64719; 64771; 64820-64822; 64834, 64835; 64837; 64905; 64918; 64994, 64995; 65051, 65052; 65066-65071; 65096; 65094, 65165; 65209; 65389, 65390; 65568; 65584; 65757, 65758
- **REGISTERED TRADEMARKS:**
22979-22981; 22989-23020
- **TRADEMARKS REGISTERED ACCORDING TO THE ACCELERATED PROCEDURE:**
22982-22988; 23021, 23022
- **INTERNATIONAL TRADEMARKS FOR WHICH A DECISION ON GRANTING PROTECTIONS IS TAKEN:**
64932-64940; 64943; 64944; 65015; 65016; 65018-65022; 65024; 65065; 65079-65092; 65097; 65099-65102; 65120-65124; 65144; 65145; 65150-65153; 65158; 65160-65162; 65167-65170; 65172; 65174-65181; 65193; 65195, 65196; 65198-65200; 65402; 65463; 65465, 65466; 65470; 65472; 65473; 65563; 65565-65567; 65570-65577; 65579; 65581-65583; 65586-65589; 67068; 62224*
- **INTERNATIONAL TRADEMARKS PROTECTED IN GEORGIA:**
52827, 52828; 53915; 54185; 60359; 61042; 61046; 61336; 61490; 61651; 61714; 61716, 61717; 61770; 61907; 62007; 62194; 62454; 62570; 62580; 62588; 62672; 62915-62919; 62999-63001; 63004, 63005; 63007; 63013; 63022, 63023; 63026-63028; 63171; 63173, 63174; 63176-63180; 63363; 63849; 63854, 63855; 63885; 63914-63918; 63920-63923; 63925-63935; 63937; 63938; 63940; 63943; 64160-64168; 64170-64174; 64272-64282; 64286-64289; 64355-64362; 64364; 64365; 64368; 64373; 64374; 64376-64378; 64437-64439; 64442-64450; 64542; 61106; 61648; 61904

APPELLATIONS OF ORIGIN AND GEOGRAPHICAL INDICATIONS OF GOODS

▪ THE RIGHT TO USE OF REGISTERED APPELLATIONS OF ORIGIN OF GOODS:

822/1; 823/1; 824/1; 791/1-12; 1/2-12; 2/2-12; 3/2-12; 4/2-12; 787/2-12; 788/2-12; 789/1-12; 790/1-12; 794/1-12; 797/2-12; 1/1-12; 2/1-12; 3/1-12; 4/1-12; 787/1-12; 788/1-12; 794/1-12; 797/1-12; 1/3-12; 2/3-12; 3/3-12; 787/3-12; 789/1-12; 799/1-12; 1/4-12; 2/4-12; 3/4-12; 4/3-12; 5/1-12; 787/4-12; 794/4-12; 1/5-12; 2/5-12; 3/5-12; 4/4-12; 787/5-12; 790/5-12; 797/5-12; 1/6-12; 2/6-12; 4/5-12; 787/6-12; 1/7-12; 2/7-12; 3/6-12; 5/2-12; 787/7-12; 790/3-12; 794/5-12; 1/8-12; 2/8-12; 3/7-12; 4/6-12; 5/3-12; 787/8-12; 788/3-12; 797/4-12; 1/9-12; 2/9-12; 3/8-12; 4/7-12; 5/4-12; 787/9-12; 789/2-12; 790/4-12; 794/6-12; 798/3-12; 1/10-12; 2/10-12; 3/9-12; 4/8-12; 5/5-12; 787/10-12; 789/3-12; 790/5-12; 794/7-12; 798/4-12; 1/11-12; 2/11-12; 3/10-12; 4/9-12; 5/6-12; 787/11-12; 789/4-12; 790/6-12; 794/8-12; 798/5-12; 2/12-12; 3/11-12; 787/12-12; 793/1-12; 794/9-12

INVENTIONS

APPLICATIONS APPROVED FOR GRANTING PATENTS

The decision can be appealed at the Chamber of Appeal of Sakpatenti within 3 months from the publication or at the Administrative Chamber of the Tbilisi City Court (Address: №6, David Aghmashenebeli Kheivani 12 km., Tbilisi) within 1 month following the publication.

PART A

A 47

(10) AP 2012 12681 A (51) Int. Cl. (2006)
A 47 B 47/02

(21) AP 2012 012681 (22) 2012 04 27

(71) PUBLIC LAW LEGAL ENTITY
STATE UNIVERSITY OF ILIA (GE)
I.Chavchavadzis Gamz. 32, 0179, Tbilisi (GE)

(72) Gigi Tevzadze (GE)

(54) **BOOKSTAND**

(57) A bookstand comprises columns 1 with bookshelves 2 fastened thereby holding elements. The upper bookshelves 2 have increasing incline depending on height, and the lower bookshelves 3 relative thereto have mirror disposition, and the ends allocation thereof has C-shaped configuration in its side cut.

Claims: 1 independent

Fig.: 7



Fig. 6

(54) **DRUG FOR PYODERMIA TREATMENT**

(57) There is represented drug for pyoderma treatment containing: bidens (Bidens tripartitus), St. John's wort (Hypericum), olive oil, beeswax, spermacti and synthomycin powder.

Claims: 1 independent

(10) AP 2012 12228 A (51) Int. Cl. (2006)
A 61 K 31/155

A 61 P 17/00

A 61 K 47/10

(21) AP 2009 012228 (22) 2009 10 21

(31) 0857146

(32) 2008 10 21

(33) FR

(71) PIERRE FABRE DERMO-COSMETIQUE (FR)
45, place Abel Gance, 92100 Boulogne-
Billancourt (FR)

(72) CHESNOY, Sophie (FR);
DELAUNOIS, Marlène (FR);
COUBETERGUES, Héra (FR);
LEFRANCOIS, Pascal (FR)

(74) George Meipariani

(85) 2011 05 19

(86) PCT/EP2009/063771, 2009 10 21

(54) **UREA-BASED FILM-FORMING
SOLUTION FOR NAIL PSORIASIS
TREATMENT**

(57) An invention relates to film-forming solution containing: urea, film-forming polymer, polar solvent, co-solvent, plasticizer and water.

Claims: 1 independent

11 dependent

A 61

(10) AP 2012 12129 A (51) Int. Cl. (2006)
A 61 K 9/06

A 61 K 35/78

(21) AP 2011 012129 (22) 2011 03 09

(71) Mariam Ionanidze (GE)
Chavchavadzis Gamz. 45/54, 4600, Kutaisi (GE);
Bagrat Basiladze (GE)
Chavchavadzis Gamz. 45/54, 4600, Kutaisi (GE)

(72) Mariam Ionanidze (GE);
Bagrat Basiladze (GE)

PART C

C 02

(10) AP 2012 11845 A (51) Int. Cl. (2006)
C 02 F 3/32

E 02 B 15/04

B 01 J 20/22

(21) AP 2010 011845 (22) 2010 06 14

(71) Nora Mamulaishvili (GE)
Javakhishvilis q. 6, b. 4, 6010, Batumi (GE)

(72) Nora Mamulaishvili (GE)

(54) **METHOD OF WATER SURFACE PURIFICATION FROM OIL AND OIL PRODUCTS**

(57) There is represented a method of water surface purification from oil and oil products providing natural sorbent – fruit fibrous particles allocation onto contaminated water surface with following harvesting and regeneration; at that, platan fruit fibrous particles are used as natural sorbent.

Claims: 1 independent

Fig.: 3

Table: 3

C 03

(10) **AP 2012 12046 A** (51) **Int. Cl. (2006)**
C 03 C 3/04
C 03 C 3/095
C 03 C 13/00

(21) AP 2010 012046 (22) 2010 12 30

- (71) Roman Verulashvili (GE)
 Arakishvilis I Chikh. 13, 0179, Tbilisi (GE);
 Izolda Kamushadze (GE)
 Nutsubidzis IV mkr., korp. 28, b. 21, 0183, Tbilisi (GE);
 Davit Verulashvili (GE)
 Arakishvilis I Chikh. 13, 0179, Tbilisi (GE);
 Ketevan Vakhtangishvili (GE)
 Chavchavadzis Gamz. 41, b. 10, 0179, Tbilisi (GE);
 Merab Gvenetadze (GE)
 Arakishvilis II Chikh. 13, 0179, Tbilisi (GE);
 Zurab Machavariani (GE)
 Baratashvilis 6/10, b. 60, 0105, Tbilisi (GE)
- (72) Roman Verulashvili (GE);
 Izolda Kamushadze (GE);
 Davit Verulashvili (GE);
 Ketevan Vakhtangishvili (GE);
 Merab Gvenetadze (GE);
 Zurab Machavariani (GE)

(54) **GLASS FIBER COMPOSITION**

(57) There is represented glass fiber composition containing SiO₂, TiO₂, Al₂O₃, Fe₂O₃+FeO, CaO, MgO, Na₂O, K₂O, La₂O₃, BaO, ZnO with components following ratio in mass%:

SiO ₂	45.0-70.0
TiO ₂	0.001-2.0
Al ₂ O ₃	5.0-20.0
Fe ₂ O ₃ +FeO	0.1-20.0
CaO	0.002-20.0
MgO	0.001-5.0
Na ₂ O	0.01-4.0
K ₂ O	0.001-25.0
La ₂ O ₃	0.001-30.0
BaO	0.001-30.0

ZnO 0.001-33.0

Claims: 1 independent

Table: 2

C 07

(10) **AP 2012 12237 A** (51) **Int. Cl. (2006)**
C 07 C 205/12
C 07 C 211/61
C 07 C 17/25
C 07 C 22/02
C 07 C 23/08

(21) AP 2009 012237 (22) 2009 09 28

(31) 08018721.4; 09161388.5

(32) 2008 10 27; 2009 05 28

(33) EP; EP

(71) SYNGENTA PARTICIPATIONS AG (CH)
 Schwarzwaldallee 215, CH-4058, Basel (CH)

(72) GRIBKOV, Denis (RU);
 ANTELMANN, Björn (DE);
 GIORDANO, Fanny (FR);
 WALTER, Harald (DE);
 DE MESMAEKER, Alain (BE)

(74) Tamara Kochlamazashvili

(85) 2011 05 25

(86) PCT/EP2009/062525, 2009 09 28

(54) **METHOD OF BENZONORBORNENES PRODUCTION**

(57) The present invention relates to novel production method of 9-dichloro-methylene-1,2,3,4-tetrahydro-1,4-methano-naphthalen-5-ylamine (I),

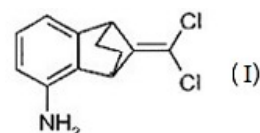

intermediate product at fungicidal benzonornbornenes, as well, as intermediates (II), (III) and (IV) production.

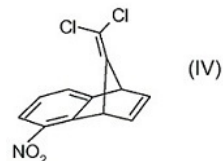
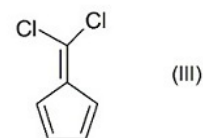

Claims: 3 independent

4 dependent

(10) AP 2012 11705 A (51) Int. Cl. (2006)

C 07 D 213/72

(21) AP 2008 011705 (22) 2008 07 29
(31) 2007-202210; 2007-202220; 2007-266000;
2008-037841

(32) 2007 08 02; 2007 08 02; 2007 10 12;
2008 02 19

(33) JP; JP; JP; JP

(71) ISHIHARA SANGYO KAISHA, LTD. (JP)
3-15, Edobori 1-chome, Nishi-ku, Osaka-shi,
Osaka, 5500002 (JP)

(72) MURAI, Shigeo (JP);
YOSHIZAWA, Hiroshi (JP);
OHSHIMA, Takeshi (JP);
MURAKAMI, Katsuyoshi (JP);
ANDO, Takayoshi (JP);
NAKAMURA, Tadashi (JP);
ADACHI, Norio (JP);
ISOGAI, Akihiko (JP)

(74) Tamara Kochlamazashvili

(85) 2010 03 01

(86) PCT/JP2008/063933, 2008 07 29

(54) **METHOD OF TOLUIDINE COMPOUND
PRODUCTION**

(57) The present invention relates to production method of fluasnam-3-chlorine-N-(3-chlorine-5-trifluorine-methyl-2-pyridil)- α,α,α -trifluorine-2,6-dinitro-p-toluidine. Fluasnam is applied as pesticide active ingredient.

Claims: 2 independent

15 dependent

(10) AP 2012 12093 A (51) Int. Cl. (2006)

C 07 D 453/02

A 61 K 31/439

A 61 P 11/00

(21) AP 2009 012093 (22) 2009 07 21

(31) 08162066.8

(32) 2008 08 08

(33) EP

(71) CHIESI FARMACEUTICI S.P.A. (IT)
Via Palermo, 26/A, I-43100, Parma (IT)

(72) AMARI, Gabriele (IT);
DELCANALE, Maurizio (IT)

(74) Shalva Gvaramadze

(85) 2011 02 07

(86) PCT/EP2009/005272, 2009 07 21

(54) **QUINUCLIDINE CARBONATE
DERIVATIVES AND MEDICINAL
COMPOSITIONS THEREOF**

(57) An invention relates to: quinuclidine carbonate derivatives of formula (I), and pharmaceutical compositions comprising thereof acting as muscarinic receptor antagonists; and usage thereof obstructive bronchitis and inflammatory diseases treatment.

Claims: 5 independent

19 dependent

PART F

F 02

(10) AP 2012 11945 A (51) Int. Cl. (2006)

F 02 B 73/00

F 02 G 1/043

(21) AP 2010 011945 (22) 2010 09 20

(71) Giorgi Vardishvili (GE)

Me-19 mkr., korp. 13, b. 41, 3700,

Rustavi (GE);

Ushangi Tsopurashvili (GE)

Me-19 mkr., korp. 16, b. 11, 3700,

Rustavi (GE);

Guram Obgaidze (GE)

Gardabani, Sop. Akhali Samgori, b. 33,
1304 (GE)

(72) Giorgi Vardishvili (GE);

Ushangi Tsopurashvili (GE);

Guram Obgaidze (GE)

(54) **COMBINED DEVICE "GUG"**

(57) A device comprises a bed 10 whereon internal combustion 2 and Stirling 3 engines are installed by pistons 12, 13, 23 located in the cylinders 5, 17, 22 and connected to cranked clevises 16 and 21 by rods 20, 24. An outlet header 6 withdrawing discharge gases is connected to chamber 4 wherein Stirling engine hot cylinder 5 is placed.

Claims: 1 independent

Fig.: 5

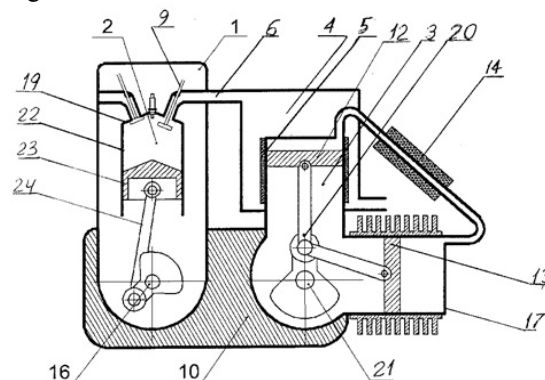

Fig. 1

F 03

(10) AP 2012 12069 A (51) Int. Cl. (2006)

F 03 B 13/12

(21) AP 2011 012069 (22) 2011 01 24

(71) Merab Chirakadze (GE)

Ir. Aabashidzis q. 16, b. 9, 0179,

Tbilisi (GE)

(72) Merab Chirakadze (GE)

(54) **WAVE ENERGY CONVERTER**

(57) Wave energy converter comprises set of operative nodes tied together, and any therefrom

includes, at least, couple of cylinders 3, and the pistons 4 and 7 mobile in each cylinder. At that, each operative node is located opposed along a float axis 1, and the pistons are performed as a hollow axis 6 planted onto the float axis connected to a blade 2. The float axis is passed through cylinders, the blade is rigidly planted onto the hollow axis, and in addition, the float axis and set of operative nodes are allocated together along wave spread direction.

Claims: 1 independent

2 dependent

Fig.: 2

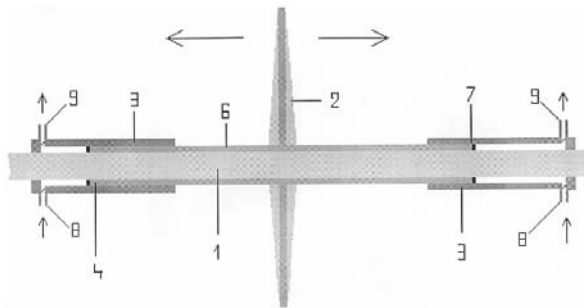

Fig. 1

PATENTED INVENTIONS

PART A

A 23

- (11) P 2012 5670 B** (51) **Int. Cl. (2006)**
A 23 L 1/06
A 23 L 1/212
- (10) AP 2012 11518 A (44) 13(353)/2012
(21) AP 2009 011518
(22) 2009 10 20
(24) 2009 10 20
(73) Soso Guruli (GE)
Metsnierebis q. 12, b. 57, Anaseuli, 3503,
Ozurgeti (GE);
Temur Revishvili (GE)
Metsnierebis q. 9, b. 13 Anaseuli, 3503,
Ozurgeti (GE);
Zurab Andguladze (GE)
sop. Dzimiti, 3526, Ozurgeti (GE);
Bakhva Dolidze (GE)
I.Shemokmedelis q. 32, 3500, Ozurgeti (GE)
(72) Soso Guruli (GE);
Temur Revishvili (GE);
Zurab Andguladze (GE);
Bakhva Dolidze (GE)
(54) **METHOD OF SUBTROPICAL EBONY
PREPARATION**
-

- (11) P 2012 5671 B** (51) **Int. Cl. (2006)**
A 23 L 1/22
- (10) AP 2012 11641 A (44) 13(353)/2012
(21) AP 2010 011641
(22) 2010 01 12
(24) 2010 01 12
(73) Zaira Shapatava (GE)
Dolidzis q., korp. 15, b. 20, 0171,
Tbilisi (GE);
Tamaz Kobaidze (GE)
Kekelidzis q. 19, b. 11, 0179, Tbilisi (GE);
Merab Zhghenti (GE)
Mukhianis das., I mkr., korp. 9, b. 19, 0172,
Tbilisi (GE);
Marine Melikishvili (GE)
Shevardenidzis q. 7, b. 7, 0177, Tbilisi (GE)
(72) Zaira Shapatava (GE);
Tamaz Kobaidze (GE);
Merab Zhghenti (GE);
Marine Melikishvili (GE)
(54) **METHOD OF SAUCE PREPARATION**
-

A 61

- (11) P 2012 5675 B** (51) **Int. Cl. (2006)**
A 61 K 9/06
A 61 K 35/78
- (10) AP 2012 12110 A (44) 13(353)/2012
(21) AP 2011 012110
(22) 2011 02 18
(24) 2011 02 18
(73) Mariam Ionanidze (GE)
Chavchavadzis gamz. 45/54, 4600,
Kutaisi (GE);
Bagrat Basiladze (GE)
Chavchavadzis gamz. 45/54, 4600,
Kutaisi (GE)
(72) Mariam Ionanidze (GE);
Bagrat Basiladze (GE)
(54) **DRUG FOR BURN TREATMENT**
-

- (11) P 2012 5674 B** (51) **Int. Cl. (2006)**
A 61 K 9/08
- (10) AP 2012 12108 A (44) 13(353)/2012
(21) AP 2011 012108
(22) 2011 02 17
(24) 2011 02 17
(73) Irine Mamageishvili (GE)
Kaukhchishvilis q. 12, 4600, Kutaisi (GE);
Inga Mamageishvili (GE)
Kaukhchishvilis q. 12, 4600, Kutaisi (GE);
Davit Mamageishvili (GE)
Kaukhchishvilis q. 12, 4600, Kutaisi (GE)
(72) Irine Mamageishvili (GE);
Inga Mamageishvili (GE);
Davit Mamageishvili (GE)
(54) **ANTHELMINTIC THERAPEUTIC
AGENT**
-

- (11) P 2012 5672 B** (51) **Int. Cl. (2006)**
A 61 K 9/24
A 61 K 9/26
A 61 K 31/513
A 61 K 31/155
A 61 K 45/06
- (10) AP 2012 11694 A (44) 13(353)/2012
(21) AP 2008 011694
(22) 2008 07 16
(24) 2008 07 16
(31) 2007-188574
(32) 2007 07 19

- (33) JP
 (73) TAKEDA PHARMACEUTICAL COMPANY LIMITED (JP)
 1-1, Doshomachi 4-chome, Chuo-ku, Osaka-shi, Osaka, 5410045 (JP)
 (72) YAMAMOTO, Kazumichi (JP);
 KOYAMA, Hiroyoshi (JP)
 (74) Shalva Gvaramadze
 (85) 2010 02 19
 (86) PCT/JP2008/063228, 2008 07 16
 (54) **SOLID COMPOSITION CONTAINING ALOGLIPTIN AND METFORMIN HYDROCHLORIDE**

- (11) P 2012 5673 B** **(51) Int. Cl. (2006)**
A 61 K 31/205
A 61 P 9/00
A 61 P 9/10
- (10) AP 2012 11832 A (44) 13(353)/2012
 (21) AP 2008 011832
 (22) 2008 12 03
 (24) 2008 12 03
 (31) 07122272.3; 07121173.1
 (32) 2007 12 04; 2007 12 04
 (33) EP; EP
 (73) "GRINDEKS" A JOINT STOCK COMPANY (LV)
 53, Krustpils St., 1057 Riga (LV)
 (72) STONANS, Ilmars (LV);
 TARARAK, Eduard (RU);
 ANDREEVA, Elena (RU)
 (74) Khatuna Imnadze
 (85) 2010 06 07
 (86) PCT/EP2008/066711, 2008 12 03
 (54) **3-(2,2,2-TRIMETHYLHYDRAZINIUM) PROPIONATE HYDROGEN FUMARATE AND DIHYDROGEN PHOSPHATE MEDICAL USAGE**

PART C

C 07

- (11) P 2012 5676 B** **(51) Int. Cl. (2006)**
C 07 C 241/02
C 07 C 243/40
- (10) AP 2012 11990 A (44) 13(353)/2012
 (21) AP 2009 011990
 (22) 2009 05 26
 (24) 2009 05 26
 (31) 08156903.0; 08164564.0
 (32) 2008 05 26; 2008 09 18
 (33) EP; EP
 (73) "GRINDEKS" A JOINT STOCK COMPANY (LV)
 53, Krustpils St., 1057 Riga (LV)

- (72) ZICANE, Daina (LV);
 TURKS, Maris (LV)
 (54) **NEW METHOD OF 3-(2,2,2-TRIMETHYLHYDRAZINIUM) PROPIONATE DIHYDRATE PREPARATION**

- (11) P 2012 5677 B** **(51) Int. Cl. (2006)**
C 07 C 241/02
C 07 C 243/14
- (10) AP 2012 11991 A (44) 13(353)/2012
 (21) AP 2009 011991
 (22) 2009 05 26
 (24) 2009 05 26
 (31) 08156903.0; 08164565.7
 (32) 2008 05 26; 2008 09 18
 (33) EP; EP
 (73) "GRINDEKS" A JOINT STOCK COMPANY (LV)
 53, Krustpils St., 1057 Riga (LV)
 (72) ZICANE, Daina (LV);
 TURKS, Maris (LV)
 (74) Khatuna Imnadze
 (85) 2010 11 04
 (86) PCT/EP2009/056370, 2009 05 26
 (54) **METHOD OF 3-(2,2-DIMETHYLHYDRAZINO) METHYLPROPIONATE PREPARATION**

- (11) P 2012 5680 B** **(51) Int. Cl. (2006)**
C 07 C 241/02
C 07 C 243/40
- (10) AP 2012 11935 A (44) 1(341)/2012
 (21) AP 2009 011935
 (22) 2009 02 19
 (24) 2009 02 19
 (31) P-08-22; P-08-23
 (32) 2008 02 19; 2008 02 19
 (33) LV; LV
 (73) "GRINDEKS, A JOINT STOCK" COMPANY (LV)
 53, Krustpils street, LV-1057 Riga (LV)
 (72) KALVINS, Ivars (LV);
 PUGOVICS, Osvalds (LV);
 CERNOBROVIJS, Aleksandrs (LV);
 IEVINA, Agnija (LV);
 LEBEDEVS, Antons (LV)
 (74) Khatuna Imnadze
 (85) 2010 08 30
 (86) PCT/EP2009/051995, 2009 02 19
 (54) **CARBONIC AND SULPHURIC ACID SALTS OF 3-(2,2,2-TRIMETHYLHYDRAZINIUM) PROPIONATE ESTERS AND THEIR USE FOR 3-(2,2,2-RIMETHYLHYDRAZINIUM) PROPIONATE DIHYDRATE PREPARATION**

- (11) P 2012 5681 B (51) Int. Cl. (2006)
C 07 C 241/02
C 07 C 243/40
- (10) AP 2012 11936 A (44) 1(341)/2012
(21) AP 2009 011936
(22) 2009 02 19
(24) 2009 02 19
(31) P-08-22; P-08-23
(32) 2008 02 19; 2008 02 19
(33) LV; LV
(73) GRINDEKS, A JOINT STOCK
COMPANY (LV)
53, Krustpils street, LV-1057 Riga (LV)
(72) KALVINS, Ivars (LV);
LEBEDEV, Antons (LV);
IEVINA, Agnija (LV);
CERNOBROVIJS, Aleksandrs (LV);
PUGOVICS, Osvalds (LV)
(74) Khatuna Imnadze
(85) 2010 08 30
(86) PCT/EP2009/051996, 2009 02 19
(54) **A ONE-POT PROCESS FOR PREPARING
3-(2,2,2-TRIMETHYLHYDRAZINIUM)
PROPIONATE DIHYDRATE**

PART E

E 21

- (11) P 2012 5678 B (51) Int. Cl. (2006)
E 21 B 3/02
E 21 B 47/18
E 21 B 43/12
E 21 B 7/04
- (10) AP 2012 9075 A (44) 12(352)/2012
(21) AP 2004 009075
(22) 2004 04 26
(24) 2004 04 26
(31) 60/465,395; 10/831,975; 10/835,521;
10/831,976
(32) 2003 04 25; 2004 04 26; 2004 04 26;
2004 04 26
(33) US; US; US; US
(73) INTERSYN TECHNOLOGIES (US)
2735 Albans, Houston, TX 77005 (US)
(72) SCHAAF, Stuart (US)
(74) George Meipariani
(85) 2005 11 24
(86) PCT/US2004/012753, 2004 04 26
(54) **SYSTEMS AND METHODS TO
CONTROL ONE OR MORE SYSTEM
COMPONENTS BY CONTINUOUSLY
VARIABLE TRANSMISSION USAGE**

PART F

F 01

- (11) P 2012 5679 B (51) Int. Cl. (2006)
F 01 B 17/02
F 01 B 9/02
F 02 G 1/02
- (10) AP 2012 11152 A (44) 12(352)/2012
(21) AP 2007 011152
(22) 2007 09 03
(24) 2007 09 03
(31) 06/07742
(32) 2006 09 05
(33) FR
(73) MDI-MOTOR DEVELOPMENT
INTERNATIONAL S.A. (LU)
23 Rue Beaumont, L-1219, Luxemburg (LU)
(72) NEGRE, Guy (FR);
NEGRE, Cyril (FR)
(74) Shalva Gvaramadze
(85) 2009 03 09
(86) PCT/EP2007/059161, 2007 09 03
(54) **COMPRESSED-AIR OR GAS AND/OR
ADDITIONAL-ENERGY ENGINE
HAVING ACTIVE EXPANSION
CHAMBER**

F 03

- (11) P 2012 5669 B (51) Int. Cl. (2006)
F 03 D 5/04
F 03 D 1/04
- (10) AP 2012 11510 A (44) 13(353)/2012
(21) AP 2008 011510
(22) 2008 02 13
(24) 2008 02 13
(31) TO2007A000233
(32) 2007 03 30
(33) IT
(73) KITE GEN RESEARCH S.R.L. (IT)
Via B. Telesio 2, I-20145 Milano (IT)
(72) TADDEI, Franco (IT);
IPPOLITO, Massimo (IT)
(74) David Zurabishvili
(85) 2009 10 16
(86) PCT/IT2008/000089, 2008 02 13
(54) **WIND SYSTEM CONVERSING ENERGY
BY KITES CONVEYANCE ON RAIL
BY DRAGGING MODULES AND,
METHOD OF ELECTRIC ENERGY
GENERATION BY SUCH SYSTEM**

PART H**H 04**

- (11) P 2012 5668 B (51) Int. Cl. (2006)
 H 04 B 7/26
 H 04 L 12/24
 H 04 W 52/00
- (10) AP 2012 10721 A (44) 13(353)/2012
(21) AP 2004 010721
(22) 2004 07 15
(24) 2004 07 15
(62) 60/487,653 2003-07-16 (US)
(31) 60/487,653
(32) 2003 07 16
(33) US
(73) INTERDIGITAL TECHNOLOGY
CORPORATION (US)
300 Delaware Avenue, Suite 527,
Wilmington, DE 19801 (US)
- (72) RUDOLF, Marian (DE);
DICK, Stephen, G. (US);
HUNKELER, Teresa, Joanne (CA);
RAHMAN, Shamim, Akbar (CA)
- (74) Tamara Kochlamazashvili
- (85) 2008 05 29
(86) PCT/US2004/022711, 2004 07 15
- (54) **METHOD AND SYSTEM FOR SAVING
MOBILE STATION PHYSICAL
MEASUREMENTS AND MAC
PERFORM STATISTIC AT ACCESS
POINT CONTROL INFORMATIONAL
BASE**
-

UTILITY MODELS

APPLICATION APPROVED FOR GRANTING PATENT

The decision can be appealed at the Chamber of Appeal of Sakpatenti within 3 months from the publication or at the Administrative Chamber of the Tbilisi City Court (Address: №6, David Aghmashenebeli Kheivani 12 km., Tbilisi) within 1 month following the publication.

PART A

A 01

(10) AU 2012 12420 U (51) Int. Cl. (2006)

A 01 G 13/02

(21) AU 2011 012420 (22) 2011 10 20

(71) Zaur Kacharava (GE)
Gldanis Mas., VIII mkr., korp. 12, b. 141,
0107, Tbilisi (GE)

(72) Zaur Kacharava (GE)

(54) DEVICE FOR AGRICULTURAL PLANT PROTECTION FROM HAIL, LOCATED ON TRELLIS WIRES

(57) A device comprises: hail netting 3 hanged on the wires 2 strained on extreme trellis piles 1, netting opening and folding mechanism 4, and a drive 16. The mechanism is performed as barrels with ears and two-arm levers unique and rigidly fastened onto separate piles tops. The barrel ears have holes 7 tied to drive for passing ropes 11 folding netting. The wires 5 with rings 6 are fastened on two-arm lever ends for passing ropes 10 folding netting. The wires 8 with rings 9 are passed through netting cells for passing ropes tied with drive and opening and folding netting. The wires 8 passed through netting cells are located symmetrically to netting longitudinal axis and adjacent to each other when netting is folded.

Claims: 1 independent

Fig.: 3

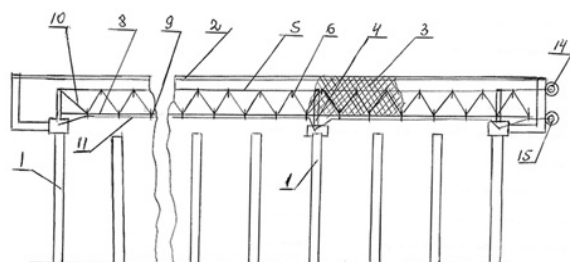

Fig. 2

PART C

C 04

(10) AU 2012 12541 U (51) Int. Cl. (2006)

C 04 B 33/00

(21) AU 2012 012541 (22) 2012 01 20

(71) Anzor Sakandelidze (GE)
Zakariadzis q. 11, b. 4, 0186, Tbilisi (GE);
Alexandre Sakandelidze (GE)
Zakariadzis q. 11, b. 4, 0186, Tbilisi (GE);
Tamaz Vashakidze (GE)
Chubinashvilis q. 21, 0112, Tbilisi (GE);
Malkhaz Tsiskarishvili (GE)
Nutsubidzis q. 17, b. 30, 0186, Tbilisi (GE)

(72) Anzor Sakandelidze (GE);
Alexandre Sakandelidze (GE);
Tamaz Vashakidze (GE);
Malkhaz Tsiskarishvili (GE)

(54) RAW MIX FOR POROUS BUILDING MATERIALS

(57) A mix contains: clay-slate, fired perlite, quartzitic sand, lime, soda, and calcium sulphate with following ratio of components (mass%):

Clay-slate	85-97
Fired perlite	0-10
Quartzitic sand	0-3
Lime	0-3
Soda	0-3
Calcium sulphate	0-3

Claims: 1 independent

(10) AU 2012 12187 U (51) Int. Cl. (2006)

C 04 B 33/04

(21) AU 2011 012187 (22) 2011 04 15

(71) Manana Andghuladze (GE)
Grishashvilis q. 46, 3500, Ozurgeti (GE);
Hamlet Gogeshvili (GE)
Parnavaz Mepis q. 1, b. 28, 3500,
Ozurgeti (GE);
Violeta Nikolaishvili (GE)
Al. Kazbegis q. 11, b. 15, 0160, Tbilisi (GE)

(72) Manana Andghuladze (GE);
Hamlet Gogeshvili (GE);
Violeta Nikolaishvili (GE)

(54) **METHOD OF BENTONITIC CLAY
ACTIVATION**

(57) There is represented bentonitic clay activation method providing clay breakage, drying, milling and processing with acid within 10-20 minutes; at that, the clay is preliminarily processed with sodium carbonate with amount of 0.1-4% clay weight, and 30-32% hydrochloric acid is applied as acid with amount of 0.4-0.7% clay dry powder weight.

Claims: 1 independent

PATENTED UTILITY MODEL

PART A

A 23

- (11) U 2012 1740 Y (51) Int. Cl. (2006)
A 23 C 9/00
A 23 C 23/00
- (10) AU 2012 12425 U (44) 12(352)/2012
(21) AU 2011 012425
(22) 2011 10 24
(24) 2011 10 24
- (73) Zurab Tskitishvili (GE)
Tsageris q. 4, b. 3, 0160, Tbilisi (GE);
Tamara Piranishvili (GE)
Gorkis q. 32, 4800, Kvareli (GE);
Givi Basiladze (GE)
I.Chavchavadzis gamz. 33, b. 35, 0162,
Tbilisi (GE)
- (72) Zurab Tskitishvili (GE);
Tamara Piranishvili (GE);
Givi Basiladze (GE)
- (54) **METHOD OF DRY FULL CREAM MILK
PRODUCTION**
-

DESIGNS

APPLICATIONS APPROVED FOR REGISTRATION

The decision can be appealed at the Chamber of Appeal of Sakpatenti within 3 months from the publication or at the Administrative Chamber of the Tbilisi City Court (Address: №6, David Aghmashenebeli Kheivani 12 km., Tbilisi) within 1 month following the publication.

- (10) AD 2012 707 S (51) 02-01
(21) AD 2012 000707
(22) 2012 06 06
(28) 2
(71) Giorgi Chukhrukidze (GE)
 Digmis Mas., III kvart., korp. 6v, b. 57, Tbilisi (GE)
(72) Giorgi Chukhrukidze (GE)
(54) LINGERIE WITH ROAD SIGN APPLICATIONS
(55)



- (10) AD 2012 711 S (51) 21-01
- (21) AD 2012 000711
- (22) 2012 07 10
- (28) 1
- (71) Teimuraz Giorgadze (GE)
Rustavelis IX Shes. 4a, 4600, Kutaisi (GE)
- (72) Teimuraz Giorgadze (GE)
- (74) Archil Geguchadze
- (54) TABLE GAME "SPECTRUM" BOARD
- (55)

The board is a 12x12 grid of numbered cells (1-121). The cells are colored in a pattern: red, green, yellow, blue, orange, and black. The grid is divided into sections labeled 'FX1.8', 'FX2', and 'FX4'. Below the grid are several rows of colored circles and text labels: 'FX10', 'FX4', 'FX2', 'FX5', 'FX8', 'FX20'. The board is divided into sections labeled 'FX1.8', 'FX2', and 'FX4'.

1

REGISTERED DESIGN

(11) D 2012 510 S

(10) AD 2012 688 S

(21) AD 2012 000688

(22) 2012 02 27

(24) 2012 02 27

(28) 10

(18) 2017 02 27

(73) Joint Stock Company "EXPERIMENTAL CONFECTIONERY ASSOCIATION "VOLOGDA" (RU)
Vologodskaya oblast, g. Vologda, ul. Promishlennaya 12, 160012 (RU)

(72) Ilja Igorevich Silkin (RU)

(74) David Zurabishvili

(54) **CAKE PACKAGE**

DESIGN REGISTERED ACCORDING TO THE ACCELERATED PROCEDURE

The decision can be appealed at the Chamber of Appeal of Sakpatenti within 3 months from the publication.

- (11) **D 2012 511 S** (51) **09-01**
(21) AD 2012 000713 (22) 2012 07 26
(24) 2012 07 26
(28) 1
(18) 2017 07 26
(73) JOINT-STOCK COMPANY "LOMISI" (GE)
Sop. Natakhtari, 3308, Mtskheta (GE)
(72) Kochaki Mehmet Tanju (TR)
(54) **BOTTLE**
(55)



1.1



1.2



1.3



1.4



1.5



1.6

**DESIGNS, WHICH HAVE BEEN REGISTERED WITH THE INTERNATIONAL
BUREAU CLAIMING PRIORITY ON THE TERRITORY OF GEORGIA**

(IN ACCORDANCE WITH THE HAGUE ACT OF 1960 AND/OR GENEVA ACT OF THE HAGUE
AGREEMENT OF 1999)

The decision can be appealed at the Chamber of Appeal of Sakpatenti within 3 months from the publication or at the Administrative Chamber of the Tbilisi City Court (Address: №6, David Aghmashenebeli Kheivani 12 km., Tbilisi) within 1 month following the publication.

(11) DM/078609

(15) 2011 06 08

(22) 2011 06 08

(28) 1

(73) NORBERT GNÄDINGER

Postfach 132, CH-9473 Gams (CH)

(85) LI

(86) CH

(87) CH

(88) CH

(89) CH

(81) II. BZ, KP, MA, MC, ME, SR. III. AL, AM, AZ, BA, EE, EG, EM, GE, GH, IS, KG, LI, LV, MD,
MK, MN, NA, OA, OM, RS, SG, SI, ST, TR, UA

(72) Norbert Gnädinger

Postfach 132, CH-9473 Gams

(54) 1. Toilet-seat

(55)

(51) 23-02

(45) 2012/27 (2012 07 13)



1

(11) DM/078615

(51) 09-01, 03, 05

(15) 2011 11 21

(45) 2012/27 (2012 07 13)

(22) 2011 11 21

(28) 26

(73) SOREMARTEC S.A.

Rue Joseph Netzer 5, B-6700 ARLON (BE)

(86) BX, EM

(87) BX, EM

(88) BX, EM

(89) EM

(81) II. MA, ME. III. AL, CH, EM, GE, HR, MK, OA, RS, TR, UA

(54) 1.-3. Shaped wrappings [packaging]; 4.-5. Containers [packaging]; 6.-9. Shaped wrappings [packaging]; 10. Bottle packaging; 11. Bottle holder [packaging]; 12. Shaped wrapping [packaging]; 13.-15. Bags [packaging]; 16. Container [packaging]; 17. Jar [packaging]; 18. Container [packaging]; 19.-21. Shaped wrappings [packaging]; 22.-25. Containers [packaging]; 26. Packaging

(55)



1.1



1.2



1.3



1.4

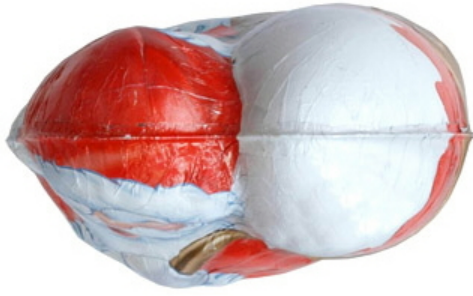

1.5



1.6



1.7



2.1



2.2



2.3



2.4

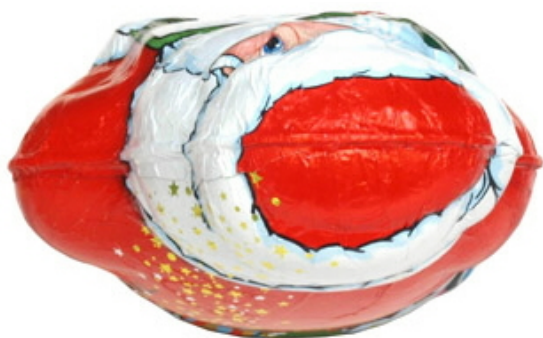

2.5



2.6



2.7



3.1



3.2



3.3



3.4



3.5



3.6



3.7

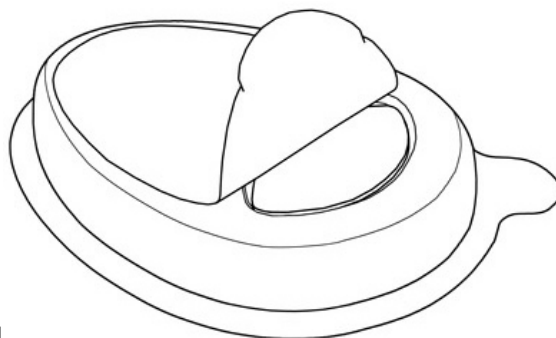
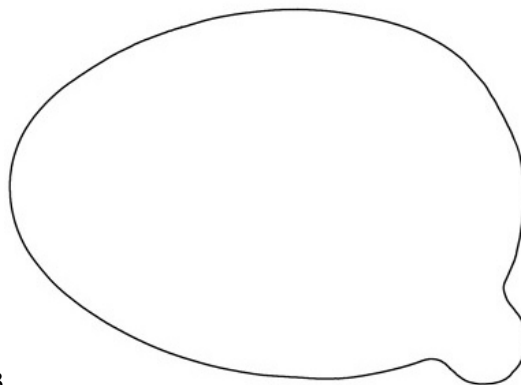
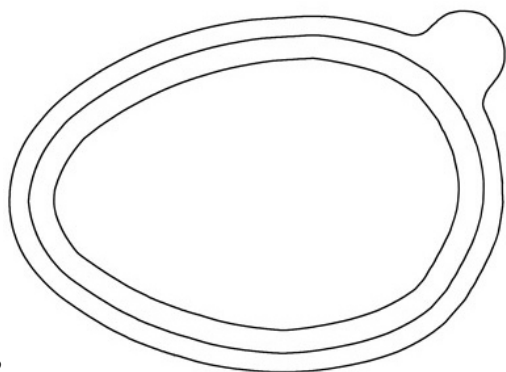
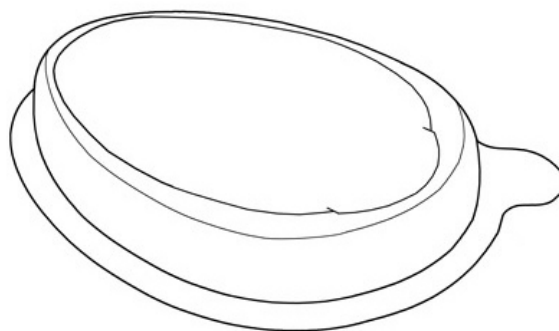
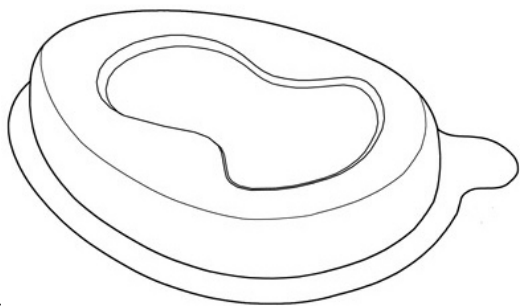







8.5



8.6



8.7



9.1



9.2



9.3



9.4



9.5



9.6



9.7

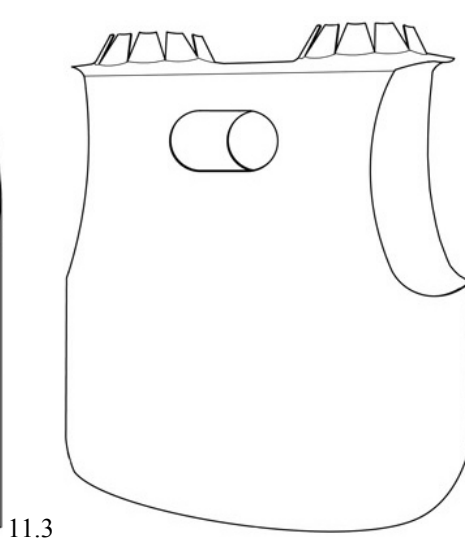
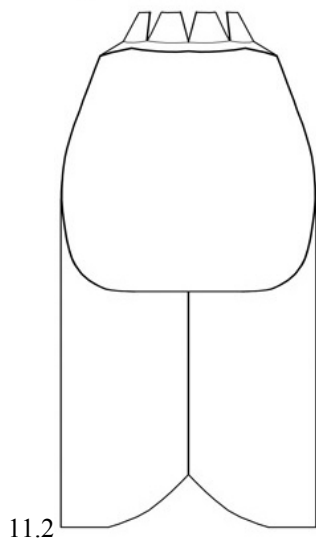
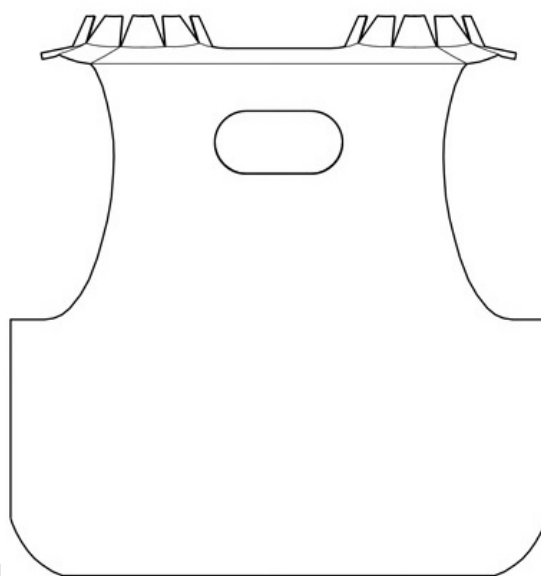
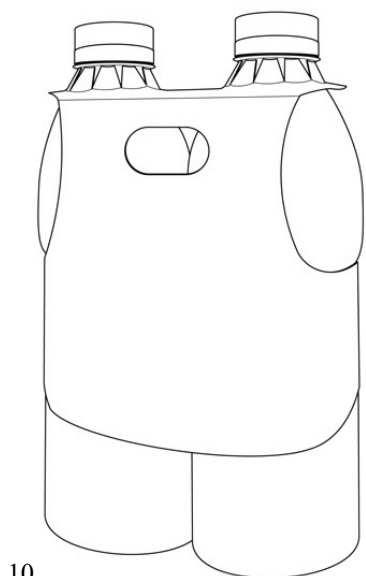



12.3



12.4



12.5



12.6



12.7

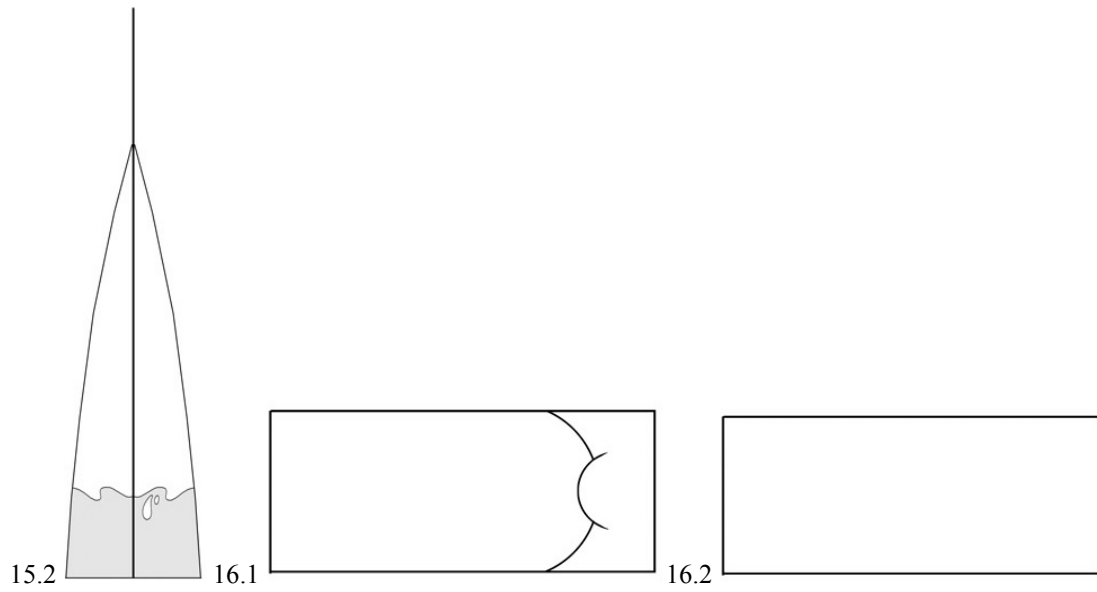
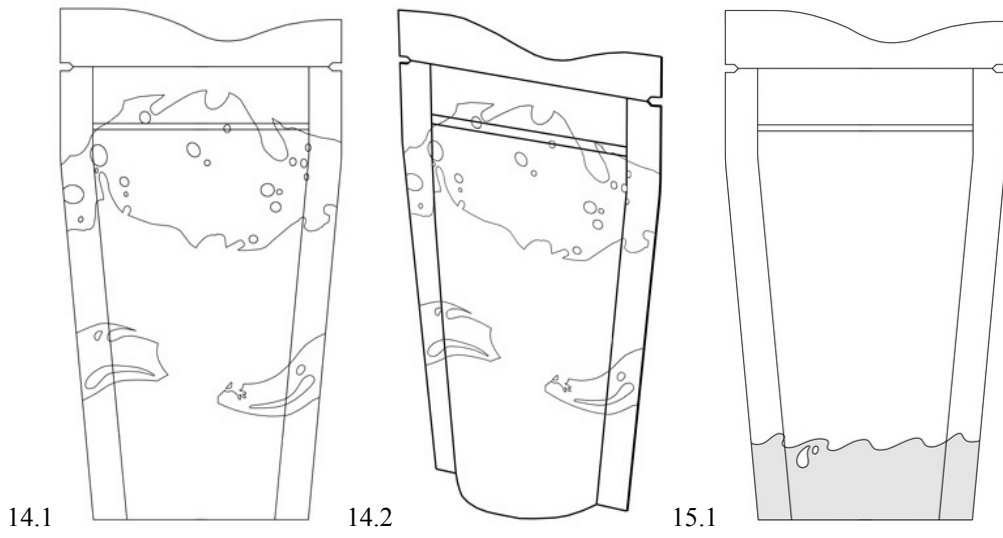
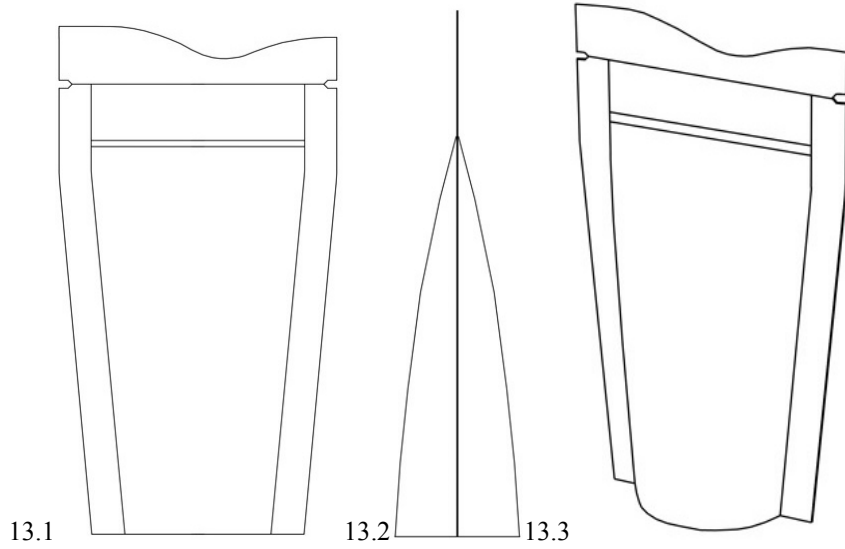

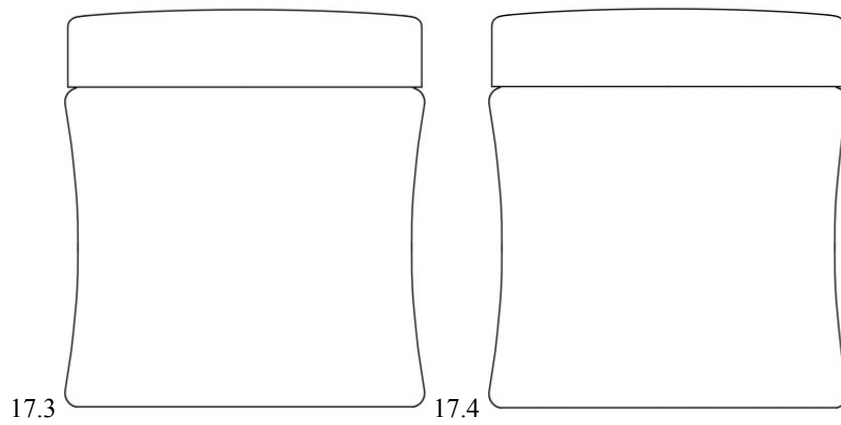
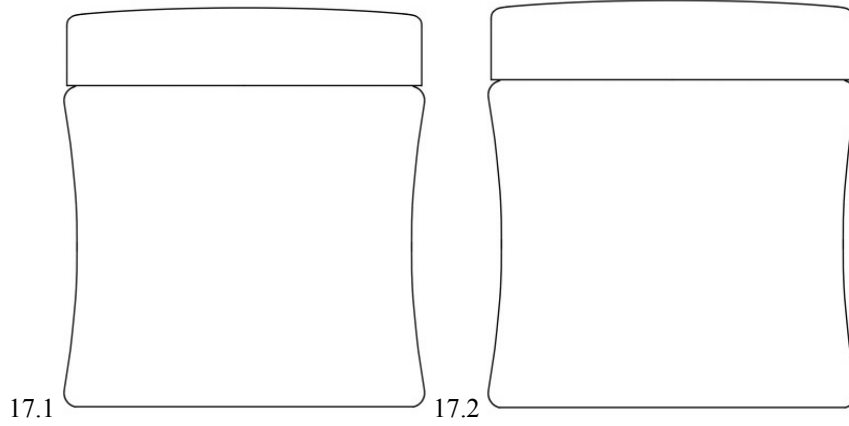
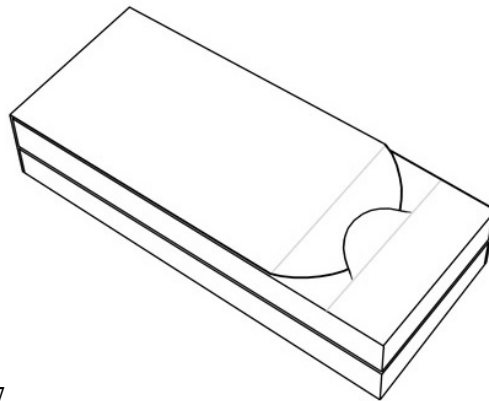
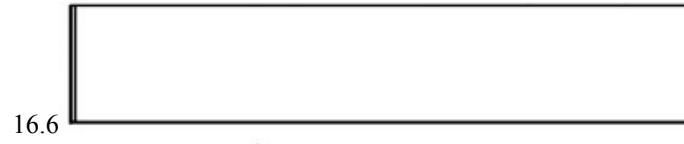
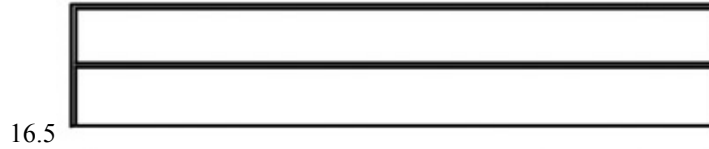
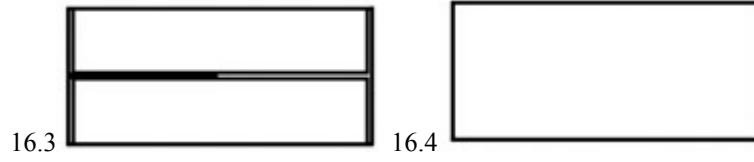

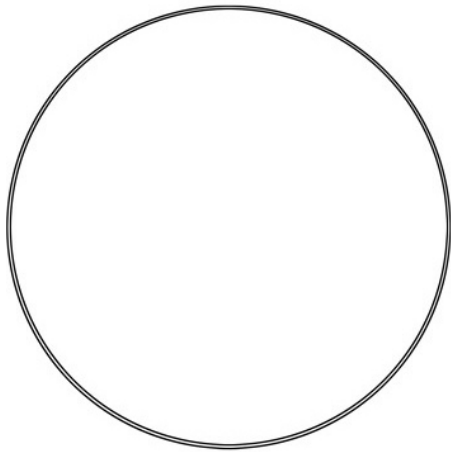

17.5

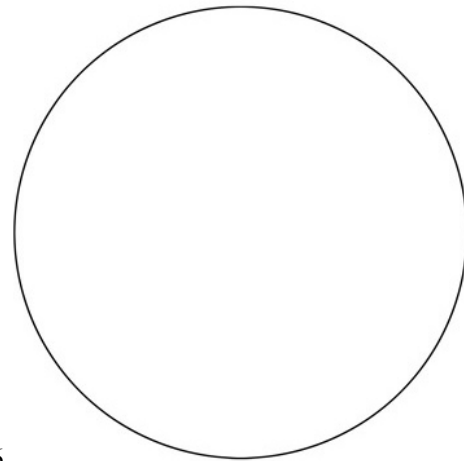

17.6

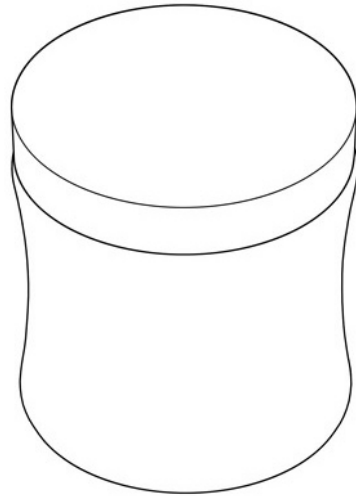

17.7

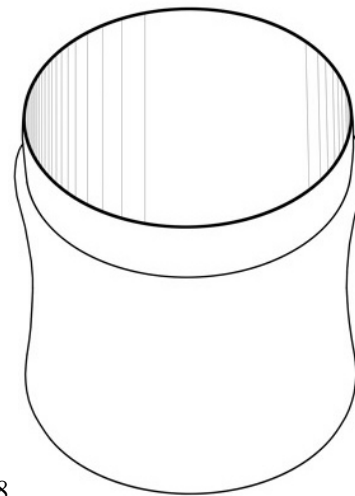

17.8

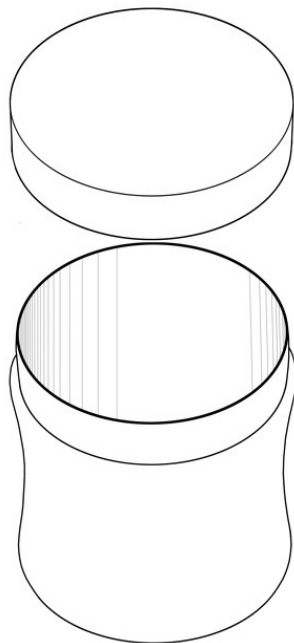

17.9

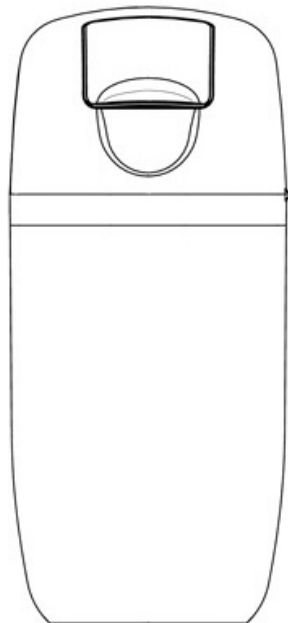

18.1

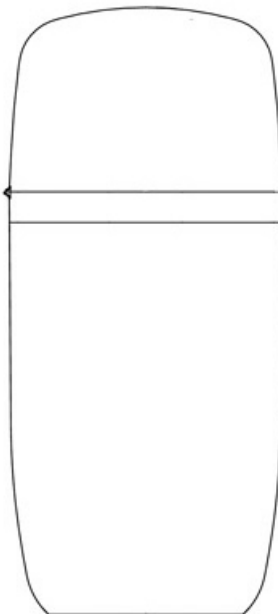

18.2

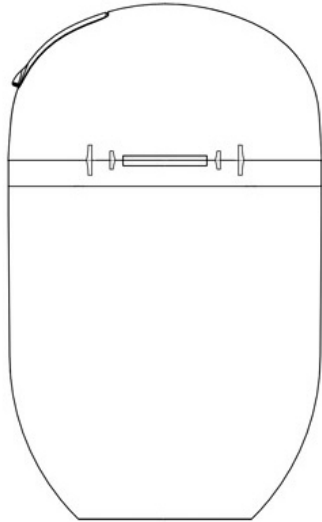

18.3



18.4

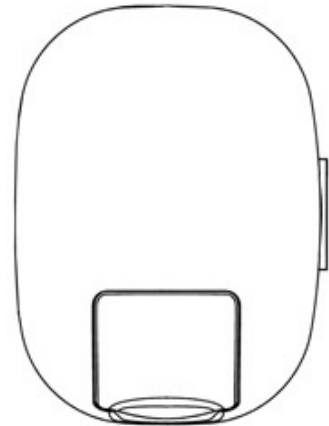

18.5

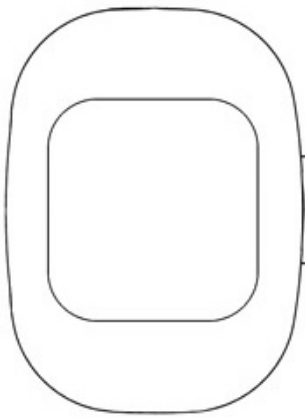

18.6

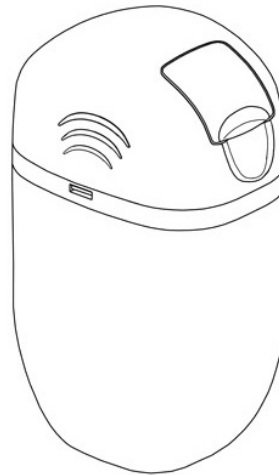

18.7



19



20



21

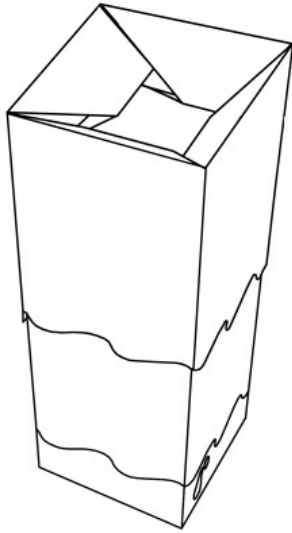

22.1

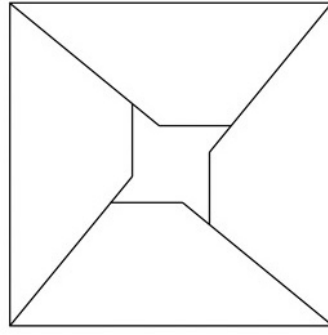

22.2

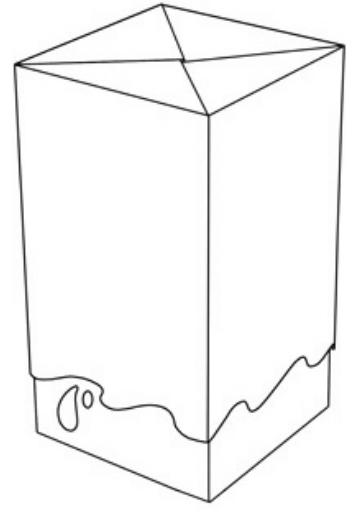

23



24.1

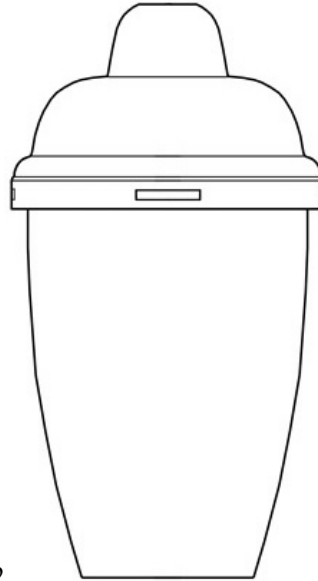

24.2

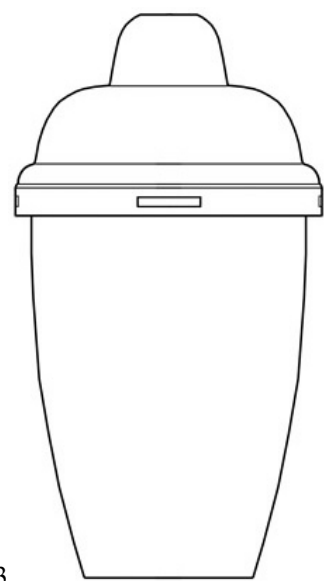

24.3

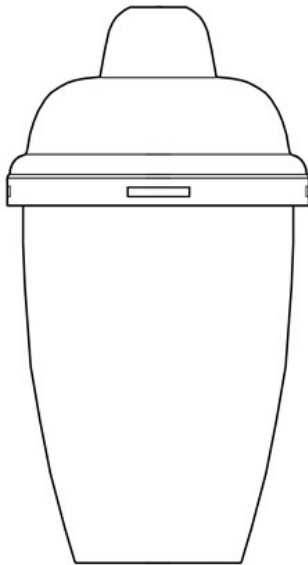

24.4

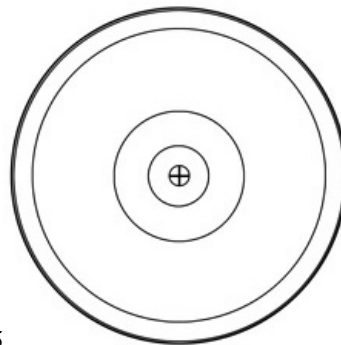

24.5

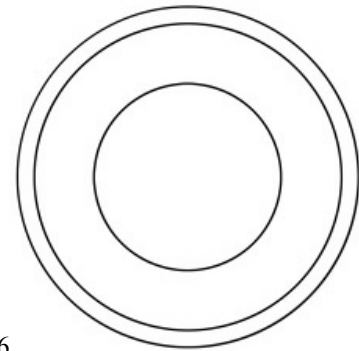

24.6



24.7

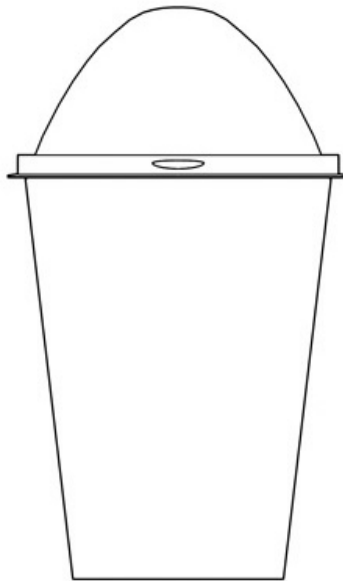

25.1

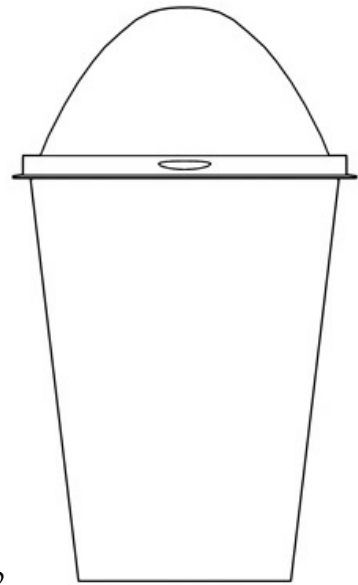

25.2



25.3

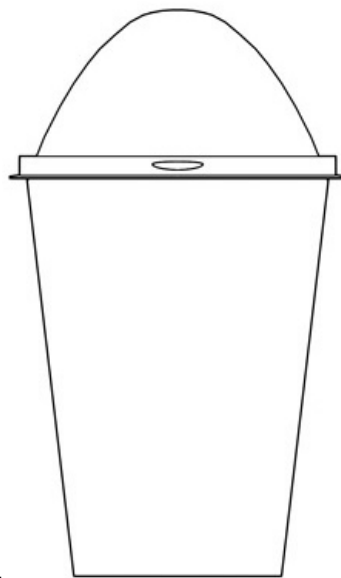

25.4

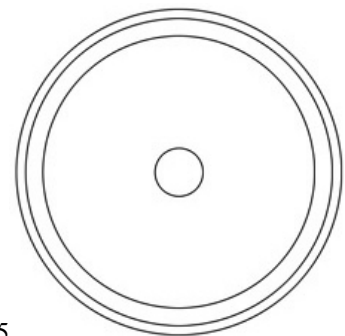

25.5

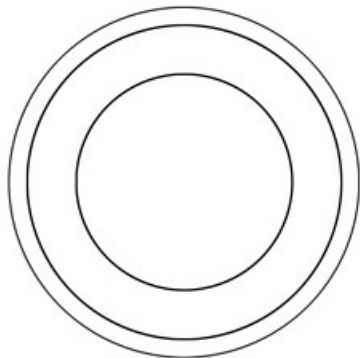

25.6



25.7

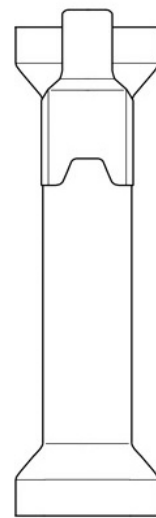

26.1

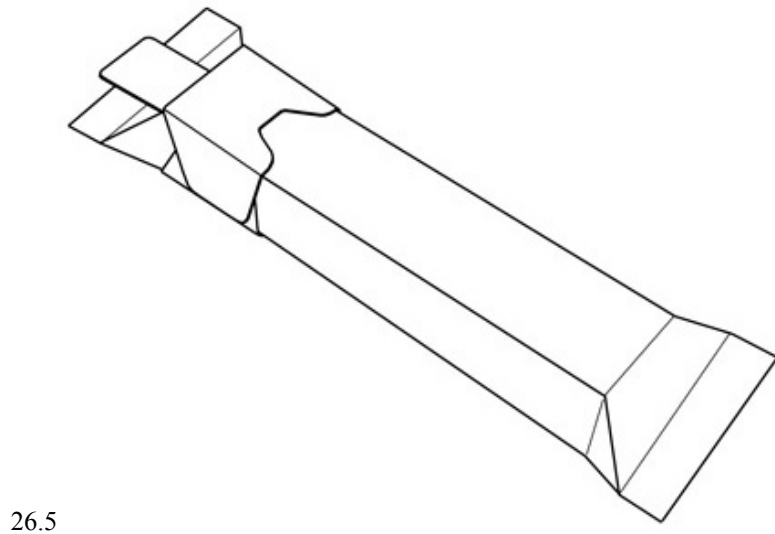
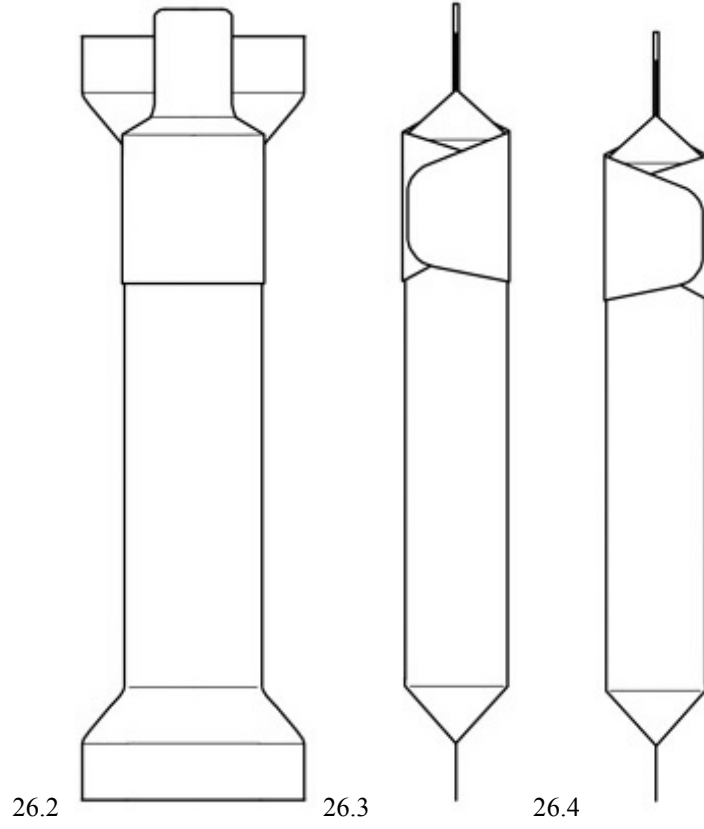

(11) DM/078627

(51) 10-02

(15) 2012 06 18

(45) 2012/27 (2012 07 13)

(22) 2012 06 18

(28) 3

(73) SWATCH AG (SWATCH SA) (SWATCH LTD)

Jakob-Stämpfli-Strasse 94, CH-2502 BIEL/BIENNE (CH)

(85) CH

(86) CH

(87) CH

(88) CH

(89) CH

(81) II. BZ, MA. III. AL, AM, AZ, BA, CH, EM, GE, HR, KG, LI, MC, MD, ME, MK, MN, NO, OM, SG, TN, TR, UA

(72) Mod. 1, 2 et 3: Cyril AUVILLE, 71, chemin des Grandes Vignes, F- 27120 MENILLES

(54) 1.-3. Wristwatches

(55)



(11) DM/077535

(51) 10-07

(15) 2012 01 20

(45) 2012/28 (2012 07 20)

(22) 2012 01 20

(28) 1

(73) GLASHÜTTER UHRENBETRIEB GMBH

Altenberger Str. 1, 01768 Glashütte (DE)

(85) DE, EM

(86) DE, EM

(87) DE, EM

(88) DE, EM

(89) EM

(81) II. BZ, MA, ME. III. AL, AM, AZ, BA, CH, EM, GE, HR, KG, LI, MC, MD, MK, MN, NO, OM, SG, TR, UA

(72) Katharina Stegmann, Am Mühlfeld 84, 01744 Paulsdorf

(54) 1. Dial

(55)



1

(11) DM/077788

(51) 11-01

(15) 2012 01 18

(45) 2012/28 (2012 07 20)

(22) 2012 01 18

(28) 7

(73) THE SWATCH GROUP MANAGEMENT SERVICES AG (THE SWATCH GROUP MANAGEMENT SERVICES SA) (THE SWATCH GROUP MANAGEMENT SERVICES LTD.)
Seevorstadt 6, CH-2501 Biel/Bienne (CH)

(85) CH

(86) CH

(87) CH

(88) CH

(89) CH

(81) II. BZ, MA, ME. III. AL, AM, AZ, BA, CH, EM, GE, HR, KG, LI, MC, MD, MK, MN, NO, OM, SG, TR, UA

(72) № 1, 2, 3, 4, 5, 6: Mélanie RAETZ, Grand Pin 19, CH-2000 Neuchâtel; №7: Christelle IFF, Route de St-Aubin 31, CH-1565 Missy

(54) 1. Necklace; 2. Bracelet; 3. Necklace; 4. Bracelet set; 5. Earrings; 6. Necklace; 7. Pendant

(55)

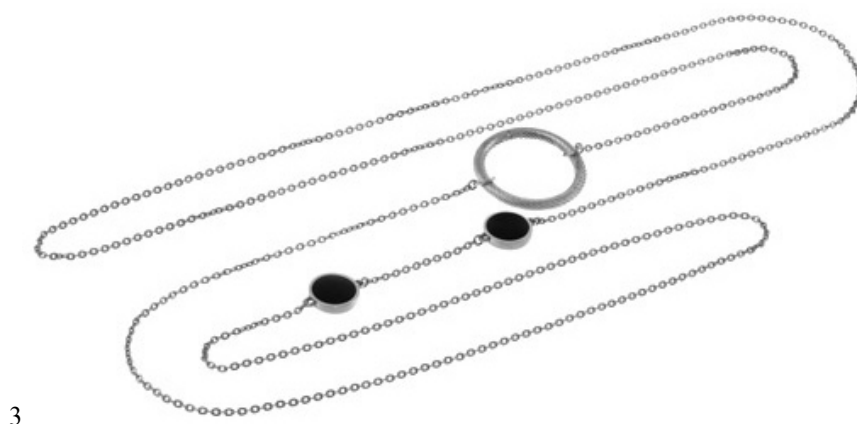

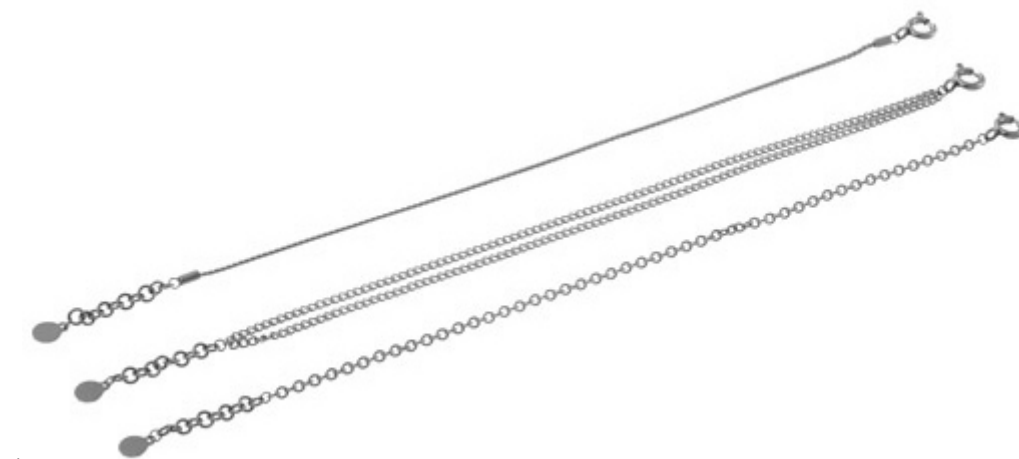

4



5

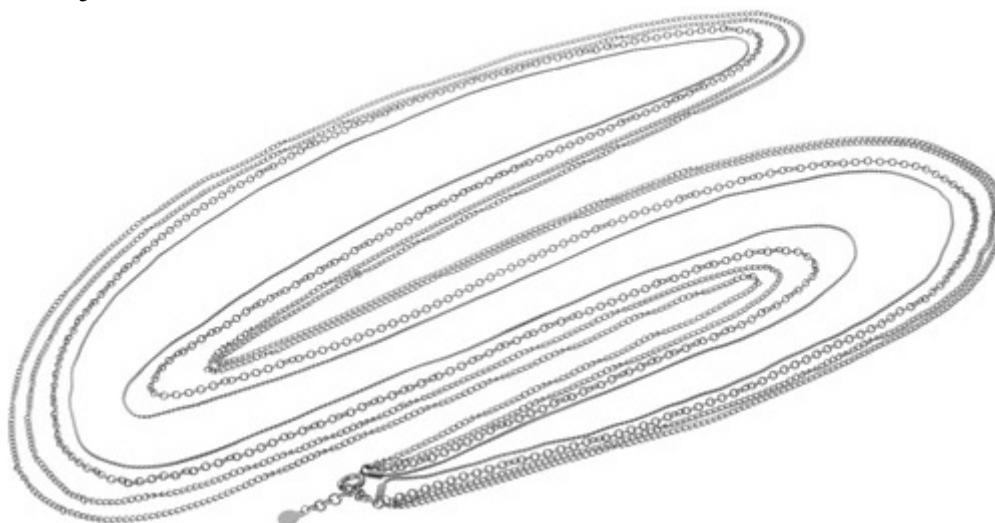

6



7

(11) DM/078640**(51) 10-02**

(15) 2012 06 27

(45) 2012/28 (2012 07 20)

(22) 2012 06 27

(28) 5

(73) SWATCH AG (SWATCH SA)(SWATCH LTD.)

Jakob-Stämpfli-Strasse 94, CH-2502 Biel/Bienne (CH)

(85) CH

(86) CH

(87) CH

(88) CH

(89) CH

(81) IL, BZ, MA, III, AL, AM, AZ, BA, CH, EM, GE, HR, KG, LI, MC, MD, ME, MK, MN, NO, OM, SG, TJ, TN, TR, UA

(72) Mod. №1: Ylenia AGATE, Swatchlab, Via Archimede 6, IT-20129 Milano; Mod. №2: Rossana BOFFI, Swatchlab, Via Archimede 6, IT-20129 Milano; Mod. №3: Claudia Carieri, Swatchlab, Via Archimede 6, IT-20129 Milano; Mod. №4: Ylenia AGATE, Swatchlab, Via Archimede 6, IT-20129 Milano; Mod. №5: Rossana BOFFI, Swatchlab, Via Archimede 6, IT-20129 Milano

(54) 1.-5. Wristwatches

(55)



(11) DM/078658

(15) 2012 05 13

(22) 2012 05 13

(28) 2

(73) ORNA FILO

20104 Zurit (IL)

(86) DE, EM

(87) n/a

(88) n/a

(89) EM

(81) III. AL, AM, AZ, BA, CH, EM, GE, HR, IS, ME, MK, NO, RS, SG, TR, UA

(72) Orna Filo

Zurit 20104, IL

(54) 1.-2. Anti-wrinkle appliance

(55)

(51) 28-03

(45) 2012/28 (2012 07 20)



1.1



1.2



1.3



1.4



1.5



1.6

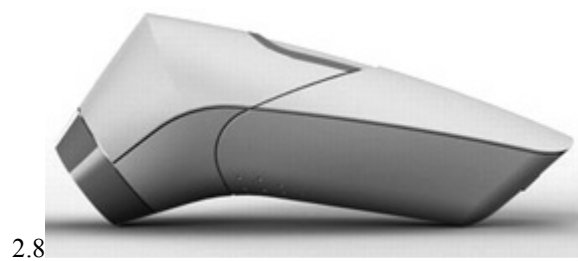
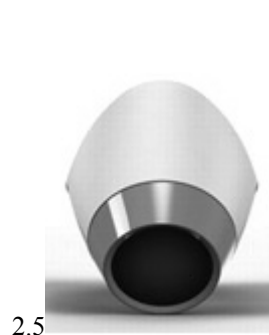
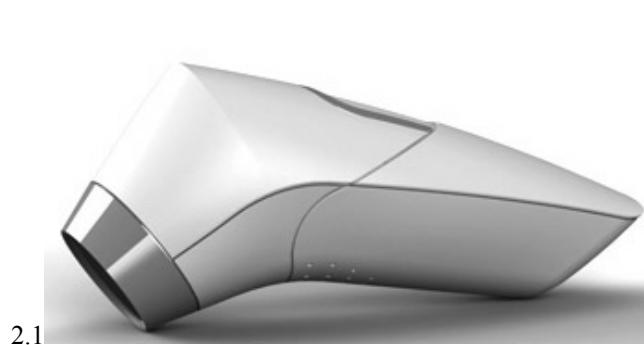

(11) DM/077876**(51) 14-01, 03**

(15) 2012 01 25

(45) 2012/29 (2012 07 27)

(22) 2012 01 25

(28) 27

(30) for designs No(s) 2: 26.07.2011; 29/398,116; US; for designs No(s) 1: 26.07.2011; 29/398,117; US; for designs No(s) 4: 27.07.2011; 29/398,192; US; for designs No(s) 5: 27.07.2011; 29/398,193; US; for designs No(s) 7: 10.08.2011; 29/399,176; US; for designs No(s) 8, 9: 10.08.2011; 29/399,215; US; for designs No(s) 6: 10.08.2011; 29/399,217; US; for designs No(s) 10: 24.08.2011; 29/400,222; US; for designs No(s) 11, 12: 19.09.2011; 29/402,001; US; for designs No(s) 13: 29.09.2011; 29/402,949; US; for designs No(s) 14: 29.09.2011; 29/402,954; US; for designs No(s) 15, 16, 17: 06.10.2011; 29/403,483; US; for designs No(s) 18, 19: 11.10.2011; 29/403,809; US; for designs No(s) 3: 14.10.2011; 29/404,077; US; for designs No(s) 22: 19.10.2011; 29/404,350; US; for designs No(s) 21: 19.10.2011; 29/404,352; US; for designs No(s) 20: 19.10.2011; 29/404,354; US; for designs No(s) 23: 19.10.2011; 29/404,358; US; for designs No(s) 24: 25.10.2011; 29/404,760; US; for designs No(s) 26: 23.11.2011; 29/407,205; US; for designs No(s) 25: 23.11.2011; 29/407,211; US; for designs No(s) 27: 08.12.2011; 29/408,218; US

(73) NOKIA CORPORATION

Keilalahdentie 4, FI-02150 Espoo (FI)

(85) EM

(86) EM

(87) EM

(88) EM

(89) EM

(81) III. AL, AM, BW, CH, EG, EM, GE, HR, IS, LI, MK, NA, SG, TR, UA

(72) № 1, 2, 3: Franziska Faoro, 34 Sandringham Road, London, NW2 5ER, U.K.; № 4, 5: Qiaokun Huang, 4-1-1601 Haifu Garden, Jiangyan Road, Haizhu District, Guangzhou, Guangdong Province, China; № 6, 7, 8, 9: Raun Forsyth, 6 Meadow Cottages, Beaconsfield, Bucks, HP9 1LT, U.K.; №10: Jukka Rautiainen, Laivanvarustajankatu 9 D44, FI-00140 Helsinki; №11, 12: Edward D. Mitchell, 3257 Rickey Court, Thousand Oaks, CA 91362, USA; Jan Stillerman, 3118 Big Sky Drive, Thousand Oaks, CA 91360, USA; Christine Oh, 4225 Via Arbolada №505, Los Angeles, CA 90042, USA; №13, 14: Yaoshao Chen, №10, Jingcheng 11th St., Taichung 403, Taiwan R.O.C.; №14, 15, 16, 17: Xiaoxi Shi, 6301 De Soto Avenue, Woodland Hills, CA 91367, USA; Iain Pottier, Springbank, High Street, Little Sandhurst, Berkshire GU47 8LR, U.K.; Jim Holtorf, 5059 Via Fresco, Camarillo, CA 93012, USA; James Barber, 19B Pemberton Road, Harringay, London N4 1AX, U.K.; №18, 19: Aki Laine, 117 Pacific St. №105, Santa Monica, CA 90405, USA; №20, 21, 22, 23: Jouko Tattari, Jaanankuja 8 B, FI-00760 Helsinki, №24: Jose M. Perez, Kellosaarenkatu 7 D 50, FI-00180 Helsinki; №25, 26: Jing Wang, Room 917 Building 22 Shanghai Salon, №4 West Tianbao Rd, Economic & Technological Development Area, Beijing 100176, China; №27: Giuseppe Russo, 15 Thorney Crescent, London SW11 3TT, U.K.

(54) 1.-9. Handsets; 10. Headset; 11.-23. Handsets; 24. Headset; 25.-27. Handsets

(55)

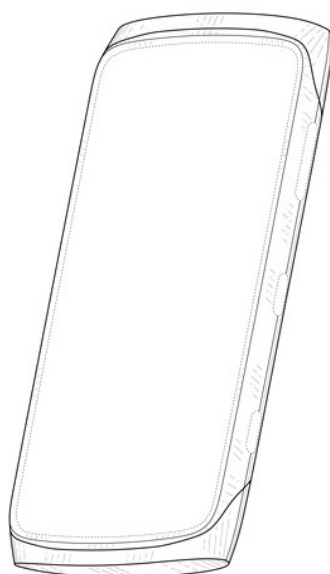

1.1

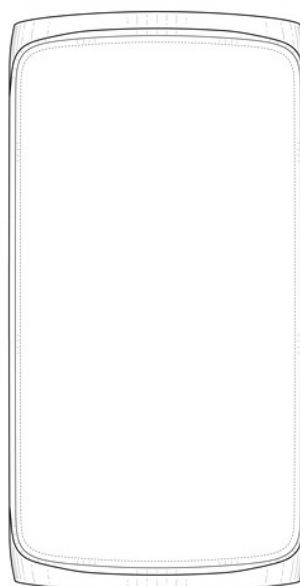

1.2



1.3

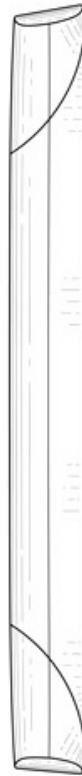

1.4



1.5



1.6



1.7

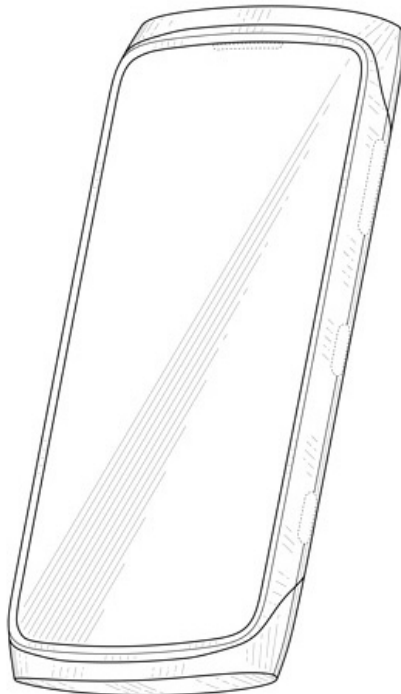

2.1

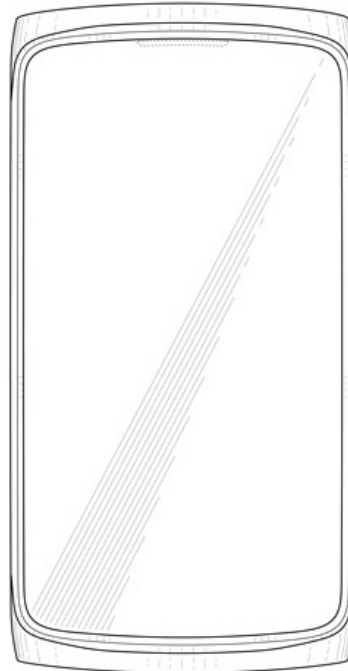

2.2



2.3



2.4



2.5



2.6



2.7

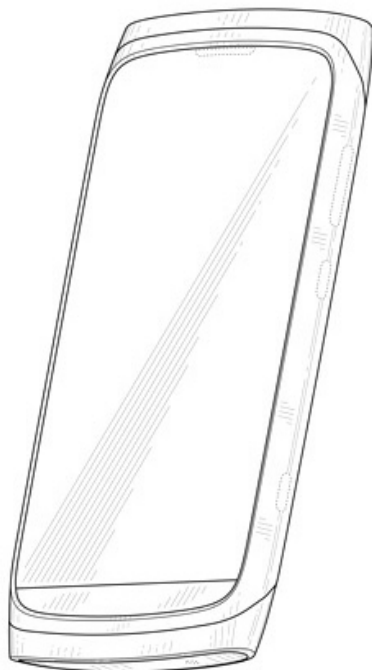

3.1

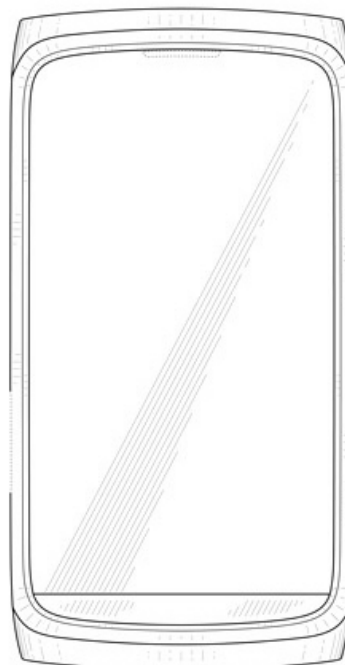

3.2

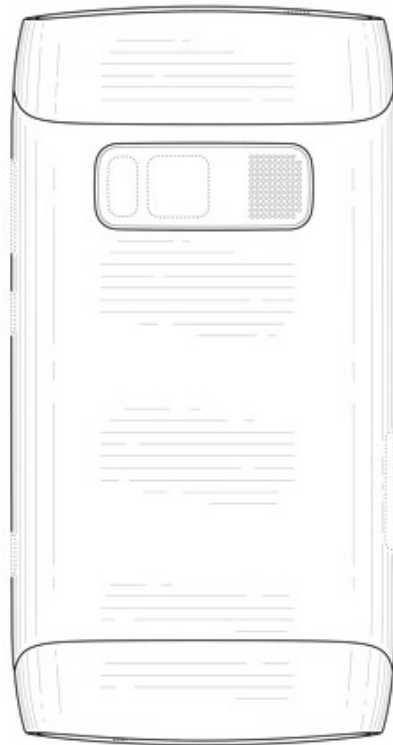

3.3



3.4



3.5



3.6



3.7

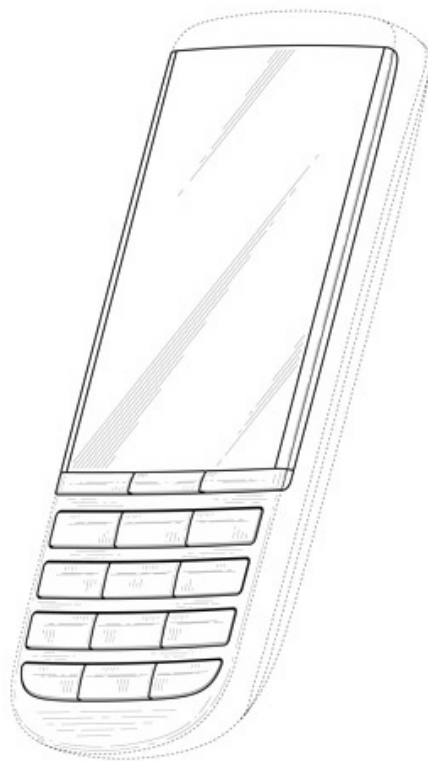

4.1

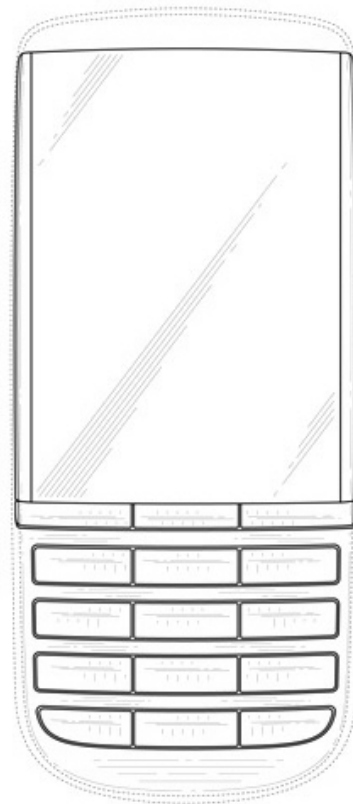

4.2

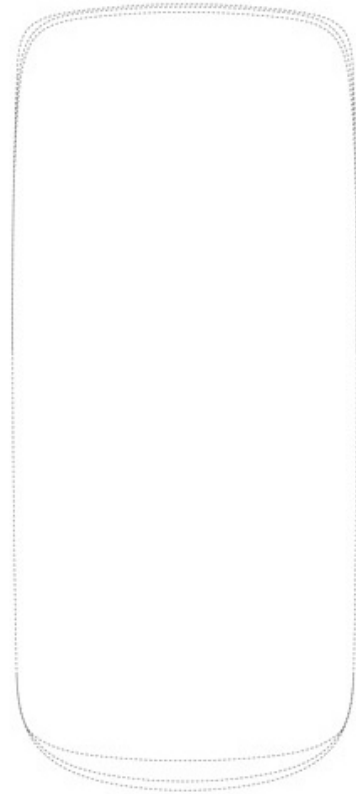

4.3

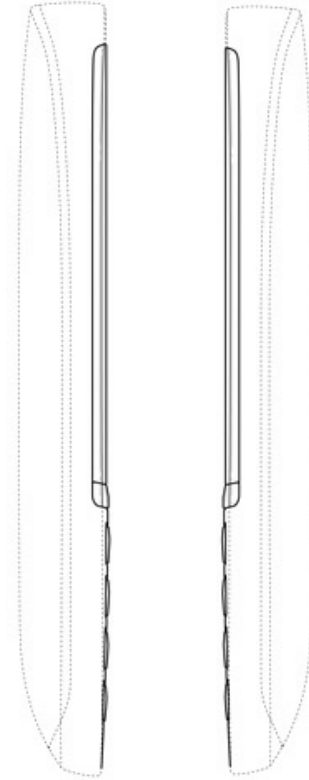

4.4

4.5



4.6



4.7

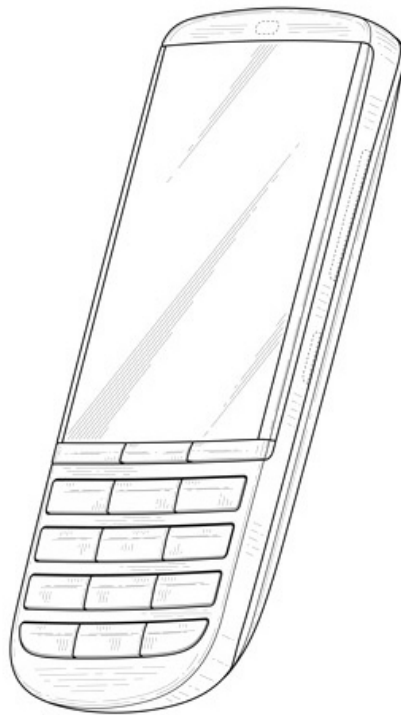

5.1

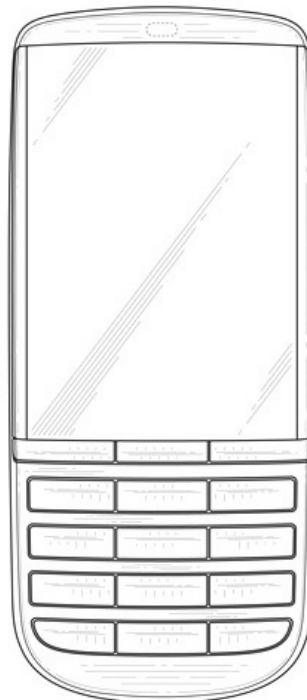

5.2



5.3

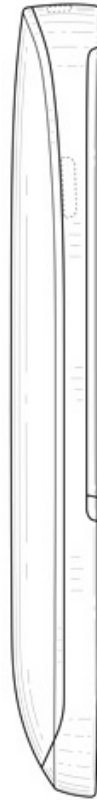

5.4

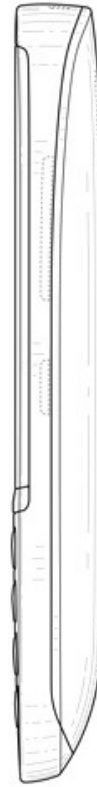

5.5

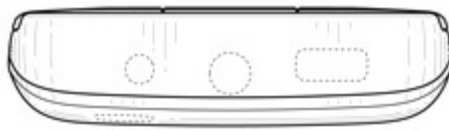

5.6

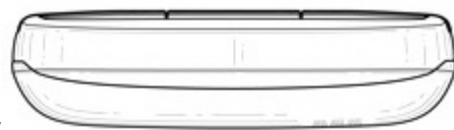

5.7

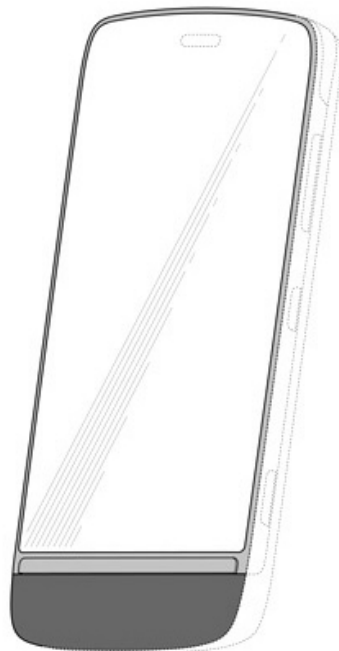

6.1

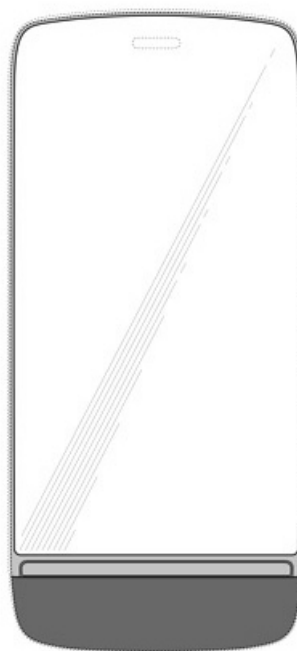

6.2

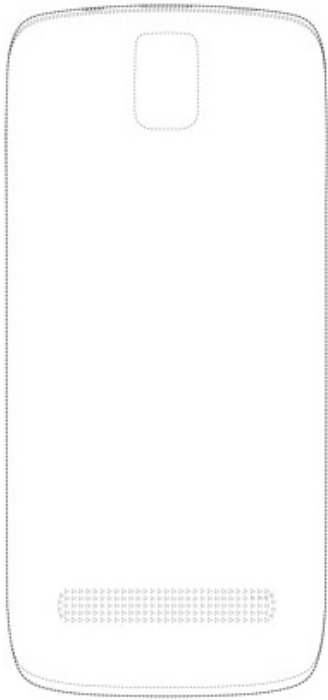

6.3



6.4



6.5



6.6



6.7

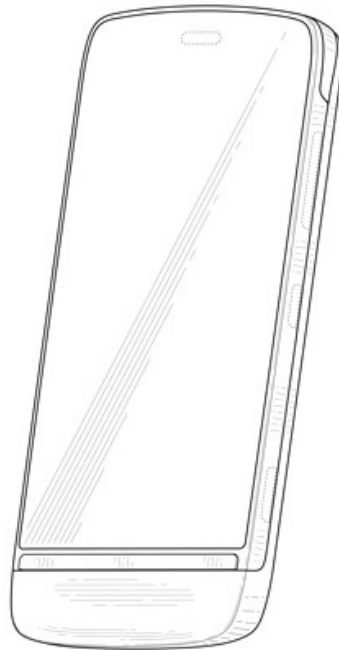

7.1

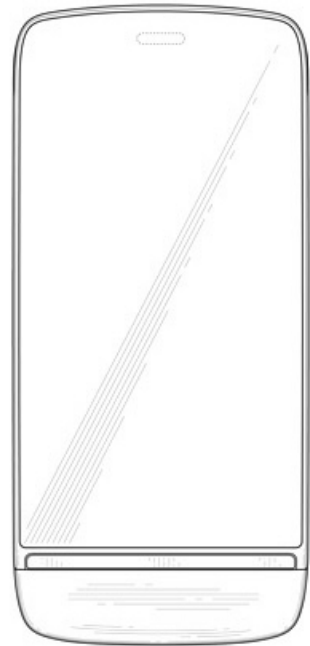

7.2

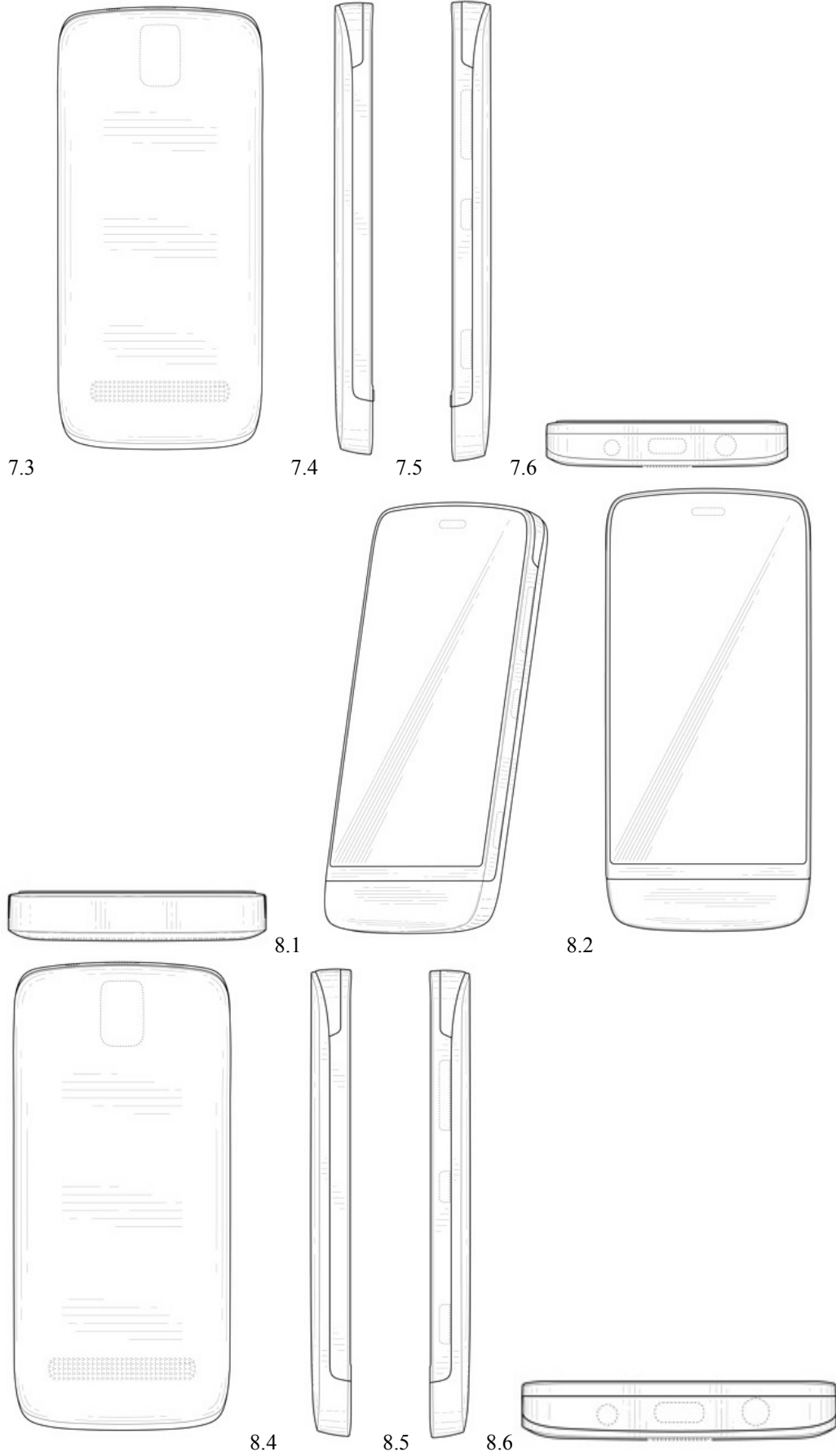

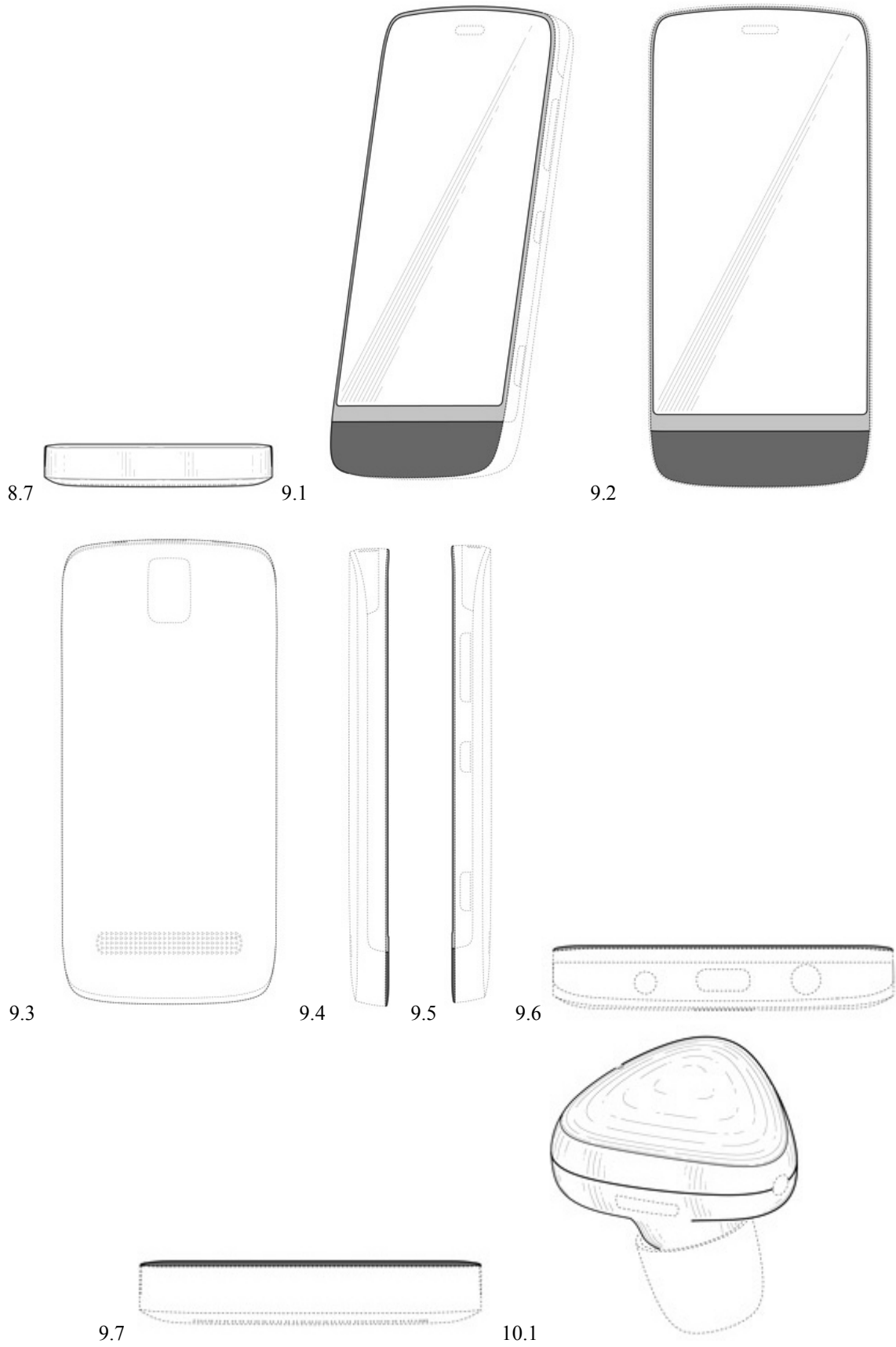

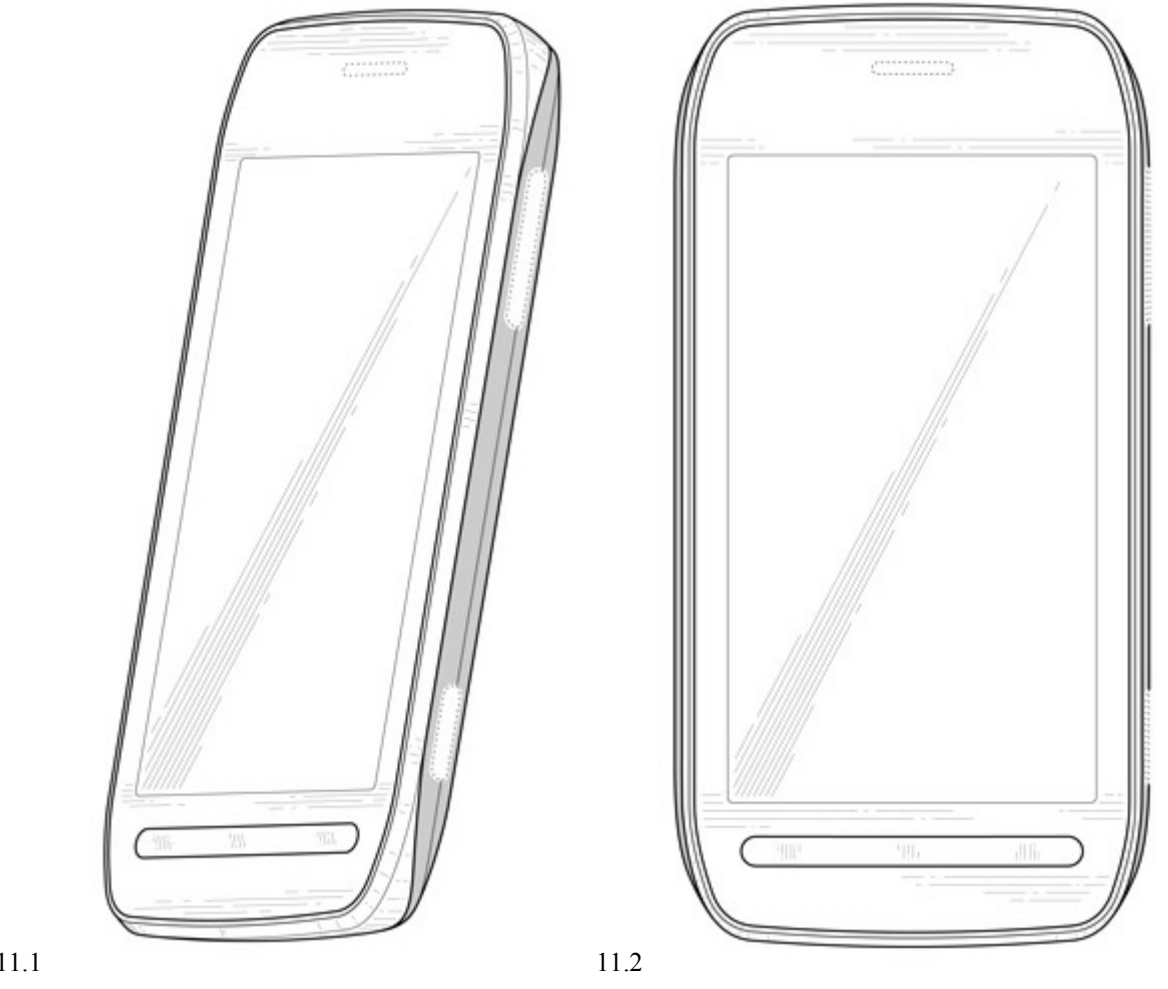
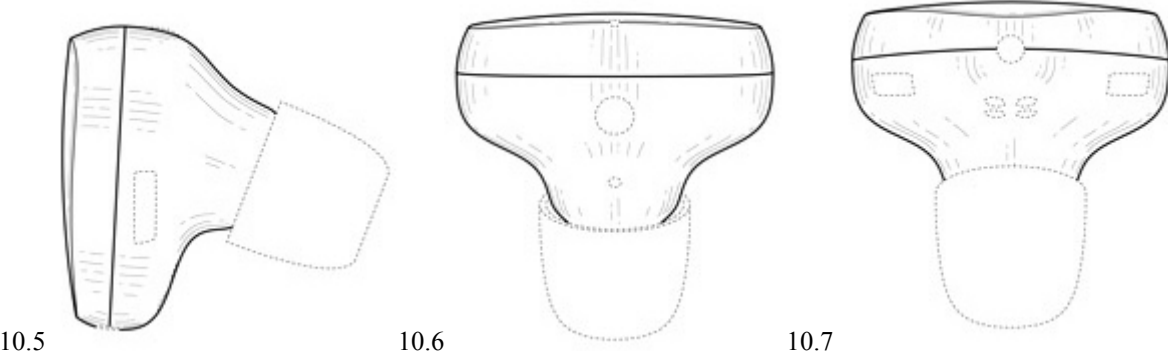
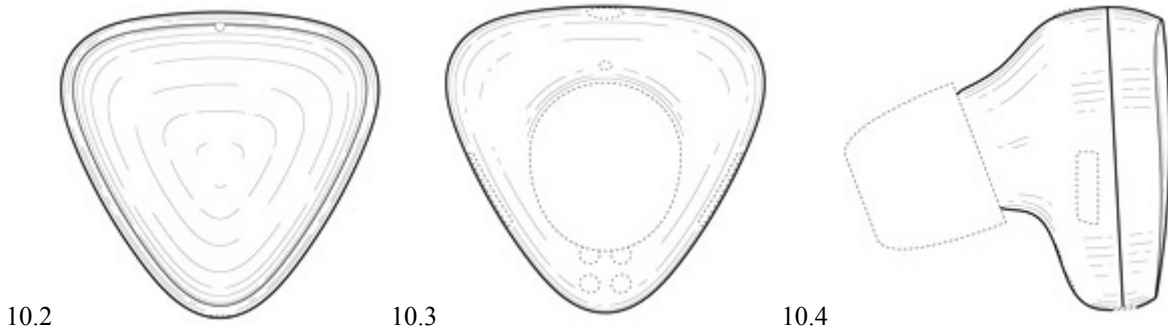

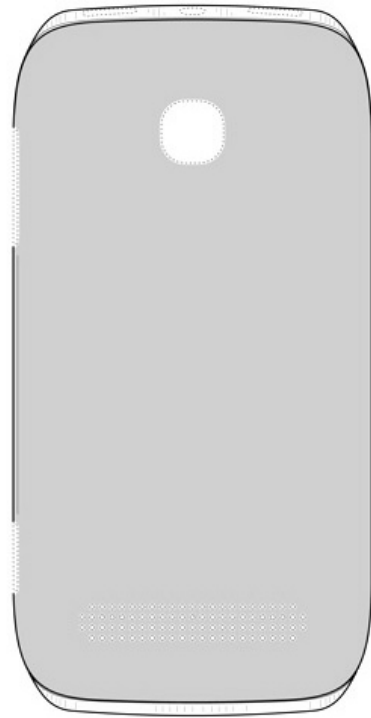

11.3

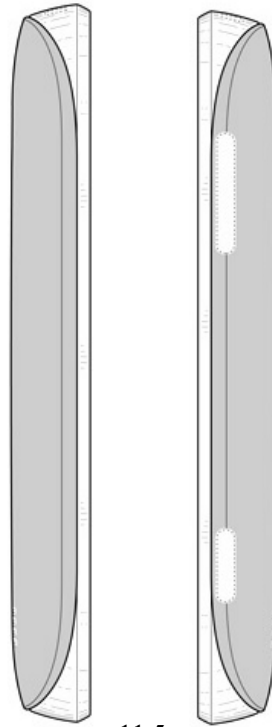

11.4

11.5



11.6



11.7

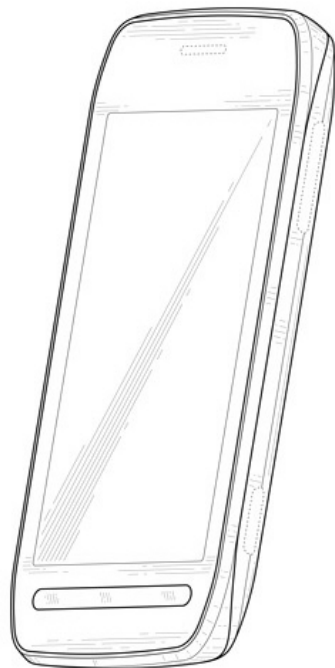

12.1

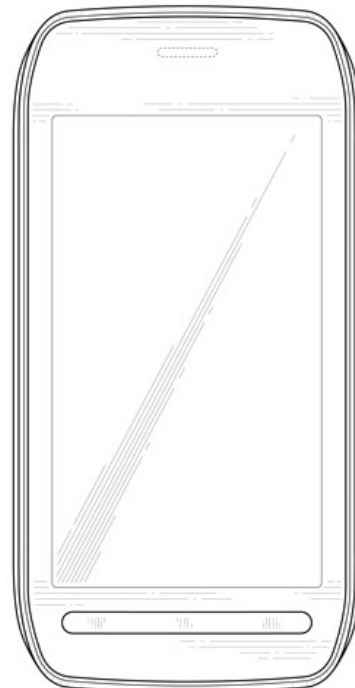

12.2



12.3



12.4



12.5



12.6

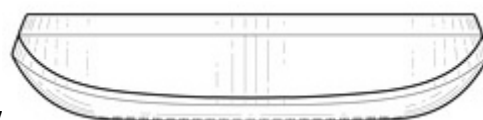

12.7

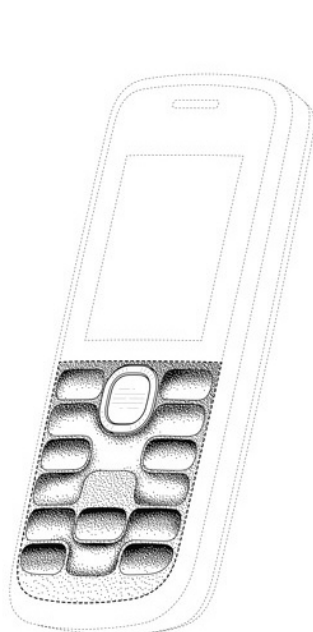

13.1

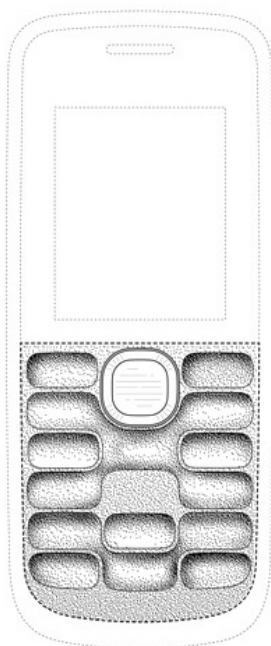

13.2



13.3



13.4

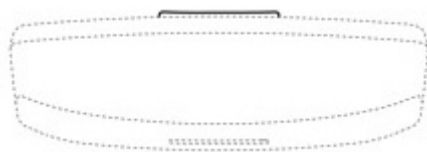

13.5



13.6

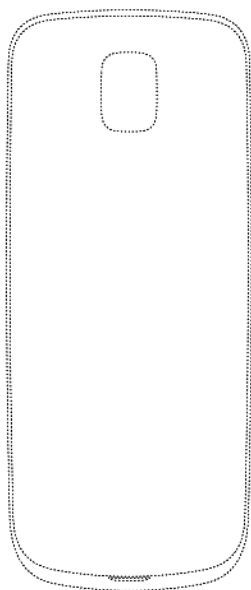

13.7

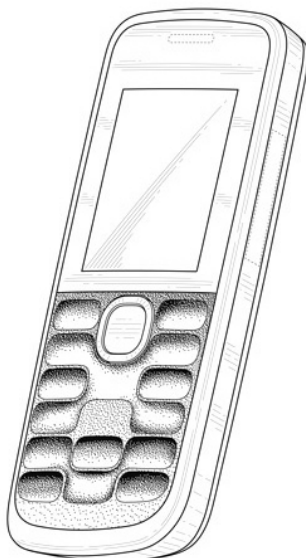

14.1

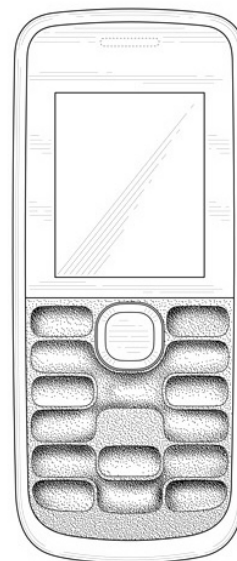

14.2

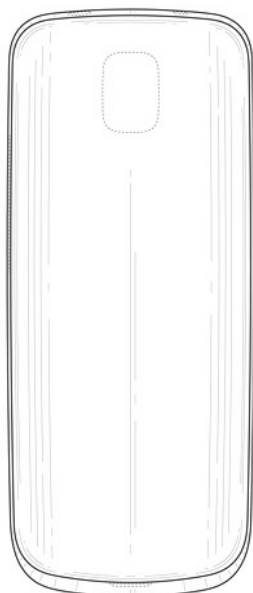

14.3



14.4



14.5



14.6



14.7

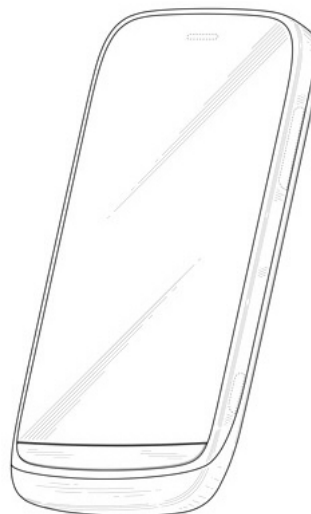

15.1

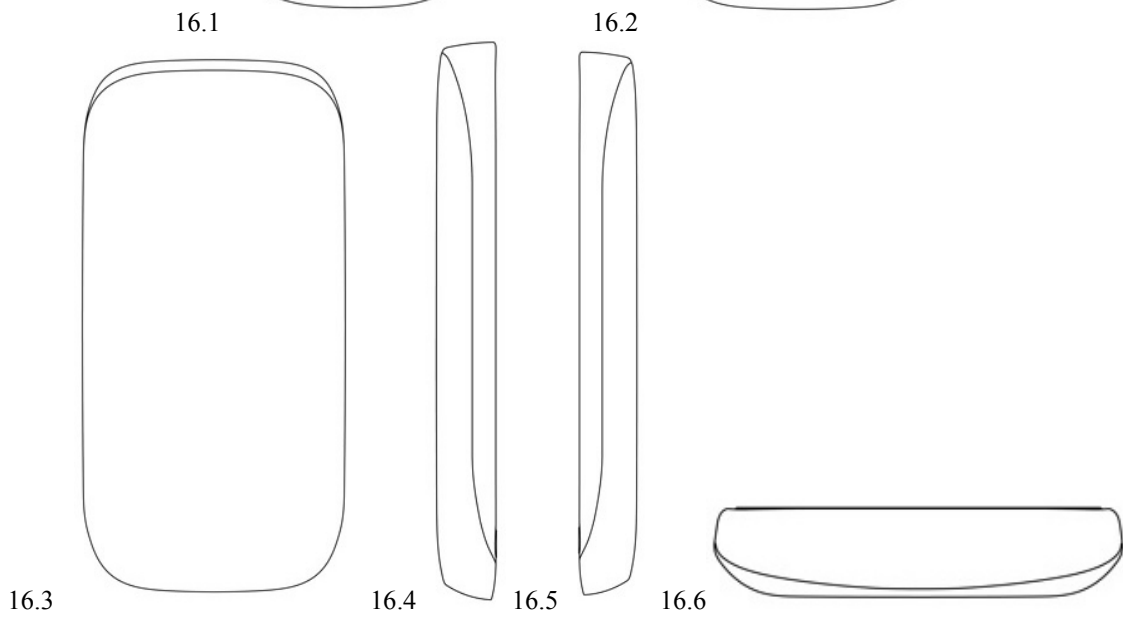
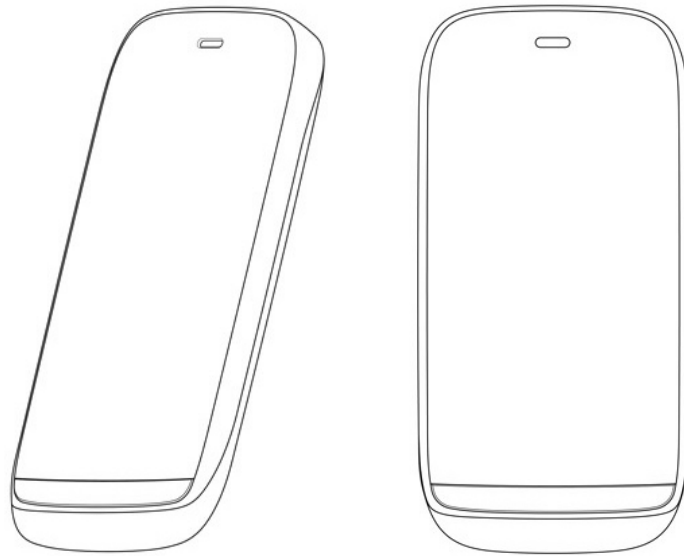
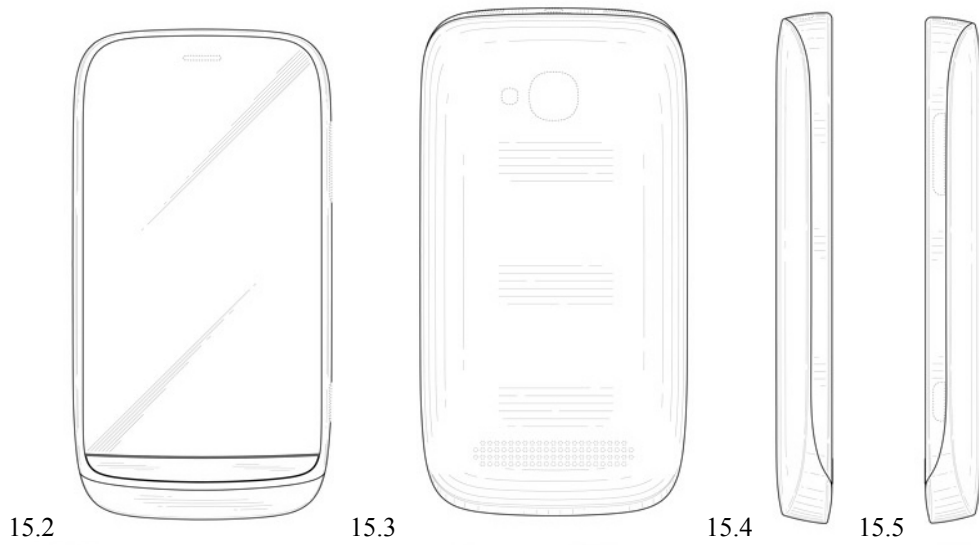

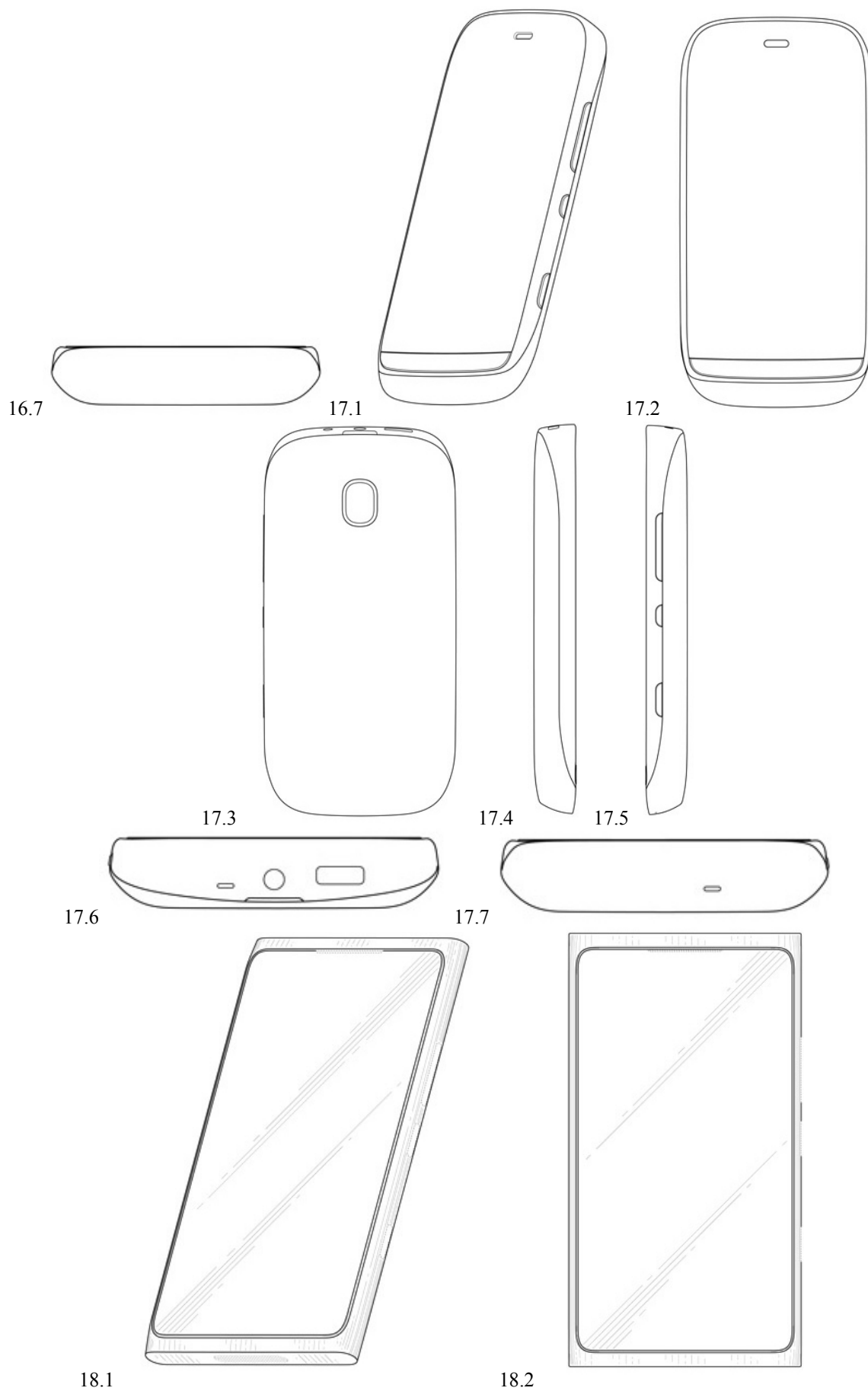

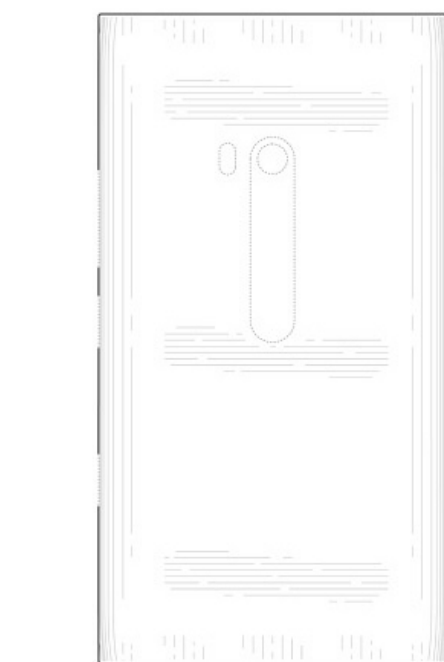

18.3



18.4



18.5

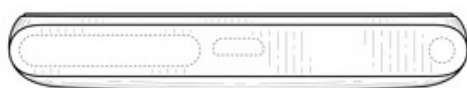

18.6



18.7

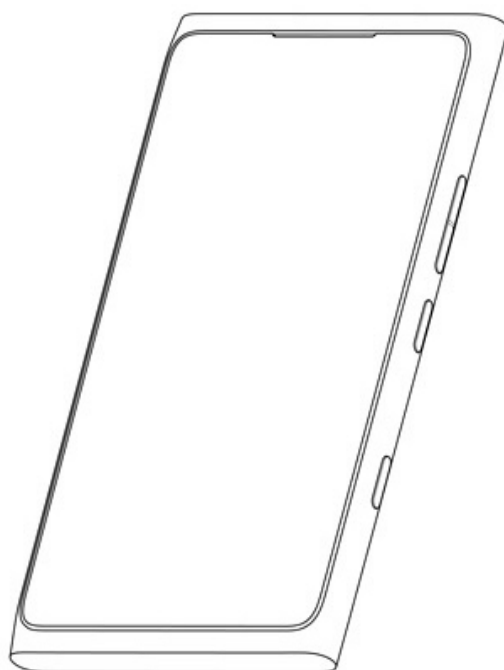

19.1

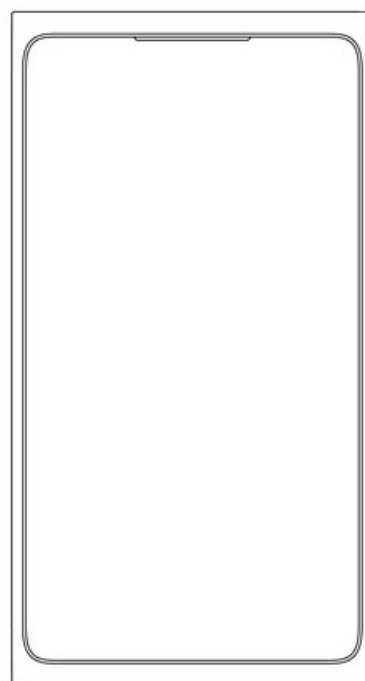

19.2

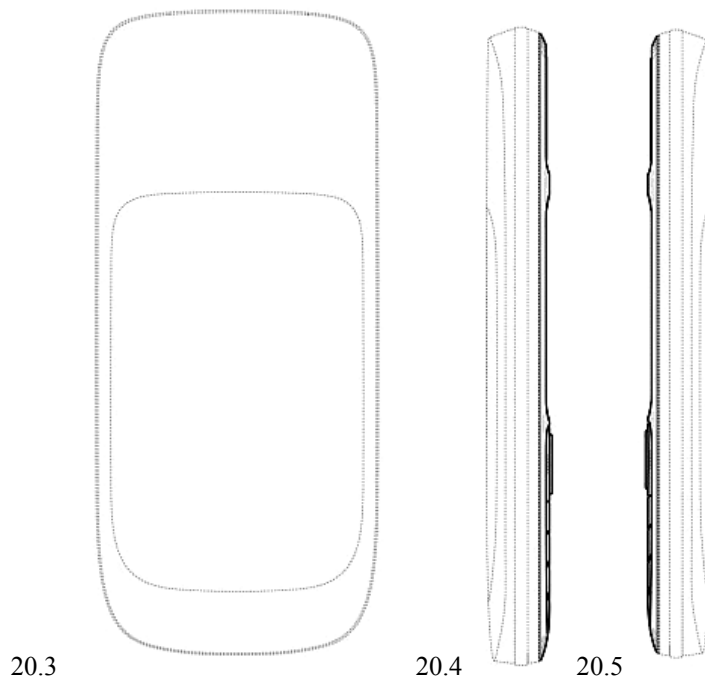
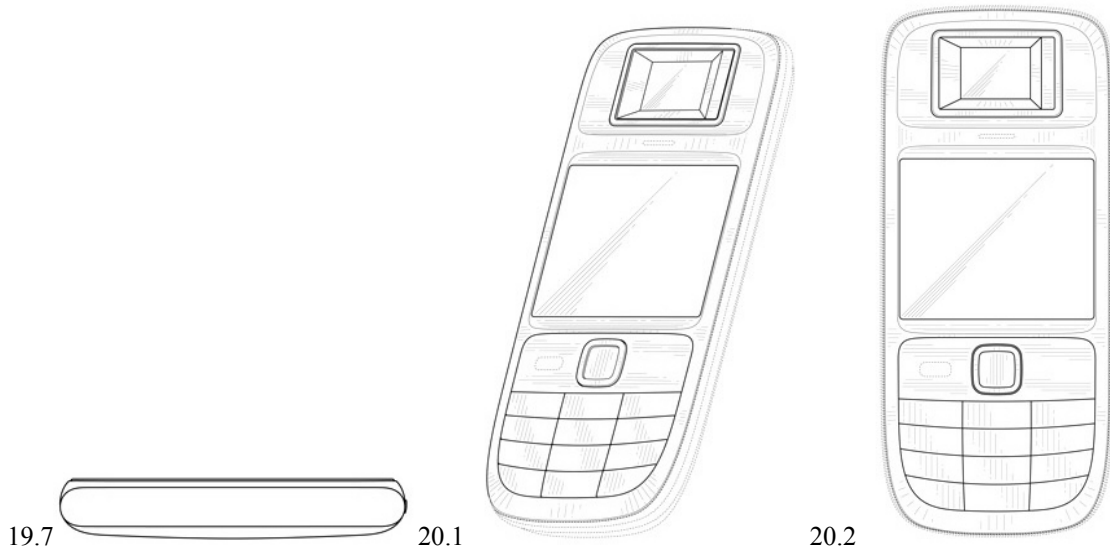
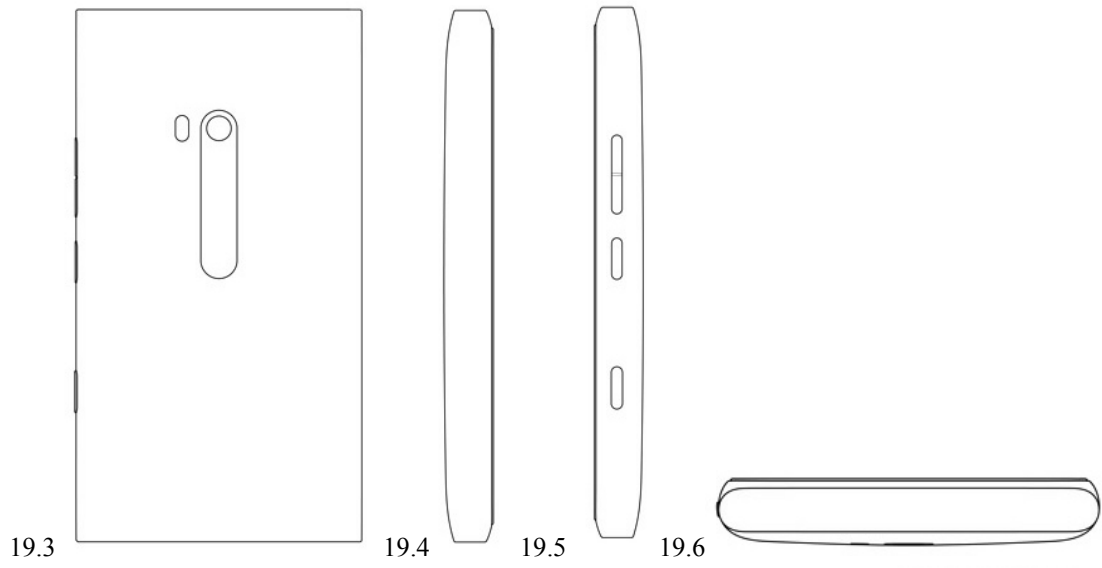

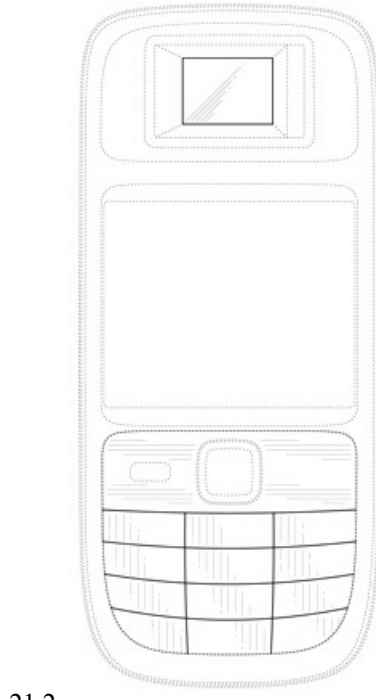
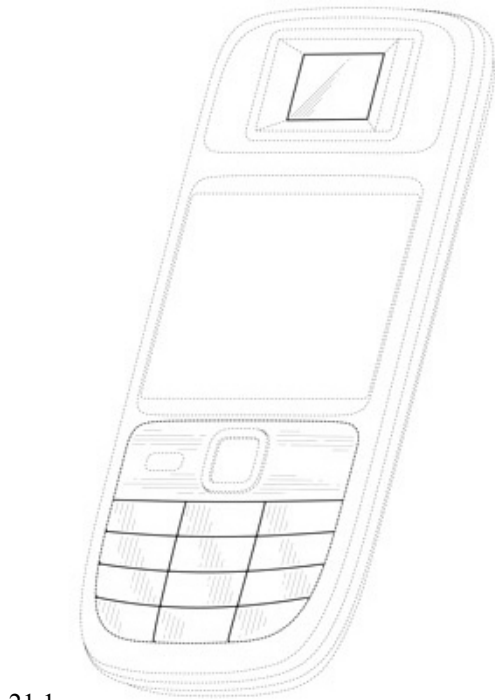

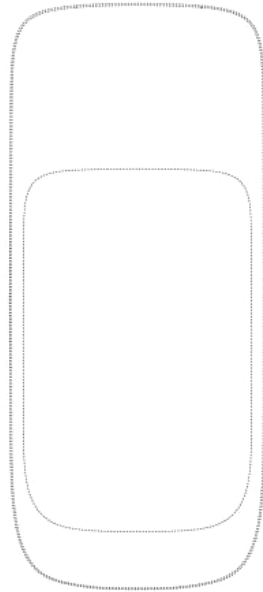

21.7

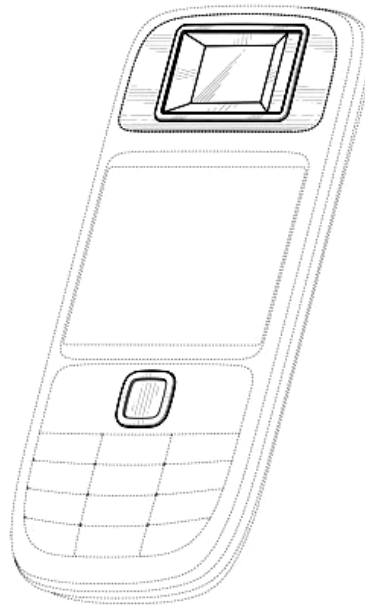

22.1

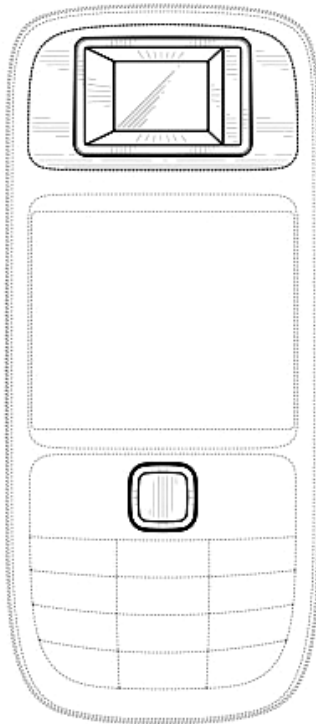

22.2



22.3



22.4



22.5

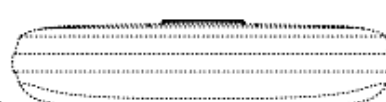

22.6

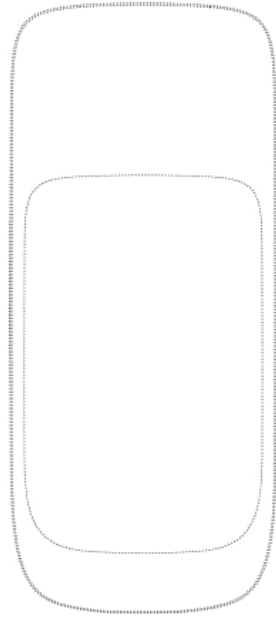

22.7



23.1



23.2



23.3



23.4



23.5

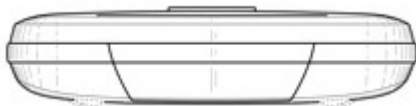

23.6

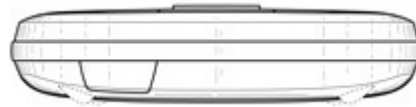

23.7



24.1



24.2

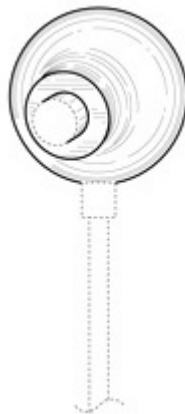

24.3

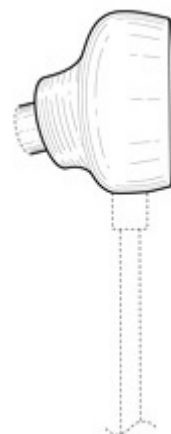

24.4

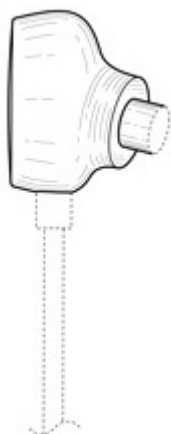

24.5



24.6



24.7

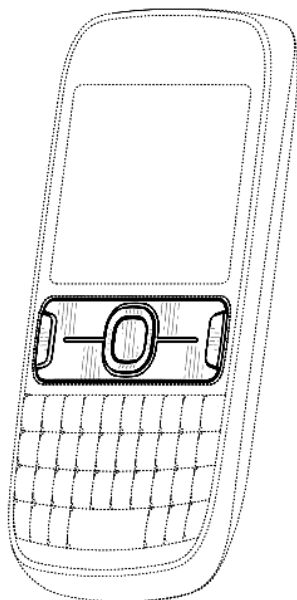

25.1

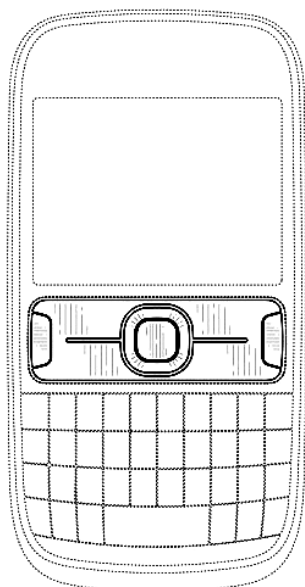

25.2



25.3

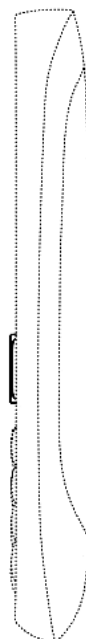

25.4



25.5



25.6

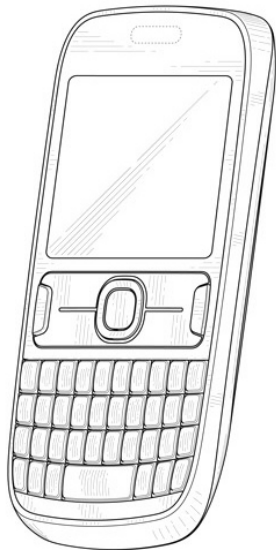

26.1

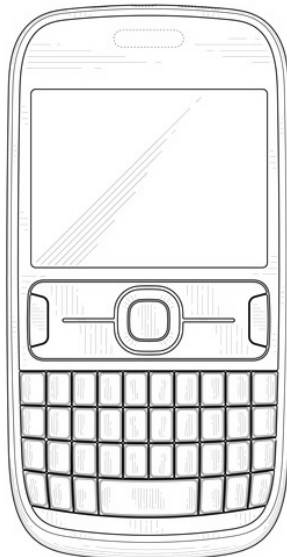

26.2



26.3



26.4

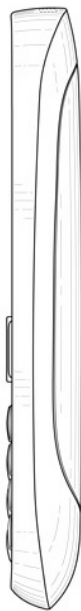

26.5



26.6



26.7

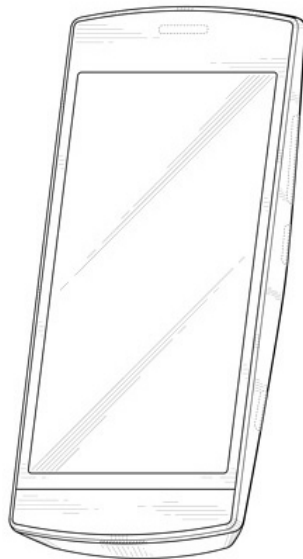

27.1

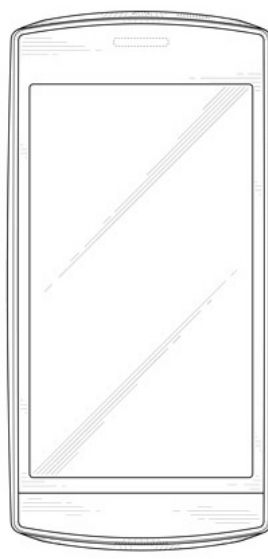

27.2

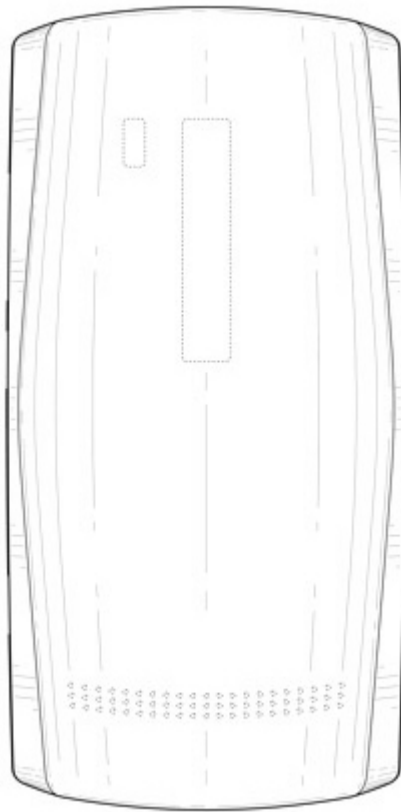

27.3



27.4



27.5

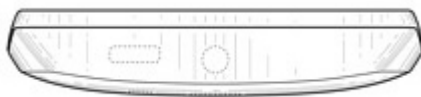

27.6

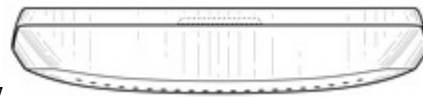

27.7

(11) DM/078698

(15) 2012 07 06

(22) 2012 07 06

(28) 2

(73) IVANA LUKOVIC

11 M. Botsari, GR-166 75 Athens (GR)

(85) EM

(86) RS

(87) GR, EM

(88) GR, EM

(89) RS

(81) III. AL, AM, BA, CH, EM, GE, HR, IS, MD, ME, MK, NO, RS, SG, TR, UA

(72) Ivana Lukovic

11 M. Botsari, 16675 Athens, Greece

(54) 1. Table; 2. Bench

(55)



1.1

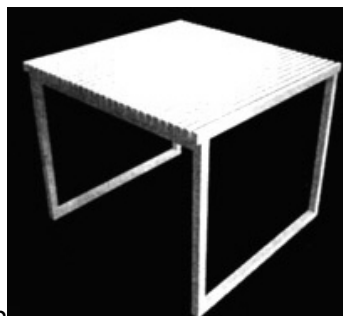

1.2



1.3



1.4

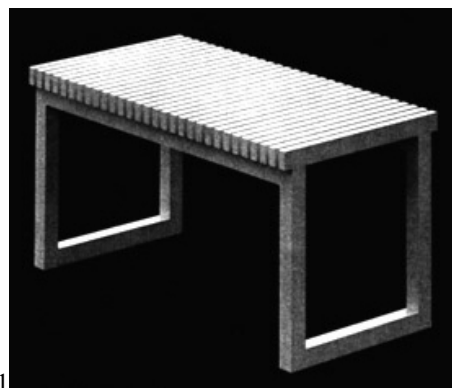

2.1

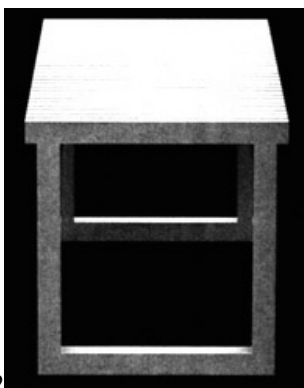

2.2



2.3

(11) DM/078705

(51) 09-01

(15) 2012 04 24

(45) 2012/29 (2012 07 27)

(22) 2012 04 24

(28) 1

(73) LABORATOIRES LA PRAIRIE SA

Industriestrasse 8, CH-8604 Volketswil (CH)

(86) n/a

(87) n/a

(88) CH

(89) CH

(81) II. BZ, CI, KP, MA, SR. III. AL, AM, AZ, BA, BW, CH, EG, EM, GE, GH, HR, IS, KG, LI, MC, MD, ME, MK, MN, NA, NO, OA, OM, RS, SG, ST, SY, TR, UA

(72) 1) Anil Kalyanpur, 14 Ellison Avenue Edison, NJ 08817 USA; 2) Richard Suhr, 21 Blaine Avenue, Unit 6 Seaside Heights, NJ 08751 USA

(54) 1. Container

(55)



(11) DM/078715

(51) 10-02

(15) 2012 07 10

(45) 2012/29 (2012 07 27)

(22) 2012 07 10

(28) 1

(73) SWATCH AG (SWATCH SA)(SWATCH LTD)

Jakob-Stämpfli-Strasse 94, CH-2502 BIEL/BIENNE (CH)

(85) CH

(86) CH

(87) CH

(88) CH

(89) CH

(81) II. BZ, MA. III. AL, AM, AZ, BA, CH, EM, GE, HR, KG, LI, MC, MD, ME, MK, MN, NO, OM, SG, TJ, TN, TR, UA

(72) Ylenia Agate

Swatchlab, Via Archimede 6, IT-20129 Milano

(54) 1. Wristwatch

(55)



1

(11) DM/078721

(15) 2012 07 13

(22) 2012 07 13

(28) 1

(73) SWATCH AG (SWATCH SA)(SWATCH LTD.)

Jakob-Stämpfli-Strasse 94, CH-2502 Biel/Bienne (CH)

(85) CH

(86) CH

(87) CH

(88) CH

(89) CH

(81) II. BZ, MA. III. AL, AM, AZ, BA, CH, EM, GE, HR, KG, LI, MC, MD, ME, MK, MN, NO, OM, SG, TJ, TN, TR, UA

(72) Fred Butler, 5 Falkland Place, London NW5 2PN (GB)

(54) 1. Wristwatch

(55)

(51) 10-02

(45) 2012/29 (2012 07 27)



1.1

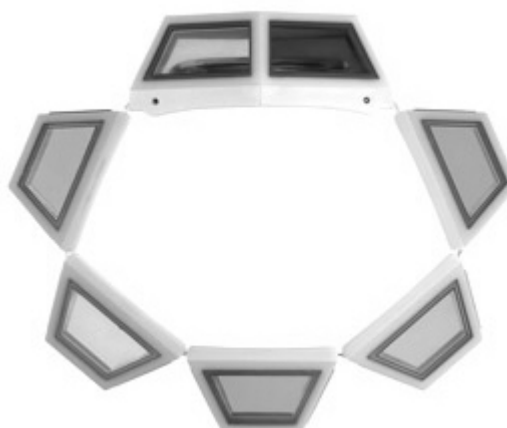

1.2



1.3

TRADEMARKS

APPLICATIONS FILED UNDER THE NATIONAL PROCEDURE APPROVED FOR REGISTRATION

The decision can be appealed at the Chamber of Appeal of Sakpatenti within 3 months from the publication or at the Administrative Chamber of the Tbilisi City Court (Address: №6, David Aghmashenebeli Kheivani 12 km., Tbilisi) within 1 month following the publication.

(260) AM 2012 64664 A
(210) AM 064664
(220) 2011 10 31
(731) HERSHEY CHOCOLATE &
CONFECTIONERY CORPORATION
4860, Robb Street, Suite 204, Wheat Ridge,
Colorado 80033, USA
(740) Tamar Kochlamazashvili
(540)



(591) Black, white
(531) 05.03.14-05.07.06-26.01.16-26.01.21-
(511) 30

(260) AM 2012 64665 A
(210) AM 064665
(220) 2011 10 31
(731) HERSHEY CHOCOLATE &
CONFECTIONERY CORPORATION
4860, Robb Street, Suite 204, Wheat Ridge,
Colorado 80033, USA
(740) Tamar Kochlamazashvili
(540)

HERSHEY'S SPECIAL DARK

(591) Black, white
(511) 30

(260) AM 2012 64686 A
(210) AM 064686
(220) 2011 11 01
(731) LTD "MARKO JORJIA"
Rkinigzis q.10, 0101, Tbilisi, Georgia
(540)



(591) Red, white
(531) 25.01.05-26.01.02-26.01.20-29.01.12-
(526) **Disclaimer** – Word "GEORGIA" in the
trademark shall not be subject to independent
protection.
(511) 29, 30, 32, 35

(260) AM 2012 64695 A
(210) AM 064695
(220) 2011 11 01
(731) ARIAN CHIMIA TECH.
68, Saech Street, Tehran, Iran (Islamic
Republic of)
(740) Nino Mgaloblishvili
(540)



(591) Brown, black
(531) 05.03.15-27.05.08-29.01.12-
(511) 5, 21

(260) AM 2012 64698 A
(210) AM 064698
(220) 2011 11 01
(731) ARIAN CHIMIA TECH.
68, Saech Street, Tehran, Iran (Islamic
Republic of)

Chamaedorea

(591) Black, white
(531) 27.05.05-
(511) 3, 5, 21

(260) AM 2012 64719 A
(210) AM 064719
(220) 2011 11 02
(731) LTD "VASADZIS PURI"
Gabriel Episkoposis q.1, 3500, Ozurgeti,
Georgia

(540)



(591) Orange, cornelian cherry
(531) 05.07.02-28.19.00-29.01.12-
(511) 30

(260) AM 2012 64771 A
(210) AM 064771
(220) 2011 11 04
(731) Integrated Systems Events, LLC
11242 Waples Mill Rd., Suit 200, Fairfax,
Virginia US 22030, USA
(740) Vakhtang Torotadze
(540)

Integrated Systems

(591) Black, white
(511) 35

(260) AM 2012 64820 A
(210) AM 064820
(220) 2011 11 08
(731) LTD "AVERSI-FARMA"
Davit Agmasheneblis gamz., 148/2, 0112,
Tbilisi, Georgia
(540)

კალევანტი
Калевант
Kalevant

(591) Black, white
(511) 5

(260) AM 2012 64821 A
(210) AM 064821
(220) 2011 11 08
(731) LTD "AVERSI-FARMA"
Davit Agmasheneblis gamz., 148/2, 0112,
Tbilisi, Georgia
(540)

კორვანტი
Корвант
Korvant

(591) Black, white
(511) 5

(260) AM 2012 64822 A
(210) AM 064822
(220) 2011 11 08

(731) LTD "AVERSI-FARMA"
Davit Agmasheneblis gamz., 148/2, 0112,
Tbilisi, Georgia

(540)

სერპენოლი
Серпенол
Serpenol

(591) Black, white
(511) 5

(260) AM 2012 64834 A
(210) AM 064834
(220) 2011 11 08
(731) LTD "AVERSI-FARMA"
Davit Agmasheneblis gamz., 148/2, 0112,
Tbilisi, Georgia

(540)

ოსტევინი
Остевин
Ostevin

(591) Black, white
(511) 5

(260) AM 2012 64835 A
(210) AM 064835
(220) 2011 11 08
(731) LTD "AVERSI-FARMA"
Davit Agmasheneblis gamz., 148/2, 0112,
Tbilisi, Georgia

(540)

ოპისტასი
Опистас
Opistas

(591) Black, white
(511) 5

(260) AM 2012 64837 A
(210) AM 064837
(220) 2011 11 08
(731) LTD "AVERSI-FARMA"
Davit Agmasheneblis gamz., 148/2, 0112,
Tbilisi, Georgia

(540)

კადერონი
Кадерон
Caderon

(591) Black, white
(511) 5

(260) AM 2012 64905 A
 (210) AM 064905
 (220) 2011 11 15
 (731) Thai Storage Battery Public Company Limited
 387 Moo 4, Soi Pattana 3, Sukhumvit Road,
 Bangpoo Industrial Estate, Praekasa
 Samutprakarn 10280, Thailand
 (740) Liliana Darakhvelidze
 (540)



(591) Black, white
 (531) 27.05.19-27.05.22-
 (511) 9

(260) AM 2012 64918 A
 (210) AM 064918
 (220) 2011 11 16
 (310) 40-2011-0048484
 (320) 2011 09 02
 (330) KR
 (731) SAMSUNG ELECTRONICS CO., LTD
 416, Maetan-dong, Yeongtong-gu, Suwon-si,
 Gyeonggi-do, Republic of Korea
 (740) Pavle Meipariani
 (540)

GALAXY NOTE

(591) Black, white
 (511) 9

(260) AM 2012 64994 A
 (210) AM 064994
 (220) 2011 11 21
 (731) GENERAL MOTORS LLC
 300 Renaissance Center, City of Detroit,
 State of Michigan 48265-3000, USA
 (740) George Taktakishvili
 (540)

INTELLILINK

(591) Black, white
 (511) 9

(260) AM 2012 64995 A
 (210) AM 064995
 (220) 2011 11 21
 (731) ORION CORPORATION
 30-10 Munbae-Dong, Yongsan-ku, Seoul,
 Republic of Korea
 (740) Shalva Gvaramadze
 (540)

MARINE BOY

(591) Black, white
 (511) 30

(260) AM 2012 65051 A
 (210) AM 065051
 (220) 2011 11 25
 (731) Caterpillar Global Mining LLC
 6744 South Howell, South Milwaukee,
 Wisconsin 53172-0500, USA
 (740) Davit Zurabishvili
 (540)

BUCYRUS

(591) Black, white
 (511) 7, 12, 37

(260) AM 2012 65052 A
 (210) AM 065052
 (220) 2011 11 25
 (731) Caterpillar Global Mining LLC
 6744 South Howell, South Milwaukee,
 Wisconsin 53172-0500, USA
 (740) Davit Zurabishvili
 (540)



(591) Black, white
 (531) 26.03.04-26.11.09-27.05.17-
 (511) 7, 12, 37

(260) AM 2012 65066 A
 (210) AM 065066
 (220) 2011 11 28
 (731) CELLTRION, INC.
 13-6, Songdo-dong, Yeonsu-gu, Incheon,
 Republic of Korea
 (740) George Taktakishvili
 (540)

ჰერზუმა

(591) Black, white
 (531) 28.19.00-
 (511) 5

(260) AM 2012 65067 A
 (210) AM 065067
 (220) 2011 11 28
 (731) CELLTRION, INC.
 13-6, Songdo-dong, Yeonsu-gu, Incheon,
 Republic of Korea
 (740) George Taktakishvili
 (540)

ჰერტუმუ

(591) Black, white
 (531) 28.19.00-
 (511) 5

(260) AM 2012 65068 A
(210) AM 065068
(220) 2011 11 28
(731) CELLTRION, INC.
13-6, Songdo-dong, Yeonsu-gu, Incheon,
Republic of Korea
(740) George Taktakishvili
(540)

სიმაბტრა

(591) Black, white
(531) 28.19.00-
(511) 5

(260) AM 2012 65069 A
(210) AM 065069
(220) 2011 11 28
(731) CELLTRION, INC.
13-6, Songdo-dong, Yeonsu-gu, Incheon,
Republic of Korea
(740) George Taktakishvili
(540)

ფლოქსელი

(591) Black, white
(531) 28.19.00-
(511) 5

(260) AM 2012 65070 A
(210) AM 065070
(220) 2011 11 28
(731) CELLTRION, INC.
13-6, Songdo-dong, Yeonsu-gu, Incheon,
Republic of Korea
(740) George Taktakishvili
(540)

ემისიმა

(591) Black, white
(531) 28.19.00-
(511) 5

(260) AM 2012 65071 A
(210) AM 065071
(220) 2011 11 28
(731) CELLTRION, INC.
13-6, Songdo-dong, Yeonsu-gu, Incheon,
Republic of Korea
(740) George Taktakishvili
(540)

რემსიმა

(591) Black, white
(531) 28.19.00-
(511) 5

(260) AM 2012 65094 A
(210) AM 065094
(220) 2011 11 29
(731) KINGSTON TECHNOLOGI
CORPORATION
17600 Newhope Street, Fountain Valley,
CALIFORNIA 92708, USA
(740) Tamaz Shilakadze
(540)

VALUE RAM

(591) Black, white
(511) 9

(260) AM 2012 65096 A
(210) AM 065096
(220) 2011 11 29
(731) KINGSTON TECHNOLOGI
CORPORATION
17600 Newhope Street, Fountain Valley,
CALIFORNIA 92708, USA
(740) Tamaz Shilakadze
(540)



(591) Black, white
(531) 02.01.23-
(511) 9

(260) AM 2012 65165 A
(210) AM 065165
(220) 2011 12 01
(731) Mamuka Israelashvili
Barnovis q. 140, 0179, Tbilisi, Georgia
(740) Tamar Machavariani
(540)

იანტარნაია ჟემჩუჟინა
Янтарная Жемчужина

(591) Black
(511) 29

(260) AM 2012 65209 A
(210) AM 065209
(220) 2011 12 05
(731) PAPPAROTI TRADING SDN. BHD.
J-1-17, Jalan 1/43, Aman Suria Damansara,
47301, Petaling Jaya, Selangor D.E.,
Malaysia
(740) Tamaz Shilakadze

(540)



(591) Black, white
 (531) 05.07.02-27.05.01-
 (511) 30, 43

(260) AM 2012 65389 A
 (210) AM 065389
 (220) 2011 12 15
 (731) NINE WEST DEVELOPMENT
 CORPORATION
 1007 Orange Street, Suite 225, Wilmington,
 Delaware 19801, USA
 (740) Tamaz Shilakadze
 (540)

LOVE FURY KISS

(591) Black, white
 (511) 3

(260) AM 2012 65390 A
 (210) AM 065390
 (220) 2011 12 15
 (731) MERCK SHARP & DOHME CORP.
 One Merck Drive, Whitehouse Station,
 New Jersey 08889, USA
 (740) Tamaz Shilakadze
 (540)

GARIXEDE

(591) Black, white
 (511) 5

(260) AM 2012 65568 A
 (210) AM 065568
 (220) 2011 12 26
 (731)) OOO "PETROSOJUZ TM"
 ul. Arsenalnaya, d.1, korp. 2, 195009
 Sankt-Peterburg, Russian Federation
 (740) Shalva Gvaramadze
 (540)

ПИКАДОР

(591) Black, white
 (511) 29, 30

(260) AM 2012 65584 A
 (210) AM 065584
 (220) 2011 12 27
 (731) GIVI BALIANI
 Naqeralis q.N11, 0103, Tbilisi, Georgia
 (540)



(591) Black, white
 (531) 24.01.15-25.01.05-25.03.05-27.05.21-
 (511) 25

(260) AM 2012 65757 A
 (210) AM 065757
 (220) 2012 01 06
 (731) ALLIED GLOBAL TOBACCO LTD
 Wey Court West, Union Road, Farnham,
 Surrey GU9 7PT, United Kingdom
 (740) Givi Akopashvili
 (540)



(591) Red, white, silver, blue, black
 (531) 19.03.24-26.04.09-26.04.18-29.01.15-
 (511) 34

(260) AM 2012 65758 A
 (210) AM 065758
 (220) 2012 01 06
 (731) ALLIED GLOBAL TOBACCO LTD
 Wey Court West, Union Road, Farnham,
 Surrey GU9 7PT, United Kingdom
 (740) Givi Akopashvili
 (540)



(591) Blue, white, silver, red, black
 (531) 19.03.24-26.04.09-26.04.18-29.01.15-
 (511) 34

REGISTERED TRADEMARKS

(111) M 2012 022979 R

(151) 2012 09 28

(181) 2022 09 28

(260) AM 2012 62368 A

(220) 2011 05 06

(732) LTD "IONFASH JORJIA"

Guramishvilis q.64, 0141, Tbilisi, Georgia

(111) M 2012 022980 R

(151) 2012 09 28

(181) 2022 09 28

(260) AM 2012 62552 A

(220) 2011 05 23

(732) MSD International Holdings GmbH

Veystrasse 20, CH-6000, Lucerne 6,
Switzerland

(111) M 2012 022981 R

(151) 2012 09 28

(181) 2022 09 28

(260) AM 2012 62900 A

(220) 2011 06 17

(732) THE PRIESTMEN ELECTRONICS

CORPORATION

107 Connie Crescent, Concord, Ontario
L4K 1L3, Canada

(111) M 2012 022989 R

(151) 2012 10 09

(181) 2022 10 09

(260) AM 2012 61454 A

(220) 2011 07 25

(732) LTD "SAAMO"

Zovretis q. 35, 0160, Tbilisi, Georgia

(111) M 2012 022990 R

(151) 2012 10 09

(181) 2022 10 09

(260) AM 2012 62382 A

(220) 2011 05 10

(732) COMPAGNIE FINANSIERE ET DE

PARTICIPATIONS ROULLIER

27 Avenue Franklin Roosevelt, 35400 Saint
Malo, France

(111) M 2012 022991 R

(151) 2012 10 09

(181) 2022 10 09

(260) AM 2012 62394 A

(220) 2011 05 11

(732) LTD Shps Simetra

Atenis q. 20, bina 28, 0179, Tbilisi, Georgia

(111) M 2012 022992 R

(151) 2012 10 09

(181) 2022 10 09

(260) AM 2012 62450 A

(220) 2011 05 17

(732)) LTD "SAAMO"

Zovretis q. 35, 0160, Tbilisi, Georgia

(111) M 2012 022993 R

(151) 2012 10 09

(181) 2022 10 09

(260) AM 2012 62555 A

(220) 2011 05 24

(732) INTEL CORPORATION

a Delaware corporation

2200 Mission College Boulevard, Santa
Clara, California 95052-8119, USA

(111) M 2012 022994 R

(151) 2012 10 09

(181) 2022 10 09

(260) AM 2012 62631 A

(220) 2011 05 31

(732) MEDEA MAMULASHVILI

Tarkhnishvilis q. 9, 0179, Tbilisi,
Georgia

(111) M 2012 022995 R

(151) 2012 10 09

(181) 2022 10 09

(260) AM 2012 62635 A

(220) 2011 05 31

(732) TEMUR KILADZE

Lomtadizis q. 24, 3500, Ozurgeti,
Georgia

(111) M 2012 022996 R

(151) 2012 10 09

(181) 2022 10 09

(260) AM 2012 62697 A

(220) 2011 06 03

(732) LTD "MEGAFUDI"

Vake-saburtalos raioni, Gelovanis gamz. 2,
0159, Tbilisi, Georgia

(111) M 2012 022997 R
 (151) 2012 10 09
 (181) 2022 10 09
 (260) AM 2012 62722 A
 (220) 2011 06 06
 (732) LTD ASPHARMA – Georgian Pharmaceutical Company
 Metekhis Str. 22, 0103, Tbilisi, Georgia

(111) M 2012 022998 R
 (151) 2012 10 09
 (181) 2022 10 09
 (260) AM 2012 62723 A
 (220) 2011 06 06
 (732) LTD ASPHARMA – Georgian Pharmaceutical Company
 Metekhis Str. 22, 0103, Tbilisi, Georgia

(111) M 2012 022999 R
 (151) 2012 10 09
 (181) 2022 10 09
 (260) AM 2012 62724 A
 (220) 2011 06 06
 (732) LTD ASPHARMA – Georgian Pharmaceutical Company
 Metekhis Str. 22, 0103, Tbilisi, Georgia

(111) M 2012 023000 R
 (151) 2012 10 09
 (181) 2022 10 09
 (260) AM 2012 62725 A
 (220) 2011 06 06
 (732) LTD ASPHARMA – Georgian Pharmaceutical Company
 Metekhis Str. 22, 0103, Tbilisi, Georgia

(111) M 2012 023001 R
 (151) 2012 10 09
 (181) 2022 10 09
 (260) AM 2012 62726 A
 (220) 2011 06 06
 (732) LTD ASPHARMA – Georgian Pharmaceutical Company
 Metekhis Str. 22, 0103, Tbilisi, Georgia

(111) M 2012 023002 R
 (151) 2012 10 09
 (181) 2022 10 09
 (260) AM 2012 62727 A
 (220) 2011 06 06
 (732) LTD ASPHARMA – Georgian Pharmaceutical Company
 Metekhis Str. 22, 0103, Tbilisi, Georgia

(111) M 2012 023003 R
 (151) 2012 10 09
 (181) 2022 10 09
 (260) AM 2012 62879 A
 (220) 2011 06 16
 (732) DR. TAMÁS SZABÓ
 H-2094 Nagykovácsi, Szt. Flórián u. 28,
 Hungary;
 Dr. Marianna Nitter
 H-1133 Budapest, Pannónia u. 66, Hungary

(111) M 2012 023004 R
 (151) 2012 10 09
 (181) 2022 10 09
 (260) AM 2012 62920 A
 (220) 2011 06 21
 (732) LTD "MEGAFUDI"
 Vake-Saburtalos raioni, Gelovanis gamz. 2,
 0159, Tbilisi, Georgia

(111) M 2012 023005 R
 (151) 2012 10 09
 (181) 2022 10 09
 (260) AM 2012 62921 A
 (220) 2011 06 21
 (732) LTD "MEGAFUDI"
 Vake-Saburtalos raioni, Gelovanis gamz. 2,
 0159, Tbilisi, Georgia

(111) M 2012 023006 R
 (151) 2012 10 09
 (181) 2022 10 09
 (260) AM 2012 62922 A
 (220) 2011 06 21
 (732) LTD "MEGAFUDI"
 Vake-Saburtalos raioni, Gelovanis gamz. 2,
 0159, Tbilisi, Georgia

(111) M 2012 023007 R
 (151) 2012 10 09
 (181) 2022 10 09
 (260) AM 2012 63035 A
 (220) 2011 07 04
 (732) Itunkaya Insaat Nakliyat Gida Tikaret
 Anonim Sirketi
 Gezimuhtarpasa Bulvari Kalyon Ismerkezi
 K:4 No:14 Gaziantep, Turkey

(111) M 2012 023008 R
 (151) 2012 10 09
 (181) 2022 10 09
 (260) AM 2012 63222 A

(220) 2011 07 14
(732) LTD "BARAMBO"
Sop. Natakhvari, 3308, Mtskheta, Georgia

(111) M 2012 023009 R
(151) 2012 10 09
(181) 2022 10 09
(260) AM 2012 63319 A
(220) 2011 07 21
(732) DAIMLER AG
Mercedesstrasse 137, 70327 Stuttgart,
Germany

(111) M 2012 023010 R
(151) 2012 10 09
(181) 2022 10 09
(260) AM 2012 63320 A
(220) 2011 07 21
(732) DAIMLER AG
Mercedesstrasse 137, 70327 Stuttgart,
Germany

(111) M 2012 023011 R
(151) 2012 10 09
(181) 2022 10 09
(260) AM 2012 63435 A
(220) 2011 07 27
(732) SS "LISI LEIQ DEVELOPMENT"
Vakis raioni, lisis tbis mimdebari (nakveti
N1/5), 0177, Tbilisi, Georgia

(111) M 2012 023012 R
(151) 2012 10 09
(181) 2022 10 09
(260) AM 2012 63673 A
(220) 2011 08 11
(732) RDZIS MTSARMOEBEL FERMERTA
ASOTSIATSIA
Davit Agmasheneblis q. 38, 4216, Tsnori,
Georgia

(111) M 2012 023013 R
(151) 2012 10 09
(181) 2022 10 09
(260) AM 2012 63674 A
(220) 2011 08 11
(732) RDZIS MTSARMOEBEL FERMERTA
ASOTSIATSIA
Davit Agmasheneblis q.38, 4216, Tsnori,
Georgia

(111) M 2012 023014 R
(151) 2012 10 09
(181) 2022 10 09
(260) AM 2012 63868 A
(220) 2011 08 29
(732) TOYOTA JIDOSHA KABUSHIKI KAISHA
(also trading as TOYOTA MOTOR
CORPORATION)
1, Toyota-Cho, Toyota-Shi, Aichi-Ken, Japan

(111) M 2012 023015 R
(151) 2012 10 09
(181) 2022 10 09
(260) AM 2012 64019 A
(220) 2011 09 12
(732) SAMSUNG ELECTRONICS CO., LTD
416, Maetan-dong, Yeongtong-gu, Suwon-si,
Gyeonggi-do, Republic of Korea

(111) M 2012 023016 R
(151) 2012 10 09
(181) 2022 10 09
(260) AM 2012 64020 A
(220) 2011 09 12
(732) SAMSUNG ELECTRONICS CO., LTD
416, Maetan-dong, Yeongtong-gu, Suwon-si,
Gyeonggi-do, Republic of Korea

(111) M 2012 023017 R
(151) 2012 10 09
(181) 2022 10 09
(260) AM 2012 64216 A
(220) 2011 09 23
(732) MANANA KHELAIYA-GABASHVILI
V. Gabashvilis 2, bina 8, 0179, Tbilisi,
Georgia

(111) M 2012 023018 R
(151) 2012 10 09
(181) 2022 10 09
(260) AM 2012 64237 A
(220) 2011 09 27
(732) STIEFEL LABORATORIES, INC.
Corporation Service Company
2711 Centerville Road, Suite 400,
Wilmington, Delaware 19801, USA

(111) M 2012 023019 R
(151) 2012 10 09
(181) 2022 10 09
(260) AM 2012 64339 A
(220) 2011 10 06
(732) GLAXOSMITHKLINE TRADING
SERVICES LIMITED
6900 Cork Airport Business Park, Kinsale
Road, Cork, Ireland

(111) M 2012 023020 R
(151) 2012 10 09
(181) 2022 10 09
(260) –
(220) 2012 06 21
(732) ACT aerosol Chemie Technik GmbH
Vaidenweg 12, 73087 Bad Boll, Germany

TRADEMARKS REGISTERED ACCORDING TO THE ACCELERATED PROCEDURE

The decision can be appealed at the Chamber of Appeal of Sakpatenti within 3 months from the publication.

(111) M 2012 22982 R

(151) 2012 09 28

(181) 2022 09 28

(210) AM 068907

(220) 2012 09 20

(732) LTD "EMBAVUD JORJIA"

Marneulis q. N37, 0165, Tbilisi, Georgia

(740) Murman Isaev

(540)



(591) Red, white

(531) 25.03.07-26.04.24-27.05.24-29.01.12-

(511) 20

(111) M 2012 22983 R

(151) 2012 10 03

(181) 2022 10 03

(210) AM 068903

(220) 2012 09 20

(732) NATIA CHKHARTISHVILI

Mtskhmetis I shesakhvevi, I chikhi N13,

Georgia

(740) Mamuka Gviviashvili

(540)

ჩვენ ვუყურებთ მოვლენებს
თქვენი თვალით

**Chven Vukurebt Movlenebs
Tqveni Tvalit**

(591) Black, white

(511) 35, 38

(111) M 2012 22984 R

(151) 2012 10 03

(181) 2022 10 03

(210) AM 068904

(220) 2012 09 20

(732) NATIA CHKHARTISHVILI

Mtskhmetis I shesakhvevi, I chikhi N13,

Georgia

(740) Mamuka Gviviashvili

(540)

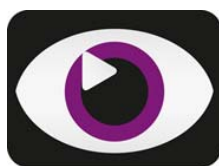

(591) Black, white, lilac

(531) 02.09.04-26.03.01-29.01.13-

(511) 35, 38

(111) M 2012 22985 R

(151) 2012 10 03

(181) 2022 10 03

(210) AM 068902

(220) 2012 09 20

(732) NATIA CHKHARTISHVILI

Mtskhmetis I shesakhvevi, I chikhi N13,

Georgia

(740) Mamuka Gviviashvili

(540)

მზერა. ტვ

MZERA.TV

(591) Black, white

(526) **Disclaimer** – The trademark is protected as a whole, word combinations „ტვ” and "TV", shall not be subject to independent protection.

(511) 38

(111) M 2012 22986 R

(151) 2012 10 08

(181) 2022 10 08

(210) AM 068930

(220) 2012 09 21

(732) LTD "METSKHRE ARKHI "

300 Aragvelis q. 1, 0144, Tbilisi, Georgia

(540)

მეცხრე არხი

(591) Black, white

(531) 28.19.00-

(526) **Disclaimer** – The trademark is protected as a whole, word combinations „არხი”, shall not be subject to independent protection.

(511) 38, 41

(111) M 2012 22987 R

(151) 2012 10 08

(181) 2022 10 08

(210) AM 068931

(220) 2012 09 21

(732) LTD "METSKHRE ARKHI "

300 Aaragvelis q. 1, 0144, Tbilisi, Georgia

(540)

CHANNEL 9

(591) Black, white

(531) 27.05.05-27.07.01-

(526) **Disclaimer** – The trademark is protected as a whole, word combination "CHANNEL", shall not be subject to independent protection.

(511) 38, 41

(111) M 2012 22988 R

(151) 2012 10 08

(181) 2022 10 08

(210) AM 068932

(220) 2012 09 21

(732) LTD "METSUKHRE ARKHI "

300 Aragvelis q. 1, 0144, Tbilisi, Georgia

(540)

TV9

(591) Black, white

(531) 27.05.05-27.07.01-

(526) **Disclaimer** – The trademark is protected as a whole, word combination "TV", shall not be subject to independent protection.

(511) 38, 41

(111) M 2012 23021 R

(151) 2012 10 09

(181) 2022 10 09

(210) AM 068674

(220) 2012 08 31

(732) FONDI TSITELI KAKACHO

Isani-Ssamgoris raionshi, naqeralas q. 5, 0103,
Tbilisi, Georgia

(740) Vakhtang Tototadze

(540)



(591) Red, black, green, brown

(531) 05.05.20-05.05.13-29.01.13-

(511) 41

(111) M 2012 23022 R

(151) 2012 10 10

(181) 2022 10 10

(210) AM 068672

(220) 2012 08 31

(732) NOBEL ILAC SANAYII VE TICARET
ANONIM SIRKETI-is tsarmomadgenloba
saqartveloshiTavisuflebis moedani n4, 0114, Tbilisi,
Georgia

(740) Shorena Kikalishvili

(540)

ბეფრონი**Befron****Бэфрон**

(591) Black, white

(511) 5

INTERNATIONAL TRADEMARKS FOR WHICH A DECISION ON GRANTING PROTECTIONS IS TAKEN

The decision can be appealed at the Chamber of Appeal of Sakpatenti within 3 months from the publication or at the Administrative Chamber of the Tbilisi City Court (Address: №6, David Aghmashenebeli Kheivani 12 km., Tbilisi) within 1 month following the publication.

(260) AM 2012 64932 A
(800) 1094854
(731) SANOFI
54 rue La Boétie, F-75008 Paris, France
(540)

SANOFI

(591) Black, white
(511)
3 – Non-medicated preparations for skin hygiene, care and maintenance; personal hygiene preparations; cosmetics; soaps; dentifrices.

5 – Prescription or non-prescription pharmaceutical and veterinary preparations, sanitary preparations for medical use; dietetic substances for medical use, chemical preparations for medical or pharmaceutical use, vaccines, food for babies; plasters, materials for dressings; material for stopping teeth, dental wax; disinfectants; vitamins, vitamin-based preparations; natural health foods and remedies made with medicinal plants included in this class; beverages and foods for medicinal use, additives and food supplements for medicinal use; mineral food supplements for medicinal use, dietary supplements, preparations made with plants, all for medicinal use; plant-based preparations and plant extracts for medicinal use; preparations for making dietetic or medicated beverages; medicinal preparations; chemical preparations for medicinal use; substances for medicinal use, medicated confectionary and sweets for medicinal use, pharmacological preparations for skin care; preparations for destroying vermin; fungicides, herbicides.

(260) AM 2012 64933 A
(800) 1094871
(731) Henkel AG & Co. KgaA
Henkelstraße 67, 40589 Düsseldorf, Germany
(540)

Fa

NATURAL & POWER

(591) Black, white

(511)
3 – Soaps for personal use, body and beauty care preparations, namely foam bath preparations, bath additives and shower gels, body lotions, deodorants for personal use.

(260) AM 2012 64934 A
(800) 1094872
(731) Henkel AG & Co. KgaA
Henkelstraße 67, 40589 Düsseldorf, Germany
(540)

Fa

NATURAL & CARE

(591) Black, white
(511)
3 – Soaps for personal use, body and beauty care preparations, namely foam bath preparations, bath additives and shower gels, body lotions, deodorants for personal use.

(260) AM 2012 64935 A
(800) 1094893
(731) SWATCH AG (SWATCH SA) (SWATCH LTD)
Jakob-Stämpfli-Strasse 94, CH-2502
Biel/Bienne, Switzerland
(540)

DR. SWATCH

(591) Black, white
(511)
14 – Timepieces and chronometric instruments and parts thereof including watch cases, dials and bands; jewelry and parts thereof.
37 – Repair and maintenance of watches, chronometers, clocks and wall clocks and jewelry.

(260) AM 2012 64936 A
(800) 1094930
(731) PRYSMIAN CAVI E SISTEMI S.R.L.
Viale Sarca, 222, I-20126 Milano (MI), Italy

(540)

FOS

(591) Black, white

(511)

9 – Electrical cables, optical cables, optical fiber, terminals (electricity), transformers, industrial plants in the form of distribution stations, switching stations, main grids and grid stations for the production and distribution of electricity including electricity distribution networks; apparatus and instruments for supervision, remote control, checking and measuring of electricity and energy consumption and for automatic operation of power plants; electrical connectors; transformers; data processing equipment and recorded computer programs to be used in the production, distribution and control of energy and electricity; solar cells and solar batteries for the generation of electricity and energy; land surveying instruments; detectors and alarm devices for industrial purposes and for use in energy production and distribution.

(260) AM 2012 64937 A

(800) 1094950

(731) Zürich Versicherungs-Gesellschaft AG
(Zurich Compagnie d'Assurances SA)
(Zurigo Compagnia di Assicurazioni SA)
(Zurich Insurance Company Ltd) (Zurich
Compañía de Seguros SA)
Mythenquai 2, CH-8002 Zürich, Switzerland

(540)

ZURICH INFOSHELF

(591) Black, white

(511)

9 – Data organizing and backup software; data accessing software.

16 – Paper, cardboard and goods made from these materials, not included in other classes; printed matter; bookbinding material; stationery.

36 – Insurance underwriting; financial affairs; monetary affairs.

(260) AM 2012 64938 A

(800) 1094954

(731) MERTKARDEŞLER DAYANIKLI
TÜKETİM MALLARI NAKLİYAT GIDA
AKARYAKIT TEKSTİL İNŞAAT VE
SANAYİ TİCARET LİMİTED ŞİRKETİ
Rıza Yalçın Cad. No: 20, Merkez Iğdır,
Turkey

(540)

babil

(591) Black, white

(511)

9 – Instruments and apparatus used for measurement including for scientific and laboratory purposes; indicators, and materials used in laboratory; apparatus for recording, transmission or reproduction of sound and images (including apparatus for data processing, communication, and reproduction purposes, computer software and hardware); magnetic, optic or exposed film record carriers; antennas, satellite antennas, amplifiers and parts thereof; automatic vending machines, ticket automates, cash machines; electronic elements used in electronic apparatus and electronic devices; counters and timers; protective clothing, protecting and life saving equipments; glasses, sun glasses, lenses and their boxes, cases, parts, and accessories; electric transmission, conversion, storage control apparatus and devices (including cables and power resources used in electrics and electronics); warning apparatus and alarms (other than vehicle alarms), electric alarm bells; electric irons and steam irons, press irons; apparatus and instruments for traffic signalization; fire-extinguishing apparatus and devices including vehicles for fire-extinguishing purposes; apparatus for electric welding machines (including welding electrodes); radars, submarine radars (sonars), night vision devices and apparatus; electric devices for destroying and repelling flies and insects; automatic doors for buildings, electric, electronic or remote control opening-closing installations for building and vehicle doors; apparatus for electrolysis and galvanization; anodes, cathodes; magnets, decorative magnets.

11 – Lighting installations (lighting apparatus for vehicles, interior and exterior sites), namely, lamps, bulbs, projector lamps, lanterns, chandeliers, lamp glasses, lamp mantles, lamps for directional signals and park lights of vehicles (bulbs), headlights, stop lights, glasses for signals and park lights, vehicle reflectors, reflector lamps, devices for heating and vapor producing installations, namely, stoves (heating apparatus), boilers for central heating and natural gas installations, gas boilers, burners, heaters, heaters for baths, radiators, heat pumps, electric water boilers, solar collectors and devices, heating apparatus for solid, liquid or gaseous fuels, cookers, acclimatization and air-conditioning devices, namely, acclimatizers, air blowing fans, ventilators, air-conditions including for vehicles; air disinfecting and cleaning devices, installations and their parts and accessories for residences; coolers, refrigerators, deep freezers, ice boxes, ice machines and devices, electric and gas operated tools, machines and equipment used in cooking and boiling, namely, toasters, bread toasters, deep fryers, gridirons, grills, ovens, stoves, corn-poppers, autoclaves, coffee and tea machines, water boilers (kettles) and their parts, electric hair-dryers, hand drying apparatus for washrooms; bath tubs, bidets,

bath installations, namely, shower enclosures, urinals (sanitary fixtures), water closets, toilet rooms, lavatories, sinks and construction elements of these installations, valves for water and heating installations, thermostatic valves as parts of heating installations, level controlling valves in tanks, regulators regulating accessories for water or gas apparatus, whirlpool-jet apparatus for automatic watering installations, water-pipes for sanitary installations, watering machines for agricultural purposes; water softening apparatus and installations, water purifying apparatus and machines, namely, water purifiers; skin moisturizing machines, tanning apparatus, sun beds, solarium devices, electric operated bed warmers and blankets (not for medical purposes); electric operated cushions heating (not for medical purposes); electric or non-electric foot warmers; foot muffs (electrically heated); hot water bottles, thermofores, aquarium filters, filtration-motor combination apparatus; aquarium heaters and lights, industrial type furnaces, industrial type dryer installations, industrial type cooling installations, cooling towers, air cooling apparatus, pasteurisers and sterilizers.

20 – Furniture, cupboards; medicine cabinets; tables, work benches, vice benches (not of metal); chests, not of metal; fixed towel dispensers, not of metal; cushions; hydrostatic beds, not for medical purposes; sleeping bags for camping; mirrors (looking glasses); beehives, honeycombs; cradles; number plates, not of metal; signboards of wood or plastics; barrels, not of metal; casks, not of metal; boxes of wood or plastics; containers, not of metal, for storage and transport; transport pallets, not of metal; packaging containers of plastic; picture frames; curtain hooks, curtain rings, curtain rods; tool handles, not of metal; latches, not of metal; stoppers for bottles, not of glass, metal or rubber; bottle caps, not of metal; corks for bottles; rivets (not of metal), screws (not of metal), pipe or cable dips of plastics; coat hangers; display boards; wax figures; statues of wood, wax, plaster or plastic; busts of wood, wax, plaster or plastic; decorations of plastic for foodstuffs; tailors' dummies; decorative wall plaques (not of textile); stuffed animals; baskets (not of metal), bakers' bread baskets, fishing baskets; nesting boxes for household pets; ladders of wood or plastic; pulleys of plastics for blinds; non-mechanical reels, not of metal, for flexible hoses; valves (not of metal) other than parts of machines; identification bracelets (not of metal) for hospitals, identity plates (not of metal); door fittings (not of metal), window fittings (not of metal); locks (other than electric), not of metal; furniture shelves; bamboo curtains, bead curtains for decoration.

21 – Non-electric cleaning tools and appliances (brushes except for painting brushes, including steel

chips, sponges, steel wool, cleaning wool, cleaning and wiping clothes made of textile, dish-washing gloves, non-electric polishing machines, carpet brooms, mops); toothbrushes, electrical toothbrushes, dental floss, shaving brushes, hair brushes, combs; non-electrical tools and utensils for household and kitchen use; ironing boards, ironing board covers, laundry drying racks, cloth hangers; cages and litter boxes for pets, plant and animal raising areas used in the household (terrariums); decorative articles, statues, knickknacks (ornamental plates), vases, cups given during sports competitions made of glass, porcelain, ceramic, clay; mousetraps, insect traps, fly catchers, flyswatters, covers for toilets; perfume burners (burners giving off scents when lit), perfume sprays and vaporizers (atomizers), non-electric devices made of sponges for removing makeup, powder puffs, boxes for toilet articles; spraying hose heads, heads for water sprinklers, watering sprinklers, garden watering sprinklers, tips connected to faucets; wrought glass, partially wrought glass, glass mosaics and glass powder for decorative purposes (except for building), glass wool (not for insulation and textile purposes).

(260) AM 2012 64939 A
 (800) 1094970
 (731) LPP S.A.
 ul. Łąkowa 39/44, PL-80-769 Gdańsk, Poland
 (540)



(591) Red, navy blue and white
 (511)
 25 – Clothing, footwear, headgear.

35 – Advertising, sale of clothing, footwear and headgear.

(260) AM 2012 64940 A
 (800) 1094979
 (731) LYONESS AUSTRIA GMBH
 Kaerntnerstrasse 9, A-8010 Graz, Austria
 (540)

LYONESS

(591) Black, white
 (511)
 9 – Magnetic data carriers, especially encoded magnetic cards, magnetic code cards and cards for identifying persons; automatic vending machines and mechanisms for coin-operated apparatus.

35 – Advertising, especially advertising for all kinds of goods and vouchers and means of cashless payments; arranging commercial transactions and services as far as included in this class; business management; office functions; business organization consultancy; advisory services for business management; public relations; publication of publicity texts; sales promotion of goods and services for others including advertisement, promotional competitions, discounts and incentives in the form of lotteries, reductions, bonus points and value added offers; on-line advertising on a computer network.

36 – Financial affairs; monetary affairs; issuance, distribution and procurement of vouchers and means of cashless payment.

38 – Providing user access to a global computer network (service providers); providing user access to information on the Internet.

41 – Providing of training, especially trainings and schoolings concerning sales promotions and customer acquisition.

(260) AM 2012 64943 A

(800) 1094983

(731) Trading and Industrial ALEF Corporation
1 Sobinova street, Dniepropetrovsk 49083,
Ukraine

(540)



(591) Blue

(511)

30 – Coffee, tea, cocoa, sugar, rice, tapioca, sago, artificial coffee; flour and preparations made from cereals, bread, pastry and confectionery, ices; honey, treacle; yeast, baking-powder; salt, mustard; vinegar, sauces (condiments); spices; ice, allspice, almond confectionery, almond paste, aniseed, aromatic preparations for food, artificial coffee, baking powder, baking soda (bicarbonate of soda for cooking purposes), crushed barley, husked barley, barley meal, bean meal, bee glue (propolis) for human consumption, beer vinegar, chocolate-based beverages, cocoa-based beverages, coffee-based beverages, flavorings (flavourings), other than essential oils, for beverages, tea-based beverages, bicarbonate of soda for cooking purposes (baking soda), binding agents for ice cream (edible ices), biscuits, bread, ginger bread, bread rolls, bread-crumbs, buns, cake paste, cake powder, cakes, edible decorations for cakes, flavorings (flavourings), other than essential oils, for cakes, rice cakes, candy for food, capers, caramels (candy), edible decorations for cakes, flavorings (flavourings),

other than essential oils, for cakes, rice cakes, candy for food, capers, caramels (candy), celery salt, cereal preparations, cereal-based snack food, chewing gum, not for medical purposes, chicory (coffee substitute), chips (cereal products), chocolate, chocolate beverages with milk, chocolate-based beverages, chow-chow (condiment), confectionery for decorating Christmas trees, chutneys (condiments), cinnamon (spice), cloves (spice), cocoa, cocoa beverages with milk, cocoa products, cocoa-based beverages, coffee, artificial coffee, coffee beverages with milk, coffee flavorings (flavourings); vegetal preparations for use as coffee substitutes; unroasted coffee; coffee-based beverages; condiments; confectionery; confectionery for decorating Christmas trees; cookies; cooking salt; corn flakes; corn flour; corn meal; corn, milled; pop corn; corn, roasted; couscous (semolina); crackers; ice cream; curry (spice); custard, edible decorations for cakes; dressings for salad; edible ices; (essences for foodstuffs, except etheric essences and essential oils; farinaceous food pastes; farinaceous foods; ferments for pastes; corn flakes; maize flakes; oat flakes; flavorings, other than essential oils; flavourings, other than essential oils, for beverages; flavourings, other than essential oils, for cakes; flavourings, other than essential oils; flavourings, other than essential oils, for beverages; flavourings, other than essential oils, for cakes; flour for food; flour-milling products; fondants (confectionery); farinaceous foods; essences for foodstuffs, except etheric essences and essential oils; frozen yoghurt (confectionery ices); frozen yogurt (confectionery ices); fruit jellies (confectionery); garden herbs, preserved (seasonings); ginger (spice); gingerbread; glucose for food; gluten for food; golden syrup; meat gravies; groats for human food; gruel, with a milk base, for food; chewing gum, not for medical purposes; halvah; hominy; hominy grits; honey; husked barley; husked oats; ice cream; binding agents for ice cream; ice for refreshment; ice, natural or artificial; iced tea; binding agents for edible ices; edible ices; powder for edible ices; infusions, not medicinal; fruit jellies (confectionery); royal jelly for human consumption, not for medical purposes; ketchup (sauce); leaven; liquorice (confectionery); lozenges (confectionery); macaroni; macarons (pastry); maize flakes; maize flour; maize meal; maize, milled; maize, roasted; malt biscuits; malt extract for food; malt for human consumption; maltose; marzipan; mayonnaise; meal; meat gravies; meat pies; meat tenderizers, for household purposes; mint for confectionery; molasses for food; muesli; mustard; mustard meal; noodles; nutmegs; oat flakes; oat-based food; oatmeal; crushed oats; husked oats; pancakes; pasta; almond paste; cake paste; soya bean paste (condiment); farinaceous food pastes; pastilles (confectionery); pastries; pastry; pasty; pâté (pastries); peanut confec-

tionery; pepper; peppermint sweets; peppers (seasonings); petit-beurre biscuits; petits fours (cakes); pies; meat pies; pizzas; popcorn; potato flour for food; cake powder; powders for ice cream; pralines; salt for preserving foodstuffs; propolis (bee glue) for human consumption; puddings; quiches; ravioli; relish (condiment); ribbon vermicelli; rice; rice cakes; rice-based snack food; bread rolls; royal jelly for human consumption, not for medical purposes; rusks; saffron (seasoning); sago; dressings for salad; cooking salt; salt for preserving foodstuffs; sandwiches; tomato sauce; sauces (condiments); sausage binding materials; sea water for cooking; seasonings; semolina; sherbets (ices); cereal-based snack food; rice-based snack food; sorbets (ices); soya bean paste (condiment); soya flour; soya sauce; spaghetti; spices; spring rolls; star aniseed; starch for food; stick liquorice (confectionery); preparations for stiffening whipped cream; sugar; sugar confectionery; sushi; natural sweeteners; sweetmeats (candy); peppermint sweets; tabbouleh; tacos; tapioca; tapioca flour for food; tarts; tea; iced tea; tea-based beverages; thickening agents for cooking foodstuffs; tomato sauce; tortillas; turmeric for food; unleavened bread; vanilla (flavoring) (flavouring); vanillin (vanilla substitute); vegetal preparations for use as coffee substitutes; vermicelli (noodles); ribbon vermicelli; vinegar; waffles; sea water for cooking; weeds (condiment); wheat flour; preparations for stiffening whipped cream; yeast; yeast in pill form, not for medical use; frozen yoghurt (confectionery ices); frozen yogurt (confectionery ices).

(260) AM 2012 64944 A
 (800) 1094985
 (731) PRYSMIAN CAVI E SISTEMI S.R.L.
 Viale Sarca, 222, I-20126 Milano (MI), Italy
 (540)



(591) Black, white
 (511)
 9 – Electrical cables, optical cables, optical fiber, terminals (electricity), transformers, industrial plants in the form of distribution stations, switching stations, main grids and grid stations for the production and distribution of electricity-including electricity distribution networks; apparatus and instruments for supervision, remote control, checking and measuring of electricity and energy consumption and for automatic operation of power plants; electrical connectors; transformers; data processing equipment and recorded computer programs to be used in the production, distribution and control of energy and electricity; solar cells and

solar batteries for the generation of electricity and energy; land surveying instruments; detectors and alarm devices for industrial purposes and for use in energy production and distribution.

(260) AM 2012 65015 A
 (800) 1095449
 (731) VAILLANT GMBH
 Berghauser Str. 40, 42859 Remscheid, Germany
 (540)



(591) Red, black and white
 (511)
 7 – Parts for combined heat and power installations, namely internal combustion engines, generators and internal combustion engines with coupled heat exchanger to generate electricity and heat production, engines (except for land vehicles), engines to be used at the cogeneration plant, gas operated power generators for combined heat and power plants, steam operated power generators for combined heat and power plants.

9 – Apparatus and installations for electricity generation, namely fuel cells; physical, electric and electronic measuring, control and regulating apparatus, included in this class, in particular for electricity, oil or gas fired heating, cooking, refrigerating, drying, ventilating, water supply, water heaters, in particular, instantaneous water heaters, storage water heaters, combination central heating and service water heaters, boilers, burners and heat storage devices, apparatus and instruments for conducting, switching, transforming, accumulating, regulating or controlling electricity; inverter, fuel cells for the use in combined heat and power plants.

11 – Apparatus for lighting, heating, steam generating, cooking, refrigerating, drying, ventilating, water supply, water heater, solar equipment (heating), boilers and burners, heat regenerators for combined heat and power plants, heat pumps being parts of combined heat and power installations; fuel cell heating apparatus.

35 – Business management, business administration, office functions, advertising, arranging of contracts for third parties with energy and electricity suppliers, producers and consumers, business management and organization consultancy services with regard to lighting, heating, steam generating, cooking, refrigerating, drying, ventilation systems, water supply, water heaters, boilers and burners, systems for combined heat and power, heat pumps, cogeneration, fuel cells, fuel cell heating appli-

ances, machinery for power and energy, machine tools, motors (except for land vehicles), measurement, and control equipment, apparatus and instruments for conducting, switching, transforming, accumulating, regulating or controlling electricity.

37 – Installation, assembly, maintenance and repair of lighting, heating, steam generating, cooking, refrigerating, drying, ventilating apparatuses, water supply, water heaters, boilers and burners, systems for combined heat and power, heat pumps, cogeneration, fuel cells, fuel cell heating appliances, machinery for power and energy, machine tools, motors (except for land vehicles), measurement, and control equipment, apparatus and instruments for conducting, switching, transforming, accumulating, regulating or controlling electricity.

39 – Transportation, packaging and storage of goods, supply of energy and fuel.

40 – Treatment and coating of metal surfaces, custom assembling of plastic and composite parts for others, production and processing of fuels and of other sources of energy.

42 – Engineering services, design and development in the fields of energy production; technical advice on heat engineering equipment; design of advertising material.

(260) AM 2012 65016 A

(800) 1095487

(731) CLOSED JOINT-STOCK COMPANY
"FABRIKA "RUSSKIY SHOKOLAD"
ul. Vereiskaya, d. 29, str. 143, RU-121357
Moscow, Russian Federation

(540)

FELICITA

(591) Black, white

(511)

30 – Cocoa; bread, pastry and confectionery.

(260) AM 2012 65018 A

(800) 1095512

(731) LIMITED LIABILITY COMPANY "MIND
LABS."
Str. 8, d. 34, ul. B. Pochtovaya, RU-105082
Moscow, Russian Federation

(540)

IMIND

(591) Black, white

(511)

9 – Scientific, nautical, surveying, photographic, cinematographic, optical, weighing, measuring, signalling, checking (supervision), life-saving and

teaching apparatus and instruments; apparatus and instruments for conducting, switching, transforming, accumulating, regulating or controlling electricity; apparatus for recording, transmission or reproduction of sound or images; magnetic data carriers, recording discs; automatic vending machines and mechanisms for coin-operated apparatus; cash registers, calculating machines, data processing equipment and computers; fire-extinguishing apparatus.

28 – Games and playthings; gymnastic and sporting articles not included in other classes; decorations for Christmas trees.

32 – Mineral and aerated waters and other non-alcoholic drinks; fruit drinks and fruit juices; syrups and other preparations for making beverages.

38 – Telecommunications.

41 – Education; providing of training; entertainment; sporting and cultural activities.

42 – Scientific and technological services and research and design relating thereto; industrial analysis and research services; design and development of computer hardware and software.

45 – Legal services; security services for the protection of property and individuals; mediation.

(260) AM 2012 65019 A

(800) 1095513

(731) RORO GmbH – R. Rott
Kalkgrub 1-2, 84427 Sankt Wolfgang,
Germany

(540)

ROROTT

(591) Black, white

(511)

6 – Base metals and the alloys thereof; construction materials made of metal; transportable constructions made of metal; materials of metal for railway tracks; cables and wires made of metal (not for electric purposes); ironmongery, small items of metal hardware; metal pipes; safes; goods made of metal, as far as included in this class; ores; doors, windows, gates, roller shutters, folding shutters, roller shutter housings as well as guide runners for roller shutters; frames for windows, doors and gates, in particular garage doors; frames with and without fixed glazing; frames with and without window glazing; connecting strips for windows, doors, gates and frames; garage doors; door, window and gate fittings; locks (with the exception of electric ones), door and door openers (not electric), door and gate closers (not electric); window, door and gate frame connectors as well as profiles for the production thereof; window, door and gate frames

as well as profiles for the production thereof; door and gate leaves, infill for door and gate leaves; all of the afore-mentioned goods made of metal, preferably made of aluminum; wall windows, exterior wall windows, roof windows, front doors, exterior doors, entrance doors, interior doors, house entrance doors, side entrance doors, multi-purpose doors, multi-purpose front doors, main entrance doors, in each case of metal; accessories for door and window openers; window sills and accessories, balcony door knobs, widening profiles for window frames; window sill connecting profiles, false edge profiles, base frame profiles, sets of cover caps for door and window fittings; plain wear strips, angled fillets for window frame corners and door frame corners, roller shutter guide rails, roller shutter new construction rails, fastening screws for roller shutter guides, roller shutter assembly set; insect protection roller blinds, knobs, door knobs, tool knobs, window knobs, openers, window openers, door openers, door handles, non-electric locks; all of the afore-mentioned goods made of metal.

9 – Locks (electric), door and gate openers (electric), door and gate closers (electric).

11 – Apparatus for lighting, heating, steam generating, cooking, refrigerating, drying, ventilating and water supply and sanitary purposes; saunas, infrared heat cabins, sauna heaters.

19 – Construction materials (not made of metal); pipes (not made of metal) for construction purposes; asphalt, pitch and bitumen; transportable constructions (not made of metal); historical monuments (not made of metal); doors, windows, gates, roller shutters; folding shutters, roller shutter housings as well as guide runners for roller shutters; frames for windows, doors and gates, in particular garage doors; frames with and without fixed glazing; frames with and without window glazing; connecting strips for windows, doors, gates and frames; construction glass, window glass (except for glass for vehicle windows); garage doors; door, window and gate frame connectors as well as profiles for the production thereof; window, door and gate frames as well as profiles for the production thereof; door and gate leaves, infill for door and gate leaves; all of the afore-mentioned goods made of wood and/or plastic; wall windows, exterior wall windows, roof windows, front doors, exterior doors, entrance doors, interior doors, house entrance doors, side entrance doors, multi-purpose doors, multi-purpose front doors, main entrance doors, in each case of wood construction; window sills and accessories, widening profiles for window frames, window sill connecting profiles, false edge profiles, base frame profiles, roller shutter guide rails, roller shutter new construction rails, roller shutter assembly sets, insect protection roller blinds, all of the afore-mentioned goods not made of metal.

20 – Furniture, mirrors, picture frames; goods (not included in other classes) of wood, cork, reed, cane, wicker, horn, bone, ivory, whalebone, shell, amber, mother-of-pearl, meerschaum and substitutes for all these materials, or plastics; door handles, not made of metal; door locks, not made of metal; door, window and gate fittings as well as locks (with the exception of electric ones), not made of metal; balcony door handles, sets of cover caps for door and window fittings, plain wearstrips, angled fillets for window frame corners and door frame corners, knobs, window knobs, tool knobs, openers, opener sets, window openers, door openers, door handles; fastening screws for roller shutter guides; all of the afore-mentioned goods not made of metal.

35 – Advertising; business management; business administration; clerical services.

37 – Installation of doors and windows; cleaning of windows; installation of glass; repair of doors and windows.

(260) AM 2012 65020 A

(800) 1095535

(731) GUMİ GIDA SANAYİ VE TİCARET
LİMİTED ŞİRKETİ

Örnek Mah. 1541., Sk. Dr. Esat, Oktay İş
Merkezi No:3, Esenyurt/İSTANBUL,

Turkey

(540)

YUMMY GUMMY

(591) Black, white

(511)

30 – Coffee, cacao; coffee or cacao based beverages, chocolate based beverages; pasta, raviolis, home made pasta; pastry and bakery products, desserts; honey, royal jelly, propolis; food flavorings; yeasts, baking powder; natural substances for improving shape and color of flour products and retarding its period of getting stale; all kinds of flour, semolina, corn starch; granulated sugar, cubed sugar, powdered sugar; teas, ice teas; confectionaries, chocolates, biscuits, crackers, wafers; chewing gums; ice cream, edible ice; salt; processed grains (cereal) and products.

(260) AM 2012 65021 A

(800) 1095539

(731) RETRACTABLE TECHNOLOGIES, INC.

511 Lobo Lane, Little Elm, TX 75068, USA

(540)



(591) Black, white

(511)

10 – Syringes for medical use, namely, needleless therapeutic syringes having a luer connector attachable to an intravenous fluid delivery system and a forwardly extending and outwardly inclined guide structure facilitating the attachment.

(260) AM 2012 65022 A

(800) 1095549

(731) KABUSHIKI KAISHA SONY COMPUTER ENTERTAINMENT (ALSO TRADING AS SONY COMPUTER ENTERTAINMENT INC.)

1-7-1 Konan, Minatoku, Tokyo 108-0075, Japan

(540)

PSVITA

(591) Black, white

(511)

9 – Optical apparatus and instruments; batteries for hand-held games with liquid crystal displays; straps for mobile phones; cleaning tapes for video tape recorders; head cleaning tapes for audio recorders or video recorders; optical pickup lens cleaning discs; cleaning discs for DVD; digital cameras; headphones; earphones; microphones; consumer electronic products, namely, audio amplifiers, audio speakers, audio receivers, electrical audio and speaker cables and connectors, home theater systems, audio decoders, video decoders, power conversion devices, power converters and power inverters; mobile computer terminal devices; remote controllers for mobile computer terminals; headphones for mobile computer terminals; mouse for mobile computer terminals; keyboards for mobile computer terminals; batteries for mobile computer terminals; earphones for mobile computer terminals; microphones for mobile computer terminals; memory cards for mobile computer terminals; handset cradles for mobile computer terminals; downloadable game programs via mobile computer terminals; other downloadable computer programs via mobile computer terminals; game programs for mobile phones; keyboards for computers; optical mouse; consumer video game consoles for use with an external display screen or monitor; game programs for consumer video game consoles for use with an external display screen or monitor; game programs for hand-held games with liquid crystal displays; game controllers for consumer video game consoles for use with an external display screen or monitor; headphones for consumer video game consoles for use with an external display screen or monitor; mouse for consumer video game consoles for use with an external display

screen or monitor; keyboards for consumer video game consoles for use with an external display screen or monitor; batteries for consumer video game consoles for use with an external display screen or monitor; earphones for consumer video game consoles for use with an external display screen or monitor; microphones for consumer video game consoles for use with an external display screen or monitor; memory cards for consumer video game consoles for use with an external display screen or monitor; handset cradles for consumer video game consoles for use with an external display screen or monitor; phonograph records; downloadable music files via the Internet; exposed cinematographic films; electronic publications; mouse exclusively for use with hand-held games with liquid crystal displays; keyboards exclusively for use with hand-held games with liquid crystal displays; memory cards exclusively for use with hand-held games with liquid crystal displays; headphones exclusively for use with hand-held games with liquid crystal displays; earphones exclusively for use with hand-held games with liquid crystal displays; microphones exclusively for use with hand-held games with liquid crystal displays; mounts connectable to AC adapters and D-terminal cables exclusively for hand-held games with liquid crystal displays; mounts exclusively for hand-held games with liquid crystal displays.

16 – Addressing machines; adhesive tapes for stationery or household purposes; albums; ball-point pens; bookmarkers; books; calendars; cards, stationery; crayons; diaries; electric pencil sharpeners; electric staplers for offices; felt writing pens; geographical maps; hand towels of paper; handkerchiefs of paper; hygienic paper; inking ribbons; instruction manuals; magazines; mechanical pencils; memo pads containing adhesive on one side of the sheets for attachment to surfaces; newsletters; newspapers; note books; pen cases; pencils; photograph stands; photographs; picture postcards; pocket memorandum books; printing paper; toilet paper; filter paper; postcard paper; rubber erasers; rulers for stationery and office use; seals, stationery; sketchbooks; specification manuals for video game programs; stands for pens and pencils; stapling presses, non-electric; stickers, stationery; strategic manuals for video games; table napkins of paper; towels of paper; writing pads.

28 – Amusement machines for use in amusement parks other than arcade video game machines; hand-held games with liquid crystal displays; cards for trading card games; astronaut-shaped toys; mini-car toys; radio control receivers and transmitters for model toys; motor controllers for model toys; toy model rockets; model toys; toy action figures; molded toy figures; dolls; dice games; chess games; dominoes; playing cards; trading card

games; playing cards and card game; billiard game playing equipment; badminton game playing equipment; archery bows; baseball gloves; bowling bags; boxing gloves; chest expanders; golf bags; golf ball markers; golf clubs; golf tees; guts for rackets for tennis or badminton; paragliders; racket cases for tennis or badminton; rackets for tennis or badminton; roller skates; ski bindings; ski cases; surf boards; waterskis.

41 – Amusement park and theme park services; arranging and conducting of concerts; arranging and conducting of seminars; arranging and conducting of workshops for training; booking of seats for shows; booking of theatre tickets; cinema presentations; conducting seminars in the field of video games; game services provided on-line from a computer network; information relating to entertainment and education, provided on-line from a computer database or the Internet; mobile library services; organization of video games; organization of competitions of video games; presentation of showing movies, shows, plays or musical performances; production of sound and image recordings on sound and image carriers; providing on-line electronic publications, not downloadable; provision of non-downloadable films, movies and television programs via an online video-on-demand service; reference libraries of literature and documentary records; rental of consumer video game consoles for use with an external display screen or monitor; ticket reservation and booking services for entertainment, sporting and cultural events; video recording services; providing game services via the Internet or computer networks; providing game services for enabling temporary use of game programs transmitted by accessing networks and to play repeatedly until power supply disconnection of consumer video game consoles for use with an external display screen or monitor; rental of memory medium recorded game programs for consumer video game consoles for use with an external display screen or monitor and electronic game machines with liquid crystal display; rental of toys.

42 – Computer rental; computer software design; computer programming; maintenance of computer software; computer software design, computer programming or maintenance of computer software for amusement apparatus adapted for use with television receivers only; creating or maintaining of websites for others; data conversion from physical to electronic media; data conversion of computer programs and data (not physical conversion); designing of machines; designing of consumer video game consoles adopted for use with an external display screen or monitor; duplication of computer programs; installation of computer software; Providing temporary use of online applications and software tools; providing temporary use of non-downloadable software applications ac-

ssible via a web site; providing temporary use of on-line non-downloadable operating software for computer networks and servers; providing temporary use of on-line non-downloadable operating software for accessing and using a cloud computing network; providing temporary use of Internet security programs; providing computer programs in data networks; providing information about computer software design, computer programming, or maintenance of computer software for defending system from unlawful computer access and for protecting security of computer networks; rental of computer programs; rental of CD-ROMs featuring programs for computer system security of video game consoles adopted for use with television for personal use; rental of server's memory.

(260) AM 2012 65024 A

(800) 1095591

(731) FERRER INTERNACIONAL S.A.

Gran Vía de Carlos III, 94, E-08028

BARCELONA, Spain

(540)

ΓΑΡΟΚΣΑΗ

(591) Black, white

(511)

5 – Antibiotic products.

(260) AM 2012 65065 A

(800) 1095998

(731) H. von Gimborn GmbH

Albert-Einstein-Strasse 6, 46446 Emmerich,

Germany

(540)

GIMBORN®

(591) Black, white

(511)

3 – Bleaching preparations and other substances for laundry use; cleaning, polishing, scouring and abrasive preparations; soaps; animal perfumes, room perfumes, essential oils, deodorants, in particular with a base of essential oils, cosmetics, hair lotions; dentifrices, cosmetics for animals, mouth washes for animals, not for medical purposes; breath freshening aerosols for animals, shampoos for pets, deodorants for animal use; medicated shampoo for use with animals.

5 – Pharmaceutical and veterinary preparations; sanitary preparations for medical purposes; dietetic substances adapted for medical and veterinary use; pharmaceutical and medicinal complementary foodstuffs for animals and additives for foodstuffs for

animals; vitamin concentrates, protein concentrates, calcium preparations, minerals, trace elements and electrolyte preparations, all for medical purposes and as additives for foodstuffs for animals, all the aforesaid goods in particular for administering to small animals, including rodents, dogs and cats; disinfectants; fungicides; disinfection preparations for household pets and cattle, including in the form of powders, sprays or collars; medicated cleaning preparations for use with animals.

16 – Printed matter; book binding material; photographs; articles of stationery; adhesives for stationery or household purposes; artists' materials; paint brushes; typewriters and office requisites (except furniture); instructional and teaching material (except apparatus); printers' type; printing blocks; paper; cardboard; boxes of cardboard or paper; posters; albums; cards; books; newspapers; prospectuses; pamphlets; calendars; writing instruments; engravings or lithographic works of art; paintings (pictures) framed or unframed; watercolour pictures; drawings; drawing instruments; paper handkerchiefs; face towels of paper; table linen of paper; toilet paper; napkins of paper and cellulose, disposable, including for animals; bag (envelopes, pouches) of paper, cardboard or plastic, for packaging; garbage bags of paper or plastic; bags and boxes of cardboard, paper or plastic for collecting animal excrement.

18 – Leather and imitations of leather, and goods made of these materials, included in this class; animal skins, hides; trunks and travelling bags; in particular collars, muzzles, whips, leads, animal fittings and harnesses, dog coats, net bags for shopping or shopping bags; bags or sachets (envelopes, pouches) of leather, for packaging; wallets; change purses; bags, backpacks, wheeled shopping bags, travelling bags; bags for climbers, bags for campers, travelling bags, beach bags, school bags; beauty cases; saddlery, bags for carrying animals (included in this class), clothing and non-edible chews for animals; the aforesaid goods in particular for household pets.

22 – Ropes, string, nets, tents, awnings, tarpaulins, sails, sacks and bags (not included in other classes); padding and stuffing materials (except of rubber or plastics); raw fibrous textile materials; stuffing materials for bedding, all for use with domestic pets; sawdust for use in animal cages.

28 – Games and playthings, including chew toys; gymnastic and sporting articles, decorations for christmas trees; christmas trees of synthetic material; appliances for physical exercise or gymnastics; gaming balls; card games or board games; sailboards and surfboards; racquets; snowshoes; skis; protective paddings (parts of sports suits); play mats for animals; playing cards.

31 – Agricultural, horticultural and forestry products and grains, included in this class; fresh fruit and vegetables, potatoes and preparations made from these goods being non-medical supplements for animal foodstuffs; seeds, natural plants and flowers; foodstuffs for animals, including foodstuffs for rodents, dogs, cats, birds and fish, and biscuits, small delicacies and reward snacks; foodstuffs for animals, mixed feed, strengthening feed, rearing feed, mineral feed; complementary foodstuffs for animals and additives for foodstuffs for animals, mineral feed supplements, not for medical purposes; edible toys for animals, in particular chewing bones, digestible chewing bones and sticks for pets, feed supplements not for veterinary purposes; malt; bedding for animals; live animals; fresh fruit and fresh vegetables, potatoes, alimentary preparations included in this class for use as additives to such foodstuffs.

(260) AM 2012 65079 A

(800) 1096012

(731) ŠKODA AUTO A.S.

Tr. Václava Klementa 869, CZ-29360 Mladá
Boleslav, Czech Republic

(540)

Škoda Rapid

(591) Black, white

(511)

12 – Automobiles and their parts; all included in this class.

(260) AM 2012 65080 A

(800) 1096016

(731) BRITISH AMERICAN TOBACCO
(BRANDS) LIMITED

Globe House, 4 Temple Place, London
WC2R 2PG, United Kingdom

(540)

iTWIST

(591) Black, white

(511)

34 – Cigarettes, tobacco and tobacco products.

(260) AM 2012 65081 A

(800) 1096053

(731) KARTONSAN KARTON SANAYİ VE
TİCARET ANONİM ŞİRKETİ

Prof. Dr. Bülent Tarcan Sokak, Pak İş
Merkezi, No:5, K:3, Gayrettepe,
BEŞİKTAŞ-İSTANBUL, Turkey

(540)

Ekoprint

(591) Black, white

(511)

16 – Paper; cardboard; goods made from paper and cardboard, not included in other classes, namely, coasters made of paper or of cardboard, articles, paper for pastry and sorbets, hand-towels of paper, paper tablecloths, paper table linen, face towels of paper, paper handkerchiefs, cardboard articles, namely, cardboard; paper bags, small paper bags, paper envelopes, small paper bags for wrapping; packaging materials, namely, cardboard packaging, paper pouches for packaging, bobbins and spools of paper or cardboard, for packaging purposes, plastic bubble packs for wrapping or packaging; carry bags of plastics, namely, plastic shopping bags, plastic trash bags, plastic lunch bags, bookbinding material, namely bookbinding tape, bookbinding wire, bookbindings, cloth for bookbinding, printing type, printing blocks, printed matter and periodical publications, namely, books, magazines, newspapers, journals, reviews, pamphlets, catalogues, leaflets, vouchers and coupons, all in the field of travel, tickets, and posters, writing paper, copy paper, parchment paper, carbon paper, paper rolls for calculating machines, notebook paper, note papers, envelopes, loose-leaf pads, book covers, notebook covers, writing instruments, namely, pencils, ballpoint pens, pen nibs, typewriters and office requisites, namely, staplers, rubber bands, punches, paper embossers, envelope sealing machines, franking machines, finger-stalls, correcting fluid for type, paint brushes, paint applicator rollers.

34 – Raw or manufactured tobacco; tobacco goods, including cigars, cigarettes, cigarillos, hand-rolling tobacco, pipe tobacco, chewing tobacco, snuff, kretek; tobacco substitutes (for non-medical purposes); smokers' articles, including cigarette paper and tubes, cigarette filters, tobacco boxes, cigarette cases and ashtrays not of precious metal, of alloys thereof or plated therewith, pipes, pocket machines for rolling cigarettes, lighters; ashtrays; matches; match boxes.

(260) AM 2012 65082 A

(800) 1096059

(731) SHL Telemedicine International Ltd.
90 Yigal Alon St. 67891 Tel Aviv, Israel

(540)

SMART HEART

(591) Black, white

(511)

9 – An end-user system which enables communication and transmission of data from a distance by a

subscriber in distress directly to a center providing emergency services (appartus in the field of science).

10 – An end-user system which enables communication and transmission of medical data from a distance by a subscriber directly to a center providing medical emergency services (appartus for medical use).

38 – Services of transmission of medical data and information.

44 – Services rendered by using a technological system which enables remote supervision of medical care.

(260) AM 2012 65083 A

(800) 1096060

(731) Nechytailo-Ridjok Olga Volodymyrivna
7/10, Luteranska St., flat 14 Kyiv, 01001,
Ukraine

(540)

Celsius

(591) Black, white

(511)

33 – Alcoholic beverages, except beer; digesters (liqueurs and spirits); aperitifs; fruit extracts, alcoholic; brandy; vermouth; wine; whisky; distilled beverages; bitters; alcoholic beverages with herbs; vodka; pepper vodka; gin; cocktails; liqueurs; alcoholic beverages containing fruit; rum; spirits (beverages); alcoholic extracts; soft drinks (light alcoholic beverages)

(260) AM 2012 65084 A

(800) 1096070

(731) STRATEGIA SOCIETA' A
RESPONSABILITA' LIMITATA
Via Enzo Ferrari, 17, I-62012 CIVITANOVA
MARCHE (MC), Italy

(540)

ELENACHI

(591) Black, white

(511)

25 – Shoes, boots, half boots, leather shoes, galoshes, rain boots, sport footwear, sandals, slippers, shoe soles, shoe heels, footwear uppers; clothing items namely sweaters, cardigans, waistcoats, suits, trousers, shorts, jumpers, raincoats, clothing made of leather, stockings and socks, stocking suspenders, sock suspenders, wind resistant jackets, ski trousers, fur coats, overcoats, skirts, dresses, jackets, undershirts, T-shirts, sports jerseys and breeches for sports, blouses, shirt collars, shirts, fou-

lards, beachwear, swimsuits, bikini, tracksuits; wedding dresses, underwear, bras, brassiere, corsets, underpants, briefs, vests, nightgowns, negligees, pyjamas, gloves, shawls, scarves, neckties, bow ties, belts for clothing, suspenders, hats, caps.

(260) AM 2012 65085 A

(800) 1096075

(731) Daimler AG

Mercedesstrasse 137, 70327 Stuttgart,

Germany

(540)

SOLOSTAR

(591) Black, white

(511)

12 – Motor vehicles and parts therefor (included in this class).

(260) AM 2012 65086 A

(800) 1096076

(731) Andrey Nikolaevich Malakhov; 17, 1/9, ul.

Ostozhenka, RU-119034 Moscow, Russian

Federation

(540)

Андрей Малахов

(591) Black, white

(511)

16 – Almanacs; atlases; posters; pamphlets; booklets; newspapers; printed publications; calendars; tear-off calendars; catalogues; books; musical greeting cards; greeting cards; postcards; magazines [periodicals]; periodicals; song books; printed matter; prospectuses; graphic reproductions; photoengravings; photographs.

41 – Education; providing of training; entertainment; sporting and cultural activities; modelling for artists; academies [education]; rental of tennis courts; lending libraries; booking of seats for shows; videotaping; nursery schools; physical education; discotheque services; animal training; dubbing; gaming; publication of books; education information; recreation information; entertainment information; movie studios; health club services; club services [entertainment or education]; night clubs; microfilming; videotape editing; production of radio and television programmes; music-halls; game services provided on-line [from a computer network]; providing on-line electronic publications [not downloadable]; religious education; gymnastic instruction; correspondence courses; practical training [demonstration]; organization of balls; organization of exhibitions for cultural or educational purposes; providing recreation facilities; arranging and conducting of colloquiums; arranging and

conducting of congresses; arranging and conducting of conferences; arranging and conducting of workshops [training]; arranging and conducting of seminars; arranging and conducting of symposiums; arranging of beauty contests; organization of competitions [education or entertainment]; operating lotteries; holiday camp services [entertainment]; organization of shows [impresario services]; organization of sports competitions; vocational guidance [education or training advice]; amusement parks; sign language interpretation; television entertainment; bookmobile services; mobile library services; providing karaoke services; providing golf facilities; providing sports facilities; providing amusement arcade services; providing cinema facilities; providing movie theatre facilities; presentation of live performances; theatre productions; educational examination; timing of sports events; videotape film production; film production; rental of sound recordings; rental of audio equipment; rental of camcorders; rental of video cameras; rental of video cassette recorders; rental of videotapes; rental of show scenery; rental of movie projectors and accessories; rental of cine-films; rental of motion pictures; rental of stadium facilities; rental of lighting apparatus for theatrical sets or television studios; rental of radio and television sets; rental of skin diving equipment; rental of sports equipment [except vehicles]; rental of stage scenery; electronic desktop publishing; publication of electronic books and journals on-line; publication of texts [other than publicity texts]; radio entertainment; entertainer services; zoological gardens; news reporters services; party planning [entertainment]; music composition services; sport camp services; subtitling; providing casino facilities [gambling]; providing museum facilities [presentation, exhibitions]; educational services; instruction services; teaching; tuition; orchestra services; translation; scriptwriting services; recording studio services; digital imaging services; photography; photographic reporting; circuses; boarding schools; production of shows; layout services, other than for advertising purposes; arranging and conducting of concerts; writing of texts, other than publicity texts; calligraphy services; ticket agency services [entertainment].

(260) AM 2012 65087 A

(800) 1096079

(731) ROBERT BOSCH GmbH

Stuttgart, Germany

(540)

Bluegranite Turbo

(591) Black, white

(511)

7 – Power tools; parts and accessories for power tools namely drills, hollow core cutters, chisels, tool holders and adapters.

8 – Manually operated tools namely drills.

(260) AM 2012 65088 A
(800) 1096094
(731) FEMALON, SOCIÉTÉ ANONYME
Rue du Travail 16, B-4460 GRÂCE-
HOLLOGNE, Belgium
(540)

DIAFERT

(591) Black, white
(511)

5 – Pharmaceutical and veterinary products; sanitary products for medical purposes; dietetic substances adapted for medical use, food for babies; plasters, materials for dressings; material for dental fillings and dental impressions; disinfectants.

10 – Surgical, medical, dental and veterinary apparatus and instruments, artificial limbs, eyes and teeth; orthopedic articles; suture materials.

(260) AM 2012 65089 A
(800) 176494
(731) SOTHYS INTERNATIONAL
128, rue du Faubourg Saint-Honoré, F-75008
PARIS, France
(540)

SOTHYS

(591) Black, white
(511)

3 – All sanitary and beauty products, perfumery, soaps, cosmetics, make-up, creams, powders.

(260) AM 2012 65090 A
(800) 352971
(731) SOTHYS INTERNATIONAL
128, rue du Faubourg Saint-Honoré, F-75008
PARIS, France
(540)



(591) Black, white
(511)

3 – Bleaching, laundering, cleaning, polishing, degreasing and abrasive preparations, beauty products, make-up, creams, powders, soaps, perfumery, essential oils, cosmetics, hair lotions, dentifrices.

(260) AM 2012 65091 A
(800) 526240
(731) Ashland Nederland B.V.
Wioldrechtseweg 39, NL-3316 BG Dordrecht,
Netherlands
(540)

ALL-CLIMATE

(591) Black, white
(511)

4 – Industrial oils and greases; lubricants; fuels (including motor spirit) and illuminants.

(260) AM 2012 65092 A
(800) 575681
(731) MORELLATO S.P.A.
Via Commerciale, 29, I-35010 FRATTE DI
S. GIUSTINA IN COLLE (PD), Italy
(540)

CHRONOSTAR

(591) Black, white
(511)

14 – Alarm clocks, wristwatches, timepieces and chronometric instruments, parts and accessories of the aforesaid goods (included in this class) such as cases for clocks, movements for clocks and watches, watch bands, watch chains.

(260) AM 2012 65097 A
(800) 608241
(731) SOCIÉTÉ DES PRODUITS NESTLÉ S.A.
CH-1800 Vevey, Switzerland
(540)

ISOSOURCE

(591) Black, white
(511)

5 – Dietetic substances for medical use, food for babies.

29 – Meat, fish, poultry and game; meat extracts; preserved, dried and cooked fruit and vegetables; jellies, jams; eggs, milk and dairy products; edible oils and fats.

(260) AM 2012 65099 A
(800) 608734
(731) Actavis Group PTC ehf.
Reykjavikurvegi 76-78, IS-220
Hafnarfjordur, Iceland
(540)

COX

(591) Black, white
(511)

5 – Pharmaceutical and veterinary products.

(260) AM 2012 65100 A
 (800) 630669
 (731) GROUPE AUCHAN société anonyme à
 directoire et conseil de surveillance
 40, avenue de Flandre, F-59170 CROIX,
 France
 (540)

IN EXTENSO

(591) Black, white
 (511)
 25 – Ready-made clothing, knitwear and hosiery,
 lingerie, underwear, pajamas, dressing gowns,
 skirts, dresses, trousers, jackets, coats, shirts, neck-
 ties, scarves, belts, gloves, hats, waterproof gar-
 ments, sportswear; footwear, socks, stockings, tig-
 hts, boots, shoes and slippers; all clothing for men,
 women and children.

(260) AM 2012 65101 A
 (800) 657935
 (731) BASF SE
 Carl-Bosch-Strasse 38, 67056 Ludwigshafen,
 Germany
 (540)

STROBY

(591) Black, white
 (511)
 5 – Fungicides, herbicides, pesticides, preparations
 for destroying vermin.

(260) AM 2012 65102 A
 (800) 665041
 (731) FISCHERWERKE GMBH & Co. KG
 Weinhalde 14-18, 72178 Waldachtal,
 Germany
 (540)



(591) Black, white
 (511)
 1 – Chemical products for use in fastening, namely
 self-hardening synthetic resin adhesive masses for
 anchoring fastening elements and filled in cartrid-
 ges and/or capsules.

(260) AM 2012 65120 A
 (800) 1023402
 (731) DURAND PRODUCTION
 Zone Industrielle, F-62440 HARNES, France
 (540)

ARECA

(591) Black, white
 (511)
 1 – Antifreeze, cooling liquids, brake fluids; grease.
 3 – Windshield cleaning liquids.
 4 – Lubricants, industrial grease; lubricating oil.

(260) AM 2012 65121 A
 (800) 1041814
 (731) JOH. WILH. VON EICKEN GMBH
 Drechslerstrasse 1-3, 23556 Lübeck,
 Germany
 (540)

Jockey

(591) Black, white
 (511)
 34 – Tobacco; tobacco products, namely cigarettes,
 cigarillos, cigars, smoking tobacco, water pipe to-
 bacco, snuff; cigarette paper; smokers' articles
 included in this class.

(260) AM 2012 65122 A
 (800) 1041967
 (731) GIOCHI PREZIOSI S.p.A.
 Via del Lauro, 7, I-20121 Milano (MI), Italy
 (540)

EMOTION PETS

(591) Black, white
 (511)
 28 – Games and playthings; gymnastic and sporting
 articles not included in other classes; decorations
 for Christmas trees.

(260) AM 2012 65123 A
 (800) 1068483
 (731) "Ararat" Food Factory LLC
 House 13/1, Arabkir 29, Yerevan, Armenia
 (540)

արարատ
ԲԵՐԷ ՈՒ ԲԱՐԻՔ

(591) Black, white
 (511)
 29 – Preserved, frozen, dried and cooked fruits and
 vegetables; jellies, jams, compotes.

(260) AM 2012 65124 A
 (800) 1080289
 (731) JAPAN TOBACCO INC.
 2-2-1 Toranomom, Minato-ku, Tokyo, Japan

(540)



(591) Dark blue, blue, light blue, silver, gray and white

(511)

34 – Raw or manufactured tobacco; smoking tobacco, pipe tobacco, rolling tobacco, chewing tobacco, snus; cigarettes, cigars, cigarillos; substances for smoking sold separately or mixed with tobacco for non-medical and non-therapeutic purposes; snuff; smokers' articles included in this class; cigarette paper, cigarette tubes and matches.

(260) AM 2012 65144 A

(800) 1096448

(731) Quercus Publishing Plc; 21 Bloomsbury Square, London WC1A 2NS, United Kingdom

(540)

QUERCUS

(591) Black, white

(511)

9 – Electronic publications (downloadable); audio books; audio books in DVD and/or CD and/or cassette and/or web cast and/or pod cast form; audio recordings; electronic books, books in disc or tape form, digital books, digital periodicals, e-books, electronic content for use with e-book readers.

16 – Paper, cardboard and goods made from these materials, not included in other classes; printed matter; printed publications; books, magazines, newsletters, manuals, handbooks, periodicals, booklets, pamphlets, maps, charts; bookbinding material; photographs; stationery; instructional and teaching material (except apparatus); printers' type; printing blocks.

41 – Education; entertainment; publishing services; providing on-line electronic publications (not downloadable), publication of books, publication of electronic books and journals online, publication of

texts (other than publicity texts); multimedia publishing of books, magazines and other texts; production of television programmes.

(260) AM 2012 65145 A

(800) 1096452

(731) ZAKRYTOE AKTSIONERNOE

OBCHTCHESTVO "T.B.M."

g. Mytishchi, Volkovskoe shosse, vladenie

15, building 1, RU-141006 Moskovskaya

oblast, Russian Federation

(540)

MAXBAR

(591) Black, white

(511)

1 – Chemicals used in industry, science and photography, as well as in agriculture, horticulture and forestry; unprocessed artificial resins, unprocessed plastics; manures; fire extinguishing compositions; tempering and soldering preparations; chemical substances for preserving foodstuffs; tanning substances; adhesives used in industry; polish removing substances; glue for industrial purposes; surface-active chemical agents; chemical preparations for the manufacture of paints; protective gases for welding; ceramic glazings; china slip; ceramic compositions for sintering [granules and powders]; chemical additives for oils; additives, chemical, to motor fuel; tan-wood; auxiliary fluids for use with abrasives; glaziers' putty; lime chloride; catalysts; caustics for industrial purposes; acids; adhesives for wall tiles; adhesives for paperhanging; cement for mending broken articles; gums [adhesives], other than for stationery or household purposes; adhesives for industrial purposes; gluten [glue], other than for stationery or household purposes; isinglass other than for stationery, household or alimentary purposes; flocculants; starch paste [adhesive], other than for stationery or household purposes; oil cement [putty]; ceramic materials in particulate form, for use as filtering media; plastics, unprocessed; filtering materials [unprocessed plastics]; filtering materials [mineral substances]; filtering materials [chemical preparations]; filtering materials [vegetable substances]; soap [metallic] for industrial purposes; emollients for industrial purposes; clarification preparations; bases [chemical preparations]; rubber preservatives; brickwork preservatives, except paints and oils; cement preservatives, except paints and oils; preservatives for tiles, except paints and oils; biological preparations, other than for medical or veterinary purposes; opacifiers for enamel or glass; separating and unstickening [ungluing] preparations; preparations for preventing the tarnishing of lenses; preparations for preventing the tarnishing of glass; cement-waterproofing preparations, except paints; wallpaper re-

moving preparations; finishing preparations for use in the manufacture of steel; corrosive preparations; dehydrating preparations for industrial purposes; degreasing preparations for use in manufacturing processes; degumming preparations; bleaching preparations [decolorants] for industrial purposes; moistening [wetting] preparations for use in dyeing; moistening [wetting] preparations for use in bleaching; damp proofing preparations, except paints, for masonry; cellulose derivatives [chemicals]; mordants for metals; solvents for varnishes; chemical reagents, other than for medical or veterinary purposes; artificial resins, unprocessed; acrylic resins, unprocessed; epoxy resins, unprocessed; calcined soda; caustic soda for industrial purposes; salts for industrial purposes; salts for coloring [colouring] metal; (compositions for the manufacture of technical ceramics; acid proof chemical compositions; fireproofing preparations; alcohol; concrete preservatives, except paints and oils; water glass [soluble glass]; industrial chemicals; glass-frosting chemicals; glass-staining chemicals; enamel and glass staining chemicals; enamel-staining chemicals; soldering chemicals; condensation-preventing chemicals; anti-tarnishing chemicals for windows; chemical preparations, except pigments, for the manufacture of enamel; color-brightening chemicals for industrial purposes.

3 – Bleaching preparations and other substances for laundry use; cleaning, polishing, scouring and abrasive preparations; soaps; perfumery, essential oils, cosmetics, hair lotions; dentifrices; abrasives; canned pressurized air for cleaning and dusting purposes; polishing stones; abrasive paper; emery paper; polishing paper; floor wax; non-slipping wax for floors; polish for furniture and flooring; windscreen cleaning liquids; non-slipping liquids for floors; greases for cosmetic purposes; smoothing stones; silicon carbide [abrasive]; carbides of metal [abrasives]; alum stones [antiseptic]; tripoli stone for polishing; corundum [abrasive]; creams for leather; waxes for leather; polishing rouge; adhesives for cosmetic purposes; whitening; cleaning chalk; emery; polishing creams; abrasive cloth; glass cloth; sharpening preparations; shining preparations [polish]; dry-cleaning preparations; floor wax removers [scouring preparations]; rust removing preparations; wallpaper cleaning preparations; diamantine [abrasive]; scouring solutions; turpentine, for degreasing; bleaching soda; washing soda, for cleaning; bleaching salts; ammonia [volatile alkali] [detergent]; stain removers; detergents other than for use in manufacturing operations and for medical purposes; degreasers other than for use in manufacturing processes; cloths impregnated with a detergent for cleaning; glass paper; soda lye.

6 – Common metals and their alloys; metal building materials; transportable buildings of metal; mate-

rials of metal for railway tracks; non-electric cables and wires of common metal; ironmongery, small items of metal hardware; pipes and tubes of metal; safes; goods of common metal not included in other classes; ores; anchors; fittings of metal for building; ingots of common metal; bolts of metal; eye bolts; bells; bells for animals; letters and numerals of common metal, except type; busts of common metal; vice benches of metal; screws of metal; aviaries of metal [structures]; gates of metal; sleeves [metal hardware]; signboards of metal; nuts of metal; nails; brads; horseshoe nails; vice claws of metal; doors of metal; memorial plaques, of metal; packaging containers of metal; jalousies of metal; tinsplate; bungs of metal; plugs of metal; bolts, flat; window fasteners of metal; crampons of metal [cramps]; rivets of metal; padlocks; locks of metal for vehicles; locks of metal, other than electric; locks of metal for bags; spring locks; box fasteners of metal; machine belt fasteners of metal; door bolts; closures of metal for containers; bolts; wall plugs of metal; latches of metal; tension links; couplings of metal for chains; door bells, non-electric; numberplates, of metal; bronzes [works of art]; works of art of common metal; ironmongery; greenhouse frames of metal; framework for building of metal; cornices of metal; skating rinks [structures of metal]; keys; knobs of metal; bed casters of metal; furniture casters of metal; pillars of metal for buildings; sealing caps of metal; tent pegs of metal; rings of common metal for keys; copper rings; ferrules of metal; ferrules of metal for handles; rings of metal; door fittings, of metal; fittings of metal for windows; buildings, transportable, of metal; buildings of metal; guard rails of metal; baskets of metal; money boxes of metal; door cases of metal; stringers [parts of staircases] of metal; tubing of metal; roofing of metal; brackets of metal for building; hooks [metal hardware]; hooks for slate [metal hardware]; hooks of metal for clothes rails; clothes hooks of metal; bands of metal for tying-up purposes; scaffolding of metal; staircases of metal; ladders of metal; steel sheets; cast steel; traps for wild animals; reinforcing materials, of metal, for concrete; reinforcing materials of metal for machine belts; reinforcing materials of metal for pipes; reinforcing materials of metal for building; building materials of metal; refractory construction materials of metal; steel masts; common metals, unwrought or semi-wrought; metals in powder form; door knockers; monuments of metal; porches of metal [building]; roof flashing of metal; flashing of metal, for building; duckboards of metal; thread of metal for tying-up purposes; house numbers of metal, non-luminous; braces of metal for handling loads; wall claddings of metal [building]; wall linings of metal [building]; cladding of metal for construction and building; moldings of metal for cornices; laths of metal; fences of metal;

latticework of metal; ironwork for doors; ironwork for windows; windows of metal; casement windows of metal; props of metal; wainscoting of metal; partitions of metal; lintels of metal; strap-hinges of metal; shims; platforms, prefabricated, of metal; floor tiles, of metal; tiles of metal for building; anchor plates; tile floorings of metal; iron slabs; handling pallets of metal; firedogs [andirons]; roof coverings of metal; floors of metal; sills of metal; ceilings of metal; brazing alloys; gold solder; silver solder; door closers, non-electric; door openers, non-electric; iron wire; washers of metal; springs [metal hardware]; rods of metal for welding; rods of metal for brazing; enclosures of metal for tombs; window frames of metal; frames of metal for building; tanks of metal; gratings of metal; furnace fireguards; pulleys of metal, other than for machines; runners of metal for sliding doors; window pulleys; door handles of metal; tool handles of metal; pilings of metal; buckles of common metal [hardware]; door scrapers; shutters of metal; outdoor blinds of metal; statues of common metal; statuettes of common metal; pegs of metal; bars for metal railings; posts of metal; steps [ladders] of metal; slings of metal for handling loads; stair treads [steps] of metal; identity plates of metal; troughs of metal for mixing mortar; greenhouses of metal, transportable; angle irons; tinplate packings; stops of metal; door stops of metal; window stops of metal; wind-driven bird-repelling devices made of metal; door panels of metal; fittings of metal for beds; fittings of metal for furniture; building or furniture fittings of nickel-silver; chains of metal; balls of steel; hinges of metal; poles of metal; window casement bolts; cotter pins; building boards of metal; insect screens of metal; furnace fire screens; lock bolts; bins of metal.

8 – Hand tools and implements, hand-operated; cutlery; side arms; razors; glaziers' diamonds [parts of hand tools]; pestles for pounding; cutting bars; sharpening steels; hand drills [hand tools]; gimlets [hand tools]; carpenters' augers; crow bars; levers; nail drawers [hand tools]; cutter bars; whetstone holders; priming irons [hand tools]; bushhammers; lifting jacks, hand-operated; drills; shovels [hand tools]; rabbeting planes; bits [hand tools]; chisels; engraving needles; abrading instruments [hand instruments]; numbering punches; goffering irons; implements for decanting liquids [hand tools]; blade sharpening instruments; glazing irons; tube cutting instruments; riveters [hand tools]; expanders [hand tools]; cutting tools [hand tools]; hand tools, hand-operated; stamping-out tools [hand tools]; picks [hand tools]; stone hammers; sharpening stones; sharpening wheels [hand tools]; centre punches [hand tools]; pickaxes; mallets [hand instruments]; punch pliers [hand tools]; blades [weapons]; annular screw plates; spanners [hand tools]; ladles [hand tools]; foundry ladles [hand tools];

breast drills; holing axes; diggers [hand tools]; rams [hand tools]; emery grinding wheels; sledgehammers; pliers; shear blades; jig-saws; spatulas [hand tools]; spades [hand tools]; trowels; taps [hand tools]; hammers [hand tools]; fullers [hand tools]; masons' hammers; riveting hammers [hand tools]; needle files; files [tools]; hand pumps; knives; shears; scissors; agricultural implements, hand-operated; stropping instruments; screwdrivers; reamer sockets; drill holders [hand tools]; perforating tools [hand tools]; saws [hand tools]; guns, hand-operated, for the extrusion of mastics; guns [hand tools]; dies [hand tools]; saw blades [parts of hand tools]; tool belts [holders]; pin punches; punches [hand tools]; reamers; frames for handsaws; saw holders; rasps [hand tools]; cutters; cleavers; paring irons [hand tools]; graving tools [hand tools]; planes; marline spikes; augers [hand tools]; bits [parts of hand tools]; hollowing bits [parts of hand tools]; pruning scissors; drawing knives; scrapers [hand tools]; mortise chisels; caulking irons; gouges [hand tools]; mitre [miter (am.)] boxes [hand tools]; clamps for carpenters or coopers; mortars for pounding; hatchets; adzes [tools]; vices; hoop cutters [hand tools]; axes; fulling tools [hand tools]; ratchets [hand tools]; tube cutters [hand tools]; squares [hand tools]; extension pieces for braces for screwtaps; metal band stretchers [hand tools]; embossers [hand tools]; scraping tools [hand tools]; milling cutters [hand tools]; awls; palette knives; nippers.

17 – Rubber, gutta-percha, asbestos, mica and goods made from these materials and not included in other classes, plastics in extruded form for use in manufacture, packing, stopping and insulating materials, flexible pipes, not of metal; shock absorbing buffers of rubber; compressed air pipe fittings, not of metal; cellulose acetate, semi-processed; balata; asbestos paper; paper for electrical capacitors; insulating paper; asbestos felt; insulating felt; plastic fibers [fibres], not for textile use; carbon fibers [fibres], other than for textile use; asbestos fibers [fibres]; vulcanized fiber [fibre]; foam supports for flower arrangements [semi-finished products]; dielectrics [insulators]; floating anti-pollution barriers; lute; insulators; insulators for railway tracks; insulators for electric mains; insulators for cables; asbestos mill boards; liquid rubber; synthetic rubber; rubber, raw or semi-worked; valves of india-rubber or vulcanized fiber [fibre]; clack valves of rubber; rings of rubber; insulating paints; latex [rubber]; insulating tape and band; adhesive bands other than stationery and not for medical or household purposes; asbestos sheets; viscose sheets, other than for packing; foil of regenerated cellulose, other than for packing; insulating oils; insulating oil for transformers; reinforcing materials, not of metal, for pipes; sound-proofing materials; insulating materials; insulating

refractory materials; packing [cushioning, stuffing] materials of rubber or plastics; non-conducting materials for retaining heat; boiler composition to prevent the radiation of heat; filtering materials [semi-processed foams or films of plastic]; sealant compounds for joints; compositions to prevent the radiation of heat; bags [envelopes, pouches] of rubber, for packaging; pipe muffers, not of metal; asbestos packing; soldering threads of plastic; threads of plastic materials, not for textile use; threads of rubber, not for use in textiles; elastic threads, not for use in textiles; stops of rubber; asbestos soles; insulating gloves; insulating plaster; plastic film other than for wrapping; anti-dazzle films for windows [tinted films]; asbestos coverings; bark coverings for sound insulation; plastic sheeting for agricultural purposes; asbestos cloth; rubber stoppers; expansion joint fillers; clutch linings; washers of rubber or vulcanized fiber [fibre]; cords of rubber; draught excluder strips; gaskets; rubber solutions; mica, raw or partly processed; acrylic resins [semi-finished products]; artificial resins [semi-finished products]; junctions, not of metal, for pipes; substances for insulating buildings against moisture; chemical compositions for repairing leaks; glass wool for insulation; fiberglass for insulation; asbestos fabrics; fiberglass fabrics for insulation; insulating fabrics; hoses of textile material; waterproof packings; foils of metal for insulating; ebonite [vulcanite] molds [moulds]; asbestos slate; mineral wool [insulator]; canvas hose pipes; asbestos safety curtains; ebonite [vulcanite].

19 – Building materials (non-metallic), non-metallic rigid pipes for building, asphalt, pitch and bitumen, non-metallic transportable buildings, monuments, not of metal; door frames, not of metal; window frames, not of metal; beams, not of metal; balustrading; huts; concrete; building paper; busts of stone, concrete or marble; binding agents for making briquettes; binding material for road repair; stained-glass windows; felt for building; gates, not of metal; diving boards, not of metal; geotextiles; gypsum; plaster; potters' clay; earth for bricks; clay; gravel; granite; doors, not of metal; folding doors, not of metal; coal tar; memorial plaques, not of metal; shingle; worked timber; veneer wood; moldable wood; jalousies, not of metal; calcareous stone; lime; limestone; works of stonemasonry; works of art of stone, concrete or marble; building stone; rubble; artificial stone; framework, not of metal, for building; greenhouse frames, not of metal; cornices, not of metal; building cardboard [asphalted]; wood pulp board, for building; paperboard for building; skating rinks [structures, not of metal]; quartz; caissons for construction work under water; bricks; fire burrs; water-pipe valves, not of metal or plastic; drain traps [valves], not of metal or plastic; cask wood; mooring bollards, not of metal; cement posts; chimney pots, not of metal;

buildings, not of metal; buildings, transportable, not of metal; stringers [parts of staircases], not of metal; roofing, not of metal; paint spraying booths, not of metal; fair huts; building timber; manufactured timber; sawn timber; wood, semi-worked; staircases, not of metal; stair-treads [steps], not of metal; reinforcing materials, not of metal, for building; bituminous products for building; tar; planks [wood for building]; road coating materials; materials for making and coating roads; fireclay; building materials, not of metal; pitch; refractory construction materials, not of metal; raw chalk; calcareous marl; mosaics for building; marble; slate powder; porches, not of metal, for building; roof flashing, not of metal; duckboards, not of metal; wall claddings, not of metal, for building; moldings, not of metal, for building; moldings, not of metal, for cornices; coatings [building materials]; laths, not of metal; scantlings [carpentry]; wood panelling; wall linings, not of metal, for building; palisading, not of metal; latticework, not of metal; windows, not of metal; shuttering, not of metal, for concrete; greenhouses, transportable, not of metal; branching pipes, not of metal; wainscotting, not of metal; signalling panels, non-luminous and non-mechanical, not of metal; parquet flooring; partitions, not of metal; floors, not of metal; lintels, not of metal; ceilings, not of metal; casement windows, not of metal; sandstone for building; platforms, prefabricated, not of metal; tiles, not of metal, for building; floor tiles, not of metal; paving slabs, not of metal; cement slabs; roofing, not of metal, incorporating solar cells; coverings, not of metal, for building; macadam; wood paving; fireproof cement coatings; paving blocks, not of metal; roof coverings, not of metal; bituminous coatings for roofing; vinyl siding; tarred strips, for building; road marking sheets and strips of synthetic material; sills, not of metal; cork [compressed]; props, not of metal; asbestos mortar; mortar for building; tanks of masonry; furrings of wood; pilings, not of metal; insect screens not of metal; shutters, not of metal; statues of stone, concrete or marble; statuettes of stone, concrete or marble; building glass; alabaster glass; safety glass; glass granules for road marking; insulating glass [building]; window glass, except glass for vehicle windows; plate glass [windows], for building; advertisement columns, not of metal; hips for roofing; terra cotta; penstock pipes, not of metal; water-pipes, not of metal; gutter pipes, not of metal; ducts, not of metal, for ventilating and air-conditioning installations; drain pipes, not of metal; chimneys, not of metal; rigid pipes, not of metal [building]; sandstone tubes; tufa; angle irons, not of metal; plywood; door panels, not of metal; foundry molds [moulds], not of metal; parquet floor boards; silos, not of metal; silica [quartz]; cement; tiles, not of metal; schists; roofing slates; slag [building material]; slag stone;

veneers; blinds [outdoor], not of metal and not of textile; clinker ballast; building panels, not of metal; masts [poles], not of metal; flashing, not of metal, for building; concrete building elements; letter boxes of masonry.

20 – Furniture, mirrors, picture frames; goods (not included in other classes) of wood, cork, reed, cane, wicker, horn, bone, ivory, whalebone, shell, amber, mother-of-pearl, meerschaum and substitutes for all these materials, or of plastics; reels, not of metal, non-mechanical, for flexible hoses; pulleys of plastics for blinds; cork bands; sideboards; busts of wood, wax, plaster or plastic; bolsters; fans for personal use, non-electric; work benches; vice benches, not of metal; coatstands; coat hangers; shoulder poles [yokes]; display stands; showcases [furniture]; newspaper display stands; signboards of wood or plastics; loading gauge rods, not of metal, for railway waggons [wagons]; nuts, not of metal; doors for furniture; curtain holders, not of textile material; bolts, dowels and pegs [pins], not of metal; screws, not of metal; divans; keyboards for hanging keys; display boards; packaging containers of plastic; flower-stands [furniture]; curtain tie-backs; plugs [dowels], not of metal; binding screws, not of metal, for cables; cable or pipe clips of plastics; rivets, not of metal; locks, other than electric, not of metal; bead curtains for decoration; closures, not of metal, for containers; bamboo; wickerwork; works of art, of wood, wax, plaster or plastic; cabinet work; settees; curtain rods; reels of wood for yarn, silk, cord; valves, not of metal, other than parts of machines; water-pipe valves of plastic; drain traps [valves] of plastic; staves of wood; plastic key cards, not encoded; saw horses; bed casters, not of metal; furniture casters, not of metal; brush mountings; wind chimes [decoration]; bassinets; tent pegs, not of metal; curtain rings; chests of drawers; containers, not of metal [storage, transport]; floating containers, not of metal; lecterns; baskets, not of metal; bottle casings of wood; arm-chairs; beds; table tops; coathooks, not of metal; curtain hooks; clothes hooks, not of metal; ladders of wood or plastics; mattresses; furniture of metal; office furniture; school furniture; sleeping bags for camping; mobiles [decoration]; curtain rails; house numbers, not of metal, non-luminous; index cabinets [furniture]; furniture; furniture partitions of wood; mirror tiles; numberplates, not of metal; identity plates, not of metal; loading pallets, not of metal; transport pallets, not of metal; handling pallets, not of metal; head-rests [furniture]; stakes for plants or trees; trestles [furniture]; magazine racks; book rests [furniture]; stands for calculating machines; flower-pot pedestals; pillows; mats, removable, for sinks; racks [furniture]; furniture shelves; shelves for storage; wood ribbon; towel closets [furniture]; inflatable publicity objects; beds for household pets; bedding, except linen; latches, not

of metal; bungs, not of metal; stair rods; reservoirs, not of metal nor of masonry; curtain rollers; tool handles, not of metal; door handles, not of metal; writing desks; seats of metal; benches [furniture]; vats, not of metal; sofas; sealing caps, not of metal; statues of wood, wax, plaster or plastic; figurines [statuettes] of wood, wax, plaster or plastic; filing cabinets; ambroid bars; counters [tables]; carts for computers [furniture]; dressing tables; tables of metal; desks [furniture]; tables; steps [ladders], not of metal; chairs [seats]; bins, not of metal; placards of wood or plastics; footstools; crates; troughs, not of metal, for mixing mortar; trolleys [furniture]; boarding stairs, not of metal, mobile, for passengers; edgings of plastic for furniture; washstands [furniture]; door fittings, not of metal; bed fittings, not of metal; moldings for picture frames; furniture fittings, not of metal; window fittings, not of metal; covers for clothing [wardrobe]; hinges, not of metal; deck chairs; poles, not of metal; screens [furniture]; cupboards; bamboo curtains; slatted indoor blinds; woven timber blinds [furniture]; indoor window blinds [shades] [furniture]; fire screens, domestic; lockers; bins of wood or plastic.

35 – Advertising; business management; business administration; office work; arranging subscriptions to telecommunication services for others; import-export agencies; advertising agencies; commercial information agencies; cost price analysis; rental of advertising space; auditing; employment agencies; computerized file management; accounting; invoicing; demonstration of goods; transcription; opinion polling; marketing studies; business information; commercial information and advice for consumers [consumer advice shop]; business research; marketing research; personnel recruitment; business management and organization consultancy; personnel management consultancy; business organization consultancy; business management consultancy; professional business consultancy; layout services for advertising purposes; business management of performing artists; news clipping services; updating of advertising material; word processing; secretarial services; shorthand; organization of exhibitions for commercial or advertising purposes; arranging newspaper subscriptions for others; organization of trade fairs for commercial or advertising purposes; shop window dressing; business appraisals; evaluation of standing timber; evaluation of wool; payroll preparation; data search in computer files for others; sponsorship search; business management assistance; commercial or industrial management assistance; presentation of goods on communication media, for retail purposes; economic forecasting; auctioneering; sales promotion for others; office machines and equipment rental; rental of advertising time on communication media; publicity material rental; rental of vending machines; rental of photocopying machines; publication of

publicity texts; typing; radio advertising; bill-posting; distribution of samples; dissemination of advertising matter; writing of publicity texts; on-line advertising on a computer network; advertising by mail order; television advertising; document reproduction; compilation of statistics; compilation of information into computer databases; business inquiries; systemization of information into computer databases; tax preparation; drawing up of statements of accounts; publicity columns preparation; psychological testing for the selection of personnel; business management of hotels; commercial administration of the licensing of the goods and services of others; administrative processing of purchase orders; public relations; modelling for advertising or sales promotion; relocation services for businesses; price comparison services; procurement services for others [purchasing goods and services for other businesses]; outsourcing services [business assistance]; telephone answering for unavailable subscribers; photocopying; efficiency experts.

37 – Building construction; repair; installation services; asphaltting; building sealing; disinfecting; rat exterminating; knife sharpening; building insulating; repair information; construction information; bricklaying; riveting; varnishing; re-tinning; scaffolding; road paving; window cleaning; upholstering; building construction supervision; rustproofing; paper hanging; painting or repair of signs; cleaning of buildings [exterior surface]; rental of construction equipment; rental of cranes [construction equipment]; rental of excavators; rental of bulldozers; plumbing; masonry; roofing services; underwater repair; cabinet making [repair]; plastering; repair of security locks; upholstery repair; pump repair; furniture restoration; restoration of works of art; demolition of buildings; warehouse construction and repair; factory construction; building of fair stalls and shops; cleaning of buildings [interior]; installation of doors and windows; elevator installation and repair; heating equipment installation and repair; burglar alarm installation and repair; furniture maintenance.

(260) AM 2012 65150 A

(800) 1096511

(731) Nordischer Maschinenbau Rud. Baader GmbH + Co. KG

Geniner Strasse 249, 23560 Lübeck, Germany

(540)



(591) Blue, white and black

(511)

7 – Filling machines; separators; fleshing machines; belt conveyors; handling apparatus for loading and

unloading; packing machines; meat choppers; belts for conveyors; conveyors (machines); moulding machines; bottle filling machines; blades and knives (parts of machines); bearings (parts of machines); pressing/separating machines; sorting machines for industry; transport belts; drums (parts of machines); machines for the food processing industry; fish and food processing machines and parts thereof, included in this class; machines for treating and processing of fish, meat and poultry as well as fruit and vegetables and products made therefrom; automatic conveyors for loading machines with goods and articles for further processing; machines for producing or treating of packaging and packaging containers, also those made of foil; machines for sealing containers, also those made of foil, as well as pouch packages; machines and apparatus for labelling packaging of goods; parts of the aforementioned machines and apparatus, included in this class; suction machines for industrial purposes; grain separators; incubators for eggs; brushes (parts of machines); compressed air engines; pressure regulators (parts of machines); pressure valves (parts of machines); packaging machines; ejectors; labellers (machines); springs (parts of machines); filtering machines; crankcases for machines, motors and engines; hangers (parts of machines); taps (parts of machines, engines or motors); cowlings (parts of machines); elevating apparatus; lifting apparatus; universal joints (cardan joints); ball bearings; automatic handling machines (manipulators); housings (parts of machines); knives (electric); blade holders (parts of machines); blade sharpening (stropping) machines; feeders (parts of machines); mixers (machines); pneumatic tube conveyors; presses for fruit; presses (machines for industrial purposes); machines and apparatus for cleaning (electric); belts for machines; robots (machines); roller bearings; grindstones (parts of machines); grease boxes (parts of machines); lubricating pumps; lubricators (parts of machines); self-oiling bearings; sieves (machines or parts of machines); control mechanisms for machines, engines or motors; stuffing boxes (parts of machines); shock absorber plungers (parts of machines); dividing machines; transmissions for machines; vacuum pumps (machines); heat exchangers (parts of machines); washing apparatus; shaft couplings (machines); tools (parts of machines); holding devices for machine tools; sausage machines; centrifugal machines; slaughtering machines; machines and apparatus for automatic transport of articles; machines and apparatus for automatic transport of animals; machines for cleaning of fish, meat, poultry as well as fruit and vegetables; machines for fumigating animals; machines for loading/unloading of animals and animal cages; machines for dosing solid or deformable food; machines for homogenizing food-stuffs.

9 – Data processing apparatus; dosage dispensers; computer peripheral devices; computer software (stored); electric sensors, IR sensors (measuring devices), microwave sensors (measuring devices); optical apparatus and instruments and checking devices consisting thereof; detectors; lasers, not for medical purposes; quantity indicators; measuring devices; weighing apparatus and instruments; weighing machines; electric switching devices, electric control panels and control cabinets; roentgen apparatus, not for medical purposes; temperature indicators; thermometers (not for medical purposes); camcorders; counters; apparatus for dosing solid or deformable food.

37 – Installation, repair, cleaning, maintenance of machines, apparatus and equipment, particularly those for treating and processing of fish, meat and poultry as well as fruit and vegetables and products made therefrom; rental and leasing of apparatus and equipment of treating and processing of fish, meat and poultry as well as fruit and vegetables and products made therefrom.

(260) AM 2012 65151 A

(800) 1096516

(731) APM Terminals B.V.

Anna van Saksenlaan 71, NL-2593 HW The Hague, Netherlands

(540)



(591) Orange

(511)

39 – Transport, packaging and storage of goods; delivery of goods; stevedoring (cargo loading and unloading of ships); freight forwarding; container rental; warehouse and store room rental; information regarding transportation and storage; logistics services; aforementioned services also in the context of the management of container terminals.

(260) AM 2012 65152 A

(800) 1096544

(731) Philip Morris Products S.A.

Quai Jeanrenaud 3, CH-2000 Neuchâtel, Switzerland

(540)

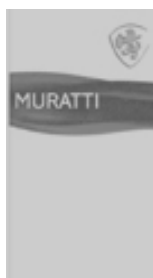

(591) Black, white

(511)

34 – Tobacco, raw or manufactured; tobacco products, including cigars, cigarettes, cigarillos, tobacco for roll-your-own cigarettes, pipe tobacco, chewing tobacco, snuff tobacco, kretek; snus; tobacco substitutes (not for medical purposes); smokers' articles, including cigarette paper and tubes, cigarette filters, tobacco tins, cigarette cases and ashtrays, pipes, pocket apparatus for rolling cigarettes, lighters; matches.

(260) AM 2012 65153 A

(800) 1096545

(731) Philip Morris Products S.A.

Quai Jeanrenaud 3, CH-2000 Neuchâtel, Switzerland

(540)

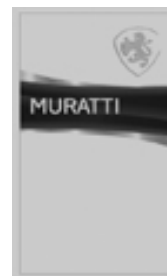

(591) Black, white

(511)

34 – Tobacco, raw or manufactured; tobacco products, including cigars, cigarettes, cigarillos, tobacco for roll-your-own cigarettes, pipe tobacco, chewing tobacco, snuff tobacco, kretek; snus; tobacco substitutes (not for medical purposes); smokers' articles, including cigarette paper and tubes, cigarette filters, tobacco tins, cigarette cases and ashtrays, pipes, pocket apparatus for rolling cigarettes, lighters; matches.

(260) AM 2012 65158 A

(800) 1096660

(731) APPLE INC.

1 Infinite Loop, Cupertino, CA 95014, USA

(540)

ASSISTIVETOUCH

(591) Black, white

(511)

9 – Operating system programs; graphical user interface software.

(260) AM 2012 65160 A

(800) 1096678

(731) DEERE & COMPANY

One John Deere Place, Moline, Illinois 61265-8098, USA

(540)

Powergard

(591) Black, white

(511)

36 – Warranty and guarantee service for equipment and vehicles.

37 – Repair and maintenance of equipment and vehicles.

(260) AM 2012 65161 A

(800) 1096697

(731) TYCO INTERNATIONAL SERVICES

GMBH

Freier Platz 10, CH-8200 Schaffhausen,
Switzerland

(540)



(591) Blue and orange

(511)

7 – Machines and machine tools; electronic components for machines, tools, automobile parts; machines for producing and for assembling printed circuit cards; labeling machines; finishing machines, setting machines and machines for creating bundles; thermal devices such as parts of the aforementioned goods, namely ventilators, compressor impellers, heat sinks.

8 – Hand tools and implements, hand-operated; tools and hand tools and related accessories; parts and components for hand tools.

9 – Scientific, nautical, surveying, photographic, cinematographic, optical, weighing, measuring, signaling, checking [supervision], life-saving and teaching apparatus and instruments; apparatus and instruments for conducting, switching, transforming, accumulating, regulating or controlling electricity; apparatus for recording, transmission or reproduction of sound or images; magnetic data carriers, recording disks; automatic vending machines and mechanisms for coin-operated apparatus; cash registers, calculating machines; data processing apparatus and computer hardware and peripheral devices for computers; computer software; computer wiring systems; electromechanical systems and parts and components related thereto; connectors and connection systems; electrical connectors, components for connectors, particularly containers; connections for equipment ("plug-in" connections); couplings, connections and joints; connector housings; components of wiring systems, particularly punchdown blocks (bars for multiple connections); jacks, plugs, connecting cords, connecting panels; wires and cables, cables of fiber

optics; underwater cables, telecommunication cables, fiber optic and wiring harnesses, electrically conductive cable terminations; collars for wiring not of metal; housings for ground connections and guard shields for high voltage cables; accessories for high voltage cables for industry in aerial and underground installations, including external terminals with oil baths, dry exterior terminals; electrical cables for lighting installations; canals for electrical wiring, cassettes for managing fiber optic cables (plug and play cassettes), components of cabling for improving transmission of signals, particularly plates, divider coils, blocks, brackets, wiring ducts, rings and clips, housing for outlets and panels, and overvoltage protector devices; communication equipment, particularly electric jacks, plugs, blocks, terminal strips, connector panels, connectors for couplings and cords, signal repeaters, signal conditioners, communication distribution frames, couplers for fiber optics, fiber optical wavelength-division multiplexers/demultiplexers, connection modules, interface modules, test modules, disconnection modules, connection and commutation chassis, switching (patching); devices for switching and monitoring electrical power supplies; control modules for connection and switching, data line emulators and monitors, transmission test kits, test cards for network switches (PBX), controllers for switching and controllers for networks, switching cards, switching cables, digital signal cross-circuit modules, transmission circuit boards, signaling sub-boards, transmission setting plates and connection designation bands; test equipment for private lines for carrying out tests on communication systems comprising test modules, service modules, signal test modules, cable reels, electrical panels and cable cages, particularly with the option of oscillation, amplification, attenuation, and comprising kits, terminals, repeating reels, terminal signal converters, signal relays, cords with plugs, monitor loudspeakers, control devices for transmission buffers, automatic level control devices, bridge transformers, pulse generators, external impellers, loop returns and control devices for test baseplates, sold as a modular unit; electrical apparatus used as components of a private line test system for carrying out tests on communication systems, particularly test modules, service modules, signal test modules, cable reels, electrical panels and cable cages, particularly with the option of oscillation, amplification, attenuation, and comprising kits, terminals, repeating reels, terminal signal converters, signal relays, cords with plugs, loudspeakers, control devices for transmission buffers, automatic level control devices, bridge transformers, external impellers, loop returns and control devices for test baseplates; electrical apparatus used as components of a private line test system for carrying out tests on return loops, for controlling and testing two-wire

communication lines, comprising an emitter and a receiver, sold as a unit; electrical apparatus used as components of a private line test system for carrying out tests on emitters and receivers, used in return loop test systems, for controlling and testing two-wire communication lines; electrical apparatus used as components of a private line test system for carrying out tests on fuse panels; electrical apparatus used as components of a private line test system for carrying out tests on terminals used in systems for condition monitoring, for controlling and supplying diagnostics for telemetry and information in a remote communication network system, particularly principal display terminals; electrical apparatus used as components of a private line test system for carrying out tests on systems for condition monitoring for controlling circuits and supplying diagnostics for telemetry and information in a remote communication network system, principal display terminals sold as a unit; electrical apparatus used as components of a private line test system for carrying out tests on audio distribution amplifiers; electrical apparatus used as components of a private line test system for carrying out tests on loudspeaker monitors; electrical apparatus used as components of a private line test system for carrying out tests on series loop access systems, for providing access to series loop circuits comprising access panels to series loops and control panels relating thereto, sold as a unit; switching panels (patching); components of apparatus for communication and communication devices, particularly terminal blocks, conference bridges, jack panels, jacks, transfer switches, coupling leads, plugs, reels for telephones, repeating reels, connector cables, solid state telegraphic relays; battery chargers, particularly battery chargers for aircraft and battery chargers for industrial and leisure vehicles; ammeters for direct current, transformers; private line test equipment for carrying out tests on communication systems comprising access modules, line selection modules, signal and/or composition modules, test modules and ohmmeters, sold as a unit, current sensors, magnetic amplifiers, diffusion filters, speed monitors for motors for monitoring the speed of electric motors, power units for providing a power supply to electrical apparatus, particularly computers; mechatronic systems, namely synergistic and systematic combinations of mechanics, electronics and computing in real-time, relays, automobile telecommunication devices, computing and industrial relays, electronic apparatus, electrical apparatus, namely electrical apparatus used in relation with the aerospace industry and the defence industry (except armaments), with computing, electronics, electrical tools, gardening tools, multiswitches, fixed stations, network interface cards, cards for computers, systems for the distribution of electrical power including rail trans-

portation systems, network wiring for buildings, automobiles, transportation namely with all kinds of water, air and land vehicles particularly aircraft, cars, trucks, boats, motor cycles, bicycles, telecommunications networks, industrial engines, lighting, machine tools and production monitoring equipment, heating, ventilation and air-conditioning, components for security systems, instrumentation and medical equipment as well as in relation with devices for assisting mobility and medical diagnostic devices and railway devices; terminals; splices, support sockets for chips; linear, digital, analogical, electronic, electrical circuits; bridge circuits; integrated circuits; electrical adapters, hybrid adapters; sensors, magnetic sensors, radar sensors, inductive sensors; gas sensors; wireless components and subsystems; antennas; aerial systems; audio- and video-receivers; GPS receivers; circuit boards; electrical distribution boxes; multi-circuit electrical bands; touch screens; tactile computers, interactive screens; monitors for computers; computer monitor bezels, computer network nodes, switches and routers; apparatus for computer networking; apparatus for linking computers in networks, apparatus for protecting computers against electrical power supply problems; items intended for single use in computer wiring ducts, items intended for single use in supporting computer cables, emergency controls for computers; broadband data interconnection computer installations; electronic components for computers; fiber optic computer installations for use with computers; components of connections ("plug-in") for computer modems; electrical processing equipment, namely connectors between wires and boards, boards and boards, cables and boards and cables and cables; inductors, high current indicators, cable wind indicators, chokes, high current indicators, drum core indicators, shielded cable reel inductors, non shielded reel inductors, electric inductors; LAN protocol magnetic elements; magnetic modules; resistors; resistances, electric; commutators; switches, electric; chip cards; fiber optic products; electro-optical products; circuit board assemblies for multiple connectors; circuit board assembly interconnections for multiple connectors; attenuators; multiplexers; amplifiers; data communication systems; heat-shrink sheathes; filters, electrical line filters; signal filters, duplexers; capacitors; transformers; couplers; batteries; battery terminals; microwave products, circuit mixers, frequency modulators; converters; heat sinks; heat sinks intended for electronic apparatus; measuring devices; controllers; radio frequency identification tags for radio frequency identification (RFID), protective devices against short circuits; switches, electric; fuses; radar systems; components of radio frequencies (RF); cabinets for loudspeakers, switchboxes (electricity), distribution boxes (electricity), cabinets intended

for computers; thermoretractable sheaths and their enclosures; electrical and electronic components for identification and labelling; electronic and electrical panels; fiber optic panels; radios; accessories for radios; converters, electric; keyboards; screens; touchscreen systems, namely touchscreens, touchscreen monitors, computer keyboards, touchscreen computers, electronic components for touchscreen technology, particularly micro controllers and electronic accessories, particularly magnetic tapes or credit card readers, small display devices for frontal display, for use with touchscreens and touchscreen computers; electrical sleeves, electrical connectors, electrical spacers, voltage surge protectors, electrical equipment for applying voltage and grounding; link boxes; electrical control cabinets; vibration indicators; electrical fuses, light-emitting diodes [LED]; telecommunication equipment, particularly terminal blocks for cables for moving and insulating; electrical protection devices (except for insulators) and against voltage surge for electrical and electronic telecommunications systems and data telecommunication systems; connectors, namely voltage surge protectors, fuses, diodes for fuses, thermo-protective switches and varistors; cable systems for telecommunication; dividers; optical dividers; multi-user wall housings; residential wall and floor cabinets for cabled or optical links; computer equipment such as gateways, switches, bridges, routers, concentrators, repeaters and network adapters, equipment and components for use in transmission of data, text, video, audio and voice transfer by broadband, radio broadcasting, cable broadcasting, coaxial cable, copper wires, fiber optics, radio, telephone, twisted pairs, wire, wireless and other telecommunication technology; computer software for use in the use and management of telecommunications systems, in equipment and in communications on such systems; electrical metal connectors and connectors, accessories for wiring for electrical distribution networks, electrical terminals and junctions, electrical locking devices; lighting controllers; systems for cables for vehicles, wiring harnesses for vehicles; controls for LEDs; systems for electrical cable harnesses and connectors; accessories for the distribution of electricity conduits; devices for managing cables, electrical lines; acoustic products, namely surface waves, sonic and ultrasonic waves traveling on the surface of a screen, systems for recognizing audio impulses, audio microphones; interfaces such as parts of the abovementioned goods; acoustic pickups, particularly audio microphones, micro controllers for tactile recognition of acoustic waves, software for tactile recognition of acoustic waves.

17 – Rubber, gutta-percha, gum, vinyl and products made of semi-processed plastics; packing, stopping and insulating materials; flexible tubes, not of metal; tubing, namely tubing and connection pieces

not of metal for pipes, tubing of rubber, heat shrink tubes, tubing for nuclear applications, sheaths for tubing; rubber products; electrical insulating products and electrical insulating materials; tubes; insulating goods and materials; casings for cables of plastic; insulating tape, tapes for cable links, tapes for securing cables, adhesive tapes; insulating sealants, insulating tape and insulating sealing products, tapes for tying cables and for fitting cables; films made of polyester; thermoretractable sheaths; shrinkable sheaths; adhesives other than for medical, stationery or household purposes; thermal devices as parts of the abovementioned goods, namely thermal conduits.

37 – Construction; repair, installation services; installation and repair of telecommunication networks; installation, maintenance and repair of telecommunication apparatus; installation, maintenance and repair of telecommunication installations, communication networks, computer networks and data networks; wiring buildings for transmitting telecommunication, wiring for telecommunication; construction; installation, maintenance and repair; installation, maintenance and repair of electrical systems and equipment; machinery installation, maintenance and repair; services involving maintenance and repair of technical products; installation and repair of telecommunication systems and facilities (computer hardware), computer hardware and computer peripheral devices; installation and repair of equipment and household infrastructure systems (computer hardware); consulting in installation and performance of data cable systems; consulting in installation of telecommunication systems and networks; all above-mentioned services particularly relating to products under guarantee.

38 – Telecommunications; services involving terrestrial, wireless and underwater communication; consulting in the field of telecommunication.

(260) AM 2012 65162 A

(800) 1096700

(731) UAB "PLUNGĖS KOOPERATINĖ
PREKYBA"

Birutės g. 50, LT-90112 Plungė, Lithuania

(540)

СЧАСТЬЕ ЕСТЬ

(591) Black, white

(511)

29 – Meat, fish, poultry and game; meat extracts; preserved, dried and cooked fruits and vegetables; jellies, jams, compotes; eggs, milk and milk products; edible oils and fats.

30 – Coffee, tea, cocoa, sugar, rice, tapioca, sago, artificial coffee; flour and preparations made from

cereals, bread, pastry and confectionery, ices; honey, treacle; yeast, baking-powder; salt, mustard; vinegar, sauces (condiments); spices; ice.

(260) AM 2012 65167 A
(800) 1096705
(731) ZENTIVA, K.S.
U Kabelovny 130, CZ-102 36 Praha 10,
Dolní Měcholupy, Czech Republic
(540)

SOFRONIE

(591) Black, white
(511)
5 – Medicines, pharmaceutical preparations for human use in the field of gynecological preparations.

(260) AM 2012 65168 A
(800) 1096708
(731) NOVARTIS AG
CH-4002 Basel, Switzerland
(540)

БРИЗХАЙЛЕР

(591) Black, white
(511)
5 – Pharmaceutical products.
10 – Medical apparatus and inhalers.

(260) AM 2012 65169 A
(800) 1096720
(731) Bruel S.p.A.
Via G.B. Verci, 40, I-36061 Bassano del
Grappa (VI), Italy
(540)



(591) Black, white
(511)
14 – Precious metals and their alloys and goods in precious metals or coated therewith, not included in other classes; jewellery, precious stones; horological and chronometric instruments.
18 – Leather and imitations of leather, and goods made of these materials and not included in other classes; animal skins, hides; trunks and travelling bags; umbrellas, parasols and walking sticks; whips, harness and saddlery.
25 – Clothing, footwear, headgear.
35 – The bringing together, for the benefit of others, of a variety of goods (excluding the transport thereof), enabling customers to conveniently view

and purchases those goods; such services may be provided by retail stores, wholesale outlets, through mail order catalogues or by means of electronic media, for example, through web sites or television shopping programmes.

(260) AM 2012 65170 A
(800) 1096722
(731) Nordischer Maschinenbau Rud. Baader
GmbH + Co. KG
Geniner Strasse 249, 23560 Lübeck,
Germany
(540)

BAADER

(591) Black, white
(511)
7 – Filling machines; separators; fleshing machines; belt conveyors; handling apparatus for loading and unloading; packing machines; meat choppers; belts for conveyors; conveyors (machines); moulding machines; bottle filling machines; blades and knives (parts of machines); bearings (parts of machines); pressing/separating machines; sorting machines for industry; transport belts; drums (parts of machines); machines for the food processing industry; fish and food processing machines and parts thereof, included in this class; machines for treating and processing of fish, meat and poultry as well as fruit and vegetables and products made therefrom; automatic conveyors for loading machines with goods and articles for further processing; machines for producing or treating of packaging and packaging containers, also those made of foil; machines for sealing containers, also those made of foil, as well as pouch packages; machines and apparatus for labelling packaging of goods; parts of the aforementioned machines and apparatus, included in this class; suction machines for industrial purposes; grain separators; incubators for eggs; brushes (parts of machines); compressed air engines; pressure regulators (parts of machines); pressure valves (parts of machines); packaging machines; ejectors; labellers (machines); springs (parts of machines); filtering machines; crankcases for machines, motors and engines; hangers (parts of machines); taps (parts of machines, engines or motors); cowlings (parts of machines); elevating apparatus; lifting apparatus; universal joints (cardan joints); ball bearings; automatic handling machines (manipulators); housings (parts of machines); knives (electric); blade holders (parts of machines); blade sharpening (stropping) machines; feeders (parts of machines); mixers (machines); pneumatic tube conveyors; presses for fruit; presses (machines for industrial purposes); machines and apparatus for cleaning (electric); belts for machines; robots (machines); roller bearings; grindstones (parts of ma-

chines); grease boxes (parts of machines); lubricating pumps; lubricators (parts of machines); self-oiling bearings; sieves (machines or parts of machines); control mechanisms for machines, engines or motors; stuffing boxes (parts of machines); shock absorber plungers (parts of machines); dividing machines; transmissions for machines; vacuum pumps (machines); heat exchangers (parts of machines); washing apparatus; shaft couplings (machines); tools (parts of machines); holding devices for machine tools; sausage machines; centrifugal machines; slaughtering machines; machines and apparatus for automatic transport of articles; machines and apparatus for automatic transport of animals; machines for cleaning of fish, meat, poultry as well as fruit and vegetables; machines for fumigating animals; machines for loading/unloading of animals and animal cages; machines for dosing solid or deformable food; machines for homogenizing food-stuffs.

9 – Data processing apparatus; dosage dispensers; computer peripheral devices; computer software (stored); electric sensors, IR sensors (measuring devices), microwave sensors (measuring devices); optical apparatus and instruments and checking devices consisting thereof; detectors; lasers, not for medical purposes; quantity indicators; measuring devices; weighing apparatus and instruments; weighing machines; electric switching devices, electric control panels and control cabinets; roentgen apparatus, not for medical purposes; temperature indicators; thermometers (not for medical purposes); camcorders; counters; apparatus for dosing solid or deformable food.

37 – Installation, repair, cleaning, maintenance of machines, apparatus and equipment, particularly those for treating and processing of fish, meat and poultry as well as fruit and vegetables and products made therefrom; rental and leasing of apparatus and equipment of treating and processing of fish, meat and poultry as well as fruit and vegetables and products made therefrom.

(260) AM 2012 65172 A

(800) 1096726

(731) PEYMAN KURUYEMİŞ GIDA
AKTARIYE KİMYEVİ MADDELER
TARIM ÜRÜNLERİ SANAYİ VE
TİCARET ANONİM ŞİRKETİ
Organize Sanayi Bölgesi 9. Cad. Eskişehir,
Turkey

(540)



(591) Red, black, white, green and yellow

(511)

29 – Nuts, roasted sun-flower seed, pistachio nut, roasted chickpeas, roasted bald seed, roasted almond, hot roasted chick peas, salty pistachio nuts, dried fruits, sun-dried fruit pulps.

(260) AM 2012 65174 A

(800) 1096743

(731) Gyumri-Garejour LLC

171, Yerevanyan highway, Gyumri, Armenia

(540)



(591) Red, white and black

(511)

32 – Beers.

(260) AM 2012 65175 A

(800) 1096760

(731) SOREMARTEC SA

Rue Joseph Netzer 5, B-6700 ARLON,
Belgium

(540)



(591) Black, orangey red, blue, orange, green, pink, beige

(511)

29 – Meat, fish, poultry and game; meat extracts; preserved, frozen, dried and cooked fruits and vegetables; jellies, jams and compotes; eggs, milk and milk products; edible oils and fats.

30 – Coffee, tea, cocoa, sugar, rice, tapioca, sago, artificial coffee; flour and preparations made from cereals, bread, pastry and confectionery, ices; honey, treacle; yeast, baking-powder; salt, mustard; vinegar, sauces (condiments); spices; ice for refreshment.

32 – Mineral and aerated waters and other non-alcoholic drinks; fruit drinks and fruit juices; syrups and other preparations for making beverages.

(260) AM 2012 65176 A

(800) 1096764

(731) DFSK MOTOR CO., LTD

East Ring Road No. 1, Shiyan, Hubei, China

(540)

DFSK

(591) Black, white

(511)

12 – Waggon; cycle cars; automobiles; motor cars; vehicle bumpers; tires for vehicle wheels; motors for land vehicles; shock absorbers for automobiles; motorcycles; bicycles.

37 – Construction information; factory construction; construction; mining extraction; upholstering; motor vehicle maintenance and repair; vehicle wash; vehicle service stations (refueling and maintenance); retreading of tires (tyres); machinery installation, maintenance and repair.

(260) AM 2012 65177 A

(800) 1096770

(731) PHILIP MORRIS PRODUCTS S.A.

Quai Jeanrenaud 3, CH-2000 Neuchâtel,
Switzerland

(540)

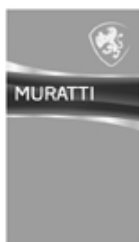

(591) Black, white

(511)

34 – Tobacco, raw or manufactured; tobacco products, including cigars, cigarettes, cigarillos, tobacco for roll-your-own cigarettes, pipe tobacco, chewing tobacco, snuff tobacco, kretek; snus; tobacco substitutes (not for medical purposes); smokers' articles, including cigarette paper and tubes, cigarette filters, tobacco tins, cigarette cases and ashtrays, pipes, pocket apparatus for rolling cigarettes, lighters; matches.

(260) AM 2012 65178 A

(800) 593402

(731) LABORATOIRE BIODERMA

75, cours Albert Thomas, F-69003 LYON,
France

(540)

SEBIUM

(591) Black, white

(511)

3 – Cleansing creams, lotions and gels for cosmetic use.

5 – Cleansing creams, lotions and gels for medical and pharmaceutical use.

(260) AM 2012 65179 A

(800) 611035

(731) FERRING B.V.

Polarisavenue 144, NL-2132 JX Hoofddorp,
Netherlands

(540)

MENOGON

(591) Black, white

(511)

5 – Pharmaceutical, veterinary and sanitary products; dietetic substances adapted for medical use, food for babies; plasters, materials for dressings; material for dental fillings and dental impressions; disinfectants; pesticides; fungicides, herbicides.

(260) AM 2012 65180 A

(800) 671910

(731) GROUPE AUCHAN société anonyme à

directoire et conseil de surveillance
40, avenue de Flandre, F-59170 CROIX,
France

(540)

VENDOME

(591) Black, white

(511)

29 – Meat, fish, poultry and game, meat extracts; charcuterie; salted meats; shellfish and crustaceans (not live); croquettes; preserved, dried and cooked fruits and vegetables; vegetable purée; preserved garden herbs; mushrooms, preserved; fruit pulp and salads; vegetable salads; canned meat, fish, vegetables and fruit, jams, marmalades, stewed fruit; pollen prepared as foodstuff; weed extracts for food; soya beans, preserved, for food; protein for human consumption; broths, consommés, soups, vegetable juices for cooking; eggs, milk, butter, cream, yogurts, cheese and other dairy products; milk beverages, milk predominating; edible oils and fats; preparations for making bouillon, potato chips; prepared meals made with the above products.

(260) AM 2012 65181 A

(800) 729035

(731) BIA Separations d.o.o.

Teslova 30, SI-1000 Ljubljana, Slovenia

(540)

**CIM Convective Interaction
Media**

(591) Black, white

(511)

– Chemicals used in industry, science, photography, and in agriculture, horticulture and forestry, particularly chemicals for the separation and purification of mixtures and the separation of pure substances; chemicals for use in chromatography;

artificial porous resins in raw form for use in chromatography.

9 – Chromatography apparatus for laboratory use; apparatus and instruments for the separation and purification of mixtures and the separation of pure substances; compact and porous hoses and stopper rings of porous artificial resins in columns or cartridges for the separation and purification of mixtures, the separation of pure substances; kits containing chemicals for use in industry, science, photography as well as in agriculture, horticulture and forestry, particularly chemicals used for the separation and purification of mixtures, the separation of pure substances, chemicals for use in chromatography, porous artificial resins for use in chromatography, compact and porous hoses and stopper rings of porous artificial resins in columns or cartridges for the separation and purification of mixtures, and the separation of pure substances.

11 – Chromatography apparatus for industrial use.

(260) AM 2012 65193 A

(800) 846112

(731) ZHEJIANG NARADA POWER SOURCE CO., LTD.

9th Floor, Building A, No. 50, Zijinghua Road, Zhejiang Province, China

(540)

Narada

(591) Black, white

(511)

9 – Batteries, electric accumulator, battery chargers, solar batteries, electric wires, electric cables, stabilized voltage power supply, distribution boxes (electricity), electroplating apparatus, accumulator boxes.

(260) AM 2012 65195 A

(800) 900981

(731) Tianjin Tasly Cie. Pharmaceutique, Limitée
Beichen Parc Industriel, de Haute-Technologie TIANJIN, China

(540)



(591) Black, white

(511)

5 – Depuratives; medicines for veterinary purposes; pesticides; surgical tissues; dental abrasives; medicines for human purposes; pharmaceutical prepa-

rations (biomedicine); dietetic foodstuffs for medical purposes; belts for sanitary napkins.

(260) AM 2012 65196 A

(800) 976339

(731) MUDO SATIS MAGAZALARI ANONIM SIRKETI

Ambarli Dolum Tesisleri, Yolu Cihangir Mah Sehit, Piyade Murat Sengoz Sok. No, AVCILAR – ISTANBUL, Turkey

(540)

MUDO

(591) Black, white

(511)

35 – Advertising agencies, publicity agencies, advertising and publication with television, radio, mail, publicity columns preparation, distribution of advertising materials, organization of trade fairs for commercial or advertising purposes, modelling for advertising or sales promotion, marketing studies, marketing information, sales promotions, shop window dressings, inquiries, public relations, office services namely secretarial services, shorthand, photocopying, typing, word processing, compilation of information into computer databases, family register management with computers, systemization of information into computer databases, telephone answering, arranging of newspaper subscriptions, rental of office machines and equipments, rental of sales machines, business managing consultancy, commercial or industrial management assistance, consultancy of business management or organization, business management of hotels, business appraisals, business information, business researches, statistical information, personnel recruitment, employment agencies, psychological testing for the selection of personnel, finding employment, drawing up of statements of accounts, book-keeping, auditing, cost price analysis, economic forecasting, payroll preparation, tax preparation, import export agencies, business management of performing artists, commercial and industrial management expertise, auctioneering, the bringing together, for the benefit of others, of a variety of goods excluding the transport thereof, enabling customers to conveniently view and purchase those goods.

(260) AM 2012 65198 A

(800) 995917

(731) Mac Pharma S.r.l.

Via Terraglio, 49, I-31100 TREVISO, Italy

(540)

SKIN SHUTTLE

(591) Black, white

(511)
3 – Bleaching preparations and other substances for laundry use; cleaning, polishing, scouring and abrasive preparations; soaps; perfumery, essential oils, cosmetics, hair lotions; dentifrices.

5 – Pharmaceutical and veterinary preparations; sanitary preparations for medical purposes; dietetic substances adapted for medical use, food for babies; plasters, materials for dressings; material for stopping teeth, dental wax; disinfectants; preparations for destroying vermin; fungicides, herbicides.

10 – Surgical, medical, dental and veterinary apparatus and instruments, artificial limbs, eyes and teeth; orthopedic articles; suture materials.

(260) AM 2012 65199 A

(800) 1003157

(731) J.T. Ronnefeldt KG

2, Jan-Weber-Strasse, 27726 Worpswede,
Germany

(540)

Ronnefeldt

(591) Black, white

(511)

16 – Goods of paper and cardboard, in particular packaging, included in this class; tea filters of paper.

21 – Porcelain and earthenware.

30 – Tea, fruit teas and herbal teas and tea-type products, included in this class.

(260) AM 2012 65200 A

(800) 1081578

(731) VASHURKIN MYKHAILO YURIIHOVYCH

b-r. Shevchenka, 258, kv. 57, m. Cherkasy
18000, Ukraine

(540)



(591) Blue and red

(511)

1 – Chemicals used in industry, science and photography, as well as in agriculture, horticulture and forestry; antifreeze; acidulated water for recharging accumulators; brake fluid; metal hardening preparations; glycerine for industrial purposes; additives, chemical, to motor fuel; disinfectants; scale removing preparations, other than for household purposes; combusting preparations (chemical additives to motor fuel); detergent additives to petrol (gasoline);

water-softening preparations; metal annealing preparations; anti-boil preparations for engine coolants; fuel-saving preparations; industrial chemicals; anti-incrustants; anti-frothing solutions for accumulators; liquids for removing sulphates from accumulators; power steering fluid; fluids for hydraulic circuits; auxiliary fluids for use with abrasives; transmission fluid; solvents for varnishes; degumming preparations; synthetic materials for absorbing oil; engine-decarbonising chemicals; oil-separating chemicals; oil-purifying chemicals; chemical additives for oils; chemical preparations for facilitating the alloying of metals; radiator flushing chemicals.

2 – Preservatives against rust and against deterioration of wood; protective preparations for metals; anti-rust greases; anti-rust oils; anti-rust preparations for preservation; anti-corrosive preparations; thinners for lacquers; thinners for paints.

4 – Industrial oils; moistening oil; lubricants; lubricating oil; cutting fluids; motor oil; industrial grease; industrial oil.

(260) AM 2012 65402 A

(800) 1098156

(731) PRUDENTIAL IP SERVICES LIMITED

Laurence Pountney Hill, London EC4R 0HH,
United Kingdom

(540)



(591) Black, white

(511)

35 – Accounting services; business management; real estate auctioneering services; maintenance of registers, management, maintenance and updating of shareholder records, company management for others, all being company registrar services; company secretarial services; data processing and data verification services; data storage and retrieval services; updating of information on a computer database; personnel management consultancy and administration services; payroll system consultancy and administration services; business management services relating to charitable services, education services, social welfare services, academic scholarship and community services; business management and organisation consultancy; business management assistance; advisory services for business management; business research.

36 – Insurance; assurance; financial services; unit trust services; real estate agency services; management, administration and valuation services;

financing and procurement of financing; loan advice; loan procurement; capital administration services; property administration and advice; financial administration services; actuarial services; mortgage, banking, investment management, trustee and financial advisory services; nominee services; provision of finance; financing services for securing of funds; pension fund administration; services for the financing of home loans; valuation of chattels; deposit taking services; funds transfer services; brokerage agencies for insurance and credit; financial services relating to lotteries; offering securities and handling subscriptions relating thereto; credit sales; guarantees and sureties; accommodation agencies and agencies for the recovery of debts; financial reports; deposits, credits and savings societies; management of wealth; financial management consultancy and administration services; advice on finance during retirement; advice on finance for retirement; advice relating to investment during retirement; advice relating to investment for retirement; financial advisory services relating to retirement plans; financial management services relating to retirement homes; retirement payment services; financial analysis; financial forecasting; financial management; financial planning; financial portfolio management; financial research; charitable fund raising; management of charitable funds; provision of finance for education services, social welfare services, academic scholarship and community services; information and advisory services relating to the above services.

41 – Educational services; nursery schools; vocational guidance (education or training advice); arranging and conducting of workshops (training); organisation of competitions (education or entertainment); organisation of sports competitions; lending libraries; publication of books; distribution (other than transportation) of video tapes; translation; entertainment; gymnastic instruction; animal training; modelling for artists; operating of lotteries; providing of training; sporting and cultural activities.

(260) AM 2012 65463 A
(800) 1007857
(731) VESTEL DIS TICARET A.S.
Organize Sanayi Bolgesi, TR-45030 Manisa,
Turkey
(540)

VESTFROST

(591) Black, white
(511)
7 – Electrical household appliances not included in other classes, including washing machines, spin driers, combined washing machines and tumble driers, wringers, dishwashers, food mixing machi-

nes, food processors, cutters [machines], grinders [machines], vacuum packing machines, rack and tray conveyors for use in combination with dishwashers, waste disposal machines, compressors for refrigerators and freezers; machines for high pressure cleaning, floor polishing machines, vacuum cleaners; welding machines and apparatus not included in other classes; parts of all the above items, such as hoses and nozzles, dust bags and filters for vacuum cleaners; all aforementioned goods related to the consumer market.

11 – Apparatus for heating, steam generating, cooking, refrigerating, freezing, drying, ventilating, air conditioning, water supply and sanitary purposes; dehumidifying and humidifying installations, devices, appliances and instruments; air conditioning and heating apparatus, appliances and instruments; electrical household appliances not included in other classes, including tumble driers, refrigerators, (deep) freezers, combined refrigerators and freezers, refrigerator cabinets, wine coolers, ovens, microwave ovens, domestic appliances for cooking or heating foods and beverages, hobs, toasters and boilers, as well as parts of all aforesaid goods; all the aforementioned goods related to the consumer market.

35 – Advertising and commercial business services; the bringing together, for the benefit of others, of a variety of goods (excluding the transport thereof) enabling customers to conveniently view and purchase those goods; business intermediary services relating to the purchase and sale of the goods mentioned in classes 7 and 11; retail services relating to the goods mentioned in classes 7 and 11.

(260) AM 2012 65465 A
(800) 1035362
(731) M.F.H. Fejlesztő Korlátolt Felelősségű
Társaság
Futó u. 47-53, BUDAPEST 1082, Hungary
(540)

TEZENIS

(591) Black, white
(511)
3 – Bleaching preparations and other substances for laundry use; cleaning, polishing, scouring and abrasive preparations; soaps; perfumery, essential oils, cosmetics, hair lotions; dentifrices.
25 – Clothing; underwear, nightwear and knitwear for men, women and children; corsetry, lingerie, stockings, tights, socks; slippers.
35 – Franchising; retail services in respect of clothing including underwear, corsetry, lingerie, nightwear and knitwear.

(260) AM 2012 65466 A
 (800) 1035852
 (731) GROUPE AUCHAN
 40 avenue de Flandre, F-59170 CROIX,
 France
 (540)



(591) Blue, white
 (511)

3 – Bleaching preparations and other substances for laundry use; preparations and products for cleaning, polishing, degreasing, abrading and scouring; softeners; soaps; perfumery, toilet water; essential oils; deodorants for personal use (perfumery); cosmetics, hair lotions; shampoos; dentifrices, mouth washes, not for medical purposes; make-up and make-up removing preparations; shaving products; toiletries; toiletry milks and oils; cosmetic preparations for baths, for skin tanning; cotton sticks for cosmetic purposes; incense; potpourris (fragrances); cotton wool for cosmetic purposes; tissues impregnated with cosmetic lotions; sunscreens (cosmetic preparations for skin tanning).

5 – Pharmaceutical preparations, veterinarians; sanitary products for medical use and for intimate hygiene; pharmaceutical preparations for skin care; dietetic substances, beverages and foodstuffs for medical purposes; nutritional additives for medical purposes; medical preparations for slimming purposes; medicinal infusions, medicinal herbs, tisanes; vitamin preparations, preparations of trace elements for human and animal use; mineral food supplements; foodstuffs and lacteal flour for babies; plasters, materials for dressings, material for stopping teeth, dental wax; antiseptics; medical or sanitary disinfectants (excluding soaps); preparations for destroying vermin; anti-insect products; insecticides; insect repellents; fungicides, herbicides; antiparasitic preparations, antiparasitic collars for animals; animal washes; sunscreen products (sunburn ointments); antiseptic cotton, absorbent cotton; sanitary pads, napkins and panties; menstruation tampons; breast-nursing pads; sterilising preparations; adhesives for dentures; deodorants, other than for personal use; air purifying preparations; solutions for use with contact lenses.

16 – Paper; cardboard (unprocessed, semi-processed or for stationery use); cardboard articles; paper or plastic packaging bags, pouches and sheets; paper sheets (stationery); printed matter; photographs, printing blocks; stationery; adhesives for stationery or household purposes; artists' materials, paintbrushes; paint boxes [articles for use in school]; modelling paste; typewriters and office requisites (except furniture); instructional or teaching material (except

apparatus); writing and drawing materials; school supplies; pencils, writing chalk, pencil lead holders, rubber erasers; envelopes; files; scrapbooks, books, periodicals, comic books; almanacs, pamphlets, writing or drawing books, catalogues; calendars; lithographs, engravings; paintings; posters, geographic maps, newspapers; paper tissues for removing make-up; babies' napkin-pants (diaper-pants) of paper and cellulose; pictures, transfers; bags for microwave cooking; toilet paper; paper bibs; paper table linen; hand-towels, paper handkerchiefs; greeting cards, greeting cards; postcards; sewing patterns; terrestrial globes; non-magnetic loyalty cards; non-magnetic identity cards.

29 – Meat, fish, poultry and game; meat extracts; charcuterie; croquettes; preserved, dried, frozen and cooked fruits, mushrooms and vegetables; fruit pulp and salads; vegetable salads; tinned meat, fish, vegetables and fruit; jams, marmalades, stewed fruit; jellies for food; pollen prepared as foodstuff; algae essences for food purposes; preserved soya beans for food; protein for human consumption; bouillon, thick soups, soups; vegetable juices for cooking; eggs, milk, butter, cream, yoghurts, cheese and other dairy goods; edible oils and fats; preparations for making bouillon, potato crisps; ready-cooked meals made with the above products.

30 – Coffee, tea, cocoa, chocolate; chocolate products; vegetal preparations for use as coffee substitutes; artificial coffee; beverages made with coffee, tea, cocoa, chocolate; non-medicinal infusions; sugar, natural sweeteners; glucose for food; rice, tapioca, sago; pasta, semolina; flours and cereal preparations; dried cereal flakes; bread, pastry, cakes, brioches, pancakes, tarts, pies; confectionery, sugar confectionery; edible ices; honey; treacle, royal jelly for human consumption, not for medical purposes; aniseed; star aniseed; malt extract for food; flavourings other than essential oils; aromatic preparations for food; yeast, baking-powder; salt; mustard; vinegar, sauces (condiments), dressings for salads; ketchup; mayonnaise; seasonings; thickening agents for cooking foodstuffs; weeds (condiments); spices; preserved pot-herbs; ice for refreshment; sandwiches; pizzas; rice-based snack foods; spring rolls; sushi, tabbouleh; tortillas; tacos; ready-cooked meals made with the above products.

32 – Beers, mineral and aerated waters and other non-alcoholic beverages; isotonic beverages; lemonades; fruit drinks and fruit juices; tomato juice; vegetable juices (beverages); syrups for beverages; preparations for making beverages (except those made with tea, coffee or cocoa, milk-based beverages); pastilles and powders for aerated drinks; essences for making beverages; preparations for making liqueurs.

(260) AM 2012 65470 A
 (800) 1045654
 (731) GROUPE AUCHAN
 40 avenue de Flandre, F-59170 CROIX,
 France
 (540)



(591) Green, yellow
 (511)

3 – Bleaching preparations and other substances for laundry use; preparations and products for cleaning, polishing, degreasing, abrading and scouring; laundry bleach; stain removers; fabric softeners; paint stripping preparations; emery papers; rust removing preparations; scouring solutions; scale removing preparations for household purposes; detergents other than for use during manufacturing processes and those for medical use; rust removing preparations; floor polishing waxes; shoe wax; leaf lustering products; adhesive materials for cosmetic use; soaps; disinfectant soap; perfumery, perfumes, toilet water; essential oils; deodorants for personal use (perfumery); cosmetics; preparations for hair care; dentifrices, make-up and make-up removing preparations; shaving preparations; toiletries; toiletry milks and oils; tissues impregnated with cosmetic lotions; sunscreens (cosmetic preparations for skin tanning); shampoos for pets; incense; scented wood; potpourris (fragrances).

5 – Pharmaceutical, veterinary preparations; sanitary products for medical use and for intimate hygiene; pharmaceutical preparations for skin care; dietetic substances, beverages and foodstuffs for medical purposes; nutritional additives for medical purposes; medical preparations for slimming purposes; medicinal infusions, medicinal herbs, tisanes; vitamin preparations, preparations of trace elements for human and animal use; mineral food supplements; foodstuffs and lacteal flour for babies; plasters, materials for dressings, material for stopping teeth, dental wax; antiseptics; medical or sanitary disinfectants (excluding soaps); preparations for destroying vermin; anti-insect products; insecticides; insect repellents; fungicides, herbicides; antiparasitic preparations, antiparasitic collars for animals; animal washes; sunscreen products (sunburn ointments); antiseptic cotton, absorbent cotton; sanitary pads, napkins and panties; menstruation tampons; breast-nursing pads; sterilizing preparations; adhesives for dentures; deodorants, other than for personal use; air purifying preparations; solutions for use with contact lenses.

8 – Hand-operated hand tools and implements; non-electric cutlery; table forks; spoons, other than for fishing and for medicines; side arms (other than firearms); scissors; hand-operated hand tools and implements for gardening; mechanical tools for chopping and cutting foodstuffs; non-electric can and tin openers; razors, razor blades; shaving cases; nail nippers and files, nail groomers; manicure sets; electric and non-electric hair clippers for personal use; depilation appliances, electric and non-electric, hair-removing tweezers.

9 – Scientific (other than medical), nautical, surveying, photographic, cinematographic, optical, weighing, measuring, signaling, monitoring (inspection) and rescue (life-saving) apparatus and instruments; teaching apparatus and instruments; apparatus and instruments for conducting, switching, transforming, accumulating, regulating or controlling electricity; material for electricity mains (wires, cables), electric switches, plugs, sockets and other contacts, fuses, socket covers; electric batteries; batteries for lighting; electric couplings; electric welding equipment; electric flat irons; apparatus for recording, transmission or reproduction of sound or images; amplifiers; headphones; loudspeakers; magnetic recording media; sound recording, magnetic and optical disks, audio and video compact disks; digital, versatile, optical disk players (DVD players); video cameras; video tapes; facsimile machines; telephone apparatus; adapters designed for telephones; battery chargers for telephones; bags, covers and cases for mobile telephones and telephone equipment; telephone answering machines; hands-free kits for telephones; television apparatus, aerials; photographic transparencies, projection apparatus and screens; flash-bulbs (photography); exposed films; cases especially made for photographic apparatus and instruments; dictation machines; automatic vending machines and mechanisms for coin-operated apparatus; automatic teller machines; cash registers, calculating machines; data processing apparatus, computers, computer peripheral devices, readers (data processing equipment); software, diskettes; modems; downloadable electronic publications; electronic agendas; apparatus for games adapted for use only with television receivers, independent display screens or monitors; video game cartridges; binoculars, spectacles (optics), contact lenses, spectacle cases; integrated circuit cards (smart cards); magnetic cards; credit and payment cards; payment gift cards; magnetic identity cards; telephone cards; directional compasses; swimming belts and jackets, diving masks and wet suits; scales; protective helmets; protection devices for personal use against accidents; nets for protection against accidents; clothing for protection against accidents, irradiation and fire; barometers; alcoholmeters; fire extinguishers; egg timers; elec-

tric locks; electric door bells; alarms; anti-theft alarms; magnets; decorative magnets (magnets).

10 – Surgical, medical, dental and veterinary apparatus and instruments; artificial limbs, eyes and teeth; inhalers; diagnostic apparatus for medical purposes; orthopedic articles and shoes; suture materials; elastic bands, maternity belts; stockings for varices; belts for medical purposes, maternity belts, umbilical belts; non-chemical contraceptives; condoms; feeding bottles, feeding bottle teats; babies' pacifiers (teats), breast-feeding teats made of latex or silicone; teething rings; nursing appliances, breast pumps; ear picks, nasal aspirator devices; spoons for administering medicine; droppers for medical purposes; thermometers for medical purposes; draw-sheets for sick beds; incontinence sheets; ice bags for medical purposes, gloves for massage; corn knives; special furnishings for medical use; physical exercise apparatus, for medical purposes, esthetic massage apparatus; soporific pillows for insomnia.

11 – Apparatus for lighting, heating, steam generating, cooking, refrigerating, drying, ventilating, disinfecting, water supply; sanitary installations; ornamental fountains; fountains; shower enclosures; wash-hand basins (parts of sanitary installations); bathtubs; faucets; apparatus for air deodorizing and purification; devices for cooling and air conditioning; cooling installations for water; electric fans for personal use; water treatment apparatus; sterilizers; filters for drinking water; solar collectors; ventilation hoods; extractor hoods for kitchens; refrigerating cabinets; refrigerating containers; electric pressure cooking saucepans; electric heaters for feeding bottles; electric kettles; barbecues; ice boxes; cooking installations; ovens; cookers; microwave ovens (cooking apparatus); freezers, refrigerators; gas lighters; bread toasters, electric coffee machines; electric deep fat fryers; ice appliances; hair driers (dryers); sauna bath installations, tanning apparatus; steam facial apparatus (saunas); electric laundry dryers; footwarmers; fireplaces; light bulbs and electric lamps; illumination lamps; headlights and lights for vehicles.

16 – Paper; cardboard (unprocessed, semi-processed or for stationery use); cardboard articles; paper or plastic packaging bags, pouches and sheets; paper sheets (stationery); printed matter, printing type; bookbinding material, photographs, printing blocks; stationery; adhesives for stationery or household purposes; artists' materials, paintbrushes; paint boxes [articles for use in school]; typewriters and office requisites (except furniture); instructional or teaching material (except apparatus); school supplies; staples for offices, thumbtacks, pencil sharpeners, correcting fluids, paper cutters; pencils, pencil lead holders, rubber erasers; envelopes; files; scrapbooks, books, periodicals; almanacs, pam-

phlets, writing or drawing books, catalogs; calendars; lithographs, engravings; paintings; posters, geographic maps, newspapers; spools for inking ribbons; mailers; postage stamps; adhesive tape dispensers (office requisites); tissues of paper for removing make-up; babies' diaper-pants of paper or cellulose; paper coffee filters; transfers (decalcomanias); garbage bags (of paper or plastic materials); bags for microwave cooking; signboards of paper or cardboard; toilet paper; table linen of paper; handtowels, paper handkerchiefs; greeting cards; postcards; sewing patterns; rosaries; terrestrial globes; coupons, discount coupons, tickets; payment gift cards; payment gift checks; non-magnetic loyalty cards; non-magnetic identity cards.

21 – Non-electric household or kitchen utensils and receptacles (neither of precious metal, nor plated therewith); utensils for kitchen and tableware use of glass, porcelain and earthenware; tableware not of precious metal; cooking pot sets, plates, bowls, tumblers, sweetmeat boxes, not of precious metal; drinking vessels; stew-pans; glass boxes; cookie jars; picnic baskets (fitted-) including dishes; thermally insulated containers for food, vacuum bottles; corkscrews; bottle openers; isothermic bags; drinking flasks for travelers, non-electric portable coolers; heaters for feeding bottles, non-electric; brushes for cleaning tanks and containers; soap dispensers; toilet paper holders; soap boxes; clothespins; trash cans; basins (receptacles), basins; articles for cleaning purposes; insect traps; indoor aquaria; flowerpots; baskets, for domestic use, not of precious metal; combs, sponges, brushes, toothbrushes, nail brushes; toiletry sets and utensils; perfume sprays; baby baths (portable); chamber pots.

29 – Meat, fish, poultry and game; meat extracts; charcuterie; croquettes; preserved, dried, frozen and cooked fruits, mushrooms and vegetables; fruit pulp and salads; vegetable salads; canned meat, fish, vegetables and fruit; jams, marmalades, stewed fruit; jellies for food; pollen prepared as foodstuff; weed extracts for food; preserved soya beans for food; protein for human consumption; broth, thick soups, soups; vegetable juices for cooking; eggs, milk, butter, cream, yogurts, cheeses and other milk products; edible oils and fats; preparations for making bouillon, potato chips; cooked dishes made with the above products.

30 – Coffee, tea, cocoa, chocolate; chocolate goods; vegetal preparations for use as coffee substitutes; artificial coffee; beverages made with coffee, tea, cocoa, chocolate; infusions, not medicinal; sugar, natural sweeteners; glucose for food; rice, tapioca, sago; pasta, semolina; flours and cereal preparations; chips (cereal products); bread, pastry, cakes, brioches, hot cakes, tarts, pies; confectionery, sugar confectionery; ices; honey; treacle, royal jelly for

human consumption, not for medical purposes; aniseed; star aniseed; malt extract for food; flavorings other than essential oils; aromatic preparations for food; yeast, baking-powder; salt; mustard; vinegar, sauces (condiments), dressings for salads; ketchup; mayonnaise; seasonings; thickening agents for cooking foodstuffs; seaweed (condiments); spices; preserved garden herbs; ice for refreshment; sandwiches; pizzas; rice-based snack foods; spring rolls; sushi, tabbouleh; tortillas; tacos; ready-cooked meals made with the above products.

31 – Agricultural, horticultural and forestry products (neither prepared, nor transformed); grains (seeds); natural turf; fresh fruits and vegetables; algae for consumption; fresh mushrooms; fresh garden herbs; live crustaceans; fish roe; plant seeds; flower bulbs; trees, shrubs; natural plants and flowers; Christmas trees; animal food and beverages; products for animal litter; malt; fishing bait (live); live animals.

32 – Beers, mineral and aerated waters and other non-alcoholic beverages; isotonic beverages; lemonades; fruit drinks and fruit juices; tomato juice; vegetable juices (beverages); syrups for beverages; preparations for making beverages (except those made with tea, coffee or cocoa, milk-based beverages); pastilles and powders for aerated drinks; essences for making beverages; preparations for making liqueurs.

(260) AM 2012 65472 A
(800) 1065722
(731) SALEWA Sportgeräte GmbH
Saturnstrasse 63, 85609 Aschheim, Germany
(540)

SALEWA

(591) Black, white
(511)

18 – Bags; rucksacks; hip bags and belt bags; suitcases; rain covers for rucksacks and bags; shoulder belts; rucksack-water-tank-systems; school bags; mountaineering sticks and hiking sticks; umbrellas; parasols; matchesacks; trekking sticks; sports bags; handbags; purses; camping bags; leather and imitations of leather as well as goods made of these materials (included in this class); small leather goods, included in this class.

25 – Clothing; footwear; headgear; hosiery; underwear; weatherproof outdoor clothing; sport clothing; hip-belts; belts; gloves; scarves.

28 – Sports articles (included in this class); ski bindings; ski sticks; skiing accessories (included in this class); skis; sports equipment; games; coverings for skis; ski bags; sleighs (sports articles); climbing harnesses (sports articles); abseiling harnesses

(sports articles); mountaineering articles (included in this class).

(260) AM 2012 65473 A
(800) 1067577
(731) "EQUATORIAL ENERGY INVESTMENTS" LTD
Oliaji Trade Center – 1st. floor, Victoria, Mahe, Seychelles
(540)



(591) White, grey, light grey, black and yellow
(511)

16 – Paper and goods made from these materials, not included in other classes; cardboard and goods made from these materials, in particular packaging material for cigarettes.

34 – Tobacco; cigarettes, cigarette filters, cigarette paper; smokers' articles; matches.

(260) AM 2012 65563 A
(800) 1099382
(731) MEGA SOFT (FUJIAN) HYGIENE PRODUCTS CO., LTD.
Yihe Industrial Mansion, Chaokeng fenglushan, Nanhuan Road, Shishi City, 362700 Fujian, China
(540)

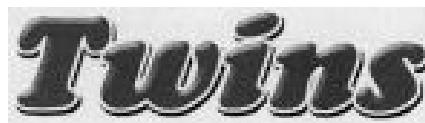

(591) Black, white
(511)

16 – Babies' napkin-pants (diaper-pants) of paper and cellulose, disposable; babies' napkins of paper and cellulose, disposable; babies' diapers of paper and cellulose, disposable; hygienic paper; paper; towels of paper; modelling materials; filtering materials (paper).

(260) AM 2012 65565 A
(800) 1099413
(731) JANSSEN R&D IRELAND
Eastgate Village, Eastgate, Little Island, Co Cork, Ireland

(540)

GALEXOS

(591) Black, white

(511)

5 – Human pharmaceutical preparations.

(260) AM 2012 65566 A

(800) 1099470

(731) DOCHIRNIE PIDPRYEMSTVO

"KONDYTERSKA
KORPORATSIIA "ROSHEN"

Elektrykiv vul., 26/9, Kyiv 04176, Ukraine

(540)

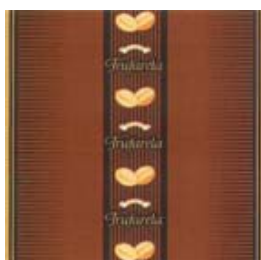

(591) Brown, white and yellow

(511)

30 – Candies, chocolate candies.

(260) AM 2012 65567 A

(800) 1099500

(731) DR. THEISS NATURWAREN GMBH

Michelinstrasse 10, 66424 Homburg,
Germany

(540)

Бейнвель

(591) Green

(511)

3 – Soaps; essential oils; cosmetics, including foam and cream additives for baths, massage oils, foot lotions, foot powders, foot creams and foot balms; hair lotions; non-medicated massage preparations.

5 – Pharmaceutical, veterinary and sanitary preparations adapted for medical use including balms for medical purposes; plasters, materials for dressings.

(260) AM 2012 65570 A

(800) 1099506

(731) Intelligent Media, UAB

Antano Tumėno g. 4, LT-01109 Vilnius,
Lithuania

(540)



(591) Red and white

(511)

16 – Paper, cardboard and goods made from these materials, not included in other classes; printed matter; bookbinding material; photographs; stationery; adhesives for stationery or household purposes; artists' materials; paint brushes; typewriters and office requisites (except furniture); instructional and teaching material (except apparatus); plastic materials for packaging (not included in other classes); printers' type; printing blocks.

41 – Education; providing of training; entertainment; sporting and cultural activities.

(260) AM 2012 65571 A

(800) 1099508

(731) SCA Hygiene Products Hoogezand B.V.

Abramskade 6, NL-9601 KM
HOOGEZAND, Netherlands

(540)

LIBERO NATURAL

(591) Black, white

(511)

3 – Cosmetic skin care products, namely wash cream, wash mousse, cleansing cream, moisturizers, skin lotions, barrier cream, zinc cream, liquid soap, skin care oil, bath oil, shampoo, conditioner and hair mousse, cotton wool, cotton sticks, tissues impregnated with cosmetic and hygiene lotions, disposable wipes impregnated with cleaning chemicals or compounds, all for baby care and personal use.

16 – Nursing table covers, bibs, disposable diapers and diaper pants for babies, made of paper and cellulose; diapers of paper and cellulose, paper cloths for washing the body; bibs and nursing table covers of paper with plastic lining; paper towels; paper napkins.

25 – Articles of clothing for babies and young children, underpants for babies and young children; babies' napkins of textile.

(260) AM 2012 65572 A

(800) 1099516

(731) Chipita Industrial and Commercial Company

S.A. with the distinctive title Chipita S.A.
12th km National Road, Athens-Lamia,
GR-144 52 Metamorphosis, Greece

(540)



(591) Red, black and white
 (511)
 29 – Potato products of all types (chips, crisps, sticks, potato flakes, fritters).
 30 – Cereal-based snack food, farinaceous foods, bread doughs; bread, bread rolls, breadcrumbs, bread products of all types (chips, crisps, sticks), rusks, bread preparations being snacks and crisps, snacks included in this class.

(260) AM 2012 65573 A
 (800) 1099527
 (731) APOLLO TYRES AG
 Mellingerstrasse 2a, CH-5400 Baden,
 Switzerland

(540)
APOLLO ENDURACE

(591) Black, white
 (511)
 12 – Tires, inner tubes and mudguard flaps for motor cars.

(260) AM 2012 65574 A
 (800) 1099528
 (731) APOLLO TYRES AG
 Mellingerstrasse 2a, CH-5400 Baden,
 Switzerland

(540)
APOLLO HAWKZ

(591) Black, white
 (511) 12 – Tires, inner tubes and mudguard flaps for motor cars.

(260) AM 2012 65575 A
 (800) 1099562
 (731) Aymerich Inver, S.L.
 Calle Severo Ochoa, 36, Elche Parque
 Industrial, E-03203 ELCHE (Alicante), Spain

(540)

(591) Black, white
 (511)
 18 – Leather and imitations of leather, and goods made of these materials and not included in other classes; animal skins, trunks and traveling bags; umbrellas, parasols and walking sticks, whips, harness and saddlery.
 25 – Clothing, footwear, headgear.
 35 – Advertising; business management; business administration; office functions.

(260) AM 2012 65576 A
 (800) 1099578
 (731) PHILIP MORRIS BRANDS SÀRL
 Quai Jeanrenaud 3, CH-2000 Neuchâtel,
 Switzerland



(591) Black, white
 (511)
 34 – Tobacco, raw or manufactured; tobacco products, including cigars, cigarettes, cigarillos, tobacco for roll-your-own cigarettes, pipe tobacco, chewing tobacco, snuff, kretek; snus; tobacco substitutes (not for medical purposes); smokers' articles, including cigarette paper and tubes, cigarette filters, tobacco pouches, cigarette cases and ashtrays, pipes, pocket machines for rolling cigarettes, lighters; matches.

(260) AM 2012 65577 A
 (800) 1099585
 (731) Chanel SARL
 Burgstrasse 26, CH-8750 Glaris, Switzerland

(540)
PERFECTION LUMIERE

(591) Black, white
 (511)
 3 – Make-up products, make-up foundations for the face.

(260) AM 2012 65579 A
 (800) 1099590
 (731) TOVARYSTVO Z OBMEZHENOIU
 VIDPOVIDALNISTIU "FELITSATA
 UKRINA"
 vul. Oranzherejna. 135 bud. 3, Kyiv 01135,
 Ukraine

(540)
ПРЕЛАКСАН

(591) Black, white
 (511)
 5 – Bacterial preparations for medical and veterinary use; bouillons for bacteriological cultures; media for bacteriological cultures; bacteriological preparations for medical and veterinary use; balms for medical purposes; biological preparations for medical purposes; biologically active additives for medical purposes; biological preparations for veterinary purposes; veterinary preparations; vitamin

preparations; edible plant fibers, non-nutritive; lacteal flour for babies; dietetic beverages adapted for medical purposes; dietetic substances adapted for medical use; dietetic foods adapted for medical purposes; dietetic food preparations adapted for medical purposes; additives to fodder for medical purposes; elixirs (pharmaceutical preparations); medicines for alleviating constipation; additives to fodder for medical purposes; medicinal drinks; medicinal infusions; medicines for veterinary purposes; medicines for human purposes; candy for medical purposes; mineral food-supplements; nutritive substances for microorganisms; mineral water salts; nutritional additives for medical purposes; laxatives; evacuants; purgatives; syrups for pharmaceutical purposes; digestives for pharmaceutical purposes; pharmaceutical preparations; ferments for pharmaceutical purposes; suppositories; chemico-pharmaceutical preparations; candy, medicated; confectionery, medicated.

(260) AM 2012 65581 A

(800) 1099618

(731) Medinova AG

Eggbühlstrasse 14, CH-8052 Zürich,
Switzerland

(540)

ФЛУОМИЗИН

(591) Black, white

(511)

5 – Pharmaceutical products as well as health care preparations.

(260) AM 2012 65582 A

(800) 1099619

(731) FABRICA MATADERO Y DESPIECE,
S.A.

Camino Santa Inés, 71, E-29590 Campanillas
(Málaga), Spain

(540)



(591) Blue, red, gold, white

(511)

29 – Meat, fish, poultry and game; meat extracts; preserved, dried and cooked fruits and vegetables; jellies, marmalade, compotes; eggs, milk and milk products; edible oils and edible fats

(260) AM 2012 65583 A

(800) 427509

(731) DENSO-Holding GmbH & Co.

Felderstrasse 24, 51371 Leverkusen, Germany
(540)



(591) Blue, black and white

(511)

1 – Chemicals for industrial and scientific use; adhesives for industrial use; protective preparations for buildings, namely impregnating preparations for stonework or blockwork; additives, particularly for the production of foam concrete, cellular concrete and refractory concrete as well as construction elements made of these materials; natural and synthetic rubbers and substitutes therefor of plastics as well as mixtures of these materials and mixtures of these materials with bituminous preparations in the form of adhesives for industrial use and mastic for use as protective preparations for buildings.

2 – Corrosion prevention inhibitors; rust preventives and corrosion preventives, wood preserving agents, corrosion inhibitor strips for stuffing elements in the construction of railcars and installations as well as the building of ships, motor vehicles and aircraft; natural and synthetic rubbers and substitutes therefor of plastics as well as mixtures with these materials and mixtures of these materials with bituminous preparations in the form of straps, tapes, panels, strips and paints, all of which are intended for use as corrosion preventives and wood preserving agents, anti-corrosive preparations and anti-corrosive coatings, anti-corrosive and sealing pastes.

7 – Mechanical tools, apparatus and machines for producing and processing corrosion preventives, protective preparations for buildings, wood conservation agents, insulation materials and sealants; microwave installations for the continuous vulcanization of rubber goods in a high-frequency field.

8 – Hand-held tools, including hand-held instruments used as tools.

9 – Rectifiers, measuring instruments and electrodes for the cathodic anti-corrosion protection of pipe ducts and tanks.

17 – Sealing and stuffing material; insulating material and thermal insulation agents for technical installations, pipes and tanks; sealants and plastic and elastic fillings for pipes made of sandstone, cement, concrete, metal or plastic; sealants and plastic and elastic fillings for the stuffing of construction elements placed one against the other, joint packings; sealing pastes, natural and synthetic rubbers and substitutes therefor of plastics as well

as mixtures of these materials and mixtures of these materials with bituminous preparations in the form of agglutinant substances for industrial use, compounds, pastes, emulsions and dispersions, profiles, straps, tapes, panels, sheets, cords, flexible pipes, pipes, plates, strips, as well as solid and foam rings, all for use as insulators and sealing elements.

19 – Asphalt, pitch, tar and bituminous preparations in the form of filling compounds, protective compounds for buildings, anti-corrosive compounds, anti-corrosive preparations and anti-corrosive coatings, as well as compounds, mastics, cords, profiles, strips, plates, boards, tapes and sealing panels; natural and synthetic rubbers and substitutes therefor of plastics as well as mixtures of these materials and mixtures of these materials with bituminous preparations in the form of paints, glues for industrial use, compounds, mastics, pastes, emulsions and dispersions, profiles, straps, tapes, panels, sheets, cords, plates, strips as well as solid and foam rings, all for use as protective preparations for buildings.

(260) AM 2012 65586 A
(800) 641675
(731) KRKA, tovarna zdravil, d.d., Novo mesto
Šmarješka cesta 6, SI-8501 Novo mesto,
Slovenia

(540)

NALGESIN

(591) Black, white
(511)
5 – Pharmaceutical preparations; medicines.

(260) AM 2012 65587 A
(800) 645426
(731) Boehringer Ingelheim International GmbH;
55218 Ingelheim, Germany
(540)

ANTISTAX

(591) Black, white
(511)
5 – Medicines; tonic preparations for medical purposes; medicinal food additives; chemicals for sanitary purposes; dietetic substances for medical use, plasters and materials for dressings.

30 – Food additives, dietetic substances and food supplements included in this class, for non-medical purposes.

(260) AM 2012 65588 A
(800) 725902
(731) Boehringer Ingelheim International GmbH
55218 Ingelheim, Germany

(540)

ANTISTAX

(591) Black, white
(511)
3 – Soaps; perfumery, essential oils, cosmetics, hair lotions; dentifrices.

(260) AM 2012 65589 A
(800) 761130
(731) REHAU AG+Co
Rheniumhaus, 95111 Rehau, Germany

(540)

RAUTITAN

(591) Black, white
(511)
6 – Junctions of metal for pipes, fastening elements of metal for pipes.

17 – Junctions not of metal for pipes, goods made from plastics (semi-finished products), sealing material for use in pipes and tubing/hoses (non metallic).

19 – Pipes (non metallic) for construction purposes, pipes (non metallic) for heating systems, pipes (non metallic) for water supply, pipes (non metallic) for drinking water systems as well as fittings.

(260) AM 2012 67068 A
(800) 1111319
(731) Boehringer Ingelheim International GmbH
55218 Ingelheim, Germany

(540)

АНТИСТАКС

(591) Black, white
(511)
3 – Bleaching preparations and other substances for laundry use; cleaning, polishing, scouring and abrasive preparations; soaps; perfumery, essential oils, cosmetics, hair lotions; dentifrices.

(260) AM 2012 62224 A*
(800) 1071720
(731) THE ABSOLUT COMPANY
AKTIEBOLAG
SE-117 97 Stockholm, Sweden

(540)

ABSOLUT
Country of Sweden
WILD TEA

(591) Black, white
(511)
33 – Alcoholic beverages (except beers).

INTERNATIONAL TRADEMARKS PROTECTED IN GEORGIA

(260) AM 2010 52827 A
(800) 992109
(151) 2008 10 16
(181) 2018 10 16
(511) 10

(260) AM 2012 61490 A
(800) 1065309
(151) 2010 08 05
(181) 2020 08 05
(511) 12

(260) AM 2010 52828 A
(800) 992110
(151) 2008 10 16
(181) 2018 10 16
(511) 10

(260) AM 2012 61651 A
(800) 1067104
(151) 2011 01 05
(181) 2021 01 05
(511) 09, 38, 42

(260) AM 2010 53915 A
(800) 1001794
(151) 2009 03 26
(181) 2019 03 26
(511) 09, 18

(260) AM 2012 61714 A
(800) 1067834
(151) 2011 01 22
(181) 2021 01 22
(511) 41

(260) AM 2010 54185 A
(800) 1003340
(151) 2009 02 17
(181) 2019 02 17
(511) 06, 17, 19, 20, 21, 22, 24, 37, 42

(260) AM 2012 61716 A
(800) 1067845
(151) 2011 01 28
(181) 2021 01 28
(511) 20

(260) AM 2011 60359 A
(800) 1054876
(151) 2010 09 08
(181) 2020 09 08
(511) 07

(260) AM 2012 61717 A
(800) 1067859
(151) 2011 01 24
(181) 2021 01 24
(511) 05

(260) AM 2011 61042 A
(800) 1060966
(151) 2010 11 15
(181) 2020 11 15
(511) 03, 05

(260) AM 2012 61770 A
(800) 997332
(151) 2009 01 21
(181) 2019 01 21
(511) 05

(260) AM 2011 61046 A
(800) 1061047
(151) 2010 10 29
(181) 2020 10 29
(511) 37, 39, 40

(260) AM 2012 61907 A
(800) 1069238
(151) 2010 10 08
(181) 2020 10 08
(511) 39

(260) AM 2011 61336 A
(800) 1063875
(151) 2011 01 14
(181) 2021 01 14
(511) 39

(260) AM 2012 62007 A
(800) 1070045
(151) 2010 10 11
(181) 2020 10 11
(511) 16, 21

(260) AM 2012 62194 A
(800) 1071345
(151) 2010 11 19
(181) 2020 11 19
(511) 18, 42

(260) AM 2012 62917 A
(800) 1077686
(151) 2010 09 08
(181) 2020 09 08
(511) 30, 35

(260) AM 2012 62454 A
(800) 1059445
(151) 2010 10 22
(181) 2020 10 22
(511) 06

(260) AM 2012 62918 A
(800) 1077702
(151) 2011 01 04
(181) 2021 01 04
(511) 07

(260) AM 2012 62570 A
(800) 1074883
(151) 2011 01 21
(181) 2021 01 21
(511) 03

(260) AM 2012 62919 A
(800) 1077724
(151) 2011 02 10
(181) 2021 02 10
(511) 03

(260) AM 2012 62580 A
(800) 1074987
(151) 2011 03 22
(181) 2021 03 22
(511) 35, 38, 41, 42

(260) AM 2012 62999 A
(800) 1078448
(151) 2011 01 26
(181) 2021 01 26
(511) 29, 30, 33

(260) AM 2012 62588 A
(800) 1075095
(151) 2011 02 17
(181) 2021 02 17
(511) 09, 18, 28, 41

(260) AM 2012 63000 A
(800) 1078453
(151) 2011 05 19
(181) 2021 05 19
(511) 05

(260) AM 2012 62672 A
(800) 1075926
(151) 2011 04 07
(181) 2021 04 07
(511) 24

(260) AM 2012 63001 A
(800) 1078454
(151) 2011 05 19
(181) 2021 05 19
(511) 05

(260) AM 2012 62915 A
(800) 1077634
(151) 2011 03 01
(181) 2021 03 01
(511) 20

(260) AM 2012 63004 A
(800) 1078463
(151) 2011 03 29
(181) 2021 03 29
(511) 30

(260) AM 2012 62916 A
(800) 1077662
(151) 2010 12 22
(181) 2020 12 22
(511) 37, 42

(260) AM 2012 63005 A
(800) 1078505
(151) 2011 05 03
(181) 2021 05 03
(511) 03, 05, 21

TRADEMARKS

(260) AM 2012 63007 A
(800) 1078673
(151) 2011 05 05
(181) 2021 05 05
(511) 32, 33, 43

(260) AM 2012 63173 A
(800) 972771
(151) 2008 04 02
(181) 2018 04 02
(511) 05

(260) AM 2012 63013 A
(800) 1078676
(151) 2011 04 26
(181) 2021 04 26
(511) 34

(260) AM 2012 63174 A
(800) 1008813
(151) 2008 12 03
(181) 2018 12 03
(511) 09, 18, 25

(260) AM 2012 63022 A
(800) 1078692
(151) 2011 04 27
(181) 2021 04 27
(511) 30

(260) AM 2012 63176 A
(800) 1010760
(151) 2009 06 22
(181) 2019 06 22
(511) 03, 05

(260) AM 2012 63023 A
(800) 1078699
(151) 2011 05 19
(181) 2021 05 19
(511) 05

(260) AM 2012 63177 A
(800) 1013303
(151) 2009 03 26
(181) 2019 03 26
(511) 09, 18

(260) AM 2012 63026 A
(800) 1078705
(151) 2011 05 10
(181) 2021 05 10
(511) 05

(260) AM 2012 63178 A
(800) 1054994
(151) 2010 08 24
(181) 2020 08 24
(511) 32

(260) AM 2012 63027 A
(800) 1078706
(151) 2011 05 10
(181) 2021 05 10
(511) 05

(260) AM 2012 63179 A
(800) 1059483
(151) 2010 11 18
(181) 2020 11 18
(511) 05

(260) AM 2012 63028 A
(800) 1078707
(151) 2011 05 10
(181) 2021 05 10
(511) 05

(260) AM 2012 63180 A
(800) 1059635
(151) 2010 10 14
(181) 2020 10 14
(511) 07

(260) AM 2012 63171 A
(800) 935517
(151) 2007 08 03
(181) 2017 08 03
(511) 05

(260) AM 2012 63363 A
(800) 1082067
(151) 2011 05 09
(181) 2021 05 09
(511) 33

(260) AM 2012 63849 A
(800) 1086190
(151) 2011 04 07
(181) 2021 04 07
(511) 19, 35, 40

(260) AM 2012 63854 A
(800) 967996
(151) 2008 01 18
(181) 2018 01 18
(511) 09

(260) AM 2012 63855 A
(800) 1018996
(151) 2009 10 08
(181) 2019 10 08
(511) 05

(260) AM 2012 63885 A
(800) 1086378
(151) 2011 06 01
(181) 2021 06 01
(511) 09, 38

(260) AM 2012 63914 A
(800) 1086713
(151) 2011 07 05
(181) 2021 07 05
(511) 09

(260) AM 2012 63915 A
(800) 1086733
(151) 2011 07 08
(181) 2021 07 08
(511) 05

(260) AM 2012 63916 A
(800) 1086839
(151) 2011 07 11
(181) 2021 07 11
(511) 17, 19, 27

(260) AM 2012 63917 A
(800) 1086867
(151) 2011 04 21
(181) 2021 04 21
(511) 01

(260) AM 2012 63918 A
(800) 1086912
(151) 2011 04 08
(181) 2021 04 08
(511) 03

(260) AM 2012 63920 A
(800) 1086922
(151) 2010 10 14
(181) 2020 10 14
(511) 32, 33

(260) AM 2012 63921 A
(800) 1086958
(151) 2011 04 08
(181) 2021 04 08
(511) 33

(260) AM 2012 63922 A
(800) 1086996
(151) 2011 04 27
(181) 2021 04 27
(511) 30

(260) AM 2012 63923 A
(800) 1086997
(151) 2011 04 27
(181) 2021 04 27
(511) 30

(260) AM 2012 63925 A
(800) 1087016
(151) 2011 05 17
(181) 2021 05 17
(511) 12, 35

(260) AM 2012 63926 A
(800) 1087039
(151) 2011 06 20
(181) 2021 06 20
(511) 05

(260) AM 2012 63927 A
(800) 391687
(151) 2002 09 04
(181) 2012 09 04
(511) 07

TRADEMARKS

(260) AM 2012 63928 A
(800) 413396A
(151) 2005 01 13
(181) 2015 01 13
(511) 25

(260) AM 2012 63929 A
(800) 435850
(151) 2008 02 16
(181) 2018 02 16
(511) 07

(260) AM 2012 63930 A
(800) 435851
(151) 2008 02 16
(181) 2018 02 16
(511) 07

(260) AM 2012 63931 A
(800) 619980
(151) 2004 05 19
(181) 2014 05 19
(511) 05

(260) AM 2012 63932 A
(800) 646346
(151) 2005 11 07
(181) 2015 11 07
(511) 05

(260) AM 2012 63933 A
(800) 701703
(151) 2008 09 22
(181) 2018 09 22
(511) 07, 08

(260) AM 2012 63934 A
(800) 743130
(151) 2010 07 10
(181) 2020 07 10
(511) 01, 02, 19

(260) AM 2012 63935 A
(800) 745942
(151) 2010 09 28
(181) 2020 09 28
(511) 05

(260) AM 2012 63937 A
(800) 800999
(151) 2003 03 17
(181) 2013 03 17
(511) 05

(260) AM 2012 63938 A
(800) 831925
(151) 2004 07 12
(181) 2014 07 12
(511) 05

(260) AM 2012 63940 A
(800) 897669
(151) 2006 06 19
(181) 2016 06 19
(511) 07

(260) AM 2012 63943 A
(800) 933225
(151) 2007 07 05
(181) 2017 07 05
(511) 07

(260) AM 2012 64160 A
(800) 1088735
(151) 2011 07 15
(181) 2021 07 15
(511) 07, 08

(260) AM 2012 64161 A
(800) 1088745
(151) 2011 05 27
(181) 2021 05 27
(511) 06

(260) AM 2012 64162 A
(800) 1088753
(151) 2011 06 16
(181) 2021 06 16
(511) 29

(260) AM 2012 64163 A
(800) 1088764
(151) 2011 07 27
(181) 2021 07 27
(511) 05

(260) AM 2012 64164 A
(800) 1088766
(151) 2011 07 19
(181) 2021 07 19
(511) 05

(260) AM 2012 64173 A
(800) 1088830
(151) 2011 07 22
(181) 2021 07 22
(511) 06, 17, 19

(260) AM 2012 64165 A
(800) 1088767
(151) 2011 07 19
(181) 2021 07 19
(511) 05

(260) AM 2012 64174 A
(800) 1088839
(151) 2011 06 23
(181) 2021 06 23
(511) 09, 16, 25, 35

(260) AM 2012 64166 A
(800) 1088768
(151) 2011 07 19
(181) 2021 07 19
(511) 05

(260) AM 2012 64272 A
(800) 1089296
(151) 2011 04 12
(181) 2021 04 12
(511) 19, 35, 37

(260) AM 2012 64167 A
(800) 1088769
(151) 2011 07 19
(181) 2021 07 19
(511) 05

(260) AM 2012 64273 A
(800) 1089387
(151) 2011 06 02
(181) 2021 06 02
(511) 03, 05

(260) AM 2012 64168 A
(800) 1088770
(151) 2011 07 19
(181) 2021 07 19
(511) 05

(260) AM 2012 64274 A
(800) 1089439
(151) 2011 07 04
(181) 2021 07 04
(511) 09

(260) AM 2012 64170 A
(800) 1088798
(151) 2011 01 18
(181) 2021 01 18
(511) 01, 03, 04, 07, 12

(260) AM 2012 64275 A
(800) 1089463
(151) 2011 08 16
(181) 2021 08 16
(511) 09

(260) AM 2012 64171 A
(800) 1088802
(151) 2011 04 20
(181) 2021 04 20
(511) 16

(260) AM 2012 64276 A
(800) 1089475
(151) 2011 08 18
(181) 2021 08 18
(511) 25

(260) AM 2012 64172 A
(800) 1088818
(151) 2011 07 14
(181) 2021 07 14
(511) 05, 29

(260) AM 2012 64277 A
(800) 1089492
(151) 2011 07 28
(181) 2021 07 28
(511) 30

TRADEMARKS

(260) AM 2012 64278 A
(800) 1089668
(151) 2011 02 24
(181) 2021 02 24
(511) 04, 09, 14, 25, 34

(260) AM 2012 64289 A
(800) 879085
(151) 2006 01 03
(181) 2016 01 03
(511) 09

(260) AM 2012 64279 A
(800) 1089695
(151) 2011 07 19
(181) 2021 07 19
(511) 09

(260) AM 2012 64355 A
(800) 1090112
(151) 2011 03 18
(181) 2021 03 18
(511) 30

(260) AM 2012 64280 A
(800) 1089696
(151) 2011 07 12
(181) 2021 07 12
(511) 09

(260) AM 2012 64356 A
(800) 1090180
(151) 2011 08 08
(181) 2021 08 08
(511) 05

(260) AM 2012 64281 A
(800) 1089731
(151) 2011 08 15
(181) 2021 08 15
(511) 11

(260) AM 2012 64357 A
(800) 1090181
(151) 2011 08 08
(181) 2021 08 08
(511) 05

(260) AM 2012 64282 A
(800) 372793
(151) 2010 10 13
(181) 2020 10 13
(511) 06, 08, 20

(260) AM 2012 64358 A
(800) 1090182
(151) 2011 08 08
(181) 2021 08 08
(511) 05

(260) AM 2012 64286 A
(800) 664635
(151) 2006 09 27
(181) 2016 09 27
(511) 01

(260) AM 2012 64359 A
(800) 1090185
(151) 2011 07 05
(181) 2021 07 05
(511) 01, 02

(260) AM 2012 64287 A
(800) 667311
(151) 2006 12 12
(181) 2016 12 12
(511) 05

(260) AM 2012 64360 A
(800) 1090239
(151) 2011 08 17
(181) 2021 08 17
(511) 30

(260) AM 2012 64288 A
(800) 747400
(151) 2010 11 28
(181) 2020 11 28
(511) 05

(260) AM 2012 64361 A
(800) 1090240
(151) 2011 08 09
(181) 2021 08 09
(511) 05

(260) AM 2012 64362 A
(800) 1090241
(151) 2011 07 29
(181) 2021 07 29
(511) 05

(260) AM 2012 64378 A
(800) 1090250
(151) 2011 08 09
(181) 2021 08 09
(511) 05

(260) AM 2012 64364 A
(800) 1090243
(151) 2011 08 09
(181) 2021 08 09
(511) 05

(260) AM 2012 64437 A
(800) 1090866
(151) 2011 05 10
(181) 2021 05 10
(511) 04, 35, 36, 37, 38, 39, 40, 42

(260) AM 2012 64365 A
(800) 1090244
(151) 2011 08 09
(181) 2021 08 09
(511) 05

(260) AM 2012 64438 A
(800) 1090869
(151) 2011 05 30
(181) 2021 05 30
(511) 09, 11

(260) AM 2012 64368 A
(800) 1090245
(151) 2011 08 09
(181) 2021 08 09
(511) 05

(260) AM 2012 64439 A
(800) 1090876
(151) 2011 05 16
(181) 2021 05 16
(511) 05, 30

(260) AM 2012 64373 A
(800) 1090246
(151) 2011 08 09
(181) 2021 08 09
(511) 05

(260) AM 2012 64442 A
(800) 1090885
(151) 2011 07 13
(181) 2021 07 13
(511) 07, 12

(260) AM 2012 64374 A
(800) 1090247
(151) 2011 07 29
(181) 2021 07 29
(511) 05

(260) AM 2012 64443 A
(800) 1090891
(151) 2011 06 13
(181) 2021 06 13
(511) 29, 30

(260) AM 2012 64376 A
(800) 1090248
(151) 2011 08 09
(181) 2021 08 09
(511) 05

(260) AM 2012 64444 A
(800) 1090912
(151) 2011 06 17
(181) 2021 06 17
(511) 06, 07, 09, 12, 13, 37, 38, 41, 42, 45

(260) AM 2012 64377 A
(800) 1090249
(151) 2011 08 09
(181) 2021 08 09
(511) 05

(260) AM 2012 64445 A
(800) 1090937
(151) 2011 08 08
(181) 2021 08 08
(511) 05

(260) AM 2012 64446 A
(800) 1091004
(151) 2011 08 11
(181) 2021 08 11
(511) 01

(260) AM 2012 61904 A
(800) 1069206
(151) 2010 07 06
(181) 2020 07 06
(511) 05, 31

(260) AM 2012 64447 A
(800) 1091008
(151) 2010 12 06
(181) 2020 12 06
(511) 09, 35, 38, 41

(260) AM 2012 64448 A
(800) 1091016
(151) 2011 08 24
(181) 2021 08 24
(511) 03

(260) AM 2012 64449 A
(800) 1091017
(151) 2011 08 24
(181) 2021 08 24
(511) 03

(260) AM 2012 64450 A
(800) 1091018
(151) 2011 08 24
(181) 2021 08 24
(511) 03

(260) AM 2012 64542 A
(800) 1091713
(151) 2011 07 29
(181) 2021 07 29
(511) 05

(260) AM 2012 61106 A
(800) 1061513
(151) 2010 12 03
(181) 2020 12 03
(511) 30, 35, 43

(260) AM 2012 61648 A
(800) 1067074
(151) 2011 01 10
(181) 2021 01 10
(511) 16, 28, 38, 41

APPELLATIONS OF ORIGIN AND GEOGRAPHICAL INDICATIONS OF GOODS

THE RIGHT TO USE OF REGISTERED APPELLATIONS OF ORIGIN OF GOODS

REGISTERED APPELLATIONS OF ORIGIN OF GOODS: **NABEGLAVI**
THE RIGHT TU USE: Joint Stock Company "TSKALI MARGEBELI"
Sopeli Nabeglavi, 4900, Chokhatauris raioni, Georgia
NUMBER OF REGISTRATION: 822/1
VALID: 2012 12 29

REGISTERED APPELLATIONS OF ORIGIN OF GOODS: **SAIRME**
THE RIGHT TU USE: LTD "SAIRME MINERAL WATERS"
kurorti "Sairme", 1000, Bagdatis raioni, Georgia
NUMBER OF REGISTRATION: 823/1
VALID: 2012 12 27

REGISTERED APPELLATIONS OF ORIGIN OF GOODS: **BORJOMI**
THE RIGHT TU USE: LTD "AIDIES BORJOMI BEVERIJI COMPANY"
Pareraveg 45, Kurasao, Antiliis Kundzulebi (Niderlandebi)
NUMBER OF REGISTRATION: 824/1
VALID: 2013 03 29

REGISTERED APPELLATIONS OF ORIGIN OF GOODS: **TELIANI**
THE RIGHT TU USE: Joint Stock Company "TELIANI VALEY"
Tbilisis gzatkecili №3, 2200, Telavi, Georgia
NUMBER OF REGISTRATION: 791/1-12
VALID: 2013 03 29

REGISTERED APPELLATIONS OF ORIGIN OF GOODS: **KHVANCHKARA**
THE RIGHT TU USE: Joint Stock Company "TELIANI VALEY"
Tbilisis gzatkecili №3, 2200, Telavi, Georgia
NUMBER OF REGISTRATION: 1/2-12
VALID: 2013 04 12

REGISTERED APPELLATIONS OF ORIGIN OF GOODS: **MUKUZANI**
THE RIGHT TU USE: Joint Stock Company "TELIANI VALEY"
Tbilisis gzatkecili №3, 2200, Telavi, Georgia
NUMBER OF REGISTRATION: 2/2-12
VALID: 2013 04 12

REGISTERED APPELLATIONS OF ORIGIN OF GOODS: **TSINANDALI**
THE RIGHT TU USE: Joint Stock Company "TELIANI VALEY"
Tbilisis gzatkecili №3, 2200, Telavi, Georgia
NUMBER OF REGISTRATION: 3/2-12
VALID: 2013 04 12

REGISTERED APPELLATIONS OF ORIGIN OF GOODS: **AKHASHENI**
THE RIGHT TU USE: Joint Stock Company "TELIANI VALEY"
Tbilisis gzatkecili №3, 2200, Telavi, Georgia
NUMBER OF REGISTRATION: 4/2-12
VALID: 2013 04 12

REGISTERED APPELLATIONS OF ORIGIN OF GOODS: **KINDZMARAULI**
THE RIGHT TU USE: Joint Stock Company "TELIANI VALEY"
Tbilisis gzatkecili №3, 2200, Telavi, Georgia
NUMBER OF REGISTRATION: 787/2-12
VALID: 2013 04 12

REGISTERED APPELLATIONS OF ORIGIN OF GOODS: **MANAVI**
THE RIGHT TU USE: Joint Stock Company "TELIANI VALEY"
Tbilisis gzatkecili №3, 2200, Telavi, Georgia
NUMBER OF REGISTRATION: 788/2-12
VALID: 2013 04 12

REGISTERED APPELLATIONS OF ORIGIN OF GOODS: **KAKHETI**
THE RIGHT TU USE: Joint Stock Company "TELIANI VALEY"
Tbilisis gzatkecili №3, 2200, Telavi, Georgia
NUMBER OF REGISTRATION: 789/1-12
VALID: 2013 04 12

REGISTERED APPELLATIONS OF ORIGIN OF GOODS: **NAPAREULI**
THE RIGHT TU USE: Joint Stock Company "TELIANI VALEY"
Tbilisis gzatkecili №3, 2200, Telavi, Georgia
NUMBER OF REGISTRATION: 790/1-12
VALID: 2013 04 12

REGISTERED APPELLATIONS OF ORIGIN OF GOODS: **VAZISUBANI**
THE RIGHT TU USE: Joint Stock Company "TELIANI VALEY"
Tbilisis gzatkecili №3, 2200, Telavi, Georgia
NUMBER OF REGISTRATION: 794/1-12
VALID: 2013 04 12

REGISTERED APPELLATIONS OF ORIGIN OF GOODS: **TVISHI**
THE RIGHT TU USE: Joint Stock Company "TELIANI VALEY"
Tbilisis gzatkecili №3, 2200, Telavi, Georgia
NUMBER OF REGISTRATION: 797/2-12
VALID: 2013 04 12

REGISTERED APPELLATIONS OF ORIGIN OF GOODS: **KHVANCHKARA**
THE RIGHT TU USE: LTD "BADAGONI"
sop. Zemo Khodasheni, 0910, Akhmetis raioni, Georgia
NUMBER OF REGISTRATION: 1/1-12
VALID: 2013 04 12

REGISTERED APPELLATIONS OF ORIGIN OF GOODS: **MUKUZANI**
THE RIGHT TU USE: LTD "BADAGONI"
sop. Zemo Khodasheni, 0910, Akhmetis raioni, Georgia
NUMBER OF REGISTRATION: 2/1-12
VALID: 2013 04 12

REGISTERED APPELLATIONS OF ORIGIN OF GOODS: **TSINANDALI**
THE RIGHT TU USE: LTD "BADAGONI"
sop. Zemo Khodasheni, 0910, Akhmetis raioni, Georgia
NUMBER OF REGISTRATION: 3/1-12
VALID: 2013 04 12

REGISTERED APPELLATIONS OF ORIGIN OF GOODS: **AKHASHENI**
THE RIGHT TU USE: LTD "BADAGONI"
sop. Zemo Khodasheni, 0910, Akhmetis raioni, Georgia
NUMBER OF REGISTRATION: 4/1-12
VALID: 2013 04 12

REGISTERED APPELLATIONS OF ORIGIN OF GOODS: **KINDZMARauli**
THE RIGHT TU USE: LTD "BADAGONI"
sop. Zemo Khodasheni, 0910, Akhmetis raioni, Georgia
NUMBER OF REGISTRATION: 787/1-12
VALID: 2013 04 12

REGISTERED APPELLATIONS OF ORIGIN OF GOODS: **MANAVI**
THE RIGHT TU USE: LTD "BADAGONI"
sop. Zemo Khodasheni, 0910, Akhmetis raioni, Georgia
NUMBER OF REGISTRATION: 788/1-12
VALID: 2013 04 12

REGISTERED APPELLATIONS OF ORIGIN OF GOODS: **VAZISUBANI**
THE RIGHT TU USE: LTD "BADAGONI"
sop. Zemo Khodasheni, 0910, Akhmetis raioni, Georgia
NUMBER OF REGISTRATION: 794/1-12
VALID: 2013 04 12

REGISTERED APPELLATIONS OF ORIGIN OF GOODS: **TVISHI**
THE RIGHT TU USE: LTD "BADAGONI"
sop. Zemo Khodasheni, 0910, Akhmetis raioni, Georgia
NUMBER OF REGISTRATION: 797/1-12
VALID: 2013 04 12

REGISTERED APPELLATIONS OF ORIGIN OF GOODS: **KHVANCHKARA**
THE RIGHT TU USE: LTD "TBILISIS MARANI"
Paliashvilis q. 33, 0179, Tbilisi, Georgia
NUMBER OF REGISTRATION: 1/3-12
VALID: 2013 04 18

REGISTERED APPELLATIONS OF ORIGIN OF GOODS: **MUKUZANI**
THE RIGHT TU USE: LTD "TBILISIS MARANI"
Paliashvilis q. 33, 0179, Tbilisi, Georgia
NUMBER OF REGISTRATION: 2/3-12
VALID: 2013 04 18

REGISTERED APPELLATIONS OF ORIGIN OF GOODS: **TSINANDALI**
THE RIGHT TU USE: LTD "TBILISIS MARANI"
Paliashvilis q. 33, 0179, Tbilisi, Georgia
NUMBER OF REGISTRATION: 3/3-12
VALID: 2013 04 18

REGISTERED APPELLATIONS OF ORIGIN OF GOODS: **KINDZMARAU LI**
THE RIGHT TU USE: LTD "TBILISIS MARANI"
Paliashvilis q. 33, 0179, Tbilisi, Georgia
NUMBER OF REGISTRATION: 787/3-12
VALID: 2013 04 18

REGISTERED APPELLATIONS OF ORIGIN OF GOODS: **KVARELI**
THE RIGHT TU USE: LTD "TBILISIS MARANI"
Paliashvilis q. 33, 0179, Tbilisi, Georgia
NUMBER OF REGISTRATION: 789/1-12
VALID: 2013 04 18

REGISTERED APPELLATIONS OF ORIGIN OF GOODS: **KOTEKHI**
THE RIGHT TU USE: Joint Stock Company "KOTEKHI"
Kukuri Qoroglishvilis q.38, 1500, Gurjaani, Georgia
NUMBER OF REGISTRATION: 799/1-12
VALID: 2013 04 18

REGISTERED APPELLATIONS OF ORIGIN OF GOODS: **KHVANCHKARA**
THE RIGHT TU USE: LTD "CORPORATION QARTULI GVINO"
Simon Chikovanis q. №35, 0171, Gurjaani, Georgia
NUMBER OF REGISTRATION: 1/4-12
VALID: 2013 04 23

REGISTERED APPELLATIONS OF ORIGIN OF GOODS: **MUKUZANI**
THE RIGHT TU USE: LTD "CORPORATION QARTULI GVINO"
Simon Chikovanis q. №35, 0171, Gurjaani, Georgia
NUMBER OF REGISTRATION: 2/4-12
VALID: 2013 04 23

REGISTERED APPELLATIONS OF ORIGIN OF GOODS: **TSINANDALI**
THE RIGHT TU USE: LTD "CORPORATION QARTULI GVINO"
Simon Chikovanis q. №35, 0171, Gurjaani, Georgia
NUMBER OF REGISTRATION: 3/4-12
VALID: 2013 04 23

REGISTERED APPELLATIONS OF ORIGIN OF GOODS: **AKHASHENI**
THE RIGHT TU USE: LTD "CORPORATION QARTULI GVINO"
Simon Chikovanis q. №35, 0171, Gurjaani, Georgia
NUMBER OF REGISTRATION: 4/3-12
VALID: 2013 04 23

REGISTERED APPELLATIONS OF ORIGIN OF GOODS: **GURJAANI**
THE RIGHT TU USE: LTD "CORPORATION QARTULI GVINO"
Simon Chikovanis q. №35, 0171, Gurjaani, Georgia
NUMBER OF REGISTRATION: 5/1-12
VALID: 2013 04 23

REGISTERED APPELLATIONS OF ORIGIN OF GOODS: **KINDZMARauli**
THE RIGHT TU USE: LTD "CORPORATION QARTULI GVINO"
Simon Chikovanis q. №35, 0171, Gurjaani, Georgia
NUMBER OF REGISTRATION: 787/4-12
VALID: 2013 04 23

REGISTERED APPELLATIONS OF ORIGIN OF GOODS: **VAZISUBANI**
THE RIGHT TU USE: LTD "CORPORATION QARTULI GVINO"
Simon Chikovanis q. №35, 0171, Gurjaani, Georgia
NUMBER OF REGISTRATION: 794/4-12
VALID: 2013 04 23

REGISTERED APPELLATIONS OF ORIGIN OF GOODS: **KHVANCHKARA**
THE RIGHT TU USE: LTD "QARTULI GVINISA DA ALKOHOLURI SASMELEBIS COMPANY"
Achinebuli, 2200, Telavi, Georgia
NUMBER OF REGISTRATION: 1/5-12
VALID: 2013 05 11

REGISTERED APPELLATIONS OF ORIGIN OF GOODS: **MUKUZANI**
THE RIGHT TU USE: LTD "QARTULI GVINISA DA ALKOHOLURI SASMELEBIS COMPANY"
Achinebuli, 2200, Telavi, Georgia
NUMBER OF REGISTRATION: 2/5-12
VALID: 2013 05 11

REGISTERED APPELLATIONS OF ORIGIN OF GOODS: **TSINANDALI**
THE RIGHT TU USE: LTD "QARTULI GVINISA DA ALKOHOLURI SASMELEBIS COMPANY"
Achinebuli, 2200, Telavi, Georgia
NUMBER OF REGISTRATION: 3/5-12
VALID: 2013 05 11

REGISTERED APPELLATIONS OF ORIGIN OF GOODS: **AKHASHENI**
THE RIGHT TU USE: LTD "QARTULI GVINISA DA ALKOHOLURI SASMELEBIS COMPANY"
Achinebuli, 2200, Telavi, Georgia
NUMBER OF REGISTRATION: 4/4-12
VALID: 2013 05 11

REGISTERED APPELLATIONS OF ORIGIN OF GOODS: **KINDZMARAU LI**
THE RIGHT TU USE: LTD "QARTULI GVINISA DA ALKOHOLURI SASMELEBIS COMPANY"
Achinebuli, 2200, Telavi, Georgia
NUMBER OF REGISTRATION: 787/5-12
VALID: 2013 05 11

REGISTERED APPELLATIONS OF ORIGIN OF GOODS: **NAPAREULI (Tsiteli)**
THE RIGHT TU USE: LTD "QARTULI GVINISA DA ALKOHOLURI SASMELEBIS COMPANY"
Achinebuli, 2200, Telavi, Georgia
NUMBER OF REGISTRATION: 790/5-12
VALID: 2013 05 11

REGISTERED APPELLATIONS OF ORIGIN OF GOODS: **TVISHI**
THE RIGHT TU USE: LTD "QARTULI GVINISA DA ALKOHOLURI SASMELEBIS COMPANY"
Achinebuli, 2200, Telavi, Georgia
NUMBER OF REGISTRATION: 797/5-12
VALID: 2013 05 11

REGISTERED APPELLATIONS OF ORIGIN OF GOODS: **KHVANCHKARA**
THE RIGHT TU USE: LTD "HELIOSI +"
Roman Rusias q. 27, 4100, Senaki, Georgia
NUMBER OF REGISTRATION: 1/6-12
VALID: 2013 06 08

REGISTERED APPELLATIONS OF ORIGIN OF GOODS: **MUKUZANI**
THE RIGHT TU USE: LTD "HELIOSI +"
Roman Rusias q. 27, 4100, Senaki, Georgia
NUMBER OF REGISTRATION: 2/6-12
VALID: 2013 06 08

REGISTERED APPELLATIONS OF ORIGIN OF GOODS: **AKHASHENI**
THE RIGHT TU USE: LTD "HELIOSI +"
Roman Rusias q. 27, 4100, Senaki, Georgia
NUMBER OF REGISTRATION: 4/5-12
VALID: 2013 06 08

REGISTERED APPELLATIONS OF ORIGIN OF GOODS: **KINDZMARAULI**
THE RIGHT TU USE: LTD "HELIOSI +"
Roman Rusias q. 27, 4100, Senaki, Georgia
NUMBER OF REGISTRATION: 787/6-12
VALID: 2013 06 08

REGISTERED APPELLATIONS OF ORIGIN OF GOODS: **KHVANCHKARA**
THE RIGHT TU USE: LTD "WINE COMPANY SUMI"
Solomon Lionidzis q. 33, 2200, Telavi, Georgia
NUMBER OF REGISTRATION: 1/7-12
VALID: 2013 07 05

REGISTERED APPELLATIONS OF ORIGIN OF GOODS: **MUKUZANI**
THE RIGHT TU USE: LTD "WINE COMPANY SUMI"
Solomon Lionidzis q. 33, 2200, Telavi, Georgia
NUMBER OF REGISTRATION: 2/7-12
VALID: 2013 07 05

REGISTERED APPELLATIONS OF ORIGIN OF GOODS: **TSINANDALI**
THE RIGHT TU USE: LTD "WINE COMPANY SUMI"
Solomon Lionidzis q. 33, 2200, Telavi, Georgia
NUMBER OF REGISTRATION: 3/6-12
VALID: 2013 07 05

REGISTERED APPELLATIONS OF ORIGIN OF GOODS: **GURJAANI**
THE RIGHT TU USE: LTD "WINE COMPANY SUMI"
Solomon Lionidzis q. 33, 2200, Telavi, Georgia
NUMBER OF REGISTRATION: 5/2-12
VALID: 2013 07 05

REGISTERED APPELLATIONS OF ORIGIN OF GOODS: **KINDZMARAULI**
THE RIGHT TU USE: LTD "WINE COMPANY SUMI"
Solomon Lionidzis q. 33, 2200, Telavi, Georgia
NUMBER OF REGISTRATION: 787/7-12
VALID: 2013 07 05

REGISTERED APPELLATIONS OF ORIGIN OF GOODS: **NAPAREULI**
THE RIGHT TU USE: LTD "WINE COMPANY SUMI"
Solomon Lionidzis q. 33, 2200, Telavi, Georgia
NUMBER OF REGISTRATION: 790/3-12
VALID: 2013 07 05

REGISTERED APPELLATIONS OF ORIGIN OF GOODS: **VAZISUBANI**
THE RIGHT TU USE: LTD "WINE COMPANY SUMI"
Solomon Lionidzis q. 33, 2200, Telavi, Georgia
NUMBER OF REGISTRATION: 794/5-12
VALID: 2013 07 05

REGISTERED APPELLATIONS OF ORIGIN OF GOODS: **KHVANCHKARA**
THE RIGHT TU USE: LTD "KAKHURI TRADICIULI MEGVINEOBA"
Ksnis q. 12, 0141, Tbilisi, Georgia
NUMBER OF REGISTRATION: 1/8-12
VALID: 2013 10 09

REGISTERED APPELLATIONS OF ORIGIN OF GOODS: **MUKUZANI**
THE RIGHT TU USE: LTD "KAKHURI TRADICIULI MEGVINEOBA"
Ksnis q. 12, 0141, Tbilisi, Georgia
NUMBER OF REGISTRATION: 2/8-12
VALID: 2013 10 09

REGISTERED APPELLATIONS OF ORIGIN OF GOODS: **TSINANDALI**
THE RIGHT TU USE: LTD "KAKHURI TRADICIULI MEGVINEOBA"
Ksnis q. 12, 0141, Tbilisi, Georgia
NUMBER OF REGISTRATION: 3/7-12
VALID: 2013 10 09

REGISTERED APPELLATIONS OF ORIGIN OF GOODS: **AKHASHENI**
THE RIGHT TU USE: LTD "KAKHURI TRADICIULI MEGVINEOBA"
Ksnis q. 12, 0141, Tbilisi, Georgia
NUMBER OF REGISTRATION: 4/6-12
VALID: 2013 10 09

REGISTERED APPELLATIONS OF ORIGIN OF GOODS: **GURJAANI**
THE RIGHT TU USE: LTD "KAKHURI TRADICIULI MEGVINEOBA"
Ksnis q. 12, 0141, Tbilisi, Georgia
NUMBER OF REGISTRATION: 5/3-12
VALID: 2013 10 09

REGISTERED APPELLATIONS OF ORIGIN OF GOODS: **KINDZMARAULI**
THE RIGHT TU USE: LTD "KAKHURI TRADICIULI MEGVINEOBA"
Ksnis q. 12, 0141, Tbilisi, Georgia
NUMBER OF REGISTRATION: 787/8-12
VALID: 2013 10 09

REGISTERED APPELLATIONS OF ORIGIN OF GOODS: **MANAVI**
THE RIGHT TU USE: LTD "KAKHURI TRADICIULI MEGVINEOBA"
Ksnis q. 12, 0141, Tbilisi, Georgia
NUMBER OF REGISTRATION: 788/3-12
VALID: 2013 10 09

REGISTERED APPELLATIONS OF ORIGIN OF GOODS: **TVISHI**
THE RIGHT TU USE: LTD "KAKHURI TRADICIULI MEGVINEOBA"
Ksnis q. 12, 0141, Tbilisi, Georgia
NUMBER OF REGISTRATION: 797/4-12
VALID: 2013 10 09

REGISTERED APPELLATIONS OF ORIGIN OF GOODS: **KHVANCHKARA**
THE RIGHT TU USE: Joint Stock Company "Corporation "KINDZMARAULI"
Ilia Chavchavadzis q. №55, 4800, Kvareli, Georgia
NUMBER OF REGISTRATION: 1/9-12
VALID: 2013 10 11

REGISTERED APPELLATIONS OF ORIGIN OF GOODS: **MUKUZANI**
THE RIGHT TU USE: Joint Stock Company "Corporation "KINDZMARAULI"
Ilia Chavchavadzis q. №55, 4800, Kvareli, Georgia
NUMBER OF REGISTRATION: 2/9-12
VALID: 2013 10 11

REGISTERED APPELLATIONS OF ORIGIN OF GOODS: **TSINANDALI**
THE RIGHT TU USE: Joint Stock Company "Corporation "KINDZMARAULI"
Ilia Chavchavadzis q. №55, 4800, Kvareli, Georgia
NUMBER OF REGISTRATION: 3/8-12
VALID: 2013 10 11

REGISTERED APPELLATIONS OF ORIGIN OF GOODS: **AKHASHENI**
THE RIGHT TU USE: Joint Stock Company "Corporation "KINDZMARAULI"
Ilia Chavchavadzis q. №55, 4800, Kvareli, Georgia
NUMBER OF REGISTRATION: 4/7-12
VALID: 2013 10 11

REGISTERED APPELLATIONS OF ORIGIN OF GOODS: **GURJAANI**
THE RIGHT TU USE: Joint Stock Company "Corporation "KINDZMARAULI"
Ilia Chavchavadzis q. №55, 4800, Kvareli, Georgia
NUMBER OF REGISTRATION: 5/4-12
VALID: 2013 10 11

REGISTERED APPELLATIONS OF ORIGIN OF GOODS: **KINDZMARAULI**
THE RIGHT TU USE: Joint Stock Company "Corporation "KINDZMARAULI"
Ilia Chavchavadzis q. №55, 4800, Kvareli, Georgia
NUMBER OF REGISTRATION: 787/9-12
VALID: 2013 10 11

REGISTERED APPELLATIONS OF ORIGIN OF GOODS: **KAKHETI (Kakhuri)**
THE RIGHT TU USE: Joint Stock Company "Corporation "KINDZMARAULI"
Ilia Chavchavadzis q. №55, 4800, Kvareli, Georgia
NUMBER OF REGISTRATION: 789/2-12
VALID: 2013 04 11

REGISTERED APPELLATIONS OF ORIGIN OF GOODS: **NAPAREULI**
THE RIGHT TU USE: Joint Stock Company "Corporation "KINDZMARAULI"
Ilia Chavchavadzis q. №55, 4800, Kvareli, Georgia
NUMBER OF REGISTRATION: 790/4-12
VALID: 2013 10 11

REGISTERED APPELLATIONS OF ORIGIN OF GOODS: **VAZISUBANI**
THE RIGHT TU USE: Joint Stock Company "Corporation "KINDZMARAULI"
Ilia Chavchavadzis q. №55, 4800, Kvareli, Georgia
NUMBER OF REGISTRATION: 794/6-12
VALID: 2013 10 11

REGISTERED APPELLATIONS OF ORIGIN OF GOODS: **KVARELI**
THE RIGHT TU USE: Joint Stock Company "Corporation "KINDZMARAULI"
Ilia Chavchavadzis q. №55, 4800, Kvareli, Georgia
NUMBER OF REGISTRATION: 798/3-12
VALID: 2013 10 11

REGISTERED APPELLATIONS OF ORIGIN OF GOODS: **KHVANCHKARA**
THE RIGHT TU USE: LTD "KAXETI-KO"
Kudigoris q. 4, 4800, Kvareli, Georgia
NUMBER OF REGISTRATION: 1/10-12
VALID: 2013 10 11

REGISTERED APPELLATIONS OF ORIGIN OF GOODS: **MUKUZANI**
THE RIGHT TU USE: LTD "KAXETI-KO"
Kudigoris q. 4, 4800, Kvareli, Georgia
NUMBER OF REGISTRATION: 2/10-12
VALID: 2013 10 11

REGISTERED APPELLATIONS OF ORIGIN OF GOODS: **TSINANDALI**
THE RIGHT TU USE: LTD "KAXETI-KO"
Kudigoris q. 4, 4800, Kvareli, Georgia
NUMBER OF REGISTRATION: 3/9-12
VALID: 2013 10 11

REGISTERED APPELLATIONS OF ORIGIN OF GOODS: **AKHASHENI**
THE RIGHT TU USE: LTD "KAXETI-KO"
Kudigoris q. 4, 4800, Kvareli, Georgia
NUMBER OF REGISTRATION: 4/8-12
VALID: 2013 10 11

REGISTERED APPELLATIONS OF ORIGIN OF GOODS: **GURJAANI**
THE RIGHT TU USE: LTD "KAXETI-KO"
Kudigoris q. 4, 4800, Kvareli, Georgia
NUMBER OF REGISTRATION: 5/5-12
VALID: 2013 10 11

REGISTERED APPELLATIONS OF ORIGIN OF GOODS: **KINDZMARAULI**
THE RIGHT TU USE: LTD "KAXETI-KO"
Kudigoris q. 4, 4800, Kvareli, Georgia
NUMBER OF REGISTRATION: 787/10-12
VALID: 2013 10 11

REGISTERED APPELLATIONS OF ORIGIN OF GOODS: **KAKHETI (Kakhuri)**
THE RIGHT TU USE: LTD "KAXETI-KO"
Kudigoris q. 4, 4800, Kvareli, Georgia
NUMBER OF REGISTRATION: 789/3-12
VALID: 2013 10 11

REGISTERED APPELLATIONS OF ORIGIN OF GOODS: **NAPAREULI**
THE RIGHT TU USE: LTD "KAXETI-KO"
Kudigoris q. 4, 4800, Kvareli, Georgia
NUMBER OF REGISTRATION: 790/5-12
VALID: 2013 10 11

REGISTERED APPELLATIONS OF ORIGIN OF GOODS: **VAZISUBANI**
THE RIGHT TU USE: LTD "KAXETI-KO"
Kudigoris q. 4, 4800, Kvareli, Georgia
NUMBER OF REGISTRATION: 794/7-12
VALID: 2013 10 11

REGISTERED APPELLATIONS OF ORIGIN OF GOODS: **KVARELI**
THE RIGHT TU USE: LTD "KAXETI-KO"
Kudigoris q. 4, 4800, Kvareli, Georgia
NUMBER OF REGISTRATION: 798/4-12
VALID: 2013 10 11

REGISTERED APPELLATIONS OF ORIGIN OF GOODS: **KHVANCHKARA**
THE RIGHT TU USE: LTD "KONCHO & COMPANY"
Erekle II q. 10, 4800, Kvareli, Georgia
NUMBER OF REGISTRATION: 1/11-12
VALID: 2013 10 11

REGISTERED APPELLATIONS OF ORIGIN OF GOODS: **MUKUZANI**
THE RIGHT TU USE: LTD "KONCHO & COMPANY"
Erekle II q. 10, 4800, Kvareli, Georgia
NUMBER OF REGISTRATION: 2/11-12
VALID: 2013 10 11

REGISTERED APPELLATIONS OF ORIGIN OF GOODS: **TSINANDALI**
THE RIGHT TU USE: LTD "KONCHO & COMPANY"
Erekle II q. 10, 4800, Kvareli, Georgia
NUMBER OF REGISTRATION: 3/10-12
VALID: 2013 10 11

REGISTERED APPELLATIONS OF ORIGIN OF GOODS: **AKHASHENI**
THE RIGHT TU USE: LTD "KONCHO & COMPANY"
Erekle II q. 10, 4800, Kvareli, Georgia
NUMBER OF REGISTRATION: 4/9-12
VALID: 2013 10 11

REGISTERED APPELLATIONS OF ORIGIN OF GOODS: **GURJAANI**
THE RIGHT TU USE: LTD "KONCHO & COMPANY"
Erekle II q. 10, 4800, Kvareli, Georgia
NUMBER OF REGISTRATION: 5/6-12
VALID: 2013 10 11

REGISTERED APPELLATIONS OF ORIGIN OF GOODS: **KINDZMARauli**
THE RIGHT TU USE: LTD "KONCHO & COMPANY"
Erekle II q. 10, 4800, Kvareli, Georgia
NUMBER OF REGISTRATION: 787/11-12
VALID: 2013 10 11

REGISTERED APPELLATIONS OF ORIGIN OF GOODS: **KAKHETI (Kakhuri)**
THE RIGHT TU USE: LTD "KONCHO & COMPANY"
Erekle II q. 10, 4800, Kvareli, Georgia
NUMBER OF REGISTRATION: 789/4-12
VALID: 2013 10 11

REGISTERED APPELLATIONS OF ORIGIN OF GOODS: **NAPAREULI**
THE RIGHT TU USE: LTD "KONCHO & COMPANY"
Erekle II q. 10, 4800, Kvareli, Georgia
NUMBER OF REGISTRATION: 790/6-12
VALID: 2013 10 11

REGISTERED APPELLATIONS OF ORIGIN OF GOODS: **VAZISUBANI**
THE RIGHT TU USE: LTD "KONCHO & COMPANY"
Erekle II q. 10, 4800, Kvareli, Georgia
NUMBER OF REGISTRATION: 794/8-12
VALID: 2013 10 11

REGISTERED APPELLATIONS OF ORIGIN OF GOODS: **KVARELI**
THE RIGHT TU USE: LTD "KONCHO & COMPANY"
Erekle II q. 10, 4800, Kvareli, Georgia
NUMBER OF REGISTRATION: 798/5-12
VALID: 2013 10 11

REGISTERED APPELLATIONS OF ORIGIN OF GOODS: **MUKUZANI**

THE RIGHT TU USE: LTD "MEGVINEOBA KHAREBA"

Davit Agmasheneblis Kheivani me-6 km, 0131, Tbilisi, Georgia

NUMBER OF REGISTRATION: 2/12-12

VALID: 2013 10 17

REGISTERED APPELLATIONS OF ORIGIN OF GOODS: **TSINANDALI**

THE RIGHT TU USE: LTD "MEGVINEOBA KHAREBA"

Davit Agmasheneblis Kheivani me-6 km, 0131, Tbilisi, Georgia

NUMBER OF REGISTRATION: 3/11-12

VALID: 2013 10 17

REGISTERED APPELLATIONS OF ORIGIN OF GOODS: **KINDZMARAULI**

THE RIGHT TU USE: LTD "MEGVINEOBA KHAREBA"

Davit Agmasheneblis Kheivani me-6 km, 0131, Tbilisi, Georgia

NUMBER OF REGISTRATION: 787/12-12

VALID: 2013 10 17

REGISTERED APPELLATIONS OF ORIGIN OF GOODS: **SVIRI**

THE RIGHT TU USE: LTD "MEGVINEOBA KHAREBA"

Davit Agmasheneblis Kheivani me-6 km, 0131, Tbilisi, Georgia

NUMBER OF REGISTRATION: 793/1-12

VALID: 2013 10 17

REGISTERED APPELLATIONS OF ORIGIN OF GOODS: **VAZISUBANI**

THE RIGHT TU USE: LTD "MEGVINEOBA KHAREBA"

Davit Agmasheneblis Kheivani me-6 km, 0131, Tbilisi, Georgia

NUMBER OF REGISTRATION: 794/9-12

VALID: 2013 10 17

OFFICIAL NOTIFICATIONS

TRADEMARKS

RENEWAL OF REGISTRATIONS

(111) M 2002 14581 R1
(156) 2012 09 04
(186) 2022 08 15
(732) Joint Stock Company "SARAJISHVILI"
Sarajishvilis gamz. 4, 0153, Tbilisi, Georgia

(111) M 2002 14626 R1
(156) 2012 09 13
(186) 2022 09 13
(732) MICROSOFT CORPORATION
One Microsoft Way, Redmond, Washington
98052-6399, USA

(111) M 2002 14643 R1
(156) 2012 09 13
(186) 2022 09 13
(732) NEC CORPORATION (A corporation duly
organized and existing under the laws of
Japan)
7-1, Shiba 5-chome, Minato-ku, Tokyo,
Japan

(111) M 2002 14656 R1
(156) 2012 09 13
(186) 2022 09 13
(732) H-D MICHIGAN, LLC
315 West Huron Street, Suite 400, Ann
Arbor, MI 48103, USA

(111) M 2002 14678 R1
(156) 2012 09 13
(186) 2022 09 13
(732) SSANGYONG MOTOR COMPANY
150-3 Chilkoi-dong, Pyungtaek-si, Kyunggi-
do, 459-050, Republic of Korea

(111) M 2002 14755 R1
(156) 2012 10 15
(186) 2022 10 15
(732) RICOH COMPANY, LTD
Tokyo, Japan

(111) M 2002 14803 R1
(156) 2012 11 15
(186) 2022 11 15
(732) EATON INDUSTRIES GMBH
Hein-Moeller-Str. 7-11, 53115 Bonn,
Germany

(111) M 2002 14804 R1
(156) 2012 11 15
(186) 2022 11 15
(732) EATON INDUSTRIES GMBH
Hein-Moeller-Str. 7-11, 53115 Bonn,
Germany

(111) M 2002 14836 R1
(156) 2012 11 28
(186) 2022 11 28
(732) FUNAI ELECTRIC COMPANY LIMITED
7-1, 7-chome, Nakagaito, Daito, Osaka,
Japan, Japan

CHANGES IN NAMES AND/OR ADDRESSES OF OWNERS

(111) M 2002 014803 R1
(732) EATON INDUSTRIES GMBH
Hein-Moeller-Str. 7-11, 53115 Bonn,
Germany
(770) MOELLER GMBH
Hein-Moeller-Str. 7-11, 53115 Bonn,
Germany
(580) 2012 10 08

(111) M 2002 014804 R1
(732) EATON INDUSTRIES GMBH
Hein-Moeller-Str. 7-11, 53115 Bonn,
Germany
(770) MOELLER GMBH
Hein-Moeller-Str. 7-11, 53115 Bonn,
Germany
(580) 2012 10 08

(111) M 2012 022901 R
(732) FISCHER PHARMACEUTICALS LTD
9 Bar Yochai Street, Bnei Brak 51553,
Israel
(770) FISCHER PHARMACEUTICALS LTD
P.O.B. 39071, Tel-Aviv 61390, Israel
(580) 2012 10 11

INVALIDATION OF TRADEMARK REGISTRATION

(111) M 2004 15792 R
 (732) LTD "SUPERMOTORI"
 Parnavaz Mepis q. 57, 6010, Batumi, Georgia
 (540)



(141) 2012 07 05
 Grounds: Sakpatenti Chairman Order №1261 of 10 10 2012
 (court decision case №2/1872-12y.)

CORRECTION OF MISTAKES

BULLETIN №	Pg.	NUMBER OF APPLICATION (10)	INTERN. INDEX	PUBLISHED	MUST BE
12(352)	27	AD 2012688 S	(71)	(10) AD 2012 688 S (51) 09-03 (21) AD 2012 000688 (22) 2012 02 27 (28) 10 (71) CLARKE INVEST GROUP LTD. (VG) N6, 3 Rd. Floor, Quomar Trading Building, P.O. box 875, Road Town, Tortola, British Virginia Islands (VG) (72) Ilja Igorevich Silkin (RU) (74) David Zurabishvili (54) CAKE PACKAGE	(10) AD 2012 688 S (51) 09-03 (21) AD 2012 000688 (22) 2012 02 27 (28) 10 (71) Joint Stock Company "EXPERIMENTAL CONFECTIONERY ASSOCIATION "VOLOGDA" (RU) Vologodskaya oblast, g. Vologda, ul. Pro mishlennaya 12, 160012 (RU) (72) Ilja Igorevich Silkin (RU) (74) David Zurabishvili (54) CAKE PACKAGE

CLASSIFICATION INDEXES

INVENTIONS

CONCORDANCE TABLE OF INTERNATIONAL CLASSIFICATION INDEX AND PUBLICATION NUMBERS

INTERNATIONAL CLASSIFICATION INDEXES (51)	NUMBER OF PUBLISHED APPLICATION (10)
A 47 B 47/02	AP 2012 12681 A
A 61 K 9/06, 35/78;	AP 2012 12129 A
A 61 K 31/155; A 61 P 17/00; A 61 K 47/10	AP 2012 12228 A
C 02 F 3/32; E 02 B 15/04; B 01 J 20/22	AP 2012 11845 A
C 03 C 3/04, 3/095, 13/00	AP 2012 12046 A
C 07 C 205/12; C 07 C 211/61; C 07 C 17/25; C 07 C 22/02; C 07 C 23/08	AP 2012 12237 A
C 07 D 213/72	AP 2012 11705 A
C 07 D 453/02; A 61 K 31/439; A 61 P 11/00	AP 2012 12093 A
F 02 B 73/00; F 02 G 1/043	AP 2012 11945 A
F 03 B 13/12	AP 2012 12069 A

CONCORDANCE TABLE OF PUBLICATION NUMBERS AND INTERNATIONAL CLASSIFICATION INDEX

NUMBER OF PUBLISHED APPLICATION (10)	INTERNATIONAL CLASSIFICATION INDEXES (51)
AP 2012 11705 A	C 07 D 213/72
AP 2012 11845 A	C 02 F 3/32; E 02 B 15/04; B 01 J 20/22
AP 2012 11945 A	F 02 B 73/00; F 02 G 1/043
AP 2012 12046 A	C 03 C 3/04, 3/095, 13/00
AP 2012 12069 A	F 03 B 13/12
AP 2012 12093 A	C 07 D 453/02; A 61 K 31/439; A 61 P 11/00
AP 2012 12129 A	A 61 K 9/06, 35/78;
AP 2012 12228 A	A 61 K 31/155; A 61 P 17/00; A 61 K 47/10
AP 2012 12237 A	C 07 C 205/12; C 07 C 211/61; C 07 C 17/25; C 07 C 22/02; C 07 C 23/08
AP 2012 12681 A	A 47 B 47/02

CONCORDANCE TABLE OF INTERNATIONAL CLASSIFICATION INDEX,
PATENT NUMBERS AND PUBLICATION NUMBERS

INTERNATIONAL CLASSIFICATION INDEX (51)	NUMBER OF PATENT (11)	NUMBER OF PUBLISHED APPLICATION (10)
A 23 L 1/06, 1/212	P 2012 5670 B	AP 2012 11518 A
A 23 L 1/22	P 2012 5671 B	AP 2012 11641 A
A 61 K 9/06, 35/78	P 2012 5675 B	AP 2012 12110 A
A 61 K 9/08;	P 2012 5674 B	AP 2012 12108 A
A 61 K 9/24; A 61 K 9/26; A 61 K 31/513; A 61 K 31/155; A 61 K 45/06	P 2012 5672 B	AP 2012 11694 A
A 61 K 31/205; A 61 P 9/00; A 61 P 9/10	P 2012 5673 B	AP 2012 11832 A
C 07 C 241/02; C 07 C 243/40	P 2012 5676 B	AP 2012 11990 A
C 07 C 241/02; C 07 C 243/14	P 2012 5677 B	AP 2012 11991 A
C 07 C 241/02; C 07 C 243/40	P 2012 5680 B	AP 2012 11935 A
C 07 C 241/02; C 07 C 243/40	P 2012 5681 B	AP 2012 11936 A
E 21 B 3/02, 47/18, 43/12, 7/04	P 2012 5678 B	AP 2012 9075 A
F 01 B 17/02; F 01 B 9/02; F 02 G 1/02	P 2012 5679 B	AP 2012 11152 A
F 03 D 5/04; F 03 D 1/04	P 2012 5669 B	AP 2012 11510 A
H 04 B 7/26; H 04 L 12/24; H 04 W 52/00	P 2012 5668 B	AP 2012 10721 A

CONCORDANCE TABLE OF PATENT NUMBERS,
PUBLICATION NUMBERS AND INTERNATIONAL CLASSIFICATION INDEX

NUMBER OF PATENT (11)	NUMBER OF PUBLISHED APPLICATION (10)	INTERNATIONAL CLASSIFICATION INDEX (51)
P 2012 5668 B	AP 2012 10721 A	H 04 B 7/26; H 04 L 12/24; H 04 W 52/00
P 2012 5669 B	AP 2012 11510 A	F 03 D 5/04; F 03 D 1/04
P 2012 5670 B	AP 2012 11518 A	A 23 L 1/06, 1/212
P 2012 5671 B	AP 2012 11641 A	A 23 L 1/22
P 2012 5672 B	AP 2012 11694 A	A 61 K 9/24; A 61 K 9/26; A 61 K 31/513; A 61 K 31/155; A 61 K 45/06
P 2012 5673 B	AP 2012 11832 A	A 61 K 31/205; A 61 P 9/00; A 61 P 9/10
P 2012 5674 B	AP 2012 12108 A	A 61 K 9/08;
P 2012 5675 B	AP 2012 12110 A	A 61 K 9/06, 35/78
P 2012 5676 B	AP 2012 11990 A	C 07 C 241/02; C 07 C 243/40
P 2012 5677 B	AP 2012 11991 A	C 07 C 241/02; C 07 C 243/14
P 2012 5678 B	AP 2012 9075 A	E 21 B 3/02, 47/18, 43/12, 7/04
P 2012 5679 B	AP 2012 11152 A	F 01 B 17/02; F 01 B 9/02; F 02 G 1/02
P 2012 5680 B	AP 2012 11935 A	C 07 C 241/02; C 07 C 243/40
P 2012 5681 B	AP 2012 11936 A	C 07 C 241/02; C 07 C 243/40

CONCORDANCE TABLE OF APPLICATION NUMBERS, PUBLICATION NUMBERS AND PATENTS

NUMBER OF APPLICATION (21)	NUMBER OF PUBLISHED APPLICATION (10)	NUMBER OF PATENT (11)
AP 2004 009075	AP 2012 9075 A	P 2012 5678 B
AP 2004 010721	AP 2012 10721 A	P 2012 5668 B
AP 2007 011152	AP 2012 11152 A	P 2012 5679 B
AP 2008 011510	AP 2012 11510 A	P 2012 5669 B
AP 2009 011518	AP 2012 11518 A	P 2012 5670 B
AP 2010 011641	AP 2012 11641 A	P 2012 5671 B
AP 2008 011694	AP 2012 11694 A	P 2012 5672 B
AP 2008 011832	AP 2012 11832 A	P 2012 5673 B
AP 2009 011935	AP 2012 11935 A	P 2012 5680 B
AP 2009 011936	AP 2012 11936 A	P 2012 5681 B
AP 2009 011990	AP 2012 11990 A	P 2012 5676 B
AP 2009 011991	AP 2012 11991 A	P 2012 5677 B
AP 2011 012108	AP 2012 12108 A	P 2012 5674 B
AP 2011 012110	AP 2012 12110 A	P 2012 5675 B

UTILITY MODELS

CONCORDANCE TABLE OF INTERNATIONAL CLASSIFICATION INDEX AND PUBLICATION NUMBERS

INTERNATIONAL CLASSIFICATION INDEXES (51)	NUMBER OF PUBLISHED APPLICATION (10)
A 01 G 13/02	AU 2012 12420 U
C 04 B 33/00	AU 2012 12541 U
C 04 B 33/04	AU 2012 12187 U

CONCORDANCE TABLE OF PUBLICATION NUMBERS AND INTERNATIONAL CLASSIFICATION INDEX

NUMBER OF PUBLISHED APPLICATION (10)	INTERNATIONAL CLASSIFICATION INDEXES (51)
AU 2012 12187 U	C 04 B 33/04
AU 2012 12420 U	A 01 G 13/02
AU 2012 12541 U	C 04 B 33/00

CONCORDANCE TABLE OF INTERNATIONAL CLASSIFICATION INDEX, PATENT NUMBERS AND PUBLICATION NUMBERS

INTERNATIONAL CLASSIFICATION INDEX (51)	NUMBER OF PATENT (11)	NUMBER OF PUBLISHED APPLICATION (10)
A 23 C 9/00; A 23 C 23/00	U 2012 1740 Y	AU 2012 12425 U

CONCORDANCE TABLE OF PATENT NUMBERS,
PUBLICATION NUMBERS AND INTERNATIONAL CLASSIFICATION INDEX

NUMBER OF PATENT (11)	NUMBER OF PUBLISHED APPLICATION (10)	INTERNATIONAL CLASSIFICATION INDEX (51)
U 2012 1740 Y	AU 2012 12425 U	A 23 C 9/00; A 23 C 23/00

CONCORDANCE TABLE OF APPLICATION NUMBERS, PUBLICATION NUMBERS
AND PATENTS

NUMBER OF APPLICATION (21)	NUMBER OF PUBLISHED APPLICATION (10)	NUMBER OF PATENT (11)
AU 2011 012425	AU 2012 12425 U	U 2012 1740 Y

DESIGNS

CONCORDANCE TABLE OF INTERNATIONAL CLASSIFICATION INDEX
AND PUBLICATION NUMBERS

INTERNATIONAL CLASSIFICATION INDEXES (51)	NUMBER OF PUBLISHED APPLICATION (10)
02-01	AD 2012 707 S
21-01	AD 2012 711 S

CONCORDANCE TABLE OF PUBLICATION NUMBERS
AND INTERNATIONAL CLASSIFICATION INDEX

NUMBER OF PUBLISHED APPLICATION (10)	INTERNATIONAL CLASSIFICATION INDEXES (51)
AD 2012 707 S	02-01
AD 2012 711 S	21-01

CONCORDANCE TABLE OF INTERNATIONAL CLASSIFICATION INDEX,
PATENT NUMBERS AND PUBLICATION NUMBERS

INTERNATIONAL CLASSIFICATION INDEX (51)	NUMBER OF PATENT (11)	NUMBER OF PUBLISHED APPLICATION (10)
09-03	D 2012 510 S	AD 2012 688 S

CONCORDANCE TABLE OF PATENT NUMBERS,
PUBLICATION NUMBERS AND INTERNATIONAL CLASSIFICATION INDEX

NUMBER OF PATENT (11)	NUMBER OF PUBLISHED APPLICATION (10)	INTERNATIONAL CLASSIFICATION INDEX (51)
D 2012 510 S	AD 2012 688 S	09-03

CONCORDANCE TABLE OF APPLICATION NUMBERS, PUBLICATION NUMBERS AND PATENTS

NUMBER OF APPLICATION (21)	NUMBER OF PUBLISHED APPLICATION (10)	NUMBER OF PATENT (11)
AD 2012 000688	AD 2012 688 S	D 2012 510 S

**DESIGN REGISTERED ACCORDING TO THE
ACCELERATED PROCEDURE**

CONCORDANCE TABLE OF INTERNATIONAL CLASSIFICATION INDEX AND PATENTS NUMBERS

INTERNATIONAL CLASSIFICATION INDEX (51)	NUMBER OF PATENT (11)
09-01	D 2012 511 S

CONCORDANCE TABLE OF PATENT NUMBERS AND INTERNATIONAL CLASSIFICATION INDEX

NUMBER OF PATENT (11)	INTERNATIONAL CLASSIFICATION INDEX (51)
D 2012 511 S	09-01

CONCORDANCE TABLE OF APPLICATION NUMBERS AND PATENT NUMBERS

NUMBER OF APPLICATION (21)	NUMBER OF PATENT (11)
AD 2012 000713	D 2012 511 S

TRADEMARKS

CONCORDANCE TABLE OF REGISTRATION NUMBERS, APPLICATION NUMBERS, PUBLICATION NUMBERS AND BULLETIN NUMBERS

NUMBER OF REGISTRATION (111)	NUMBER OF APPLICATION (210)	NUMBER OF PUBLISHED APPLICATION (260)	NUMBER OF BULLETIN
M 2012 22979 R	AM 2011 62368	AM 2012 62368 A	6(346) 2012
M 2012 22980 R	AM 2011 62552	AM 2012 62552 A	10(350) 2012
M 2012 22981 R	AM 2011 62900	AM 2012 62900 A	11(351) 2012
M 2012 22982 R	AM 2012 68907	-	20(360) 2012
M 2012 22983 R	AM 2012 68903	-	20(360) 2012
M 2012 22984 R	AM 2012 68904	-	20(360) 2012
M 2012 22985 R	AM 2012 68902	-	20(360) 2012
M 2012 22986 R	AM 2012 68930	-	20(360) 2012
M 2012 22987 R	AM 2012 68931	-	20(360) 2012
M 2012 22988 R	AM 2012 68932	-	20(360) 2012
M 2012 22989 R	AM 2011 61454	AM 2012 61454 A	8(348) 2012
M 2012 22990 R	AM 2011 62382	AM 2012 62382 A	6(346) 2012
M 2012 22991 R	AM 2011 62394	AM 2012 62394 A	6(346) 2012
M 2012 22992 R	AM 2011 62450	AM 2012 62450 A	8(348) 2012
M 2012 22993 R	AM 2011 62555	AM 2012 62555 A	10(350) 2012
M 2012 22994 R	AM 2011 62631	AM 2012 62631 A	6(346) 2012
M 2012 22995 R	AM 2011 62635	AM 2012 62635 A	6(346) 2012
M 2012 22996 R	AM 2011 62697	AM 2012 62697 A	6(346) 2012
M 2012 22997 R	AM 2011 62722	AM 2012 62722 A	6(346) 2012
M 2012 22998 R	AM 2011 62723	AM 2012 62723 A	6(346) 2012
M 2012 22999 R	AM 2011 62724	AM 2012 62724 A	6(346) 2012
M 2012 23000 R	AM 2011 62725	AM 2012 62725 A	6(346) 2012
M 2012 23001 R	AM 2011 62726	AM 2012 62726 A	6(346) 2012
M 2012 23002 R	AM 2011 62727	AM 2012 62727 A	6(346) 2012
M 2012 23003 R	AM 2011 62879	AM 2012 62879 A	6(346) 2012
M 2012 23004 R	AM 2011 62920	AM 2012 62920 A	11(351) 2012
M 2012 23005 R	AM 2011 62921	AM 2012 62921 A	11(351) 2012
M 2012 23006 R	AM 2011 62922	AM 2012 62922 A	11(351) 2012
M 2012 23007 R	AM 2011 63035	AM 2012 63035 A	6(346) 2012
M 2012 23008 R	AM 2011 63222	AM 2012 63222 A	6(346) 2012
M 2012 23009 R	AM 2011 63319	AM 2012 63319 A	9(349) 2012
M 2012 23010 R	AM 2011 63320	AM 2012 63320 A	9(349) 2012
M 2012 23011 R	AM 2011 63435	AM 2012 63435 A	5(345) 2012
M 2012 23012 R	AM 2011 63673	AM 2012 63673 A	6(346) 2012
M 2012 23013 R	AM 2011 63674	AM 2012 63674 A	6(346) 2012
M 2012 23014 R	AM 2011 63868	AM 2012 63868 A	9(349) 2012
M 2012 23015 R	AM 2011 64019	AM 2012 64019 A	8(348) 2012
M 2012 23016 R	AM 2011 64020	AM 2012 64020 A	8(348) 2012
M 2012 23017 R	AM 2011 64216	AM 2012 64216 A	8(348) 2012
M 2012 23018 R	AM 2011 64237	AM 2012 64237 A	11(351) 2012
M 2012 23019 R	AM 2011 64339	AM 2012 64339 A	11(351) 2012
M 2012 23020 R	AM 2012 67706	-	20(360) 2012
M 2012 23021 R	AM 2012 68674	-	20(360) 2012
M 2012 23022 R	AM 2012 68672	-	20(360) 2012

CONCORDANCE TABLE OF PUBLICATION NUMBERS
AND APPLICATION NUMBERS

NUMBER OF PUBLISHED APPLICATION (260)	NUMBER OF APPLICATION (210)
AM 2012 64664 A	AM 2011 64664
AM 2012 64665 A	AM 2011 64665
AM 2012 64686 A	AM 2011 64686
AM 2012 64695 A	AM 2011 64695
AM 2012 64698 A	AM 2011 64698
AM 2012 64719 A	AM 2011 64719
AM 2012 64771 A	AM 2011 64771
AM 2012 64820 A	AM 2011 64820
AM 2012 64821 A	AM 2011 64821
AM 2012 64822 A	AM 2011 64822
AM 2012 64834 A	AM 2011 64834
AM 2012 64835 A	AM 2011 64835
AM 2012 64837 A	AM 2011 64837
AM 2012 64905 A	AM 2011 64905
AM 2012 64918 A	AM 2011 64918
AM 2012 64994 A	AM 2011 64994
AM 2012 64995 A	AM 2011 64995
AM 2012 65051 A	AM 2011 65051
AM 2012 65052 A	AM 2011 65052
AM 2012 65066 A	AM 2011 65066
AM 2012 65067 A	AM 2011 65067
AM 2012 65068 A	AM 2011 65068
AM 2012 65069 A	AM 2011 65069
AM 2012 65070 A	AM 2011 65070
AM 2012 65071 A	AM 2011 65071
AM 2012 65094 A	AM 2011 65094
AM 2012 65096 A	AM 2011 65096
AM 2012 65165 A	AM 2011 65165
AM 2012 65209 A	AM 2011 65209
AM 2012 65389 A	AM 2011 65389
AM 2012 65390 A	AM 2011 65390
AM 2012 65568 A	AM 2011 65568
AM 2012 65584 A	AM 2011 65584
AM 2012 65757 A	AM 2012 65757
AM 2012 65758 A	AM 2012 65758

CONCORDANCE TABLE OF INDEX OF GOODS AND/OR SERVICES
AND APPLICATION NUMBERS

INDEX OF GOODS AND/OR SERVICES (511)	NUMBER OF PUBLISHED APPLICATION (260)
3	AM 2012 64698 A
3	AM 2012 65389 A
5	AM 2012 64695 A
5	AM 2012 64698 A
5	AM 2012 64820 A
5	AM 2012 64821 A
5	AM 2012 64822 A
5	AM 2012 64834 A
5	AM 2012 64835 A
5	AM 2012 64837 A
5	AM 2012 65066 A
5	AM 2012 65067 A
5	AM 2012 65068 A
5	AM 2012 65069 A
5	AM 2012 65070 A
5	AM 2012 65071 A
5	AM 2012 65390 A
7	AM 2012 65051 A
7	AM 2012 65052 A
9	AM 2012 64905 A
9	AM 2012 64918 A
9	AM 2012 64994 A
9	AM 2012 65094 A
9	AM 2012 65096 A
12	AM 2012 65051 A
12	AM 2012 65052 A
21	AM 2012 64695 A
21	AM 2012 64698 A
25	AM 2012 65584 A
29	AM 2012 64686 A
29	AM 2012 65165 A
29	AM 2012 65568 A
30	AM 2012 64664 A
30	AM 2012 64665 A
30	AM 2012 64686 A
30	AM 2012 64719 A
30	AM 2012 64995 A
30	AM 2012 65209 A
30	AM 2012 65568 A
32	AM 2012 64686 A
34	AM 2012 65757 A
34	AM 2012 65758 A
35	AM 2012 64686 A
35	AM 2012 64771 A
37	AM 2012 65051 A
37	AM 2012 65052 A
43	AM 2012 65209 A

CONCORDANCE TABLE OF INDEX OF GOODS AND/OR SERVICES
AND NUMBERS OF TRADEMARKS REGISTERED ACCORDING
TO THE ACCELERATED PROCEDURE

INDEX OF GOODS AND/OR SERVICES (511)	NUMBER OF REGISTERED ACCORDING TO THE ACCELERATED PROCEDURE (111)
5	M 2012 23022 R
20	M 2012 22982 R
35	M 2012 22983 R
35	M 2012 22984 R
38	M 2012 22983 R
38	M 2012 22984 R
38	M 2012 22985 R
38	M 2012 22986 R
38	M 2012 22987 R
38	M 2012 22988 R
41	M 2012 22986 R
41	M 2012 22987 R
41	M 2012 22988 R
41	M 2012 23021 R

OFFICIAL BULLETIN OF THE INDUSTRIAL PROPERTY

20(360)

EDITOR-IN-CHIEF: N. Bebrishvili

EDITORS-TRANSLATORS: E. Gabunia

PROOFREADER: L. Chanturia

COMPUTER LAYOUT: M. Ordenidze
K. Svanidze

www.sakpatenti.org.ge
E-mail: info@sakpatenti.org.ge