

NATIONAL INTELLECTUAL PROPERTY
CENTER OF GEORGIA
SAKPATENTI



НАЦИОНАЛЬНЫЙ ЦЕНТР ИНТЕЛЛЕКТУАЛЬНОЙ
СОБСТВЕННОСТИ ГРУЗИИ
САКПАТЕНТИ

OFFICIAL BULLETIN OF THE INDUSTRIAL PROPERTY

**ОФИЦИАЛЬНЫЙ БЮЛЛЕТЕНЬ
ПРОМЫШЛЕННОЙ СОБСТВЕННОСТИ**

21(313)

**2010
TBILISI
ТБИЛИСИ**

INID CODES FOR IDENTIFICATION OF BIBLIOGRAPHIC DATA

INVENTIONS, UTILITY MODELS

- (10) Number of publication for application, which has been examined
- (11) Number of patent and kind of document
- (21) Serial number of application
- (22) Date of filing of the application
- (23) Date of exhibition or the date of the earlier filing and the number of application, if any
- (24) Date from which patent may have effect
- (31) Number of priority application
- (32) Date of filing of priority application
- (33) Code of the country or regional organization allotting priority application number
- (44) Date of publication of application not granted, but examined and number of bulletin
- (45) Date of publication of registered document
- (51) International Patent Classification Index
- (54) Title of the invention
- (57) Abstract
- (60) Number of examined patent document granted by foreign patent office, date from which patent has effect and country code
- (62) Number of the earlier application and in case of divided application, date of filing an application
- (71) Name, surname and address of applicant (country code)
- (72) Name, surname of inventor (country code)
- (73) Name, surname and address of patent owner (country code)
- (74) Name, surname of representative or patent attorney
- (85) Date of commencement of the national phase of International Application
- (86) Number and date of filing of international application
- (87) Number and date of publication of international application

INDUSTRIAL DESIGNS

- (10) Number of publication for application
- (11) Number of patent and kind of document or number of registration
- (15) Date of registration/Date of patent renewal
- (18) Expected expiration date of patent or registration
- (21) Serial number of application
- (22) Date of filing of the application
- (23) Date of exhibition or the date of the earlier filing and the number of application, if any
- (24) Date from which patent may have effect
- (28) Number of industrial designs included in the application
- (30) Data relating to priority (number of application, date of filing of application, two-letter code identifying the authority with whom the priority application was made)
- (31) Number of priority application
- (32) Date of filing of priority application
- (33) Code of the country or regional organization allotting priority application number
- (34) Two-letter code according to WIPO St.3 identifying the authority with which the priority application was made
- (44) Date of publication of industrial design and number of bulletin (the first publication)
- (45) Date of publication of industrial design registered by WIPO and number of bulletin
- (51) International Classification for industrial designs (class and subclass of the Locarno Classification)
- (54) Title of the invention
- (55) Reproduction of the industrial design
- (57) Description of characteristic features of the industrial design including indication of colors
- (62) Number of the earlier application, registration and document number and if available the date of filing an application in case of divided application
- (71) Name, surname and address of applicant (country code)
- (72) Name, surname of creator (country code)
- (73) Name, surname and address of patent owner (country code)
- (74) Name, surname of representative or patent attorney
- (81) Contracting states concerned
 - II designated contracting states according to the 1960 Act
 - III designated contracting states according to the 1999 Act
- (85) Owner's permanent address
- (86) Owner's nationality
- (87) Owner's residence
- (88) State in which the owner has a real and effective industrial or commercial establishment

TRADEMARKS

- (111) – Number of registration
- (151) – Date of registration
- (156) – Date of the renewal
- (181) – Expected expiration date of registration
- (186) – Renewal expiration date of registration
- (141) – Date of cancel of duration of the mark
- (210) – Serial number of application
- (220) – Date of filing of the application
- (230) – Date concerning exhibition
- (260) – Number of application, for which favorable decision of examination about registration has been taken (publication number)
- (310) – Number of the first application
- (320) – Date of filing of the first application
- (330) – Code, identifying national or regional Office where the first application was made
- (511) – International Classification of Goods and Services for the purposes of registration of trade marks and/or list of goods and/or services classified according thereto
- (531) – Description of figurative elements of Trade Marks according to the International Classification of the Figurative Elements of Marks
- (540) – Reproduction of Trade Mark
- (550) – Nature and kind of Trade Mark
- (580) – Date of recording of any kind changes in respect of applications or registrations
- (591) – Information concerning colors claimed
- (731) – Name and address of the applicant
- (732) – Name and address of the holder of the registration
- (740) – Name and address of the representative
- (750) – Address for correspondence
- (770) – Name and address of the previous applicant or holder in case of change in ownership
- (771) – Previous name and address of the applicant or holder in case of change in ownership
- (791) – Name and address of the licensee
- (793) – Indication of conditions and/or restrictions under the license (Type of license, number of license agreement, data of license, data of validity of license)
- (800) – Certain data relating to the international registration of Trade Marks under the Protocol Relating to Madrid Agreement (International registration number)

CODES FOR PUBLICATION IN BULLETIN

- (21) AP 0000 000000 – serial number of application for invention
- (10) AP 0000 0000 A – number of published application for invention (first publication)
- (11) P 0000 0000 B – number of patent for invention (second publication)
- (21) AP1 0000 000000 – number of application for imported patent
- (11) PI 0000 0000 A – number of imported patent (first publication)
- (21) AU 0000 000000 – serial number of application for utility model
- (10) AU 0000 000 U – number of published application for utility model (first publication)
- (11) U 0000 000 Y – number of patent for utility model (second publication)
- (21) AD 0000 000000 – serial number of application for industrial design
- (10) AD 0000 000 S – number of published application for industrial design (first publication)
- (11) D 0000 000 S – number of patent for industrial design (second publication)

INTERNATIONAL PATENT CLASSIFICATION FOR INVENTIONS AND UTILITY MODELS

- SECTION A – HUMAN NECESSITIES
- SECTION B – PERFORMING OPERATIONS; TRANSPORTING
- SECTION C – CHEMISTRY; METALLURGY
- SECTION D – TEXTILES; PAPER
- SECTION E – FIXED CONSTRUCTIONS
- SECTION F – MECHANICAL ENGINEERING; LIGHTING; HEATING; WEAPONS; BLASTING
- SECTION G – PHYSICS
- SECTION H – ELECTRICITY

-
- M – Trade Mark
 - (210) AM 0000 000000 – Serial number of application;
 - (260) AAM 0000 00000 A – Publication number of application;
 - (111) M 0000 00000 R – Number of registration;
 - (111) MMM0000 00000 Rn – Number of renewals, in which n=1,2,3;
 - (111) M 0000 00000 R(P) – Number of registration under partial assignment of rights

**NATIONAL INTELLECTUAL PROPERTY CENTER OF GEORGIA
SAKPATENTI**

**НАЦИОНАЛЬНЫЙ ЦЕНТР ИНТЕЛЛЕКТУАЛЬНОЙ СОБСТВЕННОСТИ ГРУЗИИ
САКПАТЕНТИ**

**OFFICIAL BULLETIN
OF THE INDUSTRIAL PROPERTY**

**ОФИЦИАЛЬНЫЙ БЮЛЛЕТЕНЬ
ПРОМЫШЛЕННОЙ СОБСТВЕННОСТИ**

21(313)

**INVENTIONS
ИЗОБРЕТЕНИЯ**

**UTILITY MODELS
ПОЛЕЗНЫЕ МОДЕЛИ**

**INDUSTRIAL DESIGNS
ПРОМЫШЛЕННЫЕ ОБРАЗЦЫ**

**TRADEMARKS
ТОВАРНЫЕ ЗНАКИ**

DATE OF PUBLICATION **10.11.2010** ДАТА ПУБЛИКАЦИИ

INVENTIONS

ИЗОБРЕТЕНИЯ

APPLICATIONS

ЗАЯВКИ

11440, 11681; 11138; 11390; 10522; 11244; 10932; 11011; 11252; 10512; 10823; 10489; 10785; 11210

PATENTS

ПАТЕНТЫ

5109-5117

UTILITY MODELS

ПОЛЕЗНЫЕ МОДЕЛИ

APPLICATION

ЗАЯВКА

11710

PATENTS

ПАТЕНТЫ

1630-1632

INDUSTRIAL DESIGNS

ПРОИЗВОДСТВЕННЫЕ ОБРАЗЦЫ

APPLICATIONS

ЗАЯВКИ

602; 596; 610, 611; 607

PATENTS

ПАТЕНТЫ

69653-69654; 72151; 72278; 72290; 72330; 72430; 72484; 72535; 72537; 72636; 72668; 72679; 72681-72783; 72789;
72794; 72800; 72878; 72924; 72979; 72996; 73000; 73002-73004; 73047; 73078-73079; 73090-73092; 73110; 73135;
73382; 73386; 73432; 73435; 73458; 73477; 73508; 73522

TRADEMARKS

ТОВАРНЫЕ ЗНАКИ

NATIONAL

НАЦИОНАЛЬНЫЕ

48327*; 53380*; 53434*-54435*; 54103*; 55000; 55090; 55232; 55249; 55454; 55637; 55771; 55949; 56012; 56014,
56015; 56244; 56362, 56363; 56459; 56461; 56475; 56490; 56645-56649; 56653; 56679; 56731; 56738-56739;
56814-56817; 56821-56824; 56933; 56949-56951; 56953; 56960; 56990-56993; 57005-57007; 57017-57025;
57027-57030; 57035-57039; 57051; 57082; 57175; 57183-57185; 57205-57219

REGISTERED

РЕГИСТРИРОВАННЫЕ

20831-20879

INTERNATIONAL

МЕЖДУНАРОДНЫЕ

56610; 56612-56619; 56662-56673; 56701-56704; 56706-56713; 56716, 56717; 57181, 57182; 57186-57194;
57196-57199; 57232-57239; 57241; 57244-57249; 57284; 57299-57304; 57306-57312; 53693*; 53784*

CONTENTS

INVENTIONS

- Applications laid open for the purpose of taking patent granting decisions 5
- Patents for inventions 15

UTILITY MODELS

- Applications laid open for the purpose of taking patent granting decisions 19
- Patents for utility models 20

INDUSTRIAL DESIGNS

- Applications laid open for the purpose of taking patent granting decisions 22
- Patents for industrial designs, which have been registered with the international bureau 28

TRADEMARKS

- Applications filed under the national procedure, laid open for the purpose of taking patent granting decisions 49
- Registered trademarks 62
- Trademark, registered according to the accelerated procedure 67
- International trademarks, laid open for the purpose of taking on protection granting decisions 68
- International trademarks protected in Georgia 78

OFFICIAL NOTIFICATIONS

- Patents 88
- Trademarks 89

CLASSIFICATION INDEXES

INVENTIONS

- Concordance table of international classification index with reference to numbers of published applications 95
- Concordance table of numbers of published applications with reference to international classification index 96
- Concordance table of international classification index with reference to numbers of patents and numbers of published applications 96
- Concordance table of numbers of patents and numbers of published applications with reference to classification index 97
- Concordance table of numbers of applications, numbers of published applications and numbers of patents 97

UTILITY MODELS

- Concordance table of international classification index with reference to numbers of published applications 98
- Concordance table of numbers of published applications with reference to international classification index 98
- Concordance table of international classification index with reference to numbers of patents and numbers of published applications 98
- Concordance table of numbers of patents and numbers of published applications with reference to classification index 99
- Concordance table of numbers of applications, numbers of published applications and numbers of patents 99

INDUSTRIAL DESIGNS

- Concordance table of international classification index with reference to numbers of published applications 99
- Concordance table of numbers of published applications with reference to international classification index 100

TRADEMARKS

- Concordance table of numbers of registrations of trademarks numbers of applications, numbers of published applications with reference to numbers of bulletin 101
- Concordance table of numbers of published trademark applications with reference to numbers of applications 102
- Concordance table of index of goods and/or services with reference to numbers of published applications 103

СОДЕРЖАНИЕ

ИЗОБРЕТЕНИЯ

- Заявки, по которым вынесены решения о выдаче патентов 5
- Патенты на изобретения 15

ПОЛЕЗНЫЕ МОДЕЛИ

- Заявки, по которым вынесены решения о выдаче патентов 19
- Патенты на полезные модели 20

ПРОМЫШЛЕННЫЕ ОБРАЗЦЫ

- Заявки, по которым вынесены решения о выдаче патентов 22
- Патенты на промышленные образцы, которые зарегистрированы в международном бюро* 28

ТОВАРНЫЕ ЗНАКИ*

- Заявки, поданные согласно национальной процедуре, по которым вынесено решение о регистрации 49
- Зарегистрированные товарные знаки 62
- Товарные знаки, зарегистрированные по ускоренной процедуре 67
- Международные товарные знаки, по которым вынесено решение о предоставлении охраны ... 68
- Международные товарные знаки, охраняемые в Грузии 78

ОФИЦИАЛЬНЫЕ ИЗВЕЩЕНИЯ*

- Патенты 88
- Товарные знаки 89

СИСТЕМАТИЧЕСКИЕ УКАЗАТЕЛИ

ИЗОБРЕТЕНИЯ

- Таблица соответствий индексов международной классификации с номерами опубликованных заявок 95
- Таблица соответствий номеров публикаций заявок с индексами международной классификации 96
- Таблица соответствий индексов международной классификации с номерами патентов и с номерами опубликованных заявок 96
- Таблица соответствий номеров патентов и номеров публикаций заявок с индексами международной классификации 97
- Таблица соответствий номеров заявок, номеров публикаций заявок и номеров патентов 97

ПОЛЕЗНЫЕ МОДЕЛИ

- Таблица соответствий индексов международной классификации с номерами опубликованных заявок 98
- Таблица соответствий номеров публикаций заявок с индексами международной классификации 98
- Таблица соответствий индексов международной классификации с номерами патентов и с номерами опубликованных заявок 98
- Таблица соответствий номеров патентов и номеров публикаций заявок с индексами международной классификации 99
- Таблица соответствий номеров заявок, номеров публикаций заявок и номеров патентов 99

ПРОМЫШЛЕННЫЕ ОБРАЗЦЫ

- Таблица соответствий индексов международной классификации с номерами опубликованных заявок 99
- Таблица соответствий номеров публикаций заявок с индексами международной классификации 100

ТОВАРНЫЕ ЗНАКИ

- Таблица соответствий номеров регистраций товарных знаков с номерами заявок, номерами публикаций заявок и номерами бюллетеня 101
- Таблица соответствий номеров публикаций товарных знаков и номеров заявок 102
- Таблица соответствий классов товаров и/или услуг с номерами опубликованных заявок 103

* Информация представлена только на английском языке

INVENTIONS ИЗОБРЕТЕНИЯ

APPLICATIONS LAID OPEN FOR THE PURPOSE OF TAKING PATENT GRANTING DECISIONS

ЗАЯВКИ, ПО КОТОРЫМ ВЫНЕСЕНЫ РЕШЕНИЯ О ВЫДАЧЕ ПАТЕНТОВ

To appeal a decision is possible at Chamber of Appeal of Sakpatenti within 3 months from the publication or at The Board of Administrative Actions of Tbilisi City Court within a 1 month period. (Address: 12 km., №6, David Aghmashenebeli Kheivani, Tbilisi).

Обжалование решения возможно в Апелляционной палате Сакпатенти в течение 3 месяцев с даты его публикации или в течение 1 месяца в Коллегии по административным делам Тбилисского городского суда (г. Тбилиси, Аллея Давида Агмашенебели 12-й км., №6).

PART A

A 01

(10) AP 2010 11440 A (51) Int. Cl. (2006)
A 01 D 46/04

(21) AP 2009 011440 (22) 2009 08 27

(71) Nodar Maglakelidze (GE)

V.Kkhmelnitskis k. 48, korp.10, b. 713, 0136
Tbilisi (GE)

(72) Nodar Maglakelidze (GE)

(54) HINGED SYSTEM

(57) A system contains a hydrocylinder and a semirevolving mechanism executed in the form of passing through fixed on power means right 4 and left 3 plates of the upper axis 1, capable of rotation and watching the bottom axis 2. The hydrocylinder by means of the handle 5 is connected with the upper axis of the semirevolving mechanism. The axes of the semirevolving mechanism are fixed on the right and left forks 6, with which fixing arms 7 for fastening the operation organ are connected, for example, tea cutting apparatus.

Claims: 1 independent

Fig.: 3

(10) AP 2010 11440 A (51) Int. Cl. (2006)
A 01 D 46/04

(21) AP 2009 011440 (22) 2009 08 27

(71) Нодар Маглакелидзе (GE)

(72) Нодар Маглакелидзе (GE)

(54) НАВЕСНАЯ СИСТЕМА

(57) Система содержит гидроцилиндр и параллелограммный механизм, выполненный в виде проходящей через закрепляемые на энергетическом средстве правой 4 и левой 3 пластины верхней оси 1, имеющей возможность поворота

и следящей нижней оси 2. Гидроцилиндр с помощью рукоятки 5 связан с верхней осью параллелограммного механизма. Оси параллелограммного механизма закреплены на правой и левой вилках 6, с которыми связаны фиксаторы 7 для крепления рабочего органа, например, чаеподрезочного аппарата.

Пункты: 1 независ.

Фиг.: 3

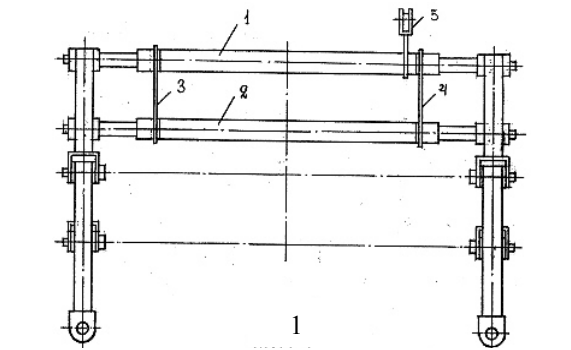

(10) AP 2010 11681 A (51) Int. Cl. (2006)
A 01 G 17/00

(21) AP 2010 011681 (22) 2010 02 09

(71) Zaur Kacharava (GE)

Gldanis mas., VIII mkr., korp.12, b.141,
0107 Tbilisi (GE);

Irakli Kacharava (GE)

Gldanis mas., VIII mkr., korp.12, b.141,
0107 Tbilisi (GE)

(72) Zaur Kacharava (GE);

Irakli Kacharava (GE)

(54) COLUMN OF THE GRAPE TRELLIS

(57) A column contains a rod consisting from underground 1 and overground 2 parts, connected with each other removedly. The underground part of the column is made of iron, on which the

elements are rigidly fixed providing stability made in the form of plates 5 or rods 6.

Claims: 1 independent

Fig.: 4

(10) AP 2010 11681 A (51) Int. Cl. (2006)
A 01 G 17/00

(21) AP 2010 011681 (22) 2010 02 09

(71) Заури Качарава (GE);

Ираклий Качарава (GE)

(72) Заури Качарава (GE);

Ираклий Качарава (GE)

(54) **СТОЛБ ВИНОГРАДНОЙ ШПАЛЕРЫ**

(57) Столб содержит стержень, состоящий из подземной 1 и надземной 2 частей, связанных друг с другом с возможностью съема. Подземная часть столба изготовлена из железа, на которой жестко закреплены обеспечивающие устойчивость элементы, выполненные в виде пластин 5 или стержней 6.

Пункты: 1 независ.

Фиг.: 4

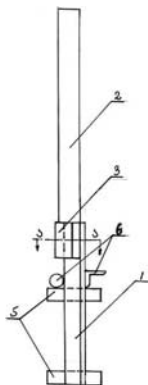

(10) AP 2010 11138 A (51) Int. Cl. (2006)
A 01 N 25/32
A 01 N 37/10
A 01 N 43/78
A 01 N 43/80
A 01 N 43/56

(21) AP 2007 011138 (22) 2007 08 03

(31) 06118443.8

(32) 2006 08 04

(33) EP

(71) BASF SE (DE)

67056 Ludwigshafen (DE)

(72) BRATZ, Matthias (DE);

BERGHAUS, Rainer (DE);

STEINBRENNER, Ulrich (DE)

(74) Alexander Kartvelishvili

(85) 2009 03 04

(86) PCT/EP2007/058092, 2007 08 03

(54) **AQUEOUS ACTIVE INGREDIENT CONCENTRATE HAVING AN HERBICIDAL EFFECT**

(57) An aqueous active ingredient concentrate in dissolved form comprising at least one 4-benzoyl-substituted pyrazol compound of the formula (I)

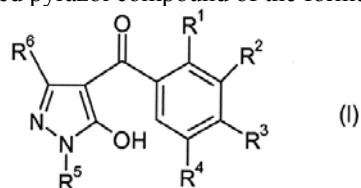

wherein R¹-R⁶ have the values indicated in the claims, at least one compound of benzoic acid of formula II

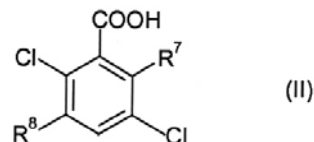

wherein R⁷ and R⁸ have the values indicated in the claims and at least one surface-active substance S selected from polyether compounds having repeat units derived from ethylene oxide, alkyl polyglycosides, and mixtures thereof. Said concentrate can be used for combating undesirable plants growth.

Claims: 4 independent

12 dependent

Fig.: 1

(10) AP 2010 11138 A (51) Int. Cl. (2006)
A 01 N 25/32
A 01 N 37/10
A 01 N 43/78
A 01 N 43/80
A 01 N 43/56

(21) AP 2007 011138 (22) 2007 08 03

(31) 06118443.8

(32) 2006 08 04

(33) EP

(71) BASF SE (DE)

(72) Mattheias Bratz (DE);

Райнер Бергхаус (DE);

Ульрих Штайнбрэннер (DE)

(74) Александр Картвелишвили

(85) 2009 03 04

(86) PCT/EP2007/058092, 2007 08 03

(54) **ВОДНЫЙ КОНЦЕНТРАТ АКТИВНЫХ ВЕЩЕСТВ С ГЕРБИЦИДНОЙ АКТИВНОСТЬЮ**

(57) Водный концентрат активных веществ в растворенной форме, содержащий, по меньшей мере, одно 4-бензоил-замещенное пиразоловое соединение формулы I

В которой R¹-R⁶ имеют указанные в формуле изобретения значения, по меньшей мере одно соединение бензойной кислоты формулы II,

В которой R⁷ и R⁸ имеют указанные в формуле изобретения значения и, по меньшей

мере, одно поверхностно-активное вещество S, выбранное из полиэфирных соединений, которые имеют производные повторяющиеся единицы этиленоксида, алкилполигликозидов или их смесей. Указанный концентрат пригоден для борьбы с ростом нежелательных растений.

Пункты: 4 независ.

12 завис.

Фиг.: 1

A 61

(10) AP 2010 11390 A (51) Int. Cl. (2006)

A 61 B 17/00

A 61 M 37/00

A 61 F 2/00

(21) AP 2009 011390 (22) 2009 07 29

(71) Tamaz Tamazashvili (GE);
Kekelidze St. 1, ap., 17, 0179, Tbilisi (GE);
Alexi Makharashvili (GE);
Qipshidzis k. 4, b.49, 0162, Tbilisi (GE);
Revaz Giorganashvili (GE);
Demetre Tavdadebulis k. 6, b.4, 0130,
Tbilisi (GE);
Irakli Bebiashvili (GE);
Todrias k. 19, b. 70, 3700, Rustavi (GE)

(72) Tamaz Tamazashvili (GE);
Alexi Makharashvili (GE);
Revaz Giorganashvili (GE);
Irakli Bebiashvili (GE);
Diana Papaskiri (GE);
Maya Kardava (GE); Lela Getsadze (GE);
Ketevan Chuchulashvili (GE)

(54) **APPARATUS FOR FORMATION OF MICROAPERTURES AT TRANSPLANTATION OF HAIR**

(57) The apparatus for formation of microapertures is provided at transplantation of hair, which at formation of microapertures of standard depth provides an opportunity of regulating the forming force with regard of individual skin thickness. Thus, the formation of microapertures and their account occur in an automatic mode.

Claims: 1 independent

Fig.: 3

(10) AP 2010 11390 A (51) Int. Cl. (2006)

A 61 B 17/00

A 61 M 37/00

A 61 F 2/00

(21) AP 2009 011390 (22) 2009 07 29

(71) Тамаз Тамазашвили (GE);
Алекси Махарашвили (GE);
Реваз Гиорганашвили (GE);
Иракий Бебиашвили (GE)

(72) Тамаз Тамазашвили (GE);
Алекси Махарашвили (GE);
Реваз Гиорганашвили (GE);

Иракий Бебиашвили (GE);

Диана Папаскири (GE);

Майя Кардава (GE);

Лела Гецадзе (GE);

Кетеван Чучулашвили (GE)

(54) **АППАРАТ ДЛЯ ФОРМИРОВАНИЯ МИКРООТВЕРСТИЙ ПРИ ТРАНСПЛАНТАЦИИ ВОЛОС**

(57) Представлен аппарат для формирования микроотверстий при трансплантации волос, который при формировании микроотверстий стандартной глубины обеспечивает возможность регулирования формирующего усилия с учетом индивидуальной плотности кожи. При этом, формирование микроотверстий и их счет происходят в автоматическом режиме.

Пункты: 1 независ.

Фиг.: 3

(10) AP 2010 10522 A (51) Int. Cl. (2006)

A 61 H 39/00

A 61 H 39/04

A 61 H 39/08

(21) AP 2006 010522 (22) 2006 07 19

(31) 2005123065; 2005134870; 2006121353;
2006122385; 2006125777

(32) 2005 07 20; 2005 11 10; 2006 06 16;
2006 06 23; 2006 07 18

(33) RU; RU; RU; RU; RU

(71) FREY MEDICAL TECHNOLOGIES AG (CH)
Place Bel-Air, c/o MGE, 1003, Lausanne (CH)

(72) MUKHINA, Mariyat (RU);
CHADAYEV, Nikolay (RU)

(74) Shalva Gvaramadze

(85) 2008 02 20

(86) PCT/RU2006/000385, 2006 07 19

(54) **NEEDLE AND DEVICE FOR REFLEXOTHERAPY**

(57) A needle comprises a rod 1 with a head 2, on the free end of which there is a retainer 3, the head of the rod is and/or the retainer are made in the form of three-dimensional, plate- or ring-shaped body, on the head of the needle there are indents 5, 13 and 15 and the rod of the needle is made relief and/or wavelike. The design of the needle makes it possible to more efficiently act on the selected acupuncture points, thereby substantially reducing the patient body excessive weight or treating the diseases thereof.

Claims: 5 independent

57 dependent

Fig.: 24

(10) AP 2010 10522 A (51) Int. Cl. (2006)

A 61 H 39/00

A 61 H 39/04

A 61 H 39/08

(21) AP 2006 010522 (22) 2006 07 19

- (31) 2005123065; 2005134870; 2006121353;
2006122385; 2006125777
(32) 2005 07 20; 2005 11 10; 2006 06 16;
2006 06 23; 2006 07 18
(33) RU; RU; RU; RU; RU
(71) ФРЕЙ МЕДИКАЛ ТЕКНОЛОДЖИС
АГ (СН)
(72) Марият Мухина (RU);
Николай Чадаев (RU)
(74) Шалва Гварамдзе
(85) 2008 02 20
(86) PCT/RU2006/000385, 2006 07 19
(54) **ИГЛА И УСТРОЙСТВО ДЛЯ**

РЕФЛЕКСОТЕРАПИИ

(57) Игла содержит стержень 1 с головкой 2, на свободном конце которого выполнен фиксатор 3, при этом головка стержня и/или фиксатор выполнен в виде объемного, пластинчатого или кольцеобразного тела, на головке иглы и/или фиксатора выполнены шипы 5,13 и 15, а стержень иглы выполнен рельефным и/или волнообразным. Конструкция иглы позволяет более эффективно воздействовать на выбранные точки акупунктуры и тем самым существенно снижать избыточную массу тела пациента или лечить его заболевания.

Пункты: 5 независ.

57 завис.

Фиг.: 24



(10) AP 2010 10932 A (51) Int. Cl. (2006)

A 61 K 33/18

A 61 K 31/10

A 61 K 47/44

A 61 K 9/02

A 61 P 15/02

A 61 P 31/04

(21) AP 2007 010932 (22) 2007 01 24

(31) 2006107864

(32) 2006 03 13

(33) RU

(71) RASNETSOV, Lev Davidovich (RU)

Nizhni-Novgorodi, ul. Gruzinskaia,

15, kv. 39, 603000 (RU)

(72) RASNETSOV, Lev Davidovich (RU);

SHVARTSMAN, Iakov Yudelevitch (RU);

LYALINA, Irina Konstantinovna (RU)

(74) Liliana Darakhvelidze

(85) 2008 10 13

(86) PCT/RU2007/000025, 2007 01 24

(54) **ANTIMICROBIAL AGENT**

(57) A suppository antimicrobial agent which as an active ingredient comprises iodine-dimethylsulphoxide combination at a ratio of 1:(1-10) and a liposoluble base in the form of the filler, wherein the iodine content in the suppository ranges from 10 to 20 mg. The suppository can be used for treatment of vaginitis.

Claims: 1 independent

5 dependent

(10) AP 2010 10932 A (51) Int. Cl. (2006)

A 61 K 33/18

A 61 K 31/10

A 61 K 47/44

A 61 K 9/02

A 61 P 15/02

A 61 P 31/04

(21) AP 2007 010932 (22) 2007 01 24

(31) 2006107864

(32) 2006 03 13

(33) RU

(71) ЛЕВ ДАВИДОВИЧ РАСНЕЦОВ (RU)

(72) Лев Давидович Раснецов (RU);

Яков Юделевич Шварцман (RU);

Ирина Константиновна Лялина (RU)

(74) Лилиана Дарахвелидзе

(85) 2008 10 13

(86) PCT/RU2007/000025, 2007 01 24

(54) **СРЕДСТВО АНТИМИКРОБНОГО**

ДЕЙСТВИЯ

(57) Средство в форме суппозитория в качестве активного ингредиента содержит комплекс йод-диметилсульфоксид в соотношении 1:(1-10), а в качестве наполнителя оно содержит жирорастворимую основу, при этом содержание йода в суппозитории составляет 10-20 мг. Применение суппозитория возможно для лечения вагинитов.

Пункты: 1 независ.

5 завис.

(10) AP 2010 11244 A (51) Int. Cl. (2006)

A 61 K 31/337

A 61 K 31/395

A 61 K 31/4745

A 61 K 31/505

A 61 K 31/517

A 61 K 31/519

A 61 K 31/5377

A 61 K 31/565

A 61 K 31/704

A 61 P 35/00

(21) AP 2007 011244 (22) 2007 10 05

(31) 2006-275841; 2007-057902

(32) 2006 10 06; 2007 03 07

(33) JP; JP

(71) TAKEDA PHARMACEUTICAL COMPANY
LIMITED (JP)

- 1-1, Doshomachi 4-chome, Chuo-ku, Osaka-shi, Osaka 5410045 (JP)
 (72) OHTA, Yoshikazu (JP);
 TAMURA, Toshiya (JP);
 TAKAGI, Shinji (JP)
 (74) Shalva Gvaramadze
 (85) 2009 05 06
 (86) PCT/JP2007/070026, 2007 10 05
 (54) **COMBINATION DRUG**
 (57) A pharmaceutical agent comprising a combination of compound of formula (1A)

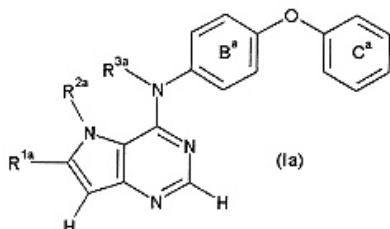

wherein R^{1a} , R^{2a} , R^{3a} , B^a and C^a have the values indicated in the claims, or salts thereof, or prodrug thereof, ER down-regulator, or anti-cancer agent; said medicinal means is useful for treatment and prophylaxis of cancer.

Claims: 2 independent
 9 dependent

Fig.: 9

- (10) AP 2010 11244 A (51) Int. Cl. (2006)
 A 61 K 31/337
 A 61 K 31/395
 A 61 K 31/4745
 A 61 K 31/505
 A 61 K 31/517
 A 61 K 31/519
 A 61 K 31/5377
 A 61 K 31/565
 A 61 K 31/704
 A 61 P 35/00

(21) AP 2007 011244 (22) 2007 10 05

(31) 2006-275841; 2007-057902

(32) 2006 10 06; 2007 03 07

(33) JP; JP

(71) ТАКЕДА ФАРМАСЬЮТИКАЛ
 КОМПАНИ ЛИМИТЕД (JP)

(72) Йошиказу Охта (JP);
 Тошия Тамура (JP);
 Шинджи Такаги (JP)

(74) Шалва Гварамадзе

(85) 2009 05 06

(86) PCT/JP2007/070026, 2007 10 05

(54) **КОМБИНИРОВАННОЕ ЛЕЧЕБНОЕ
 СРЕДСТВО**

(57) Фармацевтический агент, содержащий комбинацию соединения формулы (1a),

в которой R^{1a} , R^{2a} , R^{3a} , B^a и C^a имеют указанные в формуле изобретения значения, или его соли, или его пролекарство, даун-регулятора

ER, или противоракового агента; указанное лечебное средство пригодно для лечения и профилактики рака.

Пункты: 2 независ.

9 завис.

Фиг.: 9

PART C

C 07

- (10) AP 2010 11011 A (51) Int. Cl. (2006)
 C 07 D 209/00
 A 61 K 31/404

(21) AP 2007 011011 (22) 2007 06 07

(31) 60/804,517; 60/883,224

(32) 2006 06 12; 2007 01 03

(33) US; US

(71) NOVARTIS AG (CH)

Lichtstrasse 35, CH-4056 Basel (CH)

(72) ACEMOGLU, Murat (CH);

BAJWA, Joginder S. (US);

KARPINSKI, Piotr (US);

PAPOUTSAKIS, Dimitris (GR);

SLADE, Joel (US);

STOWASSER, Frank (DE)

(74) Alexander Kartvelishvili

(85) 2008 12 12

(86) PCT/US2007/070561, 2007 06 07

(54) **POLYMORPHS OF N-HYDROXY-3-[4-[[[2-(2-METHYL-1H-INDOL-3-YL)ETHYL]AMINO]METHYL]PHENYL]-2E-2-PROPENAMIDE**

(57) The substantially pure crystalline forms A, B, C, H_A, H_B of N-hydroxy-3-[4-[[[2-(2-methyl-1H-indol-3-yl)ethyl]amino]methyl]phenyl]-2E-2-propenamide, maleate salts, hemi-tartrate salts, mesylate salts, DL-lactate salts, L-lactate salts and D-lactate salts, mainly pure crystalline forms A, B, C, H_A, H_B, pharmaceutical composition containing them and use thereof for inhibition of protein kinase activity.

Claims: 20 independent

36 dependent

Fig.: 17

- (10) AP 2010 11011 A (51) Int. Cl. (2006)
 C 07 D 209/00
 A 61 K 31/404

(21) AP 2007 011011 (22) 2007 06 07

(31) 60/804,517; 60/883,224

(32) 2006 06 12; 2007 01 03

(33) US; US

(71) НОВАРТИС АГ (CH)

(72) Мурат Асемоглу (CH);

Джогиндер С. Баджва (US);

Пиотр Карпински (US);

Димитрис Папоуцакис (GR);

Джозел Слейд (US);
 Фрэнк Стувассер (DE)
 (74) Александр Картвелишвили
 (85) 2008 12 12
 (86) PCT/US2007/070561, 2007 06 07
 (54) **ПОЛИМОРФЫ N-ГИДРОКСИ-3-[4-[[[2-(2-МЕТИЛ-1Н-ИНДОЛ-3-ИЛ)ЭТИЛ]АМИНО]МЕТИЛ]ФЕНИЛ]-2Е-2-ПРОПЕНАМИДА**
 (57) Даны в основном чистые кристаллические формы А, В, С, Н_А, Н_В N-гидрокси-3-[4-[[[2-(2-метил-1Н-индол-3-ил)этил]амино]метил]фенил]-2Е-2-пропенамида, соли малеата, соли хемитартрата, соли мезилата, соли DL-лактата, соли L-лактата и соли D-лактата, в основном чистых кристаллических А, В, Н_А, S_А форм, содержащая их фармацевтическая композиция и применение для ингибирования активности протеин киназы.
 Пункты: 20 независ.
 36 завис.
 Фиг.: 17

(10) AP 2010 11252 A (51) Int. Cl. (2006) C 07 D 209/42 A 61 K 31/404 A 61 P 25/00 A 61 P 15/00 A 61 P 35/00 A 61 P 9/00 A 61 P 1/00

(21) AP 2007 011252 (22) 2007 10 17
 (31) 0609114
 (32) 2006 10 18
 (33) FR
 (71) LES LABORATOIRES SERVIER (FR)
 35, rue de Verdun, F-92284 SURESNES Cedex (FR)
 (72) MARCHAND, Pascal (FR);
 BABONNEAU, Vincent (FR);
 PLESSARD, Sylvie (FR);
 DUFLOS, Muriel (FR);
 BOUTIN, Jean Albert (FR);
 AUDINOT, Valérie (FR);
 DELAGRANGE, Philippe (FR);
 CAIGNARD, Daniel-Henri (FR)

(74) Tamaz Shilakadze
 (85) 2009 05 11
 (86) PCT/FR2007/001707, 2007 10 17
 (54) **NOVEL INDOLE DERIVATIVES, PROCESS FOR THE PREPARATION THEREOF AND PHARMACEUTICAL COMPOSITIONS CONTAINING THEM**
 (57) The invention relates to compounds of formula

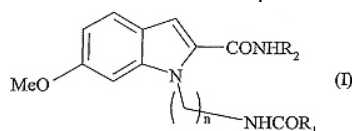

in which R₁ is an alkyl, cycloalkyl or cycloalkylalkyl group, R₂ is a linear or branched (C₁-C₆) alkyl group, and n is 1 to 6, their compositions and use thereof for treatment of disorders in the melatonergic system.

Claims: 5 independent
 6 dependent

(10) AP 2010 11252 A (51) Int. Cl. (2006) C 07 D 209/42 A 61 K 31/404 A 61 P 25/00 A 61 P 15/00 A 61 P 35/00 A 61 P 9/00 A 61 P 1/00

(21) AP 2007 011252 (22) 2007 10 17
 (31) 0609114
 (32) 2006 10 18
 (33) FR
 (71) LE LABORATOIRE SERVIER (FR)
 (72) Паскаль Маршан (FR);
 Венсан Бабонно (FR);
 Сильви Пьессар (FR);
 Мюриель Дюфло (FR);
 Жан Альбер Бутен (FR);
 Валери Одино (FR);
 Филипп Делакранж (FR);
 Даниель-Хенри Кенар (FR)

(74) Тамаз Шилакадзе
 (85) 2009 05 11
 (86) PCT/FR2007/001707, 2007 10 17
 (54) **НОВЫЕ ПРОИЗВОДНЫЕ ИНДОЛА, СПОСОБ ИХ ПОЛУЧЕНИЯ И СОДЕРЖАЩИЕ ИХ ФАРМАЦЕВТИЧЕСКИЕ КОМПОЗИЦИИ**

(57) Изобретение касается соединений индола формулы (1),
 В которой R₁ представляет собой алкильную, циклоалкильную или циклоалкилалкильную группу, R₂ представляет собой линейную или разветвленную (C₁-C₆) алкильную группу и n равен 1 до 6, их композиций и применения для лечения нарушений мелатонинергической системы.
 Пункты: 5 независ.
 6 завис.

(10) AP 2010 10512 A (51) Int. Cl. (2006) C 07 D 307/82 C 07 D 277/02 C 07 D 333/62 A 61 K 31/343 A 61 K 31/381 A 61 K 31/428 A 61 P 25/16

(21) AP 2006 010512 (22) 2006 07 17

- (31) 60/699,898
 (32) 2005 07 18
 (33) US
 (71) ORION CORPORATION (FI)
 Orionintie 1, FI-02200 Espoo (FI)
 (72) AHLMARK, Marko (FI);
 BÄCKSTRÖM, Reijo (FI);
 LUIRO, Anne (FI);
 PYSTYNEN, Jarmo (FI);
 TIAINEN, Eija (FI)
 (74) Tamaz Shilakadze
 (85) 2008 02 15
 (86) PCT/FI2006/000257, 2006 07 17
 (54) **NEW PHARMACEUTICAL
 COMPOUNDS**

(57) Compounds of formula (I),

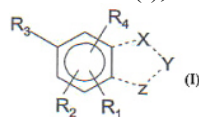

(R₁, R₂, R₃, R₄, X, Y and Z are as defined in the description), or pharmaceutically acceptable salt or ether, provided that the compound is not 2-benzyl-7-bromine-6-nitrobenzene furan-4,5-diol, pharmaceutical composition comprising them and use thereof as a medicinal means for treatment of such diseases or conditions in which COMT inhibitor is prescribed.

Claims: 4 independent
 27 dependent

- (10) AP 2010 10512 A (51) Int. Cl. (2006)
 C 07 D 307/82
 C 07 D 277/02
 C 07 D 333/62
 A 61 K 31/343
 A 61 K 31/381
 A 61 K 31/428
 A 61 P 25/16

(21) AP 2006 010512 (22) 2006 07 17

- (31) 60/699,898
 (32) 2005 07 18
 (33) US
 (71) ОРИОН КОРПОРЕЙШН (FI)
 (72) Марко Алмарк (FI);
 Рейо Бякстром (FI);
 Анне Луйро (FI);
 Ярмо Пистинен (FI);
 Эйя Тиайнен (FI)
 (74) Тамаз Шилакадзе
 (85) 2008 02 15
 (86) PCT/FI2006/000257, 2006 07 17
 (54) **НОВЫЕ ФАРМАЦЕВТИЧЕСКИЕ
 СОЕДИНЕНИЯ**

(57) Соединения формулы (I),
 (R₁, R₂, R₃, R₄, X, Y и Z определены в описании), или фармацевтически приемлемая соль или эфир, при условии, что соединение не является 2-

бензил-7-бром-6-нитробензофуран - 4,5 - диолом, содержащая его фармацевтическая композиция и использование в виде лекарственного средства для лечения таких заболеваний или состояний, при которых назначен ингибирующий агент COMT.

Пункты: 4 независ.
 27 завис.

- (10) AP 2010 10489 A (51) Int. Cl. (2006)
 C 07 D 471/04
 C 07 D 487/04
 A 61 K 31/498
 A 61 P 35/00

(21) AP 2008 010489 (22) 2008 01 28

- (31) 07/00741
 (32) 2007 02 02
 (33) FR
 (71) LES LABORATOIRES SERVIER (FR)
 12, Place de la Défense, F-92415 Courbevoix
 Cédex (FR)
 (72) CASARA, Patrick (FR);
 LE DIGUARHER Thierry (FR);
 GENESTE Olivier (FR);
 HICKMAN John (FR)
 (74) Tamaz Shilakadze
 (54) **NOVEL TRICYCLIC DERIVATIVES,
 PROCESS FOR THE PREPARATION
 THEREOF AND PHARMACEUTICAL
 COMPOSITIONS CONTAINING SAME**
 (57) Tricyclic compounds of the formula (I),

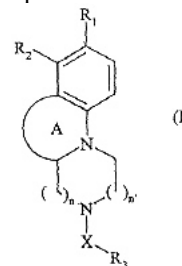

wherein values of R₁, R₂, R₃, X, n, n' are indicated in the description, pharmaceutical composition and pharmaceutical combination together with anticancer agent on its base. Use of composition and combination for preparation of anticancer medicinal means. The method for production of tricyclic compounds.

Claims: 10 independent
 12 dependent

- (10) AP 2010 10489 A (51) Int. Cl. (2006)
 C 07 D 471/04
 C 07 D 487/04
 A 61 K 31/498
 A 61 P 35/00

(21) AP 2008 010489 (22) 2008 01 28

(31) 07/00741

- (32) 2007 02 02
 (33) FR
 (71) ЛЕ ЛАБОРАТУАР СЕРВЬЕР (FR)
 (72) Патрик Казара (FR);
 Тьерри Ле Дигуре (FR);
 Оливье Женест (FR);
 Джон Хикман (FR)

(74) Тамаз Шилакадзе
 (54) **НОВЫЕ ТРИЦИКЛИЧЕСКИЕ СОЕДИНЕНИЯ, СПОСОБ ИХ ПОЛУЧЕНИЯ И СОДЕРЖАЩИЕ ИХ ФАРМАЦЕВТИЧЕСКИЕ КОМПОЗИЦИИ**

- (57) Трициклические соединения формулы (1)
 Значения R₁, R₂, R₃, X, n, n' которой определены в описании, фармацевтическая композиция и фармацевтическая комбинация вместе с противораковым агентом на их основе. Применение композиции и комбинации для приготовления противоракового лекарственного препарата. Способы получения трициклических соединений.
 Пункты: 10 независ.
 12 завис.

(10) AP 2010 10823 A (51) Int. Cl. (2006)
 C 07 D 471/04
 A 61 K 31/437
 A 61 P 3/04
 A 61 P 3/06
 A 61 P 3/10

- (21) AP 2006 010823 (22) 2006 12 19
 (31) 0512924
 (32) 2005-12-20
 (33) FR
 (71) LES LABORATOIRES SERVIER (FR)
 12, Place de la Défense, F-92415 Courbevoie
 Cédex (FR)
 (72) SUZENET, Franck (FR);
 GUILLAUMET, Gérard (FR);
 PILLARD, Christelle (FR);
 BASSENE, Carine (SN);
 DACQUET, Catherine (FR);
 KTORZA, Alain (FR);
 CAIGNARD, Daniel-Henri (FR)
 (74) Tamaz Shilakadze
 (85) 2008-07-18
 (86) PCT/FR2006/002778, 2006-12-19

(54) **NOVEL HETEROCYCLIC OXIME DERIVATIVES, PROCESS FOR THE PREPARATION THEREOF AND PHARMACEUTICAL COMPOSITIONS CONTAINING THEM**

- (57) Compounds of formula (I)

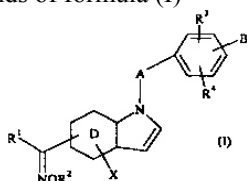

in which:
 X represents a hydrogen or halogen atom or an alkyl group,
 R¹, R², R³ and R⁴ are as defined in the description,
 A represents an alkylene chain as defined in the description,
 B represents an alkyl or alkenyl group substituted with a group,

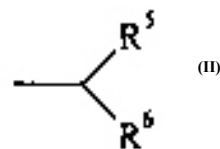

D represents a pyridine ring.

Claims: 13 independent

15 dependent

(10) AP 2010 10823 A (51) Int. Cl. (2006)
 C 07 D 471/04
 A 61 K 31/437
 A 61 P 3/04
 A 61 P 3/06
 A 61 P 3/10

- (21) AP 2006 010823 (22) 2006 12 19
 (31) 0512924
 (32) 2005.12.20
 (33) FR
 (71) ЛЕ ЛАБОРАТУАР СЕРВЬЕР (FR)
 (72) Франк Сюзен (FR);
 Жеральд Гиллом (FR);
 Кристел Пилар (FR);
 Карин Бассен (SN);
 Катрин Даке (FR);
 Ален Кторза (FR);
 Даниель-Анри Кежнар (FR)

(74) Тамаз Шилакадзе
 (85) 2008-07-18
 (86) PCT/FR2006/002778, 2006-12-19
 (54) **НОВЫЕ ПРОИЗВОДНЫЕ ГЕТЕРОЦИКЛИЧЕСКИХ ОКСИМОВ, СПОСОБ ИХ ПОЛУЧЕНИЯ И СОДЕРЖАЩИЕ ИХ ФАРМАЦЕВТИЧЕСКИЕ КОМПОЗИЦИИ**

- (57) Соединения формулы (I)

в которой:

X представляет собой водород или атом галогена или алкильную группу,
 R¹, R², R³ и R такие как определено в описании,
 A представляет собой алкиленовую цепь, как определено в описании,
 B представляет собой алкильную или алкенильную группу, замещенную группой
 D представляет собой пиридиновое ядро.

Пункты: 13 независ.

15 завис.

C 10**(10) AP 2010 10785 A (51) Int. Cl. (2006)****C 10 L 5/02****C 10 L 5/06**

(21) AP 2008 010785 (22) 2008 06 26

(71) Vladimir Akhobadze (GE)

Bibilashvili St. 7/4, 2000,

Zestafoni (GE);

Gogi Jandieri (GE)

Rustavelis chikh. 1, b. 8, 2000,

Zestafoni (GE)

(72) Vladimir Akhobadze (GE);

Gogi Jandieri (GE)

(54) METHOD OF AGGLOMERATION OF FERROALLOY PRODUCTION WASTES

(57) A method provides introducing into the material, which is subject to agglomeration, the binding components in the certain proportion in mass %, receiving the homogeneous mix, delivering in special forms and pressing simultaneously with vibrating affecting, thus, the moisture content in the mix which is subject to agglomeration is no more than 3 %.

Claims: 1 independent

Tables: 1

(10) AP 2010 10785 A (51) Int. Cl. (2006)**C 10 L 5/02****C 10 L 5/06**

(21) AP 2008 010785 (22) 2008 06 26

(71) Владимир Ахобадзе (GE);

Гуго Джандиери (GE)

(72) Владимир Ахобадзе (GE);

Гуго Джандиери (GE)

(54) СПОСОБ ОКУСКОВЫВАНИЯ ОТХОДОВ ФЕРРОСПЛАВНОГО ПРОИЗВОДСТВА

(57) Способ предусматривает введение в материал, подлежащий окусковыванию, связующих компонентов в определенном соотношении в масс %, получение однородной смеси, подачу в специальные формы и прессование одновременно с вибрационным воздействием, при этом, содержание влаги в смеси, подлежащей окусковыванию, не превышает 3 %.

Пункты: 1 независ.

Таблицы: 1

PART G**G 01****(10) AP 2010 11210 A (51) Int. Cl. (2006)****G 01 N 27/00****G 01 N 27/72****G 01 N 27/82**

(21) AP 2009 011210 (22) 2009 04 08

(71) Shota Nadiradze (GE)

Varketili 3, II m/d, build. 15, ap. 5, 0182, Tbilisi (GE);

Alexander Kartvelishvili (GE)

Vahza-Pshavela av. 59, ap.15, 0186,

Tbilisi (GE);

Yuri Nadiradze (GE)

Varketili 3, II m/d, build. 15, ap. 74,

0182, Tbilisi (GE);

Irakli Nadiradze (GE)

Varketili 3, II m/d, build. 15, ap. 5, 0182,

Tbilisi (GE);

George Kartvelishvili (GE)

Vazha-Pshavela Ave. 59, ap. 15, 0186,

Tbilisi (GE);

George Nadiradze (GE)

Varketili 3, II m/d, build. 15, ap. 74,

0182, Tbilisi (GE)

(72) Shota Nadiradze (GE);

Alexander Kartvelishvili (GE);

Yuri Nadiradze (GE);

Irakli Nadiradze (GE);

George Kartvelishvili (GE);

George Nadiradze (GE)

(54) DEVICE FOR CONTROL OF STRUCTURAL INTEGRITY OF THE LONGITUDINAL FERROMAGNETIC PRODUCTS

(57) A device contains a П-shaped electromagnet, a magnetization coil, a Hall sensor of the search of faults, amplifiers and the device of registration of faults. Thus, it in addition contains rotating together with the Hall sensor a device of perpendicular magnetization of the longitudinal ferromagnetic product.

Claims: 1 independent

Fig.: 1

(10) AP 2010 11210 A (51) Int. Cl. (2006)**G 01 N 27/00****G 01 N 27/72****G 01 N 27/82**

(21) AP 2009 011210 (22) 2009 04 08

(71) Шота Надирадзе (GE);

Александр Картвелишвили (GE);

Юрий Надирадзе (GE);

Ираклий Надирадзе (GE);

Георгий Картвелишвили (GE);

Георгий Надирадзе (GE)

(72) Шота Надирадзе (GE);

Александр Картвелишвили (GE);

Юрий Надирадзе (GE);

Ираклий Надирадзе (GE);

Георгий Картвелишвили (GE);

Георгий Надирадзе (GE)

(54) УСТРОЙСТВО КОНТРОЛЯ СТРУКТУРНОЙ ЦЕЛОСТНОСТИ ПРОДОЛЬНЫХ ФЕРРОМАГНИТНЫХ ИЗДЕЛИЙ

(57) Устройство содержит П-образный электромагнит, катушку намагничивания, датчик Холла поиска повреждений, усилители и устройство регистрации повреждений. При этом, оно дополнительно содержит вращающееся вместе с датчиком Холла устройство поперечного намагничивания продольного ферромагнитного изделия.

Пункты: 1 независ.

Фиг.: 1

PATENTS FOR INVENTIONS

ПАТЕНТЫ НА ИЗОБРЕТЕНИЯ

PART A

A 21

- (11) P 2010 5117 B (51) Int. Cl. (2006)
A 21 D 13/02
- (10) AP 2010 11176 A (44) 11(303)/2010
(21) AP 2009 011176
(22) 2009 03 20
(24) 2009 03 20
- (73) Eliza Pruidze (GE)
Rustavelis k.137/36, 4600,
Kutaisi (GE);
Maria Silagadze (GE)
26 Maisis St. 45, 4600,
Kutaisi (GE);
Gulnara Khetsuriani (GE)
Rustavelis k.120/42, 4600,
Kutaisi (GE);
Eliso Dzneladze (GE)
Parnavaz Mepis II shes. 18, 4600,
Kutaisi (GE);
Tsira Khutsidze (GE)
Chabukianis k.2, 4600, Kutaisi (GE)
- (72) Eliza Pruidze (GE);
Maria Silagadze (GE);
Gulnara Khetsuriani (GE);
Eliso Dzneladze (GE);
Tsira Khutsidze (GE)
- (54) **METHOD OF MANUFACTURE OF
GRAIN BREAD**

- (11) P 2010 5117 B (51) Int. Cl. (2006)
A 21 D 13/02
- (10) AP 2010 11176 A (44) 11(303)/2010
(21) AP 2009 011176
(22) 2009 03 20
(24) 2009 03 20
- (71) Элиза Пруидзе (GE);
Мария Силагадзе (GE);
Гульнара Хецуриани (GE);
Элисо Дзnelадзе (GE);
Цира Хуцидзе (GE)
- (72) Элиза Пруидзе (GE);
Мария Силагадзе (GE);
Гульнара Хецуриани (GE);
Элисо Дзnelадзе (GE);
Цира Хуцидзе (GE)
- (54) **СПОСОБ ПРОИЗВОДСТВА
ЗЕРНОВОГО ХЛЕБА**
-

A 23

- (11) P 2010 5113 B (51) Int. Cl. (2006)
A 23 G 3/52
- (10) AP 2010 10598 A (44) 7(299)/2010
(21) AP 2008 010598
(22) 2008 03 28
(24) 2008 03 28
- (73) Ketevan Lezhava (GE)
Sop. Etseri, 3910, Samtredia (GE);
Manana Karchava (GE)
David Agmashenebeli Ave., 1/15, 4600,
Kutaisi (GE);
Zhuzhuna Mzhavanadze (GE)
Ianetis I ubani, 3914, Samtredia (GE)
- (72) Ketevan Lezhava (GE);
Manana Karchava (GE);
Zhuzhuna Mzhavanadze (GE)
- (54) **CREAM-MARSHMALLOW**

- (11) P 2010 5113 B (51) Int. Cl. (2006)
A 23 G 3/52
- (10) AP 2010 10598 A (44) 7(299)/2010
(21) AP 2008 010598
(22) 2008 03 28
(24) 2008 03 28
- (71) Кетеван Лежава (GE);
Манана Карчава (GE);
Жужуна Мжаванадзе (GE)
- (72) Кетеван Лежава (GE);
Манана Карчава (GE);
Жужуна Мжаванадзе (GE)
- (54) **КРЕМ – ЗЕФИР**
-

PART B

B 60

- (11) P 2010 5116 B (51) Int. Cl. (2006)
B 60 G 21/04
- (10) AP 2010 10703 A (44) 13(305)/2010
(21) AP 2008 010703
(22) 2008 05 20
(24) 2008 05 20
- (73) Grigol Chelidze (GE)
Barnovis k. 23, 0108, Tbilisi (GE);
Bakur Chelidze (GE)
Barnovis k. 23, 0108, Tbilisi (GE)
- (72) Grigol Chelidze (GE);
Bakur Chelidze (GE)

**(54) REAR SEMI-DEPENDENT SUSPENSION
BRACKET OF THE CAR****(11) P 2010 5116 B (51) Int. Cl. (2006)
B 60 G 21/04**

(10) AP 2010 10703 A (44) 13(305)/2010

(21) AP 2008 010703

(22) 2008 05 20

(24) 2008 05 20

(71) Григол Челидзе (GE);

Бакур Челидзе (GE)

(72) Григол Челидзе (GE);

Бакур Челидзе (GE)

**(54) ЗАДНЯЯ ПОЛУЗАВИСИМАЯ ПОДВЕСКА
ЛЕГКОВОГО АВТОМОБИЛЯ****B 65****(11) P 2010 5114 B (51) Int. Cl. (2006)
B 65 D 5/00
B 65 D 5/44**

(10) AP 2010 10634 A (44) 11(303)/2010

(21) AP 2006 010634

(22) 2006 09 14

(24) 2006 09 14

(31) 20 2005 014 737.0

(32) 2005 09 19

(73) SEDA S.P.A. (IT)

Corso Salvatore D'Amato 84, I-80022 Arzano

Napoli (IT)

(72) D'AMATO, Gianfranco (IT)

(74) Alexander Gegechkori

(85) 2008 04 10

(86) PCT/EP2006/008985, 2006 09 14

**(54) CONTAINER AND BLANK FOR THE
PRODUCTION THEREOF****(11) P 2010 5114 B (51) Int. Cl. (2006)
B 65 D 5/00
B 65 D 5/44**

(10) AP 2010 10634 A (44) 11(303)/2010

(21) AP 2006 010634

(22) 2006 09 14

(24) 2006 09 14

(31) 20 2005 014 737.0

(32) 2005 09 19

(73) СЕДА С.П.А. (IT)

(72) Гианфранко Д'Амато (IT)

(74) Александр Гегечкори

(85) 2008 04 10

(86) PCT/EP2006/008985, 2006 09 14

**(54) КОНТЕЙНЕР И ЗАГОТОВКА ДЛЯ
ЕГО ИЗГОТОВЛЕНИЯ****PART C****C 01****(11) P 2010 5109 B (51) Int. Cl. (2006)
C 01 B 11/02
B 01 J 8/02
B 01 J 19/24
B 01 J 3/00**

(10) AP 2010 9628 A (44) 9(301)/2010

(21) AP 2005 009628

(22) 2005 02 09

(24) 2005 02 09

(31) 60/546,199; 04445030.2

(32) 2004 02 23; 2004 03 12

(33) US; EP

(73) AKZO NOBEL N.V. (NL)

P.O. Box 9300, NL-6800 SB Arnhem (NL)

(72) CHARLES, Gary (US);

BURKE, Michael (US)

(74) Guram Tsitsishvili

(85) 2006 09 21

(86) PCT/SE2005/000167, 2005 02 09

**(54) PROCESS FOR PRODUCTION OF
CHLORINE DIOXIDE****(11) P 2010 5109 B (51) Int. Cl. (2006)
C 01 B 11/02
B 01 J 8/02
B 01 J 19/24
B 01 J 3/00**

(10) AP 2010 9628 A (44) 9(301)/2010

(21) AP 2005 009628

(22) 2005 02 09

(24) 2005 02 09

(31) 60/546,199; 04445030.2

(32) 2004 02 23; 2004 03 12

(33) US; EP

(73) Акцо Нобель Н. В. (NL)

(72) Хари Чарльз(US);

Майкл Берк (US)

(74) Гурам Цицишвили

(85) 2006 09 21

(86) PCT/SE2005/000167, 2005 02 09

**(54) СПОСОБ И УСТРОЙСТВО ДЛЯ
ПОЛУЧЕНИЯ ДВУОКСИ ХЛОРА****C 07****(11) P 2010 5115 B (51) Int. Cl. (2006)
C 07 C 27/06**

(10) AP 2010 10705 A (44) 7(299)/2010

(21) AP 2006 010705
 (22) 2006 10 23
 (24) 2006 10 23
 (31) 60/728,989
 (32) 2005 10 21
 (33) US
 (73) TAYLOR BIOMASS ENERGY, LLC (US)
 350 Neelytown Road, Montgomery, NY
 12549 (US)
 (72) PAISLEY, Mark, A. (US)
 (74) Tamaz Shilakadze
 (85) 2008 05 20
 (86) PCT/US2006/041435, 2006 10 23
 (54) **PROCESS AND SYSTEM FOR
 GASIFICATION WITH IN-SITU TAR
 REMOVAL**

(11) P 2010 5115 B (51) **Int. Cl. (2006)
 C 07 C 27/06**

(10) AP 2010 10705 A (44) 7(299)/2010
 (21) AP 2006 010705
 (22) 2006 10 23
 (24) 2006 10 23
 (31) 60/728,989
 (32) 2005 10 21
 (33) US
 (73) Тейлор Биомас Энерджи, ЛЛК (US)
 (72) Марк А. Пэйсли (US)
 (74) Тамаз Шилакадзе
 (85) 2008 05 20
 (86) PCT/US2006/041435, 2006 10 23
 (54) **СПОСОБ И СИСТЕМА ДЛЯ ГАЗИФИ-
 КАЦИИ С IN-SITU УДАЛЕНИЕМ
 СМОЛЫ**

(11) P 2010 5110 B (51) **Int. Cl. (2006)
 C 07 K 14/705
 C 07 K 19/00**

(10) AP 2010 9904 A (44) 7(299)/2010
 (21) AP 2005 009904
 (22) 2005 08 03
 (24) 2005 08 03
 (31) 60/598,555
 (32) 2004 08 03
 (33) US
 (73) TRANSTECH PHARMA, INC. (US)
 4170 Mendenhall Oaks Parkway, Suite 110,
 High Point, NC 27265 (US)
 (72) MJALLI, Adnan, M.M. (US);
 TIAN, Ye, E. (US);
 WEBSTER, Jeffrey, C. (US);
 ROTHLEIN, Robert (US)
 (74) Shalva Gvaramadze
 (85) 2007 03 02
 (86) PCT/US2005/027705, 2005 08 03
 (54) **RAGE FUSION PROTEINS AND
 THEIR USE**

(11) P 2010 5110 B (51) **Int. Cl. (2006)
 C 07 K 14/705
 C 07 K 19/00**

(10) AP 2010 9904 A (44) 7(299)/2010
 (21) AP 2005 009904
 (22) 2005 08 03
 (24) 2005 08 03
 (31) 60/598,555
 (32) 2004 08 03
 (33) US
 (73) Гранстек Фарма, Инк (US)
 (72) Аднан М.М. Джалли (US);
 Ёе И. Тянь (US); Джеффри С.Вебстер (US);
 Роберт Ротлейн (US)
 (74) Шалва Гварамадзе
 (85) 2007 03 02
 (86) PCT/US2005/027705, 2005 08 03
 (54) **RAGE-СЛИТЫЕ БЕЛКИ И ИХ
 ПРИМЕНЕНИЕ**

C 12

(11) P 2010 5111 B (51) **Int. Cl. (2006)
 C 12 N 15/62
 C 07 K 14/705
 A 61 K 38/17**

(10) AP 2010 9905 A (44) 7(299)/2010
 (21) AP 2005 009905
 (22) 2005 08 03
 (24) 2005 08 03
 (31) 60/598,362
 (32) 2004 08 03
 (33) US
 (73) TRANSTECH PHARMA, INC. (US)
 4170 Mendenhall Oaks Parkway, Suite 110,
 High Point, NC 27265 (US);
 THE TRUSTEES OF COLUMBIA
 UNIVERSITY IN THE CITY OF NEW
 YORK (US)
 West 116th Street and Broadway, New York,
 NY 10027 (US)
 (72) MJALLI, Adnan, M.M. (US);
 STERN, David, M. (US); TIAN, Ye, E. (US);
 WEBSTER, Jeffrey, C. (US);
 ROTHLEIN, Robert (US);
 SCHMIDT, Ann, Marie (US); YAN, Shi, Du (US)
 (74) Shalva Gvaramadze
 (85) 2007 03 02
 (86) PCT/US2005/027694, 2005 08 03
 (54) **RAGE FUSION PROTEINS AND
 METHODS OF USE**

(11) P 2010 5111 B (51) **Int. Cl. (2006)
 C 12 N 15/62
 C 07 K 14/705
 A 61 K 38/17**

- (10) AP 2010 9905 A (44) 7(299)/2010
(21) AP 2005 009905
(22) 2005 08 03
(24) 2005 08 03
(31) 60/598,362
(32) 2004 08 03
(33) US
(73) Транстек Фарма, Инк. (US);
Зи Трастис оф Коламбия Университи
Ин зи Сити оф Нью Йорк (US)
(72) Аднан М.М. Мджалли (US);
Дэвид М. Стерн (US);
Йе И. Тянь (US);
Джеффри С. Вебстер (US);
Роберт Ротлейн (US);
Эн Мари Шмидт (US); Ши Дью Янь (US)
(74) Шалва Гварамдзе
(85) 2007 03 02
(86) PCT/US2005/027694 2005 08 03
(54) **RAGE – СЛИТЫЕ БЕЛКИ И ИХ
ПРИМЕНЕНИЕ**
-

PART E

E 04

- (11) P 2010 5112 B (51) Int. Cl. (2006)
E 04 B 7/14
(10) AP 2010 10109 A (44) 11(303)/2010
(21) AP 2007 010109
(22) 2007 06 04
(24) 2007 06 04
(73) Bichiko Surguladze (GE)
Gldanis mas., I mkr., korp. 19, b 34, 0167,
Tbilisi (GE);
Badri Champuridze (GE)
Kandelakis k. 39, 0160, Tbilisi (GE)
(72) Bichiko Surguladze (GE);
Badri Champuridze (GE)
(54) **PRELIMINARY STRAINED
STRUCTURAL COMPOSITION**
- (11) P 2010 5112 B (51) Int. Cl. (2006)
E 04 B 7/14
(10) AP 2010 10109 A (44) 11(303)/2010
(21) AP 2007 010109
(22) 2007 06 04
(24) 2007 06 04
(71) Бичико Сургуладзе (GE);
Бадри Чампуридзе (GE)
(72) Бичико Сургуладзе (GE);
Бадри Чампуридзе (GE)
(54) **ПРЕДВАРИТЕЛЬНО НАПРЯЖЕННАЯ
СТРУКТУРНАЯ КОМПОЗИЦИЯ**
-

UTILITY MODELS

ПОЛЕЗНЫЕ МОДЕЛИ

APPLICATIONS LAID OPEN FOR THE PURPOSE OF TAKING PATENT GRANTING DECISIONS

ЗАЯВКИ, ПО КОТОРЫМ ВЫНЕСЕНЫ РЕШЕНИЯ О ВЫДАЧЕ ПАТЕНТОВ

To appeal a decision is possible at Chamber of Appeal of Sakpatenti within 3 months from the publication or at The Board of Administrative Actions of Tbilisi City Court within a 1 month period. (Address: 12 km., №6, David Aghmashenebeli Kheivani, Tbilisi).

Обжалование решения возможно в Апелляционной палате Сакпатенти в течение 3 месяцев с даты его публикации или в течение 1 месяца в Коллегии по административным делам Тбилисского городского суда (г. Тбилиси, Аллея Давида Агмашенебели 12-й км., №6).

PART A

A 01

(10) AU 2010 11710 U (51) Int. Cl. (2006)
A 01 D 89/00

(21) AU 2010 011710 (22) 2010 03 02

(71) Zakharij Tskhvedadze (GE);
sop. Orbeti, 2310, Tetri Tsqaro (GE);
Vladimir Miruashvili (GE);
Dolidze St. 132, 0171, Tbilisi (GE);
Mikheil Natobadze (GE);
Tabakhmela, 1326, Tbilisi (GE)

(72) Zakharij Tskhvedadze (GE);
Vladimir Miruashvili (GE);
Mikheil Natobadze (GE)

(54) COMPRESSION BOX OF BALES FOR
BALER

(57) A compression box 2 contains a box of rectangular form fixed on the frame 1 of the baler, the box having bottom and lateral walls, the piston of the rectangular form capable of longitudinal motion inside the box having a screw clip 3 of the lath 4, which are hingedly fixed on the upper part of the lateral walls of the box, and the guides 7, 8 and 9 hingedly fixed on the frame of the baler. The guides are executed in the form of a segment of Archimedean spiral and their free ends are directed downwards.

Fig.: 1

(10) AU 2010 11710 U (51) Int. Cl. (2006)
A 01 D 89/00

(21) AU 2010 011710 (22) 2010 03 02

(71) Захария Цхведадзе (GE);
Владимир Мируашвили (GE);
Михаил Натобаидзе (GE)

(72) Захария Цхведадзе (GE);

Владимир Мируашвили (GE);
Михаил Натобаидзе (GE)

(54) КАМЕРА ПРЕССОВАНИЯ ТЮКОВ
ДЛЯ ПРЕСС-ПОДБОРЩИКА

(57) Камера прессования 2 содержит закрепленную на раме 1 пресс-подборщика коробку прямоугольной формы, имеющую днище и боковые стенки, поршень прямоугольной формы, имеющий возможность продольного перемещения внутри коробки, имеющие винтовой прижим 3 рейки 4, которые шарнирно закреплены на верхней части боковых стенок коробки, и шарнирно закрепленные на раме пресс-подборщика направляющие 7, 8 и 9. Направляющие выполнены в виде отрезка спирали Архимеда и их свободные концы направлены вниз.

Фиг.: 1

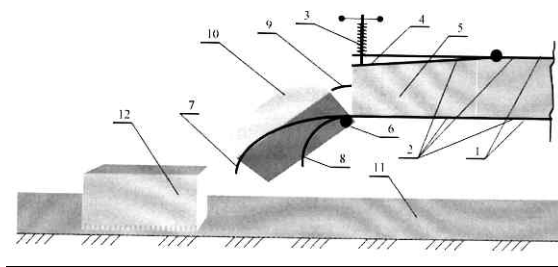

PATENTS FOR UTILITY MODELS

ПАТЕНТЫ НА ПОЛЕЗНЫЕ МОДЕЛИ

PART A

A 01

**(11) U 2010 1630 Y (51) Int. Cl. (2006)
A 01 B 49/00**

- (10) AU 2010 11485 U (44) 13(305)/2010
(21) AU 2009 011485
(22) 2009 09 25
(24) 2009 09 25
(73) Revaz Makharoblidze (GE)
Guramishvilis gamz., 5b, b. 65, 0192,
Tbilisi (GE);
Zaza Makharoblidze (GE)
Guramishvilis gamz., 5b, b. 65, 0192,
Tbilisi (GE);
Revaz Khazhomia (GE)
Bezhanishvili II gas., 24, 0192, Tbilisi (GE);
Teimuraz Japaridze (GE)
Didgoris k.40, b.14, sop. Dighomi, 0126,
Tbilisi (GE);
Igor Lagvilava (GE)
Nutsbidze perdobi, IV mkr., korp. 21, b. 29,
0183, Tbilisi (GE);
Bezhan Basilashvili (GE)
Didgoris k. 72, b. 5, 3305, sop. Digomi,
0126, Tbilisi (GE);
Leri Lomtadze (GE)
Gldanis mas., VIII mkr., korp. 27, b. 127,
0107, Tbilisi (GE);
Tamara Sanikidze (GE)
Mukhianis das., IVb mkr., korp.36, b.79,
0172, Tbilisi (GE)
(72) Revaz Makharoblidze (GE);
Zaza Makharoblidze (GE);
Revaz Khazhomia (GE);
Teimuraz Japaridze (GE);
Igor Lagvilava (GE);
Bezhan Basilashvili (GE);
Leri Lomtadze (GE);
Tamara Sanikidze (GE)
(54) **FLAT-CHISEL PLOW MACHINE FOR
TREATING SOIL IN ROW-SPACINGS
OF TEA BUSHES**

**(11) U 2010 1630 Y (51) Int. Cl. (2006)
A 01 B 49/00**

- (10) AU 2010 11485 U (44) 13(305)/2010
(21) AU 2009 011485
(22) 2009 09 25

- (24) 2009 09 25
(73) Revaz Makharoblidze (GE);
Zaza Makharoblidze (GE);
Revaz Khazhomia (GE);
Teimuraz Джапаридзе (GE);
Игорь Лагвилава (GE);
Бежан Басилашвили (GE);
Лери Ломтадзе (GE);
Тамара Саникидзе (GE)
(72) Revaz Makharoblidze (GE);
Zaza Makharoblidze (GE);
Revaz Khazhomia (GE);
Teimuraz Джапаридзе (GE);
Игорь Лагвилава (GE);
Бежан Басилашвили (GE);
Лери Ломтадзе (GE);
Тамара Саникидзе (GE)
(54) **ПЛОСКОРЕЖУЩАЯ И ГЛУБОКО-
РЫХЛИТЕЛЬНАЯ МАШИНА ДЛЯ
ОБРАБОТКИ ПОЧВЫ В МЕЖДУРЯ-
ДЬЯХ ЧАЙНЫХ КУСТОВ**

**(11) U 2010 1631 Y (51) Int. Cl. (2006)
A 01 D 46/04**

- (10) AU 2010 11502 U (44) 13(305)/2010
(21) AU 2009 011502
(22) 2009 10 08
(24) 2009 10 08
(73) Revaz Makharoblidze (GE)
Guramishvili gamz., 5b, b. 65, 0192,
Tbilisi (GE);
Zaza Makharoblidze (GE)
Guramishvili gamz., 5b, b. 65, 0192,
Tbilisi (GE);
Revaz Khazhomia (GE)
Bezhanishvili II gas, 24, 0192, Tbilisi (GE);
Igor Lagvilava (GE)
Nutsbidze perd., IV mkr, korp. 21, b. 29,
0183, Tbilisi (GE);
Teimuraz Japaridze (GE)
Didgoris k.40, b.14, sop. Dighomi, 0126,
Mtskhetis r-ni (GE);
Bezhan Basilashvili (GE)
Didgoris k. 72, b. 5, sop. Digomi,
0126, Tbilisi (GE);
Leri Lomtadze (GE)
Gldanis mas., VIII mkr., korp. 27, b. 127,
0107, Tbilisi (GE)
(72) Revaz Makharoblidze (GE);
Zaza Makharoblidze (GE);

Revaz Khazhomia (GE);
 Igor Lagvilava (GE);
 Teimuraz Japaridze (GE);
 Bezhan Basilashvili (GE);
 Leri Lomtadze (GE)

(54) **APPARATUS FOR GRINDING OF
 ROOTED SYSTEM OF TEA BUSHES**

(72) Шалва Элизбарашвили (GE)
 (54) **СПОСОБ ГЕОДЕЗИЧЕСКОЙ
 СЪЕМКИ**

(11) U 2010 1631 Y (51) Int. Cl. (2006)
 A 01 D 46/04

(10) AU 2010 11502 U (44) 13(305)/2010

(21) AU 2009 011502

(22) 2009 10 08

(24) 2009 10 08

(71) Реваз Махароблидзе (GE);
 Заза Махароблидзе (GE);
 Реваз Хажомия (GE);
 Игорь Лагвилава (GE);
 Теймураз Джапаридзе (GE);
 Бежан Басилашвили (GE);
 Лери Ломтадзе (GE)

(72) Реваз Махароблидзе (GE);
 Заза Махароблидзе (GE);
 Реваз Хажомия (GE);
 Игорь Лагвилава (GE);
 Теймураз Джапаридзе (GE);
 Бежан Басилашвили (GE);
 Лери Ломтадзе (GE)

(54) **АППАРАТ ДЛЯ ИЗМЕЛЬЧЕНИЯ
 КОРНЕВОЙ СИСТЕМЫ ЧАЙНЫХ
 КУСТОВ**

PART G

G 01

(11) U 2010 1632 Y (51) Int. Cl. (2006)
 G 01 C 11/00

(10) AU 2010 11590 U (44) 11(303)/2010

(21) AU 2009 011590

(22) 2009 12 08

(24) 2009 12 08

(73) Shalva Elizbarashvili (GE)
 Tamarashvilis k. 11, b.111, 0162,
 Tbilisi (GE);

(72) Shalva Elizbarashvili (GE)

(54) **METHOD OF GEODETIC SURVEY**

(11) U 2010 1632 Y (51) Int. Cl. (2006)
 G 01 C 11/00

(10) AU 2010 11590 U (44) 11(303)/2010

(21) AU 2009 011590

(22) 2009 12 08

(24) 2009 12 08

(73) Шалва Элизбарашвили (GE)

INDUSTRIAL DESIGNS

ПРОМЫШЛЕННЫЕ ОБРАЗЦЫ

APPLICATIONS LAID OPEN FOR THE PURPOSE OF TAKING PATENT GRANTING DECISIONS

ЗАЯВКИ, ПО КОТОРЫМ ВЫНЕСЕНЫ РЕШЕНИЯ О ВЫДАЧЕ ПАТЕНТОВ

To appeal a decision is possible at Chamber of Appeal of Sakpatenti within 3 months from the publication or at The Board of Administrative Actions of Tbilisi City Court within a 1 month period. (Address: 12 km., №6, David Aghmashenebeli Kheivani, Tbilisi).

Обжалование решения возможно в Апелляционной палате Сакпатенти в течение 3 месяцев с даты его публикации или в течение 1 месяца в Коллегии по административным делам Тбилисского городского суда (г. Тбилиси, Аллея Давида Агмашенебели 12-й км., №6).

(10) AD 2010 602 S **(51) 06-01**
(21) AD 2010 000602 (22) 2010 05 13
(28) 1
(71) Paata Benidze (GE)
Gotsiridzis k. 22, 0102, Tbilisi (GE)
(72) Paata Benidze (GE)
(54) **ARMCHAIR**

(10) AD 2010 602 S **(51) 06-01**
(21) AD 2010 000602 (22) 2010 05 13
(28) 1
(71) Паата Бенидзе (GE)
(72) Паата Бенидзе (GE)
(54) **КРЕСЛО**
(55)



1.1



1.2



1.3



1.4

(54) FURNITURE
(55)

(10) AD 2010 596 S **(51) 06-02,03,04,05**
(21) AD 2010 000596 (22) 2010 03 26
(28) 78
(71) ООО „ЭМБАВУД ДЖОРДЖИЯ“ (GE)
(72) Шамшадин Рустамов (GE)
(54) **МЕБЕЛЬ**
(55)



1



2



3



4

(10) AD 2010 596 S **(51) 06-02,03,04,05**
(21) AD 2010 000596 (22) 2010 03 26
(28) 78
(71) Shps „EMBAWOOD GEORGIA“ (GE)
Marneulis q. n37, 0165, Tbilisi (GE)
(72) Shamshadin Rustamov (GE)





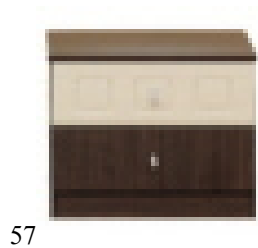

59

60

67

68



69

70

61

62



71

72



63

64



73

74



75

76



77

78



(10) AD 2010 610 S (51) 07-06
 (21) AD 2010 000610 (22) 2010 06 21
 (28) 36
 (71) Andro Tavartkiladze (GE)
 Sairmis k. 45, 0194, Tbilisi (GE)
 (72) Andro Tavartkiladze (GE)
 (54) STIRRING ROD

(10) AD 2010 610 S (51) 07-06
 (21) AD 2010 000610 (22) 2010 06 21
 (28) 36
 (71) Андро Таварткиладзе (GE)
 (72) Андро Таварткиладзе (GE)
 (54) МЕШАЛКА
 (55)

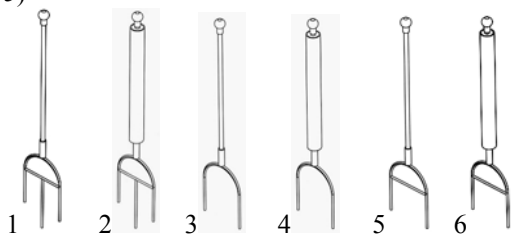

1

2

3

4

5

6

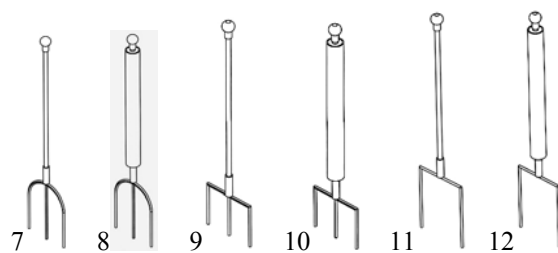

7

8

9

10

11

12

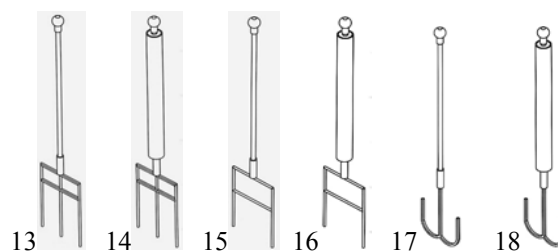

13

14

15

16

17

18

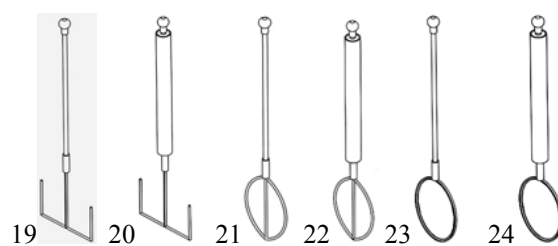

19

20

21

22

23

24

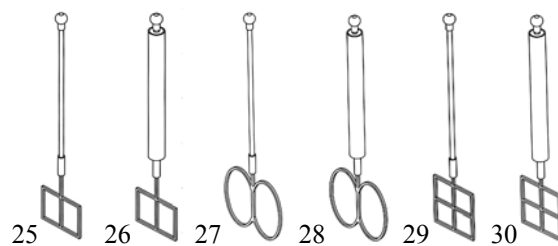

25

26

27

28

29

30

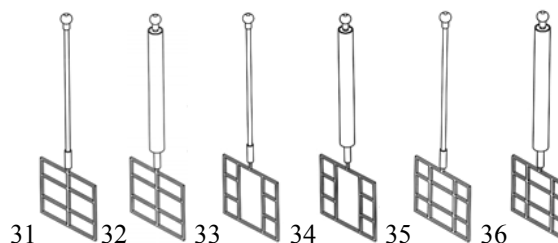

31

32

33

34

35

36

(10) AD 2010 611 S (51) 09-01
 (21) AD 2010 000611 (22) 2010 06 22
 (28) 4
 (71) Gia Obolashvili (GE)
 Vazha Pshavelasgamz. 1, korp. 3, b. 36,
 0160, Tbilisi (GE)
 (72) Gia Obolashvili (GE)
 (54) BOTTLE

(10) AD 2010 611 S (51) 09-01
 (21) AD 2010 000611 (22) 2010 06 22
 (28) 4
 (71) Гия Оболашвили (GE)

(72) Гия Оболашвили (GE)

(54) **БУТЫЛЬ**

(55)

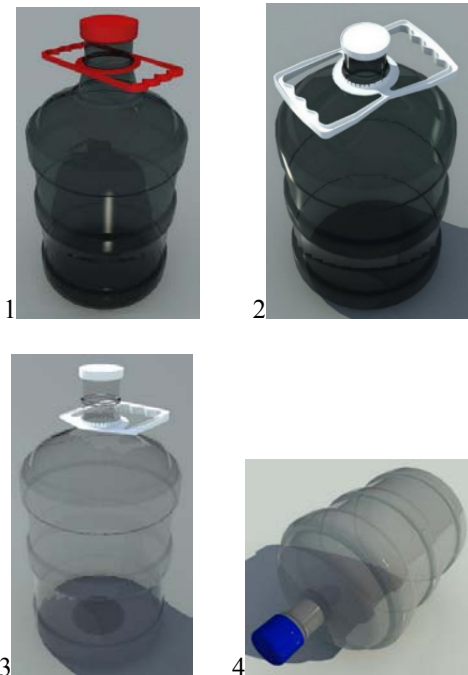

(10) AD 2010 607 S

(51) 25-02

(21) AD 2010 000607

(22) 2010 05 25

(28) 1

(71) Nodar Gvaramadze (GE)

sop. Mukhrani, 3309, Mtskheta (GE)

(72) Nodar Gvaramadze (GE)

(54) **BUILDING BLOCK ELEMENT**

(10) AD 2010 607 S

(51) 25-02

(21) AD 2010 000607

(22) 2010 05 25

(28) 1

(71) Нодар Гварамадзе (GE)

(72) Нодар Гварамадзе (GE)

(54) **СТЕНОВОЙ СТРОИТЕЛЬНЫЙ ЭЛЕМЕНТ**

(55)



**INDUSTRIAL DESIGNS, WHICH HAVE BEEN REGISTERED WITH THE
INTERNATIONAL BUREAU IN ACCORDANCE WITH THE ACT OF HAGUE
AGREEMENT OF 1960 AND/OR ACT OF GENEVA AGREEMENT CLAIMING
PRIORITY ON THE TERRITORY OF GEORGIA**

ПРОМЫШЛЕННЫЕ ОБРАЗЦЫ, КОТОРЫЕ ЗАРЕГИСТРИРОВАНЫ В МЕЖДУНАРОДНОМ
БЮРО В СООТВЕТСТВИИ С АКТОМ ГААГСКОГО СОГЛАШЕНИЯ 1960 Г.
И/ИЛИ АКТОМ ЖЕНЕВСКОГО СОГЛАШЕНИЯ С ИСТРЕБОВАНИЕМ ПРИОРИТЕТА
НА ТЕРРИТОРИИ ГРУЗИИ

(11) DM/069653 (51) Cl. 12-08
(15) 2008 01 21
(45) 2009/12 (2010 01 31)
(22) 2008 01 21
(28) 1
(30) 24.07.2007; 407 03 734.9; DE
(73) DAIMLER AG Mercedesstrasse 137, 70327
Stuttgart (DE)
(86) DE,EM
(87) DE,EM
(88) DE,EM
(89) EM

(81) III. CH, GE, MD, MK, TR.
(72) 1. Peter Pfeiffer, Dipl. -Designer, Peterstaler
Strasse 32, D-71034 Boeblingen; 2. Karlheinz
Bauer, Dipl.-Designer, Kastanienweg 52, D-73732
Esslingen; 3. Jürgen Bollmann, Dipl.-Designer,
Neckarstrasse 24, D-70569 Schoenberg; 4. Gorden
Wagener, Designer, Gentle breeze, 6, CA 92657,
California, USA
(54) Vehicle
(55)



(11) DM/069654 (51) Cl. 21-01
(15) 2008 01 21
(45) 2009/12 (2010 01 31)
(22) 2008 01 21
(28) 1
(30) 24.07.2007; 407 03 734.9; DE
(73) DAIMLER AG Mercedesstrasse 137, 70327
Stuttgart (DE)
(86) DE,EM
(87) DE,EM
(88) DE,EM
(89) EM

(81) III. CH, GE, MD, MK, TR.
(72) 1. Peter Pfeiffer, Dipl. -Designer, Peterstaler
Strasse 32, D-71034 Boeblingen;
2. Karlheinz Bauer, Dipl.-Designer, Kastanienweg
52, D-73732 Esslingen;
3. Jürgen Bollmann, Dipl.-Designer, Neckarstrasse
24, D-70569 Schoenberg;
4. Gorden Wagener, Designer, Gentle breeze, 6,
CA 92657, California, USA
(54) Toy
(55)



(11) DM/072151 (51) Cl. 09-01
(15) 2009 07 30
(45) 2009/12 (2010 01 31)
(22) 2009 07 02
(28) 1
(73) BEAUTE PRESTIGE INTERNATIONAL
28-32, avenue Victor Hugo, F-75116
PARIS (FR)

(86) FR,EM
(87) FR,EM
(89) FR
(81) I. ID, TN. II. MA, ME, RS. III. BA, CH, EG,
GE, HR, IS, SG, TR, UA. (30) 07.01.2009;
001066641; EM
(72) Arik Lévy, L design, 29 rue des Panoyaux,
F-75020 Paris
(54) 1. Flask
(55)





(11) DM/072278 (51) 10-07
 (15) 2009 09 08
 (45) 2010/02 (2010 03 31)
 (22) 2009 09 08
 (28) 3
 (30) 20.03.2009; 135963; CH
 (73) DE GRISOGONSA 176bis route de Saint Julien, CH-1228 Plan-les-Ouates (CH)
 (85) CH
 (86) CH
 (87) CH
 (88) CH
 (89) CH
 (81) I. ID, TN. II. MA, MC. III. EG, EM, GE, OM, SG, TR, UA
 (72) Fawaz GRUOSI "Les Mélézes" Chemin de Trembley, 30 CH-1997 PRANGINS SWITZERLAND
 (54) 1.-3. Watch dials
 (55)

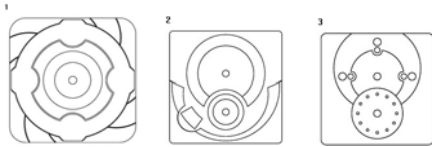

(11) DM/072290 (51) 20-02
 (15) 2009 09 17
 (45) 2010/02 (2010 03 31)
 (22) 2009 09 17
 (28) 4
 (73) FRITZ EGGER GMBH & CO. OG Tiroler Straße 16, A-3105 Unterradlberg (AT)
 (86) EM
 (87) EM
 (88) EM
 (89) EM
 (81) III. CH, EM, GE, TR, UA
 (54) 1.-4. Colour and structure selection wheels
 (55)

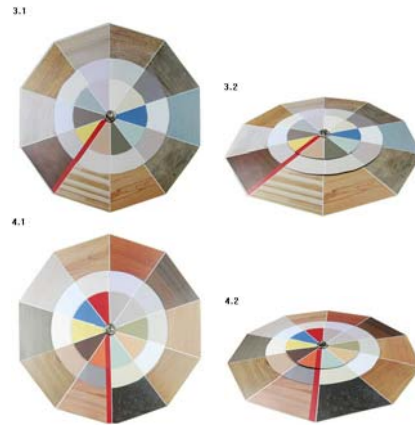
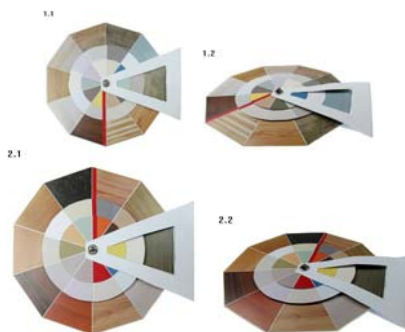

(11) DM/072330 (51) 10-07
 (15) 2009 09 11
 (45) 2010/02 (2010 03 31)
 (22) 2009 09 11
 (28) 2
 (30) 13.03.2009; 135924; CH
 (73) ROLEX SA Rue François-Dussaud 3-5-7, CH-1211 Genève 24 (CH)
 (85) CH
 (86) CH
 (87) CH
 (88) CH
 (89) CH
 (81) I. AN, ID, TN. II. BZ, KP, MA, MC, ME, RS, SR. III. AL, AM, BA, BW, EG, EM, GE, GH, HR, IS, KG, LI, MD, MK, MN, NA, OA, OM, SG, ST, SY, TR, UA.
 (72) Maria Cristina CALVANI 12, chemin David Munier 1223 COLOGNY SUISSE
 (54) 1.-2. Dials
 (55)

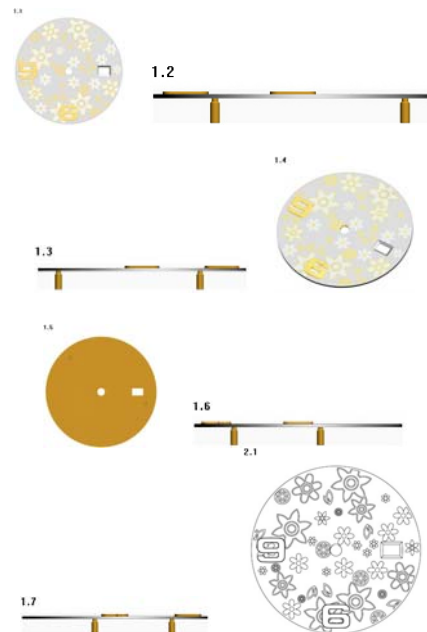

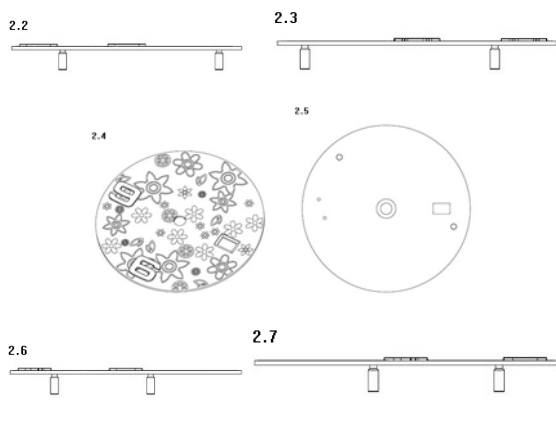

(11) DM/072430 (51) 14-02, 03
 (15) 2009 09 17
 (45) 2010/02 (2010 03 31)
 (22) 2009 05 22
 (28) 29
 (30) N28: 11.05.2009; 001508052; EM, N9:
 24.12.2008; 29/329979; US; N7, 8: 16.02.2009;
 29/322438; US; N3, 4: 18.02.2009; 29/322500; US;
 N2: 18.02.2009; 29/322501; US; N1: 18.02.2009;
 29/332503; US; N6: 06.03.2009; 29/333350; US;
 N5: 13.03.2009; 29/333726; US; N10: 18.03.2009;
 29/333965; US; N11: 18.03.2009; 29/333967; US;
 N20: 20.03.2009; 29/334126; US; N18:
 20.03.2009; 29/334128; US; N29: 20.03.2009;
 29/334129; US; N19: 20.03.2009; 29/334130; US;
 N12: 20.03.2009; 29/334156; US; N13:
 20.03.2009; 29/334157; US; N15: 20.03.2009;
 29/334158; US; N21: 23.03.2009; 29/334213; US;
 N14: 24.03.2009; 29/334318; US; N16, 17:
 24.03.2009; 29/334336; US; N22: 25.03.2009;
 29/334348; US; N27: 31.03.2009; 29/334709; US;
 N25: 31.03.2009; 29/334711; US; N26:
 31.03.2009; 29/334713; US; N23, 24: 31.03.2009;
 29/334733; US

(73) NOKIA CORPORATION Keilalahdentie 4,
 FI-02150 Espoo (FI)

(85) EM

(86) EM

(87) EM

(88) EM

(89) EM

(81) III. AL, AM, BW, CH, EG, GE, HR, IS, LI,
 MK, MN, NA, SG, SY, TR, UA.

(72) Designs 1-4: Designer 1) Crispian Tompkin,
 11960 Iowa Avenue, Apartment N4, Los Angeles,
 CA 90025, USA; Designer 2) Forrest Luu, 219
 Saint Francis Street, Apt. 30, San Gabriel, CA
 91776, USA; Design 5: Hang Liu, Jiang Fu Ji Yuan
 109-1701, Chaoyang District, Beijing 100016, CN;
 Design 6: Designer 1) Anton Fahlgren, Nordre
 Frihavnsgade 28, DK-2100 Copenhagen; Designer
 2) Thomas Christiansen, Arhusgade 88, DK-2100
 København Ø; Designs 7-8: Designer 1) Esa

Petteri Nousiainen, Hagelstamintie 10 B 4, FI-
 01512 Vantaa; Designer 2) Jussi Hämäläinen,
 Joensuukatu 7, FI-24100 Salo; Designs 9-10:
 Hang Liu, Jiang Fu Ji Yuan 109-1701, Chaoyang
 District, Beijing 100016, CN; Designs 13-16:
 Designer 1) Eduardo Salazar, 19355 Sherman Way
 N 42, Reseda, CA 91335, USA; Designer 2) Frank
 Nuovo, 1612 Stradella Road, Los Angeles, CA
 90077, USA; Designs 17-21: Designer 1) Joel
 Bridge, Flat 4 Cascades Court, 13-19 Hartfield
 Crescent, Wimbledon, London SW19 3RL, GB;
 Designer 2) Frank Nuovo, 1612 Stradella Road,
 Los Angeles, CA 90077, USA; Design 22: Sally
 Turner, Flat 48, St. Mary's Mansions, St. Mary's
 Terrace, London W2 1SH, GB; Design 23: Yao
 Shao-Pearl Chen, No. 10, Jingcheng 11th St., West
 District, Taichung City 403, Taiwan; Designs 24-
 25: Wen-Yo Lu, 915 South Marguerita Avenue,
 Apt. A, Alhambra, CA 91803-2111, USA; Designs
 26-28: Per Brickstad, Keilalahdentie 2-4, FI-02150
 Espoo; Design 29: Designer 1) Hang Liu, Jiang Fu
 Ji Yuan 109-1701, Chaoyang District, Beijing
 100016, CN; Designer 2) Xiaoming Qiang, Beijing
 Economic & Technological Development Area,
 Building 2, No. 5 DongHuan Zhong Road, 100176,
 CN

(54) 1-5. Handsets; 6. Handset front cover; 7-8.
 Speaker units; 9-13. Handsets; 14. Handset rear
 cover; 15. Handset keypad; 16-19. Handsets; 20.
 Clip for a headset; 21-24. Handsets; 25-26.
 Handsets; 27. Headset earpiece; 28.
 Handset; 29. Memory card reader

(55)

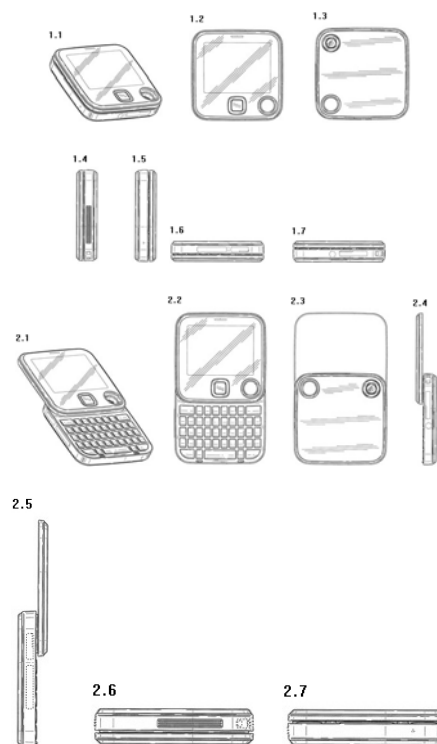

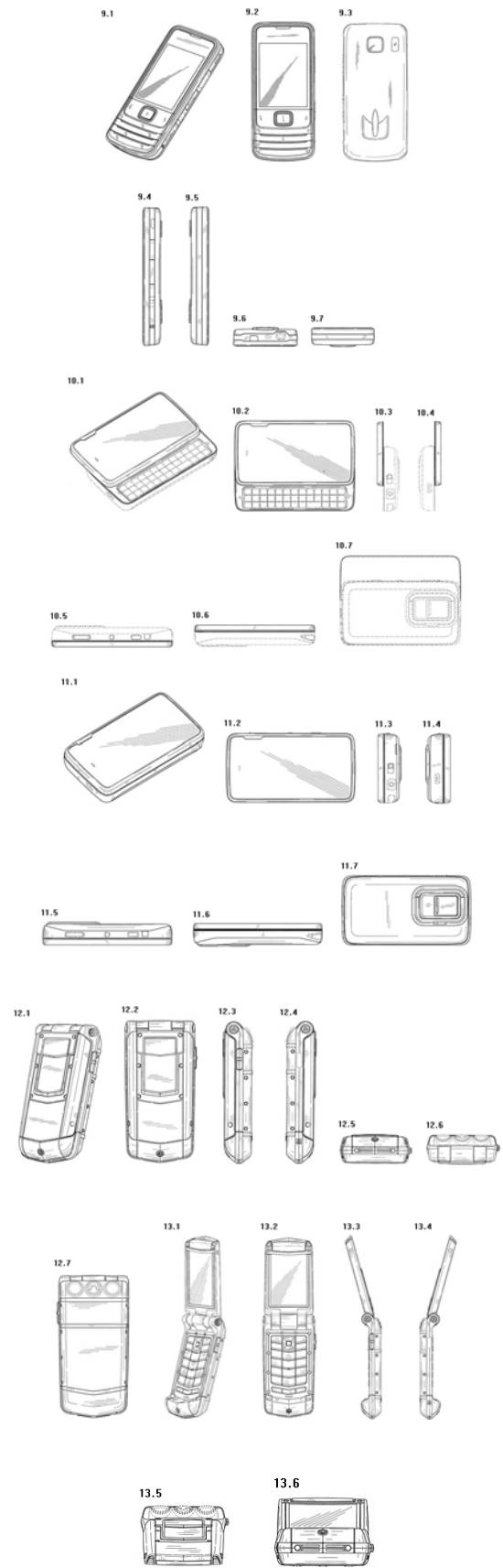
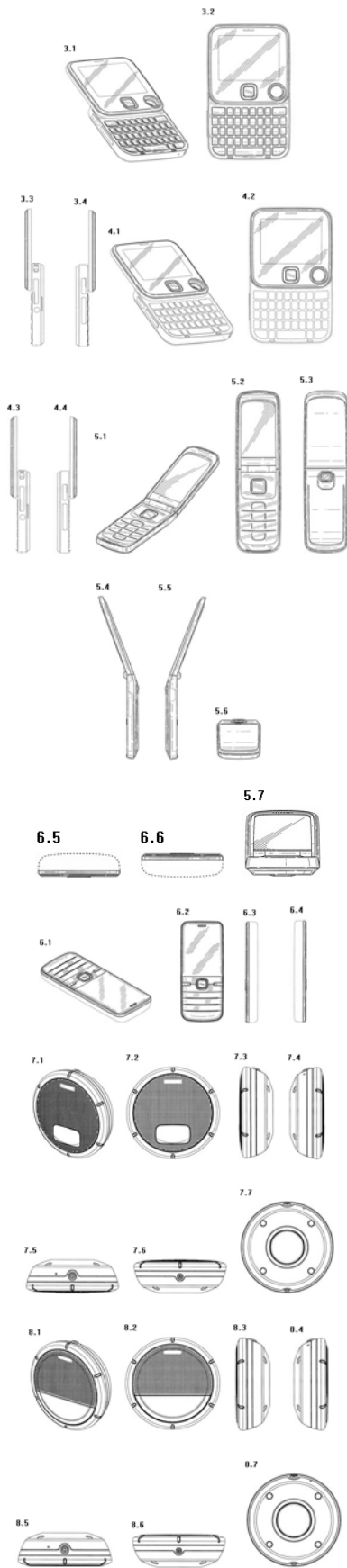

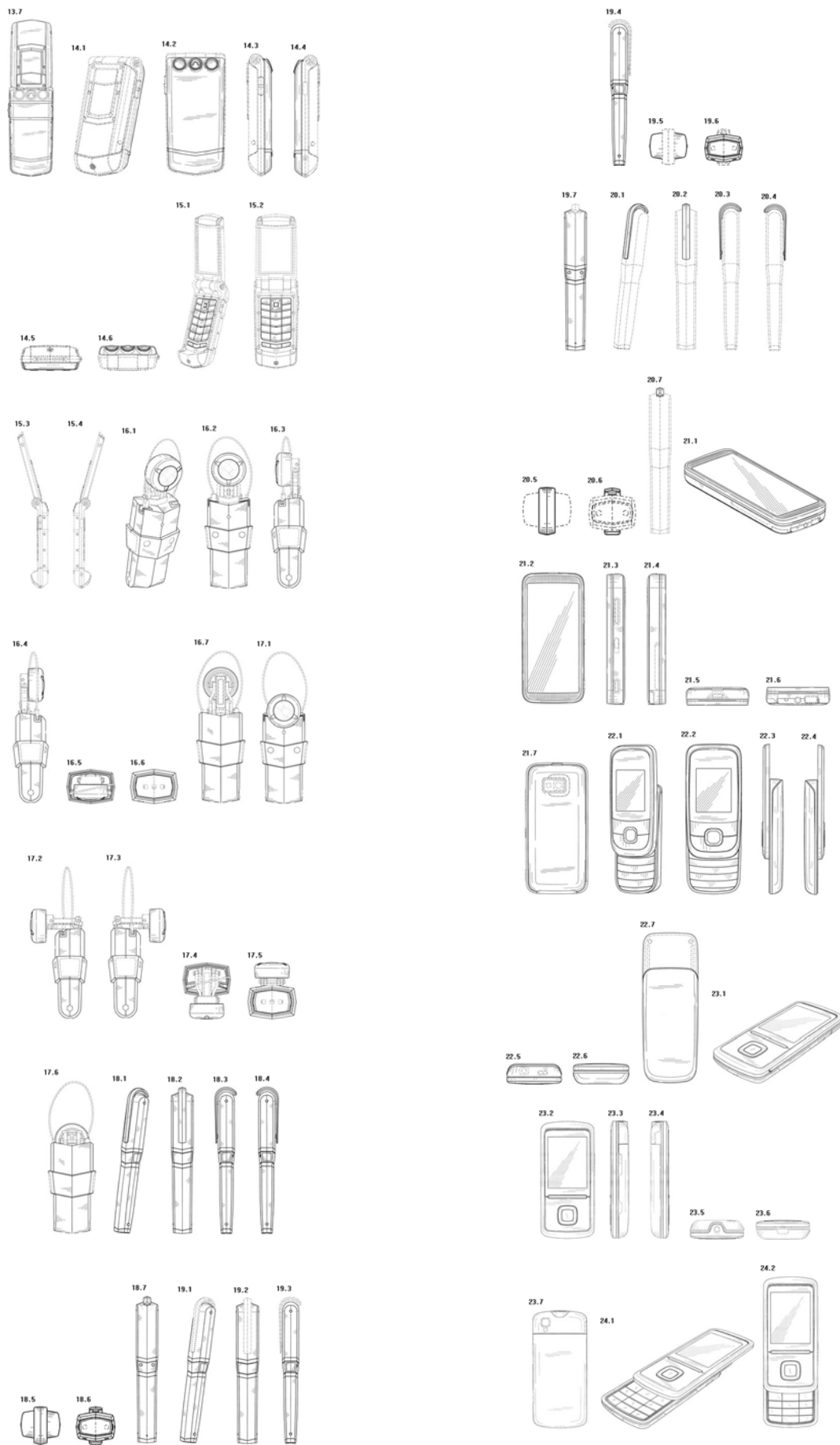

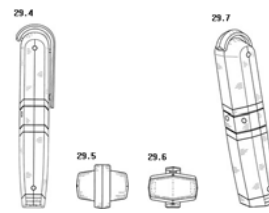
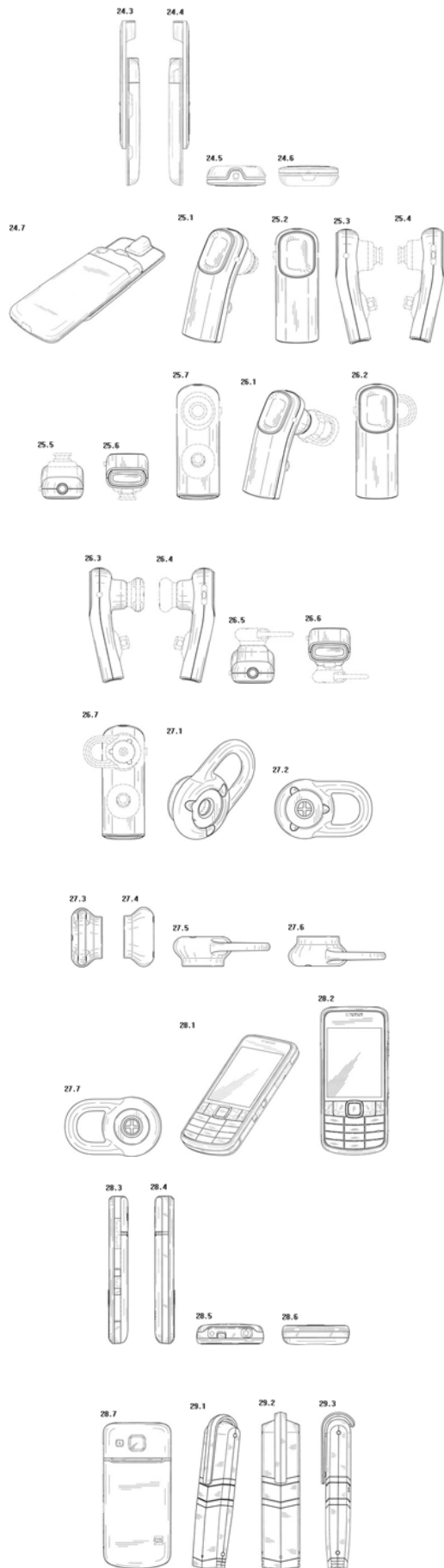

(11) DM/072484 (51) 10-02
 (15) 2009 09 16
 (45) 2010/02 (2010 03 31)
 (22) 2009 06 11
 (28) 3
 (73) MAISON ELOGA HORLOGERIE ET
 BIJOUTERIE SàRL Rue du Grenier 18, CH-2302
 La Chaux-de-Fonds (CH)
 (85) CH
 (86) CH
 (87) CH
 (88) CH
 (89) CH
 (81) I. TN. II. MA, MC. III. CH, EM, GE, HR, SG,
 SY, TR, UA
 (54) 1. Chronograph; 2.-3. Wristwatches
 (55)

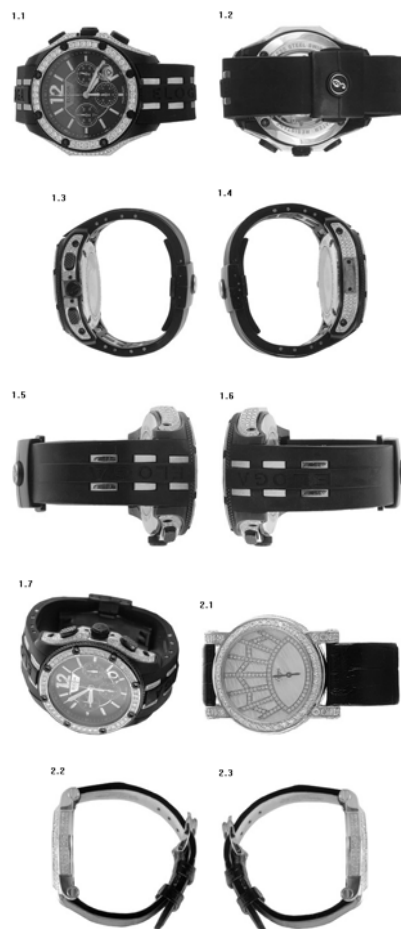



(11) DM/072535 (51) 09-01
 (15) 2009 11 05
 (45) 2010/04 (2010 05 31)
 (22) 2009 11 05
 (28) 2
 (73) KRÜGER GMBH & CO. KG Senefelderstraße
 44, 51469 Bergisch Gladbach (DE)
 (85) EM
 (86) DE,EM
 (87) DE,EM
 (88) DE,EM
 (81) I. TN. II. KP, MA, MC, ME, RS. III. CH, EG,
 EM, GE, HR, KG, LI, MD, MK, TR, UA
 (54) 1.-2. Packagings for foodstuffs
 (55)

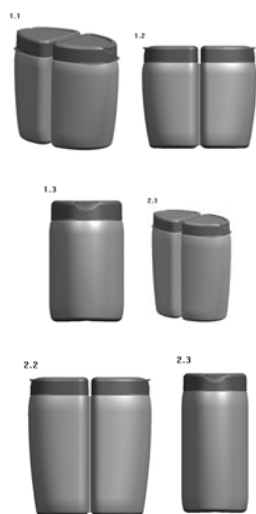

(11) DM/072537 (51) 25-02
 (15) 2009 11 11
 (45) 2010/04 (2010 05 31)
 (22) 2009 11 11
 (28) 1
 (30) 15.05.2009; 1138226; EM
 (73) RAUMPLUS GMBH & CO. KG Dortmunder
 Str. 35, 28199 Bremen (DE)
 (85) DE
 (86) DE,EM

(87) DE,EM
 (88) DE,EM
 (81) I. ID. II. RS. III. BA, CH, EG, GE, KG, MD,
 MK, SG, UA.
 (72) Carsten Bergmann, Dortmunder Strasse 35,
 28199 Bremen
 (54) 1. Part of a door
 (55)

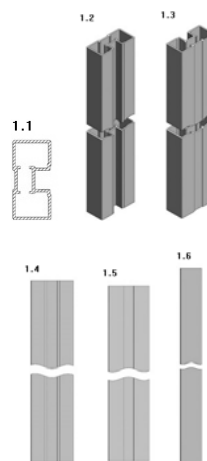

(11) DM/072636 (51) Cl. 10-02
 (15) 2009 11 09
 (45) 2009/12 (2010 01 31)
 (22) 2009 11 09
 (28) 1
 (73) SWATCH AG (SWATCH SA)
 (SWATCH LTD.) Jakob-Stämpfli-Strasse 94,
 CH-2502 Biel/Bienne (CH)
 (85) CH
 (86) CH
 (87) CH
 (88) CH
 (89) CH
 (81) I. AN, ID, TN. II. BZ, MA, MC, ME. III. AL,
 AM, CH, EG, EM, GE, HR, KG, LI, MD, MK,
 MN, OM, SG, TR, UA
 (72) Andrea ARRIGONI, SWATCHLAB,
 Via Archimede 6, IT-20129 MILANO
 (54) Wristwatch
 (55)



(11) DM/072668 (51) Cl. 10-07

(15) 2009 11 25

(45) 2009/12 (2010 01 31)

(22) 2009 11 25

(28) 1

(73) THE SWATCH GROUP MANAGEMENT SERVICES AG (THE SWATCH GROUP MANAGEMENT SERVICES SA)

(THE SWATCH GROUP MANAGEMENT SERVICES LTD.) Seevorstadt 6,

CH-2502 Bienne (CH)

(85) CH

(86) CH

(87) CH

(88) CH

(89) CH

(81) I. AN, ID, TN. II. BZ, MA, MC, ME. III. AL, AM, CH, EG, EM, GE, HR, KG, LI, MD, MK, MN, OM, SG, TR, UA

(72) Sébastien PERRET, Etude de Style, Hôtel des Postes, P.O.Box 2208, CH-2000 NEUCHÂTEL/NE

(54) Watch case

(55)

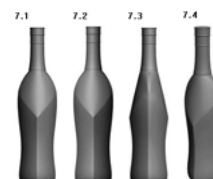
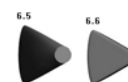
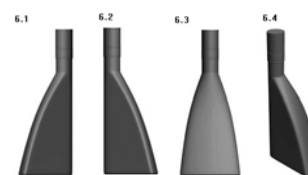
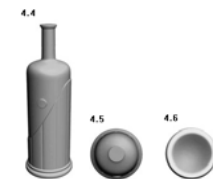
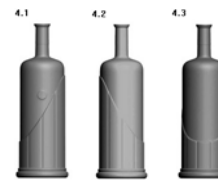
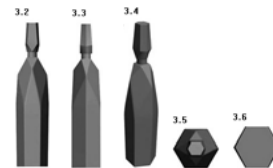
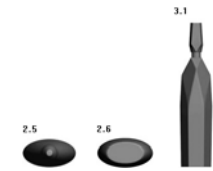
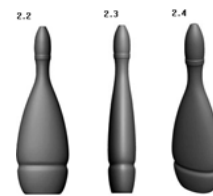

(11) DM/072679 (51) Cl. 09-01

(15) 2009 12 08

(45) 2009/12 (2010 01 31)

(22) 2009 11 06

(28) 9

(73) DOMAINE DES BROIX S.A.S. Les Broix, F-16120 TOUZAC (FR)

(85) FR,EM

(86) FR,EM

(87) FR,EM

(88) FR,EM

(89) FR

(81) I. ID. II. MC, ME. III. AL, AM, CH, EM, GE, HR, IS, KG, MD, MN, TR, UA

(72) Philippe SEYS, 279 rue Vaugirard,

F-75015 PARIS

(54) 1.-9. Bottles

(55)

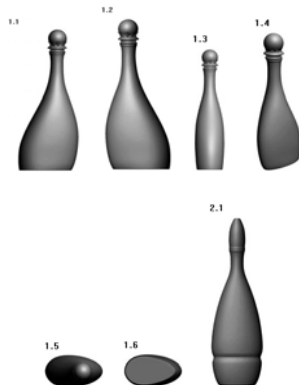

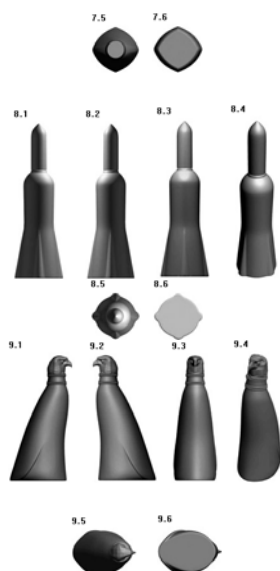

(11) DM/072681 (51) Cl. 09-05
 (15) 2009 11 23
 (45) 2009/12 (2010 01 31)
 (22) 2009 11 23
 (28) 1
 (73) RUDIGER CRUYBERGHS
 Haachtsesteenweg 1369, B-1130 BRUSSELS
 (HAREN) (BE)
 (85) EM
 (86) BX,EM
 (87) BX,EM
 (88) BX,EM
 (89) EM
 (81) II. BJ, BX, BZ, CI, DE, GA, GR, IT, KP, MA,
 MC, ME, ML, NE, RS, SN, SR. III. AL, AM, BA,
 BG, BW, CH, DK, EE, EG, EM, ES, FR, GE, GH,
 HR, HU, IS, KG, LI, LT, LV, MD, MK, MN, NA,
 OA, OM, PL, RO, SG, SI, ST, SY, TR, UA
 (72) Rudiger Cruysberghs, 1369 Haachtsesteenweg,
 B-1130 Brussels (Haren)
 (54) 1. Packaging for liquids and viscous products
 (55)



(11) DM/072782 (51) Cl. 10-02
 (15) 2009 12 09
 (45) 2009/12 (2010 01 31)
 (22) 2009 12 09
 (28) 2
 (73) SWATCH AG (SWATCH SA)
 (SWATCH LTD) Jakob-Stämpfli-Strasse 94,
 CH-2502 BIEL/BIENNE (CH)
 (85) CH
 (86) CH

(87) CH
 (88) CH
 (89) CH
 (81) I. AN, ID, TN. II. BZ, MA, MC, ME. III. AL,
 AM, CH, EM, GE, HR, KG, LI, MD, MK, MN,
 OM, SG, TR, UA
 (72) No. 1) Francesca ERRANI, SWATCHLAB,
 Via Archimede 6, IT-20129 MILANO; No.
 2) Danilo SALA, SWATCHLAB,
 Via Archimede 6, IT-20129 MILANO
 (54) 1.-2. Wristwatches
 (55)



(11) DM/072783 (51) Cl. 10-02
 (15) 2009 12 09
 (45) 2009/12 (2010 01 31)
 (22) 2009 12 09
 (28) 1
 (73) SWATCH AG (SWATCH SA)
 (SWATCH LTD) Jakob-Stämpfli-Strasse 94,
 CH-2502 BIEL/BIENNE (CH)
 (85) CH
 (86) CH
 (87) CH
 (88) CH
 (89) CH
 (81) I. AN, ID, TN. II. BZ, MA, MC, ME. III. AL,
 AM, CH, EG, EM, GE, HR, KG, LI, MD, MK,
 MN, OM, SG, TR, UA
 (72) Thomas MISCHLER, Neubrückestrasse 45,
 CH-3012 BERN
 (54) Wristwatch
 (55)



(11) DM/072789 (51) Cl. 10-02
 (15) 2009 12 16
 (45) 2009/12 (2010 01 31)
 (22) 2009 12 16
 (28) 1
 (73) SWATCH AG (SWATCH SA)
 (SWATCH LTD.) Jakob-Stämpfli-Strasse 94,
 CH-2502 Biel/Bienne (CH)
 (85) CH
 (86) CH
 (87) CH
 (88) CH
 (89) CH
 (81) I. AN, ID, TN. II. BZ, MA, MC, ME. III. AL,
 AM, CH, EG, EM, GE, HR, KG, LI, MD, MK,
 MN, OM, SG, TR, UA
 (72) Andrea ARRIGONI, SWATCHLAB,
 Via Archimede 6, IT-20129 MILANO
 (54) Wristwatch
 (55)



(11) DM/072794 (51) 10-02
 (15) 2009 12 21
 (45) 2009/12 (2010 01 31)
 (22) 2009 12 21
 (28) 11
 (73) ETA SA MANUFACTURE HORLOGERE
 SUISSE CH-2540 GRENCHEN (CH)
 (85) CH
 (86) CH
 (87) CH
 (88) CH
 (89) CH
 (81) I. AN, ID, TN. II. BZ, MA, MC, ME. III. AL,
 AM, CH, EM, GE, HR, KG, LI, MD, MK, MN,
 OM, SG, TR, UA
 (72) 1), 8), 9): Philippe MOSER, 56,
 Avenue Lignon, CH-1256 GENEVE; 2), 4), 6):
 Michaela KOCH, Albrecht-Achilles-Strasse 2,
 DE-10709 BERLIN; 5), 10): Katia DE CONTI, 48,
 avenue de THONEX, CH-1226 THONEX;
 7) Véronique STOLL, Chemin de la Marnière 14A,
 CH-2504 BIEL/BIENNE; 11) Robin NYFELE:
 Sur Savagnier 57, CH-2067 CHAUMONT

(54) 1.-11. Wristwatches



(11) DM/072800 (51) 15-05
 (15) 2009 09 09
 (45) 2010/04 (2010 05 31)
 (22) 2009 09 09
 (28) 2
 (30) 07.05.2009; DM/071808; WO
 (73) ALFRED KÄRCHER GMBH & CO. KG
 Alfred-Kärcher-Str. 28-40, 71364 Winnenden (DE)
 (85) EM
 (86) DE
 (87) DE
 (88) DE
 (81) II. KP, MA, MC, ME. III. BA, EG, GE, HR,
 LI, MD, MK, MN, OM, TR.
 (54) 1.-2. Vacuum cleaners
 (55)

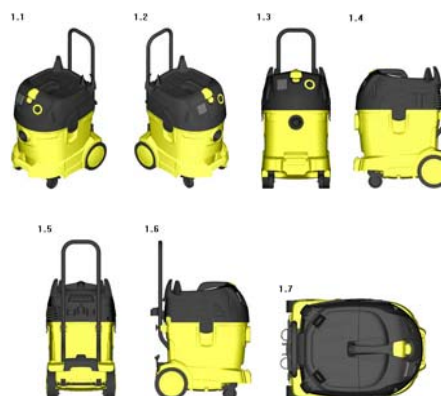

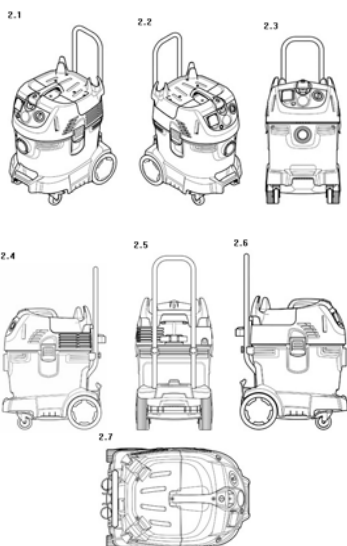

(11) DM/072878 (51) 10-02
 (15) 2010 01 08
 (45) 2010/04 (2010 05 31)
 (22) 2010 01 08
 (28) 1
 (73) SWATCH AG (SWATCH SA)
 (SWATCH LTD) Jakob-Stämpfli-Strasse 94,
 CH-2502 BIEL/BIENNE (CH)
 (85) CH
 (86) CH
 (87) CH
 (88) CH
 (81) II. BZ, MA, MC, ME. III. AL, AM, CH, EG,
 EM, GE, HR, KG, LI, MD, MK, MN, OM, SG,
 TR, UA
 (72) Danilo SALA, SWATCHLAB, Via Archimede
 6, IT-20129 MILANO
 (54) Wristwatch
 (55)



(11) DM/072924 (51) 14-01, 02, 03
 (15) 2009 09 04
 (45) 2010/02 (2010 03 31)

(22) 2009 09 04
 (28) 11
 (30) N3: 06.03.2009; 29/333351; US; N6:
 24.04.2009; 29/335917; US; N4: 12.05.2009;
 29/336936; US; N5: 12.05.2009; 29/336940; US;
 N7, 8: 14.07.2009; 29/340114; US; N9, 10:
 15.07.2009; 29/340232; US
 (73) NOKIA CORPORATION Keilalahdentie 4,
 FI-02150 Espoo (FI)
 (85) EM
 (86) EM
 (87) EM
 (88) EM
 (89) EM
 (81) III. AL, AM, BW, CH, EG, GE, HR, IS, LI,
 MK, MN, NA, SG, SY, TR, UA.
 (72) Designs 1-2: Thomas EATON, Saltbox, The
 Camp, Stroud, Gloucestershire GL6 7EU, GB;
 Design 3: Esa NOUSIAINEN, Hagelstamintie 10 B
 4, FI-01520 Vantaa; Designs 4-5: Designer 1)
 Thomas ARBISI, 791 Danver Circle, Newbury
 Park, CA 91320, USA; Designer 2) Duncan
 BURNS, 18645 Hatteras Street N203, Tarzana, CA
 91356, USA; Designer 3) Ian BUCKLE, 8 The
 Lodge, Glade Mews, Guildford, Surrey GU1 2EZ,
 GB; Design 6: WEI-JONES He, Chegongzhuang
 West Road 14, 311 Room, Beijing, CN; Designs 7-
 8: Nicolas LYLYK, Keilalahdentie 2-4, FI-02150
 Espoo; Design 9: Mikko AARRAS, Poutuntie 7 A
 1, FI-00400 Helsinki; Design 10: Lina LINER,
 Tarkk'ampujankatu 1 D 41, FI-00150 Helsinki;
 Design 11: Mikko AARRAS, Poutuntie 7 A 1, FI-
 00400 Helsinki
 (54) 1.-2, 6.-10. Handsets; 3. Headset; 4.-5.
 Netbooks; 11. Wireless receiver
 (55)

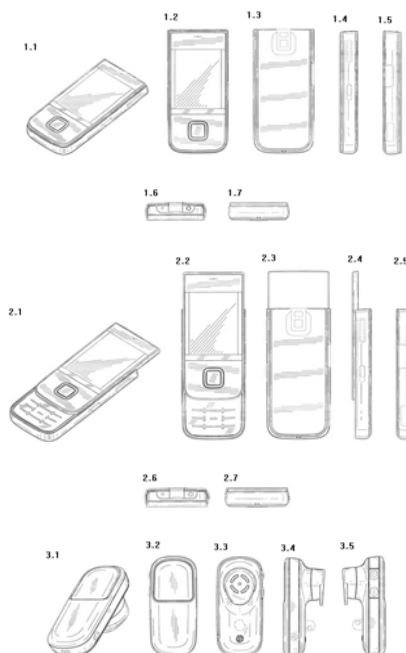

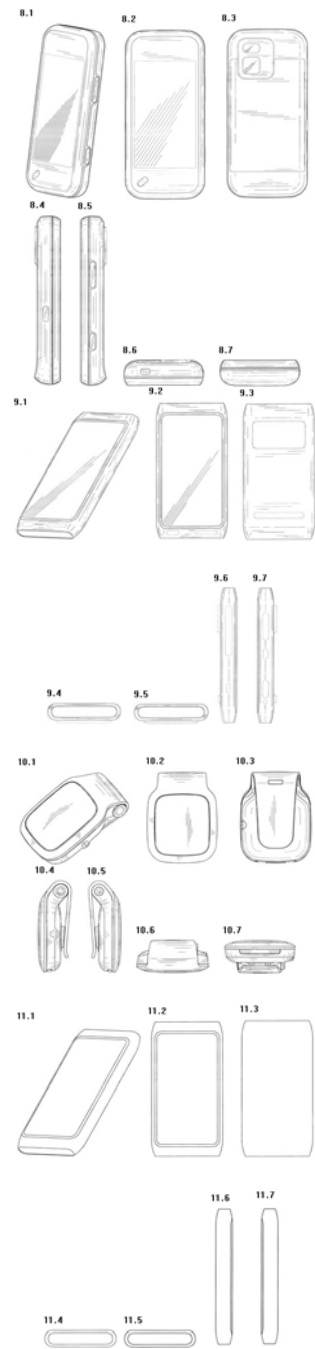
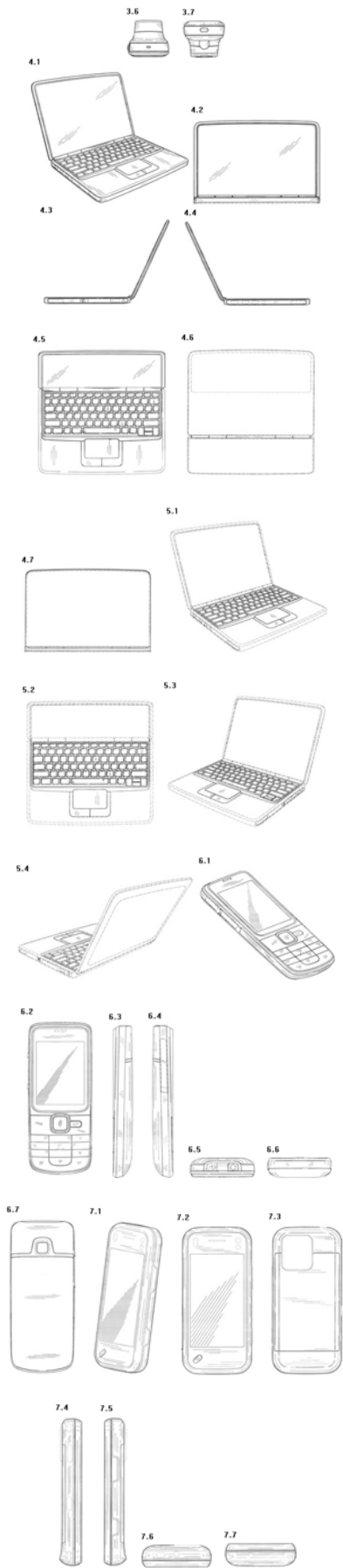

(11) DM/072979 (51) 10-02
 (15) 2010 01 22
 (45) 2010/02 (2010 03 31)
 (22) 2010 01 22
 (28) 1
 (73) RADO UHREN AG (RADO WATCH CO.LTD.) (MONTRES RADO SA) Bielstrasse 45, CH-2543 LENGNAU (CH)
 (85) CH
 (86) CH
 (87) CH
 (88) CH
 (89) CH

(81) II. BZ, MA, MC, ME. III. AL, AM, CH, EG, EM, GE, HR, KG, LI, MD, MK, MN, OM, SG, TR, UA

(72) Werner Scholpp, Elchendorffstrasse 29, 71739 Oberriexingen

(54) 1. Wristwatch

(55)

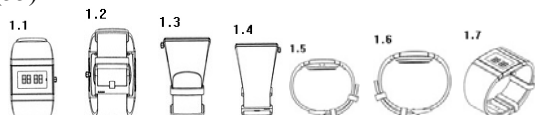

(11) DM/072996 (51) 10-02

(15) 2010 01 13

(45) 2010/02 (2010 03 31)

(22) 2010 01 13

(28) 1

(73) THE SWATCH GROUP MANAGEMENT SERVICES AG (THE SWATCH GROUP MANAGEMENT SERVICES SA)

(THE SWATCH GROUP MANAGEMENT SERVICES LTD.) Seevorstadt 6, CH-2502 BIEL/BIENNE (CH)

(85) CH

(86) CH

(87) CH

(88) CH

(89) CH

(81) II. BZ, MA, MC, ME. III. AL, AM, CH, EG, EM, GE, HR, KG, LI, MD, MK, MN, OM, SG, TR, UA

(72) Christian LATTMANN, Rue de la Jalousie 1, CH-1135 DENENS

(54) 1. Wristwatch

(55)



(11) DM/073000 (51) 10-02

(15) 2010 01 22

(45) 2010/02 (2010 03 31)

(22) 2010 01 22

(28) 1

(73) MONTRES BREGUET S.A.

CH-1344 L'ABBAYE (CH)

(85) CH

(86) CH

(87) CH

(88) CH

(89) CH

(81) II. BZ, MA, MC, ME. III. AL, AM, CH, EG, EM, GE, HR, KG, LI, MD, MK, MN, OM, SG, TR, UA

(72) Vincent LAUCELLA, Route de France 38, CH-1348 LE BRASSUS

(54) 1. Watch

(55)

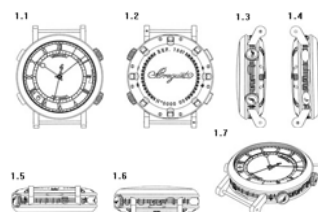

(11) DM/073002 (51) 10-02

(15) 2010 01 26

(45) 2010/02 (2010 03 31)

(22) 2010 01 26

(28) 2

(73) SWATCH AG (SWATCH SA)

(SWATCH LTD) Jakob-Stämpfli-Strasse 94, CH-2502 BIEL/BIENNE (CH)

(85) CH

(86) CH

(87) CH

(88) CH

(89) CH

(81) II. BZ, MA, MC, ME. III. AL, AM, CH, EM, GE, HR, KG, LI, MD, MK, MN, OM, SG, TR, UA

(72) N1. Francesca ERRANI, SWATCHLAB, Via Archimede 6, IT-20129 MILANO; N2.

Rossana BOFFI, SWATCHLAB, Rue St-Honoré 92-94, FR-75001 PARIS

(54) 1.-2. Wristwatches

(55)



(11) DM/073003 (51) 10-02
 (15) 2010 01 26
 (45) 2010/02 (2010 03 31)
 (22) 2010 01 26
 (28) 5
 (73) SWATCH AG (SWATCH SA)
 (SWATCH LTD) Jakob-Stämpfli-Strasse 94,
 CH-2502 BIEL/BIENNE (CH)
 (85) CH
 (86) CH
 (87) CH
 (88) CH
 (89) CH
 (81) II. BZ, MA, MC, ME. III. AL, AM, CH, EM,
 GE, HR, KG, LI, MD, MK, MN, OM, SG, TR, UA
 (72) Ly Thanh Le, Büro Destruct, Wasserweitegasse
 7, CH-3011 BERNE
 (54) 1.-5. Wristwatches
 (55)



(11) DM/073004 (51) 10-02
 (15) 2010 01 26
 (45) 2010/02 (2010 03 31)
 (22) 2010 01 26
 (28) 6
 (73) SWATCH AG (SWATCH SA)
 (SWATCH LTD) Jakob-Stämpfli-Strasse 94,
 CH-2502 BIEL/BIENNE (CH)
 (85) CH
 (86) CH
 (87) CH
 (88) CH
 (89) CH
 (81) II. BZ, MA, MC, ME. III. AL, AM, CH, EM,
 GE, HR, KG, LI, MD, MK, MN, OM, SG, TR, UA
 (72) N1 et 2: Keetra Dean DIXON, 641 East 9th
 Street 3A, 10009 NEW YORK (NY), USA; N3:
 Carri MUNDEN, CASSETTEPLAYA, Top Floor,
 37 Olhill Street, LONDON N16 6LR, GB; N4
 et 5: Claudia CARIERI, SWATCHLAB, Via
 Archimede 6, IT-20129, MILANO; N6: Adelina
 BISSOLO, SWATCHLAB, Via Archimede 6, IT-
 20129 MILANO
 (54) 1.-6. Wristwatches



(11) DM/073047 (51) 10-02
 (15) 2010 01 26
 (45) 2010/02 (2010 03 31)
 (22) 2010 01 26
 (28) 1
 (73) SWATCH AG (SWATCH SA)
 (SWATCH LTD) Jakob-Stämpfli-Strasse 94,
 CH-2502 BIEL/BIENNE (CH)
 (85) CH
 (86) CH
 (87) CH
 (88) CH
 (89) CH
 (81) II. BZ, MA, MC, ME. III. AL, AM, CH, EG,
 EM, GE, HR, KG, LI, MD, MK, MN, OM, SG,
 TR, UA
 (72) 1) Adelina BISSOLO, SWATCHLAB,
 Via Archimede 6, IT-20129 MILANO;
 2) Philippe AIRAUD, TSI DESIGN,
 Rue St-Honoré 92-94, F-75001
 (54) 1. Wristwatch
 (55)



(11) DM/073078 (51) 10-02
 (15) 2010 02 09
 (45) 2010/02 (2010 03 31)
 (22) 2010 02 09

(28) 5
 (73) SWATCH AG (SWATCH SA)
 (SWATCH LTD) Jakob-Stämpfli-Strasse 94,
 CH-2502 BIEL/BIENNE (CH)
 (85) CH
 (86) CH
 (87) CH
 (88) CH
 (89) CH

(81) II. BZ, MA, MC, ME. III. AL, AM, BA,
 CH, EM, GE, HR, KG, LI, MD, MK, MN,
 OM, SG, TR, UA
 (72) Modèle N1: Danilo SALA, SWATCHLAB,
 Via Archimede 6, IT-20129 MILANO; Modèle
 N2: Gianluca REDAELLI, SWATCHLAB,
 Via Archimede 6, IT-20129 MILANO;
 Modèle N3: Alessandra FORNARI,
 SWATCHLAB, Via Archimede 6, IT-20129
 MILANO; Modèles N4 et 5: Rossana BOFFI,
 SWATCHLAB, Via Archimede 6, IT-20129
 MILANO

(54) 1.-5. Wristwatches
 (55)



(11) DM/073079 (51) 11-01
 (15) 2010 02 09
 (45) 2010/02 (2010 03 31)
 (22) 2010 02 09
 (28) 3
 (73) THE SWATCH GROUP MANAGEMENT
 SERVICES AG (THE SWATCH GROUP
 MANAGEMENT SERVICES SA)
 (THE SWATCH GROUP MANAGEMENT
 SERVICES LTD.) Seevorstadt 6,
 CH-2501 BIEL/BIENNE (CH)
 (85) CH
 (86) CH
 (87) CH
 (88) CH
 (89) CH
 (81) II. BZ, MA, MC, ME. III. AL, AM, BA, CH,

EM, GE, HR, KG, LI, MD, MK, MN, OM, SG,
 TR, UA

(72) Arlette Elsa EMCH, Rue des Mornets 31,
 CH-2520 LA NEUVEVILLE

(54) Jewelry, particularly ring (1); earrings (2);
 necklace (3)

(55)

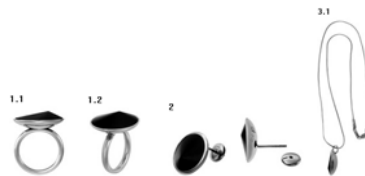

(11) DM/073090 (51) 10-02

(15) 2010 02 10

(45) 2010/02 (2010 03 31)

(22) 2010 02 10

(28) 2

(73) SWATCH AG (SWATCH SA)
 (SWATCH LTD) Jakob-Stämpfli-Strasse 94,
 CH-2502 BIEL/BIENNE (CH)

(85) CH

(86) CH

(87) CH

(88) CH

(89) CH

(81) II. BZ, MA, MC, ME. III. AL, AM, BA,
 CH, EM, GE, HR, KG, LI, MD, MK, MN,
 OM, SG, TR, UA

(72) Modèle N1: Rossana BOFFI, SWATCHLAB,
 Via Archimede 6, IT-20129 MILANO;

Modèle N2: Andrea ARRIGONI, SWATCHLAB,
 Via Archimede 6, IT-20129 MILANO

(54) 1.-2. Wristwatches

(55)



(11) DM/073091 (51) 10-02

(15) 2010 02 10

(45) 2010/02 (2010 03 31)

(22) 2010 02 10

(28) 2

(73) SWATCH AG (SWATCH SA)
(SWATCH LTD) Jakob-Stämpfli-Strasse 94,
CH-2502 BIEL/BIENNE (CH)

(85) CH
(86) CH
(87) CH
(88) CH
(89) CH

(81) II. BZ, MA, MC, ME. III. AL, AM, BA,
CH, EM, GE, HR, KG, LI, MD, MK, MN,
OM, SG, TR, UA

(72) Modèle N1: Adelina BISSOLO,
SWATCHLAB, Via Archimede 6, IT-20129
MILANO; Modèle N2: Ivan NAVARRO, 97
South 2nd. Street, BROOKLYN (NY) 11211,
USA

(54) 1.-2. Wristwatches
(55)



(11) DM/073092 (51) 10-02
(15) 2010 02 10
(45) 2010/02 (2010 03 31)
(22) 2010 02 10
(28) 8

(73) SWATCH AG (SWATCH SA)
(SWATCH LTD) Jakob-Stämpfli-Strasse 94,
CH-2502 BIEL/BIENNE (CH)

(85) CH
(86) CH
(87) CH
(88) CH
(89) CH

(81) II. BZ, MA, MC, ME. III. AL, AM, BA,
CH, EM, GE, HR, KG, LI, MD, MK, MN,
OM, SG, TR, UA

(72) Modèle N1: Rossana BOFFI, SWATCHLAB,
Via Archimede 6, IT-20129 MILANO;
Modèles N2 et 4: Lorenzo VALLONE,
SWATCHLAB, Via Archimede 6, IT-20129
MILANO; Modèle N3: Andrea ARRIGONI,
SWATCHLAB, Via Archimede 6,
IT-20129 MILANO; Modèles N5 et 6: Patrizio

VITA, SWATCHLAB, Via Archimede 6, IT-20129
MILANO; Modèles N7 et 8: Stéphane
AVRANCHES, BLADE DESIGN, Ch. du Pré
Fleuri 14, CH-1228 PLAN-LES-OUATES

(54) 1.-8. Wristwatches
(55)



(11) DM/073110 (51) 10-02, 07
(15) 2010 01 13
(45) 2010/02 (2010 03 31)
(22) 2010 01 13
(28) 6

(73) TIFFANY WATCH CO. LTD (MONTRES
TIFFANY SA) (TIFFANY UHREN AG)
Seevorstadt 6, CH-2502 BIEL/BIENNE (CH)

(85) CH
(86) CH
(87) CH
(88) CH
(89) CH

(81) II. BZ, MA, MC, ME. III. AL, AM, CH, EM,
GE, HR, KG, LI, MD, MK, MN, OM, SG, TR, UA
(72) 1) Fabrice DUPORT, Chemin du Clos 5,
CH-2034 PESEUX; 2) Fernand SOARES, Ville 1,
CH-2525 LE LANDERON

(54) 1. Wristwatch; 2.-3. watches; 4. bracelet;
5. wristwatch; 6. watch
(55)

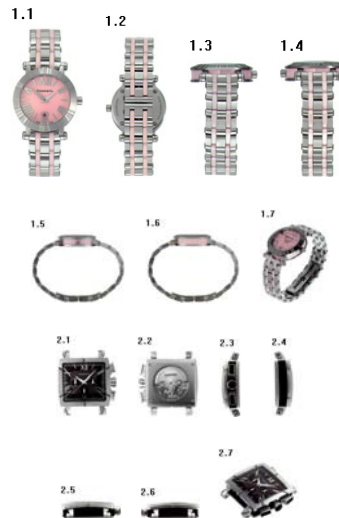

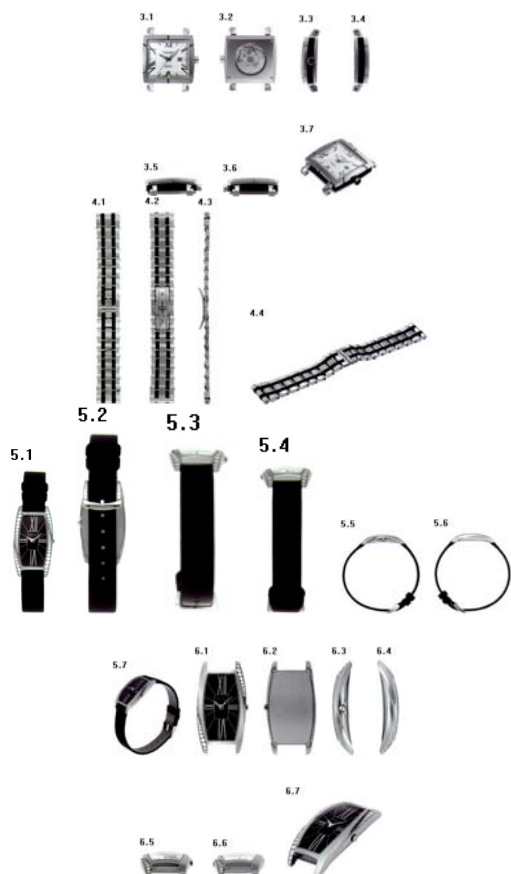

(11) DM/073135 (51) 09-03
 (15) 2010 02 17
 (45) 2010/02 (2010 03 31)
 (22) 2010 02 17
 (28) 2
 (30) 05.02.2010; 1666298; EM
 (73) CASTROL LIMITED Wakefield House,
 Pipers Way, Swindon, Wiltshire SN3 1RE (GB)
 (86) EM
 (87) EM
 (89) EM
 (81) III. AL, AM, BA, CH, EG, GE, IS, KG,
 LI, MD, MK, OA, RS, TR, UA
 (72) Tin Horse Design Limited, Pelham House,
 Pelhams Court London Road, Marlborough
 Wiltshire SN8 2AG UK
 (54) 1.-2. Containers
 (55)

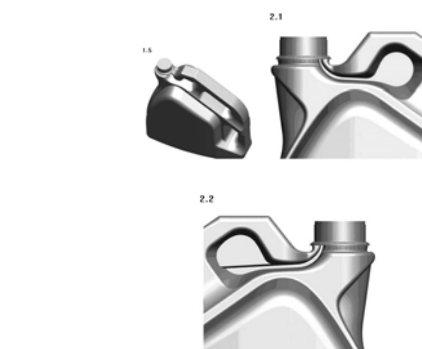
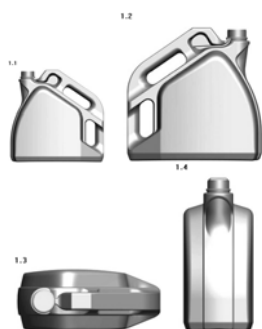

(11) DM/073382 (51) 09-01
 (15) 2010 04 02
 (45) 2010/04 (2010 05 31)
 (22) 2010 04 02
 (28) 3
 (30) N1: 06.10.2009; 1619834; EM; N2:
 14.10.2009; 1624008; EM; N3: 20.10.2009;
 1626060; EM
 (73) SAVERGLASS 3 rue de la Gare, F-60960
 FEUQUIERES (FR)
 (85) FR,EM
 (86) FR,EM
 (87) FR,EM
 (88) FR,EM
 (81) II. MC. III. AM, CH, GE, HR, MD, SG,
 TR, UA.
 (54) 1.-3. Bottles
 (55)

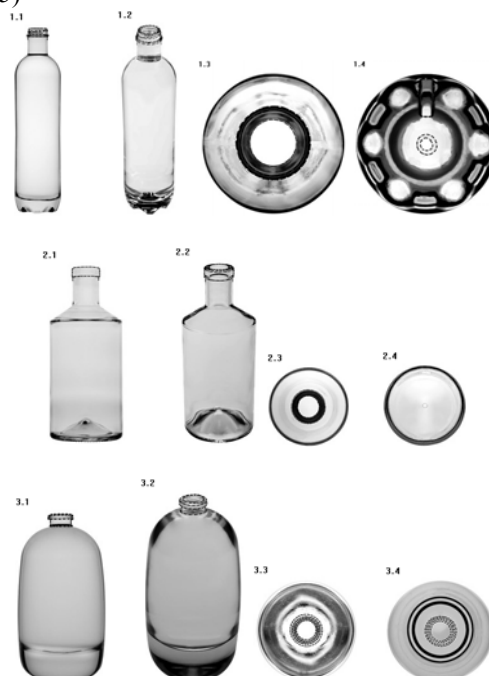

(11) DM/073386 (51) 11-01
 (15) 2010 04 08
 (45) 2010/04 (2010 05 31)

(22) 2010 04 08

(28) 8

(73) "FREY WILLE" GMBH & CO.

KG Gumpendorfer Strasse 81, A-1060 Wien (AT)

(85) EM

(86) EM

(87) EM

(88) EM

(81) III. CH, EG, EM, GE, HR, MD, MK, MN, SG,
TR, UA

(54) 1.-8. Jewellery

(55)





- (11) DM/073432 (51) 09-03
 (15) 2010 04 14
 (45) 2010/04 (2010 05 31)
 (22) 2010 04 14
 (28) 1
 (73) WARSZAWSKIE ZAKLADY ZIELARSKIE
 HERBAPOL PRZEDSIEBIORSTWO
 PANSTWOWE Ul. Olowkowa 54,
 PL-05-800 Pruszkow (PL)
 (85) PL,EM
 (86) PL,EM
 (87) PL,EM
 (88) PL,EM
 (81) III. AM, GE, KG, MD, RS
 (72) Danuta Smak, Ul. Olowkowa 54, PL-05-800
 Pruszkow
 (54) 1. Packaging for pharmaceuticals

(55)

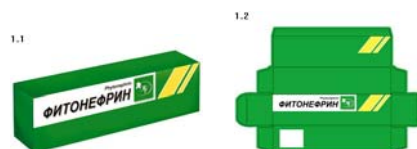

- (11) DM/073435 (51) 10-02
 (15) 2010 04 15
 (45) 2010/04 (2010 05 31)
 (22) 2010 04 15
 (28) 1
 (73) SWATCH AG (SWATCH SA)
 (SWATCH LTD) Jakob-Stämpfli-Strasse 94,
 CH-2502 BIEL/BIENNE (CH)
 (85) CH
 (86) CH
 (87) CH
 (88) CH
 (89) CH
 (81) II. BZ, MA, MC, ME. III. AL, AM, BA, CH,
 EG, EM, GE, HR, KG, LI, MD, MK, MN, OM,
 SG, TR, UA
 (72) Ylenia AGATE, SWATCHLAB,
 Via Archimede 6, IT-20129 MILANO
 (54) 1. Wristwatch
 (55)



- (11) DM/073458 (51) 18-99
 (15) 2010 04 09
 (45) 2010/04 (2010 05 31)
 (22) 2010 04 09
 (28) 4
 (73) CHECKPOINT SYSTEMS
 INTERNATIONAL GMBH Ersheimer Strasse 69,
 69434 Hirschhorn (DE)
 (86) DE,EM
 (87) EM
 (81) II. BJ, BZ, CI, GA, KP, MA, MC, ME, ML,
 NE, SN, SR. III. AL, AM, BA, BW, CH, EG, EM,
 GE, GH, HR, IS, KG, LI, MD, MK, MN, NA, OA,
 OM, RS, SG, ST, SY, TR, UA

(72) Jens Arend, Gwinnerstraße 34-36, 60388 Frankfurt am Main; Jens Schnur, Gwinnerstraße 34-36, 60388 Frankfurt am Main; Markus Gottwald, Gwinnerstraße 34-36, 60388 Frankfurt am Main; Andreas Kämmerer, Gwinnerstraße 34-36, 60388 Frankfurt am Main; Gilbert Robel, Gwinnerstraße 34-36, 60388 Frankfurt am Main; Sebastian Ohlmes, Gwinnerstraße 34-36, 60388 Frankfurt am Main

(54) 1.-4. Labelling devices

(55)

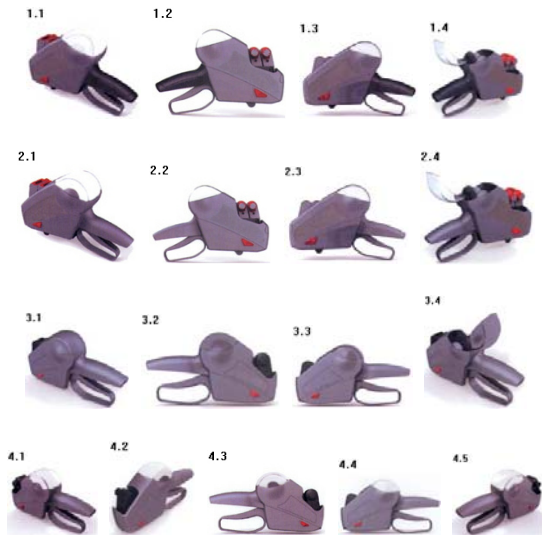

(11) DM/073477 (51) 03-01

(15) 2010 03 25

(45) 2010/04 (2010 05 31)

(22) 2010 03 25

(28) 1

(73) ADNAAN SOLOMON 136 Harvest Fields Way, Sutton Coldfield, West Midlands B75 5TJ (GB)

(85) EM

(86) EM

(87) EM

(88) EM

(81) III. AL, AM, BA, BW, CH, EG, EM, GE, GH, HR, IS, KG, LI, MD, MK, MN, NA, OA, OM, RS, SG, ST, SY, TR, UA

(72) Adnaan Solomon, 136 Harvest Fields, Way Sutton Coldfield West Midlands, B75 5TJ, UK

(54) Passport Jacket

(55)

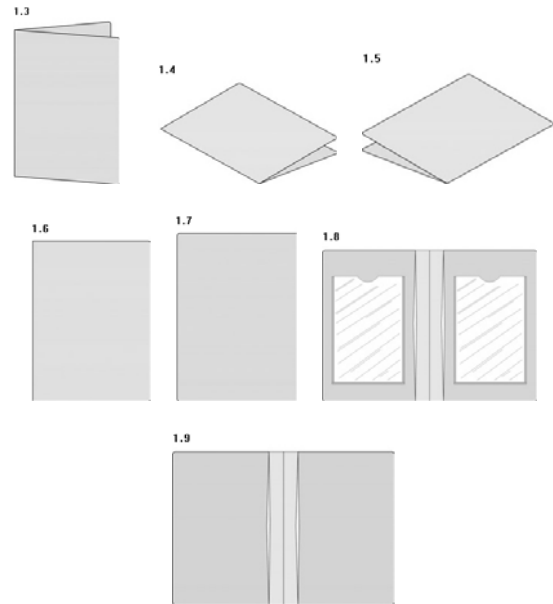
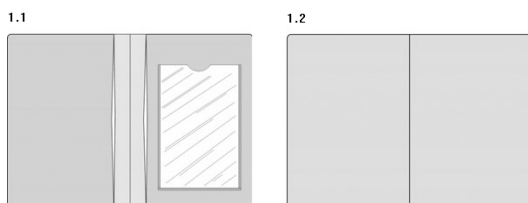

(11) DM/073508 (51) 10-02

(15) 2010 04 27

(45) 2010/04 (2010 05 31)

(22) 2010 04 27

(28) 1

(73) SWATCH AG (SWATCH SA)

(SWATCH LTD.) Jakob-Stämpfli-Strasse 94, CH-2502 Biel/Bienne (CH)

(85) CH

(86) CH

(87) CH

(88) CH

(89) CH

(81) II. BZ, MA, MC, ME. III. AL, AM, BA, CH, EG, EM, GE, HR, KG, LI, MD, MK, MN, OM, SG, TR, UA

(72) Ge PARSON, 306-310, No. 3, Lane 210 Taikang Road, CN-2000025 Shanghai

(54) Wristwatch

(55)



(11) DM/073522 (51) 10-02

(15) 2010 04 13

(45) 2010/04 (2010 05 31)

(22) 2010 04 13

(28) 2

(73) SWATCH AG (SWATCH SA)(SWATCH LTD) Jakob-Stämpfli-Strasse 94, CH-2502 BIEL/BIENNE (CH)

(85) CH

(86) CH

(87) CH

(88) CH

(89) CH

(81) II. BZ, MA, MC, ME. III. AL, AM, BA, CH, EM, GE, HR, KG, LI, MD, MK, MN, OM, SG, TR, UA

(72) N1: Ge PARSON, 306-310, No. 3, Lane 210

Taikang Road, Shanghai 200025, CN; N2:

Danilo SALA, Swatchlab, Via Archimede 6,

IT-20129 Milano

(54) 1-2. Wristwatches

(55)



TRADEMARKS

ТОВАРНЫЕ ЗНАКИ

APPLICATIONS FILED UNDER THE NATIONAL PROCEDURE, LAID OPEN FOR THE PURPOSE OF TAKING PATENT GRANTING DECISION

ЗАЯВКИ, ПОДАННЫЕ СОГЛАСНО НАЦИОНАЛЬНОЙ ПРОЦЕДУРЕ, ПО КОТОРЫМ ВЫНЕСЕНО РЕШЕНИЕ О РЕГИСТРАЦИИ

To appeal a decision is possible at Chamber of Appeal of Sakpatenti within 3 months from the publication or at The Board of Administrative Actions of Tbilisi City Court within a 1 month period. (Address: 12 kl. N 6, David Aghmashenebeli Kheivani, Tbilisi).

Обжалование решения возможно в Апелляционной палате Сакпатенти в течение 3 месяцев с даты его публикации или в течение 1 месяца в Коллегии по административным делам Тбилисского городского суда (г. Тбилиси, Аллея Давида Агмашенебели 12-й км №6)

(260) AM 48327 A *

(210) AM 048327

(220) 2008 05 30

(731) JOHNSON & JOHNSON

(Corporation organized and existing under the laws of the State of New Jersey);

One Johnson & Johnson Plaza,

New Brunswick, New Jersey 08933, USA

(740) Giorgi Taktakishvili

(540)

ONETOUCH ULTRA

(591) Black-white

(511) 5, 10

(260) AM 53380 A *

(210) AM 053380

(220) 2009 05 08

(731) SH.P.S. "G-M-P" LTD

Zemo Vedzisi Str. 103, 0160, Tbilisi

(740) Nugzar Qsovreli

(540)

ტირექსი
TIREX
ТИРЕКС

(591) Black-white

(511) 5

(260) AM 53434 A *

(210) AM 053434

(220) 2009 05 19

(731) NOVARTIS AG

4002 Basel

(740) Shalva Gvaramadze

(540)

OFLOHEXAL

(591) Black-white

(511) 5

(260) AM 53435 A *

(210) AM 053435

(220) 2009 05 19

(731) NOVARTIS AG

4002 Basel

(740) Shalva Gvaramadze

(540)

ROXIHEXAL

(591) Black-white

(511) 5

(260) AM 54103 A *

(210) AM 054103

(220) 2009 07 07

(731) JOHNSON & JOHNSON

A New Jersey Corporation;

One Johnson & Johnson Plaza,

New Brunswick, New Jersey, 08933-7001

(740) Shalva Gvaramadze

(540)

МОТИЛИУМ

(591) Black-white

(511) 3, 5

(260) AM 2010 55000 A
 (210) AM 055000
 (220) 2009 09 25
 (731) SS „TBILKIMPARMI“
 Tsuladzis k.34, 0113, Tbilisi, GE
 (540)

სენალექსი
Сеналекс
Senalex

(591) Black-white
 (511) 5

(260) AM 2010 55090 A
 (210) AM 055090
 (220) 2009 10 05
 (731) DIVERSEY, INC.
 8310 16th Street, Sturtevant, Wisconsin
 53177, USA
 (740) Shalva Gvaramadze
 (540)

DIVERSEY

(591) Black-white
 (511) 1, 3, 5, 7, 21, 37, 41

(260) AM 2010 55232 A
 (210) AM 055232
 (220) 2009 10 20
 (731) SH.P.S. „SADAZGVEVO KOMPANIA
 ALFA“
 Davit Agmasheneblis gamz. 148a, 0112,
 Tbilisi, GE
 (540)

ალფა
Alpha
Альфа

(591) Black-white
 (511) 1, 2, 4, 6, 7, 8, 9, 10, 11, 13, 14, 15, 16, 17,
 18, 19, 20, 21, 22, 23, 24, 25, 26, 27, 18, 19,
 30, 31, 32, 33, 35, 36, 37, 38, 39, 40, 41, 42,
 43, 44, 45

(260) AM 2010 55249 A
 (210) AM 055249
 (220) 2009 10 21
 (731) SH.P.S. „AVERSI-FARMA“ 0112,
 Davit Agmasheneblis gamz. 148/2, 0112,
 Tbilisi, GE

(540)

აქტიფედრინი
Актифедрин
Actifedrin

(591) Black-white
 (511) 5

(260) AM 2010 55454 A
 (210) AM 055454
 (220) 2009 10 30
 (731) SH.P.S. „ASFARMA“
 Saqartvelos farmatsevtuli kompania;
 Shevchenkos q.12, 0108, Tbilisi, GE
 (540)

IBUPREN
ИБУПРЕН
იბუპრენი

(591) Black-white
 (531) 27.05.05-28.05.00-28.19.00-
 (511) 5

(260) AM 2010 55637 A
 (210) AM 055637
 (220) 2009 11 06
 (731) SH.P.S. „AVERSI-FARMA“ 0112,
 Davit Agmasheneblis gamz. 148/2, 0112,
 Tbilisi, GE
 (540)

აგავა
АГАВА
АНАВА

(591) Black-white
 (511) 3

(260) AM 2010 55771 A
 (210) AM 055771
 (220) 2009 11 17
 (731) SH.P.S. „EM.SI.AI. PROJEQTI“
 Leonidzis q.1, 0105, Tbilisi, GE

(540)

თბილისი არტ ოტელი
TBILISI ART HOTEL

(591) Black-white
 (511) 43

(260) AM 2010 55949 A
 (210) AM 055949
 (220) 2009 12 02
 (731) MITSUBISHI JIDOSHA KOGYO
 KABUSHIKI KAISHA
 33-8, Shiba 5-chome, Minato-ku, Tokyo
 (740) Tamar Kochlamazashvili
 (540)

ASX

(591) Black-white
 (511) 12

(260) AM 2010 56012 A
 (210) AM 056012
 (220) 2009 12 04
 (731) AVENTIS PHARMA SA
 20, avenue Raymond Aron, 92160
 Antony, FR
 (740) Tamar Kochlamazashvili
 (540)

ЦЕТЕК

(591) Black-white
 (511) 5

(260) AM 2010 56014 A
 (210) AM 056014
 (220) 2009 12 04
 (731) AVENTIS PHARMA SA
 20, avenue Raymond Aron, 92160
 Antony, FR
 (740) Tamar Kochlamazashvili
 (540)

CETEK

(591) Black-white
 (511) 5

(260) AM 2010 56015 A
 (210) AM 056015
 (220) 2009 12 04
 (731) AVENTIS PHARMA SA
 20, avenue Raymond Aron, 92160
 Antony, FR
 (740) Tamar Kochlamazashvili
 (540)

ცეცეკო

(591) Black-white
 (511) 5

(260) AM 2010 56244 A
 (210) AM 056244

(220) 2009 12 16
 (310) 77/827,132; 77/827,148
 (320) 2009 09 15; 2009 09 15
 (330) US; US
 (731) HEWLETT-PACKARD DEVELOPMENT
 COMPANY, L.P.
 11445 Compaq Center Drive West, Houston,
 Texas 77070, USA
 (740) Tamar Kochlamazashvili
 (540)



(591) Black-white
 (531) 26.01.18-
 (511) 7, 36, 38, 39, 40

(260) AM 2010 56362 A
 (210) AM 056362
 (220) 2009 12 23
 (731) HARRINGTON DEVELOPMENT INC.
 Arango-Orillac Bldg. East 54 th street,
 Panama
 (740) Givi Akopashvili
 (540)

ASTRA INDIGO

(591) Black-white
 (511) 34

(260) AM 2010 56363 A
 (210) AM 056363
 (220) 2009 12 23
 (731) HARRINGTON DEVELOPMENT INC.
 Arango-Orillac Bldg. East 54 th street,
 Panama
 (740) Givi Akopashvili
 (540)

ASTRA EXPORT GRAND

(591) Black-white
 (511) 34

(260) AM 2010 56459 A
 (210) AM 056459
 (220) 2009 12 28
 (731) SH.P.S. „GREEN CARD CORPORATION”
 Marjanishvilis q. N6, 0102, Tbilisi, GE
 (540)

უნი
Uni

(591) Black-white
 (511) 9, 36

(260) AM 2010 56461 A
 (210) AM 056461
 (220) 2009 12 28
 (731) SS „SASTUMROEBISA DA
 RESTORNEBIS MENEJMENT
 JGUFI-m/group”
 Gotuas q.16, bina 61, 0160, Tbilisi, GE

(540)



(591) Black, white, red
 (531) 19.07.01-19.09.02-28.19.00-29.01.00-
 (511) 43

(260) AM 2010 56475 A
 (210) AM 056475
 (220) 2009 12 29
 (731) Mikheili Manasheridze
 Gldanis me-6 mikro raioni, korp.n18, bina 82,
 Tbilisi, GE
 (740) Tamaz Shilakadze
 (540)



(591) Red, white, black
 (531) 26.01.19-27.05.05-28.19.00-29.01.00-
 (511) 5, 10, 35

(260) AM 2010 56490 A
 (210) AM 056490
 (220) 2009 12 29
 (731) SS „Smart riteili”
 Iia Chavchavadzis gamz. 74b, 0162,
 Tbilisi, GE

(540)



(591) White, orange
 (531) 26.11.08-27.05.01-28.19.00-29.01.00-
 (511) 35

(260) AM 2010 56645 A
 (210) AM 056645
 (220) 2010 01 12
 (731) SH.P.S. „FESHEN GRUPI”
 Pekinis q. №14, 0171, Tbilisi, GE

(540)



(591) Black-white
 (531) 26.04.22-28.05.00-
 (511) 35, 41

(260) AM 2010 56646 A
 (210) AM 056646
 (220) 2010 01 12
 (731) SH.P.S. „FESHEN GRUPI”
 Pekinis q. №14, 0171, Tbilisi, GE

(540)



(591) Black-white
 (531) 26.04.22-28.05.00-
 (511) 35, 41

(260) AM 2010 56647 A
 (210) AM 056647
 (220) 2010 01 12
 (731) SH.P.S. „FESHEN GRUPI”
 Pekinis q. №14, 0171, Tbilisi, GE

(540)



(591) Black-white
 (531) 26.04.22-27.05.05-
 (511) 35, 41

(260) AM 2010 56648 A
 (210) AM 056648
 (220) 2010 01 12
 (731) SH.P.S. „FESHEN GRUPI”
 Pekinis q. №14, 0171, Tbilisi, GE

(540)



(591) Black-white
 (531) 26.04.22-27.05.04-
 (511) 35, 41

(260) AM 2010 56649 A
 (210) AM 056649
 (220) 2010 01 12
 (731) SH.P.S. „FESHEN GRUPI”
 Pekinis q. №14, 0171, Tbilisi, GE

(540)



(591) Black-white

(531) 26.04.22-28.05.00-
(511) 35, 41

(260) AM 2010 56653 A
(210) AM 056653
(220) 2010 01 12
(731) SH.P.S. „VAINMEN”
Gudiashvilis q. 11, 0105, Tbilisi, GE
(540)



(591) Light gold, black red
(531) 05.07.10-24.01.10-24.09.12-25.01.05-
27.05.04-29.01.00-
(511) 33

(260) AM 2010 56679 A
(210) AM 056679
(220) 2010 01 13
(731) SH.P.S. „FESHEN GRUPI”
Pekinis q. №14, 0171, Tbilisi, GE
(540)



(591) Black-white
(531) 26.04.22-27.05.05-
(511) 35, 41

(260) AM 2010 56731 A
(210) AM 056731
(220) 2010 01 21
(731) Russian Standard Intellectual Property
Holding AG
Zugerstrasse 49, Postfach 2528, 6330 Cham
ZAO „ROUST INC”
Pulkovskoe shosse. 52, litera A, p.Shushary,
196140, Saint-Petersburg, RU
(740) Liliana Darakhvelidze
(540)

AURORA

(591) Black-white
(511) 25, 30, 32, 33, 35, 36, 42

(260) AM 2010 56738 A
(210) AM 056738
(220) 2010 01 22

(731) SH.P.S. „GLOBALINVESTMENTI”
Berkukis q., 10 /q/ almasianis 19/21, 0171,
Tbilisi, GE
(740) Giorgi Taktakishvili
(540)



GLOBALINVESTMENT
გლობალიზაცია
ГЛОБАЛИНВЕСТМЕНТ

(591) White, black yellow, blue
(531) 26.01.12-26.01.18-27.05.05-27.05.21-
27.05.22-28.05.00-29.01.00-
(511) 35, 36, 37,

(260) AM 2010 56739 A
(210) AM 056739
(220) 2010 01 22
(731) SH.P.S. „W/M INVESTMENTI”
Tashkentis q.22, 0160, Tbilisi, GE
(740) Giorgi Taktakishvili
(540)



(591) White, grey, green
(531) 26.11.09-27.05.04-27.05.21-29.01.00-
(511) 35, 36, 37

(260) AM 2010 56814 A
(210) AM 056814
(220) 2010 01 28
(731) SS „LIBERTI BANKI”
Ilia Chavchavadzis gamz.74, 0162,
Tbilisi, GE
(540)



(591) Light blue, red, orange, blue
(531) 28.19.00-29.01.00-
(511) 36

(260) AM 2010 56815 A
(210) AM 056815
(220) 2010 01 28
(731) SS „LIBERTI BANKI”
Ilia Chavchavadzis gamz.74, 0162,
Tbilisi, GE

(540)



(591) Red, orange, light blue, black, blue
 (531) 26.01.18-26.02.03-28.19.00-29.01.00-
 (511) 36

(260) AM 2010 56816 A
 (210) AM 056816
 (220) 2010 01 28
 (731) SS „LIBERTI BANKI“
 Ilia Chavchavadzis gamz.74, 0162,
 Tbilisi, GE

(540)
 აირჩიე მშვიდი ანაბარი და მიიღე 7 მსხვილ და
 წარმატებულ ბანკს შორის ყველაზე მაღალი
 სარგებელი
 აირჩიეთ მშვიდი ანაბარი და მიიღეთ 7 მსხვილ და
 წარმატებულ ბანკს შორის ყველაზე მაღალი
 სარგებელი

(591) Red, black
 (531) 28.19.00-29.01.00-
 (511) 36

(260) AM 2010 56817 A
 (210) AM 056817
 (220) 2010 01 28
 (731) SS „LIBERTI BANKI“
 Ilia Chavchavadzis gamz.74, 0162,
 Tbilisi, GE

(540)
 აირჩიე მ7 ანაბარი და მიიღე 7 მსხვილ და
 წარმატებულ ბანკს შორის ყველაზე მაღალი
 სარგებელი
 აირჩიეთ მ7 ანაბარი და მიიღეთ 7 მსხვილ და
 წარმატებულ ბანკს შორის ყველაზე მაღალი
 სარგებელი

(591) Red, black
 (531) 28.19.00-29.01.00-
 (511) 36

(260) AM 2010 56821 A
 (210) AM 056821
 (220) 2010 01 28
 (731) SHPS „JI DA JI QOOFEREISHEN“
 Besikis q.N27, 0108, Tbilisi, GE
 (540)



(591) Dark brown, light brown, light pink

(531) 03.01.14-26.04.22-27.05.05-27.05.24-
 29.01.00-
 (511) 30, 32, 35, 41, 43

(260) AM 2010 56822 A
 (210) AM 056822
 (220) 2010 01 28
 (731) McDonald's International Property
 Company, Ltd.,
 A corporation organized and existing under
 the laws of the State of Delaware;
 2711 Centerville Road, Suite 400,
 Wilmington, Delaware 19808, USA
 (740) Shalva Gvaramadze
 (540)

CHICKEN MYTHIC

(591) Black-white
 (511) 30

(260) AM 2010 56823 A
 (210) AM 056823
 (220) 2010 01 28
 (731) McDonald's International Property
 Company, Ltd.,
 A corporation organized and existing under
 the laws of the State of Delaware;
 2711 Centerville Road, Suite 400,
 Wilmington, Delaware 19808, USA
 (740) Shalva Gvaramadze
 (540)

CBO

(591) Black-white
 (511) 30

(260) AM 2010 56824 A
 (210) AM 056824
 (220) 2010 01 28
 (731) McDonald's International Property
 Company, Ltd.,
 A corporation organized and existing under
 the laws of the State of Delaware;
 2711 Centerville Road, Suite 400,
 Wilmington, Delaware 19808, USA
 (740) Shalva Gvaramadze
 (540)

McFLURRY

(591) Black-white
 (511) 30

(260) AM 2010 56933 A
 (210) AM 056933
 (220) 2010 02 08
 (731) ANADOLU EFES BIRACILIC VE MALT

SANAYI ANONIM SIRKETI
Bahcelievler mah. Adnan Kahveci Bulvari
N5 Bahcelievler Istanbul
(740) Giorgi Taktakishvili
(540)



(591) Tobacco, red, blue, white
(531) 25.01.05-26.01.20-27.05.24-29.01.00-
(511) 32

(260) AM 2010 56949 A
(210) AM 056949
(220) 2010 02 09
(731) GENZYME CORPORATION
(a Massachusetts Corporation); 500 kendall
street, Cambridge, Massachusetts 02142
(740) Giorgi Taktakishvili
(540)

APERLURI

(591) Black-white
(511) 5

(260) AM 2010 56950 A
(210) AM 056950
(220) 2010 02 09
(731) GENZYME CORPORATION
(a Massachusetts Corporation); 500 kendall
street, Cambridge, Massachusetts 02142
(740) Giorgi Taktakishvili
(540)

ILUMERNA

(591) Black-white
(511) 5

(260) AM 2010 56951 A
(210) AM 056951
(220) 2010 02 09
(731) GENZYME CORPORATION
(a Massachusetts Corporation); 500 kendall
street, Cambridge, Massachusetts 02142
(740) Giorgi Taktakishvili
(540)

TRANSLARNA

(591) Black-white
(511) 5

(260) AM 2010 56953 A
(210) AM 056953
(220) 2010 02 09

(731) SH.P.S. „KAVIS SAKHLI-QENINGHOLI”
Kazbegis gamziri 2, 0160, Tbilisi, GE
(540)

დუქანი ლუარსაბი

(591) Black-white
(511) 43

(260) AM 2010 56960 A
(210) AM 056960
(220) 2010 02 09
(731) SH.P.S. “G-M-P” LTD
Zemo Vedzisi Str. 103, 0160, Tbilisi, GE
(740) Nugzar Qsovreli
(540)

ფერონიუმი ФЕРОНИУМ FERONIUM

(591) Black-white
(511) 5

(260) AM 2010 56990 A
(210) AM 056990
(220) 2010 02 10
(731) BROWN-FORMAN CORPORATION
850 Dixie Highway, Louisville, Kentucky
40210, USA
(740) Shalva Gvaramadze
(540)

HERRADURA

(591) Black-white
(511) 33

(260) AM 2010 56991 A
(210) AM 056991
(220) 2010 02 10
(731) BROWN-FORMAN CORPORATION
850 Dixie Highway, Louisville, Kentucky
40210, USA
(740) Shalva Gvaramadze
(540)

EL JIMADOR

(591) Black-white
(511) 33

(260) AM 2010 56992 A
(210) AM 056992
(220) 2010 02 10
(731) DISCOVER FINANCIAL SERVICES
2500 Lake Cook Road, Riverwoods,
IL 60015, USA

(740) Shalva Gvaramadze
(540)

DISCOVER

(591) Black-white
(511) 36

(260) AM 2010 56993 A
(210) AM 056993
(220) 2010 02 10
(731) DISCOVER FINANCIAL SERVICES
2500 Lake Cook Road, Riverwoods,
IL 60015, USA
(740) Shalva Gvaramadze
(540)



(591) Black, white, grey
(531) 26.03.24-26.04.11-27.01.06-27.05.04-
(511) 36

(260) AM 2010 57005 A
(210) AM 057005
(220) 2010 02 11
(731) SH.P.S. „GREEN CARD CORPORATION”
Marjanishvilis q. 6, 0102, Tbilisi, GE
(540)



(591) Orange, white
(531) 26.04.04-27.05.24-29.01.00-
(511) 9, 36

(260) AM 2010 57006 A
(210) AM 057006
(220) 2010 02 11
(731) SH.P.S. „GREEN CARD CORPORATION”
Marjanishvilis q. 6, 0102, Tbilisi, GE
(540)



U N I C A R D

(591) Green, yellow, orange, black
(531) 25.03.05-26.04.04-26.04.24-27.05.05-
29.01.00-
(511) 9, 36

(260) AM 2010 57007 A
(210) AM 057007
(220) 2010 02 11
(731) SH.P.S. „GREEN CARD CORPORATION”
Marjanishvilis q. 6, 0102, Tbilisi, GE

(540)



UNIVERSAL CARD
CORPORATION

(591) Green, dark grey, light grey, black
(531) 26.04.09-27.05.05-29.01.00-
(511) 9, 36

(260) AM 2010 57017 A
(210) AM 057017
(220) 2010 02 15
(731) SS "LIBERTI BANKI"
Ilia Chavchavadzis gamz.74, 0162,
Tbilisi, GE
(540)



(591) Red, grey
(531) 27.05.22-29.01.00-
(511) 36

(260) AM 2010 57018 A
(210) AM 057018
(220) 2010 02 15
(731) SS "LIBERTI BANKI"
Ilia Chavchavadzis gamz.74, 0162,
Tbilisi, GE
(540)



(591) Black, raspberry pink, dark salad
(531) 27.05.04-29.01.00-
(511) 36

(260) AM 2010 57019 A
(210) AM 057019
(220) 2010 02 15
(731) SS "LIBERTI BANKI"
Ilia Chavchavadzis gamz.74, 0162,
Tbilisi, GE
(540)

სმარტივი
SMARTIVI

(591) Black-white
(511) 36

(260) AM 2010 57020 A
(210) AM 057020
(220) 2010 02 15
(731) SS "LIBERTI BANKI"
Ilia Chavchavadzis gamz.74, 0162,
Tbilisi, GE

(540)

სმარტივი(591) Black-white
(511) 36

(260) AM 2010 57021 A

(210) AM 057021

(220) 2010 02 15

(731) SS "LIBERTI BANKI"

Ilia Chavchavadzis gamz.74, 0162,
Tbilisi, GE

(540)

SMARTივი(591) Black-white
(511) 36

(260) AM 2010 57022 A

(210) AM 057022

(220) 2010 02 16

(310) 2518116

(320) 2009 10 09

(330) GB

(731) GALLAHER LIMITED

Members Hill, Brooklands Road, Weybridge,
Surrey KT13 0QU

(740) Shalva Gvaramadze

(540)



(591) Black-white

(531) 05.05.20-25.01.01-27.05.01-

(511) 34

(260) AM 2010 57023 A

(210) AM 057023

(220) 2010 02 16

(731) Barnes & Noble College Booksellers, LLC

120 Mountain View Boulevard, Basking
Ridge, New Jersey 07920, USA

(740) Shalva Gvaramadze

(540)

BARNES & NOBLE

(591) Black-white

(511) 42

(260) AM 2010 57024 A

(210) AM 057024

(220) 2010 02 16

(731) Associazione Radio Maria; Via Turati 7,
22036 Erba CO, IT

(740) Shalva Gvaramadze

(540)

რადიო მარია

(591) Black-white

(511) 38, 41

(260) AM 2010 57025 A

(210) AM 057025

(220) 2010 02 17

(731) GALLAHER LIMITED

Members Hill, Brooklands Road, Weybridge,
Surrey KT13 0QU

(740) Shalva Gvaramadze

(540)

SOBRANIE

(591) Black-white

(511) 33

(260) AM 2010 57027 A

(210) AM 057027

(220) 2010 02 18

(731) MILAGRO FOOD INDUSTRIES LTD.

113 Bonner Hill Road, Kingston-upon-
Thames, Surrey KT1 3HE

(740) Pavle Meipariani

(540)

MILAGRO

(591) Black-white

(511) 30

(260) AM 2010 57028 A

(210) AM 057028

(220) 2010 02 18

(731) MILAGRO FOOD INDUSTRIES LTD.

113 Bonner Hill Road, Kingston-upon-
Thames, Surrey KT1 3HE

(740) Pavle Meipariani

(540)

D'ARTE

(591) Black-white

(511) 30

(260) AM 2010 57029 A

(210) AM 057029

(220) 2010 02 18

(731) MILAGRO FOOD INDUSTRIES LTD.

113 Bonner Hill Road, Kingston-upon-
Thames, Surrey KT1 3HE

(740) Pavle Meipariani
(540)

Rio Cafe

(591) Black-white
(511) 30

(260) AM 2010 57030 A
(210) AM 057030
(220) 2010 02 18
(731) GLOBAL CONQUISTADORS S.A.
Cuba Avenue N36-36, PO Box 0816-06748,
Panama 5, Panama
(740) Tamaz Shilakadze
(540)

DENTO-MAX

(591) Black-white
(511) 21

(260) AM 2010 57035 A
(210) AM 057035
(220) 2010 02 19
(731) SH.P.S. „ZUMERI JORJIA”
Tsabadzis q.8, 0112, Tbilisi, GE
(540)



(591) Orahge, white
(531) 26.01.12-26.11.13-26.15.01-27.05.14-
28.19.00-29.01.00-
(511) 35

(260) AM 2010 57036 A
(210) AM 057036
(220) 2010 02 22
(731) SH.P.S. „FESHEN GRUPI”
Pekinis q.14, 0171, Tbilisi, GE
(540)



(591) Black-white
(531) 26.04.22-28.19.00-
(511) 18, 24, 25, 26, 35, 41

(260) AM 2010 57037 A
(210) AM 057037
(220) 2010 02 22
(731) SH.P.S. „FESHEN GRUPI”
Pekinis q.14, 0171, Tbilisi, GE
(540)



(591) Black-white

(531) 26.04.22-27.05.05-27.05.24-
(511) 18, 24, 25, 26, 35, 41

(260) AM 2010 57038 A
(210) AM 057038
(220) 2010 02 22
(731) SH.P.S. „FESHEN GRUPI”
Pekinis q.14, 0171, Tbilisi, GE
(540)



(591) Black-white
(531) 26.04.22-27.05.05-27.05.24-
(511) 18, 24, 25, 26, 35, 41

(260) AM 2010 57039 A
(210) AM 057039
(220) 2010 02 22
(731) SH.P.S. „FESHEN GRUPI”
Pekinis q.14, 0171, Tbilisi, GE
(540)



(591) Black-white
(531) 26.04.22-28.19.00-
(511) 18, 24, 25, 26, 35, 41

(260) AM 2010 57051 A
(210) AM 057051
(220) 2010 02 23
(731) SH.P.S. „ORI NABIJI”
Gudiashvilis moedani 4, 0105, Tbilisi, GE
(740) Tamila Chokheli
(540)



(591) White, green, red, orange
(531) 05.03.14-26.04.19-27.07.01-28.19.00-
29.01.00-
(511) 35

(260) AM 2010 57082 A
(210) AM 057082
(220) 2010 02 25
(731) SH.P.S. „AMERITEQI”
Ak. Shanidzis q.21, 0179, Tbilisi, GE
(540)



(591) Red, mustard-yellow, grey, white, black

(531) 04.05.03-27.05.05-29.01.00-
(511) 35

(260) AM 2010 57175 A
(210) AM 057175
(220) 2010 03 02
(731) SUMITOMO CHEMICAL CO., LTD
27-1, Shinkawa 2-chome, Chuo-ku, Tokyo
104-8260, JP
(740) Shalva Gvaramadze
(540)

SUMIPEX

(591) Black-white
(511) 17

(260) AM 2010 57183 A
(210) AM 057183
(220) 2010 03 02
(310) 2009731710
(320) 2009 12 08
(330) RU
(731) MARS, INCORPORATED
6885 ELM Street, McLean, Virginia
22101-3883, USA
(740) Tamar Kochlamazashvili
(540)

НЕ ТОРМОЗИ. СНИКЕРСНИ!

(591) Black-white
(511) 30

(260) AM 2010 57184 A
(210) AM 057184
(220) 2010 03 02
(731) SH.P.S. „JIMARTI”
Chavchavadzis gamz.9, 0179, Tbilisi, GE
(740) Gia Grdzlishvili
(540)



ჯი.მარტი

(591) White, grey, red
(531) 26.01.12-28.19.00-29.01.00-
(511) 29, 30, 35, 43

(260) AM 2010 57185 A
(210) AM 057185
(220) 2010 03 02
(731) SH.P.S. „JIMARTI”
Chavchavadzis gamz.9, 0179, Tbilisi, GE
(740) Gia Grdzlishvili

(540)



G.m a r t

(591) White, grey, red
(531) 26.01.12-27.05.05-29.01.00-
(511) 29, 30, 35, 43

(260) AM 2010 57205 A
(210) AM 057205
(220) 2010 03 04
(731) SH.P.S. „GEOSELI”
Gotuas q. 3, 0160, Tbilisi, GE
(740) Otari Janjalashvili
(540)

„შენი ხუთეული”

(591) Black-white
(511) 16, 25, 38

(260) AM 2010 57206 A
(210) AM 057206
(220) 2010 03 04
(731) SH.P.S. „GEOSELI”
Gotuas q. 3, 0160, Tbilisi, GE
(740) Otari Janjalashvili
(540)

„შენი ბანზუმილება”

(591) Black-white
(511) 16, 25, 38

(260) AM 2010 57207 A
(210) AM 057207
(220) 2010 03 04
(731) SH.P.S. „GEOSELI”
Gotuas q. 3, 0160, Tbilisi, GE
(740) Otari Janjalashvili
(540)

„სიყვარულის ბანზუმილება”

(591) Black-white
(511) 16, 25, 38

(260) AM 2010 57208 A
(210) AM 057208
(220) 2010 03 04
(731) SH.P.S. „GEOSELI”
Gotuas q. 3, 0160, Tbilisi, GE
(740) Otari Janjalashvili
(540)

„წიბნის ბანზუმილება”

(591) Black-white
(511) 16, 25, 38

(260) AM 2010 57209 A
(210) AM 057209
(220) 2010 03 04
(731) SH.P.S. „GEOSELI”
Gotuas q. 3, 0160, Tbilisi, GE
(740) Otari Janjalashvili
(540)

„ზუმერანბი”

(591) Black-white
(511) 16, 25, 38

(260) AM 2010 57210 A
(210) AM 057210
(220) 2010 03 04
(731) SH.P.S. „GEOSELI”
Gotuas q. 3, 0160, Tbilisi, GE
(740) Otari Janjalashvili
(540)

„შენი ოცნების ფორმულა”

(591) Black-white
(511) 16, 25, 38

(260) AM 2010 57211 A
(210) AM 057211
(220) 2010 03 04
(731) SH.P.S. „GEOSELI”
Gotuas q. 3, 0160, Tbilisi, GE
(740) Otari Janjalashvili
(540)

„WAP-რენ ზუმბე”

(591) Black-white
(511) 16, 25, 38

(260) AM 2010 57212 A
(210) AM 057212
(220) 2010 03 04
(731) SH.P.S. „GEOSELI”
Gotuas q. 3, 0160, Tbilisi, GE
(740) Otari Janjalashvili
(540)

1=2

(591) Black-white
(511) 16, 25, 38

(260) AM 2010 57213 A
(210) AM 057213
(220) 2010 03 04
(731) SH.P.S. „GEOSELI”

Gotuas q. 3, 0160, Tbilisi, GE
(740) Otari Janjalashvili
(540)
„ექსტრემალური ბანზუმბილეა”
(591) Black-white
(511) 16, 25, 38

(260) AM 2010 57214 A
(210) AM 057214
(220) 2010 03 04
(731) SH.P.S. „GEOSELI”
Gotuas q. 3, 0160, Tbilisi, GE
(740) Otari Janjalashvili
(540)

„გაფხული ისევ მოღაშია”

(591) Black-white
(511) 16, 25, 38

(260) AM 2010 57215 A
(210) AM 057215
(220) 2010 03 04
(731) SH.P.S. „GEOSELI”
Gotuas q. 3, 0160, Tbilisi, GE
(740) Otari Janjalashvili
(540)

„ერთი ტონა SMS”

(591) Black-white
(511) 16, 25, 38

(260) AM 2010 57216 A
(210) AM 057216
(220) 2010 03 04
(731) SH.P.S. „GEOSELI”
Gotuas q. 3, 0160, Tbilisi, GE
(740) Otari Janjalashvili
(540)

„გაფხულის ბანზუმბილეა”

(591) Black-white
(511) 16, 25, 38

(260) AM 2010 57217 A
(210) AM 057217
(220) 2010 03 04
(731) SH.P.S. „GEOSELI”
Gotuas q. 3, 0160, Tbilisi, GE
(740) Otari Janjalashvili
(540)

„ზუმბაბე”

(591) Black-white
(511) 16, 25, 38

(260) AM 2010 57218 A
(210) AM 057218
(220) 2010 03 04
(731) SH.P.S. „GEOSELI”
Gotuas q. 3, 0160, Tbilisi, GE
(740) Otar Janjalashvili
(540)



(591) Black-white
(531) 26.04.06-28.19.00-
(511) 16, 25, 38

(260) AM 2010 57219 A
(210) AM 057219
(220) 2010 03 04
(731) SH.P.S. „GEOSELI”
Gotuas q. 3, 0160, Tbilisi, GE
(740) Otar Janjalashvili
(540)



(591) Pink, white
(531) 26.04.06-28.19.00-29.01.00-
(511) 16, 25, 38

REGISTERED TRADEMARKS

ЗАРЕГИСТРИРОВАННЫЕ ТОВАРНЫЕ ЗНАКИ

(111) M 2010 020831 R
(151) 2010 10 20
(181) 2020 10 20
(260) AM 2010 46959 A*
(220) 2008 02 07
(732) SH.P.S. „GD ALKO”
M. Aleqsidzis q.8, 0193, Tbilisi, GE

(111) M 2010 020832 R
(151) 2010 10 20
(181) 2020 10 20
(260) AM 2010 47492 A*
(220) 2008 03 07
(732) LEO PHARMA A/S
Industriparken 55, DK-2750 Ballerup

(111) M 2010 020833 R
(151) 2010 10 20
(181) 2020 10 20
(260) AM 2010 47493 A*
(220) 2008 03 07
(732) LEO PHARMA A/S
Industriparken 55, DK-2750 Ballerup

(111) M 2010 020834 R
(151) 2010 10 20
(181) 2020 10 20
(260) AM 2010 50520 A*
(220) 2008 10 17
(732) PRAVDA INTERNATIONAL
INCORPORATED
1105 N. Market Street, suite 1144,
Wilmington, Delaware 19801, USA

(111) M 2010 020835 R
(151) 2010 10 20
(181) 2020 10 20
(260) AM 2010 51105 A*
(220) 2008 12 05
(732) GLAXO GROUP LIMITED
Glaxo Wellcome House, Berkeley Avenue,
Greenford, Middlesex UB6 0NN

(111) M 2010 020836 R
(151) 2010 10 20
(181) 2020 10 20
(260) AM 2010 53329 A*
(220) 2009 05 06

(732) NOVARTIS AG
4002 Basel, CH

(111) M 2010 020837 R
(151) 2010 10 20
(181) 2020 10 20
(260) AM 2010 53330 A*
(220) 2009 05 06
(732) NOVARTIS AG
4002 Basel, CH

(111) M 2010 020838 R
(151) 2010 10 20
(181) 2020 10 20
(260) AM 2010 53331 A*
(220) 2009 05 06
(732) NOVARTIS AG
4002 Basel, CH

(111) M 2010 020839 R
(151) 2010 10 20
(181) 2020 10 20
(260) AM 2010 53332 A*
(220) 2009 05 06
(732) NOVARTIS AG
4002 Basel, CH

(111) M 2010 020840 R
(151) 2010 10 20
(181) 2020 10 20
(260) AM 2010 53660 A
(220) 2009 06 05
(732) SH.P.S. „PRIMA7”
Nakashidzis I shesakhv. N12, 0105,
Tbilisi, GE

(111) M 2010 020841 R
(151) 2010 10 20
(181) 2020 10 20
(260) AM 2010 53862 A
(220) 2009 06 17
(732) Emzar Baladze
VaJa-Pshavelas q. 7, bina 14, 6000,
Batumi, GE

(111) M 2010 020842 R
(151) 2010 10 20

(181) 2020 10 20
 (260) AM 2010 54042 A
 (220) 2009 07 02
 (732) SS „Tbilgvino”
 Sarajishvilis gamz. 2, 0153, Tbilisi, GE

(111) M 2010 020843 R
 (151) 2010 10 20
 (181) 2020 10 20
 (260) AM 2010 54127 A
 (220) 2009 07 10
 (732) SHPS „JORJIAN TREDISHENS”
 Iakob Nikoladzis q.5-a, 0109, Tbilisi, GE

(111) M 2010 020844 R
 (151) 2010 10 20
 (181) 2020 10 20
 (260) AM 2010 54373 A
 (220) 2009 07 29
 (732) Zakritoe aqtisionernoe obshchestvo "Obolon"
 Ul.bogatirskaia 3, 04655 Kiev, UA

(111) M 2010 020845 R
 (151) 2010 10 20
 (181) 2020 10 20
 (260) AM 2010 54918 A
 (220) 2009 09 22
 (732) CERASUS INC
 Calle 50 y Aquilino de la Guardia, Plaza
 Banco General, Piso 30, Panama,
 0823-05789, Panama

(111) M 2010 020846 R
 (151) 2010 10 20
 (181) 2020 10 20
 (260) AM 2010 54919 A
 (220) 2009 09 22
 (732) CERASUS INC
 Calle 50 y Aquilino de la Guardia, Plaza
 Banco General, Piso 30, Panama,
 0823-05789, Panama

(111) M 2010 020847 R
 (151) 2010 10 20
 (181) 2020 10 20
 (260) AM 2010 54920 A
 (220) 2009 09 22
 (732) CERASUS INC
 Calle 50 y Aquilino de la Guardia, Plaza
 Banco General, Piso 30, Panama,
 0823-05789, Panama

(111) M 2010 020848 R
 (151) 2010 10 20
 (181) 2020 10 20
 (260) AM 2010 54921 A
 (220) 2009 09 22
 (732) CERASUS INC
 Calle 50 y Aquilino de la Guardia, Plaza
 Banco General, Piso 30, Panama,
 0823-05789, Panama

(111) M 2010 020849 R
 (151) 2010 10 20
 (181) 2020 10 20
 (260) AM 2010 55033 A
 (220) 2009 09 30
 (732) THE COCA-COLA COMPANY
 One Coca-Cola Plaza, Atlanta, Georgia
 30313, USA

(111) M 2010 020850 R
 (151) 2010 10 20
 (181) 2020 10 20
 (260) AM 2010 55034 A
 (220) 2009 10 01
 (732) Giorgi Gogbaidze
 Griboedovis 21, 0108, Tbilisi, GE

(111) M 2010 020851 R
 (151) 2010 10 20
 (181) 2020 10 20
 (260) AM 2010 55101 A
 (220) 2009 10 07
 (732) SH.P.S. „AVERSI-FARMA”
 Davit Agmasheneblis gamz. 148/2, 0112,
 Tbilisi, GE

(111) M 2010 020852 R
 (151) 2010 10 20
 (181) 2020 10 20
 (260) AM 2010 55102 A
 (220) 2009 10 07
 (732) SH.P.S. „AVERSI-FARMA”
 Davit Agmasheneblis gamz. 148/2, 0112,
 Tbilisi, GE

(111) M 2010 020853 R
 (151) 2010 10 20
 (181) 2020 10 20
 (260) AM 2010 55220 A
 (220) 2009 10 19
 (732) PFIZER INC.
 A Delaware corporation;

235 East 42nd Street, New York,
NY 10017, US

(111) M 2010 020854 R
(151) 2010 10 20
(181) 2020 10 20
(260) AM 2010 55221 A
(220) 2009 10 19
(732) SH.P.S. „AVERSI-FARMA”
Davit Agmasheneblis gamz. 148/2, 0112,
Tbilisi, GE

(111) M 2010 020855 R
(151) 2010 10 20
(181) 2020 10 20
(260) AM 2010 55222 A
(220) 2009 10 19
(732) SH.P.S. „AVERSI-FARMA”
Davit Agmasheneblis gamz. 148/2, 0112,
Tbilisi, GE

(111) M 2010 020856 R
(151) 2010 10 20
(181) 2020 10 20
(260) AM 2010 55223 A
(220) 2009 10 19
(732) SH.P.S. „AVERSI-FARMA”
Davit Agmasheneblis gamz. 148/2, 0112,
Tbilisi, GE

(111) M 2010 020857 R
(151) 2010 10 20
(181) 2020 10 20
(260) AM 2010 55224 A
(220) 2009 10 19
(732) SH.P.S. „AVERSI-FARMA”
Davit Agmasheneblis gamz. 148/2, 0112,
Tbilisi, GE

(111) M 2010 020858 R
(151) 2010 10 20
(181) 2020 10 20
(260) AM 2010 55225 A
(220) 2009 10 19
(732) SH.P.S. „AVERSI-FARMA”
Davit Agmasheneblis gamz. 148/2, 0112,
Tbilisi, GE

(111) M 2010 020859 R
(151) 2010 10 20
(181) 2020 10 20
(260) AM 2010 55226 A

(220) 2009 10 19
(732) SH.P.S. „AVERSI-FARMA”
Davit Agmasheneblis gamz. 148/2, 0112,
Tbilisi, GE

(111) M 2010 020860 R
(151) 2010 10 20
(181) 2020 10 20
(260) AM 2010 55227 A
(220) 2009 10 19
(732) SH.P.S. „AVERSI-FARMA”
Davit Agmasheneblis gamz. 148/2, 0112,
Tbilisi, GE

(111) M 2010 020861 R
(151) 2010 10 20
(181) 2020 10 20
(260) AM 2010 55228 A
(220) 2009 10 19
(732) SH.P.S. „AVERSI-FARMA”
Davit Agmasheneblis gamz. 148/2, 0112,
Tbilisi, GE

(111) M 2010 020862 R
(151) 2010 10 20
(181) 2020 10 20
(260) AM 2010 55248 A
(220) 2009 10 21
(732) VIIV HEALTHCARE UK LIMITED
980 Great West Road, Brentford, Middlesex
TW8 9GS

(111) M 2010 020863 R
(151) 2010 10 20
(181) 2020 10 20
(260) AM 2010 55269 A
(220) 2009 10 22
(732) Davit Giorgobiani
Dolidzis q., korp.14, bina 1a, 0171,
Tbilisi, GE

(111) M 2010 020864 R
(151) 2010 10 20
(181) 2020 10 20
(260) AM 2010 55340 A
(220) 2009 10 26
(732) COLGATE-PALMOLIVE COMPANY
300 Park Avenue, NEW YORK, N.Y.
10022, USA

(111) M 2010 020865 R
(151) 2010 10 25
(181) 2020 10 25

(260) AM 2010 43463 A*	A Delaware corporation; 1040 Avenue of the Americas, New York, New York 10018, USA
(220) 2007 06 22	
(732) Открытое Акционерное общество "Пивоваренное объединение "Красный Восток-Солодовпиво" ул. Тихорецкая, д.5, 420054 г. Казань, Республика Татарстан	
(111) M 2010 020866 R	(111) M 2010 020871 R
(151) 2010 10 25	(151) 2010 10 25
(181) 2020 10 25	(181) 2020 10 25
(260) AM 2010 46964 A*	(260) AM 2010 54532 A
(220) 2008 02 07	(220) 2009 08 26
(732) CANADA DRY CORPORATION LIMITED P.O. Box 309 GT, Ugland House, South Church Street, George Town, Grand Cayman	(732) DIAGEO NORTH AMERICA, INC. A Connecticut corporation; 801 Main Avenue, Norwalk CT 06851-1127, USA
(111) M 2010 020867 R	(111) M 2010 020872 R
(151) 2010 10 25	(151) 2010 10 25
(181) 2020 10 25	(181) 2020 10 25
(260) AM 2010 46965 A*	(260) AM 2010 54639 A
(220) 2008 02 07	(220) 2009 09 02
(732) CANADA DRY CORPORATION LIMITED P.O. Box 309 GT, Ugland House, South Church Street, George Town, Grand Cayman	(732) WALLY YACHTS S.A. 231 Val Des Bons-Malades, L-2121 Kirchberg
(111) M 2010 020868 R	(111) M 2010 020873 R
(151) 2010 10 25	(151) 2010 10 27
(181) 2020 10 25	(181) 2020 10 27
(260) AM 2010 48458 A*	(260) AM 2010 46196 A*
(220) 2008 06 13	(220) 2008 07 14
(732) PANASONIC CORPORATION 1006, Oaza- Kadoma, Kadoma-shi, Osaka 571-8501, JP	(732) ALTINBAS HOLDING ANONIM SIRKETI Altinbas Plaza, Mahmutbey Dilmenler Cad. N 26 34217 Bagcilar Istanbul
(111) M 2010 020869 R	(111) M 2010 020874 R
(151) 2010 10 25	(151) 2010 10 27
(181) 2020 10 25	(181) 2020 10 27
(260) AM 2010 52294 A*	(260) AM 2010 51387 A*
(220) 2009 02 18	(220) 2008 12 24
(732) ONTEX TUKETIM URUNLERI SANAYI VE TICARET ANONIM ŞİRKETİ; YENIBOSNA MERKEZ MAH. ASENA SOK. N.2 BAHCELIEVLER, Istanbul	(732) SS „JI PI SI” Marjanishvilis q. 26, 0102, Tbilisi, GE
(111) M 2010 020870 R	(111) M 2010 020875 R
(151) 2010 10 25	(151) 2010 10 27
(181) 2020 10 25	(181) 2020 10 27
(260) AM 2010 54402 A	(260) AM 2010 53801 A
(220) 2009 08 03	(220) 2009 06 15
(732) ALPHA MEDIA GROUP INC.	(732) NEXT GROUP PLC Desford Road, Enderby, Leicester, Leicestershire, LE19 4AT
(111) M 2010 020876 R	(111) M 2010 020876 R
(151) 2010 10 27	(151) 2010 10 27
(181) 2020 10 27	(181) 2020 10 27
(260) AM 2010 54372 A	(260) AM 2010 54372 A

(220) 2009 07 29

(732) SS „JI PI SI”

Marjanishvilis q. 26, 0102, Tbilisi, GE

(111) M 2010 020877 R

(151) 2010 10 27

(181) 2020 10 27

(260) AM 2010 54511 A

(220) 2009 08 20

(732) Nino Butskhrikidze

Iosebisdzis q. 72a, b. 11, 0160, Tbilisi, GE

TRADEMARKS REGISTERED ACCORDING TO THE ACCELERATED PROCEDURE

ТОВАРНЫЕ ЗНАКИ, ЗАРЕГИСТРИРОВАННЫЕ ПО УСКОРЕННОЙ ПРОЦЕДУРЕ

To file an appeal on request of the registration cancelling is possible at Chamber of Appeal of Sakpatenti within 3 months from the publication.

Внесение иска с требованием об аннулировании регистрации возможно в Апелляционной палате Сакпатенти в течение 3 месяцев с даты ее публикации.

(111) M 2010 20878 R

(151) 2010 10 12

(181) 2020 10 12

(260) AM 2010 59825 A

(220) 2010 10 12

(732) SH.P.S. „, IBERFOODI”

Gldanis me-3 m/r, korp. 82, b. 49, 0167,
Tbilisi, GE

(540)



(591) Red, light blue, green, yellow, black, blue

(531) 03.04.02-06.19.11-25.01.01-28.05.00-
29.01.15-

(511) 35

(111) M 2010 20879 R

(151) 2010 10 12

(181) 2020 10 12

(260) AM 2010 59826 A

(220) 2010 10 12

(732) SH.P.S. „, IBERFOODI”

Gldanis me-3 m/r, korp. 82, b. 49, 0167,
Tbilisi, GE

(540)



(591) Red, light blue, green, yellow, black, blue

(531) 03.04.02-06.19.11-25.01.01-28.05.00-
29.01.15-

(511) 35

INTERNATIONAL TRADEMARKS LAID OPEN FOR THE PURPOSE OF TAKING PROTECTION GRANTING DECISIONS

МЕЖДУНАРОДНЫЕ ТОВАРНЫЕ ЗНАКИ, ПО КОТОРЫМ ВЫНЕСЕНЫ РЕШЕНИЯ О ПРЕДОСТАВЛЕНИИ ОХРАНЫ

To appeal a decision is possible at Chamber of Appeal of Sakpatenti within 3 months from the publication or at The Board of Administrative Actions of Tbilisi City Court within a 1 month period. (Address: 12 km., №6, David Aghmashenebeli Kheivani, Tbilisi).

Обжалование решения возможно в Апелляционной палате Сакпатенти в течение 3 месяцев с даты его публикации или в течение 1 месяца в Коллегии по административным делам Тбилисского городского суда (г. Тбилиси, Аллея Давида Агмашенебели 12-й км., №6).

(260) AM 2010 56610 A
(800) 1023780
(731) OBSHCHESTVO S OGRANICHENNOI
OTVETSTVENNOSTYU "SUMMA
TELEKOM"
Novovagankovski per, d. 9, str. 2,
RU-123022 Moscow, Russian Federation
(540)



(591) Green, white and orange
(511) 38

(260) AM 2010 56612 A
(800) 1023829
(731) DECATHLON
4 boulevard de Mons, F-59650
VILLENEUVE D'ASCQ, France
(540)



(591) Black, white
(511) 09, 12, 18, 22, 24, 25, 28, 35, 41

(260) AM 2010 56613 A
(800) 1023846
(731) SUBO INVESTMENTS LTD
Box 3540 Road Town Tortola, British Virgin
Islands
(540)



(591) Blue and yellow
(511) 30, 31, 32, 33

(260) AM 2010 56614 A
(800) 1023849
(731) Roche Diagnostics GmbH
Sandhofer Strasse 116, 68305 Mannheim,
Germany
(540)

COASYS

(591) Black, white
(511) 05, 10

(260) AM 2010 56615 A
(800) 1023866
(731) Duktus S.A.
Niederlassung Österreich Innsbrucker Straße
51 A-6060 Hall in Tirol (AT), Austria
(540)

DUKTUS

(591) Black, white
(511) 06, 40, 42

(260) AM 2010 56616 A
(800) 1023881
(731) PINK TV
20-22 rue de Turenne, F-75004 PARIS,
France
(540)

PINK TV

(591) Black, white
(511) 09, 35, 38, 41

(260) AM 2010 56617 A
 (800) 1023904
 (731) Zakritoe aktsionernoe obschestvo
 "Konditerskaya fabrika "Slavyanka"
 ul. Oktiabrskaya, d.20, RU-309506 Stari
 Oskol, Region de Belgorod,
 Russian Federation

(540)

КУРЬЁЗ

(591) Black, white
 (511) 30

(260) AM 2010 56618 A
 (800) 1023922
 (731) Solution Profiling Ltd
 19-20 Bridgeman Terrace Wigan, Greater
 Manchester WN1 1TD, United Kingdom

(540)



(591) Red, white and black
 (511) 09, 42

(260) AM 2010 56619 A
 (800) 1023946
 (731) Conseil de l'Europe organisation
 internationale régie par le traité relatif au
 Statut du Conseil de l'Europe en date du 5
 mai 1949; Avenue de l'Europe, F-67000
 Strasbourg, France

(540)



(591) Black, white
 (511) 35, 36, 37, 38, 39, 40, 41, 42, 43, 44, 45

(260) AM 2010 56662 A
 (800) 1024460
 (731) Otkrytoe aktsionernoe obchtchestvo
 "Savouchkin produkt"
 108, oul. Ya. Koupaly 224028 Brest, Belarus

(540)

НА ХЛЕБУШЕК

(591) Black, white
 (511) 29

(260) AM 2010 56663 A
 (800) 1024501
 (731) ASFINAG Maut Service GmbH
 Alpenstr. 94, A-5020 Salzburg, Austria

(540)



(591) Blue, yellow, anthracite, grey, white
 (511) 35, 37, 38, 39

(260) AM 2010 56664 A
 (800) 1024504
 (731) ARIAN TOOTOON SANAT COMPANY
 No. 29 Haghparast St Sarafraz St.
 1587693413 Dr. Beheshti Ave. Tehran, Iran
 (Islamic Republic of)

(540)

آرین توتون صنعت

A.T.I

(591) Black, white
 (511) 34, 35, 39

(260) AM 2010 56665 A
 (800) 264816
 (731) Henkel AG & Co. KGaA
 Henkelstrasse 67, 40589 Düsseldorf,
 Germany

(540)

HATTRIC

(591) Black, white
 (511) 01, 03, 05

(260) AM 2010 56666 A
 (800) 274265
 (731) L'OREAL, Société anonyme
 14 rue Royale, F-75008 PARIS, France

(540)

DERCOS

(591) Black, white
 (511) 03, 05, 16

(260) AM 2010 56667 A
 (800) 443784
 (731) Pierburg GmbH
 Alfred-Pierburg-Str. 1, 41460 Neuss,
 Germany

(540)

PIERBURG

(591) Black, white
(511) 06, 07, 09, 11, 12

(260) AM 2010 56668 A
(800) 460652
(731) Faber-Castell Aktiengesellschaft; Nürnberger
Strasse , 90546 Stein, Germany
(540)

FABER-CASTELL

(591) Black, white
(511) 02, 09, 16, 28

(260) AM 2010 56669 A
(800) 499779
(731) ELBA-WERK Maschinen-Gesellschaft mbH;
Bahnhofstr. 12-21, 76275 Ettlingen, Germany
(540)

ELBA

(591) Black, white
(511) 07, 08, 09, 12, 19, 20

(260) AM 2010 56670 A
(800) 523869
(731) CHIESI FARMACEUTICI S.P.A.;
via Palermo, 26/A, I-43100 PARMA (PR),
Italy
(540)

BREXIN

(591) Black, white
(511) 05

(260) AM 2010 56671 A
(800) 704907
(731) Constantia Industries AG;
Opfering 17, A-1010 Wien, Austria
(540) CONSTANTIA
(591) Black, white
(511) 16, 17, 19, 28, 35

(260) AM 2010 56672 A
(800) 805672
(731) BEIJINGSHI YUANMENGLONG PIJU
YOUXIAN ZEREN GONGSI;
Dongmen, Yuetangongyuan, Xichengqu,
CN-100045 Beijing, China
(540)

Rockfield

(591) Black, white
(511) 18

(260) AM 2010 56673 A
(800) 908007
(731) Textile S.A R.L.;
18, rue de l'Eau, L-1449 Luxembourg,
Luxembourg
(540)



(591) Red and white
(511) 24, 25

(260) AM 2010 56701 A
(800) 1024580
(731) ASFINAG Maut Service GmbH;
Alpenstr. 94, A-5020 Salzburg, Austria
(540)



(591) Blue, yellow, anthracite, grey, white
(511) 35, 37, 38, 39

(260) AM 2010 56702 A
(800) 1024582
(731) TOPLUM GÖNÜLLÜLERİ VAKFI
Burhaniye Mah. Atilla Sok. No:16,
Beylerbeyi Üsküdar İSTANBUL, Turkey
(540)



(591) Red, light red, brown, white
(511) 16, 25, 41

(260) AM 2010 56703 A
(800) 1024591
(731) Zakryte aktzionerne tovarystvo "Chumak";
vul. Kozatska, 3, m. Kakhovka Khersonska
obl. 74800, Ukraine
(540)



(591) Blue, white and gold
(511) 29, 30, 31, 32, 33, 34, 40, 43

(260) AM 2010 56704 A
(800) 1024592
(731) Beijing Xingwei Sports Goods CO., LTD.
NO 8.Minhelu, Niantan Industrial Area,
Huangcun Town, Daxing District 102600
Beijing, China
(540)



(591) Black, white
(511) 28

(260) AM 2010 56706 A
(800) 1024609
(731) CEMSAN ELEKTRİKLİ CİHAZLAR
SAN.VE TİC.LTD.ŞTİ.
Kemaliye Mah.Osman Tan Cad.No:71
VAKFIKEBİR / TRABZON, Turkey
(540)



(591) Black, white
(511) 11

(260) AM 2010 56707 A
(800) 1024621
(731) DBE Jewelry Global Limited
MCZ2025H, RM B, 1/F., La Bldg., 66
Corporation Road, Grangetown Cardiff,
Wales CF11 7AW, United Kingdom
(540)



(591) Black, white
(511) 14

(260) AM 2010 56708 A
(800) 1024630
(731) Zakrytoe aktsionernoe obshchestvo
"RENNА-HOLDING"
d. 12, ul. 4-ya Novokuzminskaya,
RU-109377 Moscow, Russian Federation

(540)

АЛЕКСЕЕВСКАЯ

(591) Black, white
(511) 29

(260) AM 2010 56709 A
(800) 1024639
(731) Otkrytoe aktsionernoe obshchestvo
"SIBUR - Russkie shiny"
Liter A, dom 5, ul. Galernaya, RU-190000
Sankt-Peterburg, Russian Federation
(540)

LandShaft

(591) Black, white
(511) 12

(260) AM 2010 56710 A
(800) 1024648
(731) OMEGA SA (OMEGA AG)
(OMEGA LTD.);
Jakob-Stämpfli-Strasse 96, CH-2502
Biel/Bienne, Switzerland
(540)

OMEGA CERAGOLD

(591) Black, white
(511) 14

(260) AM 2010 56711 A
(800) 1024672
(731) Eurofoam GmbH;
Greinerstraße 70, A-4550 Kremsmünster,
Austria
(540)

CELLPUR

(591) Black, white
(511) 10, 12, 17, 20

(260) AM 2010 56712 A
(800) 1024682
(731) FURUKAWA ROCK DRILL CO., LTD.
3-14, 2-chome, Nihonbashi Muromachi,
Chuo-ku, Tokyo 103-0022, Japan
(540)

FURUKAWA ROCK DRILL

(591) Black, white
(511) 07, 37

(260) AM 2010 56713 A
(800) 1024693

(731) Koninklijke Philips Electronics N.V.;
Groenewoudseweg 1, NL-5621
BA Eindhoven, Netherlands

(540)

OUTERSTYLERS

(591) Black, white
(511) 11

(260) AM 2010 56716 A
(800) 1024730

(731) Münchener Rückversicherungs- Gesellschaft
Aktiengesellschaft; in München
Königinstrasse 107, 80802 München,
Germany

(540)

Munich RE 

(591) Black, white
(511) 36

(260) AM 2010 56717 A
(800) 552731

(731) SOCIETE BIC;
14, rue Jeanne d'Asnieres, F-92110 CLICHY,
France

(540)

Tipp-Ex

(591) Black, white
(511) 16

(260) AM 2010 57181 A
(800) 350123

(731) LES CAVES DE LANDIRAS - LOUIS
ESCHENAUER
Route de Balizac, F-33720 LANDIRAS,
France

(540)

BARONNIERE

(591) Black, white
(511) 33

(260) AM 2010 57182 A
(800) 587893

(731) MASCHIO GASPARDO S.p.A.;
Via Marcello, 73, I-35011
CAMPODARSEGO, Italy

(540)



(591) Red
(511) 07

(260) AM 2010 57186 A
(800) 644954

(731) Parke-Davis GmbH;
Linkstr. 10, 10785 Berlin, Germany

(540)

Advinir

(591) Black, white
(511) 05

(260) AM 2010 57187 A
(800) 761791

(731) MAPA Makina Parçaları Endüstrisi Anonim
Şirketi; Yakacik Yolu, TR-81412 Kartal
Istanbul, Turkey

(540)



(591) Black, white
(511) 06, 07, 12

(260) AM 2010 57188 A
(800) 763960

(731) MAPA Makina Parçaları Endüstrisi
Anonim Şirketi
Yakacik Yolu, TR-81412 Kartal Istanbul,
Turkey

(540)

HAHN & SCHMIDT

(591) Black, red
(511) 06, 07, 12

(260) AM 2010 57189 A
(800) 771402

(731) TTS Tooltechnic Systems AG & Co. KG
Wertstrasse 20, 73240 Wendlingen, Germany

(540)

PROTOOL

(591) Black, white
(511) 07, 08, 09, 20

(260) AM 2010 57190 A
(800) 784445

(731) FIDIA FARMACEUTICI S.p.A.
Via Ponte della Fabbrica, 3/A, I-35031
ABANO TERME (PD), Italy

(540)

HYDEAL(591) Black, white
(511) 05

(260) AM 2010 57191 A

(800) 786101

(731) Novartis AG
CH-4002 Basel, Switzerland

(540)

CATAFAST(591) Black, white
(511) 05

(260) AM 2010 57192 A

(800) 808494

(731) AUDI AG; 85045 Ingolstadt, Germany

(540)

Audi Original Zubehör(591) Black, white
(511) 03, 07, 09, 11, 12, 27, 28

(260) AM 2010 57193 A

(800) 822422

(731) HUNCA KOZMETİK SANAYİ ANONİM
ŞİRKETİ
Bahçeköy Hunca Cad. No: 12, Sarıyer
İstanbul, Turkey

(540)

(591) Black, white
(511) 03

(260) AM 2010 57194 A

(800) 847968

(731) COEMI Wiśniewscy Spółka Jawna
Chechło I, ul. Pabianicka 15, PL-95-082
Dobroń, Poland

(540)

COEMI(591) Black, white
(511) 25

(260) AM 2010 57196 A

(800) 1028174

(731) Opera Software ASA

Waldemar Thrancs gate 98, N-0175 Oslo,
Norway

(540)

OPERA(591) Black, white
(511) 35, 38, 42, 45

(260) AM 2010 57197 A

(800) 1028222

(731) GUESS? IP HOLDER, L.P.
1444 South Alameda Street, Los Angeles,
CA 90021, USA

(540)

GUESS(591) Black, white
(511) 03

(260) AM 2010 57198 A

(800) 1028229

(731) SACMI COOPERATIVA MECCANICI
IMOLA SOCIETA' COOPERATIVA
Via Selice Provinciale, 17/A I-40026
IMOLA (Bologna), Italy

(540)

KEMAK(591) Black, white
(511) 07, 11, 19, 37, 42

(260) AM 2010 57199 A

(800) 1028236

(731) Wenzhou Vikotech Electrical CO., LTD.
No. 7, Zhenxing Road, Xinguang Industrial
Zone, Liushi, Yueqing Zhengjiang, China

(540)

AOELEC(591) Black, white
(511) 09

(260) AM 2010 57232 A

(800) 1028494

(731) Henkel AG & Co. KGaA
Henkelstraße 67, 40589 Düsseldorf, Germany

(540)



(591) Red and white
(511) 16

(260) AM 2010 57233 A
(800) 1028513
(731) Merck KGaA
Frankfurter Strasse 250, 64293 Darmstadt,
Germany
(540)

TIVIDA

(591) Black, white
(511) 01, 02

(260) AM 2010 57234 A
(800) 1028520
(731) SANOFI-AVENTIS
174, avenue de France, F-75013 PARIS,
France
(540)

LIHAREY

(591) Black, white
(511) 05

(260) AM 2010 57235 A
(800) 1028540
(731) CONSORZIO DELLE BUONE IDEE
SOCIETA' CONSORTILE A
RESPONSABILITA' LIMITATA
Via Tosarelli, 155, I-40055 CASTENASO
FRAZIONE VILLANOVA (Bologna), Italy
(540)

SELENELLA

(591) Black, white
(511) 29, 30, 31

(260) AM 2010 57236 A
(800) 1028578
(731) PRZEDSIĘBIORSTWO POLMOS
BIAŁYSTOK SPÓŁKA AKCYJNA
ul. Elewatorska 20, PL-15-950 Białystok,
Poland
(540)



(591) Black, white
(511) 33

(260) AM 2010 57237 A
(800) 1028579
(731) PRZEDSIĘBIORSTWO POLMOS
BIAŁYSTOK SPÓŁKA AKCYJNA
ul. Elewatorska 20, PL-15-950 Białystok,
Poland
(540)



(591) White, red, gold and black
(511) 33

(260) AM 2010 57238 A
(800) 1028584
(731) Eastman Kodak Company
343 State Street Rochester, NY 14650, USA
(540)

PLAYTOUCH

(591) Black, white
(511) 09

(260) AM 2010 57239 A
(800) 1028592
(731) Obshchestvo s ogranichennoy
otvetstvennostyu "Upravljajuschaja
kompanija "PS Grupp"
Nab. Obvodnogo kanala, 118a, liter V,
RU-190005 Saint-Petersburg,
Russian Federation
(540)



(591) Black, blue, pink, green and dark pink
(511) 03, 04, 05, 08, 14, 16, 18, 21, 25,
26, 35, 43, 44

(260) AM 2010 57241 A
(800) 1028593
(731) SABMiller International B.V.
Schouwburgplein 30-34, NL-3012
CL ROTTERDA, Netherlands
(540)

REDD'S

(591) Black, white
(511) 33

(260) AM 2010 57244 A
 (800) 1028599
 (731) Lyonesse Austria GmbH
 Gewerbepark 2, A-8565 St. Johann ob
 Hohenburg, Austria

(540)

LYONESS

(591) Black, white
 (511) 09, 35, 36, 41

(260) AM 2010 57245 A
 (800) 1028612
 (731) OMS PASLANMAZ MUTFAK ARAÇLARI
 SANAYİ VE TİCARET LİMİTED ŞİRKETİ
 Kiraç Köyü 2. Bölge 5., Cadde No:40
 İstanbul, Turkey

(540)



(591) Black, white, blue
 (511) 08, 11, 21

(260) AM 2010 57246 A
 (800) 1028619
 (731) FASTWEB S.p.A.
 Via Caracciolo, 51, I-20155 MILANO, Italy

(540)

FASTWEB

(591) Grey
 (511) 09, 25, 28, 37, 38, 41, 42

(260) AM 2010 57247 A
 (800) 1028634
 (731) British American Tobacco (Brands) Limited
 Globe House, 4 Temple Place, London
 WC2R 2PG, United Kingdom

(540)



(591) Black, white
 (511) 34

(260) AM 2010 57248 A
 (800) 1028635
 (731) British American Tobacco (Brands) Limited
 Globe House, 4 Temple Place, London
 WC2R 2PG, United Kingdom

(540)



(591) Black, white
 (511) 34

(260) AM 2010 57249 A
 (800) 1028641
 (731) GIORGIO ARMANI S.P.A.
 Milan, Swiss Branch Mendrisio; Via Penate
 4, CH-6850 Mendrisio, Switzerland

(540)

EA7
 EMPORIO ARMANI

(591) Black, white
 (511) 12, 18, 25, 28, 35

(260) AM 2010 57284 A
 (800) 915885
 (731) SARAY DÖKÜM VE MADENİ AKSAM
 SANAYİ ANONİM ŞİRKETİ
 Bağlar Mevkii Osmanpaşa, Caddesi No:89
 Güneşli-İstanbul, Turkey

(540)

SARAY 

(591) Black, white
 (511) 06

(260) AM 2010 57299 A
 (800) 1028983
 (731) OBSHESTVO S OGRANICHENNOY
 OTVETSTVENNOSTYU "TITAN"
 Shlisselburgskiy pr. 3-7, RU-192177
 Sankt-Petersburg, Russian Federation

(540)

ХЛЕБНОЕ ПОДВОРЬЕ

(591) Black, white
 (511) 32, 33, 35

(260) AM 2010 57300 A
 (800) 1029042
 (731) IMMERGAS S.P.A.
 Via Cisa Ligure 95, I-42041 BRESCELLO
 (REGGIO EMILIA), Italy

(540)



(591) Black, white
(511) 09, 11, 37

(260) AM 2010 57301 A
(800) 1029043
(731) FIDIA FARMACEUTICI S.p.A.
Via Ponte della Fabbrica, 3/A, I-35031
ABANO TERME (PD), Italy

(540)

LIPOSOM

(591) Black, white
(511) 05

(260) AM 2010 57302 A
(800) 1029059
(731) Avon Products, Inc.
World Headquarters, 1345 Avenue of the
Americas New York, NY 10105-0196, USA

(540)

URBAN EDGE

(591) Black, white
(511) 03

(260) AM 2010 57303 A
(800) 1029073
(731) HANKOOK TIRE CO., LTD.
#647-15, Yoksam-dong, Kangnam-gu Seoul,
Republic of Korea

(540)

Kontrol
technology

(591) Black, white, red
(511) 12

(260) AM 2010 57304 A
(800) 1029075
(731) GROUPE FRANCK PROVOST COIFFURE
SAS
133 rue du Faubourg Saint Honoré, F-75008
PARIS, France

(540)

FRANCK PROVOST BEAUTY

(591) Black, white
(511) 09, 16, 35, 41

(260) AM 2010 57306 A
(800) 1029100
(731) AZIENDE CHIMICHE RIUNITE
ANGELINI FRANCESCO A.C.R.A.F.
S.p.A.
Viale Amelia, 70, I-00181 ROMA, Italy

(540)



(591) Black, white
(511) 05

(260) AM 2010 57307 A
(800) 1029119
(731) ZAO "OBNINSKORGSIINTEZ"
57, Kievskoye Shosse, RU-249032 Obninsk,
Kaluga region, Russian Federation

(540)

SINTOIL

СИНТОЙЛ

(591) Black, white
(511) 07

(260) AM 2010 57308 A
(800) 1029146
(731) BasicNet S.P.A.
Largo M. Vitale 1, I-10152 Turin, Italy

(540)



(591) navy blue, orange, yellow
(511) 18, 25, 26

(260) AM 2010 57309 A
 (800) 1029165
 (731) ZHEJIANG FUDA BEARING CO., LTD.
 Pengqiao Industrial Zone, Henghe Town,
 Cixi City Zhejiang Province, China
 (540)



(591) Black, white
 (511) 06, 07, 12

(260) AM 2010 57310 A
 (800) 1029201
 (731) ZHEJIANG HUACHAO ELECTRIC
 APPLIANCE CO., LTD.
 Qianjiayang Industry Zone, Hongqiao,
 Yueqing Zhejiang, China
 (540)



(591) Black, white
 (511) 09

(260) AM 2010 57311 A
 (800) 1029220
 (731) Gunnebo AB;
 P O Box 5181, SE-402 26 GÖTEBORG,
 Sweden
 (540)

GUNNEBO

(591) Black, white
 (511) 06, 09, 19, 37, 38, 42, 45

(260) AM 2010 57312 A
 (800) 1029241
 (731) Millennium Pharmaceuticals, Inc.
 40 Landsdowne Street, Cambridge,
 MA 02139, USA
 (540)



(591) Black, white
 (511) 42, 45

(260) AM 53693 A *
 (800) 999979
 (731) Alfred Dunhill Limited
 15 Hill Street London W1J 5QT,
 United Kingdom
 (540)



(591) Black, white
 (511) 03, 09, 14, 16, 18, 25

(260) AM 53784 A *
 (800) 1000508
 (731) Limited Liability Partnership "Magisters"
 Volodymyrska str. 38, 5th floor Kyiv 01034,
 Ukraine
 (540)



(591) Blue and grey
 (511) 35, 36, 41, 42, 45

INTERNATIONAL TRADEMARKS PROTECTED IN GEORGIA

МЕЖДУНАРОДНЫЕ ТОВАРНЫЕ ЗНАКИ, ОХРАНЯЕМЫЕ В ГРУЗИИ

(260) AM 2010 55072 A
(800) 1010030
(151) 2009 03 29
(181) 2019 03 29
(511) 07, 11, 21

(260) AM 2010 55371 A
(800) 1013149
(151) 2009 07 03
(181) 2019 07 03
(511) 12, 26

(260) AM 2010 55414 A
(800) 1013754
(151) 2009 06 16
(181) 2019 06 16
(511) 02, 04, 07

(260) AM 2010 55417 A
(800) 1013808
(151) 2009 08 14
(181) 2019 08 14
(511) 30

(260) AM 2010 55418 A
(800) 1013810
(151) 2009 09 03
(181) 2019 09 03
(511) 09, 42

(260) AM 2010 55419 A
(800) 1013870
(151) 2009 09 02
(181) 2019 09 02
(511) 05

(260) AM 2010 55421 A
(800) 1013871
(151) 2009 08 31
(181) 2019 08 31
(511) 05

(260) AM 2010 55422 A
(800) 1013872
(151) 2009 09 02
(181) 2019 09 02
(511) 05

(260) AM 2010 55423 A
(800) 1013873
(151) 2009 09 02
(181) 2019 09 02
(511) 05

(260) AM 2010 55424 A
(800) 1013874
(151) 2009 09 02
(181) 2019 09 02
(511) 05

(260) AM 2010 55425 A
(800) 1013875
(151) 2009 09 02
(181) 2019 09 02
(511) 05

(260) AM 2010 55426 A
(800) 1013876
(151) 2009 09 02
(181) 2019 09 02
(511) 05

(260) AM 2010 55502 A
(800) 894931
(151) 2006 06 10
(181) 2016 06 10
(511) 35

(260) AM 2010 55504 A
(800) 937062
(151) 2007 07 11
(181) 2017 07 11
(511) 03, 09, 14, 18, 25

(260) AM 2010 55505 A
(800) 938025
(151) 2007 08 10
(181) 2017 08 10
(511) 03

(260) AM 2010 55506 A
(800) 945401
(151) 2007 10 12
(181) 2017 10 12
(511) 25

(260) AM 2010 55507 A
(800) 945586
(151) 2007 10 02
(181) 2017 10 02
(511) 03

(260) AM 2010 55508 A
(800) 971341
(151) 2008 06 18
(181) 2018 06 18
(511) 05

(260) AM 2010 55509 A
(800) 1014620
(151) 2009 08 12
(181) 2019 08 12
(511) 03, 07, 08

(260) AM 2010 55510 A
(800) 1014636
(151) 2009 09 09
(181) 2019 09 09
(511) 30

(260) AM 2010 55511 A
(800) 1014659
(151) 2009 06 25
(181) 2019 06 25
(511) 30

(260) AM 2010 55512 A
(800) 1014711
(151) 2009 08 19
(181) 2019 08 19
(511) 10, 11

(260) AM 2010 55569 A
(800) 970016
(151) 2008 04 08
(181) 2018 04 08
(511) 03, 05, 09, 10, 31, 35, 41, 42, 44

(260) AM 2010 55580 A
(800) 1015641
(151) 2009 09 03
(181) 2019 09 03
(511) 03, 05

(260) AM 2010 55581 A
(800) 1015653
(151) 2009 05 27
(181) 2019 05 27
(511) 25, 35

(260) AM 2010 55582 A
(800) 1015657
(151) 2009 10 02
(181) 2019 10 02
(511) 03

(260) AM 2010 55583 A
(800) 1015678
(151) 2009 09 21
(181) 2019 09 21
(511) 03

(260) AM 2010 55584 A
(800) 1015681
(151) 2009 06 29
(181) 2019 06 29
(511) 09

(260) AM 2010 55585 A
(800) 1015718
(151) 2009 07 08
(181) 2019 07 08
(511) 29, 31, 43

(260) AM 2010 55590 A
(800) 1015734
(151) 2009 09 03
(181) 2019 09 03
(511) 05, 29, 31, 32

(260) AM 2010 55591 A
(800) 1015740
(151) 2009 09 09
(181) 2019 09 09
(511) 30

(260) AM 2010 55592 A
(800) 1015750
(151) 2009 08 21
(181) 2019 08 21
(511) 12

(260) AM 2010 55593 A
(800) 1015757
(151) 2009 07 28
(181) 2019 07 28
(511) 06, 08, 09, 12

(260) AM 2010 55594 A
(800) 1015841
(151) 2009 07 30
(181) 2019 07 30
(511) 02

(260) AM 2010 55595 A
(800) 1015847
(151) 2009 08 13
(181) 2019 08 13
(511) 14

(260) AM 2010 55596 A
(800) 1015883
(151) 2009 07 10
(181) 2019 07 10
(511) 13

(260) AM 2010 55597 A
(800) 1015904
(151) 2009 05 18
(181) 2019 05 18
(511) 30

(260) AM 2010 55602 A
(800) 1015967
(151) 2009 09 07
(181) 2019 09 07
(511) 05

(260) AM 2010 55604 A
(800) 1015974
(151) 2009 05 29
(181) 2019 05 29
(511) 30

(260) AM 2010 55605 A
(800) 1015975
(151) 2009 03 27
(181) 2019 03 27
(511) 11

(260) AM 2010 55606 A
(800) 1015978
(151) 2009 09 03
(181) 2019 09 03
(511) 03, 05, 10, 16, 25

(260) AM 2010 55607 A
(800) 1016017
(151) 2009 06 29
(181) 2019 06 29
(511) 09, 25, 41

(260) AM 2010 55608 A
(800) 1016039
(151) 2009 08 18
(181) 2019 08 18
(511) 10

(260) AM 2010 55610 A
(800) 408028
(151) 2004 05 14
(181) 2014 05 14
(511) 05

(260) AM 2010 55611 A
(800) 507858
(151) 2006 11 28
(181) 2016 11 28
(511) 05

(260) AM 2010 55612 A
(800) 615248
(151) 2004 02 21
(181) 2014 02 21
(511) 03

(260) AM 2010 55613 A
(800) 716147
(151) 2009 03 12
(181) 2019 03 12
(511) 02, 07, 08, 09, 12, 14, 16, 18, 20, 21, 25, 26,
27, 28, 37

(260) AM 2010 55614 A
(800) 765372
(151) 2001 09 13
(181) 2011 09 13
(511) 05

(260) AM 2010 55615 A
(800) 817117
(151) 2003 12 24
(181) 2013 12 24
(511) 03

(260) AM 2010 55616 A
(800) 818105
(151) 2003 08 14
(181) 2013 08 14
(511) 30

(260) AM 2010 55617 A
(800) 824746
(151) 2004 03 26
(181) 2014 03 26
(511) 29

(260) AM 2010 55644 A
(800) 1016092
(151) 2009 05 06
(181) 2019 05 06

(511) 09, 35, 36, 37, 38, 39, 42, 45

(260) AM 2010 55651 A
(800) 1016098
(151) 2009 05 20
(181) 2019 05 20
(511) 03, 05

(260) AM 2010 55654 A
(800) 1016154
(151) 2009 02 26
(181) 2019 02 26
(511) 32

(260) AM 2010 55656 A
(800) 1016169
(151) 2009 06 22
(181) 2019 06 22
(511) 09, 16, 35, 38, 41, 42

(260) AM 2010 55659 A
(800) 1016180
(151) 2009 07 10
(181) 2019 07 10
(511) 12, 17

(260) AM 2010 55660 A
(800) 1016182
(151) 2009 06 30
(181) 2019 06 30
(511) 09, 37, 42

(260) AM 2010 55663 A
(800) 1016189
(151) 2009 08 03
(181) 2019 08 03
(511) 09, 11, 37

(260) AM 2010 55664 A
(800) 1016191
(151) 2009 08 12
(181) 2019 08 12
(511) 06, 17, 20

(260) AM 2010 55669 A
(800) 1016213
(151) 2009 09 03
(181) 2019 09 03
(511) 06, 11, 19

(260) AM 2010 55670 A
(800) 1016232
(151) 2009 09 21

(181) 2019 09 21
(511) 05

(260) AM 2010 55672 A
(800) 1016233
(151) 2009 09 21
(181) 2019 09 21
(511) 05

(260) AM 2010 55673 A
(800) 1016234
(151) 2009 09 21
(181) 2019 09 21
(511) 05

(260) AM 2010 55674 A
(800) 1016235
(151) 2009 09 17
(181) 2019 09 17
(511) 05

(260) AM 2010 55675 A
(800) 1016239
(151) 2009 09 21
(181) 2019 09 21
(511) 05

(260) AM 2010 55676 A
(800) 1016240
(151) 2009 09 21
(181) 2019 09 21
(511) 05

(260) AM 2010 55677 A
(800) 1016241
(151) 2009 09 21
(181) 2019 09 21
(511) 05

(260) AM 2010 55678 A
(800) 1016243
(151) 2009 09 24
(181) 2019 09 24
(511) 05

(260) AM 2010 55679 A
(800) 1016244
(151) 2009 09 24
(181) 2019 09 24
(511) 05

(260) AM 2010 55681 A
(800) 1016245
(151) 2009 09 24

(181) 2019 09 24
(511) 05

(260) AM 2010 55682 A
(800) 1016246
(151) 2009 09 24
(181) 2019 09 24
(511) 05

(260) AM 2010 55683 A
(800) 1016247
(151) 2009 09 24
(181) 2019 09 24
(511) 05

(260) AM 2010 55684 A
(800) 1016248
(151) 2009 09 24
(181) 2019 09 24
(511) 05

(260) AM 2010 55686 A
(800) 1016250
(151) 2009 09 24
(181) 2019 09 24
(511) 05

(260) AM 2010 55687 A
(800) 1016251
(151) 2009 09 24
(181) 2019 09 24
(511) 05

(260) AM 2010 55688 A
(800) 1016252
(151) 2009 09 24
(181) 2019 09 24
(511) 05

(260) AM 2010 55689 A
(800) 1016253
(151) 2009 09 24
(181) 2019 09 24
(511) 05

(260) AM 2010 55693 A
(800) 1016255
(151) 2009 09 25
(181) 2019 09 25
(511) 05

(260) AM 2010 55694 A
(800) 1016256

(151) 2009 09 25
(181) 2019 09 25
(511) 05

(260) AM 2010 55697 A
(800) 1016258
(151) 2009 09 25
(181) 2019 09 25
(511) 05

(260) AM 2010 55698 A
(800) 1016259
(151) 2009 09 25
(181) 2019 09 25
(511) 05

(260) AM 2010 55700 A
(800) 1016260
(151) 2009 09 25
(181) 2019 09 25
(511) 05

(260) AM 2010 55701 A
(800) 1016261
(151) 2009 09 25
(181) 2019 09 25
(511) 05

(260) AM 2010 55703 A
(800) 1016263
(151) 2009 09 25
(181) 2019 09 25
(511) 05

(260) AM 2010 55704 A
(800) 1016264
(151) 2009 09 25
(181) 2019 09 25
(511) 05

(260) AM 2010 55705 A
(800) 1016265
(151) 2009 09 25
(181) 2019 09 25
(511) 05

(260) AM 2010 55706 A
(800) 1016266
(151) 2009 09 25
(181) 2019 09 25
(511) 05

(260) AM 2010 55708 A
(800) 1016267
(151) 2009 09 25
(181) 2019 09 25
(511) 05

(260) AM 2010 55709 A
(800) 1016268
(151) 2009 09 25
(181) 2019 09 25
(511) 05

(260) AM 2010 55710 A
(800) 1016269
(151) 2009 09 25
(181) 2019 09 25
(511) 05

(260) AM 2010 55711 A
(800) 1016270
(151) 2009 09 28
(181) 2019 09 28
(511) 05

(260) AM 2010 55712 A
(800) 1016271
(151) 2009 09 28
(181) 2019 09 28
(511) 05

(260) AM 2010 55713 A
(800) 1016272
(151) 2009 09 28
(181) 2019 09 28
(511) 05

(260) AM 2010 55714 A
(800) 1016273
(151) 2009 09 28
(181) 2019 09 28
(511) 05

(260) AM 2010 55717 A
(800) 1016276
(151) 2009 09 30
(181) 2019 09 30
(511) 05

(260) AM 2010 55718 A
(800) 1016277
(151) 2009 09 30
(181) 2019 09 30
(511) 05

(260) AM 2010 55719 A
(800) 1016279
(151) 2009 09 09
(181) 2019 09 09
(511) 05

(260) AM 2010 55721 A
(800) 1016290
(151) 2009 01 06
(181) 2019 01 06
(511) 36

(260) AM 2010 55722 A
(800) 1016331
(151) 2009 07 16
(181) 2019 07 16
(511) 24

(260) AM 2010 55724 A
(800) 1016357
(151) 2009 09 09
(181) 2019 09 09
(511) 05

(260) AM 2010 55725 A
(800) 1016358
(151) 2009 08 27
(181) 2019 08 27
(511) 05

(260) AM 2010 55726 A
(800) 1016375
(151) 2009 06 17
(181) 2019 06 17
(511) 05, 35, 44

(260) AM 2010 55727 A
(800) 1016378
(151) 2009 06 09
(181) 2019 06 09
(511) 10, 16, 17

(260) AM 2010 55775 A
(800) 1013749
(151) 2009 07 14
(181) 2019 07 14
(511) 14, 34

(260) AM 2010 55776 A
(800) 566864
(151) 2001 02 04
(181) 2011 02 04
(511) 03, 42

(260) AM 2010 55777 A
(800) 690065
(151) 2008 03 24
(181) 2018 03 24
(511) 05

(260) AM 2010 55789 A
(800) 823528
(151) 2004 01 19
(181) 2014 01 19
(511) 06, 08

(260) AM 2010 55778 A
(800) 690066
(151) 2008 03 24
(181) 2018 03 24
(511) 05

(260) AM 2010 55790 A
(800) 823530
(151) 2004 01 19
(181) 2014 01 19
(511) 06, 08

(260) AM 2010 55780 A
(800) 692326
(151) 2008 05 05
(181) 2018 05 05
(511) 05

(260) AM 2010 55791 A
(800) 841928
(151) 2004 10 05
(181) 2014 10 05
(511) 03

(260) AM 2010 55781 A
(800) 702223
(151) 2008 11 06
(181) 2018 11 06
(511) 05

(260) AM 2010 55792 A
(800) 849295
(151) 2005 03 24
(181) 2015 03 24
(511) 25

(260) AM 2010 55782 A
(800) 727845
(151) 2000 02 10
(181) 2010 02 10
(511) 03

(260) AM 2010 55793 A
(800) 855814
(151) 2005 06 01
(181) 2015 06 01
(511) 33

(260) AM 2010 55783 A
(800) 742815
(151) 2000 06 13
(181) 2010 06 13
(511) 10

(260) AM 2010 55795 A
(800) 876151
(151) 2005 10 07
(181) 2015 10 07
(511) 05

(260) AM 2010 55784 A
(800) 763177
(151) 2001 06 28
(181) 2011 06 28
(511) 10

(260) AM 2010 55796 A
(800) 919816
(151) 2007 01 12
(181) 2017 01 12
(511) 14, 18, 25

(260) AM 2010 55785 A
(800) 819178
(151) 2003 10 13
(181) 2013 10 13
(511) 06, 08

(260) AM 2010 55797 A
(800) 922326
(151) 2007 01 31
(181) 2017 01 31
(511) 05

(260) AM 2010 55787 A
(800) 822999
(151) 2004 04 14
(181) 2014 04 14
(511) 02

(260) AM 2010 55798 A
(800) 943191
(151) 2007 09 28
(181) 2017 09 28
(511) 05

(260) AM 2010 55799 A
(800) 948748
(151) 2007 04 05
(181) 2017 04 05
(511) 03, 09, 14, 18, 24, 25

(260) AM 2010 55843 A
(800) 1016784
(151) 2009 07 11
(181) 2019 07 11
(511) 09, 35, 38, 41, 42

(260) AM 2010 55800 A
(800) 962873
(151) 2008 02 11
(181) 2018 02 11
(511) 05

(260) AM 2010 55844 A
(800) 1016792
(151) 2009 09 07
(181) 2019 09 07
(511) 05

(260) AM 2010 55801 A
(800) 978330
(151) 2008 08 18
(181) 2018 08 18
(511) 34

(260) AM 2010 55845 A
(800) 1016803
(151) 2009 06 26
(181) 2019 06 26
(511) 33

(260) AM 2010 55802 A
(800) 982716
(151) 2008 03 31
(181) 2018 03 31
(511) 06, 07, 09, 11

(260) AM 2010 55846 A
(800) 1016860
(151) 2009 06 16
(181) 2019 06 16
(511) 28

(260) AM 2010 55803 A
(800) 984369
(151) 2008 09 24
(181) 2018 09 24
(511) 03, 25, 35

(260) AM 2010 55847 A
(800) 1016907
(151) 2009 07 24
(181) 2019 07 24
(511) 18, 25, 26, 28

(260) AM 2010 55804 A
(800) 989568
(151) 2008 12 11
(181) 2018 12 11
(511) 05

(260) AM 2010 55848 A
(800) 1016922
(151) 2009 08 31
(181) 2019 08 31
(511) 34

(260) AM 2010 55805 A
(800) 991495
(151) 2009 01 08
(181) 2019 01 08
(511) 05

(260) AM 2010 55850 A
(800) 1016985
(151) 2009 08 26
(181) 2019 08 26
(511) 30

(260) AM 2010 55806 A
(800) 997774
(151) 2009 01 29
(181) 2019 01 29
(511) 06, 09, 19, 20

(260) AM 2010 55851 A
(800) 1017004
(151) 2009 06 15
(181) 2019 06 15
(511) 01, 02, 03, 04

(260) AM 2010 55842 A
(800) 1016713
(151) 2009 06 12
(181) 2019 06 12
(511) 01, 02, 03, 04

(260) AM 2010 55852 A
(800) 1017018
(151) 2009 04 27
(181) 2019 04 27
(511) 11, 17

(260) AM 2010 55853 A
(800) 1017024
(151) 2009 06 18
(181) 2019 06 18
(511) 32, 33, 43

(260) AM 2010 55895 A
(800) 1017329
(151) 2009 08 18
(181) 2019 08 18
(511) 33

(260) AM 2010 55854 A
(800) 1017034
(151) 2009 06 12
(181) 2019 06 12
(511) 09, 38, 41, 42, 45

(260) AM 2010 55896 A
(800) 1017345
(151) 2009 08 26
(181) 2019 08 26
(511) 34

(260) AM 2010 55855 A
(800) 1017035
(151) 2009 06 12
(181) 2019 06 12
(511) 09, 38, 41, 42, 45

(260) AM 2010 55897 A
(800) 1017348
(151) 2009 09 25
(181) 2019 09 25
(511) 14

(260) AM 2010 55856 A
(800) 1017036
(151) 2009 07 10
(181) 2019 07 10
(511) 07, 12, 28

(260) AM 2010 55898 A
(800) 1017354
(151) 2009 10 02
(181) 2019 10 02
(511) 36

(260) AM 2010 55890 A
(800) 1017267
(151) 2009 07 09
(181) 2019 07 09
(511) 25, 35

(260) AM 2010 55900 A
(800) 1017357
(151) 2009 08 31
(181) 2019 08 31
(511) 32

(260) AM 2010 55891 A
(800) 1017273
(151) 2009 09 08
(181) 2019 09 08
(511) 03, 14, 18, 25

(260) AM 2010 55901 A
(800) 1017401
(151) 2009 09 18
(181) 2019 09 18
(511) 07, 09, 11

(260) AM 2010 55892 A
(800) 1017293
(151) 2009 06 26
(181) 2019 06 26
(511) 01, 05

(260) AM 2010 55902 A
(800) 1017405
(151) 2009 06 23
(181) 2019 06 23
(511) 14

(260) AM 2010 55893 A
(800) 1017305
(151) 2009 06 30
(181) 2019 06 30
(511) 33, 35

(260) AM 2010 55904 A
(800) 1017417
(151) 2009 07 23
(181) 2019 07 23
(511) 25

(260) AM 2010 55894 A
(800) 1017320
(151) 2009 09 03
(181) 2019 09 03
(511) 01, 29, 30

(260) AM 2010 55905 A
(800) 1017426
(151) 2009 09 23
(181) 2019 09 23
(511) 04, 35

(260) AM 2010 55906 A
(800) 1017427
(151) 2008 09 26
(181) 2018 09 26
(511) 01, 02, 03, 04, 05, 06, 07, 08, 09, 10, 11, 12,
13, 14, 15, 16, 18, 20, 21, 23, 24, 25, 26, 27,
28, 29, 30, 31, 32, 33, 34, 35, 36, 38, 39, 40,
41, 42, 43, 44

(260) AM 2010 55907 A
(800) 1017446
(151) 2009 04 04
(181) 2019 04 04
(511) 18, 25, 35

OFFICIAL NOTIFICATIONS

ОФИЦИАЛЬНЫЕ ИЗВЕЩЕНИЯ

PATENTS

ПАТЕНТЫ

INDUSTRIAL DESIGNS REGISTERED WITH THE INTERNATIONAL BUREAU UNDER THE HAGUE AGREEMENT, WHICH HAVE BECOME INVALID ON THE TERRITORY OF GEORGIA

ПРОМЫШЛЕННЫЕ ОБРАЗЦЫ, ЗАРЕГИСТРИРОВАННЫЕ В МЕЖДУНАРОДНОМ БЮРО
СОГЛАСНО ГААГСКОМУ СОГЛАШЕНИЮ, ДЕЙСТВИЕ КОТОРЫХ УТРАТИЛО СИЛУ НА
ТЕРРИТОРИИ ГРУЗИИ

1. DM/066409

2. DM/066833

TRADEMARKS

ТОВАРНЫЕ ЗНАКИ

RENEWAL OF REGISTRATIONS

ПРОДЛЕНИЕ СРОКОВ ДЕЙСТВИЙ РЕГИСТРАЦИЙ

(111) M 2000 13474 R1

(156) 2010 09 15

(186) 2020 09 12

(732) ROTO FRANK AG

Stuttgarter Strasse 145-149,
D-70771 Leinfelden-Echterdingen, DE

(111) M 2000 13507 R1

(156) 2010 10 11

(186) 2020 09 28

(732) DANFOSS A/S

DK-6430 Nordborg, DK

(111) M 2000 13508 R1

(156) 2010 10 11

(186) 2020 09 28

(732) DANFOSS A/S

DK-6430 Nordborg, DK

(111) M 2001 13694 R1

(156) 2011 01 30

(186) 2021 01 30

(732) SERICOL LIMITED

Patricia Way, Pysons Road Industrial Estate,
Broadstairs, Kent CT10 2LE, England

(111) M 2001 13979 R1

(156) 2011 09 11

(186) 2021 09 11

(732) BETEK BOYA VE KIMYA SANAYI A.S.

Ankara Asfalti, Huseyin Celik Sok. N9
Kozyatagi 81090 Bostanci Istanbul

COMPLETE TRANSFER OF RIGHTS

ПОЛНАЯ ПЕРЕДАЧА ПРАВ

(111) M 1998 010386 R1
 (732) Kuchenmeister GmbH
 Goester Weg 31, 59494 Soest
 (770) A & D Nürnberger Feinbackwaren GmbH
 Thoner Weg 23, 90425 Nürnberg
 (580) 2010-10-18

(111) M 1999 011589 R1
 (732) Warner Chilcott Company, LLC
 Union Street KM 1.1, Fajardo, 00738,
 Puerto Rico
 (770) PROCTER & GAMBLE
 PHARMACEUTICALS, INC.
 One Procter & Gamble Plaza, Cincinnati,
 Ohio
 (580) 2010-10-18

(111) M 1999 011879 R1
 (732) Warner Chilcott Company, LLC
 Union Street KM 1.1, Fajardo, 00738,
 Puerto Rico
 (770) PROCTER & GAMBLE
 PHARMACEUTICALS, INC.
 One Procter & Gamble Plaza, Cincinnati,
 Ohio
 (580) 2010-10-18

(111) M 2001 013767 R
 (732) EXXON MOBIL CORPORATION
 A New Jersey corporation; 5959 Las Colinas
 Boulevard, Irving, Texas
 (770) ExxonMobil Oil Corporation
 5959 Las Colinas Boulevard, IRVING,
 Texas 75039-2298
 (580) 2010-10-15

(111) M 2003 014984 R
 (732) Abbott Medical Optics, Inc.
 1700 E. St. Andrew Place, Santa Ana,
 California 92799-5162
 (770) Advanced Medical Optics, Inc.
 A Delaware corporation; 1700 E. St. Andrew
 Place, Santa Ana, California 92799-5162
 (580) 2010-10-18

(111) M 2003 015336 R
 (732) EXXON MOBIL CORPORATION
 A New Jersey corporation; 5959 Las Colinas
 Boulevard, Irving, Texas
 (770) ExxonMobil Oil Corporation

5959 Las Colinas Boulevard, IRVING,
 Texas 75039-2298
 (580) 2010-10-15

(111) M 2008 018520 R
 (732) Shps „GAMOMTSEMLOBA DEDAENA“
 Qiqodzis q. 11, dzveli tbilisis raioni
 (770) Saertashoriso saqvelmoqmedo fondi
 "Bagrationi"; Tseretlis gamz. N95a
 (580) 2010-10-22

(111) M 2008 018721 R
 (732) Pharmateam Marketing 2000 Limited
 Silver Valley Building, 5th floor, Shlomo
 Halevi 5, Har Hotzvim Industrial Park,
 Jarusalem, Israel 97770
 (770) Saaqtsio sazogadoeba "Ji Pi Si"
 Marjanishvilis q. 26, Tbilisi
 (580) 2010-10-28

(111) M 2009 019098 R
 (732) EXXON MOBIL CORPORATION
 A New Jersey corporation; 5959 Las Colinas
 Boulevard, Irving, Texas
 (770) ExxonMobil Oil Corporation a corporation
 organized and existing under laws of the
 State of New York
 5959 Las Colinas Boulevard, Irving, Texas
 75039-2298
 (580) 2010-10-15

(111) M 2009 019282 R
 (732) Shps "sanset vilij"
 Gamrekelis q., 19, Tbilisi
 (770) Shps "Elit-Pro"
 Vazha-Pshavelas gamz. 26, Tbilisi
 (580) 2010-10-08

(111) M 2009 019283 R
 (732) Shps "sanset vilij"
 Gamrekelis q., 19, Tbilisi
 (770) Shps "Elit-Pro"
 Vazha-Pshavelas gamz. 26, Tbilisi
 (580) 2010-10-08

(111) M 1994 000216 R1
 (732) EXXON MOBIL CORPORATION
 A New Jersey corporation; 5959 Las Colinas
 Boulevard, Irving, Texas

(770) ExxonMobil Oil Corporation
5959 Las Colinas Boulevard, IRVING,
Texas 75039-2298
(580) 2010-10-15

75039-2298
(580) 2010-10-15

(111) M 1994 000217 R1
(732) EXXON MOBIL CORPORATION
A New Jersey corporation
5959 Las Colinas Boulevard, Irving, Texas
(770) ExxonMobil Oil Corporation
5959 Las Colinas Boulevard, IRVING,
Texas 75039-2298
(580) 2010-10-15

(111) M 1994 000407 R1
(732) EXXON MOBIL CORPORATION
A New Jersey corporation; 5959 Las Colinas
Boulevard, Irving, Texas
(770) ExxonMobil Oil Corporation
5959 Las Colinas Boulevard, IRVING, Texas
75039-2298
(580) 2010-10-15

(111) M 1994 000373 R1
(732) EXXON MOBIL CORPORATION
A New Jersey corporation; 5959 Las Colinas
Boulevard, Irving, Texas
(770) ExxonMobil Oil Corporation
5959 Las Colinas Boulevard, IRVING, Texas
75039-2298
(580) 2010-10-15

(111) M 1994 000408 R1
(732) EXXON MOBIL CORPORATION
A New Jersey corporation; 5959 Las Colinas
Boulevard, Irving, Texas
(770) ExxonMobil Oil Corporation
5959 Las Colinas Boulevard, IRVING, Texas
75039-2298
(580) 2010-10-15

(111) M 1994 000374 R1
(732) EXXON MOBIL CORPORATION
A New Jersey corporation; 5959 Las Colinas
Boulevard, Irving, Texas
(770) ExxonMobil Oil Corporation
5959 Las Colinas Boulevard, IRVING,
Texas 75039-2298
(580) 2010-10-15

(111) M 1994 000409 R1
(732) EXXON MOBIL CORPORATION
A New Jersey corporation; 5959 Las Colinas
Boulevard, Irving, Texas
(770) ExxonMobil Oil Corporation
5959 Las Colinas Boulevard, IRVING, Texas
75039-2298
(580) 2010-10-15

(111) M 1994 000375 R1
(732) EXXON MOBIL CORPORATION
A New Jersey corporation
5959 Las Colinas Boulevard, Irving, Texas
(770) ExxonMobil Oil Corporation
5959 Las Colinas Boulevard, IRVING, Texas
75039-2298
(580) 2010-10-15

(111) M 1994 000410 R1
(732) EXXON MOBIL CORPORATION
A New Jersey corporation; 5959 Las Colinas
Boulevard, Irving, Texas
(770) ExxonMobil Oil Corporation
5959 Las Colinas Boulevard, IRVING, Texas
75039-2298
(580) 2010-10-15

(111) M 1996 003750 R1
(732) EXXON MOBIL CORPORATION
A New Jersey corporation; 5959 Las Colinas
Boulevard, Irving, Texas
(770) ExxonMobil Oil Corporation
5959 Las Colinas Boulevard, IRVING, Texas
75039-2298
(580) 2010-10-15

(111) M 1994 000411 R1
(732) EXXON MOBIL CORPORATION
A New Jersey corporation; 5959 Las Colinas
Boulevard, Irving, Texas
(770) ExxonMobil Oil Corporation
5959 Las Colinas Boulevard, IRVING, Texas
75039-2298
(580) 2010-10-15

(111) M 1994 000400 R1
(732) EXXON MOBIL CORPORATION
A New Jersey corporation; 5959 Las Colinas
Boulevard, Irving, Texas
(770) ExxonMobil Oil Corporation
5959 Las Colinas Boulevard, IRVING, Texas

(111) M 1994 000412 R1
(732) EXXON MOBIL CORPORATION
A New Jersey corporation; 5959 Las Colinas
Boulevard, Irving, Texas
(770) ExxonMobil Oil Corporation
5959 Las Colinas Boulevard, IRVING, Texas
75039-2298
(580) 2010-10-15

(111) M 1994 000414 R1
(732) EXXON MOBIL CORPORATION
A New Jersey corporation; 5959 Las Colinas
Boulevard, Irving, Texas
(770) ExxonMobil Oil Corporation
5959 Las Colinas Boulevard, IRVING, Texas
75039-2298
(580) 2010-10-15

(111) M 1994 000415 R1
(732) EXXON MOBIL CORPORATION
A New Jersey corporation; 5959 Las Colinas
Boulevard, Irving, Texas
(770) ExxonMobil Oil Corporation
5959 Las Colinas Boulevard, IRVING, Texas
75039-2298
(580) 2010-10-15

(111) M 1994 000432 R1
(732) EXXON MOBIL CORPORATION
A New Jersey corporation; 5959 Las Colinas
Boulevard, Irving, Texas
(770) ExxonMobil Oil Corporation
5959 Las Colinas Boulevard, IRVING, Texas
75039-2298
(580) 2010-10-15

(111) M 1994 000433 R1
(732) EXXON MOBIL CORPORATION
A New Jersey corporation; 5959 Las Colinas
Boulevard, Irving, Texas
(770) ExxonMobil Oil Corporation
5959 Las Colinas Boulevard, IRVING, Texas
75039-2298
(580) 2010-10-15

(111) M 1994 000438 R1
(732) EXXON MOBIL CORPORATION
A New Jersey corporation; 5959 Las Colinas
Boulevard, Irving, Texas
(770) ExxonMobil Oil Corporation
5959 Las Colinas Boulevard, IRVING, Texas
75039-2298
(580) 2010-10-15

(111) M 1994 000445 R1
(732) EXXON MOBIL CORPORATION
A New Jersey corporation; 5959 Las Colinas
Boulevard, Irving, Texas
(770) ExxonMobil Oil Corporation
5959 Las Colinas Boulevard, IRVING, Texas
75039-2298
(580) 2010-10-15

(111) M 1997 004762 R1
(732) EXXON MOBIL CORPORATION
A New Jersey corporation; 5959 Las Colinas
Boulevard, Irving, Texas
(770) ExxonMobil Oil Corporation
5959 Las Colinas Boulevard, IRVING, Texas
75039-2298
(580) 2010-10-15

(111) M 1997 004763 R1
(732) EXXON MOBIL CORPORATION
A New Jersey corporation; 5959 Las Colinas
Boulevard, Irving, Texas
(770) ExxonMobil Oil Corporation
5959 Las Colinas Boulevard, IRVING, Texas
75039-2298
(580) 2010-10-15

(111) M 1997 004764 R1
(732) EXXON MOBIL CORPORATION
A New Jersey corporation; 5959 Las Colinas
Boulevard, Irving, Texas
(770) ExxonMobil Oil Corporation
5959 Las Colinas Boulevard, IRVING, Texas
75039-2298
(580) 2010-10-15

(111) M 1997 004765 R1
(732) EXXON MOBIL CORPORATION
A New Jersey corporation; 5959 Las Colinas
Boulevard, Irving, Texas
(770) ExxonMobil Oil Corporation
5959 Las Colinas Boulevard, IRVING, Texas
75039-2298
(580) 2010-10-15

(111) M 1995 000604 R1
(732) EXXON MOBIL CORPORATION
A New Jersey corporation; 5959 Las Colinas
Boulevard, Irving, Texas
(770) ExxonMobil Oil Corporation
5959 Las Colinas Boulevard, IRVING, Texas
75039-2298
(580) 2010-10-15

(111) M 1994 000077 R1
(732) EXXON MOBIL CORPORATION
A New Jersey corporation; 5959 Las Colinas
Boulevard, Irving, Texas
(770) ExxonMobil Oil Corporation
5959 Las Colinas Boulevard, IRVING, Texas
75039-2298

(580) 2010-10-15

(111) M 1994 000078 R1

(732) EXXON MOBIL CORPORATION

A New Jersey corporation; 5959 Las Colinas
Boulevard, Irving, Texas

(770) ExxonMobil Oil Corporation

5959 Las Colinas Boulevard, IRVING, Texas
75039-2298

(580) 2010-10-15

(111) M 1994 000079 R1

(732) EXXON MOBIL CORPORATION

A New Jersey corporation; 5959 Las Colinas
Boulevard, Irving, Texas

(770) ExxonMobil Oil Corporation

5959 Las Colinas Boulevard, IRVING, Texas
75039-2298

(580) 2010-10-15

CHANGES IN NAMES AND/OR ADDRESSES OF OWNERS

ИЗМЕНЕНИЯ ИМЕН И/ИЛИ АДРЕСОВ ВЛАДЕЛЬЦЕВ

(111) M 1998 010386 R1
(732) Lady Cake-Feine Kuchen GmbH
Thoner Weg 23, 90425 Nürnberg
(770) LADY CAKE-FEINE KUCHEN GMBH
Warweg 7, D-31089 Duingen
(580) 2010-10-18

(111) M 1998 010386 R1
(732) A & D Nürnberger Feinbackwaren GmbH
Thoner Weg 23, 90425 Nürnberg
(770) Lady Cake-Feine Kuchen GmbH
Thoner Weg 23, 90425 Nürnberg
(580) 2010-10-18

(111) M 2000 013414 R1
(732) WILLIS GROUP LIMITED
51 Lime Street, London EC3M 7DQ
(770) WILLIS CORROON GROUP LIMITED
Ten Trinity Square, London EC3P 3AX
(580) 2010-10-08

(111) M 2000 013501 R1
(732) BADISCHE TABAKMANUFAKTUR
ROTH-HAENDLE GmbH
Max-Born-Strasse 4, 22761 Hamburg
(770) BADISCHE TABAKMANUFAKTUR
ROTH-HANDLE GMBH
Industriehof 6, D-77933 Lahr/Schwarzwald
(580) 2010-10-28

CLASSIFICATION INDEXES СИСТЕМАТИЧЕСКИЕ УКАЗАТЕЛИ

INVENTIONS ИЗОБРЕТЕНИЯ

CONCORDANCE TABLE OF INTERNATIONAL CLASSIFICATION INDEX WITH REFERENCE TO NUMBERS OF PUBLISHED APPLICATIONS

ТАБЛИЦА СООТВЕТСТВИЙ ИНДЕКСОВ МЕЖДУНАРОДНОЙ КЛАССИФИКАЦИИ С НОМЕРАМИ
ОПУБЛИКОВАННЫХ ЗАЯВОК

INTERNATIONAL CLASSIFICATION INDEXES ИНДЕКСА МЕЖДУНАРОДНОЙ КЛАССИФИКАЦИИ (51)	NUMBER OF PUBLISHED APPLICATION НОМЕР ПУБЛИКАЦИИ ЗАЯВКИ (10)
A 01 D 46/04	AP 2010 11440 A
A 01 G 17/00	AP 2010 11681 A
A 01 N 25/32; A 01 N 37/10; A 01 N 43/78; A 01 N 43/80; A 01 N 43/56	AP 2010 11138 A
A 61 B 17/00; A 61 M 37/00; A 61 F 2/00	AP 2010 11390 A
A 61 H 39/00; A 61 H 39/04; A 61 H 39/08	AP 2010 10522 A
A 61 K 31/337; A 61 K 31/395; A 61 K 31/4745; A 61 K 31/505; A 61 K 31/517; A 61 K 31/519; A 61 K 31/5377; A 61 K 31/565; A 61 K 31/704; A 61 P 35/00	AP 2010 11244 A
A 61 K 33/18; A 61 K 31/10; A 61 K 47/44; A 61 K 9/02; A 61 P 15/02; A 61 P 31/04	AP 2010 10932 A
C 07 D 209/00; A 61 K 31/404	AP 2010 11011 A
C 07 D 209/42; A 61 K 31/404; A 61 P 25/00; A 61 P 15/00; A 61 P 35/00; A 61 P 9/00; A 61 P 1/00	AP 2010 11252 A
C 07 D 307/82; C 07 D 277/02; C 07 D 333/62; A 61 K 31/343; A 61 K 31/381; A 61 K 31/428; A 61 P 25/16	AP 2010 10512 A
C 07 D 471/04; A 61 K 31/437; A 61 P 3/04; A 61 P 3/06; A 61 P 3/10	AP 2010 10823 A
C 07 D 471/04; C 07 D 487/04; A 61 K 31/498; A 61 P 35/00	AP 2010 10489 A
C 10 L 5/02, 5/06	AP 2010 10785 A
G 01 N 27/00; G 01 N 27/72; G 01 N 27/82	AP 2010 11210 A

**CONCORDANCE TABLE OF NUMBERS OF PUBLISHED APPLICATIONS WITH
REFERENCE TO INTERNATIONAL CLASSIFICATION INDEX**

ТАБЛИЦА СООТВЕТСТВИЙ НОМЕРОВ ПУБЛИКАЦИЙ ЗАЯВОК С ИНДЕКСАМИ
МЕЖДУНАРОДНОЙ КЛАССИФИКАЦИИ

NUMBER OF PUBLISHED APPLICATION НОМЕР ПУБЛИКАЦИИ ЗАЯВКИ (10)	INTERNATIONAL CLASSIFICATION INDEXES ИНДЕКСА МЕЖДУНАРОДНОЙ КЛАССИФИКАЦИИ (51)
AP 2010 10489 A	C 07 D 471/04; C 07 D 487/04; A 61 K 31/498; A 61 P 35/00
AP 2010 10512 A	C 07 D 307/82; C 07 D 277/02; C 07 D 333/62; A 61 K 31/343; A 61 K 31/381; A 61 K 31/428; A 61 P 25/16
AP 2010 10522 A	A 61 H 39/00; A 61 H 39/04; A 61 H 39/08
AP 2010 10785 A	C 10 L 5/02, 5/06
AP 2010 10823 A	C 07 D 471/04; A 61 K 31/437; A 61 P 3/04; A 61 P 3/06; A 61 P 3/10
AP 2010 10932 A	A 61 K 33/18; A 61 K 31/10; A 61 K 47/44; A 61 K 9/02; A 61 P 15/02; A 61 P 31/04
AP 2010 11011 A	C 07 D 209/00; A 61 K 31/404
AP 2010 11138 A	A 01 N 25/32; A 01 N 37/10; A 01 N 43/78; A 01 N 43/80; A 01 N 43/56
AP 2010 11210 A	G 01 N 27/00; G 01 N 27/72; G 01 N 27/82
AP 2010 11244 A	A 61 K 31/337; A 61 K 31/395; A 61 K 31/4745; A 61 K 31/505; A 61 K 31/517; A 61 K 31/519; A 61 K 31/5377; A 61 K 31/565; A 61 K 31/704; A 61 P 35/00
AP 2010 11252 A	C 07 D 209/42; A 61 K 31/404; A 61 P 25/00; A 61 P 15/00; A 61 P 35/00; A 61 P 9/00; A 61 P 1/00
AP 2010 11390 A	A 61 B 17/00; A 61 M 37/00; A 61 F 2/00
AP 2010 11440 A	A 01 D 46/04
AP 2010 11681 A	A 01 G 17/00

**CONCORDANCE TABLE OF INTERNATIONAL CLASSIFICATION INDEX WITH
REFERENCE TO NUMBERS OF PATENTS AND NUMBERS OF PUBLISHED
APPLICATIONS**

ТАБЛИЦА СООТВЕТСТВИЙ ИНДЕКСОВ МЕЖДУНАРОДНОЙ КЛАССИФИКАЦИИ С НОМЕРАМИ
ПАТЕНТОВ И С НОМЕРАМИ ОПУБЛИКОВАННЫХ ЗАЯВОК

INTERNATIONAL CLASSIFICATION INDEX ИНДЕКС МЕЖДУНАРОДНОЙ КЛАССИФИКАЦИИ (51)	NUMBER OF PATENT НОМЕР ПАТЕНТА (11)	NUMBER OF PUBLISHED APPLICATION НОМЕР ПУБЛИКАЦИИ ЗАЯВКИ (10)
A 21 D 13/02	P 2010 5117 B	AP 2010 11176 A
A 23 G 3/52	P 2010 5113 B	AP 2010 10598 A
B 60 G 21/04	P 2010 5116 B	AP 2010 10703 A
B 65 D 5/00; B 65 D 5/44	P 2010 5114 B	AP 2010 10634 A
C 01 B 11/02; B 01 J 8/02, 19/24, 3/00	P 2010 5109 B	AP 2010 9628 A
C 07 C 27/06	P 2010 5115 B	AP 2010 10705 A
C 07 K 14/705, 19/00	P 2010 5110 B	AP 2010 9904 A
C 12 N 15/62; C 07 K 14/705; A 61 K 38/17	P 2010 5111 B	AP 2010 9905 A
E 04 B 7/14	P 2010 5112 B	AP 2010 10109 A

**CONCORDANCE TABLES OF NUMBERS OF PATENTS AND NUMBERS OF
PUBLISHED APPLICATIONS WITH REFERENCE TO CLASSIFICATION INDEX**

ТАБЛИЦА СООТВЕТСТВИЙ НОМЕРОВ ПАТЕНТОВ И НОМЕРОВ ПУБЛИКАЦИЙ ЗАЯВОК С
ИНДЕКСАМИ МЕЖДУНАРОДНОЙ КЛАССИФИКАЦИИ

NUMBER OF PATENT НОМЕР ПАТЕНТА (11)	NUMBER OF PUBLISHED APPLICATION НОМЕР ПУБЛИКАЦИИ ЗАЯВКИ (10)	INTERNATIONAL CLASSIFICATION INDEX ИНДЕКС МЕЖДУНАРОДНОЙ КЛАССИФИКАЦИИ (51)
P 2010 5109 B	AP 2010 9628 A	C 01 B 11/02; B 01 J 8/02, 19/24, 3/00
P 2010 5110 B	AP 2010 9904 A	C 07 K 14/705, 19/00
P 2010 5111 B	AP 2010 9905 A	C 12 N 15/62; C 07 K 14/705; A 61 K 38/17
P 2010 5112 B	AP 2010 10109 A	E 04 B 7/14
P 2010 5113 B	AP 2010 10598 A	A 23 G 3/52
P 2010 5114 B	AP 2010 10634 A	B 65 D 5/00; B 65 D 5/44
P 2010 5115 B	AP 2010 10705 A	C 07 C 27/06
P 2010 5116 B	AP 2010 10703 A	B 60 G 21/04
P 2010 5117 B	AP 2010 11176 A	A 21 D 13/02

**CONCORDANCE TABLE OF NUMBERS OF APPLICATIONS, NUMBERS OF
PUBLISHED APPLICATIONS AND NUMBERS OF PATENTS**

ТАБЛИЦА СООТВЕТСТВИЙ НОМЕРОВ ЗАЯВОК, НОМЕРОВ ПУБЛИКАЦИЙ ЗАЯВОК И НОМЕРОВ
ПАТЕНТОВ

NUMBER OF APPLICATION НОМЕР ЗАЯВКИ (21)	NUMBER OF PUBLISHED APPLICATION НОМЕР ПУБЛИКАЦИИ ЗАЯВКИ (10)	NUMBER OF PATENT НОМЕР ПАТЕНТА (11)
AP 2005 009628	AP 2010 9628 A	P 2010 5109 B
AP 2005 009904	AP 2010 9904 A	P 2010 5110 B
AP 2005 009905	AP 2010 9905 A	P 2010 5111 B
AP 2007 010109	AP 2010 10109 A	P 2010 5112 B
AP 2008 010598	AP 2010 10598 A	P 2010 5113 B
AP 2006 010634	AP 2010 10634 A	P 2010 5114 B
AP 2006 010705	AP 2010 10705 A	P 2010 5115 B
AP 2008 010703	AP 2010 10703 A	P 2010 5116 B
AP 2009 011176	AP 2010 11176 A	P 2010 5117 B

UTILITY MODELS
ПОЛЕЗНЫЕ МОДЕЛИ

CONCORDANCE TABLE OF INTERNATIONAL CLASSIFICATION INDEX WITH REFERENCE TO NUMBERS OF PUBLISHED APPLICATIONS

ТАБЛИЦА СООТВЕТСТВИЙ ИНДЕКСОВ МЕЖДУНАРОДНОЙ КЛАССИФИКАЦИИ С НОМЕРАМИ ОПУБЛИКОВАННЫХ ЗАЯВОК

INTERNATIONAL CLASSIFICATION INDEXES ИНДЕКСА МЕЖДУНАРОДНОЙ КЛАССИФИКАЦИИ (51)	NUMBER OF PUBLISHED APPLICATION НОМЕР ПУБЛИКАЦИИ ЗАЯВКИ (10)
A 01 D 89/00	AU 2010 11710 U

CONCORDANCE TABLE OF NUMBERS OF PUBLISHED APPLICATIONS WITH REFERENCE TO INTERNATIONAL CLASSIFICATION INDEX

ТАБЛИЦА СООТВЕТСТВИЙ НОМЕРОВ ПУБЛИКАЦИЙ ЗАЯВОК С ИНДЕКСАМИ МЕЖДУНАРОДНОЙ КЛАССИФИКАЦИИ

NUMBER OF PUBLISHED APPLICATION НОМЕР ПУБЛИКАЦИИ ЗАЯВКИ (10)	INTERNATIONAL CLASSIFICATION INDEXES ИНДЕКСА МЕЖДУНАРОДНОЙ КЛАССИФИКАЦИИ (51)
AU 2010 11710 U	A 01 D 89/00

CONCORDANCE TABLE OF INTERNATIONAL CLASSIFICATION INDEX WITH REFERENCE TO NUMBERS OF PATENTS AND NUMBERS OF PUBLISHED APPLICATIONS

ТАБЛИЦА СООТВЕТСТВИЙ ИНДЕКСОВ МЕЖДУНАРОДНОЙ КЛАССИФИКАЦИИ С НОМЕРАМИ ПАТЕНТОВ И С НОМЕРАМИ ОПУБЛИКОВАННЫХ ЗАЯВОК

INTERNATIONAL CLASSIFICATION INDEX ИНДЕКС МЕЖДУНАРОДНОЙ КЛАССИФИКАЦИИ (51)	NUMBER OF PATENT НОМЕР ПАТЕНТА (11)	NUMBER OF PUBLISHED APPLICATION НОМЕР ПУБЛИКАЦИИ ЗАЯВКИ (10)
A 01 B 49/00	U 2010 1630 Y	AU 2010 11485 U
A 01 D 46/04	U 2010 1631 Y	AU 2010 11502 U
G 01 C 11/00	U 2010 1632 Y	AU 2010 11590 U

CONCORDANCE TABLE OF NUMBERS OF PATENTS AND NUMBERS OF PUBLISHED APPLICATIONS WITH REFERENCE TO CLASSIFICATION INDEX

ТАБЛИЦА СООТВЕТСТВИЙ НОМЕРОВ ПАТЕНТОВ И НОМЕРОВ ПУБЛИКАЦИЙ ЗАЯВОК С ИНДЕКСАМИ МЕЖДУНАРОДНОЙ КЛАССИФИКАЦИИ

NUMBER OF PATENT НОМЕР ПАТЕНТА (11)	NUMBER OF PUBLISHED APPLICATION НОМЕР ПУБЛИКАЦИИ ЗАЯВКИ (10)	INTERNATIONAL CLASSIFICATION INDEX ИНДЕКС МЕЖДУНАРОДНОЙ КЛАССИФИКАЦИИ (51)
U 2010 1630 Y	AU 2010 11485 U	A 01 B 49/00
U 2010 1631 Y	AU 2010 11502 U	A 01 D 46/04
U 2010 1632 Y	AU 2010 11590 U	G 01 C 11/00

CONCORDANCE TABLE OF NUMBERS OF APPLICATIONS, NUMBERS OF PUBLISHED APPLICATIONS AND NUMBERS OF PATENTS

ТАБЛИЦА СООТВЕТСТВИЙ НОМЕРОВ ЗАЯВОК, НОМЕРОВ ПУБЛИКАЦИЙ ЗАЯВОК И НОМЕРОВ ПАТЕНТОВ

NUMBER OF APPLICATION НОМЕР ЗАЯВКИ (21)	NUMBER OF PUBLISHED APPLICATION НОМЕР ПУБЛИКАЦИИ ЗАЯВКИ (10)	NUMBER OF PATENT НОМЕР ПАТЕНТА (11)
AU 2009 011485	AU 2010 11485 U	U 2010 1630 Y
AU 2009 011502	AU 2010 11502 U	U 2010 1631 Y
AU 2009 011590	AU 2010 11590 U	U 2010 1632 Y

INDUSTRIAL DESIGNS
ПРОМЫШЛЕННЫЕ ОБРАЗЦЫ

CONCORDANCE TABLE OF INTERNATIONAL CLASSIFICATION INDEX WITH REFERENCE TO NUMBERS OF PUBLISHED APPLICATIONS

ТАБЛИЦА СООТВЕТСТВИЙ ИНДЕКСОВ МЕЖДУНАРОДНОЙ КЛАССИФИКАЦИИ С НОМЕРАМИ ОПУБЛИКОВАННЫХ ЗАЯВОК

INTERNATIONAL CLASSIFICATION INDEXES ИНДЕКСА МЕЖДУНАРОДНОЙ КЛАССИФИКАЦИИ (51)	NUMBER OF PUBLISHED APPLICATION НОМЕР ПУБЛИКАЦИИ ЗАЯВКИ (10)
06-01	AD 2010 602 S
06-02,03,04,05	AD 2010 596 S
07-06	AD 2010 610 S
09-01	AD 2010 611 S
25-02	AD 2010 607 S

**CONCORDANCE TABLE OF NUMBERS OF PUBLISHED APPLICATIONS WITH
REFERENCE TO INTERNATIONAL CLASSIFICATION INDEX**

ТАБЛИЦА СООТВЕТСТВИЙ НОМЕРОВ ПУБЛИКАЦИЙ ЗАЯВОК С ИНДЕКСАМИ
МЕЖДУНАРОДНОЙ КЛАССИФИКАЦИИ

NUMBER OF PUBLISHED APPLICATION НОМЕР ПУБЛИКАЦИИ ЗАЯВКИ (10)	INTERNATIONAL CLASSIFICATION INDEXES ИНДЕКСА МЕЖДУНАРОДНОЙ КЛАССИФИКАЦИИ (51)
AD 2010 596 S	06-02,03,04,05
AD 2010 602 S	06-01
AD 2010 607 S	25-02
AD 2010 610 S	07-06
AD 2010 611 S	09-01

TRADEMARKS

ТОВАРНЫЕ ЗНАКИ

CONCORDANCE TABLE OF NUMBERS OF REGISTRATIONS OF TRADEMARKS, NUMBERS OF APPLICATIONS, NUMBERS OF PUBLISHED APPLICATIONS WITH REFERENCE TO NUMBERS OF BULLETINS

ТАБЛИЦА СООТВЕТСТВИЙ НОМЕРОВ РЕГИСТРАЦИЙ ТОВАРНЫХ ЗНАКОВ С НОМЕРАМИ
ЗАЯВОК, НОМЕРАМИ ПУБЛИКАЦИЙ ЗАЯВОК И НОМЕРАМИ БЮЛЛЕТЕНЕЙ

NUMBER OF REGISTRATION НОМЕР РЕГИСТРАЦИИ (111)	NUMBER OF APPLICATION НОМЕР ЗАЯВКИ (210)	NUMBER OF PUBLISHED APPLICATION НОМЕР ПУБЛИКАЦИИ ЗАЯВКИ (260)	NUMBER OF BULLETIN НОМЕР БЮЛЛЕТЕНЯ
1	2	3	4
M 2010 20831 R	AM 2008 46959	AM 2010 46959 A*	№13(305) 2010
M 2010 20832 R	AM 2008 47492	AM 2010 47492 A*	№12(304) 2010
M 2010 20833 R	AM 2008 47493	AM 2010 47493 A*	№12(304) 2010
M 2010 20834 R	AM 2008 50520	AM 2010 50520 A*	№8(300) 2010
M 2010 20835 R	AM 2008 51105	AM 2010 51105 A*	№12(304) 2010
M 2010 20836 R	AM 2009 53329	AM 2010 53329 A*	№12(304) 2010
M 2010 20837 R	AM 2009 53330	AM 2010 53330 A*	№12(304) 2010
M 2010 20838 R	AM 2009 53331	AM 2010 53331 A*	№12(304) 2010
M 2010 20839 R	AM 2009 53332	AM 2010 53332 A*	№12(304) 2010
M 2010 20840 R	AM 2009 53660	AM 2010 53660 A	№7(299) 2010
M 2010 20841 R	AM 2009 53862	AM 2010 53862 A	№7(299) 2010
M 2010 20842 R	AM 2009 54042	AM 2010 54042 A	№7(299) 2010
M 2010 20843 R	AM 2009 54127	AM 2010 54127 A	№8(300) 2010
M 2010 20844 R	AM 2009 54373	AM 2010 54373 A	№8(300) 2010
M 2010 20845 R	AM 2009 54918	AM 2010 54918 A	№9(301) 2010
M 2010 20846 R	AM 2009 54919	AM 2010 54919 A	№9(301) 2010
M 2010 20847 R	AM 2009 54920	AM 2010 54920 A	№9(301) 2010
M 2010 20848 R	AM 2009 54921	AM 2010 54921 A	№9(301) 2010
M 2010 20849 R	AM 2009 55033	AM 2010 55033 A	№12(304) 2010
M 2010 20850 R	AM 2009 55034	AM 2010 55034 A	№12(304) 2010
M 2010 20851 R	AM 2009 55101	AM 2010 55101 A	№12(304) 2010
M 2010 20852 R	AM 2009 55102	AM 2010 55102 A	№12(304) 2010
M 2010 20853 R	AM 2009 55220	AM 2010 55220 A	№12(304) 2010
M 2010 20854 R	AM 2009 55221	AM 2010 55221 A	№12(304) 2010
M 2010 20855 R	AM 2009 55222	AM 2010 55222 A	№12(304) 2010
M 2010 20856 R	AM 2009 55223	AM 2010 55223 A	№12(304) 2010
M 2010 20857 R	AM 2009 55224	AM 2010 55224 A	№12(304) 2010
M 2010 20858 R	AM 2009 55225	AM 2010 55225 A	№12(304) 2010
M 2010 20859 R	AM 2009 55226	AM 2010 55226 A	№12(304) 2010
M 2010 20860 R	AM 2009 55227	AM 2010 55227 A	№12(304) 2010
M 2010 20861 R	AM 2009 55228	AM 2010 55228 A	№12(304) 2010
M 2010 20862 R	AM 2009 55248	AM 2010 55248 A	№12(304) 2010
M 2010 20863 R	AM 2009 55269	AM 2010 55269 A	№12(304) 2010
M 2010 20864 R	AM 2009 55340	AM 2010 55340 A	№12(304) 2010
M 2010 20865 R	AM 2007 43463	AM 2010 43463 A	№13(305) 2010
M 2010 20866 R	AM 2008 46964	AM 2010 46964 A	№13(305) 2010
M 2010 20867 R	AM 2008 46965	AM 2010 46965 A	№13(305) 2010
M 2010 20868 R	AM 2008 48458	AM 2010 48458 A	№13(305) 2010
M 2010 20869 R	AM 2009 52294	AM 2010 52294 A	№12(304) 2010
M 2010 20870 R	AM 2009 54402	AM 2010 54402 A	№8(300) 2010
M 2010 20871 R	AM 2009 54532	AM 2010 54532 A	№8(300) 2010
M 2010 20872 R	AM 2009 54639	AM 2010 54639 A	№9(301) 2010

1	2	3	4
M 2010 20873 R	AM 2007 46196	AM 2010 46196 A	№8(300) 2010
M 2010 20874 R	AM 2008 51387	AM 2010 51387 A	№8(300) 2010
M 2010 20875 R	AM 2009 53801	AM 2010 53801 A	№8(300) 2010
M 2010 20876 R	AM 2009 54372	AM 2010 54372 A	№8(300) 2010
M 2010 20877 R	AM 2009 54511	AM 2010 54511 A	№8(300) 2010
M 2010 20878 R	AM 2010 59825	AM 2010 59825 A	№21(313) 2010
M 2010 20879 R	AM 2010 59826	AM 2010 59826 A	№21(313) 2010

CONCORDANCE TABLE OF NUMBERS OF PUBLISHED TRADEMARK APPLICATIONS WITH REFERENCE TO NUMBERS OF APPLICATIONS

ТАБЛИЦА СООТВЕТСТВИЙ НОМЕРОВ ПУБЛИКАЦИЙ ТОВАРНЫХ ЗНАКОВ И НОМЕРОВ ЗАЯВОК

NUMBER OF PUBLISHED APPLICATION НОМЕР ПУБЛИКАЦИИ ЗАЯВКИ (260)	NUMBER OF APPLICATION НОМЕР ЗАЯВКИ (210)	1	2
1	2		
AM 2010 48327 A*	AM2008 48327	AM 2010 56815 A	AM 2010 56815
AM 2010 53380 A*	AM 2009 53380	AM 2010 56816 A	AM 2010 56816
AM 2010 53434 A*	AM 2009 53434	AM 2010 56817 A	AM 2010 56817
AM 2010 53435 A*	AM 2009 53435	AM 2010 56821 A	AM 2010 56821
AM 2010 54103 A*	AM 2009 54103	AM 2010 56822 A	AM 2010 56822
AM 2010 55000 A	AM 2009 55000	AM 2010 56823 A	AM 2010 56823
AM 2010 55090 A	AM 2009 55090	AM 2010 56824 A	AM 2010 56824
AM 2010 55232 A	AM 2009 55232	AM 2010 56933 A	AM 2010 56933
AM 2010 55249 A	AM 2009 55249	AM 2010 56949 A	AM 2010 56949
AM 2010 55454 A	AM 2009 55454	AM 2010 56950 A	AM 2010 56950
AM 2010 55637 A	AM 2009 55637	AM 2010 56951 A	AM 2010 56951
AM 2010 55771 A	AM 2009 55771	AM 2010 56953 A	AM 2010 56953
AM 2010 55949 A	AM 2009 55949	AM 2010 56960 A	AM 2010 56960
AM 2010 56012 A	AM 2009 56012	AM 2010 56990 A	AM 2010 56990
AM 2010 56014 A	AM 2009 56014	AM 2010 56991 A	AM 2010 56991
AM 2010 56015 A	AM 2009 56015	AM 2010 56992 A	AM2010 56992
AM 2010 56244 A	AM 2009 56244	AM 2010 56993 A	AM 2010 56993
AM 2010 56362 A	AM 2009 56362	AM 2010 57005 A	AM 2010 57005
AM 2010 56363 A	AM 2009 56363	AM 2010 57006 A	AM 2010 57006
AM 2010 56459 A	AM 2009 56459	AM 2010 57007 A	AM 2010 57007
AM 2010 56461 A	AM 2009 56461	AM 2010 57017 A	AM 2010 57017
AM 2010 56475 A	AM 2009 56475	AM 2010 57018 A	AM 2010 57018
AM 2010 56490 A	AM 2009 56490	AM 2010 57019 A	AM 2010 57019
AM 2010 56645 A	AM 2010 56645	AM 2010 57020 A	AM 2010 57020
AM 2010 56646 A	AM 2010 56646	AM 2010 57021 A	AM 2010 57021
AM 2010 56647 A	AM 2010 56647	AM 2010 57022 A	AM 2010 57022
AM 2010 56648 A	AM 2010 56648	AM 2010 57023 A	AM 2010 57023
AM 2010 56649 A	AM 2010 56649	AM 2010 57024 A	AM 2010 57024
AM 2010 56653 A	AM 2010 56653	AM 2010 57025 A	AM 2010 57025
AM 2010 56679 A	AM 2010 56679	AM 2010 57027 A	AM 2010 57027
AM 2010 56731 A	AM 2010 56731	AM 2010 57028 A	AM 2010 57028
AM 2010 56738 A	AM 2010 56738	AM 2010 57029 A	AM 2010 57029
AM 2010 56739 A	AM 2010 56739	AM 2010 57030 A	AM 2010 57030
AM 2010 56814 A	AM 2010 56814	AM 2010 57035 A	AM 2010 57035
		AM 2010 57036 A	AM 2010 57036
		AM 2010 57037 A	AM 2010 57037
		AM 2010 57038 A	AM 2010 57038
		AM 2010 57039 A	AM 2010 57039
		AM 2010 57051 A	AM 2010 57051

1	2
AM 2010 57082 A	AM 2010 57082
AM 2010 57175 A	AM 2010 57175
AM 2010 57183 A	AM 2010 57183
AM 2010 57184 A	AM 2010 57184
AM 2010 57185 A	AM 2010 57185
AM 2010 57205 A	AM 2010 57205
AM 2010 57206 A	AM 2010 57206
AM 2010 57207 A	AM 2010 57207
AM 2010 57208 A	AM 2010 57208
AM 2010 57209 A	AM 2010 57209
AM 2010 57210 A	AM 2010 57210

1	2
AM 2010 57211 A	AM 2010 57211
AM 2010 57212 A	AM 2010 57212
AM 2010 57213 A	AM 2010 57213
AM 2010 57214 A	AM 2010 57214
AM 2010 57215 A	AM 2010 57215
AM 2010 57216 A	AM 2010 57216
AM 2010 57217 A	AM 2010 57217
AM 2010 57218 A	AM 2010 57218
AM 2010 57219 A	AM 2010 57219
AM 2010 59825 A	AM 2010 59825
AM 2010 59826 A	AM 2010 59826

CONCORDANCE TABLE OF INDEX OF GOODS AND/OR SERVICES WITH REFERENCE TO NUMBERS OF PUBLISHED APPLICATIONS

ТАБЛИЦА СООТВЕТСТВИЙ КЛАССОВ ТОВАРОВ И/ИЛИ УСЛУГ С НОМЕРАМИ
ОПУБЛИКОВАННЫХ ЗАЯВОК

INDEX OF GOODS AND/OR SERVICES КЛАСС ТОВАРОВ И/ИЛИ УСЛУГ (511)	NUMBER OF PUBLISHED APPLICATION НОМЕР ОПУБЛИКОВАННОЙ ЗАЯВКИ (260)
1	2
1	AM 2010 55090 A
1	AM 2010 55232 A
2	AM 2010 55232 A
3	AM 2010 54103 A
3	AM 2010 55090 A
3	AM 2010 55637 A
4	AM 2010 55232 A
5	AM 2010 48327 A
5	AM 2010 53380 A
5	AM 2010 53434 A
5	AM 2010 53435 A
5	AM 2010 54103 A
5	AM 2010 55000 A
5	AM 2010 55090 A
5	AM 2010 55249 A
5	AM 2010 55454 A
5	AM 2010 56012 A
5	AM 2010 56014 A
5	AM 2010 56015 A
5	AM 2010 56475 A
5	AM 2010 56949 A
5	AM 2010 56950 A
5	AM 2010 56951 A
5	AM 2010 56960 A
6	AM 2010 55232 A
7	AM 2010 55090 A
7	AM 2010 55232 A
7	AM 2010 56244 A
8	AM 2010 55232 A
9	AM 2010 55232 A

1	2
9	AM 2010 56459 A
9	AM 2010 57005 A
9	AM 2010 57006 A
9	AM 2010 57007 A
10	AM 2010 48327 A
10	AM 2010 55232 A
10	AM 2010 56475 A
11	AM 2010 55232 A
12	AM 2010 55949 A
13	AM 2010 55232 A
14	AM 2010 55232 A
15	AM 2010 55232 A
16	AM 2010 55232 A
16	AM 2010 57205 A
16	AM 2010 57206 A
16	AM 2010 57207 A
16	AM 2010 57208 A
16	AM 2010 57209 A
16	AM 2010 57210 A
16	AM 2010 57211 A
16	AM 2010 57212 A
16	AM 2010 57213 A
16	AM 2010 57214 A
16	AM 2010 57215 A
16	AM 2010 57216 A
16	AM 2010 57217 A
16	AM 2010 57218 A
16	AM 2010 57219 A
17	AM 2010 55232 A
17	AM 2010 57175 A
18	AM 2010 55232 A
18	AM 2010 57036 A
18	AM 2010 57037 A
18	AM 2010 57038 A
18	AM 2010 57039 A
19	AM 2010 55232 A

1	2
20	AM 2010 55232 A
21	AM 2010 55090 A
21	AM 2010 55232 A
21	AM 2010 57030 A
22	AM 2010 55232 A
23	AM 2010 55232 A
24	AM 2010 55232 A
24	AM 2010 57036 A
24	AM 2010 57037 A
24	AM 2010 57038 A
24	AM 2010 57039 A
25	AM 2010 55232 A
25	AM 2010 56731 A
25	AM 2010 57036 A
25	AM 2010 57037 A
25	AM 2010 57038 A
25	AM 2010 57039 A
25	AM 2010 57205 A
25	AM 2010 57206 A
25	AM 2010 57207 A
25	AM 2010 57208 A
25	AM 2010 57209 A
25	AM 2010 57210 A
25	AM 2010 57211 A
25	AM 2010 57212 A
25	AM 2010 57213 A
25	AM 2010 57214 A
25	AM 2010 57215 A
25	AM 2010 57216 A
25	AM 2010 57217 A
25	AM 2010 57218 A
25	AM 2010 57219 A
26	AM 2010 55232 A
26	AM 2010 57036 A
26	AM 2010 57037 A
26	AM 2010 57038 A
26	AM 2010 57039 A
27	AM 2010 55232 A
28	AM 2010 55232 A
29	AM 2010 55232 A
29	AM 2010 57184 A
29	AM 2010 57185 A
30	AM 2010 55232 A
30	AM 2010 56731 A
30	AM 2010 56821 A
30	AM 2010 56822 A
30	AM 2010 56823 A
30	AM 2010 56824 A
30	AM 2010 57027 A
30	AM 2010 57028 A
30	AM 2010 57029 A
30	AM 2010 57183 A
30	AM 2010 57184 A
30	AM 2010 57185 A

1	2
31	AM 2010 55232 A
32	AM 2010 55232 A
32	AM 2010 56731 A
32	AM 2010 56821 A
32	AM 2010 56933 A
33	AM 2010 55232 A
33	AM 2010 56653 A
33	AM 2010 56731 A
33	AM 2010 56990 A
33	AM 2010 56991 A
33	AM 2010 57025 A
34	AM 2010 56362 A
34	AM 2010 56363 A
34	AM 2010 57022 A
35	AM 2010 55232 A
35	AM 2010 56475 A
35	AM 2010 56490 A
35	AM 2010 56645 A
35	AM 2010 56646 A
35	AM 2010 56647 A
35	AM 2010 56648 A
35	AM 2010 56649 A
35	AM 2010 56679 A
35	AM 2010 56731 A
35	AM 2010 56738 A
35	AM 2010 56739 A
35	AM 2010 56821 A
35	AM 2010 57035 A
35	AM 2010 57036 A
35	AM 2010 57037 A
35	AM 2010 57038 A
35	AM 2010 57039 A
35	AM 2010 57051 A
35	AM 2010 57082 A
35	AM 2010 57184 A
35	AM 2010 57185 A
35	AM 2010 59825 A
35	AM 2010 59826 A
36	AM 2010 55232 A
36	AM 2010 56244 A
36	AM 2010 56459 A
36	AM 2010 56731 A
36	AM 2010 56738 A
36	AM 2010 56739 A
36	AM 2010 56814 A
36	AM 2010 56815 A
36	AM 2010 56816 A
36	AM 2010 56817 A
36	AM 2010 56992 A
36	AM 2010 56993 A
36	AM 2010 57005 A
36	AM 2010 57006 A
36	AM 2010 57007 A
36	AM 2010 57017 A

1	2
36	AM 2010 57018 A
36	AM 2010 57019 A
36	AM 2010 57020 A
36	AM 2010 57021 A
37	AM 2010 55090 A
37	AM 2010 55232 A
37	AM 2010 56738 A
37	AM 2010 56739 A
38	AM 2010 55232 A
38	AM 2010 56244 A
38	AM 2010 57024 A
38	AM 2010 57205 A
38	AM 2010 57206 A
38	AM 2010 57207 A
38	AM 2010 57208 A
38	AM 2010 57209 A
38	AM 2010 57210 A
38	AM 2010 57211 A
38	AM 2010 57212 A
38	AM 2010 57213 A
38	AM 2010 57214 A
38	AM 2010 57215 A
38	AM 2010 57216 A
38	AM 2010 57217 A
38	AM 2010 57218 A
38	AM 2010 57219 A
39	AM 2010 55232 A
39	AM 2010 56244 A
40	AM 2010 55232 A
40	AM 2010 56244 A
41	AM 2010 55090 A
41	AM 2010 55232 A
41	AM 2010 56645 A
41	AM 2010 56646 A
41	AM 2010 56647 A
41	AM 2010 56648 A
41	AM 2010 56649 A
41	AM 2010 56679 A
41	AM 2010 56821 A
41	AM 2010 57024 A
41	AM 2010 57036 A
41	AM 2010 57037 A
41	AM 2010 57038 A
41	AM 2010 57039 A
42	AM 2010 55232 A
42	AM 2010 56731 A
42	AM 2010 57023 A
43	AM 2010 55232 A
43	AM 2010 55771 A
43	AM 2010 56461 A
43	AM 2010 56821 A
43	AM 2010 56953 A
43	AM 2010 57184 A
43	AM 2010 57185 A
44	AM 2010 55232 A
45	AM 2010 55232 A

OFFICIAL BULLETIN OF THE INDUSTRIAL PROPERTY
ОФИЦИАЛЬНЫЙ БЮЛЛЕТЕНЬ ПРОМЫШЛЕННОЙ СОБСТВЕННОСТИ

21 (313)

EDITOR-IN-CHIEF: N. Bebrishvili
ГЛАВНЫЙ РЕДАКТОР: *Н. Бебришвили*

EDITOR: M. Tatishvili
РЕДАКТОР: *М. Татишвили*

EDITORS-TRANSLATORS: M. Sichinava
РЕДАКТОРЫ-ПЕРЕВОДЧИКИ: *М. Сичинава*
G. Nadareishvili
Г. Надарейшвили

PROOFREADER: L. Chanturia
КОРРЕКТОР: *Л. Чантурия*

COMPUTER LAYOUT: M. Ordenidze
КОМПЬЮТЕРНАЯ ВЕРСТКА: *М. Орденидзе*

www.sakpatenti.org.ge

E-mail: info@sakpatenti.org.ge

LIST OF CODES, IN ALPHABETIC SEQUENCE, AND THE CORRESPONDING (SHORT) NAMES OF STATES, OTHER ENTITIES AND INTERGOVERNMENTAL ORGANIZATIONS (ISMO STANDARD ST.3)

AD	Andorra	GD	Grenada	NE	Niger
AE	United Arab Emirates	GG	Guernsey	NG	Nigeria
AF	Afghanistan	GH	Ghana	NI	Nicaragua
AG	Antigua and Barbuda	GI	Gibraltar	NL	Netherlands
AI	Anguilla	GT	Guatemala	NO	Norway
AL	Albania	GW	Guinea- Bissau	NP	Nepal
AM	Armenia	GY	Guyana	NR	Nauru
AN	Netherlands Antilles	HK	The Hong Kong Special Administrative Region of the People's Republic of China	NZ	New Zealand
AO	Angola	HN	Honduras	OA	African Intellectual Property Organization (OAPI)
AP	African Regional Intellectual Property Organization (ARIPO)	HR	Croatia	OM	Oman
AR	Argentina	HT	Haiti	PA	Panama
AT	Austria	HU	Hungary	PE	Peru
AU	Australia	IB	International Bureau of the World Intellectual Property Organization (WIPO)	PG	Papua New Guinea
AW	Aruba	ID	Indonesia	PH	Philippines
AZ	Azerbaijan	IE	Ireland	PK	Pakistan
BA	Bosnia and Herzegovina	IL	Israel	PL	Poland
BB	Barbados	IM	Isle of Man	PT	Portugal
BD	Bangladesh	IN	India	PW	Palau
BE	Belgium	IQ	Iraq	PY	Paraguay
BF	Burkina Faso	ID	Indonesia	QA	Qatar
BG	Bulgaria	IE	Ireland	QZ	Community Plant Variety Office (European Community) (CPVO)
BH	Bahrain	IL	Israel	RO	Romania
BI	Burundi	IM	Isle of Man	RS	Serbia
BJ	Benin	IN	India	RU	Russian Federation
BM	Bermuda	IQ	Iraq	RW	Rwanda
BN	Brunei Darussalam	IR	Iran (Islamic Republic of)	SA	Saudi Arabia
BO	Bolivia	IS	Iceland	SB	Solomon Islands
BR	Brazil	IT	Italy	SC	Seychelles
BS	Bahamas	JE	Jersey	SD	Sudan
BT	Bhutan	JM	Jamaica	SG	Singapore
BV	Bouvet Island	JO	Jordan	SH	Saint Helena
BW	Botswana	JP	Japan	SI	Slovenia
BX	Benelux Office for Intellectual Property (BOIP)	KE	Kenya	SK	Slovakia
BY	Belarus	KG	Kyrgyzstan	SL	Sierra Leone
BZ	Belize	KH	Cambodia	SM	San Marino
CA	Canada	KI	Kiribati	SN	Senegal
CD	Democratic Republic of the Congo	KM	Saint Kitts and Nevis	SO	Somalia
CF	Central African Republic	KP	Democratic People's Republic of Korea	SR	Suriname
CG	Congo	KR	Republic of Korea	ST	Sao Tome and Principe
CH	Switzerland	KW	Kuwait	SV	El Salvador
CI	Cote d'Ivoire	KY	Cayman Islands	SY	Syrian Arab Republic
CK	Cook Islands	KZ	Kazakhstan	SZ	Swaziland
CL	Chile	LA	Lao People's Democratic Republic	TC	Turks and Caicos Islands
CM	Cameroon	LB	Lebanon	TD	Chad
CN	China	LC	Saint Lucia	TG	Togo
CO	Colombia	LI	Liechtenstein	TH	Thailand
CR	Costa Rica	LK	Sri Lanka	TJ	Tajikistan
CU	Cuba	LR	Liberia	TL	Timor-Leste
CV	Cape Verde	LS	Lesotho	TM	Turkmenistan
CY	Cyprus	LT	Lithuania	TN	Tunisia
CZ	Czech Republic	LU	Luxembourg	TO	Tonga
DE	Germany	LV	Latvia	TR	Turkey
DJ	Djibouti	LY	Libyan Arab Jamahiriya	SE	Sweden
DM	Dominica	MA	Morocco	TT	Trinidad and Tobago
DO	Dominican Republic	MC	Monaco	TV	Tuvalu
DZ	Algeria	MD	Republic of Moldova	TW	Taiwan, Province of China
EA	Eurasian Patent Organization (EAPO)	ME	Montenegro	TZ	United Republic of Tanzania
EC	Ecuador	MG	Madagascar	UA	Ukraine
EE	Estonia	MK	The former Yugoslav Republic of Macedonia	UG	Uganda
EG	Egypt	ML	Mali	US	United States of America
EH	Western Sahara	MM	Myanmar	UY	Uruguay
EM	Office for Harmonization in the Internal Market (Trademarks and Designs)(OHIM)	MN	Mongolia	UZ	Uzbekistan
EP	European Patent Office (EPO)	MO	Macao	VA	Holy See
ER	Eritrea	MP	Northern Mariana Islands	VC	Saint Vincent and the Grenadines
ES	Spain	MR	Mauritania	VE	Venezuela
ET	Ethiopia	MS	Montserrat	VG	Virgin Islands (British)
FI	Finland	MT	Malta	VN	Viet Nam
FJ	Fiji	MU	Mauritius	VU	Vanuatu
FK	Falkland Islands (Malvinas)	MV	Maldives	WO	World Intellectual Property Organization (WIPO)
FO	Faroe Islands	MW	Malawi	WS	Samoa
FR	France	MX	Mexico	XN	Nordic Patent Institute (NPI)
GA	Gabon	MY	Malaysia	YE	Yemen
GB	United Kingdom	MZ	Mozambique	ZA	South Africa
GC	Patent Office of the Cooperation Council for the Arab States of the Gulf (GCC)	NA	Namibia	ZM	Zambia
				ZW	Zimbabwe