

NATIONAL INTELLECTUAL PROPERTY
CENTER OF GEORGIA
SAKPATENTI



НАЦИОНАЛЬНЫЙ ЦЕНТР ИНТЕЛЛЕКТУАЛЬНОЙ
СОБСТВЕННОСТИ ГРУЗИИ
САКПАТЕНТИ

**OFFICIAL BULLETIN
OF THE INDUSTRIAL PROPERTY**

**ОФИЦИАЛЬНЫЙ БЮЛЛЕТЕНЬ
ПРОМЫШЛЕННОЙ СОБСТВЕННОСТИ**

22(314)

**2010
TBILISI
ТБИЛИСИ**

INID CODES FOR IDENTIFICATION OF BIBLIOGRAPHIC DATA

INVENTIONS, UTILITY MODELS

- (10) Number of publication for application, which has been examined
- (11) Number of patent and kind of document
- (21) Serial number of application
- (22) Date of filing of the application
- (23) Date of exhibition or the date of the earlier filing and the number of application, if any
- (24) Date from which patent may have effect
- (31) Number of priority application
- (32) Date of filing of priority application
- (33) Code of the country or regional organization allotting priority application number
- (44) Date of publication of application not granted, but examined and number of bulletin
- (45) Date of publication of registered document
- (51) International Patent Classification Index
- (54) Title of the invention
- (57) Abstract
- (60) Number of examined patent document granted by foreign patent office, date from which patent has effect and country code
- (62) Number of the earlier application and in case of divided application, date of filing an application
- (71) Name, surname and address of applicant (country code)
- (72) Name, surname of inventor (country code)
- (73) Name, surname and address of patent owner (country code)
- (74) Name, surname of representative or patent attorney
- (85) Date of commencement of the national phase of International Application
- (86) Number and date of filing of international application
- (87) Number and date of publication of international application

INDUSTRIAL DESIGNS

- (10) Number of publication for application
- (11) Number of patent and kind of document or number of registration
- (15) Date of registration/Date of patent renewal
- (18) Expected expiration date of patent or registration
- (21) Serial number of application
- (22) Date of filing of the application
- (23) Date of exhibition or the date of the earlier filing and the number of application, if any
- (24) Date from which patent may have effect
- (28) Number of industrial designs included in the application
- (30) Data relating to priority (number of application, date of filing of application, two-letter code identifying the authority with whom the priority application was made)
- (31) Number of priority application
- (32) Date of filing of priority application
- (33) Code of the country or regional organization allotting priority application number
- (34) Two-letter code according to WIPO St.3 identifying the authority with which the priority application was made
- (44) Date of publication of industrial design and number of bulletin (the first publication)
- (45) Date of publication of industrial design registered by WIPO and number of bulletin
- (51) International Classification for industrial designs (class and subclass of the Locarno Classification)
- (54) Title of the invention
- (55) Reproduction of the industrial design
- (57) Description of characteristic features of the industrial design including indication of colors
- (62) Number of the earlier application, registration and document number and if available the date of filing an application in case of divided application
- (71) Name, surname and address of applicant (country code)
- (72) Name, surname of creator (country code)
- (73) Name, surname and address of patent owner (country code)
- (74) Name, surname of representative or patent attorney
- (81) Contracting states concerned
II designated contracting states according to the 1960 Act
III designated contracting states according to the 1999 Act
- (85) Owner's permanent address
- (86) Owner's nationality
- (87) Owner's residence
- (88) State in which the owner has a real and effective industrial or commercial establishment

TRADEMARKS

- (111) – Number of registration
- (151) – Date of registration
- (156) – Date of the renewal
- (181) – Expected expiration date of registration
- (186) – Renewal expiration date of registration
- (141) – Date of cancel of duration of the mark
- (210) – Serial number of application
- (220) – Date of filing of the application
- (230) – Date concerning exhibition
- (260) – Number of application, for which favorable decision of examination about registration has been taken (publication number)
- (310) – Number of the first application
- (320) – Date of filing of the first application
- (330) – Code, identifying national or regional Office where the first application was made
- (511) – International Classification of Goods and Services for the purposes of registration of trade marks and/or list of goods and/or services classified according thereto
- (531) – Description of figurative elements of Trade Marks according to the International Classification of the Figurative Elements of Marks
- (540) – Reproduction of Trade Mark
- (550) – Nature and kind of Trade Mark
- (580) – Date of recording of any kind changes in respect of applications or registrations
- (591) – Information concerning colors claimed
- (731) – Name and address of the applicant
- (732) – Name and address of the holder of the registration
- (740) – Name and address of the representative
- (750) – Address for correspondence
- (770) – Name and address of the previous applicant or holder in case of change in ownership
- (771) – Previous name and address of the applicant or holder in case of change in ownership
- (791) – Name and address of the licensee
- (793) – Indication of conditions and/or restrictions under the license (Type of license, number of license agreement, data of license, data of validity of license)
- (800) – Certain data relating to the international registration of Trade Marks under the Protocol Relating to Madrid Agreement (International registration number)

CODES FOR PUBLICATION IN BULLETIN

- (21) AP 0000 000000 – serial number of application for invention
- (10) AP 0000 0000 A – number of published application for invention (first publication)
- (11) P 0000 0000 B – number of patent for invention (second publication)
- (21) AP1 0000 000000 – number of application for imported patent
- (11) PI 0000 0000 A – number of imported patent (first publication)
- (21) AU 0000 000000 – serial number of application for utility model
- (10) AU 0000 000 U – number of published application for utility model (first publication)
- (11) U 0000 000 Y – number of patent for utility model (second publication)
- (21) AD 0000 000000 – serial number of application for industrial design
- (10) AD 0000 000 S – number of published application for industrial design (first publication)
- (11) D 0000 000 S – number of patent for industrial design (second publication)

INTERNATIONAL PATENT CLASSIFICATION FOR INVENTIONS AND UTILITY MODELS

- SECTION A – HUMAN NECESSITIES
- SECTION B – PERFORMING OPERATIONS; TRANSPORTING
- SECTION C – CHEMISTRY; METALLURGY
- SECTION D – TEXTILES; PAPER
- SECTION E – FIXED CONSTRUCTIONS
- SECTION F – MECHANICAL ENGINEERING; LIGHTING; HEATING; WEAPONS; BLASTING
- SECTION G – PHYSICS
- SECTION H – ELECTRICITY

-
- M – Trade Mark
 - (210) AM 0000 000000 – Serial number of application;
 - (260) AAM 0000 00000 A – Publication number of application;
 - (111) M 0000 00000 R – Number of registration;
 - (111) MMM0000 00000 Rn – Number of renewals, in which n=1,2,3;
 - (111) M 0000 00000 R(P) – Number of registration under partial assignment of rights

**NATIONAL INTELLECTUAL PROPERTY CENTER OF GEORGIA
SAKPATENTI**

**НАЦИОНАЛЬНЫЙ ЦЕНТР ИНТЕЛЛЕКТУАЛЬНОЙ СОБСТВЕННОСТИ ГРУЗИИ
САКПАТЕНТИ**

**OFFICIAL BULLETIN
OF THE INDUSTRIAL PROPERTY**

**ОФИЦИАЛЬНЫЙ БЮЛЛЕТЕНЬ
ПРОМЫШЛЕННОЙ СОБСТВЕННОСТИ**

22(314)

**INVENTIONS
ИЗОБРЕТЕНИЯ**

**UTILITY MODELS
ПОЛЕЗНЫЕ МОДЕЛИ**

**INDUSTRIAL DESIGNS
ПРОМЫШЛЕННЫЕ ОБРАЗЦЫ**

**TRADEMARKS
ТОВАРНЫЕ ЗНАКИ**

DATE OF PUBLICATION **25.11.2010** ДАТА ПУБЛИКАЦИИ

CONTENTS

PUBLISHED OBJECTS	3
INVENTIONS	
▪ Patents for inventions	4
UTILITY MODELS	
▪ Patents for utility models	9
INDUSTRIAL DESIGNS	
▪ Patents for industrial designs	11
TRADEMARKS	
▪ Applications filed under the national procedure, laid open for the purpose of taking patent granting decision	27
▪ Registered trademarks	36
▪ Trademarks registered according to the accelerated procedure	39
▪ International trademarks laid open for the purpose of taking protection granting decisions	43
▪ International trademarks protected in Georgia	60
OFFICIAL NOTIFICATIONS	
▪ TRADEMARKS	67
CLASSIFICATION INDEXES	
▪ INVENTIONS	80
▪ UTILITY MODELS	81
▪ INDUSTRIAL DESIGNS	82
▪ TRADEMARKS	84

СОДЕРЖАНИЕ

ОПУБЛИКОВАННЫЕ ОБЪЕКТЫ	3
ИЗОБРЕТЕНИЯ	
▪ Патенты на изобретения	4
ПОЛЕЗНЫЕ МОДЕЛИ	
▪ Патенты на полезные модели	9
ПРОМЫШЛЕННЫЕ ОБРАЗЦЫ*	
▪ Патенты на промышленные образцы	11
ТОВАРНЫЕ ЗНАКИ*	
▪ Заявки, поданные согласно национальной процедуре, по которым вынесено решение о регистрации	27
▪ Зарегистрированные товарные знаки	36
▪ Товарные знаки зарегистрированные по ускоренной процедуре	39
▪ Международные товарные знаки, по которым вынесены решения о предоставлении охраны	43
▪ Международные товарные знаки, охраняемые в Грузии	60
ОФИЦИАЛЬНЫЕ ИЗВЕЩЕНИЯ*	
▪ ТОВАРНЫЕ ЗНАКИ	67
СИСТЕМАТИЧЕСКИЕ УКАЗАТЕЛИ	
▪ ИЗОБРЕТЕНИЯ	80
▪ ПОЛЕЗНЫЕ МОДЕЛИ	81
▪ ПРОМЫШЛЕННЫЕ ОБРАЗЦЫ	82
▪ ТОВАРНЫЕ ЗНАКИ	84

* Информация представлена только на английском языке

PUBLISHED TITLES OF PROTECTION

ОПУБЛИКОВАННЫЕ ОБЪЕКТЫ

INVENTIONS

ИЗОБРЕТЕНИЯ

- **PATENTS:**

ПАТЕНТЫ:
5118-5125

UTILITY MODELS

ПОЛЕЗНЫЕ МОДЕЛИ

- **PATENTS:**

ПАТЕНТЫ:
1633-1636

INDUSTRIAL DESIGNS

ПРОМЫШЛЕННЫЕ ОБРАЗЦЫ

- **PATENTS:**

ПАТЕНТЫ:
442, 443; 72475; 72727; 72768; 72803; 72806; 72834; 72837; 72843, 72844; 72879-72883; 92926;
72937; 72947-72950; 72964; 73552; 73555; 73567; 73592; 73661

TRADEMARKS

ТОВАРНЫЕ ЗНАКИ

- **APPLICATIONS FILED UNDER THE NATIONAL PROCEDURE, LAID OPEN FOR THE PURPOSE OF TAKING PATENT GRANTING DECISION:**

ЗАЯВКИ, ПОДАННЫЕ СОГЛАСНО НАЦИОНАЛЬНОЙ ПРОЦЕДУРЕ, ПО КОТОРЫМ ВЫНЕСЕНО РЕШЕНИЕ О РЕГИСТРАЦИИ:

56684; 56726-56728; 56732-56735; 56794; 56810-56812; 56818-56820; 56825; 56891, 56892;
56894-56897; 56899; 56901; 56903; 56921, 56922; 56929; 56940, 56941; 56961; 56977, 56978; 57008;
57010; 57015, 57016; 57031-57033; 57042; 57052-57054; 57078; 57103, 57104; 57222; 57240; 57243;
57250; 57336; 57359; 57371

- **REGISTERED TRADEMARKS:**

ЗАРЕГИСТРИРОВАННЫЕ ТОВАРНЫЕ ЗНАКИ:
20880-20928

- **INTERNATIONAL TRADEMARKS LAID OPEN FOR THE PURPOSE OF TAKING PROTECTION GRANTING DECISIONS:**

МЕЖДУНАРОДНЫЕ ТОВАРНЫЕ ЗНАКИ, ПО КОТОРЫМ ВЫНЕСЕНЫ РЕШЕНИЯ О ПРЕДОСТАВЛЕНИИ ОХРАНЫ:

56496; 56498; 56517; 56705; 56842-56845; 56850; 56852-56859; 56910-56914; 56952; 56954-56959;
56967; 57000; 57044, 57045; 57047-57050; 57057-57064; 57100, 57101; 57105-57108; 57110;
57112-57117; 57200-57203; 57220, 57221; 57223-57231; 57286-57292; 57294-57298; 57332-57335;
57338-57349; 57352-57354; 57356, 57357; 57362, 57363; 57366-57368; 57388-57392; 57395-57408;
57410-57418

IMPORTED PATENTS

ВВОЗНЫЕ ПАТЕНТЫ

PART A

A 61

(11) PI 2010 5119 B (51) Int. Cl. (2006)

A 61 K 39/395

A 61 K 51/10

C 12 N 15/02

C 07 K 16/46

C 12 P 21/08

C 07 K 16/28

(21) API 2009 011620 (22) 2009 12 24

(24) 2009 12 24

(60) EP 2000149, 1993 11 12

(73) BIOGEN IDEC INC. (US)

14 Cambridge Center, Cambridge,

Massachusetts 02142 (US)

(72) ANDERSON, Darrell R. (US);

HANNA, Nabil (US);

LEONARD, John E. (US);

NEWMAN, Roland A. (US);

RASTETTER, William H. (US);

REFF, Mitchell E. (US)

(74) Shalva Gvaramadze

(54) **CHIMERIC ANTI-CD20 ANTIBODY**

(57) This invention refers to immunologically active, chimeric anti-CD20 antibody.

Claims: 3 independent

7 dependent

Fig.: 14

(11) PI 2010 5119 B (51) Int. Cl. (2006)

A 61 K 39/395

A 61 K 51/10

C 12 N 15/02

C 07 K 16/46

C 12 P 21/08

C 07 K 16/28

(21) API 2009 011620 (22) 2009 12 24

(24) 2009 12 24

(60) EP 2000149, 1993 11 12

(73) БАЙОДЖЕН АЙДЕК ИНК. (US)

(72) Даррел Р. Андерсон (US);

Набил Ханна (US);

Джон И. Леонард (US);

Роланд А. Ньюмен (US);

Уильям Х. Растеттер (US);

Митчелл И. Рефф (US)

(74) Шалва Гварамадзе

(54) **ХИМЕРНОЕ АНТИ-CD20 АНТИТЕЛО**

(57) Данное изобретение касается иммуноактивного химерного анти-CD20 антитела.

Пункты: 3 независ.

7 завис.

Фиг.: 14

PART C

C 07

(11) PI 2010 5118 B (51) Int. Cl. (2006)

C 07 K 16/46

A 61 K 38/17

A 61 P 25/00

C 12 N 15/66

C 07 K 16/22

A 61 P 35/00

C 12 N 13/13

(21) API 2009 011617 (22) 2009 12 24

(24) 2009 12 24

(60) EP 1325932, 1998 04 03

(73) GENENTECH INC (US)

South San-Francisco, California 94080 (US)

(72) BACA, Manuel (AU);

LOWMAN, Henry, B. (US);

WELLS, James, A. (US);

CHEN, Yvonne Man-Yee (US);

PRESTA, Leonard, G. (US)

(74) Shalva Gvaramadze

(54) **ANTI-VEGF ANTIBODIES**

(57) The invention refers to anti-VEGF antibodies, in particular to humanized anti-VEGF antibodies and variant anti-VEGF antibodies.

Claims: 9 independent

21 dependent

Fig.: 12

(11) PI 2010 5118 B (51) Int. Cl. (2006)

C 07 K 16/46

A 61 K 38/17

A 61 P 25/00

C 12 N 15/66

C 07 K 16/22

A 61 P 35/00

C 12 N 13/13

(21) API 2009 011617 (22) 2009 12 24

(24) 2009 12 24

(60) EP 1325932, 1998 04 03

- (73) ДЖЕНЕНТЕК, ИНК. (US)
 (72) Мануэл Бака (AU);
 Хенри Б. Лоумен (US);
 Джеймс А. Уэллс (US);
 Ивон Мэн-Ю Чен (US);
 Леонард Дж. Преста (US)
 (74) Шалва Гварамдзе
 (54) **АНТИ-VEGF АНТИТЕЛО**
 (57) Данное изобретение касается анти-VEGF антител, в частности гуманизированных анти-VEGF антител и вариантных анти-VEGF антител
 Пункты: 9 независ.
 21 завис.
 Фиг.: 12

PART II

H 01

(11) PI 2010 5120 B (51) Int. Cl. (2006)

H 01 B 5/10

H 01 B 7/18

- (21) API 2010 011791 (22) 2010 05 04
 (24) 2010 05 04
 (60) EP 1124235, 2001 02 06
 (73) GIFT TECHNOLOGIES LLC (US)
 24030 Premp-ton Avenue, Harbor City,
 California 90710 (US)
 (72) GOLDSWORTHY, William Brandt (US);
 KORZENIOWSKI, George (US)
 (74) Vakhtang Torotadze

(54) **COMPOSITE REINFORCED
 ELECTRICAL TRANSMISSION
 CONDUCTOR**

(57) A central load carrying conductor reinforced by composite material comprising fibers, which is surrounded by the outer sheath with high conductivity, with this the central load carrying conductor provides the necessary strength, and the sheath - transmission of the electrical signal. The central load carrying conductor consists of a plurality of individual sections which are capable of being separated from one another. The fiber-optic cable can be passed through the central load carrying conductor.

Claims: 2 independent
 9 dependent

Fig.: 9

(11) PI 2010 5120 B (51) Int. Cl. (2006)

H 01 B 5/10

H 01 B 7/18

- (21) API 2010 011791 (22) 2010 05 04
 (24) 2010 05 04

- (60) EP 1124235, 2001 02 06
 (73) ГИФТ ТЕКНОЛОДЖИС ЛЛС (US)
 (72) Уильям Брендт Голдсворси (US);
 Джордж Коржениовски (US)
 (74) Вахтанг Торотадзе
 (54) **ЭЛЕКТРОПРОВОД, АРМИРОВАННЫЙ
 КОМПРОЗИТНЫМ МАТЕРИАЛОМ**
 (57) Провод содержит центральную жилу, армированную композитным материалом, содержащим волокна, которая окружена наружной оболочкой с высокой проводимостью, при этом, центральная жила обеспечивает необходимую прочность, а оболочка же – передачу электрического сигнала. Центральная жила состоит из множества отдельных частей, которые выполнены с возможностью отделения друг от друга. В центральной жиле может быть пропущен оптоволоконный кабель.
 Пункты: 2 независ.
 9 завис.
 Фиг.: 9
-

PATENTS FOR INVENTIONS

ПАТЕНТЫ НА ИЗОБРЕТЕНИЯ

PART C

C 07

(11) P 2010 5125 B **(51) Int. Cl. (2006)**
C 07 D 209/14
A 61 K 31/4045
A 61 P 35/00

(10) AP 2010 11010 A (44) 13(305)/2010
 (21) AP 2007 011010
 (22) 2007 06 07
 (24) 2007 06 07
 (31) 60/804,523; 60/869,993
 (32) 2006 06 12; 2006 12 14
 (33) US; US
 (73) NOVARTIS AG (CH)
 Lichtstrasse 35, CH-4056 Basel (CH)
 (72) ACEMOGLU, Murat (CH);
 BAJWA, Joginder, S. (US);
 KARPINSKI, Piotr (US);
 PAPOUTSAKIS, Dimitris (GR);
 SLADE, Joel (US);
 STOWASSER, Frank (DE)
 (74) Alexander Kartvelishvili
 (85) 2008 12 12
 (86) PCT/US2007/070558, 2007 06 07
 (54) **SALTS OF N-HYDROXY-3-[4-[[[2-(2-METHYL-1H-INDOL-3-YL) ETHYL] AMINO] METHYL] PHENYL]-2E-2-PROPENAMIDE**

(11) P 2010 5125 B **(51) Int. Cl. (2006)**
C 07 D 209/14
A 61 K 31/4045
A 61 P 35/00

(10) AP 2010 11010 A (44) 13(305)/2010
 (21) AP 2007 011010
 (22) 2007 06 07
 (24) 2007 06 07
 (31) 60/804,523; 60/869,993
 (32) 2006 06 12; 2006 12 14
 (33) US; US
 (73) НОВАРТИС АГ (СН)
 (72) Мурат Асемоглу (СН);
 Джогиндер С. Баджва (US);
 Пиотр Карпински (US);
 Димитрис Папоуцакис (GR);
 Джоэл Слейд (US);
 Фрэнк Стувассер (DE)
 (74) Александр Картвелишвили
 (85) 2008 12 12

(86) PCT/US2007/070558, 2007 06 07
 (54) **СОЛИ N-ГИДРОКСИ-3-[4-[[[2-(2-МЕТИЛ-1H-ИНДОЛ-3-ИЛ) ЭТИЛ] АМИНО] МЕТИЛ]ФЕНИЛ]-2E-2-ПРОПЕНАМИДА**

(11) P 2010 5124 B **(51) Int. Cl. (2006)**
C 07 K 5/12
A 61 K 38/00
A 61 P 31/14
C 07 D 209/44
C 07 C 231/02
C 07 C 269/00
C 07 D 207/16

(10) AP 2010 10529 A (44) 7(299)/2010
 (21) AP 2006 010529
 (22) 2006 07 17
 (24) 2006 07 17
 (31) 60/702,195; 60/725,533; 60/789,800
 (32) 2005 07 25; 2005 10 11; 2006 04 06
 (33) US; US; US
 (73) INTERMUNE, INC. (US)
 3280 Bayshore Boulevard, Brisbane, CA 94005 (US);
 ARRAY BIOPHARMA, INC. (US)
 3200 Walnut Street, Boulder, CO 80301 (US)
 (72) SEIWERT, Scott D. (US);
 BLATT, Lawrence M. (US);
 ANDREWS, Steven W. (US);
 MARTIN, Pierre (CH);
 SCHUMACHER, Andreas (DE);
 BARNETT, Bradley, R. (US);
 EARLY, C., Todd (US); KAUS, Robert (US);
 KERCHER, Timothy (US);
 LIU, Weidong (CN); LYON, Michael (JM);
 NICHOLS, Paul (US); WANG, Bin (CN);
 SAMMAKIA, Tarek (US);
 KENNEDY, April (US); JIANG, Yutong (CN)
 (74) Liliana Darakhvelidze
 (85) 2008 02 25
 (86) PCT/US2006/027738, 2006 07 17
 (54) **NOVEL MACROCYCLIC INHIBITORS OF HEPATITIS C VIRUS REPLICATION**

(11) P 2010 5124 B **(51) Int. Cl. (2006)**
C 07 K 5/12
A 61 K 38/00
A 61 P 31/14
C 07 D 209/44
C 07 C 231/02

C 07 C 269/00

C 07 D 207/16

- (10) AP 2010 10529 A (44) 7(299)/2010
 (21) AP 2006 010529
 (22) 2006 07 17
 (24) 2006 07 17
 (31) 60/702,195; 60/725,533; 60/789,800
 (32) 2005 07 25; 2005 10 11; 2006 04 06
 (33) US; US; US
 (73) Интермьюн, Инк. (US);
 Эррей Биофарма, Инк. (US)
 (72) Скот Д. Сейверт (US);
 Лоренс М. Блат (US);
 Стивен В. Эндрюс (US);
 Пьер Мартин (CH);
 Андреас Шумахер (DE);
 Брэдди Р. Барнет (US); Тод С. Иэри (US);
 Тимоти Керчер (US);
 Вейдонг Лью (CN); Майкл Лайон (JM);
 Пол Никольз (US); Бин Ванг (CN);
 Тэрек Саммакиа (US);
 Эйприл Кеннеди (US);
 Ютонг Ианг (CN)
 (74) Лилиана Дарахвелидзе
 (85) 2008 02 25
 (86) PCT/US2006/027738, 2006 07 17
 (54) **НОВЫЕ МАКРОЦИКЛИЧЕСКИЕ
 ИНГИБИТОРЫ РЕПЛИКАЦИИ
 ВИРУСА ГЕПАТИТА С**

C 10

- (11) P 2010 5123 B (51) Int. Cl. (2006)
 C 10 L 1/02**
 (10) AP 2010 10484 A (44) 9(301)/2010
 (21) AP 2006 010484
 (22) 2006 06 19
 (24) 2006 06 19
 (31) 60/595,284
 (32) 2005 06 21
 (33) US
 (71) SHE BLENDS HOLDING B.V. (NL)
 Catharinastraat 21 F, NL-4811 XD
 Breda (NL)
 (72) SIJBEN, Johannes, Maria, Franciscus (NL)
 (74) Guram Tsitsishvili
 (85) 2008 01 21
 (86) PCT/NL2006/000298, 2006 06 19
 (54) **MOTOR FUEL BASED ON GASOLINE AND
 ETHANOL**
- (11) P 2010 5123 B (51) Int. Cl. (2006)
 C 10 L 1/02**
 (10) AP 2010 10484 A (44) 9(301)/2010
 (21) AP 2006 010484
 (22) 2006 06 19

- (24) 2006 06 19
 (31) 60/595,284
 (32) 2005 06 21
 (33) US
 (73) Ши Блендс Холдинг Б.В. (NL)
 (72) Йоханнес, Мария, Франсискус Сийбен (NL)
 (74) Гурам Цицишвили
 (85) 2008 01 21
 (86) PCT/NL2006/000298, 2006 06 19
 (54) **МОТОРНОЕ ТОПЛИВО НА ОСНОВЕ
 БЕНЗИНА И ВОДНОГО ЭТАНОЛА**

PART H**H 04**

- (11) P 2010 5121 B (51) Int. Cl. (2006)
 H 04 B 7/005
 H 04 B 7/216
 H 04 W 52/14**
 (10) AP 2010 9574 A (44) 7(299)/2010
 (21) AP 2005 009574
 (22) 2005 01 07
 (24) 2005 01 07
 (31) 60/535,426; 11/019,489
 (32) 2004 01 09; 2004 12 22
 (33) US; US
 (71) INTERDIGITAL TECHNOLOGY
 CORPORATION (US)
 300 Delaware Avenue, Suite 527,
 Wilmington, DE 19801 (US)
 (72) ZHANG, Guodong (CN);
 TERRY, Stephen, E. (US);
 DICK, Stephen, G. (US)
 (74) Shalva Gvaramadze
 (85) 2006 08 09
 (86) PCT/US2005/000571, 2005 01 07
 (54) **TRANSPORT FORMAT COMBINATION
 SELECTION IN A WIRELESS
 TRANSMIT/RECEIVE UNIT**
- (11) P 2010 5121 B (51) Int. Cl. (2006)
 H 04 B 7/005
 H 04 B 7/216
 H 04 W 52/14**
 (10) AP 2010 9574 A (44) 7(299)/2010
 (21) AP 2005 009574
 (22) 2005 01 07
 (24) 2005 01 07
 (31) 60/535,426; 11/019,489
 (32) 2004 01 09; 2004 12 22
 (33) US; US
 (73) Интердиджитал Текнолоджи
 Корпорейшен (US)
 (72) Гуодун Джан (CN);
 Стивен И. Терри (US);

Стивен Дж. Дик (US)
 (74) Шалва Гварамадзе
 (85) 2006 08 09
 (86) PCT/US2005/000571, 2005 01 07
 (54) **СПОСОБ И УСТРОЙСТВО ВЫБОРА
 КОМБИНАЦИИ ТРАНСПОРТНОГО
 ФОРМАТА В БЕСПРОВОДНОМ
 ПРИЕМНО-ПЕРЕДАЮЩЕМ УСТРОЙ-
 СТВЕ**

Корпорейшен (US)
 (72) Мариан Рудольф (CA);
 Стивен Дж. Дик (US);
 Тереза Джоан Ханкелер (CA);
 Шамил Акбар Рахман (CA);
 Джозеф А. Квак (US)
 (74) Шалва Гварамадзе
 (85) 2007 08 09
 (86) PCT/US2004/022495, 2004 07 14
 (54) **СПОСОБ И СИСТЕМА ПЕРЕДАЧИ
 ИНФОРМАЦИИ МЕЖДУ ОБЪЕКТА-
 МИ УПРАВЛЕНИЯ СЕТЬЮ В БЕС –
 ПРОВОДНОЙ КОММУНИКАЦИОН-
 НОЙ СИСТЕМЕ**

(11) P 2010 5122 B (51) Int. Cl. (2006)
 H 04 J 3/22
 H 04 L 12/24
 H 04 L 12/28
 H 04 W 92/10

(10) AP 2010 10247 A (44) 7(299)/2010
 (21) AP 2004 010247
 (22) 2004 07 14
 (24) 2004 07 14
 (62) 60/487,830 2003-07-16 (US);
 60/488,542 2003-07-17 (US)
 (31) 60/487,830; 60/488,542
 (32) 2003 07 16; 2003 07 17
 (33) US; US
 (71) INTERDIGITAL TECHNOLOGY
 CORPORATION (US)
 300 Delaware Avenue, Suite 527,
 Wilmington, DE 19801 (US)
 (72) RUDOLF, Marian (CA);
 DICK, Stephen, G. (US);
 HUNKELER, Teresa, Joanne (CA);
 RAHMAN, Shamim, Akbar (CA);
 KWAK, Joseph, A. (US)
 (74) Shalva Gvaramadze
 (85) 2007 08 09
 (86) PCT/US2004/022495, 2004 07 14
 (54) **METHOD AND SYSTEM FOR
 TRANSFERRING INFORMATION
 BETWEEN NETWORK MANAGEMENT
 ENTITIES OF A WIRELESS
 COMMUNICATION SYSTEM**

(11) P 2010 5122 B (51) Int. Cl.
 H 04 J 3/22
 H 04 L 12/24
 H 04 L 12/28
 H 04 W 92/10

(10) AP 2010 10247 A (44) 7(299)/2010
 (21) AP 2004 010247 (22) 2004 07 14
 (24) 2004 07 14
 (62) 60/487,830 2003-07-16 (US);
 60/488,542 2003-07-17 (US)
 (31) 60/487,830; 60/488,542
 (32) 2003 07 16; 2003 07 17
 (33) US; US
 (73) Интердиджитал Технолоджи

PATENTS FOR UTILITY MODELS

ПАТЕНТЫ НА ПОЛЕЗНЫЕ МОДЕЛИ

PART A

A 01

- (11) U 2010 1633 Y (51) Int. Cl. (2006)
A 01 B 49/00
- (10) AU 2010 11406 U (44) 13(305)/2010
(21) AU 2009 011406
(22) 2009 08 03
(24) 2009 08 03
- (73) Zurab Zhorzholiani (GE)
Didgoris k. 70, sop. Dighomi, 0126,
Tbilisi (GE);
Nikoloz Buchukuri (GE)
Dighmis mas., V kvart., korp.24a, b. 11, 0159,
Tbilisi (GE);
Otar Asatiani (GE)
Ketevan Tsamebulis gamz. 65a, b. 13, 0144,
Tbilisi (GE);
Temur Japaridze (GE)
Didgoris k. 70, b.14, 0126, Tbilisi (GE);
Karmen Bodzashvili (GE)
Gamsakhurdias gamz. 15, b. 40, 0171,
Tbilisi (GE);
Leri Lomtadze (GE)
Gldanis mas., VIII mkr., korp. 27, b. 129,
0107, Tbilisi (GE)
- (72) Zurab Zhorzholiani (GE);
Nikoloz Buchukuri (GE);
Otar Asatiani (GE);
Temur Japaridze (GE);
Karmen Bodzashvili (GE);
Leri Lomtadze (GE)
- (54) **COMBINED DEVICE FOR
CULTIVATING SOIL**

- (11) U 2010 1633 Y (51) Int. Cl. (2006)
A 01 B 49/00
- (10) AU 2010 11406 U (44) 13(305)/2010
(21) AU 2009 011406
(22) 2009 08 03
(24) 2009 08 03
- (73) Зураб Жоржوليани (GE);
Николоз Бучукури (GE);
Отар Асатиани (GE);
Темур Джапаридзе (GE);
Кармен Бодзашвили (GE);
Лери Ломтадзе (GE)
- (72) Зураб Жоржوليани (GE);
Николоз Бучукури (GE);
Отар Асатиани (GE);

Темур Джапаридзе (GE);
Кармен Бодзашвили (GE);
Лери Ломтадзе (GE)

- (54) **КОМБИНИРОВАННОЕ УСТРОЙСТВО
ДЛЯ ОБРАБОТКИ ПОЧВЫ**
-

A 21

- (11) U 2010 1634 Y (51) Int. Cl. (2006)
A 21 D 13/08
- (10) AU 2010 11449 U (44) 3(295)/2010
(21) AU 2009 011449
(22) 2009 09 03
(24) 2009 09 03
- (73) Nino Butskhrikidze (GE)
Iosebidsis k. 72a, b. 11, 0160, Tbilisi (GE)
- (72) Nino Butskhrikidze (GE)
- (74) David Zurabishvili
- (54) **CONFECTIONERY PRODUCT**
- (11) U 2010 1634 Y (51) Int. Cl. (2006)
A 21 D 13/08
- (10) AU 2010 11449 U (44) 3(295)/2010
(21) AU 2009 011449
(22) 2009 09 03
(24) 2009 09 03
- (73) Нино Буцхрикидзе (GE)
(72) Нино Буцхрикидзе (GE)
(74) Давид Зурабишвили
- (54) **КОНДИТЕРСКОЕ ИЗДЕЛИЕ**
-

PART B

B 65

- (11) U 2010 1635 Y (51) Int. Cl. (2006)
B 65 D 39/08
B 65 D 43/04
- (10) AU 2010 11452 U (44) 13(305)/2010
(21) AU 2009 011452
(22) 2009 09 07
(24) 2009 09 07
- (73) Shota Metskhvarishvili (GE)
Sop. Savane, 4300, Sachkhere (GE)
- (72) Shota Metskhvarishvili (GE)
- (54) **MEANS FOR CLOSING KVEVRI
(FIGULINE FOR KEEPING WINE)**

- (11) U 2010 1635 Y (51) Int. Cl. (2006)
B 65 D 39/08
B 65 D 43/04
- (10) AU 2010 11452 U (44) 13(305)/2010
(21) AU 2009 011452
(22) 2009 09 07
(24) 2009 09 07
(73) Шота Мецхваришвили (GE)
(72) Шота Мецхваришвили (GE)
(54) **СРЕДСТВО ДЛЯ УКУПОРКИ КВЕВРИ
(ГЛИНЯНЫЙ СОСУД ДЛЯ ХРАНЕНИЯ
ВИНА)**
-

PART E

E 04

- (11) U 2010 1636 Y (51) Int. Cl. (2006)
E 04 B 5/32
- (10) AU 2010 11604 U (44) 13(305)/2010
(21) AU 2009 011604
(22) 2009 12 15
(24) 2009 12 15
(71) Evgeni Karumidze (GE)
Bakhtionis k.9, b.29, 0194, Tbilisi (GE);
Tamara Karumidze (GE)
Bakhtionis k.9, b.29, 0194, Tbilisi (GE)
(72) Evgeni Karumidze (GE);
Tamara Karumidze (GE);
Anatoli Gogokhia (GE)
(54) **METHOD FOR MANUFACTURE OF
MONOLITHIC REINFORCED
CONCRETE FLOOR SLABS**

- (11) U 2010 1636 Y (51) Int. Cl. (2006)
E 04 B 5/32
- (10) AU 2010 11604 U (44) 13(305)/2010
(21) AU 2009 011604
(22) 2009 12 15
(24) 2009 12 15
(73) Евгений Карумидзе (GE);
Тамара Карумидзе (GE)
(72) Евгений Карумидзе (GE);
Тамара Карумидзе (GE);
Анатолий Гогохия (GE)
(54) **СПОСОБ ИЗГОТОВЛЕНИЯ МОНОЛИ-
ТНЫХ ЖЕЛЕЗОБЕТОННЫХ ПЛИТ
МЕЖЭТАЖНОГО ПЕРЕКРЫТИЯ**
-

PATENTS FOR INDUSTRIAL DESIGNS

ПАТЕНТЫ НА ПРОМЫШЛЕННЫЕ ОБРАЗЦЫ

(11) D 2010 442 S **(51) 32-00**
(10) AD 2010 571 S (44) 9(301)/2010
(21) AD 2009 000571
(22) 2009 09 30
(24) 2009 09 30
(18) 2014 09 30
(31) 1130165-0001
(32) 2009 04 01
(33) EM
(73) MARS, INCORPORATED (US)
6885 ELM Street, McLean, Virginia 22101-3883 (US)
(72) Wayne Bilton (GB);
Ian Perriman (GB)
(74) Guram Tsitsishvili
(54) **GRAPHIC CHARACTER**

(11) D 2010 443 S **(51) 32-00**
(10) AD 2010 582 S (44) 9(301)/2010
(21) AD 2009 000582
(22) 2009 12 21
(24) 2009 12 21
(18) 2014 12 21
(31) 1564238 - 0001; 1564238 - 0002
(32) 2009 06 29; 2009 06 29
(33) EM; EM
(73) Марс, Инкорпорейтид (US)
6885 Элм Стрит, Маклин, Вирджиния
22101-3883 (US)
(72) Симон Пендри (GB);
Стеф Хисман (GB)
(74) Гурам Цицишвили
(54) **ГРАФИЧЕСКИЙ СИМВОЛ**

(11) D 2010 442 S **(51) 32-00**
(10) AD 2010 571 S (44) 9(301)/2010
(21) AD 2009 000571
(22) 2009 09 30
(24) 2009 09 30
(18) 2014 09 30
(31) 1130165-0001
(32) 2009 04 01
(33) EM
(73) Марс, Инкорпорейтид (US)
6885 Элм Стрит, Маклин,
Вирджиния 22101-3883 (US)
(72) Уэйн Билтон (GB);
Ян Периманн (GB)
(74) Гурам Цицишвили
(54) **ГРАФИЧЕСКИЙ СИМВОЛ**

(11) D 2010 443 S **(51) 32-00**
(10) AD 2010 582 S (44) 9(301)/2010
(21) AD 2009 000582
(22) 2009 12 21
(24) 2009 12 21
(18) 2014 12 21
(31) 1564238 - 0001; 1564238 - 0002
(32) 2009 06 29; 2009 06 29
(33) EM; EM
(73) MARS, INCORPORATED (US)
6885 ELM Street, McLean, Virginia 22101-3883 (US)
(72) Simon Pendry (GB);
Steph Heasman (GB)
(74) Guram Tsitsishvili
(54) **GRAPHIC CHARACTER**

INDUSTRIAL DESIGNS, WHICH HAVE BEEN REGISTERED WITH THE INTERNATIONAL BUREAU IN ACCORDANCE WITH THE ACT OF HAGUE AGREEMENT OF 1960 AND/OR ACT OF GENEVA AGREEMENT CLAIMING PRIORITY ON THE TERRITORY OF GEORGIA

ПРОМЫШЛЕННЫЕ ОБРАЗЦЫ, КОТОРЫЕ ЗАРЕГИСТРИРОВАНЫ В МЕЖДУНАРОДНОМ БЮРО В СООТВЕТСТВИИ С АКТОМ ГААГСКОГО СОГЛАШЕНИЯ 1960 Г. И/ИЛИ АКТОМ ЖЕНЕВСКОГО СОГЛАШЕНИЯ С ИСТРЕБОВАНИЕМ ПРИОРИТЕТА НА ТЕРРИТОРИИ ГРУЗИИ

(11) DM/072475 (51) 15-05
 (15) 2009 10 26
 (45) 2010/05 (2010 06 30)
 (22) 2009 10 26
 (28) 18
 (30) 17.06.2009; 500664701; EM
 (73) ALFRED KÄRCHER GMBH & CO. KG
 Alfred-Kärcher-Str. 28-40, 71364 Winnenden (DE)
 (85) EM
 (86) DE
 (87) DE
 (88) DE
 (89) EM
 (81) II. KP, MA, MC, ME. III. BA, EG, GE, HR,
 LI, MD, MK, MN, OM, TR.
 (54) 1.-18. Vacuum cleaners
 (55)

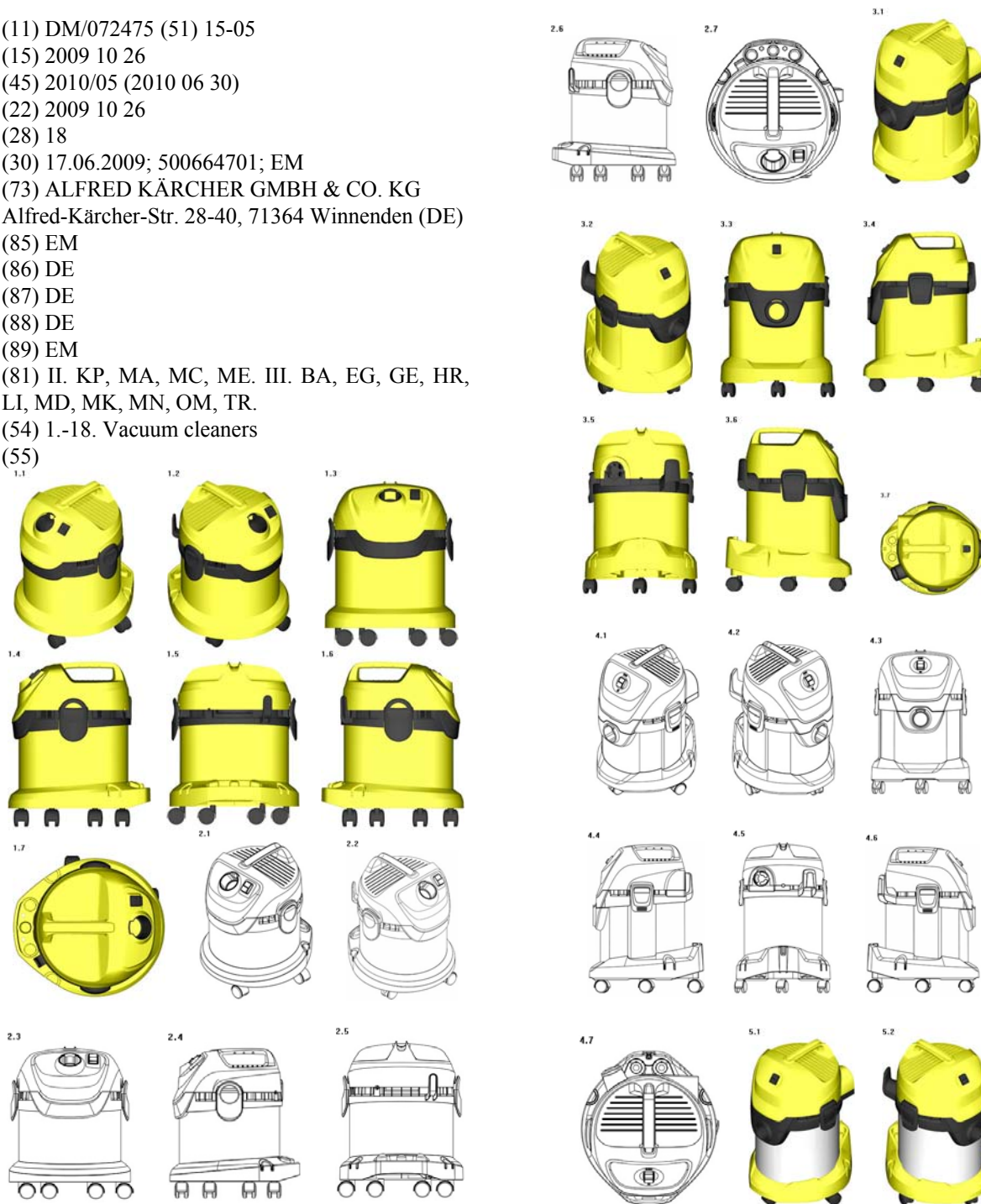

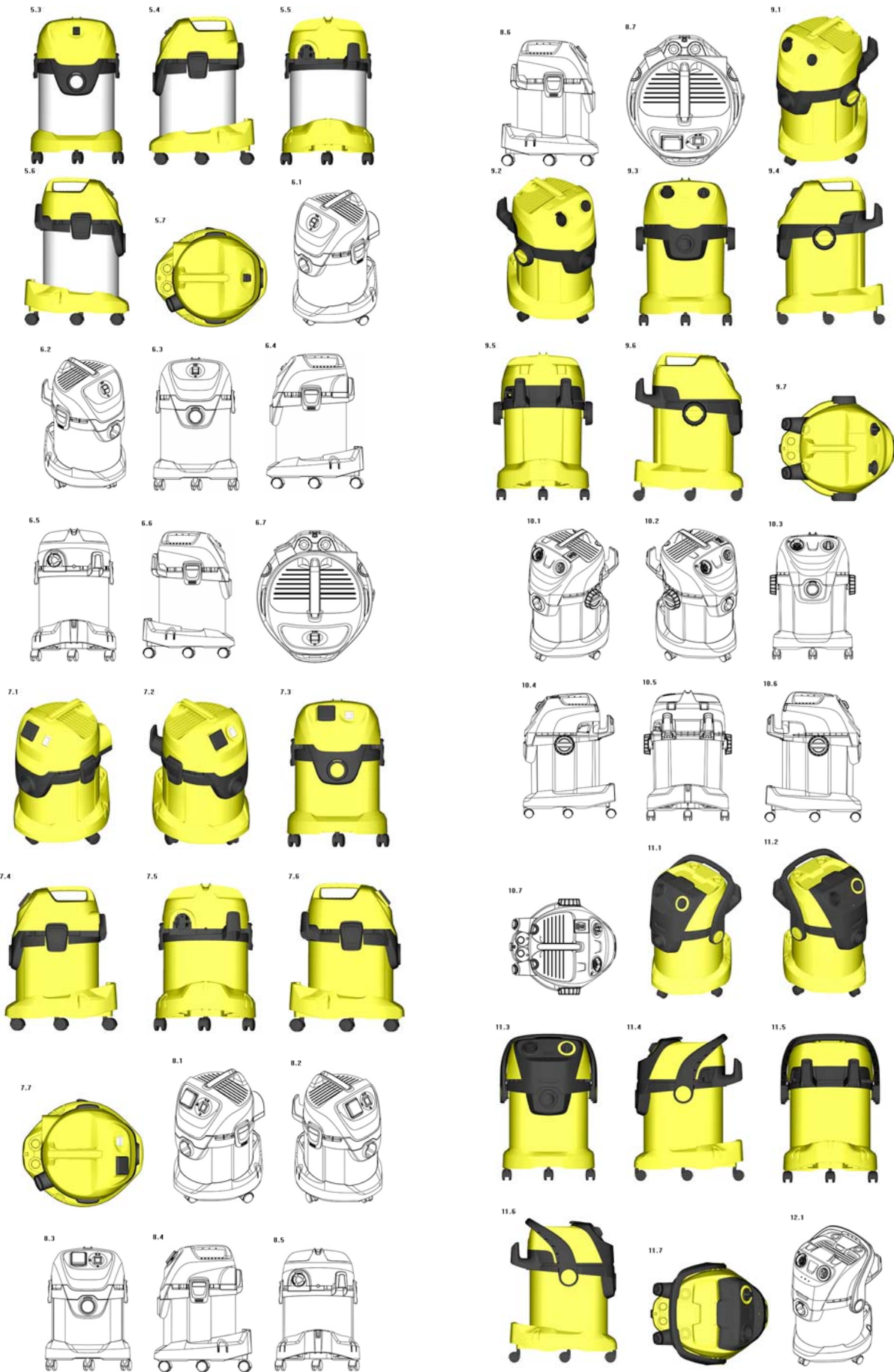

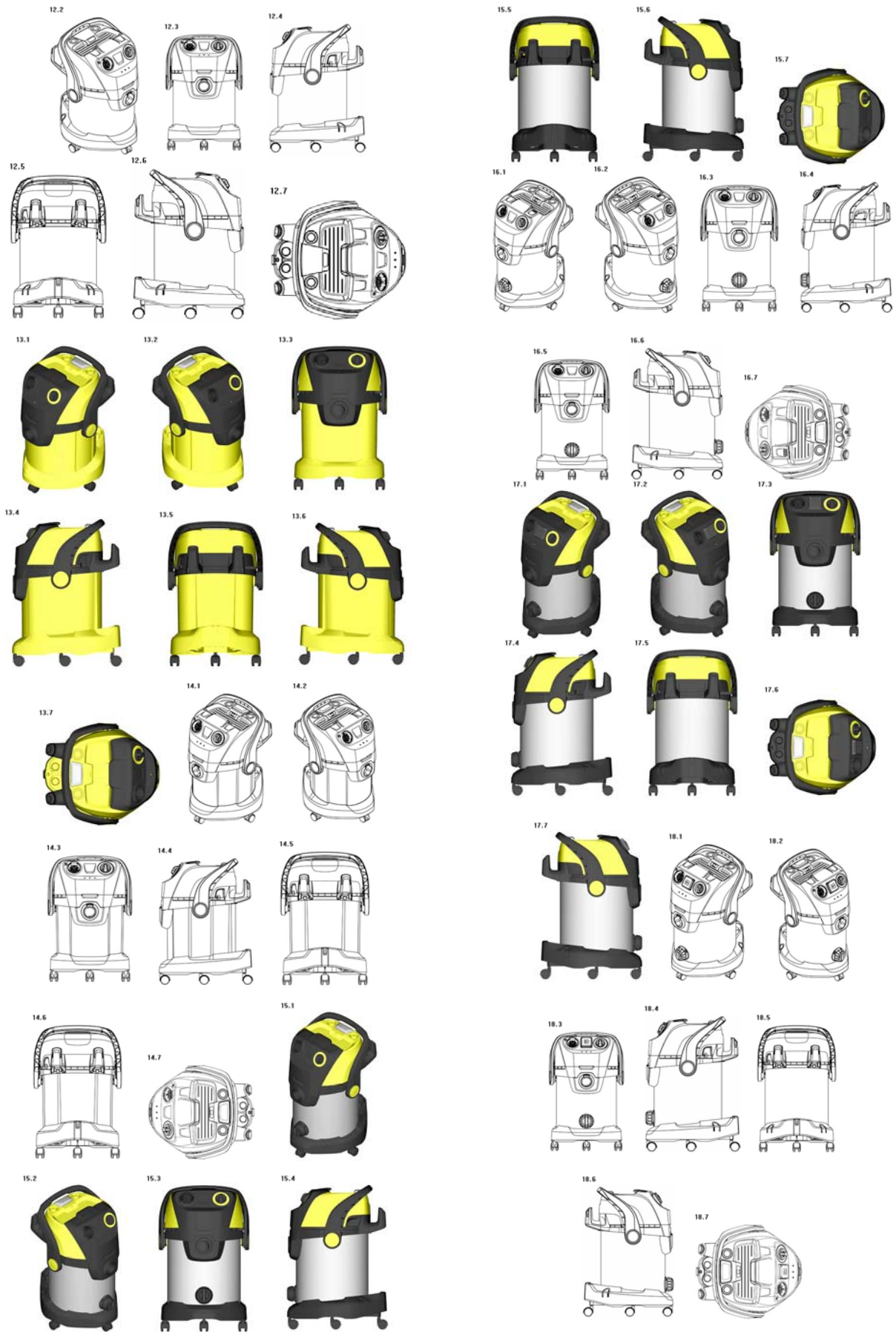

(11) DM/072727 (51) 12-16
 (15) 2009 12 15
 (45) 2010/05 (2010 06 30)
 (22) 2009 11 12
 (28) 1
 (73) VOLKSWAGEN AKTIENGESELLSCHAFT
 38436 Wolfsburg (DE)
 (85) EM
 (86) DE,EM
 (87) DE,EM
 (88) DE,EM
 (89) EM
 (81) I. AN, ID, TN. II. MA, MC, ME. III. AL, AM,
 BA, CH, EG, EM, GE, HR, IS, KG, LI, MD, MK,
 NA, OM, RS, SG, TR, UA
 (72) Dieter Dröge, Wohnstraße 17, D-34123 Kassel
 (54) 1. Windscreen protector
 (55)

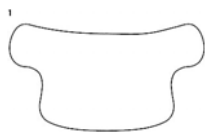

(11) DM/072768 (51) 08-03
 (15) 2009 12 17
 (45) 2010/05 (2010 06 30)
 (22) 2009 12 17
 (28) 1
 (30) 18.06.2009; 1552555-0002; EM
 (73) SCOTT CUTTERS UK LIMITED
 PO Box 3811, Marlow, Buckinghamshire
 SL7 3ZB (GB)
 (85) EM
 (86) EM
 (87) EM
 (88) EM
 (89) EM
 (81) III. CH, EG, GE, HR, MD, RS, SG, TR.
 (72) Scott Rampling, PO Box 3811, Marlow,
 Buckinghamshire SL7 3ZB, GB
 (54) 1. Cutting Device
 (55)

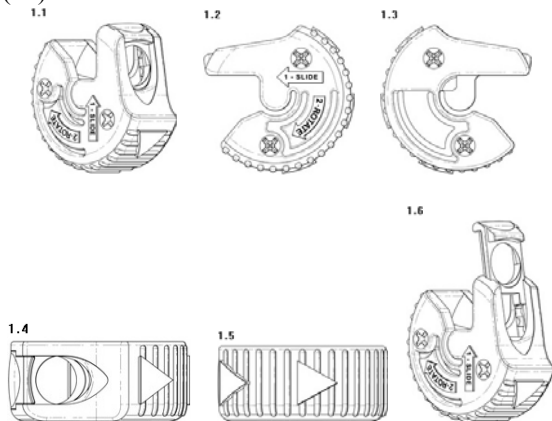

(11) DM/072803 (51) 09-01
 (15) 2009 12 23
 (45) 2010/01 (2010 02 28)
 (22) 2009 12 23
 (28) 5
 (73) DOMAINE DES BROIX S.A.S.
 Les Broix, F-16120 TOUZAC (FR)
 (85) FR
 (86) FR
 (87) FR
 (88) FR
 (89) FR
 (81) I. ID. II. MC, ME. III. AL, AM, CH, EM, GE,
 HR, IS, KG, MD, MN, TR, UA
 (72) Philippe SEYS - 81, rue Petit Rouillac, Bois de
 la Bécasse, 16290 SAINT SATURNIN (France)
 (54) 1.-6. Bottles
 (55)

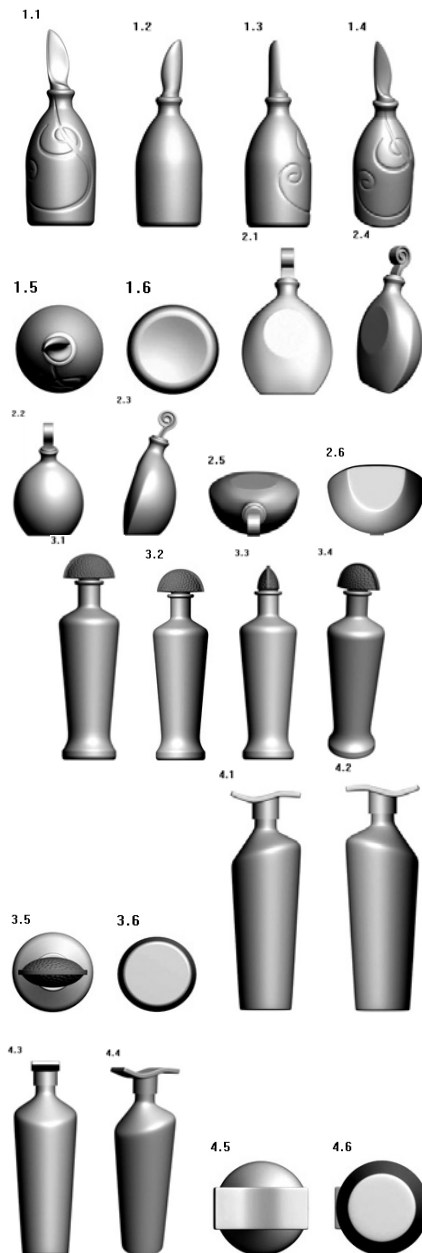

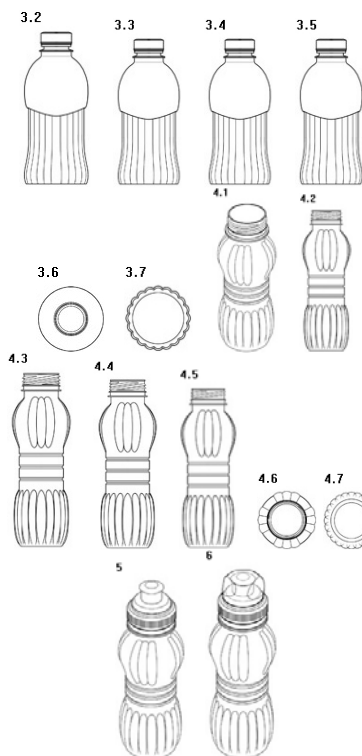
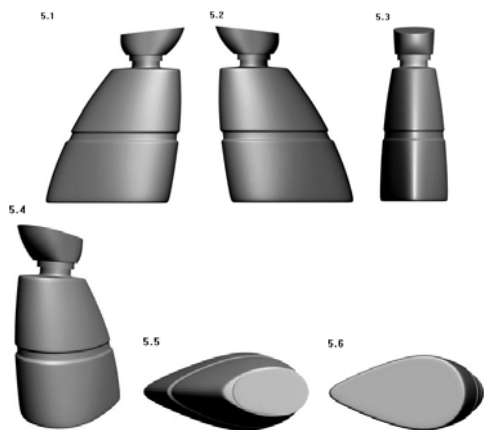

(11) DM/072806 (51) 09-03
 (15) 2009 12 28
 (45) 2010/05 (2010 06 30)
 (22) 2009 12 28
 (28) 11
 (73) SOREMARTEC S.A.
 Rue Joseph Netzer 5, B-6700 ARLON (BE)
 (86) BX
 (87) BX
 (88) BX
 (89) EM
 (81) II. MA, ME. III. AL, CH, EM, GE, HR, MK,
 RS, UA
 (54) 1.-2. Packagings or containers for food
 products; 3.-6. Containers for liquids; 7.-11.
 Packagings or containers for food products
 (55)

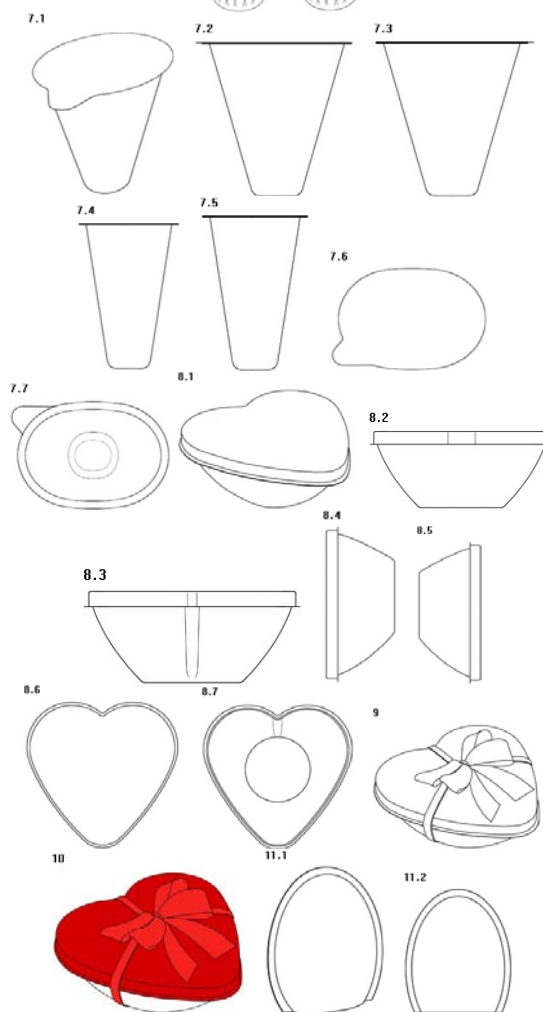
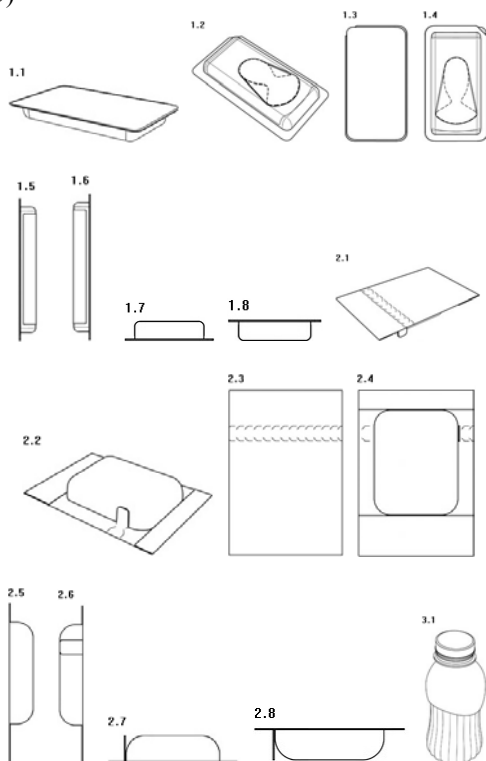

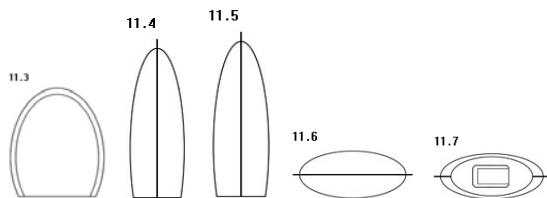

(11) DM/072834 (51) 13-03

(15) 2009 12 30

(45) 2010/01 (2010 02 28)

(22) 2009 12 30

(28) 2

(73) MAKEL ELEKTRIK MALZEMELERI
SANAYI VE TICARET ANONIM SIRKETI

Istiklal Mahallesi Maresal, Fevzi Cakmak Caddesi
N38, KIRAC ESENYURT-ISTANBUL (TR)

(85) TR

(86) TR

(87) TR

(88) TR

(89) TR

(81) III. GE, HR, KG, MD, MK, UA

(72) NECATI CALISKAN, ISTIKLAL
MAHALLESİ, MARESAL FEVZI CAKMAK
CADDESİ, N38, KIRAC SANCAKTEPE-
ISTANBUL

(54) 1.-2. Electric materials

(55)

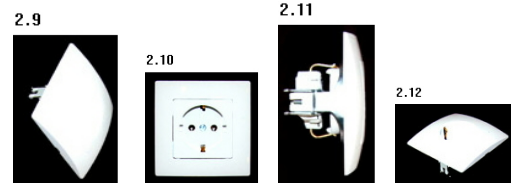
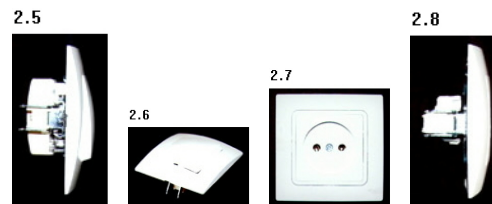
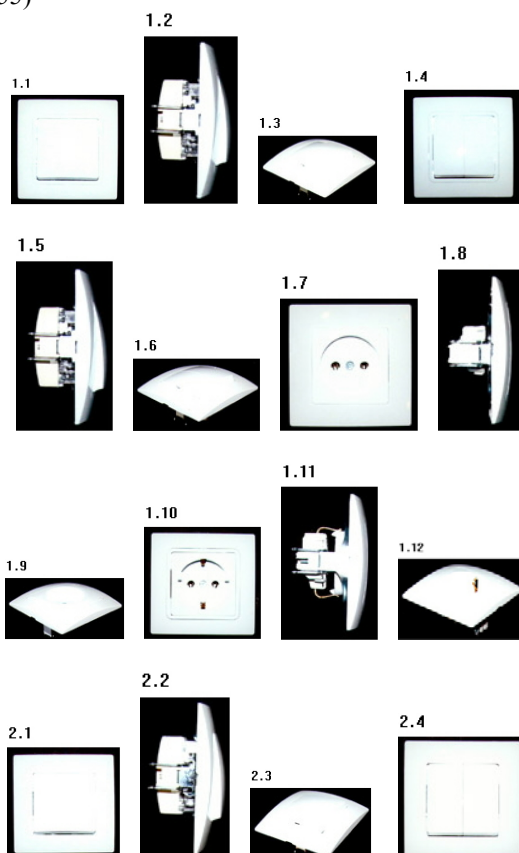

(11) DM/072837 (51) 10-07

(15) 2010 01 08

(45) 2010/01 (2010 02 28)

(22) 2010 01 08

(28) 3

(73) GLASHÜTTER UHRENBETRIEB GMBH
Altenberger Straße 1, 01768 Glashütte (DE)

(85) EM

(86) DE,EM

(87) DE,EM

(88) DE,EM

(89) EM

(81) II. BZ, MA, MC, ME. III. AL, AM, CH, EM,

GE, HR, KG, LI, MD, MK, OM, SG, TR, UA

(72) Katharina Stegmann, Molchgrund 48a, 01762
Schmiedeberg

(54) 1.-3. Watch dials

(55)



(11) DM/072843 (51) 19-08

(15) 2009 12 17

(45) 2010/05 (2010 06 30)

(22) 2009 12 17

(28) 1

(30) 03.08.2009; 001597097; EM

(73) ADOLF WÜRTH GMBH & CO. KG

Reinhold-Würth-Straße 12-17, 74653

Künzelsau (DE)

(85) EM

(86) DE,EM

(87) DE,EM

(88) DE,EM

(89) EM

(81) I. ID, TN. II. KP, MA, ME. III. AL, AM, BA,
CH, EG, EM, GE, IS, MK, MN, RS, SG, TR, UA.

(72) Wolfgang Hohl, Grabenteichweg 16, 74653
Amrichshausen Germany
(54) Label
(55)



Art.

(11) DM/072844 (51) 11-01
(15) 2009 12 30
(45) 2010/01 (2010 02 28)
(22) 2009 12 30
(28) 10
(73) THE SWATCH GROUP MANAGEMENT
SERVICES AG (THE SWATCH GROUP
MANAGEMENT SERVICES SA)
(THE SWATCH GROUP MANAGEMENT
SERVICES LTD.) Seevorstadt 6, CH-2501
BIEL/BIENNE (CH)

(85) CH
(86) CH
(87) CH
(88) CH
(89) CH
(81) I. AN, ID, TN. II. BZ, MA, MC, ME. III. AL,
AM, CH, EM, GE, HR, KG, LI, MD, MK, MN,
OM, SG, TR, UA

(72) Arlette Elsa EMCH, Rue des Mornets 31,
CH-2520 LA NEUVEVILLE
(54) 1.-7. Jewellery, especially necklaces; 2.-8.
earrings; 3.-6. charms; 4. pendant; 9. bracelet;
10. ring
(55)

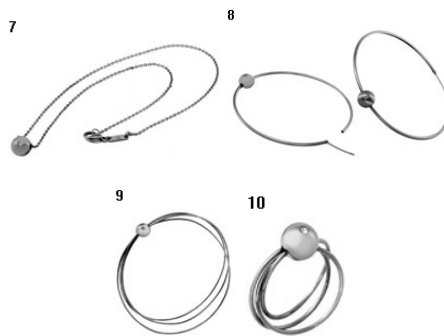
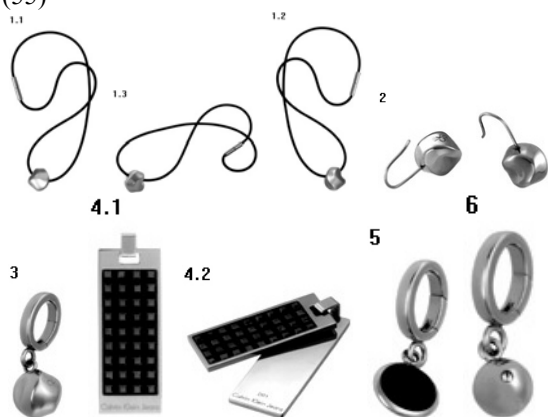

(11) DM/072879 (51) 11-01
(15) 2010 01 08
(45) 2010/01 (2010 02 28)
(22) 2010 01 08
(28) 2
(73) SWATCH AG (SWATCH SA)(SWATCH
LTD) Jakob-Stämpfli-Strasse 94, CH-2502
BIEL/BIENNE (CH)

(85) CH
(86) CH
(87) CH
(88) CH
(89) CH
(81) II. BZ, MA, MC, ME. III. AL, AM, CH, EM,
GE, HR, KG, LI, MD, MK, MN, OM, SG, TR, UA
(72) Iza EMCH, DYB Dress Your Body, Av.
Beauregard 12/C.P.CH-2036, CORMONDRECHE
(54) 1.-2. Jewelry, in particular (1) necklace, and
(2) earrings
(55)

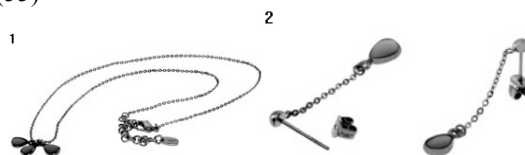

(11) DM/072880 (51) 11-01
(15) 2010 01 08
(45) 2010/01 (2010 02 28)
(22) 2010 01 08
(28) 3
(73) SWATCH AG (SWATCH SA)(SWATCH
LTD) Jakob-Stämpfli-Strasse 94,
CH-2502 BIEL/BIENNE (CH)

(85) CH
(86) CH
(87) CH
(88) CH
(89) CH
(81) II. BZ, MA, MC, ME. III. AL, AM, CH, EM,
GE, HR, KG, LI, MD, MK, MN, OM, SG, TR, UA
(72) Philippe AIRAUD, TSI DESIGN,
Rue St-Honoré 92-94, FR-75001 PARIS
(54) 1.-3. Jewelry, in particular (1) necklace,

(2) ring; (3) bracelet

(55)

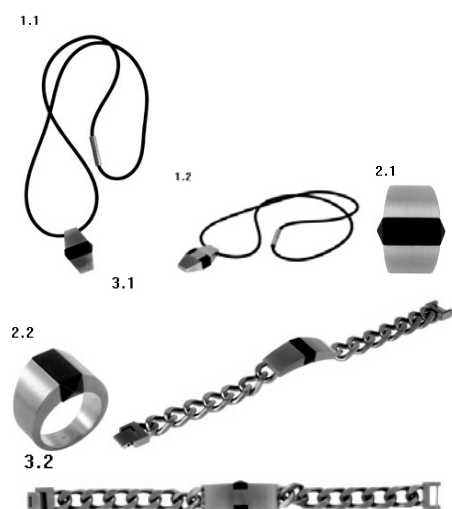

(11) DM/072881 (51) 02-07

(15) 2010 01 11

(45) 2010/01 (2010 02 28)

(22) 2010 01 11

(28) 1

(73) THE SWATCH GROUP MANAGEMENT SERVICES AG (THE SWATCH GROUP MANAGEMENT SERVICES SA)

(THE SWATCH GROUP MANAGEMENT SERVICES LTD.) Seevorstadt 6, CH-2501 BIEL/BIENNE (CH)

(85) CH

(86) CH

(87) CH

(88) CH

(89) CH

(81) II. BZ, MA, MC, ME. III. AL, AM, CH, EM, GE, HR, KG, LI, MD, MK, MN, OM, SG, TR, UA

(72) Arlette Elsa EMCH, Rue des Mornets 31, CH-2520 LA NEUVEVILLE

(54) Cuff links

(55)



(11) DM/072882 (51) 11-01

(15) 2010 01 11

(45) 2010/01 (2010 02 28)

(22) 2010 01 11

(28) 11

(73) THE SWATCH GROUP MANAGEMENT SERVICES AG (THE SWATCH GROUP MANAGEMENT SERVICES SA)

(THE SWATCH GROUP MANAGEMENT SERVICES LTD.) Seevorstadt 6,

CH-2501 BIEL/BIENNE (CH)

(85) CH

(86) CH

(87) CH

(88) CH

(89) CH

(81) II. BZ, MA, MC, ME. III. AL, AM, CH, EM, GE, HR, KG, LI, MD, MK, MN, OM, SG, TR, UA

(72) Arlette Elsa EMCH, Rue des Mornets 31,

CH-2520 LA NEUVEVILLE

(54) 1. Jewelry, in particular necklaces; 2. earrings;

3. bracelets; 4. rings; 5.-6. necklaces; 7. bracelets;

8. earrings; 9.-10. rings; 11. bracelets

(55)

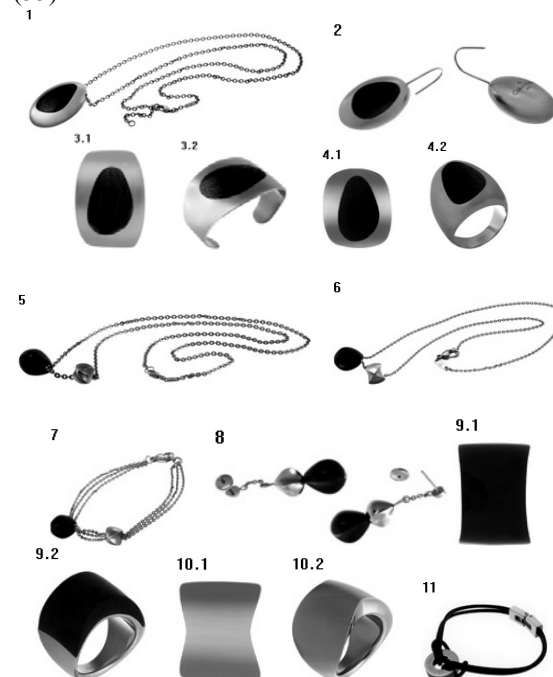

(11) DM/072883 (51) 10-02

(15) 2010 01 11

(45) 2010/01 (2010 02 28)

(22) 2010 01 11

(28) 5

(73) THE SWATCH GROUP MANAGEMENT SERVICES AG (THE SWATCH GROUP MANAGEMENT SERVICES SA)

(THE SWATCH GROUP MANAGEMENT SERVICES LTD.) Seevorstadt 6,

CH-2501 BIEL/BIENNE (CH)

(85) CH

(86) CH

(87) CH

(88) CH

(89) CH

(81) II. BZ, MA, MC, ME. III. AL, AM, CH, EM, GE, HR, KG, LI, MD, MK, MN, OM, SG, TR, UA

(72) Arlette Elsa EMCH, Rue des Mornets 31,

CH-2520 LA NEUVEVILLE

(54) 1.-3. Wristwatches; 4.-5. watches

(55)

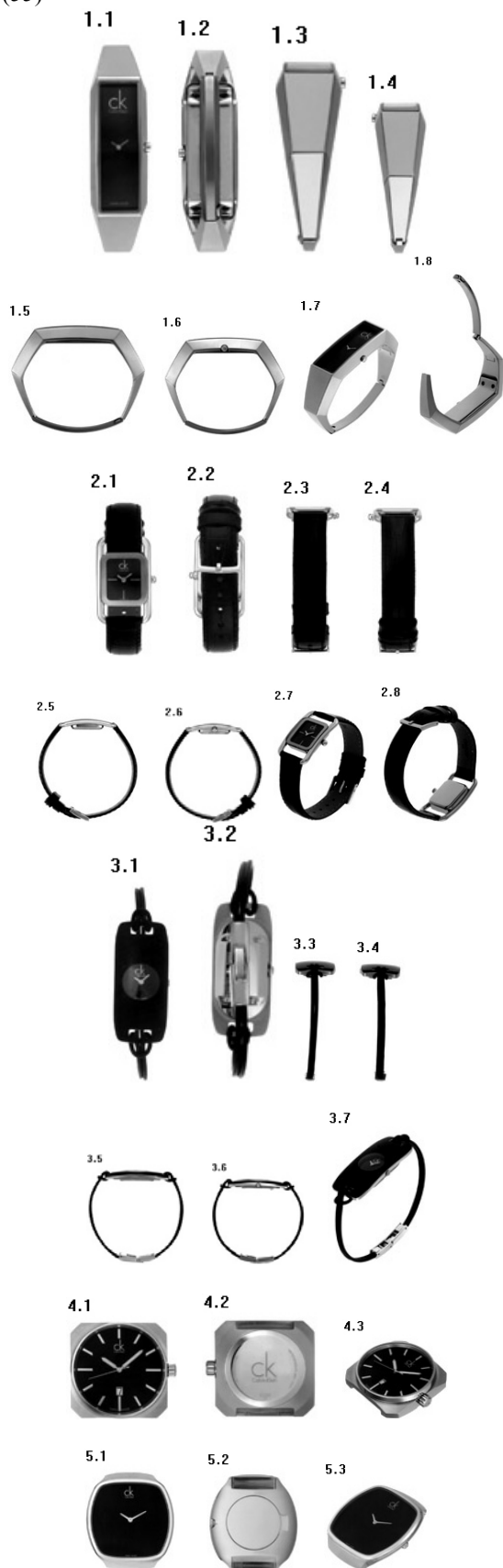

(11) DM/072926 (51) 32-00

(15) 2009 10 06

(45) 2010/01 (2010 02 28)

(22) 2009 10 06

(28) 7

(30) 14.01.2009, HEIMTEX, Francfort, Allemagne

(73) SPECIAL EDITIONS

6 rue Antoine Mottheau, F-94440 MAROLLES EN BRIE (FR)

(85) FR,EM

(86) FR,EM

(87) FR,EM

(88) FR,EM

(89) EM

(81) III. CH, EM, GE, HU, TR, UA

(54) 1.-7. Designs for application on wallpaper

(55)

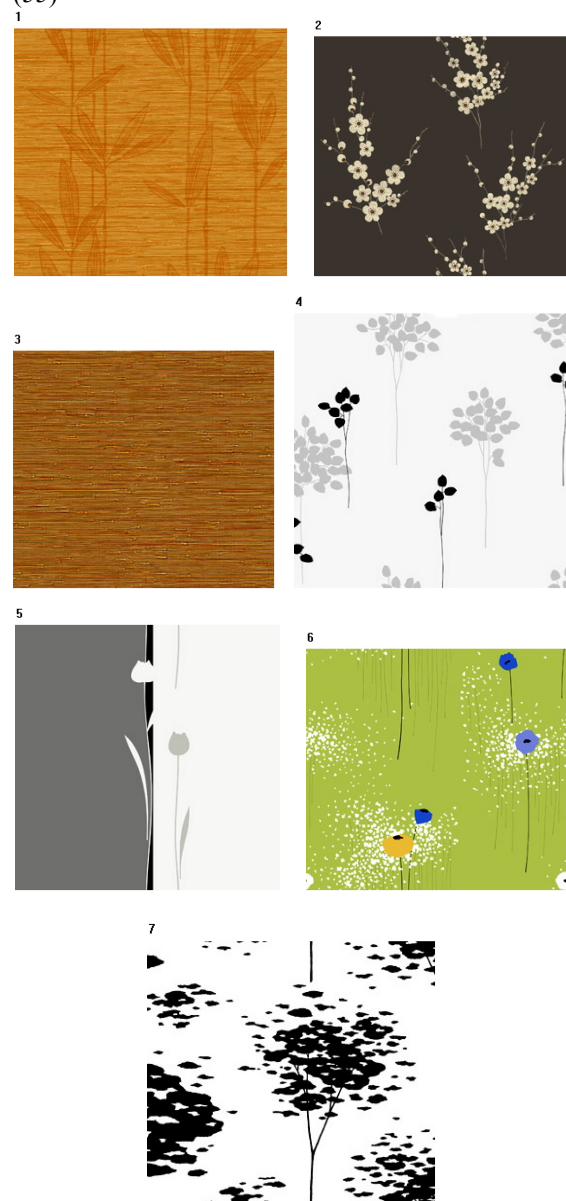

(11) DM/072937 (51) 10-07

(15) 2010 01 14

(45) 2010/01 (2010 02 28)

(22) 2010 01 14

(28) 7

(73) TISSOT S.A. Chemin des Tourelles 17,
CH-2400 LE LOCLE (CH)

(85) CH

(86) CH

(87) CH

(88) CH

(89) CH

(81) II. BZ, MA, MC, ME. III. AL, AM, CH, EM,
GE, HR, KG, LI, MD, MK, MN, OM, SG, TR, UA

(72) Modèles N1-3: SAUNDERS Laurie, Grand-
Rue 61, CH-2036 CORMONDRECHE; Modèle

N4: LAMBRIGGER Sylvie, Obergasse 7,
CH-2502 BIENNE; Modèle N°5: BARBIER

Christophe, Chemin des Cordiers 42, CH-2503
BIENNE; Modèles N°6 et 7: BRAVO MARINHO

Paulo Manuel, Chemin de la Forêt 3, CH-2068
HAUTERIVE

(54) 1. Watch case; 2.-7. Watch cases with
bracelets

(55)

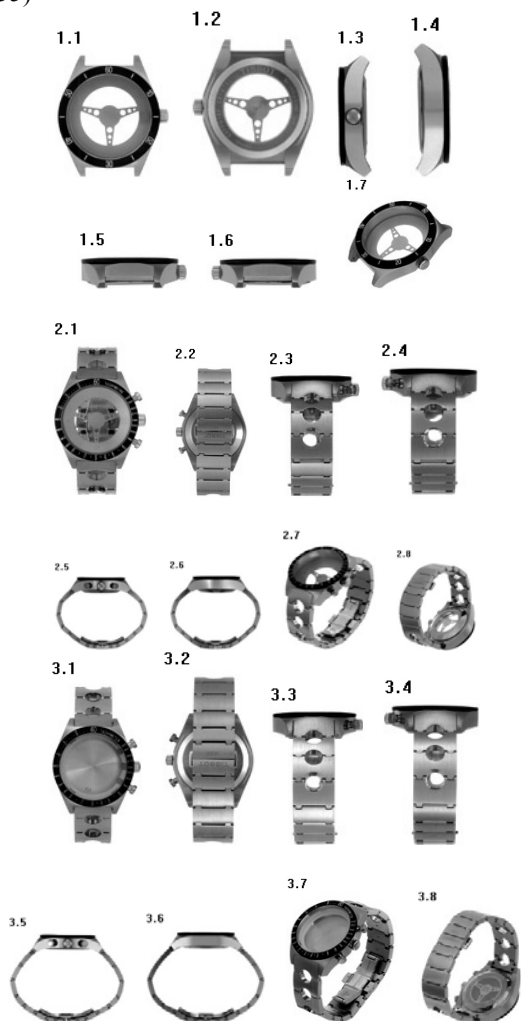

(11) DM/072947 (51) 10-02

(15) 2010 01 22

(45) 2010/01 (2010 02 28)

(22) 2010 01 22

(28) 5

(73) SWATCH AG (SWATCH SA)(SWATCH
LTD) Jakob-Stämpfli-Strasse 94,
CH-2502 BIEL/BIENNE (CH)

(85) CH

(86) CH

(87) CH

(88) CH

(89) CH

(81) II. BZ, MA, MC, ME. III. AL, AM, CH, EM, GE, HR, KG, LI, MD, MK, MN, OM, SG, TR, UA
 (72) Lukas GOLLER, Burgfrieden 38, IT-39040 SEIS (BZ)
 (54) 1.-5. Wristwatches
 (55)

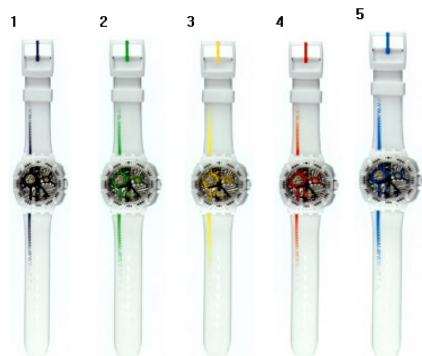

(11) DM/072948 (51) 10-07
 (15) 2010 01 22
 (45) 2010/01 (2010 02 28)
 (22) 2010 01 22
 (28) 1
 (73) RADO UHREN AG (RADO WATCH CO.LTD.) (MONTRES RADO SA) Bielstrasse 45, CH-2543 LENGNAU (CH)
 (85) CH
 (86) CH
 (87) CH
 (88) CH
 (89) CH

(81) II. BZ, MA, MC, ME. III. AL, AM, CH, EG, EM, GE, HR, KG, LI, MD, MK, MN, OM, SG, TR, UA
 (72) 1) Alessandra FURETTA, Chemin du Crêt 28, CH-2533 EVILARD; 2) Christian VERDON, Grand Rue 14, CH-1034 BOUSSENS
 (54) 1. Watch dial
 (55)

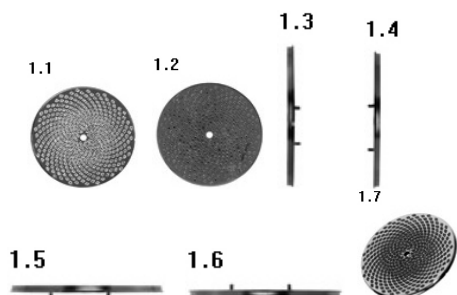

(11) DM/072949 (51) 10-02
 (15) 2010 01 22
 (45) 2010/01 (2010 02 28)
 (22) 2010 01 22
 (28) 2
 (73) RADO UHREN AG (RADO WATCH

CO.LTD.) (MONTRES RADO SA) Bielstrasse 45, CH-2543 LENGNAU (CH)
 (85) CH
 (86) CH
 (87) CH
 (88) CH
 (89) CH
 (81) II. BZ, MA, MC, ME. III. AL, AM, CH, EM, GE, HR, KG, LI, MD, MK, MN, OM, SG, TR, UA
 (72) Alessandra FURETTA, Chemin du Crêt 28, CH-2533 EVILARD
 (54) 1.-2. Wristwatches
 (55)

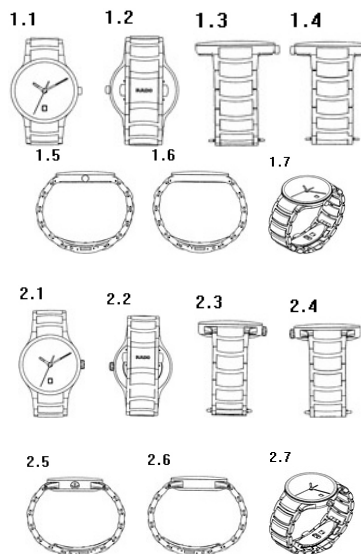

(11) DM/072950 (51) 10-02
 (15) 2010 01 22
 (45) 2010/01 (2010 02 28)
 (22) 2010 01 22
 (28) 3
 (73) RADO UHREN AG (RADO WATCH CO.LTD.) (MONTRES RADO SA) Bielstrasse 45, CH-2543 LENGNAU (CH)
 (85) CH
 (86) CH
 (87) CH
 (88) CH
 (89) CH
 (81) II. BZ, MA, MC, ME. III. AL, AM, CH, EM, GE, HR, KG, LI, MD, MK, MN, OM, SG, TR, UA
 (72) Alessandra FURETTA, Chemin du Crêt 28, CH-2533 EVILARD
 (54) 1.-3. Wristwatches
 (55)

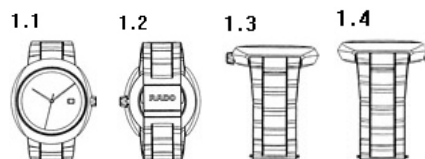

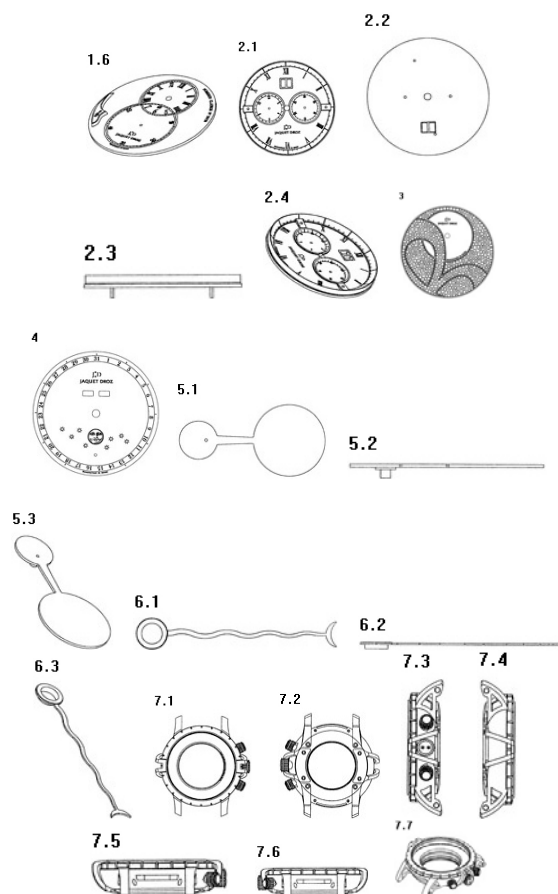
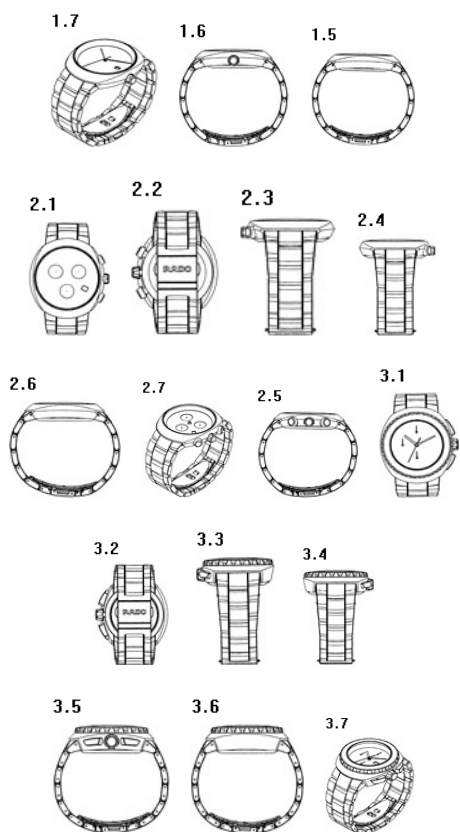

(11) DM/072964 (51) 10-07

(15) 2010 01 20

(45) 2010/01 (2010 02 28)

(22) 2010 01 20

(28) 7

(73) MONTRES JAQUET DROZ SA (MONTRES JAQUET DROZ AG) (MONTRES JAQUET DROZ LTD.) 5, rue Jaquet Droz, CH-2300 La Chaux-de-Fonds (CH)

(85) CH

(86) CH

(87) CH

(88) CH

(89) CH

(81) II. BZ, MA, MC, ME. III. AL, AM, CH, EM, GE, HR, KG, LI, MD, MK, MN, OM, SG, TR, UA

(72) Maamar BOULARAS ET Diego Böttger-Zevallos, MONTRES JAQUET DROZ SA (Montres Jaquet Droz AG) (Montres Jaquet Droz Ltd), 5, rue Jaquet Droz, CH-2300 LA CHAUX-DE-FONDS

(54) 1.-4. Dials; 5.-6. watch hands; 7. watch case

(55)

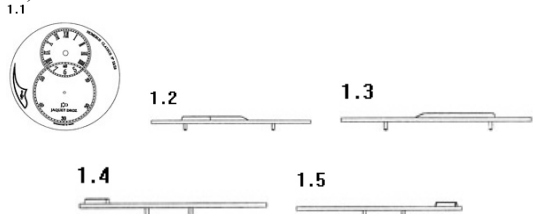

(11) DM/073552 (51) 28-99

(15) 2010 04 19

(45) 2010/05 (2010 06 30)

(22) 2010 04 19

(28) 1

(73) BALEV EOOD bul. Vladislav Varnenchik No.256, BG-9009 Varna (BG)

(85) BG,EM

(86) BG,EM

(87) BG,EM

(88) BG,EM

(89) BG

(81) II. KP, MA, ME. III. AL, AM, BA, CH, EG, EM, GE, HR, KG, MD, MK, OA, OM, RS, SY, TR, UA

(72) Dimitar Hristov Balev, kv. Vladislavovo, bl. 224, vh. 2, ap. 50, BG-9000 Varna

(54) 1. Air freshener

(55)



(11) DM/073555 (51) 11-01

(15) 2010 05 03

(45) 2010/05 (2010 06 30)

(22) 2010 05 03

(28) 39

(73) SWATCH AG (SWATCH SA)(SWATCH LTD) Jakob-Stämpfli-Strasse 94, CH-2502 BIEL/BIENNE (CH)

(85) CH

(86) CH

(87) CH

(88) CH

(89) CH

(81) II. BZ, MA, MC, ME. III. AL, AM, CH, EM, GE, HR, KG, LI, MD, MK, MN, OM, SG, TR, UA

(72) Modèles N1-4: Laura TABOR, 58A

Rushmore Road, Clapton, LONDON E5 0EX, GB;

Modèles N5-8: Philippe AIRAUD, TSI DESIGN,

Rue St-Honoré 92-94, F-75001 PARIS; Modèles

N9-12: Michaela KOCH, MICHA DESIGN,

Albrecht-Achilles-Str. 2, DE-10709 BERLIN;

Modèles N13-17: Mélanie RAETZ, MA & ME,

Sentier du Donjon 5, CH-2000 NEUCHATEL;

Modèles N18-20: Philippe AIRAUD, TSI

DESIGN, Rue St-Honoré 92-94, F-75001 PARIS;

Modèles N21-24: Michaela KOCH, MICHA

DESIGN, Albrecht-Achilles-Str. 2, DE-10709

BERLIN; Modèles N25-28: Iza EMCH, DYB

DRESS YOUR BODY, Av. Beauregard 12/C.P.,

CH-2036 CORMONDRECHE; Modèles N29-32:

Philippe AIRAUD, TSI DESIGN, Rue St-Honoré

92-94, F-75001 PARIS; Modèles N33-35:

Michaela KOCH, MICHA DESIGN, Albrecht-

Achilles-Str. 2, DE-10709 BERLIN; Modèles

N36-39: Mélanie RAETZ, MA & ME, Sentier du

Donjon 5, CH-2000 NEUCHATEL

(54) Jewelry, in particular bracelets (1, 5, 9, 13, 18,

21, 25, 29, 33, 36), pendants (2, 31), rings (3, 6, 10,

14, 15, 19, 22, 26, 30, 37), earrings (4, 7, 11, 16,

23, 27, 32, 34, 38), necklaces (8, 12, 17, 20, 24, 28,

35, 39)

(55)

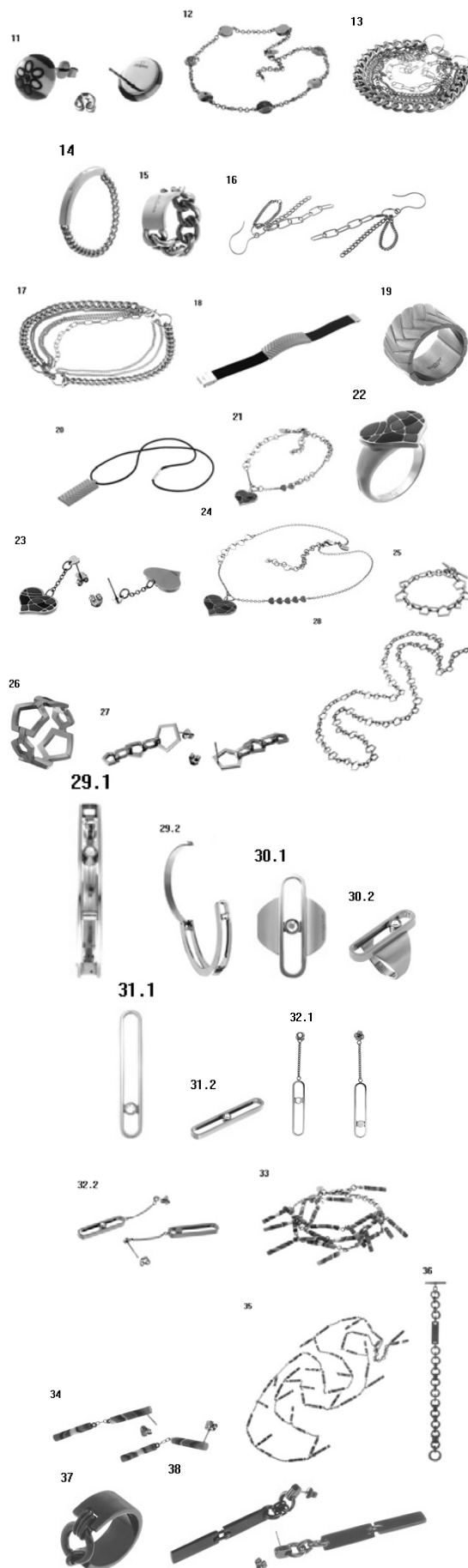
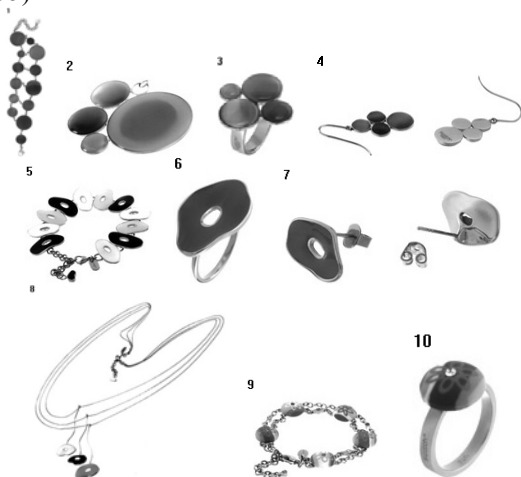



(11) DM/073567 (51) 32-00
 (15) 2010 02 24
 (45) 2010/05 (2010 06 30)
 (22) 2010 02 24
 (28) 1
 (30) 11.02.2010; 136759; CH
 (73) MARIANNE MARTINELLI Bürenweg 27,
 CH-4145 Gempen (CH)
 (85) CH
 (86) CH
 (87) CH
 (88) CH
 (89) CH
 (81) II. BZ, KP, MA, MC, ME, SR. III. AL, AM,
 BA, EG, EM, GE, HR, HU, IS, KG, LI, MD, MK,
 MN, OA, OM, RS, SG, SY, TR, UA.
 (72) Marianne Martinelli, Bürenweg 27, 4145
 Gempen Suisse
 (54) Industrial packaging pattern
 (55)

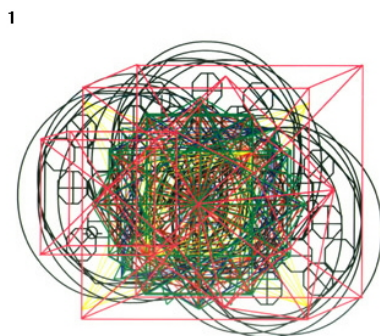

(11) DM/073592 (51) 10-02
 (15) 2010 05 17
 (45) 2010/05 (2010 06 30)
 (22) 2010 05 17
 (28) 2
 (73) THE SWATCH GROUP MANAGEMENT
 SERVICES AG (THE SWATCH GROUP
 MANAGEMENT SERVICES SA) (THE
 SWATCH GROUP MANAGEMENT SERVICES
 LTD.) Seevorstadt 6, BIEL (CH)
 (85) CH
 (86) CH
 (87) CH
 (88) CH
 (89) CH
 (81) II. BZ, MA, MC, ME. III. AL, AM, BA, CH,
 EM, GE, HR, KG, LI, MD, MK, MN, OM, SG, TR,
 UA

(72) Arlette Elsa EMCH, rue des Mornets 31, CH-
 2520 La Neuveville, SUISSE
 (54) 1. Watch; 2. wristwatch
 (55)

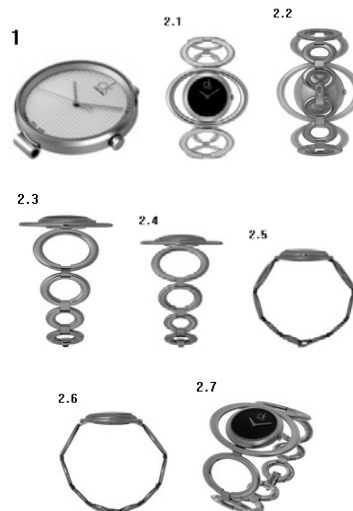

(11) DM/073661 (51) 10-02
 (15) 2010 05 25
 (45) 2010/05 (2010 06 30)
 (22) 2010 05 25
 (28) 10
 (73) SWATCH AG (SWATCH SA)(SWATCH
 LTD) Jakob-Stämpfli-Strasse 94,
 CH-2502 BIEL/BIENNE (CH)
 (85) CH
 (86) CH
 (87) CH
 (88) CH
 (89) CH
 (81) II. BZ, MA, MC, ME. III. AL, AM, BA, CH,
 EM, GE, HR, KG, LI, MD, MK, MN, OM, SG,
 TR, UA
 (72) Andrea ARRIGONI, SWATCHLAB,
 Via Archimede 6, IT-20129 MILANO
 (54) 1.-10. Wristwatches
 (55)





TRADEMARKS

ТОВАРНЫЕ ЗНАКИ

APPLICATIONS FILED UNDER THE NATIONAL PROCEDURE, LAID OPEN FOR THE PURPOSE OF TAKING PATENT GRANTING DECISION

ЗАЯВКИ, ПОДАННЫЕ СОГЛАСНО НАЦИОНАЛЬНОЙ ПРОЦЕДУРЕ, ПО КОТОРЫМ ВЫНЕСЕНО РЕШЕНИЕ О РЕГИСТРАЦИИ

To appeal a decision is possible at Chamber of Appeal of Sakpatenti within 3 months from the publication or at The Board of Administrative Actions of Tbilisi City Court within a 1 month period. (Address: 12 kl. N 6, David Aghmashenebeli Kheivani, Tbilisi).

Обжалование решения возможно в Апелляционной палате Сапатенти в течение 3 месяцев с даты его публикации или в течение 1 месяца в Коллегии по административным делам Тбилисского городского суда (г. Тбилиси, Аллея Давида Агмашенебели 12-й км., №6).

(260) AM 2010 56684 A
(210) AM 056684
(220) 2010 01 15
(731) SH.P.S "SANSHAIN JORJIA",
Qiqodzis 15, 0105, Tbilisi, Georgia
(540)



(591) White, red, gray
(531) 01.03.13–01.03.15–27.05.24–28.19.00–
29.01.00–
(511) 9, 21, 25, 28, 35, 38, 41

(260) AM 2010 56726 A
(210) AM 056726
(220) 2010 01 21
(731) RUSSIAN STANDARD INTELLECTUAL
PROPERTY HOLDING AG,
Zugerstrasse 49, Postfach 2528, 6330 Cham,
Switzerland;
ZAO "ROUST INC",
Pulkovskoe shosse., 52, litera A, p.Shushary,
196140, Saint-Petersburg, Russian
Federation
(740) Liliana Darakhvekidze
(540)

РУССКИЙ СТАНДАРТ
(591) Black, white

(511) 25, 30, 32, 33, 35, 36, 42

(260) AM 2010 56727 A
(210) AM 056727
(220) 2010 01 21
(731) RUSSIAN STANDARD INTELLECTUAL
PROPERTY HOLDING AG,
Zugerstrasse 49, Postfach 2528, 6330 Cham,
Switzerland;
ZAO "ROUST INC",
Pulkovskoe shosse., 52, litera A, p.Shushary,
196140, Saint-Petersburg, Russian
Federation
(740) Liliana Darakhvekidze
(540)

RUSSIAN STANDARD

(591) Black, white
(511) 25, 30, 32, 33, 35, 36, 42

(260) AM 2010 56728 A
(210) AM 056728
(220) 2010 01 21
(731) RUSSIAN STANDARD INTELLECTUAL
PROPERTY HOLDING AG,
Zugerstrasse 49, Postfach 2528, 6330 Cham,
Switzerland;
ZAO "ROUST INC",
Pulkovskoe shosse., 52, litera A, p.Shushary,
196140, Saint-Petersburg, Russian
Federation
(740) Liliana Darakhvekidze

(540)



(591) Blue, gray, silver, yellow, red, white
 (531) 03.01.14–03.07.01–24.01.09–24.07.05–
 25.01.19–28.05.00–29.01.00–
 (511) 33

(260) AM 2010 56732 A
 (210) AM 056732
 (220) 2010 01 21
 (731) RUSSIAN STANDARD INTELLECTUAL
 PROPERTY HOLDING AG,
 Zugerstrasse 49, Postfach 2528, 6330 Cham,
 Switzerland;
 ZAO "ROUST INC",
 Pulkovskoe shosse., 52, litera A, p.Shushary,
 196140, Saint-Petersburg, Russian
 Federation

(740) Liliana Darakhvekidze
 (540)



(591) Gray, light grey, silver, red, black
 (531) 03.01.14–03.07.01–24.01.09–25.01.19–
 28.05.00–29.01.00–
 (511) 33

(260) AM 2010 56733 A
 (210) AM 056733
 (220) 2010 01 21
 (731) ZAO "ROUST INC",
 Pulkovskoe shosse., 52, litera A,
 p. Shushary, 196140, Saint-Petersburg,
 Russian Federation;
 RUSSIAN STANDARD INTELLECTUAL
 PROPERTY HOLDING AG,
 Zugerstrasse 49, Postfach 2528, 6330 Cham,
 Switzerland

(740) Liliana Darakhvekidze
 (540)



(591) Golden, red, white
 (531) 03.01.14–03.07.01–24.01.09–24.07.05–
 25.01.19–28.05.00–29.01.00–
 (511) 33

(260) AM 2010 56734 A
 (210) AM 056734
 (220) 2010 01 21
 (731) RUSSIAN STANDARD INTELLECTUAL
 PROPERTY HOLDING AG,
 Zugerstrasse 49, Postfach 2528, 6330 Cham,
 Switzerland;
 ZAO "ROUST INC",
 Pulkovskoe shosse., 52, litera A, p.Shushary,
 196140, Saint-Petersburg, Russian
 Federation

(740) Liliana Darakhvekidze
 (540)



(591) Gray, dark gray, yellow, white, light brown,
 dark brown
 (531) 01.01.10–28.05.00–29.01.00–
 (511) 33

(260) AM 2010 56735 A
 (210) AM 056735
 (220) 2010 01 21
 (731) RUSSIAN STANDARD INTELLECTUAL
 PROPERTY HOLDING AG,
 Zugerstrasse 49, Postfach 2528, 6330 Cham,
 Switzerland;
 ZAO "ROUST INC",
 Pulkovskoe shosse., 52, litera A, p.Shushary,

196140, Saint-Petersburg, Russian Federation
 (740) Liliana Darakhvekidze
 (540)



(591) Black, white, dark red, light red
 (531) 03.01.14-03.07.01-24.01.09-25.01.19-28.05.00-29.01.00-
 (511) 33

(260) AM 2010 56794 A
 (210) AM 056794
 (220) 2010 01 27
 (731) MEDANA PHARMA S.A.,
 Ul. Wladyslawa Łokietka 10, 98-200,
 Sieradz, Poland
 (740) Davit Zurabishvili
 (540)

ПОЛВЕРТИК

(591) Black, white
 (511) 5

(260) AM 2010 56810 A
 (210) AM 056810
 (220) 2010 01 27
 (731) SH.P.S "SINGULAR JGUF",
 Dzmebi Zubalashvilebis q.2, 0108, Tbilisi,
 Georgia
 (540)



(591) Red, white, bordou
 (531) 24.15.01-24.17.04-27.05.04-27.05.05-29.01.00-
 (511) 38, 42

(260) AM 2010 56811 A
 (210) AM 056811
 (220) 2010 01 27
 (731) QUALCOMM INCORPORATED,

5775 Morehouse Drive, San Diego, California 92121-1714, USA
 (740) Shalva Gvaramadzei
 (540)

QUALCOMM

(591) Black, white
 (511) 38, 41, 42

(260) AM 2010 56812 A
 (210) AM 056812
 (220) 2010 01 28
 (731) GENZYME CORPORATION
 (a Massachusetts Corporation),
 500 kendall street, Cambridge,
 Massachusetts 02142, USA
 (740) Giorgi Taktakishvili
 (540)

CERSELVA

(591) Black, white
 (511) 5

(260) AM 2010 56818 A
 (210) AM 056818
 (220) 2010 01 28
 (731) SH.P.S "JI DA JI QOOFEREISHEN",
 Besikis q. N27, 0108, Tbilisi, Georgia
 (540)



(591) Dark brown, light brown, light pink
 (531) 26.04.22-27.05.05-27.05.24-29.01.00-
 (511) 30, 32, 35, 41, 43

(260) AM 2010 56819 A
 (210) AM 056819
 (220) 2010 01 28
 (731) SH.P.S "JI DA JI QOOFEREISHEN",
 Besikis q.N27, 0108, Tbilisi, Georgia
 (540)



(591) Dark brown, light brown, light pink
 (531) 03.01.14-26.04.22-27.05.05-27.05.24-29.01.00-
 (511) 30, 32, 35, 41, 43

(260) AM 2010 56820 A
 (210) AM 056820

(220) 2010 01 28
 (731) SH.P.S "JI DA JI QOOFEREISHEN",
 Besikis q.N27, 0108, Tbilisi, Georgia
 (540)



FINEST ICECREAM & MORE

(591) Dark brown, light brown, light pink
 (531) 03.01.14–26.04.22–27.05.05–27.05.24–
 29.01.00–
 (511) 30, 32, 35, 41, 43

(260) AM 2010 56825 A
 (210) AM 056825
 (220) 2010 01 28
 (731) McDONALD'S INTERNATIONAL
 PROPERTY COMPANY, LTD.,
 a corporation organized and existing under
 the laws of the State of Delaware,
 2711 Centerville Road, Suite 400,
 Wilmington, Delaware 19808, USA

(740) Shalva Gvaramadzei
 (540)

McWRAP

(591) Black, white
 (511) 30

(260) AM 2010 56891 A
 (210) AM 056891
 (220) 2010 02 03
 (731) SH.P.S. "GLOBALFARM",
 Tamar mefis gamz. N7/13, 0112, Tbilisi,
 Georgia

(740) Giorgi Taktakishvili
 (540)

**ZIDAMED
 ЗИДАМЕД
 ზიდამედი**

(591) Black, white
 (511) 5

(260) AM 2010 56892 A
 (210) AM 056892
 (220) 2010 02 03
 (731) SH.P.S "GLOBALFARM",
 Tamar Mefis gamz. 7/13, 0112, Tbilisi,
 Georgia
 (740) Giorgi Taktakishvili

(540)

**SLEZOL-WM
 СЛЕЗОЛ-ВМ
 სლეზოლი-ვმ**

(591) Black, white
 (511) 5

(260) AM 2010 56894 A
 (210) AM 056894
 (220) 2010 02 03
 (731) SH.P.S "GLOBALFARM",
 Tamar Mefis gamz. 7/13, 0112, Tbilisi,
 Georgia

(740) Giorgi Taktakishvili
 (540)

**SILFECT-WM
 СИЛФЕКТ-ВМ
 სილფექტი-ვმ**

(591) Black, white
 (511) 5

(260) AM 2010 56895 A
 (210) AM 056895
 (220) 2010 02 03
 (731) SH.P.S. "GLOBALFARM",
 Tamar mefis gamz. N7/13, 0112, Tbilisi,
 Georgia

(740) Giorgi Taktakishvili
 (540)

**RIVASTORON
 РИВАСТОРОН
 რივასტორონი**

(591) Black, white
 (511) 5

(260) AM 2010 56896 A
 (210) AM 056896
 (220) 2010 02 04
 (731) SH.P.S "GLOBALFARM",
 Tamar Mefis gamz. 7/13, 0112, Tbilisi,
 Georgia

(740) Giorgi Taktakishvili
 (540)

**PIROTAN
 ПИРОТАН
 პიროტანი**

(591) Black, white

(511) 5

(260) AM 2010 56897 A
 (210) AM 056897
 (220) 2010 02 04
 (731) SH.P.S "GLOBALFARMI",
 Tamar Mefis gamz. 7/13, 0112, Tbilisi,
 Georgia
 (740) Giorgi Taktakishvili
 (540)

METRON
МЕТРОН
მეტრონი

(591) Black, white
 (511) 5

(260) AM 2010 56899 A
 (210) AM 056899
 (220) 2010 02 04
 (731) SH.P.S "GLOBALFARMI",
 Tamar Mefis gamz. 7/13, 0112, Tbilisi,
 Georgia
 (740) Giorgi Taktakishvili
 (540)

GATORAL
ГАТОРАЛ
გატორალი

(591) Black, white
 (511) 5

(260) AM 2010 56901 A
 (210) AM 056901
 (220) 2010 02 04
 (731) SH.P.S "GLOBALFARMI",
 Tamar Mefis gamz. 7/13, 0112, Tbilisi,
 Georgia
 (740) Giorgi Taktakishvili
 (540)

FOSFOMED
ФОСФОМЕД
ფოსფომედი

(591) Black, white
 (511) 5

(260) AM 2010 56903 A
 (210) AM 056903
 (220) 2010 02 04
 (731) SH.P.S "GLOBALFARMI",

Tamar Mefis gamz. 7/13, 0112, Tbilisi,
 Georgia

(740) Giorgi Taktakishvili
 (540)

MEDOFASI
МЕДОФАСИ
მედოფასი

(591) Black, white
 (511) 5

(260) AM 2010 56921 A
 (210) AM 056921
 (220) 2010 02 08
 (731) SH.P.S "KEDARI",
 Iloris q. 22, bina 36, 0103, Georgia
 (540)

ქეპული

(591) Black, white
 (511) 29

(260) AM 2010 56922 A
 (210) AM 056922
 (220) 2010 02 08
 (731) SH.P.S "G-M-P" LTD ,
 Zemo Vedzisi Str. 103 , 0160, Tbilisi,
 Georgia
 (740) Nugzar Qsovreli
 (540)

ნეიროლეფსინი
НЕИРОЛЕПСИН
NEIROLEPSIN

(591) Black, white
 (511) 5

(260) AM 2010 56929 A
 (210) AM 056929
 (220) 2010 02 08
 (731) HARRINGTON DEVELOPMENT INC.,
 Arango-Orillac Bldg. East 54th Street,
 Panama, Panama
 (740) Givi Akopashvili
 (540)

WILSON

(591) Black, white
 (511) 34

(260) AM 2010 56940 A
 (210) AM 056940
 (220) 2010 02 09
 (731) SH.P.S "KAMPA",

Erekle II, 8/10, 0105, Tbilisi, Georgia
 (740) Nino Sanadiradze
 (540)



(591) Dark green, light green, white
 (531) 03.13.01–05.03.15–26.04.06–28.19.00–
 29.01.00–
 (511) 29,32,39

(260) AM 2010 56941 A
 (210) AM 056941
 (220) 2010 02 09
 (731) SH.P.S "KAMPA",
 Erekle II, 8/10, 0105, Tbilisi, Georgia
 (740) Nino Sanadiradze
 (540)



(591) Dark green, light green, white
 (531) 03.13.01–05.03.15–26.04.06–28.05.00–
 29.01.00–
 (511) 29,32,39

(260) AM 2010 56961 A
 (210) AM 056961
 (220) 2010 02 09
 (731) SH.P.S „FARMA SERVISI“,
 Guramishvilis gamz. 30, korp. I, bina 8,
 0192, Tbilisi, Georgia
 (740) Nugzar Qsovreli
 (540)



(591) Orange, white, blue
 (531) 24.13.01–24.13.13–26.02.03–28.19.00–
 29.01.13–
 (511) 35, 44

(260) AM 2010 56977 A
 (210) AM 056977
 (220) 2010 02 10
 (731) SS "NOBEL ILAC SANAYII VE TICARET

ANONIM SIRKETI"-is tsarm. saqartveloshi,
 Tavisuflebis moedani N4, 0105, Tbilisi,
 Georgia

(740) Gela Vadachkoria
 (540)

Clast
 კლასტი

(591) Black, white
 (511) 5

(260) AM 2010 56978 A
 (210) AM 056978
 (220) 2010 02 10
 (731) SS "NOBEL ILAC SANAYII VE TICARET
 ANONIM SIRKETI"-is tsarm. saqartveloshi,
 Tavisuflebis moedani N4, 0105, Tbilisi,
 Georgia
 (740) Gela Vadachkoria
 (540)

Torvas
 ტორვასი

(591) Black, white
 (511) 5

(260) AM 2010 57008 A
 (210) AM 057008
 (220) 2010 02 11
 (731) UNILEVER N.V.,
 Weena 455, 3013 AL Rotterdam,
 Netherlands
 (740) Shalva Gvaramadzei
 (540)

TWIST

(591) Black, white
 (511) 3

(260) AM 2010 57010 A
 (210) AM 057010
 (220) 2010 02 11
 (731) JULES,
 152 avenue Alfred Motte, 59100 ROUBAIX,
 France
 (740) Liliana Darakhvekidze
 (540)

ჯაქსი

(591) Black, white
 (531) 28.19.00–
 (511) 9, 14, 18, 25

- (260) AM 2010 57015 A
 (210) AM 057015
 (220) 2010 02 15
 (731) SH.P.S. "ARTFORUMI",
 Ilia Chavchavadzis 74, 0179, Tbilisi,
 Georgia
 (740) Giorgi Taktakishvili
 (540)



- (591) Pink, light pink, white
 (531) 25.07.03–27.05.04–29.01.00–
 (511) 16, 25, 32, 35, 41

- (260) AM 2010 57016 A
 (210) AM 057016
 (220) 2010 02 15
 (731) DOGADAN GIDA ÜRÜNLERI SANAYI
 VE PAZARLAMA A.S.,
 Çankiri Devlet Karayolu 7 Km. Akyurt,
 Ankara 06750, Turkey
 (740) Aleksandre Gegechkori
 (540)



- (591) Green, white
 (531) 25.03.03–27.05.24–29.01.00–
 (511) 5, 30, 32

- (260) AM 2010 57031 A
 (210) AM 057031
 (220) 2010 02 18
 (731) SH.P.S. "FARMA SERVISI",
 Guramishvilis gamz. 30, korp. I, bina 8,
 0192, Tbilisi, Georgia
 (740) Nugzar Qsovreli
 (540)



- (591) Orange, white, blue
 (531) 24.13.01–26.04.22–26.11.08–28.19.00–
 (511) 35, 44

- (260) AM 2010 57032 A
 (210) AM 057032
 (220) 2010 02 18
 (731) SH.P.S. "FARMA SERVISI",
 Guramishvilis gamz. 30, korp. I, bina 8,
 0192, Tbilisi, Georgia
 (740) Nugzar Qsovreli

- (540)
 ნარინჯისფერი ფარმაცენტრი
 ОРАНЖЕВЫЙ ФАРМАЦЕНТР
 ORANGE PHARMACENTRE

- (591) Black, white
 (511) 35, 44

- (260) AM 2010 57033 A
 (210) AM 057033
 (220) 2010 02 18
 (731) SH.P.S. "FARMA SERVISI",
 Guramishvilis gamz. 30, korp. I, bina 8,
 0192, Tbilisi, Georgia
 (740) Nugzar Qsovreli
 (540)

ნარინჯისფერი აფთიაქი
 ОРАНЖЕВАЯ АПТЕКА
 ORANGE PHARMACY

- (591) Black, white
 (511) 35, 44

- (260) AM 2010 57042 A
 (210) AM 057042
 (220) 2010 02 22
 (731) I/M DAVIT CHIKHRADZE,
 Gldanis raioni, mukhianis me-3 m/r, k. 17,
 bina 70, 0172, Tbilisi, Georgia
 (540)

ალიბაბას ხაში

- (591) Black, white
 (511) 43

- (260) AM 2010 57052 A
 (210) AM 057052
 (220) 2010 02 23
 (731) SS "LIBERTI BANKI",
 Ilia Chavchavadzis gamz.74, 0162, Tbilisi,
 Georgia
 (540)

ქველბან და ქველასთვის

- (591) Black, white
 (511) 36

- (260) AM 2010 57053 A
 (210) AM 057053
 (220) 2010 02 23
 (731) SS "LIBERTI BANKI",
 Ilia Chavchavadzis gamz.74, 0162, Tbilisi,
 Georgia

(540)
ყველგან და ყველასათვის
 (591) Black, white
 (511) 36

(260) AM 2010 57054 A
 (210) AM 057054
 (220) 2010 02 23
 (731) SS "LIBERTI BANKI",
 Iliа Chavchavadzis gamz.74, 0162, Tbilisi,
 Georgia

(540)
საღაც დაბჭირლებით
 (591) Black, white
 (511) 36

(260) AM 2010 57078 A
 (210) AM 057078
 (220) 2010 02 25
 (731) BRITISH AMERICAN TOBACCO
 (BRANDS) INC.
 (A Delaware corporation), 2711 Centerville
 Road, Suite 300, Wilmington, Delaware
 19808, USA
 (740) Tamar Kochlamazashvili
 (540)



(591) Black, white
 (531) 26.01.01–
 (511) 34

(260) AM 2010 57103 A
 (210) AM 057103
 (220) 2010 02 26
 (731) DOW AGROSCIENCESG LLC,
 a Delaware limited liability company, 9330
 Zionsville Road, Indianapolis, Indiana
 46268, USA
 (740) Tamaz Shilakadze
 (540)

DURSBAN

(591) Black, white
 (511) 5

(260) AM 2010 57104 A
 (210) AM 057104
 (220) 2010 02 26
 (731) DOW AGROSCIENCESG LLC,

a Delaware limited liability company,
 9330 Zionsville Road, Indianapolis, Indiana
 46268, USA
 (740) Tamaz Shilakadze
 (540)

NURELLE D

(591) Black, white
 (511) 5

(260) AM 2010 57222 A
 (210) AM 057222
 (220) 2010 03 04
 (731) COLGATE-PALMOLIVE COMPANY,
 300 Park Avenue, NEW YORK, N.Y.
 10022, USA
 (740) Shalva Gvaramadzei
 (540)



(591) Red, white, black, another tone blue
 (531) 02.09.10–26.04.22–27.05.05–27.05.24–
 29.01.00–
 (511) 3, 5, 21

(260) AM 2010 57240 A
 (210) AM 057240
 (220) 2010 03 05
 (731) EXELIXIS, INC.,
 a Delaware corporation, 210 East Grand
 Avenue, South San Francisco, California
 94083-0511, USA
 (740) Tamar Kochlamazashvili
 (540)

EXELIXIS

(591) Black, white
 (511) 5, 42

(260) AM 2010 57243 A
 (210) AM 057243
 (220) 2010 03 05
 (731) EXELIXIS, INC.,
 a Delaware corporation, 210 East Grand
 Avenue, South San Francisco, California
 94083-0511, USA
 (740) Tamar Kochlamazashvili
 (540)



(591) Black, white
 (531) 26.13.25–
 (511) 5, 42

(260) AM 2010 57250 A
 (210) AM 057250
 (220) 2010 03 05
 (731) SS "UNIFARMI",
 Sofeli Teklati, 4112, Senakis raioni, Georgia
 (540)

ფაქიზო
PAKIZO
ПАКИЗО

(591) Black, white
 (511) 29

(260) AM 2010 57336 A
 (210) AM 057336
 (220) 2010 03 11
 (731) UNILEVER N.V.,
 Weena 455, 3013 AL Rotterdam,
 Netherlands
 (740) Shalva Gvaramadzei
 (540)

POND'S

(591) Black, white
 (511) 3, 5, 21

(260) AM 2010 57359 A
 (210) AM 057359
 (220) 2010 03 12
 (731) SS "LIBERTI BANKI",
 Iia Chavchavadzis gamz.74, 0162, Tbilisi,
 Georgia

(540)

(591) Red, gray
 (531) 27.05.11–27.05.22–28.19.00–29.01.00–
 (511) 36

(260) AM 2010 57371 A
 (210) AM 057371
 (220) 2010 03 15
 (731) SS "LIBERTI BANKI",
 Iia Chavchavadzis gamz.74, 0162, Tbilisi,
 Georgia

(540)



(591) Red, white
 (531) 26.04.22–26.04.24–27.05.11–27.05.22–
 28.19.00–29.01.00–
 (511) 36

REGISTERED TRADEMARKS

ЗАРЕГИСТРИРОВАННЫЕ ТОВАРНЫЕ ЗНАКИ

(111) M 2010 020880 R
(151) 2010 11 03
(181) 2020 11 03
(260) AM 2010 53658 A
(220) 2009 06 05
(732) SH.P.S "KAKHURI TRADITSIULI
MEGVINEOBA";
Qsnis q.12, 0192, Tbilisi, GE

(111) M 2010 020881 R
(151) 2010 11 03
(181) 2020 11 03
(260) AM 2010 54035 A
(220) 2009 07 01
(732) LEO GABRIADZE;
Vazisubnis q., 12, bina 35, 0131, Tbilisi, GE

(111) M 2010 020882 R
(151) 2010 11 03
(181) 2020 11 03
(260) AM 2010 54121 A
(220) 2009 07 08
(732) FOUR SEASONS HOTELS
(BARBADOS) LTD.
Chancery House, High Street Bridgetown,
Barbados, West Indies

(111) M 2010 020883 R
(151) 2010 11 03
(181) 2020 11 03
(260) AM 2010 54130 A
(220) 2009 07 10
(732) PWC BUSINESS TRUST (A DELAWARE
BUSINESS TRUST);
300 Medison Avenue, New-York,
New-York 10017, USA

(111) M 2010 020884 R
(151) 2010 11 03
(181) 2020 11 03
(260) AM 2010 54131 A
(220) 2009 07 10
(732) PWC BUSINESS TRUST
(A DELAWARE BUSINESS TRUST);
300 Medison Avenue, New-York, New-York
10017, USA

(111) M 2010 020885 R
(151) 2010 11 03
(181) 2020 11 03
(260) AM 2010 54132 A
(220) 2009 07 10
(732) MARS, INCORPORATED;
6885 ELM Street, McLean, Virginia
22101-3883, USA

(111) M 2010 020886 R
(151) 2010 11 03
(181) 2020 11 03
(260) AM 2010 54135 A
(220) 2009 07 13
(732) SH.P.S "R & R GRUP";
Aerodromis dasakhleba 6, bina 2,
0182, Tbilisi, GE

(111) M 2010 020887 R
(151) 2010 11 03
(181) 2020 11 03
(260) AM 2010 54487 A
(220) 2009 08 12
(732) MARS, INCORPORATED;
6885 Elm Street, McLean, Virginia
22101-3883, USA

(111) M 2010 020888 R
(151) 2010 11 03
(181) 2020 11 03
(260) AM 2010 54554 A
(220) 2009 08 31
(732) ASTELLAS PHARMA INC.;
3-11, Nihonbashi-Honcho 2-Chome,
Chuo-ku, Tokyo 103-8411, Japan

(111) M 2010 020889 R
(151) 2010 11 03
(181) 2020 11 03
(260) AM 2010 54555 A
(220) 2009 08 31
(732) ASTELLAS PHARMA INC.;
3-11, Nihonbashi-Honcho 2-Chome,
Chuo-ku, Tokyo 103-8411, Japan

(111) M 2010 020890 R
(151) 2010 11 03

(181) 2020 11 03
 (260) AM 2010 54556 A
 (220) 2009 08 31
 (732) ASTELLAS PHARMA INC.;
 3-11, Nihonbashi-Honcho 2-Chome,
 Chuo-ku, Tokyo 103-8411, Japan

(111) M 2010 020891 R
 (151) 2010 11 03
 (181) 2020 11 03
 (260) AM 2010 54814 A
 (220) 2009 09 14
 (732) MARS, INCORPORATED,
 a Delaware corporation; 6885 Elm Street,
 McLean, Virginia 22101-3883, USA

(111) M 2010 020892 R
 (151) 2010 11 03
 (181) 2020 11 03
 (260) AM 2010 54913 A
 (220) 2009 09 21
 (732) CISCO TECHNOLOGY, INC.
 (a California corporation);
 170 West Tasman Drive, San Jose,
 California 95134, USA

(111) M 2010 020893 R
 (151) 2010 11 03
 (181) 2020 11 03
 (260) AM 2010 55035 A
 (220) 2009 10 01
 (732) GIORGI GOGBAIDZE;
 Griboedovis 21, 0108, Tbilisi, GE

(111) M 2010 020894 R
 (151) 2010 11 03
 (181) 2020 11 03
 (260) AM 2010 55104 A
 (220) 2009 10 07
 (732) SH.P.S "JANSAGI SAKVEBI";
 G. Qiqodzis 3, 0105, Tbilisi, GE

(111) M 2010 020895 R
 (151) 2010 11 03
 (181) 2020 11 03
 (260) AM 2010 55126 A
 (220) 2009 10 15
 (732) SH..PS "ASPHARMA"
 SAQARTVELOSE PHARMATSEVTULI
 KOMPANIA
 Shevchenkos q., 12, 0108, Tbilisi, GE

(111) M 2010 020896 R
 (151) 2010 11 03
 (181) 2020 11 03
 (260) AM 2010 55453 A
 (220) 2009 10 30
 (732) FREMANTLE MEDIA OPERATIONS BV;
 Media Centre, Sumatralaan 45, 1217GP
 Hilversum

(111) M 2010 020909 R
 (151) 2010 11 12
 (181) 2020 11 12
 (260) AM 2010 54374 A
 (220) 2009 07 29
 (732) BUNSHA;
 100 rue du kalvaire 59510 HEM, France

(111) M 2010 020910 R
 (151) 2010 11 12
 (181) 2020 11 12
 (260) AM 2010 54638 A
 (220) 2009 09 02
 (732) TREK BICYCLE CORPORATION;
 801 West Madison, Waterloo, Wisconsin
 53594, USA

(111) M 2010 020911 R
 (151) 2010 11 12
 (181) 2020 11 12
 (260) AM 2010 54685 A
 (220) 2009 09 07
 (732) ELISABED NIKOLADZE;
 Tsknetis q. №6, bina 2, 0162, Tbilisi, GE
 NIKOLADZE ELISO;
 Gldanis me2 mikroraioni, korp. 31, bina 88,
 0167, Tbilisi, GE

(111) M 2010 020912 R
 (151) 2010 11 12
 (181) 2020 11 12
 (260) AM 2010 54894 A
 (220) 2009 09 16
 (732) BRITISH AMERICAN TOBACCO
 (BRANDS) INC. (A DELAWARE
 CORPORATION);
 2711 Centerville Road, Suite 300,
 Wilmington, Delaware 19808, USA

(111) M 2010 020913 R
 (151) 2010 11 12
 (181) 2020 11 12
 (260) AM 2010 54908 A

(220) 2009 09 21
(732) LABORATORIOS PHOENIX S.A.I.C. Y F.;
Humahuaca 4065, Buenos Aires

(111) M 2010 020914 R
(151) 2010 11 12
(181) 2020 11 12
(260) AM 2010 54950 A
(220) 2009 09 23

(732) THE BODY SHOP INTERNATIONAL
PLC;
Watersmead, Littlehampton, West Sussex,
BN17 6LS

(111) M 2010 020915 R
(151) 2010 11 12
(181) 2020 11 12
(260) AM 2010 54951 A
(220) 2009 09 23

(732) THE BODY SHOP INTERNATIONAL
PLC;
Watersmead, Littlehampton, West Sussex,
BN17 6LS

(111) M 2010 020916 R
(151) 2010 11 12
(181) 2020 11 12
(260) AM 2010 54952 A
(220) 2009 09 23

(732) THE BODY SHOP INTERNATIONAL
PLC;
Watersmead, Littlehampton, West Sussex,
BN17 6LS

(111) M 2010 020917 R
(151) 2010 11 12
(181) 2020 11 12
(260) AM 2010 54984 A
(220) 2009 09 24

(732) ENERGY BRANDS INC.;
17-20 Whitestone Expressway, Whitestone,
New York 11357, USA

(111) M 2010 020918 R
(151) 2010 11 12
(181) 2020 11 12
(260) AM 2010 55250 A
(220) 2009 10 21

(732) GENZYME CORPORATION
(a Massachusetts Corporation);
500 Kendall Street, Cambridge, Massachusetts
02142, USA

(111) M 2010 020919 R
(151) 2010 11 12
(181) 2020 11 12
(260) AM 2010 55288 A
(220) 2009 10 22

(732) SH.P.S "RENQSAN MOBILIA";
Chavchavadzis 93, Batumi, GE

(111) M 2010 020924 R
(151) 2010 11 16
(181) 2020 11 16
(260) AM 2009 52002 A
(220) 2009 02 06

(732) ОБЩЕСТВО С ОГРАНИЧЕННОЙ
ОТВЕТСТВЕННОСТЬЮ. "ТОРГОВИЙ
ДОМ "САНТЭК";
Ул. Коптевская, д. 73, стр. 1, 125239 г.
Москва

(111) M 2010 020925 R
(151) 2010 11 16
(181) 2020 11 16
(260) AM 2010 54078 A
(220) 2009 07 06

(732) S.S. "JI PI SI";
Marjanishvilis q. 26, 0102, Tbilisi, GE

(111) M 2010 020926 R
(151) 2010 11 16
(181) 2020 11 16
(260) AM 2010 54486 A
(220) 2009 08 12

(732) SH.P.S "JTK";
M. Kostavas q.5, bina 12, 0700, Tbilisi, GE

(111) M 2010 020927 R
(151) 2010 11 16
(181) 2020 11 16
(260) AM 2010 55127 A
(220) 2009 10 15

(732) WM. WRIGLEY JR. COMPANY;
410 North Michigan Avenue, Chicago,
Illinois 60611, USA

(111) M 2010 020928 R
(151) 2010 11 16
(181) 2020 11 16
(260) AM 2010 55128 A
(220) 2009 10 15

(732) WM. WRIGLEY JR. COMPANY;
410 North Michigan Avenue, Chicago,
Illinois 60611, USA

**TRADEMARKS REGISTERED ACCORDING TO THE
ACCELERATED PROCEDURE**

**ТОВАРНЫЕ ЗНАКИ, ЗАРЕГИСТРИРОВАННЫЕ ПО
УСКОРЕННОЙ ПРОЦЕДУРЕ**

To file an appeal on request of the registration cancelling is possible at Chamber of Appeal of Sakpatenti within 3 months from the publication.

Внесение иска с требованием об аннулировании регистрации возможно в Апелляционной палате Сакпатенти в течение 3 месяцев с даты ее публикации.

(111) M 2010 20897 R
(151) 2010 11 05
(181) 2020 11 05
(260) AM 2010 60005 A
(220) 2010 10 26
(732) Dakhuruli saaqtsio sazogadoeba "Landrini"
Oqtombris sanap. 104, korp.41, Sankt-
Peterburgi
(740) Aleksandre Mchedlishvili
(540)



(591) White, red, grey, yellow, orange, bordeaux
(531) 08.01.23-26.13.25-26.15.09-19.03.03-
27.05.01-27.05.19-29.01.13-
(511) 30

(111) M 2010 20898 R
(151) 2010 11 08
(181) 2020 11 08
(260) AM 2010 59977 A
(220) 2010 10 26
(732) Harrington Development Inc.
Arango-Orillac Bldg. East 54 th street,
Panama
(740) Givi Akopashvili
(540)

TT

(591) Black-white
(511) 34

(111) M 2010 20899 R
(151) 2010 11 08
(181) 2020 11 08
(260) AM 2010 60030 A
(220) 2010 10 28
(732) Shezugduli pasukhismgeblobis sazogadoeba
"ZHURNALI NIANGI"
Gr. Robaqidzis gamz. 7, 0159, Tbilisi, GE
(540)

გაზეთი

(591) Black-white
(531) 28.19.00-
(511) 16

(111) M 2010 20900 R
(151) 2010 11 08
(181) 2020 11 08
(260) AM 2010 60032 A
(220) 2010 10 28
(732) Harrington Development Inc.
Arango-Orillac Bldg. East 54 th street,
Panama
(740) Givi Akopashvili
(540)

FX

(591) Black-white
(511) 34

(111) M 2010 20901R
(151) 2010 11 09
(181) 2020 11 09
(260) AM 2010 59976 A
(220) 2010 10 26
(732) Harrington Development Inc.
Arango-Orillac Bldg. East 54 th street,
Panama
(740) Givi Akopashvili

(540)

ZIP

(591) Black-white
(511) 34

(111) M 2010 20902 R
(151) 2010 11 10
(181) 2020 11 10
(260) AM 2010 59947 A
(220) 2010 10 22
(732) WELFAR ILAC TICARET LIMITED STI
Atatürk Hava Alani Bölgesi Plaza N319,
Yesilköy/ISTANBUL Bakirköy V.D.
801 064 2555
(740) Tea Berinashvili
(540)

BIOSTABYL
ბიოსტაბილი

(591) Black-white
(511) 5

(111) M 2010 20903 R
(151) 2010 11 10
(181) 2020 11 10
(260) AM 2010 59948 A
(220) 2010 10 22
(732) WELFAR ILAC TICARET LIMITED STI
Atatürk Hava Alani Bölgesi Plaza N319,
Yesilköy/ISTANBUL Bakirköy V.D.
801 064 2555
(740) Tea Berinashvili
(540)

DEMOTON
დემოტონი

(591) Black-white
(511) 5

(111) M 2010 20904 R
(151) 2010 11 10
(181) 2020 11 10
(260) AM 2010 59949 A
(220) 2010 10 22
(732) WELFAR ILAC TICARET LIMITED STI
Atatürk Hava Alani Bölgesi Plaza N319,
Yesilköy/ISTANBUL Bakirköy V.D.
801 064 2555
(740) Tea Berinashvili
(540)

VAGOSTABYL
ვაგოსტაბილი

(591) Black-white
(511) 5

(111) M 2010 20905 R
(151) 2010 11 10
(181) 2020 11 10
(260) AM 2010 59951 A
(220) 2010 10 22
(732) WELFAR ILAC TICARET LIMITED STI
Atatürk Hava Alani Bölgesi Plaza N319,
Yesilköy/ISTANBUL Bakirköy V.D.
801 064 2555
(740) Tea Berinashvili
(540)

RIBATRAN
რიბატრანი

(591) Black-white
(511) 5

(111) M 2010 20906 R
(151) 2010 11 10
(181) 2020 11 10
(260) AM 2010 59952 A
(220) 2010 10 22
(732) WELFAR ILAC TICARET LIMITED STI
Atatürk Hava Alani Bölgesi Plaza N319,
Yesilköy/ISTANBUL Bakirköy V.D.
801 064 2555
(740) Tea Berinashvili
(540)

LEMOXOL
ლემოქსოლი

(591) Black-white
(511) 5

(111) M 2010 20907 R
(151) 2010 11 11
(181) 2020 11 11
(260) AM 2010 60050 A
(220) 2010 10 29
(732) Shps "STANDART TOBAKO
INKORPOREITIDI"
Abuseridze-tbelis q. 13, 0120, Tbilisi, GE
(740) Giorgi Meipariani
(540)



(591) Dark claret, silver, black, white
 (531) 02.01.01-19.03.03-25.01.01-27.05.19-
 29.01.12-
 (511) 34

(111) M 2010 20908 R
 (151) 2010 11 11
 (181) 2020 11 11
 (260) AM 2010 60051 A
 (220) 2010 10 29
 (732) Shps "STANDART TOBAKO
 INKORPOREITIDI"
 Abuseridze-tbelis q. 13, 0120, Tbilisi, GE
 (740) Giorgi Meipariani
 (540)



(591) Silver, black, white
 (531) 02.01.01-19.03.03-25.01.01-27.05.19-
 29.01.12-
 (511) 34

(111) M 2010 20920 R
 (151) 2010 11 15
 (181) 2020 11 15
 (260) AM 2010 60052 A
 (220) 2010 10 29
 (732) Shps "standart tobako inkorporeitidi"
 Abuseridze-tbelis q. 13,
 0120,
 თბილისი, საქართველო
 (740) Giorgi Meipariani
 (540)



(591) Light red, dark red, grey, white
 (531) 01.03.15-19.03.03-25.01.01-28.19.00-
 29.01.12-
 (511) 34

(111) M 2010 20921 R
 (151) 2010 11 15
 (181) 2020 11 15
 (260) AM 2010 60053 A
 (220) 2010 10 29
 (732) Shps "standart tobako inkorporeitidi"
 Abuseridze-tbelis q. 13,
 0120,
 თბილისი, საქართველო
 (740) Giorgi Meipariani
 (540)



(591) Light blue, dark blue, grey, white
 (531) 01.03.15-19.03.03-25.01.01-28.19.00-
 29.01.12-
 (511) 34

(111) M 2010 20922 R
 (151) 2010 11 15
 (181) 2020 11 15
 (260) AM 2010 59795 A
 (220) 2010 10 08
 (732) Harrington Development Inc.
 Arango-Orillac Bldg. East 54 th street
 (740) Givi Akopashvili
 (540)

WHITFIELD

(591) Black-white
 (531) 27.05.17-
 (511) 34

(111) M 2010 20923 R
 (151) 2010 11 15
 (181) 2020 11 15
 (260) AM 2010 60210 A
 (220) 2010 11 11
 (732) COLGATE - PALMOLIVE COMPANY
 A Delaware corporation 300 Park Avenue,
 NEW YORK, N.Y. 10022

(740) Shalva Gvaramadze

(540)



(591) Red, white, green, black, another tone blue

(531) 05.03.14-05.05.20-25.01.01-27.05.05-
27.05.24-29.01.15-

(511) 3

**INTERNATIONAL TRADEMARKS LAID OPEN FOR THE PURPOSE OF
TAKING PROTECTION GRANTING DECISIONS**

**МЕЖДУНАРОДНЫЕ ТОВАРНЫЕ ЗНАКИ, ПО КОТОРЫМ ВЫНЕСЕНЫ РЕШЕНИЯ О
ПРЕДОСТАВЛЕНИИ ОХРАНЫ**

To appeal a decision is possible at Chamber of Appeal of Sakpatenti within 3 months from the publication or at The Board of Administrative Actions of Tbilisi City Court within a 1 month period. (Address: 12 km., №6, David Aghmashenebeli Kheivani, Tbilisi).

Обжалование решения возможно в Апелляционной палате Сакпатенти в течение 3 месяцев с даты его публикации или в течение 1 месяца в Коллегии по административным делам Тбилисского городского суда (г. Тбилиси, Аллея Давида Агмашенебели 12-й км., №6).

(260) AM 2010 56496 A

(800) 1022619

(731) OTKRYTOE AKTSIONERNOE
OBCHTCHESTVO "NEFTYANAYA
KOMPANIYA "LUKOIL";
11, Sretensky boulvar, RU-101000
MOSKVA, Russian Federation

(540)



(591) Grey

(511) 04

(260) AM 2010 56498 A

(800) 1022621

(731) OTKRYTOE AKTSIONERNOE
OBCHTCHESTVO "NEFTYANAYA
KOMPANIYA "LUKOIL";
11, Sretensky boulvar, RU-101000
MOSKVA, Russian Federation

(540)



(591) Grey

(511) 04

(260) AM 2010 56517 A

(800) 1022729

(731) RICHTER GEDEON NYRT.;
Gyömrői út 19-21, H-1103 Budapest,
Hungary

(540)

FINETTEX

(591) Black, white

(511) 05

(260) AM 2010 56705 A

(800) 1024608

(731) CEMSAN ELEKTRİKLİ CİHAZLAR
SAN.VE TİC.LTD.ŞTİ.;
Kemaliye Mah.Osman Tan Cad.No:71
VAKFIKEBİR/TRABZON, Turkey

(540)

veito

(591) Black, white

(511) 11

(260) AM 2010 56842 A

(800) 1025412

(731) Société des Produits Nestlé S.A.;
CH-1800 Vevey, Switzerland

(540)



(591) Black, white

(511) 30, 43

(260) AM 2010 56843 A

(800) 1025415

(731) AUDI AG;
85045 Ingolstadt, Germany

(540)

A plus

(591) Black, white

(511) 12, 36, 39, 41

(260) AM 2010 56844 A
 (800) 1025418
 (731) Rado Uhren AG (Rado Watch Co. Ltd)
 (Montres Rado SA);
 45, Bielstrasse, CH-2543 Lengnau,
 Switzerland

(540)



(591) Black, white
 (511) 14

(260) AM 2010 56845 A
 (800) 1025436
 (731) PIERRE FABRE DERMO-COSMETIQUE;
 45, place Abel Gance, F-92100
 BOULOGNE, France

(540)

SUNSHINE

(591) Black, white
 (511) 01, 03, 05

(260) AM 2010 56850 A
 (800) 1025465
 (731) DECATHLON;
 4 Boulevard de Mons, F-59150
 VILLENEUVE D'ASCQ, France

(540)

NYAMBA

(591) Black, white
 (511) 09, 12, 18, 25, 28, 35, 41

(260) AM 2010 56852 A
 (800) 1025475
 (731) Quick Sports International B.V.;
 Nijverheidsstraat 11, NL-3291 CH Strijen,
 Netherlands

(540)



(591) Black, white
 (511) 18, 25

(260) AM 2010 56853 A
 (800) 1025478
 (731) KANGNAI GROUP CO., LTD.;
 Kangnai Industrial Garden, China Shoe
 Capital Wenzhou Zhejiang, China

(540)

Kenol

(591) Black, white
 (511) 25

(260) AM 2010 56854 A
 (800) 1025499
 (731) Riigi Infosüsteemide Arenduskeskus;
 Rävåla 5, EE-15169 Tallinn, Estonia

(540)

X-ROAD

(591) Black, white
 (511) 09, 16, 38, 42

(260) AM 2010 56855 A
 (800) 1025500
 (731) SAP AG;
 Dietmar-Hopp-Allee 16, 69190 Walldorf,
 Germany

(540)

Clear Enterprise

(591) Black, white
 (511) 09, 16, 35, 36, 38, 41, 42

(260) AM 2010 56856 A
 (800) 1025528
 (731) Japan Tobacco Inc.;
 2-2-1 Toranomom, Minato-ku, Tokyo, Japan

(540)

**CAMEL
 ACCESS**

(591) Blue
 (511) 34, 41

(260) AM 2010 56857 A
 (800) 1025529
 (731) Japan Tobacco Inc.;
 2-2-1 Toranomom, Minato-ku, Tokyo, Japan

(540)

**DISCOVER
 MORE
 CAMEL
 ACCESS**

(591) Blue and yellow
(511) 34, 41

(260) AM 2010 56858 A
(800) 1025533
(731) Twin Disc, Inc.;
1328 Racine Street Racine, WI 53403, USA
(540)



(591) Black, white
(511) 09

(260) AM 2010 56859 A
(800) 1025543
(731) GRINDEKS, akciju sabiedriba;
LV-1057 Krustpils iela 53, Latvia
(540)

ЛИОАЛВЕН

(591) Black, white
(511) 05

(260) AM 2010 56910 A
(800) 1020954
(731) Apple Inc.;
1 Infinite Loop, Cupertino, CA 95014, USA
(540)

MAGIC MOUSE

(591) Black, white
(511) 09

(260) AM 2010 56911 A
(800) 597280
(731) PAGES VEDRENNE;
Distillerie de la Verveine du Velay, Z.I. de
Blavozy, F-43700 ST GERMAIN
LAPRADE, France
(540)

VEDRENNE

(591) Black, white
(511) 32, 33

(260) AM 2010 56912 A
(800) 619731
(731) NORBERT SCHALLER GESELLSCHAFT
M.B.H.;
Donau-City-Straße 11, A-1220 Wien, Austria

(540)



(591) Red, blue and white
(511) 06, 07, 37, 42

(260) AM 2010 56913 A
(800) 715917
(731) VALVOSANITARIA BUGATTI S.p.A.;
Via Iseo, 3, I-25045 CASTEGNATO
(Brescia), Italy
(540)



(591) Black, white
(511) 06

(260) AM 2010 56914 A
(800) 882047
(731) ZAĪMOĀĻU HOLDĪNG ANONĪM
ŠĪRKETĪ;
Halkali Caddesi No:99 Sefaköy,
Küçükçekmece İstanbul, Turkey
(540)



(591) Black, white
(511) 06, 07, 08

(260) AM 2010 56952 A
(800) 1026257
(731) Aktsionerne tovarystvo zakrytogo typu
"Kharkivska biskvitna fabryka";
vul. Lozivska, 8, Kharkiv 61017, Ukraine
(540)

ЕГЛЕ EGLE

(591) Black, white
(511) 30

(260) AM 2010 56954 A
(800) 1026258
(731) Aktsionerne tovarystvo zakrytogo typu
"Kharkivska biskvitna fabryka";
vul. Lozivska, 8, Kharkiv 61017, Ukraine

(540)

КАПРИЗУЛЯ

(591) Black, white
(511) 30

(260) AM 2010 56955 A
(800) 1026266
(731) BSH Bosch und Siemens Hausgeräte GmbH;
Carl-Wery-Str. 34, 81739 München,
Germany

(540)



(591) Grey, black, white and green
(511) 07, 09, 11

(260) AM 2010 56956 A
(800) 1026334
(731) ELITE DECOR, JSC;
Vyzhgorodska Str., 48, Kyiv 04114, Ukraine

(540)

DOMUS

(591) Black, white
(511) 06, 11, 19

(260) AM 2010 56957 A
(800) 1026359
(731) SELVA GIDA SANAYI ANONİM
ŞİRKETİ;
Fatih Mahallesi, Eski Sanayi ve Futbol
Sahasi Yani, No. 10/C KONYA, Turkey

(540)



(591) Red, yellow, white
(511) 30

(260) AM 2010 56958 A
(800) 1026362
(731) E. I. du Pont de Nemours and Company;
1007 Market Street Wilmington, DE 19898,
USA

(540)

SORONA

(591) Black, white
(511) 01, 22

(260) AM 2010 56959 A
(800) 1026363
(731) GRINDEKS, akciju sabiedrība;
Krustpils iela 53, LV-1057 Rīga, Latvia

(540)

ЛАКТОБЕКС

(591) Black, white
(511) 05, 30

(260) AM 2010 56967 A
(800) 1026395
(731) Dr. Theiss Naturwaren GmbH;
Michelinstrasse 10, 66424 Homburg,
Germany

(540)



(591) Olive green and grey
(511) 29, 30

(260) AM 2010 57000 A
(800) 810870
(731) Dr. Theiss Naturwaren GmbH;
Michelinstrasse 10, 66424 Homburg,
Germany

(540)



(591) Green
(511) 29, 30

(260) AM 2010 57044 A
(800) 1026586
(731) Ecolan Research & Development A/S;
Dampfærgevej 3, 2. DK-2100
KØBENHAVN Ø, Denmark

(540)

ECOLEAN - A LIGHTER APPROACH TO PACKAGING

(591) Black, white
(511) 01, 07, 16, 17, 19, 20

(260) AM 2010 57045 A
 (800) 1026593
 (731) ETI GIDA SANAYI VE TICARET ANONIM SIRKETI;
 Organize Sanayi Bolgesi 11 Cadde,
 ESKISEHIR, Turkey

(540)



(591) Yellow, straw coloured, brown, dark brown, light brown, red, black and white
 (511) 30

(260) AM 2010 57047 A
 (800) 1026617
 (731) Tissot SA;
 Chemin des Tourelles 17, CH-2400 Le Locle, Switzerland

(540)

TISSOT SAILING-TOUCH

(591) Black, white
 (511) 14

(260) AM 2010 57048 A
 (800) 1026625
 (731) CARTIER INTERNATIONAL AG;
 Hinterbergstrasse 22, Postfach 61, CH-6312 Steinhausen, Switzerland

(540)

CALIBRE DE CARTIER

(591) Black, white
 (511) 14

(260) AM 2010 57049 A
 (800) 1026626
 (731) CARLO PIGNATELLI S.P.A.;
 Via G. Reiss Romoli 150, I-10148 TORINO, Italy

(540)

Opere
CARLO PIGNATELLI

(591) Black, white
 (511) 18, 24, 25, 26

(260) AM 2010 57050 A
 (800) 1026646
 (731) Open Joint-Stock Company "Mediacom";
 45, Profsoyuznaya str., RU-117420 Moscow,
 Russian Federation

(540)



(591) Black, white
 (511) 03, 09, 16, 25, 35, 41

(260) AM 2010 57057 A
 (800) 1026654
 (731) LABORATOIRES SVR;
 ZAC de la Tremblaie, Rue de la Mare à Blot,
 F-91220 Le Plessis Pate, France

(540)

SVR
ères
 Irides
 CHRONOLYS

(591) Black, white, grey
 (511) 03

(260) AM 2010 57058 A
 (800) 1026658
 (731) Joint stock company "Russkij produkt";
 bld. 1, Permskaya str. RU-107143 Moscow,
 Russian Federation

(540)

Дачный

(591) Black, white
 (511) 29

(260) AM 2010 57059 A
 (800) 1026660
 (731) KRKA,
 tovarna zdravil, d.d., Novo mesto; Šmarješka
 cesta 6, SI-8501 Novo mesto, Slovenia

(540)

НИПЕРТЕН

(591) Black, white
 (511) 05

(260) AM 2010 57060 A
 (800) 1026662
 (731) KRKA,
 tovarna zdravil, d.d., Novo mesto; Šmarješka
 cesta 6, SI-8501 Novo mesto, Slovenia
 (540)

ЗОНИКСЕМ

(591) Black, white
 (511) 05

(260) AM 2010 57061 A
 (800) 1026663
 (731) KRKA,
 tovarna zdravil, d.d., Novo mesto; Šmarješka
 cesta 6, SI-8501 Novo mesto, Slovenia
 (540)

ЗУЛЬБЕКС

(591) Black, white
 (511) 05

(260) AM 2010 57062 A
 (800) 1026664
 (731) KRKA,
 tovarna zdravil, d.d., Novo mesto; Šmarješka
 cesta 6, SI-8501 Novo mesto, Slovenia
 (540)

РИН-АКВА

(591) Black, white
 (511) 05

(260) AM 2010 57063 A
 (800) 1026684
 (731) Guess? IP Holder L.P.;
 1444 South Alameda Street, Los Angeles,
 CA 90021, USA
 (540)

G BY GUESS

(591) Black, white
 (511) 09, 14, 18, 25

(260) AM 2010 57064 A
 (800) 1026704
 (731) EDNOLITCHNO DRUJESTVO S
 OGRANICHENA OTGOVORNOST
 "FINANSKONSULT";
 "ALTZEKO" str. 16, BG-4000 PLOVDIV,
 Bulgaria
 (540)

TORRO

(591) Black, white
 (511) 34

(260) AM 2010 57100 A
 (800) 1027307
 (731) Prytula Oleg Mykhaylovych;
 vul. Baseyna, 17, kv. 7 Kyiv 01004, Ukraine
 (540)

U-Impl

(591) Black, white
 (511) 10, 35, 44

(260) AM 2010 57101 A
 (800) 1027315
 (731) EUROFINS A, S.A.;
 Pº de la Castellana, 91, E-28046 MADRID,
 Spain
 (540)

 **EUROFINS A**

(591) Black, white
 (511) 35

(260) AM 2010 57105 A
 (800) 1027345
 (731) Aplus International Insurance AG;
 Bösch 65, CH-6331 Hünenberg, Switzerland
 (540)

 **A+** International
 Insurance

(591) Black, white
 (511) 36, 45

(260) AM 2010 57106 A
 (800) 1027348
 (731) Janssen Pharmaceutica NV;
 Turnhoutseweg 30, B-2340 BEERSE,
 Belgium
 (540)

RES TECHNOLOGY

(591) Black, white
 (511) 10

(260) AM 2010 57107 A
 (800) 1027350
 (731) Philip Morris Products SA;
 Quai Jeanrenaud 3, CH-2000 Neuchâtel,
 Switzerland

(540)



(591) Black, white
(511) 34

(260) AM 2010 57108 A
(800) 1027355
(731) SHOE BRANDING EUROPE BVBA;
Lindestraat 58, B-9700 Oudenaarde,
Belgium

(540)



(591) Black, white
(511) 18, 25, 28

(260) AM 2010 57110 A
(800) 1027397
(731) AZIENDE CHIMICHE RIUNITE
ANGELINI FRANCESCO A.C.R.A.F.
S.p.A.;

(540)



(591) Black, white
(511) 05

(260) AM 2010 57112 A
(800) 1010259
(731) BOR-SAN ISI SISTEMLERİ ÜRETİM VE
PAZARLAMA ANONİM ŞİRKETİ;
Mebusevleri Mah. İller Sk. No: 38,
TR-06580 TANDOĞAN-ANKARA, Turkey

(540)



(591) Red, blue
(511) 11

(260) AM 2010 57113 A
(800) 260106
(731) G. MOSCATELLI S.P.A.;

20, via Padre G.B. Martini, I-20131
MILANO, Italy

(540)



(591) Black, white
(511) 11

(260) AM 2010 57114 A
(800) 391815
(731) Parke-Davis GmbH;
Linkstr. 10, 10785 Berlin, Germany

(540)

BRONSECUR

(591) Black, white
(511) 05

(260) AM 2010 57115 A
(800) 460347
(731) BAYER SCHERING PHARMA AG;
Muellerstrasse 178, 13353 Berlin, Germany

(540)

ULTRAVIST

(591) Black, white
(511) 05

(260) AM 2010 57116 A
(800) 514045
(731) BAYER SCHERING PHARMA AG;
Muellerstrasse 178, 13353 Berlin, Germany

(540)

MAGNEVIST

(591) Black, white
(511) 05

(260) AM 2010 57117 A
(800) 544617
(731) Tissot SA;
Chemin des Tourelles 17, CH-2400 Le
Locle, Switzerland

(540)

NAVIGATOR

(591) Black, white
(511) 14

(260) AM 2010 57200 A
(800) 1028240

(731) Apple Inc.;
1 Infinite Loop, Cupertino, CA 95014, USA
(540)



(591) Black, white
(511) 09

(260) AM 2010 57201 A
(800) 1028271
(731) M. AIACH Gabriel, Maurice;
5/9 Boulevard du Château, F-92200
NEUILLY SUR SEINE, France;
Mme. UZAN Nathalie, Yvonne; 5/9
Boulevard du Château, F-92200 NEUILLY
SUR SEINE, France

(540)
EVOLUDERM

(591) Black, white
(511) 03

(260) AM 2010 57202 A
(800) 1028283
(731) SANOFI-AVENTIS;
174, avenue de France, F-75013 PARIS,
France

(540)
ADJISI

(591) Black, white
(511) 05

(260) AM 2010 57203 A
(800) 1028285
(731) Obschestvo s ogranichennoi
otvetstvennostyuu "Berlingo";
str. 4, dom 11A, pr. Shmitovskiy, RU-123100
gor. Moskva, Russian Federation

(540)
BERLINGO

(591) Black, white
(511) 08, 09, 16, 18, 35

(260) AM 2010 57220 A
(800) 1028294
(731) Volkov Aleksey Evgenyevich;
ul. Uritskogo, d.7a, kv.52, g. Zlatoust,
RU-456217 Chelyabinskaya obl.,
Russian Federation

(540)



(591) Brown, light blue, yellow, black,
orange, white
(511) 29, 35

(260) AM 2010 57221 A
(800) 1028325
(731) PANG HONG WEI;
Room 9022, Tianya Building, 2# Yabao
Road, Chaoyang District Beijing, China
(540)

D.BIGIONI

(591) Black, white
(511) 25

(260) AM 2010 57223 A
(800) 1028332
(731) BDY ELEKTRIK ITHALAT IHRACAT
SANAYI VE TICARET LIMITED
SIRKETI;
Haracci Koyu Sazlibosna Caddesi No:18/1
Arnavutkoy Gaziosmanpasa - Istanbul,
Turkey

(540)



(591) Red, white, blue
(511) 11

(260) AM 2010 57224 A
(800) 1028393
(731) SANOFI-AVENTIS;
174, avenue de France, F-75013 PARIS,
France

(540)

SAVINEO

(591) Black, white
(511) 05

(260) AM 2010 57225 A
(800) 1028394
(731) SANOFI-AVENTIS;

174, avenue de France, F-75013 PARIS,
France
(540)

SAVIMERID

(591) Black, white
(511) 05

(260) AM 2010 57226 A
(800) 1028395
(731) SANOFI-AVENTIS;
174, avenue de France, F-75013 PARIS,
France
(540)

VISAMERIN

(591) Black, white
(511) 05

(260) AM 2010 57227 A
(800) 1028397
(731) SANOFI-AVENTIS;
174, avenue de France, F-75013 PARIS,
France
(540)

ADJICIDO

(591) Black, white
(511) 05

(260) AM 2010 57228 A
(800) 1028398
(731) DAVIDE CAMPARI - MILANO S.P.A.;
Via Franco Sacchetti, 20, I-20099 SESTO
SAN GIOVANNI (MI), Italy
(540)

APEROL SPRITZ

(591) Black, white
(511) 32, 33, 43

(260) AM 2010 57229 A
(800) 1028465
(731) TimoCom Soft- und Hardware GmbH;
In der Steele 2, 40599 Düsseldorf, Germany
(540)



(591) Red, white and blue
(511) 09, 38, 42

(260) AM 2010 57230 A
(800) 1028468

(731) Eduard Gerlach GmbH Chemische Fabrik;
Bäckerstr. 4-8, 32312 Lübbecke, Germany
(540)

GERLACH

(591) Black, white
(511) 03, 10

(260) AM 2010 57231 A
(800) 1028477
(731) FUEL SYSTEMS SOLUTIONS, INC.;
780 Third Avenue, 25th Floor New York
City, NY 10017, USA
(540)



(591) Black, white, red and blue
(511) 37

(260) AM 2010 57286 A
(800) 1028838
(731) Obschestvo s ogranichennoy
otvetstvennostiu "Slavyanka plus";
ul. 1 Konnoy Armii, d.65, Stari Oskol,
RU-309506 Region de Belgorod,
Russian Federation
(540)

СЕРЕБРЯНЫЙ СТЕП

(591) Black, white
(511) 30

(260) AM 2010 57287 A
(800) 1028839
(731) Obschestvo s ogranichennoy
otvetstvennostiu "Slavyanka plus";
ul. 1 Konnoy Armii, d.65, Stari Oskol,
RU-309506 Region de Belgorod,
Russian Federation
(540)

СПАРК

(591) Black, white
(511) 30

(260) AM 2010 57288 A
(800) 1028840
(731) Obschestvo s ogranichennoy
otvetstvennostiu "Slavyanka plus";
ul. 1 Konnoy Armii, d.65, Stari Oskol,

RU-309506 Region de Belgorod,
Russian Federation
(540)

**МАЛЕНЬКОЕ
ЧУДО**

(591) Black, white
(511) 30

(260) AM 2010 57289 A
(800) 1028874
(731) FEEDBACK TRAYER, S.L.;
c.c. Monteclaro, local 16, POZUELO DE
ALARCON (Madrid), Spain
(540)

STILVID

(591) Black, white
(511) 03, 05

(260) AM 2010 57290 A
(800) 1028876
(731) Siemens Aktiengesellschaft;
Wittelsbacherplatz 2, 80333 München,
Germany
(540)

Vectron

(591) Black, white
(511) 12

(260) AM 2010 57291 A
(800) 1028881
(731) Obschestvo s ogranitchennoy
otvetstvennostiu "Slavyanka plus";
ul. 1 Konnoy Armii, d.65, Stari Oskol,
RU-309506 Region de Belgorod,
Russian Federation
(540)

ПЛАТИНОВЫЙ СТЕП

(591) Black, white
(511) 30

(260) AM 2010 57292 A
(800) 1028900
(731) SABMiller International B.V.;
Schouwburgplein 30-34, NL-3012
CL ROTTERDA, Netherlands
(540)



(591) Black, white
(511) 32

(260) AM 2010 57294 A
(800) 1028907
(731) Otkrytoe aktsionernoe obshchestvo "Aston
Produkty Pitania i Pishchevye Ingredienty";
3b, ul. 1-ya Lugovaya, RU-344002 Rostov-
na-Don, Russian Federation
(540)

SVETLITSA

(591) Black, white
(511) 29, 30

(260) AM 2010 57295 A
(800) 1028909
(731) Beijing Triumph Furniture Company Ltd;
West xiaodushe village, Maju Bridge Town,
Tongzhou District Beijing, China
(540)

CAMERICH

(591) Black, white
(511) 20, 35

(260) AM 2010 57296 A
(800) 1028910
(731) ANADOLU EFES BİRACILIK VE MALT
SANAYİ ANONİM ŞİRKETİ;
Bahçelievler Mahallesi Adnan, Kahveci
Bulvarı No:5 Bahçelievler, İSTANBUL,
Turkey
(540)



(591) White, blue, yellow, gold
(511) 43

(260) AM 2010 57297 A
(800) 1028949
(731) Nycomed GmbH;
Byk-Gulden-Str. 2, 78467 Konstanz,
Germany
(540)



(591) Blue, yellow and white
(511) 05

(260) AM 2010 57298 A
 (800) 1028958
 (731) MERO ČR, a.s.;
 Veltruská 748, CZ-278 01 Kralupy nad
 Vltavou, Czech Republic
 (540)

MERO

(591) Black, white
 (511) 04, 39

(260) AM 2010 57332 A
 (800) 1029628
 (731) Energizer SA;
 Rue Louis-Joseph-Chevrolet 43, CH-2300
 La Chaux-de-Fonds, Switzerland
 (540)



(591) Black, white
 (511) 09, 11

(260) AM 2010 57333 A
 (800) 1029629
 (731) Energizer SA;
 Rue Louis-Joseph-Chevrolet 43, CH-2300 La
 Chaux-de-Fonds, Switzerland
 (540)



(591) Black, white
 (511) 09, 11

(260) AM 2010 57334 A
 (800) 1029654
 (731) Obschestvo s Ogranichennoy
 Otvetstvennostyu "Intellektualnoe pravo";
 kv. 11, d. 63, ul. Stepana Rasina,
 RU-443099 Samara, Russian Federation
 (540)

АРИСТОКРАТ

(591) Black, white
 (511) 33

(260) AM 2010 57335 A
 (800) 1029655
 (731) Obschestvo s Ogranichennoy

Otvetstvennostyu "Intellektualnoe pravo";
 kv. 11, d. 63, ul. Stepana Rasina, RU-443099
 Samara, Russian Federation

(540)

BIG BOSS

(591) Black, white
 (511) 33

(260) AM 2010 57338 A
 (800) 1029683
 (731) Novartis AG;
 CH-4002 Basel, Switzerland
 (540)

SIGNIFOR

(591) Black, white
 (511) 05

(260) AM 2010 57339 A
 (800) 1029687
 (731) ALPMA Alpenland Maschinenbau GmbH;
 Alpenstr. 39-43, 83543 Rott am Inn,
 Germany
 (540)

CREAMOPROT

(591) Black, white
 (511) 07, 29, 40, 42

(260) AM 2010 57340 A
 (800) 1029689
 (731) DAVIDE CAMPARI - MILANO S.P.A.;
 Via Franco Sacchetti, 20 I-20099 SESTO
 SAN GIOVANNI (MILANO), Italy
 (540)



(591) Yellow, white-light blue, blue,
 golden yellow/bronze and red
 (511) 32, 33, 43

(260) AM 2010 57341 A
 (800) 1029701
 (731) DOMAINE DES BROIX S.A.S.;
 Les Broix, F-16120 TOUZAC,
 France
 (540)



(591) Black, white
(511) 33

(260) AM 2010 57342 A
(800) 1029717
(731) Society with limited liability
"Trading-production association "Amtel";
city of Korolew, Pioneer street, the house 1,
RU-141070 Moscow Region, Russian
Federation

(540)

Профилактика

(591) Black, white
(511) 33

(260) AM 2010 57343 A
(800) 1029719
(731) Dotchirne pidpriemstvo
"Konditerska korporatzia "Roshen";
vul. Pavla Usenka, 8, Kyiv 02105,
Ukraine

(540)

АССОЛЬ

(591) Black, white
(511) 30

(260) AM 2010 57344 A
(800) 1029723
(731) GOLD KİMYA ÜRÜNLERİ ÜRETİM VE
PAZARLAMA ANONİM ŞİRKETİ;
Merkez Mah. Köyaltı Mevkii Kavak Sok.
B-Blok No. 28/B Yenibosna İSTANBUL,
Turkey

(540)



(591) Black, white, red, yellow
(511) 02

(260) AM 2010 57345 A
(800) 1029732
(731) Procter & Gamble International Operations
S.A.;
47, route de Saint-Georges, CH-1213 Petit-
Lancy 1, Switzerland

(540)

ANIMAGICAL

(591) Black, white
(511) 03

(260) AM 2010 57346 A
(800) 1029756
(731) OSRAM Gesellschaft mit beschränkter
Haftung;
Hellabrunner Strasse 1, 81543 München,
Germany

(540)



(591) Blue, orange, yellow, white and silver
(511) 11

(260) AM 2010 57347 A
(800) 1029765
(731) Starbuzz Tobacco, Inc.;
2116 W. Lincoln Avenue Anaheim,
CA 92801, USA

(540)

STARBUZZ

(591) Black, white

(511) 34

(260) AM 2010 57348 A
(800) 1029766
(731) EGIS GYÓGYSZERGYÁR;
Nyilvánosan Működő Részvénytársaság,
Keresztúri út 30-38, H-1106 Budapest,
Hungary

(540)

RIPIFREN

(591) Black, white
(511) 05

(260) AM 2010 57349 A
(800) 1029767
(731) EGIS GYÓGYSZERGYÁR;
Nyilvánosan Működő Részvénytársaság,
Keresztúri út 30-38, H-1106 Budapest,
Hungary

(540)

LIPOROSA

(591) Black, white
(511) 05

(260) AM 2010 57352 A
 (800) 362733
 (731) Hedoga AG; Zellwegstrasse 17
 CH-9056 Gais, Switzerland
 (540)

CARMOLIS

(591) Black, white
 (511) 05

(260) AM 2010 57353 A
 (800) 440583
 (731) hattric fashion GmbH;
 Südring 53, 46342 Velen-Ramsdorf,
 Germany
 (540)

HATTRIC

(591) Black, white
 (511) 25

(260) AM 2010 57354 A
 (800) 612153
 (731) Greiner Bio-One GmbH;
 Bad Haller Straße 32, A-4550
 Kremsmünster, Austria
 (540)

VACUETTE

(591) Black, white
 (511) 10

(260) AM 2010 57356 A
 (800) 655863
 (731) AUDI AG;
 85045 Ingolstadt, Germany
 (540)

A4

(591) Black, white
 (511) 12

(260) AM 2010 57357 A
 (800) 920268
 (731) MILLER MARIJA VASYLIVNA;
 av. Mykolaivska, 38, Chernivtsy 58009,
 Ukraine
 (540)



(591) Black, white
 (511) 03, 05

(260) AM 2010 57362 A
 (800) 1029782
 (731) Tovarystvo z obmezhenoyu vidpovidalnisttu
 "Vyrobnnycho-investytsiyna kompaniya
 "MONBLAN";
 vul. Urytskogo, 41, k. 34 Kyiv 03035,
 Ukraine
 (540)

Smart Boy

(591) Black, white
 (511) 09

(260) AM 2010 57363 A
 (800) 1029795
 (731) Unilever N.V.;
 Weena 455, NL-3013 AL Rotterdam,
 Netherlands
 (540)



(591) Black, white
 (511) 30, 32

(260) AM 2010 57366 A
 (800) 1029797
 (731) Instytut Biotechnologii Surowic i
 Szczepionek BIOMED S.A.;
 Al. Sosnowa 8, PL-30-224 Kraków, Poland
 (540)

lactoral

(591) Black, white
 (511) 05

(260) AM 2010 57367 A
 (800) 1029798
 (731) Instytut Biotechnologii Surowic i
 Szczepionek BIOMED S.A.;
 Al. Sosnowa 8, PL-30-224 Kraków, Poland
 (540)

latopic

(591) Black, white
 (511) 05

(260) AM 2010 57368 A
 (800) 1029816
 (731) Obschestvo s ogranitchennoy
 otvetstvennostiu "Slavyanka plus";
 ul. 1 Konnoy Armii, d.65, Stari Oskol,
 RU-309506 Region de Belgorod, Russian
 Federation

(540)

БОЯРУШКА

(591) Black, white
 (511) 30

(260) AM 2010 57388 A
 (800) 1030072
 (731) ALTRAN TECHNOLOGIES;
 58, Boulevard Gouvion Saint-Cyr, F-75017
 PARIS, France

(540)

ALTRAN

(591) Black, white
 (511) 35, 41, 42

(260) AM 2010 57389 A
 (800) 1030093
 (731) Federal state unitary enterprise
 "Trading house "Kremlevskiy"
 Administration of
 the President of the Russian Federation;
 ul. Tikhvinskaya, d.4, RU-127055 Moscow,
 Russian Federation

(540)

KREMLIN AWARD

(591) Black, white
 (511) 32, 33

(260) AM 2010 57390 A
 (800) 1030095
 (731) Obschestvo s ogranitchennoy
 otvetstvennostiu "Slavyanka plus";
 ul. 1 Konnoy Armii, d.65, Stari Oskol,
 RU-309506 Region de Belgorod,
 Russian Federation

(540)

Золотой Степ

(591) Black, white
 (511) 30

(260) AM 2010 57391 A
 (800) 1030104
 (731) Lonza AG (Lonza Ltd);
 Lonzastrasse 3930 Visp Geschäftsleitung

Münchensteinerstrasse 38, CH-4002 Basel,
 Switzerland

(540)

DHAid

(591) Black, white
 (511) 01, 05, 29, 30, 32

(260) AM 2010 57392 A
 (800) 1030110
 (731) GUANGZHOU S.F. EXPRESS CO., LTD.;
 3/F and 4/F, No. 776, DongFengDong Road,
 YueXiu District, GuangZhou 510080
 GuangDong Province, China

(540)

SF AIRLINES

(591) Black, white
 (511) 16, 37, 39

(260) AM 2010 57395 A
 (800) 1030129
 (731) Chery Automobile Co., Ltd.;
 Changchun Road 8, Economy & Technology,
 Development Zone, Wuhu City, Anhui
 Prov., China

(540)

Fulwin

(591) Black, white
 (511) 12

(260) AM 2010 57396 A
 (800) 1030135
 (731) J. Choo Limited;
 4 Lancer Square, Kensington Church Street,
 London W8 4EH, United Kingdom

(540)

JIMMY CHOO

(591) Black, white
 (511) 03

(260) AM 2010 57397 A
 (800) 1030237
 (731) Tang Bing;
 2303 Room, Tianyi Famous Building,
 Longkoudong Road, Tianhe District,
 Guangzhou City Guangdong province, China

(540)



(591) White, dark green, light green
(511) 09

(260) AM 2010 57398 A
(800) 1030249
(731) bon prix Handelsgesellschaft mbH;
Haldesdorfer Strasse 61, 22179 Hamburg,
Germany
(540)



(591) Red, black, white
(511) 25

(260) AM 2010 57399 A
(800) 1030270
(731) Beiersdorf AG;
Unnastrasse 48, 20253 Hamburg, Germany
(540)



(591) Dark blue, silver, white, light blue,
dark red and rosé
(511) 03

(260) AM 2010 57400 A
(800) 1030290
(731) ROBERTO CAVALLI S.P.A.;
Piazza San Babila, 3, I-20122 Milano, Italy
(540)

roberto cavalli

(591) Black, white
(511) 08, 09, 11, 14, 16, 18, 19, 20, 23, 24, 25, 27,
28, 29, 30, 31, 32, 35, 42

(260) AM 2010 57401 A
(800) 1030317
(731) GOLFERA IN LAVEZZOLA S.p.A.;
Via dell'Industria, 6/8, Frazione Lavezzola,
I-48017 CONSELICE (Ravenna), Italy
(540)



(591) Red, blue, gold, green and white
(511) 29

(260) AM 2010 57402 A
(800) 1030319
(731) Lifeng Group Co., Ltd.;
No. 1, Li'ao Industry District, Ou Hai District
Wenzhou Zhejiang, China
(540)

REGAL RAPTOR

(591) Black, white
(511) 12, 25

(260) AM 2010 57403 A
(800) 1030397
(731) bon prix Handelsgesellschaft mbH;
Haldesdorfer Straße 61, 22179 Hamburg,
Germany
(540)

b.p.c.
bon prix collection

(591) Black, white
(511) 07, 09, 11, 14, 18, 20, 21, 24, 25, 27, 28

(260) AM 2010 57404 A
(800) 1030403
(731) WINTER HOLDING GmbH & Co. KG;
Heidelberger Strasse 9-11, 69226 Nussloch,
Germany
(540)



(591) Black, white
(511) 03, 18, 25

(260) AM 2010 57405 A
(800) 1030408
(731) Ricosta Schuhfabriken GmbH;
Dürheimer Strasse 43, 78166
Donaueschingen, Germany
(540)

RICOSTA 
Der Kinderschuh.

(591) Red, yellow, grey
(511) 25

(260) AM 2010 57406 A
 (800) 1030415
 (731) L'OREAL;
 14, rue Royale, F-75008 PARIS, France
 (540)

shu uemura

(591) Black, white
 (511) 03, 44

(260) AM 2010 57407 A
 (800) 1030427
 (731) Citadel Capital SAE;
 3 El Yemen St. El Dokki District, El Giza,
 Egypt
 (540)



(591) Blue and grey
 (511) 36

(260) AM 2010 57408 A
 (800) 1030445
 (731) ESAB AB;
 Box 8004, SE-402 77 GÖTEBORG, Sweden
 (540)

ESAB

(591) Black, white
 (511) 01, 06, 07, 08, 09, 11, 20, 42

(260) AM 2010 57410 A
 (800) 1030466
 (731) Grosjean Alexandre;
 Maisonville, F-54700 Pont à Mousson,
 France
 (540)

eupholis

(591) Black, white
 (511) 35, 38, 42

(260) AM 2010 57411 A
 (800) 403291
 (731) Pharmacia GmbH;
 Linkstrasse 10, 10785 Berlin, Germany
 (540)

Terbicolor

(591) Black, white
 (511) 05

(260) AM 2010 57412 A
 (800) 509532
 (731) Gebro Pharma GmbH;
 Bahnhofbichl 13, A-6391 Fieberbrunn,
 Austria
 (540)

HALSET

(591) Black, white
 (511) 05

(260) AM 2010 57413 A
 (800) 605649
 (731) The International Association for the
 Exchange of Students for Technical
 Experience A.s.b.l.; 51, rue Albert 1er,
 L-1117 Luxembourg, Luxembourg
 (540)



(591) Black, white
 (511) 36, 41

(260) AM 2010 57414 A
 (800) 620013
 (731) San Carlo Gruppo Alimentare S.p.A.;
 Via F. Turati, 29, I-20121 Milano, Italy
 (540)

AUTENTICA TRATTORIA

(591) Black, white
 (511) 29, 30

(260) AM 2010 57415 A
 (800) 621715
 (731) JANSSEN PHARMACEUTICA N.V.;
 Turnhoutseweg 30, B-2340 BEERSE,
 Belgium
 (540)

*Johnson's
 baby*

(591) Black, white
 (511) 03, 05, 10, 16, 25

(260) AM 2010 57416 A
 (800) 693093
 (731) Wella Aktiengesellschaft;

Berliner Allee 65, 64274 Darmstadt,
Germany

(540)

Pearl Styler

(591) Black, white

(511) 03

(260) AM 2010 57417 A

(800) 724195

(731) L'OREAL;

14, rue Royale, F-75008 PARIS, France

(540)

SERIE EXPERT

(591) Black, white

(511) 03

(260) AM 2010 57418 A

(800) 859532

(731) PAULINE SAS;

10, impasse du Grand Jardin, F-35400

SAINT MALO, France

(540)

PATRICE BREAL

(591) Violet

(511) 14, 18, 25

INTERNATIONAL TRADEMARKS PROTECTED IN GEORGIA

МЕЖДУНАРОДНЫЕ ТОВАРНЫЕ ЗНАКИ, ОХРАНЯЕМЫЕ В ГРУЗИИ

(260) AM 2008 43105 A
(800) 918426
(151) 2006 10 02
(181) 2016 10 02
(511) 01, 02, 04, 05, 06, 07, 09, 11, 16, 17, 19, 35,
37, 39, 40, 41, 42

(260) AM 2010 55728 A
(800) 1016385
(151) 2009 06 22
(181) 2019 06 22
(511) 09, 16, 35, 38, 41, 42

(260) AM 2010 55729 A
(800) 1016409
(151) 2009 09 07
(181) 2019 09 07
(511) 05

(260) AM 2010 55730 A
(800) 1016423
(151) 2009 09 09
(181) 2019 09 09
(511) 05

(260) AM 2010 55731 A
(800) 1016424
(151) 2009 09 09
(181) 2019 09 09
(511) 05

(260) AM 2010 55732 A
(800) 1016425
(151) 2009 09 07
(181) 2019 09 07
(511) 05

(260) AM 2010 55733 A
(800) 1016426
(151) 2009 09 09
(181) 2019 09 09
(511) 05

(260) AM 2010 55734 A
(800) 1016427

(151) 2009 09 09
(181) 2019 09 09
(511) 05

(260) AM 2010 55736 A
(800) 1016429
(151) 2009 09 09
(181) 2019 09 09
(511) 05

(260) AM 2010 55737 A
(800) 1016431
(151) 2009 09 09
(181) 2019 09 09
(511) 05

(260) AM 2010 55738 A
(800) 1016435
(151) 2009 05 13
(181) 2019 05 13
(511) 29, 30

(260) AM 2010 55739 A
(800) 1016448
(151) 2009 08 20
(181) 2019 08 20
(511) 03, 05, 32

(260) AM 2010 55740 A
(800) 1016468
(151) 2009 05 19
(181) 2019 05 19
(511) 16, 39, 41, 42

(260) AM 2010 55741 A
(800) 1016473
(151) 2009 07 10
(181) 2019 07 10
(511) 25

(260) AM 2010 55742 A
(800) 1016474
(151) 2009 07 10
(181) 2019 07 10

(511) 25

(260) AM 2010 55743 A
(800) 1016497
(151) 2009 08 17
(181) 2019 08 17
(511) 33

(260) AM 2010 55744 A
(800) 1016498
(151) 2009 08 17
(181) 2019 08 17
(511) 33

(260) AM 2010 55760 A
(800) 1016499
(151) 2009 09 03
(181) 2019 09 03
(511) 29, 30

(260) AM 2010 55761 A
(800) 1016502
(151) 2009 09 01
(181) 2019 09 01
(511) 05

(260) AM 2010 55762 A
(800) 1016503
(151) 2009 09 01
(181) 2019 09 01
(511) 05

(260) AM 2010 55763 A
(800) 1016504
(151) 2009 09 01
(181) 2019 09 01
(511) 05

(260) AM 2010 55764 A
(800) 1016505
(151) 2009 09 01
(181) 2019 09 01
(511) 05

(260) AM 2010 55765 A
(800) 1016532
(151) 2009 08 04
(181) 2019 08 04
(511) 36

(260) AM 2010 55767 A
(800) 1016545
(151) 2009 09 15
(181) 2019 09 15
(511) 03

(260) AM 2010 55768 A
(800) 1016565
(151) 2009 07 01
(181) 2019 07 01
(511) 32

(260) AM 2010 55769 A
(800) 1016574
(151) 2009 07 01
(181) 2019 07 01
(511) 32

(260) AM 2010 55770 A
(800) 1016654
(151) 2009 10 05
(181) 2019 10 05
(511) 09, 11, 37

(260) AM 2010 55772 A
(800) 1016704
(151) 2009 08 12
(181) 2019 08 12
(511) 17

(260) AM 2010 55774 A
(800) 1001273
(151) 2009 01 09
(181) 2019 01 09
(511) 30

(260) AM 2010 55857 A
(800) 1017051
(151) 2009 09 08
(181) 2019 09 08
(511) 03, 07, 08

(260) AM 2010 55858 A
(800) 1017066
(151) 2009 09 03
(181) 2019 09 03
(511) 04, 32, 34

(260) AM 2010 55859 A
(800) 1017075
(151) 2009 08 11

(181) 2019 08 11
(511) 12

(260) AM 2010 55860 A
(800) 1017088
(151) 2009 08 17
(181) 2019 08 17
(511) 05

(260) AM 2010 55882 A
(800) 1017089
(151) 2009 08 17
(181) 2019 08 17
(511) 05

(260) AM 2010 55883 A
(800) 1017111
(151) 2009 09 09
(181) 2019 09 09
(511) 07

(260) AM 2010 55884 A
(800) 1017150
(151) 2009 08 11
(181) 2019 08 11
(511) 34

(260) AM 2010 55885 A
(800) 1017203
(151) 2009 08 27
(181) 2019 08 27
(511) 36

(260) AM 2010 55887 A
(800) 1017231
(151) 2009 08 31
(181) 2019 08 31
(511) 16

(260) AM 2010 55889 A
(800) 1017253
(151) 2009 02 13
(181) 2019 02 13
(511) 34

(260) AM 2010 55909 A
(800) 1017464
(151) 2009 09 03
(181) 2019 09 03

(511) 29, 30

(260) AM 2010 55911 A
(800) 1017466
(151) 2009 09 03
(181) 2019 09 03
(511) 29, 31, 32

(260) AM 2010 55913 A
(800) 1017467
(151) 2009 09 03
(181) 2019 09 03
(511) 05, 29, 30

(260) AM 2010 55914 A
(800) 1017468
(151) 2009 09 03
(181) 2019 09 03
(511) 05, 31

(260) AM 2010 55915 A
(800) 1017474
(151) 2009 09 01
(181) 2019 09 01
(511) 12, 35

(260) AM 2010 55917 A
(800) 1017490
(151) 2009 09 17
(181) 2019 09 17
(511) 05

(260) AM 2010 55918 A
(800) 1017491
(151) 2009 09 17
(181) 2019 09 17
(511) 05

(260) AM 2010 55919 A
(800) 1017492
(151) 2009 09 17
(181) 2019 09 17
(511) 05

(260) AM 2010 55920 A
(800) 1017493
(151) 2009 09 17
(181) 2019 09 17
(511) 05

(260) AM 2010 55921 A
(800) 1017494
(151) 2009 09 17
(181) 2019 09 17
(511) 05

(260) AM 2010 55923 A
(800) 797277
(151) 2002 10 14
(181) 2012 10 14
(511) 03, 05, 25

(260) AM 2010 55924 A
(800) 833663
(151) 2004 09 03
(181) 2014 09 03
(511) 11

(260) AM 2010 55925 A
(800) 914430
(151) 2006 12 18
(181) 2016 12 18
(511) 11, 14, 21

(260) AM 2010 55926 A
(800) 914431
(151) 2006 12 18
(181) 2016 12 18
(511) 11, 14, 21

(260) AM 2010 55927 A
(800) 1009618
(151) 2009 04 14
(181) 2019 04 14
(511) 03, 08, 21, 26

(260) AM 2010 55928 A
(800) 1017533
(151) 2009 03 02
(181) 2019 03 02
(511) 03, 09, 16, 35, 41

(260) AM 2010 55929 A
(800) 1017534
(151) 2009 02 03
(181) 2019 02 03
(511) 03, 09, 16, 35, 41

(260) AM 2010 55930 A
(800) 1017539
(151) 2009 10 08

(181) 2019 10 08
(511) 05

(260) AM 2010 55931 A
(800) 1017540
(151) 2009 10 08
(181) 2019 10 08
(511) 05

(260) AM 2010 55932 A
(800) 1017541
(151) 2009 10 08
(181) 2019 10 08
(511) 05

(260) AM 2010 55933 A
(800) 1017543
(151) 2009 10 08
(181) 2019 10 08
(511) 05

(260) AM 2010 55934 A
(800) 1017544
(151) 2009 10 08
(181) 2019 10 08
(511) 05

(260) AM 2010 55935 A
(800) 1017545
(151) 2009 10 05
(181) 2019 10 05
(511) 05

(260) AM 2010 55936 A
(800) 1017546
(151) 2009 10 08
(181) 2019 10 08
(511) 05

(260) AM 2010 55938 A
(800) 1017590
(151) 2009 07 24
(181) 2019 07 24
(511) 03

(260) AM 2010 55939 A
(800) 1017645
(151) 2009 10 05
(181) 2019 10 05
(511) 05

(260) AM 2010 55940 A
(800) 1017646
(151) 2009 10 05
(181) 2019 10 05
(511) 05

(260) AM 2010 55941 A
(800) 1017647
(151) 2009 10 05
(181) 2019 10 05
(511) 05

(260) AM 2010 55942 A
(800) 1017648
(151) 2009 10 08
(181) 2019 10 08
(511) 05

(260) AM 2010 55943 A
(800) 1017649
(151) 2009 10 08
(181) 2019 10 08
(511) 05

(260) AM 2010 55944 A
(800) 1017650
(151) 2009 10 08
(181) 2019 10 08
(511) 05

(260) AM 2010 55945 A
(800) 1017651
(151) 2009 10 08
(181) 2019 10 08
(511) 05

(260) AM 2010 55946 A
(800) 1017670
(151) 2009 10 08
(181) 2019 10 08
(511) 25, 35

(260) AM 2010 55947 A
(800) 1017693
(151) 2009 09 16
(181) 2019 09 16
(511) 05

(260) AM 2010 55954 A
(800) 1017719
(151) 2009 08 21

(181) 2019 08 21
(511) 32

(260) AM 2010 55956 A
(800) 1017744
(151) 2009 06 05
(181) 2019 06 05
(511) 07, 09, 12, 16

(260) AM 2010 55958 A
(800) 1017745
(151) 2009 06 05
(181) 2019 06 05
(511) 07, 09, 12, 16

(260) AM 2010 55959 A
(800) 1017749
(151) 2009 07 09
(181) 2019 07 09
(511) 25, 35

(260) AM 2010 55960 A
(800) 1017751
(151) 2009 07 27
(181) 2019 07 27
(511) 07, 08

(260) AM 2010 55961 A
(800) 1017754
(151) 2009 09 01
(181) 2019 09 01
(511) 41

(260) AM 2010 55964 A
(800) 1017779
(151) 2009 10 01
(181) 2019 10 01
(511) 05

(260) AM 2010 55966 A
(800) 1017788
(151) 2009 09 29
(181) 2019 09 29
(511) 30

(260) AM 2010 55967 A
(800) 1017789
(151) 2009 04 23
(181) 2019 04 23

(511) 04, 35, 37, 39, 40, 42

(260) AM 2010 55972 A

(800) 1017801

(151) 2009 04 03

(181) 2019 04 03

(511) 01, 06, 07, 08, 09, 11, 16, 17, 19, 20, 35, 37,
40, 42

(260) AM 2010 55985 A

(800) 1017822

(151) 2009 09 30

(181) 2019 09 30

(511) 05

(260) AM 2010 55986 A

(800) 1017845

(151) 2009 10 07

(181) 2019 10 07

(511) 35, 39

(260) AM 2010 55987 A

(800) 1017864

(151) 2009 08 20

(181) 2019 08 20

(511) 35, 39, 40, 42

(260) AM 2010 55988 A

(800) 1017880

(151) 2009 09 08

(181) 2019 09 08

(511) 11

(260) AM 2010 55989 A

(800) 1017897

(151) 2009 07 23

(181) 2019 07 23

(511) 06

(260) AM 2010 55990 A

(800) 1017902

(151) 2009 07 16

(181) 2019 07 16

(511) 05, 29, 30

(260) AM 2010 55993 A

(800) 1017917

(151) 2009 08 19

(181) 2019 08 19

(511) 04, 11, 17, 22

(260) AM 2010 55994 A

(800) 1017921

(151) 2009 09 22

(181) 2019 09 22

(511) 03

(260) AM 2010 55995 A

(800) 1017935

(151) 2008 12 22

(181) 2018 12 22

(511) 12

(260) AM 2010 55996 A

(800) 1017941

(151) 2009 09 16

(181) 2019 09 16

(511) 05

(260) AM 2010 55997 A

(800) 1017949

(151) 2009 06 05

(181) 2019 06 05

(511) 25

(260) AM 2010 55998 A

(800) 1017998

(151) 2009 05 27

(181) 2019 05 27

(511) 36

(260) AM 2010 55999 A

(800) 1018012

(151) 2009 07 23

(181) 2019 07 23

(511) 05

(260) AM 2010 56000 A

(800) 1018032

(151) 2009 10 01

(181) 2019 10 01

(511) 05

(260) AM 2010 56001 A

(800) 1018033

(151) 2009 09 30

(181) 2019 09 30

(511) 05

(260) AM 2010 56002 A

(800) 1018039

(151) 2009 06 23

(181) 2019 06 23
(511) 04, 07, 09, 12, 35, 37, 39, 42

(260) AM 2010 56004 A
(800) 471489
(151) 2002 08 20
(181) 2012 08 20
(511) 05

(260) AM 2010 56008 A
(800) 628525
(151) 2004 11 03
(181) 2014 11 03
(511) 29

(260) AM 2010 56009 A
(800) 667668
(151) 2006 12 19
(181) 2016 12 19
(511) 01, 05

(260) AM 2010 56010 A
(800) 722523
(151) 2009 10 13
(181) 2019 10 13
(511) 05

(260) AM 2010 56011 A
(800) 750740
(151) 2000 07 13
(181) 2010 07 13
(511) 28

(260) AM 2010 56016 A
(800) 863511
(151) 2005 04 08
(181) 2015 04 08
(511) 16, 28, 32, 33, 36, 41

(260) AM 2010 56020 A
(800) 873206
(151) 2005 11 25
(181) 2015 11 25
(511) 01, 05

(260) AM 2010 56021 A
(800) 873207
(151) 2005 11 25
(181) 2015 11 25
(511) 01, 05

(260) AM 2010 56022 A
(800) 893063
(151) 2006 02 08
(181) 2016 02 08
(511) 41

OFFICIAL NOTIFICATIONS

ОФИЦИАЛЬНЫЕ ИЗВЕЩЕНИЯ

TRADEMARKS

ТОВАРНЫЕ ЗНАКИ

RENEWAL OF REGISTRATIONS

ПРОДЛЕНИЕ СРОКОВ ДЕЙСТВИЙ РЕГИСТРАЦИЙ

(111) M 2000 13382 R1

(156) 2010 06 09

(186) 2020 06 09

(732) GROUPEMENT FONCIER AGRICOLE
DES VIGNOBLES DE LA BARONNE
PHILIPPINE DE ROTHSCHILD
(BARONNE PHILIPPINE DE
ROTHSCHILD G.F.A.) Chateau Mouton
Rothschild, 33250 Pauillac

(111) M 2000 13473 R1

(156) 2010 09 11

(186) 2020 09 11

(732) FILA LUXEMBOURG S.A.R.L.
26, Boulevard Royal, L-2449, Luxembourg,

(111) M 2000 13482 R1

(156) 2010 11 10

(186) 2020 09 15

(732) Menarini International Operations
Luxembourg S.A.
18 Rue Dicks, 1417 Luxembourg

(111) M 2000 135 03 R1

(156) 2010 10 19

(186) 2020 09 28

(732) TARCHOMINSKIE ZAKLADY
FARMACEUTYCZNE "POLFA"
SPOLKA AKCYJNA uL. Aleksandra
Fleminga 2, 03-176 Warszawa

(111) M 2000 13513 R1

(156) 2010 10 10

(186) 2020 10 10

(732) MEDA AB
Pipers Väg 2A, Box 906 SE-170 09 Solna

(111) M 2000 13515 R1

(156) 2010 10 10

(186) 2020 10 10

(732) THE GILLETTE COMPANY
Prudential Tower Building, Boston,
Massachusetts 02199

(111) M 2000 13517 R1

(156) 2010 10 10

(186) 2020 10 10

(732) SANOFI-AVENTIS
174, Avenue de France, 75013 Paris,

(111) M 2000 13526 R1

(156) 2010 10 11

(186) 2020 10 11

(732) Gallaher Limited
Members Hill, Brooklands Road, Weybridge,
Surrey KT13 0QU

(111) M 2000 13533 R1

(156) 2010 10 13

(186) 2020 10 13

(732) DIESEL S.P.A.
Via dell' Industria 4-6, 36042 Breganze

(111) M 2000 13555 R1

(156) 2010 10 30

(186) 2020 10 30

(732) SANOFI-AVENTIS
174, Avenue de France, 75013 Paris,

(111) M 2000 13559 R1

(156) 2010 10 30

(186) 2020 10 30

(732) CHEVRON INTELLECTUAL PROPERTY

LLC, a State of Delaware, Limited Liability
Company 6001 Bollinger Canyon Road, San
Ramon, California 94583,

(111) M 2000 13575 R1

(156) 2010 10 30

(186) 2020 10 30

(732) Gallaher Limited

Members Hill, Brooklands Road, Weybridge,
Surrey KT13 0QU

(111) M 2000 13584 R1

(156) 2010 11 13

(186) 2020 11 13

(732) TECHNICOLOR

1-5 rue Jeanne d'Arc, 92130 Issy Les
Moulineaux

(111) M 2000 13588 R1

(156) 2010 11 13

(186) 2020 11 13

(732) THE PROCTER & GAMBLE COMPANY

One Procter & Gamble Plaza, Cincinnati,
Ohio

(111) M 2000 13592 R1

(156) 2010 11 15

(186) 2020 11 15

(732) A. MENARINI INDUSTRIE

FARMACEUTICHE RIUNITE S.R.L.
3, Via Sette Santi, 50131 Firenze

(111) M 2000 13593 R1

(156) 2010 11 15

(186) 2020 11 15

(732) A. MENARINI INDUSTRIE

FARMACEUTICHE RIUNITE S.R.L.
3, Via Sette Santi, 50131 Firenze

(111) M 2000 13619 R1

(156) 2010 11 28

(186) 2020 11 28

(732) YKK Corporation, a Japanese Corporation

1, Kanda Izumi-cho, Chiyoda-ku, Tokyo

(111) M 2000 13630 R1

(156) 2010 12 21

(186) 2020 12 21

(732) PFIZER PRODUCTS INC.

A Connecticut Corporation
Eastern Point Road, Groton,
Connecticut 06340

(111) M 2000 13632 R1

(156) 2010 12 21

(186) 2020 12 21

(732) PFIZER PRODUCTS INC.

A Connecticut Corporation
Eastern Point Road, Groton,
Connecticut 06340

(111) M 2000 13633 R1

(156) 2010 12 21

(186) 2020 12 21

(732) N.V. SUMATRA TOBACCO TRADING
COMPANY

Jln. Pattimura No3, Pematang Siantar,
Sumatera Utara

(111) M 2000 13638 R1

(156) 2010 12 21

(186) 2020 12 21

(732) THE GILLETTE COMPANY

Prudential Tower Building, Boston,
Massachusetts 02199

(111) M 2000 13639 R1

(156) 2010 12 21

(186) 2020 12 21

(732) THE GILLETTE COMPANY

Prudential Tower Building, Boston,
Massachusetts 02199

(111) M 2000 13654 R1

(156) 2010 12 21

(186) 2020 12 21

(732) HARRODS LIMITED

87-135 Brompton Road, Knightsbridge,
London SW1X 7XL ENGLAND

(111) M 2000 13655 R1

(156) 2010 12 21

(186) 2020 12 21

(732) HARRODS LIMITED

87-135 Brompton Road, Knightsbridge,
London SW1X 7XL ENGLAND

(111) M 2000 13663 R1

(156) 2010 12 28

(186) 2020 12 28

(732) THE GILLETTE COMPANY

Prudential Tower Building, Boston,
Massachusetts 02199

(111) M 2000 13667 R1
 (156) 2010 12 28
 (186) 2020 12 28
 (732) Gallaher Limited
 Members Hill, Brooklands Road, Weybridge,
 Surrey KT13 0QU

COMPLETE TRANSFER OF RIGHTS

ПОЛНАЯ ПЕРЕДАЧА ПРАВ

(111) M 1998 010599 R1
 (732) PIRELLI & C. S.p.A.
 Viale Piero e Alberto Pirelli, 25,
 20126 Milano, IT
 (770) SIPIR FINANCE N. V.
 Boonsweg 10-3274LH Heinenoord
 (580) 2010-11-10

(111) M 1999 011506 R1
 (732) VIIV HEALTHCARE UK LIMITED
 980 Great West Road, Brentford, Middlesex
 TW8 9GS
 (770) GLAXO GROUP LIMITED
 Glaxo Wellcome House, Berkeley Avenue,
 Greenford, Middlesex UB6 0NN
 (580) 2010-11-10

(111) M 1999 011634 R1
 (732) BAYER S.A.S.
 16, rue Jean-Marie Leclair, 69009 Lyon
 (770) BAYER S.A.S.
 16, rue Jean-Marie Leclair, 69009 Lyon
 (580) 2010-11-08

(111) M 1999 011861 R1
 (732) VIIV HEALTHCARE UK LIMITED
 980 Great West Road, Brentford, Middlesex
 TW8 9GS
 (770) GLAXO GROUP LIMITED
 Glaxo Wellcome House, Berkeley Avenue,
 Greenford, Middlesex UB6 0NN
 (580) 2010-11-10

(111) M 1999 012079 R1
 (732) VIIV HEALTHCARE UK LIMITED
 980 Great West Road, Brentford, Middlesex
 TW8 9GS

(770) GLAXO GROUP LIMITED
 Glaxo Wellcome House, Berkeley Avenue,
 Greenford, Middlesex UB6 0NN
 (580) 2010-11-10

(111) M 1999 012080 R1
 (732) VIIV HEALTHCARE UK LIMITED
 980 Great West Road, Brentford, Middlesex
 TW8 9GS
 (770) GLAXO GROUP LIMITED
 Glaxo Wellcome House, Berkeley Avenue,
 Greenford, Middlesex UB6 0NN
 (580) 2010-11-11

(111) M 1999 012105 R1
 (732) BAYER S.A.S.;
 16, rue Jean-Marie Leclair, 69009 Lyon
 (770) BAYER CROPSCIENCE S.A.
 16, rue Jean-Marie Leclair, F-69009 Lyon
 (580) 2010-11-08

(111) M 1999 012186 R1
 (732) FIAT GROUP MARKETING &
 CORPORATE COMMUNICATION S.P.A.
 Via Nizza 250, 10126 Torino, IT
 (770) FIAT AUTO S.P.A.
 Corso Giovanni Agnelli 200,
 10135 Torino, IT
 (580) 2010-11-05

(111) M 1999 012187 R1
 (732) FIAT GROUP MARKETING &
 CORPORATE COMMUNICATION S.P.A.
 Via Nizza 250, 10126 Torino, IT
 (770) FIAT AUTO S.P.A.
 Corso Giovanni Agnelli 200,

10135 Torino, IT
(580) 2010-11-05

(111) M 1999 012239 R1
(732) VIIV HEALTHCARE UK LIMITED
980 Great West Road, Brentford, Middlesex
TW8 9GS
(770) GLAXO GROUP LIMITED
Glaxo Wellcome House, Berkeley Avenue,
Greenford, Middlesex UB6 0NN
(580) 2010-11-10

(111) M 1999 012256 R1
(732) VIIV HEALTHCARE UK LIMITED
980 Great West Road, Brentford, Middlesex
TW8 9GS
(770) GLAXO GROUP LIMITED
Glaxo Wellcome House, Berkeley Avenue,
Greenford, Middlesex UB6 0NN
(580) 2010-11-10

(111) M 1999 012354 R1
(732) VIIV HEALTHCARE UK LIMITED
980 Great West Road, Brentford, Middlesex
TW8 9GS
(770) GLAXO GROUP LIMITED
Glaxo Wellcome House, Berkeley Avenue,
Greenford, Middlesex UB6 0NN
(580) 2010-11-10

(111) M 1999 012368 R1
(732) VIIV HEALTHCARE UK LIMITED
980 Great West Road, Brentford, Middlesex
TW8 9GS
(770) GLAXO GROUP LIMITED
Glaxo Wellcome House, Berkeley Avenue,
Greenford, Middlesex UB6 0NN
(580) 2010-11-10

(111) M 1999 012529 R1
(732) WESTLER FOODS LIMITED
Amotherby, Malton, North Yorkshire,
YO17 6TQ
(770) MARS INC.
6885 Elm Street, McLean, Virginia, US
(580) 2010-11-10

(111) M 2000 013458 R1
(732) VIIV HEALTHCARE UK LIMITED
980 Great West Road, Brentford, Middlesex
TW8 9GS
(770) GLAXO GROUP LIMITED
Glaxo Wellcome House, Berkeley Avenue,
Greenford, Middlesex UB6 0NN

(580) 2010-11-10

(111) M 2001 013810 R
(732) SH.P.S "STANDART TOBAKO
INKORPOREITIDI"
Abuseridze-tbelis q. 13, 0120, Tbilisi, GE
(770) STANDARD TOBACCO
INCORPORATED Ltd
3076 Sir Francis Drake's Highway,
P.O. Box 3463, Road Town, Tortola
(580) 2010-11-15

(111) M 2001 013811 R
(732) SH.P.S "STANDART TOBAKO
INKORPOREITIDI"
Abuseridze-tbelis q. 13, 0120, Tbilisi, GE
(770) STANDARD TOBACCO
INCORPORATED Ltd
3076 Sir Francis Drake's Highway,
P.O. Box 3463, Road Town, Tortola
(580) 2010-11-15

(111) M 2001 013813 R
(732) SH.P.S "STANDART TOBAKO
INKORPOREITIDI"
Abuseridze-tbelis q. 13, 0120, Tbilisi, GE
(770) STANDARD TOBACCO
INCORPORATED Ltd
3076 Sir Francis Drake's Highway,
P.O. Box 3463, Road Town, Tortola
(580) 2010-11-15

(111) M 2002 014333 R
(732) SH.P.S. "GVINIS QARKHANA
AKHASHENI"
Iumashevis q. 27, 0151, Tbilisi, GE
SH.P.S. "TIFLISSKI VINNI POGREB"
Iumashevis q.27, 0198, Tbilisi, GE
(770) SH.P.S. "GVINIS QARKHANA
AKHASHENI"
Iumashevis q. 27, 0151, Tbilisi, GE
(580) 2010-11-02

(111) M 2002 014742 R
(732) SH.P.S "STANDART TOBAKO
INKORPOREITIDI"
Abuseridze-tbelis q. 13, 0120, Tbilisi, GE
(770) STANDARD TOBACCO
INCORPORATED Ltd
3076 Sir Francis Drake's Highway,
P.O. Box 3463, Road Town, Tortola
(580) 2010-11-15

(111) M 2002 014743 R
 (732) SH.P.S "STANDART TOBAKO
 INKORPOREITIDI"
 Abuseridze-tbelis q. 13, 0120, Tbilisi, GE
 (770) STANDARD TOBACCO
 INCORPORATED Ltd
 3076 Sir Francis Drake's Highway,
 P.O. Box 3463, Road Town, Tortola
 (580) 2010-11-15

(111) M 2003 015216 R
 (732) SH.P.S "STANDART TOBAKO
 INKORPOREITIDI"
 Abuseridze-tbelis q. 13, 0120, Tbilisi, GE
 (770) STANDARD TOBACCO
 INCORPORATED Ltd
 3076 Sir Francis Drake's Highway,
 P.O. Box 3463, Road Town, Tortola
 (580) 2010-11-15

(111) M 2002 014744 R
 (732) SH.P.S "STANDART TOBAKO
 INKORPOREITIDI"
 Abuseridze-tbelis q. 13, 0120, Tbilisi, GE
 (770) STANDARD TOBACCO
 INCORPORATED Ltd
 3076 Sir Francis Drake's Highway,
 P.O. Box 3463, Road Town, Tortola
 (580) 2010-11-15

(111) M 2004 015481 R
 (732) SH.P.S "STANDART TOBAKO
 INKORPOREITIDI"
 Abuseridze-tbelis q. 13, 0120, Tbilisi, GE
 (770) STANDARD TOBACCO
 INCORPORATED Ltd
 3076 Sir Francis Drake's Highway,
 P.O. Box 3463, Road Town, Tortola
 (580) 2010-11-15

(111) M 2003 014991 R
 (732) SH.P.S. "GVINIS QARKHANA
 AKHASHENI"
 Iumashevis q. 27, 0198, Tbilisi, GE
 SH.P.S. "TIFLISSKI VINNI POGREB"
 Iumashevis q.27, 0198, Tbilisi, GE
 (770) SH.P.S. "GVINIS QARKHANA
 AKHASHENI"
 Iumashevis q. 27, 0198, Tbilisi, GE
 (580) 2010-11-02

(111) M 1996 001600 R1
 (732) BAYER S.A.S.
 16, rue Jean-Marie Leclair, 69009 Lyon
 (770) BAYER CROPSCIENCE S.A.
 16, rue Jean-Marie Leclair, F-69009 Lyon
 (580) 2010-11-08

(111) M 2003 015157 R
 (732) SH.P.S. "GVINIS QARKHANA
 AKHASHENI"
 Iumashevis q. 27, 0198, Tbilisi, GE
 SH.P.S. "TIFLISSKI VINNI POGREB"
 Iumashevis q.27, 0198, Tbilisi, GE
 (770) SH.P.S. "GVINIS QARKHANA
 AKHASHENI"
 Iumashevis q. 27, 0198, Tbilisi, GE
 (580) 2010-11-02

(111) M 2005 016163 R
 (732) VIIV HEALTHCARE UK LIMITED
 980 Great West Road, Brentford, Middlesex
 TW8 9GS
 (770) GLAXO GROUP LIMITED
 Glaxo Wellcome House, Berkeley Avenue,
 Greenford, Middlesex UB6 0NN
 (580) 2010-11-10

(111) M 2003 015211 R
 (732) SH.P.S "STANDART TOBAKO
 INKORPOREITIDI"
 Abuseridze-tbelis q. 13, 0120, Tbilisi, GE
 (770) STANDARD TOBACCO
 INCORPORATED Ltd
 3076 Sir Francis Drake's Highway,
 P.O. Box 3463, Road Town, Tortola
 (580) 2010-11-15

(111) M 2005 016316 R
 (732) KENT GIDA MADDELERI SANAYII VE
 TICARET ANONIM SIRKETI
 Cumhuriyet Mahallesi, 2253, Sokak, N11,
 Gebze, Kocaeli
 (770) INTERGUM GIDA SANAYI VE TICARET
 ANONIM SIRKETI
 Mahmutbey Merkez Mahallesi, Tasocaklari
 Yolu, N 9-11, Bagcilar, Istanbul 34550
 (580) 2010-11-05

(111) M 2006 016570 R
 (732) ELENBERG TRADE COMPANY
 LIMITED
 Suite 18B, 148 Connaught Road Central
 (770) CORTLAND MARKETING LIMITED

P.O. Box 3321, Road Town, Tortola
(580) 2010-11-10

(111) M 2006 016580 R
(732) ELENBERG TRADE COMPANY
LIMITED
Suite 18B, 148 Connaught Road Central
(770) CORTLAND MARKETING LIMITED
P.O. Box 3321, Road Town, Tortola
(580) 2010-11-10

(111) M 2008 018551 R
(732) SHPS „HOLDINGI SAQARTVELOS
MEDIIS GAERTIANEBA“
Kostavas q. 75b, Tbilisi, GE
(770) SHPS "JORJIAN BIZNES KONSALTING"
Qiqodzis q. N12, 0105, Tbilisi, GE
(580) 2010-11-02

(111) M 1996 003397 R1
(732) BAYER S.A.S.
16, rue Jean-Marie Leclair, 69009 Lyon
(770) BAYER CROPSCIENCE S.A.
16, rue Jean-Marie Leclair, F-69009 Lyon
(580) 2010-11-08

(111) M 1996 003398 R1
(732) BAYER S.A.S.
16, rue Jean-Marie Leclair, 69009 Lyon
(770) BAYER CROPSCIENCE S.A.
16, rue Jean-Marie Leclair, F-69009 Lyon
(580) 2010-11-08

(111) M 1996 003781 R1
(732) CHECKPOINT SYSTEMS
INTERNATIONAL GMBH;
Ersheimer Strasse 69, 69434
Hirschhorn/Neckar
(770) ESSELTE S.P.A.
41, viale Europa, 1 - 20 090 CUSAGO
(580) 2010-11-10

(111) M 1997 004547 R1
(732) KENT GIDA MADDELERI SANAYII VE
TICARET ANONIM SIRKETI
Cumhuriyet Mahallesi, 2253 Sokak, N11
Gebze, Kocaeli
(770) INTERGUM GIDA SANAYI VE TICARET
ANONIM SIRKETI
Mahmutbey Mahallesi, Tasocagi Yolu
Caddesi, N 19, Bagcilar, 34550 Istanbul

(580) 2010-11-05

(111) M 1997 007855 R1
(732) VIIV HEALTHCARE UK LIMITED
980 Great West Road, Brentford, Middlesex
TW8 9GS
(770) GLAXO GROUP LIMITED
Glaxo Wellcome House, Berkeley Avenue,
Greenford, Middlesex UB6 0NN
(580) 2010-11-10

(111) M 1997 007866 R1
(732) FIAT GROUP MARKETING &
CORPORATE COMMUNICATION S.P.A.
Via Nizza 250, 10126 Torino
(770) FIAT AUTO S.P.A.
Corso Giovanni Agnelli 200, 10135 Torino
(580) 2010-11-05

(111) M 1997 007867 R1
(732) FIAT GROUP MARKETING &
CORPORATE COMMUNICATION S.P.A.
Via Nizza 250, 10126 Torino
(770) FIAT AUTO S.P.A.
Corso Giovanni Agnelli 200, 10135 Torino
(580) 2010-11-05

(111) M 1997 007869 R1
(732) FIAT GROUP MARKETING &
CORPORATE COMMUNICATION S.P.A.
Via Nizza 250, 10126 Torino
(770) FIAT AUTO S.P.A.
Corso Giovanni Agnelli 200, 10135 Torino
(580) 2010-11-05

CHANGES IN NAMES AND/OR ADDRESSES OF OWNERS**ИЗМЕНЕНИЯ ИМЕН И/ИЛИ АДРЕСОВ ВЛАДЕЛЬЦЕВ**

-
- (111) M 1998 010795 R1
(732) SMITHKLINE BEECHAM LIMITED
980 Great West Road, Brentford, Middlesex
TW8 9GS
(770) SMITHKLINE BEECHAM P.L.C.
New Horizons Court, Brentford, Middlesex
TW8 9EP
(580) 2010-11-11
-
- (111) M 1998 010820 R1
(732) SMITHKLINE BEECHAM LIMITED
980 Great West Road, Brentford, Middlesex
TW8 9GS
(770) SMITHKLINE BEECHAM PLC
980 Great West Road, Brentford, Middlesex
TW8 9GS
(580) 2010-11-11
-
- (111) M 1998 010953 R1
(732) MAM BABYARTIKEL GESELLSCHAFT
M.B.H.
Lorenz-Mandl-Gasse 50, 1160 Vienna
(770) MAM BABYARTIKEL GESELLSCHAFT
M.B.H.
Degengasse 70, A-116 Vienna
(580) 2010-11-09
-
- (111) M 1998 010962 R1
(732) SMITHKLINE BEECHAM LIMITED
980 Great West Road, Brentford, Middlesex
TW8 9GS
(770) SMITHKLINE BEECHAM PLC
980 Great West Road, Brentford, Middlesex
TW8 9GS
(580) 2010-11-11
-
- (111) M 1999 011585 R1
(732) SMITHKLINE BEECHAM LIMITED
980 Great West Road, Brentford, Middlesex
TW8 9GS
(770) SMITHKLINE BEECHAM PLC
980 Great West Road, Brentford, Middlesex
TW8 9GS
(580) 2010-11-11
-
- (111) M 1999 011588 R1
(732) SMITHKLINE BEECHAM LIMITED
980 Great West Road, Brentford, Middlesex
TW8 9GS
(770) SMITHKLINE BEECHAM PLC
980 Great West Road, Brentford, Middlesex
TW8 9GS
(580) 2010-11-11
-
- (111) M 1999 012246 R1
(732) STATOIL ASA
Forusbeen 50, N-4035 Stavanger
(770) STATOIL ASA
Forusbeen 50, N-4035 Stavanger
(580) 2010-11-03
-
- (111) M 1999 012411 R1
(732) BR IP HOLDER LLC
130 Royall Street, Suite 300, P.O. Box 9141,
Canton, Massachusetts 02021, US
(770) BR IP HOLDER LLC
130 Royall Street, Canton, Massachusettes
02021, US
(580) 2010-11-10
-
- (111) M 1999 012825 R1
(732) SMITHKLINE BEECHAM LIMITED
980 Great West Road, Brentford, Middlesex
TW8 9GS
(770) SMITHKLINE BEECHAM PLC
980 Great West Road, Brentford, Middlesex
TW8 9GS
(580) 2010-11-11
-
- (111) M 2000 013473 R1
(732) FILA LUXEMBOURG S.A.R.L.
13, Boulevard du Prince Henri, L-1724,
Luxembourg
(770) FILA LUXEMBOURG S.A.R.L.
46/A J.F.Kennedy, L-1855 Luxembourg
(580) 2010-11-09
-
- (111) M 2000 013473 R1
(732) FILA LUXEMBOURG S.A.R.L.
26, Boulevard Royal, L-2449, Luxembourg,
(770) FILA LUXEMBOURG S.A.R.L.
13, Boulevard du Prince Henri, L-1724,
Luxembourg
(580) 2010-11-09
-

(111) M 2000 013503 R1
 (732) TARCHOMINSKIE ZAKLADY
 FARMACEUTYCZNE "POLFA" SPOLKA
 AKCYJNA
 ul. Aleksandra Fleminga 2, 03-176
 Warszawa
 (770) TARCHOMINSKIE ZAKLADY
 FARMACEUTYCZE "POLFA"
 Aleksandra Fleminga St.2, 03-176 Warshawa
 (580) 2010-11-03

(111) M 2000 013514 R1
 (732) PARKER PEN PRODUCTS
 17/F, Royex House, Aldermanbury Square,
 London EC2V 7HR
 (770) PARKER PEN PRODUCTS
 101 Syon Lane, Isleworth, Middlesex TW7
 5NP
 (580) 2010-11-03

(111) M 2000 013514 R1
 (732) PARKER PEN PRODUCTS
 17/F, Royex House, Aldermanbury Square,
 London EC2V 7HR
 (770) PARKER PEN PRODUCTS
 17/F, Royex House, Aldermanbury Square,
 London EC2V 7HR
 (580) 2010-11-03

(111) M 2000 013514 R1
 (732) PARKER PEN PRODUCTS
 Parker House, Estate Road, New Haven, East
 Sussexs, BN9 0AU
 (770) PARKER PEN PRODUCTS
 17/F, Royex House, Aldermanbury Square,
 London EC2V 7HR
 (580) 2010-11-03

(111) M 2000 013514 R1
 (732) PARKER PEN PRODUCTS
 Halifax Avenue, Fradley Park, Lichfield,
 Staffordshire WS13 8SS
 (770) PARKER PEN PRODUCTS
 Parker House, Estate Road, New Haven, East
 Sussexs, BN9 0AU
 (580) 2010-11-03

(111) M 2000 013533 R1
 (732) DIESEL S.P.A.
 Via dell' Industria 4-6, 36042 Breganze, IT
 (770) DIESEL S.P.A.
 7, via dell Industria, I-36060 Molvena, IT
 (580) 2010-11-02

(111) M 2000 013584 R1
 (732) THOMSON
 1-5 rue Jeanne d'Arc, 92130 Issy Les
 Moulinaux, FR
 (770) THOMSON
 46 quai Alphonse le Gallo, 92100 Boulogne
 Billancourt, France
 (580) 2010-11-05

(111) M 2000 013584 R1
 (732) TECHNICOLOR
 1-5 rue Jeanne d'Arc, 92130 Issy Les
 Moulinaux, FR
 (770) THOMSON
 1-5 rue Jeanne d'Arc, 92130 Issy Les
 Moulinaux, FR
 (580) 2010-11-05

(111) M 2001 013697 R
 (732) SMITHKLINE BEECHAM LIMITED
 980 Great West Road, Brentford, Middlesex
 TW8 9GS
 (770) SMITHKLINE BEECHAM PLC
 980 Great West Road, Brentford, Middlesex
 TW8 9GS
 (580) 2010-11-11

(111) M 2001 013698 R
 (732) SMITHKLINE BEECHAM LIMITED
 980 Great West Road, Brentford, Middlesex
 TW8 9GS
 (770) SMITHKLINE BEECHAM PLC
 980 Great West Road, Brentford, Middlesex
 TW8 9GS
 (580) 2010-11-11

(111) M 2001 013873 R
 (732) SMITHKLINE BEECHAM LIMITED
 980 Great West Road, Brentford, Middlesex
 TW8 9GS
 (770) SMITHKLINE BEECHAM PLC
 980 Great West Road, Brentford, Middlesex
 TW8 9GS
 (580) 2010-11-11

(111) M 2001 013874 R
 (732) SMITHKLINE BEECHAM LIMITED
 980 Great West Road, Brentford, Middlesex
 TW8 9GS
 (770) SMITHKLINE BEECHAM PLC
 980 Great West Road, Brentford, Middlesex
 TW8 9GS
 (580) 2010-11-11

(111) M 2001 013875 R
 (732) SMITHKLINE BEECHAM LIMITED
 980 Great West Road, Brentford, Middlesex
 TW8 9GS
 (770) SMITHKLINE BEECHAM PLC
 980 Great West Road, Brentford, Middlesex
 TW8 9GS
 (580) 2010-11-11

(111) M 2002 014239 R
 (732) SMITHKLINE BEECHAM LIMITED
 980 Great West Road, Brentford, Middlesex
 TW8 9GS
 (770) SMITHKLINE BEECHAM PLC
 980 Great West Road, Brentford, Middlesex
 TW8 9GS
 (580) 2010-11-11

(111) M 2001 014008 R
 (732) SMITHKLINE BEECHAM LIMITED
 980 Great West Road, Brentford, Middlesex
 TW8 9GS
 (770) SMITHKLINE BEECHAM PLC
 980 Great West Road, Brentford, Middlesex
 TW8 9GS
 (580) 2010-11-11

(111) M 2002 014505 R
 (732) SMITHKLINE BEECHAM LIMITED
 980 Great West Road, Brentford, Middlesex
 TW8 9GS
 (770) SMITHKLINE BEECHAM PLC
 980 Great West Road, Brentford, Middlesex
 TW8 9GS
 (580) 2010-11-11

(111) M 2001 014184 R
 (732) SMITHKLINE BEECHAM LIMITED
 980 Great West Road, Brentford, Middlesex
 TW8 9GS
 (770) SMITHKLINE BEECHAM PLC
 980 Great West Road, Brentford, Middlesex
 TW8 9GS
 (580) 2010-11-11

(111) M 2002 014770 R
 (732) SMITHKLINE BEECHAM LIMITED
 980 Great West Road, Brentford, Middlesex
 TW8 9GS
 (770) SMITHKLINE BEECHAM PLC
 980 Great West Road, Brentford, Middlesex
 TW8 9GS
 (580) 2010-11-11

(111) M 2001 014185 R
 (732) SMITHKLINE BEECHAM LIMITED
 980 Great West Road, Brentford, Middlesex
 TW8 9GS
 (770) SMITHKLINE BEECHAM PLC
 980 Great West Road, Brentford, Middlesex
 TW8 9GS
 (580) 2010-11-11

(111) M 2003 015356 R
 (732) SMITHKLINE BEECHAM LIMITED
 980 Great West Road, Brentford, Middlesex
 TW8 9GS
 (770) SMITHKLINE BEECHAM PLC
 980 Great West Road, Brentford, Middlesex
 TW8 9GS
 (580) 2010-11-11

(111) M 2001 014189 R
 (732) SMITHKLINE BEECHAM LIMITED
 980 Great West Road, Brentford, Middlesex
 TW8 9GS
 (770) SMITHKLINE BEECHAM PLC
 980 Great West Road, Brentford, Middlesex
 TW8 9GS
 (580) 2010-11-11

(111) M 2003 015358 R
 (732) SMITHKLINE BEECHAM LIMITED
 980 Great West Road, Brentford, Middlesex
 TW8 9GS
 (770) SMITHKLINE BEECHAM PLC
 980 Great West Road, Brentford, Middlesex
 TW8 9GS
 (580) 2010-11-11

(111) M 2002 014226 R
 (732) SMITHKLINE BEECHAM LIMITED
 980 Great West Road, Brentford, Middlesex
 TW8 9GS
 (770) SMITHKLINE BEECHAM PLC
 980 Great West Road, Brentford, Middlesex
 TW8 9GS
 (580) 2010-11-11

(111) M 2003 015359 R
 (732) SMITHKLINE BEECHAM LIMITED
 980 Great West Road, Brentford, Middlesex
 TW8 9GS
 (770) SMITHKLINE BEECHAM PLC
 980 Great West Road, Brentford, Middlesex
 TW8 9GS
 (580) 2010-11-11

(111) M 2005 016314 R
(732) SMITHKLINE BEECHAM LIMITED
980 Great West Road, Brentford, Middlesex
TW8 9GS
(770) SMITHKLINE BEECHAM PLC
980 Great West Road, Brentford, Middlesex
TW8 9GS
(580) 2010-11-11

(111) M 2005 016316 R
(732) INTERGUM GIDA SANAYI VE TICARET
ANONIM Sirketi
Mahmutbey Merkez Mahallesi, Tasocaklari
Yolu, N19, Bagcilar, Istanbul 34550
(770) INTERGUM GIDA SANAYI VE TICARET
ANONIM Sirketi
Mahmutbey Merkez Mahallesi, Tasocaklari
Yolu, N19-11, Bagcilar, Istanbul 34550
(580) 2010-11-05

(111) M 2006 016478 R
(732) KENT GIDA MADDELERI SANAYII VE
TICARET ANONIM Sirketi
Cumhuriyet Mahallesi, 2253, Sokak, N11,
Gebze, Kocaeli
(770) KENT GIDA MADDELERI SANAYII VE
TICARET ANONIM Sirketi
Cayirova Mahallesi, Ankara Asfalti Ustu,
Istanbul Caddesi N 111 Gebze, Kocaeli
(580) 2010-11-05

(111) M 2006 016479 R
(732) KENT GIDA MADDELERI SANAYII VE
TICARET ANONIM Sirketi
Cumhuriyet Mahallesi, 2253, Sokak, N11,
Gebze, Kocaeli
(770) KENT GIDA MADDELERI SANAYII VE
TICARET ANONIM Sirketi
Cayirova Mahallesi, Ankara Asfalti Ustu,
Istanbul Caddesi N 111 Gebze, Kocaeli
(580) 2010-11-08

(111) M 2006 016480 R
(732) KENT GIDA MADDELERI SANAYII VE
TICARET ANONIM Sirketi
Cumhuriyet Mahallesi, 2253, Sokak, N11,
Gebze, Kocaeli
(770) KENT GIDA MADDELERI SANAYII VE
TICARET ANONIM Sirketi
Cayirova Mahallesi, Ankara Asfalti Ustu,
Istanbul Caddesi N 111 Gebze, Kocaeli
(580) 2010-11-08

(111) M 2006 016481 R
(732) KENT GIDA MADDELERI SANAYII VE
TICARET ANONIM Sirketi
Cumhuriyet Mahallesi, 2253, Sokak, N11,
Gebze, Kocaeli
(770) KENT GIDA MADDELERI SANAYII VE
TICARET ANONIM Sirketi
Cayirova Mahallesi, Ankara Asfalti Ustu,
Istanbul Caddesi N 111 Gebze, Kocaeli
(580) 2010-11-08

(111) M 2006 016482 R
(732) KENT GIDA MADDELERI SANAYII VE
TICARET ANONIM Sirketi
Cumhuriyet Mahallesi, 2253, Sokak, N11,
Gebze, Kocaeli
(770) KENT GIDA MADDELERI SANAYII VE
TICARET ANONIM Sirketi
Cayirova Mahallesi, Ankara Asfalti Ustu,
Istanbul Caddesi N 111 Gebze, Kocaeli
(580) 2010-11-08

(111) M 2006 016483 R
(732) KENT GIDA MADDELERI SANAYII VE
TICARET ANONIM Sirketi
Cumhuriyet Mahallesi, 2253, Sokak, N11,
Gebze, Kocaeli
(770) KENT GIDA MADDELERI SANAYII VE
TICARET ANONIM Sirketi
Cayirova Mahallesi, Ankara Asfalti Ustu,
Istanbul Caddesi N 111 Gebze, Kocaeli
(580) 2010-11-08

(111) M 2006 016484 R
(732) KENT GIDA MADDELERI SANAYII VE
TICARET ANONIM Sirketi
Cumhuriyet Mahallesi, 2253, Sokak, N11,
Gebze, Kocaeli
(770) KENT GIDA MADDELERI SANAYII VE
TICARET ANONIM Sirketi
Cayirova Mahallesi, Ankara Asfalti Ustu,
Istanbul Caddesi N 111 Gebze, Kocaeli
(580) 2010-11-08

(111) M 2006 016485 R
(732) KENT GIDA MADDELERI SANAYII VE
TICARET ANONIM Sirketi
Cumhuriyet Mahallesi, 2253, Sokak, N11,
Gebze, Kocaeli
(770) KENT GIDA MADDELERI SANAYII VE
TICARET ANONIM Sirketi
Cayirova Mahallesi, Ankara Asfalti Ustu,
Istanbul Caddesi N 111 Gebze, Kocaeli

(580) 2010-11-08

(111) M 2006 017169 R

(732) FIL LIMITED

Pembeoke Hall, 42 Crow Lane, Pembroke
HM 19, P.O. Box HM 670, Hamilton HMCX

(770) FIDELITY INTERNATIONAL LIMITED

Pembroke Hall, 42 Crow Lane, Pembroke
HM 19, P.O. Box HM 670, Hamilton HMCX

(580) 2010-11-10

(111) M 2006 017170 R

(732) FIL LIMITED

Pembeoke Hall, 42 Crow Lane, Pembroke
HM 19, P.O. Box HM 670, Hamilton HMCX

(770) FIDELITY INTERNATIONAL LIMITED

Pembroke Hall, 42 Crow Lane, Pembroke
HM 19, P.O. Box HM 670, Hamilton HMCX

(580) 2010-11-10

(111) M 2007 018100 R

(732) SMITHKLINE BEECHAM LIMITED

980 Great West Road, Brentford, Middlesex
TW8 9GS

(770) SMITHKLINE BEECHAM PLC

980 Great West Road, Brentford, Middlesex
TW8 9GS

(580) 2010-11-11

(111) M 2009 019757 R

(732) ABDI İBRAHİM İLAÇ SANAYİ VE

TİCARET ANONİM ŞİRKETİ

Reşitpaşa Mahallesi Eski Büyükdere Caddesi
N 4, 34467 Maslak-Sarıyer-İstanbul

(770) ABDI İBRAHİM İLAÇ SANAYİ VE

TİCARET ANONİM ŞİRKETİ

Eski Büyükdere Cad. Ayazağa Yolu N5
Maslak, İstanbul

(580) 2010-11-05

(111) M 2009 019894 R

(732) SMITHKLINE BEECHAM LIMITED

980 Great West Road, Brentford, Middlesex
TW8 9GS

(770) SMITHKLINE BEECHAM PLC

980 Great West Road, Brentford, Middlesex
TW8 9GS

(580) 2010-11-11

(111) M 1996 003462 R1

(732) SMITHKLINE BEECHAM LIMITED

980 Great West Road, Brentford, Middlesex
TW8 9GS

(770) SMITHKLINE BEECHAM PLC

980 Great West Road, Brentford, Middlesex
TW8 9GS

(580) 2010-11-11

(111) M 1996 003781 R1

(732) ESSELTE S.P.A.

41, viale Europa, 1 - 20 090 CUSAGO, IT

(770) ESSELTE BUSINESS SYSTEMS S.P.A.

41, viale Europa, 1 - 20 090 CUSAGO, IT

(580) 2010-11-10

(111) M 1997 004547 R1

(732) INTERGUM GIDA SANAYİ VE TİCARET
ANONİM ŞİRKETİ

Mahmutbey Merkez Mahallesi, Tasocaklari
Yolu, N19, Bağcilar, İstanbul 34550

(770) INTERGUM GIDA SANAYİ VE TİCARET
ANONİM ŞİRKETİ

Mahmutbey Merkez Mahallesi, Tasocaklari
Yolu, N19-11, Bağcilar, İstanbul 34550

(580) 2010-11-05

(111) M 1997 007497 R1

(732) SMITHKLINE BEECHAM LIMITED

980 Great West Road, Brentford, Middlesex
TW8 9GS

(770) SMITHKLINE BEECHAM PLC

980 Great West Road, Brentford, Middlesex
TW8 9GS

(580) 2010-11-11

(111) M 1997 007574 R1

(732) SMITHKLINE BEECHAM LIMITED

980 Great West Road, Brentford, Middlesex
TW8 9GS

(770) SMITHKLINE BEECHAM PLC

980 Great West Road, Brentford, Middlesex
TW8 9GS

(580) 2010-11-11

(111) M 1997 007575 R1

(732) SMITHKLINE BEECHAM LIMITED

980 Great West Road, Brentford, Middlesex
TW8 9GS

(770) SMITHKLINE BEECHAM PLC

980 Great West Road, Brentford, Middlesex
TW8 9GS

(580) 2010-11-11

(111) M 1997 007641 R1

(732) SMITHKLINE BEECHAM LIMITED

980 Great West Road, Brentford, Middlesex
TW8 9GS
(770) SMITHKLINE BEECHAM PLC
980 Great West Road, Brentford, Middlesex
TW8 9GS
(580) 2010-11-11

(111) M 1998 009011 R1
(732) SMITHKLINE BEECHAM LIMITED
980 Great West Road, Brentford, Middlesex
TW8 9GS
(770) SMITHKLINE BEECHAM PLC
980 Great West Road, Brentford, Middlesex
TW8 9GS
(580) 2010-11-11

(111) M 1998 009011 R1
(732) SMITHKLINE BEECHAM LIMITED
980 Great West Road, Brentford, Middlesex
TW8 9GS
(770) SMITHKLINE BEECHAM PLC
980 Great West Road, Brentford, Middlesex
TW8 9GS
(580) 2010-11-11

(111) M 1998 009013 R1
(732) SMITHKLINE BEECHAM LIMITED
980 Great West Road, Brentford, Middlesex
TW8 9GS
(770) SMITHKLINE BEECHAM PLC
980 Great West Road, Brentford, Middlesex
TW8 9GS
(580) 2010-11-11

(111) M 1998 009014 R1
(732) SMITHKLINE BEECHAM LIMITED
980 Great West Road, Brentford, Middlesex
TW8 9GS
(770) SMITHKLINE BEECHAM PLC
980 Great West Road, Brentford, Middlesex
TW8 9GS
(580) 2010-11-11

(111) M 1998 009014 R1
(732) SMITHKLINE BEECHAM LIMITED
980 Great West Road, Brentford, Middlesex
TW8 9GS
(770) SMITHKLINE BEECHAM PLC
980 Great West Road, Brentford, Middlesex
TW8 9GS
(580) 2010-11-11

(111) M 1998 009015 R1
(732) SMITHKLINE BEECHAM LIMITED
980 Great West Road, Brentford, Middlesex
TW8 9GS
(770) SMITHKLINE BEECHAM PLC
980 Great West Road, Brentford, Middlesex
TW8 9GS
(580) 2010-11-11

(111) M 1998 009714 R1
(732) SMITHKLINE BEECHAM LIMITED
980 Great West Road, Brentford, Middlesex
TW8 9GS
(770) SMITHKLINE BEECHAM PLC
980 Great West Road, Brentford, Middlesex
TW8 9GS
(580) 2010-11-11

(111) M 1998 009715 R1
(732) SMITHKLINE BEECHAM LIMITED
980 Great West Road, Brentford, Middlesex
TW8 9GS
(770) SMITHKLINE BEECHAM PLC
980 Great West Road, Brentford, Middlesex
TW8 9GS
(580) 2010-11-11

(111) M 1998 009757 R1
(732) SMITHKLINE BEECHAM LIMITED
980 Great West Road, Brentford, Middlesex
TW8 9GS
(770) SMITHKLINE BEECHAM PLC
980 Great West Road, Brentford, Middlesex
TW8 9GS
(580) 2010-11-11

(111) M 1998 009899 R1
(732) SMITHKLINE BEECHAM LIMITED
980 Great West Road, Brentford, Middlesex
TW8 9GS
(770) SMITHKLINE BEECHAM PLC
980 Great West Road, Brentford, Middlesex
TW8 9GS
(580) 2010-11-11

(111) M 1998 009900 R1
(732) SMITHKLINE BEECHAM LIMITED
980 Great West Road, Brentford, Middlesex
TW8 9GS
(770) SMITHKLINE BEECHAM PLC
980 Great West Road, Brentford, Middlesex
TW8 9GS

(580) 2010-11-11

980 Great West Road, Brentford, Middlesex
TW8 9GS

(580) 2010-11-11

(111) M 1998 009901 R1

(732) SMITHKLINE BEECHAM LIMITED
980 Great West Road, Brentford, Middlesex
TW8 9GS

(770) SMITHKLINE BEECHAM PLC
980 Great West Road, Brentford, Middlesex
TW8 9GS

(580) 2010-11-11

(111) M 1998 009943 R1

(732) SMITHKLINE BEECHAM LIMITED
980 Great West Road, Brentford, Middlesex
TW8 9GS

(770) SMITHKLINE BEECHAM PLC
980 Great West Road, Brentford, Middlesex
TW8 9GS

(580) 2010-11-11

(111) M 1998 009903 R1

(732) SMITHKLINE BEECHAM LIMITED
980 Great West Road, Brentford, Middlesex
TW8 9GS

(770) SMITHKLINE BEECHAM PLC
980 Great West Road, Brentford, Middlesex
TW8 9GS

(580) 2010-11-11

(111) M 1998 009944 R1

(732) SMITHKLINE BEECHAM LIMITED
980 Great West Road, Brentford, Middlesex
TW8 9GS

(770) SMITHKLINE BEECHAM PLC
980 Great West Road, Brentford, Middlesex
TW8 9GS

(580) 2010-11-11

(111) M 1998 009931 R1

(732) SMITHKLINE BEECHAM LIMITED
980 Great West Road, Brentford, Middlesex
TW8 9GS

(770) SMITHKLINE BEECHAM PLC
980 Great West Road, Brentford, Middlesex
TW8 9GS

(580) 2010-11-11

(111) M 1998 009940 R1

(732) SMITHKLINE BEECHAM LIMITED
980 Great West Road, Brentford, Middlesex
TW8 9GS

(770) SMITHKLINE BEECHAM PLC
980 Great West Road, Brentford, Middlesex
TW8 9GS

(580) 2010-11-11

(111) M 1998 009941 R1

(732) SMITHKLINE BEECHAM LIMITED
980 Great West Road, Brentford, Middlesex
TW8 9GS

(770) SMITHKLINE BEECHAM PLC
980 Great West Road, Brentford, Middlesex
TW8 9GS

(580) 2010-11-11

(111) M 1998 009942 R1

(732) SMITHKLINE BEECHAM LIMITED
980 Great West Road, Brentford, Middlesex
TW8 9GS

(770) SMITHKLINE BEECHAM PLC

CLASSIFICATION INDEXES

СИСТЕМАТИЧЕСКИЕ УКАЗАТЕЛИ

INVENTIONS

ИЗОБРЕТЕНИЯ

CONCORDANCE TABLE OF INTERNATIONAL CLASSIFICATION INDEX WITH REFERENCE TO NUMBERS OF PATENTS AND NUMBERS OF PUBLISHED APPLICATIONS

ТАБЛИЦА СООТВЕТСТВИЙ ИНДЕКСОВ МЕЖДУНАРОДНОЙ КЛАССИФИКАЦИИ С НОМЕРАМИ
ПАТЕНТОВ И С НОМЕРАМИ ОПУБЛИКОВАННЫХ ЗАЯВОК

INTERNATIONAL CLASSIFICATION INDEX ИНДЕКС МЕЖДУНАРОДНОЙ КЛАССИФИКАЦИИ (51)	NUMBER OF PATENT НОМЕР ПАТЕНТА (11)	NUMBER OF PUBLISHED APPLICATION НОМЕР ПУБЛИКАЦИИ ЗАЯВКИ (10)
A 61 K 39/395, 51/10; C 12 N 15/02; C 07 K 16/46; C 12 P 21/08; C 07 K 16/28	PI 2010 5119 B	-
C 07 D 209/14; A 61 K 31/4045; A 61 P 35/00	P 2010 5125 B	AP 2010 11010 A
C 07 K 16/46, 38/17; A 61 P 25/00; C 12 N 15/66; C 07 K 16/22; A 61 P 35/00; C 12 N 13/13	PI 2010 5118 B	-
C 07 K 5/12; A 61 K 38/00; A 61 P 31/14; C 07 D 209/44; C 07 C 231/02; C 07 C 269/00; C 07 D 207/16	P 2010 5124 B	AP 2010 10529 A
C 10 L 1/02	P 2010 5123 B	AP 2010 10484 A
H 01 B 5/10, 7/18	PI 2010 5120 B	-
H 04 B 7/005; H 04 B 7/216; H 04 W 52/14	P 2010 5121 B	AP 2010 9574 A
H 04 J 3/22; H 04 L 12/24; H 04 L 12/28; H 04 W 92/10	P 2010 5122 B	AP 2010 10247 A

CONCORDANCE TABLES OF NUMBERS OF PATENTS AND NUMBERS OF PUBLISHED APPLICATIONS WITH REFERENCE TO CLASSIFICATION INDEX

ТАБЛИЦА СООТВЕТСТВИЙ НОМЕРОВ ПАТЕНТОВ И НОМЕРОВ ПУБЛИКАЦИЙ ЗАЯВОК С
ИНДЕКСАМИ МЕЖДУНАРОДНОЙ КЛАССИФИКАЦИИ

NUMBER OF PATENT НОМЕР ПАТЕНТА (11)	NUMBER OF PUBLISHED APPLICATION НОМЕР ПУБЛИКАЦИИ ЗАЯВКИ (10)	INTERNATIONAL CLASSIFICATION INDEX ИНДЕКС МЕЖДУНАРОДНОЙ КЛАССИФИКАЦИИ (51)
PI 2010 5118 B	-	C 07 K 16/46, 38/17; A 61 P 25/00; C 12 N 15/66; C 07 K 16/22; A 61 P 35/00; C 12 N 13/13
PI 2010 5119 B	-	A 61 K 39/395, 51/10; C 12 N 15/02; C 07 K 16/46; C 12 P 21/08; C 07 K 16/28
PI 2010 5120 B	-	H 01 B 5/10, 7/18
P 2010 5121 B	AP 2010 9574 A	H 04 B 7/005; H 04 B 7/216; H 04 W 52/14
P 2010 5122 B	AP 2010 10247 A	H 04 J 3/22; H 04 L 12/24; H 04 L 12/28; H 04 W 92/10
P 2010 5123 B	AP 2010 10484 A	C 10 L 1/02
P 2010 5124 B	AP 2010 10529 A	C 07 K 5/12; A 61 K 38/00; A 61 P 31/14; C 07 D 209/44; C 07 C 231/02; C 07 C 269/00; C 07 D 207/16
P 2010 5125 B	AP 2010 11010 A	C 07 D 209/14; A 61 K 31/4045; A 61 P 35/00

CONCORDANCE TABLE OF NUMBERS OF APPLICATIONS, NUMBERS OF PUBLISHED APPLICATIONS AND NUMBERS OF PATENTS

ТАБЛИЦА СООТВЕТСТВИЙ НОМЕРОВ ЗАЯВОК, НОМЕРОВ ПУБЛИКАЦИЙ ЗАЯВОК И НОМЕРОВ ПАТЕНТОВ

NUMBER OF APPLICATION НОМЕР ЗАЯВКИ (21)	NUMBER OF PUBLISHED APPLICATION НОМЕР ПУБЛИКАЦИИ ЗАЯВКИ (10)	NUMBER OF PATENT НОМЕР ПАТЕНТА (11)
AP 2005 009574	AP 2010 9574 A	P 2010 5121 B
AP 2004 010247	AP 2010 10247 A	P 2010 5122 B
AP 2006 010484	AP 2010 10484 A	P 2010 5123 B
AP 2006 010529	AP 2010 10529 A	P 2010 5124 B
AP 2007 011010	AP 2010 11010 A	P 2010 5125 B
API 2009 011617	-	PI 2010 5118 B
API 2009 011620	-	PI 2010 5119 B
API 2010 011791	-	PI 2010 5120 B

**UTILITY MODELS
ПОЛЕЗНЫЕ МОДЕЛИ**

CONCORDANCE TABLE OF INTERNATIONAL CLASSIFICATION INDEX WITH REFERENCE TO NUMBERS OF PATENTS AND NUMBERS OF PUBLISHED APPLICATIONS

ТАБЛИЦА СООТВЕТСТВИЙ ИНДЕКСОВ МЕЖДУНАРОДНОЙ КЛАССИФИКАЦИИ С НОМЕРАМИ ПАТЕНТОВ И С НОМЕРАМИ ОПУБЛИКОВАННЫХ ЗАЯВОК

INTERNATIONAL CLASSIFICATION INDEX ИНДЕКС МЕЖДУНАРОДНОЙ КЛАССИФИКАЦИИ (51)	NUMBER OF PATENT НОМЕР ПАТЕНТА (11)	NUMBER OF PUBLISHED APPLICATION НОМЕР ПУБЛИКАЦИИ ЗАЯВКИ (10)
A 01 B 49/00	U 2010 1633 Y	AU 2010 11406 U
A 21 D 13/08	U 2010 1634 Y	AU 2010 11449 U
B 65 D 39/08; B 65 D 43/04	U 2010 1635 Y	AU 2010 11452 U
E 04 B 5/32	U 2010 1636 Y	AU 2010 11604 U

CONCORDANCE TABLE OF NUMBERS OF PATENTS AND NUMBERS OF PUBLISHED APPLICATIONS WITH REFERENCE TO CLASSIFICATION INDEX

ТАБЛИЦА СООТВЕТСТВИЙ НОМЕРОВ ПАТЕНТОВ И НОМЕРОВ ПУБЛИКАЦИЙ ЗАЯВОК С ИНДЕКСАМИ МЕЖДУНАРОДНОЙ КЛАССИФИКАЦИИ

NUMBER OF PATENT НОМЕР ПАТЕНТА (11)	NUMBER OF PUBLISHED APPLICATION НОМЕР ПУБЛИКАЦИИ ЗАЯВКИ (10)	INTERNATIONAL CLASSIFICATION INDEX ИНДЕКС МЕЖДУНАРОДНОЙ КЛАССИФИКАЦИИ (51)
U 2010 1633 Y	AU 2010 11406 U	A 01 B 49/00
U 2010 1634 Y	AU 2010 11449 U	A 21 D 13/08
U 2010 1635 Y	AU 2010 11452 U	B 65 D 39/08; B 65 D 43/04
U 2010 1636 Y	AU 2010 11604 U	E 04 B 5/32

CONCORDANCE TABLE OF NUMBERS OF APPLICATIONS, NUMBERS OF PUBLISHED APPLICATIONS AND NUMBERS OF PATENTS

ТАБЛИЦА СООТВЕТСТВИЙ НОМЕРОВ ЗАЯВОК, НОМЕРОВ ПУБЛИКАЦИЙ ЗАЯВОК И НОМЕРОВ ПАТЕНТОВ

NUMBER OF APPLICATION НОМЕР ЗАЯВКИ (21)	NUMBER OF PUBLISHED APPLICATION НОМЕР ПУБЛИКАЦИИ ЗАЯВКИ (10)	NUMBER OF PATENT НОМЕР ПАТЕНТА (11)
AU 2009 011406	AU 2010 11406 U	U 2010 1633 Y
AU 2009 011449	AU 2010 11449 U	U 2010 1634 Y
AU 2009 011452	AU 2010 11452 U	U 2010 1635 Y
AU 2009 011604	AU 2010 11604 U	U 2010 1636 Y

**INDUSTRIAL DESIGNS
ПРОМЫШЛЕННЫЕ ОБРАЗЦЫ**

CONCORDANCE TABLE OF INTERNATIONAL CLASSIFICATION INDEX WITH REFERENCE TO NUMBERS OF PATENTS AND NUMBERS OF PUBLISHED APPLICATIONS

ТАБЛИЦА СООТВЕТСТВИЙ ИНДЕКСОВ МЕЖДУНАРОДНОЙ КЛАССИФИКАЦИИ С НОМЕРАМИ ПАТЕНТОВ И С НОМЕРАМИ ОПУБЛИКОВАННЫХ ЗАЯВОК

INTERNATIONAL CLASSIFICATION INDEX ИНДЕКС МЕЖДУНАРОДНОЙ КЛАССИФИКАЦИИ (51)	NUMBER OF PATENT НОМЕР ПАТЕНТА (11)	NUMBER OF PUBLISHED APPLICATION НОМЕР ПУБЛИКАЦИИ ЗАЯВКИ (10)
32-00	D 2010 442 S	AD 2010 571 S
32-00	D 2010 443 S	AD 2010 582 S

CONCORDANCE TABLE OF NUMBERS OF PATENTS AND NUMBERS OF PUBLISHED APPLICATIONS WITH REFERENCE TO CLASSIFICATION INDEX

ТАБЛИЦА СООТВЕТСТВИЙ НОМЕРОВ ПАТЕНТОВ И НОМЕРОВ ПУБЛИКАЦИЙ ЗАЯВОК С ИНДЕКСАМИ МЕЖДУНАРОДНОЙ КЛАССИФИКАЦИИ

NUMBER OF PATENT НОМЕР ПАТЕНТА (11)	NUMBER OF PUBLISHED APPLICATION НОМЕР ПУБЛИКАЦИИ ЗАЯВКИ (10)	INTERNATIONAL CLASSIFICATION INDEX ИНДЕКС МЕЖДУНАРОДНОЙ КЛАССИФИКАЦИИ (51)
D 2010 442 S	AD 2010 571 S	32-00
D 2010 443 S	AD 2010 582 S	32-00

**CONCORDANCE TABLE OF NUMBERS OF APPLICATIONS, NUMBERS OF
PUBLISHED APPLICATIONS AND NUMBERS OF PATENTS**ТАБЛИЦА СООТВЕТСТВИЙ НОМЕРОВ ЗАЯВОК, НОМЕРОВ ПУБЛИКАЦИЙ ЗАЯВОК И НОМЕРОВ
ПАТЕНТОВ

NUMBER OF APPLICATION НОМЕР ЗАЯВКИ (21)	NUMBER OF PUBLISHED APPLICATION НОМЕР ПУБЛИКАЦИИ ЗАЯВКИ (10)	NUMBER OF PATENT НОМЕР ПАТЕНТА (11)
AD 2009 000571	AD 2010 571 S	D 2010 442 S
AD 2009 000582	AD 2010 582 S	D 2010 443 S

TRADEMARKS

ТОВАРНЫЕ ЗНАКИ

CONCORDANCE TABLE OF NUMBERS OF REGISTRATIONS OF TRADEMARKS, NUMBERS OF APPLICATIONS, NUMBERS OF PUBLISHED APPLICATIONS WITH REFERENCE TO NUMBERS OF BULLETINS

ТАБЛИЦА СООТВЕТСТВИЙ НОМЕРОВ РЕГИСТРАЦИЙ ТОВАРНЫХ ЗНАКОВ С НОМЕРАМИ ЗАЯВОК, НОМЕРАМИ ПУБЛИКАЦИЙ ЗАЯВОК И НОМЕРАМИ БЮЛЛЕТЕНЕЙ

NUMBER OF REGISTRATION НОМЕР РЕГИСТРАЦИИ (111)	NUMBER OF APPLICATION НОМЕР ЗАЯВКИ (210)	NUMBER OF PUBLISHED APPLICATION НОМЕР ПУБЛИКАЦИИ ЗАЯВКИ (260)	NUMBER OF BULLETIN НОМЕР БЮЛЛЕТЕНЯ
M 2010 20880 R	AM 2009 53658	AM 2010 53658 A	№8(300) 2010
M 2010 20881 R	AM 2009 54035	AM 2010 54035 A	№10(302) 2010
M 2010 20882 R	AM 2009 54121	AM 2010 54121 A	№9(301) 2010
M 2010 20883 R	AM 2009 54130	AM 2010 54130 A	№9(301) 2010
M 2010 20884 R	AM 2009 54131	AM 2010 54131 A	№9(301) 2010
M 2010 20885 R	AM 2009 54132	AM 2010 54132 A	№9(301) 2010
M 2010 20886 R	AM 2009 54135	AM 2010 54135 A	№7(299) 2010
M 2010 20887 R	AM 2009 54487	AM 2010 54487 A	№9(301) 2010
M 2010 20888 R	AM 2009 54554	AM 2010 54554 A	№11(303) 2010
M 2010 20889 R	AM 2009 54555	AM 2010 54555 A	№10(302) 2010
M 2010 20890 R	AM 2009 54556	AM 2010 54556 A	№11(303) 2010
M 2010 20891 R	AM 2009 54814	AM 2010 54814 A	№11(303) 2010
M 2010 20892 R	AM 2009 54913	AM 2010 54913 A	№9(301) 2010
M 2010 20893 R	AM 2009 55035	AM 2010 55035 A	№12(304) 2010
M 2010 20894 R	AM 2009 55104	AM 2010 55104 A	№12(304) 2010
M 2010 20895 R	AM 2009 55126	AM 2010 55126 A	№12(304) 2010
M 2010 20896 R	AM 2009 55453	AM 2010 55453 A	№14(306) 2010
M 2010 20909 R	AM 2009 54374	AM 2010 54374 A	№14(306) 2010
M 2010 20910 R	AM 2009 54638	AM 2010 54638 A	№9(301) 2010
M 2010 20911 R	AM 2009 54685	AM 2010 54685 A	№9(301) 2010
M 2010 20912 R	AM 2009 54894	AM 2010 54894 A	№11(303) 2010
M 2010 20913 R	AM 2009 54908	AM 2010 54908 A	№9(301) 2010
M 2010 20914 R	AM 2009 54950	AM 2010 54950 A	№11(303) 2010
M 2010 20915 R	AM 2009 54951	AM 2010 54951 A	№11(303) 2010
M 2010 20916 R	AM 2009 54952	AM 2010 54952 A	№11(303) 2010
M 2010 20917 R	AM 2009 54984	AM 2010 54984 A	№11(303) 2010
M 2010 20918 R	AM 2009 55250	AM 2010 55250 A	№14(306) 2010
M 2010 20919 R	AM 2009 55288	AM 2010 55288 A	№14(306) 2010
M 2010 20924 R	AM 2009 52002	AM 2009 52002 A	№21(289) 2009
M 2010 20925 R	AM 2009 54078	AM 2010 54078 A	№9(301) 2010
M 2010 20926 R	AM 2009 54486	AM 2010 54486 A	№7(299) 2010
M 2010 20927 R	AM 2009 55127	AM 2010 55127 A	№11(303) 2010
M 2010 20928 R	AM 2009 55128	AM 2010 55128 A	№11(303) 2010

CONCORDANCE TABLE OF NUMBERS OF PUBLISHED TRADEMARK APPLICATIONS WITH REFERENCE TO NUMBERS OF APPLICATIONS

ТАБЛИЦА СООТВЕТСТВИЙ НОМЕРОВ ПУБЛИКАЦИЙ ТОВАРНЫХ ЗНАКОВ И НОМЕРОВ ЗАЯВОК

NUMBER OF PUBLISHED APPLICATION НОМЕР ПУБЛИКАЦИИ ЗАЯВКИ (260)	NUMBER OF APPLICATION НОМЕР ЗАЯВКИ (210)	1	2
1	2		
AM 2010 56684 A	AM 2010 56684	AM 2010 57054 A	AM 2010 57054
AM 2010 56726 A	AM 2010 56726	AM 2010 57078 A	AM 2010 57078
AM 2010 56727 A	AM 2010 56727	AM 2010 57103 A	AM 2010 57103
AM 2010 56728 A	AM 2010 56728	AM 2010 57104 A	AM 2010 57104
AM 2010 56732 A	AM 2010 56732	AM 2010 57222 A	AM 2010 57222
AM 2010 56733 A	AM 2010 56733	AM 2010 57240 A	AM 2010 57240
AM 2010 56734 A	AM 2010 56734	AM 2010 57243 A	AM 2010 57243
AM 2010 56735 A	AM 2010 56735	AM 2010 57250 A	AM 2010 57250
AM 2010 56794 A	AM 2010 56794	AM 2010 57250 A	AM 2010 57250
AM 2010 56810 A	AM 2010 56810	AM 2010 57336 A	AM 2010 57336
AM 2010 56811 A	AM 2010 56811	AM 2010 57359 A	AM 2010 57359
AM 2010 56812 A	AM 2010 56812	AM 2010 57371 A	AM 2010 57371
AM 2010 56818 A	AM 2010 56818		
AM 2010 56819 A	AM 2010 56819		
AM 2010 56820 A	AM 2010 56820		
AM 2010 56825 A	AM 2010 56825		
AM 2010 56891 A	AM 2010 56891		
AM 2010 56892 A	AM 2010 56892		
AM 2010 56894 A	AM 2010 56894		
AM 2010 56895 A	AM 2010 56895		
AM 2010 56896 A	AM 2010 56896		
AM 2010 56897 A	AM 2010 56897		
AM 2010 56899 A	AM 2010 56899		
AM 2010 56901 A	AM 2010 56901		
AM 2010 56903 A	AM 2010 56903		
AM 2010 56921 A	AM 2010 56921		
AM 2010 56922 A	AM 2010 56922		
AM 2010 56929 A	AM 2010 56929		
AM 2010 56940 A	AM 2010 56940		
AM 2010 56941 A	AM 2010 56941		
AM 2010 56961 A	AM 2010 56961		
AM 2010 56977 A	AM 2010 56977		
AM 2010 56978 A	AM 2010 56978		
AM 2010 57008 A	AM 2010 57008		
AM 2010 57010 A	AM 2010 57010		
AM 2010 57015 A	AM 2010 57015		
AM 2010 57016 A	AM 2010 57016		
AM 2010 57031 A	AM 2010 57031		
AM 2010 57032 A	AM 2010 57032		
AM 2010 57033 A	AM 2010 57033		
AM 2010 57042 A	AM 2010 57042		
AM 2010 57052 A	AM 2010 57052		
AM 2010 57053 A	AM 2010 57053		

**CONCORDANCE TABLE OF INDEX OF GOODS AND/OR SERVICES WITH
REFERENCE TO NUMBERS OF PUBLISHED APPLICATIONS**

ТАБЛИЦА СООТВЕТСТВИЙ КЛАССОВ ТОВАРОВ И/ИЛИ УСЛУГ С НОМЕРАМИ
ОПУБЛИКОВАННЫХ ЗАЯВОК

INDEX OF GOODS AND/OR SERVICES КЛАСС ТОВАРОВ И/ИЛИ УСЛУГ (511)	NUMBER OF PUBLISHED APPLICATION НОМЕР ОПУБЛИКОВАННОЙ ЗАЯВКИ (260)	1	2
1	2	25	AM 2010 56727 A
3	AM 2010 57008 A	25	AM 2010 57010 A
3	AM 2010 57222 A	25	AM 2010 57015 A
3	AM 2010 57336 A	28	AM 2010 56684 A
3	M 2010 20923 R	29	AM 2010 56921 A
5	AM 2010 56794 A	29	AM 2010 56940 A
5	AM 2010 56812 A	29	AM 2010 56941 A
5	AM 2010 56891 A	29	AM 2010 57250 A
5	AM 2010 56892 A	30	AM 2010 56726 A
5	AM 2010 56894 A	30	AM 2010 56727 A
5	AM 2010 56895 A	30	AM 2010 56818 A
5	AM 2010 56896 A	30	AM 2010 56819 A
5	AM 2010 56897 A	30	AM 2010 56820 A
5	AM 2010 56899 A	30	AM 2010 56825 A
5	AM 2010 56901 A	30	AM 2010 57016 A
5	AM 2010 56903 A	30	M 2010 20897 R
5	AM 2010 56922 A	30	AM 2010 56895 A
5	AM 2010 56977 A	32	AM 2010 56726 A
5	AM 2010 56978 A	32	AM 2010 56727 A
5	AM 2010 57016 A	32	AM 2010 56818 A
5	AM 2010 57103 A	32	AM 2010 56819 A
5	AM 2010 57104 A	32	AM 2010 56820 A
5	AM 2010 57222 A	32	AM 2010 56940 A
5	AM 2010 57240 A	32	AM 2010 56941 A
5	AM 2010 57243 A	32	AM 2010 57015 A
5	AM 2010 57336 A	32	AM 2010 57016 A
5	M 2010 20902 R	32	AM 2010 56726 A
5	M 2010 20903 R	33	AM 2010 56727 A
5	M 2010 20904 R	33	AM 2010 56728 A
5	M 2010 20905 R	33	AM 2010 56732 A
5	M 2010 20906 R	33	AM 2010 56733 A
9	AM 2010 56684 A	33	AM 2010 56734 A
9	AM 2010 57010 A	33	AM 2010 56735 A
14	AM 2010 57010 A	33	AM 2010 56929 A
16	AM 2010 57015 A	34	AM 2010 57078 A
16	M 2010 20899 R	34	M 2010 20898 R
18	AM 2010 57010 A	34	M 2010 20900 R
21	AM 2010 56684 A	34	M 2010 20901 R
21	AM 2010 57222 A	34	M 2010 20907 R
21	AM 2010 57336 A	34	M 2010 20908 R
25	AM 2010 56684 A	34	M 2010 20920 R
25	AM 2010 56726 A	34	M 2010 20921 R
		34	M 2010 20922 R
		35	AM 2010 56684 A
		35	AM 2010 56726 A
		35	AM 2010 56727 A
		35	AM 2010 56818 A
		35	AM 2010 56819 A
		35	AM 2010 56820 A

1	2
35	AM 2010 56961 A
35	AM 2010 57015 A
35	AM 2010 57031 A
35	AM 2010 57032 A
35	AM 2010 57033 A
36	AM 2010 56726 A
36	AM 2010 56727 A
36	AM 2010 57052 A
36	AM 2010 57053 A
36	AM 2010 57054 A
36	AM 2010 57359 A
36	AM 2010 57371 A
38	AM 2010 56684 A
38	AM 2010 56810 A
38	AM 2010 56811 A
39	AM 2010 56940 A
39	AM 2010 56941 A
41	AM 2010 56684 A
41	AM 2010 56811 A
41	AM 2010 56818 A
41	AM 2010 56819 A
41	AM 2010 56820 A
41	AM 2010 57015 A
42	AM 2010 56726 A
42	AM 2010 56727 A
42	AM 2010 56810 A
42	AM 2010 56811 A
42	AM 2010 57240 A
42	AM 2010 57243 A
43	AM 2010 56818 A
43	AM 2010 56819 A
43	AM 2010 56820 A
43	AM 2010 57042 A
44	AM 2010 56961 A
44	AM 2010 57031 A
44	AM 2010 57032 A
44	AM 2010 57033 A

OFFICIAL BULLETIN OF THE INDUSTRIAL PROPERTY
ОФИЦИАЛЬНЫЙ БЮЛЛЕТЕНЬ ПРОМЫШЛЕННОЙ СОБСТВЕННОСТИ

22 (314)

EDITOR-IN-CHIEF: N. Bebrishvili
ГЛАВНЫЙ РЕДАКТОР: *Н. Бебришвили*

EDITOR: M. Tatishvili
РЕДАКТОР: *М. Татишвили*

EDITORS-TRANSLATORS: M. Sichinava
РЕДАКТОРЫ-ПЕРЕВОДЧИКИ: *М. Сичинава*

G. Nadareishvili
Г. Надареишвили

PROOFREADER: L. Chanturia
КОРРЕКТОР: *Л. Чантурия*

COMPUTER LAYOUT: M. Ordenidze
КОМПЬЮТЕРНАЯ ВЕРСТКА: *М. Орденидзе*

K. Svanidze
К. Сванидзе

www.sakpatenti.org.ge

E-mail: info@sakpatenti.org.ge

МЕЖДУНАРОДНЫЕ КОДЫ ДЛЯ ИДЕНТИФИКАЦИИ БИБЛИОГРАФИЧЕСКИХ ДАННЫХ

ИЗОБРЕТЕНИЯ, ПОЛЕЗНЫЕ МОДЕЛИ

- (10) Номер публикации заявки, прошедшей экспертизу
- (11) Номер патента и код вида
- (21) Номер заявки
- (22) Дата подачи заявки
- (23) Дата выставочного приоритета или дата подачи заявки с более ранним приоритетом и, если возможно, номер заявки
- (24) Дата, с которой начинается действие патента
- (31) Номер приоритетной заявки
- (32) Дата подачи приоритетной заявки
- (33) Код страны или региональной организации, ведомство которой присвоило номер приоритетной заявке
- (44) Дата публикации еще не выданного, но прошедшего экспертизу охранного документа и номер бюллетеня
- (45) Дата публикации патентного документа, прошедшего регистрацию
- (51) Индекс международной патентной классификации
- (54) Наименование изобретения
- (57) Реферат
- (60) Номер охранного документа, прошедшего полную экспертизу, выданный иностранным патентным ведомством, дата начала действия этого охранного документа и код страны
- (62) Номер более ранней заявки и, в случае выделенной заявки, дата подачи заявки
- (71) Имя, фамилия, адрес заявителя (код страны)
- (72) Имя, фамилия изобретателя (код страны)
- (73) Имя, фамилия, адрес патентообладателя (код страны)
- (74) Имя, фамилия представителя или патентного поверенного
- (85) Дата начала действия национальной фазы международной заявки
- (86) Номер и дата подачи международной заявки
- (87) Номер и дата публикации международной заявки

ПРОМЫШЛЕННЫЕ ОБРАЗЦЫ

- (10) Номер публикации заявки, прошедшей экспертизу
- (11) Номер патента и код вида или номер регистрации
- (15) Дата регистрации/дата продления срока действия патента
- (18) Предполагаемая дата окончания срока действия патента или регистрации
- (21) Номер заявки
- (22) Дата подачи заявки
- (23) Дата выставочного приоритета или дата подачи заявки с более ранним приоритетом и, если возможно, номер заявки
- (24) Дата, с которой начинается действие патента
- (28) Количество промышленных образцов, внесенных в заявку
- (31) Номер приоритетной заявки
- (32) Дата подачи приоритетной заявки
- (33) Код страны или региональной организации, ведомство которой присвоило номер приоритетной заявке
- (34) Двухбуквенный код ВОИС в соответствии со стандартом-ST.3 для идентификации органа, где была подана приоритетная заявка
- (44) Дата публикации промышленного образца и номер бюллетеня (первая публикация)
- (45) Дата публикации промышленного образца, прошедшего регистрацию в международном бюро, и номер бюллетеня
- (51) Международная классификация промышленного образца (класс и подкласс Локарнской классификации)
- (54) Наименование промышленного образца
- (55) Изображение промышленного образца
- (57) Описание характерных особенностей промышленного образца, включая цвет
- (62) Номер более ранней заявки регистрации или документа и, в случае выделенной заявки, дата подачи заявки
- (71) Имя, фамилия, адрес заявителя (код страны)
- (72) Имя, фамилия автора (код страны)
- (73) Имя, фамилия, адрес патентообладателя (код страны)
- (74) Имя, фамилия представителя или патентного поверенного
- (81) Соответствующие участвующие страны
II. указанные страны-участницы, согласно акту 1960 года
III. указанные страны-участницы, согласно акту 1999 года;
- (85) Постоянное место жительства владельца
- (86) Гражданство владельца
- (87) Место жительства владельца
- (88) Государство, в котором владелец имеет настоящее и действующее промышленное или торговое производство**

ТОВАРНЫЕ ЗНАКИ

- (111) – Номер регистрации
- (151) – Дата регистрации
- (156) – Дата продления срока регистрации
- (181) – Предполагаемая дата окончания срока регистрации
- (186) – Предполагаемая дата продления срока регистрации
- (141) – Дата аннулирования срока действия регистрации знака
- (210) – Номер заявки
- (220) – Дата подачи заявки
- (230) – Выставочные данные
- (260) – Номер заявки, в отношении которой внесено положительное решение экспертизы о регистрации (номер публикации)
- (310) – Номер первой заявки
- (320) – Дата подачи первой заявки
- (330) – Идентификационный код национального или регионального ведомства или организации, принимающей первую заявку
- (511) – Международная классификация товара и/или услуг для регистрации товарного знака и/или перечень классифицированного товара и/или услуг
- (531) – Описание изобразительного элемента товарного знака в соответствии с Международной классификацией (Венская классификация) изобразительного элемента товарного знака
- (540) – Изображение знака
- (550) – Вид товарного знака
- (580) – Дата внесения записи на все виды изменений, связанные с регистрацией заявки и знака
- (591) – Информация о заявленных цветах
- (731) – Имя и адрес заявителя
- (732) – Имя и адрес владельца
- (740) – Имя и адрес представителя
- (750) – Адрес для переписки
- (770) – Имя и адрес заявителя или владельца до изменений в случае передачи прав
- (771) – Имя и адрес заявителя или владельца до изменений без передачи прав
- (791) – Имя и адрес лицензиата
- (793) – Указания на условия и/или ограничения по лицензии (Вид лицензии, номер лицензионного договора, дата лицензионного договора, дата действия лицензионного договора)
- (800) – Данные регистрации товарных знаков в соответствии с протоколом Мадридского договора о международной регистрации товарных знаков (номер Международной классификации)

КОДЫ ДЛЯ ПУБЛИКАЦИИ В БЮЛЛЕТЕНЕ

- (21) AP 0000 000000 – номер заявки на изобретение;
- (10) AP 0000 0000 A – номер публикации заявки на изобретение (первая публикация);
- (11) P 0000 0000 B – номер патента на изобретение (вторая публикация);
- (21) API 0000 000000 – номер заявки на взвозный патент;
- (11) PI 0000 0000 A – номер взвозного патента (первая публикация);
- (21) AU 0000 000000 – номер заявки на полезную модель;
- (10) AU 0000 000 U – номер публикации заявки на полезную модель (первая публикация);
- (11) U 0000 000 Y – номер патента на полезную модель (вторая публикация);
- (21) AD 0000 000000 – номер заявки на промышленный образец;
- (10) AD 0000 000 S – номер публикации заявки на промышленный образец (первая публикация);
- (11) D 0000 000 S – номер патента на промышленный образец (вторая публикация)

МЕЖДУНАРОДНАЯ ПАТЕНТНАЯ КЛАССИФИКАЦИЯ ИЗОБРЕТЕНИЙ И ПОЛЕЗНЫХ МОДЕЛЕЙ

- РАЗДЕЛ A – УДОВЛЕТВОРЕНИЕ ЖИЗНЕННЫХ ПОТРЕБНОСТЕЙ ЧЕЛОВЕКА
- РАЗДЕЛ B – РАЗЛИЧНЫЕ ТЕХНОЛОГИЧЕСКИЕ ПРОЦЕССЫ; ТРАНСПОРТИРОВАНИЕ
- РАЗДЕЛ C – ХИМИЯ; МЕТАЛЛУРГИЯ
- РАЗДЕЛ D – ТЕКСТИЛЬ; БУМАГА
- РАЗДЕЛ E – СТРОИТЕЛЬСТВО; ГОРНОЕ ДЕЛО
- РАЗДЕЛ F – МЕХАНИКА; ОСВЕЩЕНИЕ; ОТОПЛЕНИЕ; ДВИГАТЕЛИ И НАСОСЫ; ОРУЖИЕ И БОЕПРИПАСЫ; ВЗРЫВНЫЕ РАБОТЫ
- РАЗДЕЛ G – ФИЗИКА
- РАЗДЕЛ H – ЭЛЕКТРИЧЕСТВО

- M – Trade Mark
- (210) AM 0000 000000 – Номер заявки;
- (260) AAM 0000 00000 A – Номер публикации заявки;
- (111) M 0000 00000 R – Номер регистрации;
- (111) MMM0000 00000 Rn – Номер каждой последующей регистрации, где n=1,2,3;
- (111) M 0000 00000 R(P) – Номер регистрации при передаче частичных прав на товарный знак

LIST OF CODES, IN ALPHABETIC SEQUENCE, AND THE CORRESPONDING (SHORT) NAMES OF STATES, OTHER ENTITIES AND INTERGOVERNMENTAL ORGANIZATIONS (ISMO STANDARD ST.3)

AD	Andorra	GD	Grenada	NE	Niger
AE	United Arab Emirates	GG	Guernsey	NG	Nigeria
AF	Afghanistan	GH	Ghana	NI	Nicaragua
AG	Antigua and Barbuda	GI	Gibraltar	NL	Netherlands
AI	Anguilla	GT	Guatemala	NO	Norway
AL	Albania	GW	Guinea- Bissau	NP	Nepal
AM	Armenia	GY	Guyana	NR	Nauru
AN	Netherlands Antilles	HK	The Hong Kong Special Administrative Region of the People's Republic of China	NZ	New Zealand
AO	Angola	HN	Honduras	OA	African Intellectual Property Organization (OAPI)
AP	African Regional Intellectual Property Organization (ARIPO)	HR	Croatia	OM	Oman
AR	Argentina	HT	Haiti	PA	Panama
AT	Austria	HU	Hungary	PE	Peru
AU	Australia	IB	International Bureau of the World Intellectual Property Organization (WIPO)	PG	Papua New Guinea
AW	Aruba	ID	Indonesia	PH	Philippines
AZ	Azerbaijan	IE	Ireland	PK	Pakistan
BA	Bosnia and Herzegovina	IL	Israel	PL	Poland
BB	Barbados	IM	Isle of Man	PT	Portugal
BD	Bangladesh	IN	India	PW	Palau
BE	Belgium	IQ	Iraq	PY	Paraguay
BF	Burkina Faso	ID	Indonesia	QA	Qatar
BG	Bulgaria	IE	Ireland	QZ	Community Plant Variety Office (European Community) (CPVO)
BH	Bahrain	IL	Israel	RO	Romania
BI	Burundi	IM	Isle of Man	RS	Serbia
BJ	Benin	IN	India	RU	Russian Federation
BM	Bermuda	IQ	Iraq	RW	Rwanda
BN	Brunei Darussalam	IR	Iran (Islamic Republic of)	SA	Saudi Arabia
BO	Bolivia	IS	Iceland	SB	Solomon Islands
BR	Brazil	IT	Italy	SC	Seychelles
BS	Bahamas	JE	Jersey	SD	Sudan
BT	Bhutan	JM	Jamaica	SG	Singapore
BV	Bouvet Island	JO	Jordan	SH	Saint Helena
BW	Botswana	JP	Japan	SI	Slovenia
BX	Benelux Office for Intellectual Property (BOIP)	KE	Kenya	SK	Slovakia
BY	Belarus	KG	Kyrgyzstan	SL	Sierra Leone
BZ	Belize	KH	Cambodia	SM	San Marino
CA	Canada	KI	Kiribati	SN	Senegal
CD	Democratic Republic of the Congo	KM	Saint Kitts and Nevis	SO	Somalia
CF	Central African Republic	KP	Democratic People's Republic of Korea	SR	Suriname
CG	Congo	KR	Republic of Korea	ST	Sao Tome and Principe
CH	Switzerland	KW	Kuwait	SV	El Salvador
CI	Cote d'Ivoire	KY	Cayman Islands	SY	Syrian Arab Republic
CK	Cook Islands	KZ	Kazakhstan	SZ	Swaziland
CL	Chile	LA	Lao People's Democratic Republic	TC	Turks and Caicos Islands
CM	Cameroon	LB	Lebanon	TD	Chad
CN	China	LC	Saint Lucia	TG	Togo
CO	Colombia	LI	Liechtenstein	TH	Thailand
CR	Costa Rica	LK	Sri Lanka	TJ	Tajikistan
CU	Cuba	LR	Liberia	TL	Timor-Leste
CV	Cape Verde	LS	Lesotho	TM	Turkmenistan
CY	Cyprus	LT	Lithuania	TN	Tunisia
CZ	Czech Republic	LU	Luxembourg	TO	Tonga
DE	Germany	LV	Latvia	TR	Turkey
DJ	Djibouti	LY	Libyan Arab Jamahiriya	SE	Sweden
DM	Dominica	MA	Morocco	TT	Trinidad and Tobago
DO	Dominican Republic	MC	Monaco	TV	Tuvalu
DZ	Algeria	MD	Republic of Moldova	TW	Taiwan, Province of China
EA	Eurasian Patent Organization (EAPO)	ME	Montenegro	TZ	United Republic of Tanzania
EC	Ecuador	MG	Madagascar	UA	Ukraine
EE	Estonia	MK	The former Yugoslav Republic of Macedonia	UG	Uganda
EG	Egypt	ML	Mali	US	United States of America
EH	Western Sahara	MM	Myanmar	UY	Uruguay
EM	Office for Harmonization in the Internal Market (Trademarks and Designs)(OHIM)	MN	Mongolia	UZ	Uzbekistan
EP	European Patent Office (EPO)	MO	Macao	VA	Holy See
ER	Eritrea	MP	Northern Mariana Islands	VC	Saint Vincent and the Grenadines
ES	Spain	MR	Mauritania	VE	Venezuela
ET	Ethiopia	MS	Montserrat	VG	Virgin Islands (British)
FI	Finland	MT	Malta	VN	Viet Nam
FJ	Fiji	MU	Mauritius	VU	Vanuatu
FK	Falkland Islands (Malvinas)	MV	Maldives	WO	World Intellectual Property Organization (WIPO)
FO	Faroe Islands	MW	Malawi	WS	Samoa
FR	France	MX	Mexico	XN	Nordic Patent Institute (NPI)
GA	Gabon	MY	Malaysia	YE	Yemen
GB	United Kingdom	MZ	Mozambique	ZA	South Africa
GC	Patent Office of the Cooperation Council for the Arab States of the Gulf (GCC)	NA	Namibia	ZM	Zambia
				ZW	Zimbabwe