



**NATIONAL INTELLECTUAL PROPERTY CENTER OF GEORGIA
SAKPATENTI**

**OFFICIAL BULLETIN
OF THE INDUSTRIAL PROPERTY**

22(362)

**2012
TBILISI**

INID CODES FOR IDENTIFICATION OF BIBLIOGRAPHIC DATA

INVENTIONS, UTILITY MODELS

- (10) Number of publication for application, which has been examined
- (11) Number of patent and kind of document
- (21) Serial number of application
- (22) Date of filing of the application
- (23) Date of exhibition or the date of the earlier filing and the number of application, if any
- (24) Date from which patent may have effect
- (31) Number of priority application
- (32) Date of filing of priority application
- (33) Code of the country or regional organization allotting priority application number
- (44) Date of publication of application not granted, but examined and number of bulletin
- (45) Date of publication of registered document
- (51) International Patent Classification Index
- (54) Title of the invention
- (57) Abstract
- (60) Number of examined patent document granted by foreign patent office, date from which patent has effect and country code
- (62) Number of the earlier application and in case of divided application, date of filing an application
- (71) Name, surname and address of applicant (country code)
- (72) Name, surname of inventor (country code)
- (73) Name, surname and address of patent owner (country code)
- (74) Name, surname of representative or patent attorney
- (85) Date of commencement of the national phase of International Application
- (86) Number and date of filing of international application
- (87) Number and date of publication of international application

DESIGNS

- (10) Number of publication for application
- (11) Number of patent and kind of document or number of registration
- (15) Date of registration/Date of patent renewal
- (18) Expected expiration date of patent or registration
- (21) Serial number of application
- (22) Date of filing of the application
- (23) Date of exhibition or the date of the earlier filing and the number of application, if any
- (24) Date from which patent may have effect
- (28) Number of designs included in the application
- (30) Data relating to priority (number of application, date of filing of application, two-letter code identifying the authority with whom the priority application was made)
- (31) Number of priority application
- (32) Date of filing of priority application
- (33) Code of the country or regional organization allotting priority application number
- (34) Two-letter code according to WIPO St.3 identifying the authority with which the priority application was made
- (44) Date of publication of design and number of bulletin (the first publication)
- (45) Date of publication of design registered by WIPO and number of bulletin
- (51) International Classification for designs (class and subclass of the Locarno Classification)
- (54) Title of the invention
- (55) Reproduction of the design
- (57) Description of characteristic features of the design including indication of colors
- (58) Date of recording of any kind of amendment in the Register
- (62) Number of the earlier application, registration and document number and if available the date of filing an application in case of divided application
- (71) Name, surname and address of applicant (country code)
- (72) Name, surname of creator (country code)
- (73) Name, surname and address of patent owner (country code)
- (74) Name, surname of representative or patent attorney
- (81) Contracting states concerned
 - II designated contracting states according to the 1960 Act
 - III designated contracting states according to the 1999 Act
- (85) Owner's permanent address
- (86) Owner's nationality
- (87) Owner's residence
- (88) State in which the owner has a real and effective industrial or commercial establishment

TRADEMARKS

- (111) – Number of registration
- (151) – Date of registration
- (156) – Date of the renewal
- (181) – Expected expiration date of registration
- (186) – Renewal expiration date of registration
- (141) – Date of cancel of duration of the mark
- (210) – Serial number of application
- (220) – Date of filing of the application
- (230) – Date concerning exhibition
- (260) – Number of application, for which favorable decision of examination about registration has been taken (publication number)
- (310) – Number of the first application
- (320) – Date of filing of the first application
- (330) – Code, identifying national or regional Office where the first application was made
- (511) – International Classification of Goods and Services for the purposes of registration of trade marks and/or list of goods and/or services classified according thereto
- (531) – Description of figurative elements of Trade Marks according to the International Classification of the Figurative Elements of Marks
- (540) – Reproduction of Trade Mark
- (550) – Nature and kind of Trade Mark
- (580) – Date of recording of any kind changes in respect of applications or registrations
- (591) – Information concerning colors claimed
- (731) – Name and address of the applicant
- (732) – Name and address of the holder of the registration
- (740) – Name and address of the representative
- (750) – Address for correspondence
- (770) – Name and address of the previous applicant or holder in case of change in ownership
- (771) – Previous name and address of the applicant or holder in case of change in ownership
- (791) – Name and address of the licensee
- (793) – Indication of conditions and/or restrictions under the license (Type of license, number of license agreement, data of license, data of validity of license)
- (800) – Certain data relating to the international registration of Trade Marks under the Protocol Relating to Madrid Agreement (International registration number)

CODES FOR PUBLICATION IN BULLETIN

- (21) AP 0000 000000 – serial number of application for invention
- (10) AP 0000 0000 A – number of published application for invention (first publication)
- (11) P 0000 0000 B – number of patent for invention (second publication)
- (21) API 0000 000000 – number of application for imported patent
- (11) PI 0000 0000 A – number of imported patent (first publication)
- (21) AU 0000 000000 – serial number of application for utility model
- (10) AU 0000 000 U – number of published application for utility model (first publication)
- (11) U 0000 000 Y – number of patent for utility model (second publication)
- (21) AD 0000 000000 – serial number of application for design
- (10) AD 0000 000 S – number of published application for design (first publication)
- (11) D 0000 000 S – number of patent for design (second publication)

INTERNATIONAL PATENT CLASSIFICATION FOR INVENTIONS AND UTILITY MODELS

- SECTION A – HUMAN NECESSITIES
- SECTION B – PERFORMING OPERATIONS; TRANSPORTING
- SECTION C – CHEMISTRY; METALLURGY
- SECTION D – TEXTILES; PAPER
- SECTION E – FIXED CONSTRUCTIONS
- SECTION F – MECHANICAL ENGINEERING; LIGHTING; HEATING; WEAPONS; BLASTING
- SECTION G – PHYSICS
- SECTION H – ELECTRICITY

-
- M – Trade Mark
 - (210) AM 0000 000000 – Serial number of application;
 - (260) AAM 0000 00000 A – Publication number of application;
 - (111) M 0000 00000 R – Number of registration;
 - (111) MMM0000 00000 Rn – Number of renewals, in which n=1,2,3;
 - (111) M 0000 00000 R(P) – Number of registration under partial assignment of rights
-

LIST OF CODES, IN ALPHABETIC SEQUENCE, AND THE CORRESPONDING (SHORT) NAMES OF STATES, OTHER ENTITIES AND INTERGOVERNMENTAL ORGANIZATIONS
(WIPO STANDARD ST.3)

AD	Andorra				
AE	United Arab Emirates				
AF	Afghanistan				
AG	Antigua and Barbuda				
AI	Anguilla				
AL	Albania				
AM	Armenia				
AN	Netherlands Antilles				
AO	Angola				
AP	African Regional Intellectual Property Organization (ARIPO)				
AR	Argentina				
AT	Austria				
AU	Australia				
AW	Aruba				
AZ	Azerbaijan				
BA	Bosnia and Herzegovina				
BB	Barbados				
BD	Bangladesh				
BE	Belgium				
BF	Burkina Faso				
BG	Bulgaria				
BH	Bahrain				
BI	Burundi				
BJ	Benin				
BM	Bermuda				
BN	Brunei Darussalam				
BO	Bolivia				
BR	Brazil				
BS	Bahamas				
BT	Bhutan				
BV	Bouvet Island				
BW	Botswana				
BX	Benelux Office for Intellectual Property (BOIP)				
BY	Belarus				
BZ	Belize				
CA	Canada				
CD	Democratic Republic of the Congo				
CF	Central African Republic				
CG	Congo				
CH	Switzerland				
CI	Cote d'Ivoire				
CK	Cook Islands				
CL	Chile				
CM	Cameroon				
CN	China				
CO	Colombia				
CR	Costa Rica				
CU	Cuba				
CV	Cape Verde				
CY	Cyprus				
CZ	Czech Republic				
DE	Germany				
DJ	Djibouti				
DM	Dominica				
DO	Dominican Republic				
DZ	Algeria				
EA	Eurasian Patent Organization (EAPO)				
EC	Ecuador				
EE	Estonia				
EG	Egypt				
EH	Western Sahara				
EM	Office for Harmonization in the Internal Market (Trademarks and Designs)(OHIM)				
EP	European Patent Office (EPO)				
ER	Eritrea				
ES	Spain				
ET	Ethiopia				
FI	Finland				
FJ	Fiji				
FK	Falkland Islands (Malvinas)				
FO	Faroe Islands				
FR	France				
GA	Gabon				
GB	United Kingdom				
GC	Patent Office of the Cooperation Council				
			for the Arab States of the Gulf (GCC)		
		GD	Grenada		
		GG	Guernsey		
		GH	Ghana		
		GI	Gibraltar		
		GT	Guatemala		
		GW	Guinea- Bissau		
		GY	Guyana		
		HK	The Hong Kong Special Administrative Region of the People's Republic of China		
		HN	Honduras		
		HR	Croatia		
		HT	Haiti		
		HU	Hungary		
		IB	International Bureau of the World Intellectual Property Organization (WIPO)		
		ID	Indonesia		
		IE	Ireland		
		IL	Israel		
		IM	Isle of Man		
		IN	India		
		IQ	Iraq		
		ID	Indonesia		
		IE	Ireland		
		IL	Israel		
		IM	Isle of Man		
		IN	India		
		IQ	Iraq		
		IR	Iran (Islamic Republic of)		
		IS	Iceland		
		IT	Italy		
		JE	Jersey		
		JM	Jamaica		
		JO	Jordan		
		JP	Japan		
		KE	Kenya		
		KG	Kyrgyzstan		
		KH	Cambodia		
		KI	Kiribati		
		KM	Saint Kitts and Nevis		
		KP	Democratic People's Republic of Korea		
		KR	Republic of Korea		
		KW	Kuwait		
		KY	Cayman Islands		
		KZ	Kazakhstan		
		LA	Lao People's Democratic Republic		
		LB	Lebanon		
		LC	Saint Lucia		
		LI	Liechtenstein		
		LK	Sri Lanka		
		LR	Liberia		
		LS	Lesotho		
		LT	Lithuania		
		LU	Luxembourg		
		LV	Latvia		
		LY	Libyan Arab Jamahiriya		
		MA	Morocco		
		MC	Monaco		
		MD	Republic of Moldova		
		ME	Montenegro		
		MG	Madagascar		
		MK	The former Yugoslav Republic of Macedonia		
		ML	Mali		
		MM	Myanmar		
		MN	Mongolia		
		MO	Macao		
		MP	Northern Mariana Islands		
		MR	Mauritania		
		MS	Montserrat		
		MT	Malta		
		MU	Mauritius		
		MV	Maldives		
		MW	Malawi		
		MX	Mexico		
		MY	Malaysia		
		MZ	Mozambique		
		NA	Namibia		
		NE	Niger		
		NG	Nigeria		
		NI	Nicaragua		
		NL	Netherlands		
		NO	Norway		
		NP	Nepal		
		NR	Nauru		
		NZ	New Zealand		
		OA	African Intellectual Property Organization (OAPI)		
		OM	Oman		
		PA	Panama		
		PE	Peru		
		PG	Papua New Guinea		
		PH	Philippines		
		PK	Pakistan		
		PL	Poland		
		PT	Portugal		
		PW	Palau		
		PY	Paraguay		
		QA	Qatar		
		QZ	Community Plant Variety Office (European Community) (CPVO)		
		RO	Romania		
		RS	Serbia		
		RU	Russian Federation		
		RW	Rwanda		
		SA	Saudi Arabia		
		SB	Solomon Islands		
		SC	Seychelles		
		SD	Sudan		
		SG	Singapore		
		SH	Saint Helena		
		SI	Slovenia		
		SK	Slovakia		
		SL	Sierra Leone		
		SM	San Marino		
		SN	Senegal		
		SO	Somalia		
		SR	Suriname		
		ST	Sao Tome and Principe		
		SV	El Salvador		
		SY	Syrian Arab Republic		
		SZ	Swaziland		
		TC	Turks and Caicos Islands		
		TD	Chad		
		TG	Togo		
		TH	Thailand		
		TJ	Tajikistan		
		TL	Timor-Leste		
		TM	Turkmenistan		
		TN	Tunisia		
		TO	Tonga		
		TR	Turkey		
		SE	Sweden		
		TT	Trinidad and Tobago		
		TV	Tuvalu		
		TW	Taiwan, Province of China		
		TZ	United Republic of Tanzania		
		UA	Ukraine		
		UG	Uganda		
		US	United States of America		
		UY	Uruguay		
		UZ	Uzbekistan		
		VA	Holy See		
		VC	Saint Vincent and the Grenadines		
		VE	Venezuela		
		VG	Virgin Islands (British)		
		VN	Viet Nam		
		VU	Vanuatu		
		WO	World Intellectual Property Organization (WIPO)		
		WS	Samoa		
		XN	Nordic Patent Institute (NPI)		
		YE	Yemen		
		ZA	South Africa		
		ZM	Zambia		
		ZW	Zimbabwe		

**NATIONAL INTELLECTUAL PROPERTY CENTER OF GEORGIA
SAKPATENTI**

**OFFICIAL BULLETIN
OF THE INDUSTRIAL PROPERTY**

22(362)

INVENTIONS

UTILITY MODELS

DESIGNS

TRADEMARKS

**APPELLATIONS OF ORIGIN AND GEOGRAPHICAL
INDICATIONS OF GOODS**

DATE OF PUBLICATION

2012 11 26

CONTENTS

PUBLISHED TITLES OF PROTECTION	2
INVENTIONS	
▪ APPLICATIONS APPROVED FOR GRANTING PATENTS	4
▪ PATENTED INVENTIONS	9
UTILITY MODELS	
▪ APPLICATIONS APPROVED FOR GRANTING PATENTS	12
▪ PATENTED UTILITY MODEL	13
DESIGNS	
▪ REGISTERED DESIGNS	14
▪ DESIGN REGISTERED ACCORDING TO THE ACCELERATED PROCEDURE	15
TRADEMARKS	
▪ APPLICATIONS FILED UNDER THE NATIONAL PROCEDURE APPROVED FOR REGISTRATION	17
▪ REGISTERED TRADEMARKS	26
▪ TRADEMARKS REGISTERED ACCORDING TO THE ACCELERATED PROCEDURE	31
▪ INTERNATIONAL TRADEMARKS FOR WHICH A DECISION ON GANTING PROTECTION IS TAKEN	33
▪ INTERNATIONAL TRADEMARKS PROTECTED IN GEORGIA	128
APPELLATIONS OF ORIGIN AND GEOGRAPHICAL INDICATIONS OF GOODS	
▪ REGISTERED APPELLATIONS OF ORIGIN OF GOODS	134
▪ THE RIGHT TO USE OF REGISTERED APPELLATIONS OF ORIGIN OF GOODS	135
OFFICIAL NOTIFICATIONS	
TRADEMARKS	
▪ RENEWAL OF REGISTRATIONS	136
▪ COMPLETE TRANSFER OF RIGHTS	138
▪ CHANGES IN NAMES AND/OR ADDRESSES OF OWNERS	140
▪ INVALIDATION OF TRADEMARKS REGISTRATIONS	143
CLASSIFICATION INDEXES	
INVENTIONS	144
UTILITY MODELS	147
DESIGNS	148
TRADEMARKS	150

PUBLISHED TITLES OF PROTECTION

INVENTIONS

- **APPLICATIONS APPROVED FOR GRANTING PATENTS:**
12244; 12029; 12153; 12114; 11914; 12155; 11872; 11690; 12057; 12273; 11919; 11924
- **PATENTED INVENTIONS:**
5691-5700

UTILITY MODELS

- **APPLICATIONS APPROVED FOR GRANTING PATENTS:**
12638; 12702
- **PATENTED UTILITY MODEL:**
1741; 1748

DESIGNS

- **REGISTERED DESIGNS:**
518; 514-517
- **DESIGN REGISTERED ACCORDING TO THE ACCELERATED PROCEDURE:**
519

TRADEMARKS

- **APPLICATIONS FILED UNDER THE NATIONAL PROCEDURE APPROVED FOR REGISTRATION:**
63576; 64021; 64134; 65287-65292; 65381; 65393; 65412; 65467-65469; 65509; 65569; 65623; 65644; 65741; 65809; 65829-65831; 65834, 65835; 65859; 65861, 65862; 65864; 65874, 65875; 65997; 66022; 66079-66084; 66087; 66125; 66200; 66202-66209; 66211; 66246; 66275, 66276; 66483, 66484; 61120*; 64026*; 64138*
- **REGISTERED TRADEMARKS:**
23025-23061; 23065-23083
- **TRADEMARKS REGISTERED ACCORDING TO THE ACCELERATED PROCEDURE:**
23024; 23061-23064; 23084
- **INTERNATIONAL TRADEMARKS FOR WHICH A DECISION ON GRANTING PROTECTIONS IS TAKEN:**
63472; 64075; 64292; 64310; 64316; 64388; 64434; 64457; 64601; 64604; 64609; 64632; 64669-64675; 64677-64683; 64685; 64699-64703; 64706-64710; 64723, 64724; 64726-64735; 64739-64741; 64743; 64746; 64748-64751; 64766; 64892; 64977, 64978; 64981; 65007; 65009-65010; 65013, 65014; 65023; 65117; 65171; 65192; 65216; 65218-65221; 65228-65230; 65233, 65234; 65250-65253; 65256-65261; 65309; 65315-65317; 65319; 65321-65332; 65334-65336; 65339; 65418; 65420-65432; 65434, 65435; 65437-65443; 65445, 65446; 65448-65453; 65474-65476; 65580; 65585; 65597; 65609-65622; 65624; 65628-65634; 65636, 65637; 65939-65842; 65877-65879; 65889, 65890; 65895-65897; 65996; 66053-66055; 66062; 66064-66066; 66069; 66074; 66141; 66149; 67194; 67372, 67373; 62677*; 62734*
- **INTERNATIONAL TRADEMARKS PROTECTED IN GEORGIA:**
61583; 62017; 62469; 62896; 62907; 63002; 63025; 63073-63085; 63142, 63143; 63145, 63146; 63149-63159; 63313-63318; 63321; 63323-63326; 63332, 63333; 63388-63391; 63394; 63396; 63399, 63400, 63402-63406; 63449; 63456-63458; 63464, 63465; 63572; 63818; 63820; 63824; 63902; 63907; 63910; 63912; 64169; 64407; 64583; 64752-64755; 64786-64792; 615547

APPELLATIONS OF ORIGIN AND GEOGRAPHICAL INDICATIONS OF GOODS

- **REGISTERED APPELLATIONS OF ORIGIN OF GOODS:**
827-829
- **THE RIGHT TO USE OF REGISTERED APPELLATIONS OF ORIGIN OF GOODS:**
3/6-12

INVENTIONS

APPLICATIONS APPROVED FOR GRANTING PATENTS

The decision can be appealed at the Chamber of Appeal of Sakpatenti within 3 months from the publication or at the Administrative Chamber of the Tbilisi City Court (Address: №6, David Aghmashenebeli Kheivani 12 km., Tbilisi) within 1 month following the publication.

PART A

A 61

- (10) AP 2012 12244 A (51) Int. Cl. (2006)
A 61 K 31/44
A 61 K 47/26
A 61 K 47/34
A 01 N 43/40
A 61 K 8/34
A 61 K 8/49
A 61 K 8/60
- (21) AP 2009 012244 (22) 2009 11 13
(31) 08450183.2
(32) 2008 11 14
(33) EP
(71) ARTAN HOLDING AG (LI)
Landstrasse 40, 9495 Triesen (LI)
(72) AYDINOGLU, Ahmet Melih (TR)
(74) Alexander Gegechkori
(85) 2011 06 01
(86) PCT/EP2009/065111, 2009 11 13
(54) **OCTENIDINE COMPOSITION**
(57) There is represented treating combination containing octenidine and polyalcohol of formula
(H-C-OH)_a(HO-C-OH)_b(H-C-H)_c,
wherein a, b and c are integer.
Claims: 4 independent
13 dependent
Fig.: 4

PART C

C 07

- (10) AP 2012 12029 A (51) Int. Cl. (2006)
C 07 D 231/56
C 07 D 403/12
C 07 D 405/14
C 07 D 417/12
C 07 D 471/14
C 07 D 471/04
C 07 D 513/04
A 61 K 31/4155
A 61 P 3/10
- (21) AP 2009 012029 (22) 2009 05 15
(31) 61/054,052; 61/108,370;
PCT/US2009/044190
(32) 2008 05 16; 2008 10 24; 2009 05 15
(33) US; US; WO
(71) TAKEDA CALIFORNIA, INC. (US)
2711 Centerwille Road, Suite 400,
Wilmington, Newcastle, DE (US)
(72) CHERUVALLATH, Zacharia (US);
JENNINGS, Andrew, John (GB);
STAFFORD, Jeffrey, A. (US);
WANG, Haxia (US);
GWALTNEY, Stephen, L. (US);
SABAT, Mark (US);
TANG, Mingnam (US)
(74) Alexander Gegechkori
(85) 2010 12 14
(86) PCT/US2009/044190, 2009 05 15
(54) **GLUCOKINASE ACTIVATORS**
(57) There are represented: compound of formula,

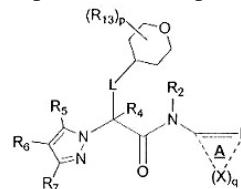

wherein values R₂, R₄, R₅, R₆, R₇, R₁₃, L, X and A are provided in the description, pharmaceutical compositions on a basis thereof, and application therefor glucokinase activation.

Claims: 4 independent
34 dependent

Table: 1
Fig.: 1

(10) AP 2012 12153 A (51) **Int. Cl. (2006)**
C 07 D 401/14
A 61 K 31/444

(21) AP 2009 012153 (22) 2009 08 26

(31) 2008-218851; 2008-269099

(32) 2008 08 27; 2008 10 17

(33) JP; JP

(71) TAKEDA PHARMACEUTICAL
 COMPANY LIMITED (JP)
 1-1, Doshomachi 4-chome, Chuo-ku,
 Osaka-shi, Osaka 541-0045 (JP)

(72) NISHIDA, Haruyuki (JP);
 ARIKAWA, Yasuyoshi (JP);
 FUJIMORI, Ikuo (JP)

(74) Shalva Gvaramadze

(85) 2011 03 25

(86) PCT/JP2009/065279, 2009 08 26

(54) **PYRROLE COMPOUNDS**

(57) There are represented: compound of formula
 (Ia-2),

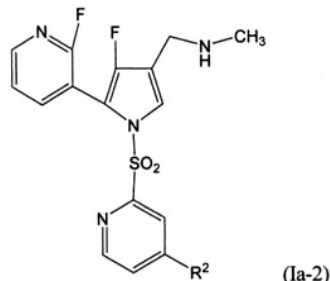

wherein values R² are provided in the description,
 pharmaceutical compositions on a basis thereof,
 and application thereat the treatment of digestive
 system diseases and caused thereby complications.

Claims: 6 independent

4 dependent

Table: 4

Fig.: 3

(10) AP 2012 12114 A (51) **Int. Cl. (2006)**
C 07 D 487/04
A 61 K 31/519
A 61 P 35/00

(21) AP 2009 012114 (22) 2009 08 20

(31) 61/091,037; PCT/EP2009/060793

(32) 2008 08 22

(33) US; WO

(71) NOVARTIS AG (CH)
 Lichtstrasse 35, CH-4056 Basel (CH);
 ASTEX THERAPEUTICS LTD. (GB)
 436 Cambridge Science Park, Milton Road,
 Cambridge CB4 0QA (GB)

(72) BESONG, Gilbert (DE);
 BRAIN, Christopher Thomas (GB);
 BROOKS, Clinton A. (US);
 CONGREVE, Miles Stuart (GB);
 DAGOSTIN, Claudio (IT);

HE, Guo (US);
 HOU, Ying (CN);
 HOWARD, Steven (GB);
 LI, Yue (CN);
 LU, Yipin (CN);
 MORTENSON, Paul (GB);
 SMITH, Troy (US);
 SUNG, Moo (KR);
 WOODHEAD, Steven (GB);
 WRONA, Wojciech (US);
 LAGU, Baharat (US)

(74) Alexander Kartvelishvili

(85) 2011 02 22

(86) PCT/EP2009/060793, 2009 08 20

(54) **PYRROLOPYRIMIDINE COMPOUNDS**
AS CDK INHIBITORS

(57) An invention relates to: pyrrolopyrimidine
 compounds of common formula I,

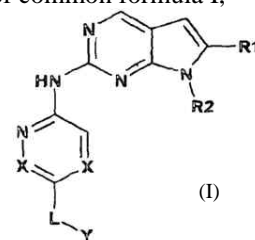

compositions containing thereof, and their
 application at the treatment of disorders related
 with protein kinase and various tumors among
 thereof.

Claims: 12 independent

16 dependent

(10) AP 2012 11914 A (51) **Int. Cl. (2006)**
C 07 D 487/04
A 61 K 31/519
A 61 P 35/00

(21) AP 2009 011914 (22) 2009 01 12

(31) 109/CHE/2008

(32) 2008 01 11

(33) IN

(71) NATCO PHARMA LIMITED (IN)
 "Natco House", Road 2, Banjara Hills
 Hyderabad, 500 033 Andhra Pradesh (IN)

(72) KONAKANCHI, Durga, Prasad (IN);
 PULA, Subba Rao (IN);
 ANANTHANENI, Lakshmi (IN);
 PILLI, Ramakrishna (IN);
 PULLA REDDY, Muddasani (IN);
 ADIBHATLA KALI SATYA,
 Bhujanga Rao (IN);
 VENKAI AH CHOWDARY,
 Nannapaneni (IN)

(74) Tamaz Shilakadze

(85) 2010 08 10

(86) PCT/IN2009/000037, 2009 01 12

(54) **NOVEL PYRAZOLO [3,4-D] PYRIMIDINE**
DERIVATIVES AS ANTI-CANCER
AGENTS

(57) There are represented: compound of formula (I),

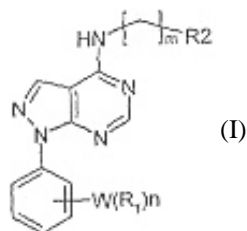

wherein values R_1 , R_2 , and W thereof are provided in the description, obtaining method thereof, pharmaceutical compositions on a basis thereof, and application thereat hyperproliferative disorders treatment in mammal.

Claims: 4 independent

6 dependent

C 09

(10) AP 2012 12155 A (51) Int. Cl. (2006)
C 09 B 61/00

(21) AP 2009 012155 (22) 2009 10 01

(31) 12/245,367

(32) 2008 10 03

(33) US

(71) ECOFLORA S.A. (CO)

Kolómetro 1.7 Via San Antonio-El Carme
Parque Tecnológico de Antioquia Costado
Derecho Carmen de Viboral Antioquia (CO)

(72) ECHEVERRI LOPEZ, Luis, Fernando (CO);
ZAPATA PORRAS, Sandra, Patricia (CO);
TORRES ROLDAN, Luis, Fernando (CO)

(74) Shalva Gvaramadze

(85) 2011 03 28

(86) PCT/IB2009/007024, 2009 10 01

(54) **BLUE COLORANT DERIVED FROM
GENIPA AMERICANA FRUIT**

(57) There is represented blue colorant obtaining method in both, liquid and powder form. The method provides obtaining nontreated juice, received from Genipa americana fruit pulp, mixing therewith glycine and heating obtained blend, or with glycine and starch and, also, obtained blend dehydration.

Claims: 3 independent

9 dependent

PART E

E 02

(10) AP 2012 11872 A (51) Int. Cl. (2006)
E 02 B 15/00

(21) AP 2010 011872 (22) 2010 06 28

(71) Davit Gelenidze (GE)

Rustavis Gzatk. 28, b. 57, 0165, Tbilisi (GE);

Teimuraz Gochitashvili (GE)

Tsuladzis I shes., 4, 0113, Tbilisi (GE);

Giorgi Gelenidze (GE)

Rustavis Gzatk. 40a, b. 32, 0165, Tbilisi (GE);

Tsotne Gelenidze (GE)

Rustavis Gzatk. 40a, b. 32, 0165, Tbilisi (GE);

Medgar Gelenidze (GE)

Rustavis Gzatk. 28, b. 57, 0165, Tbilisi (GE)

(72) Davit Gelenidze (GE);

Teimuraz Gochitashvili (GE);

Giorgi Gelenidze (GE);

Tsotne Gelenidze (GE);

Medgar Gelenidze (GE)

(54) **METHOD OF CHARGING AND
KEEPING WATER**

(57) There is represented water charging and keeping method. The method provides coating reservoir bottom with waterproof material, covering therewith earth or gravel, collecting meteorological sediments in reservoir and covering water surface with steamproof plates lighter then water.

Claims: 1 independent

E 05

(10) AP 2012 11690 A (51) Int. Cl. (2006)
E 05 B 51/00
E 05 B 47/00

(21) AP 2010 011690 (22) 2010 02 16

(71) Tamaz Mushkudiani (GE)

Bakhtrionis q. 29, b. 76, 0194, Tbilisi (GE);

Levan Mushkudiani (GE)

Bakhtrionis q. 29, b. 76, 0194, Tbilisi (GE);

Lasha Mushkudiani (GE)

Bakhtrionis q. 29, b. 76, 0194, Tbilisi (GE)

(72) Tamaz Mushkudiani (GE);

Levan Mushkudiani (GE);

Lasha Mushkudiani (GE)

(54) **COMBINATION LOCK**

(57) There is represented a combination lock comprising: a case 9 with the multipoint switches 10, 11, 12, 13, 14, 15 fixed thereon, springed sluice, the handles, a mechanism 31, 32 moving the sluice, and an energy source 35. The multipoint switches are fixed on the case in a row or several rows mechanically tied to each other, which are also mechanically tied to a row of limbs 28, 29, 30 having equal amount of switches in a row located on withoutside of door. Each row of switches are switched to the sluice mechanism, on one's side

also tied to springed sluice. A plug socket 48 for switching to standby energy source from withoutside of door is fixed on the case.

Claims: 2 independent
4 dependent

Fig.: 2

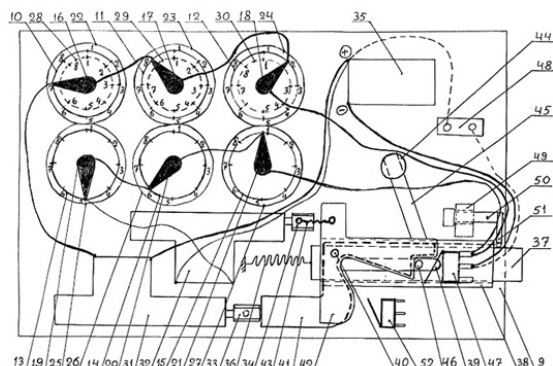

Fig. 1

PART F

F 24

(10) AP 2012 12057 A (51) Int. Cl. (2006)
F 24 J 3/08
F 28 D 21/00
F 25 B 30/06

(21) AP 2009 012057 (22) 2009 06 15
(31) 61/131,967
(32) 2008 06 13
(33) US

(71) PARRELLA, Michael, J. (US)
40 Keliogg Hill Road, Weston,
CT 06883 (US)

(72) PARRELLA, Michael, J. (US)

(74) Shalva Gvaramadze

(85) 2011 01 13

(86) PCT/US2009/003592, 2009 06 15

(54) **SYSTEM AND METHOD OF CAPTURING GEOMETHERMAL ENERGY FROM DRILLED WELL AND ITS GENERATING INTO ELECTRICITY**

(57) There is represented closed-loop solid-state system capturing heat and outputing electricity from drilled well geothermal heat by heat flow without needing water large quantity to conduct heat from the ground. The present invention is contemplated to be used in depleted oil or gas wells, as well as newly drilled wells to generate electricity with harmless method for environment. Geothermal heat is conducted from the Earth to a heat exchanging element to heat the pipe contents. The insulation is laid on the pipes, on the area between well bottom and surface to exclude heat

dissipation at pipe heated contents travel to the surface.

Claims: 4 independent
96 dependent

Fig.: 6

PART G

G 01

(10) AP 2012 12273 A (51) Int. Cl. (2006)
G 01 K 13/00
G 01 K 11/12

(21) AP 2009 012273 (22) 2009 11 13

(31) 08425748.4

(32) 2008 11 25

(33) EP

(71) AZIENDE CHIMICHE RIUNITE
ANGELINI FRANCESCO A.C.R.A.F.
S.p.A. (IT)
Viale Amelia 70, I-00181 Roma (IT)

(72) MASCIAMBRUNI, Roberto (IT)

(74) Liliana Darakhvelidze

(85) 2011 06 24

(86) PCT/EP2009/065113, 2009 11 13

(54) **PACKAGING MATERIAL FOR PHARMACEUTICAL PRODUCT WITH SUCH COLOURED ELEMENT AT PRELIMINARILY SPECIFIED TEMPERATURE DISCOLOURING PARTIALLY REVEALING MARKING, AND METHOD OF SUCH MATERIAL PRODUCTION**

(57) There is represented packaging material comprising a coloured element partially discolouring revealing marking at about 38°C. The element is formed by a first portion forming marking printed with conventional ink, and a second portion printed with thermochromic ink. The thermochromic ink is coloured below about 38°C and becomes colourless when this temperature is reached or exceeded. Said two portions are arranged so, that the first portion is invisible below about 38°C, but becomes visible when this temperature is reached or exceeded.

Claims: 2 independent

13 dependent

Fig.: 5

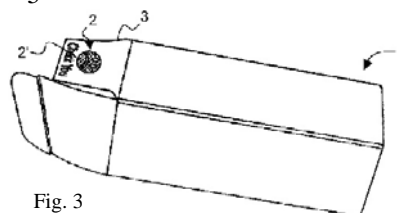

Fig. 3

G 06**(10) AP 2012 11919 A (51) Int. Cl. (2006)
G 06 F 17/30**

- (21) AP 2009 011919 (22) 2009 03 23
 (31) 61/070,344; 12/172,326; 12/353,760;
 12/353,817; 12/408,581
 (32) 2008 03 21; 2008 07 14; 2009 01 14;
 2009 01 14; 2009 03 20
 (33) US; US; US; US; US
 (71) SUNRISE R & D HOLDINGS, LLC (US)
 1014 Vine Street, Cincinnati, OH 45202 (US)
 (72) BONNER, Brett, Bracewell (US);
 OSBORNE, John, Edward, II (US);
 HJELM, Christopher, Todd (US);
 JONES, Titus, Arthur (US);
 PERKINS, Dion, Brent (US)

(74) Alexander Gegechkori

(85) 2010 08 17

(86) PCT/US2009/001804, 2009 03 23

**(54) ACQUIRING ACTUAL REAL-TIME
SHOPPER BEHAVIOR DATA DURING
SHOPPER'S PRODUCT SELECTION**

(57) An invention provides systems of acquiring actual real-time shopper behavior data during product selection by a shopper in a store. More specifically, there are disclosed systems of using communications network, a First Moment of Truth device and a data collections device to track actual real-time shopper behavior data relating to the presumed locations of shoppers in a store, the time spent by a shopper while considering a product for selection and products chosen for purchase, and location of time spent.

Claims: 1 independent

8 dependent

Fig.: 12

PART H**H 01****(10) AP 2012 11924 A (51) Int. Cl. (2006)****H 01 M 8/00****H 01 M 8/08****H 01 M 8/22****H 01 M 4/20****H 01 M 4/29****H 01 M 4/30****C 25 B 1/00****C 25 B 1/28****C 25 B 1/30****C 25 B 1/32****C 25 B 1/46**

(21) AP 2010 011924 (22) 2010 08 20

(71) Giorgi Agladze (GE)

D. Aghmasheneblis Gamz. 86/90, sad. 1,
b. 1, 0102, Tbilisi (GE)

(72) Giorgi Agladze (GE);

Paata Nikoleishvili (GE)

**(54) FUEL ELEMENT SYSTEM WITH
BOROHYDRIDE OXIDATION AND
METHOD OF ALKALI METALS
METABORATE, PEROXIDE AND/OR
PERBORATE COGENERATION**

(57) There is represented: fuel element system with borohydride oxidation for alkali metals metaborate, peroxide and/or perborate cogeneration comprising carbonic cathode, carbonic anode as catalyst containing nickel or platinum group metals, ion-selective diaphragm, cathodic and anodic cells and catholyte and anolyte circulation system; at that, it comprises carbonic gas-diffusion cathode free from catalyst. Anode in hot condition is pressed from one side of ion-selective diaphragm so, that anode surface without diaphragm is directed to anodic cell, which as anolyte contains water solution of alkali metals borohydride 0.1-2 mole/litre and hydroxide 0.3-2 mole/litre mix. Anode surface with diaphragm is directed to cathodic cell, which as catholyte contains water solution of alkali metal hydroxide of 0.3-2 mole/litre concentration; at that, a reactor is executed with cooling and filtering means. There is also represented cogeneration method at said system of electricity, metaborate, peroxide and/or perborate of alkali metals.

Claims: 2 independent

Fig.: 1

PATENTED INVENTIONS

PART A

A 61

(11) P 2012 5693 B (51) Int. Cl. (2006)
 A 61 K 31/70
 A 61 K 39/395
 A 61 K 38/16
 C 07 K 14/00
 C 07 K 16/00
 C 07 H 21/00

(10) AP 2012 11415 A (44) 15(355)/2012
 (21) AP 2008 011415
 (22) 2008 01 09
 (24) 2008 01 09
 (31) 60/879,324
 (32) 2007 01 09
 (33) US
 (73) BIOGEN IDEC MA INC. (US)
 14 Cambridge Center, Cambridge,
 MA 02142 (US)
 (72) MI, Sha (US);
 PEPINSKY, R., Blake (US);
 SHAO, Zhaohui (US);
 GARBER, Ellen, A. (US);
 MIKLASZ, Steven, D. (US)
 (74) Shalva Gvaramadze
 (85) 2009 08 07
 (86) PCT/US2008/000316, 2008 01 09
 (54) **SP35 ANTIBODIES AND USAGE
 THEREOF**

PART B

B 60

(11) P 2012 5694 B (51) Int. Cl. (2006)
 B 60 P 3/40
 B 60 P 3/41

(10) AP 2012 11430 A (44) 15(355)/2012
 (21) AP 2009 011430
 (22) 2009 08 19
 (24) 2009 08 19
 (73) Igor Gelashvili (GE)
 Rustavis Gzatk. 28a, b. 1, 0165, Tbilisi (GE);
 Zaur Balamtsarashvili (GE)
 Saburtalos q. 37, b. 12, 0160,
 Tbilisi (GE);
 Zaur Chitidze (GE)
 Tarkhnishvilis q. 16, b. 19, 0179, Tbilisi (GE);

Alexander Gelashvili (GE)
 Rustavis Gzatk. 28a, b. 1, 0165, Tbilisi (GE);
 Vakhtang Abaishvili (GE)
 Shartavas q. 6, b. 52, 0160, Tbilisi (GE)
 (72) Igor Gelashvili (GE);
 Zaur Balamtsarashvili (GE);
 Zaur Chitidze (GE);
 Alexander Gelashvili (GE);
 Vakhtang Abaishvili (GE)
 (54) **SELF-LOADING SKIDDER**

B 61

(11) P 2012 5695 B (51) Int. Cl. (2006)
 B 61 B 7/00
 B 61 B 7/02

(10) AP 2012 11432 A (44) 15(355)/2012
 (21) AP 2009 011432
 (22) 2009 08 19
 (24) 2009 08 19
 (73) Igor Gelashvili (GE)
 Rustavis Gzatk. 28a, b. 1, 0165, Tbilisi (GE);
 Zaur Balamtsarashvili (GE)
 Saburtalos q. 37, b. 12, 0160, Tbilisi (GE);
 Zaur Chitidze (GE)
 Tarkhnishvilis q. 16, b. 19, 0179, Tbilisi (GE);
 Alexander Gelashvili (GE)
 Rustavis Gzatk. 28a, b. 1, 0165, Tbilisi (GE);
 Vakhtang Abaishvili (GE)
 Shartavas q. 6, b. 52, 0160, Tbilisi (GE)
 (72) Igor Gelashvili (GE);
 Zaur Balamtsarashvili (GE);
 Zaur Chitidze (GE);
 Alexander Gelashvili (GE);
 Vakhtang Abaishvili (GE)
 (54) **TIMBER DOUBLE-SIDED CABLE
 SKIDDER**

PART C**C 07 D 473/16****C 07 D 487/04****C 07 D 487/08****C 01**

- (11) P 2012 5699 B** (51) **Int. Cl. (2006)**
C 01 B 3/04
C 01 B 17/04
- (10) AP 2012 12212 A (44) 15(355)/2012
(21) AP 2011 012212
(22) 2011 04 29
(24) 2011 04 29
(73) Merab Jibladze (GE)
I. Chavchavadzis gamz. 16, b. 23, 0179,
Tbilisi (GE);
Tamaz Batsikadze (GE)
R. Laghidzis q.16, 0108, Tbilisi (GE);
Givi Tsintsadze (GE)
Vazisubani, IV mkr., I kvart., korp. 22,
b. 20, 0152, Tbilisi (GE);
Guram Dgebuadze (GE)
Tsinamdzghvrishvili q. 121, b. 94, 0164,
Tbilisi (GE);
Alexander Mikaberidze (GE)
Tamarashvili q.11, b. 114, 0162, Tbilisi (GE);
Zurab Razmadze (GE)
Barnovis q. 26, 0108, Tbilisi (GE);
Guram Varshalomidze (GE)
Baratashvili q. 20, 6010, Batumi (GE);
Murad Kharaiashvili (GE)
I.Chavchavadzis gamz. 37, korp. 4a, b. 1,
0179, Tbilisi (GE)
- (72) Merab Jibladze (GE);
Tamaz Batsikadze (GE);
Givi Tsintsadze (GE);
Guram Dgebuadze (GE);
Alexander Mikaberidze (GE);
Zurab Razmadze (GE);
Guram Varshalomidze (GE);
Murad Kharaiashvili (GE)
- (54) **PLANT FOR HYDROGEN
SULFIDE DECOMPOSITION**

C 07

- (11) P 2012 5691 B** (51) **Int. Cl. (2006)**
C 07 D 213/74
C 07 D 239/48
C 07 D 239/95
C 07 D 401/12
C 07 D 401/14
C 07 D 403/12
C 07 D 403/14
C 07 D 413/12
C 07 D 417/12
C 07 D 451/02
C 07 D 453/02
C 07 D 471/04

- (10) AP 2012 11295 A (44) 15(355)/2012
(21) AP 2007 011295
(22) 2007 11 20
(24) 2007 11 20
(31) 60/869,299; 60/966,449
(32) 2006 12 08; 2007 08 28
(33) US; US
(73) IRM LLC (US)
131 Front Street, P.O. Box HM 2899,
Hamilton, HM LX (BM) (US)
- (72) MICHELLYS, Pierre-Yves (FR);
PEI, Wei (CN);
MARSILJE, Thomas H. (US);
CHEN, Bei (CN);
UNO, Tetsuo (JP);
Jin, Yunho (KR);
JIANG, Tao (CN)
- (74) Alexander Kartvelishvili
(85) 2009 06 08
(86) PCT/US2007/085304, 2007 11 20
(54) **COMPOUNDS AND COMPOSITIONS AS
PROTEIN KINASE INHIBITORS**

PART E**E 02**

- (11) P 2012 5696 B** (51) **Int. Cl. (2006)**
E 02 F 3/42
- (10) AP 2012 11670 A (44) 15(355)/2012
(21) AP 2010 011670
(22) 2010 01 29
(24) 2010 01 29
(73) Vazha Gogadze (GE)
9 Aprilis Kheivani 15/60, 4400, Poti (GE);
Giorgi Gogadze (GE)
9 Aprilis Kheivani 15/60, 4400, Poti (GE)
- (72) Vazha Gogadze (GE);
Giorgi Gogadze (GE)
- (54) **BUCKET LOADER**

PART F**F 03**

- (11) **P 2012 5700 B** (51) **Int. Cl. (2006)**
F 03 D 5/00
F 03 D 3/00
F 03 D 7/00
F 03 D 7/06
- (10) AP 2012 10947 A (44) 10(350)/2012
(21) AP 2006 010947
(22) 2006 05 10
(24) 2006 05 10
(73) KITE GEN RESEARCH S.R.L. (IT)
Via B. Telesio 2, I-20145 Milano (IT)
(72) MASSIMO, Ippolito (IT)
(74) David Zurabishvili
(85) 2008 10 27
(86) PCT/IT2006/000343, 2006 05 10
(54) **SYSTEM AND PROCESS FOR
AUTOMATICALLY CONTROLLING
FLIGHT OF POWER WING AIRFOILS**

PART G**G 01**

- (11) **P 2012 5692 B** (51) **Int. Cl. (2006)**
G 01 N 3/56
- (10) AP 2012 11344 A (44) 15(355)/2012
(21) AP 2009 011344
(22) 2009 07 01
(24) 2009 07 01
(73) Tinatin Maghlakelidze (GE)
Ninoshvilis q. 185, 4618, Kutaisi (GE);
Archil Geguchadze (GE)
Chekhovis q. 25, 4618, Kutaisi (GE)
(72) Tinatin Maghlakelidze (GE);
Archil Geguchadze (GE)
(54) **DEVICE TESTING SHOE SOLE
ON WEAR RESISTANCE**

G 06

- (11) **P 2012 5697 B** (51) **Int. Cl. (2006)**
G 06 Q 50/00
G 06 Q 20/00
G 01 F 15/06
G 01 D 4/00
- (10) AP 2012 12097 A (44) 13(353)/2012
(21) AP 2008 012097
(22) 2008 08 28
(24) 2008 08 28

- (31) MX/a/2008/009100
(32) 2008 07 14
(33) MX
(73) SISTEMAS INTEGRALES DE MEDICIÓN
CONTROL STELLUM S.A. DE C.V (MX)
Paseo de la Reforma 2608-PH, Colonia Lomas
Altas, CP 11950, Distrito Federal,
Mexico (MX)
(72) NERI-BADILLO, Edurardo Agustín (MX)
(74) Alexander Kvernadze
(85) 2011 02 08
(86) PCT/MX2008/000114, 2008 08 28
(54) **PREPAYMENT SYSTEM FOR WATER
OR GAS SUPPLEMENT BY MEANS OF
WIRELESS INTELLIGENT CARD AND
METER FOR SAID SYSTEM**

PART H**H 01**

- (11) **P 2012 5698 B** (51) **Int. Cl. (2006)**
H 01 S 3/06
H 01 S 3/14
- (10) AP 2012 12099 A (44) 15(355)/2012
(21) AP 2011 012099
(22) 2011 02 09
(24) 2011 02 09
(73) Merab Jibladze (GE)
I. Chavchavadzis gamz. 16, b. 23, 0128,
Tbilisi (GE)
(72) Merab Jibladze (GE)
(54) **NANOLASER**

UTILITY MODELS

APPLICATION APPROVED FOR GRANTING PATENT

The decision can be appealed at the Chamber of Appeal of Sakpatenti within 3 months from the publication or at the Administrative Chamber of the Tbilisi City Court (Address: №6, David Aghmashenebeli Kheivani 12 km., Tbilisi) within 1 month following the publication.

PART B

B 60

- (10) AU 2012 12638 U (51) Int. Cl. (2006)
B 60 L 15/00
(21) AU 2012 012638 (22) 2012 03 21
(71) TBILISI BRANCH OF ELECTROMOVING
COMPOSITION REPAIR FACTORY (GE)
Tskalsadenis q. 55, 0153, Tbilisi (GE)
(72) Boris Gogitauri (GE);
Gocha Janashia (GE);
Jambul Jgerenaia (GE);
Lasha Torchinava (GE);
Alexandre Bibilashvili (GE);
Zurab Vachiberidze (GE);
Shalva Vardzelashvili (GE);
Avtandil Vachadze (GE);
Bacho Alchibaia (GE)
(54) **TRANSIT VEHICLE DRIVE MOTOR
CONTROL SYSTEM**

(57) A control system consists of: coded activator and power circuit comprising drive motors of first group and sequentially switched thereto first current sensor, drive motors of second group and sequentially switched thereto a second current sensor switched to drive motor anchor chain, field-tensity meters, reverser points sequentially switched to the current sensors, field coils and electric motor field regulator switched parallel to the reverser points. Coded activator is executed with software of current passing flowing in the motors, basically throughout voltage regulator and starting-breaking resistors and with program control ability of closing voltage regulator.

Claims: 1 independent

Fig.: 1

PART F

F 24

- (10) AU 2012 12702 U (51) Int. Cl. (2006)
F 24 J 2/44
(21) AU 2012 012702 (22) 2012 05 07
(71) Nugzar Meladze (GE)
Bakhtrionis q. korp. 2, b. 41, 0194,
Tbilisi (GE)
(72) Nugzar Meladze (GE)
(54) **SOLAR STATION SUPPLYING WITH
HOT WATER**

(57) Solar station comprises: solar collector 1, water tank 9 having heat insulation 8, the conduits 6 and 10 of cold and hot water connected thereto, circulating pump 5, a thermoregulator executed as signal multiplication relay 12 and solar energy receiver sensor 13. At that, solar energy receiver sensor is switched to signal multiplication relay connected to circulating pump, and solar collector is building 2 metallic roof 3 wholly or partially covered with glass plates 4. Water tank having heat insulation is connected to: solar collector by means of circulating pump and cold water conduit from one side, and hot water conduit from another side; at that, hot water is supplied by gravity from the collector, and water tank is allocated lower of solar collector level.

Claims: 1 independent

Fig.: 2

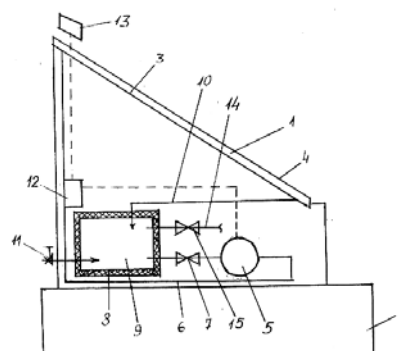

Fig. 1

PATENTED UTILITY MODELS**PART A****A 23**

- (11) U 2012 1741 Y (51) Int. Cl. (2006)**
A 23 C 19/00
- (10) AU 2012 12481 U (44) 15(355)/2012
(21) AU 2011 012481
(22) 2011 12 01
(24) 2011 12 01
(73) Raja Anikushina (GE)
Mukhianis Dasakh. II mkr., korp. 1, b. 75,
0172, Tbilisi (GE);
Margarita Berulava (GE)
Mukhianis Dasakh. II mkr., korp. 1, b. 75,
0172, Tbilisi (GE)
(72) Raja Anikushina (GE);
Margarita Berulava (GE)
(54) **METHOD OF CHEESE PRODUCTION**
-

- (11) U 2012 1748 Y (51) Int. Cl. (2006)**
A 23 C 19/00
- (10) AU 2012 12482 U (44) 15(355)/2012
(21) AU 2011 012482
(22) 2011 12 01
(24) 2011 12 01
(73) Raja Anikushina (GE)
Mukhianis Dasakh. II mkr., korp. 1, b. 75,
0172, Tbilisi (GE);
Margarita Berulava (GE)
Mukhianis Dasakh. II mkr., korp. 1, b. 75,
0172, Tbilisi (GE)
(72) Raja Anikushina (GE);
Margarita Berulava (GE)
(54) **METHOD OF SMOKED CHEESE**
PRODUCTION
-

DESIGNS

REGISTERED DESIGNS

(11) AD 2012 518 S **(51) 09-05**
(10) AD 2012 692 S (44) 15(355)/2012
(21) AD 2012 000692
(22) 2012 03 15
(24) 2012 03 15
(28) 1
(18) 2017 03 15
(73) Ia Bakhtadze (GE)
 Shartava str. 18, b. 15, 0160, Tbilisi (GE)
(72) Ia Bakhtadze (GE)
(54) **FOODSTUFF PAKAGING**

(11) AD 2012 517 S **(51) 19-06**
(10) AD 2012 686 S (44) 13(353)/2012
(21) AD 2012 000686
(22) 2012 02 23
(24) 2012 02 23
(28) 7
(18) 2017 02 23
(73) ERICH KRAUSE FINLAND OY (FI)
 Henry Fordin katu 5 N, 00150 Helsinki (FI)
(72) Dmitry Beloglazov (RU)
(74) Alexander Gegechkori
(54) **WRITING ACCESSORY**

(11) AD 2012 514 S **(51) 19-06**
(10) AD 2012 683 S (44) 13(353)/2012
(21) AD 2012 000683
(22) 2012 02 23
(24) 2012 02 23
(28) 2
(18) 2017 02 23
(73) ERICH KRAUSE FINLAND OY (FI)
 Henry Fordin katu 5 N, 00150 Helsinki (FI)
(72) Dmitry Beloglazov (RU)
(74) Alexander Gegechkori
(54) **WRITING ACCESSORY**

(11) AD 2012 515 S **(51) 19-06**
(10) AD 2012 684 S (44) 13(353)/2012
(21) AD 2012 000684
(22) 2012 02 23
(24) 2012 02 23
(28) 5
(18) 2017 02 23
(73) ERICH KRAUSE FINLAND OY (FI)
 Henry Fordin katu 5 N, 00150 Helsinki (FI)
(72) Dmitry Beloglazov (RU)
(74) Alexander Gegechkori
(54) **WRITING ACCESSORY**

(11) AD 2012 516 S **(51) 19-06**
(10) AD 2012 685 S (44) 13(353)/2012
(21) AD 2012 000685
(22) 2012 02 23
(24) 2012 02 23
(28) 2
(18) 2017 02 23
(73) ERICH KRAUSE FINLAND OY (FI)
 Henry Fordin katu 5 N, 00150 Helsinki (FI)
(72) Dmitry Beloglazov (RU)
(74) Alexander Gegechkori
(54) **WRITING ACCESSORY**

DESIGN REGISTERED ACCORDING TO THE ACCELERATED PROCEDURE

The decision can be appealed at the Chamber of Appeal of Sakpatenti within 3 months from the publication.

- (11) **D 2012 519 S** (51) 09-03
 (21) AD 2012 000725 (22) 2012 10 22
 (24) 2012 10 22
 (28) 4
 (18) 2017 10 22
 (73) HARRINGTON DEVELOPMENT INC. (PA)
 Arango-Orillac Bldg, East 54th Street (PA)
 (72) Giorgi Kurdadze (GE)
 (54) **CIGARETTE BOX**
 (55)



1.1



1.2



1.3



2.1



2.2



2.3



3.1



3.2



3.3



4.1



4.2



4.3

TRADEMARKS

APPLICATIONS FILED UNDER THE NATIONAL PROCEDURE APPROVED FOR REGISTRATION

The decision can be appealed at the Chamber of Appeal of Sakpatenti within 3 months from the publication or at the Administrative Chamber of the Tbilisi City Court (Address: №6, David Aghmashenebeli Kheivani 12 km., Tbilisi) within 1 month following the publication.

(260) AM 2012 63576 A

(210) AM 063576

(220) 2011 08 05

(731) VALERIAN KHUBULAVA

Corneliusgase 2-8, Vienna, 1060, 1060,
Austria

(540)



(591) Black, white

(531) 27.05.01-28.19.00-

(511) 30, 32, 33

(260) AM 2012 64021 A

(210) AM 064021

(220) 2011 09 12

(731) H.J. HEINZ COMPANY

One PPG PPlace, Suite 3100, Pittsburgh,
PA 15222, USA

(740) Tamar Kochlamazashvili

(540)

ЛЮБОПЫШКИ

(591) Black, white

(511) 5, 30

(260) AM 2012 64134 A

(210) AM 064134

(220) 2011 09 16

(731) LTD "KAKHURI TRADITSIULI

MEGVINEOBA"

Ksnis q. 12, 0141, 0141, Tbilisi, Georgia

(540)

Wine Cellar "Velistsikhe Veranda"

ღვინის მარანი

"ველისციხის ვერანდა"

(591) Black, white

(526) **DISCLAIMER** – The trademark is protected as a whole, word combinations "Velistsikhe" „ველისციხის“ "Vine Cellar" და ღვინის მარანი“, shall not be subject to independent protection.

(511) 43

(260) AM 2012 65287 A

(210) AM 065287

(220) 2011 12 12

(731) HOME BOX OFFICE, INC.

1100 Avenue of the Americas, New York,
New York 10036, USA

(740) Tamar Kochlamazashvili

(540)

HELLO LOVER

(591) Black, white

(511) 3

(260) AM 2012 65288 A

(210) AM 065288

(220) 2011 12 12

(731) JOINT STOCK COMPANY "LOMISI"

Sopeli Natakhtari, 3308, Mtskhets raioni,
Georgia

(540)

ნატახტარი ორიგინალი

(591) Black, white

(526) **DISCLAIMER** – „ორიგინალი“, shall not be subject to independent protection.

(511) 32

(260) AM 2012 65289 A

(210) AM 065289

(220) 2011 12 12

(731) JOINT STOCK COMPANY "LOMISI"

Sopeli Natakhtari, 3308, Mtskhets raioni,
Georgia

(540)

ნატახტარი ნამდვილი

(591) Black, white

(511) 32

(260) AM 2012 65290 A

(210) AM 065290

(220) 2011 12 12

(731) JOINT STOCK COMPANY "LOMISI"

Sopeli Natakhtari, 3308, Mtskhets raioni,
Georgia

(540)

ნატახტარი გენიალური

(591) Black, white

(526) **DISCLAIMER** – „გენიალური“, shall not be subject to independent protection.

(511) 32

(260) AM 2012 65291 A

(210) AM 065291

(220) 2011 12 12

(731) GENERAL MOTORS LLC

300 Renaissance Center, City of Detroit,
State of Michigan 48265-3000,
USA

(740) George Taktakishvili

(540)

XTS

(591) Black, white

(511) 12

(260) AM 2012 65292 A

(210) AM 065292

(220) 2011 12 12

(731) JOHNSON CONTROLS TECHNOLOGY
COMPANY

915 East 32nd Street, City of Holland,
State of Michigan 49423, USA

(740) George Taktakishvili

(540)

POWERFRAME

(591) Black, white

(511) 9

(260) AM 2012 65381 A

(210) AM 065381

(220) 2012 06 01

(731) LTD "ELIF TEQSTILI"

Lilos bazroba, savachro tsentri "GS",
magazia N1, 0151, Tbilisi, Georgia

(540)



(591)) Black, white, orange

(531) 26.01.20-26.04.10-27.05.24-29.01.13-

(511) 25, 35

(260) AM 2012 65393 A

(210) AM 065393

(220) 2012 03 09

(731) ZVIADI BOCHORISHVILI

Sofeli Digomi, 0126, Tbilisi, Georgia

(740) David Gelashvili

(540)

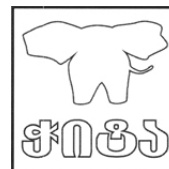

(591) Black, white

(531) 03.02.01-28.19.00-

(511) 16, 28, 35

(260) AM 2012 65412 A

(210) AM 065412

(220) 2011 12 16

(731) SIN HOLDING LIMITED.

OMC CHAMBERS, WICKHAMS CAY 1,
ROAD TOWN, Tortola, British Virgin
Islands

(740) Khatuna Imnadze

(540)



(591) Black, white

(531) 26.01.04-26.01.20-26.02.01-

(511) 1, 4

(260) AM 2012 65467 A

(210) AM 065467

(220) 2011 12 20

(731) LTD "ISTANBUL-TEQSTILI GEORGIA"

Davit Agmasheneblis kheivani, me-7
kilometri, 0131, Tbilisi, Georgia

(540)



(591) Yellow, red

(531) 01.03.07-25.05.02-26.11.13-27.05.11-
29.01.12-

(526) **DISCLAIMER** – "HOMETEXTILE", shall not be subject to independent protection.

(511) 20, 24

(260) AM 2012 65468 A
 (210) AM 065468
 (220) 2011 12 20
 (731) LTD "ISTANBUL-TEQSTILI GEORGIA"
 Davit Agmasheneblis kheivani, me-7
 kilometri, 0131, Tbilisi, Georgia
 (540)



(591) Yellow, red
 (531) 25.05.02-26.11.13-27.05.10-29.01.12-
 (526) **DISCLAIMER** – "products of quality HO-
 METEXTILE", shall not be subject to independent
 protection.
 (511) 20

(260) AM 2012 65469 A
 (210) AM 065469
 (220) 2011 12 20
 (731) LTD "BARAMBO"
 Sop. Natakhvari, 3308, Mtskheta, Georgia
 (540)

აგობა
Алба
Alba

(591) Black, white
 (511) 30

(260) AM 2012 65509 A
 (210) AM 065509
 (220) 2011 12 22
 (731) DKH Retail Limited
 Unit 60 The Runnings, Cheltenham,
 Gloucestershire GL51 9NW, United Kingdom
 (740) Liliana Darakhvelidze
 (540)

SUPERDRY

(591) Black, white
 (511) 3, 9, 14, 18, 25, 35

(260) AM 2012 65569 A
 (210) AM 065569
 (220) 2011 12 26
 (731) CASTROL LIMITED
 Wakefield House Pipers Way, Swindon,
 Wiltshire, SN3 1RE, United Kingdom
 (740) Shalva Gvaramadze

(540)



(591) White, red, gree
 (531) 26.01.12-26.15.01-29.01.13-
 (511) 4

(260) AM 2012 65623 A
 (210) AM 065623
 (220) 2011 12 28
 (731) LTD "LIKA-JORJIA"
 Gagarinis II shes., N4, 0160, Tbilisi, Georgia
 (740) George Taktakishvili
 (540)

BABYLAND

(591) Black, white
 (531) 27.05.17-
 (511) 35

(260) AM 2012 65644 A
 (210) AM 065644
 (220) 2011 12 29
 (731) SAAQTSIO SAZOGADOEBA "LOMISI"
 Sopeli Natakhvari, 3308, Mtskhets raioni,
 Georgia
 (740) Elguja Amozashvili
 (540)



(591) Black, white
 (531) 19.07.16-19.07.22-
 (511) 32

(260) AM 2012 65741 A
 (210) AM 065741
 (220) 2012 01 06
 (731) EVON PRODUCTS, INC.
 World Headquarters, 1345 Avenue of

the Americas, New York, NY 10105-0196,
USA
(740) Natela Otaridze
(540)

BE YOUR BEST WITH THE BEST

(591) Black, white
(511) 35, 41

(260) AM 2012 65809 A
(210) AM 065809
(220) 2012 01 10
(731) HOME BOX OFFICE, INC.
1100 Avenue of the Americas, New York,
New York 10036, USA
(740) Tamar Kochlamazashvili
(540)

SEX AND THE CITY

(591) Black, white
(511) 3

(260) AM 2012 65829 A
(210) AM 065829
(220) 2012 01 11
(731) SAAQTSIO SAZOGADOEBA "LOMISI"
Sopeli Natakhtari, 3308, Mtskhetyis raioni,
Georgia
(740) Elguja Amozashvili
(540)

Natakhtari Genuine

(591) Black, white
(526) **DISCLAIMER** – "Genuine", shall not be
subject to independent protection.
(511) 32

(260) AM 2012 65830 A
(210) AM 065830
(220) 2012 01 11
(731) SAAQTSIO SAZOGADOEBA "LOMISI"
Sofeli Natakhtari, 3308, Mtskhetyis raioni,
Georgia
(740) Elguja Amozashvili
(540)

Natakhtari Real

(591) Black, white
(526) **DISCLAIMER** – "Real", shall not be subject
to independent protection.
(511) 32

(260) AM 2012 65831 A
(210) AM 065831
(220) 2012 01 11

(731) SAAQTSIO SAZOGADOEBA "LOMISI"
Sopeli Natakhtari, 3308, Mtskhetyis raioni,
Georgia
(740) Elguja Amozashvili
(540)

Natakhtari Original

(591) Black, white
(526) **DISCLAIMER** – "Original", shall not be
subject to independent protection.
(511) 32

(260) AM 2012 65834 A
(210) AM 065834
(220) 2012 01 11
(731) SOFIO TOROSHELIDZE
Kobulets q.3/15, bina 45, 0179, Georgia;
BESIKI TSIKHELASHVILI
Mukhiani I m/r, korp. 9, bina 46, 0172,
Tbilisi, Georgia;
IRAKLI BIBILASHVILI
Jiqias q.6, 0186, Tbilisi, Georgia;
MIKHEILI CHELIDZE
Temqa 10a kvartali, korpusi 42, bina 42,
0178, Tbilisi, Georgia
(540)

ELDRINE

(591) Black, white
(511) 41

(260) AM 2012 65835 A
(210) AM 065835
(220) 2012 01 11
(731) MAGTIKOMI
A. Politkovskaias q. 5, 0186, Tbilisi, Georgia
(540)



(591) Red, sky
(531) 26.04.09-26.11.12-27.05.05-28.19.00-
29.01.12-
(511) 38

(260) AM 2012 65859 A
(210) AM 065859
(220) 2012 01 12
(731) BRIDGESTONE CORPORATION
10-1, Kyobashi 1-Chome, Chuo-ku, Tokyo,
Japan
(740) Shalva Gvaramadze
(540)

BLIZZAK SPIKE

(591) Black, white
(511) 12

(260) AM 2012 65861 A
(210) AM 065861
(220) 2012 01 12
(731) Unilever N.V.
Weena 455, 3013 AL Rotterdam, Netherlands
(740) Shalva Gvaramadze
(540)



(591) White, red, light brown
(531) 26.01.02-26.01.20-29.01.13-
(511) 29, 30, 31

(260) AM 2012 65862 A
(210) AM 065862
(220) 2012 01 12
(731) Knorr Naehrmitel Sktiengesellschaft
Bahnhofstrasse 19, 8240 THAYNGEN,
Switzerland
(740) Shalva Gvaramadze
(540)

KNORR

(591) Black, white
(511) 5, 29, 30, 31, 32

(260) AM 2012 65864 A
(210) AM 065864
(220) 2012 01 13
(731) LTD "EVRO BIZNES JGUFU"
Marjanishvilis 3, bina 55, 0102, Tbilisi,
Georgia
(540)

ევრო მედი EURO MEDI ЕВРО МЕДИ

(591) ლურჯი
(511) 44

(260) AM 2012 65874 A
(210) AM 065874
(220) 2012 01 16
(731) Unilever N.V.
Weena 455, 3013 AL Rotterdam, Netherlands
(740) Shalva Gvaramadze
(540)

LUX

(591) Black, white
(511) 3

(260) AM 2012 65875 A
(210) AM 065875
(220) 2012 01 16
(731) Unilever N.V.
Weena 455, 3013 AL Rotterdam, Netherlands
(740) Shalva Gvaramadze
(540)

DOMESTOS

(591) Black, white
(511) 3, 5, 21

(260) AM 2012 65997 A
(210) AM 065997
(220) 2012 01 27
(731) RANBAXY LABORATORIES LIMITED
Plot N90, Sector-32, Gurgaon-122001,
Haryana, India
(740) Tamar Kochlamazashvili
(540)

ПЕМОЗАР

(591) Black, white
(511) 5

(260) AM 2012 66022 A
(210) AM 066022
(220) 2012 01 31
(731) LTD "SANTREIDI"
Varketili-3, III a m/r, korpusi 340, bina 8,
0163, Tbilisi, Georgia
(540)

МОЯ СЕМЬЯ

(591) Black, white
(511) 3

(260) AM 2012 66079 A
(210) AM 066079
(220) 2012 02 06
(731) LTD "SILQNETI"
Tsinamdzgvrishvilis q.95, 0112, Tbilisi,
Georgia
(540)



(591) Blue, white
(531) 26.04.22-27.05.19-27.05.24-29.01.04-
(511) 38

(260) AM 2012 66080 A
 (210) AM 066080
 (220) 2012 02 06
 (731) LTD "SILQNETI"
 Tsinamdzgvrishvilis q.95, 0112, Tbilisi,
 Georgia



(591) Blue, white
 (531) 26.04.22-27.05.19-27.05.24-29.01.04-
 (511) 38

(260) AM 2012 66081 A
 (210) AM 066081
 (220) 2012 02 06
 (731) LTD "SILQNETI"
 Tsinamdzgvrishvilis q.95, 0112, Tbilisi,
 Georgia



(591) Blue, white, black
 (531) 26.02.01-26.04.24-27.05.21-27.07.11-
 29.01.13-
 (511) 38

(260) AM 2012 66082 A
 (210) AM 066082
 (220) 2012 02 06
 (731) LTD "SILQNETI"
 Tsinamdzgvrishvilis q.95, 0112, Tbilisi,
 Georgia



(591) Blue, black, grey
 (531) 26.02.01-26.13.25-27.05.11-28.19.00-
 29.01.13-
 (511) 38

(260) AM 2012 66083 A
 (210) AM 066083
 (220) 2012 02 06
 (731) LTD "SILQNETI"
 Tsinamdzgvrishvilis q.95, 0112, Tbilisi,
 Georgia

(540)

Silk
სილქ
Силк

(591) Black, white
 (511) 38

(260) AM 2012 66084 A
 (210) AM 066084
 (220) 2012 02 06
 (731) LTD "SILQNETI"
 Tsinamdzgvrishvilis q.95, 0112, Tbilisi,
 Georgia



(591) Blue, white
 (531) 26.04.22-27.05.19-27.05.24-29.01.04-
 (511) 38

(260) AM 2012 66087 A
 (210) AM 066087
 (220) 2012 02 06
 (731) LTD "MARIGOLDI"
 Davit Agmasheneblis 71, 0102, Tbilisi,
 Georgia



(591) Golden, black
 (531) 26.01.06-27.05.10-29.01.12-
 (511) 25

(260) AM 2012 66125 A
 (210) AM 066125
 (220) 2012 02 08
 (731) LTD SAMEDITSINO TSENTRI "TSITO"
 Faliashvilis 40, 0179, Tbilisi, Georgia
 (740) Maia Tsotsoria
 (540)



(591) Blue, red
 (531) 14.07.12-16.03.15-27.03.15-29.01.12-
 (511) 44

(260) AM 2012 66200 A
 (210) AM 066200
 (220) 2012 02 14
 (731) NISSAN JIDOSHA KABUSHIKI KAISHA
 (also trading as Nissan Motor Co., Ltd.),
 N2 Takaracho, Kanagawa-ku, Yokoha-
 ma-shi, Kanagawa-ken, Japan
 (740) Shalva Gvaramadze
 (540)

I N F I N I T I

(591) Black, white
 (531) 27.05.15-
 (511) 1, 2, 3, 4, 5

(260) AM 2012 66202 A
 (210) AM 066202
 (220) 2012 02 14
 (731) NISSAN JIDOSHA KABUSHIKI KAISHA
 (also trading as Nissan Motor Co., Ltd.),
 N2 Takaracho, Kanagawa-ku, Yokoha-
 ma-shi, Kanagawa-ken, Japan
 (740) Shalva Gvaramadze
 (540)

I N F I N I T I

(591) Black, white
 (531) 27.05.15-
 (511) 7

(260) AM 2012 66203 A
 (210) AM 066203
 (220) 2012 02 14
 (731) NISSAN JIDOSHA KABUSHIKI KAISHA
 (also trading as Nissan Motor Co., Ltd.),
 N2 Takaracho, Kanagawa-ku, Yokoha-
 ma-shi, Kanagawa-ken, Japan
 (740) Shalva Gvaramadze
 (540)

I N F I N I T I

(591) Black, white
 (531) 27.05.15-
 (511) 35, 37, 38, 39, 41, 42, 45

(260) AM 2012 66204 A
 (210) AM 066204
 (220) 2012 02 14
 (731) NISSAN JIDOSHA KABUSHIKI KAISHA
 (also trading as Nissan Motor Co., Ltd.),
 N2 Takaracho, Kanagawa-ku, Yokoha-
 ma-shi, Kanagawa-ken, Japan
 (740) Shalva Gvaramadze
 (540)

I N F I N I T I

(591) Black, white
 (511) 36

(260) AM 2012 66205 A
 (210) AM 066205
 (220) 2012 02 14
 (731) NISSAN JIDOSHA KABUSHIKI KAISHA
 (also trading as Nissan Motor Co., Ltd.),
 N2 Takaracho, Kanagawa-ku, Yokoha-
 ma-shi, Kanagawa-ken, Japan
 (740) Shalva Gvaramadze
 (540)



(591) Black, white
 (531) 24.11.25-26.01.02-26.01.10-26.03.23-
 (511) 1, 2, 3, 4, 5

(260) AM 2012 66206 A
 (210) AM 066206
 (220) 2012 02 14
 (731) NISSAN JIDOSHA KABUSHIKI KAISHA
 (also trading as Nissan Motor Co., Ltd.),
 N2 Takaracho, Kanagawa-ku, Yokoha-
 ma-shi, Kanagawa-ken, Japan

(740) Shalva Gvaramadze
 (540)



(591) Black, white
 (531) 24.11.25-26.01.02-26.01.10-26.03.23-
 (511) 6, 8, 14, 16, 18, 20, 21, 24, 25, 26, 27, 28,
 30, 33, 34

(260) AM 2012 66207 A
 (210) AM 066207
 (220) 2012 02 14
 (731) NISSAN JIDOSHA KABUSHIKI KAISHA
 (also trading as Nissan Motor Co., Ltd.),
 N2 Takaracho, Kanagawa-ku, Yokoha-
 ma-shi, Kanagawa-ken, Japan
 (740) Shalva Gvaramadze
 (540)



(591) Black, white
 (531) 24.11.25-26.01.02-26.01.10-26.03.23-
 (511) 7

(260) AM 2012 66208 A
 (210) AM 066208
 (220) 2012 02 14
 (731) NISSAN JIDOSHA KABUSHIKI KAISHA
 (also trading as Nissan Motor Co., Ltd.),
 N2 Takaracho, Kanagawa-ku, Yokoha-
 ma-shi, Kanagawa-ken, Japan
 (740) Shalva Gvaramadze
 (540)



(591) Black, white
 (531) 24.11.25-26.01.02-26.01.10-26.03.23-
 (511) 35, 37, 38, 39, 41, 42, 45

(260) AM 2012 66209 A
 (210) AM 066209
 (220) 2012 02 14
 (731) NISSAN JIDOSHA KABUSHIKI KAISHA
 (also trading as Nissan Motor Co., Ltd.),
 N2 Takaracho, Kanagawa-ku, Yokoha-
 ma-shi, Kanagawa-ken, Japan
 (740) Shalva Gvaramadze
 (540)



(591) Black, white
 (531) 24.11.25-26.01.02-26.01.10-26.03.23-
 (511) 36

(260) AM 2012 66211 A
 (210) AM 066211
 (220) 2012 02 15
 (731) NIKOLOZ MAKHVILADZE
 I. Khvichias q. 7a, 0160, Tbilisi, Georgia
 (540)

შპს ქ. მხიარულთა და საზრიანთა კლუბი
 მანსანკანი



(591) Gree, blue, sky
 (531) 02.09.08-26.13.25-29.01.12-
 (511) 41

(260) AM 2012 66246 A
 (210) AM 066246
 (220) 2012 02 17
 (731) KT & G Corporation
 100, Pyeongchon-dong Daedeok-gu,
 Taejeon 306-712, Republic of Korea
 (740) Pavle Meipariani
 (540)

SENSE

(591) Black, white
 (511) 34

(260) AM 2012 66275 A
 (210) AM 066275
 (220) 2012 02 20
 (731) Unilever N.V.
 Weena 455, 3013 AL Rotterdam, Netherlands
 (740) Shalva Gvaramadze
 (540)

CRYSTAL SHINE

(591) Black, white
 (511) 3

(260) AM 2012 66276 A
 (210) AM 066276
 (220) 2012 02 20
 (731) Unilever N.V.
 Weena 455, 3013 AL Rotterdam, Netherlands
 (740) Shalva Gvaramadze
 (540)

NUTRI SHINE

(591) Black, white
 (511) 3

(260) AM 2012 66483 A
 (210) AM 066483
 (220) 2012 03 12
 (731) EFKO FOODS PLC
 Boumpoulinas, 11, 1st Floor, 1060 Nicosia,
 Cyprus
 (740) Tamaz Shilakadze
 (540)

ALTERO

(591) Black, white
 (511) 29

(260) AM 2012 66484 A
 (210) AM 066484
 (220) 2012 03 12
 (731) LTD "KOORDINIRUIUSHCHI
 RASPREDELITELNI TSENTR
 "EFKO-KASKAD"

Ul. Frunze, d.4, g. Aleqseevka, 309850,
Belgorodskaya oblasti, Russian Federation
(740) Tamaz Shilakadze
(540)

Живая Еда

(591) Black, white
(511) 30

subparagraph (i) of paragraph 1 of Article 4 of the
Trademark Law of Georgia, the word "Georgia" are
included in a trademark as an unpro-ected part.
(511) 41

(260) AM 2012 61120 A*
(210) AM 061120
(220) 2011 02 02
(731) Joint Stock Company "GAMOFENEBIS
TSENTRI"
Akaki Tseretlis gamz. 118, 0119, Tbilisi,
Georgia
(740) Ekaterine Kereselidze
(540)



(591) Light khaki, white, black
(531) 26.01.06-27.05.05-27.05.24-29.01.13-
(511) 41

(260) AM 2012 64026 A*
(210) AM 064026
(220) 2011 09 13
(731) RECKITT & COLMAN (OVERSEAS)
LIMITED
Dansom Lane, Hull, HU8 7DS, United
Kingdom
(740) Liliana Darakhvelidze

(540)

УЛЬТИМА

(591) Black, white
(511) 5

(260) AM 2012 64138 A*
(210) AM 064138
(220) 2011 09 19
(731) CHABUKI AMIRANASHVILI
Nutsbidzis plato, me-3 mkr., I kv., 13/45,
bina 7, Tbilisi, Georgia
(740) Khatuna Imnadze
(540)

GEORGIAN LEGEND

(591) Black, white
(526) **DISCLAIMER** – according to the consent of
the Ministry of Culture, on the basis of

REGISTERED TRADEMARKS

(111) M 2012 023025 R
 (151) 2012 11 02
 (181) 2022 11 02
 (260) AM 2012 62963 A
 (220) 2011 06 23
 (732) LTD "ARMUNJI"
 Zurab Chavchavadzis 56, 4800, Kvareli,
 Georgia

(111) M 2012 023030 R
 (151) 2012 11 02
 (181) 2022 11 02
 (260) AM 2012 62346 A
 (220) 2011 05 06
 (732) Joint Stock Company "LISI LEIQ
 DEVELOPMENT"
 Vakis raioni, Lisis Tbis mimdebared (nakveti
 N1/5), 0177, Tbilisi, Georgia

(111) M 2012 023026 R
 (151) 2012 11 02
 (181) 2022 11 02
 (260) AM 2112 57803 A
 (220) 2011 03 17
 (732) LTD "PRIMA-VITA"
 Tamar Mepis gamz. 7/13, 0112, Tbilisi,
 Georgia

(111) M 2012 023031 R
 (151) 2012 11 02
 (181) 2022 11 02
 (260) AM 2012 62348 A
 (220) 2011 05 06
 (732) Joint Stock Company "LISI LEIQ
 DEVELOPMENT"
 Vakis raioni, Lisis Tbis mimdebared (nakveti
 N1/5), 0177, Tbilisi, Georgia

(111) M 2012 023027 R
 (151) 2012 11 02
 (181) 2022 11 02
 (260) AM 2012 60310 A
 (220) 2010 11 17
 (732) DINERS CLUB INTERNATIONAL LTD.,
 a New York Corporation
 2500 Lake Cook Road, Riverwoods, Illinois
 60015, USA

(111) M 2012 023032 R
 (151) 2012 11 02
 (181) 2022 11 02
 (260) AM 2012 62349 A
 (220) 2011 05 06
 (732) Joint Stock Company "LISI LEIQ
 DEVELOPMENT"
 Vakis raioni, Lisis Tbis mimdebared (nakveti
 N1/5), 0177, Tbilisi, Georgia

(111) M 2012 023028 R
 (151) 2012 11 02
 (181) 2022 11 02
 (260) AM 2012 62061 A
 (220) 2011 04 13
 (732) LTD "EM Konsultatsiebi Da Programuli
 Uzrunvelkofa, EMCoS"
 Besikis moed. 3, 0108, Tbilisi, Georgia

(111) M 2012 023033 R
 (151) 2012 11 02
 (181) 2022 11 02
 (260) AM 2012 62462 A
 (220) 2011 05 18
 (732) ALEQSANDRE GOGITIDZE
 Takaishvilis q. 44/50, bina 27, 6000, Batumi,
 Georgia

(111) M 2012 023029 R
 (151) 2012 11 02
 (181) 2022 11 02
 (260) AM 2012 62345 A
 (220) 2011 05 06
 (732) Joint Stock Company "LISI LEIQ
 DEVELOPMENT"
 Vakis raioni, lisis tbis mimdebared (nakveti
 N1/5), 0177, Tbilisi, Georgia

(111) M 2012 023034 R
 (151) 2012 11 02
 (181) 2022 11 02
 (260) AM 2012 62809 A
 (220) 2011 06 10
 (732) LTD "BRITANUL-QARTULI SATSARMO
 EVROMEDIKALI"
 Saq. Samkhedro gzisa da Akhmetelis quchis
 gadakveta, 0159, Tbilisi, Georgia

(111) M 2012 023035 R (151) 2012 11 02 (181) 2022 11 02 (260) AM 2012 62815 A (220) 2011 06 10 (732) LTD "BRITANUL-QARTULI SATSARMO EVROMEDIKALI" Saq. samkhedro gzisa da Akhmetelis quchis gadakveta, 0159, Tbilisi, Georgia	Vazha-Pshavelas gamz. 33, 0177, Tbilisi, Georgia
(111) M 2012 023036 R (151) 2012 11 02 (181) 2022 11 02 (260) AM 2012 63407 A (220) 2011 07 26 (732) LIPSY LIMITED Desford Road, Enderby, Leicester, LE19 4AT, United Kingdom	(111) M 2012 023041 R (151) 2012 11 02 (181) 2022 11 02 (260) AM 2012 63830 A (220) 2011 08 23 (732) GALLAHER LIMITED Members Hill, Brooklands Road, Weybridge, Surrey KT13 0QU, United Kingdom
(111) M 2012 023037 R (151) 2012 11 02 (181) 2022 11 02 (260) AM 2012 63408 A (220) 2011 07 26 (732) LIPSY LIMITED Desford Road, Enderby, Leicester, LE19 4AT, United Kingdom	(111) M 2012 023042 R (151) 2012 11 02 (181) 2022 11 02 (260) AM 2012 63872 A (220) 2011 09 01 (732) THE HERCULES TIRE & RUBBER COMPANY a Connecticut corporation 16380 U.S. Route 224 East, suite 200, Findly, OH 4580, USA
(111) M 2012 023038 R (151) 2012 11 02 (181) 2022 11 02 (260) AM 2012 63741 A (220) 2011 08 15 (732) CORPORACION HABANOS S.A. Avenida 3ra. No. 2006 entre 20 y 22, Miramar, Playa, Ciudad de La Habana, Cuba	(111) M 2012 023043 R (151) 2012 11 02 (181) 2022 11 02 (260) AM 2012 63959 A (220) 2011 09 07 (732) JW LIFE SCIENCE CORPORATION 416, Hanjin-ri, Songak-eup, Dangjin-gun, Chungcheongnam-do, 343-823, Republic of Korea
(111) M 2012 023039 R (151) 2012 11 02 (181) 2022 11 02 (260) AM 2012 63773 A (220) 2011 08 18 (732) "SIMONI" Baqteriofagis mimdebared, 0160, Tbilisi, Georgia	(111) M 2012 023044 R (151) 2012 11 02 (181) 2022 11 02 (260) AM 2012 64027 A (220) 2011 09 13 (732) Частное акционерное общество "КРЕАТИВ" Проспект Промышленный, 19, г. Кировоград, Ukraine
(111) M 2012 023040 R (151) 2012 11 02 (181) 2022 11 02 (260) AM 2012 63793 A (220) 2011 08 19 (732) TSMU TBILISI STATE MEDICAL UNIVERSITY	(111) M 2012 023045 R (151) 2012 11 02 (181) 2022 11 02 (260) AM 2012 64105 A (220) 2011 09 15 (732) GlaxoSmithKline Trading Services Limited 6900 Cork Airport Business Park, Kinsale Road, Cork, Ireland

-
- (111) M 2012 023046 R
(151) 2012 11 02
(181) 2022 11 02
(260) AM 2012 64106 A
(220) 2011 09 15
(732) GlaxoSmithKline Trading Services Limited
6900 Cork Airport Business Park, Kinsale
Road, Cork, Ireland
-
- (111) M 2012 023047 R
(151) 2012 11 02
(181) 2022 11 02
(260) AM 2012 64153 A
(220) 2011 09 21
(732) LTD "AVERSI-FARMA"
Davit Agmasheneblis gamz., 148/2, 0112,
Tbilisi, Georgia
-
- (111) M 2012 023048 R
(151) 2012 11 02
(181) 2022 11 02
(260) AM 2012 64155 A
(220) 2011 09 21
(732) NEW BALANCE ATHLETIC SHOE, INC.
20 Guest Street, Boston, MA 02135, USA
-
- (111) M 2012 023049 R
(151) 2012 11 02
(181) 2022 11 02
(260) AM 2012 64235 A
(220) 2011 09 27
(732) Abdi İbrahim İlaç Sanayi ve Ticaret Anonim
Şirketi
Reşitpaşa Mahallesi Eski Büyükdere Caddesi
N 4 34467 Maslak-Sarıyer-İstanbul, Turkey
-
- (111) M 2012 023050 R
(151) 2012 11 02
(181) 2022 11 02
(260) AM 2012 64236 A
(220) 2011 09 27
(732) PAYLESS SHOESOURCE WORLDWIDE
INC.
Jayhawk Towers, 700 Southwest Jackson
Street, Suite 202, Topeka, Kansas 66603, USA
-
- (111) M 2012 023051 R
(151) 2012 11 02
(181) 2022 11 02
(260) AM 2012 64240 A
(220) 2011 09 27
(732) PAYLESS SHOESOURCE WORLDWIDE
INC.
-
- Jayhawk Towers, 700 Southwest Jackson
Street, Suite 202, Topeka, Kansas 66603, USA
-
- (111) M 2012 023052 R
(151) 2012 11 02
(181) 2022 11 02
(260) AM 2012 64283 A
(220) 2011 09 29
(732) Abdi İbrahim İlaç Sanayi ve Ticaret Anonim
Şirketi
Reşitpaşa Mahallesi Eski Büyükdere Caddesi
N4, 34467 Maslak-Sarıyer-İstanbul, Turkey
-
- (111) M 2012 023053 R
(151) 2012 11 02
(181) 2022 11 02
(260) AM 2012 64284 A
(220) 2011 09 29
(732) Abdi İbrahim İlaç Sanayi ve Ticaret Anonim
Şirketi
Reşitpaşa Mahallesi Eski Büyükdere Caddesi
N4, 34467 Maslak-Sarıyer-İstanbul, Turkey
-
- (111) M 2012 023054 R
(151) 2012 11 02
(181) 2022 11 02
(260) AM 2012 64372 A
(220) 2011 10 10
(732) SUN SAME ENTERPRISES CO., LTD.
N31, Lane 349, Chung Cheng S. Rd.,
Yongkang Dist., Tainan City 710, Taiwan,
R.O.C., China
-
- (111) M 2012 023055 R
(151) 2012 11 02
(181) 2022 11 02
(260) AM 2012 64812 A
(220) 2011 11 08
(732) LTD "AVERSI-FARMA"
Davit Agmasheneblis gamz., 148/2, 0112,
Tbilisi, Georgia
-
- (111) M 2012 023056 R
(151) 2012 11 02
(181) 2022 11 02
(260) AM 2012 64814 A
(220) 2011 11 08
(732) LTD "AVERSI-FARMA"
Davit Agmasheneblis gamz., 148/2, 0112,
Tbilisi, Georgia
-

(111) M 2012 023057 R
 (151) 2012 11 02
 (181) 2022 11 02
 (260) AM 2012 64815 A
 (220) 2011 11 08
 (732) LTD "AVERSI-FARMA"
 Davit Agmasheneblis gamz., 148/2, 0112,
 Tbilisi, Georgia

(111) M 2012 023058 R
 (151) 2012 11 02
 (181) 2022 11 02
 (260) AM 2012 64818 A
 (220) 2011 11 08
 (732) LTD "AVERSI-FARMA"
 Davit Agmasheneblis gamz., 148/2, 0112,
 Tbilisi, Georgia

(111) M 2012 023059 R
 (151) 2012 11 02
 (181) 2022 11 02
 (260) AM 2012 64819 A
 (220) 2011 11 08
 (732) LTD "AVERSI-FARMA"
 Davit Agmasheneblis gamz., 148/2, 0112,
 Tbilisi, Georgia

(111) M 2012 023060 R
 (151) 2012 11 02
 (181) 2022 11 02
 (260) AM 2012 64844 A
 (220) 2011 11 09
 (732) ORION CORPORATION
 Orionintie 1, 02200 Espoo, Finland

(111) M 2012 023065 R
 (151) 2012 11 12
 (181) 2022 11 12
 (260) AM 2012 62685 A
 (220) 2011 06 03
 (732) Joint Stock Company "Sastumroebisa Da
 Restornebis Menejment Jgupi -EM/GROUP"
 Marshal Gelovanis gamz. 2, me-5 sartuli,
 0159, Tbilisi, Georgia

(111) M 2012 023066 R
 (151) 2012 11 12
 (181) 2022 11 12
 (260) AM 2012 62686 A
 (220) 2011 06 03
 (732) Joint Stock Company "Sastumroebisa Da
 Restornebis Menejment Jgupi -EM/GROUP"
 Marshal Gelovanis gamz. 2, me-5 sartuli,
 0159, Tbilisi, Georgia

(111) M 2012 023067 R
 (151) 2012 11 12
 (181) 2022 11 12
 (260) AM 2012 62687 A
 (220) 2011 06 03
 (732) Joint Stock Company "Sastumroebisa Da
 Restornebis Menejment Jgupi -EM/GROUP"
 Marshal Gelovanis gamz. 2, me-5 sartuli,
 0159, Tbilisi, Georgia

(111) M 2012 023068 R
 (151) 2012 11 12
 (181) 2022 11 12
 (260) AM 2012 62688 A
 (220) 2011 06 03
 (732) Joint Stock Company "Sastumroebisa Da
 Restornebis Menejment Jgupi -EM/GROUP"
 Marshal Gelovanis gamz. 2, me-5 sartuli,
 0159, Tbilisi, Georgia

(111) M 2012 023069 R
 (151) 2012 11 12
 (181) 2022 11 12
 (260) AM 2012 62689 A
 (220) 2011 06 03
 (732) Joint Stock Company "Sastumroebisa Da
 Restornebis Menejment Jgupi -EM/GROUP"
 Marshal Gelovanis gamz. 2, me-5 sartuli,
 0159, Tbilisi, Georgia

(111) M 2012 023070 R
 (151) 2012 11 12
 (181) 2022 11 12
 (260) AM 2012 62690 A
 (220) 2011 06 03
 (732) Joint Stock Company "Sastumroebisa Da
 Restornebis Menejment Jgupi -EM/GROUP"
 Marshal Gelovanis gamz. 2, me-5 sartuli,
 0159, Tbilisi, Georgia

(111) M 2012 023071 R
 (151) 2012 11 12
 (181) 2022 11 12
 (260) AM 2012 62819 A
 (220) 2011 06 13
 (732) LTD MISO "MO MONEY CREDIT"
 Ggamsaxurdias shesaxvevi N4, sartuli 1, bina
 N4, vake-saburtalos raioni, 0171, Georgia

(111) M 2012 023072 R
 (151) 2012 11 12
 (181) 2022 11 12
 (260) AM 2012 62884 A
 (220) 2011 06 17

(732) Joint Stock Company "JI PI SI"
Marjanishvilis q.26, 0102, Tbilisi, Georgia

(111) M 2012 023073 R
(151) 2012 11 12
(181) 2022 11 12
(260) AM 2012 63184 A
(220) 2011 07 12
(732) LTD "britanul-qartuli satsarmo evromedikali"
Saq. samkhedro gzisa da Akhmetelis quchis
gadakveta, 0159, Tbilisi, Georgia

(111) M 2012 023074 R
(151) 2012 11 12
(181) 2022 11 12
(260) AM 2012 63392 A
(220) 2011 07 26
(732) PRO BONO BIO ENTREPRENEUR
LIMITED
4 th Floor, Reading Bridge House, georg
Street, Reading, Berkshire RG1 8LS,
United Kingdom

(111) M 2012 023075 R
(151) 2012 11 12
(181) 2022 11 12
(260) AM 2012 63393 A
(220) 2011 07 26
(732) PRO BONO BIO ENTREPRENEUR
LIMITED
4 th Floor, Reading Bridge House, georg
Street, Reading, Berkshire RG1 8LS,
United Kingdom

(111) M 2012 023076 R
(151) 2012 11 12
(181) 2022 11 12
(260) AM 2012 63411 A
(220) 2011 07 26
(732) Joint Stock Company "QARTULI LUDIS
KOMPANIA"
Sop. Saguramo, 3308, Mtskhetis raioni,
Georgia

(111) M 2012 023077 R
(151) 2012 11 12
(181) 2022 11 12
(260) AM 2012 63463 A
(220) 2011 07 29
(732) Joint Stock Company "QARTULI LUDIS
KOMPANIA"
Sop. Saguramo, 3308, Mtskhetis raioni,
Georgia

(111) M 2012 023078 R
(151) 2012 11 12
(181) 2022 11 12
(260) AM 2012 63871 A
(220) 2011 08 31
(732) FORBES LLC
60 Fifth Avenue, New York, 10011, USA

(111) M 2012 023079 R
(151) 2012 11 12
(181) 2022 11 12
(260) AM 2012 63873 A
(220) 2011 09 01
(732) The Hercules Tire & Rubber Company
a Connecticut corporation
16380 U.S. Route 224 East, suite 200,
Findly, OH 4580, USA

(111) M 2012 023080 R
(151) 2012 11 12
(181) 2022 11 12
(260) AM 2012 63979 A
(220) 2011 09 09
(732) KABUSHIKI KAISHA SONY COMPUTER
ENTERTAINMENT,
also trading as SONY COMPUTER
ENTERTAINMENT INC.
I-I, AKASAKA 7-CHOME, MINATO-KU,
TOKYO, Japan

(111) M 2012 023081 R
(151) 2012 11 12
(181) 2022 11 12
(260) AM 2012 64146 A
(220) 2011 09 20
(732) LTD "TOBI"
Rustavelis gamz. 40-40a, 0108, Tbilisi, Georgia

(111) M 2012 023082 R
(151) 2012 11 12
(181) 2022 11 12
(260) AM 2012 64149 A
(220) 2011 09 21
(732) BRITISH AMERICAN TOBACCO
(BRANDS) LIMITED
Global House, 4 Temple Place, London
WC2R 2 PG, United Kingdom

(111) M 2012 023083 R
(151) 2012 11 12
(181) 2022 11 12
(260) AM 2012 64508 A
(220) 2011 10 20
(732) MARS, INCORPORATED
6885 ELM Street, McLean, Virginia
22101-3883, USA

TRADEMARKS REGISTERED ACCORDING TO THE ACCELERATED PROCEDURE

The decision can be appealed at the Chamber of Appeal of Sakpatenti within 3 months from the publication.

(111) M 2012 23024 R
(151) 2012 10 29
(181) 2022 10 29
(210) AM 069079
(220) 2012 09 28
(732) LTD "PROPUSI"
K. Shevardnadze Str. 9, ap. 4, 0160,
Tbilisi, Georgia
(740) George Taktakishvili
(540)



(591) White, blue, turquoise
(531) 27.05.03-29.01.12-
(511) 3

(540)



(591) Blue, red
(531) 06.01.04-26.02.01-27.05.01-29.01.13-
(526) **DISCLAIMER** – "SPRING" and "WATER",
shall not be subject to independent legal protection.
(511) 32, 35

(111) M 2012 23061 R
(151) 2012 11 06
(181) 2022 11 06
(210) AM 069341
(220) 2012 10 23
(732) Elvir Hasanov
Mazniashvili Str. 2, 3000, Marneuli,
Georgia
(540)

RALLY TRANSMISSION BELTS

(591) Black-white
(526) **DISCLAIMER** – The trademark is protected
as a whole, except "BELTS", shall not be subject to
independent legal protection.
(511) 12

(111) M 2012 23063 R
(151) 2012 11 09
(181) 2022 11 06
(210) AM 069305
(220) 2012 10 17
(732) LTD "VINTIJI"
Potis tavisupali industriuli zona,
nakveti 307, satskobi 1D-1, 4400, Tbilisi,
Georgia
(740) Alexander Vacharadze
(540)



PRIMA MATERIA

(591) Black-white
(531) 03.11.10-26.11.12-27.05.05-
(511) 3

(111) M 2012 23062 R
(151) 2012 11 07
(181) 2022 11 07
(210) AM 069405
(220) 2012 10 25
(732) LTD "WATER FORS CORPORATION"
I. Chavchavadze Av. 26, 0179, Tbilisi,
Georgia

(111) M 2012 23064 R

(151) 2012 11 09

(181) 2022 11 09

(210) AM 069364

(220) 2012 10 24

(732) LTD "METROMAT"

Didube-Chuguretis raioni,
Davit Agmasheneblis gamz. 197,
Tsabadzis q. 1, bina 12, 0112, Tbilisi,
Georgia

(540)



(591) Orange, green

(531) 01.15.03-28.19.00-29.01.13-

(511) 35

(111) M 2012 23084 R

(151) 2012 11 13

(181) 2022 11 13

(210) AM 069431

(220) 2012 10 26

(732) LTD "AS GEORGIA"

Isani-Samgoris raioni, Vazisubani, IV m/r,
2 kvart., korp. 9, bina 83, 0152, Tbilisi,
Georgia

(740) Valentina Semilet

(540)

Dirsy
დირსი

(591) Black-white

(511) 37

INTERNATIONAL TRADEMARKS FOR WHICH A DECISION ON GRANTING PROTECTIONS IS TAKEN

The decision can be appealed at the Chamber of Appeal of Sakpatenti within 3 months from the publication or at the Administrative Chamber of the Tbilisi City Court (Address: №6, David Aghmashenebeli Kheivani 12 km., Tbilisi) within 1 month following the publication.

(260) AM 2012 63472 A

(800) 1083253

(731) Otkrytoe aktsionerhoe obchtchestvo

"Savouchkin produkt"

108, oul. Ya. Koupaly, 224028 Brest, Belarus

(540)



(591) Black, white

(511)

29 – Sour cream; ryazhenka (fermented baked milk); sour clotted milk.

(260) AM 2012 64075 A

(800) 1088396

(731) IMRAN HUSSAIN, RIZWANA HUSSAIN

MAARIAH HUSSAIN, DANYAAL

HUSSAIN,

ZAHRA HUSSAIN; 2A Woodhall Park

Avenue, Leeds, West Yorkshire LS28 7HF,

United Kingdom

(540)

DURAPLAST

(591) Black, white

(511)

5 – Medicines, plasters, liquid bandage sprays, heat plasters, medicated plasters, corn plasters and rings, cooling sprays, materials for dressings, bindings and bandages; cotton wool, cotton sticks and cotton wool pads, disinfectants, insect repellants; medicated ointments and creams.

(260) AM 2012 64292 A

(800) 953443

(731) BNS GIDA VE TURIZM HIZMETLERI

LIMITED SIRKETI

32.Ada Yesim Sitesi 14 K.2 D.4, Atasehir

ISTANBUL, Turkey

(540)



(591) Black, white, red

(511)

43 – Food and beverage supplying services; cafeterias; canteens; catering; cocktail hall services; restaurants; self-service restaurants; snack-bars; rental services for food service equipment.

(260) AM 2012 64310 A

(800) 1089803

(731) COMEDY CLUB PRODUCTION IP

(Cyprus) LIMITED

Theklas Lysioty, 35, Eagl Star House, 5 floor,

CY-3030 Limassol, Cyprus

(540)



(591) Red, white, black, grey and dark red

(511)

9 – DVD players; ticket dispensers; juke boxes, musical; distribution machines, automatic; motor fire engines; answering machines; accumulators, electric; accumulators, electric, for vehicles; actinometers; alidades; altimeters; ammeters; anemometers; anodes; aerials; anticathodes; apertometers [optics]; divers' apparatus; high-frequency apparatus; testing apparatus not for medical purposes; remote control apparatus; electro-dynamic apparatus for the remote control of railway points; electro-dynamic apparatus for the remote control of signals; monitoring apparatus, electric; sound recording apparatus; distillation apparatus for scientific purposes; diffraction apparatus [microscopy]; air analysis apparatus; apparatus to check stamping

mail; sound transmitting apparatus; electrical apparatus for sealing plastics [packaging]; apparatus for fermentation [laboratory apparatus]; electric arc cutting apparatus; electric arc welding apparatus; electric welding apparatus; breathing apparatus, except for artificial respiration; breathing apparatus for underwater swimming; x-rays producing apparatus and installations, not for medical purposes; cash registers; electric apparatus for commutation; intercommunication apparatus; stills for laboratory experiments; projection apparatus; roentgen apparatus not for medical purposes; radiological apparatus for industrial purposes; soldering apparatus, electric; blueprint apparatus; blinkers [signalling lights]; stereoscopic apparatus; telegraphs [apparatus]; telephone apparatus; telephone transmitters; phototelegraphy apparatus; igniting apparatus, electric, for igniting at a distance; acid hydrometers; salinometers; acidimeters for batteries; aerometers; beacons, luminous; barometers; anode batteries; galvanic batteries; batteries for pocketlamps; batteries for lighting; solar batteries; batteries, electric; balances [steelyards]; gasoline pumps for service stations; betatrons; binoculars; electronic tags for goods; magnetic tape units for computers; computer memories; fire hose nozzles; encoded identification bracelets, magnetic; safety tarpaulins; signalling buoys; life buoys; marking buoys; directional compasses; vacuum gauges; electrolyzers; variometers; scales; letter scales; weighbridges; precision balances; levelling staffs [surveying instruments]; camcorders; video cassettes; video telephones; video screens; viewfinders, photographic; plugs, sockets and other contacts [electric connections]; micrometer screws for optical instruments; viscosimeters; circuit closers; wavemeters; voltmeters; coin-operated gates for car parks or parking lots; mechanical signs; switchboxes [electricity]; current rectifiers; jigs [measuring instruments]; gas testing instruments; gasometers; galvanometers; heliographic apparatus; hygrometers; hydrometers; weights; peepholes [magnifying lenses] for doors; holograms; plotters; loudspeakers; sounding leads; plumb bobs; range finders; densimeters; densitometers; optical goods; detectors; galena crystals [detectors]; smoke detectors; counterfeit [false] coin detectors; slides [photography]; slide projectors; diaphragms [photography]; dictating machines; dynamometers; floppy disks; sound recording discs; disks, magnetic; optical discs; calculating disks; disk drives for computers; juke boxes for computers; DNA chips; electronic

notice boards; capacity measures; swimming jackets; bullet-proof waistcoats; life jackets; identification threads for electric wires; nose clips for divers and swimmers; locks, electric; bells [warning devices]; alarm bells, electric; electric door bells; signal bells; acoustic conduits; mirrors for inspecting work; road signs, luminous or mechanical; signs, luminous; marine depth finders; probes for scientific purposes; buzzers; buzzers, electric; needles for record players; gauges; pressure measuring apparatus; simulators for the steering and control of vehicles; inverters [electricity]; pressure indicators; indicators [electricity]; temperature indicators; incubators for bacteria culture; measuring instruments; mathematical instruments; levelling instruments; surveying instruments; azimuth instruments; interfaces for computers; ionisation apparatus, not for the treatment of air; spark-guards; coaxial cables; fibre optic cables; cables, electric; calipers; slide calipers; screw-tapping gauges; calculating machines; pocket calculators; decompression chambers; cinematographic cameras; electronic pens [visual display units]; holders for electric coils; identity cards, magnetic; video game cartridges; encoded cards, magnetic; riding helmets; protective helmets; carriers for dark plates [photography]; automated teller machines [ATM]; cathodes; choking coils [impedance]; coils, electric; electromagnetic coils; spools [photography]; cinematographic film, exposed; computer keyboards; solenoid valves [electromagnetic switches]; wire connectors [electricity]; electronic agendas; push buttons for bells; mouse pads; magnetic encoders; anti-dazzle shades; collectors, electric; calibrating rings; protective suits for aviators; commutators; compact discs [audio-video]; compact discs [read-only memory]; comparators; marine compasses; computers; notebook computers; capacitors; contacts, electric; contacts, electric, of precious metal; wind socks for indicating wind direction; branch boxes [electricity]; distribution boxes [electricity]; connectors [electricity]; junction boxes [electricity]; accumulator boxes; cabinets for loudspeakers; diving suits; reflecting discs for wear, for the prevention of traffic accidents; covers for electric outlets; logs [measuring instruments]; lasers, not for medical purposes; lactodensimeters; lactometers; darkroom lamps [photography]; neon signs; thermionic lamps and tubes; thermionic valves [radio]; amplifying tubes; flashlights [photography] head cleaning tapes [recording]; magnetic tapes; videotapes; surveying chains; fire escapes; rulers [measuring instruments];

slide-rules; contact lenses; correcting lenses [optics]; optical lenses; lens hoods; optical condensers; sounding lines; electricity conduits; measuring spoons; magnifying glasses [optics]; thread counters; magnets; decorative magnets; resuscitation mannequins [teaching apparatus]; mouse [data processing equipment]; manometers; divers' masks; solderers' helmets; protective masks; materials for electricity mains [wires, cables]; accounting machines; voting machines; money counting and sorting machines; material testing instruments and machines; hemline markers; megaphones; diaphragms [acoustics]; diaphragms for scientific apparatus; metal detectors for industrial or military purposes; metronomes; rules [measuring instruments]; carpenters' rules; dressmakers' measures; mechanisms for counter-operated apparatus; coin-operated mechanisms for television sets; shutter releases [photography]; micrometers; microprocessors; microscopes; microtomes; microphones; modems; lightning arresters; monitors [computer hardware]; animated cartoons; terminals [electricity]; junction sleeves for electric cables; cases fitted with dissecting instruments [microscopy]; teeth protectors; knee-pads for workers; self-regulating fuel pumps; fuel dispensing pumps for service stations; headphones; surveyors' levels; verniers; sound recording carriers; magnetic data media; optical data media; socks, electrically heated; sheaths for electric cables; identification sheaths for electric wires; weighing machines; punched card machines for offices; furniture especially made for laboratories; shoes for protection against accidents, irradiation and fire; objectives [lenses] [optics]; lenses for astrophotography; egg-candlers; fire extinguishing apparatus; electrified fences; limiters [electricity]; clothing for protection against accidents, irradiation and fire; clothing for protection against fire; asbestos clothing for protection against fire; clothing especially made for laboratories; ozonisers [ozonators]; octants; eyepieces; ohmmeters; wrist rests for use with computers; spectacle frames; eyeglass frames; oscillographs; plumb lines; mirrors [optics]; spectacles [optics]; sunglasses; goggles for sports; signalling panels, luminous or mechanical; radio pagers; pince-nez; electronic pocket translators; transmitters [telecommunication]; transmitters of electronic signals; switches, electric; periscopes; gloves for divers; asbestos gloves for protection against accidents; gloves for protection against accidents; gloves for protection against x-rays for industrial purposes; furnaces for laboratory

experiments; pipettes; pyrometers; planimeters; plane tables [surveying instruments]; plates for batteries; wafers [silicon slices]; compact disc players; cassette players; sound recording strips; roentgen films, exposed; films, exposed; life-saving rafts; laboratory trays; semi-conductors; polarimeters; fire engines; water wings; measuring glassware; swimming belts; life belts; circuit breakers; fuses; converters, electric; telerupters; food analysis apparatus; diagnostic apparatus, not for medical purposes; hair-curlers, electrically heated; distance measuring apparatus; speed measuring apparatus [photography]; appliances for measuring the thickness of leather; appliances for measuring the thickness of skins; speed checking apparatus for vehicles; teaching apparatus; time recording apparatus; make-up removing appliances, electric; distance recording apparatus; apparatus and instruments for astronomy; surveying apparatus and instruments; weighing apparatus and instruments; nautical apparatus and instruments; optical apparatus and instruments; apparatus and instruments for physics; chemistry apparatus and instruments; measuring apparatus; measuring devices, electric; boiler control instruments; cosmographic instruments; meteorological instruments; naval signalling apparatus; observation instruments; navigation apparatus for vehicles [on-board computers]; satellite navigational apparatus; regulating apparatus, electric; precision measuring apparatus; instruments containing eyepieces; audio and video receivers; prisms [optics]; cigar lighters for automobiles; printers for use with computers; apparatus for changing record player needles; retorts' stands; drainers for use in photography; cleaning apparatus for phonograph records; fire beaters; sighting telescopes for firearms; test tubes; pressure indicator plugs for valves; magnetic wires; telegraph wires; telephone wires; wires, electric; conductors, electric; copper wire, insulated; fuse wire; computer software, recorded; computer game programs; computer programs [downloadable software]; record players; central processing units [processors]; rods for water diviners; electronic publications, downloadable; distribution consoles [electricity]; control panels [electricity]; radar apparatus; vacuum tubes [radio]; masts for wireless aerials; transmitting sets [telecommunication]; radios; vehicle radios; frames for photographic transparencies; screens for photoengraving; walkie-talkies; voltage surge protectors; voltage regulators for vehicles; light dimmers [regulators], electric; stage lighting regulators; speed

regulators for record players; cell switches [electricity]; washing trays [photography]; marking gauges [joinery]; time switches, automatic; relays, electric; safety restraints, other than for vehicle seats and sports equipment; x-ray photographs, other than for medical purposes; rheostats; respirators, other than for artificial respiration; respirators for filtering air; retorts; refractometers; refractors; grids for batteries; horns for loudspeakers; saccharometers; optical fibers [fibres] [light conducting filaments]; traffic-light apparatus [signalling devices]; dog whistles; signalling whistles; whistle alarms; sextants; inductors [electricity]; life nets; nets for protection against accidents; fire alarms; signals, luminous or mechanical; sirens; scanners [data processing equipment]; integrated circuit cards [smart cards]; connections for electric lines; connections, electric; sonars; sound locating instruments; lighting ballasts; resistances, electric; spectrograph apparatus; spectroscopes; speed indicators; alcoholmeters; satellites for scientific purposes; protection devices for personal use against accidents; audio-visual teaching apparatus; radiotelegraphy sets; radiotelephony sets; spectacle glasses; optical glass; glass covered with an electrical conductor; anti-glare glasses; personal stereos; stereoscopes; fire boats; sulphitometers; hands free kits for phones; drying racks [photography]; spherometers; integrated circuits; printed circuits; counters; parking meters; postage stamp meters; kilometer recorders for vehicles; revolution counters; abacuses; taximeters; ear plugs; ear plugs for divers; tachometers; word processors; television apparatus; telescopes; teleprompters; teleprinters; portable telephones; theodolites; thermometers, not for medical purposes; thermostats; thermostats for vehicles; crucibles [laboratory]; tone arms for record players; totalizers; transistors [electronic]; protractors [measuring instruments]; battery chargers; transformers [electricity]; vehicle breakdown warning triangles; starter cables for motors; discharge tubes, electric, other than for lighting; capillary tubes; x-rays tubes not for medical purposes; telephone receivers; turnstiles, automatic; quantity indicators; automatic indicators of low pressure in vehicle tires [tyres]; petrol gauges; water level indicators; electric loss indicators; light-emitting electronic pointers; gradient indicators; levels [instruments for determining the horizontal]; mercury levels; spirit levels; urinometers; amplifiers; particle accelerators; sprinkler systems for fire protection; electric installations for the remote control of industrial operations; steering

apparatus, automatic, for vehicles; balancing apparatus; video recorders; sound reproduction apparatus; invoicing machines; galvanizing apparatus; door closers, electric; tape recorders; protection devices against x-rays [roentgen rays], not for medical purposes; apparatus for games adapted for use with an external display screen or monitor; railway traffic safety appliances; data processing apparatus; door openers, electric; oxygen transvasing apparatus; theft prevention installations, electric; electric devices for attracting and killing insects; amusement apparatus adapted for use with an external display screen or monitor; time clocks [time recording devices]; film cutting apparatus; drying apparatus for photographic prints; optical character readers; elevator operating apparatus; centering apparatus for photographic transparencies; dosage dispensers; acoustic [sound] alarms; sounding apparatus and machines; life saving apparatus and equipment; editing appliances for cinematographic films; cathodic anti-corrosion apparatus; couplers [data processing equipment]; computer peripheral devices; anti-interference devices [electricity]; demagnetizing apparatus for magnetic tapes; acoustic couplers; anti-theft warning apparatus; alarms; fog signals, non-explosive; adding machines; readers [data processing equipment]; heat regulating apparatus; photocopiers [photographic, electrostatic, thermic]; bar code readers; flat irons, electric; filters for respiratory masks; filters for ultraviolet rays, for photography; filters [photography]; magic lanterns; optical lamps; signal lanterns; cameras [photography]; glazing apparatus for photographic prints; shutters [photography]; darkrooms [photography]; photometers; flash-bulbs [photography]; enlarging apparatus [photography]; photovoltaic cells; containers for contact lenses; spectacle cases; eyeglass cases; containers for microscope slides; cases especially made for photographic apparatus and instruments; chromatography apparatus for laboratory use; chronographs [time recording apparatus]; eyeglass chains; cyclotrons; compasses [measuring instruments]; frequency meters; egg timers [sandglasses]; fire blankets; chips [integrated circuits]; pedometers; meteorological balloons; electrified rails for mounting spot lights; asbestos screens for firemen; protective helmets for sports; eyeglass cords; tripods for cameras; eyeshades; switchboards; distribution boards [electricity]; workmen's protective face-shields; projection screens; radiology screens for industrial purposes; fluorescent screens; screens [photography]; exposure meters [light meters]; wel-

ding electrodes; soldering irons, electric; ducts [electricity]; galvanic cells; epidiascopes; ergometers; armatures [electricity].

35 – Arranging subscriptions to telecommunication services for others; import-export agencies; commercial information agencies; advertising agencies; cost price analysis; rental of advertising space; auditing; employment agencies; computerized file management; accounting; invoicing; demonstration of goods; transcription; opinion polling; marketing studies; business information; commercial information and advice for consumers [consumer advice shop]; business investigations; marketing research; personnel recruitment; business management and organization consultancy; personnel management consultancy; business organization consultancy; business management consultancy; professional business consultancy; layout services for advertising purposes; business management of performing artists; news clipping services; updating of advertising material; word processing; secretarial services; shorthand; organization of exhibitions for commercial or advertising purposes; arranging newspaper subscriptions for others; organization of trade fairs for commercial or advertising purposes; shop window dressing; business appraisals; evaluation of standing timber; evaluation of wool; payroll preparation; data search in computer files for others; sponsorship search; business management assistance; commercial or industrial management assistance; presentation of goods on communication media, for retail purposes; economic forecasting; auctioneering; sales promotion for others; office machines and equipment rental; rental of advertising time on communication media; publicity material rental; rental of vending machines; rental of photocopying machines; publication of publicity texts; typing; radio advertising; bill-posting; outdoor advertising; distribution of samples; direct mail advertising; writing of publicity texts; advertising; on-line advertising on a computer network; advertising by mail order; television advertising; document reproduction; compilation of statistics; compilation of information into computer databases; business inquiries; systemization of information into computer databases; tax preparation; drawing up of statements of accounts; publicity columns preparation; psychological testing for the selection of personnel; business management of hotels; commercial administration of the licensing of the goods and services of others; administrative processing of purchase

orders; public relations; modelling for advertising or sales promotion; relocation services for businesses; price comparison services; procurement services for others [purchasing goods and services for other businesses]; outsourcing services [business assistance]; telephone answering for unavailable subscribers; photocopying; efficiency experts.

38 – News agencies; television broadcasting; cable television broadcasting; electronic bulletin board services [telecommunications services]; information about telecommunication; telecommunications routing and junction services; providing internet chatrooms; providing user access to a global computer network [service providers]; providing access to databases; providing telecommunications connections to a global computer network; providing telecommunication channels for teleshopping services; message sending; computer aided transmission of messages and images; sending of telegrams; transmission of telegrams; electronic mail; rental of message sending apparatus; rental of access time to global computer networks; rental of modems; rental of telecommunication equipment; rental of telephones; rental of facsimile apparatus; radio broadcasting; communications by fiber [fibre] optic networks; cellular telephone communication; communications by computer terminals; satellite transmission; communications by telegrams; communications by telephone; facsimile transmission; paging services [radio, telephone or other means of electronic communication]; teleconferencing services; telex services; voice mail services; telegraph services; telephone services.

41 – Modelling for artists; academies [education]; rental of tennis courts; lending libraries; booking of seats for shows; videotaping; nursery schools; physical education; discotheque services; animal training; dubbing; gaming; publication of books; education information; recreation information; entertainment information; movie studios; health club services; club services [entertainment or education]; night clubs; layout services, other than for advertising purposes; microfilming; videotape editing; production of radio and television programmes; music-halls; game services provided on-line from a computer network; providing on-line electronic publications, not downloadable; religious education; gymnastic instruction; correspondence courses; practical training [demonstration]; organization of balls; organization of exhibitions for cultural or educational purposes; providing recreation facilities; arranging and conducting of colloquiums; arranging and conducting of congresses; arranging and conducting of conferences; arranging and conducting of concerts; arranging and conducting of workshops [training]; arranging and conducting of

seminars; arranging and conducting of symposiums; arranging of beauty contests; organization of competitions [education or entertainment]; operating lotteries; holiday camp services [entertainment]; organization of shows [impresario services]; organization of sports competitions; vocational guidance [education or training advice]; amusement parks; sign language interpretation; television entertainment; bookmobile services; providing karaoke services; providing golf facilities; providing sports facilities; providing amusement arcade services; movie theatre presentations; presentation of live performances; theatre productions; educational examination; timing of sports events; videotape film production; film production; rental of sound recordings; rental of audio equipment; rental of video cameras; rental of video cassette recorders; rental of videotapes; rental of show scenery; rental of movie projectors and accessories; rental of motion pictures; rental of stadium facilities; rental of lighting apparatus for theatrical sets or television studios; rental of radio and television sets; rental of skin diving equipment; rental of sports equipment, except vehicles; rental of stage scenery; electronic desktop publishing; publication of electronic books and journals on-line; publication of texts, other than publicity texts; radio entertainment; entertainer services; entertainment; writing of texts, other than publicity texts; zoological gardens; news reporters services; party planning [entertainment]; music composition services; sport camp services; subtitling; providing casino facilities [gambling]; calligraphy services; providing museum facilities [presentation, exhibitions]; tuition; orchestra services; translation; scriptwriting services; ticket agency services [entertainment]; recording studio services; digital imaging services; photography; photographic reporting; circuses; boarding schools; production of shows.

(260) AM 2012 64316 A

(800) 1089920

(731) ORKA TEKSTİL SANAYİ VE TURİZM
TİCARET ANONİM ŞİRKETİ

Gürsel Mahallesi, Yalim Sokak, No:5,
OKMEYDANI – İSTANBUL, Turkey

(540)



(591) Black, white

(511)

3 – Detergents for household use and laundry preparations, bleaching preparations for household use, laundry starch, fabric softeners for laundry use, lime removers for laundry use, granulated soaps, polishing preparations for household use; essential oils for aromatherapy use, perfumes and colognes,

cosmetics and cosmetic preparations, namely, shaving lotions, non-medicated stimulating lotions for the skin, rose oil for cosmetic purposes, essential oils for use in manufacturing processes, cotton sticks for cosmetic purposes, nail varnish for cosmetic purposes, lipsticks, cosmetic preparations for eyelashes namely mascaras, hair dyes, hair care kits comprising non-medicated hair care preparations namely, shampoo, eyeliner pencils, nail polish remover, after-shave creams, shower and bath gel, petroleum jelly for cosmetic purposes, depilatories, henna for cosmetic purposes, cosmetic preparations for slimming and for skin tanning, make-up kits comprised of cosmetics; antiperspirants for personal use, deodorants and antiperspirants; soaps for personal use namely, medicated soaps, perfumed soaps, liquid soaps, hand soaps, disinfectant soaps, cosmetic soaps, antiperspirant soaps; toothpastes, dentifrices in the form of chewing gum, dental bleaching gel, tooth powders, denture cleaning preparations, non-medicated mouth wash and rinse, tartar preventing toothpastes; emery paper, abrasive paste, pumice stones for personal use; leather polishes, polishes for metallic items, furniture polishes, floor polishes.

9 – Apparatus and instruments used for measurement for scientific purposes and used in laboratory, apparatus for recording, transmission or reproduction of sound and images including data processing apparatus, communication devices, computer software and hardware; magnetic and optical data media and exposed camera films; antennas, satellite antennas, amplifiers and parts thereof; automatic vending machines, automatic ticket dispensers, cash machines; electronic devices used in machines and devices, electronic semi-conductors, electronic integrated circuits, electronic chips; electric meters, water meters, gas meters, counters and timers used for measuring the consumption in a unit of time; protective clothing, life saving and protecting equipments; eyeglasses, sun glasses and their lenses, cases, parts and accessories; apparatus and instruments for transmitting, converting and storing electrical energy including cables and power supplies used in electric and electronic apparatus; electric door bells, alarms other than vehicle alarms; electric irons, steam irons, electric press irons; traffic-light apparatus (signalling devices); reflectors for traffic signals; fire-extinguishing apparatus; electric welding apparatus including welding electrodes; radars, submarine radars (sonars), night vision providing and increasing devices and apparatus, namely, night vision goggles; electric devices for attracting and killing insects; automatic controls for doors, automatic turnstiles, electric or electronic door opening and closing installations for buildings; remote controls for opening & closing vehicle doors; electrolyzers, galvanizing apparatus, anodes, cathodes; magnets, decorative magnets.

25 – Clothing, namely, trousers, jackets, overcoats, coats, skirts, suits, jerseys, waistcoats, shirts, T-shirts, sweatshirts, dresses, bermuda shorts, shorts, pajamas, pullovers, jeans, tracksuits, rainwear, beachwear, bathing suits, swimming suits; clothing for sports (for exclusive use for sports), clothing for babies, namely, shirts, pants, coats, dresses; underclothing, namely, boxer shorts, brassieres, briefs, pants, socks; footwear, namely shoes excluding orthopedic shoes, sandals, waterproof boots, walking boots, bootees, sporting shoes, slippers; shoe parts namely heelpieces, insoles for footwear, footwear uppers; headgear, namely caps, skull caps, sports caps, hats, berets; gloves (clothing), stockings, belts (clothing), camisoles, sarongs, scarves, neck scarves, shawls, collars, neckties, ties, suspender belts.

35 – Advertising agency services, marketing and publicity bureau services including commercial or advertisement exhibition and trade fair organization services; providing office functions; business management; business administration; import and export agencies; business investigations, evaluations, expert appraisals, information and research of Industrial and commercial goods; auctioneering; the bringing together, for the benefit of others, of cosmetics and cosmetic preparations, protective clothing, life saving and protecting equipments, eyeglasses, sun glasses, lenses and their boxes, cases, clothing, footwear and headgear (excluding the transport thereof), enabling customers to conveniently view and purchase those goods; such services may be provided by retail stores, wholesale outlets, through mail order catalogues or by means of electronic media, for example, through Web sites or television shopping programmes.

(260) AM 2012 64388 A

(800) 1090453

(731) Distilleries Group Toorank B.V.
Edisonstraat 80, NL-6902 PK Zevenaar,
Netherlands

(540)



(591) Black, white

(511)

33 – Alcoholic beverages and spirits, except beers.

(260) AM 2012 64434 A

(800) 1090855

(731) BEIQI FOTON MOTOR CO., LTD.

Laoniawan Village North, Shayang Road,
Shahe Town, Changping District, 102206
Beijing, China

(540)

FOTON

(591) Black, white

(511)

37 – Housing construction; building construction supervision; construction information; repair information; building inspection in the course of building construction; asphaltting; rental of bulldozers; rental of construction equipment; construction; underwater construction; demolition of buildings; warehouse construction and repair; building sealing; damp-proofing (building); rental of excavators; furnace installation and repair; factory-construction; pipeline construction and maintenance; pumicing; riveting; rental of cleaning machines; scaffolding; road paving; underwater repair; building of fair stalls and shops; rental of cranes (construction equipment); rental of road sweeping machines; mining extraction; quarrying services; drilling of wells; cleaning of buildings (interior); upholstery repair; chimney sweeping; painting or repair of signs; window cleaning; paper hanging; painting, interior and exterior; varnishing; cleaning of buildings (exterior surface); roofing services; street cleaning; irrigation devices installation and repair; machinery installation, maintenance and repair; electric appliance installation and repair; air conditioning apparatus installation and repair; freezing equipment installation and repair; office machine and equipment installation, maintenance and repair; kitchen equipment installation and repair; installation of computer hardware; interference suppression in electrical apparatus; installation and maintenance of medical devices; installation and maintenance of sanitary apparatus; installation and maintenance of bathing apparatus; installation and maintenance of lighting apparatus; motor vehicle maintenance and repair; vehicle lubrication; vehicle lubrication (greasing); vehicle wash; vehicle polishing; anti-rust treatment for vehicles; vehicle service stations; vehicle maintenance; vehicle cleaning; airplane mending; airplane maintenance and repair; rustproofing; re-tinning; painting services; retreading of tires (tyres); vulcanization of tires (tyres) (repair); elevator installation and repair; fire alarm installation and repair; burglar alarm installation and repair; shoe repair; telephone installation and repair; knife sharpening; pump repair; umbrella repair; parasol repair; artificial snow-making services; repairing hand tools; installation and repair of musical instruments; installation and maintenance of entertainment, physical training apparatus; upholstering.

(260) AM 2012 64457 A
 (800) 1091111
 (731) SEMPERIT TECHNISCHE PRODUKTE
 GESELLSCHAFT M.B.H.
 Modecenterstrasse 22, A-1030 WIEN,
 Austria

(540)

SIGMA

(591) Black, white

(511)

17 – Fittings and mountings of pipes, hoses, lines and couplings; flexible pipes (not of metal), flexible pipes of textile material; hoses, pipelines and conduits, couplings, hose clamps, hose and pipe adapters, as far as included in this class; couplings for flexible pipes; junction/ connection pieces, hose fittings/hose couplings, as far as included in this class; connection pipes for adapters.

35 – Advertising, business management, business administration; office functions; development and updating of promotional material, PR (public relations), personnel recruitment; dissemination of advertising matter; implementation of community promotions, advertising in and with all media, on company signs, vehicles, posters, flags, professional clothing and other advertising media and materials; organization and staging/realization of trade fairs and exhibitions for economic and advertising purposes, publication of advertising texts; market research; marketing (marketing research); opinion research; sales promotion for third parties; rental of advertising material or advertising space; distribution of promotional materials; demonstration/presentation of goods for advertising purposes; distribution of samples for advertising purposes; retail and wholesale services relating to transport hose systems.

(260) AM 2012 64601 A
 (800) 1092352
 (731) ATHBAH STUD LIMITED
 International House 41 The Parade, St Helier,
 Jersey JE2 3QQ, Channel Islands, United
 Kingdom

(540)



(591) Black, white

(511)

5 – Pharmaceutical preparations for bloodstock.

10 – Veterinary apparatus and instruments.

18 – Leather and imitations of leather; animal skins, hides; trunks and travelling bags; handbags, rucksacks, purses; umbrellas, parasols and walking sticks; whips, harness and saddlery; clothing for animals; covers for animals; horse blankets and horse rugs; horse collars; nose bags; pads for horse saddles; reins; stirrups.

31 – Foodstuffs for animals; live animals; live animals, namely horses.

35 – Wholesale services connected with the sale of livery and equipment, namely, horse blankets and rugs, horse boxes, horse stables, saddlery, whips, crops, harness, reins, horse tack, horse stirrups, treads and bridles, horse bits, stable equipment, namely, buckets, hayracks, feed bowls, drinking bowls, food bins, mangers, stable grilles and tack boxes; wholesale services connected with the sale of riding and racing wear, namely, breeches, jodhpurs, riding boots, riding hats, riding helmets, riding jackets, riding trousers, riding tops, riding vests, sunglasses; retail services connected with the sale of livery and equipment, namely, horse blankets and rugs, horse boxes, horse stables, saddlery, whips, crops, harness, reins, horse tack, horse stirrups, treads and bridles, horse bits, stable equipment, namely, buckets, hayracks, feed bowls, drinking bowls, food bins, mangers, stable grilles and tack boxes; retail services connected with the sale of riding and racing wear, namely, breeches, jodhpurs, riding boots, riding hats, riding helmets, riding jackets, riding trousers, riding tops, riding vests, sunglasses; retail services connected with the sale of horses; advertising and promotional services; administration services; all the aforesaid services relating to promoting the breeding, care, training, treatment and racing of horses; promoting and facilitating the business acquisition and distribution of business knowledge of the various arts and sciences connected with horses and the use and management thereof.

36 – Bloodstock insurance.

39 – Logistics services relating to bloodstock.

41 – Education, instruction and training all relating to the breeding, care, training, treatment and racing of horses; arranging and conducting of conferences and exhibitions; arranging and conducting of competitions; organisation of sports events and race meetings; organising horse shows and horse races; entertainment services; provision of educational information relating to the breeding, care, training, treatment and racing of horses; educational consultancy services relating to horses; organisation of horse racing events; organisation of race meetings;

organisation of horse jumping events; organisation of horse dressage events; organisation of horse endurance events; organisation of horse shows.

42 – Quality control for the certification services relating to the breeding, care, training, treatment and racing of horses.

44 – Veterinary and insemination services; veterinary laboratory services.

(260) AM 2012 64604 A

(800) 1092389

(731) BAYER AKTIENGESELLSCHAFT
Kaiser-Wilhelm-Allee, 51373 Leverkusen,
Germany

(540)

SOCENTUM

(591) Black, white

(511)

5 – Pharmaceutical preparations and substances.

10 – Medical instruments and apparatus, inhaling and atomizing apparatus for medical purposes.

(260) AM 2012 64605 A

(800) 1092410

(731) NEMIROFF INTELLECTUAL PROPERTY
ESTABLISHMENT
Städtle 31, FL-9490 Vaduz, Liechtenstein

(540)



(591) Grey, yellow, blue, white, brown and black

(511)

33 – Alcoholic beverages (except beers).

(260) AM 2012 64606 A

(800) 318753A

(731) CHANEL SARL
Burgstrasse 26, CH-8750 GLARUS,
Switzerland

(540)

CHANEL

(591) Black, white

(511)

32 – Mineral and carbonated waters, beers, lemonades, syrups, fruit juices and all other beverages.

33 – Wines, sparkling wines, ciders, aperitifs, alcohols and eaux-de-vie (brandy), liqueurs and various spirits.

(260) AM 2012 64607 A

(800) 764190

(731) GML AG Aktiengesellschaft für
Medizintechnik und Logistikmanagement
Martin-Behaim-Str. 20, 63263 Neu-Isenburg,
Germany

(540)

GML

(591) Black, white

(511)

5 – Pharmaceutical products and preparations for health care.

36 – Financial planning, financing, administration and letting of real estate; financial consulting in the field of safety, financial consulting for water treatment systems and media supply systems for medical installations.

37 – Maintaining and servicing of medico-technical apparatuses and systems, erecting of real estate, installation of water treatment systems and media supply systems for medical installations.

42 – Renting, leasing of medico-technical apparatuses and systems; construction planning, technical planning of real estate, network planning for electronic data processing; construction consulting, consulting in the field of safety, technical consulting in the introduction of quality management systems; technical consulting and planning of water treatment systems and media supply systems for medical installations.

(260) AM 2012 64608 A

(800) 838604

(731) RĪGAS PIENA KOMBINĀTS, A/S
Bauskas Iela 180, LV-1004 Rīga, Latvia

(540)



(591) Dark blue, blue, light blue, white

(511)

29 – Milk and milk products, including milk based desserts; edible oils and fats; eggs; preserved, dried and cooked fruits and vegetables; jellies, jams, compotes.

30 – Ice cream; ice cream based desserts, ice; pastry and confectionery.

(260) AM 2012 64609 A

(800) 928432

(731) INDUSTRIA DE DISEÑO TEXTIL, S.A.

(INDITEX, S.A.)

Avda. de la Diputación, "Edificio Inditex",

E-15142 Arteixo (A CORUÑA),

Spain

(540)

BERSHKA

(591) Black, white

(511)

9 – Scientific, nautical, surveying, photographic, cinematographic, optical, weighing, measuring, signalling, monitoring (supervision), emergency (life-saving) and teaching apparatus and instruments; apparatus and instruments for conducting, switching, transforming, accumulating, regulating or controlling electricity; apparatus for recording, transmitting, reproducing sound or images; magnetic data media; sound recording disks; automatic vending machines and mechanisms for coin-operated apparatus; cash registers; calculating machines; data processing and computer equipment; computer peripheral devices; fire extinguishers; anti-dazzle spectacles; eyeglasses (pince-nez); optical lenses; pince-nez chains; contact lenses; pince-nez cords; dressmakers' measures; spectacles (optics); spectacle lenses; spectacles cases; spectacle frames and lenses (eyeglasses); sunglasses; cases for eyeglasses and for contact lenses; shoes for protection against accidents irradiation and fire; bulletproof, swimming and lifesaving jackets; fire protection suits and clothing; gloves for divers; gloves for protection against accidents; wetsuits; magnetic cards; magnetic identity cards; clothing for protection against accidents and irradiation; protective suits for aviators; electronic agendas; electric appliances for removing make-up; telephone sets; personal scales (weighing apparatus); compasses; accounting machines; protective helmets; spyglasses; chronographs (time recording apparatus); measuring spoons; pedometers; compact discs (audio-video), compact disks (read-only memories); mirrors (optics); floats for bathing and swimming; binoculars (optics); printers for use with computers; temperature indicators; instruments containing eyepieces; game programs; cassette players; bar code readers; signal and magical lanterns, optical lamps; magnifying glasses (optics); dictating machines and invoicing machines; mechanisms for counter-operated apparatus; weights; electric, galvanic and solar batteries; electric irons; computer software (recorded); recorded computer operating programs; mouse (data processing equipment);

electronic pocket translators; transistors (electronics); thermometers (not for medical use); apparatus for games adapted for use with television receivers only; intercoms; video cassettes; animated cartoons; teaching apparatus; baby cry detectors; walkie-talkies; electronic publications (downloadable); sandglasses; acoustic alarms; anti-theft alarms; fire alarms; mousepads; loudspeakers; apparatus for sound amplification; antennae; anti-dazzle shades; headsets for telephones; headsets (for music); telephone answering machines; false coin detectors; teeth protectors; money counting and sorting machines; apparatus for measuring the thickness of skins and the leathers; electronic tags for goods; sports glasses; magnets; light-emitting electronic pointers; ear plugs; mobile telephones.

18 – Leather and imitation leather, goods made of these materials not included in other classes; animal skins, hides; trunks and suitcases; umbrellas, parasols and walking sticks; whips and saddlery; bags for campers and climbers; handbag frames; frames for umbrellas or parasols; bags; purses; travelling bags leather lining for footwear; travelling cases and key cases (leatherware); attaché cases; purses not made of precious metal; school bags; garment bags for travel; hatboxes of leather; leather bags for carrying children wheeled shopping bags (shopping trolleys); containers and boxes of leather or leatherboard; boxes of vulcanized fiber; pocket wallets; briefcases; school bags; vanity cases; animal collars; leather leashes; leather laces; umbrella covers; covers for horse saddles; backpacks; rucksacks; music cases; bags for merchandise packaging (envelopes pouches); leather thread; document holders (pocket wallets); suitcase handles; handles for walking sticks and umbrellas; whips; horse blankets; furniture coverings of leather; clothing for animals.

35 – Advertising; commercial business management; business administration; office work; services of assistance in the business management or commercial functions of an industrial or commercial company; organisation of exhibitions with commercial or advertising purposes; promotion services provided by a commercial company by means of a customer loyalty card; modelling for advertising or sales promotion; publishing of advertising texts; shop window dressing; services of assistance for the operation of commercial companies as franchises; demonstration of goods; organization of trade fairs for commercial or advertising purposes; sales promotion (for others); public auctions; services of promotion and management of commercial centres; services of assistance in the commercial functions of business consisting in the management of orders via global communication networks; retail and wholesale sales services, or sales services via global computer networks, by mail

order, by catalogue, by telephone, via televised broadcasts and via other electronic means; import-export agencies; online advertising on a computer network; procurement services for others (purchasing goods and services for other business); newspaper subscription services (for others); distribution of samples; compilation and systemization of information into computer databases; management of computer files; public relations; wholesale and retail services.

(260) AM 2012 64632 A

(800) 1092571

(731) SER DAYANIKLI TÜKETİM MALLARI
İÇ VE DIŞ TICARET SANAYİ LIMITED
ŞİRKETİ
Organize Sanayi Bölgesi 11., Cad No: 14,
Kayseri, Turkey

(540)

OSCAR

(591) Black, white

(511)

9 – Electric steam irons, electric press irons.

11 – Device for heating and steam generating installations; stoves, natural gas stoves; boilers, steam boilers, heat exchangers not parts of machines, burners for heating and natural gas installations; room heater, water heaters which can also be used as room heaters, water heaters, radiators, heat pumps, electrical water boilers, solar energy collectors and devices, climatization devices and ventilation devices; air conditioners, electric fans for household purposes, ventilators, air-conditioners including those for vehicles, air purifying and filtering machines and their accessories for rooms, cooling apparatus and installations; refrigerators, deep freezers, ice boxes, ice machines and devices, cooking and boiling apparatus and installations; electrical pans, pressure cookers (electrical), toast machines, toasters, deep fryers (electrical), barbecues, grills, ovens, furnaces, electrical cooking utensils, pop corn machines, electrical autoclaves, electrical coffee and tea makers, electrical kettles, electrical hair dryers, hand drying apparatus, skin moisturizing apparatus, solarium apparatus, electrical laundry dryers, water softening apparatus; water purification apparatus and installations; waste purification installations, lighters used in kitchen as a part of cooking and heating device, electrical heating apparatus, heating apparatus for solid, liquid or gas fuels; kitchen ranges, industrial type bakers' ovens, industrial type drying installations, industrial type cooling installations, cooling towers, cold storages, taps for water and gas installations, level controlling valves in tanks, regulating valves for tanks; taps and fountains for automatic watering installations; handsets and spirals for showers.

(260) AM 2012 64669 A

(800) 1092698

(731) Meda AB

Pipers väg 2 A, Box 906, SE-170 09 Solna,
Sweden

(540)

AZEFLU

(591) Black, white

(511)

5 – Pharmaceutical and veterinary preparations.

(260) AM 2012 64670 A

(800) 1092699

(731) Meda AB

Box 906, SE-170 09 SOLNA, Sweden

(540)

SYNAZE

(591) Black, white

(511)

5 – Pharmaceutical and veterinary preparations.

(260) AM 2012 64671 A

(800) 1092710

(731) OBSHCHESTVO S OGRANICHENNOY
OTVETSTVENNOSTYU "REKONA"
Staropetrovskiy proezd,1, stroenie 1,
RU-125130 Moscow, Russian Federation

(540)



(591) Golden

(511)

33 – Alcoholic beverages (except beer), namely aperitifs; arak [arrack]; brandy; wine; piquette; whisky; vodka; gin; digesters [liqueurs and spirits]; cocktails; liqueurs; alcoholic beverages, except beer; alcoholic beverages containing fruit; spirits [beverages]; distilled beverages; hydromel [mead]; peppermint liqueurs; bitters; rum; sake; cider; rice alcohol; alcoholic extracts; fruit extracts, alcoholic; alcoholic essences.

(260) AM 2012 64672 A

(800) 1092722

(731) OTKRYTOE AKTSIONERNOE

OBSHCHESTVO KONTSEERN "KALINA"

80, ul. Komsomolskaya, RU-620138

Ekaterinburg, Russian Federation

(540)

Beautology

(591) Black, white

(511)

3 – Abrasives; amber (perfume); scale removing preparations for household purposes; antiperspirants; antistatic preparations for household purposes; breath freshening sprays; canned pressurized air for cleaning and dusting purposes; hair balsams; lip balms; shaving stones, antiseptic; polishing stones; abrasive paper; emery paper; polishing paper; petroleum jelly for cosmetic purposes; cotton wool for cosmetic purposes; cotton pads; cotton sticks for cosmetic purposes; aromatics (essential oils); cake flavourings (essential oils); flavourings for beverages (essential oils); sachets for perfuming linen; scented water; javelle water; lavender water; eau de parfum; toilet water; laundry wax; floor wax; non-slipping wax for floors; moustache wax; tailors' wax; polish for furniture and flooring; shoe wax; cosmetic gels; hair setting gels; heliotropine; shower gels; dental bleaching gels; geraniol; make-up; deodorants for personal use; roll-on deodorants; solid deodorants; stick deodorants; scented wood; perfumes; non-slipping liquids for floors; wind-screen cleaning liquids; greases for cosmetic purposes; volcanic ash for cleaning; perfumery; decorative transfers for cosmetic purposes; ionone (perfumery); smoothing stones; eyebrow pencils; lip pencils; cosmetic pencils; silicon carbide (abrasive); carbides of metal (abrasives); alum stones (antiseptic); tripoli stone for polishing; adhesives for affixing false eyelashes; adhesives for affixing false hair; hair conditioners; quillaia bark for washing; corundum (abrasive); laundry blueing; beard dyes; colorants for toilet purposes; cosmetic dyes; laundry starch; cosmetic creams; skin whitening creams; hand care cream; foot care cream; creams for leather; jewellers' rouge; incense; hair spray; nail polish; after-shave lotions; hair lotions; lotions for cosmetic purposes; beauty masks; hair masks; oils for perfumes and scents; oils for cosmetic purposes; oils for toilet purposes; essential oils; essential oils of cedarwood; essential oils of lemon; oils for cleaning purposes; bergamot oil; gaultheria oil; jasmine oil; lavender oil; almond oil; rose oil; oil of turpentine for degreasing; adhesives for cosmetic purposes; whitening; cleaning chalk; almond milk for cosmetic purposes; cleansing milk for toilet purposes; musk (perfumery); soap; disinfectant soap; baby soap; deodorant soap; shaving soap; soap for brightening textile; cakes of toilet soap; creamy soap; liquid soap; medicated soap; antiperspirant soap; soap for foot perspiration; moisturizing soap; nourishing soap; almond soap; mint for perfumery; styling mousse; cosmetic kits; emery; false nails; eau de cologne; bases for flower perfumes; joss sticks; polishing creams; pastes for razor strops; dentifrices; pumice stone; styling foam; hydrogen peroxide for cosmetic purposes; cosmetic peelings; abrasive cloth; glass cloth; lipsticks; pomades for cosmetic purposes; shaving pre-

parations; cosmetic preparations for baths; toiletries; hair waving preparations; laundry soaking preparations; sharpening preparations; smoothing preparations (starching); leather bleaching preparations; denture polishes; refurbishing preparations; mouth washes, not for medical purposes; cosmetic preparations for slimming purposes; laundry glaze; fabric softeners for laundry use; washing preparations; dry-cleaning preparations; colour-removing preparations; paint stripping preparations; varnish-removing preparations; floor wax removers (scouring preparations); rust removing preparations; nail care preparations; cleaning preparations; preparations for cleaning dentures; wallpaper cleaning preparations; preparations for cleaning waste pipes; color-brightening chemicals for household purposes (laundry); make-up powder; diamantine (abrasive); scouring solutions; false eyelashes; tissues impregnated with cosmetic lotions; saffrol; turpentine, for degreasing; scrubs; potpourris (fragrances); bleaching soda; washing soda, for cleaning; bath salts, not for medical purposes; bleaching salts; leather preservatives (polishes); fumigation preparations (perfumes); hair styling preparations; hair fixation preparations; ammonia (volatile alkali) (detergent); volatile alkali (ammonia) (detergent); astringents for cosmetic purposes; eyebrow cosmetics; stain removers; make-up preparations; sunscreen preparations; sun-tanning preparations (cosmetics); hair colorants; hair dyes; neutralizers for permanent waving; preparations to make the leaves of plants shiny; make-up removing preparations; cosmetic preparations for eyelashes; depilatory preparations; cosmetic preparations for skin care; body care preparation; boot cream; boot polish; shoe cream; shoe polish; cosmetics; cosmetics for animals; mascara; detergents other than for use in manufacturing operations and for medical purposes; cleaning preparations for bath and shower; gel cleaning preparations; creamy cleaning preparations; degreasers other than for use in manufacturing processes; bleaching preparations (decolorants) for cosmetic purposes; antiperspirants (toiletries); talcum powder, for toilet use; terpenes (essential oils); cloths impregnated with a detergent for cleaning; shampoos; shampoos for pets; glass paper; sandpaper; soda lye; extracts of flowers (perfumes); oil.

5 – Acaricides; aconitine; alkaloids for medical purposes; algicides; aldehydes for pharmaceutical purposes; dental amalgams of gold; dental amalgams; amino acids for veterinary purposes; amino acids for medical purposes; antibiotics; aluminium acetate for pharmaceutical purposes; acetates for pharmaceutical purposes; germicides; balms for medical purposes; hygienic bandages; bandages for dressings; biocides; bracelets for medical purposes; anti-rheumatism bracelets; bromine for pharmaceutical purposes; paper for mustard plasters; fly catching paper; mothproofing paper; petroleum jelly

for medical purposes; vaccines; oxygen baths; antiseptic cotton; absorbent cotton; cotton for medical purposes; dietetic substances adapted for medical use; radiological contrast substances for medical purposes; nutritive substances for microorganisms; radioactive substances for medical purposes; bismuth subnitrate for pharmaceutical purposes; melissa water for pharmaceutical purposes; sea water for medicinal bathing; mineral water for medical purposes; thermal water; edible plant fibers, non-nutritive; molding wax for dentists; gases for medical purposes; guaiacol for pharmaceutical purposes; hematogen; hemoglobin; hydrastine; hydrastinine; glycerine for medical purposes; glycerophosphates; glucose for medical purposes; gentian for pharmaceutical purposes; hormones for medical purposes; mustard for pharmaceutical purposes; mustard plasters; mud for baths; medicinal mud; gamboge for medical purposes; gurjun (gurjon, gurjan) balsam for medical purposes; deodorants, other than for personal use; deodorants for clothing and textiles; diastase for medical purposes; digitalin; additives to fodder for medical purposes; mineral food-supplements; nutritional additives for medical purposes; yeast for pharmaceutical purposes; gelatin for medical purposes; cod liver oil; isotopes for medical purposes; insecticides; iodine for pharmaceutical purposes; iodides for pharmaceutical purposes; alkaline iodides for pharmaceutical purposes; iodoform; calomel; cream of tartar for pharmaceutical purposes; tartar for pharmaceutical purposes; camphor for medical purposes; capsules for medicines; candy for medical purposes; hemostatic pencils; wart pencils; caustic pencils; carbolineum (parasiticide); caustics for pharmaceutical purposes; cachou for pharmaceutical purposes; quassia for medical purposes; quebracho for medical purposes; oxygen for medical purposes; gallic acid for pharmaceutical purposes; acids for pharmaceutical purposes; adhesives for dentures; adhesive bands for medical purposes; cocaine; collodion for pharmaceutical purposes; corn rings for the feet; anti-rheumatism rings; candy, medicated; confectionery, medicated; angostura bark for medical purposes; barks for pharmaceutical purposes; cedar wood for use as an insect repellent; condurango bark for medical purposes; croton bark; mangrove bark for pharmaceutical purposes; myrobalan bark for pharmaceutical purposes; cinchona for medical purposes; medicinal roots; rhubarb roots for pharmaceutical purposes; lint for medical purposes; starch for dietetic or pharmaceutical purposes; creosote for pharmaceutical purposes; blood for medical purposes; cultures of microorganisms for medical and veterinary use; curare; dental lacquer; liquorice for pharmaceutical purposes; lactose; milk sugar (lactose); adhesive plaster; court plaster; sticking plasters; medicines for alleviating constipation; lecithin for medical purposes; lotions for veterinary

purposes; dog lotions; lotions for pharmaceutical purposes; lupulin for pharmaceutical purposes; magnesia for pharmaceutical purposes; liniments; ointments for pharmaceutical purposes; sunburn ointments; mercurial ointments; frostbite salve for pharmaceutical purposes; gauze for dressings; anti-horse-fly oils; medicinal oils; mustard oil for medical purposes; camphor oil for medical purposes; castor oil for medical purposes; oil of turpentine for pharmaceutical purposes; dill oil for medical purposes; dental mastics; dental abrasives; dental impression materials; teeth filling material; dressings, medical; surgical dressings; drugs for medical purposes; medicines for veterinary purposes; serotherapeutic medicines; medicines for human purposes; medicines for dental purposes; menthol; medicinal drinks; moleskin for medical purposes; albuminous milk; milk of almonds for pharmaceutical purposes; royal jelly (for medical purposes); milk ferments for pharmaceutical purposes; Irish moss for medical purposes; lacteal flour for babies; flour for pharmaceutical purposes; linseed meal for pharmaceutical purposes; fishmeal for pharmaceutical purposes; fly catching adhesives; mint for pharmaceutical purposes; first-aid boxes, filled; medicine cases, portable, filled; dietetic beverages adapted for medical purposes; malted milk beverages for medical purposes; narcotics; medicinal infusions; tincture of iodine; eucalyptol for pharmaceutical purposes; tinctures for medical purposes; opium; opodeldoc; decoctions for pharmaceutical purposes; antiparasitic collars for animals; stick liquorice for pharmaceutical purposes; sulphur sticks (disinfectants); pants, absorbent, for incontinents; pectin for pharmaceutical purposes; napkins for incontinents; pepsins for pharmaceutical purposes; peptones for pharmaceutical purposes; hydrogen peroxide for medical purposes; pills for pharmaceutical purposes; leeches for medical purposes; blood plasma; plasters for medical purposes; eyepatches for medical purposes; poultices; compresses; scapulars for surgical purposes; bunion pads; breast-nursing pads; pomades for medical purposes; powder of cantharides; pyrethrum powder; belts for sanitary napkins (towels); anti-uric preparations; bacterial preparations for medical and veterinary use; bacteriological preparations for medical and veterinary use; balsamic preparations for medical purposes; albuminous preparations for medical purposes; biological preparations for veterinary purposes; biological preparations for medical purposes; veterinary preparations; bismuth preparations for pharmaceutical purposes; vitamin preparations; diagnostic preparations for medical purposes; therapeutic preparations for the bath; hemorrhoid preparations; preparations for callouses; preparations to facilitate teething; preparations for the treatment of burns; fumigation preparations for medical purposes; organotherapy preparations; air freshening preparations;

air purifying preparations; bronchodilating preparations; sterilising preparations; soil-sterilising preparations; corn remedies; pharmaceutical preparations for treating dandruff; pesticides; herbicides; weed killers; preparations for destroying dry rot fungus; larvae exterminating preparations; fly destroying preparations; preparations for destroying mice; slug exterminating preparations; vermin destroying preparations; pharmaceutical preparations for skin care; contact lens cleaning preparations; preparations of lime for pharmaceutical purposes; bath preparations, medicated; medicinal hair growth preparations; opiates; anticryptogamic preparations; preparations of trace elements for human and animal use; sulphonamides (medicines); pharmaceutical preparations; sunburn preparations for pharmaceutical purposes; enzyme preparations for veterinary purposes; enzyme preparations for medical purposes; chemico-pharmaceutical preparations; chemical preparations for veterinary purposes; chemical preparations for the diagnosis of pregnancy; chemical preparations for medical purposes; chemical preparations to treat wheat blight (smut); vine disease treating chemicals; chemical preparations to treat mildew; chemical preparations for treating phylloxera; chemical preparations for pharmaceutical purposes; chilblain preparations; mothproofing preparations; eye-wash; lead water; chemical conductors for electrocardiograph electrodes; albuminous foodstuffs for medical purposes; food for babies; dietetic foods adapted for medical purposes; by-products of the processing of cereals for medical purposes; menstruation bandages; panty liners (sanitary); radium for medical purposes; hydrated chloral for pharmaceutical purposes; solvents for removing adhesive plasters; vaginal washes; solutions for contact lenses; chemical reagents for medical or veterinary purposes; gum for medical purposes; rubber for dental purposes; chewing gum for medical purposes; insect repellent incense; insect repellents; repellents for dogs; sanitary napkins; sanitary towels; tissues impregnated with pharmaceutical lotions; sarsaparilla (for medical purposes); sugar for medical purposes; asthmatic tea; fumigating pastilles; fumigating sticks; suppositories; linseed for pharmaceutical purposes; tobacco-free cigarettes for medical purposes; siccatives (drying agents) for medical purposes; syrups for pharmaceutical purposes; turpentine for pharmaceutical purposes; milking grease; greases for veterinary purposes; greases for medical purposes; soporifics; bicarbonate of soda for pharmaceutical purposes; salts for mineral water baths; bath salts for medical purposes; salts for medical purposes; potassium salts for medical purposes; sodium salts for medical purposes; smelling salts; mineral water salts; malt for pharmaceutical purposes; semen for artificial insemination; alcohol for pharmaceutical purposes; alloys of precious metals for dental pur-

poses; ergot for pharmaceutical purposes; anaesthetics; antiseptics; analgesics; adjuvants for medical purposes; styptic preparations; anthelmintics; disinfectants for hygiene purposes; disinfectants for chemical toilets; appetite suppressants for medical purposes; medical preparations for slimming purposes; parasiticides; mouthwashes for medical purposes; febrifuges; depuratives; animal washes; detergents for medical purposes; cattle washes; dog washes; vesicants; articles for headache; remedies for perspiration; remedies for foot perspiration; chemical contraceptives; antiparasitic preparations; evacuants; laxatives; purgatives; tonics (medicines); nervines; digestives for pharmaceutical purposes; media for bacteriological cultures; steroids; strychnine; serums; sal ammoniac lozenges; menstruation tampons; vulnerary sponges; thymol for pharmaceutical purposes; surgical cloth (tissues); surgical tissues; smoking herbs for medical purposes; medicinal herbs; tranquillizers; surgical implants (living tissues); sanitary panties; charcoal for pharmaceutical purposes; fennel for medical purposes; porcelain for dental prostheses; phenol for pharmaceutical purposes; enzymes for veterinary purposes; enzymes for medical purposes; ferments for pharmaceutical purposes; formic aldehyde for pharmaceutical purposes; phosphates for pharmaceutical purposes; fungicides; quinine for medical purposes; chinoline for medical purposes; diabetic bread; chloroform; flowers of sulphur for pharmaceutical purposes; cement for animal hooves; bone cement for surgical and orthopedic purposes; dental cements; herbs teas for medicinal purposes; reducing tea for medical purposes; eucalyptus for pharmaceutical purposes; tobacco extracts (insecticides); extracts of hops for pharmaceutical purposes; elixirs (pharmaceutical preparations); ethers for pharmaceutical purposes; esters for pharmaceutical purposes; cellulose ethers for pharmaceutical purposes; jujube, medicated; rat poison; poisons; bacterial poisons; jalap.

24 – Tissues of textile for removing make-up.

(260) AM 2012 64673 A

(800) 1092762

(731) ERREA'SPORT S.p.A.

Via G. Di Vittorio, 2/1, Frazione San Polo,
I-43056 TORRILE (PARMA), Italy

(540)



(591) Black, white

(511)

18 – Bags; multipurpose sports bags; handbags; bags of leather and imitations of leather; gentle-

men's handbags; canvas bags; bags for balls; camping, beach, travelling bags; key cases (leatherware); beach bags; bum bags; cosmetic bags sold empty; school rucksacks; trunks; travelling bags; valises; rucksacks; umbrellas; walking sticks; parasols; leatherware; briefcases; leather and imitations of leather; satchels; business cards cases; purses, not of precious metal; carrying cases for documents; sports bags; football bags; wetsuit bags.

25 – Sportswear and leisurewear for women and children, including jerseys, tee-shirts, vests, sweaters, pullovers, polo shirts, shirts, skirts, trousers, shorts, Bermuda shorts, jackets, overcoats, jeans, jerseys, neckties, suits, overalls, full tracksuits for sports teams; training suits; sports kits, including kits for football, five-a-side football, volleyball, rugby and basketball; clothing for football, five-a-side football, volleyball, rugby, basketball, tennis, cycling, golf, baseball, spinning, running and exercise in general, not included in other classes; trousers; ski suits; belts (clothing); belts for sports; footwear; shoes; shoes for sports, including shoes for football, five-a-side football, volleyball, rugby, basketball, tennis, cycling, golf, baseball, spinning, running, gymnastics and exercise in general, not included in other classes; ski boots; swim shoes; slippers; headwear; hats; caps; bonnets; ear muffs; sweatbands and headbands; hats and berets for sport in general; bandanas; gloves (clothing); mufflers; wristbands; stockings; socks; sweat-absorbent stockings; slippers; panty hose; underwear; briefs; brassieres; singlets; underpants; boxer shorts; g-strings; leg warmers; Bermuda shorts; elastic T-shirts; nightwear; beach clothes and swimwear; including bathing suits; swimming trunks; bath robes; rainwear.

28 – Bags adapted for carrying sporting articles; gymnastic apparatus; athletic training devices; gymnastic and sporting articles not included in other classes; balls for games; playground balls; gloves for goalkeepers; gloves for games; shin guards (sports articles); knee guards; body protectors for sports; sports equipment.

(260) AM 2012 64674 A
(800) 1092775
(731) AGC Glass Europe
Chaussée de La Hulpe 166, B-1170
Bruxelles, Belgium
(540)

PYROPANE

(591) Black, white
(511)
9 – Glass covered with an electrical conductor; parts and fittings for the aforesaid goods, not included in other classes.

19 – Building materials, not of metal; flat glass and sheet glass for building; fireproof glass for building; building glass; glass for windows; insulating fire retardant glass; fireproof glass (except building glass); glazings; double glazing; multiple glazing units; windows and window frames not of metal; parts and accessories for the aforesaid goods, not included in other classes.

21 – Unworked or semi-worked glass (except glass used in building); flat glass and sheet glass (except glass used in building); parts and accessories for the aforesaid goods, not included in other classes.

(260) AM 2012 64675 A
(800) 1092811
(731) SANOFI
54 rue La Boétie, F-75008 Paris, France
(540)

SANOFI

(591) Black, white
(511)
1 – Chemical preparations used for making pharmaceutical and cosmetic preparations.

9 – Audio and video cassettes, CD-ROMs and computer programs, for use in the pharmaceutical and medical field.

10 – Surgical and medical apparatus and instruments.

16 – Printed matter; prints; newspapers, magazines; journals; periodicals; pamphlets; books.

38 – Telecommunications; radio, electronic, telephone, computer and remote data processing communications; computer communication including via any Internet-type network; computer-assisted transmission of messages and images; transmission of pharmaceutical or medical information via any means including via any Internet-type network; transmission of information to all health professionals.

41 – Teaching; providing of training, training in the pharmaceutical and medical field; arranging and conducting of conferences, conventions and seminars; publishing of magazines, books, manuals and databases in the medical field.

42 – Scientific and technological services as well as research services, namely chemical research, biological and pharmaceutical research; computer software and database design and development.

44 – Medical services; veterinary services; hygiene and beauty care; pharmacy and health consultancy.

(260) AM 2012 64677 A

(800) 1092820

(731) Simfer Dayanikli Tüketim Marmülleri Ticaret ve Sanayi Anonim Şirketi
Evren Mah. Bahar Cad., Polat İş Merkezi,
A Blok Kat.4 No.9 Güneşli Bağcılar İstanbul
(TR), Turkey

(540)

CARINO

(591) Black, white

(511)

9 – Irons (terms considered too vague by the International Bureau – rule 13(2)(b) of the Common Regulations), electrical and steam irons, press irons.

11 – Device for heating and steam generating installations; stoves, natural gas stoves; boilers, steam boilers, exchangers, burners for heating and natural gas installations; room heater, water heaters which can also be used as room heaters, water heaters, radiators, heat pumps, electrical water boilers, solar energy collectors and devices, climatization devices and ventilation devices; air conditioners, fans (article blower), ventilators, air-conditioners including those for vehicles, air purifying and filtering machines and their accessories for rooms, cooling apparatus and installations; refrigerators, deep freezers, ice boxes, ice machines and devices, cooking and boiling apparatus and installations; electrical pans, pressure cookers (electrical), toast machines, toasters, deep fryers (electrical), barbecues, grills, ovens, furnaces, electrical cooking utensils, pop corn machines, electrical autoclaves, electrical coffee and tea machines, electrical kettles, electrical hair dryers, hand drying apparatus, skin moisturizing apparatus, solarium apparatus, electrical laundry dryers, water softening apparatus; water purification apparatus and installations; waste purification installations, lighters used in kitchen as a part of cooking and heating device, electrical heating apparatus, heating apparatus for solid, liquid or gas fuels; kitchen ranges, industrial type bakers' ovens, industrial type drying installations, industrial type cooling installations, cooling towers, cold storages, taps for water and gas installations, level controlling valves in tanks, regulating valves for tanks; taps and fountains for automatic watering installations; handsets and spirals for showers.

(260) AM 2012 64678 A

(800) 1092842

(731) TEDDY S.P.A.
Via Coriano, 58, Gros Rimini Blocco, 97,
I-47924 RIMINI, Italy

(540)



(591) Black, white

(511)

18 – Bags, handbags, pochettes, wallets, valises, trunks, beauty sets sold empty, briefcases, umbrellas, hip pouches and rucksacks.

25 – Clothing, especially dresses, skirts, trousers, shirts, blousons, overcoats, gabardines, jackets and pullovers, waistcoats, hats, mufflers, scarves, socks and tights, gloves, belts for clothing; shoes, boots, sandals, clogs and slippers.

35 – Retail services in shops and retail sales establishments for clothing and footwear, including, dresses, skirts, ladies' suits, trousers, shirts, blousons, overcoats, gabardines, jackets and pullovers, under-shirts, hats, mufflers, scarves, socks and tights, gloves, belts for clothing, handbags, sunglasses, shoes, boots, sandals, clogs and slippers; retail sales services in shops and retail sales establishments and stores for consignment sales presenting clothing, footwear, handbags; retail sale services in wholesale stores presenting clothing, footwear and handbags; commercial or administrative assistance in connection with the establishment and/or operation of the above-mentioned stores and establishments.

(260) AM 2012 64679 A

(800) 1092868

(731) OSRAM AG
Hellabrunner Straße 1, 81543 München,
Germany

(540)

LEDDriving

(591) Black, white

(511)

9 – Apparatus and instruments for conducting, switching, transforming, accumulating, regulating or controlling electricity; lasers, not for medical purposes; light control systems; light-emitting diodes, including organic light-emitting diodes, laser diodes, especially power laser diodes, semiconductor power laser diodes for material processing, semi-conductor components, fibre optical light conductors inclusive LED operated fibre optical light conductors, optocouplers, optical sensors, light barriers, light-emitting diode modules (modules with light functions, constructed from light-emitting diodes, including organic light-emitting diodes with light functions), especially for lighting and signaling applications, displays, including organic light-emitting diode technology displays; parts for all the aforesaid goods, included in this class.

11 – Apparatus for lighting, especially electric lamps and luminaires; lighting apparatus and systems consisting of lighting apparatus, especially lighting apparatus and systems based on light emitting diodes (LEDs), including organic light-

emitting diodes, LED lamps and LED luminaires and their parts, lighting lamps and lighting apparatus and facilities consisting of lighting lamps and lighting apparatus as well as their parts (included in this class) on basis of light emitting diodes (LED); LED-modules, namely modules constructed of LED's (inclusive organic LED's) with light functions and for lighting applications.

(260) AM 2012 64680 A

(800) 1092869

(731) INDUSTRIA DE DISEÑO TEXTIL, S.A.
(INDITEX, S.A.)

Avda. de la Diputación, Edificio Inditex,
E-15142 ARTEIXO (A CORUÑA), Spain

(540)

ZARA BASIC

(591) Black, white

(511)

3 – Bleaching preparations and other substances for laundry use; cleaning, polishing, degreasing and abrasive preparations; soap; perfumery, essential oils, cosmetics, hair lotions; dentifrices; abrasives; oils for toilet purposes; adhesives for cosmetic purposes; adhesives for affixing false eyelashes; adhesives for affixing false hair; eau de Cologne; toilet water; scented water; starch for laundry purposes; blueing for laundry; cotton sticks for cosmetic purposes; shoe wax; laundry wax; tailors' wax; shoemakers' wax; mustache wax; depilatory wax; parquet floor wax; non-slipping wax for floors; waxes for leather; shampoos for pets; shampoos; hair dyes; cosmetic preparations for eyelashes; cosmetics for animals; eyebrow cosmetics; cosmetic creams; creams for footwear; floor wax removers; bleaching preparations [decolorants] for cosmetic purposes; deodorants for personal use; detergents other than for use in manufacturing operations and for medical purposes; starch for laundry; extracts of flowers (perfumes); greases for cosmetic purposes; incense; soap for foot perspiration; disinfectant soap; deodorant soap; hair and nail sprays; cosmetic pencils; lipsticks; cleansing milk for toilet purposes; lye; shaving products; after-shave lotions; lotions for cosmetic purposes; scented wood; beauty masks; decorative transfers for cosmetic purposes; cosmetic kits; cloths impregnated with a detergent for cleaning; cakes of toilet soap; perfumes; false nails and eyelashes; pumice stone; make-up powder; pomades for cosmetic purposes; potpourris; cosmetic preparations for slimming purposes; cosmetic preparations for baths; sunscreen preparations; hair waving preparations; sunscreen products; cosmetic products for skin care; dry-cleaning products; make-up products; toiletries; depilatory products; make-up removing preparations; mouth washes, not for medical purposes; nail care products; sachets for

perfuming linen; nail polish removing products; color-removing products; color-brightening chemicals for household purposes (laundry); stain removers; bath salts not for medical purposes; fabric softeners for laundry use; talcum powder for toiletry purposes; cosmetic dyes; tissues impregnated with cosmetic lotions.

18 – Leather and imitations of leather, and goods made of these materials and not included in other classes; animal skins; trunks and traveling bags; umbrellas, parasols and walking sticks; whips, harness and saddlery; pads for horse saddles; umbrella rings; blinkers (harness); handbag frames; frames for umbrellas or parasols; harness for animals; harness; saddlery; shoulder belts [straps] of leather; mountaineering sticks; walking-stick seats; bags for campers, bags for sports; sling bags for carrying infants; bags (envelopes, pouches) of leather, for packaging; tool bags of leather, empty; bags for climbers; beach bags; net bags for shopping; wheeled shopping bags; traveling bags; shopping bags; bags for mountaineering, camping and for the beach; travel bags; handbags; sports bags; boxes of leather or leather board; muzzles; bridles; halters; hat boxes of leather; boxes of vulcanized fibre; purses (handbags); pocket wallets; briefcases; school satchels and document holders; leatherboard; bands of leather; vanity cases, not fitted; traveling trunks; collars for animals; leather leads; straps for skates; straps for soldiers' equipment; harness straps; straps of leather (saddlery); straps for animals; imitation leather; butts; handles for suitcases; walking stick handles; umbrella handles; sheaths of leather, for packaging; stirrups; traveling sets and key cases (leatherware); bits for animals (harness); umbrella covers; casings, of leather, for springs; saddle cloths for horses; harness fittings; trimmings of leather for furniture; decorations for horses; leather thread; whips; haversacks; attaché cases; horse blankets; school bags; backpacks; moleskin (imitation of leather); purses; nose bags; hides (animal skins); chamois leather, other than for cleaning purposes; curried skins; parts of rubber for stirrups; furniture coverings of leather; reins; knee-pads for horses; clothing for pets; envelopes of leather, for packaging; suit holders; riding saddles; fastenings for saddles; card cases (notecases); leather straps; traces (harness); valves of leather; music cases.

25 – Clothing, footwear, headgear; coats; bath robes; esparto shoes or sandals; non-slipping devices for footwear; clothing articles; bibs, not of paper; bath slippers; headbands (clothing); dressing gowns; caps; boas (necklets); teddies (underwear); berets; footmuffs, not electrically heated; pockets for clothing; lace boots; boots; half-boots; scarves; socks; sports and beach footwear; pants; shirts; tee-shirts; singlets; bodices; layettes (clothing); shirt yokes; boot uppers; hoods; waistcoats; shawls; fis-

hing vests; jackets; stuff jackets; belts (clothing); money belts (clothing); caps; slippers (undergarments); neckties; corsets (underclothing); detachable collars; collars; aprons (clothing); petticoats; slippers; collars (clothing); fur stoles; girdles; skirts; ready-made linings (parts of clothing); headscarves; overcoats; gabardines (clothing); caps; shower caps; bathing caps and sandals; bonnets; gloves (clothing); fittings of metal for footwear; waterproof clothing; jerseys (clothing); underwear; liveries; sock suspenders; stocking suspenders; muffs (clothing); mantillas; stockings; mittens; ear muffs (clothing); footwear uppers; trousers; pantyhose; babies' diapers of textile; babies' pants; pocket squares; Ascots; parkas; shirt fronts; pelerines; pelisses; furs (clothing); pajamas; inner soles; spats; knitwear; tips for footwear; cuffs; heelpieces for footwear; clothing for gymnastics; outerclothing; underclothing; sandals; saris; underpants; dress shields; hats; soles for footwear; heels; studs for football boots; braces for clothing; headgear for wear; wimples; togas; trouser straps; bathing suits; masquerade costumes; wet suits for water-skiing; clothing for gymnastics; suits; turbans; uniforms; veils; clothing of leather; knitted clothing; imitation leather clothing; paper clothing; beach clothes; dresses; clothing for motorists and cyclists; cap peaks; slippers; gymnastic shoes; shoes; wooden shoes.

(260) AM 2012 64681 A

(800) 1092871

(731) SHENZHEN CREATION JEWELRY CO., LTD.

6 Floor, West Floor 5 and East Floor 2,
Building 4, Shuibei Industrial Park Luohu
District, Shenzhen, China

(540)



(591) Black, white

(511)

14 – Alloys of precious metal; silver ornaments; silver arts and crafts; chains (jewellery, jewelry (Am.)); precious stones; rings (jewellery, jewelry (Am.)); jade carving watches.

35 – Advertising; business management assistance; franchise business management; sales promotion (for others); personnel management consultancy; relocation services for businesses; compilation of information into computer databases; accounting; sponsorship search; marking tender prices.

36 – Insurance underwriting; financial management; jewelry appraisal; real estate agencies; brokerage; surety services; factoring; mortgage services; charitable fund raising; financial information.

(260) AM 2012 64682 A

(800) 1092882

(731) BAĞTUR OTOMOTİV SANAYİ VE
TİCARET LİMİTED SİRKETİ

Namik Kemal Caddesi, Çakiraga Cami
Sokak, Göktas, İshani No:2 Kat:2 No:203,
Aksaray-İstanbul, Turkey

(540)

BAGSTAR

(591) Black, white

(511)

7 – Machines, machine tools and industrial robots to process and give shape to wooden, metal, glass, plastic materials and mine; construction machines, working machines; lifting, carrying and transmission machines including elevators, moving staircases and winches; machines and robots to process grain, fruit, vegetable and food; agricultural tools and machinery; engines and motors not for land vehicles, electrical motors, their parts and apparatus except for land vehicles; bearings, ball and rolling bearings; hydraulic jacks for wheel removing and mounting; alternators, generators, electricity generator, solar-powered electricity generators; machines for painting, automatic spray guns for paint, electric punching machines and guns, electric glue guns, machine guns for compressed air and liquids, electric hand drills, hand saws (machines), electric air compressors, washing installations for vehicles; welding machines, namely, electric welding machines, electric point welding machines; printing machines and apparatus; packaging machines, bottling and capping machines, industrial printing machines, namely, labelers, classifiers; textile machines, sewing machines; pumps other than machine and motor parts; electrically operated kitchen machines used for chopping, grinding, crushing, trimming and crumbling; washing machines, dishwashers, floor polishing machines, carpet cleaning machines; electric vacuum cleaners and their parts.

12 – Automobiles, trucks, buses, tow trucks, tractors, refrigerated vehicles, namely, trailers, trucks, vehicles mixing and transporting concrete, military vehicles for transport purposes, namely, boats, automobiles; ambulances, watering trucks, hose trucks, sports cars, motorized golf carts, garbage trucks, mobile funeral service vehicles, namely, hearses; trailers for transporting mobile kitchens, forklifts, namely, fork lift trucks, sewage trucks, automobile engines, automobile chassis, axles for land vehicles; automobile parts, namely, ax-

letrees, connecting rods for land vehicles other than parts of motors and engines; transmissions gear-boxes, parts for land vehicles, namely, clutches; jet engines for use with land vehicles, transmission chains for land vehicles, gears for vehicles, land vehicle tires, wheel rims for vehicles, connecting pushrods for land vehicles, not being engine parts; automobile bodies, automobile bumpers, land vehicle doors, automobile hoods, automobile fenders, vehicle parts, namely shock absorbers; hydraulic, pneumatic, electric or mechanical suspension springs for motor cars, vehicle parts, namely cylinders and parts, namely, springs for shock absorbers for motor cars, brake cylinders; brakes for land vehicles, brake linings and shoes for land vehicles, fuel tanks for vehicles, namely, land vehicles, automobiles; mudguards of bicycles and motorbikes, bicycles, motorbikes, mopeds and motorized scooters, and their bodies, handlebars; land vehicle trunks, tipping bodies for lorries, tractor trailers, frigorific trunks for trailers; vehicle seats, head supports for motor car seats, safety seats for children in vehicles, shaped and fitted vehicle covers, sunshades for automobile windshields, trailer hitches for vehicles profile bars made of metal or synthetic materials for vehicles for decoration purposes; directional signals for vehicles, windshield wipers for vehicles, windshield wiper arms for land vehicles; tires, inner tubes and tubeless tires, all for vehicles; tire-fixing sets comprised of tire patches and tire valves; rubber patches for vehicle tires, adhesive rubber patches for repairing inner tubes; valves for vehicle tires; windows for vehicles, safety windows for vehicles, rearview mirrors and side mirrors for vehicles; land vehicle parts, namely tire chains, car door wedges; car door wedges, bicycle and ski carriers, saddles for vehicles, namely, bicycles; tire inflating pumps; anti-theft alarms for motor cars, horns for vehicles, namely automobiles; safety belts for automobiles, airbags for vehicles, vehicle seat covers; baby strollers, wheelchairs, baby carriages; railway hand cars, shopping carts, single or multi-cycle, railway hand cars, carrier tricycles, and household goods handling carts, namely shopping carts; railway vehicles, namely locomotives, trains, tramways, street cars, wagon cars; water vehicles and parts, namely, rowboats, motorboats, ships, yachts, cutter boats, boats, ferryboats, canoes, steering gears, rudders, spars, timbers, fenders, screw propellers, funnels (smokestacks), hulls for water vehicles; air vehicles and parts, namely dirigible air balloons, airplanes, helicopters, space vehicles and parachutes.

35 – Advertising agencies services, marketing and publicity bureaus services including commercial or advertisement exhibition and trade fair organization services; providing office functions; business management; business administration; import and export agencies; business investigations, evaluations, ex-

pert appraisals, information and research of Industrial and commercial goods; auctioneering; the bringing together, for the benefit of others, of spare parts for vehicles, machines, machine tools and industrial robots and vehicle parts (excluding the transport thereof), enabling customers to conveniently view and purchase those goods; such services may be provided by retail stores, wholesale outlets, through mail order catalogues or by means of electronic media, for example, through web sites or television shopping programmes.

(260) AM 2012 64683 A

(800) 1092886

(731) STORA ENSO OYJ

Kanavaranta 1, FI-00160 Helsinki, Finland

(540)



(591) Black, white

(511)

1 – Chemicals used in industry, science and photography, as well as in agriculture, horticulture and forestry; chemical substances for preserving food-stuffs; pulp; paper pulp; fluffpulp.

16 – Paper, cardboard and goods made from these materials, not included in other classes; printed matter; bookbinding material; photographs; stationery; adhesives for stationery or household purposes; artists' materials; paint brushes; typewriters and office requisites (except furniture); instructional and teaching material (except apparatus); plastic materials for packaging (not included in other classes); printers' type; printing blocks; paper; cardboard; paper and cardboard for multiple purposes; paper and cardboard for packaging purposes; paper and cardboard for graphic and printing purposes; corrugated paper and cardboard; cores and coreboard; book and printing paper.

19 – Building materials including sawn timber for use in joinery, furniture and construction, sawn timber for use as building materials for furniture, beams, doors, door frames, windows, window frames, interior panels, interior and exterior walls and wall elements, partition elements, flooring, roofing, ceiling, scaffoldings, garden furniture, exterior claddings, saunas, rough and semi-finished sawn wood products and components; laminated building materials; prefabricated construction elements for external and internal walls, ceilings and roofs.

(260) AM 2012 64685 A
 (800) 1092888
 (731) STORA ENSO OYJ
 Kanavaranta 1, FI-00160 Helsinki, Finland
 (540)



storaenso

(591) Black, white
 (511)

1 – Chemicals used in industry, science and photography, as well as in agriculture, horticulture and forestry; chemical substances for preserving food-stuffs; pulp; paper pulp; fluffpulp.

16 – Paper, cardboard and goods made from these materials, not included in other classes; printed matter; bookbinding material; photographs; stationery; adhesives for stationery or household purposes; artists' materials; paint brushes; typewriters and office requisites (except furniture); instructional and teaching material (except apparatus); plastic materials for packaging (not included in other classes); printers' type; printing blocks; paper; cardboard; paper and cardboard for multiple purposes; paper and cardboard for packaging purposes; paper and cardboard for graphic and printing purposes; corrugated paper and cardboard; cores and core-board; book and printing paper.

19 – Building materials including sawn timber for use in joinery, furniture and construction, sawn timber for use as building materials for furniture, beams, doors, door frames, windows, window frames, interior panels, interior and exterior walls and wall elements, partition elements, flooring, roofing, ceiling, scaffoldings, garden furniture, exterior claddings, saunas, rough and semi-finished sawn wood products and components; laminated building materials; prefabricated construction elements for external and internal walls, ceilings and roofs.

(260) AM 2012 64699 A
 (800) 1092935
 (731) ZAKŁADY FARMACEUTYCZNE
 "POLPHARMA" SPÓŁKA AKCYJNA
 Peplńska 19, PL-83-200 STAROGARD
 GDANSKI, Poland
 (540)

MEMOTROPIL

МЕМОТРОПИЛ

(591) Black, white
 (511)

5 – Pharmaceutical products.

(260) AM 2012 64700 A
 (800) 1092936
 (731) ZAKŁADY FARMACEUTYCZNE
 "POLPHARMA" SPÓŁKA AKCYJNA
 Peplńska 19, PL-83-200 STAROGARD
 GDANSKI, Poland
 (540)

DIACARB
ДИАКАРБ

(591) Black, white

(511)

5 – Pharmaceutical products.

(260) AM 2012 64701 A
 (800) 1092991
 (731) NUFARM
 28, boulevard Camélinat, F-92230
 GENNEVILLIERS, France
 (540)

ALLUM

(591) Black, white

(511)

5 – Pesticides, fungicides, herbicides, insecticides.

(260) AM 2012 64702 A
 (800) 1093004
 (731) HANSA TEE GMBH
 Enge Str. 1, 21335 Lüneburg, Germany
 (540)

ALDERMANN TEE

(591) Black, white

(511)

30 – Tea.

(260) AM 2012 64703 A
 (800) 1093027
 (731) BSH Bosch und Siemens Hausgeräte GmbH
 Carl-Wery-Str. 34, 81739 München, Germany
 (540)

IQ800

(591) Black, white

(511)

7 – Electric household and kitchen machines and apparatus (included in this class), in particular electric kitchen machines and apparatus, including mincing machines, mixing and kneading machines, fruit pressing machines, electric juice extractors, juice centrifuges, grinders, slicing machines, electric motor driven tools, electric can openers, knife sharpeners as well as machines and devices for the preparation of beverages and/or food, pumps for dispensing cooled beverages, for use in combi-

nation with appliances for cooling of beverages; electric waste disposal units, including waste masticators and compressors; dishwashers; electric machines and appliances for treating laundry and clothing, including washing machines, spin driers, laundry presses, ironing machines (included in this class); electric cleaning apparatus for household use, including window cleaning devices and shoe cleaning devices, vacuum cleaners; wet and dry vacuum cleaners; parts for the aforementioned goods, included in this class, in particular hoses, pipes, dust filters and dust filter bags, all for vacuum cleaners.

11 – Heating, steam producing and cooking devices, in particular ovens, cooking, baking, frying, grilling, toasting, thawing and food and plate warming apparatus, hot water appliances; immersion heaters, cooking pots, electric; microwave appliances, waffle irons (electric); egg boiling apparatus, deep fryers (electric); electric tea and coffee making apparatus, electric espresso machines, electric coffee machines (included in this class); cooling devices, in particular refrigerators, freezers, cooling cabinets, beverage cooling apparatus; combination apparatus for cooling and freezing, deep freezing apparatus, ice-makers; ice-cream makers; dryers, in particular laundry dryers, tumble dryers for laundry use; hand dryers; hair dryers; infrared lamps (not for medical purposes); electric heating pads (not for medical purposes); electric heating covers (not for medical purposes); ventilation devices, in particular ventilators, grease filter devices and extractor devices, including extractor hoods; air conditioning devices and devices to improve air quality, air humidifiers, air deodorising apparatus; deodorising apparatus, not for personal use, air purifying apparatus; water piping devices, as well as sanitary equipment, in particular fittings for steam, air and water piping equipment, warm water devices, storage water heaters and continuous flow water heaters; kitchen sinks; heat pumps; parts of all the aforementioned goods included in this class; taps for dispensing cooled beverages, for use in combination with appliances for cooling of beverages.

(260) AM 2012 64706 A

(800) 1093052

(731) IMPETUS PORTUGAL-TÊXTEIS, S.A.

Rua da Fabrica, 45 Apúlia, P-4740-141

Esposende, Portugal

(540)

IMPETUS
TEXT

(591) Black, white

(511)

25 – Clothing, shoes, headgear.

(260) AM 2012 64707 A

(800) 1093056

(731) Ballantines Intervest Ltd

OMC Chambers, Wickhams Cay 1, Road

Town, Tortola, British Virgin Islands

(540)

INTERTOOL

(591) Black, white

(511)

7 – Machines and machine tools; motors and engines (except for land vehicles); machine coupling and transmission components (except for land vehicles); agricultural implements other than hand-operated; incubators for eggs; acetylene cleaning apparatus; adhesive bands for pulleys; adhesive tape dispensers, machines; aerated beverages making machines; aerated water making apparatus; aerating pumps for aquaria; aerators; aerocondensers; aeronautical engines; aeroplane engines; agitators; agricultural elevators; agricultural machines; air brushes for applying colour; air condensers; air cushion devices for moving loads; engines for air cushion vehicles; air pumps, garage installations; air suction machines; alternators; anti-friction bearings for machines; anti-pollution devices for motors and engines; aprons, parts of machines; automatic grappels for marine purposes; axles for machines; ball rings for bearings; ball-bearings; bearing brackets for machines; bearings, parts of machines; bearings for transmission shafts; beaters, electric; beating machines; apparatus for drawing up beer under pressure; beer pumps; bellows, machines; belt conveyors; belts for conveyors; belts for machines; belts for motors and engines; bending machines; beverage preparation machines, electromechanical; bicycle assembling machines; bicycle dynamos; binding apparatus for hay; bitumen making machines; blade holders, parts of machines; blade sharpening, stropping, machines; blades, parts of machines; blenders, electric, for household purposes; blowing machines for the compression, exhaustion and transport of gases; blowing machines for the compression, sucking and carrying of grain; bobbins for weaving looms; machine boiler scale collectors; boiler tubes, parts of machines; bookbinding apparatus and machines for industrial purposes; bottle capping machines; bottle filling machines; bottle sealing machines; bottle stoppering machines; bottle washing machines; boxes for matrices, printing; braiding machines; brake linings other than for vehicles; brake segments other than for vehicles; brake shoes other than for vehicles; bread cutting machines; brewing machines; brushes, parts of machines; brushes, electrically operated; bulldozers; butter machines; calendars; capstans; carbon brushes, electricity; carburetter fee-

ders; carburettors; card clothing, parts of carding machines; carding machines; machines and apparatus for carpet shampooing, electric; cartridges for filtering machines; catalytic converters; central vacuum cleaning installations; centrifugal machines; centrifugal mills; centrifugal pumps; chaff cutter blades; chain saws; chisels for machines; chucks, parts of machines; churns; cigarette machines for industrial purposes; cinder sifters, machines; clack valves, parts of machines; machines and apparatus for cleaning, electric; cleaning appliances utilizing steam; clippers, machines, clutches other than for land vehicles; coalcutting machines; coffee grinders, other than hand-operated; coin-operated washing machines; compressed air engines; compressed air guns for the extrusion of mastics; compressed air machines; compressed air pumps; compressors, machines; compressors for refrigerators; concrete mixers, machines; condensers, steam, parts of machines; condensing installations; connecting rods for machines, motors and engines; control cables for machines, engines or motors; control mechanisms for machines, engines or motors; hydraulic controls for machines, motors and engines; pneumatic controls for machines, motors and engines; converters for steel works; conveyors, machines; cord making machines; couplings other than for land vehicles; cowlings, parts of machines; cranes, lifting and hoisting apparatus; crank shafts; crankcases for machines, motors and engines; cranks, parts of machines; cream/milk separators; motorized cultivators; cultivators, machines; current generators; curtain drawing devices, electrically operated; cutters, machines; cutting blow pipes, gas-operated; cutting machines; cylinder heads for engines; cylinders for machines; cylinders for motors and engines; dairy machines; darning machines; de-aerators for feedwater; degreasers, machines; derricks; die-cutting and tapping machines; die-stamping machines; diggers, machines; dishwashers; disintegrators; garbage, waste disposals; ditchers, ploughs; dividing machines; hydraulic door openers and closers, parts of machines; pneumatic door openers and closers, parts of machines; drainage machines; drill chucks, parts of machines; drilling bits, parts of machines; drilling heads, parts of machines; drilling machines; drilling rigs, floating or non-floating; electric hand drills; driving chains other than for land vehicles; driving motors other than for land vehicles; drums, parts of machines; drying machines; dust exhausting installations for cleaning purposes; dust removing installations for cleaning purposes; dyeing machines; dynamo belts; dynamo brushes; dynamos; earth moving machines; edible pastes making machines; ejectors; electric hammers; electromechanical machines for chemical industry; elevating apparatus, elevator belts; elevator chains, parts of machines; elevators, lifts; embossing machines; emergency power generators; engines for boats; engraving machines; excavators; exhausts for motors and engines; expansion tanks, parts of

machines; fan belts for motors and engines; fans for motors and engines; mechanized livestock feeders; feeders, parts of machines; feeding apparatus for engine boilers; feedwater regulators; filling machines; filter presses; filtering machines; filters, parts of machines or engines; filters for cleaning cooling air, for engines; finishing machines; fittings for engine boilers; fleshing machines; flour mill machines; flour mills; flues for engine boilers; fodder presses; food preparation machines, electromechanical; food processors, electric; forge bellows; foundry machines; freewheels other than for land vehicles; friezing machines; fruit presses, electric, for household purposes; fuel conversion apparatus for internal combustion engines; fuel economisers for motors and engines; gear boxes other than for land vehicles; gears for weaving looms; gears, other than for land vehicles; generators of electricity; glass working machines; glaziers' diamonds, parts of machines; glow plugs for diesel engines; glue guns, electric; grain husking machines; grain separators; grating machines for vegetables; grease boxes, parts of machines; grease rings, parts of machines; grinders/crushers, electric, for household purposes; grinding machines; grindstones, parts of machines; guides for machines; guns, tools using explosives; hammers, parts of machines; hand-held tools, other than hand-operated; handling apparatus for loading and unloading; handling machines, automatic, manipulators; hangers, parts of machines; harrows; harvesting machines; haulage apparatus, mining; heat exchangers, parts of machines; heel-making machines; hemming machines; high pressure washers; hoists; holding devices for machine tools; hoppers, mechanical discharging; hosiery looms; housings, parts of machines; hydraulic engines and motors; hydraulic turbines; igniting devices for internal combustion engines; igniting magnetos; igniting magnetos for engines; incubators for eggs; injectors for engines; inking apparatus for printing machines; ironing machines; jacks, machines; jet engines other than for land vehicles; joints, parts of engines; journal boxes, parts of machines; journals, parts of machines; kick starters for motorcycles; kitchen machines, electric; kneading machines; knitting machines; knives, parts of machines; knives for mowing machines; knives, electric; labellers, machines; lace making machines; lasts for shoes, parts of machines; lathes, machine tools; lawnmowers, machines; leather paring machines; leather-working machines; lifting apparatus; lifts, other than ski-lifts; loading ramps; loom shafts; looms, machines; lubricating pumps; lubricators, parts of machines; machine fly-wheels; machine tools; machine wheels; machine wheelwork; machines for the textile industry; exhaust manifold for engines; matrices for use in printing; meat choppers, machines; metal drawing machines; metalworking machines; milking machines; teat cups, suction cups, for milking machines; milling machines; mills, machines; mills for household purposes, other than hand-operated; millstones; mine borers; mineral

water making machines; mineworking machines; mixers, machines; mixing machines; mortising machines; motors for boats; motors, electric, other than for land vehicles; motors, other than for land vehicles; moulding machines; moulds, parts of machines; moving pavements, sidewalks; moving staircases, escalators; mud catchers and collectors, machines; mufflers for motors and engines; net hauling machines, fishing; notchers, machine tools; oil refining machines; ore treating machines; packaging machines; packing machines; painting machines; paper feeders, printing; paper machines; papermaking machines; parquet wax-polishers, electric; pedal drives for sewing machines; pepper mills other than hand-operated; piston segments; pistons, parts of machines or engines; pistons for cylinders; pistons for engines; planing machines; ploughs; ploughshares; pneumatic hammers; pneumatic transporters; pneumatic tube conveyors; machines and apparatus for polishing, electric; potters' wheels; power hammers; presses, machines for industrial purposes; pressure reducers, parts of machines; pressure regulators, parts of machines; pressure valves, parts of machines; printing cylinders; printing machines; printing machines for use on sheet metal; printing plates; printing presses; printing rollers for machines; propulsion mechanisms other than for land vehicles; puddling machines; pulleys; pulleys, parts of machines; pulverisers, machines; pump diaphragms; pumps, machines; pumps, parts of machines, engines or motors; pumps for heating installations; punches for punching machines; punching machines; rack and pinion jacks; racket stringing machines; radiators, cooling, for motors and engines; rail-laying machines; railroad constructing machines; rakes for raking machines; raking machines; rams, machines; reapers; reapers and binders; reapers and threshers; reduction gears other than for land vehicles; reeling apparatus, mechanical; reels, parts of machines; reels, mechanical, for flexible hoses; regulators, parts of machines; rinsing machines; riveting machines; road making machines; road sweeping machines, self-propelled; robots, machines; roller bearings; roller bridges; rolling mill cylinders; rolling mills; root slicers, machines; rotary printing presses; rotary steam presses, portable, for fabrics; satinizing machines; sausage machines; saw benches, parts of machines; saw blades, parts of machines; saws, machines; scissors, electric; sealing machines for industrial purposes; self-oiling bearings; separators; sewage pulverizers; sewing machines; shaft couplings, machines; sharpening machines; sheaf-binding machines; shearing machines for animals; shears, electric; shock absorber plungers, parts of machines; shoe polishers, electric; shovels, mechanical; shredders, machines for industrial use; shuttles, parts of machines; sieves, machines or parts of machines; sifters; sifting installations; sifting machines; sizing machines; slide rests, parts of machines; sliders for knitting machines; smoothing presses; snow ploughs;

soldering apparatus, gas-operated; soldering blow pipes, gas-operated; soldering irons, gas-operated; sorting machines for industry; sowers, machines; sparking plugs for internal combustion engines; speed governors for machines, engines and motors; spinning frames; spinning machines; spinning wheels; spray guns for paint; springs, parts of machines; stalk separators, machines; stamping machines; stands for machines; starters for motors and engines; stators, parts of machines; steam engine boilers; steam engines; steam traps; steam/oil separators; steamrollers; stereotype machines; stitching machines; stone working machines; straw, chaff, cutters; stuffing boxes, parts of machines; suction machines for industrial purposes; sugar making machines; superchargers; superheaters; swaging machines; tables for machines; tambours for embroidery machines; taps, parts of machines, engines or motors; tarring machines; tedding machines; thermic lances, machines; threading machines; threshing machines; tilt hammers; tin openers, electric; tobacco processing machines; tools, parts of machines; torque converters other than for land vehicles; transmission chains other than for land vehicles; transmission shafts, other than for land vehicles; transmissions for machines; transmissions, other than for land vehicles; trimming machines; trueing machines; turbines other than for land vehicles; turbocompressors; turf removing ploughs; tympan, parts of printing presses; typecasting machines; type-setting machines, photocomposition; type-setting machines, printing; typographic machines; typographic presses; universal joints, cardan joints; vacuum cleaner attachments for disseminating perfumes and disinfectants; vacuum cleaner bags; vacuum cleaner hoses; vacuum cleaners; vacuum pumps, machines; valves, parts of machines; vibrators, machines, for industrial use; vulcanisation apparatus; waggon lifts; washing apparatus; washing installations for vehicles; washing machines; washing machines, laundry; waste compacting machines; water heaters, parts of machines; water separators; machines and apparatus for wax-polishing, electric; weaving looms; weeding machines; welding machines, electric; whisks, electric, for household purposes; whitewashing machines; winches; wine presses; winnowers; woodworking machines; wrapping machines; wringing machines for laundry.

8 – Hand tools and implements (hand-operated); cutlery; side arms; razors; abrading instruments, hand instruments; adzes, tools; agricultural implements, hand-operated; annular screw plates; augers, hand tools; awls; axes; bayonets; beard clippers; bill-hooks; bits, hand tools; bits, parts of hand tools; blade sharpening instruments; blades, hand tools; blades, weapons; blades for planes; border shears; borers; bow saws; braiders, hand tools; branding irons; breast drills; budding knives; can openers, non-electric; carpenters' augers; cattle shearers; cattle stunning appliances; caulking irons; centre pun-

ches, hand tools; cheese slicers, non-electric; chisels; choppers, knives; clamps for carpenters or coopers; cleavers; crimping irons; crow bars; curling tongs; cuticle tweezers; cutter bars; cutters; cutting bars; cutting tools, hand tools; daggers; implements for decanting liquids, hand tools; depilation appliances, electric and non-electric; dies, hand tools; diggers, hand tools; ditchers, hand tools; drawing knives; drill holders, hand tools; drills; ear-piercing apparatus; earth rammers, hand tools; edge tools, hand tools; egg slicers, non-electric; embossers, hand tools; emery grinding wheels; engraving needles; expanders, hand tools; extension pieces for braces for screw taps; eyelash curlers; farriers' knives; files, tools; fingernail polishers, electric or non-electric; fire irons; fireplace bellows, hand tools; flat irons, non-electric; forks; foundry ladles, hand tools; frames for handsaws; fruit pickers, hand tools; fullers, hand tools; fulling tools, hand tools; garden tools, hand-operated; gimlets, hand tools; glaziers' diamonds, parts of hand tools; goffering irons; gouges, hand tools; grafting tools, hand tools; graving tools, hand tools; grindstones, hand tools; guns, hand tools; guns, hand-operated, for the extrusion of mastics; hackles, hand tools; Hainault scythes; hair clippers for animals, hand instruments; hair clippers for personal use, electric and non-electric; hand implements for hair curling, non-electric; hair-removing tweezers; hammer sharpeners; hammers, hand tools; hand drills, hand tools; hand pumps; hand tools, hand-operated; harpoons; harpoons for fishing; hatchets; hoes, hand tools; holing axes; hollowing bits, parts of hand tools; hoop cutters, hand tools; hunting knives; ice picks; insecticide vaporizers, hand tools; irons, non-electric hand tools; jig-saws; knives; ladles, hand tools; lasts, shoemakers' hand tools; lawn clippers, hand instruments; leather strops; levers; lifting jacks, hand-operated; livestock marking tools; machetes; mallets, hand instruments; manicure sets; manicure sets, electric; marline spikes; masons' hammers; mattocks; milling cutters, hand tools; mincing knives, hand tools; mitre, miter (am.), boxes, hand tools; money scoops; mortars for pounding; mortise chisels; moulding irons; nail clippers, electric or non-electric; nail drawers, hand tools; nail extractors; nail files; nail files, electric; nail nippers; nail punches; needle files; needle-threaders; numbering punches; nutcrackers; oyster openers; palette knives; paring irons, hand tools; paring knives; pedicure sets; penknives; perforating tools, hand tools; pickaxes; pickhammers; picks, hand tools; pin punches; pincers; pizza cutters, non-electric; plane irons; planes; plant parasite killing apparatus; pliers; polishing irons, glazing tools; priming irons, hand tools; pruning knives; pruning scissors; pruning shears; punch pliers, hand tools; punch rings, knuckle dusters; punches, hand tools; rabbiting planes; rakes, hand tools; rammers, hand tools;

rams, hand tools; rasps, hand tools; ratchets, hand tools; razor blades; razor cases; razor strops; razors, electric or non-electric; reamer sockets; reamers; riveters, hand tools; riveting hammers, hand tools; sabres; sand trap rakes; saw blades, parts of hand tools; saw holders; saws, hand tools; scaling knives; scissors; scrapers, hand tools; scraping tools, hand tools; screwdrivers; scythe rings; scythe stones; scythes; sharpening instruments; sharpening steels; sharpening stones; shaving cases; shear blades; shearers, hand instruments; shears; shovels, hand tools; sickles; side arms, other than firearms; silver plate, knives, forks and spoons; instruments and tools for skinning animals; skinning appliances and instruments for butchers' animals; appliances and instruments for slaughtering butchers' animals; sledgehammers; spades, hand tools; spanners, hand tools; spatulas, hand tools; spoons; squares, hand tools; stamping-out tools, hand tools; stone hammers; stretchers for wire and metal bands, hand tools; stropping instruments; sugar tongs; sword scabbards; swords; syringes for spraying insecticides; table cutlery, knives, forks and spoons; table forks; taps, hand tools; apparatus for tattooing; thistle extirpators, hand tools; instruments for punching tickets; tool belts, holders; tree pruners; trowels; trowels, gardening; truncheons; tube cutters, hand tools; tube cutting instruments; tweezers; vegetable choppers; vegetable slicers; vices; weeding forks, hand tools; whetstone holders; wick trimmers, scissors; wrenches, hand tools.

9 – Scientific, nautical, surveying, photographic, cinematographic, optical, weighing, measuring, signalling, checking (supervision), life-saving and teaching apparatus and instruments; apparatus and instruments for conducting, switching, transforming, accumulating, regulating or controlling electricity; apparatus for recording, transmission or reproduction of sound or images; magnetic data carriers, recording discs; automatic vending machines and mechanisms for coin-operated apparatus; cash registers, calculating machines, data processing equipment and computers; fire-extinguishing apparatus; abacuses; accounting machines; accumulators, electric; acid hydrometers; acidimeters for batteries; acoustic, sound, alarms; acoustic conduits; actinometers; adding machines; aerials; aerometers; electronic agendas; air analysis apparatus; alarm bells, electric; alarms; alcoholmeters; alidades; altimeters; ammeters; amplifiers; amplifying tubes; amusement apparatus adapted for use with an external display screen or monitor; anemometers; animated cartoons; anode batteries; anodes; answering machines; anticathodes; anti-dazzle shades; anti-glare glasses; anti-interference devices, electricity; anti-theft warning apparatus; apertometers, optics; armatures, electricity; asbestos clothing for protection against fire; asbestos gloves for protection against accidents; asbestos screens for fire-

men; apparatus and instruments for astronomy; electric devices for attracting and killing insects; audiovisual teaching apparatus; automated teller machines, ATM; azimuth instruments; balances, steelyards; balancing apparatus; bar code readers; barometers; batteries for lighting; batteries for pocket lamps; batteries, electric; batteries, electric, for vehicles; battery boxes; battery chargers; battery jars; beacons, luminous; bells, warning devices; betatrons; binoculars; blueprint apparatus; boiler control instruments; branch boxes, electricity; breathing apparatus for underwater swimming; breathing apparatus, except for artificial respiration; bullet-proof waistcoats, vests (am.); buzzers; buzzers, electric; cabinets for loudspeakers; coaxial cables; cables, electric; calculating disks; calculating machines; calibrating rings; calipers; camcorders; cameras, photography; capacity measures; capillary tubes; carpenters' rules; carriers for dark plates, photography; cases especially made for photographic apparatus and instruments; cases fitted with dissecting instruments, microscopy; cash registers; cassette players; cathodes; cathodic anti-corrosion apparatus; cell switches, electricity; centering apparatus for photographic transparencies; chargers for electric batteries; chemistry apparatus and instruments; chips, integrated circuits; choking coils, impedance; chromatography apparatus for laboratory use; chronographs, time recording apparatus; cigar lighters for automobiles; cinematographic cameras; cinematographic film, exposed; circuit breakers; circuit closers; cleaning apparatus for phonograph records; clothing especially made for laboratories; clothing for protection against accidents, irradiation and fire; clothing for protection against fire; coils, electric; mechanisms for coin-operated apparatus; coin-operated gates for car parks or parking lots; coin-operated mechanisms for television sets; collectors, electric; electric apparatus for commutation; commutators; compact disc players; compact discs, audio-video; compact discs, read-only memory; comparators; directional compasses; compasses, measuring instruments; computer game programs; computer keyboards; computer memories; computer operating programs, recorded; computer peripheral devices; computer programmes, programs, recorded; computer programs, downloadable software; computer software, recorded; computers; optical condensers; condensers, capacitors; conductors, electric; connections for electric lines; connectors, electricity; contact lenses; contacts, electric; contacts, electric, of precious metal; containers for contact lenses; containers for microscope slides; control panels, electricity; converters, electric; copper wire, insulated; correcting lenses, optics; cosmographic instruments; counterfeit, false, coin detectors; mechanisms for counter-operated apparatus; counters; acoustic couplers; couplers, data processing equipment; couplings, electric; co-

vers for electric outlets; crucibles, laboratory; current rectifiers; cyclotrons; darkroom lamps, photography; darkrooms, photography; data processing apparatus; decompression chambers; demagnetizing apparatus for magnetic tapes; densimeters; densitometers; detectors; diagnostic apparatus, not for medical purposes; diaphragms, acoustics; diaphragms, photography; diaphragms for scientific apparatus; dictating machines; diffraction apparatus, microscopy; discharge tubes, electric, other than for lighting; disk drives for computers; disks, magnetic; distance measuring apparatus; distance recording apparatus; distillation apparatus for scientific purposes; distribution boards, electricity; distribution boxes, electricity; distribution consoles, electricity; distribution machines, automatic; divers' apparatus; divers' masks; diving suits; DNA chips; dog whistles; door closers, electric; door openers, electric; dosage dispensers; drainers for use in photography; dressmakers' measures; drying apparatus for photographic prints; drying racks, photography; ducts, electricity; DVD players; dynamometers; ear plugs; ear plugs for divers; editing appliances for cinematographic films; egg timers, sandglasses; egg-candlers; electric arc cutting apparatus; electric arc welding apparatus; electric door bells; electric installations for the remote control of industrial operations; electric loss indicators; electric welding apparatus; electricity conduits; materials for electricity mains, wires, cables; electrified rails for mounting spot lights; electro-dynamic apparatus for the remote control of railway points; electro-dynamic apparatus for the remote control of signals; electrolyzers; electromagnetic coils; electronic pens, visual display units; electronic pocket translators; electronic tags for goods; electroplating apparatus; elevator operating apparatus; encoded cards, magnetic; encoded identification bracelets, magnetic; enlarging apparatus, photography; epidiascopes; ergometers; exposure meters, light meters; extinguishers; eyeglass cases; eyeglass chains; eyeglass cords; eyepieces; instruments containing eyepieces; eyeshades; facsimile machines; electrified fences; apparatus for fermentation, laboratory apparatus; fibre, fiber (am.), optic cables; film cutting apparatus; films, exposed; filters, photography; filters for respiratory masks; filters for ultraviolet rays, for photography; fire alarms; fire beaters; fire blankets; fire boats; fire engines; fire escapes; fire hose nozzles; flash-bulbs, photography; flashing lights, luminous signals; flashlights, photography; flat irons, electric; floppy disks; fluorescent screens; fog signals, non-explosive; food analysis apparatus; frames for photographic transparencies; apparatus to check franking; frequency meters; fuel dispensing pumps for service stations; furnaces for laboratory experiments; furniture especially made for laboratories; fuse wire; fuses; galena crystals, detectors; galvanic batteries; galvanic cells; galvanizing

apparatus; galvanometers; apparatus for games adapted for use with an external display screen or monitor; garments for protection against fire; gas testing instruments; gasoline gauges; gasoline pumps for service stations; gasometers; gauges; glass covered with an electrical conductor; glazing apparatus for photographic prints; gloves for divers; gloves for protection against accidents; gloves for protection against X-rays for industrial purposes; goggles for sports; grids for batteries; hair-curlers, electrically heated; hands free kits for phones; head cleaning tapes, recording; headphones; heat regulating apparatus; heliographic apparatus; protective helmets for sports; hemline markers; high-frequency apparatus; holders for electric coils; holograms; horns for loudspeakers; hydrometers; hygrometers; identification sheaths for electric wires; identification threads for electric wires; identity cards, magnetic; igniting apparatus, electric, for igniting at a distance; incubators for bacteria culture; indicators, electricity; inductors, electricity; integrated circuit cards, smart cards; integrated circuits; intercommunication apparatus; interfaces for computers; inverters, electricity; invoicing machines; ionisation apparatus, not for the treatment of air; jigs, measuring instruments; juke boxes for computers; juke boxes, musical; junction boxes, electricity; junction sleeves for electric cables; knee-pads for workers; laboratory trays; lactodensimeters; lactometers; lasers, not for medical purposes; appliances for measuring the thickness of leather; lens hoods; lenses for astrophotography; letter scales; levelling instruments; levelling staffs, surveying instruments; levels, instruments for determining the horizontal; life belts; life buoys; life jackets; life saving apparatus and equipment; life-saving rafts; light dimmers, regulators, electric; lighting ballasts; lightning conductors, rods; limiters, electricity; locks, electric; logs, measuring instruments; loudspeakers; magic lanterns; magnetic data media; magnetic encoders; magnetic tape units for computers; magnetic tapes; magnetic wires; magnets; decorative magnets; magnifying glasses, optics; make-up removing appliances, electric; marine compasses; marine depth finders; marking buoys; marking gauges, joinery; masts for wireless aeri-als; material testing instruments and machines; mathematical instruments; measures; measuring apparatus; measuring devices, electric; measuring glassware; measuring instruments; measuring spoons; mechanical signs; megaphones; mercury levels; metal detectors for industrial or military purposes; meteorological balloons; meteorological instruments; metronomes; micrometer screws for optical instruments; micrometers; microphones; microprocessors; microscopes; microtomes; milage recorders for vehicles; mirrors, optics; mirrors for inspecting work; modems; money counting and sorting machines; monitoring apparatus, electric; monitors, computer hard-

ware; monitors, computer programs; motor fire engines; mouse, data processing equipment; mouse pads; nautical apparatus and instruments; naval signalling apparatus; navigation apparatus for vehicles, on-board computers; navigational instruments; needles for record players; neon signs; nets for protection against accidents; nose clips for divers and swimmers; notebook computers; electronic notice boards; objectives, lenses, optics; observation instruments; octants; ohmmeters; optical apparatus and instruments; optical character readers; optical data media; optical discs; optical fibers, fibres, light conducting filaments; optical glass; optical goods; optical lanterns; optical lenses; oscillographs; oxygen transvasing apparatus; ozonisers, ozonators; parking meters; particle accelerators; pedometers; peepholes, magnifying lenses, for doors; periscopes; phonograph records; photocopiers, photographic, electrostatic, thermic; photometers; phototelegraphy apparatus; photovoltaic cells; apparatus and instruments for physics; pince-nez; pince-nez mountings; pipettes; plane tables, surveying instruments; planimeters; plates for batteries; plotters; plumb bobs; plumb lines; pocket calculators; light-emitting electronic pointers; polarimeters; postage stamp meters; precision balances; precision measuring apparatus; pressure gauges; automatic indicators of low pressure in vehicle tires, tyres; pressure indicator plugs for valves; pressure indicators; pressure measuring apparatus; printed circuits; printers for use with computers; prisms, optics; probes for scientific purposes; processors, central processing units; projection apparatus; projection screens; protection devices against X-rays, roentgen rays, not for medical purposes; protection devices for personal use against accidents; protective helmets; protective masks; protective suits for aviators; protractors, measuring instruments; electronic publications, downloadable; punched card machines for offices; push buttons for bells; pyrometers; quantity indicators; radar apparatus; radio pagers; radiological apparatus for industrial purposes; radiology screens for industrial purposes; radios; radiotelegraphy sets; radiotelephony sets; railway traffic safety appliances; range finders; readers, data processing equipment; audio and video receivers; apparatus for changing record player needles; record players; reflecting discs for wear, for the prevention of traffic accidents; refractometers; refractors; regulating apparatus, electric; relays, electric; remote control apparatus; resistances, electric; respirators for filtering air; respiratory masks, other than for artificial respiration; resuscitation mannequins, teaching apparatus; retorts; retorts' stands; revolution counters; rheostats; riding helmets; road signs, luminous or mechanical; rods for water diviners; roentgen apparatus not for medical purposes; rulers, measuring instruments; rules, measuring instruments; saccharometers; safety nets; safety restra-

ints, other than for vehicle seats and sports equipment; safety tarpaulins; salinometers; satellite navigational apparatus; satellites for scientific purposes; scales; scanners, data processing equipment; screens, photography; screens for photoengraving; screw-tapping gauges; electrical apparatus for sealing plastics, packaging; self-regulating fuel pumps; semi-conductors; sextants; sheaths for electric cables; shoes for protection against accidents, irradiation and fire; shutter releases, photography; shutters, photography; sighting telescopes for firearms; signal bells; signal lanterns; signalling buoys; signalling panels, luminous or mechanical; signalling whistles; signals, luminous or mechanical; signs, luminous; simulators for the steering and control of vehicles; sirens; apparatus for measuring the thickness of skins; slide calipers; slide projectors; slide-rules; slope indicators; smoke detectors; sockets, plugs and other contacts, electric connections; socks, electrically heated; solar batteries; solderers' helmets; soldering apparatus, electric; soldering irons, electric; solenoid valves, electromagnetic switches; sonars; sound locating instruments; sound recording apparatus; sound recording carriers; sound recording strips; sound reproduction apparatus; sound transmitting apparatus; sounding apparatus and machines; sounding leads; sounding lines; spark-guards; speaking tubes; spectacle cases; spectacle frames; spectacle glasses; spectacles, optics; spectrograph apparatus; spectrometers; speed checking apparatus for vehicles; speed indicators; speed measuring apparatus, photography; speed regulators for record players; spherometers; spirit levels; spools, photography; sprinkler systems for fire protection; stage lighting regulators; stands for photographic apparatus; starter cables for motors; steering apparatus, automatic, for vehicles; personal stereos; stereoscopes; stereoscopic apparatus; stills for laboratory experiments; sulphitometers; sunglasses; surveying apparatus and instruments; surveying chains; surveying instruments; surveyors' levels; swimming belts; swimming jackets; switchboards; switchboxes, electricity; switches, electric; tachometers; tape recorders; taximeters; teaching apparatus; teeth protectors; telegraph wires; telegraphs, apparatus; telephone apparatus; telephone receivers; telephone transmitters; telephone wires; portable telephones; teleprinters; teleprompters; telerupters; telescopes; television apparatus; temperature indicators; terminals, electricity; test tubes; testing apparatus not for medical purposes; theft prevention installations, electric; theodolites; thermionic lamps and tubes; thermionic valves, radio; thermometers, not for medical purposes; thermostats; thermostats for vehicles; thread counters; ticket dispensers; time clocks, time recording devices; time recording apparatus; time switches, automatic; tone arms for record players; totalizers; traffic-light apparatus, signalling devices; transfor-

mers, electricity; transistors, electronic; transmitters, telecommunication; transmitters of electronic signals; transmitting sets, telecommunication; transparencies, photography; tripods for cameras; turnstiles, automatic; urinometers; vacuum gauges; vacuum tubes, radio; variometers; vehicle breakdown warning triangles; vehicle radios; verniers; video cassettes; video game cartridges; video recorders; video screens; video telephones; videotapes; viewfinders, photographic; viscosimeters; voltage regulators for vehicles; voltage surge protectors; voltmeters; voting machines; wafers, silicon slices; walkie-talkies; washing trays, photography; water level indicators; water wings; wavemeters; weighbridges; weighing apparatus and instruments; weighing machines; weights; welding electrodes; whistle alarms; wind socks for indicating wind direction; wire connectors, electricity; wires, electric; word processors; workmen's protective face-shields; wrist rests for use with computers; X-ray films, exposed; X-ray photographs, other than for medical purposes; X-rays producing apparatus and installations, not for medical purposes; X-rays tubes not for medical purposes.

(260) AM 2012 64708 A
 (800) 1093057
 (731) BALLANTINES INTERVEST LTD
 OMC Chambers, Wickhams Cay 1, Road
 Town, Tortola, British Virgin Islands
 (540)



(591) Black, white
 (511)

7 – Machines and machine tools; motors and engines (except for land vehicles); machine coupling and transmission components (except for land vehicles); agricultural implements other than hand-operated; incubators for eggs; acetylene cleaning apparatus; adhesive bands for pulleys; adhesive tape dispensers, machines; aerated beverages making machines; aerated water making apparatus; aerating pumps for aquaria; aerators; aerocondensers; aeronautical engines; aeroplane engines; agitators; agricultural elevators; agricultural machines; air brushes for applying colour; air condensers; air cushion devices for moving loads; engines for air cushion vehicles; air pumps, garage installations; air suction machines; alternators; anti-friction bearings for machines; anti-pollution devices for motors and engines; aprons, parts of machines; automatic grapnels for marine purposes; axles for machines; ball rings for bearings; ball-bearings; bearing brackets for machines; bearings, parts of

machines; bearings for transmission shafts; beaters, electric; beating machines; apparatus for drawing up beer under pressure; beer pumps; bellows, machines; belt conveyors; belts for conveyors; belts for machines; belts for motors and engines; bending machines; beverage preparation machines, electromechanical; bicycle assembling machines; bicycle dynamos; binding apparatus for hay; bitumen making machines; blade holders, parts of machines; blade sharpening, stropping, machines; blades, parts of machines; blenders, electric, for household purposes; blowing machines for the compression, exhaustion and transport of gases; blowing machines for the compression, sucking and carrying of grain; bobbins for weaving looms; machine boiler scale collectors; boiler tubes, parts of machines; bookbinding apparatus and machines for industrial purposes; bottle capping machines; bottle filling machines; bottle sealing machines; bottle stoppering machines; bottle washing machines; boxes for matrices, printing; braiding machines; brake linings other than for vehicles; brake segments other than for vehicles; brake shoes other than for vehicles; bread cutting machines; brewing machines; brushes, parts of machines; brushes, electrically operated; bulldozers; butter machines; calendars; capstans; carbon brushes, electricity; carburetter feeders; carburetters; card clothing, parts of carding machines; carding machines; machines and apparatus for carpet shampooing, electric; cartridges for filtering machines; catalytic converters; central vacuum cleaning installations; centrifugal machines; centrifugal mills; centrifugal pumps; chaff cutter blades; chain saws; chisels for machines; chucks, parts of machines; churns; cigarette machines for industrial purposes; cinder sifters, machines; clack valves, parts of machines; machines and apparatus for cleaning, electric; cleaning appliances utilizing steam; clippers, machines, clutches other than for land vehicles; coalcutting machines; coffee grinders, other than hand-operated; coin-operated washing machines; compressed air engines; compressed air guns for the extrusion of mastics; compressed air machines; compressed air pumps; compressors, machines; compressors for refrigerators; concrete mixers, machines; condensers, steam, parts of machines; condensing installations; connecting rods for machines, motors and engines; control cables for machines, engines or motors; control mechanisms for machines, engines or motors; hydraulic controls for machines, motors and engines; pneumatic controls for machines, motors and engines; converters for steel works; conveyors, machines; cord making machines; couplings other than for land vehicles; cowlings, parts of machines; cranes, lifting and hoisting apparatus; crank shafts; crankcases for machines, motors and engines; cranks, parts of machines; cream/milk separators; motorized cultivators; cultivators, machines; cur-

rent generators; curtain drawing devices, electrically operated; cutters, machines; cutting blow pipes, gas-operated; cutting machines; cylinder heads for engines; cylinders for machines; cylinders for motors and engines; dairy machines; darning machines; de-aerators for feedwater; degreasers, machines; derricks; die-cutting and tapping machines; die-stamping machines; diggers, machines; dishwashers; disintegrators; garbage, waste disposals; ditchers, ploughs; dividing machines; hydraulic door openers and closers, parts of machines; pneumatic door openers and closers, parts of machines; drainage machines; drill chucks, parts of machines; drilling bits, parts of machines; drilling heads, parts of machines; drilling machines; drilling rigs, floating or non-floating; electric hand drills; driving chains other than for land vehicles; driving motors other than for land vehicles; drums, parts of machines; drying machines; dust exhausting installations for cleaning purposes; dust removing installations for cleaning purposes; dyeing machines; dynamo belts; dynamo brushes; dynamos; earth moving machines; edible pastes making machines; ejectors; electric hammers; electromechanical machines for chemical industry; elevating apparatus, elevator belts; elevator chains, parts of machines; elevators, lifts; embossing machines; emergency power generators; engines for boats; engraving machines; excavators; exhausts for motors and engines; expansion tanks, parts of machines; fan belts for motors and engines; fans for motors and engines; mechanized livestock feeders; feeders, parts of machines; feeding apparatus for engine boilers; feedwater regulators; filling machines; filter presses; filtering machines; filters, parts of machines or engines; filters for cleaning cooling air, for engines; finishing machines; fittings for engine boilers; fleshing machines; flour mill machines; flour mills; flues for engine boilers; fodder presses; food preparation machines, electromechanical; food processors, electric; forge bellows; foundry machines; freewheels other than for land vehicles; friezing machines; fruit presses, electric, for household purposes; fuel conversion apparatus for internal combustion engines; fuel economisers for motors and engines; gear boxes other than for land vehicles; gears for weaving looms; gears, other than for land vehicles; generators of electricity; glass working machines; glaziers' diamonds, parts of machines; glow plugs for diesel engines; glue guns, electric; grain husking machines; grain separators; grating machines for vegetables; grease boxes, parts of machines; grease rings, parts of machines; grinders/crushers, electric, for household purposes; grinding machines; grindstones, parts of machines; guides for machines; guns, tools using explosives; hammers, parts of machines; hand-held tools, other than hand-operated; handling apparatus for loading and unloading; handling machines, automatic,

manipulators; hangers, parts of machines; harrows; harvesting machines; haulage apparatus, mining; heat exchangers, parts of machines; heel-making machines; hemming machines; high pressure washers; hoists; holding devices for machine tools; hoppers, mechanical discharging; hosiery looms; housings, parts of machines; hydraulic engines and motors; hydraulic turbines; igniting devices for internal combustion engines; igniting magnetos; igniting magnetos for engines; incubators for eggs; injectors for engines; inking apparatus for printing machines; ironing machines; jacks, machines; jet engines other than for land vehicles; joints, parts of engines; journal boxes, parts of machines; journals, parts of machines; kick starters for motorcycles; kitchen machines, electric; kneading machines; knitting machines; knives, parts of machines; knives for mowing machines; knives, electric; labellers, machines; lace making machines; lasts for shoes, parts of machines; lathes, machine tools; lawnmowers, machines; leather paring machines; leather-working machines; lifting apparatus; lifts, other than ski-lifts; loading ramps; loom shafts; looms, machines; lubricating pumps; lubricators, parts of machines; machine fly-wheels; machine tools; machine wheels; machine wheelwork; machines for the textile industry; exhaust manifold for engines; matrices for use in printing; meat choppers, machines; metal drawing machines; metal-working machines; milking machines; teat cups, suction cups, for milking machines; milling machines; mills, machines; mills for household purposes, other than hand-operated; millstones; mine borers; mineral water making machines; mineworking machines; mixers, machines; mixing machines; mortising machines; motors for boats; motors, electric, other than for land vehicles; motors, other than for land vehicles; moulding machines; moulds, parts of machines; moving pavements, sidewalks; moving staircases, escalators; mud catchers and collectors, machines; mufflers for motors and engines; net hauling machines, fishing; notchers, machine tools; oil refining machines; ore treating machines; packaging machines; packing machines; painting machines; paper feeders, printing; paper machines; papermaking machines; parquet wax-polishers, electric; pedal drives for sewing machines; pepper mills other than hand-operated; piston segments; pistons, parts of machines or engines; pistons for cylinders; pistons for engines; planing machines; ploughs; ploughshares; pneumatic hammers; pneumatic transporters; pneumatic tube conveyors; machines and apparatus for polishing, electric; potters' wheels; power hammers; presses, machines for industrial purposes; pressure reducers, parts of machines; pressure regulators, parts of machines; pressure valves, parts of machines; printing cylinders; printing machines; printing machines for use on sheet metal; printing plates; printing presses;

printing rollers for machines; propulsion mechanisms other than for land vehicles; puddling machines; pulleys; pulleys, parts of machines; pulverisers, machines; pump diaphragms; pumps, machines; pumps, parts of machines, engines or motors; pumps for heating installations; punches for punching machines; punching machines; rack and pinion jacks; racket stringing machines; radiators, cooling, for motors and engines; rail-laying machines; railroad constructing machines; rakes for raking machines; raking machines; rams, machines; reapers; reapers and binders; reapers and threshers; reduction gears other than for land vehicles; reeling apparatus, mechanical; reels, parts of machines; reels, mechanical, for flexible hoses; regulators, parts of machines; rinsing machines; riveting machines; road making machines; road sweeping machines, self-propelled; robots, machines; roller bearings; roller bridges; rolling mill cylinders; rolling mills; root slicers, machines; rotary printing presses; rotary steam presses, portable, for fabrics; satinizing machines; sausage machines; saw benches, parts of machines; saw blades, parts of machines; saws, machines; scissors, electric; sealing machines for industrial purposes; self-oiling bearings; separators; sewage pulverizers; sewing machines; shaft couplings, machines; sharpening machines; sheaf-binding machines; shearing machines for animals; shears, electric; shock absorber plungers, parts of machines; shoe polishers, electric; shovels, mechanical; shredders, machines for industrial use; shuttles, parts of machines; sieves, machines or parts of machines; sifters; sifting installations; sifting machines; sizing machines; slide rests, parts of machines; sliders for knitting machines; smoothing presses; snow ploughs; soldering apparatus, gas-operated; soldering blow pipes, gas-operated; soldering irons, gas-operated; sorting machines for industry; sowers, machines; sparking plugs for internal combustion engines; speed governors for machines, engines and motors; spinning frames; spinning machines; spinning wheels; spray guns for paint; springs, parts of machines; stalk separators, machines; stamping machines; stands for machines; starters for motors and engines; stators, parts of machines; steam engine boilers; steam engines; steam traps; steam/oil separators; steamrollers; stereotype machines; stitching machines; stone working machines; straw, chaff, cutters; stuffing boxes, parts of machines; suction machines for industrial purposes; sugar making machines; superchargers; superheaters; swaging machines; tables for machines; tambours for embroidery machines; taps, parts of machines, engines or motors; tarring machines; tedding machines; thermic lances, machines; threading machines; threshing machines; tilt hammers; tin openers, electric; tobacco processing machines; tools, parts of machines; torque converters other than for land

vehicles; transmission chains other than for land vehicles; transmission shafts, other than for land vehicles; transmissions for machines; transmittsions, other than for land vehicles; trimming machines; trueing machines; turbines other than for land vehicles; turbocompressors; turf removing ploughs; tympan, parts of printing presses; typecasting machines; type-setting machines, photocomposition; type-setting machines, printing; typographic machines; typographic presses; universal joints, cardan joints; vacuum cleaner attachments for disseminating perfumes and disinfectants; vacuum cleaner bags; vacuum cleaner hoses; vacuum cleaners; vacuum pumps, machines; valves, parts of machines; vibrators, machines, for industrial use; vulcanisation apparatus; waggon lifts; washing apparatus; washing installations for vehicles; washing machines; washing machines, laundry; waste compacting machines; water heaters, parts of machines; water separators; machines and apparatus for wax-polishing, electric; weaving looms; weeding machines; welding machines, electric; whisks, electric, for household purposes; whitewashing machines; winches; wine presses; winnowers; woodworking machines; wrapping machines; wringing machines for laundry.

8 – Hand tools and implements (hand-operated); cutlery; side arms; razors; abrading instruments, hand instruments; adzes, tools; agricultural implements, hand-operated; annular screw plates; augers, hand tools; awls; axes; bayonets; beard clippers; bill-hooks; bits, hand tools; bits, parts of hand tools; blade sharpening instruments; blades, hand tools; blades, weapons; blades for planes; border shears; borers; bow saws; braiders, hand tools; branding irons; breast drills; budding knives; can openers, non-electric; carpenters' augers; cattle shearers; cattle stunning appliances; caulking irons; centre punches, hand tools; cheese slicers, non-electric; chisels; choppers, knives; clamps for carpenters or co-operators; cleavers; crimping irons; crow bars; curling tongs; cuticle tweezers; cutter bars; cutters; cutting bars; cutting tools, hand tools; daggers; implements for decanting liquids, hand tools; depilation appliances, electric and non-electric; dies, hand tools; diggers, hand tools; ditchers, hand tools; drawing knives; drill holders, hand tools; drills; ear-piercing apparatus; earth rammers, hand tools; edge tools, hand tools; egg slicers, non-electric; embossers, hand tools; emery grinding wheels; engraving needles; expanders, hand tools; extension pieces for braces for screw taps; eyelash curlers; farriers' knives; files, tools; fingernail polishers, electric or non-electric; fire irons; fireplace bellows, hand tools; flat irons, non-electric; forks; foundry ladles, hand tools; frames for handsaws; fruit pickers, hand tools; fullers, hand tools; fulling tools, hand tools; garden tools, hand-operated; gimlets, hand tools; glaziers' diamonds, parts of hand tools; goffering

irons; gouges, hand tools; grafting tools, hand tools; graving tools, hand tools; grindstones, hand tools; guns, hand tools; guns, hand-operated, for the extrusion of mastics; hackles, hand tools; Hainault scythes; hair clippers for animals, hand instruments; hair clippers for personal use, electric and non-electric; hand implements for hair curling, non-electric; hair-removing tweezers; hammer sharpeners; hammers, hand tools; hand drills, hand tools; hand pumps; hand tools, hand-operated; harpoons; harpoons for fishing; hatchets; hoes, hand tools; holing axes; hollowing bits, parts of hand tools; hoop cutters, hand tools; hunting knives; ice picks; insecticide vaporizers, hand tools; irons, non-electric hand tools; jig-saws; knives; ladles, hand tools; lasts, shoemakers' hand tools; lawn clippers, hand instruments; leather strops; levers; lifting jacks, hand-operated; livestock marking tools; machetes; mallets, hand instruments; manicure sets; manicure sets, electric; marline spikes; masons' hammers; mattocks; milling cutters, hand tools; mincing knives, hand tools; mitre, miter (am.), boxes, hand tools; money scoops; mortars for pounding; mortise chisels; moulding irons; nail clippers, electric or non-electric; nail drawers, hand tools; nail extractors; nail files; nail files, electric; nail nippers; nail punches; needle files; needle-threaders; numbering punches; nutcrackers; oyster openers; palette knives; paring irons, hand tools; paring knives; pedicure sets; penknives; perforating tools, hand tools; pickaxes; pickhammers; picks, hand tools; pin punches; pincers; pizza cutters, non-electric; plane irons; planes; plant parasite killing apparatus; pliers; polishing irons, glazing tools; priming irons, hand tools; pruning knives; pruning scissors; pruning shears; punch pliers, hand tools; punch rings, knuckle dusters; punches, hand tools; rabbeting planes; rakes, hand tools; rammers, hand tools; rams, hand tools; rasps, hand tools; ratchets, hand tools; razor blades; razor cases; razor strops; razors, electric or non-electric; reamer sockets; reamers; riveters, hand tools; riveting hammers, hand tools; sabres; sand trap rakes; saw blades, parts of hand tools; saw holders; saws, hand tools; scaling knives; scissors; scrapers, hand tools; scraping tools, hand tools; screwdrivers; scythe rings; scythe stones; scythes; sharpening instruments; sharpening steels; sharpening stones; shaving cases; shear blades; shearers, hand instruments; shears; shovels, hand tools; sickles; side arms, other than firearms; silver plate, knives, forks and spoons; instruments and tools for skinning animals; skinning appliances and instruments for butchers' animals; appliances and instruments for slaughtering butchers' animals; sledgehammers; spades, hand tools; spanners, hand tools; spatulas, hand tools; spoons; squares, hand tools; stamping-out tools, hand tools; stone hammers; stretchers for wire and metal bands, hand tools; stopping instruments; sugar tongs; sword

scabbards; swords; syringes for spraying insecticides; table cutlery, knives, forks and spoons; table forks; taps, hand tools; apparatus for tattooing; thistle extirpators, hand tools; instruments for punching tickets; tool belts, holders; tree pruners; trowels; trowels, gardening; truncheons; tube cutters, hand tools; tube cutting instruments; tweezers; vegetable choppers; vegetable slicers; vices; weeding forks, hand tools; whetstone holders; wick trimmers, scissors; wrenches, hand tools.

9 – Scientific, nautical, surveying, photographic, cinematographic, optical, weighing, measuring, signalling, checking (supervision), life-saving and teaching apparatus and instruments; apparatus and instruments for conducting, switching, transforming, accumulating, regulating or controlling electricity; apparatus for recording, transmission or reproduction of sound or images; magnetic data carriers, recording discs; automatic vending machines and mechanisms for coin-operated apparatus; cash registers, calculating machines, data processing equipment and computers; fire-extinguishing apparatus; abacuses; accounting machines; accumulators, electric; acid hydrometers; acidimeters for batteries; acoustic, sound, alarms; acoustic conduits; actinometers; adding machines; aerials; aerometers; electronic agendas; air analysis apparatus; alarm bells, electric; alarms; alcoholmeters; alidades; altimeters; ammeters; amplifiers; amplifying tubes; amusement apparatus adapted for use with an external display screen or monitor; anemometers; animated cartoons; anode batteries; anodes; answering machines; anticathodes; anti-dazzle shades; anti-glare glasses; anti-interference devices, electricity; anti-theft warning apparatus; apertometers, optics; armatures, electricity; asbestos clothing for protection against fire; asbestos gloves for protection against accidents; asbestos screens for firemen; apparatus and instruments for astronomy; electric devices for attracting and killing insects; audiovisual teaching apparatus; automated teller machines, ATM; azimuth instruments; balances, steelyards; balancing apparatus; bar code readers; barometers; batteries for lighting; batteries for pocket lamps; batteries, electric; batteries, electric, for vehicles; battery boxes; battery chargers; battery jars; beacons, luminous; bells, warning devices; betatrons; binoculars; blueprint apparatus; boiler control instruments; branch boxes, electricity; breathing apparatus for underwater swimming; breathing apparatus, except for artificial respiration; bullet-proof waistcoats, vests (am.); buzzers; buzzers, electric; cabinets for loudspeakers; coaxial cables; cables, electric; calculating disks; calculating machines; calibrating rings; calipers; camcorders; cameras, photography; capacity measures; capillary tubes; carpenters' rules; carriers for dark plates, photography; cases especially made for photographic apparatus and instruments; cases fitted with di-

secting instruments, microscopy; cash registers; cassette players; cathodes; cathodic anti-corrosion apparatus; cell switches, electricity; centering apparatus for photographic transparencies; chargers for electric batteries; chemistry apparatus and instruments; chips, integrated circuits; choking coils, impedance; chromatography apparatus for laboratory use; chronographs, time recording apparatus; cigar lighters for automobiles; cinematographic cameras; cinematographic film, exposed; circuit breakers; circuit closers; cleaning apparatus for phonograph records; clothing especially made for laboratories; clothing for protection against accidents, irradiation and fire; clothing for protection against fire; coils, electric; mechanisms for coin-operated apparatus; coin-operated gates for car parks or parking lots; coin-operated mechanisms for television sets; collectors, electric; electric apparatus for commutation; commutators; compact disc players; compact discs, audio-video; compact discs, read-only memory; comparators; directional compasses; compasses, measuring instruments; computer game programs; computer keyboards; computer memories; computer operating programs, recorded; computer peripheral devices; computer programmes, programs, recorded; computer programs, downloadable software; computer software, recorded; computers; optical condensers; condensers, capacitors; conductors, electric; connections for electric lines; connectors, electricity; contact lenses; contacts, electric; contacts, electric, of precious metal; containers for contact lenses; containers for microscope slides; control panels, electricity; converters, electric; copper wire, insulated; correcting lenses, optics; cosmographic instruments; counterfeit, false, coin detectors; mechanisms for counter-operated apparatus; counters; acoustic couplers; couplers, data processing equipment; couplings, electric; covers for electric outlets; crucibles, laboratory; current rectifiers; cyclotrons; darkroom lamps, photography; darkrooms, photography; data processing apparatus; decompression chambers; demagnetizing apparatus for magnetic tapes; densimeters; densitometers; detectors; diagnostic apparatus, not for medical purposes; diaphragms, acoustics; diaphragms, photography; diaphragms for scientific apparatus; dictating machines; diffraction apparatus, microscopy; discharge tubes, electric, other than for lighting; disk drives for computers; disks, magnetic; distance measuring apparatus; distance recording apparatus; distillation apparatus for scientific purposes; distribution boards, electricity; distribution boxes, electricity; distribution consoles, electricity; distribution machines, automatic; divers' apparatus; divers' masks; diving suits; DNA chips; dog whistles; door closers, electric; door openers, electric; dosage dispensers; drainers for use in photography; dressmakers' measures; drying apparatus for photographic prints; drying racks, photography; ducts,

electricity; DVD players; dynamometers; ear plugs; ear plugs for divers; editing appliances for cinematographic films; egg timers, sandglasses; egg-candlers; electric arc cutting apparatus; electric arc welding apparatus; electric door bells; electric installations for the remote control of industrial operations; electric loss indicators; electric welding apparatus; electricity conduits; materials for electricity mains, wires, cables; electrified rails for mounting spot lights; electro-dynamic apparatus for the remote control of railway points; electro-dynamic apparatus for the remote control of signals; electrolyzers; electromagnetic coils; electronic pens, visual display units; electronic pocket translators; electronic tags for goods; electroplating apparatus; elevator operating apparatus; encoded cards, magnetic; encoded identification bracelets, magnetic; enlarging apparatus, photography; epidiascopes; ergometers; exposure meters, light meters; extinguishers; eyeglass cases; eyeglass chains; eyeglass cords; eyepieces; instruments containing eyepieces; eyeshades; facsimile machines; electrified fences; apparatus for fermentation, laboratory apparatus; fibre, fiber (am.), optic cables; film cutting apparatus; films, exposed; filters, photography; filters for respiratory masks; filters for ultraviolet rays, for photography; fire alarms; fire beaters; fire blankets; fire boats; fire engines; fire escapes; fire hose nozzles; flash-bulbs, photography; flashing lights, luminous signals; flashlights, photography; flat irons, electric; floppy disks; fluorescent screens; fog signals, non-explosive; food analysis apparatus; frames for photographic transparencies; apparatus to check franking; frequency meters; fuel dispensing pumps for service stations; furnaces for laboratory experiments; furniture especially made for laboratories; fuse wire; fuses; galena crystals, detectors; galvanic batteries; galvanic cells; galvanizing apparatus; galvanometers; apparatus for games adapted for use with an external display screen or monitor; garments for protection against fire; gas testing instruments; gasoline gauges; gasoline pumps for service stations; gasometers; gauges; glass covered with an electrical conductor; glazing apparatus for photographic prints; gloves for divers; gloves for protection against accidents; gloves for protection against X-rays for industrial purposes; goggles for sports; grids for batteries; hair-curlers, electrically heated; hands free kits for phones; head cleaning tapes, recording; headphones; heat regulating apparatus; heliographic apparatus; protective helmets for sports; hemline markers; high-frequency apparatus; holders for electric coils; holograms; horns for loudspeakers; hydrometers; hygrometers; identification sheaths for electric wires; identification threads for electric wires; identity cards, magnetic; igniting apparatus, electric, for igniting at a distance; incubators for bacteria culture; indicators, electricity; inductors, electricity; in-

tegrated circuit cards, smart cards; integrated circuits; intercommunication apparatus; interfaces for computers; inverters, electricity; invoicing machines; ionisation apparatus, not for the treatment of air; jigs, measuring instruments; juke boxes for computers; juke boxes, musical; junction boxes, electricity; junction sleeves for electric cables; kneepads for workers; laboratory trays; lactodensimeters; lactometers; lasers, not for medical purposes; appliances for measuring the thickness of leather; lens hoods; lenses for astrophotography; letter scales; levelling instruments; levelling staffs, surveying instruments; levels, instruments for determining the horizontal; life belts; life buoys; life jackets; life saving apparatus and equipment; life-saving rafts; light dimmers, regulators, electric; lighting ballasts; lightning conductors, rods; limiters, electricity; locks, electric; logs, measuring instruments; loudspeakers; magic lanterns; magnetic data media; magnetic encoders; magnetic tape units for computers; magnetic tapes; magnetic wires; magnets; decorative magnets; magnifying glasses, optics; make-up removing appliances, electric; marine compasses; marine depth finders; marking buoys; marking gauges, joinery; masts for wireless aerials; material testing instruments and machines; mathematical instruments; measures; measuring apparatus; measuring devices, electric; measuring glassware; measuring instruments; measuring spoons; mechanical signs; megaphones; mercury levels; metal detectors for industrial or military purposes; meteorological balloons; meteorological instruments; metronomes; micrometer screws for optical instruments; micrometers; microphones; microprocessors; microscopes; microtomes; milage recorders for vehicles; mirrors, optics; mirrors for inspecting work; modems; money counting and sorting machines; monitoring apparatus, electric; monitors, computer hardware; monitors, computer programs; motor fire engines; mouse, data processing equipment; mouse pads; nautical apparatus and instruments; naval signalling apparatus; navigation apparatus for vehicles, on-board computers; navigational instruments; needles for record players; neon signs; nets for protection against accidents; nose clips for divers and swimmers; notebook computers; electronic notice boards; objectives, lenses, optics; observation instruments; octants; ohmmeters; optical apparatus and instruments; optical character readers; optical data media; optical discs; optical fibers, fibres, light conducting filaments; optical glass; optical goods; optical lanterns; optical lenses; oscillographs; oxygen transvasing apparatus; ozonisers, ozonators; parking meters; particle accelerators; pedometers; peepholes, magnifying lenses, for doors; periscopes; phonograph records; photocopiers, photographic, electrostatic, thermic; photometers; phototelegraphy apparatus; photovoltaic cells; apparatus and instruments

for physics; pince-nez; pince-nez mountings; pipettes; plane tables, surveying instruments; planimeters; plates for batteries; plotters; plumb bobs; plumb lines; pocket calculators; light-emitting electronic pointers; polarimeters; postage stamp meters; precision balances; precision measuring apparatus; pressure gauges; automatic indicators of low pressure in vehicle tires, tyres; pressure indicator plugs for valves; pressure indicators; pressure measuring apparatus; printed circuits; printers for use with computers; prisms, optics; probes for scientific purposes; processors, central processing units; projection apparatus; projection screens; protection devices against X-rays, roentgen rays, not for medical purposes; protection devices for personal use against accidents; protective helmets; protective masks; protective suits for aviators; protractors, measuring instruments; electronic publications, downloadable; punched card machines for offices; push buttons for bells; pyrometers; quantity indicators; radar apparatus; radio pagers; radiological apparatus for industrial purposes; radiology screens for industrial purposes; radios; radiotelegraphy sets; radiotelephony sets; railway traffic safety appliances; range finders; readers, data processing equipment; audio and video receivers; apparatus for changing record player needles; record players; reflecting discs for wear, for the prevention of traffic accidents; refractometers; refractors; regulating apparatus, electric; relays, electric; remote control apparatus; resistances, electric; respirators for filtering air; respiratory masks, other than for artificial respiration; resuscitation mannequins, teaching apparatus; retorts; retorts' stands; revolution counters; rheostats; riding helmets; road signs, luminous or mechanical; rods for water diviners; roentgen apparatus not for medical purposes; rulers, measuring instruments; rules, measuring instruments; saccharometers; safety nets; safety restraints, other than for vehicle seats and sports equipment; safety tarpaulins; salinometers; satellite navigational apparatus; satellites for scientific purposes; scales; scanners, data processing equipment; screens, photography; screens for photoengraving; screw-tapping gauges; electrical apparatus for sealing plastics, packaging; self-regulating fuel pumps; semi-conductors; sextants; sheaths for electric cables; shoes for protection against accidents, irradiation and fire; shutter releases, photography; shutters, photography; sighting telescopes for firearms; signal bells; signal lanterns; signalling buoys; signalling panels, luminous or mechanical; signalling whistles; signals, luminous or mechanical; signs, luminous; simulators for the steering and control of vehicles; sirens; apparatus for measuring the thickness of skins; slide calipers; slide projectors; slide-rules; slope indicators; smoke detectors; sockets, plugs and other contacts, electric connections; socks, electrically heated; solar batteries; solderers' helmets;

soldering apparatus, electric; soldering irons, electric; solenoid valves, electromagnetic switches; sonars; sound locating instruments; sound recording apparatus; sound recording carriers; sound recording strips; sound reproduction apparatus; sound transmitting apparatus; sounding apparatus and machines; sounding leads; sounding lines; spark-guards; speaking tubes; spectacle cases; spectacle frames; spectacle glasses; spectacles, optics; spectrograph apparatus; spectroscopes; speed checking apparatus for vehicles; speed indicators; speed measuring apparatus, photography; speed regulators for record players; spherometers; spirit levels; spools, photography; sprinkler systems for fire protection; stage lighting regulators; stands for photographic apparatus; starter cables for motors; steering apparatus, automatic, for vehicles; personal stereos; stereoscopes; stereoscopic apparatus; stills for laboratory experiments; sulphitometers; sunglasses; surveying apparatus and instruments; surveying chains; surveying instruments; surveyors' levels; swimming belts; swimming jackets; switchboards; switchboxes, electricity; switches, electric; tachometers; tape recorders; taximeters; teaching apparatus; teeth protectors; telegraph wires; telegraphs, apparatus; telephone apparatus; telephone receivers; telephone transmitters; telephone wires; portable telephones; teleprinters; teleprompters; telerupters; telescopes; television apparatus; temperature indicators; terminals, electricity; test tubes; testing apparatus not for medical purposes; theft prevention installations, electric; theodolites; thermionic lamps and tubes; thermionic valves, radio; thermometers, not for medical purposes; thermostats; thermostats for vehicles; thread counters; ticket dispensers; time clocks, time recording devices; time recording apparatus; time switches, automatic; tone arms for record players; totalizers; traffic-light apparatus, signalling devices; transformers, electricity; transistors, electronic; transmitters, telecommunication; transmitters of electronic signals; transmitting sets, telecommunication; transparencies, photography; tripods for cameras; turnstiles, automatic; urinometers; vacuum gauges; vacuum tubes, radio; variometers; vehicle breakdown warning triangles; vehicle radios; verniers; video cassettes; video game cartridges; video recorders; video screens; video telephones; videotapes; viewfinders, photographic; viscosimeters; voltage regulators for vehicles; voltage surge protectors; voltmeters; voting machines; wafers, silicon slices; walkie-talkies; washing trays, photography; water level indicators; water wings; wavemeters; weighbridges; weighing apparatus and instruments; weighing machines; weights; welding electrodes; whistle alarms; wind socks for indicating wind direction; wire connectors, electricity; wires, electric; word processors; workmen's protective face-shields; wrist rests for use with computers; X-ray films, exposed; X-ray photographs,

other than for medical purposes; X-rays producing apparatus and installations, not for medical purposes; X-rays tubes not for medical purposes.

(260) AM 2012 64709 A

(800) 1093078

(731) "Ararat" Food Factory LLC

House 13/1, Arabkir 29, Yerevan, Armenia

(540)

ararat tea

(591) Black, white

(511)

30 – Tea, herbal tea (other than for medical use) fruit tea, tea with flavour additive, granular tea, instant tea, tea in bags, ice tea.

(260) AM 2012 64710 A

(800) 1093091

(731) SHANGHAI PECHOIN DAILY

CHEMICAL CO.,LTD

Room 353, No. 1250, Xinzha Road, Shanghai City, China

(540)

百雀羚

(591) Black, white

(511)

3 – Hair lotion; bath lotion; polishes for leather; refurbishing preparations; perfumery for cosmetics; cosmetics; cleaning preparations; dentifrices; pot-pourris (fragrances); cosmetics for animals.

(260) AM 2012 64723 A

(800) 1093120

(731) MERCK SHARP & DOHME CORP.

One Merck Drive, Whitehouse Station,
New Jersey 08889-100, USA

(540)

TYVANTRA

(591) Black, white

(511)

5 – Pharmaceutical preparations for the treatment of migraine.

(260) AM 2012 64724 A

(800) 1093129

(731) KPM-Königliche Porzellan-Manufaktur

Berlin GmbH

Wegelystrasse 1, 10623 Berlin, Germany

(540)



(591) Black, white

(511)

8 – Cutlery, forks and spoons; sugar tongs.

11 – Lamps for domestic use; lamp stands and lamp frames made of porcelain.

14 – Goods made of precious metals and their alloys or coated therewith (as far as included in this class); jewelry, in particular jewelry made of glass, porcelain and earthenware; horological and chronometric instruments; cuff-links; tie pins; key rings (fantasy jewelry); medallions (jewelry).

21 – Glassware, porcelain and earthenware (as far as included in this class); porcelain ware including services (tableware); cups, butter dishes, egg cups, coffee service, tableware, salt and pepper spreaders; dishes, tea services, sugar bowls; drinking glasses and drinking vessels; containers for household and kitchen; figures (statuettes of porcelain, terra-cotta or glass); painted glassware; candlesticks; napkin rings.

24 – Textiles and textile goods, as far as included in this class; bed and table covers; textile napkins, place mats (sets) not of paper; table linen, not of paper; handkerchiefs of textiles; bed linen, bed spreads; bed covers; damask; bales made of textiles; flags, pennants (not of paper), household linen; curtains of textile or plastics; pillow shams; furniture coverings of plastics, blinds (roller blinds) of textiles or plastics; towels of textile; textile wallpapers.

(260) AM 2012 64726 A

(800) 1093131

(731) PAULINE

10 Impasse du Grand Jardin – ZAC de
la Moinerie, F-35400 SAINT MALO,
France

(540)

PATRICE BREAL

(591) Black, white

(511)

3 – Toiletries; tissues impregnated with cosmetic lotions; cleansing milks; anti-perspirants, soaps, soap bars, deodorants for personal use; deodorant soaps; oils for cosmetic purposes; oils for perfumes and scents; oils as toiletries; perfumery, eaux de

toilette, scented water, perfumes, cologne; essential oils; ethereal oils; flower extracts (perfumery); cosmetics, cosmetic preparations for skin, body and facial care; cosmetic creams; cosmetic lotions; cosmetic sun-tanning preparations; beauty masks; cosmetic bath preparations; bath salts, not for medical purposes; aromatics (essential oils); cosmetics (kits); cosmetic preparations for slimming purposes; cotton buds for cosmetic purposes; after-shave lotions; cotton wool for cosmetic purposes; depilatories; depilatory preparations; nail care preparations; dentifrices; make-up and make-up removing preparations, lipsticks, mascara, make-up, nail polish; eyelash cosmetics; eyebrow cosmetics; eyebrow pencils; make-up powder; cosmetic pencils; cosmetic hair care preparations; hair lotions; hair dyes; hair styling waxes; hair-care oils; hair gels; hair sprays; bleach for cosmetic purposes, shampoos, hair sprays; decorative transfers for cosmetic purposes; false nails; false eyelashes; incense; sachets for perfuming linen; potpourris.

9 – Eyewear; glasses (optics); sunglasses; eyeglass frames; eyeglass cases; eyeglass lenses; sound and video recordings; compact disks and CD-ROMs; pre-recorded compact disks and CD-ROMs containing information in the field of fashion, and/or entertainment, and/or music, and/or video, and/or film, and/or books, and/or television, and/or games and/or sports; optical data media; pre-payment musical automata (jukeboxes); apparatus, instruments and media for recording, reproducing, storing, processing, manipulating, transmitting, broadcasting, retrieval, downloading and reproducing of music, sounds, images, texts, data; computer software for transmitting sound, images, texts and data via communication networks; receivers and transmitters (audio; video); tapes; cassettes, audio cassettes, video cassettes; magnetic cards; memory or microchip cards; compact disks and other data media; optical and magnetic devices, all containing or designed to contain audio and/or video recordings; audio and/or video recordings; headphones; cases for mobile telephones; cases for apparatus, instruments and media for recording, reproducing, storing, processing, manipulating, transmitting, broadcasting, retrieval, downloading and reproducing of music, sounds, images, texts, data; downloadable electronic publications; protective helmets for sports; cases for eyeglasses (leather goods).

14 – Precious metals and their alloys other than for dental use, jewelry, precious stones, timepieces and chronometric instruments; watches, watch cases, watch bands, alarm clocks, clocks; ring bands, rings (jewelry), earrings, bracelets, brooches (jewelry), necklaces, fashion jewelry, charms, tie clips, tie pins, jewelry cases of precious metal; boxes of precious metal; jewelry cases (of precious metal); statues of precious metal.

16 – Paper, cardboard (unprocessed, semi-finished or for stationery purposes); printed matter; stationery; pencils; pens; electric or non-electric pencil sharpeners; transfers (decalcomanias); paper clips; cases; bookmarkers; page markers; bookmarks; note clips; bookends; non-textile labels; plastic packaging materials, namely plastic packaging bags, sachets, films and sheets; sachets (envelopes, small bags) for packaging (of paper); packages and/or packaging cartons; posters; advertisement boards of paper or cardboard; albums; stickers (stationery articles); pads (stationery); calendars; notebooks; booklets; binders (office requisites); document folders; catalogs; printed matter; newspapers; pamphlets; publications, particularly publications in the field of fashion; bookbindings; bookbinding articles; indexes; magazines (periodicals); postcards; office requisites (except furniture); boxes of cardboard or paper; waste paper baskets.

18 – Leather and imitation leather, goods made thereof (leather and imitation leather) not included in other classes, namely travel chests, bags and sets, vanity cases, trunks, small suitcases, school satchels, briefcases and document cases, suitcases, card holders, purses and wallets (not of precious metal), backpacks, handbags; umbrellas, parasols, sunshades and walking sticks; whips, harness and saddlery; key cases (leather goods); school bags; purses; attaché cases; school book bags; beach bags; shopping bags; wheeled bags; garment bags (for travel); sports bags other than those adapted to the goods for which they are intended); boxes of leather or imitation leather; strips of leather or imitation leather; straps of leather, imitation leather or leatherboard; animal collars of leather or imitation leather; clothing for animals; leashes; muzzles; animal skins, pelts and hides of leather or imitation leather goods (except cases adapted to the goods for which they are intended), gloves and belts.

21 – Cookery of precious metal, napkin rings of precious metal, tea sets of precious metal, vases of precious metal.

24 – Fabrics for textile use, bed and table covers, lingerie fabric, table and household linen (except paper table linen), upholstery fabrics, bed covers, bedspreads, sheets, mattress covers, textile hand towels, cushion cases, quilt covers, tablecloths (not of paper), plaids, pillowcases, curtains of textile or plastic, table napkins of textile, bath towels of textile; bath linen (except clothing); bath towels; washcloths; cotton fabrics, cotton goods; sleeping bags; textile blinds; stickable adhesive fabrics; elastic fabrics; labels of fabric, cloths, fiberglass fabrics for textile use; filtering materials of textile, calico fabrics; jersey fabrics; jute fabrics; woollen cloths; woollen fabrics; linen fabrics; bed linens;

fabrics of imitation animal skins; wall hangings of textile, eiderdowns (down coverlets).

25 – Clothing, men's clothing, women's clothing, children's clothing; suits, jumpsuits (clothing); clothing of leather or imitation leather; dresses, skirts, underskirts, pants, Bermuda shorts, shorts; shirts, short-sleeved shirts, blouses, singlets, T-shirts, tanktops; vests, sweaters, pullovers, knitwear; jackets, gabardines, raincoats, coats, overcoats, parkas, pea jackets, chasubles; sportswear, sports footwear, cycling shorts; bathing caps, bathing trunks, bathing suits, bathrobes, bath sandals, bath slippers; pajamas, nightshirts, dressing gowns, suspenders, belts (clothing), socks, tights; collar protectors, sashes for wear, scarves, furs, muffs, mittens, gloves (clothing); shawls, ponchos, underclothing, underwear, lingerie, underclothing, undershorts, panties, all-in-ones (underclothing), bodysuits (leotards), crop tops, briefs, brassieres; layettes; headgear; headbands (clothing), berets, caps (headgear), baseball caps, hats, earmuffs, hoods, visors (headgear); footwear (except orthopedic footwear); sandals, boots, espadrilles, booties, slippers.

35 – Retail sale of clothing, underclothing, footwear, headgear, fashion accessories, namely optical goods, jewelry, watches, gloves, belts, hats, footwear, home accessories, namely table linens, bed linens, statues, lamps, candles, household linens, jewelry, cosmetics, perfumery, luggage; wholesale of clothing, underclothing, footwear, headgear, fashion accessories, namely optical goods, jewelry, watches, gloves, belts, hats, footwear, home accessories, namely table linens, bed linens, statues, lamps, candles, household linen, jewelry, cosmetics, perfumery, luggage; commercial information and advice for consumers; import-export services in relation to clothing, underclothing, footwear, headgear, fashion accessories, home accessories, household linens, jewelry, cosmetics, perfumery, luggage; advertising; services for distributing advertisements, publishing of advertising texts, sales promotion for third parties, bill-posting; services for updating advertising literature; distribution and dissemination of advertising materials, namely samples; goods demonstration services; modeling services for advertising or sales promotion; advertising, namely preparation of media plans; services relating to exhibition planning for commercial or advertising purposes; advertising sponsorship service; business management; business administration; office functions; data recording and processing services, namely the input, collection and systemization of data; computer file management services; collection of data in a central file; systemization of data in a central file; business management assistance services; business management and organization consultancy; corporate management assistance provided to commercial or industrial companies;

retail sale in the field of entertainment, namely pre-recorded musical and audiovisual works; retail store services for the retail sale of entertainment goods, namely pre-recorded musical and audiovisual works.

41 – Entertainment, radio entertainment, television entertainment, entertainment information; providing of training; videotape recording (filming), providing online electronic publications (not downloadable); services for editing and publishing of texts, illustrations, books, magazines, newspapers, periodicals and more generally of any publication other than advertising texts, including electronic and digital publications; publishing of texts, images, audio and/or video works, particularly via communications networks; organization of lotteries and games of all kinds; organization of exhibitions for cultural or educational purposes; organization of competitions (education or entertainment); organization of sports competitions; production of films, production of shows, particularly concerts, musical shows; videotape film production; music production; practical training (demonstration); online game services (via a computer network); leisure services; organization of beauty contests; organization of shows (impresario services), organization of events in the field of fashion; organization and conducting of training workshops, organization and conducting of colloquiums, conventions, seminars, symposiums; photography, photographic reporting; party planning (entertainment); music publishing services; entertainment, via communications networks; editing of multimedia content in connection with fashion, music, videos, films, entertainment, games, sports.

42 – Computer systems analysis; graphic arts design services, packaging design services, fashion design services, styling; reconstitution of databases; computer systems design, computer software design, installation of computer software, updating of computer software, rental of computer software; quality control; research in cosmetology; creation and maintenance of web sites for third parties, hosting of computer sites (web sites).

(260) AM 2012 64727 A

(800) 1093149

(731) RICHTER GEDEON NYRT.

Gyömrői út 19-21, H-1103 BUDAPEST,
Hungary

(540)

OVALIA

(591) Black, white

(511)

5 – Pharmaceutical preparations, namely oral contraceptives.

(260) AM 2012 64728 A
 (800) 1093168
 (731) Nemiroff Intellectual Property Establishment
 Städtle 31, FL-9490 Vaduz, Liechtenstein
 (540)



(591) Black, white
 (511)
 33 – Alcoholic beverages (except beers).

(260) AM 2012 64729 A
 (800) 1093180
 (731) NiDA SAAT SANAYİ VE DIŞ TİCARET
 LİMİTED ŞİRKETİ
 Tahtakale Mah. Tahtakale Cad. No. 55
 Menekse Han No. 34-40, Eminönü-Istanbul,
 Turkey
 (540)

WAINER

(591) Black, white
 (511)
 14 – Jewelry goods (including their imitation);
 gold, jewels, precious stones and jewelry made
 from these, cuff-links, necktie brooches and statues,
 knick knacks of precious metal; watches and horo-
 logical instruments (including chronometers and
 their parts, watch cordons).

(260) AM 2012 64730 A
 (800) 1093210
 (731) GUANGXI GOLDEN THROAT CO., LTD
 No. 28, Yuejin Road, 545001 Liuzhou City,
 Guangxi, China
 (540)



幽幽清泉

(591) Black, white
 (511)
 5 – Medicines for human uses; medicated candy;
 sterilizing preparations; gases for medical purposes;

Chinese patent medicines; pharmaceutical prepara-
 tions; medicinal tea; medicated liquor; syrups for
 medical purposes; contact lens cleaning prepara-
 tions; candy for medical purposes; chewing gum for
 medical purposes; dietetic substances adapted for
 medical use; dietetic beverages adapted for medical
 purposes; food for babies; air purifying prepara-
 tions; medicines for veterinary purposes; pesticides;
 sanitary towels; adhesive bands for medical pur-
 poses; medicinal health kits filled with Chinese
 medicines; teeth filling material.

30 – Coffee; coffee-based beverages; tea; tea beve-
 rages; sugar; candy; honey; dietetic substances in
 liquid form not for medical purposes; chewing
 gum, not for medical purposes; pastries; instant
 rice; gruel with eight ingredient for foods; cereal
 preparations; oat flakes; noodles; instant noodles;
 sesame paste; crispy rice, namely, rice-based snack
 foods; soybean milk; starch for food; ice cream;
 salt; vinegar; soy sauces; condiments; yeast; essen-
 ces for foodstuffs, except etheric essences and es-
 sential oils; meat tenderizers for household pur-
 poses.

(260) AM 2012 64731 A
 (800) 1093224
 (731) INDUSTRIA DE DISEÑO TEXTIL
 S.A.(INDITEX S.A.)
 Avenida de la Diputación, Edificio Inditex,
 E-15142 Arteixo (A Coruña), Spain
 (540)

ANXERI

(591) Black, white
 (511)
 3 – Bleaching preparations and other substances for
 laundry use; cleaning, polishing, degreasing and
 abrasive preparations; soap; perfumery, essential
 oils, cosmetics, hair lotions; dentifrices; shoe po-
 lish, cream and wax; polishes; shampoos; cosmetic
 kits; depilatory preparations; make-up removing
 preparations; deodorants for personal use (perfume-
 ry); lipsticks; cosmetic pencils; hair and nail sprays;
 lacquer-removing preparations; tissues impregnated
 with cosmetic lotions; cleaning wipes or towelettes
 pre-moistened or impregnated with cosmetic lotions
 or cleansers; after-shave lotions; lotions for cos-
 metical purposes; make-up preparations; pomades for
 cosmetic purposes; stain removers; sachets for
 perfuming linen; nail care preparations; bleaching
 preparations [decolorants] for cosmetic purposes;
 extracts of flowers (perfumes); incense; scented
 wood; decorative transfers for cosmetic purposes;
 false nails and eyelashes; pumice stone; fragrant
 potpourris; cosmetic preparations for slimming pur-
 poses; cosmetic preparations for baths; hair waving
 preparations; washing preparations; toiletries;
 mouth care products not for medical use; bath salts

excluding those for medical use; hygienic products for cleaning purposes; oils for toilet purposes; sunscreens (cosmetic sun-tanning preparations); eau de Cologne; deodorant soap; talcum powder for toiletry use; adhesives for cosmetic purposes; greases for cosmetic purposes; abrasives; shaving products; brightening chemicals for household use (washing of linen); cotton sticks for cosmetic purposes; beauty masks; mustache wax; laundry bleach; hair dyes; eyebrow cosmetics; depilatory wax; cleaning wax; shampoos for pets; cosmetics for animals; cosmetic creams; disinfectant soap; cakes of toilet soap; soap for foot perspiration; detergents other than those used in manufacturing and not for medical use; starch for laundry purposes; cleansing milks; bleaching preparations; dry-cleaning preparations; scented water; perfumes; cosmetics for eyelashes; cosmetic preparations for skin care; make-up powder; adhesives for affixing false hair; fabric softeners; cosmetic dyes; preparations for removing dyes; toilet water.

9 – Scientific, nautical, surveying, photographic, cinematographic, optical, weighing, measuring, signalling, checking [supervision], life-saving and teaching apparatus and instruments; apparatus and instruments for conducting, switching, transforming, accumulating, regulating or controlling electricity; apparatus for recording, transmission or reproduction of sound or images; magnetic data carriers, recording discs; automatic vending machines and mechanisms for coin-operated apparatus; cash registers, calculating machines, data processing equipment and computers; extinguishers; computer peripheral devices; anti-glare glasses; eyeglasses (pince-nez); optical lenses; pince-nez chains; contact lenses; pince-nez cords; dressmakers' measures; spectacles (optics); spectacle lenses; spectacle cases; spectacle frames and lenses (pince-nez); sunglasses; cases for eyeglasses and for contact lenses; shoes for protection against accidents, irradiation and fire; bulletproof, swimming and lifesaving jackets; fire protection suits and clothing; gloves for divers; gloves for protection against accidents; wet-suits; encoded cards, magnetic; clothing for protection against accidents and radiation; protective suits for aviators; electronic agendas; electric appliances for removing make-up; telephone apparatus; weighing scales; directional compasses; accounting machines; protective helmets; protective sports helmets; telescopes; chronographs (time recording apparatus); measuring spoons; pedometers; compact disks (audio-video); compact discs; mirrors (optics); floats for bathing and swimming; binoculars; temperature indicators; instruments for spectacles; game programs; cassette players; barcode readers; signal and magical lanterns, optical lamps; magnifying glasses (optics); dictating and invoicing machines; mechanisms for counter-operated apparatus; weights; electric, galvanic and

solar batteries; flat irons, electric; computer software (recorded); electronic pocket translators; transistors (electronic); thermometers excluding those for medical use; apparatus for games adapted for use with television receivers only; intercommunication apparatus; video cassettes; animated cartoons; teaching apparatus; baby cry detectors; walkie-talkies; electronic publications (downloaded electronically); egg timers; acoustic [sound] alarms; anti-theft warning apparatus; fire alarms; computer mouse pads; loudspeakers; amplifiers; antennas; anti-glare visors; telephone receivers; headsets (for music); answering machines; counterfeit coin detectors; teeth protectors; machines for counting and sorting cash; apparatus for measuring the thickness of skins and leather, electronic tags for goods; goggles for sports; magnets; light-emitting electronic pointers; ear plugs; portable telephones; enlarging apparatus (photography); apparatus and instruments for astronomy; thermionic valves (radio); juke boxes; scales; life-saving rafts; tape recorders; head cleaning tapes; video tapes; magnetic tapes; demagnetizing apparatus for magnetic tapes; barometers; batteries, electric; ticket dispensers; hair-curlers, electrically heated; calculating machines; heat regulating apparatus; cameras (cinematographic apparatus); video cameras; video game cartridges; magnetic encoders; measuring glassware; revolution counters; transparencies; slide projection apparatus; dynamometers; reflecting disks, for wear, for the prevention of traffic accidents; hemline markers; dosage dispensers; cigar lighters for automobiles; covers for electric outlets; radio-telephony sets; scanners (data processing equipment); cases (optical); flash-bulbs (photography); devices and machines for photocopying (including electrostatic or thermal apparatus and machines); holograms; compact disc players; signs, luminous; neon signs; video recorders; electric measuring apparatus; megaphones; computer memories; microphones; microprocessors; modems; breathing apparatus for underwater swimming; objectives [lenses] (optics); ozonisers; projection screens; switches, electric; dog whistles; push buttons for bells; radios; audio and video receivers; wrist rests for computer equipment; balances (steelyards); television apparatus; temperature indicators; record players; word processing apparatus; video telephones; portable music players.

14 – Precious metals and their alloys and goods in precious metals or coated therewith, not included in other classes; jewelry, precious stones; horological and chronometric instruments; ornamental pins; tie pins; boxes of precious metal for needles; cases for needles of precious metal; napkin rings of precious metal; works of art of precious metal; key rings [trinkets or fobs]; medals; coins; silverware (with the exception of cutlery, table forks and spoons); badges of precious metal; ornaments of precious

metal for footwear and hats; ashtrays of precious metal for smokers; cuff links; trays of precious metal, for household use; watch chains; watch cases; candelabra of precious metal; tableware of precious metal; cruets of precious metal; vases of precious metal; coffee and tea services of precious metal; household and kitchen containers of precious metal; threads of precious metal (jewelry); jewel cases of precious metal; cigarette cases of precious metal; powder compacts of precious metal; ornaments (jewelry); silver ornaments; jewelry of yellow amber; clips and amulets (jewelry); rings (jewelry); ornaments (adornments) of jet; tea infusers of precious metal; bracelets (jewelry); brooches (jewelry); chains (jewelry); boxes of precious metal; epergnes of precious metal; necklaces (jewelry); tie clasps; watch glasses; chronographs (watches); alarm clocks; diamonds; trinkets (pendants); paste jewelry; cases for clock and watch-making; ivory; medallions (jewelry); precious stones; earrings; pearls (jewelry); watchbands; watches.

16 – Paper, cardboard and goods made from these materials, not included in other classes; printed matter; bookbinding material; photographs; stationery; adhesives for stationery or for household use; artists' materials; paintbrushes; typewriters and office articles (except furniture); instructional and teaching material (except apparatus); plastic materials for packaging (not included in other classes); printing type; printing blocks; engravings; boxes of cardboard or paper; patterns for dressmaking and sewing; napkins of paper for removing make-up; stencil cases; labels, not of textile; table linen of paper; table napkins of paper; babies' diapers of paper or cellulose (disposable); babies' diaper-pants of paper or cellulose (disposable); handkerchiefs of paper; pen cases; checkbook holders; writing cases (sets); inking sheets for document reproducing machines; bags (envelopes, pouches) for packaging (of paper or plastics); tailors' chalk; face towels of paper; hat boxes; tracing cloth and paper; cloth for bookbinding; canvas for painting; hand towels of paper; albums; almanacs; hand labelling appliances; document files; writing articles and instruments; decalcomanias; calendars; posters; document files; catalogues; pictures; carrying pouches; drawings; daily newspapers; newspapers; magazines (periodicals); books; lithographs; wrapping paper; toilet paper; paperweights; mats for beer glasses; book-markers; bookends; ink; inkwells; bibs of paper; drawing materials; graphic prints; school supplies; writing slates; comic books; trays for sorting and counting coins; embroidery designs; garbage bags of paper or of plastics; geographical maps; terrestrial globes; office moisteners; plastics for modelling; blueprints; stencils (stationery); paper or cardboard placards; cards; steel letters and nibs; aquarelles; indoor aquaria; adhesive tape dispen-

sers; adhesive tapes and bands for stationery or household use; stickers (stationery); cigar bands; files (office requisites); modelling clay; arithmetical tables; drawer liners of paper (perfumed or not); architects' models; atlases; paper flags and pennants; tickets; pads (stationery); ball-point pens; bags for microwave cooking; writing board erasers; rubber erasers; erasing products; bottle packaging and sleeves of cardboard or paper; painters' easels; song books; charcoal pencils; writing paper; advertisement boards of paper or cardboard; booklets; ink sticks; modelling wax, not for dental purposes; sealing wax; drawing pins; paper tapes and ribbons; inking ribbons for computer printers; ribbons for typewriters; paper clip surfaces (office requisites); cabinets for stationery (office requisites); compasses for drawing; paper clasps (paper clips); paper knives (office requisites); writing or drawing books; paintings [pictures], framed or unframed; finger-stalls (office requisites); bookbinding material; gummed cloth for stationery purposes; inking pads; squares (rulers); shields (paper seals); greeting cards; filter paper; covers (stationery); photograph stands; elastic bands for offices; staplers (stationery); paper clasps and clips; loose leaf paper (stationery); pencil sharpeners; pencil holders; luminous paper; palettes for painters; silver paper; waxed paper; modelling paste; office perforators; painters' brushes; house painters' rollers; postcards; printed publications; rosaries; blotters; envelopes (stationery).

18 – Leather and imitations of leather, and goods made of these materials and not included in other classes; animal skins; trunks and travelling bags; umbrellas, parasols and walking sticks; whips, harness and saddlery; bags for climbers and campers, beach bags; handbag frames; frames for umbrellas or parasols; alpenstocks; bags for campers, bags for sports; bags for climbers; net bags for shopping; travelling bags; bags [envelopes, pouches] of leather, for packaging; bags; leather lining for footwear; travelling cases and key cases (leatherware); attaché cases; coin purses, not of precious metal; garment bags for travel; hat boxes of leather; sling bags for carrying infants; wheeled shopping bags; containers and boxes of leather or leatherboard; boxes of vulcanised fibre; pocket wallets; briefcases (leatherware); school bags; bags for schoolchildren and document holders; school satchels; vanity cases; collars for animals; leather leashes; leather leads; umbrella covers; saddle cloths for horses; haversacks; backpacks; backpacks for school; leather liners for music cases; reins for horses; bags (wrappings, pouches) for packaging (of leather); leather thread; suitcase handles; handles for walking sticks and umbrellas; whips; horse blankets; furniture coverings of leather; clothing for pets; pads for horse saddles; umbrella rings; blinkers (harness); harness fittings of iron (trappings);

harnesses for animals; harness for animals; harness fittings, not of precious metal; walking-stick seats; shoulder belts (straps), of leather; unfitted leather tool bags; chain mesh purses (not of precious metal); beach bags; muzzles; bridles (harnesses); head-stalls; leatherboard; bands of leather; travelling trunks; shopping bags; straps for soldiers' equipment; harness traces; leather straps (saddlery); straps for skates; imitation leather; trimmings of leather for furniture; leather straps; butts; curried skins; cat-o'-nine tails; fur coverings (furs for coats or adornment); stirrup leathers; parts of rubber for stirrups; bits for animals (harness); saddlery; reins; carrying cases; moleskin (imitation leather); fur; chamois leather, other than for cleaning purposes; nose bags (feed bags); net bags for shopping; springs (casings, of leather, for plate); knee-pads for horses; riding saddles; fastenings for saddles (bellybands), cardholders (document holders) (wallets); traces (harness); valves of leather.

21 – Utensils and containers for household and kitchen use; combs and sponges; brushes; material for brush-making; articles for cleaning purposes; steel wool; glass, unworked or semi-worked, except building glass; glassware, porcelain and earthenware not included in other classes; bottle openers; oil cruets (not of precious metal); cocktail stirrers; candle extinguishers, not of precious metal; non-electric appliances for removing make-up; sugar bowls, not of precious metal; trays for household use, not of precious metal; baby baths (portable); cloth for washing floors; glass bowls; tea balls (not of precious metal); candy boxes, not of precious metal; bottles; shaving brushes; pottery; coffeepots, non-electric; chests; heaters for feeding bottles, non-electric; shoe horns; candelabra (candlesticks), not of precious metal; pipettes; flycatchers; epergnes, not of precious metal; baskets for household use, not of precious metal; strainers, not of precious metal; trouser stretchers; ice pails; tie presses; door handles (knobs) of porcelain; comb cases; ironing board covers; gardening gloves; gloves for household use; polishing gloves; shoe trees; piggy banks, not of metal; soap boxes; decanters; bird-cages; toilet cases; works of art of porcelain, terracotta or glass; toothpick containers, not of precious metal; carpet beaters; bread bins; cleaning cloths and wipes; pepper pots; clothes pegs and washing lines; dishes, not of precious metal; feather-dusters; shaving brush holders; sponge holders; toilet paper holders; trouser presses; perfume sprayers and vaporizers; graters; crumb trays; coasters for bottles, not of paper nor of table linen; trivets [table utensils]; boot jacks; salt shakers, not of precious metal; clothes drying racks; tea and coffee services not of precious materials; napkin rings, not of precious metal; washing and ironing boards; bread boards; carving boards; cups; shirt stretchers; shoe-trees; teapots; flower pots; toilet utensils; tableware

not of precious metal; glasses (receptacles); cruets, not of precious metal; thermally insulated containers for food and beverages; cleaning cloths impregnated with detergent; toothbrushes; toothbrushes, electric; floss for dental purposes; fruit presses, not electric and for household use (squeezers); button-hooks; steel wool for cleaning; aerosol dispensers, not for medical use; siphons for carbonated water; insulating flasks; roses for watering cans; cotton waste for cleaning; pestles (kitchen utensils); garlic presses (kitchen utensils); glass bulbs (receptacles); poultry rings; litter boxes for pets; cages for pets; animal bristles (brushware); buckskin for cleaning; vessels; buckets; dish covers; bird baths; mess-tins; cooking pot sets; beaters, non-electric; drinking vessels; bottle gourds; glass jars (carboys); isothermic bags; demijohns; glass flasks (containers); nozzles for sprinkler hose; powder puffs; refrigerating bottles; porcelain grips; busts of china, terra-cotta or glass; hairbrushes; stew-pans; pots; pot lids; boxes of glass; coffee grinders, hand operated; boxes of metal, for dispensing paper towels; tins for biscuits and snacks; tea caddies (not of precious metal); cauldrons; butter and cheese dish covers; candle rings, not of precious metal; pitchers, not of precious metal; carousel trays (kitchen utensils); basting spoons, for kitchen use; earthenware saucers; brushes for washing up; electric brushes (excluding parts of machines); rat traps; ceramics for household purposes; beer jugs; fitted picnic baskets; closures for pot lids (cooking pots); cooking utensils, non-electric; cookery molds; glue-pots; washtubs; feeding troughs for animals; fruit cups; corkscrews, pastry cutters; cosmetic utensils; sifters (household utensils); enamelled glass; fiberglass thread, not for textile use; glass for vehicles; painted glassware; goblets; of paper or plastic; beakers (not of precious metals); dustbins; flowerpot covers, not of paper; mixing spoons (kitchen utensils); knife rests for the table; bowls; demijohns; dusting apparatus, non-electric; deodorizing apparatus for personal use; soap dispensers; water apparatus for cleaning teeth and gums; funnels; non-electric floor polishers; non-electric shoe polishers; salad bowls, not of precious metal; brooms; mops; carpet sweepers; brushes for cleaning tanks and containers; bowls; enamelled glass; spatulas (kitchen utensils); spice sets; statues and statuettes of porcelain, earthenware or glass; scouring pads; coffee filters, non-electric; filters for household use; holders for flowers and plants (flower arranging); flasks, not of precious metal; deep fryers, non-electric; frying pans; scrubbing brushes (brushes); basins (vessels); fume absorbers for household use; chamois leather for cleaning; pitchers; ice pails; ice cube molds; egg cups, not of precious metal; soap dishes; vegetable dishes; signboards of porcelain or glass; liqueur sets; cabarets (trays), not of precious metal; furniture dusters; confectioners'

decorating bags; butter dishes; cooking pots (stew pans); shakers; molds (kitchen utensils); mosaics of glass, not for building; portable coolers, not electric; pressure cookers [autoclaves], non-electric; chamber pots; basins; scoops (table accessories); toothpicks; candelabra, not of precious metal; rolling pins, domestic; perfume burners; spouts; flat-iron stands; holders for flowers and plants (flower arranging); saucers, not of precious metal; powder compacts, not of precious metal; currycombs; mouse traps; containers for household use (not of precious metal); articles for refrigerating foods containing liquids for heat exchange, for household use; watering cans; sprinklers; watering devices; punches (kitchen utensils); services (tableware) not of precious metal; soup bowls, not of precious metal; ice-cream freezers; sieves (household utensils); abrasive pads for kitchen purposes; glass stoppers; bowls; buckets made of woven fabrics; stretchers for clothing; indoor terrariums [plant cultivation]; napkin holders, not of precious metal; non-electric kitchen mixers; urns, not of precious metal; spits (kitchen utensils); powdered glass for decoration.

24 – Textiles and textile goods, not included in other classes; bed and table covers; bath linen (except clothing); napkins, of cloth, for removing make-up; labels of cloth; linings (textile); washing mitts; wall hangings of textile; handkerchiefs of textile; curtains of textile or plastic; household linen; towels of textile; travelling rugs; net curtains; curtain holders of textile material; banners and flags (not of paper); eiderdowns (down coverlets); loose covers for furniture; covers for cushions; mattress covers; pillow cases; mosquito nets; glass-cloths; billiard cloth; table covers; traced cloths for embroidery; upholstery fabrics; face towels of textile; sleeping bags (sheeting); cotton fabrics; sackcloth (fabric); traced cloths for embroidery; brocades; lining fabric for shoes; fabric for boots and shoes; bedspreads; bed blankets; trellis (cloth); zephyr (cloth); centerpieces; chevots (fabric); ticks (mattress covers); textile or plastic shower curtains; crepe (fabric); crepon; bed throws; damask; elastic woven material; oilcloth for use as tablecloths; gummed cloth other than for stationery; esparto fabric; chenille fabric; felt; flannel (fabric); toilet seat covers; gauze (cloth); jersey (fabric); woollen cloths and fabrics; lingerie fabric; linen cloth; textile placemats; tablecloths, not of paper; printer's blankets of textile; marabouts (cloth); upholstery fabrics; fabric of imitation animal skins; knitted fabrics; cheese cloth; ramie fabric; rayon fabric (artificial silk); silk; taffeta (cloth); fiberglass fabrics, for textile use; adhesive fabric for application by heat; patterned linen; velvet; tulle.

25 – Clothing, footwear, headgear; clothing for motorists and cyclists; bibs, not of paper; headbands (clothing); bath robes; swimming suits, bathing

caps and sandals; boas (necklets); babies' diaper pants (of textile materials); scarves; sports and beach footwear; hoods (clothing); shawls; belts (clothing); money belts (clothing); wet suits for water-skiing; neckties; corsets (girdles); mufflers; fur stoles; scarves; caps; caps; gloves (clothing); waterproof clothing; girdles; underclothing; mantillas; stockings; socks; neckerchiefs; babies' diapers of textile; furs (clothing); pajamas; soles for footwear; heels; veils (clothing); braces for clothing; gymnastic and sports outfits; layettes (clothing for babies); collars (clothing); jerseys; mittens; ear warmers (clothing); inner soles; bow ties; pareus; wristbands; dress shields; beach clothes; overalls; pockets for clothing; sock suspenders; stocking suspenders; petticoats; tights (complete stockings or leotards); aprons (clothing); head dresses (headgear); masquerade costumes; uniforms; visors (hatmaking); wooden shoes; caps; garters; coats; esparto shoes or sandals; non-slip devices for footwear; bath robes; bath slippers; toques; blouses; bodies (articles of underclothing); berets; footmuffs, not electrically heated; lace boots; boots; boot uppers; studs for football boots; half-boots; iron fittings for shoes; tips for footwear; welts for footwear; heelpieces for boots and shoes (heel reinforcements); pants; shirts; shirt yokes; shirt fronts; tee-shirts; T-shirts (short sleeved); bodices; waistcoats; jackets; fishing vests; stuff jackets; combinations (clothing); slippers (undergarments); ready-made clothing; detachable collars and collars; clothing of leather; imitation leather clothing; shower caps; slippers; skirts; trousers; ready-made linings (parts of clothing); overcoats; gabardines (for clothing); gymnastic shoes; jumpers (for wear); pullovers; sweaters; liveries; muffs (for wear); footwear uppers; pocket squares (clothing); parkas; pelerines; pelisses; spats; leggings; knitwear; knitted clothing; clothing for gymnastics; outerclothing; underwear; sandals; saris; underpants; hats; wimples (for wear); togas; gaiter straps; suits; turbans; suits; clothing articles; slippers; shoes; sport shoes.

26 – Lace and embroidery, ribbons and braid; buttons, hooks and eyes, pins and needles; artificial flowers; glass beads (adornments for clothing); pin cushions; hat and shoe ornaments (not of precious metal); haberdashery (except thread); hair bands; armbands; reins for guiding children; brooches (clothing accessories); sewing boxes; belt clasps; shoe laces; wreaths of artificial flowers; tea cosies; ornamental novelty badges; sewing thimbles; bows for the hair; needle cases, not of precious metal; buckles (clothing accessories); shoe buckles; shoulder pads for clothing; hair pins; badges for wear, not of precious metal; tinsels (trimmings for clothing); numerals or letters for marking linen; ribbon eyelets; barrettes (hair-slides); lace trimmings; birds' feathers (clothing accessories); top-knots; zip fasteners; competitors' numbers; ornamental parts applied by heat for textile materials (haberdashery);

clasps for carpets and rugs; snap fasteners; ostrich feathers (clothing accessories); whalebones for corsets; bands (prizes); cords for rimming, for clothing; tassels (haberdashery); expanding bands for holding sleeves; hair ornaments; false hair; hair nets; shoe eyelets; chenille (lace trimmings); frills (lacework); clips for cyclists; fastenings for clothing; self-adhesive ribbons (haberdashery); elastic ribbons; ribbons for gathering curtains; laces for clothing; collar supports; false hems; rosettes (haberdashery); festoons (embroidery); fringes; artificial fruit; braids; hair coloring caps; artificial garlands; darning eggs; trimmings for clothing; tresses of hair; wigs; silver embroidery; dress fastenings; borders for clothing; rosettes (haberdashery); zip fasteners for bags; braces (dressmaking); fastenings for braces; skirt flounces; braids; toupees; shoe hooks.

35 – Advertising; business management; business administration; office functions; assistance in the business management or commercial functions of an industrial or commercial company; organization of exhibitions and fairs for commercial or advertising purpose; promotion services provided by a commercial company by means of a customer loyalty card; modelling for advertising or sales promotion; publishing of advertising texts; shop window dressing; assistance for the operation of commercial companies as franchises; demonstration of goods; sales promotion for others; auctioneering; promoting and managing of commercial centers; providing assistance in the commercial functions of businesses, namely the management of orders via global communication networks; import-export agencies; on-line advertising on a computer network; procurement services for others (purchasing goods and services for other businesses); distribution of samples; computerized file management; public relations; commercial information agencies; advertising agencies; rental of vending machines; rental of advertising space; dissemination of advertising matter; business management assistance; data search in computer files (for others); compilation of information into computer databases; transcription; publicity columns preparation; commercial or industrial management assistance; business management of performing artists; direct mail advertising; updating of advertising material; document reproduction; marketing studies; bill-posting (advertising); opinion polling; systemization of information into computer databases; publication of publicity texts; bringing together, for the benefit of others, of a variety of goods (excluding the transport thereof), enabling customers to conveniently view and purchase those goods; agency services for sales and arranging sales; wholesale and retail sale services, as well as selling via global computer networks, mail order, catalog, telephone, television or radio programs and via other electronic means of bleaching preparations and other substances for laundry use, cleaning, polishing,

scouring and abrasive preparations, soaps, perfume-ry, essential oils, cosmetics, hair lotions, dentifrices, shoe polish, cream and wax, polishes, shampoos, cosmetic sets, depilatory preparations, make-up removing preparations, deodorants for personal use (perfumery), lipsticks, cosmetic pencils, hair and nail sprays, lacquer-removing preparations, tissues impregnated with cosmetic lotions, cleaning wipes or towelettes pre-moistened or impregnated with cosmetic lotions or cleansers, after-shave lotions, lotions for cosmetic purposes, make-up preparations, pomades for cosmetic purposes, stain removers, sachets for perfuming linen, nail care preparations, coloring substances for cosmetic use, extracts of flowers (perfumery), incense, scented wood, decorative transfers for cosmetic purposes, false nails and eyelashes, pumice stone, fragrant potpourris, cosmetic preparations for slimming purposes, cosmetic preparations for baths, hair waving preparations, washing preparations, toiletries, mouth care products not for medical use, bath salts not for medical use, hygienic products for cleaning purposes, oils for toilet purposes, sunscreens (cosmetic sun-tanning preparations), eau de Cologne, deodorant soap, talcum powder for toiletry use, adhesives for cosmetic purposes, greases for cosmetic use, abrasives, shaving products, colour-brightening chemicals for household use (laundering), cotton buds for cosmetic purposes, beauty masks, mustache wax, laundry bleach, hair dyes, eyebrow cosmetics, depilatory wax, cleaning wax, shampoos for pets, cosmetics for animals, cosmetic creams, disinfectant soap, cakes of toilet soap, soap for foot perspiration, detergents excluding those used in manufacturing and for medical use, starch paste, toilette milks, laundry preparations, dry cleaning preparations, scented waters, perfumes, cosmetics for eyelashes, cosmetic preparations for skin care, make-up powder, adhesives for affixing false hair, fabric softeners, cosmetic dyes, preparations for removing dyes, toilet water, scientific, nautical, surveying, electric, photographic, cinematographic, optical, weighing, measuring, signalling, checking (supervision), life-saving and teaching apparatus and instruments, apparatus and instruments for conducting, switching, transforming, accumulating, regulating, or controlling electricity, apparatus for recording, transmission or reproduction of sound or images, magnetic data carriers, recording disks, automatic vending machines and mechanisms for apparatus subject to payment, cash registers, calculating machines, data processing equipment and computers, fire extinguishers, computer peripheral devices, anti-glare spectacles, eye glasses, optical lenses; pince-nez chains, contact lenses, pince-nez cords, dressmakers' measures, spectacles, spectacle lenses, cases for spectacles, spectacle frames and lenses (pince-nez), sunglasses, cases for eyeglasses and for contact lenses, shoes for protection against accidents, irradiation and fire, bulletproof, swimming and lifesaving jackets; fire protection suits and clothing, gloves for divers,

gloves for protection against accidents, wetsuits, magnetic cards, clothing for protection against accidents and radiation, protective suits for aviators, electronic agendas, electric appliances for removing make-up, telephone apparatus, weighing scales, compasses, accounting machines, protective helmets, protective sports helmets, spy glasses, chronographs (time recording apparatus), measuring spoons, pedometers, compact disks (audio-video), compact disks, mirrors (optics), floats for bathing and swimming, binoculars (optics), temperature indicators, instruments for spectacles, game programs, cassette players, barcode readers, signal and magical lanterns, optical lamps, magnifying glasses (optics), dictating and invoicing machines, mechanisms for counter-operated apparatus, weights, electric, galvanic and solar batteries, electric flat irons, computer software (recorded), electronic pocket translators, transistors (electronic), thermometers not for medical use, apparatus for games adapted for use with television receivers only, inter-communication apparatus, video cassettes, animated cartoons, teaching apparatus, baby cry detectors, walkie-talkies, electronic publications (downloadable), sand glasses, sound alarms, anti-theft warning apparatus, fire alarms, computer mouse pads, loudspeakers, amplifiers, aerials, anti-glare visors, telephone headsets, headsets (for music), answering machines, counterfeit coin detectors, teeth protectors, machines for counting and sorting money, apparatus for measuring the thickness of skins and leather, electronic tags for goods, goggles for sports, magnets, light-emitting electronic pointers, ear plugs, mobile telephones, enlarging apparatus (photography), apparatus and instruments for astronomy, thermionic valves (radio), juke boxes, scales, life-saving rafts, tape recorders, head cleaning tapes, video tapes, magnetic tapes, demagnetizing apparatus for magnetic tapes, barometers, electric batteries, ticket dispensers, hair-curlers, electrically heated, calculating machines, heat regulating apparatus, cameras (cinematographic apparatus), video cameras, video game cartridges, magnetic encoders, measuring glassware, revolution counters, slides, slide projection apparatus, dynamometers, reflecting disks, for wear, for the prevention of traffic accidents, hemline markers, dosage dispensers, cigar lighters for automobiles, covers for electric outlets, hardware, radio-telephones, scanners (data processing equipment) (computing), cases (optics), flashlight bulbs (photography), apparatus and equipment for photocopying (including electrostatic or thermal apparatus and machines), holograms, compact disc players, luminous signs, neon signs, video recorders, electrical measuring devices, megaphones, computer memories, microphones, microprocessors, modem, breathing apparatus for underwater swimming, objectives (lenses), ozonizers, projection screens, electric switches, dog whistles, push buttons for bells, radios, audio and video receivers, wrist rests for computer equipment, balances (steelyards), televi-

sion apparatus; temperature indicators, record players, word processors, video telephones, portable music players, precious metals and their alloys and goods in precious metals or coated therewith, jewelry, precious stones, horological and chronometric instruments, ornamental pins, tie pins, boxes of precious metal for needles, cases for needles of precious metal, napkin rings of precious metal, works of art of precious metal, key rings (trinkets or fobs), medals; coins, silverware (with the exception of cutlery, table forks and spoons), badges of precious metal, ornaments of precious metal for footwear and hats, ashtrays of precious metal for smokers, cuff links, trays for household use, of precious metal, watch chains, clock cases, candelabra of precious metal, tableware of precious metal, cruets of precious metal, vases of precious metal, coffee and tea services of precious metal, household and kitchen containers of precious metal, threads of precious metal (jewelry), jewel cases of precious metal, cigarette cases of precious metal, powder compacts of precious metal, ornaments (jewelry), silver ornaments, jewelry of yellow amber, clips and amulets (jewelry), rings (jewelry), ornaments (adornments) of jet, tea infusers of precious metal, bracelets (jewelry), brooches (jewelry), chains (jewelry), boxes of precious metal, epergnes of precious metal, necklaces (jewelry), tie clasps, watch glasses, chronographs (watches), alarm clocks, diamonds, trinkets, paste jewelry, cases for clock and watch-making, ivory ornaments, medallions (jewelry), precious stones, earrings, pearls (jewelry), watchstraps, watches, paper, cardboard and goods made thereof, printed matter, bookbinding material, photographs, stationery products, adhesives for stationery or for household use, artists' materials, paintbrushes, typewriters and office articles (except furniture), instructional and teaching material (except apparatus), plastic materials for packaging, printers' type, printing blocks, engravings, boxes of cardboard or paper, patterns for dressmaking and sewing, napkins of paper for removing make-up, stencil cases, non-textile labels, table linen of paper, table napkins of paper, babies' diapers of paper and cellulose (disposable), babies' diaper-pants of paper and cellulose (disposable), handkerchiefs of paper, pen cases, chequebook holders, writing cases (sets), inking sheets for document reproducing machines, bags (envelopes, pouches) for packaging (of paper or plastics), tailors' chalk, face towels of paper, hat boxes, tracing cloth and paper, bookbinding cloth, canvas for painting, towels of paper, albums, almanacs, hand labelling appliances, document files, writing articles and instruments, decals, calendars, posters; folders for papers, catalogues, collecting and exchange cards, drawing sets, newspapers, periodicals, magazines (periodicals), books, lithographs, wrapping paper, toilet paper, paperweights, mats for beer glasses, bookmarkers, bookends, ink; inkwells, bibs of paper, drawing materials, graphic prints, school supplies, writing slates, comic books, trays for sorting

and counting money, embroidery designs, garbage bags of paper or of plastics, geographical maps, terrestrial globes, office moisteners, plastics for modelling, plans, stencils (stationery), paper or cardboard placards, cards, steel letters and nibs, aquar-elles, indoor aquaria, adhesive tape dispensers, adhesive tapes and bands for stationery or house-hold use, stickers (stationery), cigar bands, files (office requisites), modelling clay, calculating tables, drawer liners of paper (perfumed or out), archi-tects' models, atlases, paper flags and pennants, tickets, pads (stationery), ball-point pens, bags for microwave cooking, writing board erasers, rubber erasers, erasing products, bottle packaging and sleeves of cardboard or paper, painters' easels, song books, charcoal pencils, writing paper; advertise-ment boards of paper or cardboard; booklets, ink sticks, modelling wax, not for dental purposes, seal-ing wax, drawing pins, paper tapes and ribbons, inking ribbons for computer printers, ribbons for typewriters, paper clip surfaces (office requisites), cabinets for stationery (office requisites), compas-ses for drawing, paper clasps (paper clips), paper knives (office requisites), writing or drawing books, paintings (pictures) framed or unframed, finger-stalls (office requisites), bookbinding material, gum-med cloth for stationery purposes, inking pads, squares (rulers), shields (paper seals), greeting cards, filter paper, covers (stationery), photograph stands, elastic bands for offices, staplers (station-ery), staples (paper holders or clips), loose leaf pa-per (stationery), pencil sharpeners, pencil holders, luminous paper, palettes for painters, silver paper, waxed paper, modelling paste, office perforators, painters' brushes, house painters' rollers, postcards, printed publications, chaplets, blotters, envelopes (stationery), leather and imitations of leather, goods made of these materials, animal skins and hides, trunks and traveling bags, umbrellas, parasols and walking sticks, whips, harness and saddlery, bags for climbers and campers, beach bags, handbag frames, frames for umbrellas or parasols, alpen-stocks, bags for campers, bags for sports, bags for climbers, net bags for shopping, traveling bags, bags of leather for packaging, handbags, leather lining for footwear, travelling cases and key cases (leatherware), briefcases for documents, purses, not of precious metal, garment bags for travel, hat bo-xes of leather, sling bags for carrying infants, wheeled shopping bags, containers and boxes of leather or leatherboard, boxes of vulcanized fiber, pocket wallets, briefcases, school bags, school bags and document holders, school satchels, vanity cases non fitted, collars for animals, leather leashes; lea-ther leads, umbrella covers, saddle cloths for horses, backpacks, rucksacks, school satchels, leather li-nings for music cases, halters, bags (wrappings, small bags) for packaging (leather), leather thread, suitcase handles, handles for walking sticks and umbrellas, whips, horse blankets, furniture cove-rings of leather, clothing for animals, pads for horse saddles, umbrella rings, blinkers (harness), harness

fittings of iron (trappings), harnesses for animals, tack, harness fittings, not of precious metal, wal-king-stick seats, shoulder belts (straps), of leather, unfitted leather tool bags, chain mesh purses (not of precious metal), beach bags, muzzles, bridles (har-ness), halters, leatherboard, bands of leather, tra-velling trunks, shopping bags, straps for soldiers' equipment, harness straps, leather straps (saddlery), straps for skates, imitation leather, leather trim-mings for furniture, leather thongs, butts (parts of hides), curried skins, cat-o-nine tails, fur coverings (pelts for coats or adornment), stirrup leathers, parts of rubber for stirrups, bits for animals (harness), saddlery, reins, attache cases, moleskin (imitation leather), fur, chamois leather, other than for clean-ing purposes, nose bags (feed bags), net bags for shopping, springs (casings, of leather, for plate), knee-pads for horses, riding saddles, fastenings for saddles (girth straps), card holders (document hol-ders) (wallets), traces harness), valves of leather, utensils and containers for household and kitchen use, combs and sponges, brushes, material for brush-making, cleaning materials, steelwool, un-worked or semi-worked glass (except building glass), glassware, porcelain and earthenware, bottle openers, oil cruets, not of precious metal, cocktail stirrers, candle extinguishers, not of precious metal, non-electric appliances for removing make-up, sugar bowls, not of precious metal, trays for hou-sehold use, not of precious metal, baby baths (por-table), cloth for washing floors, glass bowls, tea balls, not of precious metal, candy boxes, not of precious metal, bottles, shaving brushes, pottery, non-electric coffee-pots, cases, non-electric heaters for feeding bottles, shoe horns, candle holders (candlesticks), not of precious metal, wine tasters, flycatchers, table centrepieces not of precious metal, baskets for household use, not of precious metal, strainers, not of precious metal, trouser stret-chers, ice pails, tie presses, door handles (knobs) of porcelain, comb cases, ironing board covers, gar-dening gloves, gloves for household use, polishing gloves, shoe trees, piggy banks, not of metal, soap boxes, jars, bird cages, toiletry sets, works of art, of porcelain, terra-cotta or glass, toothpick holders, not of precious metal, carpet beaters, bread bins, cleaning cloths and wipes, pepper pots, clothes pegs and washing lines, dishes not of precious metal, feather-dusters, shaving brush holders, sponge hol-ders toilet paper holders, trouser presses, perfume sprayers and vaporizers, graters, crumb trays, coas-ters for bottles not of paper nor of table linen, trivets (table utensils), boot jacks, salt shakers, not of precious metal, clothes drying racks, tea and coffee services not of precious materials, napkin holders, not of precious metal, washing and ironing boards, bread boards, carving boards, cups shirt stretchers, shoe-trees, teapots, flower pots, toilet utensils, tableware, not of precious metal, glasses (containers), cruets, not of precious metal, thermally insulated containers for food and beverages, cleaning cloths impregnated with detergent, tooth-

brushes, electric toothbrushes, dental floss, juice extractors not electric and for household use (juicers), buttonhooks, steel wool for cleaning, aerosol dispensers, not for medical use, siphons for carbonated water, vacuum bottles, nozzles for watering cans, cotton waste for cleaning, pestle (kitchen utensils), garlic press (kitchen utensils), glass bulbs (receptacles), poultry rings, litter boxes for pets, cages for pets, animal bristles (brushware), buckskin for cleaning, vessels, buckets, dish covers, bathtubs bird baths, mess-tins, cooking pot sets, non-electric beaters, drinking vessels, bottle gourds, glass jars (carboys), isothermic bags, demijohns, glass flasks (containers), nozzles for sprinkler hose, powder puffs, refrigerating bottles, porcelain grips, busts of china, terra-cotta or glass, hairbrushes, casseroles, pots, pot lids, boxes of glass, coffee grinders, hand operated, metal boxes for dispensing paper towels, tins for biscuits and snacks, tea caddies (not of precious metal), cauldrons, butter and cheese dish covers, candle rings, not of precious metal, pitchers, not of precious metal, carousel trays (kitchen utensils), basting spoons, for kitchen use, saucepans, brushes for washing up, electric brushes (excluding parts of machines), rat traps, ceramics for household purposes, beer mugs, fitted picnic baskets, closures for pot lids (stew pans), cooking utensils, non-electric, cookery molds, glue-pots, washtubs, mangers for animals, fruit cups, corkscrews, pastry cutters, cosmetic implements, sifters (household utensils), enamelled glass, fiberglass thread, not for textile use, glass for vehicles, painted glassware, cups of paper or plastic, mugs not of precious metals, dustbins, non-paper cachepots, mixing spoons (kitchen utensils), knife rests for the table, basins, demijohns, dusting apparatus, non-electric, deodorising apparatus for personal use, soap dispensers, water apparatus for cleaning teeth and gums, funnels, non-electric floor polishers, non-electric shoe polishers, salad bowls, not of precious metal, brooms, mops, carpet sweepers, brushes for cleaning tanks and containers, bowls, enamelled glass, spatulas (kitchen utensils), spice sets, statues and statuettes of porcelain, earthenware or glass, scouring pads of metal, coffee filters, non-electric, filters for household use, holders for flowers and plants (flower arranging), flasks, not of precious metal, deep fryers, non-electric, frying pans, scrubbing brushes (brushes), basins (vessels), fume absorbers for household use, buckskin for cleaning, crocks, coolers, ice cube molds, egg cups, not of precious metal, soap dishes, vegetable dishes, signboards of porcelain or glass, liqueur sets, cabarets (trays), not of precious metal, furniture dusters, confectioners' decorating bags, butter dishes, cooking pots (pans), hand mixers, molds [kitchen utensils], mosaics of glass, not for building, portable coolers, non-electric pressure cookers, urinals, wash basins, scoops (table accessories), toothpicks, candelabra, not of precious metal, rolling pins, perfume burners, spouts, media carrying flat-iron stands, holders for flowers and plants

(flower arranging), saucers, not of precious metal, powder compacts, not of precious metal, curry-combs, mouse traps, containers for household use (not of precious metal), articles for refrigeration foods containing liquids for heat exchange, for household use, watering cans, sprinklers, watering devices, punches (kitchen utensils), services (tableware) not of precious metal, soup bowls, not of precious metal, vessels of metal for making ices and iced drinks, sieves (household utensils), abrasive pads for kitchen purposes, glass caps, mugs, buckets made of woven fabrics, stretchers for clothing, indoor terrariums (plant cultivation), napkin holders not of precious metal, non-electric kitchen mixers, urns, not of precious metal, spits (kitchen utensils), powdered glass for decoration, textiles and textile goods, bed and table linen, bath linen (except clothing), napkins, of cloth, for removing make-up, labels of cloth, linings, toilet gloves, wall hangings of textile, handkerchiefs of textile, curtains of textile or plastic, household linen, towels of textile, travelling rugs, net curtains, curtain holders of textile material, banners and flags (not of paper), eiderdowns (down coverlets), loose covers for furniture, covers for cushions, mattress covers, pillow cases, mosquito nets, glass-cloths, billiard cloth, table covers, fabric covered in patterns for the embroidery, upholstery fabrics, face towels of textile, sleeping bags (sewn covers to replace sheets), cotton fabrics, sackcloth, traced cloths for embroidery, brocades, lining fabric for shoes, fabric for boots and shoes, bedspreads, bed blankets, trellis (cloth), zephyr (cloth), table centrepieces, cheviots (fabric), ticks (mattress covers), textile or plastic shower curtains, crepe (fabric), crepon, throws, damask, elastic woven material, oilcloth for use as tablecloths, gummed cloth other than for stationery, esparto fabric, chenille fabric, felt, flannel (fabric), toilet seat covers, gauze (cloth), jersey (fabric), woollen cloths and fabrics, lingerie fabric, linen cloth, textile placemats, tablecloths, not of paper, printer's blankets of textile, marabouts (cloth), upholstery fabrics, fabric of imitation animal skins, knitted fabrics, cheese cloth, ramie fabric, rayon fabric artificial silk, silk cloths, taffeta (cloth), fiberglass fabrics, for textile use, adhesive fabric for application by heat, diapered linen (patterned), velvet, tulle, clothing, footwear, headgear, clothing for motorists and cyclists, bibs, not of paper, headbands (clothing), bath robes, swimming suits, bathing caps and sandals, boas (necklets), babies' pants (of textile materials), sashes, sports and beach footwear, hoods (clothing), shawls, belts (clothing), money belts (clothing), water-skiing suits, neckties, corsets (girdles), sashes, stoles, scarves, caps, beanie hats, gloves (clothing), waterproof clothing, sashes (undergarments), underclothing, mantillas, stockings, socks, neckerchiefs, baby nappies of textile materials, furs (clothing), pajamas, soles for footwear, heels, veils (clothing), suspender belts, gymnastic and sports outfits, layettes (baby clothing), capes (for wear), sports shirts, mittens, ear

muffs (clothing), stencil plates, bow ties, sarongs, cuffs for clothing, dress shields, beach clothes, dressing gowns, pockets for clothing, sock suspenders, suspenders belts, petticoats, tights (complete stockings or leotards), aprons (clothing), headdress (headgear), masquerade costumes, uniforms, visors (hatmaking), galoshes, head coverings, garters, coats, espadrilles, non-slipping devices for boots and shoes, bath robes, bath slippers, toques, blouses, bodices (undergarments), berets, footmuffs, not electrically heated, ankle boots, boots, boot uppers, studs for football boots, half-boots, fittings of metal for shoes and boots, tips for footwear, welts for boots and shoes, heelpieces for boots and shoes (heel reinforcements), boxer shorts, shirts, shirt yokes, shirt fronts, tee-shirts, chemisettes, bodices, waistcoats, jackets, fishing jackets, stuff jackets, combinations lace trimmings, birds' feathers (clothing accessories), top-knots, zip fasteners (haberdashery), competitors' numbers, ornamental parts applied by heat for textile materials (haberdashery), clasps for carpets and rugs, snap fasteners, ostrich feathers (clothing accessories), whalebones for corsets, bands (prizes), cords for rimming, for clothing, tassels (lace trimmings), expanding bands for holding sleeves, hair ornaments, false hair, hair nets, shoe eyelets, chenille (lace trimmings), jabots (lace trimmings), clips for cyclists, fastenings for clothing, self-adhesive ribbons (haberdashery), elastic ribbons, ribbons for gathering curtains, laces for clothing, collar supports, false hems, rosettes (lace trimmings), festoons (embroidery), fringes, artificial fruit, braids, hair coloring caps, artificial garlands, darning eggs, trimmings for clothing, tresses of hair, wigs, silver embroidery, dress fastenings, borders for clothing, rosettes (lace trimmings), zip fasteners for bags, ties (dressmaking), fasteners for braces, skirt flounces, plaits, toupees, shoe hooks.

(260) AM 2012 64732 A

(800) 1093231

(731) ASSAN PANEL SANAYİ VE TİCARET ANONİM ŞİRKETİ

E-5 Karayolu Üzeri 32. Km., Assan Tesisleri, Tuzla, İSTANBUL, Turkey

(540)

ASSAN PANEL

(591) Black, white

(511)

17 – Side coatings made of heat insulating foam.

(260) AM 2012 64733 A

(800) 1093268

(731) BETTY BLUE S.P.A.

Via Viadagola, 30, Fraz. Quarto Inferiore, GRANAROLO DELL'EMILIA (BO), Italy

(540)



(591) Black, white

(511)

9 – Scientific, nautical, surveying, photographic, cinematographic, optical, weighing, measuring, signalling, checking (supervision), life-saving and teaching apparatus and instruments; apparatus and instruments for conducting, switching, transforming, accumulating, regulating or controlling electricity; apparatus for recording, transmission or reproduction of sound or images; magnetic data carriers, recording discs; automatic vending machines and mechanisms for coin-operated apparatus; cash registers, calculating machines, data processing equipment and computers; fire-extinguishing apparatus.

35 – Organization of exhibitions for commercial and publicity purposes; on behalf of a third party, retailing and wholesaling of a variety of goods in the field of fashion (except the transport thereof), including perfumery, cosmetics, spectacles, jewellery, watches, leatherwear including bags, handbags, travelling bags, trunks, backpacks, rucksacks, briefcases, valises, key cases, clothing, footwear, hats, berets, in shops, department stores, in order to enable consumer to easily purchase those goods.

(260) AM 2012 64734 A

(800) 1093273

(731) 4B Company S.r.l.

Via Guido Rossa, 1, I-63833

MONTEGIORGIO (Fermo), Italy

(540)

brosway

(591) Black, white

(511)

9 – Scientific, nautical apparatus and instruments namely anemometers; surveying apparatus and instruments, namely distance measuring apparatus; photographic, cinematographic apparatus and instruments, namely video cameras, still cameras; instruments optical, namely eye glasses, sunglasses, optical glass; weighing instruments, namely balances; measuring instruments, namely rules, compasses; signaling, checking (supervision), life-saving and teaching apparatus and instruments; apparatus and instruments for conducting, switching, transforming, accumulating, regulating or controlling electricity; computers, hardware and software; apparatus for recording, transmission or reproduction of sound or images, namely hi-fis, amplifiers, hi-fi, audio, video and computer electrical connectors; magnetic data carriers, namely hard disk players

and recorders, floppy disk and floppy disk drives, recording discs; automatic vending machines and mechanisms for coin-operated apparatus; cash registers, calculating machines, data processing equipment and computers; fire-extinguishing apparatus.

16 – Paper, cardboard and goods made from these materials, not included in other classes, namely writing paper and printing paper; printed matter; book binding material; photographs; stationery; adhesives for stationery or household purposes; artists' materials; paint brushes; typewriters and office requisites (except furniture); instructional and teaching material (except apparatus); plastic materials for packaging (not included in other classes); printers' type; printing blocks.

25 – Clothing, namely coats, jackets, skirts, trousers, shorts, jerseys, shirts; footwear, namely boots, slippers, mules; headgear namely caps and hats.

(260) AM 2012 64735 A

(800) 1093317

(731) medac Gesellschaft für klinische
Spezialpräparate mbH
Theaterstraße 6, 22880 Wedel, Germany

(540)

Spectrila

(591) Black, white

(511)

5 – Pharmaceutical preparations, medicines, chemical preparations for medical purposes, plasters, surgical dressing; disinfectants.

(260) AM 2012 64739 A

(800) 1093348

(731) Zahra Hussain, Imran Hussain, Rizvana
Hussain, Maariah Hussain, Danyaal Hussain
2A Woodhall Park Avenue, Leeds, West
Yorkshire LS28 7HF, United Kingdom

(540)



(591) White, blue

(511)

3 – Lip gloss; lip balm; lip coatings [cosmetic]; non-medicated lip protectors; sun protectors for lips [cosmetics]; non-medicated lip coatings; non-medicated lip care preparations; non-medicated lip salves; lip protectors [cosmetic]; lip balm [non-medicated]; non-medicated lip balms.

5 – Medicated lip care preparations; medicated lip protectors; sun protectors for lips for medical purposes; medicated lip coatings; medicated lip balm; medicated lip balms; medicated lip salves.

(260) AM 2012 64740 A

(800) 1093380

(731) WORRUS HOLDING S.A.
67, rue Ermesinde, L-1469 Luxembourg,
Luxembourg

(540)

oodji

(591) Black, white

(511)

20 – Furniture, mirrors, picture frames, goods (not included in other classes) of wood, cork, reed, cane, wicker, horn, bone, ivory, whalebone, shell, amber, mother-of-pearl, meerschaum and substitutes for all these materials, or of plastics, namely barrels, not of metal; busts of wood, wax, plaster or plastic; costume stands; fans for personal use, non-electric; coatstands; coat hangers; shoulder poles; display stands; showcases [furniture]; newspaper display stands; signboards of wood or plastics; doors for furniture; curtain holders, not of textile material; display boards; flower-stands [furniture]; curtain tie-backs; rivets, not of metal; tortoiseshell imitation; locks, other than electric, not of metal; bead curtains for decoration; bottle closures, not of metal; closures, not of metal, for containers; mirrors; hand-held mirrors; bamboo; scratching posts for cats; animal hooves; coral; meerschaum; whalebone, unworked or semi-worked; stag antlers; tortoiseshell; shells; horn, unworked or semi-worked; animal horns; rattan; ivory, unworked or semi-worked; corozo; plaited straw, except matting; wickerwork; works of art of wood, wax, plaster or plastic; cabinet work; reeds; settees; curtain rods; reels of wood for yarn, silk, cord; plastic key cards, not encoded; mats for infant playpens; bed casters, not of metal; furniture casters, not of metal; wind chimers; bassinets; curtain rings; chests of drawers; containers, not of metal for storage and transportation; baskets, not of metal; hampers; bakers' bread baskets; trays, not of metal; bottle casings of wood; armchairs; bedsteads of wood; beds; table tops; coat hooks, not of metal; curtain hooks; clothes hooks, not of metal; playpens for babies; tailors' dummies; air mattresses, not for medical purposes; spring mattresses; mattresses; water beds, not for medical purposes; furniture for trading halls, namely dressing booths, non-metal shelf brackets, clothes rods; furniture of metal; office furniture; school furniture; sleeping bags for camping; mobiles; curtain rails; index cabinets; furniture; mother-of-pearl, unworked or semi-worked; mirror tiles; ambroid plates; registration plates, not of metal; identity plates, not of metal; head-rests [furniture]; stakes for plants or trees; trestles; magazine racks; book rests [furniture]; flower-pot pedestals; pet cushions; pillows; cushions; air pillows, not for medical purposes; racks [furniture]; shelves for

filing-cabinets; furniture shelves; shelves for storage; wood ribbon; straw edgings; towel closets; hat stands; inflatable publicity objects; beds for household pets; bedding, except linen; plugs, not of metal; corks for bottles; corks; desks; embroidery frames; picture frames; tanks, not of metal nor of masonry; curtain rollers; tool handles, not of metal; knife handles, not of metal; door handles, not of metal; writing desks; benches; straws for drinking; vats, not of metal; sofas; statues of wood, wax, plaster or plastic; silvered glass; filing cabinets; counters including counters for cash registers; umbrella stands; trolleys for computers; dressing tables; draughtman's tables; tables of metal; desks; tea trolleys; dinner wagons; tables; steps, not of metal; chairs; high chairs for babies; bins, not of metal; placards of wood or plastics; stools; crates; trolleys; straw plaits; edgings of plastic for furniture; decorations of plastic for foodstuffs; washstands; wax figures; door fittings, not of metal; bed fittings, not of metal; mouldings for picture frames; furniture fittings, not of metal; window fittings, not of metal; infant walkers; garment covers; easy chairs; poles, not of metal; screens; meat chests, not of metal; plate racks; bamboo curtains; slatted indoor blinds; woven timber blinds; indoor window blinds; fire screens, domestic; yellow amber; lockers; boxes of wood or plastic; chests for toys; letter boxes, not of metal or masonry; bottle racks; towel dispensers, fixed, not of metal.

21 – Household or kitchen utensils and containers; combs and sponges; brushes (except paint brushes); brush-making materials; articles for cleaning purposes; steelwool; unworked or semi-worked glass (except glass used in building); glassware, porcelain and earthenware not included in other classes namely China ornaments; dishes; paper plates; saucers; mugs; candy boxes; lunch boxes; bottles; carboys; busts of china, terra-cotta or glass; vases; epergnes; fruit cups; baby baths, portable; waffle irons, non-electric; ice buckets; coal scuttles; buckets made of woven fabrics; cooking skewers, of metal; napkin holders; trouser stretchers; clothing stretchers; shirt stretchers; hair for brushes; carpet beaters; signboards of porcelain or glass; candle extinguishers; flower pots; cruets; decanters; large-toothed combs for the hair; combs for animals; abrasive sponges for scrubbing the skin; sponges for household purposes; toilet sponges; deodorising apparatus for personal use; sponge holders; toothpick holders; soap holders; holders for flowers and plants; shaving brush stands; toilet paper holders; ironing boards; cutting boards for the kitchen; bread boards; washing boards; strainers; containers for household or kitchen use; boxes of glass; heat insulated containers for beverages; thermally insulated containers for food; glass flasks; closures for pot lids; chamois leather for cleaning; toothpicks; ceramics for household purposes; majolica;

works of art, of porcelain, terra-cotta or glass; brush goods; cleaning instruments, hand-operated; stew-pans; flower-pot covers, not of paper; shaving brushes; cages for household pets; polishing leather; napkin rings; towel rails and rings; piggy banks, not of metal; bread baskets, domestic; baskets for domestic use; feeding troughs for animals; cookie jars; tea caddies; coffee percolators, non-electric; coffeepots, non-electric; coffee grinders, hand-operated; beer mugs; tankards; pot lids; butter-dish covers; dish covers; cheese-dish covers; buttonhooks; jugs; perfume burners; portable cold-boxes, non-electric; watering cans; mixing spoons; basting spoons, for kitchen use; scoops; tart scoops; spatulas; butter dishes; polishing materials for making shiny, except preparations, paper and stone; pepper mills, hand-operated; feather-dusters; brooms; isothermic bags; bowls; mosaics of glass, not for building; saucepan scourers of metal; soap boxes; cooking pot sets; spouts; fitted picnic baskets; toilet cases; cookie cutters; pastry cutters; sprinklers; sprinklers for watering flowers and plants; chopsticks; cocktail stirrers; pepper pots; gloves for household purposes; polishing gloves; gardening gloves; plates to prevent milk boiling over; trays for domestic purposes; trays for domestic purposes, of paper; lazy susans; vegetable dishes; cabarets; heaters for feeding bottles, non-electric; candlesticks; trivets; coasters, not of paper and other than table linen; menu card holders; knife rests for the table; flat-iron stands; egg cups; grill supports; abrasive pads for kitchen purposes; pads for cleaning; drinking troughs; powdered glass for decoration; pottery; cooking pots; autoclaves, non-electric; painted glassware; tableware, other than knives, forks and spoons; porcelain ware; earthenware; crystal; cosmetic utensils; toilet utensils; trouser presses; cruet stands for oil and vinegar; spice sets; appliances for removing make up, non-electric; food cooling devices containing heat exchange fluids, for household purposes; toilet paper dispensers; apparatus for wax-polishing, non-electric; bottle openers; crumb trays; tie presses; clothes-pegs; glass stoppers; powder compacts; perfume vaporizers; powder puffs; soap dispensers; combs; electric combs; grills; sifters; drinking horns; shoe horns; candle rings; knobs of porcelain; salad bowls; sugar bowls; beaters, non-electric; whisks, non-electric, for household purposes; services [dishes]; coffee services; liqueur sets; tea services; cinder sifters; tea strainers; siphons for carbonated water; rolling pins, domestic; hot pots, not electrically heated; steel wool for cleaning; currycombs; fruit presses, non-electric, for household purposes; salt cellars; drinking vessels; vessels of metal for making ices and iced drinks; refrigerating bottles; cups of paper or plastic; glass; drinking glasses; statues of porcelain, terra-cotta or glass; statuettes of porcelain, terra-cotta or glass; opal glass; glass incur-

porating fine electrical conductors; enamelled glass; glass, unworked or semi-worked, except building glass; soup bowls; clothes racks, for drying; basins [receptacles]; table plates; disposable table plates; graters; vacuum bottles; indoor terrariums; cloth for washing floors; cloths for cleaning; dusting cloths; furniture dusters; litter trays for pets; urns; aerosol dispensers, not for medical purposes; water apparatus for cleaning teeth and gums; kitchen mixers, non-electric; wax-polishing appliances, non-electric, for shoes; sprinkling devices; utensils for household purposes; kitchen utensils; cooking utensils, non-electric; coffee filters, non-electric; flasks; bottle gourds; molds; ice cube molds; cake molds; deep fryers, non-electric; comb cases; bread bins; teapots; kettles, non-electric; cups; garlic presses; ironing board covers, shaped; tea balls; glass bowls; mops; shakers; corkscrews; dishwashing brushes; brushes for cleaning tanks and containers; lamp-glass brushes; scrubbing brushes; toothbrushes; toothbrushes, electric; animal bristles; carpet sweepers; brushes for footwear; toilet brushes; electric brushes, except parts of machines; brushes; eyebrow brushes; nail brushes; boxes of metal, for dispensing paper towels; garbage cans.

(260) AM 2012 64741 A

(800) 1093387

(731) Vidkryte aktsionerne tovarystvo

"KYIVMEDPREPARAT"

vul. Saksaganskogo, 139, Kyiv 01032,
Ukraine

(540)

НЕЙРОКСОН

(591) Black, white

(511)

3 – Abrasives, petroleum jelly for cosmetic purposes, cosmetic preparations for baths, bath salts, not for medical purposes, cotton wool for cosmetic purposes, cotton sticks for cosmetic purposes, cosmetic preparations for slimming purposes, depilatory preparations, astringents for cosmetic purposes, disinfectant soap, deodorants for personal use, deodorant soap, shampoos for pets, ethereal essences, essential oils, greases for cosmetic purposes, degreasers other than for use in manufacturing processes, dentifrices, silicon carbide (abrasive), carbides of metal (abrasives), adhesives for cosmetic purposes, corundum (abrasive), cosmetics, cosmetics for animals, beauty masks, cosmetic kits, cosmetic creams, cakes of toilet soap, polishing preparations, medicated soap, lotions for cosmetic purposes, after-shave lotions, detergents other than for use in manufacturing operations and for medical purposes, washing preparations, soap, soap for foot

perspiration, antiperspirant soap, cleansing milk for toilet purposes, flavorings for beverages (essential oils), ammonia (volatile alkali) (detergent), eau de Cologne, oils for perfumes and scents, oils for cosmetic purposes, oils for toilet purposes, oils for cleaning purposes, perfumery, perfumes, hydrogen peroxide for cosmetic purposes, pomades for cosmetic purposes, soda lye, sunscreen preparations, talcum powder, for toilet use, toiletries, paint stripping preparations, cosmetic dyes, cleaning preparations, shampoos, shampoos for pets.

5 – Analgesics; anesthetics; antibiotics; first-aid boxes, filled; bacterial preparations for medical and veterinary use, bacteriological preparations for medical and veterinary use, balms for medical purposes; balsamic preparations for medical purposes; biological preparations for veterinary purposes; biological preparations for medical purposes, vaginal washes, vaccines, therapeutic preparations for the bath; bath preparations, medicated; bath salts for medical purposes; veterinary preparations; vitamin preparations; haemorrhoid preparations; sanitary panties; hygienic bandages; sanitary pads; hormones for medical purposes; disinfectants for hygiene purposes; diagnostic preparations for medical purposes; dietetic substances adapted for medical use; eucalyptus for pharmaceutical purposes; elixirs (pharmaceutical preparations); nervines; sedatives; adjuvants for medical purposes; camphor for medical purposes; camphor oil for medical purposes; cachets for pharmaceutical purposes; capsules for medicines; castor oil for medical purposes; barks for pharmaceutical purposes; medicinal roots; additives to fodder for medical purposes; depuratives; styptic preparations; medicines for veterinary purposes; medicines for human purposes; medicinal tea; medicinal herbs; medicinal drinks; medicinal infusions; medicinal oils; liniments; lotions for veterinary purposes; lotions for pharmaceutical purposes; ointments for pharmaceutical purposes; menthol; mint for pharmaceutical purposes; tinctures for medical purposes; ootherapy preparations; napkins for incontinents; pills for pharmaceutical purposes; laxatives; purgatives; febrifuges; anti-uric preparations; syrups for pharmaceutical purposes; soporifics; medicinal alcohol; sterilising preparations; pastilles for pharmaceutical purposes; digestives for pharmaceutical purposes; herbs teas for medicinal purposes; pharmaceutical preparations; enzymes for veterinary purposes; enzymes for medical purposes; ferments for pharmaceutical purposes; enzyme preparations for veterinary purposes; enzyme preparations for medical purposes; dietetic foods adapted for medical purposes; pants, absorbent, for incontinents; chemico-pharmaceutical preparations; chemical preparations for veterinary purposes; chemical preparations for medical purposes; chemical preparations for pharmaceutical purposes.

(260) AM 2012 64743 A

(800) 1093388

(731) Vidkryte akcionerne tovarystvo

"KYIVMEDPREPARAT"

vul. Saksaganskogo, 139, Kyiv 01032,

Ukraine

(540)

МЕПЕНАМ

(591) Black, white

(511)

3 – Abrasives, petroleum jelly for cosmetic purposes, cosmetic preparations for baths, bath salts, not for medical purposes, cotton wool for cosmetic purposes, cotton sticks for cosmetic purposes, cosmetic preparations for slimming purposes, depilatory preparations, astringents for cosmetic purposes, disinfectant soap, deodorants for personal use, deodorant soap, shampoos for pets, ethereal essences, essential oils, greases for cosmetic purposes, degreasers other than for use in manufacturing processes, dentifrices, silicon carbide (abrasive), carbides of metal (abrasives), adhesives for cosmetic purposes, corundum (abrasive), cosmetics, cosmetics for animals, beauty masks, cosmetic kits, cosmetic creams, cakes of toilet soap, polishing preparations, medicated soap, lotions for cosmetic purposes, after-shave lotions, detergents other than for use in manufacturing operations and for medical purposes, washing preparations, soap, soap for foot perspiration, antiperspirant soap, cleansing milk for toilet purposes, flavorings for beverages (essential oils), ammonia (volatile alkali) (detergent), eau de Cologne, oils for perfumes and scents, oils for cosmetic purposes, oils for toilet purposes, oils for cleaning purposes, perfumery, perfumes, hydrogen peroxide for cosmetic purposes, pomades for cosmetic purposes, soda lye, sunscreen preparations, talcum powder, for toilet use, toiletries, paint stripping preparations, cosmetic dyes, cleaning preparations, shampoos, shampoos for pets.

5 – Analgesics; anesthetics; antibiotics; first-aid boxes, filled; bacterial preparations for medical and veterinary use, bacteriological preparations for medical and veterinary use, balms for medical purposes; balsamic preparations for medical purposes; biological preparations for veterinary purposes; biological preparations for medical purposes, vaginal washes, vaccines, therapeutic preparations for the bath; bath preparations, medicated; bath salts for medical purposes; veterinary preparations; vitamin preparations; haemorrhoid preparations; sanitary panties; hygienic bandages; sanitary pads; hormones for medical purposes; disinfectants for hygiene purposes; diagnostic preparations for medical purposes; dietetic substances adapted for medical use; eucalyptus for pharmaceutical purposes; elixirs (pharmaceutical preparations); nervines; sedatives; adjuvants for medical purposes; camphor for medi-

cal purposes; camphor oil for medical purposes; cachets for pharmaceutical purposes; capsules for medicines; castor oil for medical purposes; barks for pharmaceutical purposes; medicinal roots; additives to fodder for medical purposes; depuratives; styptic preparations; medicines for veterinary purposes; medicines for human purposes; medicinal tea; medicinal herbs; medicinal drinks; medicinal infusions; medicinal oils; liniments; lotions for veterinary purposes; lotions for pharmaceutical purposes; ointments for pharmaceutical purposes; menthol; mint for pharmaceutical purposes; tinctures for medical purposes; ophotherapy preparations; napkins for incontinents; pills for pharmaceutical purposes; laxatives; purgatives; febrifuges; anti-uric preparations; syrups for pharmaceutical purposes; soporifics; medicinal alcohol; sterilising preparations; pastilles for pharmaceutical purposes; digestives for pharmaceutical purposes; herbs teas for medicinal purposes; pharmaceutical preparations; enzymes for veterinary purposes; enzymes for medical purposes; ferments for pharmaceutical purposes; enzyme preparations for veterinary purposes; enzyme preparations for medical purposes; dietetic foods adapted for medical purposes; pants, absorbent, for incontinents; chemico-pharmaceutical preparations; chemical preparations for veterinary purposes; chemical preparations for medical purposes; chemical preparations for pharmaceutical purposes.

(260) AM 2012 64746 A

(800) 1093412

(731) SEDA SUISSE AG

Rigistrasse 3, CH-6300 Zug, Switzerland

(540)



(591) Black, white

(511)

16 – Packaging materials of paper, cardboard, foam and plastic, insofar as included in this class, particularly containers and packaging made from the aforesaid packaging materials for ice creams, dairy products, beverages and fast-food products.

20 – Packaging containers of plastic.

21 – Containers and apparatus for household and kitchen use (neither of precious metals, nor of coated metals); isothermic containers of all kinds, particularly containers for hot beverages and cold beverages.

(260) AM 2012 64748 A

(800) 1093454

(731) ESTETRA

société anonyme; Rue du Travail 16, B-4460
Grâce-Hollogne, Belgium

(540)

Estelle

(591) Black, white

(511)

5 – Pharmaceutical products, except pharmaceutical and medical products for use in cosmetic dermatology; veterinary products; sanitary products for medical purposes; dietetic substances adapted for medical use, food for babies; plasters, materials for dressings; material for dental fillings and dental impressions; disinfectants; pesticides; fungicides, herbicides.

(260) AM 2012 64749 A

(800) 1093455

(731) Nemiroff Intellectual Property Establishment
Städtle 31, FL-9490 Vaduz, Liechtenstein

(540)

(591) Grey, green, white, brown, yellow, orange
and black

(511)

33 – Alcoholic beverages (except beers).

(260) AM 2012 64750 A

(800) 1093456

(731) Nemiroff Intellectual Property Establishment
Städtle 31, FL-9490 Vaduz, Liechtenstein

(540)



(591) Black, white

(511)

33 – Alcoholic beverages (except beers).

(260) AM 2012 64751 A

(800) 1093475

(731) PRADA S.A.

23, rue Aldringen, L-1118 Luxembourg,
Luxembourg

(540)

LUNA ROSSA

(591) Red, white

(511)

3 – Cosmetics, namely, day and night creams, skin cleansing lotions and creams for the face and body, bubble baths; shaving foam, after-shave, make-up, foundation, nail varnish, personal deodorants for men and women, hand soaps and baby soaps, shampoos, hair rinses; perfumes, eau-de-toilette and essential oils for personal use for men and women; hair care products, namely, hair sprays.

9 – Scientific, nautical, surveying, photographic, cinematographic, optical, weighing, measuring, signalling, checking (supervision), life-saving and teaching apparatus and instruments; compasses; alarms; anti-theft warning apparatus; cigar lighters for automobiles; electric batteries for vehicles; battery chargers; apparatus and instruments for conducting, switching, transforming, accumulating, regulating or controlling electricity; media players and their covers and their cases and their accessories; apparatus for recording, transmission or reproduction of sound or images; telephones, including mobile phones and wireless phones, and their covers and their cases and their accessories; compact disc players; media players and their covers and their cases and their accessories; magnetic data carriers, recording discs; automatic vending machines and mechanisms for coin-operated apparatus; cash registers; calculating machines, data processing equipment and computers; computer game programs; computer peripheral devices; computers; laptop computers; notebook computers; netbooks; fire-extinguishing apparatus; electronic agendas; amusement apparatus adapted for use with television receivers only; binoculars; cases made for photographic apparatus and instruments; navigation apparatus for vehicles (on-board computers); navigational instruments; contact lenses, containers for contact lenses, eyeglass chains, eyeglass cords, eyeglass frames, eyeglasses; eyepieces, sunglasses, glasses; spectacles; spectacle cases; spectacles chains; spectacle frames; spectacle lenses; goggles for sports; protective helmets; helmets for sports; protective helmets for sports; clothing and footwear for protection against accidents.

25 – Clothing, namely, shirts, blouses, suits, skirts, coats, trousers, dresses, pullovers, pajamas, socks and stockings, jumpers, corselets, suspenders, underpants, underclothes, t-shirts, sweaters, scarves, ties, raincoats, overcoats, swimwear, jackets, wind

jackets, ski trousers, belts, fur coats, headscarves, gloves, dressing gowns and bathrobes; footwear, namely shoes, slippers and boots; hats and caps.

(260) AM 2012 64766 A
(800) 1093605
(731) JOINT STOCK COMPANY "YASNAYA POLYANA"
83, Odoyevskoye shosse, RU-300036
g. Tula, Russian Federation

(540)



(591) Brown, dark brown, light brown, white
(511)
30 – Gingerbread.

(260) AM 2012 64892 A
(800) 816396
(731) ALLIED BRANDS S.R.L.
Corso Plebisciti, 9, I-20129 MILANO, Italy

(540)

TURATI

(591) Black, white
(511)
30 – Coffee, tea, cocoa, sugar, rice, tapioca, sago, artificial coffee; flour and preparations made from cereals, bread, pastry and confectionery, ices; honey, treacle; yeast, baking-powder; salt, mustard; vinegar, sauces (condiments); spices; ice for refreshment.

(260) AM 2012 64977 A
(800) 508054
(731) MERVE OPTIK SANAYI VE TICARET ANONIM SIRKETI
Seyh Mehmet Geylani Mahallesi, Mimar Kemalettin Caddesi No: 22-24, Kat:4/62, Eminönü-Fatih-Istanbul, Turkey

(540)

MUSTANG

(591) Black, white
(511)
9 – Spectacle frames and other optical goods.

(260) AM 2012 64978 A
(800) 923197
(731) DAVID AUSTIN ROSES LIMITED
Bowling Green Lane, Albrighton, Wolverhampton WV7 3HB, United Kingdom

(540)

DAVID AUSTIN

(591) Black, white
(511)
3 – Perfume; toiletries; cosmetics; soaps; essential oils.
16 – Printed matter; diaries; calendars; books; carrier bags; paper sacks; stationery.
26 – Artificial flowers; silk flowers.
31 – Live plants.

(260) AM 2012 64981 A
(800) 1062552
(731) Novartis AG
CH-4002 Basel, Switzerland

(540)

RASITRIO

(591) Black, white
(511)
5 – Pharmaceutical preparations.

(260) AM 2012 65007 A
(800) 1095344
(731) BSH Bosch und Siemens Hausgeräte GmbH
Carl-Wery-Str. 34, 81739 München, Germany

(540)

MultiBox

(591) Black, white
(511)
11 – Apparatus for heating, steam generating and cooking, in particular stoves, baking, roasting, grilling, toasting, defrosting and heating devices, water heaters, immersion heaters, slow-cookers, microwave ovens, waffle irons (electric), egg-boilers, deep-fat fryers (electric); electrical tea and coffee makers, espresso coffee machines, automatic coffee machines (included in this class); refrigerating apparatus, in particular refrigerators, chest freezers, refrigerated cabinets, beverage-cooling apparatus, fridge-freezers, freezers, ice machines and apparatus; drying apparatus, in particular including tumble dryers, laundry drying machines, hand dryers, hair dryers; infrared lamps (other than for medical use); heating pads (not for medical purposes), electric blankets (not for medical purposes); ventilation apparatus, in particular fans, extractor hood filters, extractor hood equipment and extractor hoods, air conditioning apparatus and devices for improving air quality, humidifiers, air deodorisers, fragrance dispensing apparatus (not for personal use); air purifying apparatus, apparatus for water supply and sanitary purposes, in particular including fittings for steam, air and water supply installations; water heaters, storage water heaters and instantaneous water

heaters; kitchen sinks; heat pumps; parts for all the aforesaid goods, included in this class; mechanical taps (dispensers) for dispensing chilled beverages for use in combination with apparatus for chilling beverages.

(260) AM 2012 65009 A

(800) 1095355

(731) Tovarystvo z obmezhenoyu vidpovidalnistyu Alfa-Grupa
vul. Kirova, 6, Sumy 40030, Ukraine

(540)

DELFI

(591) Black, white

(511)

2 – Paints, varnishes, lacquers; preservatives against rust and against deterioration of wood; colorants; mordants; raw natural resins; metals in foil and powder form for painters, decorators, printers and artists; agglutinants for paints; enamels (varnishes); protective preparations for metals; badigeon; pigments; coatings (paints); anti-corrosive preparations; thinners for lacquers, thinners for paints.

(260) AM 2012 65010 A

(800) 1095373

(731) Public Joint Stock Company
"Pharmstandard"

Likhachevsky proezd, d. 5 "B",
g. Dolgoprudny, RU-141700 Moscow
Region, Russian Federation

(540)

HEKCT

(591) Black, white

(511)

5 – Mineral food-supplements; Nutritional additives for medical purposes; Pharmaceutical preparations.

(260) AM 2012 65013 A

(800) 1095435

(731) KARTONSAN KARTON SANAYİ VE

TİCARET ANONİM ŞİRKETİ

Prof. Dr. Bülent Tarcan Sokak, Pak İş
Merkezi, No:5, K:3, Gayrettepe, BEŞİKTAŞ-
İSTANBUL, Turkey

(540)

Lüxtriplex

(591) Black, white

(511)

16 – Paper; cardboard; goods made from paper and cardboard, not included in other classes, namely coasters made of paper or of cardboard, articles, paper for pastry and sorbets, hand-towels of paper,

paper tablecloths, paper table linen, face towels of paper, paper handkerchiefs, cardboard articles namely cardboard; paper bags, small paper bags, paper envelopes, small paper bags for wrapping; packaging materials, namely, cardboard packaging, paper pouches for packaging, bobbins and spools of paper or cardboard, for packaging purposes, plastic bubble packs for wrapping or packaging; carry bags of plastics, namely, plastic shopping bags, plastic trash bags, plastic lunch bags, bookbinding material, namely bookbinding tape, bookbinding wire, bookbindings, cloth for bookbinding, printing type, printing blocks, printed matter and periodical publications, namely, books, magazines, newspapers, journals, reviews, pamphlets, catalogues, leaflets, vouchers and coupons, all in the field of travel, tickets, and posters, writing paper, copy paper, parchment paper, carbon paper, paper rolls for calculating machines, notebook paper, note papers, envelopes, loose-leaf pads, book covers, notebook covers, writing instruments, namely, pencils, ballpoint pens, pen nibs, typewriters and office requisites, namely, staplers, rubber bands, punches, paper embossers, envelope sealing machines, franking machines, finger-stalls, correcting fluid for type, paint brushes, paint applicator rollers.

(260) AM 2012 65014 A

(800) 1095436

(731) KARTONSAN KARTON SANAYİ VE
TİCARET ANONİM ŞİRKETİ

Prof. Dr. Bülent Tarcan Sokak, Pak İş
Merkezi, No:5, K:3, Gayrettepe, BEŞİKTAŞ-
İSTANBUL, Turkey

(540)

Normprint

(591) Black, white

(511)

16 – Paper; cardboard; goods made from paper and cardboard, not included in other classes, namely coasters made of paper or of cardboard, articles, paper for pastry and sorbets, hand-towels of paper, paper tablecloths, paper table linen, face towels of paper, paper handkerchiefs, cardboard articles namely cardboard; paper bags, small paper bags, paper envelopes, small paper bags for wrapping; packaging materials, namely, cardboard packaging, paper pouches for packaging, bobbins and spools of paper or cardboard, for packaging purposes, plastic bubble packs for wrapping or packaging; carry bags of plastics, namely, plastic shopping bags, plastic trash bags, plastic lunch bags, bookbinding material, namely bookbinding tape, bookbinding wire, bookbindings, cloth for bookbinding, printing type, printing blocks, printed matter and periodical publications, namely, books, magazines, newspapers, journals, reviews, pamphlets, catalogues, leaflets,

vouchers and coupons, all in the field of travel, tickets, and posters, writing paper, copy paper, parchment paper, carbon paper, paper rolls for calculating machines, notebook paper, note papers, envelopes, loose-leaf pads, book covers, notebook covers, writing instruments, namely, pencils, ballpoint pens, pen nibs, typewriters and office requisites, namely, staplers, rubber bands, punches, paper embossers, envelope sealing machines, franking machines, finger-stalls, correcting fluid for type, paint brushes, paint applicator rollers.

(260) AM 2012 65023 A

(800) 1095555

(731) PERKINS HOLDINGS LIMITED

Eastfield, Peterborough, PE1 5 NA, United Kingdom

(540)



(591) Black, white

(511)

1 – Chemicals used in industry, science and photography, as well as in agriculture, horticulture and forestry; unprocessed artificial resins; unprocessed plastics; manures; fire extinguishing compositions; tempering and soldering preparations; chemical substances for preserving foodstuffs; tanning substances; adhesives used in industry; cement for repairs; detergents for use in industrial and manufacturing processes; chemical fluids for dewatering; anti-freeze; sealants; adhesives for industrial use; silicones; silicon; silicates; liquifying chemicals (ungluing agents); chemical additives to motor fuel; anti-knock substances for internal combustion engines; unprocessed acrylic resins; unprocessed epoxy resins; mastic for tyres; oil and petroleum dispersants; coolants; conditioners for cooling systems; cleaners for cooling systems; chemical preparations for locking screw threads; battery fluid; colour brightening chemicals; filtering materials; hydraulic fluids; chemical fuel additives; compositions for repairing vehicles tyres; gasket making chemicals; unprocessed artificial and synthetic resins; putty.

2 – Paints, varnishes, lacquers; preservatives against rust and against deterioration of wood; colorants; mordants; raw natural resins; metals in foil and powder form for painters, decorators, printers and artists; primers; anti-corrosive preparations; anti-rust oils and greases; natural resins and gum resins; thinners; metal preservatives; sealant primers; anti-corrosion substances; coatings (paints) for use on vehicles and on parts of vehicles.

4 – Industrial oils and greases; lubricants; dust absorbing, wetting, and binding compositions; fuels (including motor spirit) and illuminants; candles and wicks for lighting; non-chemical additives to motor fuel; diesel oil; fuel oils and mixtures; wax; motor fuel; anti-seizure compounds; greases for use with ball and roller bearings and bushings; petroleum ether.

6 – Common metals and their alloys; metal building materials; transportable buildings of metal; materials of metal for railway tracks; non-electric cables and wires of common metal; ironmongery, small items of metal hardware; pipes and tubes of metal; safes; goods of common metal not included in other classes; ores; metal industrial hose couplings and metal industrial hose fittings; fasteners; flanges; pins; sealing caps; shims; springs; conrod nuts; packaging containers; fastening, securing and sealing devices; plugs; straps; clips; nuts; bolts; screws; rings; washers; seals; ties; nipples; bindings; bungs; caps; closures; collars; clamps; couplings; hooks; links; nails; pegs; rivets; guards; tanks; drain plugs; cotter pins; drawbar pins; clevis pins; locking pins; eye bolts; snap rings; thread inserts; rain traps and drain caps; pipe extensions; deflectors; grids; plates; track hardware; welding rods; cable and wire; pipes and tubing; chains; slings and pulleys; badges; bells; locks and padlocks; number plates; knobs of metal; wear resistant metal alloys; wear resistant metal alloys for use on equipment in mining, construction, agriculture and material handling, including chocky bars, heat shrouds, side bar protectors and wear plates; all the aforementioned of metal; parts and fittings for all the aforesaid goods.

7 – Machines and machine tools; motors and engines (except for land vehicles); machine coupling and transmission components (except for land vehicles); agricultural implements other than hand-operated; incubators for eggs; engines and motors, diesel engines; starting devices for engines and motors; exhausts and exhaust fittings; power transmission systems; compressors (superchargers); ignition devices, fuelling devices and controlling devices for internal combustion engines; lubricating apparatus and cooling apparatus (radiators) all included in this class; electric generators; transmissions; replacement parts for earth moving machinery and diesel engines; valves; sparks plugs; air filters; water regulators; oils filters; machine couplings; machine tools; assembly presses; starters; pumps; diggers; excavators; bulldozers; loaders; cranes; feller machines; bunching machines; scraping machines; paving machines; agricultural machines; cutting machines; compactors; filters; belts being parts of machines; surge alleviators; blades; earth moving machines; steam rollers; forestry machines; pipe laying machines; compacting machi-

nes; buckets for earth moving machines; hydraulic jacks; welding machines and apparatus; bits being parts of machines; construction machines; mining machines; farming machines; material handling machines and generators; digging machines; demolition, gripping and lifting apparatus and instruments other than hand operated; hydraulic components; hydraulic components including hydraulic pumps, hydraulic motors, hydraulic valves and hydraulic cylinders; ground engaging machines and tools, including bucket tips and adapters (for machine tools), cutting edges and segments, cutting edges and segments for buckets, motor graders, blades and scrapers, wear protection products for machines and machine tools, namely chocky bars, heat shrouds, side bar protectors and wear plates, ripper shanks and tips for machines and machine tools; parts, fittings and components for all the aforesaid goods; cutting torches.

9 – Scientific, nautical, surveying, photographic, cinematographic, optical, weighing, measuring, signalling, checking (supervision), life-saving and teaching apparatus and instruments; apparatus and instruments for conducting, switching, transforming, accumulating, regulating or controlling electricity; apparatus for recording, transmission or reproduction of sound or images; magnetic data carriers, recording discs; automatic vending machines and mechanisms for coin-operated apparatus; cash registers, calculating machines, data processing equipment and computers; fire-extinguishing apparatus; electrical and electronic apparatus and instruments; measuring and testing apparatus and instruments; electric cable and wire; electric conduits; switches; pressure switches; connectors; jump leads; fuses; circuit testers; voltage testers; fuse holders; transformers; battery testing apparatus for sale in kit form; thermostats; gauges; levelling apparatus and instruments; tape measures and rules; microscopes; tachometers; diagnostic apparatus and instruments; meters; thermometers; alarms; electric horns; flasher units; reflectors; mirrors; aerials; battery chargers; weighing apparatus and instruments; computers and computer programmes; computer software; calculating machines; laser pointers; protective clothing; protective headgear; audio visual teaching apparatus; video tapes; vehicle warning triangles; audio tapes; compact discs; holders for discs; cards bearing magnetic strips; calculators; electric couplings; petrol pumps; levels; electric locks; radios; vehicle radios; batteries; starters; speed checking apparatus and instruments; battery cables; connectors for sale in kit form; electrical terminals; water temperature regulators; probes; ammeters; battery testers; terminals; gas detectors; flow meters; ohmmeters; pressure measurement tools; welding apparatus; battery ground strap connectors; battery tie down connectors; conduit and wire protectors; emergency jump start apparatus;

emergency jump start receptacle assemblies; voltage converters; parts and fittings for all the aforesaid goods.

12 – Vehicles; apparatus for locomotion by land, air or water; parts for vehicles; engines and motors; diesel engines for land vehicles; starting devices for engines and motors; power transmission systems; sun-blinds adapted for automobiles and windscreens (including tinted windscreens); transmissions and axles; transmissions and axles for construction trucks; earthmoving vehicles and off-highway vehicles; replacement parts for off-highway trucks for loading and hauling; attachments for vehicles for earth and material hauling and handling including trucks and tractors; land vehicles; construction vehicles; mining vehicles; farming vehicles and material handling vehicles; undercarriage components and tracks for tractors and other track-type vehicles; tyres, inner tube and wheels for vehicles; skidders; undercarriage structural parts; undercarriage components; parts, fittings and components for all the aforesaid goods.

17 – Rubber, gutta-percha, gum, asbestos, mica and goods made from these materials and not included in other classes; plastics in extruded form for use in manufacture; packing, stopping and insulating materials; flexible pipes not of metal; non-metal industrial hose couplings; industrial hoses made of non-metal, plastic, or rubber for use in hydraulics; sealant compounds for joints; adhesive tapes; insulators; seals; gaskets; acrylic resins; goods made from rubber and from plastics and not included in other classes; flexible pipes; tape; hoses; hosing; semi-processed brake linings; clutch linings; cylinder jointing; insulating gloves; coupling and joints not of metal; rings of rubber or of plastic; materials for repairing tyres; rubber sealing materials; rubber washers; insulating tape and band; expansion joint fillers; fillers; chemical compositions for repairing leaks; rubber tubes and valves; packing materials; padding materials; electrical tape; parts and fittings for all the aforesaid goods.

(260) AM 2012 65117 A

(800) 899182

(731) Special Cosmetics B.V.

Samsonweg 22, NL-1521 RC Wormervee,
Netherlands

(540)



(591) Black, white

(511)

3 – Bleaching, preparations and other substances for laundry use; cleaning, polishing, scouring and

abrasive preparations; soaps; perfumery, essential oils, cosmetics, hair lotions; dentifrices; cosmetics, including make-up products; cosmetic products for skin care.

21 – Household or kitchen utensils and containers (not of precious metal or coated therewith); combs and sponges; brushes (except paint brushes); brush-making materials; articles for cleaning purposes; steelwool; unworked or semi-worked glass (except glass used in building); glassware, porcelain and earthenware not included in other classes; pencils and brushes for applying cosmetic.

(260) AM 2012 65171 A

(800) 1096723

(731) Zhu Huaicai

No. 1 Building, Xikeng Village, Lingtang
Committee, Hedong Town, Qingyuan
District, Ji'an City, Jiangxi Province, China

(540)

POLYKING 金利金

(591) Black, white

(511)

1 – Unprocessed plastics; plastic made of synthetic resin; molding compound; nylon 66 salt; plasticizer; chemical preparations for scientific purposes (not for the medical or veterinary); adhesives for industrial purposes; carbonic acid; sizing preparations (chemical preparations); saccharin.

17 – Plastic board; plastic pipe; watering hoses; sound insulating material; insulating materials; stuffing of rubber or plastic; glue cover; seals; horseshoes of nonmetal; rubber, raw or semi-worked.

(260) AM 2012 65192 A

(800) 816862

(731) Ball Wholesale ApS

Kløvermarken 29, DK-7190 Billund,
Denmark

(540)

ZIZZI

(591) Black, white

(511)

14 – Precious metals and their alloys and goods in precious metals or coated therewith, not included in other classes; jewellery, precious stones, horological and chronometric instruments.

24 – Textiles and textile goods, not included in other classes; bed and table covers.

26 – Lace and embroidery, ribbons and braid; buttons and hooks and eyes, pins and needles; artificial flowers.

(260) AM 2012 65216 A

(800) 1096859

(731) BOSCH SICHERHEITSSYSTEME GMBH
85630 Grasbrunn, Germany

(540)

OMNEO

(591) Black, white

(511)

9 – Communication network protocols for transmission of audio and video signals as well as control devices of audio and video systems about digital networks.

(260) AM 2012 65218 A

(800) 1096874

(731) Aktsionernoye obshchestvo Inostrannoye
predpriyatiye "Efes Karaganda pivovarennyy
zavod"
ul. Gogolya, 75, 100014 g. Karaganda,
Kazakstan

(540)

Кружка свежего

(591) Black, white

(511)

35 – Advertising; business management; business administration; office functions.

(260) AM 2012 65219 A

(800) 1096890

(731) AVON PRODUCTS, INC.

World Headquarters, 1345 Avenue of
the Americas, New York, NY 10105-0196,
USA

(540)

SUPER DRAMA

(591) Black, white

(511)

3 – Non-medicated toilet preparations; toiletries; skin care preparations; skin moisturizers; body and beauty care preparations; powders, creams and lotions, all for the face, hands and body; soaps; shower and bath preparations; beauty masks; talcum powder; nail polish; nail polish remover; enamel for nails; false nails; adhesives for cosmetic purposes; cosmetics; eye make-up remover, eye shadow, eye liner, mascara, lipstick, lip liner, lip gloss; make-up foundation; blusher; tissues impregnated with cosmetic lotions; cotton sticks for cosmetic purposes; cotton wool for cosmetic purposes; preparations for cleaning, moisturising, colouring and styling the hair; preparations for cleaning the teeth; shaving and aftershave preparations; perfumes, fragrance, toilet waters, eau de cologne; deodorants and antiperspirants for personal use; essential oils (cosmetic); all the aforesaid being alone, in combination

and/or in gift sets comprised of some or all of these items.

(260) AM 2012 65220 A
(800) 1096916
(731) SHOIN MANAKHIMOV
Smolenskaya nabareshnaya 5/13 kv 43,
Moscow, Russian Federation
(540)

STAHLBERG

(591) Black, white
(511)
7 – Electrical appliances for use in home as dish-washers, food processors, food grinders, mixers, juice squeezers, electric can openers, electrical knife sharpeners, parts and components for all the above; all included in this class.

8 – Hand tools for use in kitchen; cutlery, forks and spoons; all included in this class.

11 – Kitchen hoods; hair dryers, facilities, equipment and containers to cool and freeze; refrigerators, freezers; water heating apparatus; electrical instruments and tools for cooking and baking; electric pots and pans; roasting machines; stove, cooking and baking ovens, grills, microwave ovens; toasters; parts and components for all the above; all included in this class; electric coffee machines, electrical kettles.

21 – Tools and containers for home and kitchen; pots, pans, bowls, cups and glasses, plates, trays; accessories and cleaning products for house tools and kitchen tools as sponges, cloths, steel wool; all included in this class.

(260) AM 2012 65221 A
(800) 1096929
(731) "Gazpromneft – lubricants" Ltd
125a, ul. Profsoyuznaya, RU-117647
Moscow, Russian Federation
(540)

Sibi® MOTOR
ЛЮКС

(591) Blue, green
(511)
4 – Industrial oils and greases; lubricants; fuels (including motor spirit); illuminants; combustible oil; fuel oil; lubricating oil; industrial oil; motor oil; lubricating grease.

(260) AM 2012 65228 A
(800) 1096932
(731) Koppert B.V.
Veilingweg 14, NL-2651 BE Berkel en
Rodenrijs, Netherlands
(540)

NATUPOOL

(591) Black, white
(511)
20 – Beehives, nest boxes for bumblebees.
31 – Live animals, particularly bumblebees.

(260) AM 2012 65229 A
(800) 1096937
(731) EcoPharm Patent Management AG
Haldenstrasse 5, CH-6342 Baar, Switzerland
(540)

РУНИХОЛ

(591) Black, white
(511)
5 – Drugs for medical purposes; medicines for veterinary purposes; medicines for human purposes; pharmaceutical preparations.

(260) AM 2012 65230 A
(800) 1096951
(731) Bavaria N.V.
De stater 1, NL-5737 RV Lieshout,
Netherlands
(540)



(591) Taupe, brown, red, blue
(511)
32 – Beers; mineral and aerated waters and other non-alcoholic drinks; fruit drinks and fruit juices; syrups and other preparations for making beverages.

(260) AM 2012 65233 A
(800) 1096965
(731) GENENTECH, INC.
1 DNA Way, South San Francisco,
CA 94080, USA

(540)

GENENTECH

(591) Black, white

(511)

5 – Pharmaceuticals namely, hormones, polypeptides and proteins.

(260) AM 2012 65234 A

(800) 1096967

(731) MINTERTON SERVICES LIMITED

Waterside House, 35 North Wharf Road,
London W2 1NW, United Kingdom

(540)

SAVILE ROW INSPIRED

(591) Black, white

(511)

18 – Articles made of leather or imitation leather; skins, hides, bags, handbags, trunks (luggage), suitcases, travelling bags, umbrellas, parasols, walking sticks, rucksacks, haversacks; bags for campers or climbers; beach bags; luggage straps; luggage tags; fabric carrier bags.

25 – Clothing, footwear, headgear.

40 – Tailoring services, alteration of clothes.

42 – Clothing design services.

(260) AM 2012 65250 A

(800) 1096981

(731) ROCHE DIAGNOSTICS GMBH

Sandhofer Strasse 116, 68305 Mannheim,
Germany

(540)

SOLO

(591) Black, white

(511)

10 – Medical devices for the infusion of therapeutic fluid and parts and attachments for these devices.

(260) AM 2012 65251 A

(800) 1097043

(731) FM GROUP WORLD ANDRZEJ

TRAWIŃSKI SPÓLKA KOMANDYTOWA
ul. Żmigrodzka 247, PL-51-129 Wrocław,
Poland

(540)

FM FEDERICO MAHORA

(591) Black, white

(511)

3 – Bleaching preparations and other substances for laundry use; cleaning, polishing, scouring and abrasive preparations; soaps; perfumery, essential oils, cosmetics, hair lotions; dentifrices.

5 – Germicides; salts for mineral water baths; air fresheners.

21 – Household or kitchen utensils and containers; combs and sponges; brushes except paint brushes; brush-making materials; articles for cleaning purposes; glassware, porcelain; and earthenware not included in other classes; cosmetic accessories, powder compacts made not of precious metals, eyebrow brushes, eyelash brushes, nail brushes, cosmetic applicators, perfume atomizers, toilet cases for toiletries; bottles; cleansing cotton; appliances for removing make up, non-electric; comb cases; gloves for household purposes.

(260) AM 2012 65252 A

(800) 1097047

(731) Mahindra Yueda (Yancheng) Tractor

Company, Ltd.

No.9, Nenjiang Road, Yancheng Economic
Development Zone, 224002 Jiangsu, China

(540)

HUANGHAI JINMA

(591) Black, white

(511)

12 – Locomotives; tractors; vehicles chassis; cycle cars; electric bicycles; funiculars; luggage trucks; omnibuses; tires for vehicle wheels; repair outfits for inner tubes.

37 – Repair information; rental of road sweeping machines; machine installation, maintenance and repair; electric appliance installation and repair; motor vehicle maintenance and repair; rustproofing; retreading of tires (tyres); burglar alarm installation and repair; vehicle service stations (refueling and maintenance); shipbuilding.

(260) AM 2012 65253 A

(800) 1097058

(731) Reebok International Limited

4th Floor 11-12 Pall Mall, London SW1Y
5LU, United Kingdom

(540)

REEBOK

(591) Black, white

(511)

18 – Bags, luggage.

25 – Clothing, footwear, headgear.

28 – Balls, fitness equipment and other sporting equipment.

(260) AM 2012 65256 A

(800) 1097112

(731) Otkrytoe Aktsionernoe Obschestvo

Kontsern "Kalina"
80, ul. Komsomolskaya, RU-620138
Ekaterinburg, Russian Federation

(540)



(591) Green, white and grey

(511)

3 – Petroleum jelly for cosmetic purposes; cotton wool for cosmetic purposes; aromatics [essential oils]; cake flavourings [essential oils]; flavorings for beverages [essential oils]; sachets for perfuming linen; laundry wax; moustache wax; dental bleaching gels; make-up; greases for cosmetic purposes; blueing for laundry; beard dyes; cosmetic dyes; laundry starch; cosmetic creams; creams for leather; after-shave lotions; hair lotions; lotions for cosmetic purposes; beauty masks; oils for perfumes and scents; oils for cosmetic purposes; oils for toilet purposes; essential oils; essential oils of cedarwood; essential oils of citron; oils for cleaning purposes; bergamot oil; gaultheria oil; jasmine oil; lavender oil; almond oil; rose oil; oil of turpentine for degreasing; adhesives for cosmetic purposes; almond milk for cosmetic purposes; cleansing milk for toilet purposes; shaving soap; polishing wax; dentifrices; shaving preparations; cosmetic preparations for baths; toiletries; hair waving preparations; laundry soaking preparations; leather bleaching preparations; denture polishes; furbishing preparations; mouth washes, not for medical purposes; cosmetic preparations for slimming purposes; laundry glaze; fabric softeners for laundry use; laundry bleach; dry-cleaning preparations; make-up removing preparations; nail care preparations; cleaning preparations; preparations for cleaning dentures; make-up powder; bleaching soda; washing soda, for cleaning; bath salts, not for medical purposes; bleaching salts; preservatives for leather [polishes]; astringents for cosmetic purposes; eyebrow cosmetics; stain removers; make-up preparations; sunscreen preparations; hair colorants; neutralizers for permanent waving; depilatory preparations; cosmetic preparations for skin care; boot cream; cosmetics; cosmetics for animals; mascara; detergents other than for use in manufacturing operations and for medical purposes; degreasers other than for use in manufacturing processes; bleaching preparations (decolorants) for cosmetic purposes; antiperspirants [toiletries]; talcum powder, for toilet use; terpenes [essential oils].

5 – Balms for medical purposes; petroleum jelly for medical purposes; molding wax for dentists; glucose for medical purposes; mud for baths; medicinal mud; yeast for pharmaceutical purposes; gelatine for medical purposes; starch for dietetic or pharmaceutical purposes; dental lacquer; medicines for alleviating constipation; liniments; ointments for pharmaceutical purposes; sunburn ointments; mercurial ointments; frostbite salve for pharmaceutical purposes; anti-horse-fly oils; medicinal oils; mustard oil for medical purposes; camphor oil for medical purposes; castor oil for medical purposes; oil of turpentine for pharmaceutical purposes; dill oil for medical purposes; dental mastics; powder of cantharides; pyrethrum powder; balsamic preparations for medical purposes; pesticides; herbicides; preparations for destroying dry rot fungus; larvae exterminating preparations; fly destroying preparations; preparations for destroying mice; slug exterminating preparations; vermin destroying preparations; pharmaceutical preparations for skin care; medicinal hair growth preparations; sunburn preparations for pharmaceutical purposes; chilblain preparations; mothproofing preparations; milking grease; greases for veterinary purposes; greases for medical purposes; medical preparations for slimming purposes; remedies for foot perspiration.

(260) AM 2012 65257 A

(800) 1097131

(731) GRINDEKS akciju sabiedrība
Krustpils iela 53, LV-1057 Rīga, Latvia

(540)



(591) Yellow, orange, red, brown, white, black, grey and green

(511)

5 – Pharmaceutical and veterinary preparations; sanitary preparations for medical purposes; dietetic substances adapted for medical use, food for babies; plasters, materials for dressings; material for stopping teeth, dental wax; disinfectants; preparations for destroying vermin; fungicides, herbicides.

(260) AM 2012 65258 A

(800) 1097132

(731) GRINDEKS, akciju sabiedrība
Krustpils iela 53, LV-1057 Rīga, Latvia

(540)



(591) Yellow, orange, red, brown, white, black and grey

(511)

5 – Pharmaceutical and veterinary preparations; sanitary preparations for medical purposes; dietetic substances adapted for medical use, food for babies; plasters, materials for dressings; material for stopping teeth, dental wax; disinfectants; preparations for destroying vermin; fungicides, herbicides.

(260) AM 2012 65259 A

(800) 1097161

(731) SANOFI

54 rue La Boétie, F-75008 Paris, France

(540)

ERVOXI

(591) Black, white

(511)

5 – Pharmaceutical products for the treatment of autoimmune diseases, inflammatory diseases, rheumatoid arthritis and ankylosing spondylarthritis.

(260) AM 2012 65260 A

(800) 1097179

(731) POFER S.r.l.

Via Oberdan, 37/39, I-45037 MELARA (RO), Italy

(540)

POFER

(591) Black, white

(511)

7 – Machines and machine tools.

(260) AM 2012 65261 A

(800) 1097180

(731) BAUSCH & LOMB INCORPORATED

One Bausch & Lomb place, Rochester, NEW YORK, NY 14604, USA

(540)

ARTELAC SPLASH

(591) Black, white

(511)

5 – Ophthalmic pharmaceutical preparations and substances.

(260) AM 2012 65309 A

(800) 652566

(731) MAVIC SAS

Les Croiselets, F-74370 METZ-TESSY, France

(540)

MAVIC

(591) Black, white

(511)

9 – Apparatus for measuring, signaling and checking (supervision); revolution counters, counters, speed indicators, luminous signs, mechanical and electronic testers, helmets, particularly for cyclists, videotapes.

(260) AM 2012 65315 A

(800) 811079

(731) GROUPE AUCHAN société anonyme à

directoire et conseil de surveillance

40, avenue de Flandre, F-59170 CROIX, France

(540)

TECHNIPRO

(591) Black, white

(511)

7 – Machine tools; construction and civil engineering machinery; machinery for working metal, wood, leather or plastics; packaging machines; machines for the textile industry; agricultural machines; printing machines; machines for bookbinding; diggers (machines); shears and electric shears; cutting machines; reels, mechanical, for flexible hoses; saws (machines), blades and saw blades (machine parts); cleaning machines; glue guns, electric; pneumatic hammers; compressed air pistols for putty extrusion; mixers; molding machines; grinding machines; sharpening machines; welding apparatus, gas-operated, welding machines, electric; generators of electricity; machines and airbrushes for painting; shovels, mechanical; electric hand drills; sanding machines; planing machines; riveting machines; robots (machines); motors, other than for land vehicles; vacuum cleaners; parquet wax-polishers, electric; electric cleaning machines and apparatus; machines and apparatus for carpet shampooing, electric; cleaning appliances utilizing steam.

9 – Weighing, measuring and signaling apparatus and instruments; spirit levels; material for electricity mains (wires, cables), plugs, sockets and other contacts, fuses, electric batteries; switches, electric; sheaths for electric cables; accumulators, electric; apparatus for recharging electrical storage batteries; ammeters; batteries, electric; batteries for lighting; switchboxes (electricity); branch boxes (electricity); control panels (electricity); encoded cards, magnetic; credit and payment cards; identity cards, magnetic; flat irons, electric; scales; protective helmets; nets for protection against accidents; barometers; extinguishers; alarms; anti-theft alarms; electric arc welding apparatus.

11 – Apparatus for lighting, heating, steam generating, cooking, refrigerating, drying, ventilating, disinfecting, water supply; water conduit installations; faucets for pipes; heating boilers; incinerators; glue-heating appliances; cooling appliances and installations; apparatus and machines for air purification, cooling and conditioning; cooling installations for water; extractor hoods for kitchens; pressure cooking saucepans, electric; cooking installations; cookers; ovens; freezers, refrigerators; cold rooms and cabinets; ice machines and apparatus; refrigerating containers; gas lighters; bread toasters; coffee machines, electric; deep fryers, electric; sauna bath installations, tanning apparatus, light bulbs and electric lamps; sockets for electric lights; arc lamps.

(260) AM 2012 65316 A

(800) 813759

(731) MORELLATO S.P.A.

Via Commerciale, 29, I-35010 FRATTE DI
S. GIUSTINA IN COLLE (PD), Italy

(540)

MORELLATO

(591) Black, white

(511)

14 – Precious metals and their alloys and goods in precious metals or coated therewith, not included in other classes; jewellery, precious stones; horological and chronometric instruments.

(260) AM 2012 65317 A

(800) 833289

(731) UAB "SCT Lubricants"

Silutes pl. 119, LT-95112 Klaipeda,
Lithuania

(540)

PEMCO

(591) Black, white

(511)

2 – Sliding lacquers.

3 – Washing and cleaning agent; cleaning, polishing, scouring and abrasive preparations; cleaning agent for oil-soiled engines and other dirty technical articles; cleaning agent for fuel pipes and fuel injection systems of engines, in particular of motorcar engines; cleaning products for automobiles, namely products used during their cleaning, products for preserving lacquers, liquid products and pastes for cleaning and preserving lacquers, waxes for lacquers, shampoos; washing products for use with vehicle washing installations, liquid and powdered substances for washing and pre-washing for use with steam jet apparatus and with high-pressure cleaning tools; cleaning products for plastic mate-

rials, products for cleaning motor car convertible tops, cleaning preparations for oil-soiled engines and for other dirty technical articles, cleaning products for plastic materials, cleaning products for quilted upholstery, cleaning products for wheel rims, cleaning preparations for fuel lines and for injection installations for engines particularly for car engines.

4 – Lubricants; dust absorbing, dust wetting and dust bonding agents; fuels (including engine fuels); industrial oils and greases, including motor oils, gear oils, compressor oils as well as hydraulic oils; contact oils and greases; non-chemical additives for industrial oils and for fuels particularly petrol and diesel fuel; non-chemical additives for industrial grease, industrial oils, motor oils, gear oils, compressor oils and hydraulic oils.

(260) AM 2012 65319 A

(800) 892544

(731) NOVARTIS AG

CH-4002 Basel, Switzerland

(540)

BILTRIS

(591) Black, white

(511)

5 – Pharmaceutical preparations, vaccines, pharmaceutical preparations for diagnostic purposes.

(260) AM 2012 65321 A

(800) 950257

(731) Zakrytoe Aktsionernoe Obschestvo

"Natsionalnaya Khimicheskaya Kompania"
4A, str. 2, ul. Chistova, RU-109390 Moskva,
Russian Federation

(540)



(591) Red, blue, light blue and white

(511)

3 – Bleaching preparations and other substances for laundry use; cleaning, polishing, scouring and abrasive preparations; soap; perfumery, essential oils, cosmetics, hair lotions; dentifrices; abrasives; amber (perfume); scale removing preparations for household purposes; antistatic preparations for household purposes; breath freshening sprays; shaving stones, antiseptic; polishing stones; abrasive paper; emery paper; polishing paper; petroleum jelly for cosmetic purposes; cotton wool for cosmetic purposes; cotton sticks for cosmetic purposes; aromatics (essential oils); flavourings for cakes (essential oils); flavorings for beverages (essential oils); sachets for perfuming linen; scented water; javelle

water; lavender water; toilet water; laundry wax; parquet floor wax; mustache wax; tailors' wax; polish for furniture and flooring; shoe wax; heliotropine; geraniol; make-up; deodorants for personal use; scented wood; perfumes; windshield cleaning liquids; greases for cosmetic purposes; volcanic ash for cleaning; perfumery; decorative transfers for cosmetic purposes; ionone (perfumery); smoothing stones; eyebrow pencils; cosmetic pencils; silicon carbide (abrasive); carbides of metal (abrasives); alum stones (antiseptic); tripoli stone for polishing; adhesives for affixing false eyelashes; adhesives for affixing false hair; quillaia bark for washing; corundum (abrasive); blueing for laundry; beard dyes; colorants for toilet purposes; cosmetic dyes; starch for laundry purposes; cosmetic creams; skin whitening creams; creams for leather; polishing rouge; incense; hair spray; nail polish; after-shave lotions; hair lotions; lotions for cosmetic purposes; beauty masks; oils for perfumes and scents; oils for cosmetic purposes; oils for toilet purposes; essential oils; essential oils of cedarwood; essential oils of lemon; oils for cleaning purposes; bergamot oil; gaultheria oil; jasmine oil; lavender oil; almond oil; rose oil; oil of turpentine for degreasing; adhesives for cosmetic purposes; whiting; cleaning chalk; almond milk for cosmetic purposes; cleansing milk for toilet purposes; musk (perfumery); soap; disinfectant soap; deodorant soap; shaving soap; soap for brightening textile; cakes of toilet soap; medicated soap; antiperspirant soap; soap for foot perspiration; almond soap; mint for perfumery; cosmetic kits; emery; false nails; eau de Cologne; bases for flower perfumes; polishing wax; pastes for razor strops; dentifrices; pumice stone; hydrogen peroxide for cosmetic purposes; abrasive cloth; glass cloth; lipsticks; pomades for cosmetic purposes; shaving preparations; cosmetic preparations for baths; toiletries; hair waving preparations; preparations for soaking laundry; grinding preparations; smoothing preparations; leather bleaching preparations; denture polishes; refurbishing preparations; mouth washes, not for medical purposes; cosmetic preparations for slimming purposes; starch glaze for laundry purposes; fabric softeners for laundry use; laundry preparations; dry-cleaning preparations; make-up removing preparations; paint stripping preparations; lacquer-removing preparations; floor wax removers; rust removing preparations; nail care preparations; cleaning preparations; preparations for cleaning dentures; wallpaper cleaning preparations; preparations for cleaning waste pipes; color-brightening chemicals for household purposes (laundry); make-up powder; diamantine (abrasive); scouring solutions; false eyelashes; tissues impregnated with cosmetic lotions; saflol; turpentine, for degreasing; potpourris; bleaching soda; washing soda, for cleaning; bath salts, not for medical purposes; bleaching salts; preservatives for leather (po-

lishes); fumigation preparations (perfumes); ammonia [volatile alkali]; astringents for cosmetic purposes; eyebrow cosmetics; stain removers; make-up preparations; sunscreen preparations; hair dyes; neutralizers for permanent waving; cosmetic preparations for eyelashes; depilatory wax; cosmetic preparations for skin care; shoe polish; cosmetics; cosmetics for animals; mascara; detergents other than for use in manufacturing operations and for medical purposes; degreasers other than for use in manufacturing processes; bleaching preparations [decolorants] for cosmetic purposes; antiperspirants; talcum powder, for toilet use; terpenes; shampoos; shampoos for pets; glass paper (glass); soda lye; extracts of flowers (perfumes); ethereal essences; badian essence; mint essence; non-slipping wax for floors; non-slipping liquids for floors; canned pressurized air for cleaning and dusting purposes; dental bleaching gels; preparations to make the leaves of plants shiny; perfumed candles; cloths impregnated with a detergent for cleaning; aerosols for dry degreasing agents (term considered too vague by the international bureau (rule 13(2)(b)) of the Common Regulations).

21 – Household and kitchen utensils and containers neither of precious metal nor coated therewith; combs and sponges; brushes, except paint brushes; material for brush-making; articles for cleaning purposes; steel wool; glass, unworked or semi-worked, except building glass; glassware, porcelain and earthenware not included in other classes; deep fryers, non-electric; buckets; china ornaments; dishes, not of precious metal; paper plates; saucers, not of precious metal; goblets, not of precious metal; candy boxes, not of precious metal; lunch boxes; bottles; demijohns; busts of china, terra-cotta or glass; vases not of precious metal; centerpieces not of precious metal; fruit cups; bird baths; baby baths (portable); plungers for clearing blocked drains; waffle irons, non-electric; ice buckets; coal scuttles; buckets made of woven fabrics; skewers (metal needles) for cooking; napkin holders not of precious metal; trouser stretchers; clothing stretchers; shirt stretchers; hair for brushes; birdcages; funnels; carpet beaters, not being machines; signboards of porcelain or glass; candle extinguishers, not of precious metal; flower pots; chamber pots; glue-pots; cruets, not of precious metal; decanters; large-toothed combs for the hair; combs for animals; abrasive sponges for scrubbing the skin; sponges for household purposes; toilet sponges; deodorising apparatus for personal use; sponge holders; toothpick holders, not of precious metal; soap holders; holders for flowers and plants (flower arranging); shaving brush stands; ironing boards; cutting boards for the kitchen; bread boards; washing boards; strainers, not of precious metal; smoke absorbers for household purposes; household or kitchen containers (not made of precious metal);

kitchen containers, not of precious metal; glass bulbs (receptacles); glass jars; heat-insulated containers; thermally insulated containers for food; glass flasks (containers); frying pans; closures for pot lids; chamois leather for cleaning; toothpicks; ceramics for household purposes; majolica; works of art, of porcelain, terra-cotta or glass; brush goods; cleaning instruments, hand-operated; stew-pans; covers, not of paper, for flower pots; shaving brushes; cages for household pets; polishing leather; shoe trees; napkin rings, not of precious metal; poultry rings; piggy banks, not of metal; bread baskets, domestic; baskets, for domestic use, not of precious metal; feeding troughs; cookie jars; tea caddies, not of precious metal; washtubs; earthenware saucepans; mess-tins; cauldrons; coffee percolators, non-electric; coffee-pots, non-electric, not of precious metal; coffee grinders, hand-operated; fused silica (semi-wrought products) other than for building purposes; beer mugs; tankards, not of precious metal; rat traps; pot lids; butter-dish covers; dish covers; cheese-dish covers; button-hooks; jugs; perfume burners; portable coldboxes, non-electric; watering cans; insect traps; mixing spoons (kitchen utensils); basting spoons, for kitchen use; scoops (tableware); pie servers; spatulas (kitchen utensils); butter dishes; material for brush-making; polishing materials (for shining, excluding preparations, paper and stone); noodle machines, hand-operated; polishing apparatus and machines, for household purposes, non-electric; pepper mills, hand-operated; feather-dusters; brooms; isothermic bags; confectioners' decorating bags; bowls; mosaics of glass, not for building; saucepan scourers of metal; soap boxes; mouse traps; cooking pot sets; nozzles for watering cans; spouts; nozzles for sprinkler hose; fitted picnic baskets, including dishes; toilet cases; floss for dental purposes; fiberglass thread, not for textile use; cookie [biscuit] cutters; pastry cutters; sprinklers; syringes for watering flowers and plants; cotton waste for cleaning; wool waste for cleaning; cleaning tow; chopsticks; cocktail stirrers; pepper pots, not of precious metal; gloves for household purposes; polishing gloves; gardening gloves; plates to prevent milk boiling over; trays for domestic purposes, not of precious metal; trays for domestic purposes, of paper; lazy susans; vegetable dishes; cabarets (trays) not of precious metal; heaters for feeding bottles, non-electric; candlesticks, not of precious metal; trivets (table utensils); coasters, not of paper and other than table linen; menu card holders; knife rests for the table; flat-iron stands; egg cups, not of precious metal; grill supports; abrasive pads for kitchen purposes; scouring pads; drinking troughs; powdered glass for decoration; pottery; cooking pots; pressure cookers [autoclaves], non-electric; painted glassware; tableware not of precious metal; porcelain ware; earthenware; crystal (glassware);

cosmetic utensils; toilet utensils; trouser presses; oil cruets, not of precious metal; spice sets; appliances for removing make-up, non-electric; food cooling devices containing heat exchange fluids, for household purposes; toilet paper dispensers; apparatus for wax-polishing, non-electric; bottle openers; glove stretchers; boot jacks; crumb trays; tie presses; clothes-pegs; glass stoppers; powder compacts, not of precious metal; perfume vaporizers; powder puffs; dusting apparatus, non-electric; soap dispensers; combs; electric combs; grills (cooking utensils); sifters (household utensils); drinking horns; shoe horns; candle rings, not of precious metal; knobs of porcelain; salad bowls, not of precious metal; sugar bowls, not of precious metal; beaters, non-electric; whisks, non-electric, for household purposes; services (tableware, not of precious metal; coffee services, not of precious metal; liqueur sets; tea services, not of precious metal; cinder sifters (household utensils); tea strainers not of precious metal; siphons for carbonated water; pipettes (wine-tasters); rolling pins, domestic; hot pots, not electrically heated; steel wool for cleaning; currycombs; blenders, non-electric, for household purposes; fruit presses, non-electric, for household purposes; salt cellars, not of precious metal; drinking vessels; vessels of metal for making ices and iced drinks; refrigerating bottles; sacred vessels, not of precious metal; cups of paper or plastic; glass (receptacles); drinking glasses; statues of porcelain, terra-cotta or glass; figurines [statuettes] of porcelain, terra-cotta or glass; glass for vehicle windows (semi-finished product); plate glass (raw material); opaline glass; glass incorporating fine electrical conductors; enamelled glass; glass, unworked or semi-worked, except building glass; glass wool other than for insulation; fibreglass other than for insulation or textile use; vitreous silica fibers [fibres], not for textile use; soup bowls, not of precious metal; clothes racks, for drying; basins (receptacles); table plates, not of precious metal; graters (household utensils); insulating flasks; indoor terrariums (plant cultivation); cloth for washing floors; cloths for cleaning; dusting cloths; furniture dusters; litter trays for pets; urns, not of precious metal; aerosol dispensers, not for medical purposes; water apparatus for cleaning teeth and gums; mixing machines, non-electric, for household purposes; wax-polishing appliances, non-electric, for shoes; watering devices; utensils for household purposes, not of precious metal; kitchen utensils, not of precious metal; cooking utensils, non-electric; strainers for household purposes; coffee filters, non-electric; flasks, not of precious metal; drinking flasks for travellers; molds (kitchen utensils); ice cube molds; cookery molds; comb cases; bread bins; fly swatters; teapots, not of precious metal; kettles, non-electric; cups, not of precious metal; garlic presses (kitchen utensils); iron-

ning board covers, shaped; tea infusers, not of precious metal; glass bowls; mops; shakers; corkscrews; pig bristles; dishwashing brushes; brushes for cleaning tanks and containers; lamp-glass brushes; horse brushes; scrubbing brushes; toothbrushes; toothbrushes, electric; animal bristles (brushware); carpet sweepers; brushes for footwear; toilet brushes; electric brushes, except parts of machines; brushes; eyebrow brushes; nail brushes; nest eggs, artificial; troughs for livestock; boxes of metal, for dispensing paper towels; dustbins; disposable table plates; towel rails and rings not of precious metal; toilet paper roll holders; adhesive roller brushes (term considered too vague by the international bureau (rule 13(2)(b)) of the Common Regulations).

(260) AM 2012 65322 A
(800) 960117
(731) QlikTech International AB
Scheelevägen 24-26, SE-223 63 Lund,
Sweden
(540)

QLIKVIEW

(591) Black, white
(511)
9 – Stored computer programmes for commercial analysis and reporting; computer systems for commercial analysis and reporting; information processing system for commercial analysis and reporting; data communication system for commercial analysis and reporting; mechanical, optical or magnetic recording carriers for recording and reproduction of sound and images, herein including phonograph records, video tapes, discs (magnetic) and optical discs all for commercial analysis and reporting; exposed films; apparatus for recording, transmission or reproduction of sound and images all for commercial analysis and reporting.

42 – Scientific and industrial research; computer programming services for commercial analysis and reporting; design of computer machine and computer software for commercial analysis and reporting; maintenance, updating and improvement of computer software programs for commercial analysis and reporting; research and development regarding new products for commercial analysis and reporting; professional consultancy relating to computer hardware, computer software and data processing for commercial analysis and reporting; consulting services regarding computer hardware and computer systems for commercial analysis and reporting; computer consulting for commercial analysis and reporting; computer systems analysis for commercial analysis and reporting; rental of computer hardware and computer peripherals.

(260) AM 2012 65323 A
(800) 962990
(731) SANTINI SRL
Via Romagna, 23, I-62010 MORROVALLE
(MACERATA), Italy
(540)



(591) Black, white
(511)
18 – Leather and imitation leather, goods made of these materials not included in other classes; suitcases.
25 – Clothing, footwear.

(260) AM 2012 65324 A
(800) 965524
(731) QlikTech International AB
Scheelevägen 24-26, SE-223 63 Lund,
Sweden
(540)



(591) Black, white
(511)
9 – Stored computer software programs for combining, analyzing, and creating reports of business information, namely sales, accounts receivable, real estate, and purchasing information, derived from one or more sources; computer software systems comprising computers and software for combining, analyzing, and creating reports of business information, namely sales, accounts receivable, real estate, and purchasing information, derived from one or more sources.

42 – Computer programming, excluding programming for computer and video game software; design of computer software for business intelligence; maintenance, updating and improvement of computer software for combining, analyzing, and creating reports of business information, namely sales, accounts receivable, real estate, and purchasing information, derived from one or more sources; research and development services regarding new business software products; consultant services regarding computer software systems for combining, analyzing, and creating reports of business information, namely sales, accounts receivable, real estate, and purchasing information, derived from one or more sources; electronic data processing (EDP) consultancy, namely computer consultation in the

field of electronic data processing; computer systems analysis; hiring-out of computer hardware and computer equipment, namely rental of computer hardware and computer equipment.

(260) AM 2012 65325 A
(800) 970630

(731) EDLONITCHNO DRUJESTVO S
OGRANITCHENA OTGOVORNOST
"KOMAK MEDIKAL
oulitsa "Odrin" 131 appart. 22, raion
Vazrajdane, BG-1303 SOFIA, Bulgaria

(540)



(591) White, blue and light blue
(511)

35 – Advertising; business management; business administration; office functions; business organization consultancy; marketing studies; sales promotion (for others); demonstration of goods; procurement services for others (purchasing goods and services for other businesses).

42 – Scientific and technological services and research and design relating thereto; industrial analysis and research services; bacteriological research; biological research; material testing; quality control; chemical analysis; chemical research.

44 – Medical services; veterinary services; hygienic and beauty care for human beings or animals.

(260) AM 2012 65326 A
(800) 1021659

(731) BODY-SOLID, INC.
1900 South Des Plaines Avenue, Forest Park,
IL 60130, USA

(540)

BODY-SOLID

(591) Black, white
(511)

28 – Exercise, sporting and fitness equipment; namely, weights, weight stands, weightlifting benches, weightlifting machines, weightlifting belts and ankle straps, weightlifting accessories, and floor mats.

(260) AM 2012 65327 A
(800) 1049824

(731) GlaxoSmithKline LLC Corporation Service
Company
2711 Centerville Road, Suite 400,
Wilmington, New Castle, DE 19808, USA

(540)

KRISABLIS

(591) Black, white
(511)

5 – Pharmaceutical and medicinal preparations and substances; vaccines.

(260) AM 2012 65328 A
(800) 1049825

(731) GlaxoSmithKline LLC Corporation Service
Company
2711 Centerville Road, Suite 400,
Wilmington, New Castle, DE 19808, USA

(540)

TAFINLAR

(591) Black, white
(511)

5 – Pharmaceutical and medicinal preparations and substances; vaccines.

(260) AM 2012 65329 A
(800) 1051591

(731) GlaxoSmithKline LLC Corporation Service
Company
2711 Centerville Road, Suite 400,
Wilmington, New Castle, DE 19808, USA

(540)

RAFINLAR

(591) Black, white
(511)

5 – Pharmaceutical and medicinal preparations and substances; vaccines.

(260) AM 2012 65330 A
(800) 1071778

(731) Time Products (UK) Limited
34 Dover Street, London W1S 4NG,
United Kingdom

(540)

SEKONDA

(591) Black, white
(511)

14 – Horological and chronometric apparatus and instruments; clocks; watches; stop-watches; jewellery; brooches; bracelets; badges of precious metal; boxes of precious metal; cases for watches and clocks; buckles of precious metal; clock and watch hands; watch chains; clock and watch dials; clock and watch movements; watch springs; watch straps; earrings; keyrings of precious metal; necklaces; paste jewellery; sundials; tie-clips; tie-pins.

(260) AM 2012 65331 A
 (800) 1097547
 (731) LANXESS DEUTSCHLAND GMBH
 51369 Leverkusen, Germany
 (540)

VELCORIN

(591) Black, white
 (511)
 1 – Indicator paper, indicator badges and indicator strips for the detection/diagnosis of gases; litmus paper.
 9 – Gas analysis, gas monitoring units.

(260) AM 2012 65332 A
 (800) 1097582
 (731) Razer (Asia-Pacific) Pte Ltd
 514 CHAI CHEE LANE, #07-05,
 SINGAPORE 469029, Singapore
 (540)



(591) Black, white
 (511)
 9 – Computers; laptop computers; notebook computers; handheld computers; personal digital assistants; computer and video game apparatus adapted for use with television receivers or other external display screens or monitors; computer displays; computer monitors; computer hardware; computer soundcards; computer peripherals; computer and video game controllers; computer mice; computer keyboards; computer keypads; computer graphics tablets; computer pens; computer joysticks; computer trackballs; computer game apparatus and video game apparatus (adapted for use with an external display screen or monitor) namely flight yokes, steering wheels, accelerator pedals, brake pedals and guns; motion sensors for computer and video games; apparatus for recording, transmission or reproduction of data, sound or images; audio equipment and apparatus; earphones; headphones; microphones; headsets; loudspeakers; apparatus for cable management for the aforementioned goods; batteries and power supplies for the aforementioned goods; parts and spare parts of the aforementioned goods as far as included in this class; computer software and computer software drivers for the aforementioned goods; computer and video games (software); computer mice mats; bags, pouches, cases and covers adapted for holding and storing the aforementioned goods.

18 – Bags; messenger bags; sport bags; travel bags; backpacks; knapsacks.

25 – Clothing; polo shirts; T-shirts; sweatshirts; headgear; caps; sweatbands.

28 – Games and playthings; electronic games and playthings other than those adapted for use with television receivers; video game apparatus other than those adapted for use with television receivers; handheld video game apparatus other than those adapted for use with television receivers; parts and spare parts of the aforementioned goods as far as included in this class; bags, pouches, cases and covers adapted for holding and storing the aforementioned goods.

(260) AM 2012 65334 A
 (800) 1097589
 (731) Styron Europe GmbH
 Bachtobelstrass 3, CH-8810 Horgen,
 Switzerland
 (540)

TRINSEO

(591) Black, white
 (511)
 1 – Styrene; unprocessed synthetic resins; acrylonitrile-butadiene-styrene.

17 – Synthetic rubber; latex for industrial use; and latex for use in the manufacture of finished goods, namely, carpet, carpet backing, rubber and foam mats, foam and acoustic underlays, foam, adhesives, paper, cardboard, paperboard, packaging board, hygienic wipes, canvas, bonded leather, wood fiber board, flexible abrasives, concrete, concrete structures, non-metal ceiling tile, pavers, mortars, mastics, grouts, felts, garments, mesh fabric, footwear and parts thereof, coatings and primers for creating vapor, moisture, and water barriers, automotive sound dampening coatings, seed coating, masking tape, track and playground surfaces, non-skid pads, bedding, mattresses, polyester spunbond, glass fibers, synthetic resin adhesives for laminating purposes, textiles, sealants, and waterproof membranes.

(260) AM 2012 65335 A
 (800) 1097601
 (731) UAB "ACME kompiuteriq komponentai"
 Jonavos g. 196, LT-44132 Kaunas, Lithuania
 (540)



(591) Blue, light blue, black and grey
 (511)
 9 – Sound, image and data recording, transmitting or reproduction apparatus; magnetic data media,

record discs; data processing apparatus; computers and their accessories.

35 – Advertising; business management; business administration; office functions; the bringing together for the benefit of others, of variety of goods (excluding the transport thereof), namely sound, image and data recording, transmitting or reproduction apparatus, magnetic data media, record discs, data processing apparatus, computers and their accessories, enabling customers to conveniently view and purchase those goods in wholesale and retail shops, teleshops, by mail order catalogues, Web sites.

(260) AM 2012 65336 A

(800) 1097624

(731) WELLA GMBH

Sulzbacher Straße 40, 65824 Schwalbach am Taunus, Germany

(540)

BLONDOR

(591) Black, white

(511)

3 – Soaps; perfumeries; essential oils; preparations for body and beauty care, namely preparations for cleaning, care and embellishing the hair; dentifrices.

(260) AM 2012 65339 A

(800) 1097629

(731) OBSHCHESTVO S OGRANICHENNOY OTVETSTVENNOSTYU "PREMIUM"

dom 128, ulitsa Krepilnaya, poselok Kuposrosnyi, RU-400019 Volgograd, Russian Federation

(540)



(591) Black, white

(511)

1 – Glaziers' putty; adhesives for wall tiles; adhesives for paperhanging; gums [adhesives], other than for stationery or household purposes; adhesives for industrial purposes; oil cement [putty]; solvents for varnishes; foundry molding [moulding] preparations; compositions for the manufacture of technical ceramics; adhesive preparations for surgical bandages.

2 – Paints; mordants; natural resins, raw; whites [colorants or paints]; primers; colorants; asbestos paints; distempers; fireproof paints; enamels for painting; ceramic paints; lacquers; mastic [natural

resin]; thickeners for paints; zinc oxide [pigment]; pigments; coatings [paints]; protective preparations for metals; wood mordants; thinners for lacquers; thinners for paints; whitewash; badigeon; fixatives [varnishes]; enamels [varnishes]; silver emulsions [pigments].

17 – Guttapercha; asbestos; flexible tubes, not of metal; asbestos felt; asbestos fibers [fibres]; lute; insulators; asbestos mill boards; insulating paints; adhesive bands other than stationery and not for medical or household purposes; asbestos sheets; asbestos packing; asbestos soles; asbestos coverings; asbestos cloth; gaskets; artificial resins [semi-finished products]; asbestos fabrics; asbestos slate.

19 – Bitumen; monuments, not of metal; gypsum; plaster; wood pulp board, for building.

(260) AM 2012 65418 A

(800) 1098417

(731) JU.CLA.S. – S.R.L.

Via Mirandola, 49/A, Fraz. Settimo, I-37026 PESCANTINA (VR), Italy

(540)



(591) White and green

(511)

7 – Machines and machine tools for the oenological industry, for the food industry, for the drinks Industry and machines and machine tools for flotation, cartridges for filtering machines, filtering machines, filters (parts of machines or engines).

9 – Scientific, nautical, surveying, photographic, cinematographic, optical, weighing, measuring, signalling, checking (supervision), life-saving and teaching apparatus and instruments; apparatus and instruments for conducting, switching, transforming, accumulating, regulating or controlling electricity; apparatus for recording, transmission or reproduction of sound or images; magnetic data carriers, recording discs; automatic vending machines and mechanisms for coin-operated apparatus; cash registers, calculating machines, data processing equipment and computers; fire-extinguishing apparatus; oenological microfiltration machines for the food and drinks industry, filtering units for the musts clarification and the wine stabilization, spare parts suitable for all the above-mentioned goods; apparatus for dosing and dispensing oenological adjuvants, detergent solutions and sanitizers all in the wine making process, oxygen transvasing apparatus for use in making wine.

(260) AM 2012 65420 A
 (800) 1098439
 (731) Company Limited "UK Solnechnye
 produkty"
 d. 3, 1-y Grayvoronovsky pr-d, RU-109518
 Moscow, Russian Federation

(540)

СОЛНЕЧНАЯ ЛИНИЯ

(591) Black, white

(511)

29 – Meat, fish, poultry and game; meat extracts; vegetables and fruits preserved, dried and cooked; jellies, jams, stewed fruits; eggs, milk and milk products; butters and edible fats, including margarine, vegetable oils, butter, fat-containing mixtures for bread slices.

30 – Coffee, tea, cocoa, sugar, rice, tapioca, sago, artificial coffee; meal and cereal preparations, bakery products, pastries, ice cream; honey, golden syrup; yeast, baking powder; salt, mustard; vinegar, condiments (including mayonnaise, ketchup and other sauces); spices; edible ices.

(260) AM 2012 65421 A
 (800) 1098475
 (731) CHANGMAO BIOCHEMICAL
 ENGINEERING CO., LTD.
 No.1228, Changjiang North Road, Xinbei
 District, Changzhou City, Jiangsu Province,
 China

(540)



(591) Black, white

(511)

1 – Acid; tartaric acid; salts for chemical preparations; ammonium salts; ester; artificial sweeteners for chemical preparations; maleic anhydride; sodium salt for chemical preparations; L-phenylalanine; aspartame.

(260) AM 2012 65422 A
 (800) 1098493
 (731) MAGIC PRODUCTION GROUP (M.P.G.)
 SA
 Findel Business Center, Complexe B,
 Rue de Trèves, L-2632 FINDEL,
 Luxembourg

(540)



(591) Dark green, light green, dark yellow, light yellow, white, black

(511)

9 – Scientific, nautical, surveying, photographic, cinematographic, optical, weighing, measuring, signaling, checking (supervision), life-saving and teaching apparatus and instruments; apparatus and instruments for conducting, switching, transforming, accumulating, regulating or controlling electricity; apparatus for recording, transmission or reproduction of sound or images; magnetic data media; sound recording disks; automatic vending machines and mechanisms for coin-operated apparatus; cash registers, calculating machines, data processing equipment and computers; extinguishers.

16 – Paper, cardboard and goods made from these materials, not included in other classes; printed matter; bookbinding material; photographs; stationery; adhesives (glues) for stationery or household purposes; artists' materials; paintbrushes; typewriters and office requisites (except furniture); instructional or teaching material (except apparatus); plastic materials for packaging (not included in other classes); printing type; printing blocks.

28 – Games, toys; gymnastic and sporting articles not included in other classes; decorations for Christmas trees.

30 – Coffee, tea, cocoa, sugar, rice, tapioca, sago, artificial coffee; flour and preparations made from cereals, bread, pastry and confectionery, ices; honey, treacle; yeast, baking-powder; salt, mustard; vinegar, sauces (condiments); spices; ice for refreshment.

35 – Advertising; business management; business administration; office functions.

38 – Telecommunications.

41 – Teaching; providing of training; entertainment; sporting and cultural activities.

(260) AM 2012 65423 A
 (800) 367748A
 (731) SECO Tools Aktiebolag
 SE-737 82 Fagersta, Sweden

(540)

PRAMET

(591) Black, white

(511)

6 – Friction materials not included in other classes; powdered brass and nickel brass, pressed parts

made of sintered metals, iron powders, sprayed powdered ferrometallic alloys and sprayed non-ferrous metal powders.

7 – Dies with hard carbides, clamping jaws of hard carbide for folding dies, guide bushings, die blocks and nozzles made of hard carbide, other instruments and tools with hard carbides, diamond dies, diamond crowns (for drilling), diamond bosses for drilling crowns.

8 – Dies with hard carbides, clamping jaws of hard carbide for folding dies, die blocks and nozzles made of hard carbide, other instruments and tools with hard carbides; diamond crowns (for drilling), diamond boss for drilling crowns; diamond dies.

(260) AM 2012 65424 A

(800) 381575

(731) fischerwerke GmbH & Co. KG
Weinhalde 14-18, 72178 Waldachtal,
Germany

(540)



(591) Black, white

(511)

6 – Connecting elements, namely pins, pegs and bolts made of metal and accessories thereof, i.e. special screws such as screw hooks, pitons, double threaded screws with different diameters.

8 – Hammer tools for making holes for pins, pegs or bolts.

20 – Connecting elements, namely pins, pegs and bolts made of synthetic materials or partly of synthetic materials and partly of metals and accessories thereof, i.e. collar nuts, resealing caps; collars for cables and pipes of synthetic materials; lugs of synthetic materials for accessories.

(260) AM 2012 65425 A

(800) 382584

(731) SAMSON AG
3, Weismüllerstrasse, 60314 FRANKFURT,
Germany

(540)

SAMSON

(591) Black, white

(511)

7 – Machine tools and their parts; lathes; sliding lathes with one or several shafts or tool carriers; turret lathes; drilling machines, milling machines, sharpening and polishing machines; semi-automatic and automatic machine tools, semi-automatic and automatic lathes, semi-automatic and automatic

drilling, milling and sharpening machines; semi-automatic and automatic adjusting, regulating, controlling, copying, driving, and clamping devices for machine tools, lathes, drilling machines, milling machines and for machines for reproducing by means of millworking; controlling machines for the aforementioned machines; tool holders, chucks and clamping apparatus, gear systems, counter gears, reduction gears, revolving heads, lead screws, stud bolts, sliding brackets, slide rests for the aforementioned machines.

9 – Semi-automatic and automatic measuring and counting devices for machine tools, lathes, drilling machines and machines for milling and reproducing by means of millworking.

(260) AM 2012 65426 A

(800) 520726

(731) ESTEBAN
Zone industrielle, LE GUA, F-34880
LAVERUNE, France

(540)

ESTEBAN

(591) Black, white

(511)

3 – Bleaching preparations and other substances for laundry use; cleaning, polishing, grease removing and abrasive preparations; soaps; perfumery, essential oils, cosmetics, hair lotions; dentifrices; sachets for perfuming linen; perfumery products; perfume products; bases for flower perfumes; incense; scented water; flower extracts; oils for perfumes and scents; devices containing perfume for use as air fresheners.

4 – Industrial oils and greases; lubricants; dust absorbing, wetting and binding compositions; fuel (including petrol) and illuminants; candles, wicks; tapers; tallow candles.

21 – Household or kitchen utensils and containers (neither of precious metal nor coated therewith); combs and sponges; brushes (except paintbrushes); brushware materials; cleaning equipment; steel-wool; unworked or semiworked glass (except glass used in building); glassware, porcelain and earthenware not included in other classes; perfume vaporizers; perfume sprayers; perfume burners; flasks (not made of precious metal), candlesticks; candle holders.

(260) AM 2012 65427 A

(800) 549593

(731) GRAS SAVOYE
Société par Actions Simplifiée, 33-34
Quai de Dion Bouton, F-92800 Puteaux,
France

(540)

GRAS SAVOYE

(591) Black, white

(511)

35 – Publication of publicity texts; assistance in setting up, managing insurance or reinsurance companies, in whatever form, insurance or reinsurance brokerage companies.

36 – Insurance and reinsurance brokering; insurance and reinsurance consulting; insurance and reinsurance auditing services; underwriting on behalf of insurers and reinsurers; insurance and reinsurance agents; claim management on behalf of insurers; insurance services in connection with the management of reinsurance accounts; risk audits consulting in connection with risk management and financing; consulting in connection with social protection and welfare; advice on risk protection and prevention provided by insurance brokers or by insurance advisors; risk engineering; design and assistance in carrying out monitoring of prevention and protection.

(260) AM 2012 65428 A

(800) 560033

(731) KONINKLIJKE BUNGE B.V.

Aert van Nesstraat 45, NL-3012 CA
Rotterdam, Netherlands

(540)

CEREOL

(591) Black, white

(511)

29 – Meat, fish, poultry and game; meat extracts; preserved, dried and cooked fruit and vegetables; jellies, jams; eggs, milk and dairy products; edible oils and fats; salad dressings; canned foods.

30 – Coffee, tea, cocoa, sugar, rice, tapioca, sago, artificial coffee; flour and preparations made from cereals, bread, pastry and confectionery, edible ices; honey, treacle; yeast, baking-powder; salt, mustard; vinegar, sauces (except salad dressings); spices; ice for refreshment.

(260) AM 2012 65429 A

(800) 623192

(731) GROUPE AUCHAN société anonyme à
directoire et conseil de surveillance

40, avenue de Flandre, F-59170 CROIX,
France

(540)

PIERRE CHANAU

(591) Black, white

(511)

33 – Wines, spirits and liqueurs.

(260) AM 2012 65430 A

(800) 631910

(731) LINCO BAXO INDUSTRIE REFRATTARI
S.P.A.

51/8, via Carlo Boncompagni, I-20139
MILANO, Italy

(540)



(591) Black, white

(511)

19 – Building materials not of metal; refractory materials, materials made of cements included in this class.

(260) AM 2012 65431 A

(800) 632476

(731) GECCO Import-Export Handelsgesellschaft
mbH

Fillgradergasse 5, A-1060 Wien, Austria

(540)

VITASAN

(591) Black, white

(511)

3 – Bleaching preparations and other substances for laundry use; cleaning, polishing, degreasing and abrasive preparations; soap; perfumery, essential oils, cosmetics, hair lotions; dentifrices.

5 – Pharmaceutical and sanitary products; dietetic substances without malt for medical use, dietetic food products without malt for medical use, food for babies; plasters, materials for dressings; disinfectants; pesticides; fungicides, herbicides.

(260) AM 2012 65432 A

(800) 640057

(731) GRAS SAVOYE

Société par Actions Simplifiée, 33-34 Quai
de Dion Bouton, F-92800 Puteaux, France

(540)



(591) Black, white

(511)

35 – Publication of advertising texts, assistance in setting up, managing insurance or reinsurance companies, in whatever form insurance or reinsurance brokerage companies.

36 – Insurance and reinsurance brokering, insurance and reinsurance consulting; insurance and rein-

insurance auditing services; underwriting on behalf of insurers and reinsurers; insurance and reinsurance agents; claim management on behalf of insurers; insurance services in connection with the management of reinsurance accounts; risk auditing, consulting in connection with risk management and financing consulting in connection with social protection and welfare; advice on risk protection and prevention provided by insurance brokers or by insurance advisors; risk engineering; design and assistance in carrying out prevention and protection monitoring as services provided by insurers.

(260) AM 2012 65434 A

(800) 649773

(731) GROUPE LACTALIS

10 rue Adolphe Beck, F-53000 LAVAL,
France

(540)

RONDELÉ

(591) Black, white

(511)

29 – Milk, cheeses and other milk goods.

(260) AM 2012 65435 A

(800) 670280

(731) GROUPE AUCHAN société anonyme à
directoire et conseil de surveillance

40, avenue de Flandre, F-59170 CROIX,
France

(540)

GENIUM

(591) Black, white

(511)

7 – Machine tools; mechanically operated hand-held tools; construction and civil engineering machinery; machines used in metallurgy, wood-working or processing of plastic materials and packaging; machines for the textile industry; machines for use in agriculture; printing machines; machines for bookbinding; stamping machines; harvesters; shears and electric shears; root cutters (machines); cutting machines; turf removing ploughs; mechanical reels for flexible hoses; lawnmowers (machines); weeding machines; saws (machines) and saw blades (machine parts); sowers (machines); mowing and reaping machines; cleaning machines; steam engines; vehicle washing installations; washing machines; laundry washers; dishwashing machines; spin driers; sewing machines; knitting machines; electric kitchen machines for chopping, milling, squeezing, mixing and cutting; electric food processors; electric cutters; electric tin openers; electromechanical appliances for preparing beverages; electric grinders/crushers for household purposes; centrifuges (machines); electric adhesive guns; bla-

des and saw blades (machine parts); chucks and cranks (machine parts); pneumatic hammers; compressed air guns for putty extrusion; blenders; moulding machines; tools (machine parts); machines and airbrushes for painting; power shovels; electric hand drills; sanding machines; planing machines; riveting machines; robots (machines); carburettors; petrol savers for motors and engines; anti-pollution devices for motors and engines; joints (motor and engine parts); cardan coupling joints; crankcases for machines, motors and engines; starter motors and exhausts for motors and engines; cylinder heads and cylinders for motors and engines; belts for machines, dynamo, fans for motors and engines; filters (machine or engine parts).

(260) AM 2012 65437 A

(800) 714763

(731) Fielmann AG

Weidestrasse 118, 22083 Hamburg,
Germany

(540)

fielmann

(591) Black, white

(511)

3 – Cleaning preparations for optical vision aids, namely glasses, spectacle frames and contact lenses as well as photographic apparatus and hearing aids.

5 – Disinfectants for optical vision aids, namely glasses, spectacle frames and contact lenses as well as photographic apparatus and hearing aids.

9 – Glasses and contact lenses, sun glasses, glasses also as mounted and unmounted monocles as well as vision aids with magnifying power, spectacle frames of metal and/or plastics, spectacle glasses, magnifying glasses, reading glasses, nippers, telescopes, microscopes, opera glasses, accessories and optical articles of all kind for the aforementioned goods, namely spectacle cases, spectacle chains, spectacle straps, adapted containers; electronic apparatus and data processing equipment for eye optics, in particular eyesight measuring instruments; photographic apparatus of all kinds, namely photographic apparatus and photo cameras with accessories, namely objectives, exposure tables, plates, films, photographic papers, developers, adapted containers for the aforementioned goods.

10 – Hearing aids and their parts and audio-acoustic accessories, namely batteries, earphones, strings, tubes, switches, connecting amplifiers, transformers with and without amplifiers for the transformation of acoustic signals into optical signals; electric aids for people with a hearing deficiency; ear adapters and otoplastics; means of protection against noise in the form of plastic or adapted ear inserts.

35 – Consulting in connection with the organization and conduct of companies, in particular of franchises; personnel and management consulting; placement services, accounting; distribution of printed matter and of samples for advertising purposes, in particular to franchises; development and design of texts for advertising and commercials; market research, public opinion research; drawing up of economic forecasts; advertising of business equipment and window decorations; sales promotion for third parties.

36 – Financing services; financial operations, real estate affairs, all aforementioned services in particular for the promotion of franchise systems by granting of loans and development aids as well as renting of real estate for franchisees.

37 – Repair and maintenance of the goods mentioned in classes 3, 5, 9 and 10, in particular repair of vision aids, photographic apparatus and hearing aids as well as of devices for the protection of the ear.

39 – Transport, packing and storage of goods, in particular for the operation of franchise systems.

41 – Education and teaching, in particular organization of continuation seminars for franchisees; entertainment.

42 – Services of opticians, in particular adaptation of glasses and contact lenses, including the mounting, determination of the visual faculty; issue of certificates for public authorities and health insurance schemes in the aforementioned fields; services of a hearing aid acoustician, in particular consultation in questions of improvement of the hearing ability, conducting hearing and speech tests; management and exploitation of industrial property rights; computer programming, in particular within the scope of franchise systems; rental of computer soft and hardware; development and layout of shop fittings and window decorations.

(260) AM 2012 65438 A

(800) 757398

(731) ZENTIVA, K.S.

U Kabelovny 130, CZ-102 36 Praha 10,
Dolní Měcholupy, Czech Republic

(540)

NEUROL

(591) Black, white

(511)

5 – Medicinal and dietary products.

(260) AM 2012 65439 A

(800) 800480

(731) THE GATES CORPORATION

1551 Wewatta Street, Denver, Colorado
80202, USA

(540)



(591) Black, white

(511)

6 – Metal hose couplings; metal hose clamps; belt pulleys and sprockets; belt tensioners.

7 – Sprockets and pulleys, variable diameter pulleys, adjustable pulleys, dual pulley tensioning systems; tensioners, lockable tensioning devices, tensioning idlers, being parts of engines, machines or motors; belts for engines and motors, power transmission belts for engines and motors, timing belts for engines and motors, v-ribbed belts for engines and motors, v-belts for engines and motors; crankshaft dampers for engines; radiator caps for cooling radiators for motors and engines; oil caps; hose crimping machines; hydraulic hose and coupling assemblies; radiator caps for cooling radiators for motors, engines and vehicles.

9 – Belt tensiometers, thermostats, testers for radiator caps for cooling radiators for motors, engines and vehicles and fuel cap testers; pre-recorded CD-ROMs featuring computer software for designing belt drives and information about belts, pulleys, hoses, couplings, and ordering information therefor; pre-recorded computer software for use in the design of power transmission systems; pre-recorded computer software for use in drawing designs for power transmission systems; laser system for aligning industrial pulleys comprised of laser light source and a reflector; electronically controlled belt tensioners whereby belt tension forces are controlled; software for electronic control of belt tensioners; belt tensioner control systems, comprising microprocessors, actuators and force measurement instruments using software for the control of belt tension forces; electrical power transmission drive system components including sensing instruments for system monitoring and temperature/load control; each of aforesaid products used individually or in combination.

12 – Pneumatic shock absorbing springs for vehicles and their air sleeve rubber components; fuel caps; power steering hose assemblies and kits for vehicles; belts and power transmission belts for land vehicles; moulded interior and boot parts for vehicles; mudguards and splash guards for vehicles; anti-static strips for vehicles.

17 – Flexible tubes, not of metal, hose assemblies, belt sprockets and pulleys; hose clamps, hose clamping sleeves; dimensionally stable mouldings of

non-woven fibres in the form of blocks, plates, strips or sheets; protective sleeves for flexible tubes; protective devices adapted to flexible tubes; hose bend restrictors.

(260) AM 2012 65440 A

(800) 801173

(731) THE GATES CORPORATION

1551 Wewatta Street, Denver, Colorado
80202, USA

(540)

GATES

(591) Black, white

(511)

6 – Metal hose couplings; metal hose clamps; belt pulleys and sprockets; belt tensioners.

7 – Sprockets and pulleys, variable diameter pulleys, adjustable lock center pulleys, dual pulley tensioning systems; tensioners, lockable tensioning devices, tensioning idlers, being parts of engines, machines or motors; belts for engines and motors, power transmission belts for engines and motors, timing belts for engines and motors, v-ribbed belts for engines and motors, v-belts for engines and motors; crankshaft dampers for engines; radiator caps for cooling radiators for motors and engines; oil caps; hose crimping machines; hydraulic hose and coupling assemblies; radiator caps for cooling radiators for motors and engines of vehicles.

9 – Belt tensionometers, thermostats, testers for radiator caps for cooling radiators for motors, engines and vehicles and fuel cap testers; pre-recorded CD-ROMs featuring computer software for designing belt drives and information about belts, pulleys, hoses, couplings, and ordering information therefor; pre-recorded computer software for use in the design of power transmission systems; pre-recorded computer software for use in drawing designs for power transmission systems; laser system for aligning industrial pulleys comprised of laser light source and a reflector; electronically controlled belt tensioners whereby belt tension forces are controlled; software for electronic control of belt tensioners; belt tensioner control systems, comprising microprocessors, actuators and force measurement instruments using software for the control of belt tension forces; electrical power transmission drive system components including sensing instruments for system monitoring and temperature/load control; each of aforesaid products used individually or in combination.

12 – Pneumatic shock absorbing springs for vehicles and their airsleeve rubber components; fuel caps; power steering hose assemblies and kits for vehicles; belts and power transmission belts for land vehicles; moulded interior and boot parts for

vehicles; mudguards and splash guards for vehicles; anti-static strips for vehicles.

17 – Flexible tubes, not of metal, hose assemblies, belt sprockets and pulleys; hose clamps, hose clamping sleeves; dimensionally stable mouldings of non-woven fibres in the form of blocks, plates, strips or sheets; protective sleeves for flexible tubes; protective devices adapted to flexible tubes; hose bend restrictors.

(260) AM 2012 65441 A

(800) 808831

(731) NOBLE CHOCOLATES

naamloze vennootschap; Handelsstraat 5,
B-8630 Veurne, Belgium

(540)



(591) Black, white

(511)

30 – Chocolate and chocolate products, such as pralines, sweets, seafood, truffles; biscuits, such as cheese biscuits, confectionery, sugar goods; snacks and mixtures of snacks (not included in other classes), appetizers not included in other classes; popcorn; crackers; flours and cereal preparations, bread, pastry and confectionery.

(260) AM 2012 65442 A

(800) 811614

(731) RAINBOW S.R.L.

snc, via Brece, I-60025 LORETO (AN),
Italy

(540)



(591) Black, white

(511)

3 – Bleaching preparations and other substances for laundry use; cleaning, polishing, scouring and abrasive preparations; soaps; perfumery, essential oils, cosmetics, hair lotions; dentifrices.

16 – Paper, cardboard and goods made from these materials, not included in other classes; printed matter; bookbinding material; photographs; stationery; adhesives for stationery or household purposes; artists' materials; paint brushes; typewriters and office requisites (except furniture); instructional and teaching material (except apparatus); plastic

materials for packaging (not included in other classes); printers' type; printing blocks.

25 – Clothing, footwear, headgear.

28 – Games and playthings; gymnastic and sporting articles not included in other classes; decorations for Christmas tree

(260) AM 2012 65443 A

(800) 823013

(731) AKTSIONERNO DRUJESTVO "VINPROM PESHTERA"

"Brezovska" str. 126, BG-4003 PLOVDIV,
Bulgaria

(540)

ALASKA

(591) Black, white

(511)

33 – Alcoholic beverages (except beers).

(260) AM 2012 65445 A

(800) 863451

(731) GROUPE AUCHAN

40 avenue de Flandre, F-59170 CROIX,
France

(540)

SELECLINE

(591) Black, white

(511)

9 – Scientific (other than medical), photographic, cinematographic, optical, weighing, measuring, signaling, checking (inspection), emergency (life-saving) apparatus and instruments; teaching apparatus and instruments; apparatus and instruments for conducting, switching, transforming, accumulating, regulating or controlling electricity; material for electricity mains (electric wires and cables), plugs, sockets and other contacts, fuses, socket covers; electric cells and batteries; ignition batteries; apparatus for recording, transmitting and reproducing sound or images; magnetic recording media; sound recording, magnetic and optical disks, audio and video compact disks; hi-fi systems; compact disk players; DVD players and recorders; video recorders; amplifiers; headphones; video cameras; videotapes; video screens; loudspeakers; facsimile machines; telephone apparatus; television apparatus, antennas; automatic vending machines and mechanisms for coin-operated apparatus; cash registers, calculating machines, data processing equipment, computers, computer peripheral devices, readers (computer equipment); software, floppy disks; electronic agendas; slides, projection apparatus and screens, dictating machines; flash bulbs (photography); exposed films; apparatus for games adapted for use with television receivers only; video game

cartridges; binoculars (optics), spectacles (optics), contact lenses, spectacle cases; magnetic cards; electric flat irons; barometers; alcoholmeters; fire extinguishers; electric locks; electric door bells; alarms; anti-theft alarms.

(260) AM 2012 65446 A

(800) 868318

(731) ZHEJIANG SEMIR GARMENT CO., LTD.

No. 1189 Semir Mansion, Lihongqiao Road,
Wenzhou, Zhejiang, China

(540)

(591) Black, white

(511)

25 – Clothing; layettes; children's clothing; gloves (clothing); gymnastic shoes; swimsuits.

(260) AM 2012 65448 A

(800) 875727

(731) ZHEJIANG SEMIR GARMENT CO., LTD.

No. 1189 Semir Mansion, Lihongqiao Road,
Wenzhou, Zhejiang, China

(540)

(591) Black, white

(511)

25 – Clothing; shoes; hats; hosiery; gloves (clothing); neckties; bathing suits; scarves; leather belts (clothing); wedding dresses.

(260) AM 2012 65449 A

(800) 879030

(731) GROUPE AUCHAN

40 avenue de Flandre, F-59170 CROIX,
France

(540)

SELECLINE

(591) Black, white

(511)

7 – Machine tools; mechanically operated hand-held tools; engines, other than for land vehicles; electric hand drills; compressed air pumps; electric glue guns; spray guns for paint; printing machines; clippers (machines); lawnmowers (machines); agricultural instruments other than manually-operated ones, egg incubators; electromechanical appliances for preparing foods; electric kitchen machines and robots; electric knives and shears; electric whisks;

electric tin openers; electric fruit presses for domestic use; centrifuges (machines); electric grinders/crushers for household purposes; electric shoe polishers; washing apparatus; vehicle washing installations; laundry and dishwashing machines; spin dryers; washing machines; vacuum cleaners; electric parquet wax-polishers; electric machines and apparatus for cleaning; electrical carpet and rug shampooing machines; steam cleaning apparatus; construction and civil engineering machinery; machines for packaging and for working wood, leather or plastics; machines for the textile industry; sewing and knitting machines; bookbinding apparatus.

8 – Hand-operated hand tools and implements; non-electric cutlery; forks; spoons, other than for fishing and for medicines; side arms; scissors; shears; saws, screwdrivers, secateurs, bill-hooks; hand-operated hand tools and implements for gardening; rakes, shovels, pickaxes, pliers, hammers, whetstones, lawn clippers (hand instruments); plant parasite killing apparatus; insecticide sprayers; mechanical tools for chopping and cutting foodstuffs; non-electric tin openers; razors, razor blades; shaving sets; nail nippers and files, nail cutting implements; manicure sets; electric and non-electric hair clippers for personal use; curling tongs; electric or non-electric depilation appliances, hair-removing tweezers.

11 – Apparatus for lighting, heating, steam generating, cooking, refrigerating, drying, ventilating, air conditioning, disinfecting and water supply; sanitary installations; shower cubicles; bathtubs; solar collectors; cooling appliances and installations; air cooling apparatus; cooling installations for water; extractor hoods for kitchens; electric pressure cookers; electric kettles; electric bottle warmers; sterilizers; barbecues; ice boxes; cooking installations; stoves; ovens; freezers, refrigerators; cold rooms and cabinets; ice machines and apparatus; refrigerating containers; gas lighters; bread toasters; electric coffee makers; electric deep fryers; electric lamps; hair dryers; sauna bath installations, tanning apparatus; light bulbs and electric lamps, filters for drinking water.

(260) AM 2012 65450 A

(800) 881756

(731) Guna S.p.A.

Via Palmanova, 71, I-20132 MILANO, Italy

(540)



(591) Black, white

(511)

3 – Soaps; perfumery, essential oils, cosmetics, hair lotions; dentifrices.

5 – Pharmaceutical and veterinary preparations; sanitary preparations for medical purposes; dietetic substances adapted for medical use, food for babies; materials for dressings; disinfectants.

9 – Scientific apparatus and instruments.

16 – Printed matter.

32 – Mineral and aerated waters and other non-alcoholic drinks; fruit drinks and fruit juices; syrups and other preparations for making beverages.

39 – Transport; packaging and storage of goods; travel arrangement.

41 – Education; providing of training; entertainment; sporting and cultural activities.

(260) AM 2012 65451 A

(800) 888610

(731) VAN NOTEN Andries, naamloze

vennootschap

Godefriduskaai 36, B-2000 Antwerpen,

Belgium

(540)

DRIES VAN NOTEN

(591) Black, white

(511)

18 – Leather and imitations of leather, and goods made of these materials and not included in other classes; animal skins, hides; trunks and travelling bags; umbrellas, parasols and walking sticks; whips, harness and saddlery.

25 – Clothing, footwear, headgear.

(260) AM 2012 65452 A

(800) 905776

(731) DEBENHAMS RETAIL PLC

1 Welbeck Street, London W1G 0AA,

United Kingdom

(540)

RED HERRING

(591) Black, white

(511)

25 – Articles of clothing; footwear; boots, shoes, slippers, sandals, trainers, socks and hosiery; headgear; hats; caps; berets; scarves; gloves; mittens; belts (being articles of clothing).

(260) AM 2012 65453 A

(800) 915143

(731) DEBENHAMS RETAIL PLC

1 Welbeck Street, London W1G 0AA,

United Kingdom

(540)

MANTARAY

(591) Black, white

(511)

25 – Articles of clothing; footwear; boots; shoes; slippers; trainers; sandals; socks; hosiery; headgear; hats; caps; berets; scarves; gloves; mittens; belts (being articles of clothing).

(260) AM 2012 65474 A

(800) 1068455

(731) KUSMI TEA

32-34 rue Marbeuf, F-75008 PARIS, France

(540)

KUSMI TEA

(591) Black, white

(511)

30 – Coffee, tea, cocoa, sugar, artificial coffee; flours and cereal preparations, bread, pastry and confectionery, edible ices; honey, treacle; yeast, baking-powder; salt, mustard; vinegar, sauces [condiments]; spices; ice for refreshment; pancakes; cookies; biscuits; cakes; rusks; confectionery; chocolate; beverages made with cocoa, coffee, chocolate or tea; infusions, not medicinal.

(260) AM 2012 65475 A

(800) 1070917

(731) Rockwool International A/S

Hovedgaden 584, DK-2640 Hedehusene, Denmark

(540)



(591) Black, white

(511)

17 – Insulation materials (not of metal).

19 – Building materials (not of metal).

(260) AM 2012 65476 A

(800) 1072317

(731) PUBLIC JOINT STOCK COMPANY "PHARMSTANDARD"

Likhachevsky proezd, d. 5 "B", g. Dolgoprudny, RU-141700 Moscow Region, Russian Federation

(540)

**ОКТОЛИПЕН
OCTOLIPEN**

(591) Black, white

(511)

5 – Pharmaceutical, veterinary preparations and sanitary preparations.

(260) AM 2012 65580 A

(800) 1099601

(731) AMIDEL SÀRL

c/o Multifiduciaire Fribourg SA, Rue Faucigny 5, CH-1700 Fribourg, Switzerland

(540)



(591) Red, brown, gray and black

(511)

33 – Alcoholic beverages (except beer); spirits; vodka; all the aforesaid goods of Polish origin.

(260) AM 2012 65585 A

(800) 565660

(731) COCHLEAR AG

Margarethenstrasse 47, CH-4053 BÂLE, Switzerland

(540)

NUCLEUS

(591) Black, white

(511)

10 – Medical apparatus for technical use and implants.

(260) AM 2012 65597 A

(800) 899904

(731) FRITZ EGGER GMBH & CO. OG

Weiberndorf 20, A-6380 St. Johann in Tirol, Austria

(540)

ZOOM

(591) Black, white

(511)

17 – Laminated plastics (semi-finished goods) for the laminating of chip boards and wood fiber boards.

19 – Building materials (non-metallic); laminated or non-laminated chip boards and wood fiber boards; laminated wood fiber panels; wooden

articles such as supports, boards, beams and pre-fabricated building materials for civil engineering, laminated floors, flat laminates; window sills.

20 – Furniture and parts for furniture made from wood fiber boards or chip boards such as work tops, fronts for furniture, panels as parts of furniture, edgings for furniture.

(260) AM 2012 65609 A

(800) 937719

(731) COMPAGNIE GERVAIS DANONE
17 boulevard Haussmann, F-75009 PARIS,
France

(540)

IMUNITASS

(591) Black, white

(511)

29 – Milk, milk powder, flavored jellified milks and whipped milk products; dairy products, namely: dairy desserts, yogurts, drinking yogurts, soft white cheese, beverages mainly consisting of milk or dairy products, milk beverages mainly consisting of milk, milk beverages containing fruits; plain or flavored fermented dairy products.

(260) AM 2012 65610 A

(800) 949598

(731) COMPAGNIE GERVAIS DANONE
17 boulevard Haussmann, F-75009 PARIS,
France

(540)



(591) Blue, red and white

(511)

29 – Milk, milk powder, flavored jellified milks and whipped milk products; dairy products, namely: dairy desserts, yogurts, drinking yogurts, soft white cheese, beverages mainly consisting of milk or dairy products, milk beverages mainly consisting of milk, milk beverages containing fruits; plain or flavored fermented dairy products.

30 – Coffee, tea, cocoa, chocolate, coffee-based beverages, cocoa-based beverages, chocolate-based beverages, sugar, rice, puffed rice, tapioca; flours, tarts and pies (sweet or savoury), pizzas; pasta (plain or flavoured and/or filled), cereal preparations, breakfast cereals; prepared dishes mainly containing pasta; prepared dishes essentially consisting of pastry; bread, rusks, biscuits (sweet or savoury), wafers, waffles, cakes, pastries; all these goods being plain and/or topped and/or filled and/or

flavoured; savoury or sweet cocktail snacks containing baking dough, biscuit mixture or pastry mixture; confectionery, edible ices, ice creams essentially made with yoghurt, ice-creams, sorbets (edible ices), frozen yoghurts (confectionery ices), flavoured frozen water; honey, salt, mustard, vinegar, sauces (condiments), sweet sauces, pasta sauces, spices.

(260) AM 2012 65611 A

(800) 966997

(731) Zakrytoe aktsionernoe obshchestvo
"PharmFirma "Sotex"
d. 11, pos. Belikovo, Selskoe poselenie
Bereznjakovskoe, Sergievo-Posadsky
municipalny rayon, RU-141345
Moscowskaya obl., Russian Federation

(540)

ЦЕПЕТОН

CERETONUM

(591) Black, white

(511)

5 – Pharmaceutical and veterinary preparations; sanitary preparations for medical purposes; dietetic substances adapted for medical use, food for babies; plasters, materials for dressings; material for stopping teeth, dental wax; disinfectants; preparations for destroying vermin; fungicides, herbicides.

(260) AM 2012 65612 A

(800) 969606

(731) THE NET-A-PORTER GROUP LIMITED
1 The Village Offices, Westfield, Ariel Way,
London W12 7GF, United Kingdom

(540)

NET-A-PORTER

(591) Black, white

(511)

35 – Retail services relating to clothing, headgear and footwear, jewellery, watches, fashion accessories, textiles, cosmetics, non-medicated toilet preparations, eye wear, carrying cases, leather goods, handbags and all manner of bags, the bringing together for the benefit of others of the aforesaid goods enabling customers to conveniently view and purchase such goods; the provision of retail services via a mail order catalogue for the aforesaid goods; the provision of on-line retail services from an Internet website for the aforesaid goods; the provision of retail services via a television channel for all the aforesaid goods; the provision of retail services via a telephone or mobile phone for all the aforesaid goods; the provision of retail services by way of direct marketing; the provision of infor-

mation and advice in relation to retail services; business management consultancy; provision of advice and assistance in the selection of goods; advertising for others.

(260) AM 2012 65613 A

(800) 973364

(731) Akzo Nobel N.V.

Velperweg 76, NL-6824 BM Arnhem,
Netherlands

(540)



(591) Black, white

(511)

1 – Chemical products for industrial, photographic and scientific purposes, as well as for agricultural, horticultural and forestry purposes; surfactants (surface active materials); synthetic resins as raw materials; detergents and cleaning materials for industrial use; emulsifiers; emulsifying agents, dispersants, solvents, wetting agents; chemical products for clarifying colors and dyes, for industrial use; bleaches, degreasers for use in manufacturing processes; grease removal preparations for use in manufacturing processes; chemical impregnating agents; chemical wetting agents; chemical preparations for oil pigments for industrial use; oil and water purification products; chemical reagents for use in the manufacture of chemical products and for use in scientific research; chemical products for waterproofing textiles excipients, bearers and substrates, not for medical applications, for industrial, agricultural, horticultural and forestry purposes; chemical materials, chemical compounds and mixtures, dispersants and suspensions for use in industry; silicone-based coatings, which are not paints or building materials; mineral oils for industrial use, for leather tanning and for conserving foodstuffs; glycerides, fatty acids, gelatin for industrial purposes; modified starch for use as a powder layer for manufacturing and packaging processes and procedures; polymers, including redispersible polymer powders; resistant starch for industrial use; synthetic resins and plastics as raw materials; glues and adhesives for industrial use and use in the building industry; adhesives, including adhesives for the edges and overlap strips and for repairing wallpaper and other wall coverings; wood hardening preparations; adhesives for preventing wheel bolts from coming loose; additives for glues and adhesives; blueprint paper; light sensitive paper; light sensitive films, but not exposed;

photographic paper and photometric paper; light sensitive plates; sensitizers; starch for industrial use; putty; salts (chemical products); sensitized paper to absorb ink for use with video printers.

2 – Paints, varnishes, lacquers; powder paints, timber coatings (paints); enamel paints and coil coatings; hardeners, drying agents (desiccants), thinners, dyes, all being additives for paints, varnishes and lacquers; preservatives against rust and against deterioration of wood; primers; wood stains; mastic; inks, printing ink pastes, stains; natural resins as raw materials, metals in sheet and powder form for painters, decorators, printers and artists, silicone-based coatings (paints).

3 – Bleaches; sugar soap; paint-removing soaps; preparations and compounds for removing moulds and deposits; compounds and mixtures for removing deposits (other than as part of manufacturing processes); paints and varnish removers; preparations for cleaning floor tiles, concrete, paving and natural stone; preparations and mixtures for removing sealants; polishes, degreasers and abrasives; starch; domestic cleaners.

5 – Disinfectants; biocides; mineral food supplements for human and veterinary use.

7 – Mixers; paint spraying equipment and paint spraying guns.

9 – Computer programs; computer software; data processing equipments; computer software for market research; computer databases, computer software for recording, monitoring, compiling, analyzing, designing and predicting consumer trends; electronic data input and output interface equipment for use with computers; electronic publications.

16 – Paper, cardboard; printed matter; printed publications on the finishing, decorations and furnishing of buildings; glues and adhesives of domestic and office use; frames photographs, writing materials, materials for artists; stickers, stencils, transfers and stencils for use in home decoration; office supplies (excluding furniture); brushes and other suchlike devices for applying paint, glues, sealants, oils included in this class; materials for painters, namely finishing and decorating tools for use when painting and tools for changing the appearance of wet paint layers; large and small paintbrushes; paint rollers; sponges for applying paint; palettes for painters; self-adhesive masking tape.

17 – Sealing, packing, filling and insulating material; materials and products for insulating roofs, doors and windows; resin-based materials for sealing wood and filling holes, cracks, splits and other imperfections; insulating varnishes; materials and compounds for thermal insulation; sealing agents; sealants for filling holes; plastics (intermediate products) in sheet, board and rod form for use in

manufacturing processes and for sealing packaging and insulation purposes; expanding foam; filler in the form of expanding foam for filling holes and cavities; sealing strips for doors and windows.

19 – Non-metallic building materials; cement and cement mixtures; cement and mortar for filling holes; non-metallic building materials for filling, repairing and touching up cracks, splits, cavities and other imperfections in walls, floors, ceilings and other surfaces; tile adhesive; mortar and plaster preparations; mortar for use as a coating; coatings in the form of plaster of Paris; silicone-based coatings (building materials).

30 – Salt.

37 – Building and construction; repair and maintenance; installation work.

40 – Treatment of materials; paint mixing services; coloring paints, varnishes, lacquers and stains; providing information and giving advice on mixing paints and on coloring paints, varnishes, lacquers and stains.

41 – Education and training; training and instruction; educational and training services in the areas of computers, computerization, computer programming, computer software, information technology, computer networks, the Internet, intranet, extranets and websites; production and publication of information relating to education in the above areas; education, instruction and training in the areas of selecting and designing (home) interiors, as well as in the area of color selection for paints, varnishes, lacquers and stains.

42 – Technological services; scientific and Industrial research; chemical analysis and research services, as well as relevant advice and technical information; technical research; technological and scientific research into the exploitation of natural, biological resources; information fashion and trends in the use and application of colors, paints, varnishes, lacquers and stains; technical and architectural advice on the selection of furnishing for homes and buildings and the selection of colors for paints, varnishes, lacquers and stains; professional, technical and technological consultancy on the analysis, selection, development and manufacture of chemical products and paints, varnishes, lacquers and stains; interior and exterior architecture and consultancy on such matters; design of computer software; designing of interiors, home furnishing, furniture, decorating, decor and color specification; industrial and graphic design.

(260) AM 2012 65614 A

(800) 1004033

(731) TERGAN DERİ ÜRÜNLERİ SANAYİ VE

TİCARET ANONİM ŞİRKETİ
Ayrancı Sanayi Sitesi Yaşar Doğu Sokak
No:8, BAYRAMPAŞA – İSTANBUL,
Turkey

(540)

TERGAN

(591) Black, white

(511)

18 – Leather and imitations of leather, and goods made of these materials and not included in other classes; animal skins, hides; trunks and travelling bags; umbrellas, parasols and walking sticks; whips, harness and saddlery.

25 – Clothing, footwear, headgear.

35 – Advertising; business management; business administration; office functions, bringing together, for the benefit of others, of a variety of goods (excluding the transport thereof), enabling customers to conveniently view and purchase those goods.

(260) AM 2012 65615 A

(800) 1041322

(731) GROUPE PSYCHOLOGIES

149 rue Anatole France, F-92300

LEVALLOIS PERRET, France

(540)



(591) Black, white

(511)

16 – Printed goods, printed matter, newspapers and periodicals, magazines, journals, books, printed publications, catalogs, prospectuses, albums, atlases; bookbinding material; photographs; stationery; writing or drawing books, notepads, note books; fountain pens and fountain pen cartridges, fountain pen holders, pencils, pencil sharpeners; drawing sets; staplers, staples; files, folders for documents; labels of cardboard; letter trays; bookends; adhesives for stationery or household purposes; stickers and transfers; artists' materials; paintbrushes; drawing pads; typewriters and office requisites (except furniture); instructional and teaching material (except apparatus); printers' type; printing blocks; articles of paper or cardboard, namely: calendars, agendas, poster-bills and posters, patterns for making

clothes, packaging of cardboard or of paper; plastic materials for packaging, namely bags and sachets.

(260) AM 2012 65616 A
(800) 1066490
(731) D.C.K. Concessions Limited
Porters House, Station Court, Radford Way,
Billericay CM12 0DZ, United Kingdom
(540)



(591) Rose
(511)
9 – Spectacles; sunglasses; spectacle cases.

14 – Imitation jewellery; jewellery; jewellery of precious metals and precious stones; earrings; bracelets; stud earrings; rings; finger rings; necklaces; chokers; body jewels; watches; watch cases; watch bracelets; parts of watches.

18 – Bags; cases, of leather or leatherboard; travelling bags; trunks; suitcases; handbags; purses; umbrellas; parasols.

25 – Belts; girdles.

26 – Hairdressers' wares, namely hair curling pins; hair bands; hair nets; hair fasteners; hair accessories; hair slides; Alice bands; bows for the hair; barrettes; clips for the hair; hair pins; hair extensions; hair ornaments.

(260) AM 2012 65617 A
(800) 1066873
(731) D.C.K. Concessions Limited
Porters House, Station Court, Radford Way,
Billericay CM12 0DZ, United Kingdom
(540)

DIVA

(591) Black, white
(511)
9 – Spectacles; sunglasses; spectacle cases.

14 – Imitation jewellery; jewellery; jewellery of precious metals and precious stones; earrings; bracelets; stud earrings; rings; finger rings; necklaces; chokers; body jewels; watches; watch cases; watch bracelets; parts of watches.

18 – Bags; cases, of leather or leatherboard; travelling bags; trunks; suitcases; handbags; purses; umbrellas; parasols.

25 – Belts; girdles.

26 – Hairdressers' wares, namely hair curling pins; hair bands; hair nets; hair fasteners; hair accessories; hair slides; Alice bands; bows for the hair; barrettes; clips for the hair; hair pins; hair extensions; hair ornaments.

(260) AM 2012 65618 A
(800) 1078031
(731) AMOR Gummiwaren GmbH
August-Rost-Str. 4, 99310 Arnstadt,
Germany
(540)



(591) Black, white
(511)
5 – Hygienic compounds for medical purposes; lubricants and massage fluid for medical purposes, as far as included in this class.

28 – Games, toys, accessories for erotic partner-games, as far as included in this class.

(260) AM 2012 65619 A
(800) 1082092
(731) VICENTE GANDIA PLÁ, S.A.
Ctra. Cheste a Godella, s/n, E-46370
CHIVA (VALENCIA), Spain
(540)

RAIZA

(591) Black, white
(511)
33 – Alcoholic beverages (except beers), especially wines and sparkling wines.

(260) AM 2012 65620 A
(800) 1088412
(731) HAYAT KİMYA SANAYİ ANONİM
ŞİRKETİ
Mahir İz Caddesi No: 23, Altunizade
İSTANBUL, Turkey
(540)



(591) Blue, dark blue, white
(511)
3 – Cleaning preparations for laundry use, dishwashing and household cleaning preparations, laundry bleach, laundry starch, washing soda for cleaning, laundry blue, gelatinous soaps, laundry polishing

products, laundry whiteners, anti-lime substances, granulated soap, anti lime scales; soaps, liquid hand soaps, mechanics cleansing powders, cream cleansing products, glass cleaning substances, floor and carpet cleaning substances, scouring and polishing preparations, dishwasher salts and brighteners, drain cleaners, toilet cleaner automatic dishwashing machine detergents (powder, gel and compact), dishwashing machine salts and polishers, home cleaning substances, namely cleaning products for general purposes, general cleaning liquids and powders, droplight cleaners, oven cleaners, furniture cleaners and polishers, perfumes, volatile oils (essential oils), Cologne, lotions, deodorants, eau de Cologne, eau de parfum, eau de toilette, after shaves, rose waters, antiperspirants for personal use, shaving lotions, shaving cream, shaving foam, shaving soaps, shaving Cologne, shaving lotions, after shave creams, balsam and lotions, hair care substances, hair creams, hair lotions, hair gel, hair nourishers, hair spray, hair dyes, brilliantine, shampoos, shampoos with cream, dandruff shampoo, hair foam, spray gels, bath foam, bath salts, bath milk, bath oil, shower gels, liquid body shampoo, petroleum jelly; baby care products, baby shampoo, baby shampoos with cream, baby lotions, baby oils and gels, baby rash creams, baby powders, baby soaps, tissues impregnated with cosmetic lotions for babies, tissues impregnated with cosmetic lotions, baby detergents and soaps, baby laundry softeners, baby laundry whiteners, stain remover and whitening preparations for baby clothes, laundry fragrance for baby clothes, natural substances for producing cosmetic and perfumery products and soaps, preparations for body and beauty care, face and skin cleaners, cleansing milks, tonics, moisturizers, creams, face-packs, self-tanning creams, anti-wrinkle creams, make-up removers, hand, face and body lotions, milks, powders, sun creams, oils and milks, after sun moisturizing creams and gels, foundation, powder, blushers, eye shadow, mascara, eye brow dye, rouge, lip polish, lipsticks, lip moisturizers, skin care creams, nail polish, nail varnish, nail polish removers, nail hardeners, nail nourishers, lip, eye-brow and eye liner, epilating wax, depilators, depilatory creams, henna; slimming cosmetic products; cellulite creams, skin firming creams for cosmetic purposes, cosmetic sets, teeth care products; toothpaste, tooth cleansing powders, dental wash, mouthwash for non-medical use, cleaning preparations for dentures, anti tartar toothpaste, mouth spray, mouth care water, tooth cleansing and polishing products, papers using for cosmetic purposes, cotton, cosmetic preparations, tissues soaked with cosmetic substances, cottony swabs, ear cleaning swabs, wet tissues impregnated with cosmetic lotions, cotton and papers for removing make-up; polishes; polishes for leather-wear, polishes for floors; make-up remover wipes.

5 – Hygienic products: hygienic products for body secretions including those used for incontinent patients and menstruations, namely pads, tampons, diapers, panties; odor repellents for rooms, vehicles and other places, air fresheners, deodorants other than for personal use; disinfectants, antiseptics (bacteria killers), detergents for medical purposes, tissues impregnated with anti-bacterial property for babies, glycerine for medical purposes; toilet disinfectants.

16 – Paper towels, napkins, toilet papers, handkerchiefs, baby diapers; babies' bibs of paper, paper tablecloths, place mats, glass and plate coasters; paper products for decoration purposes.

(260) AM 2012 65621 A

(800) 1099658

(731) KIRAÇ METAL ÜRÜNLERİ SANAYİ VE TİCARET LİMİTED ŞİRKETİ

Organize Sanayi Bölgesi Şehitler Blv. NO:21, ESKİŞEHİR, Turkey

(540)

 INNOVATRAY

(591) Black, white

(511)

6 – Ores of metal, namely, zinc ores, iron ores, lead ores, manganese ores, chrome ores, common metals, unwrought and semi-worked, for further manufacture, namely, irons and steels, nickel, tin and its alloys, zinc based alloys, copper based alloys, iron alloys, lead-tin alloys, aluminum and its alloys; steel plates and sheets, cast iron for use in building; steel frames for building, metal cladding for construction and building, metal building materials, portable metal buildings, metal floors, metal staircases, portable metal staircases; non-electric cables, metal cable wire, metal rods for brazing and welding; metal hardware, namely, screws, nails, bolts, nuts, metal pins for use in mounting insects, metal chains, pulley; ducts of metal for ventilating and air conditioning and heating installations; boards of metal, namely, advertising boards, wall boards of metal; metal license plates, non-luminous and non-mechanical metal road signs, loading and unloading pallets of metal; metal pipes for liquid and gas transfer, metal pipe couplings and joints, metal pipe collars, metal junctions for pipes, metal pipe mufflers, elbows of metal for pipes, metal valves other than parts of machines, metal taps for casks; materials of metal for railway construction, metal rails, metal railway crossovers; metallic molds for metal casting; works of art of common metal, sculptures made of non-precious metal, statuettes of non-precious metal, monuments of non-precious metal, busts of non-precious metal, metal bottle caps; poles of metal, for electric lines, telegraph poles of metal,

metal fence posts; metal ropes, belts of metal for handling loads, loading and unloading pallets of metal, tow ropes of metal.

9 – Scientific, nautical, surveying, photographic, cinematographic, optical, weighing, measuring, signaling, checking (supervision), apparatus for recording, transmission or reproduction of sound and images, radios, television receivers; vending machines, ticket vending machines, cash dispensers; electronic devices used in machines and devices: electronic semi-conductors, electronic integrated circuits, electronic chips for the manufacture of integrated circuits, light switches (light sensors); electric meters, water meters, gas meters, parking meters, timers, lifesaving apparatus (namely, flotation vests, life jackets and life nets); eyeglasses, sunglasses, contact lenses and their containers, eyeglass cases; electric plugs, electric sockets, electric junction boxes, electric switches, circuit breakers, electrical fuses, lighting ballasts; electronic controller panel, to manage the power, electric connectors and sockets; adaptors for use with portable electronic devices and battery chargers, electric wires and cables, fiber optic cables used in electrics, electronics and telephone lines, power supplies (electrical), accumulators (batteries), solar cells; electric door bells, alarms other than vehicle alarms, namely, burglar alarms, fire alarms; irons, namely, electric and steam irons; warning triangles to indicate vehicle breakdowns, reflectors for traffic signals; fire engines, fire extinguishers; welding electrodes, welding helmets, welding masks, electric welding torches; electric devices for attracting and killing insects; automatic controllers for revolving doors, automatic turnstiles, remote controls for opening and closing vehicle doors; anodes, electrolysis apparatus for electroplating purposes and galvanizing machines.

(260) AM 2012 65622 A

(800) 1099683

(731) SOCIÉTÉ AIR FRANCE

45, rue de Paris, F-95747 ROISSY-CHARLES-DE-GAULLE, France

(540)



(591) Black, white

(511)

18 – Collars for animals, hat boxes of leather, leather or leatherboard boxes and cases, vulcanized fiber boxes and cases, purses, walking sticks, walking-stick seats, school bags, card cases (wallets), key cases (leatherware), traveling trunks, vanity ca-

ses (not fitted), attaché cases, school bags, school satchels, sling bags for carrying infants, umbrella covers, clothing for animals, leather leashes, trunks, suitcases, business cases, purses not of precious metal, muzzles, parasols, umbrellas, sun umbrellas, empty tool bags, rucksacks, handbags, shopping bags, wheeled bags, beach bags, traveling bags, packaging bags (envelopes, pouches) of leather, garment bags for travel, briefcases, valises, traveling sets (leather goods), cabin sets, sports bags other than those acting as cases for sports articles.

35 – Advertising, advertising by mail order, radio advertising, television advertising, advertising via the Internet, intranets and extranets, business management, business administration, office functions, marketing and promotion services for airlines, services for subscribing to newspapers, magazines, reviews, periodicals or newsletters (for third parties), business management and organization consultancy, professional business consulting, efficiency experts, business information, business inquiries, outdoor advertising, business appraisals, commercial information agencies, cost price analysis, dissemination of advertising matter, rental of office machines and apparatus, transcription of communications, accounting, personnel management consultancy, personnel recruitment, advertising mailing, distribution and dissemination of advertising materials (leaflets, prospectuses, printed matter, samples), commercial or industrial management assistance, updating of advertising material, document reproduction, organization of exhibitions for commercial and advertising purposes, organisation of competitions (advertising or sales promotions), data compilation and systemization into computer databases, computerized file management, computerized file management especially on the Internet, or extranet or intranet networks, database management on the Internet, or extranet or intranet networks, rental of advertising space, opinion polling, projects (assistance to business management), sales promotion (for others), publication of advertising texts, public relations, drawing up of statements of accounts, secretarial services, statistical information, auditing, management of promotional bonuses, customer and staff loyalty programs through promotional or advertising activities, services to manage a loyalty program in the air transport sector, placing and reception of orders for goods and services via the Internet, intranets and extranets, auctioneering especially on the Internet, or extranet or intranet networks, shop-window dressing, demonstration of goods, marketing studies, market research, economic forecasts, services of models for advertising purposes or sales promotion, retail sale of transport tickets, plane tickets, travel tickets, reservations for hotel rooms, places or tables in restaurants or reservations for motor vehicles espe-

cially via Internet networks, intranets or extranets, administrative or business management of loyalty points or vouchers in customer loyalty programmes, business information, advertising and sales promotion services for others through the management of commercial Internet sites, retail sales services for food products, perfumes, cosmetics, jewels, luggage, luggage labels, leather goods, watches, timepieces, spectacles, clothing, footwear, headgear, table or bath linen, writing articles, writing instruments, office articles, games, toys, photographic equipment, apparatus for transmitting data, sound and/or images, data storage media, razors, current adapters, umbrellas, parasols, tableware, candles, printed matter, stationery, tobacco and articles for smokers; services involving telephone answering services; representation of airlines and of car rental companies.

39 – Transportation, packing and storage of goods, transportation of passengers, transportation of travelers, animal transport, arrangement of tours, escorting of travelers, air hostess services (escort of travelers), air transportation, air transportation, freighting, tourist offices (except for hotel and boarding-house reservation), travel agency services, bus or coach services, car transport, chauffeur services, parcel delivery, packaging of goods, message delivery, delivery of newspapers, magazines, pamphlets or safety instructions in airports or on board aeroplanes, storage of goods, distribution (delivery) of luggage, meals, beverages, goods, merchandise, wrapping of goods, storage information, arranging of tours, freight forwarding services, freight (shipping of goods), transport, travel or vehicle rental information, information on transporting passengers, goods and animals, vehicle rental, courier services (messages or merchandise), car parking, reservation of travel tickets, transport documents or air tickets, storage, taxi transport, sightseeing, freight forwarding, transport reservation, reservations for the transport of passengers, goods and animals, reservations for travel and for vehicle rental, guarded transport of valuables, car shuttle services, luggage, goods and passenger check-in services, loading and unloading of aircraft, provision of aircraft, mass passenger transit, assistance in case of vehicle breakdown (towing), automobile rental, rental of storage containers, freight brokerage, transportation brokerage, rental of warehouses, garages, rental of wheelchairs, providing wheelchairs for passengers in airports, parking space rental, piloting, salvaging, rescue operations (transport), loan, rental and provision of air vehicles or airplanes, professional consulting in the air transport sector, delivery of food products, beverages, meals or meal trays, uploading and unloading cargo on board aeroplanes for the equipment of aircraft cabins, cockpits and holds, handling of baggage and goods especially in airports, handling (loading/unloading) of access ramps

or steps, organizing transfers and transits of passengers, crews, flight personnel or luggage from one airport or aircraft to another airport or aircraft, distribution of energy especially on board aeroplanes.

(260) AM 2012 65624 A
 (800) 1099697
 (731) UPSUN INDUSTRIAL GROUP CO., LTD.
 1-5, No.97 Yueyi Road, 1-5, No.132
 Mingyang Road, Yuecheng Town, Yueqing
 City, Zhejiang Province, China
 (540)

UPSUN

(591) Black, white
 (511)
 9 – Converters, electric; switches, electric; relays, electric; circuit breakers; sockets, plugs and other contacts (electric connections); distribution boxes (electricity); semiconductors; remote control apparatus.

(260) AM 2012 65628 A
 (800) 1099715
 (731) Tine SA
 Dronning Eufemias gate 6, N-0191 Oslo,
 Norway
 (540)



(591) Red, yellow, blue
 (511)
 29 – Milk and milk products; cheese; dairy products; edible oils and fats.

(260) AM 2012 65629 A
 (800) 1099725
 (731) Gem International Anstalt c/o Feger
 Treuunternehmen reg
 Heiligkreuz 40, FL-9490 Vaduz,
 Liechtenstein
 (540)

MORELLI ' S

(591) Black, white
 (511)
 43 – Café and coffee bar services; food and drink preparation services; food and drink takeaway services.

(260) AM 2012 65630 A
 (800) 1099738
 (731) RHODIA OPERATIONS
 40 rue de la Haie-Coq, F-93306
 AUBERVILLIERS, France
 (540)

RHOVEA

(591) Black, white
 (511)
 1 – Industrial chemicals; chemicals used in perfumery, cosmetics, additives and plastics industries; active and intermediary agents for synthetic purposes used in perfumery, cosmetics, additives and plastics industries; chemicals containing vanillin used in perfumery, cosmetics, additives and plastics industries.

5 – Chemicals products used in pharmaceutical products industries; active and intermediary agents for synthetic purposes used in pharmaceutical products industries; chemicals containing vanillin used in pharmaceutical products industries.

(260) AM 2012 65631 A
 (800) 1099743
 (731) TM Investment Sp. z o.o.
 Brzeznica 18, PL-39-207 Brzeznica,
 Poland
 (540)

BESTON

(591) Black, white
 (511)
 1 – Chemical preparations for dyeing enamel and glass, chemical products for the manufacture of dyes, chemicals for color vibrancy for industrial purposes, adhesives for industrial purposes, adhesives for wallpaper, wall tile, for posters, for footwear, preservatives for cement, bricks, tiles and walls (except paints and oils), solvents for paints; putty.

2 – Anti-corrosion agents for mortar cement, varnishes and enamels, wood preservatives, paints, watercolors paints, bactericidal, fireproof and anti-pollution paint; enamel paints used in ceramics; metal foils for painters, shoe dyes, corrosion inhibitor to metals, anti-rust greases and oils, paint thinners and varnishes, fixatives, thickeners for paints and dyes.

17 – Insulating paints, oils and varnishes, insulating tapes, insulating mortar and putty, sealing materials.

19 – Plaster, insulation systems (building parts) for external walls of buildings, non-metallic building materials including building boards.

(260) AM 2012 65632 A
 (800) 1099800
 (731) Obshchestvo s ogranichennoy
 otvetstvennostyu "E.M.M."
 d. 1, per. Chernyshevskogo, RU-127473
 Moscow, Russian Federation
 (540)



(591) Black, white
 (511)
 12 – Vehicles; apparatus for locomotion by land, air or water.

(260) AM 2012 65633 A
 (800) 1099809
 (731) CELGENE CORPORATION
 86 Morris Avenue, Summit, NJ 07901, USA
 (540)



(591) Green, orange, gold and blue
 (511)
 5 – Pharmaceutical preparations, namely, cytokine inhibitory drugs; pharmaceutical preparations that modulate the immune system; pharmaceutical preparations for the treatment of certain cancers and blood diseases and printed dosage instructional manuals sold together as a unit.

(260) AM 2012 65634 A
 (800) 1099810
 (731) CELGENE CORPORATION
 86 Morris Avenue, Summit, NJ 07901, USA
 (540)



(591) Blue and gold
 (511)
 5 – Pharmaceutical preparations for the treatment of blood disease and cancer and printed dosage instructional manuals sold together as a unit.

(260) AM 2012 65636 A
 (800) 1099838
 (731) Kioto Clear Energy AG
 Solarstr. 1, A-9300 St. Veit/Glan-
 Industriepark, Austria

(540)

(591) Red and black
(511)

11 – Heating systems using alternative types of energy; heating, ventilating, water supply and sanitary apparatus and installations; water heaters and storage water heaters, heat accumulators; collectors using solar energy; solar heating systems.

(260) AM 2012 65637 A

(800) 1099856

(731) Heber Biotec, S.A. (Consejo de Stado)
Calle 186 esquina a 31, Cubanacán,
Municipio Playa, Provincia Ciudad de la
Habana, Cuba

(540)

HEBERPROT-P

(591) Black, white

(511)

5 – Pharmaceutical products; dietetic, veterinary and sanitary substances; food for babies; plasters, materials for dressings; disinfectants; fungicides, herbicides.

(260) AM 2012 65839 A

(800) 1102011

(731) Obshchestvo s ogranichennoy
otvetstvennostyu "RUSINVEST"
Novomytishchenskiy prospekt, 41, korp. 1,
Mytishchi, RU-141018 Moskovskaya Oblast,
Russian Federation

(540)



(591) Black, white

(511)

33 – Aperitifs; brandy; wine; piquette; whisky; vodka; gin; digesters [liqueurs and spirits]; cocktails; liqueurs; alcoholic beverages, except beer; alcoholic beverages containing fruit; spirits [beverages]; distilled beverages; mead [hydromel]; peppermint liqueurs; bitters; rum; sake; cider; rice alcohol;

alcoholic extracts; fruit extracts, alcoholic; alcoholic essences.

(260) AM 2012 65840 A

(800) 1102013

(731) MIDAC S.P.A

Via A. Volta, 2, I-37038 Soave (VR), Italy

(540)



(591) Black, white

(511)

9 – Batteries; Storage batteries.

(260) AM 2012 65841 A

(800) 1102035

(731) ASTELLAS PHARMA INC.

3-11, Nihonbashi-Honcho 2-chome, Chuo-ku, Tokyo 103-8411, Japan

(540)



(591) Red and gray

(511)

36 – Providing grants to patients and their families for improving their quality of life; providing grants to medical research organizations and business associations in support of scientific, medical and business meetings and workshops; providing grants to educational institutions and research organizations in support of educating the public about medical issues; providing grants for the supporting of programs and activities that work towards the advancement of healthier societies; providing grants for basic scientific research; providing grants for the examination of public health; providing grants for the examination of environmental policy issues; providing grants for the support of educational and cultural exchange program; providing grants for other purposes.

(260) AM 2012 65842 A

(800) 1102068

(731) APT INTERNATIONAL Ko, LIMITED

Rm 804, Sino Center, 582-592 Natan rd, Kin, Hong Kong, China

(540)



(591) Black, white

(511)

7 – Bearings [parts of machines]; ball rings for bearings; bearing brackets for machines; anti-friction bearings for machines; roller bearings; self-oiling bearings; bearings for transmission shafts; ball-bearings; journal boxes [parts of machines].

35 – Marketing studies; marketing research; import-export agencies; commercial information agencies; sales promotion for others; commercial or industrial management assistance; demonstration of goods; organization of exhibitions and trade fairs for commercial or advertising purposes; procurement services for others [purchasing goods and services for other businesses].

(260) AM 2012 65877 A

(800) 1102337

(731) Harbin Pharm Group Sanjing Pharmaceutical Co., Ltd.
No. 76, Hengshan Road, Nangang District
Harbin, China

(540)



(591) Black, white

(511)

5 – Opodeldoc; pharmaceutical preparations for treating dandruff; medicines for human purposes; germicides; biochemical drugs; disinfectants for hygiene purposes; medicines for dental purposes; medicinal drinks; iodides for pharmaceutical purposes; dietetic substances adapted for medical use; active pharmaceutical ingredients, namely pharmaceutical preparations and substances.

30 – Tea substitute; chicken extract of worm grass, namely, flavourings, other than essential oils (terms considered too vague by the International Bureau – rule 13.2.b) of the Common Regulations); royal jelly for human consumption, not for medical purposes; non-medical nutrition liquids, namely, herbal food beverages (terms considered too vague by the International Bureau – rule 13.2.b) of the Common Regulations); non-medical nutrition grease, namely, autumn pear grease (terms considered too vague by the International Bureau – rule 13.2.b) of the Common Regulations); molasses for food; propolis (bee glue) for human consumption.

32 – Non-alcoholic fruit extracts; waters (beverages); vegetable juices (beverages); fruit nectars, non-alcoholic; preparations for making beverages; aerated water; aperitifs, non-alcoholic; lactic acid beverages (fruit products, non-dairy); cocktails, non-alcoholic; non-alcoholic beverages flavored with tea.

(260) AM 2012 65878 A

(800) 1102339

(731) TG OTELCILIK INSAAT VE TURIZM
ISLETMECILIGI ANONIM SIRKETI
Kayi Plaza Guzeloba Mahallesi, Ay-1 Sokak
No:1 Kat:4, Antalya, Turkey

(540)



(591) Dark blue, white, red, green

(511)

39 – Overland, air and maritime transporting services: transport brokerage services, cargo brokerage services, ship agency services, ambulance services, private chauffeur services, piloting services, tourist offices (except hotel reservations), travel reservation services, tour arranging services, message and good courier services, messages delivery services, goods delivery services, services of distributing goods via mail, product carriage and delivery services, newspaper distribution services, package delivery services.

41 – Symposium, lecture, conference and seminar organization and conducting services, magazine, book, newspaper publishing services, organization of sports events and competitions; entertainment services; services related to art activities: services of providing cinema activities, theatre services, orchestra services, concert arrangement services, show arrangement services, reservation services for shows, modeling services for artists, rental services for stage and show decorations.

43 – Services of supplying food and beverages: restaurant services, self-service restaurant services, eating house services, cafeteria services, cafe services, canteen services, cocktail lounge services, snack-bar services, bar services, catering services, services of leasing food and beverage service vehicles; temporary accommodation services: hotel, motel, hostel, holiday village, guest housing, tent leasing services, youth camping services, reservation services.

(260) AM 2012 65879 A
 (800) 1102369
 (731) B.R.
 32 avenue des Champs Elysées, F-75008
 PARIS, France

(540)



(591) Blue, white, yellow
 (511)

3 – Soap, perfumery goods, essential oils, cosmetics, cosmetic creams for facial and body skin care, hair lotions, shampoos, dentifrices, incense, deodorants for personal use (perfumery); cosmetic preparations for slimming purposes; cosmetic preparations for toning purposes; make-up removing preparations; beauty masks, except wipes; shaving preparations, after-shave lotions, tissues impregnated with cosmetic lotions, nail care preparations.

(260) AM 2012 65889 A
 (800) 1102475
 (731) GREE, INC.

10-1, Roppongi 6-chome, Minato-ku, Tokyo
 106-6112, Japan

(540)



(591) Black, white
 (511)

36 – Electronic fund transfer; issue of tokens of value.

38 – Telecommunication services provided via electronic bulletin board; telecommunication services provided via mobile phones; telecommunication services provided via computers.

45 – Provision of personal information including profiles and diaries on an electronic bulletin board on the Internet; providing information on finding and introducing friends via the Internet Websites; providing geographical map information including providing geographical map information via the Internet and email; providing fashion information; providing information on newspaper articles; marriage partner introduction or dating services.

(260) AM 2012 65890 A
 (800) 1102485
 (731) Peter Thum

31 Union Square West, 6D, New York NY
 10003, USA

(540)



(591) Black, white
 (511)

14 – Jewelry; watches.

18 – Leather handbags; luggage.

25 – Men's apparel, namely, blazers, belts, boots, hats, jackets, jeans, overcoats, pants, raincoats, scarves, shorts, shoes, socks, suits, sweaters, ties, tuxedos, vests; women's apparel, namely, blazers, blouses, belts, boots, coats, dresses, hats, jackets, jeans, raincoats, scarves, shorts, skirts, overcoats, pants, shoes, socks, stockings, suits, sweaters and vests.

(260) AM 2012 65895 A
 (800) 1102655

(731) Soluzioni Informatiche SRL
 Viale Giuseppe Mazzini, 6, I-00195 Roma,
 Italy

(540)



(591) Black, white
 (511)

41 – Education; providing of training; entertainment; sporting and cultural activities.

42 – Scientific and technological services and research and design relating thereto; industrial analysis and research services; design and development of computer hardware and software.

(260) AM 2012 65896 A
 (800) 1102678

(731) VOROLA FINANCIAL LTD
 33 Porter Road, P.O. Box 3169, PMB 103,
 Road Town, British Virgin Islands

(540)



(591) Black, white
 (511)

14 – Precious metals and their alloys and goods in precious metals or coated therewith, not included in other classes; jewellery, precious stones; horological and chronometric instruments.

18 – Leather and imitations of leather, and goods made of these materials and not included in other classes; animal skins, hides; trunks and travelling bags; umbrellas, parasols and walking sticks; whips, harness and saddlery.

25 – Clothing, footwear, headgear.

35 – Presentation of goods on communication media, for retail purposes; sales promotion for others; procurement services for others [purchasing goods and services for other businesses].

(260) AM 2012 65897 A

(800) 1102679

(731) VOROLA FINANCIAL LTD

33 Porter Road, P.O. Box 3169, PMB 103,
Road Town, British Virgin Islands

(540)



(591) Black, white

(511)

14 – Precious metals and their alloys and goods in precious metals or coated therewith, not included in other classes; jewellery, precious stones; horological and chronometric instruments.

18 – Leather and imitations of leather, and goods made of these materials and not included in other classes; animal skins, hides; trunks and travelling bags; umbrellas, parasols and walking sticks; whips, harness and saddlery.

25 – Clothing, footwear, headgear.

35 – Presentation of goods on communication media, for retail purposes; sales promotion for others; procurement services for others [purchasing goods and services for other businesses].

(260) AM 2012 65996 A

(800) 1103299

(731) Obshchestvo s ogranichennoy

otvetstvennostiyu "Upravlyauzshchaya
kompaniya seti salonov "PALCHIKI"
ulitsa Staraya Basmannaya, 25, RU-105066
Moscow, Russian Federation

(540)



(591) Rose, white

(511)

3 – Cotton wool for cosmetic purposes; cotton sticks for cosmetic purposes; greases for cosmetic

purposes; perfumery; decorative transfers for cosmetic purposes; cosmetic dyes; nail polish; lotions for cosmetic purposes; oils for cosmetic purposes; oils for toilet purposes; essential oils; oils for cleaning purposes; adhesives for cosmetic purposes; medicated soap; cosmetic kits; false nails; toiletries; lacquer-removing preparations; nail care preparations; tissues impregnated with cosmetic lotions; antiperspirants; talcum powder, for toilet use.

16 – Booklets ; calendars; catalogues; printed matter; prospectuses; bags of paper or plastics for packaging.

35 – Organization of exhibitions for commercial or advertising purposes; organization of trade fairs for commercial or advertising purposes; sales promotion for others; modelling for advertising or sales promotion.

44 – Beauty salons; manicuring; massage; visagists' services; tattooing; plastic surgery.

(260) AM 2012 66053 A

(800) 1103610

(731) AUDI AG

85057 Ingolstadt, Germany

(540)



Audi

(591) Black, white

(511)

12 – Vehicles and their constructive parts; apparatus for locomotion by land, air or water.

35 – Advertising; business management; business administration; office functions.

37 – Building construction; repair, namely repair for vehicles; installation services.

(260) AM 2012 66054 A

(800) 1103611

(731) AUDI AG; 85057 Ingolstadt, Germany

(540)

Audi 
Vorsprung durch Technik

(591) Black, white

(511) 1

2 – Vehicles and their constructive parts; apparatus for locomotion by land, air or water.

35 – Advertising; business management; business administration; office functions.

37 – Building construction; repair, namely repair for vehicles; installation services.

(260) AM 2012 66055 A
 (800) 1103613
 (731) HENKEL AG & CO. KGAA
 Henkelstraße 6, 40589 Düsseldorf, Germany
 (540)



(591) Green, red, blue, black and white
 (511)
 16 – Adhesives for stationery and household purposes.

(260) AM 2012 66062 A
 (800) 1103614
 (731) Henkel AG & Co. KgaA
 Henkelstraße 67, 40589 Düsseldorf,
 Germany
 (540)



(591) Green, red, black and white
 (511)
 16 – Adhesives for stationery and household purposes.

(260) AM 2012 66064 A
 (800) 1103618
 (731) OTKRITIE Financial Corporation JSC
 2, bldg. 4, Letnikovskaya str, RU-115114
 Moscow, Russian Federation
 (540)



(591) Blue, white
 (511)
 35 – advertising; business management; business administration; office functions; arranging subscriptions to telecommunication services for others; import-export agencies; commercial information agencies; advertising agencies; cost price analysis; rental of advertising space; auditing; employment

agencies; computerized file management; accounting; invoicing; demonstration of goods; transcription; opinion polling; marketing studies; business information; commercial information and advice for consumers; business investigations, business research; marketing research; personnel recruitment; business management and organization consultancy; personnel management consultancy; business organization consultancy; business management consultancy; professional business consultancy; layout services for advertising purposes; business management of performing artists; news clipping services; updating of advertising material; word processing; secretarial services; shorthand; organization of exhibitions for commercial or advertising purposes; arranging newspaper subscriptions for others; organization of trade fairs for commercial or advertising purposes; shop window dressing; business appraisals; evaluation of standing timber; evaluation of wool; payroll preparation; data search in computer files for others; sponsorship search; business management assistance; commercial or industrial management assistance; presentation of goods on communication media, for retail purposes; economic forecasting; auctioneering; sales promotion for others; office machines and equipment rental; rental of advertising time on communication media; publicity material rental; rental of vending machines; rental of photocopying machines; publication of publicity texts; typing; radio advertising; bill-posting, outdoor advertising; distribution of samples; direct mail advertising, dissemination of advertising matter; writing of publicity texts; on-line advertising on a computer network; advertising by mail order; television advertising, television commercials; document reproduction; compilation of statistics; compilation of information into computer databases; business inquiries; systemization of information into computer databases; tax preparation; drawing up of statements of accounts; publicity columns preparation; psychological testing for the selection of personnel; business management of hotels; commercial administration of the licensing of the goods and services of others; administrative processing of purchase orders; public relations; modelling for advertising or sales promotion; relocation services for businesses; price comparison services; procurement services for others (purchasing goods and services for other businesses); outsourcing services; telephone answering for unavailable subscribers; photocopying; efficiency experts.

36 – financial affairs; monetary affairs; real estate affairs; credit bureaux; debt collection agencies; real estate agencies; customs brokerage; financial analysis; leasing of farms; hire-purchase financing, lease-purchase financing; savings banks; accommodation bureaux; rent collection; issuing of travellers' checks; issuance of credit cards; issue of tokens of

value; capital investments, fund investments; insurance information; financial information; clearing, financial; insurance consultancy; financial consultancy; stock exchange quotations; business liquidation services, financial; brokerage; financial management; exchanging money; debit card services; credit card services; home banking; factoring; organization of collections; antique appraisal; jewellery appraisal; stamp appraisal; real estate appraisal; numismatic appraisal; art appraisal; financial evaluation (insurance, banking, real estate); repair costs evaluation; electronic funds transfer; bail-bonding, guarantees; securities brokerage, stocks and bonds brokerage; housing agents, real estate brokers; insurance brokerage; loans; lending against security; check (cheque) verification; charitable fund raising; leasing of real estate; rental of offices (real estate); renting of apartments; financial sponsorship; mortgage banking; instalment loans; insurance; apartment house management; real estate management; actuarial services; banking; retirement payment services; fiduciary, trusteeship; mutual funds; financing services; safe deposit services; deposits of valuables; fiscal assessments.

(260) AM 2012 66065 A

(800) 1103631

(731) HOLDHAM

9 rue Guyon de Gercheville, F-14200
Hérouville-Saint-Clair, France

(540)

**OPTIK
PAPER** 

Feel the difference

(591) Black, white

(511)

16 – Paper, pads of paper, indexes, writing pads, writing or drawing books, note books, sheets of paper in all formats, planners.

(260) AM 2012 66066 A

(800) 1103674

(731) Obshchestvo s ogranichennoy

otvetstvennostju "InterTech"

per. Garazhny, 4, off. 201, RU-680014

KHABAROVSK, Russian Federation

(540)

INTERTECH

(591) Black, white

(511)

3 – Abrasive preparations and materials.

7 – Electric and pneumatic tools for construction and renovation, including screwdrivers, wrenches, machines for polishing; perforators; jigsaw (power tool); circular saws; milling machines, chainsaws, planing machines, electric drills; painting machines; woodworking machines (electric and pneumatic), metal-working tools, stone-working tools; winches; compressors [machines]; woodworking machines, including saws machines, smooth planing machines, electric planers, contour band saw machine, scroll saw, lathes [machine tools]; stone working machines and machines for cutting stone; metalworking machines, die-cutting and tapping machines; milling machines, drilling machines; machines for cutting metal; vacuum cleaner for construction work; welding machines, inverter welding machines, semi-automatic welding machines; generators of electricity; gasoline chain saws; electric and gasoline trimmers [machines]; saw blades [parts of machines]; milling cutter [parts of machines]; drilling bits.

8 – Hand tools and implements (hand-operated); cutlery; side arms; razors; spanner [hand tools]; reversible handles [hand tools]; ends for reversible handles; connectors and adapters for reversible handles; hacksaw blades for metal and wood; screwdrivers; combination cutting pliers; wire cutter; pliers; scissors; bolt cutter; vices; knives; hammers [hand tools]; sledgehammers; mallets [hand instruments]; axes; mortise chisels; files [tools]; needle files; tap wrenches; finishing tool, including dings, floats, palette knives, straightener; cutters for tile [hand tools]; tube cutters [hand tools]; riveting hammers [hand tools]; guns, hand-operated, for hermetics and foams; borers for perforating tools and drills; drill holders [hand tools]; saw blades [parts of hand tools]; lifting jacks, hand operated; glass cutters, hand operated.

12 – Vehicles; apparatus for locomotion by land, air or water, including wheelbarrows.

17 – Rubber, gutta-percha, gum, asbestos, mica and goods made from these materials and not included in other classes; plastics in extruded form for use in manufacture; packing, stopping and insulating materials; flexible pipes, not of metal.

20 – Goods (not included in other classes) of plastics, including plastic boxes for tools.

21 – Brushes, including metal brushes.

(260) AM 2012 66069 A

(800) 1103692

(731) YAN CHENG HUA SHENG BIAN YA QI

ZHI ZAO YOU XIAN GONG SI

Longcheng Road, Yanlong Street, Yandu

District, Yancheng City, 224000 Jiangsu,

China

(540)



(591) Black, white

(511)

9 – Converters, electric; distribution boxes (electricity); distribution boards (electricity); high and low voltage switch board; distribution consoles (electricity); voltage regulators; current rectifiers; connectors (electricity); high voltage explosion protection device; power station automatization equipment.

(260) AM 2012 66074 A

(800) 1103732

(731) Toruńskie Zakłady Materiałów
Opatunkowych, Spółka Akcyjna
Żółkiewskiego 20/26, PL-87-100 Toruń,
Poland

(540)



(591) Black, white

(511)

5 – Sanitary towels, panty liners.

(260) AM 2012 66141 A

(800) 1104131

(731) ZHANG DELONG
Rm.4A 25, B Building, Ritan International
Trade Center, No. 17 Ritan North Road,
Chaoyang District, Beijing, China

(540)

**CITY CLASS**

(591) Black, white

(511)

25 – Shirts; dresses; fur clothing; imitation leather clothing; clothing of leather; fur cape stoles for ladies; down garments; suits; shoes; knitwear.

(260) AM 2012 66149 A

(800) 1104256

(731) K&B MEDI-GALEN KFT.
Gasparich u. 14. H-8900 Zalaegerszeg,
Hungary

(540)



(591) Black, white, blue, green, brown

(511)

3 – Bleaching preparations and other substances for laundry use; cleaning, polishing, scouring and abrasive preparations; soaps; perfumery, essential oils, cosmetics, hair lotions; dentifrices; dentifrices with a base of herbs or herbal extracts.

5 – Pharmaceutical and veterinary preparations; sanitary preparations for medical purposes; dietetic substances adapted for medical use, food for babies; plasters, materials for dressings; material for stopping teeth, dental wax; disinfectants; preparations for destroying vermin; fungicides, herbicides; sanitary preparations.

(260) AM 2012 67194 A

(800) 1112290

(731) OTKRITIE Financial Corporation JSC
2, bldg. 4, Letnikovskaya str, RU-115114
Moscow, Russian Federation

(540)



(591) Blue and white

(511)

35 – advertising; business management; business administration; office functions; arranging subscriptions to telecommunication services for others; import-export agencies; commercial information agencies; advertising agencies; cost price analysis; rental of advertising space; auditing; employment agencies; computerized file management; accounting; invoicing; demonstration of goods; transcription; opinion polling; marketing studies; business information; commercial information and advice for consumers; business investigations, business research; marketing research; personnel recruitment; business management and organization consultancy; personnel management consultancy; business organization consultancy; business management consultancy; professional business consultancy; layout services for advertising purposes; business management of performing artists; news clipping services; updating of advertising material; word processing; secretarial services; shorthand; organization of exhibitions for commercial or advertising purposes; arranging newspaper subscriptions for others; organization of trade fairs for commercial or advertising purposes; shop window dressing; bu-

business appraisals; evaluation of standing timber; evaluation of wool; payroll preparation; data search in computer files for others; sponsorship search; business management assistance; commercial or industrial management assistance; presentation of goods on communication media, for retail purposes; economic forecasting; auctioneering; sales promotion for others; office machines and equipment rental; rental of advertising time on communication media; publicity material rental; rental of vending machines; rental of photocopying machines; publication of publicity texts; typing; radio advertising; bill-posting, outdoor advertising; distribution of samples; direct mail advertising, dissemination of advertising matter; writing of publicity texts; on-line advertising on a computer network; advertising by mail order; television advertising, television commercials; document reproduction; compilation of statistics; compilation of information into computer databases; business inquiries; systemization of information into computer databases; tax preparation; drawing up of statements of accounts; publicity columns preparation; psychological testing for the selection of personnel; business management of hotels; commercial administration of the licensing of the goods and services of others; administrative processing of purchase orders; public relations; modelling for advertising or sales promotion; relocation services for businesses; price comparison services; procurement services for others (purchasing goods and services for other businesses); outsourcing services; telephone answering for unavailable subscribers; photocopying; efficiency experts.

36 – financial affairs; monetary affairs; real estate affairs; credit bureaux; debt collection agencies; real estate agencies; customs brokerage; financial analysis; leasing of farms; hire-purchase financing, lease-purchase financing; savings banks; accommodation bureaux; rent collection; issuing of travellers' checks; issuance of credit cards; issue of tokens of value; capital investments, fund investments; insurance information; financial information; clearing financial; insurance consultancy; financial consultancy; stock exchange quotations; business liquidation services, financial; brokerage; financial management; exchanging money; debit card services; credit card services; home banking; factoring; organization of collections; antique appraisal; jewellery appraisal; stamp appraisal; real estate appraisal; numismatic appraisal; art appraisal; financial evaluation (insurance, banking, real estate); repair costs evaluation; electronic funds transfer; bail-bonding, guarantees; securities brokerage, stocks and bonds brokerage; housing agents, real estate brokers; insurance brokerage; loans; lending against security; check (cheque) verification; charitable fund raising; leasing of real estate; rental of offices (real estate); renting of apartments; financial spon-

sorship; mortgage banking; instalment loans; insurance; apartment house management; real estate management; actuarial services; banking; retirement payment services; fiduciary, trusteeship; mutual funds; financing services; safe deposit services; deposits of valuables; fiscal assessments.

(260) AM 2012 67372 A

(800) 1113731

(731) OTKRITIE Financial Corporation JSC
2, bldg. 4, Letnikovskaya str, RU-115114
Moscow, Russian Federation

(540)



(591) Blue and white

(511)

35 – Advertising; business management; business administration; office functions; arranging subscriptions to telecommunication services for others; import-export agencies; commercial information agencies; advertising agencies; cost price analysis; rental of advertising space; auditing; employment agencies; computerized file management; accounting; invoicing; demonstration of goods; transcription; opinion polling; marketing studies; business information; commercial information and advice for consumers; business investigations; business research; marketing research; personnel recruitment; business management and organization consultancy; personnel management consultancy; business organization consultancy; business management consultancy; professional business consultancy; layout services for advertising purposes; business management of performing artists; news clipping services; updating of advertising material; word processing; secretarial services; shorthand; organization of exhibitions for commercial or advertising purposes; arranging newspaper subscriptions for others; organization of trade fairs for commercial or advertising purposes; shop window dressing; business appraisals; evaluation of standing timber; evaluation of wool; payroll preparation; data search in computer files for others; sponsorship search; business management assistance; commercial or industrial management assistance; presentation of goods on communication media, for retail purposes; economic forecasting; auctioneering; sales promotion for others; office machines and equipment rental; rental of advertising time on communication media; publicity material rental; rental of vending machines; rental of photocopying machines; publication of publicity texts; typing; radio advertising; bill-posting; outdoor advertising; distribution of samples; direct mail advertising; dissemination of

advertising matter; writing of publicity texts; on-line advertising on a computer network; advertising by mail order; television advertising; television commercials; document reproduction; compilation of statistics; compilation of information into computer databases; business inquiries; systemization of information into computer databases; tax preparation; drawing up of statements of accounts; publicity columns preparation; psychological testing for the selection of personnel; business management of hotels; commercial administration of the licensing of the goods and services of others; administrative processing of purchase orders; public relations; modelling for advertising or sales promotion; relocation services for businesses; price comparison services; procurement services for others [purchasing goods and services for other businesses]; outsourcing services; telephone answering for unavailable subscribers; photocopying; efficiency experts.

36 – Financial affairs; monetary affairs; real estate affairs; credit bureaux; debt collection agencies; real estate agencies; customs brokerage; financial analysis; leasing of farms; hire-purchase financing; lease-purchase financing; savings banks; accommodation bureaux; rent collection; issuing of travellers' checks; issuance of credit cards; issue of tokens of value; capital investments; fund investments; insurance information; financial information; clearing, financial; insurance consultancy; financial consultancy; stock exchange quotations; business liquidation services, financial; brokerage; financial management; exchanging money; debit card services; credit card services; home banking; factoring; organization of collections; antique appraisal; jewellery appraisal; stamp appraisal; real estate appraisal; numismatic appraisal; art appraisal; financial evaluation [insurance, banking, real estate]; repair costs evaluation; electronic funds transfer; bail-bonding; guarantees; securities brokerage; stocks and bonds brokerage; housing agents; real estate brokers; insurance brokerage; loans; lending against security; check [cheque] verification; charitable fund raising; leasing of real estate; rental of offices [real estate]; renting of apartments; financial sponsorship; mortgage banking; instalment loans; insurance; apartment house management; real estate management; actuarial services; banking; retirement payment services; fiduciary; trusteeship; mutual funds; financing services; safe deposit services; deposits of valuables; fiscal assessments.

(260) AM 2012 67373 A

(800) 1113732

(731) OTKRITIE Financial Corporation JSC
2, bldg. 4, Letnikovskaya str, RU-115114
Moscow, Russian Federation

(540)



(591) Blue and white

(511)

35 – Advertising; business management; business administration; office functions; arranging subscriptions to telecommunication services for others; import-export agencies; commercial information agencies; advertising agencies; cost price analysis; rental of advertising space; auditing; employment agencies; computerized file management; accounting; invoicing; demonstration of goods; transcription; opinion polling; marketing studies; business information; commercial information and advice for consumers; business investigations; business research; marketing research; personnel recruitment; business management and organization consultancy; personnel management consultancy; business organization consultancy; business management consultancy; professional business consultancy; layout services for advertising purposes; business management of performing artists; news clipping services; updating of advertising material; word processing; secretarial services; shorthand; organization of exhibitions for commercial or advertising purposes; arranging newspaper subscriptions for others; organization of trade fairs for commercial or advertising purposes; shop window dressing; business appraisals; evaluation of standing timber; evaluation of wool; payroll preparation; data search in computer files for others; sponsorship search; business management assistance; commercial or industrial management assistance; presentation of goods on communication media, for retail purposes; economic forecasting; auctioneering; sales promotion for others; office machines and equipment rental; rental of advertising time on communication media; publicity material rental; rental of vending machines; rental of photocopying machines; publication of publicity texts; typing; radio advertising; bill-posting; outdoor advertising; distribution of samples; direct mail advertising; dissemination of advertising matter; writing of publicity texts; on-line advertising on a computer network; advertising by mail order; television advertising; television commercials; document reproduction; compilation of statistics; compilation of information into computer databases; business inquiries; systemization of information into computer databases; tax preparation; drawing up of statements of accounts; publicity columns preparation; psychological testing for the selection of personnel; business management of hotels; commercial administration of the licensing of the goods and services of others; administrative processing of purchase

orders; public relations; modelling for advertising or sales promotion; relocation services for businesses; price comparison services; procurement services for others [purchasing goods and services for other businesses]; outsourcing services; telephone answering for unavailable subscribers; photocopying; efficiency experts.

36 – Financial affairs; monetary affairs; real estate affairs; credit bureaux; debt collection agencies; real estate agencies; customs brokerage; financial analysis; leasing of farms; hire-purchase financing; lease-purchase financing; savings banks; accommodation bureaux; rent collection; issuing of travellers' checks; issuance of credit cards; issue of tokens of value; capital investments; fund investments; insurance information; financial information; clearing, financial; insurance consultancy; financial consultancy; stock exchange quotations; business liquidation services, financial; brokerage; financial management; exchanging money; debit card services; credit card services; home banking; factoring; organization of collections; antique appraisal; jewellery appraisal; stamp appraisal; real estate appraisal; numismatic appraisal; art appraisal; financial evaluation [insurance, banking, real estate]; repair costs evaluation; electronic funds transfer; bail-bonding; guarantees; securities brokerage; stocks and bonds brokerage; housing agents; real estate brokers; insurance brokerage; loans; lending against security; check [cheque] verification; charitable fund raising; leasing of real estate; rental of offices [real estate]; renting of apartments; financial sponsorship; mortgage banking; instalment loans; insurance; apartment house management; real estate management; actuarial services; banking; retirement payment services; fiduciary; trusteeship; mutual funds; financing services; safe deposit services; deposits of valuables; fiscal assessments.

(260) AM 2012 62677 A*

(800) 918385

(731) CONTINENTAL REIFEN DEUTSCHLAND
GMBH

Vahrenwalder Str. 9, 30165 Hannover,
Germany

(540)

CONTITECH

(591) Black, white

(511)

6 – Metal building materials; metal materials for railway engineering; metal cables and wires (not for electrical purposes); ironmongery and small items of metal hardware; metal pipes and flexible tubes; metal hose and pipe connectors; metal hose and pipe couplings, mountings as included in this class; metal conduits for ventilation and air-conditioning systems; metal goods as included in this class.

7 – Machines and machine tools; engines (excluding engines for land vehicles); engine components for all types of engines; pneumatic drives for machines and engines; driving belts, straps, v-belts, multi-rib belts, toothed belts, synchronous belts, burl belts, double toothed belts, flat straps, stroke belts (machine parts), pumping belts, transportation straps, conveyor belts and conveyor straps; parts and accessories for driving belts, conveyors, transportation straps, conveyor belts, conveyors included in this class; transportation belts for moving people included in this class; pulleys (machine parts); machine parts, namely springs, pneumatic springs, shock absorber pistons, vibration dampers; pressure cylinders; bellows cylinders; shaped rubber and rubber-metal parts for oscillation dampers and power transmissions, included in this class; engine bearings, hydraulic bearings, rotational vibration attenuators; valves (machine parts); flexible couplings (connections) not for land vehicles; shaft couplings not for land vehicles; shaft couplings (machines).

9 – Scientific, nautical, surveying, photographic, cinematographic, optical, weighing, measuring, signalling, checking (supervision), life-saving and teaching apparatus and instruments, included in this class; measuring devices and measuring instruments; apparatuses and instruments for conducting, switching, converting, storing, regulating and controlling electrical current; electrical fuses, electrical relays, transponders; sensors; magnetic, electronic and optical recording carriers (excluded unexposed films); magnetic cards; cards with integrated circuits (smartcards), phone cards; data processing devices and computers; stored computer programs and software; rescue equipment, namely rescue rafts, rescue canvases, rescue rings, life buoys, life jackets.

12 – Vehicles; apparatus for locomotion by land, air or water, as well as their parts and accessories, included in this class; motor vehicles and their parts; engines for land vehicles; brakes, parts and accessories for brakes; brake disks; brake sleeves; axles and axle modules, axle sleeves; shock absorbers and springs for vehicles and their parts, in particular pneumatic springs, air pressure springs, gas springs, air supply unities for pneumatic spring systems, shock absorbers and suspension struts for vehicles; shock absorber springs for vehicles; bearing springs for vehicles; vibration absorbers and rotational vibration attenuators (except as land vehicle engine components) for vehicles, vehicle engines, steering units, vehicle cabs and drivers' seats; hydraulic bearings as components of vehicles included in this class; shaped rubber and rubber-metal parts for oscillation dampers and power transmissions included in this class; railway couplings; couplings (connections) for land vehic-

les; clutches for land vehicles; railway car couplings; drive chains, driving belts, drive belts, drive straps included in this class; chains and track chains for vehicles; cooling, heating, braking, fuel, charge air, oil and hydraulic hoses as components and accessories for vehicles included in this class; interior linings for motor vehicles and rail-mounted vehicles; airbag coverings; linings for dashboards; interior upholstery for vehicles; vehicle seats; head restraints for vehicle seats; rubber or plastic passageway bellows for track vehicles and articulated buses; balloons (aircraft); airships (aircraft).

16 – Printed matter, printers' type, printing blocks, printing blankets not made of textiles; printing blankets made of rubber and plastic; parts and accessories for the aforementioned goods, included in this class; paper, cardboard (carton) and goods made from these materials, included in this class; atlases, calendars, geographic maps, publications (written), ball pens and pencils, pennants and flags (of paper), paper serviettes, bookbinding articles; photographs; stationery; adhesives for stationery or household purposes; artists' materials; typewriters and office requisites (except furniture); instructional and teaching material (except machinery), including textbooks, magazines, repair and/or user instructions; plastic packaging materials, included in this class.

17 – Natural rubber, gutta-percha, rubber, asbestos, mica and articles made from it, included in this class; plastic articles (semi-finished); sealing, packing and insulation material; hoses (not of metal); hose connections (not of metal); mountings for pipes (not of metal); rubber compensators; pipe sealants; sealing sleeves, sealing rings, membranes (included in this class); rubber pads (shock absorbers); valves made of rubber and rubber substitutes; rubber sheeting and rubber sleeves for protecting machine parts; mats made of rubber and rubber substitutes for vibration and shock absorption in track laying; oil absorption mats in rubber and rubber substitutes; rubber valves; profiles made of rubber and plastic for sunroof, door, window, engine compartment sealing, included in this class; upholstery material of rubber or plastic; plastic sheeting (except for packing purposes) including sheeting for sealing and insulation purposes, roof and pond sheeting; bellows, passageway bellows of rubber or plastic for airport passenger bridges; parts and accessories for all aforementioned goods included in this class.

(540)

LOVE FOOD WITH LURPAK

(591) Black, white

(511)

29 – Dairy products, including especially butter, butter with flavour additives, ghee, spreadable (mixed products with butter), cheese, milk and preserved milk, edible oils and fats.

(260) AM 2012 62734 A*

(800) 1076059

(731) Mejeriforeningen Danish Dairy Board
Sønderhøj 1, DK-8260 Viby J, Denmark

INTERNATIONAL TRADEMARKS PROTECTED IN GEORGIA

(260) AM 2011 61583 A
(800) 1066411
(151) 2010 12 23
(181) 2020 12 23
(511) 35, 39

(260) AM 2012 63074 A
(800) 906534
(151) 2006 07 31
(181) 2016 07 31
(511) 09, 42

(260) AM 2012 62017 A
(800) 483299
(151) 2004 01 26
(181) 2014 01 26
(511) 05

(260) AM 2012 63075 A
(800) 912519
(151) 2006 12 19
(181) 2016 12 19
(511) 03, 05, 08, 10, 21, 25, 28, 35

(260) AM 2012 62469 A
(800) 1073788
(151) 2011 02 09
(181) 2021 02 09
(511) 35, 36, 41, 45

(260) AM 2012 63076 A
(800) 960041
(151) 2008 01 25
(181) 2018 01 25
(511) 03, 16, 18, 24, 25, 28, 35

(260) AM 2012 62896 A
(800) 1071906
(151) 2011 03 17
(181) 2021 03 17
(511) 25

(260) AM 2012 63077 A
(800) 967378
(151) 2007 12 05
(181) 2017 12 05
(511) 32

(260) AM 2012 62907 A
(800) 1077582
(151) 2011 02 08
(181) 2021 02 08
(511) 01, 04, 37

(260) AM 2012 63078 A
(800) 971326
(151) 2008 06 24
(181) 2018 06 24
(511) 25

(260) AM 2012 63002 A
(800) 1078455
(151) 2011 05 05
(181) 2021 05 05
(511) 11

(260) AM 2012 63079 A
(800) 977321
(151) 2008 08 22
(181) 2018 08 22
(511) 05

(260) AM 2012 63025 A
(800) 1078700
(151) 2011 05 11
(181) 2021 05 11
(511) 33

(260) AM 2012 63080 A
(800) 980611
(151) 2008 08 19
(181) 2018 08 19
(511) 25

(260) AM 2012 63073 A
(800) 891158
(151) 2006 04 10
(181) 2016 04 10
(511) 07, 09, 11

(260) AM 2012 63081 A
(800) 984121
(151) 2008 09 01
(181) 2018 09 01
(511) 18, 25, 35

(260) AM 2012 63082 A
(800) 1000182
(151) 2009 03 12
(181) 2019 03 12
(511) 18, 25, 35

(260) AM 2012 63149 A
(800) 1080036
(151) 2011 05 16
(181) 2021 05 16
(511) 05

(260) AM 2012 63083 A
(800) 1010886
(151) 2009 07 06
(181) 2019 07 06
(511) 33

(260) AM 2012 63150 A
(800) 1080037
(151) 2011 05 16
(181) 2021 05 16
(511) 05

(260) AM 2012 63084 A
(800) 1012380
(151) 2009 06 18
(181) 2019 06 18
(511) 32

(260) AM 2012 63151 A
(800) 1080048
(151) 2011 05 24
(181) 2021 05 24
(511) 03, 05, 42, 44

(260) AM 2012 63085 A
(800) 1035009
(151) 2010 01 29
(181) 2020 01 29
(511) 18

(260) AM 2012 63152 A
(800) 1080054
(151) 2011 05 19
(181) 2021 05 19
(511) 05

(260) AM 2012 63142 A
(800) 1080010
(151) 2011 05 19
(181) 2021 05 19
(511) 05

(260) AM 2012 63153 A
(800) 1080060
(151) 2011 05 16
(181) 2021 05 16
(511) 05

(260) AM 2012 63143 A
(800) 1080024
(151) 2011 01 27
(181) 2021 01 27
(511) 33

(260) AM 2012 63154 A
(800) 1080080
(151) 2010 11 05
(181) 2020 11 05
(511) 07, 09

(260) AM 2012 63145 A
(800) 1080026
(151) 2011 01 27
(181) 2021 01 27
(511) 33

(260) AM 2012 63155 A
(800) 1080085
(151) 2010 12 06
(181) 2020 12 06
(511) 09, 35, 38, 41

(260) AM 2012 63146 A
(800) 1080033
(151) 2011 05 16
(181) 2021 05 16
(511) 05

(260) AM 2012 63156 A
(800) 1080086
(151) 2010 12 06
(181) 2020 12 06
(511) 09, 35, 38, 41

(260) AM 2012 63157 A
 (800) 1080090
 (151) 2011 01 24
 (181) 2021 01 24
 (511) 30

(260) AM 2012 63318 A
 (800) 1072247
 (151) 2011 02 14
 (181) 2021 02 14
 (511) 03, 44

(260) AM 2012 63158 A
 (800) 1080094
 (151) 2010 12 31
 (181) 2020 12 31
 (511) 03, 05

(260) AM 2012 63321 A
 (800) 1081466
 (151) 2011 06 06
 (181) 2021 06 06
 (511) 07, 42

(260) AM 2012 63159 A
 (800) 1080099
 (151) 2011 02 24
 (181) 2021 02 24
 (511) 30

(260) AM 2012 63323 A
 (800) 1081477
 (151) 2011 04 20
 (181) 2021 04 20
 (511) 05

(260) AM 2012 63313 A
 (800) 666558
 (151) 2007 01 10
 (181) 2017 01 10
 (511) 03, 05

(260) AM 2012 63324 A
 (800) 1081482
 (151) 2011 05 19
 (181) 2021 05 19
 (511) 12

(260) AM 2012 63314 A
 (800) 723362
 (151) 2009 10 14
 (181) 2019 10 14
 (511) 04, 37, 39

(260) AM 2012 63325 A
 (800) 1081489
 (151) 2011 01 18
 (181) 2021 01 18
 (511) 45

(260) AM 2012 63315 A
 (800) 733973
 (151) 2010 03 31
 (181) 2020 03 31
 (511) 04, 37, 39

(260) AM 2012 63326 A
 (800) 1081561
 (151) 2011 04 06

 (181) 2021 04 06
 (511) 41

(260) AM 2012 63316 A
 (800) 1011777
 (151) 2009 02 19
 (181) 2019 02 19
 (511) 01, 02, 03, 04, 05, 06, 07, 08, 09, 10, 11, 12,
 13, 14, 15, 16, 17, 18, 19, 20, 21, 22, 23, 24,
 25, 26, 27, 28, 29, 30, 31, 32, 33, 34, 35, 36,
 37, 38, 39, 40, 41, 42, 43, 44, 45

(260) AM 2012 63332 A
 (800) 1081597
 (151) 2011 06 08
 (181) 2021 06 08
 (511) 30

(260) AM 2012 63317 A
 (800) 1029906
 (151) 2009 12 03
 (181) 2019 12 03
 (511) 03

(260) AM 2012 63333 A
 (800) 1081624
 (151) 2011 05 06
 (181) 2021 05 06
 (511) 25, 35

(260) AM 2012 63388 A
(800) 431413
(151) 2007 07 27
(181) 2017 07 27
(511) 05

(260) AM 2012 63389 A
(800) 443627
(151) 2009 02 16
(181) 2019 02 16
(511) 05

(260) AM 2012 63390 A
(800) 571872
(151) 2011 05 06
(181) 2021 05 06
(511) 06, 09, 11, 17, 19

(260) AM 2012 63391 A
(800) 597374
(151) 2003 03 01
(181) 2013 03 01
(511) 32

(260) AM 2012 63394 A
(800) 614999
(151) 2004 02 16
(181) 2014 02 16
(511) 33

(260) AM 2012 63396 A
(800) 617165
(151) 2004 03 11
(181) 2014 03 11
(511) 32

(260) AM 2012 63399 A
(800) 868006
(151) 2005 10 18
(181) 2015 10 18
(511) 29, 30

(260) AM 2012 63400 A
(800) 871878
(151) 2004 09 24
(181) 2014 09 24
(511) 06, 17, 19

(260) AM 2012 63402 A
(800) 1025736
(151) 2009 10 01
(181) 2019 10 01
(511) 29, 30, 31, 32

(260) AM 2012 63403 A
(800) 1044881
(151) 2010 07 01
(181) 2020 07 01
(511) 05

(260) AM 2012 63404 A
(800) 1053493
(151) 2010 09 24
(181) 2020 09 24
(511) 09

(260) AM 2012 63405 A
(800) 1065518
(151) 2010 11 29
(181) 2020 11 29
(511) 07, 09

(260) AM 2012 63406 A
(800) 1075998
(151) 2011 03 02
(181) 2021 03 02
(511) 09, 12, 20, 29, 30, 32, 42

(260) AM 2012 63449 A
(800) 1082834
(151) 2011 03 21
(181) 2021 03 21
(511) 05, 31

(260) AM 2012 63456 A
(800) 1082952
(151) 2011 05 26
(181) 2021 05 26
(511) 33

(260) AM 2012 63457 A
(800) 1082957
(151) 2011 04 20
(181) 2021 04 20
(511) 09

(260) AM 2012 63458 A
(800) 1082983
(151) 2011 06 06
(181) 2021 06 06
(511) 12, 35, 37

(260) AM 2012 63464 A
(800) 1082986
(151) 2010 12 06
(181) 2020 12 06
(511) 09, 35, 38, 41

(260) AM 2012 63465 A
(800) 1083004
(151) 2011 06 03
(181) 2021 06 03
(511) 43

(260) AM 2012 63572 A
(800) 1048342
(151) 2010 06 10
(181) 2020 06 10
(511) 07

(260) AM 2012 63818 A
(800) 1085759
(151) 2011 03 31
(181) 2021 03 31
(511) 03

(260) AM 2012 63820 A
(800) 1085773
(151) 2011 06 09
(181) 2021 06 09
(511) 33

(260) AM 2012 63824 A
(800) 1085811
(151) 2011 05 05
(181) 2021 05 05
(511) 01, 03, 05, 09, 10, 16, 35, 38, 40, 41, 42, 44

(260) AM 2012 63902 A
(800) 1086522
(151) 2011 06 28
(181) 2021 06 28
(511) 07, 16, 20

(260) AM 2012 63907 A
(800) 1086621
(151) 2011 04 07
(181) 2021 04 07
(511) 03, 05, 21

(260) AM 2012 63910 A
(800) 1086681
(151) 2011 04 29
(181) 2021 04 29
(511) 29, 30, 35

(260) AM 2012 63912 A
(800) 1086684
(151) 2011 05 25
(181) 2021 05 25
(511) 05, 09, 10, 16, 21, 25

(260) AM 2012 64169 A
(800) 1088796
(151) 2011 03 17
(181) 2021 03 17
(511) 03, 05

(260) AM 2012 64407 A
(800) 1090736
(151) 2011 08 11
(181) 2021 08 11
(511) 05

(260) AM 2012 64583 A
(800) 1092197
(151) 2011 07 28
(181) 2021 07 28
(511) 03, 05, 44

(260) AM 2012 64752 A
(800) 1093485
(151) 2011 09 16
(181) 2021 09 16
(511) 26

(260) AM 2012 64753 A
(800) 1093494
(151) 2011 03 31
(181) 2021 03 31
(511) 07, 08, 09, 35

(260) AM 2012 64754 A
(800) 1093498
(151) 2011 05 20
(181) 2021 05 20
(511) 05

(260) AM 2012 64792 A
(800) 1085464
(151) 2011 06 28
(181) 2021 06 28
(511) 03, 05, 10, 35

(260) AM 2012 64755 A
(800) 1093504
(151) 2011 09 23
(181) 2021 09 23
(511) 09, 38, 42

(260) AM 2112 61547 A
(800) 1065854
(151) 2010 12 09
(181) 2020 12 09
(511) 07, 09, 11

(260) AM 2012 64786 A
(800) 1093849
(151) 2011 08 18
(181) 2021 08 18
(511) 29, 30

(260) AM 2012 64787 A
(800) 1093863
(151) 2011 09 23
(181) 2021 09 23
(511) 09

(260) AM 2012 64788 A
(800) 1093873
(151) 2011 09 22
(181) 2021 09 22
(511) 05

(260) AM 2012 64789 A
(800) 666559
(151) 2007 01 10
(181) 2017 01 10
(511) 03

(260) AM 2012 64790 A
(800) 988319
(151) 2008 11 12
(181) 2018 11 12
(511) 09

(260) AM 2012 64791 A
(800) 1070450
(151) 2011 02 01
(181) 2021 02 01
(511) 34

APPELLATIONS OF ORIGIN AND GEOGRAPHICAL INDICATIONS OF GOODS

REGISTERED APPELLATIONS OF ORIGIN OF GOODS

Number of national registration: 827
Date of national registration: 2012 11 15
Number of international registration: 901
Date of international registration: 2012 01 10
Appellations of origin: **LOCHE DE LAMBAYEQUE**
Country code: PE, Peru
Goods: 29 – Loche (Crookneck squash).

Number of national registration: 828
Date of national registration: 2012 11 15
Number of international registration: 902
Date of international registration: 2012 01 10
Appellations of origin: **KAFÉ MACHU PICCHU-HUADQUIÑA**
Country code: PE, Peru
Goods: 30 – Green coffee beans.

Number of national registration: 829
Date of national registration: 2012 11 15
Number of international registration: 903
Date of international registration: 2012 01 10
Appellations of origin: **MACA JUNÍN-PASCO**
Country code: PE, Peru
Goods: 31 – Maca (fresh and dried).

THE RIGHT TO USE OF REGISTERED APPELLATIONS
OF ORIGIN OF GOODS

Registered appellations of origin of goods: **TSINANDALI**
The right to use: LTD "WINE COMPANY SHUMI"
Solomon Lionidze Str. 33, 2200. Telavi, Georgia
Number of registration: 3/6-12
Valid: 2013 07 05

OFFICIAL NOTIFICATIONS

TRADEMARKS

RENEWAL OF REGISTRATIONS

(111) M 2002 14359 R1

(156) 2012 09 13

(186) 2022 03 27

(732) JOHNSON & JOHNSON

One Johnson & Johnson Plaza,
New Brunswick, New Jersey 08933, USA

(111) M 2002 14448 R1

(156) 2012 10 09

(186) 2022 05 01

(732) LTD "PIRVELI ZHURNALI"

Saburtalos q. 32, Tbilisi, Georgia

(111) M 2002 14515 R1

(156) 2012 09 13

(186) 2022 06 13

(732) JOHNSON & JOHNSON

One Johnson & Johnson Plaza,
New Brunswick, New Jersey 08933, USA

(111) M 2002 14525 R1

(156) 2012 09 13

(186) 2022 06 13

(732) JOHNSON & JOHNSON

One Johnson & Johnson Plaza,
New Brunswick, New Jersey 08933, USA

(111) M 2002 14526 R1

(156) 2012 09 13

(186) 2022 06 13

(732) JOHNSON & JOHNSON

One Johnson & Johnson Plaza,
New Brunswick, New Jersey 08933, USA

(111) M 2002 14528 R1

(156) 2012 09 06

(186) 2022 06 13

(732) LTD "POSEIDONI"

Kakhetis gzatketsili 14, 3800, Sagarejo,
Georgia

(111) M 2002 14541 R1

(156) 2012 09 27

(186) 2022 06 27

(732) Joint Stock Company BANKI

"RESPUBLIKA"

Grigol Abashidzis q.N2, 0179, Tbilisi,
Georgia

(111) M 2002 14588 R1

(156) 2012 08 15

(186) 2022 08 15

(732) KIMBERLY-CLARK WORLDWIDE, INC.
NEENAH, WI 54956, USA

(111) M 2002 14705 R1

(156) 2012 09 30

(186) 2022 09 30

(732) MENARINI INTERNATIONAL
OPERATIONS LUXEMBURG S.A.

1, Avenue De La Gare, 1611 Luxembourg,
Luxembourg

(111) M 2002 14706 R1

(156) 2012 09 30

(186) 2022 09 30

(732) MENARINI INTERNATIONAL
OPERATIONS LUXEMBURG S.A.

1, Avenue De La Gare, 1611 Luxembourg,
Luxembourg

(111) M 2002 14765 R1

(156) 2012 10 15

(186) 2022 10 15

(732) HYUNDAI MOTOR COMPANY

231, Yangjae-Dong, Seocho-Gu, Seoul,
137-938, Republic of Korea

(111) M 2002 14766 R1

(156) 2012 10 15

(186) 2022 10 15

(732) THE AMERICAN SOCIETY OF
MECHANICAL ENGINEERING

Three Park Avenue, New-York, New-York
10016-5990, USA

(111) M 2002 14776P R1

(156) 2012 10 29

(186) 2022 10 29

(732) TIMEX NEDERLAND B.V.

Herengracht 466, 1017 CA, Amsterdam,
Netherlands

(111) M 2002 14782 R1
(156) 2012 10 29
(186) 2022 10 29
(732) WELLA GMBH
Sulzbacher Strasse 40, 65824 Schwalbach am
Taunus, Germany

(111) M 2002 14785 R1
(156) 2012 10 29
(186) 2022 10 29
(732) AZIENDE CHIMICHE RIUNITE
ANGELINI FRANCESCO A.C.R.A.F.
S.p.A.
Viale Amelia 70, 00181 Roma, Italy

(111) M 2002 14788 R1
(156) 2012 11 15
(186) 2022 11 15
(732) CENTOCOR ORTHO BIOTECH INC.
800 Ridgeriew Drive, Horsham, Pennsylvania
19044, USA

(111) M 2002 14809 R1
(156) 2012 11 28
(186) 2022 11 28
(732) JOHNSON & JOHNSON
One Johnson & Johnson Plaza,
New Brunswick, New Jersey 08933, USA

(111) M 2002 14810 R1
(156) 2012 11 28
(186) 2022 11 28
(732) LTD "BORJOMI PRODAQTI"
Dasakheba Larebi, 1200, Borjomi, Georgia

(111) M 2002 14811 R1
(156) 2012 11 28
(186) 2022 11 28
(732) LTD "BORJOMI PRODAQTI"
Dasakheba Larebi, 1200, Borjomi, Georgia

(111) M 2002 14818 R1
(156) 2012 11 28
(186) 2022 11 28
(732) JOHNSON & JOHNSON
One Johnson & Johnson Plaza,
New Brunswick, New Jersey 08933, USA

(111) M 2002 14852 R1
(156) 2012 12 12
(186) 2022 12 12
(732) GREAT LAKES CHEMICAL
CORPORATION
9025 North River Road, Suite 400,
Indianapolis, Indiana 46240, USA

(111) M 2003 14861 R1
(156) 2013 01 14
(186) 2023 01 14
(732) SHELL BRANDS INTERNATIONAL AG
Baareratte, 6340 Baar, Switzerland

(111) M 2003 14882 R1
(156) 2013 01 14
(186) 2023 01 14
(732) MARRIOTT WORLDWIDE
CORPORATION, a Maryland Corporation
10400 Fernwood Road, Bethesda, Maryland
20817, USA

(111) M 2003 14883 R1
(156) 2013 01 14
(186) 2023 01 14
(732) MARRIOTT WORLDWIDE
CORPORATION, a Maryland Corporation
10400 Fernwood Road, Bethesda, Maryland
20817, USA

(111) M 2003 14918 R1
(156) 2013 01 30
(186) 2023 01 30
(732) PROCTER & GAMBLE BUSINESS
SERVICES CANADA COMPANY
Suite 800, 1959 Upper Water Street, P.O.Box
997, Halifax, Nova Scotia, B3J 2x2, Canada

(111) M 2003 15065 R1
(156) 2013 03 28
(186) 2023 03 28
(732) AKBAR BROTHERS LIMITED
N334, T.B. Jayah Mawatha, Colombo 10
Sri Lanka,

(111) M 2003 15186 R1
(156) 2013 06 27
(186) 2023 06 27
(732) MATTEL, INCORPORATED
333 Continental Boulevard, El Segundo,
California 90245, USA

COMPLETE TRANSFER OF RIGHTS

(111) M 2003 015240 R
(732) MSD INTERNATIONAL GMBH
Weyrstrasse 20, 6000 Lucerne 6, Switzerland
(770) MSP Singapore Company, LLC
600 North Beach Road, Unit 10-03/10,
Singapore 188778, Singapore
(580) 2012 11 08

(111) M 2003 015241 R
(732) MSD INTERNATIONAL GMBH
Weyrstrasse 20, 6000 Lucerne 6, Switzerland
(770) MSP Singapore Company, LLC
600 North Beach Road, Unit 10-03/10,
Singapore 188778, Singapore
(580) 2012 11 08

(111) M 2004 015689 R
(732) MSD INTERNATIONAL GMBH
Weyrstrasse 20, 6000 Lucerne 6, Switzerland
(770) MSP Singapore Company, LLC
600 North Beach Road, Unit 10-03/10,
Singapore 188778, Singapore
(580) 2012 11 08

(111) M 2004 015695 R
(732) MSD INTERNATIONAL GMBH,
Weyrstrasse 20, 6000 Lucerne 6, Switzerland
(770) MSP Singapore Company, LLC,
600 North Beach Road, Unit 10-03/10,
Singapore 188778, Singapore
(580) 2012 11 08

(111) M 2004 015696 R
(732) MSD INTERNATIONAL GMBH
Weyrstrasse 20, 6000 Lucerne 6, Switzerland
(770) MSP Singapore Company, LLC
600 North Beach Road, Unit 10-03/10,
Singapore 188778, Singapore
(580) 2012 11 08

(111) M 2004 015699 R
(732) MSD INTERNATIONAL GMBH
Weyrstrasse 20, 6000 Lucerne 6, Switzerland
(770) MSP Singapore Company, LLC
600 North Beach Road, Unit 10-03/10,
Singapore 188778, Singapore
(580) 2012 11 08

(111) M 2004 015700 R
(732) MSD INTERNATIONAL GMBH
Weyrstrasse 20, 6000 Lucerne 6, Switzerland
(770) MSP Singapore Company, LLC
600 North Beach Road, Unit 10-03/10,
Singapore 188778, Singapore
(580) 2012 11 08

(111) M 2007 017565 R
(732) HERBA RICEMILLS, S.L.U.
Calle Real, 43, 41920 Sevilla, Spain
(770) DEOLEO, S.A.
Parque Empresarial Rivas Futura, Marie
Curie, 7, 4 a planta, Edificio Beta, 28521
RIVAS VACIAMADRID (Madrid)seo de la
Castellana 51, 28046 MADRID, Spain
(580) 2012 10 15

(111) M 2009 020014 R
(732) STRAKAN INTERNATIONAL S.À R.L.
13-15, avenue de la Liberté, L-1931
Luxembourg, Luxembourg
(770) OREXO AB
Box 303, SE-75105 Uppsala, Sweden
(580) 2012 10 16

(111) M 2010 020291 R
(732) AFFINIA INTERNATIONAL INC.,
A DELAWARE CORPOPATION
1101 Technology Drive, Ann Arbor,
Michigan 48108, USA
(770) Brake Parts Inc LLC
4400 prime Parkway, McHenry, Illinois
60050, USA
(580) 2012 11 08

(111) M 2010 020670 R
(732) LTD "TBILISIS PARKI"
Mtatsminda, zeda plato, 0105, Tbilisi,
Georgia
(770) LTD "MTATSMINDIS PARKI"
Funikulioris zeda ferdobi, 0105, Tbilisi,
Georgia
(580) 2012 10 15

(111) M 1996 002165 R1
(732) CLININGEN HEALTHCARE LIMITED
Pitcairn House, First Avenue, Burton on
Trent, DE14 2 WW, United Kingdom

(770) ASTRAZENECA AB
Vastra Malarehamnen 9, 15185 Sodertalje,
Sweden
(580) 2012 11 09

(111) M 2012 022695 R
(732) Joint Stock Company "LIBERTI KAPITALI"
Ilia chavchavadzis gamz.74, 0162, Tbilisi,
Georgia
(770) LTD "LIBERTI HOLDING JORJIA"
Ilia chavchavadzis gamz.74, 0162, Tbilisi,
Georgia
(580) 2012 10 16

(111) M 1997 004756 R1
(732) Fazer Invest Oy,
P. O. Box 4, 00941 Helsinki, Finland
(770) Fazer Suklaa Oy,
Fazerintie 6, FIN- 01230 Vantaa, Finland
(580) 2012 10 16

CHANGES IN NAMES AND/OR ADDRESSES OF OWNERS

(111) M 2003 015240 R
 (732) MSP Singapore Company, LLC
 300 Beach Road, The Concourse N12-08,
 Singapore 199555, Singapore
 (580) 2012 11 08

(770) MSP Singapore Company, LLC
 300 Beach Road, The Concourse N13-05/06,
 Singapore 199555, Singapore
 (580) 2012 11 08

(111) M 2003 015240 R
 (732) MSP Singapore Company, LLC
 600 North Beach Road, Unit 10-03/10,
 Singapore 188778, Singapore
 (770) MSP Singapore Company, LLC
 300 Beach Road, The Concourse N12-08,
 Singapore 199555, Singapore
 (580) 2012 11 08

(111) M 2003 015241 R
 (732) MSP Singapore Company, LLC
 300 Beach Road, The Concourse N12-08,
 Singapore 199555, Singapore
 (770) MSP Singapore Company, LLC
 300 Beach Road, The Concourse N13-05/06,
 Singapore 199555, Singapore
 (580) 2012 11 08

(111) M 2003 015241 R
 (732) MSP Singapore Company, LLC
 600 North Beach Road, Unit 10-03/10,
 Singapore 188778, Singapore
 (770) MSP Singapore Company, LLC
 300 Beach Road, The Concourse N12-08,
 Singapore 199555, Singapore
 (580) 2012 11 08

(111) M 2004 015689 R
 (732) MSP Singapore Company, LLC
 300 Beach Road, The Concourse N12-08,
 Singapore 199555, Singapore
 (770) MSP Singapore Company, LLC
 300 Beach Road, The Concourse N13-05/06,
 Singapore 199555, Singapore
 (580) 2012 11 08

(111) M 2004 015689 R
 (732) MSP Singapore Company, LLC
 600 North Beach Road, Unit 10-03/10,
 Singapore 188778, Singapore
 (770) MSP Singapore Company, LLC

300 Beach Road, The Concourse N12-08,
 Singapore 199555, Singapore
 (580) 2012 11 08

(111) M 2004 015695 R
 (732) MSP Singapore Company, LLC
 300 Beach Road, The Concourse N12-08,
 Singapore 199555, Singapore
 (770) MSP Singapore Company LLC
 limited liability company organized
 under the laws of Delaware, USA,
 300 Beach Road, The Concourse N12-08,
 Singapore 199555, Singapore
 (580) 2012 11 08

(111) M 2004 015695 R
 (732) MSP Singapore Company, LLC
 600 North Beach Road, Unit 10-03/10,
 Singapore 188778, Singapore
 (770) MSP Singapore Company, LLC
 300 Beach Road, The Concourse N12-08,
 Singapore 199555, Singapore
 (580) 2012 11 08

(111) M 2004 015696 R
 (732) MSP Singapore Company, LLC
 300 Beach Road, The Concourse N12-08,
 Singapore 199555, Singapore
 (770) MSP Singapore Company, LLC
 limited liability company organized under
 the laws of Delaware, USA,
 300 Beach Road, The Concourse N12-08,
 Singapore 199555, Singapore
 (580) 2012 11 08

(111) M 2004 015696 R
 (732) MSP Singapore Company, LLC
 600 North Beach Road, Unit 10-03/10,
 Singapore 188778, Singapore
 (770) MSP Singapore Company, LLC
 300 Beach Road, The Concourse N12-08,
 Singapore 199555, Singapore
 (580) 2012 11 08

(111) M 2004 015699 R
 (732) MSP Singapore Company, LLC
 300 Beach Road, The Concourse N12-08,
 Singapore 199555, Singapore
 (770) MSP Singapore Company, LLC

limited liability company organized under the laws of Delaware, USA,
300 Beach Road, The Concourse N12-08,
Singapore 199555, Singapore
(580) 2012 11 08

(111) M 2004 015699 R
(732) MSP Singapore Company, LLC
600 North Beach Road, Unit 10-03/10,
Singapore 188778, Singapore
(770) MSP Singapore Company, LLC
300 Beach Road, The Concourse N12-08,
Singapore 199555, Singapore
(580) 2012 11 08

(111) M 2004 015700 R
(732) MSP Singapore Company, LLC
300 Beach Road, The Concourse N12-08,
Singapore 199555, Singapore
(770) MSP Singapore Company, LLC
limited liability company organized under
the laws of Delaware, USA,
300 Beach Road, The Concourse N12-08,
Singapore 199555, Singapore
(580) 2012 11 08

(111) M 2004 015700 R
(732) MSP Singapore Company, LLC
600 North Beach Road, Unit 10-03/10,
Singapore 188778, Singapore
(770) MSP Singapore Company, LLC,
300 Beach Road, The Concourse N12-08,
Singapore 199555, Singapore
(580) 2012 11 08

(111) M 2007 017565 R
(732) SOS CORPORACION ALIMENTARIA,
S.A.
Parque Empresarial Rivas Futura, Marie
Curie, 7, 4 a planta, Edificio Beta, 28521
RIVAS V ACIAMADRID (Madrid)seo de la
Castellana 51, 28046 MADRID, Spain
(770) SOS CORPORACION ALIMENTARIA,
S.A.
Paseo de la Castellana 51, 28046 MADRID,
Spain
(580) 2012 10 15

(111) M 2007 017565 R
(732) DEOLEO, S.A.
Parque Empresarial Rivas Futura, Marie
Curie, 7, 4 a planta, Edificio Beta, 28521
RIVAS VACIAMADRID (Madrid)seo de la
Castellana 51, 28046 MADRID, Spain

(770) SOS CORPORACION ALIMENTARIA,
S.A.
Parque Empresarial Rivas Futura, Marie
Curie, 7, 4 a planta, Edificio Beta, 28521
RIVAS VACIAMADRID (Madrid)seo de la
Castellana 51, 28046 MADRID, Spain
(580) 2012 10 15

(111) M 1996 002251 R1
(732) HEWLETT-PACKARD DEVELOPMENT
COMPANY, L.P.
11445 Compaq Center Drive West, Houston,
Texas 77070, USA
(770) HEWLETT-PACKARD DEVELOPMENT
COMPANY L.P.
20555 S.H. 249, Houston, Texas 77070, USA
(580) 2012 11 01

(111) M 2012 022695 R
(732) LTD "LIBERTI HOLDING JORJIA"
Ilia chavchavadzis gamz.74, 0162, Tbilisi,
Georgia
(770) LTD "LIBERTI KAPITALI"
Ilia Chavchavadzis gamz. 74, bina 34, 0162,
Tbilisi, Georgia
(580) 2012 10 16

(111) M 1997 004756 R1
(732) FAZER SUKLAA OY
Fazerintie 6, FIN- 01230 Vantaa, Finland
(770) CLOETTA FAZER CHOCOLATES LTD.
Fazerintie 6, FIN- 01230 Vantaa, Finland
(580) 2012 10 16

(111) M 1995 000541 R1
(732) JOHNSON & JOHNSON GMBH
Johnson & Johnson Platz 2 (Raiffeisenstrasse
9), 41470 Neuss, Germany
(770) JOHNSON & JOHNSON GMBH
Dusseldorf, Germany
(580) 2012 10 15

(111) M 1997 007304 R1
(732) AKZO NOBEL CHEMICALS B.V.
Stationsstraat 77, 3811 LE Amersfoort,
Netherlands
(770) AKZO NOBEL CHEMICALS B.V.
4, Stationsplein, NL-3818 LE Amersfoort,
Netherlands
(580) 2012 11 09

(111) M 1998 008284 R1

(732) PERNOD RICARD USA, LLC
a Delaware Limited Liability Company
100 Manhattan Road, Purchase, New York
10577, USA

(770) PERNOD RICARD USA, LLC
an Indiana limited liability company,
100 Manhattan Road, Purchase, New York
10577, USA

(580) 2012 10 15

(111) M 1998 008284 R1

(732) Absolut Holding Filial (Swedish branch o
Absolut Holding Inc.)
P.O. Box 47170, 100 74 Stockholm, Sweden

(770) Pernod Ricard Nordie Holding
Inc. USA, Filial (Swedish branch of PERNO
RICARD NORDIC HOLDING, INC.,
a Delaware corporation), P.O. Box 47170,
SE-100 74 Stockholm, Sweden

(580) 2012 10 15

INVALIDATION OF TRADEMARK REGISTRATION

(111) M 2002 14330 R
(141) 2012 08 20, Not payment for prolongation of registration on the following of 10 years
(732) LTD "Gvinis Karkhana AKHASHENI"
Iamushevis q. 27, 0198, Tbilisi, Georgia;
LTD "TBILISSKI VINNI POGREB"
Gamsakhurdias gamz. 44, 0160,
Tbilisi, Georgia

(111) M 2002 14331 R
(141) 2012 08 20, Not payment for prolongation of registration on the following of 10 years
(732) LTD "Gvinis Karkhana AKHASHENI"
Iamushevis q. 27, 0198, Tbilisi, Georgia

(111) M 2002 14332 R
(141) 2012 08 20, Not payment for prolongation of registration on the following of 10 years
(732) LTD "Gvinis Karkhana AKHASHENI"
Iamushevis q. 27, 0198, Tbilisi, Georgia

(111) M 2002 14333 R
(141) 2012 08 20, Not payment for prolongation of registration on the following of 10 years
(732) LTD "Gvinis Karkhana AKHASHENI"
Iamushevis q. 27, 0198, Tbilisi, Georgia;
LTD "TBILISSKI VINNI POGREB"
Iamushevis q. 27, 0198, Tbilisi, Georgia

(111) M 2002 14334 R
(141) 2012 08 20, Not payment for prolongation of registration on the following of 10 years
(732) LTD "Gvinis Karkhana AKHASHENI"
Iamushevis q. 27, 0198, Tbilisi, Georgia

(111) M 2004 15792 R
(141) 2012 07 23(court decision case №2-74/12)
(732) LTD "SUPERMOTORI"
Parnavaz Mepis q. 57, 6010, Batumi, Georgia

CLASSIFICATION INDEXES

INVENTIONS

CONCORDANCE TABLE OF INTERNATIONAL CLASSIFICATION INDEX AND PUBLICATION NUMBERS

INTERNATIONAL CLASSIFICATION INDEXES (51)	NUMBER OF PUBLISHED APPLICATION (10)
A 61 K 31/44; A 61 K 47/26; A 61 K 47/34; A 01 N 43/40; A 61 K 8/34; A 61 K 8/49; A 61 K 8/60	AP 2012 12244 A
C 07 D 231/56; C 07 D 403/12; C 07 D 405/14; C 07 D 417/12; C 07 D 471/14; C 07 D 471/04; C 07 D 513/04; A 61 K 31/4155; A 61 P 3/10	AP 2012 12029 A
C 07 D 401/14; A 61 K 31/444	AP 2012 12153 A
C 07 D 487/04; A 61 K 31/519; A 61 P 35/00	AP 2012 12114 A
C 07 D 487/04; A 61 K 31/519; A 61 P 35/00	AP 2012 11914 A
C 09 B 61/00	AP 2012 12155 A
E 02 B 15/00	AP 2012 11872 A
E 05 B 51/00; E 05 B 47/00	AP 2012 11690 A
F 24 J 3/08; F 28 D 21/00; F 25 B 30/06	AP 2012 12057 A
G 01 K 13/00; G 01 K 11/12	AP 2012 12273 A
G 06 F 17/30	AP 2012 11919 A
H 01 M 8/00, 8/08, 8/22, 4/20, 4/29, 4/30; C 25 B 1/00, 1/28, 1/30, 1/32, 1/46	AP 2012 11924 A

CONCORDANCE TABLE OF PUBLICATION NUMBERS AND INTERNATIONAL CLASSIFICATION INDEX

NUMBER OF PUBLISHED APPLICATION (10)	INTERNATIONAL CLASSIFICATION INDEXES (51)
AP 2012 11690 A	E 05 B 51/00; E 05 B 47/00
AP 2012 11872 A	E 02 B 15/00
AP 2012 11914 A	C 07 D 487/04; A 61 K 31/519; A 61 P 35/00
AP 2012 11919 A	G 06 F 17/30
AP 2012 11924 A	H 01 M 8/00, 8/08, 8/22, 4/20, 4/29, 4/30; C 25 B 1/00, 1/28, 1/30, 1/32, 1/46
AP 2012 12029 A	C 07 D 231/56; C 07 D 403/12; C 07 D 405/14; C 07 D 417/12; C 07 D 471/14; C 07 D 471/04; C 07 D 513/04; A 61 K 31/4155; A 61 P 3/10
AP 2012 12057 A	F 24 J 3/08; F 28 D 21/00; F 25 B 30/06
AP 2012 12114 A	C 07 D 487/04; A 61 K 31/519; A 61 P 35/00
AP 2012 12153 A	C 07 D 401/14; A 61 K 31/444
AP 2012 12155 A	C 09 B 61/00
AP 2012 12244 A	A 61 K 31/44; A 61 K 47/26; A 61 K 47/34; A 01 N 43/40; A 61 K 8/34; A 61 K 8/49; A 61 K 8/60
AP 2012 12273 A	G 01 K 13/00; G 01 K 11/12

**CONCORDANCE TABLE OF INTERNATIONAL CLASSIFICATION INDEX,
PATENT NUMBERS AND PUBLICATION NUMBERS**

INTERNATIONAL CLASSIFICATION INDEX (51)	NUMBER OF PATENT (11)	NUMBER OF PUBLISHED APPLICATION (10)
A 61 K 31/70, 39/395, 38/16; C 07 K 14/00, 16/00; C 07 H 21/00	P 2012 5693 B	AP 2012 11415 A
B 60 P 3/40; B 60 P 3/41	P 2012 5694 B	AP 2012 11430 A
B 61 B 7/00; B 61 B 7/02	P 2012 5695 B	AP 2012 11432 A
C 01 B 3/04; C 01 B 17/04	P 2012 5699 B	AP 2012 12212 A
C 07 D 213/74; C 07 D 239/48; C 07 D 239/95; C 07 D 401/12; C 07 D 401/14; C 07 D 403/12; C 07 D 403/14; C 07 D 413/12; C 07 D 417/12; C 07 D 451/02; C 07 D 453/02; C 07 D 471/04; C 07 D 473/16; C 07 D 487/04; C 07 D 487/08	P 2012 5691 B	AP 2012 11295 A
E 02 F 3/42	P 2012 5696 B	AP 2012 11670 A
F 03 D 5/00; F 03 D 3/00; F 03 D 7/00; F 03 D 7/06	P 2012 5700 B	AP 2012 10947 A
G 01 N 3/56	P 2012 5692 B	AP 2012 11344 A
G 06 Q 50/00; G 06 Q 20/00; G 01 F 15/06; G 01 D 4/00	P 2012 5697 B	AP 2012 12097 A
H 01 S 3/06; H 01 S 3/14	P 2012 5698 B	AP 2012 12099 A

**CONCORDANCE TABLE OF PATENT NUMBERS,
PUBLICATION NUMBERS AND INTERNATIONAL CLASSIFICATION INDEX**

NUMBER OF PATENT (11)	NUMBER OF PUBLISHED APPLICATION (10)	INTERNATIONAL CLASSIFICATION INDEX (51)
P 2012 5691 B	AP 2012 11295 A	C 07 D 213/74; C 07 D 239/48; C 07 D 239/95; C 07 D 401/12; C 07 D 401/14; C 07 D 403/12; C 07 D 403/14; C 07 D 413/12; C 07 D 417/12; C 07 D 451/02; C 07 D 453/02; C 07 D 471/04; C 07 D 473/16; C 07 D 487/04; C 07 D 487/08
P 2012 5692 B	AP 2012 11344 A	G 01 N 3/56
P 2012 5693 B	AP 2012 11415 A	A 61 K 31/70, 39/395, 38/16; C 07 K 14/00, 16/00; C 07 H 21/00
P 2012 5694 B	AP 2012 11430 A	B 60 P 3/40; B 60 P 3/41
P 2012 5695 B	AP 2012 11432 A	B 61 B 7/00; B 61 B 7/02
P 2012 5696 B	AP 2012 11670 A	E 02 F 3/42
P 2012 5697 B	AP 2012 12097 A	G 06 Q 50/00; G 06 Q 20/00; G 01 F 15/06; G 01 D 4/00
P 2012 5698 B	AP 2012 12099 A	H 01 S 3/06; H 01 S 3/14
P 2012 5699 B	AP 2012 12212 A	C 01 B 3/04; C 01 B 17/04
P 2012 5700 B	AP 2012 10947 A	F 03 D 5/00; F 03 D 3/00; F 03 D 7/00; F 03 D 7/06

**CONCORDANCE TABLE OF APPLICATION NUMBERS, PUBLICATION NUMBERS
AND PATENTS**

NUMBER OF APPLICATION (21)	NUMBER OF PUBLISHED APPLICATION (10)	NUMBER OF PATENT (11)
AP 2006 010947	AP 2012 10947 A	P 2012 5700 B
AP 2007 011295	AP 2012 11295 A	P 2012 5691 B
AP 2009 011344	AP 2012 11344 A	P 2012 5692 B
AP 2008 011415	AP 2012 11415 A	P 2012 5693 B
AP 2009 011430	AP 2012 11430 A	P 2012 5694 B
AP 2009 011432	AP 2012 11432 A	P 2012 5695 B
AP 2010 011670	AP 2012 11670 A	P 2012 5696 B
AP 2008 012097	AP 2012 12097 A	P 2012 5697 B
AP 2011 012099	AP 2012 12099 A	P 2012 5698 B
AP 2011 012212	AP 2012 12212 A	P 2012 5699 B

UTILITY MODELS

**CONCORDANCE TABLE OF INTERNATIONAL CLASSIFICATION INDEX
AND PUBLICATION NUMBERS**

INTERNATIONAL CLASSIFICATION INDEXES (51)	NUMBER OF PUBLISHED APPLICATION (10)
B 60 L 15/00	AU 2012 12638 U
F 24 J 2/44	AU 2012 12702 U

**CONCORDANCE TABLE OF PUBLICATION NUMBERS
AND INTERNATIONAL CLASSIFICATION INDEX**

NUMBER OF PUBLISHED APPLICATION (10)	INTERNATIONAL CLASSIFICATION INDEXES (51)
AU 2012 12638 U	B 60 L 15/00
AU 2012 12702 U	F 24 J 2/44

**CONCORDANCE TABLE OF INTERNATIONAL CLASSIFICATION INDEX,
PATENT NUMBERS AND PUBLICATION NUMBERS**

INTERNATIONAL CLASSIFICATION INDEX (51)	NUMBER OF PATENT (11)	NUMBER OF PUBLISHED APPLICATION (10)
A 23 C 19/00	U 2012 1741 Y	AU 2012 12481 U
A 23 C 19/00	U 2012 1748 Y	AU 2012 12482 U

**CONCORDANCE TABLE OF PATENT NUMBERS,
PUBLICATION NUMBERS AND INTERNATIONAL CLASSIFICATION INDEX**

NUMBER OF PATENT (11)	NUMBER OF PUBLISHED APPLICATION (10)	INTERNATIONAL CLASSIFICATION INDEX (51)
U 2012 1741 Y	AU 2012 12481 U	A 23 C 19/00
U 2012 1748 Y	AU 2012 12482 U	A 23 C 19/00

**CONCORDANCE TABLE OF APPLICATION NUMBERS, PUBLICATION NUMBERS
AND PATENTS**

NUMBER OF APPLICATION (21)	NUMBER OF PUBLISHED APPLICATION (10)	NUMBER OF PATENT (11)
AU 2011 012481	AU 2012 12481 U	U 2012 1741 Y
AU 2011 012482	AU 2012 12482 U	U 2012 1748 Y

DESIGNS

**CONCORDANCE TABLE OF INTERNATIONAL CLASSIFICATION INDEX,
PATENT NUMBERS AND PUBLICATION NUMBERS**

INTERNATIONAL CLASSIFICATION INDEX (51)	NUMBER OF PATENT (11)	NUMBER OF PUBLISHED APPLICATION (10)
09-05	D 2012 518 S	AD 2012 692 S
19-06	D 2012 514 S	AD 2012 683 S
19-06	D 2012 515 S	AD 2012 684 S
19-06	D 2012 516 S	AD 2012 685 S
19-06	D 2012 517 S	AD 2012 686 S

**CONCORDANCE TABLE OF PATENT NUMBERS,
PUBLICATION NUMBERS AND INTERNATIONAL CLASSIFICATION INDEX**

NUMBER OF PATENT (11)	NUMBER OF PUBLISHED APPLICATION (10)	INTERNATIONAL CLASSIFICATION INDEX (51)
D 2012 514 S	AD 2012 683 S	19-06
D 2012 515 S	AD 2012 684 S	19-06
D 2012 516 S	AD 2012 685 S	19-06
D 2012 517 S	AD 2012 686 S	19-06
D 2012 518 S	AD 2012 692 S	09-05

**CONCORDANCE TABLE OF APPLICATION NUMBERS, PUBLICATION NUMBERS
AND PATENTS**

NUMBER OF APPLICATION (21)	NUMBER OF PUBLISHED APPLICATION (10)	NUMBER OF PATENT (11)
AD 2012 000683	AD 2012 683 S	D 2012 514 S
AD 2012 000684	AD 2012 684 S	D 2012 515 S
AD 2012 000685	AD 2012 685 S	D 2012 516 S
AD 2012 000686	AD 2012 686 S	D 2012 517 S
AD 2012 000692	AD 2012 692 S	D 2012 518 S

**DESIGN REGISTERED ACCORDING TO THE
ACCELERATED PROCEDURE**

**CONCORDANCE TABLE OF INTERNATIONAL CLASSIFICATION INDEX
AND PATENTS NUMBERS**

INTERNATIONAL CLASSIFICATION INDEX (51)	NUMBER OF PATENT (11)
09-03	D 2012 519 S

**CONCORDANCE TABLE OF PATENT NUMBERS AND INTERNATIONAL
CLASSIFICATION INDEX**

NUMBER OF PATENT (11)	INTERNATIONAL CLASSIFICATION INDEX (51)
D 2012 519 S	09-03

**CONCORDANCE TABLE OF APPLICATION NUMBERS
AND PATENT NUMBERS**

NUMBER OF APPLICATION (21)	NUMBER OF PATENT (11)
AD 2012 000725	D 2012 519 S

TRADEMARKS

CONCORDANCE TABLE OF REGISTRATION NUMBERS, APPLICATION NUMBERS, PUBLICATION NUMBERS AND BULLETIN NUMBERS

NUMBER OF REGISTRATION (111)	NUMBER OF APPLICATION (210)	NUMBER OF PUBLISHED APPLICATION (260)	NUMBER OF BULLETIN
1	2	3	4
M 2012 23024 R	AM 2012 69079	-	22(362) 2012
M 2012 23025 R	AM 2011 62963	AM 2012 62963 A	14(354) 2012
M 2012 23026 R	AM 2010 57803	AM 2112 57803 A	1(341) 2012
M 2012 23027 R	AM 2010 60310	AM 2012 60310 A	12(352) 2012
M 2012 23028 R	AM 2011 62061	AM 2012 62061 A	13(353) 2012
M 2012 23029 R	AM 2011 62345	AM 2012 62345 A	6(346) 2012
M 2012 23030 R	AM 2011 62346	AM 2012 62346 A	6(346) 2012
M 2012 23031 R	AM 2011 62348	AM 2012 62348 A	6(346) 2012
M 2012 23032 R	AM 2011 62349	AM 2012 62349 A	6(346) 2012
M 2012 23033 R	AM 2011 62462	AM 2012 62462 A	6(346) 2012
M 2012 23034 R	AM 2011 62809	AM 2012 62809 A	6(346) 2012
M 2012 23035 R	AM 2011 62815	AM 2012 62815 A	6(346) 2012
M 2012 23036 R	AM 2011 63407	AM 2012 63407 A	9(349) 2012
M 2012 23037 R	AM 2011 63408	AM 2012 63408 A	9(349) 2012
M 2012 23038 R	AM 2011 63741	AM 2012 63741 A	7(347) 2012
M 2012 23039 R	AM 2011 63773	AM 2012 63773 A	13(353) 2012
M 2012 23040 R	AM 2011 63793	AM 2012 63793 A	13(353) 2012
M 2012 23041 R	AM 2011 63830	AM 2012 63830 A	13(353) 2012
M 2012 23042 R	AM 2011 63872	AM 2012 63872 A	10(350) 2012
M 2012 23043 R	AM 2011 63959	AM 2012 63959 A	11(351) 2012
M 2012 23044 R	AM 2011 64027	AM 2012 64027 A	13(353) 2012
M 2012 23045 R	AM 2011 64105	AM 2012 64105 A	13(353) 2012
M 2012 23046 R	AM 2011 64106	AM 2012 64106 A	13(353) 2012
M 2012 23047 R	AM 2011 64153	AM 2012 64153 A	12(352) 2012
M 2012 23048 R	AM 2011 64155	AM 2012 64155 A	12(352) 2012
M 2012 23049 R	AM 2011 64235	AM 2012 64235 A	12(352) 2012
M 2012 23050 R	AM 2011 64236	AM 2012 64236 A	12(352) 2012
M 2012 23051 R	AM 2011 64240	AM 2012 64240 A	12(352) 2012
M 2012 23052 R	AM 2011 64283	AM 2012 64283 A	12(352) 2012
M 2012 23053 R	AM 2011 64284	AM 2012 64284 A	12(352) 2012
M 2012 23054 R	AM 2011 64372	AM 2012 64372 A	11(351) 2012
M 2012 23055 R	AM 2011 64812	AM 2012 64812 A	13(353) 2012
M 2012 23056 R	AM 2011 64814	AM 2012 64814 A	13(353) 2012
M 2012 23057 R	AM 2011 64815	AM 2012 64815 A	13(353) 2012
M 2012 23058 R	AM 2011 64818	AM 2012 64818 A	13(353) 2012
M 2012 23059 R	AM 2011 64819	AM 2012 64819 A	13(353) 2012
M 2012 23060 R	AM 2011 64844	AM 2012 64844 A	13(353) 2012
M 2012 23061 R	AM 2012 69341	-	22(362) 2012
M 2012 23062 R	AM 2012 69405	-	22(362) 2012
M 2012 23063 R	AM 2012 69305	-	22(362) 2012
M 2012 23064 R	AM 2012 69364	-	22(362) 2012
M 2012 23065 R	AM 2011 62685	AM 2012 62685 A	10(350) 2012
M 2012 23066 R	AM 2011 62686	AM 2012 62686 A	10(350) 2012
M 2012 23067 R	AM 2011 62687	AM 2012 62687 A	10(350) 2012

1	2	3	4
M 2012 23068 R	AM 2011 62688	AM 2012 62688 A	10(350) 2012
M 2012 23069 R	AM 2011 62689	AM 2012 62689 A	10(350) 2012
M 2012 23070 R	AM 2011 62690	AM 2012 62690 A	10(350) 2012
M 2012 23071 R	AM 2011 62819	AM 2012 62819 A	10(350) 2012
M 2012 23072 R	AM 2011 62884	AM 2012 62884 A	11(351) 2012
M 2012 23073 R	AM 2011 63184	AM 2012 63184 A	8(348) 2012
M 2012 23074 R	AM 2011 63392	AM 2012 63392 A	9(349) 2012
M 2012 23075 R	AM 2011 63393	AM 2012 63393 A	9(349) 2012
M 2012 23076 R	AM 2011 63411	AM 2012 63411 A	8(348) 2012
M 2012 23077 R	AM 2011 63463	AM 2012 63463 A	8(348) 2012
M 2012 23078 R	AM 2011 63871	AM 2012 63871 A	13(353) 2012
M 2012 23079 R	AM 2011 63873	AM 2012 63873 A	13(353) 2012
M 2012 23080 R	AM 2011 63979	AM 2012 63979 A	13(353) 2012
M 2012 23081 R	AM 2011 64146	AM 2012 64146 A	11(351) 2012
M 2012 23082 R	AM 2011 64149	AM 2012 64149 A	12(352) 2012
M 2012 23083 R	AM 2011 64508	AM 2012 64508 A	13(353) 2012
M 2012 23084 R	AM 2012 69431	-	22(362) 2012

**CONCORDANCE TABLE OF PUBLICATION NUMBERS
AND APPLICATION NUMBERS**

NUMBER OF PUBLISHED APPLICATION (260)	NUMBER OF APPLICATION (210)	1	2
		1	2
AM 2012 63576 A	AM 2011 63576	AM 2012 65864 A	AM 2012 65864
AM 2012 64021 A	AM 2011 64021	AM 2012 65874 A	AM 2012 65874
AM 2012 64134 A	AM 2011 64134	AM 2012 65875 A	AM 2012 65875
AM 2012 65287 A	AM 2011 65287	AM 2012 65997 A	AM 2012 65997
AM 2012 65288 A	AM 2011 65288	AM 2012 66022 A	AM 2012 66022
AM 2012 65289 A	AM 2011 65289	AM 2012 66079 A	AM 2012 66079
AM 2012 65290 A	AM 2011 65290	AM 2012 66080 A	AM 2012 66080
AM 2012 65291 A	AM 2011 65291	AM 2012 66081 A	AM 2012 66081
AM 2012 65292 A	AM 2011 65292	AM 2012 66082 A	AM 2012 66082
AM 2012 65381 A	AM 2011 65381	AM 2012 66083 A	AM 2012 66083
AM 2012 65393 A	AM 2012 65393	AM 2012 66084 A	AM 2012 66084
AM 2012 65412 A	AM 2011 65412	AM 2012 66087 A	AM 2012 66087
AM 2012 65467 A	AM 2011 65467	AM 2012 66125 A	AM 2012 66125
AM 2012 65468 A	AM 2011 65468	AM 2012 66200 A	AM 2012 66200
AM 2012 65469 A	AM 2011 65469	AM 2012 66202 A	AM 2012 66202
AM 2012 65509 A	AM 2011 65509	AM 2012 66203 A	AM 2012 66203
AM 2012 65569 A	AM 2011 65569	AM 2012 66204 A	AM 2012 66204
AM 2012 65623 A	AM 2011 65623	AM 2012 66205 A	AM 2012 66205
AM 2012 65644 A	AM 2011 65644	AM 2012 66206 A	AM 2012 66206
AM 2012 65741 A	AM 2012 65741	AM 2012 66207 A	AM 2012 66207
AM 2012 65809 A	AM 2012 65809	AM 2012 66208 A	AM 2012 66208
AM 2012 65829 A	AM 2012 65829	AM 2012 66209 A	AM 2012 66209
AM 2012 65830 A	AM 2012 65830	AM 2012 66211 A	AM 2012 66211
AM 2012 65831 A	AM 2012 65831	AM 2012 66246 A	AM 2012 66246
AM 2012 65834 A	AM 2012 65834	AM 2012 66275 A	AM 2012 66275
AM 2012 65835 A	AM 2012 65835	AM 2012 66276 A	AM 2012 66276
AM 2012 65859 A	AM 2012 65859	AM 2012 66483 A	AM 2012 66483
AM 2012 65861 A	AM 2012 65861	AM 2012 66484 A	AM 2012 66484
AM 2012 65862 A	AM 2012 65862	AM 2012 61120 A*	AM 2011 61120
		AM 2012 64026 A*	AM 2011 64026
		AM 2012 64138 A*	AM 2011 64138

**CONCORDANCE TABLE OF INDEX OF GOODS AND/OR SERVICES
AND APPLICATION NUMBERS**

INDEX OF GOODS AND/OR SERVICES (511)	NUMBER OF PUBLISHED APPLICATION (260)	1	2
1	2		
1	AM 2012 65412 A	25	AM 2012 65381 A
1	AM 2012 66200 A	25	AM 2012 65509 A
1	AM 2012 66205 A	25	AM 2012 66087 A
2	AM 2012 66200 A	25	AM 2012 66206 A
2	AM 2012 66205 A	26	AM 2012 66206 A
3	AM 2012 65287 A	27	AM 2012 66206 A
3	AM 2012 65509 A	28	AM 2012 65393 A
3	AM 2012 65809 A	28	AM 2012 66206 A
3	AM 2012 65874 A	29	AM 2012 65861 A
3	AM 2012 65875 A	29	AM 2012 65862 A
3	AM 2012 66022 A	29	AM 2012 66483 A
3	AM 2012 66200 A	30	AM 2012 63576 A
3	AM 2012 66205 A	30	AM 2012 64021 A
3	AM 2012 66275 A	30	AM 2012 65469 A
3	AM 2012 66276 A	30	AM 2012 65861 A
4	AM 2012 65412 A	30	AM 2012 65862 A
4	AM 2012 65569 A	30	AM 2012 66206 A
4	AM 2012 66200 A	30	AM 2012 66484 A
4	AM 2012 66205 A	31	AM 2012 65861 A
5	AM 2012 64021 A	31	AM 2012 65862 A
5	AM 2012 65862 A	32	AM 2012 63576 A
5	AM 2012 65875 A	32	AM 2012 65288 A
5	AM 2012 65997 A	32	AM 2012 65289 A
5	AM 2012 66200 A	32	AM 2012 65290 A
5	AM 2012 66205 A	32	AM 2012 65644 A
5	AM 2012 64026 A*	32	AM 2012 65829 A
6	AM 2012 66206 A	32	AM 2012 65830 A
7	AM 2012 66202 A	32	AM 2012 65831 A
7	AM 2012 66207 A	32	AM 2012 65862 A
8	AM 2012 66206 A	33	AM 2012 63576 A
9	AM 2012 65292 A	33	AM 2012 66206 A
9	AM 2012 65509 A	34	AM 2012 66206 A
12	AM 2012 65291 A	34	AM 2012 66246 A
12	AM 2012 65859 A	35	AM 2012 65381 A
14	AM 2012 65509 A	35	AM 2012 65393 A
14	AM 2012 66206 A	35	AM 2012 65509 A
16	AM 2012 65393 A	35	AM 2012 65623 A
16	AM 2012 66206 A	35	AM 2012 65741 A
18	AM 2012 65509 A	35	AM 2012 66203 A
18	AM 2012 66206 A	35	AM 2012 66208 A
20	AM 2012 65467 A	36	AM 2012 66204 A
20	AM 2012 65468 A	36	AM 2012 66209 A
20	AM 2012 66206 A	37	AM 2012 66203 A
21	AM 2012 65875 A	37	AM 2012 66208 A
21	AM 2012 66206 A	38	AM 2012 65835 A
24	AM 2012 65467 A	38	AM 2012 66079 A
24	AM 2012 66206 A	38	AM 2012 66080 A
		38	AM 2012 66081 A
		38	AM 2012 66082 A
		38	AM 2012 66083 A

1	2
38	AM 2012 66084 A
38	AM 2012 66203 A
38	AM 2012 66208 A
39	AM 2012 66203 A
39	AM 2012 66208 A
41	AM 2012 65741 A
41	AM 2012 65834 A
41	AM 2012 66203 A
41	AM 2012 66208 A
41	AM 2012 66211 A

1	2
41	AM 2012 61120 A*
41	AM 2012 64138 A*
42	AM 2012 66203 A
42	AM 2012 66208 A
43	AM 2012 64134 A
44	AM 2012 65864 A
44	AM 2012 66125 A
45	AM 2012 66203 A
45	AM 2012 66208 A

CONCORDANCE TABLE OF INDEX OF GOODS AND/OR SERVICES
AND NUMBERS OF TRADEMARKS REGISTERED ACCORDING
TO THE ACCELERATED PROCEDURE

INDEX OF GOODS AND/OR SERVICES (511)	NUMBER OF REGISTERED ACCORDING TO THE ACCELERATED PROCEDURE (111)
3	M 2012 23024 R
3	M 2012 23063 R
12	M 2012 23061 R
32	M 2012 23062 R
35	M 2012 23062 R
35	M 2012 23064 R
37	M 2012 23084 R

OFFICIAL BULLETIN OF THE INDUSTRIAL PROPERTY

22(362)

EDITOR-IN-CHIEF: N. Bebrishvili

EDITORS-TRANSLATORS: E. Gabunia

PROOFREADER: L. Chanturia

COMPUTER LAYOUT: M. Ordenidze
K. Svanidze

www.sakpatenti.org.ge

E-mail: info@sakpatenti.org.ge