

NATIONAL INTELLECTUAL PROPERTY
CENTER OF GEORGIA
SAKPATENTI



НАЦИОНАЛЬНЫЙ ЦЕНТР ИНТЕЛЛЕКТУАЛЬНОЙ
СОБСТВЕННОСТИ ГРУЗИИ
САКПАТЕНТИ

OFFICIAL BULLETIN OF THE INDUSTRIAL PROPERTY

**ОФИЦИАЛЬНЫЙ БЮЛЛЕТЕНЬ
ПРОМЫШЛЕННОЙ СОБСТВЕННОСТИ**

4(320)

**2011
TBILISI
ТБИЛИСИ**

INID CODES FOR IDENTIFICATION OF BIBLIOGRAPHIC DATA

INVENTIONS, UTILITY MODELS

- (10) Number of publication for application, which has been examined
- (11) Number of patent and kind of document
- (21) Serial number of application
- (22) Date of filing of the application
- (23) Date of exhibition or the date of the earlier filing and the number of application, if any
- (24) Date from which patent may have effect
- (31) Number of priority application
- (32) Date of filing of priority application
- (33) Code of the country or regional organization allotting priority application number
- (44) Date of publication of application not granted, but examined and number of bulletin
- (45) Date of publication of registered document
- (51) International Patent Classification Index
- (54) Title of the invention
- (57) Abstract
- (60) Number of examined patent document granted by foreign patent office, date from which patent has effect and country code
- (62) Number of the earlier application and in case of divided application, date of filing an application
- (71) Name, surname and address of applicant (country code)
- (72) Name, surname of inventor (country code)
- (73) Name, surname and address of patent owner (country code)
- (74) Name, surname of representative or patent attorney
- (85) Date of commencement of the national phase of International Application
- (86) Number and date of filing of international application
- (87) Number and date of publication of international application

INDUSTRIAL DESIGNS

- (10) Number of publication for application
- (11) Number of patent and kind of document or number of registration
- (15) Date of registration/Date of patent renewal
- (18) Expected expiration date of patent or registration
- (21) Serial number of application
- (22) Date of filing of the application
- (23) Date of exhibition or the date of the earlier filing and the number of application, if any
- (24) Date from which patent may have effect
- (28) Number of industrial designs included in the application
- (30) Data relating to priority (number of application, date of filing of application, two-letter code identifying the authority with whom the priority application was made)
- (31) Number of priority application
- (32) Date of filing of priority application
- (33) Code of the country or regional organization allotting priority application number
- (34) Two-letter code according to WIPO St.3 identifying the authority with which the priority application was made
- (44) Date of publication of industrial design and number of bulletin (the first publication)
- (45) Date of publication of industrial design registered by WIPO and number of bulletin
- (51) International Classification for industrial designs (class and subclass of the Locarno Classification)
- (54) Title of the invention
- (55) Reproduction of the industrial design
- (57) Description of characteristic features of the industrial design including indication of colors
- (62) Number of the earlier application, registration and document number and if available the date of filing an application in case of divided application
- (71) Name, surname and address of applicant (country code)
- (72) Name, surname of creator (country code)
- (73) Name, surname and address of patent owner (country code)
- (74) Name, surname of representative or patent attorney
- (81) Contracting states concerned
 - II designated contracting states according to the 1960 Act
 - III designated contracting states according to the 1999 Act
- (85) Owner's permanent address
- (86) Owner's nationality
- (87) Owner's residence
- (88) State in which the owner has a real and effective industrial or commercial establishment

TRADEMARKS

- (111) – Number of registration
- (151) – Date of registration
- (156) – Date of the renewal
- (181) – Expected expiration date of registration
- (186) – Renewal expiration date of registration
- (141) – Date of cancel of duration of the mark
- (210) – Serial number of application
- (220) – Date of filing of the application
- (230) – Date concerning exhibition
- (260) – Number of application, for which favorable decision of examination about registration has been taken (publication number)
- (310) – Number of the first application
- (320) – Date of filing of the first application
- (330) – Code, identifying national or regional Office where the first application was made
- (511) – International Classification of Goods and Services for the purposes of registration of trade marks and/or list of goods and/or services classified according thereto
- (531) – Description of figurative elements of Trade Marks according to the International Classification of the Figurative Elements of Marks
- (540) – Reproduction of Trade Mark
- (550) – Nature and kind of Trade Mark
- (580) – Date of recording of any kind changes in respect of applications or registrations
- (591) – Information concerning colors claimed
- (731) – Name and address of the applicant
- (732) – Name and address of the holder of the registration
- (740) – Name and address of the representative
- (750) – Address for correspondence
- (770) – Name and address of the previous applicant or holder in case of change in ownership
- (771) – Previous name and address of the applicant or holder in case of change in ownership
- (791) – Name and address of the licensee
- (793) – Indication of conditions and/or restrictions under the license (Type of license, number of license agreement, data of license, data of validity of license)
- (800) – Certain data relating to the international registration of Trade Marks under the Protocol Relating to Madrid Agreement (International registration number)

CODES FOR PUBLICATION IN BULLETIN

- (21) AP 0000 000000 – serial number of application for invention
- (10) AP 0000 0000 A – number of published application for invention (first publication)
- (11) P 0000 0000 B – number of patent for invention (second publication)
- (21) AP1 0000 000000 – number of application for imported patent
- (11) PI 0000 0000 A – number of imported patent (first publication)
- (21) AU 0000 000000 – serial number of application for utility model
- (10) AU 0000 000 U – number of published application for utility model (first publication)
- (11) U 0000 000 Y – number of patent for utility model (second publication)
- (21) AD 0000 000000 – serial number of application for industrial design
- (10) AD 0000 000 S – number of published application for industrial design (first publication)
- (11) D 0000 000 S – number of patent for industrial design (second publication)

INTERNATIONAL PATENT CLASSIFICATION FOR INVENTIONS AND UTILITY MODELS

- SECTION A – HUMAN NECESSITIES
- SECTION B – PERFORMING OPERATIONS; TRANSPORTING
- SECTION C – CHEMISTRY; METALLURGY
- SECTION D – TEXTILES; PAPER
- SECTION E – FIXED CONSTRUCTIONS
- SECTION F – MECHANICAL ENGINEERING; LIGHTING; HEATING; WEAPONS; BLASTING
- SECTION G – PHYSICS
- SECTION H – ELECTRICITY

-
- M – Trade Mark
 - (210) AM 0000 000000 – Serial number of application;
 - (260) AAM 0000 00000 A – Publication number of application;
 - (111) M 0000 00000 R – Number of registration;
 - (111) MMM0000 00000 Rn – Number of renewals, in which n=1,2,3;
 - (111) M 0000 00000 R(P) – Number of registration under partial assignment of rights

МЕЖДУНАРОДНЫЕ КОДЫ ДЛЯ ИДЕНТИФИКАЦИИ БИБЛИОГРАФИЧЕСКИХ ДАННЫХ

ИЗОБРЕТЕНИЯ, ПОЛЕЗНЫЕ МОДЕЛИ

- (10) Номер публикации заявки, прошедшей экспертизу
- (11) Номер патента и код вида
- (21) Номер заявки
- (22) Дата подачи заявки
- (23) Дата выставочного приоритета или дата подачи заявки с более ранним приоритетом и, если возможно, номер заявки
- (24) Дата, с которой начинается действие патента
- (31) Номер приоритетной заявки
- (32) Дата подачи приоритетной заявки
- (33) Код страны или региональной организации, ведомство которой присвоило номер приоритетной заявке
- (44) Дата публикации еще не выданного, но прошедшего экспертизу охранного документа и номер бюллетеня
- (45) Дата публикации патентного документа, прошедшего регистрацию
- (51) Индекс международной патентной классификации
- (54) Наименование изобретения
- (57) Реферат
- (60) Номер охранного документа, прошедшего полную экспертизу, выданный иностранным патентным ведомством, дата начала действия этого охранного документа и код страны
- (62) Номер более ранней заявки и, в случае выделенной заявки, дата подачи заявки
- (71) Имя, фамилия, адрес заявителя (код страны)
- (72) Имя, фамилия изобретателя (код страны)
- (73) Имя, фамилия, адрес патентообладателя (код страны)
- (74) Имя, фамилия представителя или патентного поверенного
- (85) Дата начала действия национальной фазы международной заявки
- (86) Номер и дата подачи международной заявки
- (87) Номер и дата публикации международной заявки

ПРОМЫШЛЕННЫЕ ОБРАЗЦЫ

- (10) Номер публикации заявки, прошедшей экспертизу
- (11) Номер патента и код вида или номер регистрации
- (15) Дата регистрации/дата продления срока действия патента
- (18) Предполагаемая дата окончания срока действия патента или регистрации
- (21) Номер заявки
- (22) Дата подачи заявки
- (23) Дата выставочного приоритета или дата подачи заявки с более ранним приоритетом и, если возможно, номер заявки
- (24) Дата, с которой начинается действие патента
- (28) Количество промышленных образцов, внесенных в заявку
- (31) Номер приоритетной заявки
- (32) Дата подачи приоритетной заявки
- (33) Код страны или региональной организации, ведомство которой присвоило номер приоритетной заявке
- (34) Двухбуквенный код ВОИС в соответствии со стандартом-ST.3 для идентификации органа, где была подана приоритетная заявка
- (44) Дата публикации промышленного образца и номер бюллетеня (первая публикация)
- (45) Дата публикации промышленного образца, прошедшего регистрацию в международном бюро, и номер бюллетеня
- (51) Международная классификация промышленного образца (класс и подкласс Локарнской классификации)
- (54) Наименование промышленного образца
- (55) Изображение промышленного образца
- (57) Описание характерных особенностей промышленного образца, включая цвет
- (62) Номер более ранней заявки регистрации или документа и, в случае выделенной заявки, дата подачи заявки
- (71) Имя, фамилия, адрес заявителя (код страны)
- (72) Имя, фамилия автора (код страны)
- (73) Имя, фамилия, адрес патентообладателя (код страны)
- (74) Имя, фамилия представителя или патентного поверенного
- (81) Соответствующие участвующие страны
II. указанные страны-участницы, согласно акту 1960 года
III. указанные страны-участницы, согласно акту 1999 года;
- (85) Постоянное место жительства владельца
- (86) Гражданство владельца
- (87) Место жительства владельца
- (88) Государство, в котором владелец имеет настоящее и действующее промышленное или торговое производство**

ТОВАРНЫЕ ЗНАКИ

- (111) – Номер регистрации
- (151) – Дата регистрации
- (156) – Дата продления срока регистрации
- (181) – Предполагаемая дата окончания срока регистрации
- (186) – Предполагаемая дата продления срока регистрации
- (141) – Дата аннулирования срока действия регистрации знака
- (210) – Номер заявки
- (220) – Дата подачи заявки
- (230) – Выставочные данные
- (260) – Номер заявки, в отношении которой внесено положительное решение экспертизы о регистрации (номер публикации)
- (310) – Номер первой заявки
- (320) – Дата подачи первой заявки
- (330) – Идентификационный код национального или регионального ведомства или организации, принимающей первую заявку
- (511) – Международная классификация товара и/или услуг для регистрации товарного знака и/или перечень классифицированного товара и/или услуг
- (531) – Описание изобразительного элемента товарного знака в соответствии с Международной классификацией (Венская классификация) изобразительного элемента товарного знака
- (540) – Изображение знака
- (550) – Вид товарного знака
- (580) – Дата внесения записи на все виды изменений, связанные с регистрацией заявки и знака
- (591) – Информация о заявленных цветах
- (731) – Имя и адрес заявителя
- (732) – Имя и адрес владельца
- (740) – Имя и адрес представителя
- (750) – Адрес для переписки
- (770) – Имя и адрес заявителя или владельца до изменений в случае передачи прав
- (771) – Имя и адрес заявителя или владельца до изменений без передачи прав
- (791) – Имя и адрес лицензиата
- (793) – Указания на условия и/или ограничения по лицензии (Вид лицензии, номер лицензионного договора, дата лицензионного договора, дата действия лицензионного договора)
- (800) – Данные регистрации товарных знаков в соответствии с протоколом Мадридского договора о международной регистрации товарных знаков (номер Международной классификации)

КОДЫ ДЛЯ ПУБЛИКАЦИИ В БЮЛЛЕТЕНЕ

- (21) AP 0000 000000 – номер заявки на изобретение;
- (10) AP 0000 0000 A – номер публикации заявки на изобретение (первая публикация);
- (11) P 0000 0000 B – номер патента на изобретение (вторая публикация);
- (21) API 0000 000000 – номер заявки на взносной патент;
- (11) PI 0000 0000 A – номер взносного патента (первая публикация);
- (21) AU 0000 000000 – номер заявки на полезную модель;
- (10) AU 0000 000 U – номер публикации заявки на полезную модель (первая публикация);
- (11) U 0000 000 Y – номер патента на полезную модель (вторая публикация);
- (21) AD 0000 000000 – номер заявки на промышленный образец;
- (10) AD 0000 000 S – номер публикации заявки на промышленный образец (первая публикация);
- (11) D 0000 000 S – номер патента на промышленный образец (вторая публикация)

МЕЖДУНАРОДНАЯ ПАТЕНТНАЯ КЛАССИФИКАЦИЯ ИЗОБРЕТЕНИЙ И ПОЛЕЗНЫХ МОДЕЛЕЙ

- РАЗДЕЛ A – УДОВЛЕТВОРЕНИЕ ЖИЗНЕННЫХ ПОТРЕБНОСТЕЙ ЧЕЛОВЕКА
- РАЗДЕЛ B – РАЗЛИЧНЫЕ ТЕХНОЛОГИЧЕСКИЕ ПРОЦЕССЫ; ТРАНСПОРТИРОВАНИЕ
- РАЗДЕЛ C – ХИМИЯ; МЕТАЛЛУРГИЯ
- РАЗДЕЛ D – ТЕКСТИЛЬ; БУМАГА
- РАЗДЕЛ E – СТРОИТЕЛЬСТВО; ГОРНОЕ ДЕЛО
- РАЗДЕЛ F – МЕХАНИКА; ОСВЕЩЕНИЕ; ОТОПЛЕНИЕ; ДВИГАТЕЛИ И НАСОСЫ; ОРУЖИЕ И БОЕПРИПАСЫ; ВЗРЫВНЫЕ РАБОТЫ
- РАЗДЕЛ G – ФИЗИКА
- РАЗДЕЛ H – ЭЛЕКТРИЧЕСТВО

- M – Trade Mark
- (210) AM 0000 000000 – Номер заявки;
- (260) AAM 0000 00000 A – Номер публикации заявки;
- (111) M 0000 00000 R – Номер регистрации;
- (111) MMM0000 00000 Rn – Номер каждой последующей регистрации, где n=1,2,3;
- (111) M 0000 00000 R(P) – Номер регистрации при передаче частичных прав на товарный знак

LIST OF CODES, IN ALPHABETIC SEQUENCE, AND THE CORRESPONDING (SHORT) NAMES OF STATES, OTHER ENTITIES AND INTERGOVERNMENTAL ORGANIZATIONS
(WIPO STANDARD ST.3)

AD	Andorra				
AE	United Arab Emirates				
AF	Afghanistan				
AG	Antigua and Barbuda				
AI	Anguilla				
AL	Albania				
AM	Armenia				
AN	Netherlands Antilles				
AO	Angola				
AP	African Regional Intellectual Property Organization (ARIPO)				
AR	Argentina				
AT	Austria				
AU	Australia				
AW	Aruba				
AZ	Azerbaijan				
BA	Bosnia and Herzegovina				
BB	Barbados				
BD	Bangladesh				
BE	Belgium				
BF	Burkina Faso				
BG	Bulgaria				
BH	Bahrain				
BI	Burundi				
BJ	Benin				
BM	Bermuda				
BN	Brunei Darussalam				
BO	Bolivia				
BR	Brazil				
BS	Bahamas				
BT	Bhutan				
BV	Bouvet Island				
BW	Botswana				
BX	Benelux Office for Intellectual Property (BOIP)				
BY	Belarus				
BZ	Belize				
CA	Canada				
CD	Democratic Republic of the Congo				
CF	Central African Republic				
CG	Congo				
CH	Switzerland				
CI	Cote d'Ivoire				
CK	Cook Islands				
CL	Chile				
CM	Cameroon				
CN	China				
CO	Colombia				
CR	Costa Rica				
CU	Cuba				
CV	Cape Verde				
CY	Cyprus				
CZ	Czech Republic				
DE	Germany				
DJ	Djibouti				
DM	Dominica				
DO	Dominican Republic				
DZ	Algeria				
EA	Eurasian Patent Organization (EAPO)				
EC	Ecuador				
EE	Estonia				
EG	Egypt				
EH	Western Sahara				
EM	Office for Harmonization in the Internal Market (Trademarks and Designs)(OHIM)				
EP	European Patent Office (EPO)				
ER	Eritrea				
ES	Spain				
ET	Ethiopia				
FI	Finland				
FJ	Fiji				
FK	Falkland Islands (Malvinas)				
FO	Faroe Islands				
FR	France				
GA	Gabon				
GB	United Kingdom				
GC	Patent Office of the Cooperation Council for the Arab States of the Gulf (GCC)				
GD	Grenada				
GG	Guernsey				
GH	Ghana				
GI	Gibraltar				
GT	Guatemala				
GW	Guinea- Bissau				
GY	Guyana				
HK	The Hong Kong Special Administrative Region of the People's Republic of China				
HN	Honduras				
HR	Croatia				
HT	Haiti				
HU	Hungary				
IB	International Bureau of the World Intellectual Property Organization (WIPO)				
ID	Indonesia				
IE	Ireland				
IL	Israel				
IM	Isle of Man				
IN	India				
IQ	Iraq				
ID	Indonesia				
IE	Ireland				
IL	Israel				
IM	Isle of Man				
IN	India				
IQ	Iraq				
IR	Iran (Islamic Republic of)				
IS	Iceland				
IT	Italy				
JE	Jersey				
JM	Jamaica				
JO	Jordan				
JP	Japan				
KE	Kenya				
KG	Kyrgyzstan				
KH	Cambodia				
KI	Kiribati				
KM	Saint Kitts and Nevis				
KP	Democratic People's Republic of Korea				
KR	Republic of Korea				
KW	Kuwait				
KY	Cayman Islands				
KZ	Kazakhstan				
LA	Lao People's Democratic Republic				
LB	Lebanon				
LC	Saint Lucia				
LI	Liechtenstein				
LK	Sri Lanka				
LR	Liberia				
LS	Lesotho				
LT	Lithuania				
LU	Luxembourg				
LV	Latvia				
LY	Libyan Arab Jamahiriya				
MA	Morocco				
MC	Monaco				
MD	Republic of Moldova				
ME	Montenegro				
MG	Madagascar				
MK	The former Yugoslav Republic of Macedonia				
ML	Mali				
MM	Myanmar				
MN	Mongolia				
MO	Macao				
MP	Northern Mariana Islands				
MR	Mauritania				
MS	Montserrat				
MT	Malta				
MU	Mauritius				
MV	Maldives				
MW	Malawi				
MX	Mexico				
MY	Malaysia				
MZ	Mozambique				
NA	Namibia				
NE	Niger				
NG	Nigeria				
NI	Nicaragua				
NL	Netherlands				
NO	Norway				
NP	Nepal				
NR	Nauru				
NZ	New Zealand				
OA	African Intellectual Property Organization (OAPI)				
OM	Oman				
PA	Panama				
PE	Peru				
PG	Papua New Guinea				
PH	Philippines				
PK	Pakistan				
PL	Poland				
PT	Portugal				
PW	Palau				
PY	Paraguay				
QA	Qatar				
QZ	Community Plant Variety Office (European Community) (CPVO)				
RO	Romania				
RS	Serbia				
RU	Russian Federation				
RW	Rwanda				
SA	Saudi Arabia				
SB	Solomon Islands				
SC	Seychelles				
SD	Sudan				
SG	Singapore				
SH	Saint Helena				
SI	Slovenia				
SK	Slovakia				
SL	Sierra Leone				
SM	San Marino				
SN	Senegal				
SO	Somalia				
SR	Suriname				
ST	Sao Tome and Principe				
SV	El Salvador				
SY	Syrian Arab Republic				
SZ	Swaziland				
TC	Turks and Caicos Islands				
TD	Chad				
TG	Togo				
TH	Thailand				
TJ	Tajikistan				
TL	Timor-Leste				
TM	Turkmenistan				
TN	Tunisia				
TO	Tonga				
TR	Turkey				
SE	Sweden				
TT	Trinidad and Tobago				
TV	Tuvalu				
TW	Taiwan, Province of China				
TZ	United Republic of Tanzania				
UA	Ukraine				
UG	Uganda				
US	United States of America				
UY	Uruguay				
UZ	Uzbekistan				
VA	Holy See				
VC	Saint Vincent and the Grenadines				
VE	Venezuela				
VG	Virgin Islands (British)				
VN	Viet Nam				
VU	Vanuatu				
WO	World Intellectual Property Organization (WIPO)				
WS	Samoa				
XN	Nordic Patent Institute (NPI)				
YE	Yemen				
ZA	South Africa				
ZM	Zambia				
ZW	Zimbabwe				

**NATIONAL INTELLECTUAL PROPERTY CENTER OF GEORGIA
SAKPATENTI**

**НАЦИОНАЛЬНЫЙ ЦЕНТР ИНТЕЛЛЕКТУАЛЬНОЙ СОБСТВЕННОСТИ ГРУЗИИ
САКПАТЕНТИ**

**OFFICIAL BULLETIN
OF THE INDUSTRIAL PROPERTY**

**ОФИЦИАЛЬНЫЙ БЮЛЛЕТЕНЬ
ПРОМЫШЛЕННОЙ СОБСТВЕННОСТИ**

4(320)

**INVENTIONS
ИЗОБРЕТЕНИЯ**

**UTILITY MODELS
ПОЛЕЗНЫЕ МОДЕЛИ**

**INDUSTRIAL DESIGNS
ПРОМЫШЛЕННЫЕ ОБРАЗЦЫ**

**TRADEMARKS
ТОВАРНЫЕ ЗНАКИ**

DATE OF PUBLICATION **25.02.2011** ДАТА ПУБЛИКАЦИИ

CONTENTS

PUBLISHED TITLES OF PROTECTION	4
INVENTIONS	
▪ Patents for inventions	5
UTILITY MODELS	
▪ Patents for utility models	7
INDUSTRIAL DESIGNS	
▪ Patents for industrial designs	9
▪ Designs, which have been registered with the International Bureau	10
TRADEMARKS	
▪ Applications filed under the national procedure, laid open for the purpose of taking patent granting decision	26
▪ Registered Trademarks	33
▪ Trademarks registered according to the accelerated procedure	37
▪ International trademarks laid open for the purpose of taking protection granting decisions	40
▪ International trademarks protected in Georgia	63
OFFICIAL NOTIFICATIONS	
▪ PATENTS	68
▪ TRADEMARKS	70
CLASSIFICATION INDEXES	
▪ INVENTIONS	83
▪ UTILITY MODELS	84
▪ INDUSTRIAL DESIGNS	85
▪ TRADEMARKS	87

СОДЕРЖАНИЕ

ОПУБЛИКОВАННЫЕ ОБЪЕКТЫ	4
ИЗОБРЕТЕНИЯ	
▪ Патенты на изобретения	5
ПОЛЕЗНЫЕ МОДЕЛИ	
▪ Патенты на полезные модели	7
ПРОМЫШЛЕННЫЕ ОБРАЗЦЫ*	
▪ Патенты на промышленные образцы	9
▪ Дизайны зарегистрированные в международном бюро	10
ТОВАРНЫЕ ЗНАКИ*	
▪ Заявки, поданные согласно национальной процедуре, по которым вынесено решение о регистрации	26
▪ Зарегистрированные Товарные знаки	33
▪ Товарные знаки зарегистрированные по ускоренной процедуре	37
▪ Международные товарные знаки, по которым вынесены решения о предоставлении охраны	40
▪ Международные товарные знаки, охраняемые в Грузии	63
ОФИЦИАЛЬНЫЕ ИЗВЕЩЕНИЯ*	
▪ ПАТЕНТЫ	68
▪ ТОВАРНЫЕ ЗНАКИ	70
СИСТЕМАТИЧЕСКИЕ УКАЗАТЕЛИ	
▪ ИЗОБРЕТЕНИЯ	83
▪ ПОЛЕЗНЫЕ МОДЕЛИ	84
▪ ПРОМЫШЛЕННЫЕ ОБРАЗЦЫ	85
▪ ТОВАРНЫЕ ЗНАКИ	87

* Информация представлена только на английском языке

PUBLISHED TITLES OF PROTECTION
ОПУБЛИКОВАННЫЕ ОБЪЕКТЫ

INVENTIONS

ИЗОБРЕТЕНИЯ

▪ **PATENTS:**

ПАТЕНТЫ:
5166-5169

UTILITY MODELS

ПОЛЕЗНЫЕ МОДЕЛИ

▪ **PATENTS:**

ПАТЕНТЫ:
1646-1650

INDUSTRIAL DESIGNS

ПРОМЫШЛЕННЫЕ ОБРАЗЦЫ

▪ **PATENTS:**

ПАТЕНТЫ:
451-453

▪ **DESIGNS, WHICH HAVE BEEN REGISTERED WITH THE INTERNATIONAL BUREAU:**

ДИЗАЙНЫ ЗАРЕГИСТРИРОВАННЫЕ В МЕЖДУНАРОДНОМ БЮРО:

72649; 72733; 73389; 73616; 73656; 73714; 73728; 74244; 74247; 74259; 74408, 74409; 74412-74415;
74419; 74420; 74422; 74429-74433; 74443; 74456; 74468, 74469; 74473; 74475; 74516; 74546, 74547;
74560; 74588, 74589; 74600

TRADEMARKS

ТОВАРНЫЕ ЗНАКИ

▪ **APPLICATIONS FILED UNDER THE NATIONAL PROCEDURE, LAID OPEN FOR THE PURPOSE OF TAKING PATENT GRANTING DECISION:**

ЗАЯВКИ, ПОДАННЫЕ СОГЛАСНО НАЦИОНАЛЬНОЙ ПРОЦЕДУРЕ, ПО КОТОРЫМ ВЫНЕСЕНО РЕШЕНИЕ
О РЕГИСТРАЦИИ:

57795, 57796; 57962-57964; 57985; 57988; 58078; 58157; 58161, 58162; 58165; 58230-58241; 58244;
58282; 58284, 58285, 58307; 58360, 58361, 58367; 58373, 58376-58382; 58399-58402; 58404, 58405;
58471

▪ **REGISTERED TRADEMARKS:**

ЗАРЕГИСТРИРОВАННЫЕ ТОВАРНЫЕ ЗНАКИ:
21130-21167

▪ **TRADEMARKS REGISTERED ACCORDING TO THE ACCELERATED PROCEDURE:**

ТОВАРНЫЕ ЗНАКИ ЗАРЕГИСТРИРОВАННЫЕ ПО УСКОРЕННОЙ ПРОЦЕДУРЕ :
21115-21129

▪ **INTERNATIONAL TRADEMARKS LAID OPEN FOR THE PURPOSE OF TAKING PROTECTION GRANTING DECISIONS:**

МЕЖДУНАРОДНЫЕ ТОВАРНЫЕ ЗНАКИ, ПО КОТОРЫМ ВЫНЕСЕНЫ РЕШЕНИЯ О ПРЕДОСТАВЛЕНИИ ОХРАНЫ:

56013; 57321; 57375; 57510; 57557; 57569; 57614; 57762; 57822; 57863; 57882; 57893; 57940, 57941;
57944; 58050-58054; 58060; 58063-58070; 58106; 58120-58130; 58134-58136; 581192-58198; 58200,
58201; 58203-58218; 58221-58225; 58255; 58261-58267; 58269-58275; 58291, 58292; 58394;
58296-58306; 58309, 58310; 58315; 58317-58320; 58322-58329; 58354-58359; 58362, 58363; 58368,
58369; 58371, 58372; 58449-58454; 58456-58461; 58474; 58495-58514; 58532-58537; 58541; 58543,
58544; 58546-58549; 58551; 58597-58599; 58602; 58604; 58646-58650; 58652, 58653

▪ **INTERNATIONAL TRADEMARKS PROTECTED IN GEORGIA:**

МЕЖДУНАРОДНЫЕ ТОВАРНЫЕ ЗНАКИ, ОХРАНЯЕМЫЕ В ГРУЗИИ:

53693; 53784; 56610; 56612-56619; 56662-56673; 56701-56704; 56706-56713; 56716, 56717; 56939;
57181, 57182; 57186-57194; 57197-57199; 57232-57239; 57241; 57244-57249; 57284; 57299-57304;
57306-57312

PATENTS FOR INVENTIONS

ПАТЕНТЫ НА ИЗОБРЕТЕНИЯ

PART A

A 43

- (11) P 2011 5167 B** **(51) Int. Cl. (2006)**
A 43 B 7/12
A 43 B 13/16
(44) 17(309)/2010
- (10) AP 2010 8705 A
(21) AP 2003 008705
(22) 2003 09 18
(24) 2003 09 18
(31) PD2002A000246
(32) 2002 09 24
(33) IT
(21) AP 2003 008705 (22) 2003 09 18
(31) PD2002A000246
(32) 2002 09 24
(33) IT
(73) GEOX S.P.A. (IT)
Via Feltrina Centro 16, I-31044 Montebelluna,
Località Biadene - (Treviso) (IT)
- (72) POLEGATO MORETTI, Mario (IT)
(74) Alexander Mikadze
(85) 2005 03 18
(86) PCT/EP2003/010395, 2003 09 18
(54) **WATERPROOF AND BREATHABLE
SOLE FOR SHOES, AND SHOE
MANUFACTURED WITH SUCH SOLE**

- (11) P 2011 5167 B** **(51) Int. Cl. (2006)**
A 43 B 7/12
A 43 B 13/16
(44) 17(309)/2010
- (10) AP 2010 8705 A
(21) AP 2003 008705
(22) 2003 09 18
(24) 2003 09 18
(31) PD2002A000246
(32) 2002 09 24
(33) IT
(71) ДЖЕОКС С. П. А. (ИТ)
(72) Марио Полегато Моретти (ИТ)
(74) Александр Микадзе
(85) 2005 03 18
(86) PCT/EP2003/010395, 2003 09 18
(54) **ВОДОНЕПРОНИЦАЕМАЯ И ВОЗДУ-
ХОПРОНИЦАЕМАЯ ОБУВНАЯ
ПОДОШВА И ОБУВЬ, ИЗГОТОВЛЕН-
НАЯ С ПРИМЕНЕНИЕМ ЭТОЙ
ПОДОШВЫ**

A 61

- (11) P 2011 5169 B** **(51) Int. Cl. (2006)**
A 61 K 36/00
A 61 K 9/06
(44) 15(307)/2010
- (10) AP 2010 10924 A
(21) AP 2008 010924
(22) 2008 10 02
(24) 2008 10 02
(73) Nino Pailodze (GE)
III mas., I kvart., korp. "g", b. 53, 0182,
Tbilisi (GE)
(72) Nino Pailodze (GE)
(54) **OINTMENT**

- (11) P 2011 5169 B** **(51) Int. Cl. (2006)**
A 61 K 36/00
A 61 K 9/06
(44) 15(307)/2010
- (10) AP 2010 10924 A
(21) AP 2008 010924
(22) 2008 10 02
(24) 2008 10 02
(73) Нино Пайлодзе (GE)
(72) Нино Пайлодзе (GE)
(54) **МАЗЬ**

PART B

B 65

- (11) P 2011 5168 B** **(51) Int. Cl. (2006)**
B 65 D 83/04
(44) 15(307)/2010
- (10) AP 2010 10681 A
(21) AP 2006 010681
(22) 2006 09 26
(24) 2006 09 26
(31) P0500919
(32) 2005 10 05
(33) HU
(73) CHINOIN GYOGYSZER ES VEGYESZETI
TERMEKEK GYARA ZRT (HU)
Tó u. 1-5, H-1045 Budapest (HU)
(72) ERDELYI, Zoltán (HU).
(74) Khatuna Imnadze
(85) 2008 05 05
(86) PCT/HU2006/000083, 2006 09 26

(54) **DEVICE FOR PACKAGING AND DISPENSING OF SOLID SHAPED BODIES, ESPECIALLY ORAL TABLETS OR/AND CAPSULES**

(11) P 2011 5168 B (51) Int. Cl. (2006)
B 65 D 83/04

(10) AP 2010 10681 A (44) 15(307)/2010
(21) AP 2006 010681
(22) 2006 09 26
(24) 2006 09 26
(31) P0500919
(32) 2005 10 05
(33) HU
(73) ХИНОИН ДЪЕДЪСЕР ЭШ ВЕДЪЕСИТИ
ТЕРМЕКЕК ДЪЯРА РТ (HU)
(72) Золтан Эрдеи (HU)
(74) Хатуна Имнадзе
(85) 2008 05 05
(86) PCT/HU2006/000083, 2006 09 26
(54) **УСТРОЙСТВО ДЛЯ ХРАНЕНИЯ И РАЗДАЧИ ТВЕРДЫХ ФАСОННЫХ ТЕЛ, В ЧАСТНОСТИ ОРАЛЬНЫХ ТАБЛЕТОК И/ИЛИ КАПСУЛ**

POLENZANI, Lorenzo (IT);
MANGANO, Giordina (IT);
GARRONE, Beatrice (IT);
GUGLIELMOTTI, Angelo (IT)

(74) Liliana Darakhvelidze
(85) 2009 02 13
(86) PCT/EP2007/055901, 2007 06 14
(54) **2-ARYLINDOLE DERIVATIVES AS mPGES-I INHIBITORS**

(11) P 2011 5166 B (51) Int. Cl. (2006)
C 07 D 209/08
C 07 D 209/10
C 07 D 209/12
C 07 D 401/04
A 61 K 31/40
A 61 K 31/435
A 61 P 35/00
A 61 P 29/00

(10) AP 2010 11112 A (44) 15(307)/2010
(21) AP 2007 011112
(22) 2007 06 14
(24) 2007 06 14
(31) MI2006A 001368
(32) 2006 07 14
(73) АЗЪЕНДЕ КИМИЧЕ РЫОНИТЕ
АНДЖЕЛИНИ ФРАНЧЕСКО
А.К.Р.А.Ф. С.П.А (IT)
(72) Мария Алессандра Алиси (IT);
Никола Каззолла (IT);
Барбара Гарофало (IT);
Гвидо Фурлотти (IT);
Катерина Мауджери (IT);
Розелла Омбратто (IT);
Изабелла Колетта (IT);
Лоренцо Полензани (IT);
Джиорджина Мангано (IT);
Беатриче Гарроне (IT);
Анджело Гуглиелмотти (IT)
(74) Лилиана Дарахвелидзе
(85) 2009 02 13
(86) PCT/EP2007/055901, 2007 06 14
(54) **ПРОИЗВОДНЫЕ 2-АРИЛИНДОЛА КАК ИНГИБИТОРЫ mPGRS-1**

PART C

C 07

(11) P 2011 5166 B (51) Int. Cl. (2006)
C 07 D 209/08
C 07 D 209/10
C 07 D 209/12
C 07 D 401/04
A 61 K 31/40
A 61 K 31/435
A 61 P 35/00
A 61 P 29/00

(10) AP 2010 11112 A (44) 15(307)/2010
(21) AP 2007 011112
(22) 2007 06 14
(24) 2007 06 14
(31) MI2006A 001368
(32) 2006 07 14
(33) IT
(73) AZIENDE CHIMICHE RIUNITE ANGELINI
FRANCESCO A.C.R.A.F. S.p.A. (IT)
Viale Amelia, 70, I-00181 Roma (IT)
(72) ALISI, Maria Alessandra (IT);
CAZZOLLA, Nicola (IT);
GAROFALO, Barbara (IT);
FURLOTTI, Guido (IT);
MAUGERI, Caterina (IT);
OMBRATO, Rosella (IT);
COLETTA, Isabella (IT);

PATENTS FOR UTILITY MODELS

ПАТЕНТЫ НА ПОЛЕЗНЫЕ МОДЕЛИ

PART A

A 45

- (11) U 2011 1647 Y (51) Int. Cl. (2006)
A 45 D 26/00
(10) AU 2010 11611 U (44) 19(311)/2010
(21) AU 2009 011611
(22) 2009 12 21
(24) 2009 12 21
(73) Revaz Javakhishvili (GE)
Nutsubidzis perd., IV mkr., nakv. 69, 0183,
Tbilisi (GE);
George Javakhishvili (GE)
Nutsubidzis perd., IV mkr., nakv. 69, 0183,
Tbilisi (GE)
(72) Revaz Javakhishvili (GE);
George Javakhishvili (GE)
(54) **DEVICE FOR EPILATION**

- (11) U 2011 1647 Y (51) Int. Cl. (2006)
A 45 D 26/00
(10) AU 2010 11611 U (44) 19(311)/2010
(21) AU 2009 011611
(22) 2009 12 21
(24) 2009 12 21
(73) Реваз Джавахишвили (GE);
Георгий Джавахишвили (GE)
(72) Реваз Джавахишвили (GE);
Георгий Джавахишвили (GE)
(54) **УСТРОЙСТВО ДЛЯ ЭПИЛЯЦИИ**

A 47

- (11) U 2011 1649 Y (51) Int. Cl. (2006)
A 47 D 9/00
(10) AU 2010 11310 U (44) 5(297)/2010
(21) AU 2009 011310
(22) 2009 06 15
(24) 2009 06 15
(73) George Goguadze (GE)
Sop. Tkhinvala, 3307, Tbilisi (GE)
(72) George Goguadze (GE)
(54) **CRIB**
- (11) U 2011 1649 Y (51) Int. Cl. (2006)
A 47 D 9/00
(10) AU 2010 11310 U (44) 5(297)/2010
(21) AU 2009 011310

- (22) 2009 06 15
(24) 2009 06 15
(73) Георгий Гогуадзе (GE)
(72) Георгий Гогуадзе (GE)
(54) **ДЕТСКАЯ КРОВАТЬ**

PART E

E 02

- (11) U 2011 1646 Y (51) Int. Cl. (2006)
E 02 B 3/00
(10) AU 2010 11583 U (44) 19(311)/2010
(21) AU 2009 011583
(22) 2009 12 01
(24) 2009 12 01
(73) Roland Zhorzholiani (GE)
Bogdan Khmelnitski St. 17v, ap. 40, 0121,
Tbilisi (GE)
(72) Roland Zhorzholiani (GE)
(54) **CONSTRUCTION FOR REGULATION
OF RIVER-BED**

- (11) U 2011 1646 Y (51) Int. Cl. (2006)
E 02 B 3/00
(10) AU 2010 11583 U (44) 19(311)/2010
(21) AU 2009 011583
(22) 2009 12 01
(24) 2009 12 01
(73) Роланд Жоржوليани (GE)
(72) Роланд Жоржوليани (GE)
(54) **СООРУЖЕНИЕ ДЛЯ РЕГУЛИРОВА-
НИЯ РУСЛА РЕКИ**

-
- (11) U 2011 1648 Y (51) Int. Cl. (2006)
E 02 D 29/02
(10) AU 2010 11313 U (44) 19(311)/2010
(21) AU 2009 011313
(22) 2009 06 16
(24) 2009 06 16
(73) Roland Zhorzholiani (GE)
Bogdan Khmelnitski St. 17v, ap. 40, 0121,
Tbilisi (GE)
(72) Roland Zhorzhorliani (GE)
(54) **ANTI-AVALANCHE AND ANTI
ROCKSLIDE STRUCTURE**

- (11) U 2011 1648 Y (51) Int. Cl. (2006)
E 02 D 29/02
(10) AU 2010 11313 U (44) 19(311)/2010
(21) AU 2009 011313
(22) 2009 06 16
(24) 2009 06 16
(73) Роланд Жоржолиани (GE)
(72) Роланд Жоржолиани (GE)
(54) ПРОТИВОЛАВИННОЕ И ПРОТИВО-
ОПОЛЗНЕВОЕ СООРУЖЕНИЕ
-

PART G

G 06

- (11) U 2011 1650 Y (51) Int. Cl. (2006)
G 06 Q 20/00
(10) AU 2010 10890 U (44) 19(311)/2010
(21) AU 2007 010890
(22) 2007 08 28
(24) 2007 08 28
(73) URBIS TELECOM CORPORATION (GB)
British Virgin Islands, Road Town, Tortola
1000, 90 Main Street (GB)
(72) AHMEDZADE, Bahram Kamal oglu (AZ)
(74) Vakhtang Torotadze
(85) 2008 09 08
(86) PCT/AZ2007/000006, 2007 08 28
(54) METHOD AND SYSTEM FOR
PROCESSING CREDITS FOR USE BY
SUBSCRIBERS OF COMMUNICATION
NETWORKS

- (11) U 2011 1650 Y (51) Int. Cl. (2006)
G 06 Q 20/00
(10) AU 2010 10890 U (44) 19(311)/2010
(21) AU 2007 010890
(22) 2007 08 28
(24) 2007 08 28
(73) УРБИС ТЕЛЕКОМ КОРПОРЕЙШН (GB)
(72) Бахрам Камал оглы Ахмедзаде (AZ)
(74) Вахтанг Торотадзе
(85) 2008 09 08
(86) PCT/AZ2007/000006, 2007 08 28
(54) СПОСОБ ОБРАБОТКИ КРЕДИТОВ,
ПРЕДНАЗНАЧЕННЫХ ДЛЯ АБОНЕН-
ТОВ КОММУНИКАЦИОННОЙ СЕТИ
-

PATENT FOR INDUSTRIAL DESIGN

ПАТЕНТ НА ПРОМЫШЛЕННЫЙ ОБРАЗЕЦ

(11) D 2011 453 S **(51) 09-05**
(10) AD 2010 599 S (44) 19(311)/2010
(21) AD 2010 000599
(22) 2010 04 29
(24) 2010 04 29
(18) 2015 04 29
(28) 3
(73) Alexander Kavtaradze (GE)
Varketili 3, I mkr., korp. 18, b. 80, 0163,
Tbilisi (GE)
(72) Alexander Kavtaradze (GE)
(54) **PACK FOR PAPER NAPKINS**

(11) D 2011 453 S **(51) 09-05**
(10) AD 2010 599 S (44) 19(311)/2010
(21) AD 2010 000599
(22) 2010 04 29
(24) 2010 04 29
(18) 2015 04 29
(28) 3
(73) Александр Кавтарадзе (GE)
(72) Александр Кавтарадзе (GE)
(54) **УПАКОВКА БУМАЖНЫХ САЛФЕТОК**

(11) D 2011 451 S **(51) 9-07**
(10) AD 2010 594 S (44) 19(311)/2010
(21) AD 2010 000594
(22) 2010 03 09
(24) 2010 03 09
(18) 2015 03 09
(28) 2
(31) 2009502816
(32) 2009 10 13
(33) RU
(73) PRIORITY CLUB INC. (VG)
Geneva Place, Waterfront Drive, P/O Box
3469, Road Town, Tortola (VG)
(72) Andrey Vasiljevich Strelets (RU)
(74) Tamaz Shilakadze
(54) **MEANS FOR CLOSING BOTTLES**

(11) D 2011 451 S **(51) 9-07**
(10) AD 2010 594 S (44) 19(311)/2010
(21) AD 2010 000594
(22) 2010 03 09
(24) 2010 03 09
(18) 2015 03 09
(28) 2
(31) 2009502816

(32) 2009 10 13
(33) RU
(73) ПРАЙОРИТИ КЛАБ ИНК. (VG)
(72) Андрей Васильевич Стрелец (RU)
(74) Тамаз Шилакадзе
(54) **УКУПОРОЧНОЕ СРЕДСТВО ДЛЯ
БУТЫЛКИ**

(11) D 2011 452 S **(51) 12-07**
(10) AD 2010 597 S (44) 19(311)/2010
(21) AD 2010 000597
(22) 2010 04 19
(24) 2010 04 19
(18) 2015 04 19
(28) 2
(73) Pantiko Tordia (GE)
Ak. Tsereteli Ave. 12a, ap. 35, 0154,
Tbilisi (GE)
(72) Pantiko Tordia (GE)
(54) **LIGHT CIVIL AIRPLANE OF
BUSINESS-CLASS**

(11) D 2011 452 S **(51) 12-07**
(10) AD 2010 597 S (44) 19(311)/2010
(21) AD 2010 000597
(22) 2010 04 19
(24) 2010 04 19
(18) 2015 04 19
(28) 2
(73) Пантико Тордия (GE)
(72) Пантико Тордия (GE)
(54) **ЛЕГКИЙ ГРАЖДАНСКИЙ САМОЛЕТ
БИЗНЕС-КЛАССА**

**DESIGNS, WHICH HAVE BEEN REGISTERED WITH THE INTERNATIONAL
BUREAU CLAIMING PRIORITY ON THE TERRITORY OF GEORGIA**
(IN ACCORDANCE WITH THE ACT OF HAGUE AGREEMENT OF 1960 AND/OR ACT
OF GENEVA AGREEMENT OF 1999)

ДИЗАЙНЫ, КОТОРЫЕ ЗАРЕГИСТРИРОВАНЫ В МЕЖДУНАРОДНОМ БЮРО С ИСТРЕБОВАНИЕМ
ПРИОРИТЕТА НА ТЕРРИТОРИИ ГРУЗИИ

(В СООТВЕТСТВИИ С АКТОМ ГААГСКОГО СОГЛАШЕНИЯ 1960 г. И/ИЛИ АКТОМ ЖЕНЕВСКОГО СОГЛАШЕНИЯ 1999 г.)

- (11) DM/072649 (51) 15-05
 (15) 2009 10 29
 (45) 2010/09 (2010 10 31)
 (22) 2009 10 29
 (28) 5
 (30) 29.10.2010
 (73) ALFRED KÄRCHER GMBH & CO. KG
 Alfred-Kärcher-Str. 28-40, 71364 Winnenden (DE)
 (85) EM
 (86) DE,EM
 (87) DE,EM
 (88) DE,EM
 (81) II. KP, MA, MC, ME. III. BA, CH, EG, EM,
 GE, HR, LI, MD, MK, MN, OM, TR
 (54) 1.-3. Vacuum cleaners; 4.-5. Parts of vacuum
 cleaners
 (55)

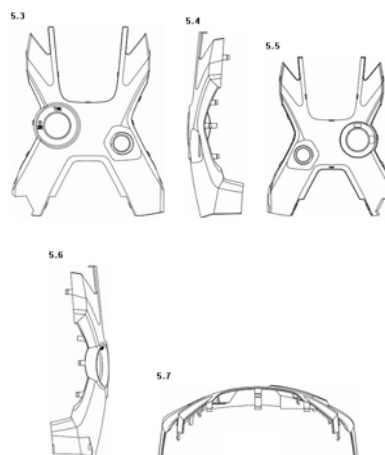
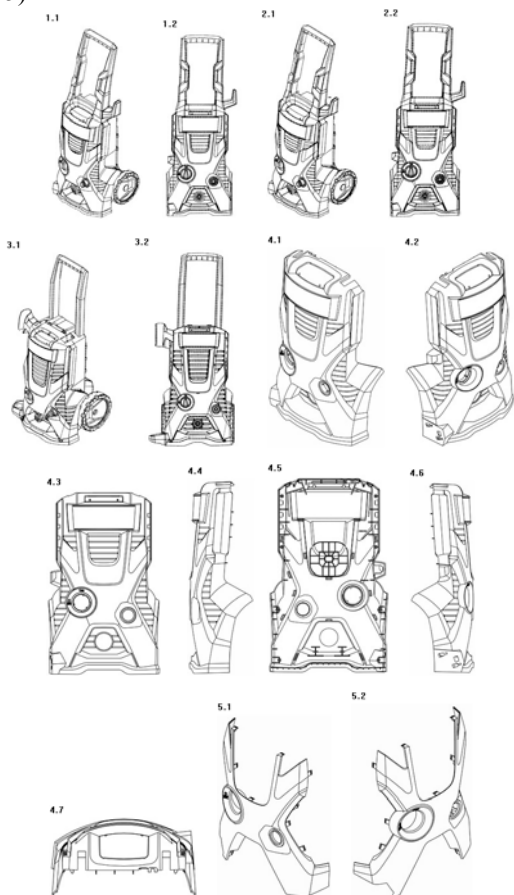

- (11) DM/072733 (51) 15-05
 (15) 2009 11 26
 (45) 2010/10 (2010 11 30)
 (22) 2009 11 26
 (28) 4
 (73) ALFRED KÄRCHER GMBH & CO. KG
 Alfred-Kärcher-Str. 28-40, 71364
 Winnenden (DE)
 (85) EM
 (86) DE,EM
 (87) DE,EM
 (88) DE,EM
 (81) II. KP, MA, MC, ME. III. BA, CH, EG, EM,
 GE, HR, LI, MD, MK, MN, OM, TR
 (54) 1-2. High pressure cleaners (parts of);
 3-4. Vacuum cleaners (parts of)
 (55)

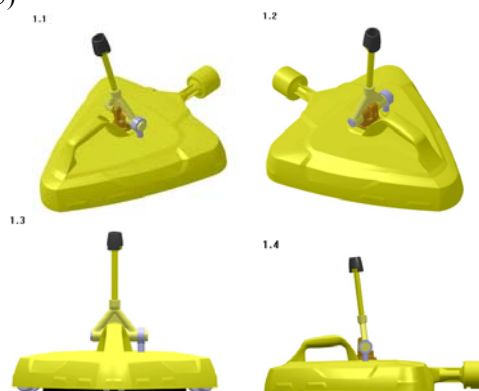

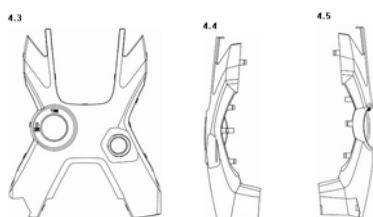
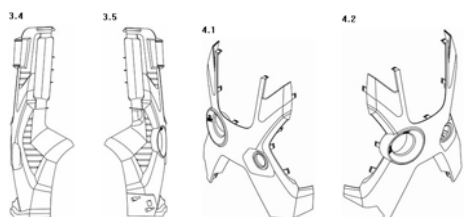
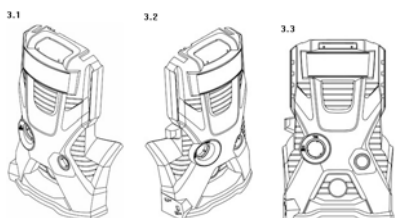
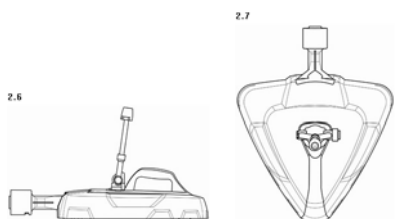
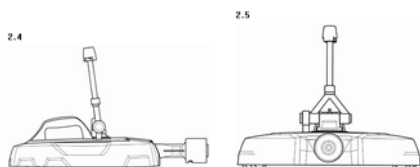
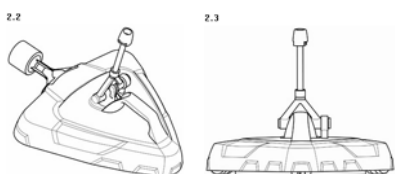
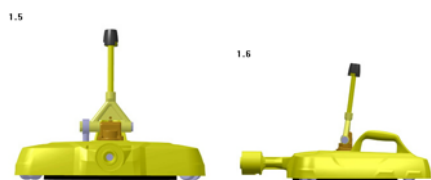

(11) DM/073389 (51) 01-01
 (15) 2010 04 06
 (45) 2010/09 (2010 10 31)
 (22) 2010 04 06
 (28) 1
 (73) BOLȘACOV DMITRII
 Str. Alecu Russo nr. 55, ap. 126, MD-2044
 Chișinău (MD)
 (85) MD
 (86) MD
 (87) MD
 (88) MD
 (81) III. AM, BA, CH, EM, GE, HR, KG, MD, RS,
 TR, UA
 (72) BOLSACOV Dmitrii
 Str. Alecu Ruso nr. 55, ap. 126, MD-2044
 Chisinau
 (54) 1. Biscuit
 (55)



(11) DM/073616 (51) 07-01
 (15) 2010 04 25
 (45) 2010/09 (2010 10 31)
 (22) 2010 04 25
 (28) 5
 (73) BHS TABLETOP AG
 Ludwigsmuehle 1, 95100 Selb (DE)
 (86) DE,EM
 (87) DE,EM
 (81) II. BZ, KP, MA, MC, ME, SR. III. AL, AM,
 BA, BW, CH, EG, EM, GE, GH, HR, IS, KG,
 LI, MD, MK, MN, NA, OA, OM, RS, SG, ST,
 SY, TR, UA
 (72) Christian Haas, Jahnstrasse 31, 80469
 München
 (54) 1. Dish; 2. Bowl; 3. Plate; 4. Square plate;
 5. Soup plate
 (55)



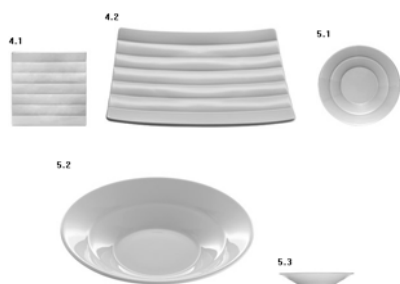

- (11) DM/073656 (51) 10-05, 06
- (15) 2010 05 05
- (45) 2010/10 (2010 11 30)
- (22) 2010 05 05
- (28) 2
- (30) N1, 2: 11.04.2010, LIGHT+BUILDING 2010, Frankfurt, Germany
- (73) OLYMPIA ELECTRONICS N.LAKASAS – P.ARVANITIDIS S.A. 72 klm Old National Road Thessalonikis-Katerinis, GR-600 61 Kolindros, Pieria (GR)
- (86) GR,EM
- (87) GR,EM
- (88) GR,EM
- (81) II. MA, ME. III. AL, BA, EG, EM, GE, HR, MD, MK, RS, TR, UA
- (72) Nikolaos Lakasas, 72 klm Old National Road, Thessalonikis - Katerinis, GR-600 61 Kolindros-Pieria
- (54) 1. Siren and beacon for fire detection;
2. Fire extinguishing panel
- (55)

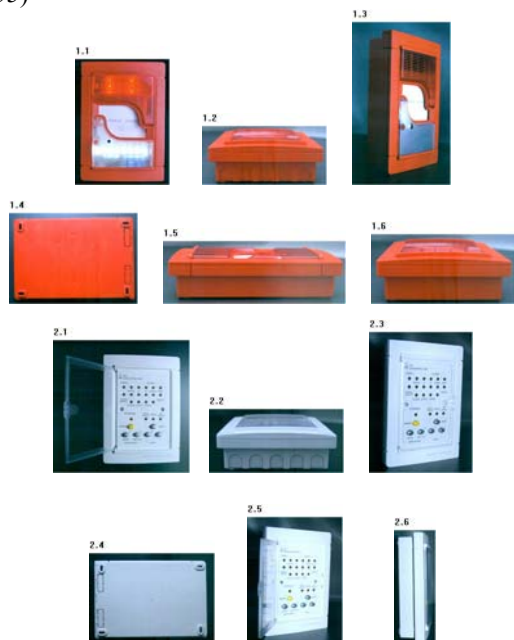

- (11) DM/073714 (51) 24-01
- (15) 2010 05 21
- (45) 2010/10 (2010 11 30)

- (22) 2010 05 21
- (28) 1
- (30) 19.03.2010; D-0018/2010; RS
- (73) GORAN MILANOVIĆ Krušedolska 15, 11351 Vinča (RS)
- (85) RS
- (86) RS
- (87) RS
- (88) RS
- (81) II. BX, GR, IT, KP, MA, MC, ME. III. AL, BA, BG, CH, DE, DK, EE, EG, ES, FR, GE, HR, HU, LI, LT, LV, MK, PL, RO, SG, SI, SY, TR, UA
- (72) Goran Milanovic, Krušedolska 15, RS-11351 Vinča
- (54) 1. Adapter for a dental apparatus for water and air
- (55)



- (11) DM/073728 (51) 07-01
- (15) 2010 05 25
- (45) 2010/10 (2010 11 30)
- (22) 2010 04 04
- (28) 9
- (73) PORZELLANFABRIK SCHÖNWALD, ZWEIGNIEDERLASSUNG DER BHS TABLETOP AG Rehauer Str. 44-54, 95173 Schönwald (DE)
- (86) DE,EM
- (87) DE,EM
- (81) II. CI, MA, MC, ME. III. BA, CH, EG, EM, GE, GH, HR, LI, MK, OM, RS, SG, SY, TR, UA
- (72) Mr. Nico Michler, Rosenheimer Str. 145b, 81671 Munich, Germany
- (54) 1. Coffepot; 2. Cup; 3. Plate oval;
4. Platter tortilla; 5. Salad bowl; 6. Plate;
7. Bowl; 8. Bowl large; 9. Teapot
- (55)



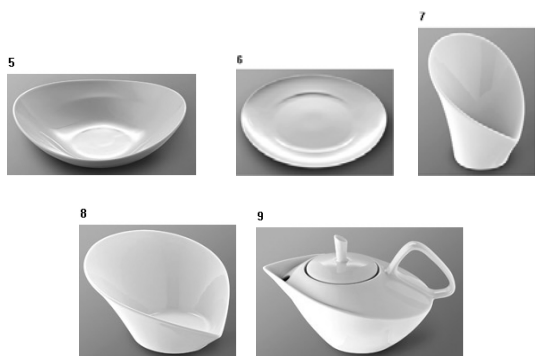

- (11) DM/074244 (51) 10-02
 (15) 2010 09 01
 (45) 2010/09 (2010 10 31)
 (22) 2010 09 01
 (28) 2
 (73) "FREY WILLE" GMBH & CO KG
 Gumpendorferstrasse 81, A-1060 Vienna (AT)
 (85) EM
 (86) EM
 (87) EM
 (88) EM
 (81) III. CH, EG, EM, GE, HR, MD, MK, MN, SG,
 TR, UA
 (54) 1.-2. Wrist watches
 (55)

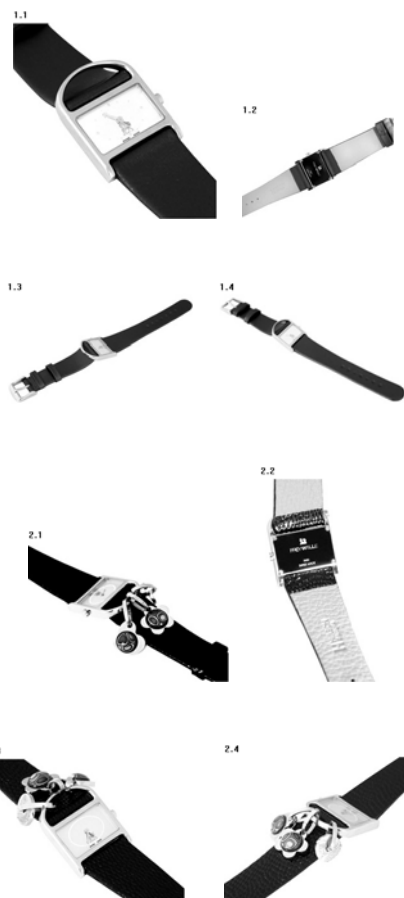

- (11) DM/074247 (51) 11-01
 (15) 2010 09 14
 (45) 2010/09 (2010 10 31)
 (22) 2010 09 14
 (28) 1
 (30) 15.03.2010; 136922; CH
 (73) DE GRISOGONO SA 176bis route de Saint
 Julien, CH-1228 Plan-les-Ouates (CH)
 (85) CH
 (86) CH
 (87) CH
 (88) CH
 (81) II. KP, MA, MC. III. EG, EM, GE, OM, SG,
 TR, UA.
 (72) Fawaz GRUOSI, "Les Mélézes"
 Chemin de Trembley, 30, CH-1197
 PRANGINS
 (54) 1. Ring
 (55)

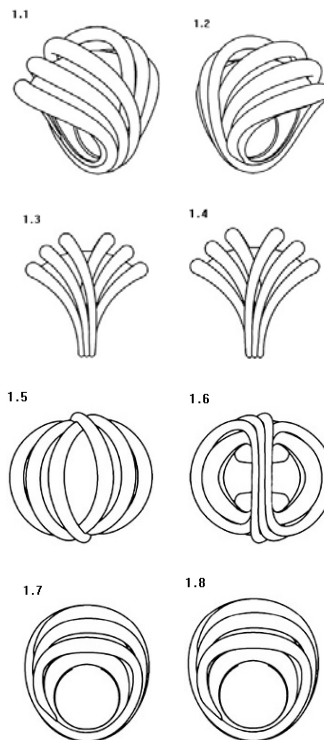

- (11) DM/074259 (51) 11-01
 (15) 2010 09 08
 (45) 2010/09 (2010 10 31)
 (22) 2010 09 08
 (28) 8
 (73) "FREY WILLE" GMBH & CO KG
 Gumpendorferstrasse 81, A-1060 Vienna (AT)
 (85) EM
 (86) EM
 (87) EM
 (88) EM
 (81) III. CH, EG, EM, GE, HR, MD, MK, MN, SG,
 TR, UA

(54) 1.-4. Charms; 5.-8. Bracelets

(55)



(88) CH

(81) II. BZ, MA, MC, ME. III. AL, AM, BA, CH, EM, GE, HR, KG, LI, MD, MK, MN, NO, OM, SG, TR, UA

(72) Arlette Elsa EMCH
Rue des Mornets 31 CH-2520 LA
NEUVEVILLE SUISSE

(54) Cuff links

(55)



(11) DM/074409 (51) 11-01

(15) 2010 08 24

(45) 2010/09 (2010 10 31)

(22) 2010 08 24

(28) 30

(73) THE SWATCH GROUP MANAGEMENT SERVICES AG (THE SWATCH GROUP MANAGEMENT SERVICES SA) (THE SWATCH GROUP MANAGEMENT SERVICES LTD) Seevorstadt 6, CH-2502 Biel/Bienne (CH)

(85) CH

(86) CH

(87) CH

(88) CH

(81) II. BZ, MA, MC, ME. III. AL, AM, BA, CH, EM, GE, HR, KG, LI, MD, MK, MN, NO, OM, SG, TR, UA

(72) Arlette Elsa EMCH Rue des Mornets 31
CH-2520 LA NEUVEVILLE SUISSE

(54) 1. Bracelet; 2. ring; 3.-4. earrings; 5.-6. rings; 7. ring; 8. bracelet; 9. ring; 10. earrings; 11. bracelet; 12. necklace; 13. ring; 14. earrings; 15.-16. bracelets; 17. pendant; 18. ring; 19. bracelet; 20. pendant; 21. ring; 22. earrings; 23. bracelet; 24. ring; 25. bracelet; 26. ring; 27. earrings; 28. ring; 29. bracelet; 30. ring

(55)



(11) DM/074408 (51) 02-07

(15) 2010 08 24

(45) 2010/09 (2010 10 31)

(22) 2010 08 24

(28) 1

(73) THE SWATCH GROUP MANAGEMENT SERVICES AG (THE SWATCH GROUP MANAGEMENT SERVICES SA) (THE SWATCH GROUP MANAGEMENT SERVICES LTD) Seevorstadt 6, CH-2502 Biel/Bienne (CH)

(85) CH

(86) CH

(87) CH

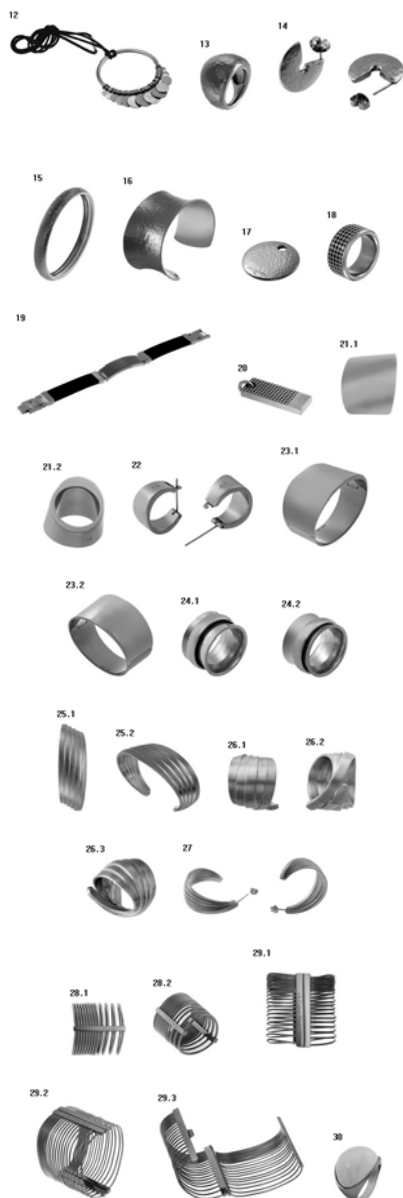

- (11) DM/074412 (51) 10-02
 (15) 2010 09 03
 (45) 2010/09 (2010 10 31)
 (22) 2010 09 03
 (28) 1
 (73) SWATCH AG (SWATCH SA)
 (SWATCH LTD.) Jakob-Stämpfli-Strasse 94,
 CH-2502 Biel/Bienne (CH)
 (85) CH
 (86) CH
 (87) CH
 (88) CH
 (81) II. BZ, MA, MC, ME. III. AL, AM, BA, CH,
 EM, GE, HR, KG, LI, MD, MK, MN, NO,
 OM, SG, TR, UA
 (72) Axelle Dorado, Avenue Tivoli 8, CH-1007
 Lausanne (Suisse)
 (54) 1. Wristwatch

(55)



- (11) DM/074413 (51) 10-02
 (15) 2010 09 03
 (45) 2010/09 (2010 10 31)
 (22) 2010 09 03
 (28) 3
 (73) SWATCH AG (SWATCH SA)
 (SWATCH LTD.) Jakob-Stämpfli-Strasse 94,
 CH-2502 Biel/Bienne (CH)
 (85) CH
 (86) CH
 (87) CH
 (88) CH
 (81) II. BZ, MA, MC, ME. III. AL, AM, BA, CH,
 EM, GE, HR, KG, LI, MD, MK, MN, NO,
 OM, SG, TR, UA
 (72) Mod. N1: Takashi Koshii, 4-32-22-201
 Kamikitazawa, Setagayaku TOKYO (Japon);
 Mod. N2: Francesca Errani, Swatchlab, Via
 Archimede 6, IT-20129 MILANO (Italie);
 Mod. N3: Francesca Errani, Swatchlab, Via
 Archimede 6, IT-20129 MILANO (Italie)
 (54) 1.-3. Wristwatches
 (55)



- (11) DM/074414 (51) 10-02
 (15) 2010 09 03
 (45) 2010/09 (2010 10 31)
 (22) 2010 09 03
 (28) 7
 (73) SWATCH AG (SWATCH SA)
 (SWATCH LTD.) Jakob-Stämpfli-Strasse 94,
 CH-2502 Biel/Bienne (CH)
 (85) CH
 (86) CH
 (87) CH
 (88) CH
 (81) II. BZ, MA, MC, ME. III. AL, AM, BA, CH,

EM, GE, HR, KG, LI, MD, MK, MN, NO,
OM, SG, TR, UA

- (72) Mod. N: Adelina Bissolo, Swatchlab, Via Archimede 6, IT-20129 Milano (Italie);
Mod.N2 à 7: Patrizio Vita, Swatchlab, Via Archimede 6, IT-20129 Milano (Italie) et Stéphane Avranches, Blade Design, Ch. du Pré Fleuri 14, CH-1228 Plan Les Ouates (Suisse)

(54) 1.-7. Wristwatches

(55)



(11) DM/074415 (51) 10-02

(15) 2010 09 06

(45) 2010/09 (2010 10 31)

(22) 2010 09 06

(28) 6

(73) SWATCH AG (SWATCH SA)
(SWATCH LTD.) Jakob-Stämpfli-Strasse 94,
CH-2502 Biel/Bienne (CH)

(85) CH

(86) CH

(87) CH

(88) CH

(81) II. BZ, MA, MC, ME. III. AL, AM, BA, CH,
EM, GE, HR, KG, LI, MD, MK, MN, NO,
OM, SG, TR, UA

- (72) Mod. N1: Ylenia Agate, Swatchlab, Via Archimede 6, IT-20129 Milano (Italie);
Mod. N2: Adelina Bissolo, Swatchlab, Via Archimede 6, IT-20129 Milano (Italie);
Mod. N3: Adelina Bissolo, Swatchlab, Via Archimede 6, IT-20129 Milano (Italie);
Mod. N4: Rossana Boffi, Swatchlab, Via Archimede 6, IT-20129 Milano (Italie) et Philippe Airaud, TSI DESIGN, Rue St-Honoré 92-94, 75001 PARIS /FR;
Mod. N5: Rossana Boffi, Swatchlab, Via Archimede 6, IT-20129 Milano (Italie);

Mod. N6: Rossana Boffi, Swatchlab,
Via Archimede 6, IT-20129 Milano (Italie)

(54) 1.-6. Wristwatches

(55)



(11) DM/074419 (51) 10-02

(15) 2010 09 10

(45) 2010/09 (2010 10 31)

(22) 2010 09 10

(28) 5

(73) SWATCH AG (SWATCH SA)
(SWATCH LTD.) Jakob-Stämpfli-Strasse 94,
CH-2502 Biel/Bienne (CH)

(85) CH

(86) CH

(87) CH

(88) CH

(81) II. BZ, MA, MC, ME. III. AL, AM, BA, CH,
EM, GE, HR, KG, LI, MD, MK, MN, NO,
OM, SG, TR, UA

- (72) Mod.N1: Adelina Bissolo, SWATCHLAB, Via Archimede 6, IT-20129 Milano (Italie);
Mod.N2: Andrea Arrigoni, SWATCHLAB, Via Archimede 6, IT-20129 Milano (Italie);
Mod.N3: Andrea Arrigoni, SWATCHLAB, Via Archimede 6, IT-20129 Milano (Italie);
Mod.N4: Andrea Arrigoni, SWATCHLAB, Via Archimede 6, IT-20129 Milano (Italie);
Mod.N5: Adelina Bissolo, SWATCHLAB, Via Archimede 6, IT-20129 Milano (Italie)

(54) 1.-5. Wristwatches

(55)



(11) DM/074420 (51) 10-02, 07
 (15) 2010 09 10
 (45) 2010/09 (2010 10 31)
 (22) 2010 09 10
 (28) 4
 (73) THE SWATCH GROUP MANAGEMENT SERVICES AG (THE SWATCH GROUP MANAGEMENT SERVICES SA) (THE SWATCH GROUP MANAGEMENT SERVICES LTD.) Seevorstadt 6, CH-2501 Biel/Bienne (CH)

(85) CH
 (86) CH
 (87) CH
 (88) CH
 (81) II. BZ, GR, MA, MC, ME. III. AL, AM, BA, CH, EM, GE, KG, LI, MD, MK, MN, NO, OM, SG, TR, UA

(72) Arlette Elsa EMCH Rue des Mornets 31 CH-2520 LA NEUVEVILLE SUISSE

(54) 1. Watch case with bracelet; 2. watch; 3.-4. watch cases

(55)

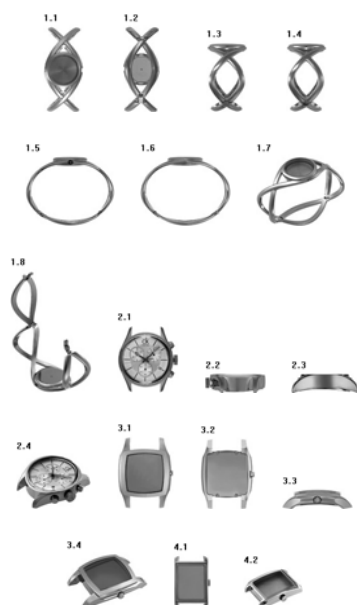

(11) DM/074422 (51) 10-02
 (15) 2010 09 13
 (45) 2010/09 (2010 10 31)
 (22) 2010 09 13
 (28) 5
 (73) SWATCH AG (SWATCH SA) (SWATCH LTD.) Jakob-Stämpfli-Strasse 94, CH-2502 Biel/Bienne (CH)

(85) CH
 (86) CH
 (87) CH
 (88) CH
 (81) II. BZ, MA, MC, ME. III. AL, AM, BA, CH, EM, GE, HR, KG, LI, MD, MK, MN, NO,

OM, SG, TR, UA

(72) Patrizio VITA, Swatchlab, Via Archimede 6, IT-20129 MILANO (Italie)

(54) 1.-5. Wristwatches

(55)



(11) DM/074429 (51) 10-02

(15) 2010 09 08

(45) 2010/10 (2010 11 30)

(22) 2010 09 08

(28) 4

(73) SWATCH AG (SWATCH SA)

(SWATCH LTD.) Jakob-Stämpfli-Strasse 94, CH-2502 Biel/Bienne (CH)

(85) CH

(86) CH

(87) CH

(88) CH

(81) II. BZ, MA, MC, ME. III. AL, AM, BA, CH, EM, GE, HR, KG, LI, MD, MK, MN, NO, OM, SG, TR, UA

(72) Mod. N1: Laura Tabor, 28 Hamilton Park Ave, GB-GLASGOW G12 8DT (Scotland); Claudia Carieri, Swatchlab, Via Archimede 6, IT-20129 Milano (Italie); Mod. N2: Laura Tabor, 28 Hamilton Park Ave, GB-GLASGOW G12 8DT (Scotland); Claudia Carieri, Swatchlab, Via Archimede 6, IT-20129 Milano (Italie); Mod. N3: Philippe Airaud, TSI Design, Rue St-Honoré 92-94, FR-75001 Paris (France); Claudia Carieri, Swatchlab, Via Archimede 6, IT-20129 Milano (Italie); Adelina Bissolo, Swatchlab, Via Archimede 6, IT-20129 Milano (Italie); Mod. N4: Andrea Arrigoni, Swatchlab, Via Archimede 6, IT-20129 Milano (Italie)

(54) 1.-4. Wristwatches

(55)



- (11) DM/074430 (51) 10-02
 (15) 2010 09 10
 (45) 2010/10 (2010 11 30)
 (22) 2010 09 10
 (28) 2
 (73) SWATCH AG (SWATCH SA)
 (SWATCH LTD.) Jakob-Stämpfli-Strasse 94,
 CH-2502 Biel/Bienne (CH)
 (85) CH
 (86) CH
 (87) CH
 (88) CH
 (81) II. BZ, MA, MC, ME. III. AL, AM, BA, CH,
 EM, GE, HR, KG, LI, MD, MK, MN, NO,
 OM, SG, TR, UA
 (72) Mod. N1: Francesca ERRANI, Swatchlab,
 Via Archimede 6, IT-20129 MILANO (Italie);
 Mod. N2: Adelina BISSOLO, Swatchlab,
 Via Archimede 6, IT-20129 MILANO (Italie)
 (54) 1.-2. Wristwatches
 (55)

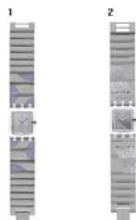

- (11) DM/074431 (51) 10-02
 (15) 2010 09 06
 (45) 2010/10 (2010 11 30)
 (22) 2010 09 06
 (28) 6
 (73) SWATCH AG (SWATCH SA)
 (SWATCH LTD.) Jakob-Stämpfli-Strasse 94,
 CH-2502 Biel/Bienne (CH)
 (85) CH
 (86) CH
 (87) CH
 (88) CH
 (81) II. BZ, MA, MC, ME. III. AL, AM, BA, CH,
 EM, GE, HR, KG, LI, MD, MK, MN, NO,
 OM, SG, TR, UA
 (72) Mod. N1: Rossana Boffi, Swatchlab,
 Via Archimede 6, IT-20129 Milano (Italie);
 Mod. N2: Lorenzo Vallone, Swatchlab,
 Via Archimede 6, IT-20129 Milano (Italie);
 Mod. N3: Ylenia Agate, Swatchlab,
 Via Archimede 6, IT-20129 Milano (Italie);
 Mod. N4: Patrizio Vita, Swatchlab,
 Via Archimede 6, IT-20129 Milano (Italie);
 Mod. N5: Danilo Sala, Swatchlab,
 Via Archimede 6, IT-20129 Milano (Italie);
 Mod. N6: Danilo Sala, Swatchlab,
 Via Archimede 6, IT-20129 Milano (Italie)
 (54) 1.-6. Wristwatches



- (11) DM/074432 (51) 10-02
 (15) 2010 09 16
 (45) 2010/10 (2010 11 30)
 (22) 2010 09 16
 (28) 9
 (73) SWATCH AG (SWATCH SA)
 (SWATCH LTD.) Jakob-Stämpfli-Strasse 94,
 CH-2502 Biel/Bienne (CH)
 (85) CH
 (86) CH
 (87) CH
 (88) CH
 (81) II. BZ, MA, MC, ME. III. AL, AM, BA, CH,
 EM, GE, HR, KG, LI, MD, MK, MN, NO,
 OM, SG, TR, UA
 (72) Mod.N1 à 8: John Rankin Waddel, Rankin
 Photography, Ms. Sandra Barron, 110-114
 Grafton Road, Kentish Town, GB-LONDON
 NW5 4BA; Mod.N9: Claudia Carieri,
 Swatchlab, Via Archimede 6, IT-20129
 Milano (Italie)
 (54) 1.-9. Wristwatches
 (55)



9.3



- (11) DM/074433 (51) 10-02
 (15) 2010 09 16
 (45) 2010/10 (2010 11 30)
 (22) 2010 09 16
 (28) 6
 (73) SWATCH AG (SWATCH SA)
 (SWATCH LTD.) Jakob-Stämpfli-Strasse 94,
 CH-2502 Biel/Bienne (CH)
 (85) CH
 (86) CH
 (87) CH
 (88) CH
 (81) II. BZ, MA, MC, ME. III. AL, AM, BA, CH,
 EM, GE, HR, KG, LI, MD, MK, MN, NO,
 OM, SG, TR, UA
 (72) Mod. N1 à N5: Patrizio Vita, Swatchlab,
 Via Archimede 6, IT-20129 Milano (Italie);
 Mod. N6: Danilo Sala, Swatchlab,
 Via Archimede 6, IT-20129 Milano (Italie)
 (54) 1.-6. Wristwatches
 (55)



- (11) DM/074443 (51) 10-02, 07
 (15) 2010 08 25
 (45) 2010/10 (2010 11 30)
 (22) 2010 08 25
 (28) 19
 (73) THE SWATCH GROUP MANAGEMENT
 SERVICES AG (THE SWATCH GROUP
 MANAGEMENT SERVICES SA)
 (THE SWATCH GROUP MANAGEMENT
 SERVICES LTD.) Seevorstadt 6, CH-2501
 BIEL/BIENNE (CH)
 (85) CH
 (86) CH
 (87) CH
 (88) CH
 (81) II. BZ, MA, MC, ME. III. AL, AM, BA, CH,

- EM, GE, HR, KG, LI, MD, MK, MN, NO,
 OM, SG, TR, UA
 (72) Arlette Elsa, EMCH Rue des Mornets 31,
 CH-2520 LA NEUVEVILLE
 (54) 1. Watch case; 2. Watch bracelet; 3. Bracelet
 with watch case; 4-5 Wristwatches;
 6-8 Watches; 9. Wristwatch; 10. Dial;
 11-18 Watches; 19. Wristwatch
 (55)

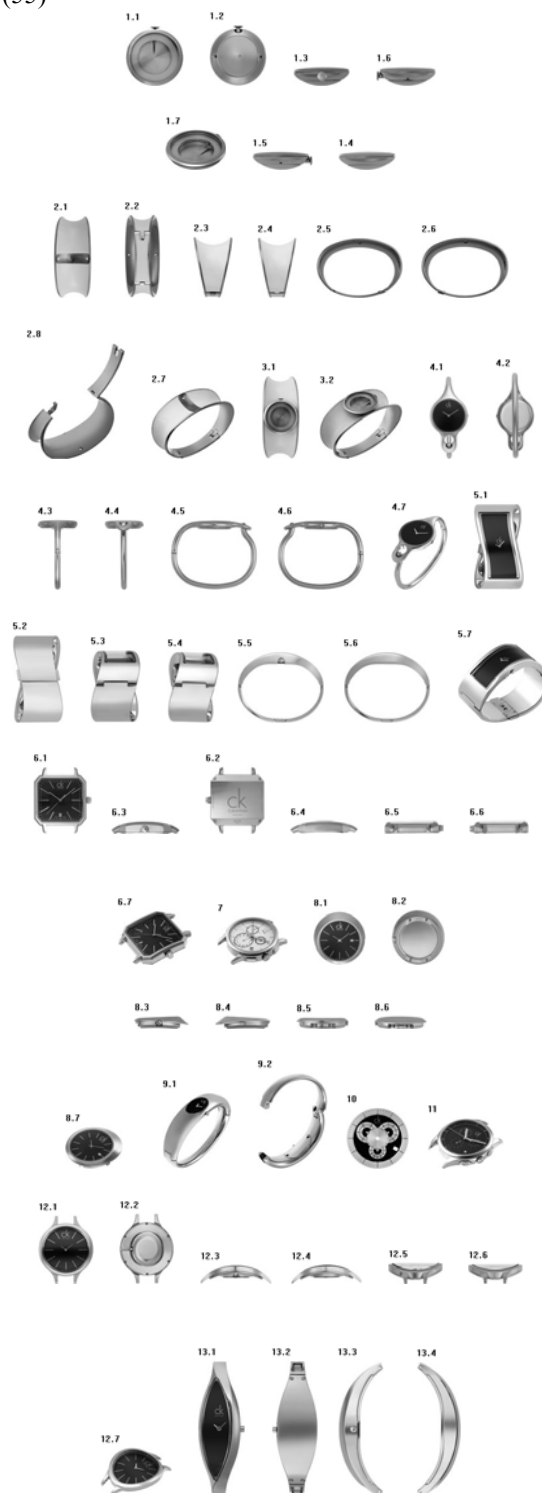

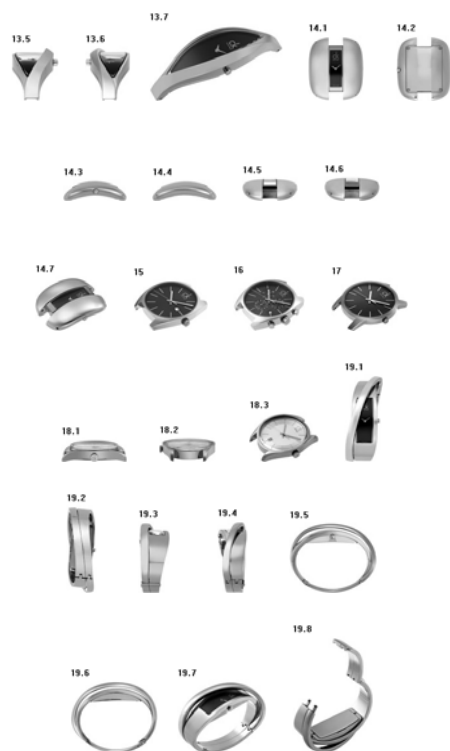

- (11) DM/074456 (51) 10-02
 (15) 2010 09 28
 (45) 2010/10 (2010 11 30)
 (22) 2010 09 28
 (28) 1
 (73) SWATCH AG (SWATCH SA)
 (SWATCH LTD.) Jakob-Stämpfli-Strasse 94,
 CH-2502 Biel/Bienne (CH)
 (85) CH
 (86) CH
 (87) CH
 (88) CH
 (81) II. BZ, MA, MC, ME. III. AL, AM, BA, CH,
 EM, GE, HR, KG, LI, MD, MK, MN, NO,
 OM, SG, TR, UA
 (72) Rossana Boffi, Swatchlab, Via Archimede 6,
 IT-20129 Milano
 (54) 1. Wristwatch
 (55)



- (11) DM/074468 (51) 10-02
 (15) 2010 09 29
 (45) 2010/10 (2010 11 30)
 (22) 2010 09 29
 (28) 4
 (73) SWATCH AG (SWATCH SA)
 (SWATCH LTD) Jakob-Stämpfli-Strasse 94,
 CH-2502 BIEL/BIENNE (CH)
 (85) CH
 (86) CH
 (87) CH
 (88) CH
 (81) II. BZ, MA, MC, ME. III. AL, AM, BA, CH,
 EM, GE, HR, KG, LI, MD, MK, MN, NO,
 OM, SG, TR, UA
 (72) Modèles N1-2: Andrea Arrigoni, Swatchlab,
 Via Archimede 6, IT-20129 Milano;
 Modèle N3: Danilo Sala, Swatchlab,
 Via Archimede 6, IT-20129 Milano;
 Modèle N4: Rossana Boffi, Swatchlab,
 Via Archimede 6, IT-20129 Milano
 (54) 1.-4. Wristwatches
 (55)



- (11) DM/074469 (51) 10-02
 (15) 2010 09 29
 (45) 2010/10 (2010 11 30)
 (22) 2010 09 29
 (28) 2
 (73) SWATCH AG (SWATCH SA)
 (SWATCH LTD.) Jakob-Stämpfli-Strasse 94,
 CH-2502 Biel/Bienne (CH)
 (85) CH
 (86) CH
 (87) CH
 (88) CH
 (81) II. BZ, MA, MC, ME. III. AL, AM, BA, CH,
 EM, GE, HR, KG, LI, MD, MK, MN, NO,
 OM, SG, TR, UA
 (72) Danilo Sala, Swatchlab, Via Archimede 6,
 IT-20129 Milano
 (54) 1.-2. Wristwatches

(55)



(11) DM/074473 (51) 10-02

(15) 2010 09 29

(45) 2010/10 (2010 11 30)

(22) 2010 09 29

(28) 4

(73) SWATCH AG (SWATCH SA)

(SWATCH LTD.) Jakob-Stämpfli-Strasse 94,
CH-2502 Biel/Bienne (CH)

(85) CH

(86) CH

(87) CH

(88) CH

(81) II. BZ, MA, MC, ME. III. AL, AM, BA, CH,
EM, GE, HR, KG, LI, MD, MK, MN, NO,
OM, SG, TR, UA(72) Barbara CURTI, Swatchlab, Via Archimede 6,
IT-20129 Milano

(54) 1.-4. Wristwatches

(55)



(11) DM/074475 (51) 10-02

(15) 2010 09 29

(45) 2010/10 (2010 11 30)

(22) 2010 09 29

(28) 7

(73) SWATCH AG (SWATCH SA)

(SWATCH LTD) Jakob-Stämpfli-Strasse 94,
CH-2502 BIEL/BIENNE (CH)

(85) CH

(86) CH

(87) CH

(88) CH

(81) II. BZ, MA, MC. III. AL, AM, BA, CH, EM,
GE, HR, KG, LI, MD, MK, MN, NO, OM, SG,
TR, UA(72) Modèles N1-2: Terje Haakonsen, Adm.
Borresens vei 6G, N-0286 Oslo;Modèles N3-5: Jasmine Fung Hei Wah, Flat 3,
1/F, Ming Hoi House, Ming Nga Court, Tai Po,
NT., Hong Kong, CN; Modèles N6-7: Hideaki
Kawashima, c/o Tomio Koyama Gallery,
1-3-2, MF, Kiyosumi, Koto-Ku, Tokyo, JP

(54) 1.-7. Wristwatches

(55)



(11) DM/074516 (51) 11-01

(15) 2010 10 07

(45) 2010/10 (2010 11 30)

(22) 2010 10 07

(28) 6

(73) "FREY WILLE" GMBH & CO KG

Gumpendorferstrasse 81, A-1060 Vienna (AT)

(85) EM

(86) EM

(87) EM

(88) EM

(81) III. CH, EG, EM, GE, HR, MD, MK, MN, SG,
TR, UA

(54) 1.-4. Bracelets; 5.-6. Pendants

(55)

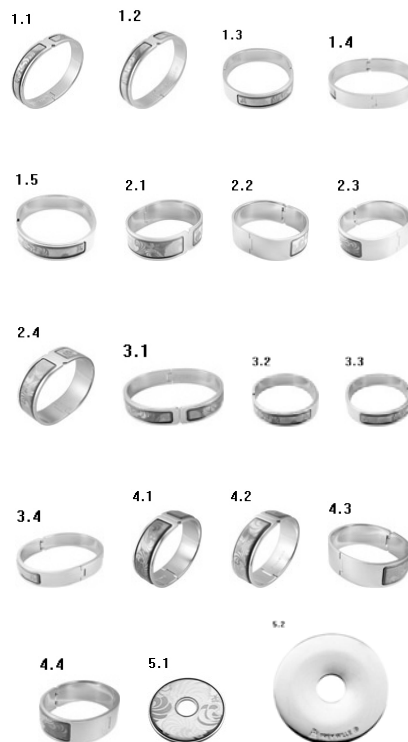

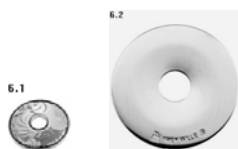

- (11) DM/074546 (51) 10-02
- (15) 2010 10 18
- (45) 2010/10 (2010 11 30)
- (22) 2010 10 18
- (28) 10
- (73) SWATCH AG (SWATCH SA)
(SWATCH LTD.) Jakob-Stämpfli-Strasse 94,
CH-2502 Biel/Bienne (CH)
- (85) CH
- (86) CH
- (87) CH
- (88) CH
- (81) II. BZ, MA, MC, ME. III. AL, AM, BA, CH,
EM, GE, HR, KG, LI, MD, MK, MN, NO,
OM, SG, TR, UA
- (72) Mod. N1: Gary Baseman, 137 North
Larchmont Blvd. N129, 90004 Los Angeles
(CA)/USA; Mod. N2: Joe Ledbetter, 915
Mateo St., Suite N313, 90021 Los Angeles
(CA)/USA; Mod. N3: Russel Valentine
Karablin, SSUR, 1224 S. Ogden Dr., 90019
Los Angeles (CA)/USA; Mod. N4: Jeremy
Andrew, "Jeremyville", Suite 514, 50-58
Macleay Street, 2011 Potts Point NSW/
Australie; Mod. N5: Jeremy Madl "MAD",
MAD Toy Design, Inc., 8613 W 152nd
Terrace, 66223 Overland Park (KS)/USA;
Mod. N6: Frank Kozik, Happy Plastics, Inc.,
577 14th Ave. N3, 94118 San Francisco (CA)
/ USA; Mod. N7: Tara McPherson, 173
Bedford Ave.N3, 11211 Brooklyn/USA;
Mod. N8: Cedric Mailharrou Fantomas "Tilt",
7 route d'Agde, 31500 Toulouse/ France;
Mod. N9: Frank Kozik, Happy Plastics, Inc.,
577 14th Ave. N3, 94118 San Francisco (CA)/
USA; Mod. N10: Frank Kozik, Happy Plastics,
Inc., 577 14th Ave. N3, 94118 San Francisco
(CA)/USA;

(54) 1.-10. Wristwatches

(55)



- (11) DM/074547 (51) 21-01
- (15) 2010 10 18
- (45) 2010/10 (2010 11 30)
- (22) 2010 10 18
- (28) 9
- (73) SWATCH AG (SWATCH SA)
(SWATCH LTD.) Jakob-Stämpfli-Strasse 94,
CH-2502 Biel/Bienne (CH)
- (85) CH
- (86) CH
- (87) CH
- (88) CH
- (81) II. BZ, MA, MC, ME. III. AL, AM, BA, CH,
EM, GE, HR, KG, LI, MD, MK, MN, NO,
OM, SG, TR, UA
- (72) Mod. N1: Gary Baseman, 137 North
Larchmont Blvd. N129, 90004 Los Angeles
(CA)/USA; Mod. N2: Joe Ledbetter, 915
Mateo St., Suite N313, 90021 Los Angeles
(CA)/USA; Mod. N3: Russel Valentine
Karablin, SSUR, 1224 S. Ogden Dr., 90019
Los Angeles (CA)/USA; Mod. N4: Jeremy
Andrew, "Jeremyville", Suite 514, 50-58
Macleay Street, 2011 Potts Point NSW/
Australie; Mod. N5: Jeremy Madl "MAD",
MAD Toy Design, Inc., 8613 W 152nd
Terrace, 66223 Overland Park (KS)/USA;
Mod. N6: Frank Kozik, Happy Plastics, Inc.,
577 14th Ave. N3, 94118 San Francisco (CA)/
USA; Mod. N7: Tara McPherson, 173 Bedford
Avenue N3, 11211 Brooklyn/USA;
Mod. N8: Cedric Mailharrou Fantomas "Tilt",
7 route d'Agde, 31500 Toulouse/France;
Mod. N9: Frank Kozik, Happy Plastics, Inc.,
577 14th Ave.N3, 94118 San Francisco
(CA)/USA

(54) 1.-9. Figurines (toys)

(55)



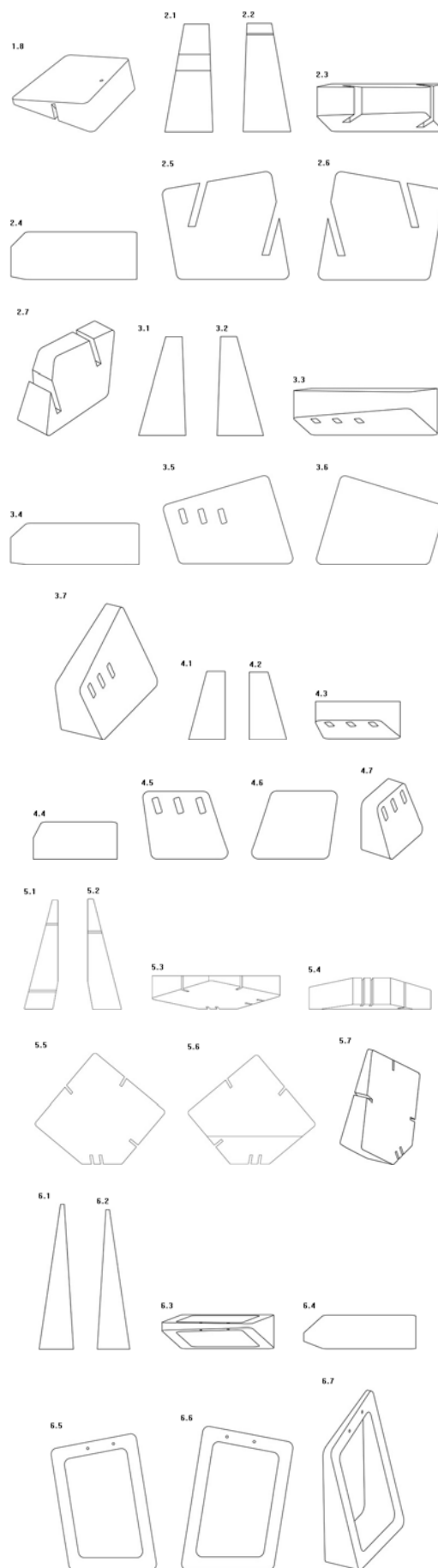

- (11) DM/074560 (51) 20-02
- (15) 2010 10 21
- (45) 2010/10 (2010 11 30)
- (22) 2010 10 21
- (28) 9
- (73) SWATCH AG (SWATCH SA)
(SWATCH LTD.) Jakob-Stämpfli-Strasse 94,
CH-2502 Biel/Bienne (CH)
- (85) CH
- (86) CH
- (87) CH
- (88) CH
- (81) II. BZ, MA, MC, ME. III. AL, AM, BA, CH,
EM, GE, HR, KG, LI, MD, MK, MN, NO,
OM, SG, TR, UA
- (72) Vanessa GEROTTO, Rue Fontaine-André 14,
2000 Neuchâtel (Suisse)
- (54) 1.-3. Display units for bracelets; 4. display unit
for jewelry; 5. display unit for necklaces;
6. display unit for earrings; 7. display unit for
rings; 8. display unit for earrings; 9. display
unit for necklaces
- (55)

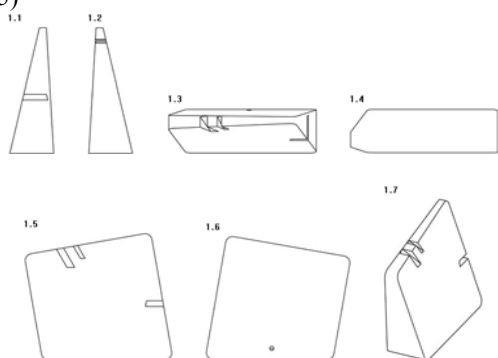

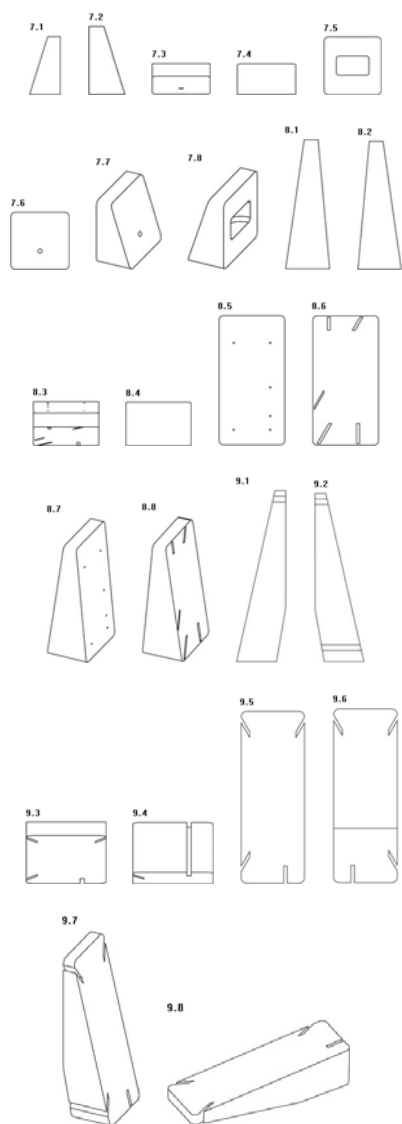

- (11) DM/074588 (51) 20-03
 (15) 2010 08 18
 (45) 2010/10 (2010 11 30)
 (22) 2010 08 18
 (28) 1
 (30) 19.02.2010; 001197016; EM
 (73) CHECKPOINT SYSTEMS
 INTERNATIONAL GMBH Ersheimer Strasse
 69, 69434 Hirschhorn (DE)
 (86) DE,EM
 (87) EM
 (81) III. AL, AM, BA, BW, CH, EG, GE, GH, HR,
 IS, KG, LI, MD, MK, MN, NA, NO, OA, OM,
 RS, SG, ST, SY, TR, UA.
 (72) Oliver Stuke, Peterstaler Strasse 119, 69118
 Heidelberg
 (54) 1. Label holder
 (55)

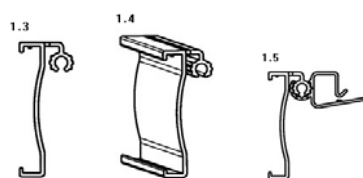
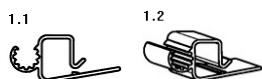

- (11) DM/074589 (51) 09-01
 (15) 2010 09 30
 (45) 2010/10 (2010 11 30)
 (22) 2010 09 30
 (28) 1
 (73) SAVERGLASS
 3 rue de la Gare, F-60960 FEUQUIERES (FR)
 (85) FR,EM
 (86) FR,EM
 (87) FR,EM
 (88) FR,EM
 (81) II. MC. III. AM, CH, GE, HR, MD, SG,
 TR, UA
 (54) 1. Bottle
 (55)



- (11) DM/074600 (51) 11-01
 (15) 2010 10 14
 (45) 2010/10 (2010 11 30)
 (22) 2010 10 14
 (28) 28
 (73) SWATCH AG (SWATCH SA)
 (SWATCH LTD.) Jakob-Stämpfli-Strasse 94,
 CH-2502 Biel/Bienne (CH)
 (85) CH
 (86) CH
 (87) CH
 (88) CH
 (81) II. BZ, MA, MC, ME. III. AL, AM, BA, CH,
 EM, GE, HR, KG, LI, MD, MK, MN, NO,
 OM, SG, TR, UA
 (72) N1, 20, 21, 22, 23, 24, 25, 26, 27, 28: Iza
 Emch, DYB Dress Your Body SA,
 Av. Beauregard 12, CH-2036 Cormondrèche;
 N2, 3, 4, 5, 6, 7, 8, 9, 10, 11, 12, 13, 14, 15:
 Philippe Airaud, TSI Design SA,
 Rue St-Honoré 92-94, F-75001 Paris; N 16, 17,
 18, 19: Michaela Koch, Micha Design,
 Albrecht-Achilles-Str. 2, D-10709 Berlin
 (54) Necklace; 2. Ring; 3. Earrings; 4. Bracelet;
 5. Necklace; 6. Ring; 7. Earrings; 8. Pendant;
 9. Ring; 10. Earrings; 11. Bracelet;
 12. Necklace; 13. Ring; 14. Bracelet;
 15. Necklace; 16. Ring; 17. Earrings;
 18. Bracelet; 19.-20. Necklaces; 21. Ring;

22. Earrings; Bracelet; 24. Necklace; 25. Ring;
26. Earrings; 27. Bracelet; 28. Necklace

(55)

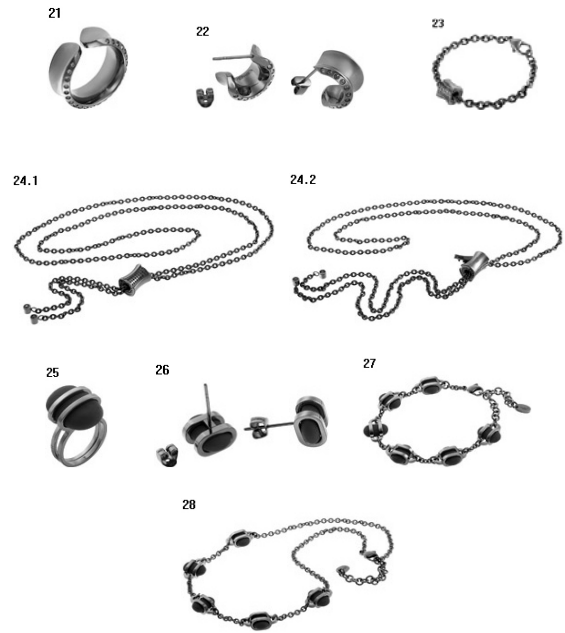
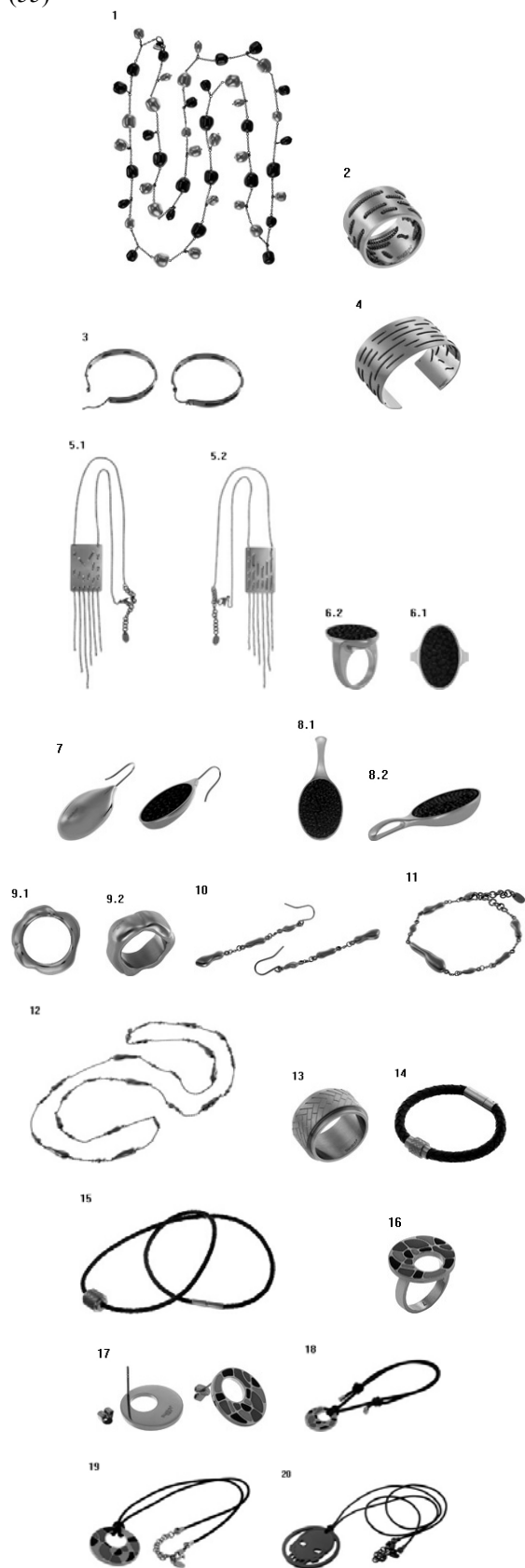

TRADEMARKS

ТОВАРНЫЕ ЗНАКИ

APPLICATIONS FILED UNDER THE NATIONAL PROCEDURE LAID OPEN FOR THE PURPOSE OF TAKING PATENT GRANTING DECISIONS

ЗАЯВКИ, ВНЕСЕННЫЕ СОГЛАСНО НАЦИОНАЛЬНОЙ ПРОЦЕДУРЕ, ПО КОТОРЫМ
ВЫНЕСЕНЫ РЕШЕНИЯ О РЕГИСТРАЦИИ

To appeal a decision is possible at Chamber of Appeal of Sakpatenti within 3 months from the publication or at The Board of Administrative Actions of Tbilisi City Court within a 1 month period. (Address: 12 km., №6, David Aghmashenebeli Kheivani, Tbilisi).

Обжалование решения возможно в Апелляционной палате Сакпатенти в течение 3 месяцев с даты его публикации или в течение 1 месяца в Коллегии по административным делам Тбилисского городского суда (Адрес: г. Тбилиси, Аллея Давида Агмашенебели 12-й км., №6).

(260) AM 2011 57795 A
(210) AM 057795
(220) 2010 04 22
(731) ABBOTT LABORATORIES
Abbott Park, Illinois 60064, USA
(740) Tamar Kochlamazashvili
(540)

НОРВИР

(591) Black, white
(511) 5

(260) AM 2011 57796 A
(210) AM 057796
(220) 2010 04 22
(731) ABBOTT LABORATORIES
Abbott Park, Illinois 60064, USA
(740) Tamar Kochlamazashvili
(540)

NORVIR

(591) Black, white
(511) 5

(260) AM 2011 57962 A
(210) AM 057962
(220) 2010 05 05
(731) S.S. "JI PI SI"
Marjanishvilis q. 26, 0102, Tbilisi, Georgia
(740) Davit Zurabishvili
(540)

ექსპრეს კლინიკა
Express Clinic

(591) Black, white
(511) 5, 10, 35, 42, 44, 45

(260) AM 2011 57963 A
(210) AM 057963
(220) 2010 05 05
(731) S.S. "JI PI SI"
Marjanishvilis q. 26, 0102, Tbilisi, Georgia
(740) Davit Zurabishvili
(540)



(591) Motton blue
(531) 24.13.01-26.11.12-29.01.00-
(511) 5, 10, 35, 42, 44, 45

(260) AM 2011 57964 A
(210) AM 057964
(220) 2010 05 05
(731) S.S. "JI PI SI"
Marjanishvilis q. 26, 0102, Tbilisi, Georgia
(740) Davit Zurabishvili
(540)

**ბაიმარტივი ჯანმრთელობაზე
ზრუნვა**

(591) Black, white
(511) 5, 10, 35, 42, 44, 45

(260) AM 2011 57985 A
(210) AM 057985
(220) 2010 05 06

(731) LTD "ASADOV FRUIT"
 Pekini str. N39a, Apt. N42, 0160,
 Tbilisi, Georgia
 (740) Shalva Gvaramadze
 (540)



(591) Black, white, re, light blue, another tone
 green, yellow
 (531) 05.07.18-18.03.23-27.05.04-29.01.00-
 (511) 29, 31, 35, 43

(260) AM 2011 57988 A
 (210) AM 057988
 (220) 2010 05 07
 (731) TAMRON CO., LTD.
 1385, Hasunuma, Minuma-ku, Saitama-Shi,
 Saitama-ken, Japan
 (740) Shalva Gvaramadze
 (540)

TAMRON

(591) Black, white
 (511) 9

(260) AM 2011 58078 A
 (210) AM 058078
 (220) 2010 05 14
 (731) OBSHHESTVO S OGRANICHENNOI
 OTVETSTVENNOSTIU "BRIJTAUN
 INVEST"
 Moskovi, ul. Altufevskoe shose, 2a, 127273,
 Russian Federation
 (740) Tamaz Shilakadze
 (540)

LISS

(591) Black, white
 (511) 29

(260) AM 2011 58157 A
 (210) AM 058157
 (220) 2010 05 20
 (731) SH.P.S „PRIMA-VITA”
 Tamar Mefis gamz. 7/13, 0112, Tbilisi,
 Georgia
 (740) George Taktakishvili

(540)

ნოლტრექსი
Noltrex
Нолтрекс

(591) Black, white
 (511) 5

(260) AM 2011 58161 A
 (210) AM 058161
 (220) 2010 05 20
 (731) SOLDEX LIMITED
 P.O. Box 3321, Drake Chambers, Road
 Town, Tortola, British
 (740) Vakhtang Torotadze
 (540)



(591) Black, white
 (531) 05.05.20-25.01.01-27.05.05-
 (511) 3, 5, 16

(260) AM 2011 58162 A
 (210) AM 058162
 (220) 2010 05 20
 (731) SOLDEX LIMITED
 P.O. Box 3321, Drake Chambers, Road
 Town, Tortola, British
 (740) Vakhtang Torotadze
 (540)



(591) Black, white
 (531) 27.05.03-
 (511) 29, 31

(260) AM 2011 58165 A
 (210) AM 058165
 (220) 2010 05 21
 (731) SH.P.S "GLAVSPIRTPROMI"
 Paliashvilis q., 26, 0179, Tbilisi, Georgia
 (540)

ალიონი
Alioni
Алиони

(591) Black, white
 (511) 33

(260) AM 2011 58230 A
(210) AM 058230
(220) 2010 05 27
(731) BILIM ILAC SANAYI VE TICARET A.S.
Ayazağa Köyü Yolu N6, TR-34398
Maslak, İstanbul, Turkey
(740) Davit Zurabishvili
(540)

BILIMATEROZ

(591) Black, white
(511) 5

(260) AM 2011 58231 A
(210) AM 058231
(220) 2010 05 27
(731) BILIM ILAC SANAYI VE TICARET A.S.
Ayazağa Köyü Yolu N6, TR-34398
Maslak, İstanbul, Turkey
(740) Davit Zurabishvili
(540)

BILIMGLIFIX

(591) Black, white
(511) 5

(260) AM 2011 58232 A
(210) AM 058232
(220) 2010 05 27
(731) BILIM ILAC SANAYI VE TICARET A.S.
Ayazağa Köyü Yolu N6, TR-34398
Maslak, İstanbul, Turkey
(740) Davit Zurabishvili
(540)

BILIMGLIFOR

(591) Black, white
(511) 5

(260) AM 2011 58233 A
(210) AM 058233
(220) 2010 05 27
(731) BILIM ILAC SANAYI VE TICARET A.S.
Ayazağa Köyü Yolu N6, TR-34398
Maslak, İstanbul, Turkey
(740) Davit Zurabishvili
(540)

BILIMFERIMAX

(591) Black, white
(511) 5

(260) AM 2011 58234 A
(210) AM 058234
(220) 2010 05 27
(731) BILIM ILAC SANAYI VE TICARET A.S.

Ayazağa Köyü Yolu N6, TR-34398
Maslak, İstanbul, Turkey
(740) Davit Zurabishvili
(540)

BILIMCORONIS

(591) Black, white
(511) 5

(260) AM 2011 58235 A
(210) AM 058235
(220) 2010 05 27
(731) BILIM ILAC SANAYI VE TICARET A.S.
Ayazağa Köyü Yolu N6, TR-34398
Maslak, İstanbul, Turkey
(740) Davit Zurabishvili
(540)

BILIMZESPIRA

(591) Black, white
(511) 5

(260) AM 2011 58236 A
(210) AM 058236
(220) 2010 05 27
(731) BILIM ILAC SANAYI VE TICARET A.S.
Ayazağa Köyü Yolu N6, TR-34398
Maslak, İstanbul, Turkey
(740) Davit Zurabishvili
(540)

BILIMSPAZMOTEK

(591) Black, white
(511) 5

(260) AM 2011 58237 A
(210) AM 058237
(220) 2010 05 27
(731) BILIM ILAC SANAYI VE TICARET A.S.
Ayazağa Köyü Yolu N6, TR-34398
Maslak, İstanbul, Turkey
(740) Davit Zurabishvili
(540)

BILIMESTER-VIT

(591) Black, white
(511) 5

(260) AM 2011 58238 A
(210) AM 058238
(220) 2010 05 27
(731) BILIM ILAC SANAYI VE TICARET A.S.
Ayazağa Köyü Yolu N6, TR-34398
Maslak, İstanbul, Turkey
(740) Davit Zurabishvili

(540)

BILIMDILOXOL(591) Black, white
(511) 5

(260) AM 2011 58239 A

(210) AM 058239

(220) 2010 05 27

(731) BILIM ILAC SANAYI VE TICARET A.S.

Ayazağa Köyü Yolu N6, TR-34398

Maslak, İstanbul, Turkey

(740) Davit Zurabishvili

(540)

BILIMLOSIRAM(591) Black, white
(511) 5

(260) AM 2011 58240 A

(210) AM 058240

(220) 2010 05 27

(731) BILIM ILAC SANAYI VE TICARET A.S.

Ayazağa Köyü Yolu N6, TR-34398

Maslak, İstanbul, Turkey

(740) Davit Zurabishvili

(540)

BILIMNEUROVIT(591) Black, white
(511) 5

(260) AM 2011 58241 A

(210) AM 058241

(220) 2010 05 27

(731) LONDON DAIRY LIMITED

Analyst House, P.O. Box 16, 20-26 Peel

Road, Souglas, Isle Man, United Kingdom

(740) Tamaz Shilakadze

(540)



(591) Black, white, tobacco, blue, dark blue

(531) 25.01.05-27.05.05-29.01.00-

(511) 30

(260) AM 2011 58244 A

(210) AM 058244

(220) 2010 05 28

(731) AGIO PHARMACEUTICALS LTD.

A-38, Nandjyot, Ind. Estate, Kurla-Andheri

Road, Safedpool, Mumbai 400 072, India

(740) Aleksander Kvernadze

(540)

КАНИЗОН ПЛЮС(591) Black, white
(511) 5

(260) AM 2011 58282 A

(210) AM 058282

(220) 2010 06 03

(731) SH.P.S. "GLOBALFARMI"

Tamar mefis gamz. N7/13, 0112, Tbilisi,

Georgia

(740) SH.P.S. "MIKADZE, GEGECHKORI,

TAKTAKISHVILI"

(540)

Menoflavon**Менофлавон****მენოფლავონი**(591) Black, white
(511) 5

(260) AM 2011 58284 A

(210) AM 058284

(220) 2010 06 03

(731) SH.P.S. "GLOBALFARMI"

Tamar mefis gamz. N7/13, 0112, Tbilisi,

Georgia

(740) SH.P.S. "MIKADZE, GEGECHKORI,

TAKTAKISHVILI"

(540)

Asibrox**Асиброкс****ასიბროქსი**(591) Black, white
(511) 5

(260) AM 2011 58285 A

(210) AM 058285

(220) 2010 06 03

(731) SH.P.S. "GLOBALFARMI"

Tamar mefis gamz. N7/13, 0112, Tbilisi,

Georgia

(740) SH.P.S. "MIKADZE, GEGECHKORI,

TAKTAKISHVILI"

(540)

Fibrolinase**Фибролиназа****ფიბროლინაზა**(591) Black, white
(511) 5

(260) AM 2011 58307 A
(210) AM 058307
(220) 2010 06 04
(731) S.S. "JI PI SI"
Marjanishvilis q. 26, 0102, Tbilisi, Georgia
(740) Davit Zurabishvili
(540)

სოლვეკაინი
SOLVECAIN

(591) Black, white
(511) 5

(260) AM 2011 58360 A
(210) AM 058360
(220) 2010 06 09
(731) BERLIN-CHEMIE AG
Glienicke Weg 125, 12489 Berlin, Germany
(740) გიორგი ღვინჯილია
(540)

БЕРЛИПРИЛ

(591) Black, white
(511) 5

(260) AM 2011 58361 A
(210) AM 058361
(220) 2010 06 09
(731) SH.P.S "LUQSI 2004"
Tevdore mgvdilis qucha N53, 0154, Tbilisi,
Georgia
(740) Nugzar Ksovreli
(540)

ბარაქა
Baraqa
Барака

(591) Black, white
(511) 29

(260) AM 2011 58367 A
(210) AM 058367
(220) 2010 06 09
(731) BASF SE
Carl-Bosch-Strasse 38, Ludwigshafen am
Rhein, Germany
(740) Tamar Kochlamazashvili
(540)

ACCRESTO

(591) Black, white
(511) 1, 5

(260) AM 2011 58373 A
(210) AM 058373

(220) 2010 06 10
(731) ALLIED GLOBAL TOBACCO LIMITED
Wey Court West, Union Road, Farnham,
GU9 7PT Surrey, United Kingdom
(740) Givi Akopashvili
(540)

PICCADILLY

(591) Black, white
(531) 27.05.05-
(511) 34

(260) AM 2011 58376 A
(210) AM 058376
(220) 2010 06 11
(731) HIMALAYA GLOBAL HOLDINGS LTD.
Dubai International Financial Centre, The
Gate, Level 12, Suite 27, P.O. Box 506807,
Dubai, United Arab Emirates
(740) პავლე მეიფარიანი
(540)

Organique by Himalaya

(591) Black, white
(511) 3, 5

(260) AM 2011 58377 A
(210) AM 058377
(220) 2010 06 11
(731) BURGER KING CORPORATION
5505 Blue Lagoon Drive, Miami, Florida
33126, USA
(740) Tamaz Shilakadze
(540)

BURGER KING

(591) Black, white
(531) 27.05.05-
(511) 29, 30, 31, 32, 43

(260) AM 2011 58378 A
(210) AM 058378
(220) 2010 06 11
(731) BURGER KING CORPORATION
5505 Blue Lagoon Drive, Miami, Florida
33126, USA
(740) Tamaz Shilakadze
(540)



(591) Black, white
(531) 26.01.19-26.02.01-26.11.12-
(511) 29, 30, 31, 32, 43

(260) AM 2011 58379 A
 (210) AM 058379
 (220) 2010 06 11
 (731) BURGER KING CORPORATION
 5505 Blue Lagoon Drive, Miami, Florida
 33126, USA
 (740) Tamaz Shilakadze
 (540)

BK

(591) Black, white
 (531) 27.05.05-
 (511) 29, 30, 43

(260) AM 2011 58380 A
 (210) AM 058380
 (220) 2010 06 11
 (731) BURGER KING CORPORATION
 5505 Blue Lagoon Drive, Miami, Florida
 33126, USA
 (740) Tamaz Shilakadze
 (540)

WHOPPER

(591) Black, white
 (531) 27.05.05-
 (511) 29, 30, 43

(260) AM 2011 58381 A
 (210) AM 058381
 (220) 2010 06 11
 (731) BURGER KING CORPORATION
 5505 Blue Lagoon Drive, Miami, Florida
 33126, USA
 (740) Tamaz Shilakadze
 (540)

HAVE IT YOUR WAY

(591) Black, white
 (531) 27.05.05-
 (511) 29, 30, 43

(260) AM 2011 58382 A
 (210) AM 058382
 (220) 2010 06 11
 (731) BURGER KING CORPORATION
 5505 Blue Lagoon Drive, Miami, Florida
 33126, USA
 (740) Tamaz Shilakadze
 (540)

HOME OF THE WHOPPER

(591) Black, white
 (531) 27.05.05-
 (511) 29, 30, 43

(260) AM 2011 58399 A
 (210) AM 058399
 (220) 2010 06 16
 (731) SH.P.S "PRIMA-VITA"
 Tamar Mefis gamz. 7/13, 0112, Tbilisi,
 Georgia
 (740) George Taktakishvili
 (540)

უნიფლექსი
Uniflex
Унифлекс

(591) Black, white
 (511) 5

(260) AM 2011 58400 A
 (210) AM 058400
 (220) 2010 06 16
 (731) SH.P.S "PRIMA-VITA"
 Tamar Mefis gamz. 7/13, 0112, Tbilisi,
 Georgia
 (740) George Taktakishvili
 (540)

აცვიკლორი
ACYCLOR
АЦИКЛОР

(591) Black, white
 (511) 5

(260) AM 2011 58401 A
 (210) AM 058401
 (220) 2010 06 16
 (731) SH.P.S "PRIMA-VITA"
 Tamar Mefis gamz. 7/13, 0112, Tbilisi,
 Georgia
 (740) George Taktakishvili
 (540)

ოსტეროზი
Osteroz
Остероз

(591) Black, white
 (511) 5

(260) AM 2011 58402 A
 (210) AM 058402
 (220) 2010 06 16
 (731) COMPAGNIE GERVAIS DANONE
 (a Franch Corporation)
 17 Boulevard Haussmann, 75009 Paris,
 France
 (740) Tamaz Shilakadze

(540)

NUTRIDAY

(591) Black, white

(511) 29

(260) AM 2011 58404 A

(210) AM 058404

(220) 2010 06 18

(731) NATURXAN LLC

9110 Red Branch Road, Columbia, Maryland,
21045-2024, USA

(740) Tamaz Shilakadze

(540)

AQUASTA

(591) Black, white

(511) 31

(260) AM 2011 58405 A

(210) AM 058405

(220) 2010 06 18

(731) SH.P.S "GOLD NIADI"

Nino Ramishvilis qucha N27a (ilia
Chavchavadzis I chikhi, korpusi 27/27a,
I sartuli), 0179, Tbilisi, Georgia

(540)



(591) Golden

(531) 26.01.18-27.05.05-27.05.22-29.01.00-

(511) 30, 32, 33, 35, 36, 37

(260) AM 2011 58471 A

(210) AM 058471

(220) 2010 06 28

(731) PAROC OY AB

Lakkisepantie 23, 00620, Helsinki, Finland

(740) George Taktakishvili

(540)

პაროკ

(591) Black, white

(511) 17, 19, 37

REGISTERED TRADEMARKS
ЗАРЕГИСТРИРОВАННЫЕ ТОВАРНЫЕ ЗНАКИ

(111) M 2011 021130 R

(151) 2011 02 11

(181) 2021 02 11

(260) AM 2008 47691 A

(220) 2008 03 28

(732) SH.P.S „AVERSI-FARMA“

Davit Agmasheneblis gamz., 148/2, 0112,
Tbilisi, Georgia

(111) M 2011 021131 R

(151) 2011 02 11

(181) 2021 02 11

(260) AM 2010 55599 A

(220) 2009 11 05

(732) SH.P.S "RAFSODI 11"

Kakhetis gzatketsili, Lilos bazroba, magazia
N112, 0109, Tbilisi, Georgia

(111) M 2011 021132 R

(151) 2011 02 11

(181) 2021 02 11

(260) AM 2010 55786 A

(220) 2009 11 17

(732) HI LIMITED PARTNERSHIP

a limited partnership formed under the laws of
the State of Florida, with Hooters Enterprises,
LLC (a Georgia limited liability company) as
general partner;
1815 The Exchange, Atlanta, GA 30339,
USA

(111) M 2011 021133 R

(151) 2011 02 11

(181) 2021 02 11

(260) AM 2010 55788 A

(220) 2009 11 17

(732) HI LIMITED PARTNERSHIP

a limited partnership formed under the laws of
the State of Florida, with Hooters Enterprises,
LLC (a Georgia limited liability company) as
general partner;
1815 The Exchange, Atlanta, GA 30339,
USA

(111) M 2011 021134 R

(151) 2011 02 11

(181) 2021 02 11

(260) AM 2010 55827 A

(220) 2009 11 24

(732) NINO SHAVLAKADZE

Vazha-Pshavelas gamz. 6 kv, korp. 18, b. 57,
0186, Tbilisi, Georgia

(111) M 2011 021135 R

(151) 2011 02 11

(181) 2021 02 11

(260) AM 2010 55862 A

(220) 2009 11 26

(732) PLASPAK PLASTIK VE AMBALAJ

SANAYI VE TICARET LIMITED SIRKETI
Sehit Muhtar Gad. N17/6 Taksim, Istanbul,
Turkey

(111) M 2011 021136 R

(151) 2011 02 11

(181) 2021 02 11

(260) AM 2010 56033 A

(220) 2009 12 07

(732) SH.P.S "AVERSI-FARMA"

Davit Agmasheneblis gamz., 148/2, 0112,
Tbilisi, Georgia

(111) M 2011 021137 R

(151) 2011 02 11

(181) 2021 02 11

(260) AM 2010 56034 A

(220) 2009 12 07

(732) SH.P.S "AVERSI-FARMA"

Davit Agmasheneblis gamz., 148/2, 0112,
Tbilisi, Georgia

(111) M 2011 021138 R

(151) 2011 02 11

(181) 2021 02 11

(260) AM 2010 56035 A

(220) 2009 12 07

(732) SH.P.S "AVERSI-FARMA"

Davit Agmasheneblis gamz., 148/2, 0112,
Tbilisi, Georgia

(111) M 2011 021139 R

(151) 2011 02 11

(181) 2021 02 11

(260) AM 2010 56036 A

(220) 2009 12 07

(732) SH.P.S "AVERSI-FARMA"
 Davit Agmasheneblis gamz., 148/2, 0112,
 Tbilisi, Georgia

(260) AM 2010 56654 A
 (220) 2010 01 12
 (732) SH.P.S "BARAMBO"
 Tashkentis q. N23, 0160, Tbilisi, Georgia

(111) M 2011 021140 R
 (151) 2011 02 11
 (181) 2021 02 11
 (260) AM 2010 56037 A
 (220) 2009 12 07
 (732) SH.P.S "AVERSI-FARMA"
 Davit Agmasheneblis gamz., 148/2, 0112,
 Tbilisi, Georgia

(111) M 2011 021146 R
 (151) 2011 02 11
 (181) 2021 02 11
 (260) AM 2010 56655 A
 (220) 2010 01 12
 (732) SH.P.S "BARAMBO"
 Tashkentis q. N23, 0160, Tbilisi, Georgia

(111) M 2011 021141 R
 (151) 2011 02 11
 (181) 2021 02 11
 (260) AM 2010 56038 A
 (220) 2009 12 07
 (732) SH.P.S "AVERSI-FARMA"
 Davit Agmasheneblis gamz., 148/2, 0112,
 Tbilisi, Georgia

(111) M 2011 021147 R
 (151) 2011 02 11
 (181) 2021 02 11
 (260) AM 2010 56677 A
 (220) 2010 01 13
 (732) GLAXOSMITHKLINE TRADING
 SERVICES LIMITED
 6900 Cork Airport Business Park, Kinsale
 Road, Cork, Ireland

(111) M 2011 021142 R
 (151) 2011 02 11
 (181) 2021 02 11
 (260) AM 2010 56039 A
 (220) 2009 12 07
 (732) SH.P.S "AVERSI-FARMA"
 Davit Agmasheneblis gamz., 148/2, 0112,
 Tbilisi, Georgia

(111) M 2011 021148 R
 (151) 2011 02 11
 (181) 2021 02 11
 (260) AM 2010 56678 A
 (220) 2010 01 13
 (732) GLAXOSMITHKLINE TRADING
 SERVICES LIMITED
 6900 Cork Airport Business Park, Kinsale
 Road, Cork, Ireland

(111) M 2011 021143 R
 (151) 2011 02 11
 (181) 2021 02 11
 (260) AM 2010 56222 A
 (220) 2009 12 15
 (732) SH.P.S "TBILISI MOLI"
 Il. Chavchavadzis gamz. 76, 0162, Tbilisi,
 Georgia

(111) M 2011 021149 R
 (151) 2011 02 11
 (181) 2021 02 11
 (260) AM 2010 56847 A
 (220) 2010 02 01
 (732) SS "KOR STANDART BANKI"
 Ilia Chavchavazis gamz.43, 0162, Tbilisi, GE

(111) M 2011 021144 R
 (151) 2011 02 11
 (181) 2021 02 11
 (260) AM 2010 56290 A
 (220) 2009 12 18
 (732) SH.P.S "AVERSI-FARMA"
 Davit Agmasheneblis gamz., 148/2, 0112,
 Tbilisi, Georgia

(111) M 2011 021150 R
 (151) 2011 02 11
 (181) 2021 02 11
 (260) AM 2010 56848 A
 (220) 2010 02 01
 (732) SS "KOR STANDART BANKI"
 Ilia Chavchavazis gamz.43, 0162, Tbilisi, GE

(111) M 2011 021145 R
 (151) 2011 02 11
 (181) 2021 02 11

(111) M 2011 021151 R
 (151) 2011 02 11
 (181) 2021 02 11

(260) AM 2010 56849 A
 (220) 2010 02 01
 (732) SS "KOR STANDART BANKI"
 Ilia Chavchavazis gamz.43, 0162, Tbilisi, GE

(111) M 2011 021152 R
 (151) 2011 02 11
 (181) 2021 02 11
 (260) AM 2010 56881 A
 (220) 2010 02 03
 (732) KONSTANTINE ZHGENTI
 I. Abashidzis N62, Bina 10, 0162, Tbilisi, GE

(111) M 2011 021153 R
 (151) 2011 02 11
 (181) 2021 02 11
 (260) AM 2010 56918 A
 (220) 2010 02 05
 (732) KRAFT FOODS DEUTSCHLAND
 HOLDING GMBH
 Langemarckstrasse 4-20, 28199 Bremen,
 Germany

(111) M 2011 021154 R
 (151) 2011 02 11
 (181) 2021 02 11
 (260) AM 2010 57492 A
 (220) 2010 03 25
 (732) HAMID SHARIATI
 Marjvena sanapiro 2a, b. 53, 0105,
 Tbilisi, GE

(111) M 2011 021155 R
 (151) 2011 02 11
 (181) 2021 02 11
 (260) AM 2010 56846 A
 (220) 2010 02 01
 (732) SS "KOR STANDART BANKI"
 Ilia Chavchavazis gamz.43, 0162, Tbilisi, GE

(111) M 2011 021156 R
 (151) 2011 02 11
 (181) 2021 02 11
 (260) AM 2010 56302 A
 (220) 2009 12 18
 (732) SH.P.S "ASPHARMA" - SAQARTVELOS
 PHARMATSEVTULI KOMPANIA
 Shevchenkos q., 12, 0108, Tbilisi, GE

(111) M 2011 021157 R
 (151) 2011 02 14
 (181) 2021 02 14

(260) AM 2010 54637 A
 (220) 2009 09 02
 (732) TREK BICYCLE CORPORATION
 801 West Madison, Waterloo, Wisconsin
 53594, USA

(111) M 2011 021158 R
 (151) 2011 02 14
 (181) 2021 02 14
 (260) AM 2010 55457 A
 (220) 2009 11 02
 (732) BILAL MOHAMMAD AL HAMWI
 Real Estate N5668, AL Hai Alshamali, 40 th
 Street, Madamet AL Sham, Reef Damascus,
 Syrian Arab Republic

(111) M 2011 021159 R
 (151) 2011 02 14
 (181) 2021 02 14
 (260) AM 2010 55619 A
 (220) 2009 11 05
 (732) MEDANA PHARMA S.A.
 Ul. Wladyslawa Łokietka 10, 98-200, Sieradz,
 Poland

(111) M 2011 021160 R
 (151) 2011 02 14
 (181) 2021 02 14
 (260) AM 2010 55620 A
 (220) 2009 11 05
 (732) MEDANA PHARMA S.A.
 Ul. Wladyslawa Łokietka 10, 98-200, Sieradz,
 Poland

(111) M 2011 021161 R
 (151) 2011 02 14
 (181) 2021 02 14
 (260) AM 2010 55621 A
 (220) 2009 11 05
 (732) MEDANA PHARMA S.A.
 Ul. Wladyslawa Łokietka 10, 98-200, Sieradz,
 Poland

(111) M 2011 021162 R
 (151) 2011 02 14
 (181) 2021 02 14
 (260) AM 2010 55645 A
 (220) 2009 11 09
 (732) PT DJARUM
 Dl. Jend. A Yani N28, Kudus, 59317,
 Indonesia

(111) M 2011 021163 R
(151) 2011 02 14
(181) 2021 02 14
(260) AM 2010 55646 A
(220) 2009 11 09
(732) PT DJARUM
Dl. Jend. A Yani N28, Kudus, 59317,
Indonesia

(111) M 2011 021164 R
(151) 2011 02 14
(181) 2021 02 14
(260) AM 2010 55647 A
(220) 2009 11 09
(732) PT DJARUM
Dl. Jend. A Yani N28, Kudus, 59317,
Indonesia

(111) M 2011 021165 R
(151) 2011 02 14
(181) 2021 02 14
(260) AM 2010 55648 A
(220) 2009 11 09
(732) PT DJARUM
Dl. Jend. A Yani N28, Kudus, 59317,
Indonesia

(111) M 2011 021166 R
(151) 2011 02 14
(181) 2021 02 14
(260) AM 2010 56018 A
(220) 2009 12 07
(732) BERLIN-CHEMIE AG
Glienicke Weg 125, 12489 Berlin, Germany

(111) M 2011 021167 R
(151) 2011 02 14
(181) 2021 02 14
(260) AM 2010 56019 A
(220) 2009 12 07
(732) BERLIN-CHEMIE AG
Glienicke Weg 125, 12489 Berlin, Germany

TRADEMARKS REGISTERED ACCORDING TO THE ACCELERATED PROCEDURE

ТОВАРНЫЕ ЗНАКИ, ЗАРЕГИСТРИРОВАННЫЕ ПО УСКОРЕННОЙ ПРОЦЕДУРЕ

To file an appeal on request of the registration cancelling is possible at Chamber of Appeal of Sakpatenti within 3 months from the publication.

Внесение иска с требованием об аннулировании регистрации возможно в Апелляционной палате Сакпатенти в течение 3 месяцев с даты ее публикации.

(111) M 2011 21115 R
(151) 2011 01 28
(181) 2021 01 28
(220) 2011 01 06
(732) HARRINGTON DEVELOPMENT INC.
Arango-Orillac Bldg. East 54 th street,
Panama
(740) Givi Akopashvili
(540)

**PRIME
LUXX**

(591) Black, white
(531) 27.05.05-
(511) 34

(111) M 2011 21116 R
(151) 2011 01 28
(181) 2021 01 28
(220) 2011 01 06
(732) HARRINGTON DEVELOPMENT INC.
Arango-Orillac Bldg. East 54 th street,
Panama
(740) Givi Akopashvili
(540)

LUXX

(591) Black, white
(531) 27.05.05-
(511) 34

(111) M 2011 21117 R
(151) 2011 01 31
(181) 2021 01 31
(220) 2011 01 26
(732) SH.P.S "TONUSI"
Khvamlis q.14, 0112, Tbilisi, Georgia
(740) Alexander Kartvelishvili
(540)



(591) White, blue, green, grey, black
(531) 24.13.01-28.19.00-29.01.14-
(511) 35

(111) M 2011 21118 R
(151) 2011 01 31
(181) 2021 01 31
(220) 2011 01 24
(732) OIL IMPEX BUSINESS KORPORATION
P.O. box 3321, Drake Chambers, Road Toun,
Tortola, British
(740) Davit Zurabishvili
(540)

ЗОЛОТАЯ МАРКА

(591) Black, white
(511) 29

(111) M 2011 21119 R
(151) 2011 02 01
(181) 2021 02 01
(220) 2011 01 25
(732) SH.P.S "STANDARD TOBAKO
INKORPOREITIDI"
Abuseridze-Tbelis q.13, , 0120, Tbilisi,
Georgia
(740) George Meipariani
(540)



(591) Black, white
(531) 03.02.13-05.01.12-27.05.03-
(511) 34

(111) M 2011 21120 R
(151) 2011 02 08
(181) 2021 02 08

(220) 2011 01 31
(732) SH.P.S "SUMELA-XXI"
Tseretlis gamz.1, 0102, Tbilisi, Georgia
(540)



(591) Red, yellow, carrot-red, black
(531) 01.03.08-03.03.03-25.01.01-25.01.05-
29.01.13-
(511) 34

(111) M 2011 21121 R
(151) 2011 02 10
(181) 2021 02 10
(220) 2011 02 02
(732) HERBALIFE INTERNATIONAL, INC.
800 W. Olympic Blvd., suite 406, Los
Angeles, CA 90015, USA
(740) Natalia Babakishvili
(540)

HERBALIFE

(591) Black, white
(511) 3, 29, 30, 32, 35

(111) M 2011 21122 R
(151) 2011 02 10
(181) 2021 02 10
(220) 2011 02 02
(732) HERBALIFE INTERNATIONAL, INC.
800 W. Olympic Blvd., suite 406, Los
Angeles, CA 90015, USA
(740) Natalia Babakishvili
(540)

HERBALIFELINE

(591) Black, white
(511) 30

(111) M 2011 21123 R
(151) 2011 02 10
(181) 2021 02 10
(220) 2011 02 02
(732) HERBALIFE INTERNATIONAL, INC.
800 W. Olympic Blvd., suite 406, Los
Angeles, CA 90015, USA
(740) Natalia Babakishvili
(540)

LIFTOFF

(591) Black, white
(511) 32

(111) M 2011 21124 R
(151) 2011 02 10
(181) 2021 02 10
(220) 2011 02 02
(732) HERBALIFE INTERNATIONAL, INC.
800 W. Olympic Blvd., suite 406, Los
Angeles, CA 90015, USA
(740) Natalia Babakishvili
(540)

NITWORKS

(591) Black, white
(511) 32

(111) M 2011 21125 R
(151) 2011 02 10
(181) 2021 02 10
(220) 2011 02 02
(732) HERBALIFE INTERNATIONAL, INC.
800 W. Olympic Blvd., suite 406, Los
Angeles, CA 90015, USA
(740) Natalia Babakishvili
(540)

NOURIFUSION

(591) Black, white
(511) 3

(111) M 2011 21126 R
(151) 2011 02 10
(181) 2021 02 10
(220) 2011 02 02
(732) HERBALIFE INTERNATIONAL, INC.
800 W. Olympic Blvd., suite 406, Los
Angeles, CA 90015, USA
(740) Natalia Babakishvili
(540)

XTRA-CAL

(591) Black, white
(511) 30

(111) M 2011 21127 R
(151) 2011 02 10
(181) 2021 02 10
(220) 2011 02 02
(732) HERBALIFE INTERNATIONAL, INC.
800 W. Olympic Blvd., suite 406, Los
Angeles, CA 90015, USA
(740) Natalia Babakishvili

(540)



(591) Green

(531) 05.03.13-05.03.15-26.01.15-29.01.03-

(511) 3, 29, 30, 32,35

(111) M 2011 21128 R

(151) 2011 02 10

(181) 2021 02 10

(220) 2011 02 08

(732) GEDEVAN BABUNASHVILI

Mujirishvilis q.n7 (Babiskhevis 7), 0103,

Tbilisi, Georgia

(540)

(591) White, black, light blue, lilac, yellow,
raspberry pink, red, brown(531) 02.01.08-09.09.01-09.09.03-10.03.01-
10.03.04-26.04.14-26.04.16-26.04.24-
26.04.18-26.11.12-

(511) 3, 35

(111) M 2011 21129 R

(151) 2011 02 10

(181) 2021 02 10

(220) 2011 02 04

(732) SH.P.S "IBER-INFO"

Vazha-Fshavelas gamz.41, me-4 sartuli, 0177,

Tbilisi, Georgia

(540)

ინფო ბუღალტერი
Инфо Бухгалтер
Info Bukhgalter

(591) Black, white

(511) 9

**INTERNATIONAL TRADEMARKS LAID OPEN FOR THE PURPOSE
OF TAKING PROTECTION GRANTING DECISIONS**
**МЕЖДУНАРОДНЫЕ ТОВАРНЫЕ ЗНАКИ, ПО КОТОРЫМ ВЫНЕСЕНЫ РЕШЕНИЯ
О ПРЕДОСТАВЛЕНИИ ОХРАНЫ**

To appeal a decision is possible at Chamber of Appeal of Sakpatenti within 3 months from the publication or at The Board of Administrative Actions of Tbilisi City Court within a 1 month period. (Address: 12 km., №6, David Aghmashenebeli Kheivani, Tbilisi).

Обжалование решения возможно в Апелляционной палате Сакпатенти в течение 3 месяцев с даты его публикации или в течение 1 месяца в Коллегии по административным делам Тбилисского городского суда (Адрес: г. Тбилиси, Аллея Давида Агмашенебели 12-й км., №6).

(260) AM 2011 56013 A
(800) 836606
(731) AKTCIONERNE TOVARYSTVO
ZAKRYTOGO TYPU
"KCHARKISVSKA BISKVITNA
FABRYKA"
vul Lozovska, 8,m. UA-61017 Kcharkiv,
Ukraine
(540)



(591) Red, yellow
(511) 30

(260) AM 2011 57321 A
(800) 1029419
(731) STRAUSS COFFEE B.V.
Prof. J.H. Bavincklaan 2, NL-1183 AT
Amstelveen, Netherlands
(540)

il **MAESTRO**

(591) Black, white
(511) 11

(260) AM 2011 57375 A
(800) 1029883
(731) HANKOOK TIRE CO., LTD.
N647-15, Yoksam-dong, Kangnam-gu Seoul,
Republic of Korea
(540)

HANKOOK AURORA

(591) Black, white
(511) 12

(260) AM 2011 57510 A
(800) 679526
(731) REPETTO SOCIÉTÉ ANONYME
22, rue de la Paix, F-75002 PARIS, France
(540)

repetto

(591) Black, white
(511) 25

(260) AM 2011 57557 A
(800) 1031394
(731) HI-TRON USA, LLC
12751 Maplewood Court Poway, CA 92064, USA
(540)

REVO

(591) Black, white
(511) 09

(260) AM 2011 57569 A
(800) 1031619
(731) AECOM LIMITED
Aecom House, 63-77 Victoria Street
St. Albans, Hertfordshire AL1 3ER,
United Kingdom
(540)

AECOM

(591) Black, white
(511) 37, 39, 40, 42

(260) AM 2011 57614 A
(800) 1032194
(731) AZIENDE CHIMICHE RIUNITE
ANGELINI FRANCESCO A.C.R.A.F. S.p.A.
Viale Amelia, 70, I-00181 ROMA, Italy
(540)

ANGELINI

(591) Black, white
(511) 05

(260) AM 2011 57762 A
(800) 1033648
(731) CSL BEHRING GMBH
Emil-von-Behring-Strasse 76, 35041
Marburg, Germany
(540)

Гемате

(591) Black, white
(511) 05

(260) AM 2011 57822 A
(800) 986774
(731) PHARMATRANS SANAQ AG
Birsigstrasse 79, CH-4011 Basel, Switzerland
(540)

PrimaCard

(591) Black, white
(511) 05, 10, 44

(260) AM 2011 57863 A
(800) 1034299
(731) ZAKRYTE AKTSIONERNE
TOVARYSTVO "ELFA"
9 Simji Sosninyh Str. Kyiv 03680, Ukraine
(540)

Pink Elephant

(591) Black, white
(511) 03, 25, 28

(260) AM 2011 57882 A
(800) 1034469
(731) CHANSON COSMETICS INC.
5-10, Kuniyoshida 2-chome, Suruga-ku,
Shizuoka-shi Shizuoka 422-8615, Japan
(540)

CHANSON

(591) Black, white
(511) 03

(260) AM 2011 57893 A
(800) 1034680
(731) PURPLE WINE COMPANY, LLC
P.O. Box 390 Graton, CA 95444, USA
(540)

MARK WEST

(591) Black, white
(511) 33

(260) AM 2011 57940 A
(800) 1035227
(731) RICHTER GEDEON NYRT.
Gyömrői út 19-21, H-1103 Budapest,
Hungary
(540)

КОНТРЕКС

(591) Black, white
(511) 05

(260) AM 2011 57941 A
(800) 1035254
(731) BETEK BOYA VE KİMYA SANAYİ
ANONİM ŞİRKETİ
Kaynarca, Kavakpınar Mah., Tandoğan Cad.
Kocamezarlık Karşısı, Pendik - İSTANBUL,
Turkey
(540)



(591) Black, white, red, green, blue
(511) 16

(260) AM 2011 57944 A
(800) 1035286
(731) OBCHTCHESTVO S OGRANITCHENNOI
OTVETSTVENNOSTIOU "ENKA TC"
19, oul. Yartsevskaya, RU-121552
MOSKVA, Russian Federation
(540)

CITYSTORE

СИТИСТОР

(591) Black, white
(511) 35

(260) AM 2011 58050 A
(800) 1036092
(731) ZHEJIANG TOPSUN LOGISTIC
CONTROL CO., LTD.
Shaao village (Electrical & Mechanical
Industrial Zone), Zhugang Town, Yuhuan
County, Taizhou 317600 Zhejiang, China
(540)

KINGROY
New Roy New Era

(591) Black, white
(511) 06, 07, 08, 22

(260) AM 2011 58051 A
 (800) 1036138
 (731) Henkel AG & Co. KGaA
 Henkelstrasse 67, 40589 Düsseldorf,
 Germany
 (540)

ПЕМОС

(591) Black, white
 (511) 03

(260) AM 2011 58052 A
 (800) 1036139
 (731) EATON CORPORATION
 1111 Superior Avenue Cleveland, OH 44114,
 USA
 (540)

EATON

(591) Black, white
 (511) 09

(260) AM 2011 58053 A
 (800) 1036144
 (731) SCHIESSER AG
 Schützenstrasse 18, 78315 Radolfzell,
 Germany
 (540)

UNCOVER

(591) Black, white
 (511) 18, 25

(260) AM 2011 58054 A
 (800) 1036145
 (731) VERMOP Salmon GmbH
 Zeppelinstraße 24, 82205 Gilching, Germany
 (540)

CHROME

(591) Black, white
 (511) 21

(260) AM 2011 58060 A
 (800) 1036169
 (731) OSRAM GMBH
 Hellabrunner Strasse 1, 81543 München,
 Germany
 (540)

LEDVANCE

(591) Black, white
 (511) 11

(260) AM 2011 58063 A
 (800) 1036275

(731) ALFA WASSERMANN HUNGARY Kft.
 Garibaldi u. 4, H-1054 Budapest, Hungary
 (540)

АЛАНЕРВ

(591) Black, white
 (511) 05

(260) AM 2011 58064 A
 (800) 1036290
 (731) DMP S.R.L.
 Viale delle Terme, 15, I-35030
 GALZIGNANO TERME (Padova), Italy
 (540)



(591) Black, white
 (511) 18, 25

(260) AM 2011 58065 A
 (800) 570944
 (731) E. I. DU PONT DE NEMOURS AND
 COMPANY
 1007 Market Street Wilmington, Delaware
 19898, USA
 (540)

Permahyd

(591) Black, white
 (511) 02

(260) AM 2011 58066 A
 (800) 588999
 (731) BLASER JAGDWAFFEN GMBH
 1, Ziegelstadel, 88316 Isny, Germany
 (540)

BLASER

(591) Black, white
 (511) 09, 13

(260) AM 2011 58067 A
 (800) 617595
 (731) TMD FRICTION SERVICES GMBH
 Schlebuscher Straße 99, 51381 Leverkusen,
 Germany
 (540)

TEXTAR

(591) Black, white
 (511) 01, 07, 09, 17

(260) AM 2011 58068 A
 (800) 804560

(731) MEDINOVA Ltd.
Eggbühlstrasse 14, CH-8052 Zürich,
Switzerland

(540)

FLUOMIZIN

(591) Black, white
(511) 05

(260) AM 2011 58069 A
(800) 823772
(731) N.V. ORGANON
Kloosterstraat 6, NL-5349 AB Oss,
Netherlands

(540)

SAPHRIS

(591) Black, white
(511) 05

(260) AM 2011 58070 A
(800) 841767
(731) MEDINOVA AG
Eggbühlstrasse 14, CH-8052 Zürich,
Switzerland

(540)

MEDINOVA

(591) Black, white
(511) 03, 05

(260) AM 2011 58106 A
(800) 1036493
(731) OBCHTCHESTVO S OGRANITCHENNOI
OTVETSTVENNOSTYOU "KING-LION
FOUDS"
dom 58, ulitsa Kantemirovskaya, RU-115477
Moskva, Russian Federation

(540)



(591) White, black, light grey, grey, dark grey, light
yellow, yellow, dark yellow, orange, light
green, green, dark green, light red, red, dark
red, light brown, brown, dark brown, light
beige, beige, dark beige and lilac

(511) 29, 30

(260) AM 2011 58120 A
(800) 1036623
(731) "BOSNALIJEK" FARMACEUTSKA I
HEMIJSKA INDUSTRIJA, DIONIČKO
DRUŠTVO

Jukićeva 53, 71000 Sarajevo, Bosnia and
Herzegovina

(540)

TOMICIN

(591) Black, white
(511) 05

(260) AM 2011 58121 A
(800) 1036624
(731) "BOSNALIJEK" FARMACEUTSKA I
HEMIJSKA INDUSTRIJA, DIONIČKO
DRUŠTVO
Jukićeva 53, 71000 Sarajevo, Bosnia and
Herzegovina

(540)

HIZOKVIN

(591) Black, white
(511) 05

(260) AM 2011 58122 A
(800) 1036625
(731) "BOSNALIJEK" FARMACEUTSKA I
HEMIJSKA INDUSTRIJA, DIONIČKO
DRUŠTVO
Jukićeva 53, 71000 Sarajevo, Bosnia and
Herzegovina

(540)

DORZOMOLL

(591) Black, white
(511) 05

(260) AM 2011 58123 A
(800) 1036626
(731) "BOSNALIJEK" FARMACEUTSKA I
HEMIJSKA INDUSTRIJA, DIONIČKO
DRUŠTVO
Jukićeva 53, 71000 Sarajevo, Bosnia and
Herzegovina

(540)

DERSATIL

(591) Black, white
(511) 05

(260) AM 2011 58124 A
(800) 1036627
(731) "BOSNALIJEK" FARMACEUTSKA I
HEMIJSKA INDUSTRIJA, DIONIČKO
DRUŠTVO
Jukićeva 53, 71000 Sarajevo, Bosnia and
Herzegovina

(540)

EXMAL

(591) Black, white
(511) 05

(260) AM 2011 58125 A
(800) 1036628
(731) "BOSNALIJEK" FARMACEUTSKA I
HEMIJSKA INDUSTRIJA, DIONIČKO
DRUŠTVO
Jukićeva 53, 71000 Sarajevo, Bosnia and
Herzegovina

(540)

SEXTIN

(591) Black, white
(511) 05

(260) AM 2011 58126 A
(800) 1036641
(731) DECATHLON
4 boulevard de Mons, F-59650
VILLENEUVE D'ASCQ, France

(540)

QUECHUA

(591) Black, white
(511) 11, 14

(260) AM 2011 58127 A
(800) 1036642
(731) EURONUT GIDA SANAYİ VE TİCARET
ANONİM ŞİRKETİ
Kavaklı Beldesi Cumhuriyet Mahallesi,
Cumhuriyet Caddesi, Harman Sok. N1
Silivri Beykoz İSTANBUL, Turkey

(540)



(591) Red, white
(511) 29

(260) AM 2011 58128 A
(800) 1036686
(731) ARES TRADING S.A.
Zone Industrielle de l'Ouriettaz, CH-1170
Aubonne, Switzerland

(540)

VADEGI

(591) Black, white
(511) 05

(260) AM 2011 58129 A
(800) 1036687

(731) ARES TRADING S.A.
Zone Industrielle de l'Ouriettaz, CH-1170
Aubonne, Switzerland

(540)

XUDACI

(591) Black, white
(511) 05

(260) AM 2011 58130 A
(800) 1036688
(731) ARES TRADING S.A.
Zone Industrielle de l'Ouriettaz, CH-1170
Aubonne, Switzerland

(540)

SANZESA

(591) Black, white
(511) 05

(260) AM 2011 58134 A
(800) 1036689
(731) ARES TRADING S.A.
Zone Industrielle de l'Ouriettaz, CH-1170
Aubonne, Switzerland

(540)

SANZEZA

(591) Black, white
(511) 05

(260) AM 2011 58135 A
(800) 1036690
(731) ARES TRADING S.A.
Zone Industrielle de l'Ouriettaz, CH-1170
Aubonne, Switzerland

(540)

BELCANZI

(591) Black, white

(511) 05

(260) AM 2011 58136 A
(800) 1036716
(731) SARİBEKİR AMBALAJ SANAYİ VE
TİCARET ANONİM ŞİRKETİ
P.M. Paşa Mah., Musa Çavuş Sok. N 14
Silivri - İSTANBUL, Turkey

(540)

SBK

(591) Black, white
(511) 06, 07, 16, 20, 21, 29, 40

(260) AM 2011 58192 A
 (800) 1037191
 (731) ARES TRADING S.A.
 Zone Industrielle de l'Ouriettaz, CH-1170
 Aubonne, Switzerland

(540)

STEDRALIF

(591) Black, white
 (511) 05

(260) AM 2011 58193 A
 (800) 1037192
 (731) Ares Trading S.A.
 Zone Industrielle de l'Ouriettaz, CH-1170
 Aubonne, Switzerland

(540)

FREPENSO

(591) Black, white
 (511) 05

(260) AM 2011 58194 A
 (800) 1037220
 (731) CCL PENINSULAR, S.A.
 Pº de la Castellana, 91, E-28046 MADRID,
 Spain

(540)



(591) Red, grey
 (511) 35

(260) AM 2011 58195 A
 (800) 1037232
 (731) PABLOSKY, S.L.
 C/ Maestro Guerrero, 24, E-45510
 FUENSALIDA (Toledo), Spain

(540)



(591) Black, white
 (511) 25, 28, 35

(260) AM 2011 58196 A
 (800) 1037251
 (731) RĪGAS PIENA KOMBINĀTS, A/S
 Bauskas Iela 180, LV-1004 Rīga, Latvia

(540)



(591) Light bleu, dark blue and white
 (511) 29, 30, 32

(260) AM 2011 58197 A
 (800) 1037261
 (731) HANS PRIES GMBH & CO. KG
 Bergedorfer Strasse, 27777 Ganderkesee,
 Germany

(540)

TOPRAN

(591) Black, white
 (511) 06, 07, 09, 11, 12, 17

(260) AM 2011 58198 A
 (800) 1037311
 (731) KRAFT FOODS GLOBAL BRANDS LLC
 Three Lakes Drive, Northfield, IL 60093,
 USA

(540)

BARNI

(591) Black, white
 (511) 30

(260) AM 2011 58200 A
 (800) 1037365
 (731) DOLORGIET GMBH & Co. KG
 Otto-von-Guericke-Strasse 1, 53757 Sankt
 Augustin, Germany

(540)

Cipronerton

(591) Black, white
 (511) 05

(260) AM 2011 58201 A
 (800) 1037398
 (731) AGRICULTURAL BANK OF GREECE
 S.A. with distinctive title ATE BANK
 Panepistimiou Str. 23, GR-105 64 Athens,
 Greece

(540)



(591) Green, white
 (511) 36

(260) AM 2011 58203 A
 (800) 1037423
 (731) KRAFT FOODS GLOBAL BRANDS LLC,
 A DELAWARE COMPANY
 Three Lakes Drive Northfield, Illinois
 60093, USA

(540)



(591) Light-blue, white, blue, black, yellow, brown and beige

(511) 30

(260) AM 2011 58204 A

(800) 1037441

(731) PAYSAFECARD.COM WERTKARTEN
AG Am Euro Platz 2, A-1120 Wien, Austria

(540)

PAYSAFECARD

(591) Black, white

(511) 36

(260) AM 2011 58205 A

(800) 1037514

(731) ANTHONY BECHU
82 rue Lecourbe, F-75015 PARIS, France

(540)

Anthony BECHU Architecte

(591) Black, white

(511) 42

(260) AM 2011 58206 A

(800) 1037515

(731) KOFOLA HOLDING A.S.
Nad Porubkou 2278/31a, CZ-708 00 Ostrava,
Czech Republic

(540)



(591) Yellow, red, white, blue, brown, pink, green, black, ginger and orange

(511) 28, 30, 32

(260) AM 2011 58207 A

(800) 1037533

(731) SOCIETY WITH LIMITED LIABILITY
"KS-DEALING"
d. 16, str.1, ul. 1-aya Magistralnaya,
RU-123007 Moscow, Russian Federation

(540)

Старплик

(591) Black, white

(511) 06, 19

(260) AM 2011 58208 A

(800) 1037561

(731) POWER SOURCE INDUSTRIES CO.
Ltd.; No. 61 Yudong 1st Road, Dongcheng,
Yangdong, Yangjiang Guangdong, China

(540)

LITEMAID

(591) Black, white

(511) 09, 11

(260) AM 2011 58209 A

(800) 1037583

(731) SALVATORE FERRAGAMO ITALIA
S.P.A.
Via dei Tornabuoni, 2, I-50123 Firenze, Italy

(540)

ATTIMO

(591) Black, white

(511) 03

(260) AM 2011 58210 A

(800) 1037590

(731) CHERY AUTOMOBILE CO., LTD.
Economy & Technology Development Zone,
Wuhu City Anhui Province, China

(540)

TIGGO

(591) Black, white

(511) 12

(260) AM 2011 58211 A

(800) 1037620

(731) ADIDAS AG
Adi-Dassler-Strasse 1, 91074
Herzogenaurach, Germany

(540)

adidas

(591) Black, white

(511) 25

(260) AM 2011 58212 A

(800) 1037625

(731) GUCCIO GUCCI S.P.A.
Via Tornabuoni, 73/R, I-50123 FIRENZE,
Italy

(540)

GUCCI FOREVER NOW

(591) Black, white

(511) 14, 18, 24

(260) AM 2011 58213 A
 (800) 1037646
 (731) ZAKRYTOE AKTSIONERNOE
 OBSHCHESTVO "GRUPPA COMPANY
 DERNEK"
 11, ul. Pisemskogo, RU-630110 Novosibirsk,
 Russian Federation

(540)

Lezard

(591) Black, white
 (511) 01, 02, 06, 09, 11, 19, 27

(260) AM 2011 58214 A
 (800) 1037709
 (731) NINGBO SMAL ELECTRICS CO.,LTD.
 No.737-1 Xinjian Road (N.) Yuyao 315400
 Zhejiang, China

(540)

SMAL

(591) Black, white
 (511) 11

(260) AM 2011 58215 A
 (800) 1037720
 (731) CARLSBERG A/S
 Ny Carlsberg Vej 100, DK-1760 Copenhagen
 V., Denmark

(540)

CARLSBERG

(591) Black, white
 (511) 25, 32, 33, 43

(260) AM 2011 58216 A
 (800) 1037724
 (731) Philip Morris Products S.A.
 Quai Jeanrenaud 3, CH-2000 Neuchâtel,
 Switzerland

(540)

L & M TRIPLE MINT

(591) Black, white
 (511) 34

(260) AM 2011 58217 A
 (800) 1037727
 (731) SIGMA-TAU INDUSTRIE
 FARMACEUTICHE RIUNITE S.p.A.
 Viale Shakespeare, 47, I-00144 ROMA, Italy

(540)



(591) Dark red and white

(511) 05

(260) AM 2011 58218 A
 (800) 1037729
 (731) SANOFI-AVENTIS
 174, avenue de France, F-75013 PARIS,
 France

(540)

MULSEVO

(591) Black, white
 (511) 05

(260) AM 2011 58221 A
 (800) 1037734
 (731) PHILIP MORRIS PRODUCTS S.A.
 Quai Jeanrenaud 3, CH-2000 Neuchâtel,
 Switzerland

(540)



(591) Black, white
 (511) 34

(260) AM 2011 58222 A
 (800) 1037737
 (731) PHILIP MORRIS PRODUCTS S.A.
 Quai Jeanrenaud 3, CH-2000 Neuchâtel,
 Switzerland

(540)

L & M TRIPLE BLEND OF HIGH QUALITY TOBACCOS

(591) Black, white
 (511) 34

(260) AM 2011 58223 A
 (800) 1037740
 (731) PHILIP MORRIS PRODUCTS S.A.
 Quai Jeanrenaud 3, CH-2000 Neuchâtel,
 Switzerland

(540)

L & M TOTAL HARMONY IN TASTE

(591) Black, white
 (511) 34

(260) AM 2011 58224 A
 (800) 186971
 (731) WALTER MEIER (KLIMA
 INTERNATIONAL) AG
 Talstrasse 35-37, CH-8808 Pfäffikon,
 Switzerland

(540)

CONDAIR

(591) Black, white
(511) 11

(260) AM 2011 58225 A

(800) 812284

(731) GALENIKA A.D.
Batajnički drum b.b. BEOGRAD-ZEMUN,
Serbia

(540)

DIKLOFEN

(591) Black, white
(511) 05

(260) AM 2011 58255 A

(800) 1037835

(731) VIENNA INSURANCE GROUP
Wiener Städtische Versicherung AG
Schottenring 30, A-1010 Vienna, Austria

(540)



(591) Black, white, red
(511) 36

(260) AM 2011 58261 A

(800) 1037934

(731) PARFUMS CHRISTIAN DIOR
33 avenue Hoche, F-75008 PARIS, France

(540)

ESCALE AUX MARQUISES

(591) Black, white
(511) 03

(260) AM 2011 58262 A

(800) 1037939

(731) BIOFARMA
22, rue Garnier, F-92200 NEUILLY-SUR-
SEINE, France

(540)

TERTENSAM

(591) Black, white
(511) 05

(260) AM 2011 58263 A

(800) 1037946

(731) PHILIP MORRIS PRODUCTS S.A.
Quai Jeanrenaud 3, CH-2003 Neuchâtel,
Switzerland

(540)

PARLIAMENT PLEASURE BEYOND

(591) Black, white
(511) 34

(260) AM 2011 58264 A

(800) 1037965

(731) PHILIP MORRIS PRODUCTS S.A.
Quai Jeanrenaud 3, CH-2000 Neuchâtel,
Switzerland

(540)

L & M TRIPLE FILTE

(591) Black, white
(511) 34

(260) AM 2011 58265 A

(800) 1037967

(731) PHILIP MORRIS PRODUCTS S.A.
Quai Jeanrenaud 3, CH-2000 Neuchâtel,
Switzerland

(540)

PARLIAMENT RESERVE

(591) Black, white
(511) 34

(260) AM 2011 58266 A

(800) 1037969

(731) PHILIP MORRIS PRODUCTS S.A.
Quai Jeanrenaud 3, CH-2000 Neuchâtel,
Switzerland

(540)

CHESTERFIELD A TRADITION OF SMOKING PLEASURE

(591) Black, white
(511) 34

(260) AM 2011 58267 A

(800) 1037975

(731) MONUS D.O.O.
Aleksandra Dubčeka 14, 11080
BEOGRAD-ZEMUN, Serbia

(540)

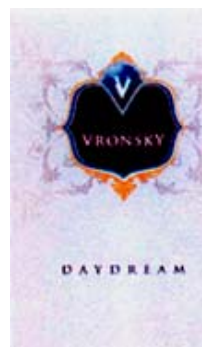

(591) Ocher, brown, blue, white and gold
(511) 34

(260) AM 2011 58269 A
(800) 1037981
(731) INOSTRANNOE TCHASTNOE
OUNITARNOE PROIZVODSTVENNO-
TORGOVOE PREDPRIATIE "KARAVAN"
KORPORATSII "KAMBERLI
MARKETING KORP."
komm. 2, d. 1, oul. Zavodskaia, Zaslavl
223034 Minskaia obl., Belarus

(540)



(591) Brown, orange, beige
(511) 30

(260) AM 2011 58270 A
(800) 1037998
(731) ACCREDITATION BOARD FOR
ENGINEERING AND TECHNOLOGY,
INC.
111 Market Place Suite 1050, Baltimore,
MD 21202, USA

(540)

ABET

(591) Black, white
(511) 42

(260) AM 2011 58271 A
(800) 1038011
(731) TORREFAZIONE OMKAFE' - S.R.L.
Viale Vannetti, 18, I-38066 RIVA DEL
GARDA (Trento), Italy

(540)

OMKAFE'

(591) Black, white
(511) 30

(260) AM 2011 58272 A
(800) 1038018
(731) ERCEM TEKSTİL SANAYİ VE TİCARET
ANONİM ŞİRKETİ
Meşrutiyet Mahallesi. Samanyolu, Sokak
Bilge
Han. No. 5/3, Şişli/Osmanbey İstanbul,
Turkey

(540)



(591) Black, white
(511) 14, 18, 25

(260) AM 2011 58273 A
(800) 1038029
(731) DMP S.R.L.
Viale delle Terme, 15, I-35030
GALZIGNANO TERME (Padova), Italy

(540)

YOUTUTOI

(591) Black, white
(511) 18, 25

(260) AM 2011 58274 A
(800) 1038052
(731) ZENTIVA, K.S.
U Kabelovny 130, CZ-102 37 Praha
10 - Dolní Měcholupy, Czech Republic

(540)

SPIROKAST

(591) Black, white
(511) 05

(260) AM 2011 58275 A
(800) 1038057
(731) GALLAHER LIMITED
Members Hill, Brooklands Road, Weybridge,
Surrey KT13 0QU, United Kingdom

(540)



(591) Red-pink-purple and metallic silver
(511) 34

(260) AM 2011 58291 A
 (800) 1038260
 (731) PROCTER & GAMBLE
 MANUFACTURING COLOGNE GMBH
 Wilhelm-Mausser-Str. 40, 50827 Köln,
 Germany

(540)

ROYAL DESIRE

(591) Black, white
 (511) 03

(260) AM 2011 58292 A
 (800) 1038263
 (731) HOGAN LOVELLS INTERNATIONAL LLP
 Atlantic House, Holborn Viaduct, London
 EC1A 2FG, United Kingdom

(540)

HOGAN LOVELLS

(591) Black, white
 (511) 16, 35, 36, 41, 45

(260) AM 2011 58294 A
 (800) 1038298
 (731) RACE CAT GMBH
 Weideweg 11, 89257 Illertissen, Germany

(540)

Race Cat

(591) Black, white
 (511) 32, 33

(260) AM 2011 58296 A
 (800) 1038305
 (731) AKTSIONERNE TOVARYSTVO
 ZAKRYTOGO TYPU "KHARKIVSKA
 BISKVITNA FABRYKA"
 vul. Lozivska, 8, Kharkiv 61017, Ukraine

(540)

АЗИАТКА АЗИАТКА

(591) Black, white
 (511) 30

(260) AM 2011 58297 A
 (800) 1038309
 (731) F. HOFFMANN-LA ROCHE AG
 Grenzacherstrasse 124, CH-4070 Basel,
 Switzerland

(540)

ADCYTA

(591) Black, white
 (511) 05

(260) AM 2011 58298 A
 (800) 1038378
 (731) YELKEN KALIP PENCERE KAPI
 AKSESUARLARI VE METAL SANAYİ
 TİCARET ANONİM ŞİRKETİ
 Atatürk Sanayi Bölgesi Mustafa, İnan
 Caddesi N47, Hadimköy, Çatalca,
 İSTANBUL, Turkey

(540)

PAVO

(591) Black, white
 (511) 06, 20

(260) AM 2011 58299 A
 (800) 1038387
 (731) OPTIBET, SIA
 Brivibas iela 99, LV-1001 Riga, Latvia

(540)

optibet

(591) Black, white
 (511) 41

(260) AM 2011 58300 A
 (800) 1038392
 (731) ARAV HOLDING S.r.l.
 a Socio Unico Via Nuova Sarno, 558/A,
 I-80036 PALMA CAMPANIA (NA),
 Italy

(540)



(591) Black, white
 (511) 09, 14, 18, 25, 35

(260) AM 2011 58301 A
 (800) 1038401
 (731) RHEEM MANUFACTURING COMPANY
 1100 Abernathy Road, N.E., Suite 1400,
 500 Northpark Town Center Atlanta,
 GA 30328, USA

(540)



(591) Black, white
 (511) 11

(260) AM 2011 58302 A
 (800) 1038408
 (731) SOVMESTNOE OBSHESTVO S

OGRANICHENNOJ
OTVETSTVENNOSTYU "PP POLESIE"
d. 179, ul. Proletarskaja, 225306 Kobrin,
Brestskaja obl., Belarus

(540)



(591) Yellow, red, white, black
(511) 11, 21, 28

(260) AM 2011 58303 A
(800) 388253
(731) P.A. JANSEN GMBH U. CO. KG
53474 BAD NEUENHR-AHRWEILER,
Germany

(540)

JANSEN

(591) Black, white
(511) 02, 04, 16

(260) AM 2011 58304 A
(800) 746804
(731) AYKUTLAR TEKSTIL SANAYI VE DIS
TICARET LIMITED ŞİRKETİ
Nişanca Mahallesi, Türkeliçaddesi, Latif
Sokak No. 12, Eminönü - ISTANBUL,
Turkey

(540)



(591) Black, white, red, green
(511) 25

(260) AM 2011 58305 A
(800) 936142
(731) CPG
4, rue de Buci, F-75006 PARIS, France

(540)



(591) Black, white
(511) 30, 43

(260) AM 2011 58306 A

(800) 964110
(731) PININFARINA EXTRA S.R.L.
Via Bruno Buozzi, 6, I-10121 TORINO, Italy

(540)

pininfarina

(591) Black, white
(511) 03

(260) AM 2011 58309 A
(800) 992077
(731) FINANCIERE BATTEUR
Avenue du Général de Gaulle, F-14200
HEROUVILLE SAINT CLAIR, France

(540)

МАРИМЕР

(591) Black, white
(511) 03, 05

(260) AM 2011 58310 A
(800) 1026891
(731) U-IMPL SWITZERLAND GMBH
Aarbergstrasse 107A, CH-2502 Biel/Bienne,
Switzerland

(540)



(591) Black, white
(511) 05, 10

(260) AM 2011 58315 A
(800) 1038416
(731) JAPAN TOBACCO INC.
2-2-1, Toranomom, Minato-ku Tokyo
105-8422, Japan

(540)

ZERO STYLE

(591) Black, white
(511) 34

(260) AM 2011 58317 A
(800) 1038438
(731) DMP S.R.L.
Viale delle Terme, 15, I-35030
GALZIGNANO TERME (Padova), Italy

(540)



(591) Black, white, grey
(511) 25

(260) AM 2011 58318 A
(800) 1038446
(731) GRINDEKS
akciju sabiedrība Krustpils iela 53, LV-1057
Rīga, Latvia
(540)



(591) Blue, light blue, red, orange, white,
grey and black
(511) 05

(260) AM 2011 58319 A
(800) 1038463
(731) WINEZERO S.R.L.
Via Manin, 3, I-20121 MILANO, Italy
(540)

WINEZERO

(591) Red and black
(511) 32, 33

(260) AM 2011 58320 A
(800) 1038467
(731) BOBKOV GLEB VIKTOROVICH
B. Cheremushkinskaya ul, d.24, k.1, kv.111,
RU-117218 Moscow, Russian Federation
(540)

Непоседа

(591) Black, white
(511) 03, 05, 35

(260) AM 2011 58322 A
(800) 1038487
(731) VINREAL S.R.L.
Str. Ferapontievsaia 1, MD-3801 Comrat,
UTA Găgăuzia, Republic of Moldova
(540)

**СЕМЬ ЛЮБИМЫХ
РОЗ**

(591) Black, white
(511) 33

(260) AM 2011 58323 A
(800) 1038498

(731) TEMSA GLOBAL SANAYI VE TICARET
ANONIM SIRKETI
Mersin Yolu Üzeri 10. Km. Seyhan Adana,
Turkey

(540)

TEMSA GLOBAL

(591) Black, white, blue
(511) 12

(260) AM 2011 58324 A
(800) 1038500
(731) OBSHESTVO S OGRANITCHENNOY
OTVETSTVENNOSTIU "SLAVYANKA
PLUS"
ul. 1 Konnoy Armii, d.65, Stari Oskol,
RU-309506 Region de Belgorod,
Russian Federation

(540)

ФАНТ

(591) Black, white
(511) 30

(260) AM 2011 58325 A
(800) 1038501
(731) OBSHESTVO S OGRANITCHENNOY
OTVETSTVENNOSTIU "SLAVYANKA
PLUS"
ul. 1 Konnoy Armii, d.65, Stari Oskol,
RU-309506 Region de Belgorod,
Russian Federation

(540)

НОВОЕ ЧУДО

(591) Black, white
(511) 30

(260) AM 2011 58326 A
(800) 1038511
(731) XIAMEN GOLDEN DRAGON BUS
CO.,LTD
Huli Street, Huli Industry Zone Xiamen,
China

(540)

GOLDEN JOURNEY

(591) Black, white
(511) 12, 37, 39

(260) AM 2011 58327 A
(800) 1038521
(731) HURSULTAN PASLANMAZ MUTFAK
ESYALARI SANAYI VE TICARET

ANONIM SIRKETI
Omerli Koy Yolu Aynali Cesme, Mevkii
Ilgaz Cad. Bila No. Hadimkoy, Turkey

(540)

FALEZ

(591) Black, white
(511) 08, 21

(260) AM 2011 58328 A
(800) 1038543
(731) DR. THEISS NATURWAREN GMBH
Michelinstrasse 10, 66424 Homburg,
Germany

(540)



(591) Red, white and dark green
(511) 03, 44

(260) AM 2011 58329 A
(800) 1038563
(731) DOTCHIRNE PIDPRIEMSTVO
"KONDIERSKA KORPORATZIA
"ROSHEN"
vul. Pavla Usenka, 8, Kyiv 02105, Ukraine

(540)

Crazy Bee

(591) Black, white
(511) 30

(260) AM 2011 58354 A
(800) 1038844
(731) DERKACH NATALIYA
23/25 Klinichna Str., apt. 173 Kyiv 03110,
Ukraine

(540)

HYALUAL

(591) Black, white
(511) 03, 05, 10, 44

(260) AM 2011 58355 A
(800) 1038893
(731) COMPAGNIE FRANÇAISE DE LA
GRANDE CHARTREUSE
10, boulevard Edgar Kofler, F-38500
VOIRON, France

(540)

VERTICAL

(591) Black, white
(511) 33

(260) AM 2011 58356 A
(800) 1038895
(731) PROFIOFFICE GMBH
Beyerbach Str. 9, 65830 Kriftel, Germany

(540)



(591) Black, white
(511) 06, 09, 16

(260) AM 2011 58357 A
(800) 1038938
(731) IRONWOOD PHARMACEUTICALS, INC
320 Bent Street Cambridge, MA 02141, USA

(540)

LIBSUTA

(591) Black, white
(511) 05

(260) AM 2011 58358 A
(800) 1038952
(731) HYDRO BUILDING SYSTEMS S.p.A.
Via Meucci, 5, I-20060 ORNAGO
(MILANO), Italy

(540)



(591) Black, white
(511) 06, 07, 08

(260) AM 2011 58359 A
(800) 1038963
(731) MARTIN UND GERDA ESSL
SOZIALPREIS GEMEINNÜTZIGE
PRIVATSTIFTUNG
Aufeldstraße 17-23, A-3403 Klosterneuburg,
Austria

(540)



(591) Black, white
(511) 35, 36, 37, 41, 42, 45

(260) AM 2011 58362 A
 (800) 1038970
 (731) APPLE INC.
 1 Infinite Loop, Cupertino, CA 95014, USA
 (540)



(591) Black, white, red, blue, yellow, brown, pink
 (511) 09

(260) AM 2011 58363 A
 (800) 1038977
 (731) CONSOLIDATED ARTISTS B.V.
 Lijnbaan 68, NL-3012 EP ROTTERDAM,
 Netherlands
 (540)



(591) Black, white
 (511) 18, 25

(260) AM 2011 58368 A
 (800) 1038984
 (731) PROJECT SERVICE S.R.L.
 Via Matteotti, 311, I-25063 GARDONNE
 VAL TROMPIA (BS), Italy
 (540)



(591) Black with water effect/metal and silver
 (511) 11

(260) AM 2011 58369 A
 (800) 1038987
 (731) ÖZLEM SÜER TEKSTİL TASARIM
 DANIŞMANLIK TİCARET LİMİTED
 ŞİRKETİ
 Maçka Caddesi Narmanlı, Apartmanı N12
 K:4 D:29, TEŞVİKİYE - İSTANBUL,
 Turkey
 (540)



ÖZLEM SÜER

(591) Black, white
 (511) 25

(260) AM 2011 58371 A
 (800) 1028987
 (731) SANOFI-AVENTIS
 174, avenue de France, F-75013 PARIS,
 France
 (540)

BGSTAR

(591) Black, white
 (511) 10

(260) AM 2011 58372 A
 (800) 789466A
 (731) VKR HOLDING A/S
 Breettevej 18, DK-2970 Hursholm, Denmark
 (540)



(591) Orange
 (511) 09, 11, 37

(260) AM 2011 58449 A
 (800) 1039294
 (731) IRONWOOD PHARMACEUTICALS, INC.
 320 Bent Street Cambridge, MA 02141, USA
 (540)

LINZESS

(591) Black, white
 (511) 05

(260) AM 2011 58450 A
 (800) 1039301
 (731) GUCCIO GUCCI S.P.A.
 Via Tornabuoni, 73/R, I-50123 FIRENZE,
 Italy
 (540)



(591) Black, white
 (511) 09, 14, 18, 25, 26, 28

(260) AM 2011 58451 A
 (800) 1039328
 (731) Opel Eisenach GmbH
 Adam-Opel-Strasse 100, 99817 Eisenach,
 Germany
 (540)

ADAM

(591) Black, white
(511) 12

(260) AM 2011 58452 A
(800) 1039329
(731) OBSHCHESTVO S OGRANICHENNOY
OTVETSTVENNOSTYU
"PRIMER-ELBOR"
pl. Volodarskogo, 20a, g. Borovichi,
RU-174411 Novgorodskaya obl.,
Russian Federation

(540)



(591) White, black, grey and red
(511) 06, 07, 20

(260) AM 2011 58453 A
(800) 1039343
(731) OBSHCHESTVO S OGRANICHENNOY
OTVETSTVENNOSTYU
"SPLAT-COSMETICA"
ul. Stromynka, dom 19, korp. 2, RU-107076
Moscow, Russian Federation

(540)

AIBO

(591) Black, white
(511) 03, 05

(260) AM 2011 58454 A
(800) 1039374
(731) CSC PHARMACEUTICALS HANDELS
GMBH
Gewerbestrasse 18-20, Gewerbegebiet
Klein-Engersdorf, A-2102 Bisamberg, Austria

(540)

SILVAN BIO

(591) Black, white
(511) 05, 29, 30

(260) AM 2011 58456 A
(800) 1039388
(731) WIRTSCHAFTSKAMMER ÖSTERREICH
Wiedner Hauptstrasse 63, A-1045 Vienna, Austria
(540)



(591) Black, red and white
(511) 16, 35, 41

(260) AM 2011 58457 A
(800) 1039390
(731) Opera Software ASA
Waldemar Thranes gate 98, N-0175 Oslo,
Norway
(540)



(591) Red and grey
(511) 9, 35, 38, 42, 45

(260) AM 2011 58458 A
(800) 1039391
(731) BEYHAN AYAKKABI DERİ TEKSTİL VE
İNŞAAT SANAYİ TİCARET LİMİTED
ŞİRKETİ
Aykosan Ayakkabıcılar, Sanayi Sitesi D
Block K:4 N149
Küçükçekmece / İSTANBUL, Turkey

(540)



(591) Yellow, green
(511) 25

(260) AM 2011 58459 A
(800) 1039406
(731) THYSSEN KRUPP AG
Kaiser-Wilhelm-Strasse 100, 47166 Duisburg,
Germany;
THYSSENKRUPP AG
Altendorfer Strasse 120, 45143 Essen,
Germany

(540)



(591) Blue, grey, white and black
(511) 01, 04, 06, 07, 09, 11, 12, 17, 19, 20, 35, 36,
37, 38, 39, 40, 41, 42, 44

(260) AM 2011 58460 A
(800) 1039427
(731) OBSHCHESTVO S OGRANICHENNOY
OTVETSTVENNOSTYU "AGROINVEST"
Fabritsiusa ul., d.42, korp.1, RU-125363
Moscow, Russian Federation
(540)



(591) Red, black, white, yellow, green, brown,
light-brown and light-green
(511) 29, 30, 31

(260) AM 2011 58461 A
(800) 950319
(731) MEDICE ARZNEIMITTEL PÜTTER
GMBH & CO. KG
Kuhloweg 37, 58638 Iserlohn, Germany
(540)

Medikinet

(591) Black, white
(511) 05

(260) AM 2011 58474 A
(800) 1039448
(731) LITARC LIGHTING & ELECTRONIC
LTD.
3A 3Floor, 1-3 Anbailijing Yuan, Shennan
Road, Futian District, Shenzhen Guangdong,
China
(540)

litarc

(591) Black, white
(511) 09, 11

(260) AM 2011 58495 A
(800) 1039609
(731) ARES TRADING S.A.
Zone Industrielle de l'Ouriettaz, CH-1170
Aubonne, Switzerland
(540)

XAMPENSO

(591) Black, white
(511) 05

(260) AM 2011 58496 A
(800) 1039611
(731) ARES TRADING S.A.
Zone Industrielle de l'Ouriettaz, CH-1170
Aubonne, Switzerland
(540)

BALKARMO

(591) Black, white
(511) 05

(260) AM 2011 58497 A
(800) 1039612
(731) ARES TRADING S.A.

Zone Industrielle de l'Ouriettaz, CH-1170
Aubonne, Switzerland

(540)

FRECONTRIS

(591) Black, white
(511) 05

(260) AM 2011 58498 A
(800) 1039619
(731) HENKEL AG & CO. KGAA
40589 Düsseldorf, Germany
(540)



(591) Light blue, blue, black and white
(511) 01, 07

(260) AM 2011 58499 A
(800) 1039640
(731) OBSHESTVO S OGRANICHENNOY
OTVETSTVENNOSTYU "TITAN"
Shlisselburgskiy pr. 3-7, RU-192177
Sankt-Petersburg, Russian Federation
(540)

ISTRITSA

(591) Black, white
(511) 32, 33

(260) AM 2011 58500 A
(800) 1039699
(731) PHILIP MORRIS PRODUCTS S.A.
Quai Jeanrenaud 3, CH-2000 Neuchâtel,
Switzerland
(540)

CHESTERFIELD ORIGINAL BLUE

(591) Black, white
(511) 34

(260) AM 2011 58501 A
(800) 1039700
(731) PHILIP MORRIS PRODUCTS S.A.
Quai Jeanrenaud 3, CH-2000 Neuchâtel,
Switzerland
(540)

CHESTERFIELD CLASSIC WHITE

(591) Black, white
(511) 34

(260) AM 2011 58502 A
(800) 1039701
(731) PHILIP MORRIS PRODUCTS S.A.
Quai Jeanrenaud 3, CH-2000 Neuchâtel,
Switzerland
(540)



(591) Black, white
(511) 34

(260) AM 2011 58503 A
(800) 1039702
(731) PHILIP MORRIS PRODUCTS S.A.
Quai Jeanrenaud 3, CH-2000 Neuchâtel,
Switzerland
(540)



(591) Gold, silver and gray
(511) 34

(260) AM 2011 58504 A
(800) 1039703
(731) PHILIP MORRIS PRODUCTS S.A.
Quai Jeanrenaud 3, CH-2000 Neuchâtel,
Switzerland
(540)

SMOOTHFLO

(591) Black, white
(511) 34

(260) AM 2011 58505 A
(800) 1039705
(731) PHILIP MORRIS PRODUCTS S.A.
Quai Jeanrenaud 3, CH-2000 Neuchâtel,
Switzerland

(540)



(591) Black, white
(511) 34

(260) AM 2011 58506 A
(800) 1039707
(731) PHILIP MORRIS PRODUCTS S.A.
Quai Jeanrenaud 3, CH-2000 Neuchâtel,
Switzerland
(540)

SOFTFLO

(591) Black, white
(511) 34

(260) AM 2011 58507 A
(800) 1039708
(731) PHILIP MORRIS PRODUCTS S.A.
Quai Jeanrenaud 3, CH-2000 Neuchâtel,
Switzerland
(540)

L & M GREEN LABEL

(591) Black, white
(511) 34

(260) AM 2011 58508 A
(800) 1039709
(731) PHILIP MORRIS PRODUCTS S.A.
Quai Jeanrenaud 3, CH-2000 Neuchâtel,
Switzerland
(540)



(591) Black, white
(511) 34

(260) AM 2011 58509 A
(800) 1039710
(731) PHILIP MORRIS PRODUCTS S.A.
Quai Jeanrenaud 3, CH-2000 Neuchâtel,
Switzerland

(540)



(591) Dark blue, light blue and white
(511) 34

(260) AM 2011 58510 A

(800) 1039719

(731) PHILIP MORRIS PRODUCTS S.A.

Quai Jeanrenaud 3, CH-2000 Neuchâtel,
Switzerland

(540)

OUTSIDE IS IN

(591) Black, white

(511) 34

(260) AM 2011 58511 A

(800) 1039720

(731) PHILIP MORRIS PRODUCTS S.A.

Quai Jeanrenaud 3, CH-2000 Neuchâtel,
Switzerland

(540)

Chesterfield

(591) Black, white

(511) 34

(260) AM 2011 58512 A

(800) 1039721

(731) PHILIP MORRIS PRODUCTS S.A.

Quai Jeanrenaud 3, CH-2000 Neuchâtel,
Switzerland

(540)



(591) Red, gray, black, white and silver

(511) 34

(260) AM 2011 58513 A

(800) 1039722

(731) PHILIP MORRIS PRODUCTS S.A.

Quai Jeanrenaud 3, CH-2000 Neuchâtel,
Switzerland

(540)



(591) Blue, dark blue, green, light green, white, gray

(511) 34

(260) AM 2011 58514 A

(800) 1039724

(731) PHILIP MORRIS PRODUCTS S.A.

Quai Jeanrenaud 3, CH-2000 Neuchâtel,
Switzerland

(540)



(591) Red, gray, black, white and silver

(511) 34

(260) AM 2011 58532 A

(800) 702283

(731) CAISSE CENTRALE DE REASSURANCE
(CCR)

société anonyme; 31, rue de Courcelles,
F-75008 PARIS, France

(540)

CCR

(591) Black, white

(511) 16, 35, 36

(260) AM 2011 58533 A
 (800) 880562
 (731) ARAV HOLDING S.r.l. a Socio Unico
 Via Nuova Sarno, 558/A, I-80036 PALMA
 CAMPANIA (NA), Italy
 (540)

 SILVIAN HEACH

(591) Black, white
 (511) 09, 14, 18, 25, 35

(260) AM 2011 58534 A
 (800) 891716
 (731) TMC ITALIA SPA
 Viale dell'industria, 65, I-21052 Busto Arsizio
 (VA), Italy
 (540)



(591) Black, white
 (511) 07, 09

(260) AM 2011 58535 A
 (800) 946665
 (731) OTKRYTOE AKTSIONERNOE
 OBCHTCHESTVO "SLOUTSKIY
 SAKHARORAFINADNY KOMBINAT"
 d. 6, oul. Golovachtchenko Minskaya obl.
 223610 Sloutsk, Belarus
 (540)



(591) Black, white
 (511) 30

(260) AM 2011 58536 A
 (800) 952074
 (731) MAYA TEKSTİL SANAYİ VE TİCARET
 LİMİTED ŞİRKETİ
 Ekmekçioglu Mevkii Osmangazi Caddesi
 Merve Mahallesi N 24 Yenidogan
 ÜMRANIYE - İSTANBUL, Turkey
 (540)



(591) black and orange
 (511) 24

(260) AM 2011 58537 A
 (800) 952387
 (731) MAYA TEKSTİL SANAYİ VE TİCARET
 LİMİTED ŞİRKETİ
 Ekmekçioglu Mevkii Osmangazi Caddesi
 Merve Mahallesi N 24 Yenidogan
 ÜMRANIYE - İSTANBUL, Turkey
 (540)



(591) Black, white and red
 (511) 24

(260) AM 2011 58541 A
 (800) 1039940
 (731) VYROBNYCHO-KOMERCIJNE
 PIDPRYJEMSTVO "UKRPROMINVEST"
 prov. Vodoprovodnyj, 9, smt. Oktjabr's'ke,
 Krasnogvardijs'kyj rajon Avtonomna
 Respublika Krym 97060, Ukraine
 (540)



(591) Blue, red and black
 (511) 09

(260) AM 2011 58543 A
 (800) 1039949
 (731) HESBURGER AS
 Punane tn. 43, EE-13619 Tallinn, Estonia
 (540)

HESBURGER

(591) Black, white
 (511) 29, 30, 43

(260) AM 2011 58544 A
 (800) 1039978
 (731) OBSHCHESTVO S OGRANICHENNOY
 OTVETVETSTVENNOSTYU
 "SANDUNOVSKIE BANI"
 Neglinnaya str. 14, bld. 3-7, RU-107031
 Moscow, Russian Federation
 (540)



SANDUNY

1808

(591) Dark green
(511) 44

(260) AM 2011 58546 A
(800) 1039995
(731) M.G.M. MOTORI ELETTRICI S.p.A.
Via Fermi, 44, I-20094 ASSAGO
(MILANO), Italy

(540)

MGMRESTOP

(591) Black, white
(511) 07

(260) AM 2011 58547 A
(800) 1040027
(731) SC MEDIAFAX SA
B-dul. Mareşal Averescu nr. 8-10, corp C,
et. 1, sector 1, 070000 BUCUREŞTI,
Romania

(540)

MEDIAFAX

(591) Red, grey
(511) 09, 16, 35, 38, 41, 42

(260) AM 2011 58548 A
(800) 1040041
(731) SHENZHEN NOPOSION
AGROCHEMICALS CO., LTD.
113 Reservoir Road, Xixiang, Baoan District,
Shenzhen Guangdong Province, China

(540)

NOPOSION

(591) Green, yellow
(511) 05

(260) AM 2011 58549 A
(800) 1040048
(731) REPETTO
22, rue de la Paix, F-75002 PARIS, France

(540)

Repetto

(591) Black, white
(511) 18

(260) AM 2011 58551 A
(800) 1040065
(731) APPLE INC.
1 Infinite Loop, Cupertino, CA 95014, USA

(540)



(591) Black, white
(511) 09

(260) AM 2011 58597 A
(800) 1040629
(731) HERO AG
CH-5600 Lenzburg, Switzerland

(540)



(591) Light blue, dark blue, silver and grey
(511) 05, 29, 32

(260) AM 2011 58598 A
(800) 1040633
(731) PROCTER & GAMBLE
MANUFACTURING COLOGNE GMBH
Wilhelm-Mauser-Str. 40, 50827 Köln,
Germany

(540)

DANGEROUS WOMAN

(591) Black, white
(511) 03

(260) AM 2011 58599 A
(800) 606027
(731) BIG DUTCHMAN
AKTIENGESELLSCHAFT
2, Auf der Lage, 49377
VECHTA-CALVESLAGE, Germany

(540)

Big Dutchman

(591) Black, white
(511) 06, 07, 09, 11, 19, 20, 21

(260) AM 2011 58602 A
(800) 704192
(731) INDUSTRIA DE DISEÑO TEXTIL, S.A.
(INDITEX, S.A.)
Avda. de la Diputación, "Edificio Inditex",
E-15142 Arteixo (A CORUÑA), Spain

(540)



(591) Black, white
(511) 25

(260) AM 2011 58604 A
(800) 1014368
(731) ARAV HOLDING S.R.L. A SOCIO UNICO
Via Nuova Sarno, 558/A, I-80036 PALMA
CAMPANIA (NA), Italy
(540)



(591) Black, white
(511) 09, 14, 18, 25, 35

(260) AM 2011 58646 A
(800) 1040643
(731) FÉDÉRATION INTERNATIONALE DE
FOOTBALL ASSOCIATION (FIFA),
IP UNIT
FIFA-Strasse 20, CH-8044 Zürich,
Switzerland
(540)



(591) Black, white
(511) 27, 35, 37

(260) AM 2011 58647 A
(800) 1040656
(731) SANDER MANAGEMENT LLP
Cornwall Buildings, 45-51 Newhall Str.,
office 330 Birmingham B3 3QR,
United Kingdom
(540)

Sensual City

(591) Black, white
(511) 25, 35

(260) AM 2011 58648 A
(800) 1040688
(731) PHILIP MORRIS PRODUCTS S.A.
Quai Jeanrenaud 3, CH-2000 Neuchâtel,
Switzerland
(540)



(591) Red, gray, dark gray and white
(511) 34

(260) AM 2011 58649 A
(800) 1040697
(731) SGC ENERGIA, SGPS, S.A.
Estrada de Alfragide 67, Alfrapark, Edifício
SGC, P-2614-519 AMADORA, Portugal
(540)

XTLH TECHNOLOGY

(591) Black, white
(511) 04, 40, 42

(260) AM 2011 58650 A
(800) 1040727
(731) SGC ENERGIA, SGPS, S.A.
Estrada de Alfragide 67, Alfrapark, Edifício
SGC, P-2614-519 AMADORA, Portugal
(540)

XTLH

(591) Black, white
(511) 04, 40, 42

(260) AM 2011 58652 A
(800) 1040734
(731) SGC ENERGIA, SGPS, S.A.
Estrada de Alfragide 67, Alfrapark, Edifício
SGC, P-2614-519 AMADORA, Portugal
(540)

TECNOLOGIA XTLH

(591) Black, white
(511) 04, 40, 42

(260) AM 2011 58653 A
(800) 1040736
(731) ARKEMA FRANCE
420 rue d'Estienne d'Orves, F-92700
Colombes, France

(540)

OROGLAS

(591) Black, white
(511) 01, 09, 12, 16, 17, 19, 20

INTERNATIONAL TRADEMARKS PROTECTED IN GEORGIA
МЕЖДУНАРОДНЫЕ ТОВАРНЫЕ ЗНАКИ, ОХРАНЯЕМЫЕ В ГРУЗИИ

(260) AM 2010 53693 A
(800) 999979
(151) 2009 02 23
(181) 2019 02 23
(511) 03, 09, 14, 16, 18, 25

(260) AM 2010 53784 A
(800) 1000508
(151) 2008 10 16
(181) 2018 10 16
(511) 35, 36, 41, 42, 45

(260) AM 2010 56610 A
(800) 1023780
(151) 2009 08 10
(181) 2019 08 10
(511) 38

(260) AM 2010 56612 A
(800) 1023829
(151) 2009 08 31
(181) 2019 08 31
(511) 09, 12, 18, 22, 24, 25, 28, 35, 41

(260) AM 2010 56613 A
(800) 1023846
(151) 2009 11 06
(181) 2019 11 06
(511) 30, 31, 32, 33

(260) AM 2010 56614 A
(800) 1023849
(151) 2009 11 23
(181) 2019 11 23
(511) 05, 10

(260) AM 2010 56615 A
(800) 1023866
(151) 2009 09 04
(181) 2019 09 04
(511) 06, 40, 42

(260) AM 2010 56616 A
(800) 1023881

(151) 2009 01 23
(181) 2019 01 23
(511) 09, 35, 38, 41

(260) AM 2010 56617 A
(800) 1023904
(151) 2009 05 29
(181) 2019 05 29
(511) 30

(260) AM 2010 56618 A
(800) 1023922
(151) 2009 06 09
(181) 2019 06 09
(511) 09, 42

(260) AM 2010 56619 A
(800) 1023946
(151) 2009 08 31
(181) 2019 08 31
(511) 35, 36, 37, 38, 39, 40, 41, 42, 43, 44, 45

(260) AM 2010 56662 A
(800) 1024460
(151) 2009 11 12
(181) 2019 11 12
(511) 29

(260) AM 2010 56663 A
(800) 1024501
(151) 2009 12 05
(181) 2019 12 05
(511) 35, 37, 38, 39

(260) AM 2010 56664 A
(800) 1024504
(151) 2009 12 08
(181) 2019 12 08
(511) 34, 35, 39

(260) AM 2010 56665 A
(800) 264816
(151) 2003 01 22
(181) 2013 01 22

(511) 01, 03, 05

(260) AM 2010 56666 A
 (800) 274265
 (151) 2003 09 23
 (181) 2013 09 23
 (511) 03, 05, 16

(260) AM 2010 56667 A
 (800) 443784
 (151) 2008 10 12
 (181) 2018 10 12
 (511) 06, 07, 09, 11, 12

(260) AM 2010 56668 A
 (800) 460652
 (151) 2001 04 23
 (181) 2011 04 23
 (511) 02, 09, 16, 28

(260) AM 2010 56669 A
 (800) 499779
 (151) 2005 07 30
 (181) 2015 07 30
 (511) 07, 08, 09, 12, 19, 20

(260) AM 2010 56670 A
 (800) 523869
 (151) 2008 05 17
 (181) 2018 05 17
 (511) 05

(260) AM 2010 56671 A
 (800) 704907
 (151) 2008 10 28
 (181) 2018 10 28
 (511) 16, 17, 19, 28, 35

(260) AM 2010 56672 A
 (800) 805672
 (151) 2003 06 10
 (181) 2013 06 10
 (511) 18

(260) AM 2010 56673 A
 (800) 908007
 (151) 2006 11 09
 (181) 2016 11 09
 (511) 24, 25

(260) AM 2010 56701 A
 (800) 1024580
 (151) 2009 12 05
 (181) 2019 12 05
 (511) 35, 37, 38, 39

(260) AM 2010 56702 A
 (800) 1024582
 (151) 2009 11 16
 (181) 2019 11 16
 (511) 16, 25, 41

(260) AM 2010 56703 A
 (800) 1024591
 (151) 2009 10 29
 (181) 2019 10 29
 (511) 29, 30, 31, 32, 33, 34, 40, 43

(260) AM 2010 56704 A
 (800) 1024592
 (151) 2009 08 06
 (181) 2019 08 06
 (511) 28

(260) AM 2010 56706 A
 (800) 1024609
 (151) 2009 07 29
 (181) 2019 07 29
 (511) 11

(260) AM 2010 56707 A
 (800) 1024621
 (151) 2009 07 20
 (181) 2019 07 20
 (511) 14

(260) AM 2010 56708 A
 (800) 1024630
 (151) 2009 09 08
 (181) 2019 09 08
 (511) 29

(260) AM 2010 56709 A
 (800) 1024639
 (151) 2009 10 07
 (181) 2019 10 07
 (511) 12

(260) AM 2010 56710 A
 (800) 1024648
 (151) 2009 11 27

(181) 2019 11 27
(511) 14

(260) AM 2010 56711 A
(800) 1024672
(151) 2009 09 08
(181) 2019 09 08
(511) 10, 12, 17, 20

(260) AM 2010 56712 A
(800) 1024682
(151) 2009 12 02
(181) 2019 12 02
(511) 07, 37

(260) AM 2010 56713 A
(800) 1024693
(151) 2009 11 27
(181) 2019 11 27
(511) 11

(260) AM 2010 56716 A
(800) 1024730
(151) 2009 10 27
(181) 2019 10 27
(511) 36

(260) AM 2010 56717 A
(800) 552731
(151) 2000 04 24
(181) 2010 04 24
(511) 16

(260) AM 2010 56939 A
(800) 1026226
(151) 2009 10 22
(181) 2019 10 22
(511) 29, 30, 43

(260) AM 2010 57181 A
(800) 350123
(151) 2008 10 22
(181) 2018 10 22
(511) 33

(260) AM 2010 57182 A
(800) 587893
(151) 2002 07 23
(181) 2012 07 23

(511) 07

(260) AM 2010 57186 A
(800) 644954
(151) 2005 09 20
(181) 2015 09 20
(511) 05

(260) AM 2010 57187 A
(800) 761791
(151) 2001 07 23
(181) 2011 07 23
(511) 06, 07, 12

(260) AM 2010 57188 A
(800) 763960
(151) 2001 07 24
(181) 2011 07 24
(511) 06, 07, 12

(260) AM 2010 57189 A
(800) 771402
(151) 2001 10 09
(181) 2011 10 09
(511) 07, 08, 09, 20

(260) AM 2010 57190 A
(800) 784445
(151) 2002 06 10
(181) 2012 06 10
(511) 05

(260) AM 2010 57191 A
(800) 786101
(151) 2002 08 14
(181) 2012 08 14
(511) 05

(260) AM 2010 57192 A
(800) 808494
(151) 2003 07 07
(181) 2013 07 07
(511) 03, 07, 09, 11, 12, 27, 28

(260) AM 2010 57193 A
(800) 822422
(151) 2003 11 10
(181) 2013 11 10
(511) 03

(260) AM 2010 57194 A
 (800) 847968
 (151) 2005 04 04
 (181) 2015 04 04
 (511) 25

(260) AM 2010 57197 A
 (800) 1028222
 (151) 2010 02 01
 (181) 2020 02 01
 (511) 03

(260) AM 2010 57198 A
 (800) 1028229
 (151) 2009 11 18
 (181) 2019 11 18
 (511) 07, 11, 19, 37, 42

(260) AM 2010 57199 A
 (800) 1028236
 (151) 2009 11 04
 (181) 2019 11 04
 (511) 09

(260) AM 2010 57232 A
 (800) 1028494
 (151) 2009 12 03
 (181) 2019 12 03
 (511) 16

(260) AM 2010 57233 A
 (800) 1028513
 (151) 2009 12 14
 (181) 2019 12 14
 (511) 01, 02

(260) AM 2010 57234 A
 (800) 1028520
 (151) 2009 12 17
 (181) 2019 12 17
 (511) 05

(260) AM 2010 57235 A
 (800) 1028540
 (151) 2010 01 05
 (181) 2020 01 05
 (511) 29, 30, 31

(260) AM 2010 57236 A
 (800) 1028578

(151) 2009 12 16
 (181) 2019 12 16
 (511) 33

(260) AM 2010 57237 A
 (800) 1028579
 (151) 2009 12 16
 (181) 2019 12 16
 (511) 33

(260) AM 2010 57238 A
 (800) 1028584
 (151) 2010 01 28
 (181) 2020 01 28
 (511) 09

(260) AM 2010 57239 A
 (800) 1028592
 (151) 2009 10 14
 (181) 2019 10 14
 (511) 03, 04, 05, 08, 14, 16, 18, 21, 25, 26, 35,
 43, 44

(260) AM 2010 57241 A
 (800) 1028593
 (151) 2010 01 13
 (181) 2020 01 13
 (511) 33

(260) AM 2010 57244 A
 (800) 1028599
 (151) 2009 07 24
 (181) 2019 07 24
 (511) 09, 35, 36, 41

(260) AM 2010 57245 A
 (800) 1028612
 (151) 2009 09 24
 (181) 2019 09 24
 (511) 08, 11, 21

(260) AM 2010 57246 A
 (800) 1028619
 (151) 2009 09 02
 (181) 2019 09 02
 (511) 09, 25, 28, 37, 38, 41, 42

(260) AM 2010 57247 A
 (800) 1028634

(151) 2009 11 24
(181) 2019 11 24
(511) 34

(260) AM 2010 57248 A
(800) 1028635
(151) 2009 11 24
(181) 2019 11 24
(511) 34

(260) AM 2010 57249 A
(800) 1028641
(151) 2009 12 15
(181) 2019 12 15
(511) 12, 18, 25, 28, 35

(260) AM 2010 57284 A
(800) 915885
(151) 2006 12 15
(181) 2016 12 15
(511) 06

(260) AM 2010 57299 A
(800) 1028983
(151) 2009 11 13
(181) 2019 11 13
(511) 32, 33, 35

(260) AM 2010 57300 A
(800) 1029042
(151) 2009 12 03
(181) 2019 12 03
(511) 09, 11, 37

(260) AM 2010 57301 A
(800) 1029043
(151) 2009 12 03
(181) 2019 12 03
(511) 05

(260) AM 2010 57302 A
(800) 1029059
(151) 2010 01 22
(181) 2020 01 22
(511) 03

(260) AM 2010 57303 A
(800) 1029073
(151) 2009 07 29
(181) 2019 07 29

(511) 12

(260) AM 2010 57304 A
(800) 1029075
(151) 2009 10 28
(181) 2019 10 28
(511) 09, 16, 35, 41

(260) AM 2010 57306 A
(800) 1029100
(151) 2009 12 03
(181) 2019 12 03
(511) 05

(260) AM 2010 57307 A
(800) 1029119
(151) 2009 07 24
(181) 2019 07 24
(511) 07

(260) AM 2010 57308 A
(800) 1029146
(151) 2009 10 16
(181) 2019 10 16
(511) 18, 25, 26

(260) AM 2010 57309 A
(800) 1029165
(151) 2009 11 04
(181) 2019 11 04
(511) 06, 07, 12

(260) AM 2010 57310 A
(800) 1029201
(151) 2009 11 27
(181) 2019 11 27
(511) 09

(260) AM 2010 57311 A
(800) 1029220
(151) 2010 01 18
(181) 2020 01 18
(511) 06, 09, 19, 37, 38, 42, 45

(260) AM 2010 57312 A
(800) 1029241
(151) 2010 02 01
(181) 2020 02 01
(511) 42, 45

OFFICIAL NOTIFICATIONS
ОФИЦИАЛЬНЫЕ ИЗВЕЩЕНИЯ

PATENTS
ПАТЕНТЫ

**PATENTS, FOR WHICH A DECISION HAS BEEN TAKEN
ABOUT THEIR TERMINATION**

ПАТЕНТЫ, ПО КОТОРЫМ ВЫНЕСЕНО РЕШЕНИЕ О ПРЕКРАЩЕНИИ ИХ ДЕЙСТВИЯ

INVENTIONS
ИЗОБРЕТЕНИЯ

NUMBER OF PATENT НОМЕР ПАТЕНТА	DATE OF TERMINATION (month, date, years) ДАТА ПРЕКРАЩЕНИЯ ДЕЙСТВИЯ (месяц, число, год)
1003(4831093)	9/11/1990
1007(4830528)	6/22/1990
1599	2/07/1990
1824	3/15/1990
193(1717065)	5/28/1990
2164	5/18/1990
2681	1/30/1990
426(1831300)	9/28/1990
638(4802400)	3/16/1990
783(822754)	1/23/1976
805(607546)	7/16/1976
889(5052358)	11/23/1990
929(5052834)	2/10/1990
942(797540)	1/24/1977
1058(1131481)	7/22/1977

UTILITY MODELS
ПОЛЕЗНЫЕ МОДЕЛИ

NUMBER OF PATENT НОМЕР ПАТЕНТА	DATE OF TERMINATION (month, date, years) ДАТА ПРЕКРАЩЕНИЯ ДЕЙСТВИЯ (месяц, число, год)
1008	12/04/2002
1021	12/17/2002
1040	3/26/2002
936	2/20/2002
962	10/1/2002
963	7/30/2002
972	11/14/2002
974	7/19/2002
978	8/6/2002
979	8/6/2002
981	11/14/2002
994	11/22/2002
997	12/19/2002
999	9/3/2002

INDUSTRIAL DESIGNS
ПРОМЫШЛЕННЫЕ ОБРАЗЦЫ

NUMBER OF PATENT НОМЕР ПАТЕНТА	DATE OF TERMINATION (month, date, years) ДАТА ПРЕКРАЩЕНИЯ ДЕЙСТВИЯ (месяц, число, год)
22(37902)	6/30/1993
23(19227)	6/30/1993
20(21687)	6/30/1993
19(22909)	6/30/1993

TRADEMARKS
ТОВАРНЫЕ ЗНАКИ

RENEWAL OF REGISTRATIONS
ПРОДЛЕНИЕ СРОКОВ ДЕЙСТВИЙ РЕГИСТРАЦИЙ

(111) M 2000 13576 R1

(156) 2010 10 30

(186) 2020 10 30

(732) HYUNDAI MOTOR COMPANY

(a Korean limited liability company
incorporated under the laws of Republic
of Korea)

231, Yangjae-Dong, Seocho-Gu, Seoul,
137-938, Republic of Korea

(111) M 2000 13624 R1

(156) 2010 12 27

(186) 2020 12 21

(732) AGILENT TECHNOLOGIES, INC.

5301 Stevens Creek Boulevard, Santa Claram
CA 95051, USA

(111) M 2000 13625 R1

(156) 2010 12 27

(186) 2020 12 21

(732) AGILENT TECHNOLOGIES, INC.

5301 Stevens Creek Boulevard, Santa Claram
CA 95051, USA

(111) M 2001 13737 R1

(156) 2011 02 20

(186) 2021 02 20

(732) ELI LILLY AND COMPANY

Lilly Corporate Center, Indianapolis, Indiana,
USA

(111) M 2001 13758 R1

(156) 2011 02 20

(186) 2021 02 20

(732) PLAYBOY ENTERPRISES

INTERNATIONAL, INC.
680 North Lake Shore Drive, Chicago, Illinois
60611, USA

(111) M 2001 13762 R1

(156) 2011 02 22

(186) 2021 02 22

(732) TWENTIETH CENTURY FOX FILM

CORPORATION (a Delaware Corporation)
10201 West Pico Boulevard, Los Angeles,
California 90035, USA

(111) M 2001 13763 R1

(156) 2011 02 22

(186) 2021 02 22

(732) TWENTIETH CENTURY FOX FILM

CORPORATION (a Delaware Corporation)
10201 West Pico Boulevard, Los Angeles,
California 90035, USA

(111) M 2001 13776 R1

(156) 2011 02 22

(186) 2021 02 22

(732) INTERNATIONAL FOODSTUFFS CO.

Al-Wahda Street, Industrial Area N1, P.O.
BOX 4115, Sharjah, United Arab Emirates

(111) M 2001 13800 R1

(156) 2011 03 02

(186) 2021 03 02

(732) KAO KABUSHIKI KAISHA

(also trading as KAO CORPORATION)
14-10 Nihonbashi Kayaba-cho 1-chome,
Chuo-ku, Tokyo, Japan

(111) M 2001 13862 R1

(156) 2011 05 29

(186) 2021 05 29

(732) TAKEDA PHARMACEUTICAL
COMPANY LIMITED

1-1, Doshomachi 4-chome, Chuo-ku, Osaka,
Japan

(111) M 2001 13868 R1

(156) 2011 05 29

(186) 2021 05 29

(732) EVYAP SABUN YAG GLISERIN SANAYI
VE TICARET ANONIM SIRKETI

Ayazaga Cendere Yolu No.10/A 80670
Levent Istanbul, Turkey

(111) M 2001 14128 R1
(156) 2011 10 31
(186) 2021 10 31
(732) MONSTER WORLDWIDE, INC.
622 Third Avenue, New York, New York
10017, USA

(111) M 2001 14178 R1
(156) 2011 12 13
(186) 2021 12 13
(732) PLAYBOY ENTERPRISES
INTERNATIONAL, INC.
680 North Lake Shore Drive, Chicago, Illinois
60611, USA

COMPLETE TRANSFER OF RIGHTS

ПОЛНАЯ ПЕРЕДАЧА ПРАВ

(111) M 2009 019509 R
(732) RETAIL ROYALTY COPANY
101 Convention Center Drive Las Vegas,
Nevada 89109, USA
(770) PAYLESS SHOESOURCE WORLDWIDE,
INC.
Jayhawk Towers, 700 SW jackson Street,
Suite 202, Topeka, KS 66603, USA
(580) 2011-02-14

(111) M 2009 019510 R
(732) RETAIL ROYALTY COPANY
101 Convention Center Drive Las Vegas,
Nevada 89109, USA
(770) PAYLESS SHOESOURCE WORLDWIDE,
INC.
Jayhawk Towers, 700 SW jackson Street,
Suite 202, Topeka, KS 66603, USA
(580) 2011-02-14

(111) M 2009 019511 R
(732) RETAIL ROYALTY COPANY
101 Convention Center Drive Las Vegas,
Nevada 89109, USA
(770) PAYLESS SHOESOURCE WORLDWIDE,
INC.
Jayhawk Towers, 700 SW jackson Street,
Suite 202, Topeka, KS 66603, USA
(580) 2011-02-14

(111) M 2010 020685 R
(732) RETAIL ROYALTY COPANY
101 Convention Center Drive Las Vegas,
Nevada 89109, USA
(770) PAYLESS SHOESOURCE WORLDWIDE,
INC.
Jayhawk Towers, 700 SW jackson Street,
Suite 202, Topeka, KS 66603, USA
(580) 2011-02-14

CHANGES IN NAMES AND/OR ADDRESSES OF OWNERS

ИЗМЕНЕНИЯ ИМЕН И/ИЛИ АДРЕСОВ ВЛАДЕЛЬЦЕВ

(111) M 1998 010960 R1
(732) MARKEM-IMAJE CORPORATION
150, Congress Street, Keene, New Hampshire
03431, USA
(770) MARKEM CORPORATION
150, Congress Street, Keene, New Hampshire
03431, USA
(580) 2011-02-14

(111) M 1998 011029 R1
(732) GLAXOSMITHKLINE LLC,
CORPORATION SERVICE COMPANY
2711 Centerville Road, Suite 400,
Wilmington, Delaware 19808, USA
(770) SMITHKLINE BEECHAM
CORPORATION
One Franklin Plaza, Philadelphia,
Pennsylvania 19101, USA
(580) 2011-02-11

(111) M 1998 011069 R1
(732) GLAXOSMITHKLINE LLC,
CORPORATION SERVICE COMPANY
2711 Centerville Road, Suite 400,
Wilmington, Delaware 19808, USA
(770) SMITHKLINE BEECHAM
CORPORATION
One Franklin Plaza, Philadelphia,
Pennsylvania 19101, USA
(580) 2011-02-11

(111) M 1999 012422 R1
(732) GLAXOSMITHKLINE LLC,
CORPORATION SERVICE COMPANY
2711 Centerville Road, Suite 400,
Wilmington, Delaware 19808, USA
(770) SMITHKLINE BEECHAM
CORPORATION
One Franklin Plaza, Philadelphia,
Pennsylvania 19101, USA
(580) 2011-02-11

(111) M 1999 012423 R1
(732) GLAXOSMITHKLINE LLC,
CORPORATION SERVICE COMPANY
2711 Centerville Road, Suite 400,
Wilmington, Delaware 19808, USA

(770) SMITHKLINE BEECHAM
CORPORATION
One Franklin Plaza, Philadelphia,
Pennsylvania 19101, USA
(580) 2011-02-11

(111) M 1999 012447 R1
(732) GLAXOSMITHKLINE LLC,
CORPORATION SERVICE COMPANY
2711 Centerville Road, Suite 400,
Wilmington, Delaware 19808, USA
(770) SMITHKLINE BEECHAM
CORPORATION
One Franklin Plaza, Philadelphia,
Pennsylvania 19101, USA
(580) 2011-02-11

(111) M 1999 012448 R1
(732) GLAXOSMITHKLINE LLC,
CORPORATION SERVICE COMPANY
2711 Centerville Road, Suite 400,
Wilmington, Delaware 19808, USA
(770) SMITHKLINE BEECHAM
CORPORATION
One Franklin Plaza, Philadelphia,
Pennsylvania 19101, USA
(580) 2011-02-11

(111) M 1999 012449 R1
(732) GLAXOSMITHKLINE LLC,
CORPORATION SERVICE COMPANY
2711 Centerville Road, Suite 400,
Wilmington, Delaware 19808, USA
(770) SMITHKLINE BEECHAM
CORPORATION
One Franklin Plaza, Philadelphia,
Pennsylvania 19101, USA
(580) 2011-02-11

(111) M 1999 012452 R1
(732) GLAXOSMITHKLINE LLC,
CORPORATION SERVICE COMPANY
2711 Centerville Road, Suite 400,
Wilmington, Delaware 19808, USA
(770) SMITHKLINE BEECHAM
CORPORATION
One Franklin Plaza, Philadelphia,

Pennsylvania 19101, USA
(580) 2011-02-11

(111) M 1999 012453 R1
(732) GLAXOSMITHKLINE LLC,
CORPORATION SERVICE COMPANY
2711 Centerville Road, Suite 400,
Wilmington, Delaware 19808, USA
(770) SMITHKLINE BEECHAM
CORPORATION
One Franklin Plaza, Philadelphia,
Pennsylvania 19101, USA
(580) 2011-02-11

(111) M 2000 013576 R1
(732) HYUNDAI MOTOR COMPANY
(a Korean limited liability company
incorporated under the laws of Republic
of Korea) 231, Yangjae-Dong, Seocho-Gu,
Seoul, 137-938, Republic of Korea
(770) HYUNDAI MOTOR COMPANY
(a Korean limited liability company
incorporated under the laws of Republic
of Korea) 140-2, Kye-Dong, Chongro-ku,
Seoul, Republic of Korea
(580) 2010-12-15

(111) M 2000 013624 R1
(732) AGILENT TECHNOLOGIES, INC.
5301 Stevens Creek Boulevard, Santa Claram
CA 95051, USA
(770) AGILENT TECHNOLOGIES, INC.
3000 Hanover Street, Palo Alto, California,
94304-1181, USA
(580) 2011-02-14

(111) M 2000 013625 R1
(732) AGILENT TECHNOLOGIES, INC.
5301 Stevens Creek Boulevard, Santa Claram
CA 95051, USA
(770) AGILENT TECHNOLOGIES, INC.
3000 Hanover Street, Palo Alto, California,
94304-1181, USA
(580) 2011-02-14

(111) M 2007 017330 R
(732) GLAXOSMITHKLINE LLC,
CORPORATION SERVICE COMPANY
2711 Centerville Road, Suite 400,
Wilmington, Delaware 19808, USA
(770) SMITHKLINE BEECHAM
CORPORATION
One Franklin Plaza, Philadelphia,

Pennsylvania 19102, USA
(580) 2011-02-11

(111) M 2007 017331 R
(732) GLAXOSMITHKLINE LLC,
CORPORATION SERVICE COMPANY
2711 Centerville Road, Suite 400,
Wilmington, Delaware 19808, USA
(770) SMITHKLINE BEECHAM
CORPORATION
One Franklin Plaza, Philadelphia,
Pennsylvania 19102, USA
(580) 2011-02-11

(111) M 2010 020302 R
(732) GLAXOSMITHKLINE LLC,
CORPORATION SERVICE COMPANY
2711 Centerville Road, Suite 400,
Wilmington, Delaware 19808, USA
(770) SMITHKLINE BEECHAM
CORPORATION
One Franklin Plaza, Philadelphia,
Pennsylvania 19102, USA
(580) 2011-02-11

(111) M 1997 004441 R1
(732) GLAXOSMITHKLINE LLC,
CORPORATION SERVICE COMPANY
2711 Centerville Road, Suite 400,
Wilmington, Delaware 19808, USA
(770) SMITHKLINE BEECHAM
CORPORATION
One Franklin Plaza, Philadelphia
19101, USA
(580) 2011-02-11

(111) M 1997 005422 R1
(732) GLAXOSMITHKLINE LLC,
CORPORATION SERVICE COMPANY
2711 Centerville Road, Suite 400,
Wilmington, Delaware 19808, USA
(770) SMITHKLINE BEECHAM
CORPORATION
One Franklin Plaza, Philadelphia
19101, USA
(580) 2011-02-11

(111) M 1998 008348 R1
(732) GLAXOSMITHKLINE LLC,
CORPORATION SERVICE COMPANY
2711 Centerville Road, Suite 400,
Wilmington, Delaware 19808, USA

(770) SMITHKLINE BEECHAM
CORPORATION
One Franklin Plaza, Philadelphia
19101, USA
(580) 2011-02-11

(111) M 1998 009031 R1
(732) GLAXOSMITHKLINE LLC,
CORPORATION SERVICE COMPANY
2711 Centerville Road, Suite 400,
Wilmington, Delaware 19808, USA
(770) SMITHKLINE BEECHAM
CORPORATION
One Franklin Plaza, Philadelphia
19101, USA
(580) 2011-02-11

(111) M 1998 009797 R1
(732) GLAXOSMITHKLINE LLC,
CORPORATION SERVICE COMPANY
2711 Centerville Road, Suite 400,
Wilmington, Delaware 19808, USA
(770) SMITHKLINE BEECHAM
CORPORATION
One Franklin Plaza, Philadelphia
19101, USA
(580) 2011-02-11

(111) M 1998 009914 R1
(732) GLAXOSMITHKLINE LLC,
CORPORATION SERVICE COMPANY
2711 Centerville Road, Suite 400,
Wilmington, Delaware 19808, USA
(770) SMITHKLINE BEECHAM
CORPORATION
One Franklin Plaza, Philadelphia
19101, USA
(580) 2011-02-11

(111) M 1998 009921 R1
(732) GLAXOSMITHKLINE LLC,
CORPORATION SERVICE COMPANY
2711 Centerville Road, Suite 400,
Wilmington, Delaware 19808, USA
(770) SMITHKLINE BEECHAM
CORPORATION
One Franklin Plaza, Philadelphia
19101, USA
(580) 2011-02-11

INVALIDATION OF TRADEMARKS REGISTRATIONS
АНУЛИРОВАНИЕ РЕГИСТРАЦИИ ТОВАРНЫХ ЗНАКОВ

(111) M 2000 13161 R
(141) 2010-09-02,
(732) BARNES & NOBLE COLLEGE
BOOKSTORES, INK
33, East 17 th Street, New York,
New York 10003,USA

(111) M 2000 13220 R
(141) 2010-10-04,
(732) PELIKAN VERTRIEBSGESELLSCHAFT
MBH & CO. KG
Werftstrasse 9, 30163 Hannover, Germany

(111) M 2000 13223 R
(141) 2010-10-06,
(732) RAVIZZA FARMACEUTICI S.P.A.
Via Europa 35, 2053 Muggio, Milano, Italy

(111) M 2000 13225 R
(141) 2010-10-11,
(732) UNILEVER N.V.
Weena 455, NL-3013 AL Rotterdam,
Netherlands

(111) M 2000 13228 R
(141) 2010-10-14,
(732) NOVO NORDISK A/S
Novo Alle, DK-2880 Bagsvaerd

(111) M 2000 13229 R
(141) 2010-10-14,
(732) NOVO NORDISK A/S
Novo Alle, DK-2880 Bagsvaerd

(111) M 2000 13231 R
(141) 2010-10-14,
(732) CREATONS RIVERS S.A.
4, rue Michel Labrousse, 31000 Toulouse

(111) M 2000 13232 R
(141) 2010-10-14,
(732) INTEL CORPORATION
2200 Mission College Boulevard,
Santa Clara, California 95052-8119

(111) M 2000 13233 R
(141) 2010-10-14,
(732) JT INTERNATIONAL EUROPE LIMITED
East Wing, 3rd Floor, 3 Shortlands,
Hammersmith International Centre,
London W6 8EQ

(111) M 2000 13234 R
(141) 2010-10-14,
(732) AGIO SIGARENFABRIEKEN N.V.
Wolverstraat 3, 5525 AR Duizel,
The Netherlands

(111) M 2000 13240 R
(141) 2010-10-14,
(732) WYETH
Five Giralda Farms, Madison, New Jersey
07940

(111) M 2000 13241 R
(141) 2010-10-14,
(732) WYETH
Five Giralda Farms, Madison, New Jersey
07940

(111) M 2000 13242 R
(141) 2010-10-14,
(732) F. HOFFMANN - LA ROCHE AG
CH-4002 Basel

(111) M 2000 13245 R
(141) 2010-10-21,
(732) VIAN LTD
Bratya Buston Blvd. N.27, Building 40,
Entrance A, Aptment 43, Sofia

(111) M 2000 13246 R
(141) 2010-10-21,
(732) VIAN LTD
Bratya Buston Blvd. N.27, Building 40,
Entrance A, Aptment 43, Sofia

(111) M 2000 13247 R
(141) 2010-10-21,
(732) VIAN LTD

Bratya Buston Blvd. N.27, Building 40,
Entrance A, Aptment 43, Sofia

(111) M 2000 13250 R
(141) 2010-10-21,
(732) VIAN LTD

Bratya Buston Blvd. N.27, Building 40,
Entrance A, Aptment 43, Sofia

(111) M 2000 13251 R
(141) 2010-10-21,
(732) VIAN LTD

Bratya Buston Blvd. N.27, Building 40,
Entrance A, Aptment 43, Sofia

(111) M 2000 13257 R
(141) 2010-10-27,
(732) MARS, INCORPORATED

6885 Elm Street Mclean, Virginia
22101-3883

(111) M 2000 13260 R
(141) 2010 06 25 under the owner's request
(732) SUN MICROSYSTEMS, INC.

4150 Network Circle, Santa Clara,
California 95054

(111) M 2000 13261 R
(141) 2010-10-27,
(732) COMPAGNIE GENERALE DES

ETABLISSEMENTS MICHELIN-
MICHELIN & CIE Societe en Commandite
par Actions
12 Cours Sablon, 63040 CLERMONT-
FERRAND CEDEX 09

(111) M 2000 13262 R
(141) 2010-10-27,
(732) COMPAGNIE GENERALE DES

ETABLISSEMENTS MICHELIN-
MICHELIN & CIE Societe en Commandite
par Actions
12 Cours Sablon, 63040 CLERMONT-
FERRAND CEDEX 09

(111) M 2000 13263 R
(141) 2010-10-27,
(732) COMPAGNIE GENERALE DES

ETABLISSEMENTS MICHELIN-
MICHELIN & CIE Societe en Commandite
par Actions
12 Cours Sablon, 63040 CLERMONT-
FERRAND CEDEX 09

(111) M 2000 13264 R
(141) 2010-10-27,

(732) COMPAGNIE GENERALE DES
ETABLISSEMENTS MICHELIN-
MICHELIN & CIE Societe en Commandite
par Actions
12 Cours Sablon, 63040 CLERMONT-
FERRAND CEDEX 09

(111) M 2000 13266 R
(141) 2010-10-27,

(732) DEVIDE CAMPARI-MILANO S.p.A.
27 Via Filippo Turati, 20121 Milan

(111) M 2000 13275 R
(141) 2010-10-27,

(732) CADBURY UK LIMITED
P.O. Box 12, Bournville Lane, Bournville,
Birmingham B30 2LU

(111) M 2000 13276 R
(141) 2010-10-27,

(732) CADBURY UK LIMITED
P.O. Box 12, Bournville Lane,
Bournville, Birmingham B30 2LU

(111) M 2000 13279 R
(141) 2010-10-27,

(732) ZAO. "GRUPPA PREDPRIJATIY "OST"
Noginskiy rayon, Chernogolovka, tretiy
proezd, d. 16, 142432 Moskovskaya oblast

(111) M 2000 13298 R
(141) 2010-12-01,

(732) S.S. "SAIRME"
Ninoshvilis q. 14, 1000, Bagdadi

(111) M 2000 13299 R
(141) 2010-12-01,

(732) SH.P.S. "KOLKHETI-90"
Chubinashvilis 55, 0102, Tbilisi

(111) M 2000 13300 R
(141) 2010-12-01,

(732) SPIRITS INTERNATIONAL B.V.
1A, Rue Thomas Edison, L-1445 Strassen,
Luxemburg

(111) M 2000 13302 R
(141) 2010-12-01,

(732) GLOBAL TELESYSTEMS GROUP,
Inc. (a Delaware Corporation)

1751 Pinnacle Drive, North Tower, 12 th
Floor, Mclean, Virginia 22101

(111) M 2000 13306 R
(141) 2010-12-01,
(732) THE GILLETTE COMPANY
Prudential Tower Building, Boston,
Massachusetts 02199

(111) M 2000 13307 R
(141) 2010-12-01,
(732) STUSSY, INC.,
a California corporation
17426 Daimler Street, Irvine,
California 92614

(111) M 2000 13309 R
(141) 2010-12-01,
(732) JOHN PLAYER & SONS LIMITED
56, Park West Road, Nangor Road, Dublin 12

(111) M 2000 13318 R
(141) 2010-12-01,
(732) SHEZGUDULI PASUKHISMGELOBIS
SAZOGADOEBA "ASKANA"
Chokhatauris q .20, 384370, Ozurgeti

(111) M 2000 13323 R
(141) 2010-12-09,
(732) OPEL EISENACH GMBH
Adam-Opel-Strasse 100, 99817 Eisenach

(111) M 2000 13327 R
(141) 2010-12-09,
(732) PARKER PEN PRODUCTS
101 Syon Lane, Isleworth, Middlesex
TW7 5NP

(111) M 2000 13330 R
(141) 2010-12-09,
(732) INTEL CORPORATION
2200 Mission College Boulevard, Santa
Clara, California 95052-8119

(111) M 2000 13331 R
(141) 2010-12-09,
(732) INTEL CORPORATION
2200 Mission College Boulevard, Santa
Clara, California 95052-8119

(111) M 2000 13333 R
(141) 2010-12-09,
(732) UNILEVER N.V.
Weena 455, NL-3013 AL Rotterdam

(111) M 2000 13335 R
(141) 2010-12-09,
(732) BRISTOL-MYERS SQUIBB COMPANY
(a Delaware Corporation)
345 Park Avenue, New York, New York
10154

(111) M 2000 13336 R
(141) 2010-12-09,
(732) THE GILLETTE COMPANY
Prudential Tower Building, Boston,
Massachusetts 02199

(111) M 2000 13339 R
(141) 2010-12-09,
(732) INTEL CORPORATION
2200 Mission College Boulevard, Santa
Clara, California 95052-8119

(111) M 2000 13345 R
(141) 2010-12-09,
(732) MARRIOTT WORLDWIDE
CORPORATION
10400 Fernwood Road, Bethesda, Maryland
20817

(111) M 2000 13348 R
(141) 2010-12-09,
(732) PHILIP MORRIS PRODUCTS S.A.
Quai Jeanrenaud 3, 2000 NEUCHATEL

(111) M 2000 13350 R
(141) 2010-12-09,
(732) HARTFORD HOUSE, LTD
P.O. Box 4549, Boulder, Colorado 80306

(111) M 2000 13351 R
(141) 2010-12-09,
(732) HARTFORD HOUSE, LTD
P.O. Box 4549, Boulder, Colorado 80306

(111) M 2000 13352 R
(141) 2010-12-09,
(732) HARTFORD HOUSE, LTD
P.O. Box 4549, Boulder, Colorado 80306

(111) M 2000 13353 R
 (141) 2010-12-09,
 (732) HARTFORD HOUSE, LTD
 P.O. Box 4549, Boulder, Colorado 80306

992-28, Siheung-dong, Kumchon-ku, Seoul

(111) M 2000 13356 R
 (141) 2010-12-09,
 (732) SH.P.S. "SAQARTVELOS TAQSEBISA DA
 AVTOBUSEBIS KOMPANIA"
 Lisis tbis mimdebare teritoria, Tbilisi

(111) M 2000 13386 R
 (141) 2010-12-09,
 (732) SAAQTSIO SAZOGADOEBA "JI DA JI"
 Leselidzis q.14, 0113, Tbilisi

(111) M 2000 13358 R
 (141) 2010-12-09,
 (732) BUNDY AMERICAN CORPORATION
 a Delaware Corporation
 11460 Cronridge Drive, Suite 120, Owings
 Mill, Maryland 21117

(111) M 2000 13390 R
 (141) 2010-12-31,
 (732) E.I. DU PONT de NEMOURS and
 COMPANY
 1007 Market Street, Wilmington,
 Delaware 19898

(111) M 2000 13369 R
 (141) 2010-12-09,
 (732) E.I. DU PONT de NEMOURS and
 COMPANY
 1007 Market Street, Wilmington, Delaware
 19898

(111) M 2000 13391 R
 (141) 2010-12-31,
 (732) WARNACO U.S., INC., a Delaware
 Corporation
 470 Wheelers Farms Road, Milford,
 Connecticut 06460

(111) M 2000 13372 R
 (141) 2010-12-09,
 (732) KRAFT FOODS GLOBAL BRANDS LLC
 Three Lakes Drive, Northfield, Illinois 60093

(111) M 2000 13392 R
 (141) 2010-12-31,
 (732) WARNACO U.S., INC., a Delaware
 Corporation
 470 Wheelers Farms Road, Milford,
 Connecticut 06460

(111) M 2000 13373 R
 (141) 2010-12-09,
 (732) KIMBERLY-CLARK WORLDWIDE, INC.
 NEENAH, WI 54956

(111) M 2000 13393 R
 (141) 2010-12-31,
 (732) WARNACO U.S., INC., a Delaware
 Corporation
 470 Wheelers Farms Road, Milford,
 Connecticut 06460

(111) M 2000 13379 R
 (141) 2010-12-09,
 (732) BETA TEMIZLIK MADDELERI SANAYI
 VE TICARET A.S.
 Meclisi Mebusan Cad., Atlantik Han
 N 1-39/A Kabatas/Istanbul

(111) M 2000 13394 R
 (141) 2010-12-31,
 (732) WARNACO U.S., INC., a Delaware
 Corporation
 470 Wheelers Farms Road, Milford,
 Connecticut 06460

(111) M 2000 13380 R
 (141) 2010-12-09,
 (732) MARS, INCORPORATED
 6885 Elm Street Mclean, Virginia
 22101-3883

(111) M 2000 13395 R
 (141) 2010-12-31,
 (732) WARNACO U.S., INC., a Delaware
 Corporation
 470 Wheelers Farms Road, Milford,
 Connecticut 06460

(111) M 2000 13384 R
 (141) 2010-12-09,
 (732) KIA MOTORS CORPORATION

(111) M 2000 13396 R
 (141) 2010-12-31,

(732) WARNACO U.S., INC., a Delaware Corporation
470 Wheelers Farms Road, Milford,
Connecticut 06460

(111) M 2000 13397 R
(141) 2010-12-31,
(732) WARNACO U.S., INC., a Delaware Corporation
470 Wheelers Farms Road, Milford,
Connecticut 06460

(111) M 2000 13398 R
(141) 2010-12-31,
(732) WARNACO U.S., INC., a Delaware Corporation
470 Wheelers Farms Road, Milford,
Connecticut 06460

(111) M 2000 13399 R
(141) 2010-12-31,
(732) WARNACO U.S., INC., a Delaware Corporation
470 Wheelers Farms Road, Milford,
Connecticut 06460

(111) M 2000 13400 R
(141) 2010-12-31,
(732) WARNACO U.S., INC., a Delaware Corporation
470 Wheelers Farms Road, Milford,
Connecticut 06460

(111) M 2000 13401 R
(141) 2010-12-31,
(732) WARNACO U.S., INC., a Delaware Corporation
470 Wheelers Farms Road, Milford,
Connecticut 06460

(111) M 2000 13402 R
(141) 2010-12-31,
(732) WARNACO U.S., INC., a Delaware Corporation
470 Wheelers Farms Road, Milford,
Connecticut 06460

(111) M 2000 13403 R
(141) 2010-12-31,
(732) WARNACO U.S., INC., a Delaware Corporation

470 Wheelers Farms Road, Milford,
Connecticut 06460

(111) M 2000 13404 R
(141) 2010-12-31,
(732) WARNACO U.S., INC., a Delaware Corporation
470 Wheelers Farms Road, Milford,
Connecticut 06460

(111) M 2000 13407 R
(141) 2011-01-03,
(732) SPIRITS INTERNATIONAL B.V.
1A, Rue Thomas Edison, L-1445 Strassen,
Luxemburg

(111) M 2000 13408 R
(141) 2011-01-03,
(732) SPIRITS INTERNATIONAL B.V.
1A, Rue Thomas Edison, L-1445 Strassen,
Luxemburg

(111) M 2000 13409 R
(141) 2011-01-03,
(732) SPIRITS INTERNATIONAL B.V.
1A, Rue Thomas Edison, L-1445 Strassen,
Luxemburg

(111) M 2000 13411 R
(141) 2011-01-03,
(732) SPIRITS INTERNATIONAL B.V.
1A, Rue Thomas Edison, L-1445 Strassen,
Luxemburg

(111) M 2000 13412 R
(141) 2011-01-03,
(732) SPIRITS INTERNATIONAL B.V.
1A, Rue Thomas Edison, L-1445 Strassen,
Luxemburg

(111) M 2000 13413 R
(141) 2011-01-03,
(732) SPIRITS INTERNATIONAL B.V.
1A, Rue Thomas Edison, L-1445 Strassen,
Luxemburg

(111) M 2000 13415 R
(141) 2011-01-06,
(732) WILLIS GROUP LIMITED
Ten Trinity Square, London EC3P 3AX

(111) M 2000 13416 R
(141) 2011-01-10,
(732) LEAF UNITED KINGDOM LIMITED
Carlyle Road, Greenbank, Bristol BS5 6HR

(111) M 2000 13417 R
(141) 2011-01-10,
(732) LEAF UNITED KINGDOM LIMITED
Carlyle Road, Greenbank, Bristol BS5 6HR

(111) M 2000 13424 R
(141) 2011-01-13,
(732) WARNACO U.S., INC.
(A Delaware Corporation)
470 Wheelers Farms Road, Milford,
Connecticut 06460

(111) M 2000 13425 R
(141) 2011-01-13,
(732) PENHALIGON'S LIMITED
(a U.K. Corporation)
Unit 5-7, Blenheim Court, Brewery Road,
N7 9NY London

(111) M 2000 13428 R
(141) 2011-01-13,
(732) HEINRICH MACK NACHF.
GmbH & Co., KG
Heinrich-Mack-Strasse, 35 D-89257
Illertissen

(111) M 2000 13429 R
(141) 2011-01-13,
(732) HEINRICH MACK NACHF.
GmbH & Co., KG
Heinrich-Mack-Strasse, 35 D-89257
Illertissen

(111) M 2000 13431 R
(141) 2011-01-13,
(732) HEINRICH MACK NACHF.
GmbH & Co., KG
Heinrich-Mack-Strasse, 35 D-89257
Illertissen

(111) M 2000 13432 R
(141) 2011-01-13,
(732) HEINRICH MACK NACHF.
GmbH & Co., KG
Heinrich-Mack-Strasse, 35 D-89257
Illertissen

(111) M 2000 13435 R
(141) 2011-01-20,
(732) SUN MICROSISTEMS, INC.
2550 Garcia Avenue, Mountain View,
California 94043-1100

(111) M 2000 13440 R
(141) 2011-01-27,
(732) ZF SACHS AG
Ernst-Sachs-Strasse 62, D-97424
Schweinfurt, Germany

(111) M 2000 13441 R
(141) 2011-01-27,
(732) JOHNSON & JOHNSON
One Johnson & Johnson Plaza,
New Brunswick, New Jersey 08933

INVALIDATION OF INTERNATIONAL TRADEMARK

ПРИЗНАНИЕ МЕЖДУНАРОДНОГО ТОВАРНОГО ЗНАКА НЕДЕЙСТВИТЕЛЬНЫМ

(800) 794109
(141) 02 11 2011
(151) 2002 12 04
(731) МЕРНА AG
Dornacherstrasse 114, Postfach 445, CH-4147 Aesch BL, CH
(540) LAZOLEC
(591) Black, white
(511) 05

The registration is cancelled on the base of the Court Decision by Order № 81 of „Sakpatenti” Chairman of 10 February, 2011.

The number of decision: 2/3674-10
The date of taking decision: 2010 11 24

CLASSIFICATION INDEXES

СИСТЕМАТИЧЕСКИЕ УКАЗАТЕЛИ

INVENTIONS

ИЗОБРЕТЕНИЯ

CONCORDANCE TABLE OF INTERNATIONAL CLASSIFICATION INDEX WITH REFERENCE TO NUMBERS OF PATENTS AND NUMBERS OF PUBLISHED APPLICATIONS

ТАБЛИЦА СООТВЕТСТВИЙ ИНДЕКСОВ МЕЖДУНАРОДНОЙ КЛАССИФИКАЦИИ
С НОМЕРАМИ ПАТЕНТОВ И С НОМЕРАМИ ОПУБЛИКОВАННЫХ ЗАЯВОК

INTERNATIONAL CLASSIFICATION INDEX ИНДЕКС МЕЖДУНАРОДНОЙ КЛАССИФИКАЦИИ (51)	NUMBER OF PATENT НОМЕР ПАТЕНТА (11)	NUMBER OF PUBLISHED APPLICATION НОМЕР ПУБЛИКАЦИИ ЗАЯВКИ (10)
1	2	3
A 43 B 7/12, 13/16	P 2011 5167 B	AP 2010 8705 A
A 61K 36/00; A 61 K 9/06	P 2011 5169 B	AP 2010 10924 A
B 65 D 83/04	P 2011 5168 B	AP 2010 10681 A
C 07 D 209/08; C 07 D 209/10; C 07 D 209/12; C 07 D 401/04; A 61 K 31/40; A 61 K 31/435; A 61 P 35/00; A 61 P 29/00	P 2011 5166 B	AP 2010 11112 A

CONCORDANCE TABLES OF NUMBERS OF PATENTS AND NUMBERS OF PUBLISHED APPLICATIONS WITH REFERENCE TO CLASSIFICATION INDEX

ТАБЛИЦА СООТВЕТСТВИЙ НОМЕРОВ ПАТЕНТОВ И НОМЕРОВ ПУБЛИКАЦИЙ ЗАЯВОК
С ИНДЕКСАМИ МЕЖДУНАРОДНОЙ КЛАССИФИКАЦИИ

NUMBER OF PATENT НОМЕР ПАТЕНТА (11)	NUMBER OF PUBLISHED APPLICATION НОМЕР ПУБЛИКАЦИИ ЗАЯВКИ (10)	INTERNATIONAL CLASSIFICATION INDEX ИНДЕКС МЕЖДУНАРОДНОЙ КЛАССИФИКАЦИИ (51)
P 2011 5166 B	AP 2010 11112 A	C 07 D 209/08; C 07 D 209/10; C 07 D 209/12; C 07 D 401/04; A 61 K 31/40; A 61 K 31/435; A 61 P 35/00; A 61 P 29/00
P 2011 5167 B	AP 2010 8705 A	A 43 B 7/12, 13/16
P 2011 5168 B	AP 2010 10681 A	B 65 D 83/04
P 2011 5169 B	AP 2010 10924 A	A 61K 36/00; A 61 K 9/06

**CONCORDANCE TABLE OF NUMBERS OF APPLICATIONS, NUMBERS
OF PUBLISHED APPLICATIONS AND NUMBERS OF PATENTS**

ТАБЛИЦА СООТВЕТСТВИЙ НОМЕРОВ ЗАЯВОК, НОМЕРОВ ПУБЛИКАЦИЙ
ЗАЯВОК И НОМЕРОВ ПАТЕНТОВ

NUMBER OF APPLICATION НОМЕР ЗАЯВКИ (21)	NUMBER OF PUBLISHED APPLICATION НОМЕР ПУБЛИКАЦИИ ЗАЯВКИ (10)	NUMBER OF PATENT НОМЕР ПАТЕНТА (11)
AP 2003 008705	AP 2010 8705 A	P 2011 5167 B
AP 2006 010681	AP 2010 10681 A	P 2011 5168 B
AP 2008 010924	AP 2010 10924 A	P 2011 5169 B
AP 2007 011112	AP 2010 11112 A	P 2011 5166 B

UTILITY MODELS

ПОЛЕЗНЫЕ МОДЕЛИ

**CONCORDANCE TABLE OF INTERNATIONAL CLASSIFICATION INDEX
WITH REFERENCE TO NUMBERS OF PATENTS AND NUMBERS
OF PUBLISHED APPLICATIONS**

ТАБЛИЦА СООТВЕТСТВИЙ ИНДЕКСОВ МЕЖДУНАРОДНОЙ КЛАССИФИКАЦИИ
С НОМЕРАМИ ПАТЕНТОВ И С НОМЕРАМИ ОПУБЛИКОВАННЫХ ЗАЯВОК

INTERNATIONAL CLASSIFICATION INDEX ИНДЕКС МЕЖДУНАРОДНОЙ КЛАССИФИКАЦИИ (51)	NUMBER OF PATENT НОМЕР ПАТЕНТА (11)	NUMBER OF PUBLISHED APPLICATION НОМЕР ПУБЛИКАЦИИ ЗАЯВКИ (10)
A 45 D 26/00	U 2011 1647 Y	AU 2010 11611 U
A 47 D 9/00	U 2011 1649 Y	AU 2010 11310 U
E 02 B 3/00	U 2011 1646 Y	AU 2010 11583 U
E 02 D 29/02	U 2011 1648 Y	AU 2010 11313 U
G 06 Q 20/00	U 2011 1650 Y	AU 2010 10890 U

**CONCORDANCE TABLES OF NUMBERS OF PATENTS AND NUMBERS
OF PUBLISHED APPLICATIONS WITH REFERENCE
TO CLASSIFICATION INDEX**

ТАБЛИЦА СООТВЕТСТВИЙ НОМЕРОВ ПАТЕНТОВ И НОМЕРОВ ПУБЛИКАЦИЙ ЗАЯВОК
С ИНДЕКСАМИ МЕЖДУНАРОДНОЙ КЛАССИФИКАЦИИ

NUMBER OF PATENT НОМЕР ПАТЕНТА (11)	NUMBER OF PUBLISHED APPLICATION НОМЕР ПУБЛИКАЦИИ ЗАЯВКИ (10)	INTERNATIONAL CLASSIFICATION INDEX ИНДЕКС МЕЖДУНАРОДНОЙ КЛАССИФИКАЦИИ (51)
U 2011 1646 Y	AU 2010 11583 U	E 02 B 3/00
U 2011 1647 Y	AU 2010 11611 U	A 45 D 26/00
U 2011 1648 Y	AU 2010 11313 U	E 02 D 29/02
U 2011 1649 Y	AU 2010 11310 U	A 47 D 9/00
U 2011 1650 Y	AU 2010 10890 U	G 06 Q 20/00

CONCORDANCE TABLE OF NUMBERS OF APPLICATIONS, NUMBERS OF PUBLISHED APPLICATIONS AND NUMBERS OF PATENTS

ТАБЛИЦА СООТВЕТСТВИЙ НОМЕРОВ ЗАЯВОК, НОМЕРОВ ПУБЛИКАЦИЙ ЗАЯВОК И НОМЕРОВ ПАТЕНТОВ

NUMBER OF APPLICATION НОМЕР ЗАЯВКИ (21)	NUMBER OF PUBLISHED APPLICATION НОМЕР ПУБЛИКАЦИИ ЗАЯВКИ (10)	NUMBER OF PATENT НОМЕР ПАТЕНТА (11)
AU 2007 010890	AU 2010 10890 U	U 2011 1650 Y
AU 2009 011310	AU 2010 11310 U	U 2011 1649 Y
AU 2009 011313	AU 2010 11313 U	U 2011 1648 Y
AU 2009 011583	AU 2010 11583 U	U 2011 1646 Y
AU 2009 011611	AU 2010 11611 U	U 2011 1647 Y

INDUSTRIAL DESIGNS

ПРОМЫШЛЕННЫЕ ОБРАЗЦЫ

CONCORDANCE TABLE OF INTERNATIONAL CLASSIFICATION INDEX WITH REFERENCE TO NUMBERS OF PATENTS AND NUMBERS OF PUBLISHED APPLICATIONS

ТАБЛИЦА СООТВЕТСТВИЙ ИНДЕКСОВ МЕЖДУНАРОДНОЙ КЛАССИФИКАЦИИ С НОМЕРАМИ ПАТЕНТОВ И С НОМЕРАМИ ОПУБЛИКОВАННЫХ ЗАЯВОК

INTERNATIONAL CLASSIFICATION INDEX ИНДЕКС МЕЖДУНАРОДНОЙ КЛАССИФИКАЦИИ (51)	NUMBER OF PATENT НОМЕР ПАТЕНТА (11)	NUMBER OF PUBLISHED APPLICATION НОМЕР ПУБЛИКАЦИИ ЗАЯВКИ (10)
09-05	D 2011 453 S	AD 2010 599 S
09-07	D 2011 451 S	AD 2010 594 S
12-07	D 2011 452 S	AD 2010 597 S

CONCORDANCE TABLES OF NUMBERS OF PATENTS AND NUMBERS OF PUBLISHED APPLICATIONS WITH REFERENCE TO CLASSIFICATION INDEX

ТАБЛИЦА СООТВЕТСТВИЙ НОМЕРОВ ПАТЕНТОВ И НОМЕРОВ ПУБЛИКАЦИЙ ЗАЯВОК С ИНДЕКСАМИ МЕЖДУНАРОДНОЙ КЛАССИФИКАЦИИ

NUMBER OF PATENT НОМЕР ПАТЕНТА (11)	NUMBER OF PUBLISHED APPLICATION НОМЕР ПУБЛИКАЦИИ ЗАЯВКИ (10)	INTERNATIONAL CLASSIFICATION INDEX ИНДЕКС МЕЖДУНАРОДНОЙ КЛАССИФИКАЦИИ (51)
D 2011 451 S	AD 2010 594 S	09-07
D 2011 452 S	AD 2010 597 S	12-07
D 2011 453 S	AD 2010 599 S	09-05

**CONCORDANCE TABLE OF NUMBERS OF APPLICATIONS, NUMBERS
OF PUBLISHED APPLICATIONS AND NUMBERS OF PATENTS**

ТАБЛИЦА СООТВЕТСТВИЙ НОМЕРОВ ЗАЯВОК, НОМЕРОВ ПУБЛИКАЦИЙ ЗАЯВОК
И НОМЕРОВ ПАТЕНТОВ

NUMBER OF APPLICATION НОМЕР ЗАЯВКИ (21)	NUMBER OF PUBLISHED APPLICATION НОМЕР ПУБЛИКАЦИИ ЗАЯВКИ (10)	NUMBER OF PATENT НОМЕР ПАТЕНТА (11)
AD 2010 000594	AD 2010 594 S	D 2011 451 S
AD 2010 000597	AD 2010 597 S	D 2011 452 S
AD 2010 000599	AD 2010 599 S	D 2011 453 S

TRADEMARKS ТОВАРНЫЕ ЗНАКИ

CONCORDANCE TABLE OF NUMBERS OF REGISTRATIONS OF TRADEMARKS, NUMBERS OF APPLICATIONS, NUMBERS OF PUBLISHED APPLICATIONS WITH REFERENCE TO NUMBERS OF BULLETINS

ТАБЛИЦА СООТВЕТСТВИЙ НОМЕРОВ РЕГИСТРАЦИЙ ТОВАРНЫХ ЗНАКОВ С НОМЕРАМИ
ЗАЯВОК, НОМЕРАМИ ПУБЛИКАЦИЙ ЗАЯВОК И НОМЕРАМИ БЮЛЛЕТЕНЕЙ

NUMBER OF REGISTRATION НОМЕР РЕГИСТРАЦИИ (111)	NUMBER OF APPLICATION НОМЕР ЗАЯВКИ (210)	NUMBER OF PUBLISHED APPLICATION НОМЕР ПУБЛИКАЦИИ ЗАЯВКИ (260)	NUMBER OF BULLETIN НОМЕР БЮЛЛЕТЕНЯ
M 2011 21115 R	AM 2011 60817	-	№4(320) 2011
M 2011 21116 R	AM 2011 60818	-	№4(320) 2011
M 2011 21117 R	AM 2011 60965	-	№4(320) 2011
M 2011 21118 R	AM 2011 60948	-	№4(320) 2011
M 2011 21119 R	AM 2011 60956	-	№4(320) 2011
M 2011 21120 R	AM 2011 61024	-	№4(320) 2011
M 2011 21121 R	AM 2011 61107	-	№4(320) 2011
M 2011 21122 R	AM 2011 61108	-	№4(320) 2011
M 2011 21123 R	AM 2011 61109	-	№4(320) 2011
M 2011 21124 R	AM 2011 61110	-	№4(320) 2011
M 2011 21125 R	AM 2011 61111	-	№4(320) 2011
M 2011 21126 R	AM 2011 61112	-	№4(320) 2011
M 2011 21127 R	AM 2011 61113	-	№4(320) 2011
M 2011 21128 R	AM 2011 61225	-	№4(320) 2011
M 2011 21129 R	AM 2011 61155	-	№4(320) 2011
M 2011 21130 R	AM 2008 47691	AM 2008 47691 A	№24(268) 2008
M 2011 21131 R	AM 2009 55599	AM 2010 55599 A	№16(308) 2010
M 2011 21132 R	AM 2009 55786	AM 2010 55786 A	№17(309) 2010
M 2011 21133 R	AM 2009 55788	AM 2010 55788 A	№17(309) 2010
M 2011 21134 R	AM 2009 55827	AM 2010 55827 A	№19(311) 2010
M 2011 21135 R	AM 2009 55862	AM 2010 55862 A	№16(308) 2010
M 2011 21136 R	AM 2009 56033	AM 2010 56033 A	№20(312) 2010
M 2011 21137 R	AM 2009 56034	AM 2010 56034 A	№20(312) 2010
M 2011 21138 R	AM 2009 56035	AM 2010 56035 A	№20(312) 2010
M 2011 21139 R	AM 2009 56036	AM 2010 56036 A	№19(311) 2010
M 2011 21140 R	AM 2009 56037	AM 2010 56037 A	№19(311) 2010
M 2011 21141 R	AM 2009 56038	AM 2010 56038 A	№19(311) 2010
M 2011 21142 R	AM 2009 56039	AM 2010 56039 A	№19(311) 2010
M 2011 21143 R	AM 2009 56222	AM 2010 56222 A	№19(311) 2010
M 2011 21144 R	AM 2009 56290	AM 2010 56290 A	№20(312) 2010
M 2011 21145 R	AM 2010 56654	AM 2010 56654 A	№20(312) 2010
M 2011 21146 R	AM 2010 56655	AM 2010 56655 A	№20(312) 2010
M 2011 21147 R	AM 2010 56677	AM 2010 56677 A	№20(312) 2010
M 2011 21148 R	AM 2010 56678	AM 2010 56678 A	№20(312) 2010
M 2011 21149 R	AM 2010 56847	AM 2010 56847 A	№19(311) 2010
M 2011 21150 R	AM 2010 56848	AM 2010 56848 A	№19(311) 2010
M 2011 21151 R	AM 2010 56849	AM 2010 56849 A	№19(311) 2010
M 2011 21152 R	AM 2010 56881	AM 2010 56881 A	№18(310) 2010

1	2	3	4
M 2011 21153 R	AM 2010 56918	AM 2010 56918 A	№19(311) 2010
M 2011 21154 R	AM 2010 57492	AM 2010 57492 A	№19(311) 2010
M 2011 21155 R	AM 2010 56846	AM 2010 56846 A	№19(311) 2010
M 2011 21156 R	AM 2009 56302	AM 2010 56302 A	№17(309) 2010
M 2011 21157 R	AM 2009 54637	AM 2010 54637 A	№17(309) 2010
M 2011 21158 R	AM 2009 55457	AM 2010 55457 A	№15(307) 2010
M 2011 21159 R	AM 2009 55619	AM 2010 55619 A	№15(307) 2010
M 2011 21160 R	AM 2009 55620	AM 2010 55620 A	№15(307) 2010
M 2011 21161 R	AM 2009 55621	AM 2010 55621 A	№15(307) 2010
M 2011 21162 R	AM 2009 55645	AM 2010 55645 A	№16(308) 2010
M 2011 21163 R	AM 2009 55646	AM 2010 55646 A	№16(308) 2010
M 2011 21164 R	AM 2009 55647	AM 2010 55647 A	№16(308) 2010
M 2011 21165 R	AM 2009 55648	AM 2010 55648 A	№15(307) 2010
M 2011 21166 R	AM 2009 56018	AM 2010 56018 A	№16(308) 2010
M 2011 21167 R	AM 2009 56019	AM 2010 56019 A	№17(309) 2010

CONCORDANCE TABLE OF NUMBERS OF PUBLISHED TRADEMARK APPLICATIONS WITH REFERENCE TO NUMBERS OF APPLICATIONS

ТАБЛИЦА СООТВЕТСТВИЙ НОМЕРОВ ПУБЛИКАЦИЙ ТОВАРНЫХ ЗНАКОВ И НОМЕРОВ ЗАЯВОК

NUMBER OF PUBLISHED APPLICATION НОМЕР ПУБЛИКАЦИИ ЗАЯВКИ (260)	NUMBER OF APPLICATION НОМЕР ЗАЯВКИ (210)	1	2
1	2		
AM 2011 57795 A	AM 2010 57795	AM 2011 58239 A	AM 2010 58239
AM 2011 57796 A	AM 2010 57796	AM 2011 58240 A	AM 2010 58240
AM 2011 57962 A	AM 2010 57962	AM 2011 58241 A	AM 2010 58241
AM 2011 57963 A	AM 2010 57963	AM 2011 58244 A	AM 2010 58244
AM 2011 57964 A	AM 2010 57964	AM 2011 58282 A	AM 2010 58282
AM 2011 57985 A	AM 2010 57985	AM 2011 58284 A	AM 2010 58284
AM 2011 57988 A	AM 2010 57988	AM 2011 58285 A	AM 2010 58285
AM 2011 58078 A	AM 2010 58078	AM 2011 58307 A	AM 2010 58307
AM 2011 58157 A	AM 2010 58157	AM 2011 58360 A	AM 2010 58360
AM 2011 58161 A	AM 2010 58161	AM 2011 58361 A	AM 2010 58361
AM 2011 58162 A	AM 2010 58162	AM 2011 58367 A	AM 2010 58367
AM 2011 58165 A	AM 2010 58165	AM 2011 58373 A	AM 2010 58373
AM 2011 58230 A	AM 2010 58230	AM 2011 58376 A	AM 2010 58376
AM 2011 58231 A	AM 2010 58231	AM 2011 58377 A	AM 2010 58377
AM 2011 58232 A	AM 2010 58232	AM 2011 58379 A	AM 2010 58379
AM 2011 58233 A	AM 2010 58233	AM 2011 58380 A	AM 2010 58380
AM 2011 58234 A	AM 2010 58234	AM 2011 58381 A	AM 2010 58381
AM 2011 58235 A	AM 2010 58235	AM 2011 58382 A	AM 2010 58382
AM 2011 58236 A	AM 2010 58236	AM 2011 58399 A	AM 2010 58399
AM 2011 58237 A	AM 2010 58237	AM 2011 58400 A	AM 2010 58400
AM 2011 58238 A	AM 2010 58238	AM 2011 58401 A	AM 2010 58401
		AM 2011 58402 A	AM 2010 58402
		AM 2011 58404 A	AM 2010 58404
		AM 2011 58405 A	AM 2010 58405
		AM 2011 58471 A	AM 2010 58471

**CONCORDANCE TABLE OF INDEX OF GOODS AND/OR SERVICES
WITH REFERENCE TO NUMBERS OF PUBLISHED APPLICATIONS**

ТАБЛИЦА СООТВЕТСТВИЙ КЛАССОВ ТОВАРОВ И/ИЛИ УСЛУГ С НОМЕРАМИ
ОПУБЛИКОВАННЫХ ЗАЯВОК

INDEX OF GOODS AND/OR SERVICES КЛАСС ТОВАРОВ И/ИЛИ УСЛУГ (511)	NUMBER OF PUBLISHED APPLICATION НОМЕР ОПУБЛИКОВАННОЙ ЗАЯВКИ (260)	1	2
1	2		
1	AM 2011 58367 A	29	AM 2011 58162 A
3	AM 2011 58161 A	29	AM 2011 58361 A
3	AM 2011 58376 A	29	AM 2011 58377 A
5	AM 2011 57795 A	29	AM 2011 58378 A
5	AM 2011 57796 A	29	AM 2011 58379 A
5	AM 2011 57962 A	29	AM 2011 58380 A
5	AM 2011 57963 A	29	AM 2011 58381 A
5	AM 2011 57964 A	29	AM 2011 58382 A
5	AM 2011 58157 A	29	AM 2011 58402 A
5	AM 2011 58161 A	30	AM 2011 58241 A
5	AM 2011 58230 A	30	AM 2011 58377 A
5	AM 2011 58231 A	30	AM 2011 58378 A
5	AM 2011 58232 A	30	AM 2011 58379 A
5	AM 2011 58233 A	30	AM 2011 58380 A
5	AM 2011 58234 A	30	AM 2011 58381 A
5	AM 2011 58235 A	30	AM 2011 58382 A
5	AM 2011 58236 A	30	AM 2011 58405 A
5	AM 2011 58237 A	31	AM 2011 57985 A
5	AM 2011 58238 A	31	AM 2011 58162 A
5	AM 2011 58239 A	31	AM 2011 58377 A
5	AM 2011 58240 A	31	AM 2011 58378 A
5	AM 2011 58244 A	31	AM 2011 58404 A
5	AM 2011 58282 A	32	AM 2011 58377 A
5	AM 2011 58284 A	32	AM 2011 58378 A
5	AM 2011 58285 A	32	AM 2011 58405 A
5	AM 2011 58307 A	33	AM 2011 58165 A
5	AM 2011 58360 A	33	AM 2011 58405 A
5	AM 2011 58367 A	34	AM 2011 58373 A
5	AM 2011 58376 A	35	AM 2011 57962 A
5	AM 2011 58399 A	35	AM 2011 57963 A
5	AM 2011 58400 A	35	AM 2011 57964 A
5	AM 2011 58401 A	35	AM 2011 57985 A
9	AM 2011 57988 A	35	AM 2011 58405 A
10	AM 2011 57962 A	36	AM 2011 58405 A
10	AM 2011 57963 A	37	AM 2011 58405 A
10	AM 2011 57964 A	37	AM 2011 58471 A
16	AM 2011 58161 A	42	AM 2011 57962 A
17	AM 2011 58471 A	42	AM 2011 57963 A
19	AM 2011 58471 A	42	AM 2011 57964 A
29	AM 2011 57985 A	43	AM 2011 57985 A
29	AM 2011 58078 A	43	AM 2011 58377 A
		43	AM 2011 58378 A
		43	AM 2011 58379 A
		43	AM 2011 58380 A
		43	AM 2011 58381 A
		43	AM 2011 58382 A
		44	AM 2011 57962 A

1	2
44	AM 2011 57963 A
44	AM 2011 57964 A
45	AM 2011 57962 A
45	AM 2011 57963 A
45	AM 2011 57964 A

**CONCORDANCE TABLE OF INDEX OF GOODS AND/OR SERVICES
WITH REFERENCE TO NUMBERS OF REGISTERED ACCORDING TO THE
ACCELERATED PROCEDURE**

ТАБЛИЦА СООТВЕТСТВИЙ КЛАССОВ ТОВАРОВ И/ИЛИ УСЛУГ С НОМЕРАМИ РЕГИСТРАЦИИ
ПО УСКОРЕННОЙ ПРОЦЕДУРЕ

INDEX OF GOODS AND/OR SERVICES КЛАСС ТОВАРОВ И/ИЛИ УСЛУГ (511)	NUMBER OF REGISTERED ACCORDING TO THE ACCELERATED PROCEDURE НОМЕР РЕГИСТРАЦИИ ТОВАРНЫХ ЗНАКОВ ЗАРЕГИСТРИРОВАННЫХ ПО УСКОРЕННОЙ ПРОЦЕДУРЕ (111)
3	M 2011 21121 R
3	M 2011 21125 R
3	M 2011 21127 R
3	M 2011 21128 R
9	M 2011 21129 R
29	M 2011 21118 R
29	M 2011 21121 R
29	M 2011 21127 R
30	M 2011 21121 R
30	M 2011 21122 R
30	M 2011 21126 R
30	M 2011 21127 R
32	M 2011 21121 R
32	M 2011 21123 R
32	M 2011 21124 R
32	M 2011 21127 R
34	M 2011 21115 R
34	M 2011 21116 R
34	M 2011 21119 R
34	M 2011 21120 R
35	M 2011 21117 R
35	M 2011 21121 R
35	M 2011 21127 R
35	M 2011 21128 R

OFFICIAL BULLETIN OF THE INDUSTRIAL PROPERTY
ОФИЦИАЛЬНЫЙ БЮЛЛЕТЕНЬ ПРОМЫШЛЕННОЙ СОБСТВЕННОСТИ

4 (320)

EDITOR-IN-CHIEF: N. Bebrishvili
ГЛАВНЫЙ РЕДАКТОР: *Н. Бебришвили*

EDITOR: A. Shikhashvili
РЕДАКТОР: *А. Шихашвили*

EDITORS-TRANSLATORS: M. Sichinava
РЕДАКТОРЫ-ПЕРЕВОДЧИКИ: *М. Сичинава*

G. Nadareishvili
Г. Надареишвили

PROOFREADER: L. Chanturia
КОРРЕКТОР: *Л. Чантурия*

COMPUTER LAYOUT: M. Ordenidze
КОМПЬЮТЕРНАЯ ВЕРСТКА: *М. Орденидзе*

K. Svanidze
К. Сванидзе