



**NATIONAL INTELLECTUAL PROPERTY CENTER OF GEORGIA
SAKPATENTI**

**OFFICIAL BULLETIN
OF THE INDUSTRIAL PROPERTY**

6(370)

**2013
TBILISI**

INID CODES FOR IDENTIFICATION OF BIBLIOGRAPHIC DATA

INVENTIONS, UTILITY MODELS

- (10) Number of publication for application, which has been examined
- (11) Number of patent and kind of document
- (21) Serial number of application
- (22) Date of filing of the application
- (23) Date of exhibition or the date of the earlier filing and the number of application, if any
- (24) Date from which patent may have effect
- (31) Number of priority application
- (32) Date of filing of priority application
- (33) Code of the country or regional organization allotting priority application number
- (44) Date of publication of application not granted, but examined and number of bulletin
- (45) Date of publication of registered document
- (51) International Patent Classification Index
- (54) Title of the invention
- (57) Abstract
- (60) Number of examined patent document granted by foreign patent office, date from which patent has effect and country code
- (62) Number of the earlier application and in case of divided application, date of filing an application
- (71) Name, surname and address of applicant (country code)
- (72) Name, surname of inventor (country code)
- (73) Name, surname and address of patent owner (country code)
- (74) Name, surname of representative or patent attorney
- (85) Date of commencement of the national phase of International Application
- (86) Number and date of filing of international application
- (87) Number and date of publication of international application

DESIGNS

- (10) Number of publication for application
- (11) Number of patent and kind of document or number of registration
- (15) Date of registration/Date of patent renewal
- (18) Expected expiration date of patent or registration
- (21) Serial number of application
- (22) Date of filing of the application
- (23) Date of exhibition or the date of the earlier filing and the number of application, if any
- (24) Date from which patent may have effect
- (28) Number of designs included in the application
- (30) Data relating to priority (number of application, date of filing of application, two-letter code identifying the authority with whom the priority application was made)
- (31) Number of priority application
- (32) Date of filing of priority application
- (33) Code of the country or regional organization allotting priority application number
- (34) Two-letter code according to WIPO St.3 identifying the authority with which the priority application was made
- (44) Date of publication of design and number of bulletin (the first publication)
- (45) Date of publication of design registered by WIPO and number of bulletin
- (51) International Classification for designs (class and subclass of the Locarno Classification)
- (54) Title of the invention
- (55) Reproduction of the design
- (57) Description of characteristic features of the design including indication of colors
- (58) Date of recording of any kind of amendment in the Register
- (62) Number of the earlier application, registration and document number and if available the date of filing an application in case of divided application
- (71) Name, surname and address of applicant (country code)
- (72) Name, surname of creator (country code)
- (73) Name, surname and address of patent owner (country code)
- (74) Name, surname of representative or patent attorney
- (81) Contracting states concerned
 - II designated contracting states according to the 1960 Act
 - III designated contracting states according to the 1999 Act
- (85) Owner's permanent address
- (86) Owner's nationality
- (87) Owner's residence
- (88) State in which the owner has a real and effective industrial or commercial establishment

TRADEMARKS

- (111) – Number of registration
- (151) – Date of registration
- (156) – Date of the renewal
- (181) – Expected expiration date of registration
- (186) – Renewal expiration date of registration
- (141) – Date of cancel of duration of the mark
- (210) – Serial number of application
- (220) – Date of filing of the application
- (230) – Data concerning exhibition
- (260) – Number of application, for which favorable decision of examination about registration has been taken (publication number)
- (310) – Number of the first application
- (320) – Date of filing of the first application
- (330) – Code, identifying national or regional Office where the first application was made
- (511) – International Classification of Goods and Services for the purposes of registration of trade marks and/or list of goods and/or services classified according thereto
- (531) – Description of figurative elements of Trade Marks according to the International Classification of the Figurative Elements of Marks
- (540) – Reproduction of Trade Mark
- (550) – Nature and kind of Trade Mark
- (580) – Date of recording of any kind changes in respect of applications or registrations
- (591) – Information concerning colors claimed
- (731) – Name and address of the applicant
- (732) – Name and address of the holder of the registration
- (740) – Name and address of the representative
- (750) – Address for correspondence
- (770) – Name and address of the previous applicant or holder in case of change in ownership
- (771) – Previous name and address of the applicant or holder in case of change in ownership
- (791) – Name and address of the licensee
- (793) – Indication of conditions and/or restrictions under the license (Type of license, number of license agreement, data of license, data of validity of license)
- (800) – Certain data relating to the international registration of Trade Marks under the Protocol Relating to Madrid Agreement (International registration number)

CODES FOR PUBLICATION IN BULLETIN

- (21) AP 0000 000000 – serial number of application for invention
- (10) AP 0000 0000 A – number of published application for invention (first publication)
- (11) P 0000 0000 B – number of patent for invention (second publication)
- (21) API 0000 000000 – number of application for imported patent
- (11) PI 0000 0000 A – number of imported patent (first publication)
- (21) AU 0000 000000 – serial number of application for utility model
- (10) AU 0000 000 U – number of published application for utility model (first publication)
- (11) U 0000 000 Y – number of patent for utility model (second publication)
- (21) AD 0000 000000 – serial number of application for design
- (10) AD 0000 000 S – number of published application for design (first publication)
- (11) D 0000 000 S – number of patent for design (second publication)

INTERNATIONAL PATENT CLASSIFICATION FOR INVENTIONS AND UTILITY MODELS

- SECTION A – HUMAN NECESSITIES
- SECTION B – PERFORMING OPERATIONS; TRANSPORTING
- SECTION C – CHEMISTRY; METALLURGY
- SECTION D – TEXTILES; PAPER
- SECTION E – FIXED CONSTRUCTIONS
- SECTION F – MECHANICAL ENGINEERING; LIGHTING; HEATING; WEAPONS; BLASTING
- SECTION G – PHYSICS
- SECTION H – ELECTRICITY

-
- M – Trade Mark
 - (210) AM 0000 000000 – Serial number of application;
 - (260) AAM 0000 00000 A – Publication number of application;
 - (111) M 0000 00000 R – Number of registration;
 - (111) MMM0000 00000 Rn – Number of renewals, in which n=1,2,3;
 - (111) M 0000 00000 R(P) – Number of registration under partial assignment of rights
-

LIST OF CODES, IN ALPHABETIC SEQUENCE, AND THE CORRESPONDING (SHORT) NAMES OF STATES, OTHER ENTITIES AND INTERGOVERNMENTAL ORGANIZATIONS
(WIPO STANDARD ST.3)

| | | | | | |
|----|--|--|--|--|--|
| AD | Andorra | | | | |
| AE | United Arab Emirates | | | | |
| AF | Afghanistan | | | | |
| AG | Antigua and Barbuda | | | | |
| AI | Anguilla | | | | |
| AL | Albania | | | | |
| AM | Armenia | | | | |
| AN | Netherlands Antilles | | | | |
| AO | Angola | | | | |
| AP | African Regional Intellectual Property Organization (ARIPO) | | | | |
| AR | Argentina | | | | |
| AT | Austria | | | | |
| AU | Australia | | | | |
| AW | Aruba | | | | |
| AZ | Azerbaijan | | | | |
| BA | Bosnia and Herzegovina | | | | |
| BB | Barbados | | | | |
| BD | Bangladesh | | | | |
| BE | Belgium | | | | |
| BF | Burkina Faso | | | | |
| BG | Bulgaria | | | | |
| BH | Bahrain | | | | |
| BI | Burundi | | | | |
| BJ | Benin | | | | |
| BM | Bermuda | | | | |
| BN | Brunei Darussalam | | | | |
| BO | Bolivia | | | | |
| BR | Brazil | | | | |
| BS | Bahamas | | | | |
| BT | Bhutan | | | | |
| BV | Bouvet Island | | | | |
| BW | Botswana | | | | |
| BX | Benelux Office for Intellectual Property (BOIP) | | | | |
| BY | Belarus | | | | |
| BZ | Belize | | | | |
| CA | Canada | | | | |
| CD | Democratic Republic of the Congo | | | | |
| CF | Central African Republic | | | | |
| CG | Congo | | | | |
| CH | Switzerland | | | | |
| CI | Cote d'Ivoire | | | | |
| CK | Cook Islands | | | | |
| CL | Chile | | | | |
| CM | Cameroon | | | | |
| CN | China | | | | |
| CO | Colombia | | | | |
| CR | Costa Rica | | | | |
| CU | Cuba | | | | |
| CV | Cape Verde | | | | |
| CY | Cyprus | | | | |
| CZ | Czech Republic | | | | |
| DE | Germany | | | | |
| DJ | Djibouti | | | | |
| DM | Dominica | | | | |
| DO | Dominican Republic | | | | |
| DZ | Algeria | | | | |
| EA | Eurasian Patent Organization (EAPO) | | | | |
| EC | Ecuador | | | | |
| EE | Estonia | | | | |
| EG | Egypt | | | | |
| EH | Western Sahara | | | | |
| EM | Office for Harmonization in the Internal Market (Trademarks and Designs)(OHIM) | | | | |
| EP | European Patent Office (EPO) | | | | |
| ER | Eritrea | | | | |
| ES | Spain | | | | |
| ET | Ethiopia | | | | |
| FI | Finland | | | | |
| FJ | Fiji | | | | |
| FK | Falkland Islands (Malvinas) | | | | |
| FO | Faroe Islands | | | | |
| FR | France | | | | |
| GA | Gabon | | | | |
| GB | United Kingdom | | | | |
| GC | Patent Office of the Cooperation Council for the Arab States of the Gulf (GCC) | | | | |
| GD | Grenada | | | | |
| GG | Guernsey | | | | |
| GH | Ghana | | | | |
| GI | Gibraltar | | | | |
| GT | Guatemala | | | | |
| GW | Guinea- Bissau | | | | |
| GY | Guyana | | | | |
| HK | The Hong Kong Special Administrative Region of the People's Republic of China | | | | |
| HN | Honduras | | | | |
| HR | Croatia | | | | |
| HT | Haiti | | | | |
| HU | Hungary | | | | |
| IB | International Bureau of the World Intellectual Property Organization (WIPO) | | | | |
| ID | Indonesia | | | | |
| IE | Ireland | | | | |
| IL | Israel | | | | |
| IM | Isle of Man | | | | |
| IN | India | | | | |
| IQ | Iraq | | | | |
| ID | Indonesia | | | | |
| IE | Ireland | | | | |
| IL | Israel | | | | |
| IM | Isle of Man | | | | |
| IN | India | | | | |
| IQ | Iraq | | | | |
| IR | Iran (Islamic Republic of) | | | | |
| IS | Iceland | | | | |
| IT | Italy | | | | |
| JE | Jersey | | | | |
| JM | Jamaica | | | | |
| JO | Jordan | | | | |
| JP | Japan | | | | |
| KE | Kenya | | | | |
| KG | Kyrgyzstan | | | | |
| KH | Cambodia | | | | |
| KI | Kiribati | | | | |
| KM | Saint Kitts and Nevis | | | | |
| KP | Democratic People's Republic of Korea | | | | |
| KR | Republic of Korea | | | | |
| KW | Kuwait | | | | |
| KY | Cayman Islands | | | | |
| KZ | Kazakhstan | | | | |
| LA | Lao People's Democratic Republic | | | | |
| LB | Lebanon | | | | |
| LC | Saint Lucia | | | | |
| LI | Liechtenstein | | | | |
| LK | Sri Lanka | | | | |
| LR | Liberia | | | | |
| LS | Lesotho | | | | |
| LT | Lithuania | | | | |
| LU | Luxembourg | | | | |
| LV | Latvia | | | | |
| LY | Libyan Arab Jamahiriya | | | | |
| MA | Morocco | | | | |
| MC | Monaco | | | | |
| MD | Republic of Moldova | | | | |
| ME | Montenegro | | | | |
| MG | Madagascar | | | | |
| MK | The former Yugoslav Republic of Macedonia | | | | |
| ML | Mali | | | | |
| MM | Myanmar | | | | |
| MN | Mongolia | | | | |
| MO | Macao | | | | |
| MP | Northern Mariana Islands | | | | |
| MR | Mauritania | | | | |
| MS | Montserrat | | | | |
| MT | Malta | | | | |
| MU | Mauritius | | | | |
| MV | Maldives | | | | |
| MW | Malawi | | | | |
| MX | Mexico | | | | |
| MY | Malaysia | | | | |
| MZ | Mozambique | | | | |
| NA | Namibia | | | | |
| NE | Niger | | | | |
| NG | Nigeria | | | | |
| NI | Nicaragua | | | | |
| NL | Netherlands | | | | |
| NO | Norway | | | | |
| NP | Nepal | | | | |
| NR | Nauru | | | | |
| NZ | New Zealand | | | | |
| OA | African Intellectual Property Organization (OAPI) | | | | |
| OM | Oman | | | | |
| PA | Panama | | | | |
| PE | Peru | | | | |
| PG | Papua New Guinea | | | | |
| PH | Philippines | | | | |
| PK | Pakistan | | | | |
| PL | Poland | | | | |
| PT | Portugal | | | | |
| PW | Palau | | | | |
| PY | Paraguay | | | | |
| QA | Qatar | | | | |
| QZ | Community Plant Variety Office (European Community) (CPVO) | | | | |
| RO | Romania | | | | |
| RS | Serbia | | | | |
| RU | Russian Federation | | | | |
| RW | Rwanda | | | | |
| SA | Saudi Arabia | | | | |
| SB | Solomon Islands | | | | |
| SC | Seychelles | | | | |
| SD | Sudan | | | | |
| SG | Singapore | | | | |
| SH | Saint Helena | | | | |
| SI | Slovenia | | | | |
| SK | Slovakia | | | | |
| SL | Sierra Leone | | | | |
| SM | San Marino | | | | |
| SN | Senegal | | | | |
| SO | Somalia | | | | |
| SR | Suriname | | | | |
| ST | Sao Tome and Principe | | | | |
| SV | El Salvador | | | | |
| SY | Syrian Arab Republic | | | | |
| SZ | Swaziland | | | | |
| TC | Turks and Caicos Islands | | | | |
| TD | Chad | | | | |
| TG | Togo | | | | |
| TH | Thailand | | | | |
| TJ | Tajikistan | | | | |
| TL | Timor-Leste | | | | |
| TM | Turkmenistan | | | | |
| TN | Tunisia | | | | |
| TO | Tonga | | | | |
| TR | Turkey | | | | |
| SE | Sweden | | | | |
| TT | Trinidad and Tobago | | | | |
| TV | Tuvalu | | | | |
| TW | Taiwan, Province of China | | | | |
| TZ | United Republic of Tanzania | | | | |
| UA | Ukraine | | | | |
| UG | Uganda | | | | |
| US | United States of America | | | | |
| UY | Uruguay | | | | |
| UZ | Uzbekistan | | | | |
| VA | Holy See | | | | |
| VC | Saint Vincent and the Grenadines | | | | |
| VE | Venezuela | | | | |
| VG | Virgin Islands (British) | | | | |
| VN | Viet Nam | | | | |
| VU | Vanuatu | | | | |
| WO | World Intellectual Property Organization (WIPO) | | | | |
| WS | Samoa | | | | |
| XN | Nordic Patent Institute (NPI) | | | | |
| YE | Yemen | | | | |
| ZA | South Africa | | | | |
| ZM | Zambia | | | | |
| ZW | Zimbabwe | | | | |

**NATIONAL INTELLECTUAL PROPERTY CENTER OF GEORGIA
SAKPATENTI**

**OFFICIAL BULLETIN
OF THE INDUSTRIAL PROPERTY**

6(370)

INVENTIONS

UTILITY MODELS

DESIGNS

TRADEMARKS

**APPELLATIONS OF ORIGIN AND GEOGRAPHICAL
INDICATIONS OF GOODS**

DATE OF PUBLICATION

2013 03 25

CONTENTS

| | |
|--|----------|
| PUBLISHED TITLES OF PROTECTION | 2 |
| INVENTIONS | |
| ▪ APPLICATIONS APPROVED FOR GRANTING PATENTS | 4 |
| ▪ PATENTED INVENTIONS | 11 |
| UTILITY MODELS | |
| ▪ APPLICATION APPROVED FOR GRANTING PATENT | 13 |
| ▪ PATENTED UTILITY MODELS | 15 |
| DESIGNS | |
| ▪ APPLICATIONS APPROVED FOR GRANTING PATENTS | 16 |
| ▪ REGISTERED DESIGN | 23 |
| TRADEMARKS | |
| ▪ APPLICATIONS FILED UNDER THE NATIONAL PROCEDURE APPROVED FOR REGISTRATION | 24 |
| ▪ REGISTERED TRADEMARKS | 27 |
| ▪ TRADEMARKS REGISTERED ACCORDING TO THE ACCELERATED PROCEDURE | 31 |
| ▪ INTERNATIONAL TRADEMARKS FOR WHICH A DECISION ON GANTING PROTECTION IS TAKEN | 35 |
| ▪ INTERNATIONAL TRADEMARKS PROTECTED IN GEORGIA | 86 |
| APPELLATIONS OF ORIGIN AND GEOGRAPHICAL INDICATIONS OF GOODS | |
| ▪ APPELLATIONS OF ORIGIN OF GOODS FILED IN GEORGIA FOR EXAMINATION UNDER LISBON AGREEMENT, ON THE BASIS OF THE INTERNATIONAL REGISTRATION | 100 |
| ▪ THE RIGHT TO USE OF REGISTERED APPELLATIONS OF ORIGIN OF GOODS | 100 |
| OFFICIAL NOTIFICATIONS | |
| TRADEMARKS | |
| ▪ RENEWAL OF REGISTRATIONS | 101 |
| ▪ CHANGES IN NAMES AND/OR ADDRESSES OF OWNERS | 102 |
| ▪ LICENSE AGREEMENTS | 105 |
| CLASSIFICATION INDEXES | |
| INVENTIONS | 106 |
| UTILITY MODELS | 108 |
| DESIGNS | 109 |
| TRADEMARKS | 111 |

PUBLISHED TITLES OF PROTECTION

INVENTIONS

- **APPLICATIONS APPROVED FOR GRANTING PATENTS:**
12683; 12528; 12190; 12509; 12325, 12326; 12156; 12068; 11955; 12171; 10866; 12610, 12611; 11921; 12164; 11075; 12173; 12246
- **PATENTED INVENTIONS:**
5791-5795

UTILITY MODELS

- **APPLICATIONS APPROVED FOR GRANTING PATENT:**
12070; 12659; 12571; 12016; 12695
- **PATENTED UTILITY MODELS:**
1760-1763

DESIGNS

- **APPLICATIONS APPROVED FOR GRANTING PATENTS:**
726-728
- **REGISTERED DESIGN:**
535

TRADEMARKS

- **APPLICATIONS FILED UNDER THE NATIONAL PROCEDURE APPROVED FOR REGISTRATION:**
66278; 66345; 67175; 67180, 67181; 67183-67185; 67198; 67245; 67288; 67427; 68504, 68505; 68551-68554
- **REGISTERED TRADEMARKS:**
23420-23457; 23461-23465
- **TRADEMARKS REGISTERED ACCORDING TO THE ACCELERATED PROCEDURE:**
23413-23419; 23466-23474
- **INTERNATIONAL TRADEMARKS FOR WHICH A DECISION ON GRANTING PROTECTIONS IS TAKEN:**
66945; 66985, 66986; 66988-66993; 66995-67004; 67038-67042; 67044-67048; 67050-67054; 67080-67085; 67087, 67088; 67090-67092; 67095-67099; 67100; 67127; 67140-67142; 67145-67150; 67152, 67153; 67209; 67222-67225; 67227-67234; 67264-67270; 67272-67276; 67283-67286; 67289; 67291; 67350-67357; 67362; 67364; 67366-67369; 67374; 67419-67421; 67425, 67426; 67430; 67437, 67438; 67476-67478; 67484-67486; 67488-67490; 67492; 67494; 67556; 67624; 67626; 67628-67631; 67633, 67634; 67636; 67640; 67642; 67874; 64291*; 64411*; 65025*; 65843*
- **INTERNATIONAL TRADEMARKS PROTECTED IN GEORGIA:**
62532; 63525; 64394; 64676; 64879-64891; 64893-64895; 64971; 64975, 64976; 64979, 64980; 65005, 65006; 65011, 65012; 65105-65107; 65109-65111; 65125-65127; 65129; 65132, 65133; 65135-65138; 65140; 65163; 65182, 65183; 65190, 65191; 65261; 65293-65296; 65303; 65340-65342; 65344, 65345; 65347-65349; 65352-65357; 65359-65362; 65364-65367; 65457, 65458; 65460, 65461; 65481-65483; 65485-65487; 65508; 65511, 65512; 65518; 65525, 65526; 65532; 65534-65539; 65591; 65596; 65651; 65654; 65674; 65680-65682; 65685; 65703; 65706; 65712-65715; 65720, 65721; 65723; 65725-65727; 65732, 65733; 65778; 65780; 65782-65784; 65786; 65788-65795; 65798, 65799; 65801, 65802; 65807; 65813; 65848, 65849; 65852; 65855-65858; 65912, 65913; 65916; 65918, 65919; 65921; 65923; 65948, 65949; 65951-65955; 65962; 65966; 65974-65976; 65978; 65985-65987; 66017; 66027; 66051, 66052; 66101-66103; 66105-66108; 66140; 66143-66148; 66153; 66155-66160; 61410-61414; 61458-61462; 61557-61561; 61638; 61644; 61721; 61794; 61796; 61798; 61801; 61976, 61977; 61979, 61980; 61982, 61983

APPELLATIONS OF ORIGIN AND GEOGRAPHICAL INDICATIONS OF GOODS

- **APPELLATIONS OF ORIGIN OF GOODS:**
1091/06
- **THE RIGHT TO USE OF REGISTERED APPELLATIONS OF ORIGIN OF GOODS:**
788/2-13

INVENTIONS

APPLICATIONS APPROVED FOR GRANTING PATENTS

The decision can be appealed at the Chamber of Appeal of Sakpatenti within 3 months from the publication or at the Mtskheta District Court Administrative Cases Board (Address: №17, Samkhedro str., Mtskheta), within 1 month following the publication.

PART A

A 01

(10) AP 2013 12683 A (51) Int. Cl. (2006)
A 01 D 46/26

(21) AP 2012 012683 (22) 2012 04 27

(71) Nugzar Ebanoidze (GE)

Zurab Chavchavadzis q. 50, Koteji 2/38,

4600, Kutaisi (GE);

Vitali Dundua (GE)

Gamsakhurduas q. 12/63, 4600,

Kutaisi (GE)

(72) Nugzar Ebanoidze (GE);

Vitali Dundua (GE).

(54) MACHINE SHAKING OFF FRUITAGE

(57) There is represented a machine comprising: power means frame, and an actuator connected to power means drive 2 and allocated from their both sides. The actuator is executed as the endless chains 3 allocated on horizontal plane, the flexible hammers 4 are fixed therewith determined interval. The actuator is connected to the frame by means of shed system executed as a blanket 5 and the tractions 6 hingedly connected thereto and springed relative to them. The blanket is located in a guide 8 executed on the frame, and by means of hydrocylinder 9 is movable in crosswise direction. Endless chains with flexible hammers driving is carried out by means of: cardan drives 10 connected to drive, and conic reduction gears 11.

Claims: 1 independent

Fig.: 1

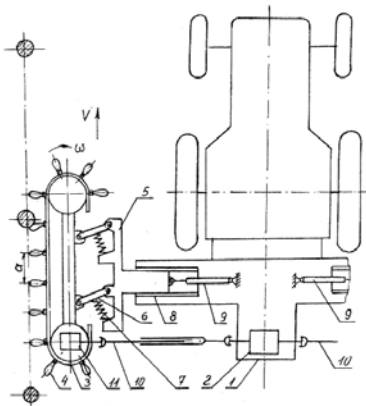

Fig. 1

A 47

(10) AP 2013 12528 A (51) Int. Cl. (2006)
A 47 G 19/22

(21) AP 2012 012528 (22) 2012 02 06

(71) Kakha Chomakhidze (GE)

Ioselianis q. 19, 0171, Tbilisi (GE)

(72) Kakha Chomakhidze (GE)

(54) GLASS

(57) There is represented a glass comprising located in a case 1 a capacity 4 rigid on horizontal axis 2 inserted in a case wall. The capacity has a convex bottom 3 with a hole 7, capacity external surface is relevant to case internal surface and able to: slip on case internal surface and rotate around the axis taken throughout the case into a handle 5 rotatable in a guide adjacent to the case. Arched dog 6 one end is brought in the axis, and a cap 8, matched on capacity bottom hole 7, is retained on another end thereof. Between the handle and the case the capacity and dog rotation mechanism 9 is located and collected on dog 6 end, is managed by handle rotation, and is linked to the axis.

Claims: 1 independent

Fig.: 11

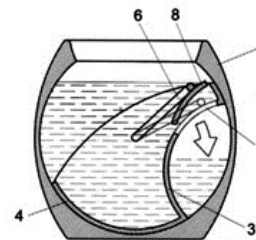

Fig. 8

A 61

(10) AP 2013 12190 A (51) Int. Cl. (2006)
A 61 K 31/216

A 61 K 31/513

A 61 P 35/00

A 61 P 35/04

(21) AP 2009 012190 (22) 2009 09 15

(31) 08164589.7; 09151211.1

(32) 2008 09 18; 2009 01 23

(33) EP; EP

(71) "GRINDEKS", A JOINT STOCK
COMPANY (LV)

- 53, Krustpils Street, 1057 Riga (LV)
 (72) STONANS, Ilmars (LV);
 KALVINS, Ivars (LV);
 SESTAKOVA, Irina (LV)
 (74) Khatuna Imnadze
 (85) 2011 04 18
 (86) PCT/EP2009/061948, 2009 09 15
 (54) **PHARMACEUTICAL COMBINATION
 OF 1-(2-TETRAHYDROFURYL)-5-
 FLUOROURACIL AND CAFFEIC ACID
 PHENETHYL ESTER
 FOR TUMOR ORAL TREATMENT**
 (57) There is represented medicine containing combination of 1-(2-tetrahydrofuryl)-5-fluorouracil and caffeic acid phenethyl ester. Said medicine is applied at tumor treatment.
 Claims: 6 independent
 1 dependent

- (10) AP 2013 12509 A (51) Int. Cl. (2006)
 A 61 K 35/56**
 (21) AP 2011 012509 (22) 2011 12 21
 (71) LTD "ABC PHARMACIA" (GE)
 Marjvena Sanapiro, N10a, 0108, Tbilisi (GE)
 (72) Beka Bezhanidze (GE)
 (74) Shalva Gvaramazde
 (54) **METHOD OF MEDICINE PREPARATION AND APPLICATION THEREAT ADOLESCENT'S GROWTH STIMULATION**
 (57) There is represented medicine preparation method with bath sponge – Euspongia officinalis, which is dried, cut, fried at 47-52°C and milled; received powder is mixed gradually with lactose powder till receiving bath sponge final combination of 31.1-31.5 microgram in 100g mixture. Preparation received with method provided above is applied at adolescents' growth stimulation.
 Claims: 2 independent

- (10) AP 2013 12325 A (51) Int. Cl. (2006)
 A 61 K 36/00
 A 61 K 35/64
 A 61 K 35/54**
 (21) AP 2011 012325 (22) 2011 08 04
 (71) Manana Shubitidze (GE)
 Gldanis III mkr., korp. 13a, b. 32, 0167, Tbilisi (GE)
 (72) Manana Shubitidze (GE)
 (54) **OINTMENT FOR SKIN SUPPURATIVE DISEASES, WOUNDS AND BURN TREATMENT**
 (57) There is represented an ointment containing: galipot, vitellus oil, sea-buckthorn oil, olive oil, castor oil, beeswax, and sunflower or corn oil.
 Claims: 1 independent

- (10) AP 2013 12326 A (51) Int. Cl. (2006)
 A 61 K 36/00
 A 61 K 35/64**
 (21) AP 2011 012326 (22) 2011 08 04
 (71) Manana Shubitidze (GE)
 Gldanis III mkr., korp. 13a, b. 32, 0167, Tbilisi (GE)
 (72) Manana Shubitidze (GE)
 (54) **DRUG FOR TUBERCULOSIS (T.B.)**
 (57) There is represented T.B. drug containing: galipot, sea-buckthorn oil, castor oil, olive oil, propolis, beeswax, and sunflower or corn oil.
 Claims: 1 independent

PART B

B 01

- (10) AP 2013 12156 A (51) Int. Cl. (2006)
 B 01 J 20/18
 C 02 F 1/28
 C 02 F 1/64**
 (21) AP 2011 012156 (22) 2011 03 29
 (71) Tamaz Agladze (GE)
 Ioselianis q. 2, b. 62, 0171, Tbilisi (GE);
 Jemal Shengelia (GE)
 Nutsbidzis q. 2, b. 9, 0177, Tbilisi (GE)
 (72) Tamaz Agladze (GE);
 Jemal Shengelia (GE)
 (54) **METHOD OF OBTAINING FILTER MEDIUM FOR PURIFICATION WATER CONTAINING MANGANESE DIOXIDE**
 (57) There is represented filter medium obtaining method for water containing manganese dioxide purification. The method provides manganese ore drying at 100-105°C and breaking thereto a fraction with 3.0+0.5 mm dimension. At that, dried and broken manganese ore is processed with 100-120 g/l HNO₃ water solution at 75-95°C; received suspension is filtered; solid phase is: washed with water at 85-95°C, and dried at 100-105°C; and oxidized manganese ore concentrate, wherein manganese oxidizing rate is equal approximately to 3, is taken as initial raw material.
 Claims: 1 independent

B 21

- (10) AP 2013 12068 A (51) Int. Cl. (2006)
 B 21 C 23/14
 B 21 C 25/02**
 (21) AP 2011 012068 (22) 2011 01 21
 (71) Jemal Lomsadze (GE)
 Panaskertelis q. 19, b. 170, 0194, Tbilisi (GE);

Zurab Lomsadze (GE)
Panaskertelis q. 19, b. 170, 0194,
Tbilisi (GE);
Sandro Katamadze (GE)
Pekinis q. 13, ღ. 57, 0171, Tbilisi (GE);
Slava Mebonia (GE)
Gldanis Khevi, korp. 3a, b. 55, 0153,
Tbilisi (GE)

- (72) Jemal Lomsadze (GE);
Zurab Lomsadze (GE);
Sandro Katamadze (GE);
Slava Mebonia (GE)

(54) **PROFILE ARTICLES COMPRESSING TOOL**

(57) There is represented profile articles compressing tool comprising array 1 and puncheon 2. The array has conic 5 and calibrating 6 areas with projections 3 and deepenings 4; at that, projections and deepenings are: allocated along array internal perimeter symmetrically and executed with heightening ability towards puncheon motion. Furthermore, puncheon cross-section is a mirror imprint of cross-section of array calibrating area.

Claims: 1 independent

Fig.: 1

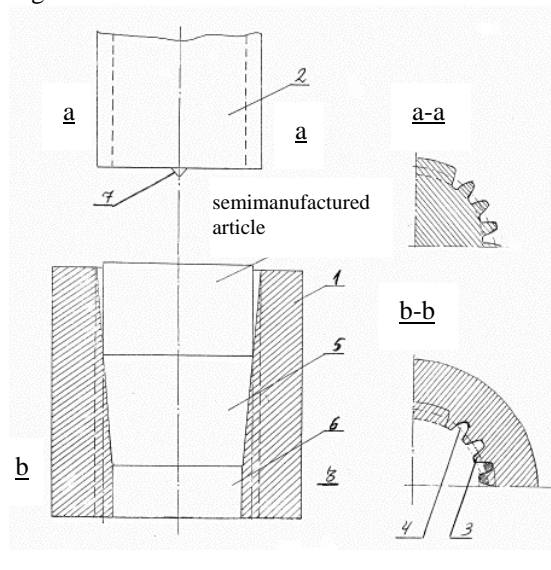

B 60

(10) AP 2013 11955 A (51) Int. Cl. (2006)
B 60 G 21/06

(21) AP 2010 011955 (22) 2010 09 29

- (71) Otar Asatiani (GE)
Ketevan Tsamebulis Gamz. 65a, b. 13, 0144,
Tbilisi (GE);
Revaz Makharoblidze (GE)
Guramishvilis Gamz. 5b, b. 65, 0192,
Tbilisi (GE);
Igor Lagvilava (GE)
Nutsubidzis Perd., IV mkr., korp. 21, b. 29,
0183, Tbilisi (GE);
Avtandil Kobakhidze (GE)

Nutsubidzis Perd., II mkr., IV kvart.,
korp. 1, b. 30, 0183, (GE);
Roland Japaridze (GE)
Bukhaidzis q. 21, 0102, Tbilisi (GE);
Nikoloz Buchukuri (GE)
Dighmis Mas., V kvart., korp. 24a, b. 11,
0159, Tbilisi (GE);
Leila Kordzakhia (GE)
Sop. Dighomi, 0126, Tbilisi (GE)

- (72) Otar Asatiani (GE);
Revaz Makharoblidze (GE);
Igor Lagvilava (GE);
Avtandil Kobakhidze (GE);
Roland Japaridze (GE);
Nikoloz Buchukuri (GE);
Leila Kordzakhia (GE)

(54) **AUTOMATIC LOAD DEVICE OF FORE TANDEM WHEELS OF MOTOR VEHICLE TANDEM WHEELED CHASSIS**

(57) There is represented a chassis 1 comprising three-point shed mechanism 2 attaching tillage tools, which central traction is executed as springed dynamometer 3 having electric switch button 7 connecting an accumulator 5 with an electromagnetic valve 8 by means of electricity cables 6. By means of conduits 12 an electromagnetic hydraulic valve is tied to: hydrocylinder 9 from one side, and oil tank 11 and pump 10 – from another. An axis 17 is inserted rotatable in blacket jacks 15 and 16 rigidly forced on longitudinal skids 13 and 14, on which one end a lever 19, and on another end double-arm lever 18 are rigidly forced; at that, double-arm lever vertical side is hingedly connected to hydrocylinder rod hinged onto longitudinal skid. Springed buffers 22 and 23 are hingedly connected to levers forced on said axis ends and are attached on reducers cases 20 and 21 close to both fore wheels of tandem wheeled chassis.

Claims: 1 independent

Fig.: 2

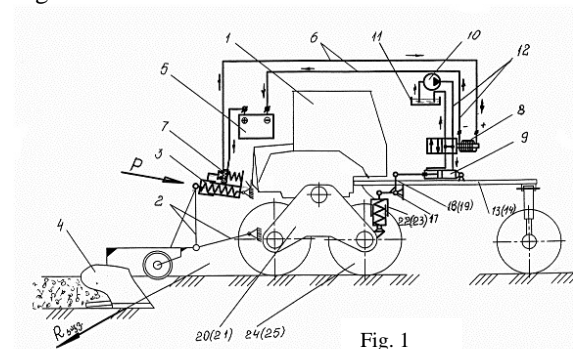

PART C

C 02

- (10) AP 2013 12171 A (51) Int. Cl. (2006)
C 02 F 1/00
- (21) AP 2011 012171 (22) 2011 04 06
- (71) Tsitsino Kurtskhalia (GE)
Iv. Javakhishvili q. 73, 0164, Tbilisi (GE);
Nikoloz Enukidze (GE)
Uznadzis q. 35, 0190, Tbilisi (GE);
Zaira Simonia (GE)
Saakadzis q. 84, 0180, Tbilisi (GE);
Nodar Chkheidze (GE)
Rustavelis q. 2/27, b. 60, 6000, Batumi (GE);
Eter Nadirashvili (GE)
Vazisubani, IV mkr., I kvart., korp. 8,
b. 132, 0177, Tbilisi (GE);
Gulnara Pavliashvili (GE)
Vazha-Pshavelas Gamz., VI kvart.,
korp. 15, b. 41, 0186, Tbilisi (GE);
Giorgi Burjanadze (GE)
Dighmis Mas., VI kvart., korp. 5, b. 25,
0159, Tbilisi (GE)
- (72) Nikoloz Enukidze (GE);
Zaira Simonia (GE);
Nodar Chkheidze (GE);
Eter Nadirashvili (GE);
Gulnara Pavliashvili (GE);
Giorgi Burjanadze (GE)

(54) **METHOD OF COPPER-BEARING ORE
PIT-RUN WATERS PURIFICATION**

(57) There is represented opper-bearing ore pit-run waters purification method providing water purification from heavy metals with electro dialysis method; at that, iron ions removal from water is executed by means of CaCO₃ sorbent, and following water purification from heavy metals and concentration thereof is executed by means of electro dialyzer – concentrator.

Claims: 1 independent

Table: 3

C 05

- (10) AP 2013 10866 A (51) Int. Cl. (2006)
C 05 C 1/02
- (21) AP 2007 010866 (22) 2007 01 13
- (31) 60/758,642; 11/622,878
- (32) 2006 01 13; 2007 01 12
- (33) US; US
- (71) HONEYWELL ITERNATIONAL INC. (US)
101 Columbia Road, Law Department, P.O.
2245, Morristown, NJ 07962-2245 (US)
- (72) KWEEDER, James, A.(US);
WILLIAMS, Richard, J. (US)
- (74) Tamar Kochlamazashvili
- (85) 2008 08 13
- (86) PCT/US2007/060535, 2007 01 13

(54) **STABILIZED COMPOSITIONS
CONTAINING AMMONIUM NITRATE**

(57) There is represented fertilizing composition containing ammonium nitrate as double salt containing ammonium nitrate and another component choisen from group consisting of: ammonium sulfate, ammonium phosphate, calcium nitrate, magnesium nitrate, ammonium molybdenate, ammonium hexafluosilicate, neodymium hydroxynitrate, and combination of two or several therefrom. At that, formed novel compound is crystallographically different from components consisting thereof and contains at least one stabilizing agent in quantity of 0.1-20 mass% choisen from deoxidizing agents and agents forming ammonium.

Claims: 1 independent

15 dependent

Table: 5

C 07

- (10) AP 2013 12610 A (51) Int. Cl. (2006)
C 07 D 231/56
C 07 F 3/02

(21) AP 2010 012610 (22) 2010 07 28

(31) 09425314.3

(32) 2009 08 03

(33) EP

(71) AZIENDE CHIMICHE RIUNITE
ANGELINI FRANCESCO
A.C.R.A.F. S.p.A. (IT)
Viale Amelia, 70 I-00181 Roma (IT)

(72) CARACCILO TORCHIAROLO, Giuliano (IT);
IACOANGELI, Tommaso (IT);
FURLOTTI, Guido (IT)

(74) Liliana Darakhvelidze

(85) 2012 03 02

(86) PCT/EP2010/060941, 2010 07 28

(54) **METHOD OF 1-BENZYL-3-HYDROXY-
METHYL-1H-INDAZOLE PREPARATION,
DERIVATIVES THEREOF, AND REQUI-
RED MAGNESIUM INTERMEDIATES**

(57) There is represented preparation method of 1-benzyl-3-hydroxymethyl-1H-indazole of formula (I)

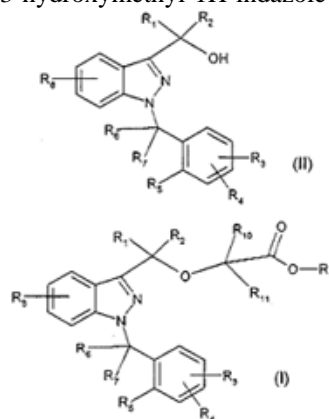

and derivatives thereby compounds of formula (II) conversion.

Claims: 1 independent
5 dependent

(10) AP 2013 12611 A **(51) Int. Cl. (2006)**
C 07 D 231/56
C 07 F 3/02

(21) AP 2010 012611 (22) 2010 07 28
(31) 09425314.0
(32) 2009 08 03
(33) EP

(71) AZIENDE CHIMICHE RIUNITE
ANGELINI FRANCESCO
A.C.R.A.F. S.p.A. (IT)
Viale Amelia, 70 I-00181 Roma (IT)

(72) CARACCILO TORCHIAROLO, Giuliano (IT);
IACOANGELI, Tommaso (IT);
FURLOTTI, Guido (IT)

(74) Liliana Darakhvelidze
(85) 2012 03 02

(86) PCT/EP2010/060937, 2010 07 28

**(54) METHOD OF 1-BENZYL-3-HYDROXY-
METHYL-1H-INDAZOLE PREPARATION,
DERIVATIVES THEREOF,
AND REQUIRED MAGNESIUM
INTERMEDIATES**

(57) There is represented preparation method of
benzyl-3-hydroxymethyl-1H-indazole of formula (II)

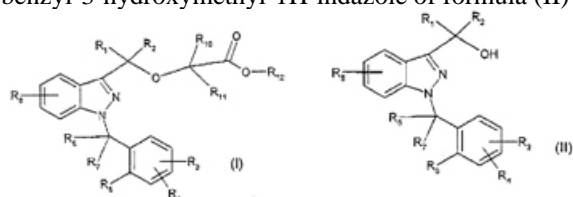

and said compound application for 1-benzyl-3-
hydroxymethyl-1H-indazole of formula (I) prepa-
ration.

Claims: 2 independent
11 dependent

(10) AP 2013 11921 A **(51) Int. Cl. (2006)**
C 07 D 475/04
A 61 K 31/519

(21) AP 2008 011921 (22) 2008 02 20
(31) PCT/EP2008/052037
(32) 2008 02 20
(33) WO

(71) GNOSIS S.P.A. (IT)
Via Laboratori Autobianchi, 1,
I-20033 Desio, (MI) (IT)

(72) VALOTI, Ermanno (IT);
BIANCHI, Davide (IT);
VALETTI, Marco (IT)

(74) Tamaz Shilakadze
(85) 2010 08 17

(86) PCT/EP2008/052037, 2008 02 20

**(54) FOLATES, COMPOSITIONS AND
USAGE THEREOF**

(57) Present invention relates to: folates, compo-
sitions and usage thereof. In particular, the
invention describes: crystalline and amorphous
compound – folate or reduced folate or natural or
unnatural isomer at least of one organic base, as
well as compositions and usage thereof.

Claims: 3 independent
15 dependent

PART E

E 05

(10) AP 2013 12164 A **(51) Int. Cl. (2006)**
E 05 B 35/00

(21) AP 2009 012164 (22) 2009 08 25
(31) 193931
(32) 2008 09 07

(33) IL
(71) MUL-T-LOCK TECHNOLOGIES LTD. (IL)
PO Box 637, 81104, Yavne, Israel (IL)

(72) BEN-AHARON, Effi (IL);
MARKBREIT, Dani (IL)

1- (74) Tamara Kochlamazashvili
(85) 2011 04 01

(86) PCT/US2009/054835, 2009 08 25

**(54) KEY DEVICE COMPRISING CONTACT
ELEMENT AND LOCK ASSEMBLY**

(57) There is represented a key device, which is
applicable for one or several locks. The device
comprises a shaft portion and at least one movable
key combination element retained on the shaft
portion, and includes first and second portions. The
first portion is located along the shaft portion, and
the second one is located offset to the first one.

Claims: 3 independent
7 dependent

Fig.: 23

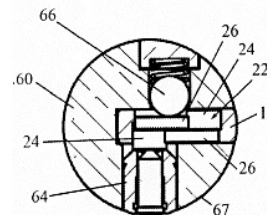
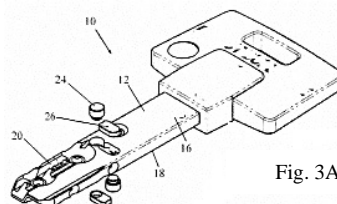

Fig. 8A

PART F**F 01****(10) AP 2013 11075 A (51) Int. Cl. (2006)****F 01 B 17/02****F 02 G 1/04****F 01 K 25/08**

(21) AP 2007 011075 (22) 2007 07 17

(31) 0606647

(32) 2006 07 21

(33) FR

(71) MDI - MOTOR DEVELOPMENT

INTERNATIONAL S.A. (LU)

23 rue Beaumont, L-1219 Luxemburg (LU)

(72) NEGRE, Guy (FR);

NEGRE, Cyril (FR)

(74) Shalva Gvaramadze

(85) 2009 01 21

(86) PCT/EP2007/057380, 2007 07 17

(54) METHOD OF CRYOGENIC ENGINE**WORKING AT AMBIENT****TEMPERATURE THERMAL ENERGY****AND CONSTANT PRESSURE**

(57) There is represented a method providing engine working at ambient temperature thermal and constant pressure with continuous 'cold' combustion at constant pressure and an active chamber operating with cryogenic fluid (A2) stored in liquid phase thereof, and used as work gas in gaseous phase thereof and operating in closed cycle with return to liquid phase thereof. Initially liquid cryogenic fluid is vaporized in gaseous phase at very low temperatures and supplies the inlet (A4) of gas compression device (B), which then discharges this compressed work gas, still at low temperature, and through a heat exchanger with ambient temperature (C), into a work tank or external expansion chamber (19) fitted or not fitted with heating device, where temperature and volume thereof will considerably increase in order, that later passing into a relief device (D) will be available. The relief device provides work and for example comprises an active chamber according to international patent application WO 2005/049968. Represented cryogenic engines can be applied for land vehicles, motor vehicles, buses, motorcycles, boats, aircraft, standby generators, cogeneration sets, and stationary engines.

Claims: 3 independent

13 dependent

Fig.: 5

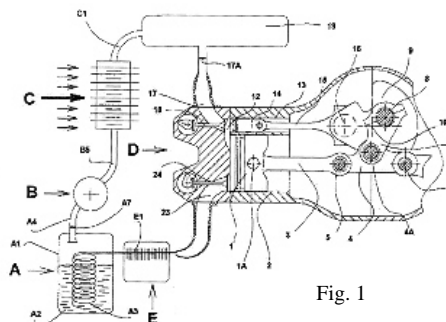

Fig. 1

F 16**(10) AP 2013 12173 A (51) Int. Cl. (2006)****F 16 H 1/00**

(21) AP 2011 012173 (22) 2011 04 07

(71) Revaz Varsimashvili (GE)

Vazha-Pshavelas Gamz., V kvart., korp. 4,

b. 82, 0186, Tbilisi (GE);

Merab Kakhiani (GE)

Tamarashvili q. 13 (Saburtalos q.-is

mkhridan), b. 1, 0186, Tbilisi (GE);

Zurab Varsimashvili (GE)

Mtskhethis q. 20, b. 34, 0179, Tbilisi (GE);

Akaki Kakhiani (GE)

Sulkhan Tsintsadzis q. 56, b.1, 0177,

Tbilisi (GE);

Revaz Kakhiani (GE)

Sulkhan Tsintsadzis q. 56, b.1, 0177,

Tbilisi (GE)

(72) Revaz Varsimashvili (GE);

Merab Kakhiani (GE);

Zurab Varsimashvili (GE);

Akaki Kakhiani (GE);

Revaz Kakhiani (GE)

(54) SPEED VARIATOR

(57) A speed variator comprises at least two tooth gears 1 and 2 toothed externally or internally. At that, one tooth gear rim is equipped with teeth having incomplete length, and another is equipped with teeth 4 and 3 having complete length and equal height; at that, teeth are allocated on the rim along flat and/or space curved lines, which represent function of given alternate gear ratio.

Claims: 1 independent

Fig.: 14

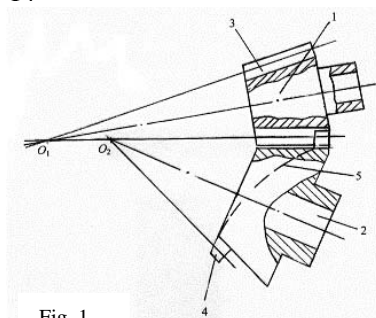

Fig. 1

PART H

H 01

(10) AP 2013 12246 A (51) Int. Cl. (2006)
H 01 S 3/20

(21) AP 2011 012246 (22) 2011 06 01

(71) Merab Jibladze (GE)

I.Chavchavadzis Gamz. 16, b. 23, 0128,

Tbilisi (GE);

Guram Dgebuadze (GE)

Tsinamdzghvrishvilis q. 121, b. 94, 0164,

Tbilisi (GE);

Alexandre Mikaberidze (GE)

Tamarashvilis q. 11, b. 114, 0162,

Tbilisi (GE);

Zurab Razmadze (GE)

Barnovis q. 26, 0108, Tbilisi (GE);

Giorgi Mumladze (GE)

Bogdan Khmelnitskis q. 8, b. 35, 0113,

Tbilisi (GE)

(72) Merab Jibladze (GE);

Guram Dgebuadze (GE);

Alexandre Mikaberidze (GE);

Zurab Razmadze (GE);

Giorgi Mumladze (GE)

(54) **LASER ON MICRO AND/OR
NANOPARTICLES POWDER
SUSPENSION**

(57) There is represented a laser comprising: an optical resonator, cooling and actuating systems, and an active element, which actuation is implemented by light flow. The active element is executed as a laser material, for example, suspension with micro and/or nano size particles powder of neodymium glass, existed in a telescope. The laser is executed with ability of suspension circulation and cooling by means of pump.

Claims: 1 independent

1 dependent

Fig.: 1

PATENTED INVENTIONS

PART A

A 61

- (11) P 2013 5792 B** **(51) Int. Cl. (2006)**
 A 61 K 31/437
 A 61 K 31/4709
 A 61 K 31/496
 A 61 K 31/573
 A 61 K 38/08
 A 61 P 19/02
- (10) AP 2012 12055 A (44) 23(363)/2012
 (21) AP 2009 012055
 (22) 2009 07 03
 (24) 2009 07 03
 (31) MI 2008 A 001264
 (32) 2008 07 11
 (33) IT
 (86) PCT/EP2009/004847, 2009 07 03
 (73) ISTITUTO LUSO FARMACO D'ITALIA
 S.P.A. (IT)
 Via Walter Tobagi, 8 I-20068 Peschiera
 Borromeo (MI) (IT)
 (72) GIULIANI, Sandro (IT);
 MAGGI, Carlo, Alberto (IT)
 (74) Shalva Gvaramadze
 (54) **PHARMACEUTICAL COMPOSITIONS
 BASED ON KININ B2 RECEPTOR
 ANTAGONISTS AND CORTICOSTE-
 ROIDS, AND USAGE THEREOF**

- (11) P 2013 5791 B** **(51) Int. Cl. (2006)**
 A 61 K 31/513
 A 61 K 31/44
 A 61 K 31/131
 A 61 P 3/10
- (10) AP 2012 10608 A (44) 23(363)/2012
 (21) AP 2006 010608
 (22) 2006 09 13
 (24) 2006 09 13
 (31) 60/717,558; 60/747,273
 (32) 2005 09 14; 2006 05 15
 (33) US; US
 (86) PCT/US2006/035708, 2006 09 13
 (73) TAKEDA PHARMACEUTICAL
 COMPANY LIMITED (JP)
 1-1, Doshomachi 4-chome, Chuo-ku,
 Osaka-shi, Osaka 541-0045 (JP)
 (72) CHRISTOPHER, Ronald, J (US);
 COVINGTON, Paul (US)
 (74) Tamara Kochlamazashvili
 (54) **USAGE OF DIPEPTIDYL PEPTIDASE
 INHIBITORS**

PART B

B 65

- (11) P 2013 5794 B** **(51) Int. Cl. (2006)**
 B 65 G 27/00
- (10) AP 2012 12175 A (44) 23(363)/2012
 (21) AP 2011 012175
 (22) 2011 04 08
 (24) 2011 04 08
 (73) Viktor Zviadauri (GE)
 Vazha-Pshavelas V kvart., korp. 4, b. 79,
 0186, Tbilisi (GE);
 Tengiz Nadiradze (GE)
 Bakhtrionis q. 7a, b. 33, 0194, Tbilisi (GE);
 Merab Chelidze (GE)
 G. Chitaias q. 38, 0164, Tbilisi (GE);
 Giorgi Tumanishvili (GE)
 Didi Dighomi, III mkr., korp. 4, b. 85,
 0131, Tbilisi (GE);
 Guram Gogia (GE)
 Oniashvilis q. 13, 0175, Tbilisi (GE)
 (72) Viktor Zviadauri (GE);
 Tengiz Nadiradze (GE);
 Merab Chelidze (GE);
 Giorgi Tumanishvili (GE);
 Guram Gogia (GE)
 (54) **VIBRATION CONVEYOR**

PART C

C 07

- (11) P 2013 5793 B** **(51) Int. Cl. (2006)**
 C 07 D 231/40
 C 07 D 401/12
 C 07 D 403/12
 C 07 D 513/04
 A 61 K 31/4427
 A 61 K 31/4155
 A 61 K 31/4178
 A 61 K 31/506
 A 61 K 31/497
 A 61 P 3/00
- (10) AP 2012 12135 A (44) 23(363)/2012
 (21) AP 2009 012135
 (22) 2009 08 28
 (24) 2009 08 28
 (31) 61/096,056; 61/232,578
 (32) 2008 09 11; 2009 08 10

UTILITY MODELS

APPLICATION APPROVED FOR GRANTING PATENT

The decision can be appealed at the Chamber of Appeal of Sakpatenti within 3 months from the publication or at the Mtskheta District Court Administrative Cases Board (Address: №17, Samkhedro str., Mtskheta), within 1 month following the publication.

PART A

A 61

(10) AU 2013 12070 U (51) Int. Cl. (2006)

A 61 K 36/00

(21) AU 2011 012070 (22) 2011 01 24

(71) Raul Gotsiridze (GE)

Luka Asatianis q. 2/27, b. 53, 6000,

Batumi (GE);

Aliosha Bakuridze (GE)

Janashias q. 30/55, 0179, Tbilisi (GE)

(72) Raul Gotsiridze (GE);

Aliosha Bakuridze (GE)

(54) **HERBAL MEDICINE WITH
HEPATOPROTECTIVE EFFECT**

(57) An utility model concerns medicine and relates to: herbal medicine preparation on basis of gentian, valerian, immortelle, pot marigold and Circassian walnut; and application thereat the treatment of patients with hepatitis C.

Claims: 3 independent

(10) AU 2013 12659 U (51) Int. Cl. (2006)

A 61 M 3/00

(21) AU 2012 012659 (22) 2012 04 05

(71) Gocha Chichinadze (GE)

Pekinis q. 7, b. 62, 0160, Tbilisi (GE)

(72) Gocha Chichinadze (GE)

(54) **DEVICE FOR SYRINGE**

(57) There is represented a device comprising П-shaped case 1. Bush-shaped nest 2 for syringe case is fixed on case end, and another end is equipped with syringe pillar means 3 executed as a screw 4 inserted in thread hole 5 executed in case closed end.

Claims: 1 independent

Fig.: 2

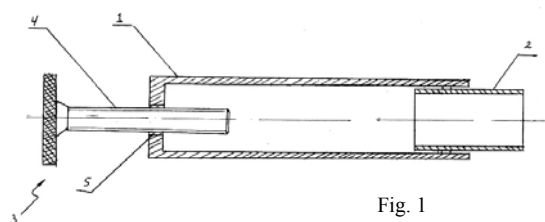

Fig. 1

PART B

B 67

(10) AU 2013 12571 U (51) Int. Cl. (2006)

B 67 D 1/04

(21) AU 2012 012571 (22) 2012 02 13

(71) LTD "KINDZMARAULIS MARANI" (GE)

Sop. Gavazi, 4805, Kvareli (GE)

(72) Gocha Tsintsadze (GE)

(74) Vakhtang Torotadze

(54) **METHOD OF WINE STORAGE AND
BOTTLING AT RETAIL TRADE**

(57) There is represented a method providing: inert gas, for example nitrogen or argon, retention in space above wine surface existed in sealed a reservoir (1) equipped with pouring crane (3), and gas additional supplement from a gas vessel (4) linked to the reservoir with a gas conduit (8) simultaneously with bottling wine self-flowing from pouring crane (3) located in reservoir (1) lower part. The inert gas is supplied under pressure no less than 0.5 kg/cm² in space above wine surface for left wine storage; and filling the reservoir (1) with wine is executed directly at trade entity. Accordingly, the gas vessel (4) is equipped with a reducer (7), and is allocated between the gas vessel (4) and the reservoir (1); and before reservoir (1) filling with wine the inert gas supplement is quitted, and the reservoir is filled through open upper hatch (2), which later will be closed, and inert gas supplement will be renewed.

Claims: 1 independent

2 dependent

Fig.: 1

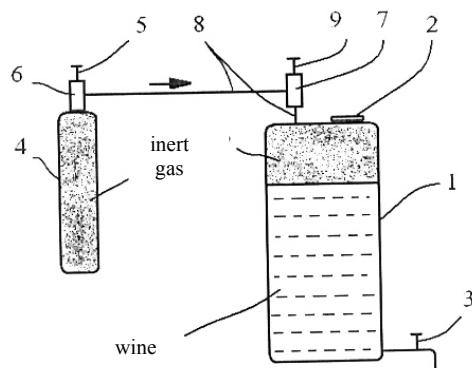

PART C

C 12

(10) AU 2013 12016 U (51) Int. Cl. (2006)
C 12 N 7/00
A 61 K 35/76

(21) AU 2010 012016 (22) 2010 11 26

(71) CO "POLIMERPHARM" (GE)
D. Aghmasheneblis Kheivani
12-th kilometer, 0131, Tbilisi (GE)

(72) Ramaz Katsarava (GE);
Vasil Tabidze (GE);
Alexandre Gholijashvili (GE);
Alexandre Gogiberidze (GE);
Vakhtang Beridze (GE)

(54) METHOD OF OBTAINING BACTERIOPHAGE

(57) There is represented bacteriophage obtaining method providing bacteriophage and excipient mix drying. At that, drying mix represented as solution or suspension is executed by rotary spraying with rate 0.6-1.2 l/h by: air flow heated up to 65-95°C, and generated vapour and powder separation.

Claims: 1 independent

Table: 5

Fig.: 1

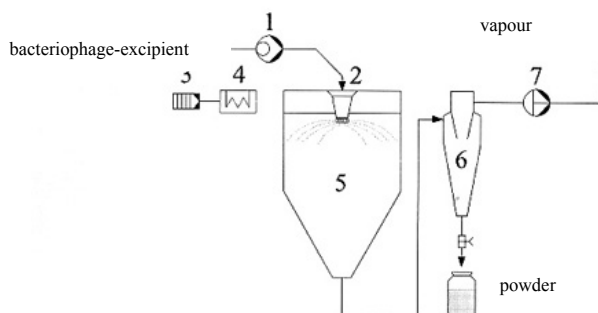

narilly inserted in lock memory are keyed in the lock board by them to open the door.

Claims: 1 independent

PART E

E 05

(10) AU 2013 12695 U (51) Int. Cl. (2006)
E 05 F 1/00

(21) AU 2012 012695 (22) 2012 05 04

(71) Maka Sirbiladze (GE)
Ir. Abashidzis q. 64, b. 33, 0162,
Tbilisi (GE)

(72) Maka Sirbiladze (GE)

(54) METHOD OF APARTMENT HOUSE APPROACH DOOR OPENING

(57) There is represented a method providing door equipment with: board comprising alphabet letters, and lock having code memory. Secret codes choisen by tenants and/or names thereof prelimi-

PATENTED UTILITY MODELS

PART A

A 61

- (11) U 2013 1760 Y** **(51) Int. Cl. (2006)**
A 61 K 8/97
- (10) AP 2012 12317 U (44) 23(363)/2012
 (21) AU 2011 012317
 (22) 2011 07 25
 (24) 2011 07 25
 (73) Ketino Imedashvili (GE)
 III Masivi, Kalaubnis q. korp. 6d, b. 2,
 0152, Tbilisi (GE)
 (72) Ketino Imedashvili (GE)
**(54) METHOD OF OBTAINING AVAILABLE
 SOLUTION FROM GRAPEVINE
 WASTE**

- (11) U 2013 1761 Y** **(51) Int. Cl. (2006)**
A 61 K 9/02
- (10) AP 2012 12492 U (44) 23(363)/2012
 (21) AU 2011 012492
 (22) 2011 12 06
 (24) 2011 12 06
 (73) LTD "AVERSI-RATSIONALI" (GE)
 Chirnakhulis q. 14, 0198, Tbilisi (GE)
 (72) Malkhaz Kurtanidze (GE)
 (74) Shalva Gvaramadze
**(54) ADRENO- AND DOPAMINOMIMETIC
 DRUG SHAPED AS STERILE
 CONCENTRATE**

- (11) U 2013 1762 Y** **(51) Int. Cl. (2006)**
A 61 K 9/02
- (10) AP 2012 12493 U (44) 23(363)/2012
 (21) AU 2011 012493
 (22) 2011 12 06
 (24) 2011 12 06
 (73) LTD "AVERSI-RATSIONALI" (GE)
 Chirnakhulis q. 14, 0198, Tbilisi (GE)
 (72) Malkhaz Kurtanidze (GE)
 (74) Shalva Gvaramadze
**(54) COMBINED HEPATOPROTECTIVE
 VEGETABLE PREPARATION SHAPED
 AS CAPSULE**

- (11) U 2013 1763 Y** **(51) Int. Cl. (2006)**
A 61 N 5/06
- (10) AP 2012 12650 U (44) 23(363)/2012
 (21) AU 2012 012650
 (22) 2012 03 29

- (24) 2012 03 29
 (73) Merab Jibladze (GE)
 I.Chavchavadzis Gamz. 16, b. 23, 0179,
 Tbilisi (GE);
 Enriko Beridze (GE)
 T. Tabidzis I shesakhv. 10, b. 3, 0179,
 Tbilisi (GE);
 Zurab Razmadze (GE)
 Barnovis q. 26, 0108, Tbilisi (GE)
 (72) Merab Jibladze (GE);
 Enriko Beridze (GE);
 Zurab Razmadze (GE)
**(54) PHOTOTHERAPEUTIC DEVICE
 "AISI 2"**

DESIGNS

APPLICATION APPROVED FOR REGISTRATION

The decision can be appealed at the Chamber of Appeal of Sakpatenti within 3 months from the publication or at the Mtskheta District Court Administrative Cases Board (Address: №17, Samkhedro str., Mtskheta), within 1 month following the publication.

(10) **AD 2013 726 S** (51) **32-00**

(21) AD 2012 000726

(22) 2012 10 23

(28) 1

(71) LTD "NEMERA" (GE)

Vazha-Pshavelas II kvart., korp. 5, b. 50, 0186, Tbilisi (GE)

(72) Anri Sidamonidze (GE)

(74) David Dzamukashvili

(54) **GRAPHICAL SYMBOL**

(55)

1 **GLOBAL**

- (10) AD 2013 727 S (51) 32-00
(21) AD 2012 000727
(22) 2012 10 23
(28) 12
(71) LTD "NEMERA" (GE)
Vazha-Pshavelas II kvart., korp. 5, b. 50, 0186, Tbilisi (GE)
(72) Anri Sidamonidze (GE)
(74) David Dzamukashvili
(54) GAS CYLINDER APPEARANCE
(55)



1



2



3



4



5



6



7



8



9



10



11



12

- (10) AD 2013 728 S (51) 32-00
- (21) AD 2012 000728
- (22) 2012 10 23
- (28) 11
- (71) LTD "NEMERA" (GE)
Vazha-Pshavelas II kvart., korp. 5, b. 50, 0186, Tbilisi (GE)
- (72) Anri Sidamonidze (GE)
- (74) David Dzamukashvili
- (54) PACKAGE DESIGN (FOR CARTON)
- (55)

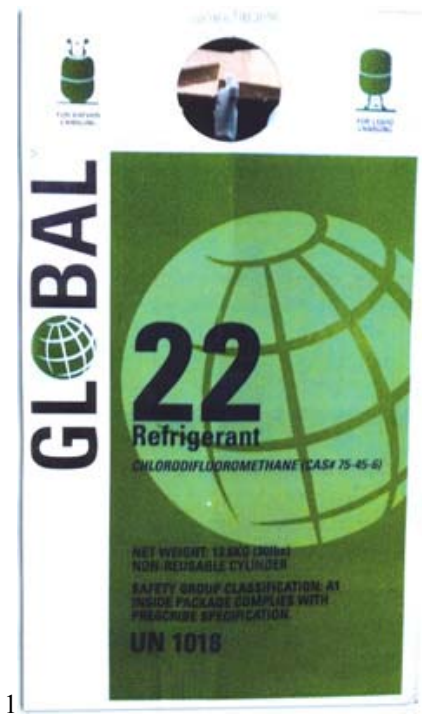

1



2



3



4



5

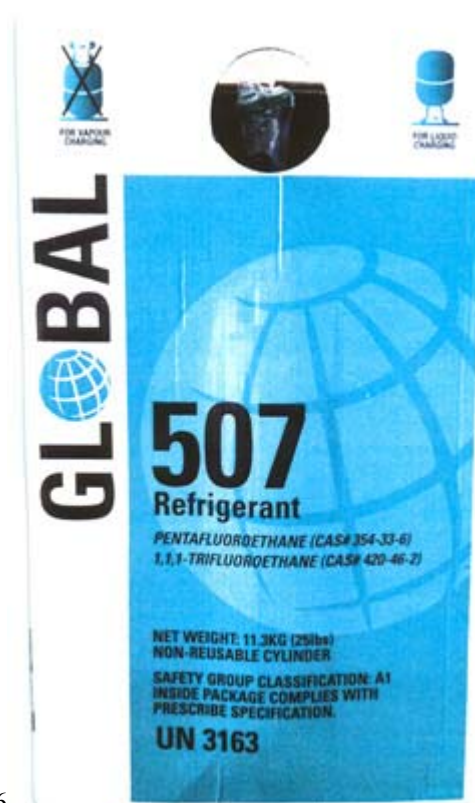

6



7



8

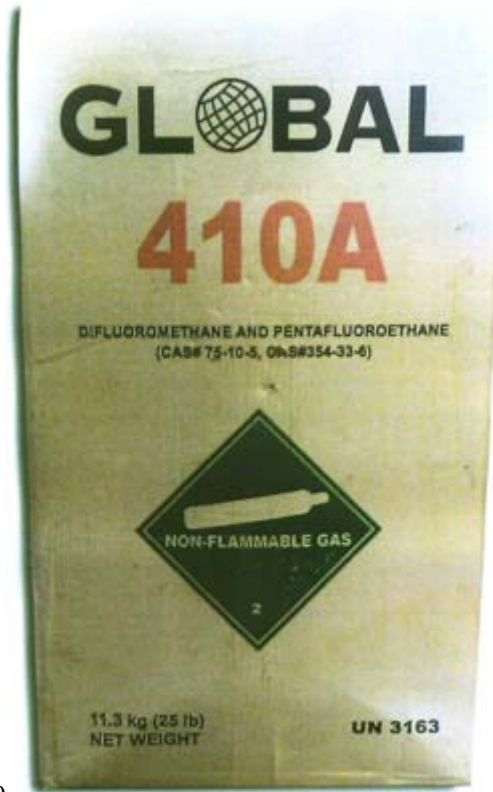

9



10



11

REGISTERED DESIGN

- (11) **D 2013 535 S** (51) **09-01**
(10) AD 2012 709 S (44) 23(363)/2012
(21) AD 2012 000709
(22) 2012 06 21
(24) 2012 06 21
(18) 2017 06 21
(73) LTD "CHARGALIS TSKAROEBI" (GE)
Iosebidzis q. 60, b. 1, 0160, Tbilisi, Georgia
(72) Vakhtang Duchidze (GE)
(74) Giorgi Kartvelishvili
(54) **BOTTLE**
-

TRADEMARKS

APPLICATIONS FILED UNDER THE NATIONAL PROCEDURE APPROVED FOR REGISTRATION

The decision can be appealed at the Chamber of Appeal of Sakpatenti within 3 months from the publication or at the Mtskheta District Court Administrative Cases Board (Address: №17, Samkhedro str., Mtskheta), within 1 month following the publication.

(260) AM 2013 66278 A
(210) AM 066278
(220) 2012 02 21
(731) ÖZMAYA SANAYİ A. Ş.
Eski Adana Yolu Üzeri P.K.50, 01960
Ceyhan/ADANA, Turkey
(740) Giorgi Taktakishvili
(540)



(591) White, green
(531) 03.01.01-26.01.15-26.04.22-26.11.08-
27.05.24-29.01.12-
(511) 30

(260) AM 2013 66345 A
(210) AM 066345
(220) 2012 02 27
(731) KAREN VARDANIANI
Baironis q.3, bina 36, Erevani, Armenia
(740) Davit Zurabishvili
(540)

Розы

(591) Black, white
(511) 30

(260) AM 2013 67175 A
(210) AM 067175
(220) 2012 04 27
(731) HANKOOK TIRE CO., LTD
N647-15, Yoksam-dong, Kangnam-gu,
Seoul, Republic of Korea
(740) Giorgi Taktakishvili
(540)



(591) Black, white
(531) 26.11.12-26.13.25-27.05.17-
(511) 12

(260) AM 2013 67180 A
(210) AM 067180
(220) 2012 04 30
(731) SPIRITS PRODUCT INTERNATIONAL
INTELLECTUAL PROPERTY B.V.
7, Rue Nicolas Bové, 1253 Luxembourg,
Luxembourg
(740) Davit Zurabishvili
(540)

GRADUS ICE

(591) Black, white
(511) 33

(260) AM 2013 67181 A
(210) AM 067181
(220) 2012 04 30
(731) SPIRITS PRODUCT INTERNATIONAL
INTELLECTUAL PROPERTY B.V.
7, Rue Nicolas Bové, 1253 Luxembourg,
Luxembourg
(740) Davit Zurabishvili
(540)

GRADUS BLACK ГРАДУС БЛЭК

(591) Black, white
(511) 33

(260) AM 2013 67183 A
(210) AM 067183
(220) 2012 04 30
(731) FRS Hotel Group (Lux) S.à r.l.
37, rue d'Anvers, L-1130 Luxembourg,
Grand-Duchy of Luxembourg, Luxembourg
(740) Shalva Gvaramadze
(540)

FAIRMONT

(591) Black, white
(511) 3, 16, 18, 20, 25, 30, 35, 36, 41, 43, 44

(260) AM 2013 67184 A
(210) AM 067184
(220) 2012 04 30

(731) FRS Hotel Group (Lux) S.à r.l.
37, rue d'Anvers, L-1130 Luxembourg,
Grand-Duchy of Luxembourg, Luxembourg

(740) Shalva Gvaramadze
(540)

FAIRMONT HERITAGE PLACE

(591) Black, white
(511) 36, 43

(260) AM 2013 67185 A

(210) AM 067185

(220) 2012 04 30

(731) FRS Hotel Group (Lux) S.à r.l.
37, rue d'Anvers, L-1130 Luxembourg,
Grand-Duchy of Luxembourg, Luxembourg

(740) Shalva Gvaramadze
(540)



(591) Black, white
(531) 27.05.08-27.05.21-
(511) 24, 25, 30, 36, 43

(260) AM 2013 67198 A

(210) AM 067198

(220) 2012 05 01

(731) LTD "TOLIA"
Gamsakhurdias gamz.25, 0194, Tbilisi,
Georgia

(540)

ტოსკა ბლუ
ТОСКА БЛУ
TOSCA BLU

(591) Black, white
(511) 25, 35

(260) AM 2013 67245 A

(210) AM 067245

(220) 2012 05 04

(731) LTD QAHVEJI PARKETI
Tseretlis gamz. N74, korp. 6, Tbilisi,
Georgia

(740) Giorgi Taktakishvili
(540)



(591) Yellow, dark grey, grey, black

(531) 01.15.15-26.01.11-26.01.18-27.05.11-
29.01.14-

(511) 19

(260) AM 2013 67288 A

(210) AM 067288

(220) 2012 05 10

(731) HANKOOK TIRE CO.
Ltd, N647-15, Yoksam-dong, Kangnam-gu,
Seoul, Republic of Korea

(740) Giorgi Taktakishvili

(540)

HANKOOK VANTRA

(591) Black, white

(531) 27.05.17-

(511) 12

(260) AM 2013 67427 A

(210) AM 067427

(220) 2012 05 25

(731) ZELMER Market sp. z o.o.
ul. Hofmawej 19, 35-019 Rzeszow, Poland

(740) Pavle Meipariani

(540)

zELMER
საიმელოა

(591) Black, white

(531) 27.05.19-28.19.00-

(526) **DISCLAIMER** – The trademark is protected
as a whole, the word „საიმელოა“ shall not be
subject to independent legal protection.

(511) 7, 9, 11

(260) AM 2013 68504 A

(210) AM 068504

(220) 2012 08 22

(731) OREN BABRY
8306, Vilshire Boulevard, #580, Beverly
Hills, California 90211, LA, USA

(740) Davit Dzamukashvili

(540)

Pini
FOLIUM
PX

(591) Black, white

(531) 26.11.09-27.05.05-

(511) 5

(260) AM 2013 68505 A
 (210) AM 068505
 (220) 2012 08 22
 (731) OREN BABRY
 8306, Vilshire Boulevard, #580, Beverly Hills, California 90211, LA, USA
 (740) Davit Dzamukashvili
 (540)

FOLIUM

(591) Black, white
 (511) 5

(260) AM 2013 68551 A
 (210) AM 068551
 (220) 2012 08 24
 (731) SAQARTVELOS IUSTITSIIS SAMINISTRO
 Gorgaslis N24a, 0114, Tbilisi, Georgia
 (540)



იუსტიციის სახლი
 ყველაფერი ერთ სივრცეში

PUBLIC SERVICE HALL
 Everything in one space

(591) Red, green, yellow, carrot, lemon, light green, light carrot, grey and dark grey
 (531) 05.03.13-05.05.20-26.03.23-27.05.05-28.19.00-29.01.15-
 (511) 35, 45

(260) AM 2013 68552 A
 (210) AM 068552
 (220) 2012 08 24
 (731) SAQARTVELOS IUSTITSIIS SAMINISTRO
 Gorgaslis N24a, 0114, Tbilisi, Georgia
 (540)

Just Café

(591) Black, white
 (511) 35, 43, 45

(260) AM 2013 68553 A
 (210) AM 068553
 (220) 2012 08 24
 (731) SAQARTVELOS IUSTITSIIS SAMINISTRO
 Gorgaslis N24a, 0114, Tbilisi, Georgia
 (540)

Just Drive

(591) Black, white
 (511) 35, 45

(260) AM 2013 68554 A
 (210) AM 068554
 (220) 2012 08 24
 (731) SAQARTVELOS IUSTITSIIS SAMINISTRO
 Gorgaslis N24a, 0114, Tbilisi, Georgia
 (540)



(591) Black, white
 (531) 24.17.10-
 (511) 35, 45

REGISTERED TRADEMARKS

(111) M 2013 023420 R
 (151) 2013 03 13
 (181) 2023 03 13
 (260) AM 2012 63532 A
 (220) 2011 08 03
 (732) LTD "RAKEEN DEVELOPMENTI"
 Baratashvilis q. 2, 0105, Tbilisi, Georgia

(111) M 2013 023421 R
 (151) 2013 03 13
 (181) 2023 03 13
 (260) AM 2012 63533 A
 (220) 2011 08 03
 (732) LTD "RAKEEN DEVELOPMENTI"
 Baratashvilis q. 2, 0105, Tbilisi, Georgia

(111) M 2013 023422 R
 (151) 2013 03 13
 (181) 2023 03 13
 (260) AM 2012 64321 A
 (220) 2011 10 06
 (732) LTD MINIMALI
 Vakhtang Chiqovanis q. N4, 0177, Tbilisi,
 Georgia

(111) M 2013 023423 R
 (151) 2013 03 13
 (181) 2023 03 13
 (260) AM 2012 64375 A
 (220) 2011 10 10
 (732) Societe Nationale d'Exploitation
 Industrielle des Tabacs et Allumettes,
 SASU
 143 boulevard Romain Rolland, Paris 75014,
 France

(111) M 2013 023424 R
 (151) 2013 03 13
 (181) 2023 03 13
 (260) AM 2012 64692 A
 (220) 2011 11 01
 (732) ARIAN CHIMIA TECH.
 68, Saech Street, Tehran, Iran (Islamic
 Republic of)

(111) M 2013 023425 R
 (151) 2013 03 13
 (181) 2023 03 13
 (260) AM 2012 64806 A

(220) 2011 11 08
 (732) LTD "AVERSI-FARMA"
 Davit Agmasheneblis gamz., 148/2, 0112,
 Tbilisi, Georgia

(111) M 2013 023426 R
 (151) 2013 03 13
 (181) 2023 03 13
 (260) AM 2012 64807 A
 (220) 2011 11 08
 (732) LTD "AVERSI-FARMA"
 Davit Agmasheneblis gamz., 148/2, 0112,
 Tbilisi, Georgia

(111) M 2013 023427 R
 (151) 2013 03 13
 (181) 2023 03 13
 (260) AM 2012 64808 A
 (220) 2011 11 08
 (732) LTD "AVERSI-FARMA"
 Davit Agmasheneblis gamz., 148/2, 0112,
 Tbilisi, Georgia

(111) M 2013 023428 R
 (151) 2013 03 13
 (181) 2023 03 13
 (260) AM 2012 64809 A
 (220) 2011 11 08
 (732) LTD "AVERSI-FARMA"
 Davit Agmasheneblis gamz., 148/2, 0112,
 Tbilisi, Georgia

(111) M 2013 023429 R
 (151) 2013 03 13
 (181) 2023 03 13
 (260) AM 2012 64810 A
 (220) 2011 11 08
 (732) LTD "AVERSI-FARMA"
 Davit Agmasheneblis gamz., 148/2, 0112,
 Tbilisi, Georgia

(111) M 2013 023430 R
 (151) 2013 03 13
 (181) 2023 03 13
 (260) AM 2012 64811 A
 (220) 2011 11 08
 (732) LTD "AVERSI-FARMA"
 Davit Agmasheneblis gamz., 148/2, 0112,
 Tbilisi, Georgia

(111) M 2013 023431 R
(151) 2013 03 13
(181) 2023 03 13
(260) AM 2012 64830 A
(220) 2011 11 08
(732) LTD "AVERSI-FARMA"
Davit Agmasheneblis gamz., 148/2, 0112,
Tbilisi, Georgia

(111) M 2013 023432 R
(151) 2013 03 13
(181) 2023 03 13
(260) AM 2012 64831 A
(220) 2011 11 08
(732) LTD "AVERSI-FARMA"
Davit Agmasheneblis gamz., 148/2, 0112,
Tbilisi, Georgia

(111) M 2013 023433 R
(151) 2013 03 13
(181) 2023 03 13
(260) AM 2012 64832 A
(220) 2011 11 08
(732) LTD "AVERSI-FARMA"
Davit Agmasheneblis gamz., 148/2, 0112,
Tbilisi, Georgia

(111) M 2013 023434 R
(151) 2013 03 13
(181) 2023 03 13
(260) AM 2012 64833 A
(220) 2011 11 08
(732) LTD "AVERSI-FARMA"
Davit Agmasheneblis gamz., 148/2, 0112,
Tbilisi, Georgia

(111) M 2013 023435 R
(151) 2013 03 13
(181) 2023 03 13
(260) AM 2012 64838 A
(220) 2011 11 08
(732) LTD "AVERSI-FARMA"
Davit Agmasheneblis gamz., 148/2, 0112,
Tbilisi, Georgia

(111) M 2013 023436 R
(151) 2013 03 13
(181) 2023 03 13
(260) AM 2012 64839 A
(220) 2011 11 08
(732) LTD "AVERSI-FARMA"
Davit Agmasheneblis gamz., 148/2, 0112,
Tbilisi, Georgia

(111) M 2013 023437 R
(151) 2013 03 13
(181) 2023 03 13
(260) AM 2012 64840 A
(220) 2011 11 08
(732) LTD "AVERSI-FARMA"
Davit Agmasheneblis gamz., 148/2, 0112,
Tbilisi, Georgia

(111) M 2013 023438 R
(151) 2013 03 13
(181) 2023 03 13
(260) AM 2012 64841 A
(220) 2011 11 08
(732) LTD "AVERSI-FARMA"
Davit Agmasheneblis gamz., 148/2, 0112,
Tbilisi, Georgia

(111) M 2013 023439 R
(151) 2013 03 13
(181) 2023 03 13
(260) AM 2012 64918 A
(220) 2011 11 16
(732) SAMSUNG ELECTRONICS CO., LTD
416, Maetan-dong, Yeongtong-gu, Suwon-si,
Gyeonggi-do, Republic of Korea

(111) M 2013 023440 R
(151) 2013 03 13
(181) 2023 03 13
(260) AM 2012 64974 A
(220) 2011 11 17
(732) OLEINA SA
13 Route de Florissant, 1206 GENEVE,
Switzerland

(111) M 2013 023441 R
(151) 2013 03 13
(181) 2023 03 13
(260) AM 2012 64996 A
(220) 2011 11 21
(732) LTD never land
Varketili 3, i mkr., korp. 29, b. 17, 0163,
Tbilisi, Georgia

(111) M 2013 023442 R
(151) 2013 03 13
(181) 2023 03 13
(260) AM 2012 65093 A
(220) 2011 11 29
(732) KINGSTON TECHNOLOGI CORPORATION
17600 Newhope Street, Fountain Valley,
CALIFORNIA 92708, USA

| | |
|---|---|
| (111) M 2013 023443 R (151) 2013 03 13 (181) 2023 03 13 (260) AM 2012 65378 A (220) 2011 12 15 (732) LTD "SHAVI ZGVIS SAERTASHORISO UNIVERSITETI" Davit Agmasheneblis kheivani, me-13 km/n2, 0131, Tbilisi, Georgia | Wakefield House Pipers Way, Swindon, Wiltshire, SN3 1RE, United Kingdom |
| (111) M 2013 023444 R (151) 2013 03 13 (181) 2023 03 13 (260) AM 2012 65391 A (220) 2011 12 15 (732) MERCK SHARP & DOHME CORP. One Merck Drive, Whitehouse Station, New Jersey 08889, USA | (111) M 2013 023449 R (151) 2013 03 13 (181) 2023 03 13 (260) AM 2012 65584 A (220) 2011 12 27 (732) GIVI BALIANI Naqeralis q.N11, 0103, Tbilisi, Georgia |
| (111) M 2013 023445 R (151) 2013 03 13 (181) 2023 03 13 (260) AM 2012 65412 A (220) 2011 12 16 (732) SIN HOLDING LIMITED. OMC CHAMBERS, WICKHAMS CAY 1, ROAD TOWN, Tortola, British Virgin Islands | (111) M 2013 023450 R (151) 2013 03 13 (181) 2023 03 13 (260) AM 2012 65744 A (220) 2012 01 06 (732) BIONIME CORPORATION 694 Renhua road, Dali Dist., Taichung City 412, Taiwan, Province of China |
| (111) M 2013 023446 R (151) 2013 03 13 (181) 2023 03 13 (260) AM 2012 65489 A (220) 2011 12 21 (732) UNIVERSAL CITI STUDIOS LLC 100 Universal City Plaza, Universal City, California 91608, USA | (111) M 2013 023451 R (151) 2013 03 13 (181) 2023 03 13 (260) AM 2012 65835 A (220) 2012 01 11 (732) LTD MAGTIKOMI A. Politkovskaias q.5, 0186, Tbilisi, Georgia |
| (111) M 2013 023447 R (151) 2013 03 13 (181) 2023 03 13 (260) AM 2012 65490 A (220) 2011 12 21 (732) UNIVERSAL CITI STUDIOS LLC 100 Universal City Plaza, Universal City, California 91608, USA | (111) M 2013 023452 R (151) 2013 03 13 (181) 2023 03 13 (260) AM 2012 65859 A (220) 2012 01 12 (732) BRIDGESTONE CORPORATION 10-1, Kyobashi 1-Chome, Chuo-ku, Tokyo, Japan |
| (111) M 2013 023448 R (151) 2013 03 13 (181) 2023 03 13 (260) AM 2012 65569 A (220) 2011 12 26 (732) CASTROL LIMITED | (111) M 2013 023453 R (151) 2013 03 13 (181) 2023 03 13 (260) AM 2012 65861 A (220) 2012 01 12 (732) UNILEVER N.V. Weena 455, 3013 AL Rotterdam, Netherlands |
| (111) M 2013 023448 R (151) 2013 03 13 (181) 2023 03 13 (260) AM 2012 65569 A (220) 2011 12 26 (732) CASTROL LIMITED | (111) M 2013 023454 R (151) 2013 03 13 (181) 2023 03 13 (260) AM 2012 65862 A (220) 2012 01 12 (732) KRR NAEHRMITTEL |

SKTIENGESELLSCHAFT
Bahnhofstrasse 19, 8240 THAYNGEN,
Switzerland

(111) M 2013 023455 R
(151) 2013 03 13
(181) 2023 03 13
(260) AM 2012 65874 A
(220) 2012 01 16
(732) UNILEVER N.V.
Weena 455, 3013 AL Rotterdam,
Netherlands

(111) M 2013 023456 R
(151) 2013 03 13
(181) 2023 03 13
(260) AM 2012 65875 A
(220) 2012 01 16
(732) UNILEVER N.V.
Weena 455, 3013 AL Rotterdam,
Netherlands

(111) M 2013 023457 R
(151) 2013 03 13
(181) 2023 03 13
(260) AM 2012 65944 A
(220) 2012 01 23
(732) NISSAN JIDOSHA KABUSHIKI KAISHA
(also trading as Nissan Motor Co., Ltd.)
.2 Takaracho, Kanagawa-ku, Yokohama-shi,
Kanagawa-ken, Japan

(111) M 2013 023461 R
(151) 2013 03 13
(181) 2023 03 13
(260) AM 2012 66009 A
(220) 2012 01 30
(732) LTD QARTO
Evgeni kharadzis q. 2a, 0153, Tbilisi,
Georgia

(111) M 2013 023462 R
(151) 2013 03 13
(181) 2023 03 13
(260) AM 2012 66014 A
(220) 2012 01 31
(732) NELFRANCE EXPORT SA.
Ave. Francisco de Orellana, N234, Blue
Towers Building 1, Floor 15, Office 1501,
Guayaquil, Ecuador

(111) M 2013 023463 R
(151) 2013 03 13
(181) 2023 03 13
(260) AM 2012 66125 A
(220) 2012 02 08
(732) LTD SAMEDITSI TSENTRI "TSITO"
Faliashvilis 40, 0179, Tbilisi, Georgia

(111) M 2013 023464 R
(151) 2013 03 13
(181) 2023 03 13
(260) AM 2012 66275 A
(220) 2012 02 20
(732) UNILEVER N.V.
Weena 455, 3013 AL Rotterdam,
Netherlands

(111) M 2013 023465 R
(151) 2013 03 13
(181) 2023 03 13
(260) AM 2012 66276 A
(220) 2012 02 20
(732) UNILEVER N.V.
Weena 455, 3013 AL Rotterdam,
Netherlands

TRADEMARKS REGISTERED ACCORDING TO THE ACCELERATED PROCEDURE

The decision can be appealed at the Chamber of Appeal of Sakpatenti within 3 months from the publication.

(111) M 2013 23413 R

(151) 2013 03 11

(181) 2023 03 11

(210) AM 070930

(220) 2013 02 19

(732) LTD KRISTALBETI

Vazha-Fshavelas gamziri 42-44, 0177,
Tbilisi, Georgia

(540)



(591) Black, yellow, white

(531) 26.04.22-26.04.24-27.05.17-27.05.24-
29.01.13-

(511) 9, 41

(526) **DISCLAIMER** – The trademark is protected as a whole, word markings "Nougaut", "Hyra", "с изюмом", "3 родзинками" shall not be subject to independent protection.

(511) 30

(111) M 2013 23415 R

(151) 2013 03 11

(181) 2023 03 11

(210) AM 070935

(220) 2013 02 19

(732) DOTCHIRNE PIDPRIEMSTVO

"KONDITERSKA KORPORATZIA
"ROSHEN"

vul. Pavla Usenka, 8, Kyiv 02105, Ukraine

(740) Alexander Gegechkori

(540)



(591) White, yellow, cream, light green, green,
brown, black

(531) 05.01.20-05.01.21-26.11.07-27.05.19-
29.01.15-

(526) **DISCLAIMER** – The trademark is protected as a whole, word markings "Nougaut", "Hyra", "ванильная", "ванильна" shall not be subject to independent protection.

(511) 30

(111) M 2013 23414 R

(151) 2013 03 11

(181) 2023 03 11

(210) AM 070934

(220) 2013 02 19

(732) DOTCHIRNE PIDPRIEMSTVO

"KONDITERSKA KORPORATZIA
"ROSHEN"

vul. Pavla Usenka, 8, Kyiv 02105, Ukraine

(740) Alexander Gegechkori

(540)

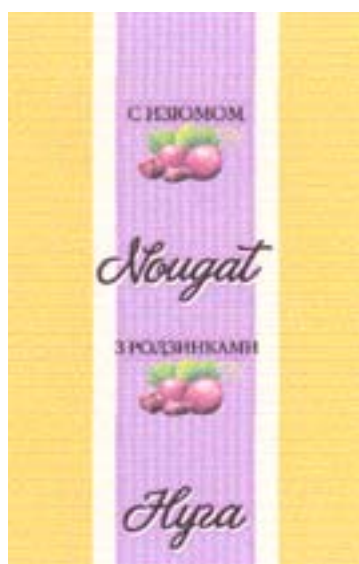

(591) White, yellow, cream, light lilac, lilac,
dark lilac, green, black

(531) 05.07.06-05.07.10-26.11.07-27.05.19-
29.01.15-

(111) M 2016 23416 R

(151) 2013 03 11

(181) 2023 03 11

(210) AM 070936

(220) 2013 02 19

(732) DOTCHIRNE PIDPRIEMSTVO
"KONDITERSKA KORPORATZIA
"ROSHEN"
vul. Pavla Usenka, 8, Kyiv 02105, Ukraine
(740) Alexander Gegechkori
(540)



(591) White, yellow, cream, green, brown
(531) 05.05.04-08.03.01-11.03.04-25.01.01-
29.01.15-
(526) **DISCLAIMER** – The trademark is protected
as a whole, word marking "Молоко" shall not be
subject to independent protection.
(511) 30

(111) M 2013 23417 R
(151) 2013 03 11
(181) 2023 03 11
(210) AM 070937
(220) 2013 02 19
(732) DOTCHIRNE PIDPRIEMSTVO
"KONDITERSKA KORPORATZIA
"ROSHEN"
vul. Pavla Usenka, 8, Kyiv 02105, Ukraine
(740) Alexander Gegechkori
(540)



(591) White, blue, cream, brown
(531) 08.01.23-08.03.01-28.05.00-29.01.15-
(526) **DISCLAIMER** – The trademark is protected
as a whole, word marking "Молоко" shall not be
subject to independent protection.
(511) 30

(111) M 2013 23418 R
(151) 2013 03 12
(181) 2023 03 12
(210) AM 071055
(220) 2013 02 25
(732) LTD "KAVA JORJIA"
Guramishvilis gamz. n12a, korp.n5 da
araletis quchis da kofili sabavshvo bagis
mimdebared, 0192, Tbilisi, Georgia
(540)



(591) Dark cornelian cherry (brown), light green,
white
(531) 01.15.11-05.07.01-27.05.11-
(511) 30

(111) M 2013 23419 R
(151) 2013 03 13
(181) 2023 03 13
(210) AM 070989
(220) 2013 02 21
(732) LTD "ALFA"
Tevdore Mgvdlis q. 53, 0154, Tbilisi,
Georgia
(740) Nugzar Ksovreli
(540)



(591) Dark brown, blue, red, yellow, brown
(531) 05.05.04-26.01.19-27.05.01-29.01.15-
(526) **DISCLAIMER** – The trademark is protected
as a whole, marking "Golden" shall not be subject
to independent protection.
(511) 29

(111) M 2013 23466 R
 (151) 2013 03 15
 (181) 2023 03 15
 (210) AM 071150
 (220) 2013 02 28
 (732) LTD CBD DEVELOPMENT
 Meliqishvilis gamziri n10, Georgia
 (740) Natela Otariidze
 (540)

East Point Shopping Village

(591) Black-white
 (511) 25, 35, 36, 37, 38, 39, 41, 43, 45

(111) M 2013 23467 R
 (151) 2013 03 15
 (181) 2023 03 15
 (210) AM 071151
 (220) 2013 02 28
 (732) LTD CBD DEVELOPMENT
 Meliqishvilis gamziri n10, Georgia
 (740) Natela Otariidze
 (540)



(591) Raspberry, sky, orange, yellow, lettuce,
 dark blue, black
 (531) 01.03.02-01.03.13-01.03.15-27.05.11-
 27.05.21-29.01.15-
 (511) 25, 35, 36, 37, 38, 39, 41, 43, 45

(111) M 2013 23468 R
 (151) 2013 03 15
 (181) 2023 03 15
 (210) AM 071152
 (220) 2013 02 28
 (732) LTD CBD DEVELOPMENT
 Meliqishvilis gamziri n10, Georgia
 (740) Natela Otariidze
 (540)

East Point

(591) Black-white
 (511) 25, 35, 36, 37, 38, 39, 41, 43, 45

(111) M 2013 23469 R
 (151) 2013 03 15
 (181) 2023 03 15
 (210) AM 071147
 (220) 2013 02 28
 (732) LTD "FIRMA "DISNA"
 Lavrskaia q.16, 01015 q. Kiev, Ukraine
 (740) Davit Zurabishvili
 (540)



(591) Black, white, beige, bordeaux, green
 (531) 01.03.07-07.01.03-19.07.01-29.01.15-
 (526) **DISCLAIMER** – The trademark is protected
 as a whole, word marking "Kartuli Wine" shall not
 be subject to independent protection.
 (511) 33

(111) M 2013 23470 R
 (151) 2013 03 18
 (181) 2023 03 18
 (210) AM 071143
 (220) 2013 02 28
 (732) PASHA Bank OJSC
 15 Yusif Mammadaliyev Street,
 Sabail district, Baku AZ 1005, Azerbaijan
 (740) Tamar Kochlamazashvili
 (540)



(591) White, golden
 (531) 26.04.09-27.05.17-29.01.02-
 (526) **DISCLAIMER** – The trademark is protected
 as a whole, word marking "Bank" shall not be
 subject to independent protection.
 (511) 36, 38, 39, 41

(111) M 2013 23471 R

(151) 2013 03 18

(181) 2023 03 18

(210) AM 071144

(220) 2013 02 28

(732) PASHA Bank OJSC

15 Yusif Mammadaliyev Street,
Sabail district, Baku AZ 1005, Azerbaijan

(740) Tamar Kochlamazashvili

(540)



(591) Red, green, white

(531) 26.04.09-27.05.17-29.01.12-

(526) **DISCLAIMER** – The trademark is protected as a whole, word marking "Bank" shall not be subject to independent protection.

(511) 36, 38, 39, 41

(111) M 2013 23472 R

(151) 2013 03 18

(181) 2023 03 18

(210) AM 071169

(220) 2013 03 01

(732) Joint-Stock Company

"QARTULI LUDIS KOMPANIA"
Sop. Saguramo, 3311, Mtskheta, Georgia

(740) Ana Vachnadze

(540)



(591) White, red, black, blue, golden

(531) 05.07.02-25.01.05-25.01.19-26.01.18-

27.05.22-28.19.00-29.01.15-

(511) 32

(111) M 2013 23473 R

(151) 2013 03 18

(181) 2023 03 18

(210) AM 071197

(220) 2013 03 04

(732) LTD "BULGARTABAC HOLDING
GROUP FIZ"

Tavisupali industriuli zona (Navsadguris
kopili eqstensiuri ganvitarebis zona),
nakvetis shida nomeri 1b-7t/68, Poti, Georgia

(740) Ketevan Sokhivadze

(540)



(591) Dark blue, sky, white

(531) 01.01.09-27.05.21-29.01.04-

(511) 35

(111) M 2013 23474 R

(151) 2013 03 18

(181) 2023 03 18

(210) AM 071142

(220) 2013 02 28

(732) PASHA Bank OJSC

15 Yusif Mammadaliyev Street,
Sabail district, Baku AZ 1005, Azerbaijan

(740) Tamar Kochlamazashvili

(540)



(591) Black-white

(531) 26.04.09-27.05.17-

(511) 36, 38, 39, 41

INTERNATIONAL TRADEMARKS FOR WHICH A DECISION ON GRANTING PROTECTIONS IS TAKEN

The decision can be appealed at the Chamber of Appeal of Sakpatenti within 3 months from the publication or at the Mtskheta District Court Administrative Cases Board (Address: №17, Samkhedro str., Mtskheta), within 1 month following the publication.

(260) AM 2013 66945 A

(800) 737916

(731) GROUPE AUCHAN

40 avenue de Flandre, F-59170 CROIX,
France

(540)



(591) Black, white

(511)

9 – Scientific (other than medical), nautical, surveying, photographic, cinematographic, optical, weighing, measuring, signaling, checking (supervision) and life-saving apparatus and instruments; teaching apparatus and instruments; apparatus for recording, transmission or reproduction of sound or images; magnetic data media; sound recording, magnetic and optical disks, audio and video compact disks; camcorders; videotapes; magnetic or optical data media; data media such as disks, diskettes, tapes, cassettes; encoded cards, magnetic; identity cards, magnetic; telecommunications apparatus; data processing apparatus, computers, computer peripheral devices, computer software; electronic agendas; games apparatus designed solely to be used with television sets; video game cartridges; safety restraints other than for vehicle seats or sports equipment; navigational instruments; binoculars, spectacles (optics), spectacle cases, telescopes, directional compasses; swimming belts and jackets; floats for bathing and swimming; pince-nez; diving masks and wet suits; revolution counters; kilometer recorders for vehicles; teeth protectors; nets for protection against accidents; protective helmets.

12 – Vehicles; apparatus for locomotion by land, air or water; automobiles, boats; motorcycles, bicycles; parachutes; trailers (vehicles); chains and sunblinds adapted for automobiles; vehicle brake fittings and parts; rearview mirrors; tires, inner tubes and spikes for tires; anti-skid chains; safety belts for vehicle seats, children's safety seats for vehicles and bicycles; tires, kickstands, pneumatic tubular tires, wheel rims, wheels, spokes, bodies, nets, brakes, handlebars, direction indicators, bells, saddles and bicycle pumps; adhesive disks made of

rubber and repair outfits for inner tubes; safety seats for children for cycles; vehicle covers, seat covers for vehicles; saddle covers for bicycles; luggage carriers, bicycle racks, ski-carriers for vehicles; pushchairs; anti-theft devices for vehicles, anti-theft alarms for vehicles; golf carts.

25 – Ready-made clothing; knitwear; lingerie; underwear; pajamas; dressing gowns; sweaters, skirts, frocks, trousers, jackets, coats, shirts, scarves, sashes for wear; neckties, braces for clothing, belts, gloves (clothing); hats, caps, caps; waterproof clothing; clothing for sports (excluding diving clothing); footwear; socks, tights; boots, footwear (excluding orthopedic footwear); beach footwear, ski boots; boots for sports; swimming suits and swimming trunks; bath robes.

28 – Games and playthings; gymnastic and sporting articles (excluding clothing, footwear and mats); stationary exercise bicycles; machines for physical exercises; appliances for gymnastics; chest expanders (exercisers), dumb-bells; bowls, play balls and balloons; rackets, gut and strings for rackets; boxing, baseball and golf gloves; shin guards, knee guards; nets for sports; archery implements; clay pigeon traps; targets, darts; fencing weapons; discs for sports; fishing tackle, rods for fishing; floats for fishing; harpoon guns (sports articles); fish hooks; lines and reels for fishing; landing nets for anglers; creels (fishing equipment); hunting and fishing lures; flippers for swimming; skis; ski bindings; scrapers for skis; sole coverings for skis; waterskis; skis and surf boards; sailboards; skating boots with skates attached; ice skates; roller skates; skateboards; kites; paragliders; hang gliders; swimming pools (sports or play articles); appliances for electronic games other than those designed solely for use with a television set.

(260) AM 2013 66985 A

(800) 1110597

(731) SOCIÉTÉ DES PRODUITS NESTLÉ S.A.
CH-1800 Vevey, Switzerland

(540)



(591) Red, beige, green and white

(511)

29 – Vegetables and potatoes (preserved, dried or cooked), fruit (preserved, dried or cooked), mushrooms (preserved, dried or cooked); meat, poultry, game, fish and seafood, all these goods in the form of extracts, soups, jellies, spreads, preserves, cooked, deep-frozen or dehydrated dishes; jams; eggs; preserved soya beans for human consumption; edible oils and fats; protein preparations for human consumption; sausages; charcuterie, peanut butter; soups, concentrated soups, preparations for making soups, thick soups, stock, also as cubes, tablets or powder, concentrates of stock, preparations for making stock, broth.

30 – Flours, cereal preparations, bread, yeast, pastries; biscuits, cakes, cookies, wafers, caramels, puddings; rice, pasta, noodles; rice, flour or cereal-based foodstuffs, also in the form of cooked dishes; pizzas, sandwiches; oven-ready preparations of farinaceous paste and cake dough; powder mixtures for cakes; sauces, soya sauce; ketchup; products for flavoring or seasoning foodstuffs; edible spices, condiments, salad dressings, mayonnaise; mustard; vinegar.

(260) AM 2013 66986 A

(800) 1110599

(731) OCTAL HOLDINGS & CO.

P.O. Box 3786, Postal Code 112 Ruwi, Oman

(540)

DPET

(591) Black, white

(511)

16 – Amorphous polyethylene terephthalate plastic film sheets used for packaging food and consumer goods.

(260) AM 2013 66988 A

(800) 1110605

(731) BRENDSON COMPANY LIMITED

Charalampou Mouskou, 20 ABC BUSINESS

CENTER, 1-st floor, Flat/Office 101,

CY-8010 Paphos, Cyprus

(540)

Nega

(591) Black, white

(511)

21 – Aerosol dispensers, not for medical purposes; shaving brushes; boxes of metal, for dispensing paper towels; brushes; cosmetics (utensils); large-toothed combs for the hair; deodorising apparatus for personal use; soap dispensers; abrasive sponges for scrubbing the skin; toilet sponges; comb cases;

scrubbing brushes; powder puffs; toilet cases; combs; electric combs; powder compacts; animal bristles (brushware); eyebrow brushes; toilet brushes; toilet utensils.

(260) AM 2013 66989 A

(800) 1110628

(731) VITAL PHARMACEUTICALS, INC.

15751 S.W. 41st Street, Suite 300, Davie,

FL 33331, USA

(540)

REDLINE

(591) Black, white

(511)

5 – Nutritional supplements.

(260) AM 2013 66990 A

(800) 1110634

(731) WEICHAI POWER CO., LTD.

197, Section A, Fu Shou East Street, Hight

Technology Industrial, Development Zone,

Weifang City, Shangdong province, China

(540)



(591) Black, white

(511)

4 – Industrial oil; lubricating oil for precision instrument; lubricating oil; gear oils; fuel; mineral fuel; industrial wax; lamp wicks; dust removing preparations; electrical energy.

37 – Building construction supervision; construction; mining extraction; heating equipment installation and repair; upholstery; machinery installation, maintenance and repair; motor vehicle maintenance and repair; shipbuilding; vulcanization of tires (tyres) (repair); cabinet making (repair).

(260) AM 2013 66991 A

(800) 1110636

(731) SHAANXI HEAVY-DUTY AUTOMOBILE CO., LTD.

Jingwei Industrial Park, Xi'An Economic and

Technological Development Zone Xi'An

710200 Shaanxi, China

(540)

SHACMAN

(591) Black, white

(511)

35 – Import-export agencies; sales promotion for others; marketing studies; business information;

organizing technology exhibitions for commercial or advertising purposes; organization of exhibitions for commercial or advertising purposes; professional business consultancy; organization of trade fairs for commercial or advertising purposes; business appraisals.

37 – Motor vehicle maintenance and repair; car wash; vehicle wash; vehicle greasing; vehicle lubrication (greasing); vehicle service stations (refueling and maintenance); vehicle maintenance; vehicle fueling station; anti-rust treatment for vehicles.

(260) AM 2013 66992 A
(800) 1110637
(731) Yara International ASA
P.O. Box 2464 Solli, N-0202 Oslo, Norway
(540)

NOXCARE

(591) Black, white
(511)

6 – Common metals and their alloys; metal building materials; transportable buildings of metal; materials of metal for railway tracks; non-electric cables and wires of common metal; ironmongery, small items of metal hardware; pipes and tubes of metal; safes; goods of common metal, not included in other classes; ores.

7 – Machines and machine tools; motors and engines (except for land vehicles); machine coupling and transmission components (except for land vehicles); agricultural implements other than hand-operated; incubators for eggs.

37 – Building construction; repair; installation services.

42 – Scientific and technological services and research and design relating thereto; industrial analysis and research services; design and development of computer hardware and software; engineering services.

(260) AM 2013 66993 A
(800) 1110642
(731) ZENTIVA GROUP, A.S.
U kabelovny 130 CZ-102 37 Praha
10 – dolní Měcholupy, Czech Republic
(540)

ZENTIVA LAB

(591) Black, white
(511)

5 – Medicines, drugs, pharmaceutical preparations for human use, vitamins, chemical preparations and substances for pharmaceutical use other than disinfectants and cosmetics, tonic preparations and dietetic preparations for medical use, medicinal

infusions, medicinal wines and teas, diagnostic products for medical use, vaccines, serums and blood products, cultures of microorganisms included in this class.

(260) AM 2013 66995 A
(800) 1110655
(731) ŠKODA AUTO A.S.
Tř. Václava Klementa 869, CZ-29360
Mladá Boleslav, Czech Republic
(540)



(591) Black, white
(511)

12 – Automobiles and their parts, all included in this class.

35 – Advertisement and advertising services.

36 – Financial and insurance services, rental and leasing, all related to automobiles.

37 – After-sales and repair services, all related to automobiles.

42 – Technical consultancy, all related to automobiles.

(260) AM 2013 66996 A
(800) 1110696
(731) Tovarystvo z obmezhenoiu vidpovidalnistiu
"MTI"
blvr. L. Ukrainky, 4, Kyiv 01023, Ukraine
(540)

INTERTOP

(591) Black, white
(511)

3 – Bleaching preparations and other substances for laundry use; cleaning, polishing, scouring and abrasive preparations; soaps; perfumery, essential oils, cosmetics, hair lotions; dentifrices.

16 – Fountain pens, pamphlets, booklets, placards of paper or cardboard, printed publications, greeting cards, newspapers, graphic prints, printed matter, labels, not of textile, magazines (periodicals), newsletters, calendars, office requisites, except furniture, stationery, cardboard articles, catalogues, boxes of cardboard or paper, conical paper bags, bags (envelopes, pouches) of paper or plastics, for packaging, periodicals, writing materials, writing cases (sets), writing instruments, plastic cling film, extensible, for palletization, plastic film for wrap-

ping, plastic cling film, extensible, for palletization, flags of paper, prospectuses, photographs.

18 – Goods made of leather and imitations of leather, included in this class; trunks and travelling bags; umbrellas, parasols and walking sticks; whips, harness and saddlery.

21 – Household or kitchen utensils and containers (not of precious metal or coated therewith); combs and sponges; brushes (except paint brushes); brush-making materials; articles for cleaning purposes; steelwool; unworked or semi-worked glass (except glass used in building); glassware, porcelain and earthenware included in this class.

25 – Clothing, footwear, headgear.

26 – Lace and embroidery, ribbons and braid; buttons, hooks and eyes, pins and needles; artificial flowers.

28 – Games and playthings; gymnastic and sporting articles not included in other classes; decorations for Christmas trees.

35 – Administrative processing of purchase orders, organization of exhibitions and trade fairs for commercial or advertising purposes, demonstration of goods, marketing studies, opinion polling, business research, business information, business management assistance, compilation of information into computer databases, import-export agencies, commercial information and advice for consumers (consumer advice shop), business organization consultancy, modelling for advertising or sales promotion, writing of publicity texts, updating of advertising material, shop window dressing, procurement services for others (purchasing goods and services for other businesses), presentation of goods on communication media, for retail purposes, radio advertising, advertising by mail order, advertising, on-line advertising on a computer network, dissemination of advertising matter, sales promotion for others, television advertising, systemization of information into computer databases.

(260) AM 2013 66997 A

(800) 1110697

(731) Tovarystvo z obmezheniou vidpovidalnistiu "MTI"

blvr. L. Ukrainky, 4, Kyiv 01023, Ukraine

(540)



(591) Black, white

(511)

3 – Bleaching preparations and other substances for laundry use; cleaning, polishing, scouring and

abrasive preparations; soaps; perfumery, essential oils, cosmetics, hair lotions; dentifrices.

16 – Fountain pens, pamphlets, booklets, placards of paper or cardboard, printed publications, greeting cards, newspapers, graphic prints, printed matter, labels, not of textile, magazines (periodicals), newsletters, calendars, office requisites, except furniture, stationery, cardboard articles, catalogues, boxes of cardboard or paper, conical paper bags, bags (envelopes, pouches) of paper or plastics, for packaging, periodicals, writing materials, writing cases (sets), writing instruments, plastic cling film, extensible, for palletization, plastic film for wrapping, plastic cling film, extensible, for palletization, flags of paper, prospectuses, photographs.

18 – Goods made of leather and imitations of leather, included in this class; trunks and travelling bags; umbrellas, parasols and walking sticks; whips, harness and saddlery.

25 – Clothing, footwear, headgear.

26 – Lace and embroidery, ribbons and braid; buttons, hooks and eyes, pins and needles; artificial flowers.

28 – Games and playthings; gymnastic and sporting articles not included in other classes; decorations for Christmas trees.

35 – Administrative processing of purchase orders, organization of exhibitions and trade fairs for commercial or advertising purposes, demonstration of goods, marketing studies, opinion polling, business research, business information, business management assistance, compilation of information into computer databases, import-export agencies, commercial information and advice for consumers (consumer advice shop), business organization consultancy, modelling for advertising or sales promotion, writing of publicity texts, updating of advertising material, shop window dressing, procurement services for others (purchasing goods and services for other businesses), presentation of goods on communication media, for retail purposes, radio advertising, advertising by mail order, advertising, on-line advertising on a computer network, dissemination of advertising matter, sales promotion for others, television advertising, systemization of information into computer databases.

(260) AM 2013 66998 A

(800) 1110698

(731) Tovarystvo z obmezheniou vidpovidalnistiu "MTI"

blvr. L. Ukrainky, 4, Kyiv 01023, Ukraine

(540)

plato

(591) Black, white

(511)

3 – Bleaching preparations and other substances for laundry use; cleaning, polishing, scouring and abrasive preparations; soaps; perfumery, essential oils, cosmetics, hair lotions; dentifrices.

16 – Fountain pens, pamphlets, booklets, placards of paper or cardboard, printed publications, greeting cards, newspapers, graphic prints, printed matter, labels, not of textile, magazines (periodicals), newsletters, calendars, office requisites, except furniture, stationery, cardboard articles, catalogues, boxes of cardboard or paper, conical paper bags, bags (envelopes, pouches) of paper or plastics, for packaging, periodicals, writing materials, writing cases (sets), writing instruments, plastic cling film, extensible, for palletization, plastic film for wrapping, plastic cling film, extensible, for palletization, flags of paper, prospectuses, photographs.

18 – Goods made of leather and imitations of leather, included in this class; trunks and travelling bags; umbrellas, parasols and walking sticks; whips, harness and saddlery.

20 – Furniture, mirrors, picture frames; goods (not included in other classes) of wood, cork, reed, cane, wicker, horn, bone, ivory, whalebone, shell, amber, mother-of-pearl, meerschaum and substitutes for all these materials, or of plastics.

21 – Household or kitchen utensils and containers (not of precious metal or coated therewith); combs and sponges; brushes (except paint brushes); brush-making materials; articles for cleaning purposes; steelwool; unworked or semi-worked glass (except glass used in building); glassware, porcelain and earthenware included in this class.

25 – Clothing, footwear, headgear.

26 – Lace and embroidery, ribbons and braid; buttons, hooks and eyes, pins and needles; artificial flowers.

28 – Games and playthings; gymnastic and sporting articles not included in other classes; decorations for Christmas trees.

35 – Administrative processing of purchase orders, organization of exhibitions and trade fairs for commercial or advertising purposes, demonstration of goods, marketing studies, opinion polling, business research, business information, business management assistance, compilation of information into computer databases, import-export agencies, commercial information and advice for consumers (consumer advice shop), business organization consultancy, modelling for advertising or sales promotion, writing of publicity texts, updating of advertising material, shop window dressing, procurement services for others (purchasing goods and services for

other businesses), presentation of goods on communication media, for retail purposes, radio advertising, advertising by mail order, advertising, on-line advertising on a computer network, dissemination of advertising matter, sales promotion for others, television advertising, systemization of information into computer databases.

(260) AM 2013 66999 A

(800) 1110699

(731) Tovarystvo z obmezheniou vidpovidalnistiu "MTI"

blvr. L. Ukrainky, 4, Kyiv 01023, Ukraine

(540)



(591) Black, purple and white

(511)

16 – Fountain pens, pamphlets, booklets, placards of paper or cardboard, printed publications, greeting cards, newspapers, graphic prints, printed matter, labels, not of textile, magazines (periodicals), newsletters, calendars, office requisites, except furniture, stationery, cardboard articles, catalogues, boxes of cardboard or paper, conical paper bags, bags (envelopes, pouches) of paper or plastics, for packaging, periodicals, writing materials, writing cases (sets), writing instruments, plastic cling film, extensible, for palletization, plastic film for wrapping, plastic cling film, extensible, for palletization, flags of paper, prospectuses, photographs.

18 – Goods made of leather and imitations of leather, included in this class; trunks and travelling bags; umbrellas, parasols and walking sticks; whips, harness and saddlery.

25 – Clothing, footwear, headgear.

26 – Lace and embroidery, ribbons and braid; buttons, hooks and eyes, pins and needles; artificial flowers.

35 – Administrative processing of purchase orders, organization of exhibitions and trade fairs for commercial or advertising purposes, demonstration of goods, marketing studies, opinion polling, business research, business information, business management assistance, compilation of information into computer databases, import-export agencies, commercial information and advice for consumers (consumer advice shop), business organization consultancy, modelling for advertising or sales promotion, writing of publicity texts, updating of advertising material, shop window dressing, procurement services for others (purchasing goods and services for other businesses), presentation of goods on

communication media, for retail purposes, radio advertising, advertising by mail order, advertising, on-line advertising on a computer network, dissemination of advertising matter, sales promotion for others, television advertising, systemization of information into computer databases.

(260) AM 2013 67000 A

(800) 1110731

(731) EVER Neuro Pharma GmbH
Oberburgau 3, A-4866 Unterach am Attersee,
Austria

(540)

VASERUCTIL

(591) Black, white

(511)

5 – Pharmaceutical and veterinary preparations.

(260) AM 2013 67001 A

(800) 1110732

(731) EVER Neuro Pharma GmbH
Oberburgau 3, A-4866 Unterach am Attersee,
Austria

(540)

TACHYBEN

(591) Black, white

(511)

5 – Pharmaceutical and veterinary preparations.

(260) AM 2013 67002 A

(800) 1110742

(731) Open-Type Joint Stock Company
"ROT FRONT"
2-oy Novokuznetskiy pereulok, d. 13/15,
RU-113184 Moscow, Russian Federation

(540)



(591) Red, white and bronze

(511)

30 – Sweetmeats [candy]; caramels [candy]; pralines [candy]; fondants [confectionery]; chocolate; pastries; waffles; halvah; cocoa; cake.

(260) AM 2013 67003 A

(800) 1110771

(731) EcoPharm Patent Management AG
Haldenstrasse 5, CH-6342 Baar,
Switzerland

(540)

REMAXOL

(591) Black, white

(511)

5 – Drugs for medical purposes; medicines for veterinary purposes; medicines for human purposes; pharmaceutical preparations.

(260) AM 2013 67004 A

(800) 1110772

(731) EcoPharm Patent Management AG
Haldenstrasse 5, CH-6342 Baar,
Switzerland

(540)

РЕМАКСОЛ

(591) Black, white

(511)

5 – Drugs for medical purposes; medicines for veterinary purposes; medicines for human purposes; pharmaceutical preparations.

(260) AM 2013 67038 A

(800) 678311

(731) EGIS GYÓGYSZERGYÁR Nyilvánosan
Működő Részvénytársaság
Kereszturi út 30-38, H-1106 Budapest,
Hungary

(540)

TIREGIS

(591) Black, white

(511)

5 – Pharmaceutical, veterinary and sanitary products, dietetic foodstuffs for medical use, food for babies, products for destroying vermin, fungicides, herbicides, disinfectants.

(260) AM 2013 67039 A

(800) 807276

(731) Crucell Switzerland AG
Rehhagstrasse 79, CH-3018 Bern,
Switzerland

(540)

EPAXAL

(591) Black, white

(511)

5 – Vaccines against hepatitis.

(260) AM 2013 67040 A

(800) 840060

(731) Obchtchestvo s ogranichennoi
otvetstvennostiou "LABORATORIA
SOVREMENNOGO ZDOROVIA"
ul. Khimzavodskaia, 11/206 RU-633004

Berdk, Novosibirskaia obl., Russian Federation

(540)

РИТМЫ ЗДОРОВЬЯ

(591) Black, white

(511)

5 – Albuminous foodstuffs for medical use; dietetic foodstuffs for medical use; food for babies, antiseptics; balms for medical use; biocides; dietetic beverages for medical use; medicinal mud; fumigating sticks; disinfectants for sanitary use; digestives for pharmaceutical use; sea water for medicinal bathing; lacteal flour (for babies); ferments for pharmaceutical use; germicides; medicinal herbs; oils for medical use; medicinal infusions; liniments; lotions for pharmaceutical use; nervines; bread for diabetics; albuminous preparations for medical use; bacterial preparations for medical or veterinary use; biological preparations for medical use; vitamin preparations; preparations of trace elements for human and animal use; therapeutic preparations for bathing; opotherapy products; pharmaceutical products for treating dandruff; pharmaceutical products for skin care; mouth care products for medical use; medicinal roots; tonics (medicines); remedies for perspiration; serums; sanitary napkins; tissues impregnated with pharmaceutical lotions; dietetic substances for medical use; mineral food supplements; styptic preparations, herbal teas.

(260) AM 2013 67041 A

(800) 878186

(731) KUK HANDELSGESELLSCHAFT M.B.H.
Auleiten 4, A-4910 Ried im Innkreis, Austria

(540)

KUK

(591) Black, white

(511)

35 – Provision of services for third parties, namely business investigations and preparation of business information, market studies, commercial information agencies, market research, market development study, grouping of products for third parties enabling consumers to view and purchase them at their convenience; grouping of raw materials for foodstuffs and pharmaceuticals enabling consumers to view and purchase them at their convenience; promotion of products; business organization advice, professional business consulting, commercial or industrial management assistance.

42 – Scientific and technological services and research and design relating thereto; industrial analysis and research services; research and development services concerning new products for third parties; product development.

44 – Pharmacy consulting; information provided to consumers and customers concerning the effect and sanitary tolerance of pharmaceutical products, nutraceutical products and of raw materials for foodstuffs.

(260) AM 2013 67042 A

(800) 880621

(731) LABORATOIRE NUXE
19 rue Péclet, F-75015 PARIS, France

(540)

NUXELLENC

(591) Black, white

(511)

3 – Cosmetics; personal deodorants; essential oils; soaps, cleansing milks; creams, gels, milks, lotions, masks, pomades, powders and preparations for skin care; cosmetic products for lip care; cosmetic sunscreens, sunscreen preparations (cosmetics), sun-tanning preparations; depilatory products; hair lotions, shampoos; cosmetic bath preparations; all these goods being of biological or natural origin.

(260) AM 2013 67044 A

(800) 894039

(731) NUTRICIA INTERNATIONAL B.V.
Schiphol Boulevard 105, NL-1118 BG
Schiphol Airport, Netherlands

(540)



(591) Black, white

(511)

5 – Dietetic substances adapted for medical use, food for babies.

29 – Milk and milk products.

(260) AM 2013 67045 A

(800) 939118

(731) COIN S.P.A.
Via Terraglio, 17, Frazione Mestre, I-30174
VENEZIA, Italy

(540)

coincasadesign

(591) White, black and beige

(511)

8 – Hand tools and implements (hand-operated); cutlery; side arms; razors.

11 – Apparatus for lighting, heating, steam generating, cooking, refrigerating, drying, ventilating, water supply and sanitary purposes.

16 – Paper, cardboard and goods made from these materials, not included in other classes; printed matter; bookbinding material; photographs; stationery; adhesives for stationery or household purposes; artists' materials; paint brushes; typewriters and office requisites (except furniture); instructional and teaching material (except apparatus); plastic materials for packaging (not included in other classes); printers' type; printing blocks.

20 – Furniture, mirrors, picture frames; goods (not included in other classes) of wood, cork, reed, cane, wicker, horn, bone, ivory, whalebone, shell, amber, mother-of-pearl, meerschaum and substitutes for all these materials, or of plastics.

21 – Household or kitchen utensils and containers (not of precious metal or coated therewith); combs and sponges; brushes (except paint brushes); brush-making materials; articles for cleaning purposes; steelwool; unworked or semi-worked glass (except glass used in building); glassware, porcelain and earthenware not included in other classes.

24 – Textiles and textile goods, not included in other classes; bed and table covers.

27 – Carpets, rugs, mats and matting, linoleum and other materials for covering existing floors; wall hangings (non-textile).

28 – Games and playthings; gymnastic and sporting articles not included in other classes; decorations for Christmas trees, playing cards.

35 – Advertising; business management; business administration; office functions.

(260) AM 2013 67046 A

(800) 1005137

(731) GLOBERIDE, Inc.

3-14-16, Maesawa, Higashikurume-shi,
Tokyo 203-8511, Japan

(540)



(591) Black, white

(511)

18 – Bags; umbrellas and their parts; handbag frames; purse frames; horseshoes; bags and the like; pouches and the like; leather and fur (unworked or semi-worked).

25 – Clothing; headgear for wear; boots; tennis shoes; golf shoes; suspenders (braces); waistbands; belts for clothing; footwear (other than boots for sports); clothes for sports; boots for sports.

28 – Fishing tackle; golf implements; tennis rackets; amusement machines and apparatus for use in amusement parks (other than arcade video game machines); toys for domestic pets; toys; dolls; go games; Japanese playing cards (utagaruta); Japanese chess (shogi games); dice; Japanese dice games (sugoroku); dice cups; diamond games; chess games; checkers (checker sets); conjuring apparatus; dominoes; playing cards; Japanese playing cards (hanafuda); mah-jong; game machines and apparatus; billiard equipment; sports equipment.

(260) AM 2013 67047 A

(800) 1099104

(731) TESCO STORES LIMITED

Tesco House, Delamare Road Cheshunt,
Hertfordshire EN8 9SL, United Kingdom

(540)

F&F

(591) Black, white

(511)

2 – Paints, varnishes, lacquers; preservatives against rust and against deterioration of wood; colorants; mordants; raw natural resins; metals in foil and powder form for painters, decorators, printers and artists; emulsions; dyes; enamels; painters' colours; distempers; paint and varnish driers; wood preservatives; wood stains; anti-corrosive and anti-fouling compositions; anti-corrosive oils; preservatives against rust; shoe dyes; leather stains; food colorants and food dyes; ink toners for photocopiers; printing inks.

3 – Bleaching preparations and other substances for laundry use; cleaning, polishing, scouring and abrasive preparations; soaps; perfumery, essential oils, cosmetics, hair lotions; dentifrices; deodorants for personal use; waxing substances and preparations; non-medicated toiletries; cosmetic preparations; skin care preparations; non-medicated preparations for the application to, conditioning and care of hair, scalp, skin and nails; make-up preparations; antiperspirants; perfumes; body sprays and eau de Cologne; essential oils; potpourri; face and body masks; face and body scrubs; facial washes; skin cleansers and hydrators; skin toners; skin moisturizers; depilatory preparations; shampoos; sun-tanning preparations; after-shave lotions; shaving preparations; bath salts (not for medical purposes); beauty masks; bleaching preparations for cosmetic purposes; pumice stone; cotton wool and sticks for cosmetic purposes; non-medicated talcum powder for toilet purposes; emery; false eyelashes; false nails; nail care preparations; nail varnish; colorants for toilet use; dyes, lotions, waving, styling preparations and spray for hair; incense; tissues impregnated with cosmetic lotions; cosmetic wipes; cosmetic preparations for slimming purposes; cos-

metic preparations for the care of babies' and infants' bodies; paint stripping preparations; sandpaper; shoe polish and wax; toothpastes; pot pourri; incense cones; incense spray; incense sachets; incense sticks; essential oils for use in air fresheners.

4 – Industrial oils and greases; motor oils; fuels; lubricants; firelighters; candles; wicks; tapers; non-electronic night lights included in this class; illuminants; dust absorbing, wetting and binding compositions; charcoal, coke, coal, wood for burning, briquettes.

5 – Pharmaceutical and veterinary preparations; sanitary preparations for medical purposes; dietetic substances adapted for medical use, food for babies; plasters, materials for dressings; material for stopping teeth, dental wax; disinfectants; preparations for destroying vermin; fungicides, herbicides; foods and beverages which are adapted for medical purposes; air deodorising preparations; adhesive for dentures; analgesics; antiseptics; medicated bath preparations and salts; medicated massage oils; contact lens cleaning preparations and solutions; medicated confectionery; corn remedies; chemical preparations for the prediction of ovulation and diagnosis of pregnancy; eye washes; filled first-aid boxes; herb teas and infusions for medical purposes; napkins and pants for incontinence; medicinal infusions; tissues impregnated with pharmaceutical lotions; sanitary preparations; menstruation pads and tampons; medical preparations for slimming purposes; sunburn ointment and preparations for pharmaceutical purposes; contraceptive preparations; vitamins; vitamin preparations; nutritional supplements; patches incorporating a pharmaceutical preparation; animal washes; anti-parasitic preparations and collars for animals; insecticides; air freshening and purifying preparations; air fresheners; air freshening preparations; air purifying preparations; room air fresheners; fragrant preparations contained in ceramic diffusers for deodorising the air; household deodorants; preparations for neutralising odours; parasiticides; insect repellents fungicides; first aid kits.

6 – Common metals and their alloys; metal building materials; transportable buildings of metal; materials of metal for railway tracks; non-electric cables and wires of common metal; ironmongery, small items of metal hardware; pipes and tubes of metal; safes; goods of common metal not included in other classes; ores; unwrought and partly wrought common metals; metallic windows and doors; metallic framed conservatories; door and window furnishings made of metal or made wholly or substantially of metal; door knockers; metal gates; grave-stones of metal; climbing iron; metal number plates; spurs; tent pegs of metal; metal nuts; bolts; screws; metal barrels; nails; locks; keys; metal letter boxes; ladders (metal); greenhouses, cloches,

portable sheds and frames (all being of metal or wholly or substantially of metal); bins; boxes; articles for use as plumbing fittings; materials for use in plumbing; metallic foil; chains for animals; animal traps.

8 – Cutlery, razors and razor blades; pen knives, palette knives; hand operated hand tools and implements; vegetable shredders and slicers; non-electric can openers; irons; cuticle tweezers and nippers; depilation appliances, electric and non-electric; hair-removing tweezers; beard clippers; crimping irons; curling tongs; pedicure sets; nail files; needle-threaders; scissors; harpoons for fishing.

9 – Scientific, nautical, surveying, photographic, cinematographic, optical, weighing, measuring, signalling, supervision, life-saving and teaching apparatus and instruments; apparatus and instruments for conducting, switching, transforming, accumulating, regulating or controlling electricity; apparatus for recording, transmission or reproduction of sound or images; magnetic data carriers, recording discs; automatic vending machines and mechanisms for coin operated apparatus; cash registers; calculating machines, data processing equipment and computers; fire-extinguishing apparatus; recorded media, computer hardware and firmware; computer software; software downloadable from the Internet; downloadable electronic publications; compact discs; digital music; telecommunications apparatus; computer games equipment adapted for use with an external display screen or monitor; mouse mats; mobile phone accessories; contact lenses, spectacles and sunglasses; clothing for protection against injury, accident, irradiation or fire; furniture adapted for laboratory use; digital thermometers; batteries; household electrical apparatus; smoke detectors and smoke alarms; electrically operated lighters; guards for electric sockets; magnets; fire blankets and extinguishers.

11 – Apparatus for lighting, heating, steam generating, cooking, refrigerating, drying, ventilating, water supply and sanitary purposes; air conditioning apparatus; electric kettles; gas and electric cookers; vehicle lights and vehicle air conditioning units; installations, equipment and apparatus for cooling, sanitising, filtering, purifying, deodorising, evaporating and sterilising; coffee machines; bathroom installations and fittings; air conditioners for vehicles; lamp fittings for vehicles; aquaria apparatus; electric lights for Christmas trees; hair dryers; domestic fireplaces; torches; foot warmers; hot water bottles; ornamental fountains; electric blankets; ice boxes, freezers; ice making machines; water softeners; air conditioning units and humidifiers; night lights; parts and fittings for all the aforesaid.

12 – Vehicles; apparatus for locomotion by land, air or water; wheelchairs; motors and engines for land

vehicles; vehicle body parts and transmissions; mopeds; scooters; motor cycles; bicycles; tyres and wheels for vehicles and bicycles; perambulators; prams; pushchairs, baby carriages; wheelbarrows; trolleys; anti-theft alarms and devices for vehicles; vehicle safety restraint apparatus and equipment; child restraints, seat belts and harnesses; accessories for perambulators and baby carriages; parts and fittings for all the aforesaid; chair lifts; boats; rubber dinghies; seat covers; wind-shields; luggage nets and luggage carriers.

14 – Watches; jewellery and costume jewellery; articles made of precious and semi-precious stones and alloys.

16 – Paper, cardboard and goods made from these materials; printed matter; book binding material; photographs; stationery; adhesives for stationery or household purposes; artists' materials; paint brushes; typewriters; packaging materials; printers' type; printing blocks; disposable nappies of paper for babies; printed publications; paint boxes for children; cheque book holders; copying and recording paper; greeting cards; catalogues; cardboard; cardboard articles; periodical publications; books; magazines; newspapers; adhesive materials and tapes; office requisites; teaching materials; drawing and painting instruments and requisites; easels; modelling materials; paintings; posters; postcards; bookends; bubble packs; chalk; blackboards; writing slates and tablets; erasing articles; fountain pens and nibs; paperweights; table linen of paper; bags for microwave cooking; bags of paper or of plastic; plastic cling film; toilet paper; albums and almanacs; babies' diapers and napkin-pants; blinds of paper; terrestrial globes; tickets and timetables; paper tissues for removing makeup; paper towels; wrapping paper; printed plastic cards; printed cards, bank cards, cash cards, debit cards, credit cards, cheque cards, cheques, cheque books, address stamps and machines; paper place mats; paper coffee filters; calendars; writing instruments.

18 – Leather and imitations of leather, and goods made of these materials and not included in other classes; suitcases, bags, attaché cases, haversacks, hat boxes, briefcases, belts of leather handbags, key cases, leather laces, music cases, wallets and purses, satchels; wheeled shopping bags; trunks; game bags; harnesses, collars for animals, leads and muzzles; fur and articles made from fur; umbrellas; parasols; walking sticks.

20 – Furniture; mirrors; picture frames; drinking straws; works of art and ornaments made of wood, wax, bamboo, cork, reed, cane, wicker, horn, bone, ivory, whalebone, shell, amber, mother-of-pearl, meerschaum, plaster and substitutes for all these materials or of plastics; sleeping bags; ladders; barrels not of metal; air mattresses, cushions and

pillows; bead curtains for decoration and parts and fittings not of cotton; beds, bedding (except linen) and non-metallic bed fittings and materials; display boards; cots and cradles; cushions; non-metallic door and window fittings; kennels for household pets; animal and pet carriers; slatted indoor blinds; coat hangers and coat hooks; non-metallic infant walkers; inflatable publicity objects; non-metallic jewellery cases; plastic key cards; non-metallic number plates; playpens for babies; shelving; baby walkers.

21 – Household or kitchen utensils and containers (not of precious metal or coated therewith); combs and sponges; brushes (except paintbrushes); articles for cleaning purposes; glass; glassware; porcelain and earthenware not included in other classes; baby baths; portable baths; candlesticks (not of precious metal); gloves for household purposes; non-electric whisks, blenders, presses, grinders, polishers, pressure cookers, mills for household purposes; shoe appliances, toothbrushes; trouser presses and stretchers for clothing; fitted vanity cases; watering devices; non-metallic piggy banks; cash boxes; animal and pet cages; animal and pet litter trays and boxes; containers for household pets; animal traps; animal and pet accessories; indoor terraria.

24 – Textiles and textile goods, not included in other classes; bed and table covers; plastic coverings for furniture; pillow or cushion covers; plastic or textile or net curtains; upholstery fabrics; woollen fabric; eiderdowns.

25 – Clothing, footwear, headgear.

26 – Lace and embroidery, ribbons and braid; buttons, hooks and eyes, pins and needles; artificial flowers; hair ornaments; false hair, badges to wear, not of precious metal; zip fasteners for bags; hat ornaments, not of precious metals; hair bands; knitting needles; needle cases; pin cushions; sewing boxes and sewing needles; sewing thimbles; shoe fasteners; shoe laces; shoe ornaments, not of precious metals; shoulder pads (for clothing); tapes for curtain headings; trouser clips for cyclists; toupees; wigs; zippers.

27 – Floor coverings; carpets; carpets for vehicles; bath mats; rugs; mats; matting; linoleum; wall hangings (non-textile); wallpaper; artificial turf.

28 – Games and playthings; playing cards; gymnastic and sporting articles; decorations for Christmas trees; childrens' toy bicycles; toys and dolls; artificial snow for Christmas trees; synthetic Christmas trees; Christmas crackers; marionettes; confetti; sports equipment; toy scooters; in-line skates and roller skates.

35 – Retail services, retail store services, retail electronic shopping services all connected with the sale of paints, varnishes, lacquers, preservatives

against rust and against deterioration of wood, colorants, mordants, raw natural resins, metals in foil and powder form for painters, decorators, printers and artists, emulsions, dyes, enamels, painters' colours, distempers, japans, paint and varnish driers, wood preservatives, wood stains, anti-corrosive and anti-fouling compositions, anti-corrosive oils, preservatives against rust, shoe dyes, leather stains, wallpaper removing preparations, food colorants and food dyes, ink toners for photocopiers, printing inks, bleaching preparations and other substances for laundry use, cleaning, polishing, scouring and abrasive preparations, soaps, perfumery, essential oils, cosmetics, hair lotions, dentifrices, deodorants for personal use, waxing substances and preparations, non-medicated toiletries, cosmetic preparations, skin care preparations, non-medicated preparations for the application to, conditioning and care of hair, scalp, skin and nails, make-up preparations, antiperspirants, perfumes, body sprays and eau de Cologne, potpourri, face and body masks, face and body scrubs, facial washes, skin cleansers and hydrators, skin toners, skin moisturizers, depilatory preparations, toilet articles, shampoos, sun-tanning preparations, after-shave lotions, shaving preparations, bath salts, beauty masks, bleaching preparations for cosmetic purposes, pumice stone, cotton wool and sticks for cosmetic purposes, non-medicated talcum powder for toilet purposes, emery, false eyelashes, false nails, nail care preparations, nail varnish, colorants, dyes, lotions, waving, styling preparations and spray for hair, incense, tissues impregnated with cosmetic lotions, cosmetic wipes, cosmetic preparations for slimming purposes, cosmetic preparations for the care of babies' and infants' bodies, paint stripping preparations, sandpaper, shoe polish and wax, toothpastes, pot pourri, incense cones, incense spray, incense sachets, incense sticks, essential oils for use in air fresheners, industrial oils and greases, motor oils, fuels, lubricants, firelighters, candles, wicks, tapers, night lights, illuminants, dust absorbing, wetting and binding compositions, charcoal, coke, coal, wood for burning, briquettes, pharmaceutical and veterinary preparations, sanitary preparations for medical purposes, dietetic substances adapted for medical use, food for babies, plasters, materials for dressings, material for stopping teeth, dental wax, disinfectants, preparations for destroying vermin, fungicides, herbicides, foods and beverages which are adapted for medical purposes, air deodorising preparations, adhesive for dentures, analgesics, antiseptics, medicated bath preparations and salts, medicated massage oils, contact lens cleaning preparations and solutions, medicated confectionery, corn remedies, chemical preparations for the prediction of ovulation and diagnosis of pregnancy, eye washes, filled first-aid boxes, herb teas and infusions for medical purposes, napkins and pants

for incontinence, medicinal infusions, tissues impregnated with pharmaceutical lotions, sanitary preparations, menstruation pads and tampons, medical preparations for slimming purposes, sunburn ointment and preparations for pharmaceutical purposes, contraceptive preparations, vitamins, vitamin preparations, nutritional supplements, patches incorporating a pharmaceutical preparation, animal washes, anti-parasitic preparations and collars for animals, insecticides, air freshening and purifying preparations, air fresheners, air freshening preparations, air purifying preparations, room air fresheners, fragrant preparations contained in ceramic diffusers for deodorising the air, deodorants, preparations for neutralising odours, parasiticides, insect repellents fungicides, first aid kits, common metals and their alloys, metal building materials, transportable buildings of metal, materials of metal for railway tracks, non-electric cables and wires of common metal, ironmongery, small items of metal hardware, pipes and tubes of metal, safes, goods of common metal, ores, unwrought and partly wrought common metals, metallic windows and doors, metallic framed conservatories, door and window furnishings made of metal or made wholly or substantially of metal, door knockers, metal gates, gravestones of metal, climbing iron, metal number plates, spurs, metal stirrups, tent pegs of metal, nuts, bolts, screws, barrels, nails, locks, keys, metal letter boxes, ladders (metal), shelving, greenhouses, cloches, portable sheds and frames (all being of metal or wholly or substantially of metal), bins, boxes, articles for use as plumbing fittings, materials for use in plumbing, metallic foil, chains for animals, animal traps, cutlery, razors and razor blades, pen knives, palette knives, hand operated hand tools and implements, vegetable shredders and slicers, non-electric can openers, irons, cuticle tweezers and nippers, depilation appliances, electric and non-electric, hair-removing tweezers, beard clippers, crimping irons, curling tongs, pedicure sets, nail files, needle-threaders, scissors, harpoons for fishing, scientific, nautical, surveying, photographic, cinematographic, optical, weighing, measuring, signalling, supervision, life-saving and teaching apparatus and instruments, apparatus and instruments for conducting, switching, transforming, accumulating, regulating or controlling electricity, apparatus for recording, transmission or reproduction of sound or images, magnetic data carriers, recording discs, automatic vending machines and mechanisms for coin operated apparatus, cash registers, calculating machines, data processing equipment and computers, fire-extinguishing apparatus, recorded media, computer hardware and firmware, computer software, software downloadable from the Internet, downloadable electronic publications, compact discs, digital music, telecommunications apparatus, computer games equipment adapted for use with an

external display screen or monitor, mouse mats, mobile phone accessories, contact lenses, spectacles and sunglasses, clothing for protection against injury, accident, irradiation or fire, furniture adapted for laboratory use, digital thermometers, batteries, household electrical apparatus, smoke detectors and smoke alarms, electrically operated lighters, guards for electric sockets, magnets, fire blankets and extinguishers, apparatus for lighting, heating, steam generating, cooking, refrigerating, drying, ventilating, water supply and sanitary purposes, air conditioning apparatus, electric kettles, gas and electric cookers, vehicle lights and vehicle air conditioning units, installations, equipment and apparatus for cooling, sanitising, filtering, purifying, deodorising, evaporating and sterilising, coffee machines, bathroom installations and fittings, air conditioners for vehicles, lamp fittings for vehicles, aquaria apparatus, electric lights for Christmas trees, hair dryers, domestic fireplaces, torches, foot warmers, hot water bottles, ornamental fountains, electric blankets, ice boxes, freezers, ice making machines, water softeners, air conditioning units and humidifiers, vehicles, apparatus for locomotion by land, air or water, wheelchairs, motors and engines for land vehicles, vehicle body parts and transmissions, mopeds, scooters, motor cycles, bicycles, tyres and wheels for vehicles and bicycles, perambulators, prams, pushchairs, baby carriages, wheelbarrows, trolleys, anti-theft alarms and devices for vehicles, vehicle safety restraint apparatus and equipment, child restraints, seat belts and harnesses, baby walkers, accessories for perambulators and baby carriages, chair lifts, boats, rubber dinghies, seat covers, wind-shields, luggage nets and luggage carriers, watches, jewellery and costume jewellery, articles made of precious and semi-precious stones and alloys, paper, cardboard and goods made from these materials, printed matter, book binding material, photographs, stationery, adhesives for stationery or household purposes, artists' materials, paint brushes, typewriters, packaging materials, printers' type, printing blocks, disposable nappies of paper for babies, printed publications, paint boxes for children, cheque book holders, copying and recording paper, greeting cards, catalogues, cardboard, cardboard articles, periodical publications, books, magazines, newspapers, adhesive materials and tapes, office requisites, teaching materials, drawing and painting instruments and requisites, easels, modelling materials, paintings, posters, postcards, bookends, bubble packs, chalk, blackboards, writing slates and tablets, erasing articles, fountain pens and nibs, paperweights, table linen of paper, bags for microwave cooking, paper replacement bags for vacuum cleaners, bags of paper or of plastic, plastic cling film, toilet paper, albums and almanacs, babies' diapers and napkin-pants, blinds of paper, terrestrial globes, tickets and timetables,

paper tissues for removing makeup, paper towels, wrapping paper, printed plastic cards, printed cards, bank cards, cash cards, debit cards, credit cards, cheque cards, cheques, cheque books, address stamps and machines, paper place mats, paper coffee filters, calendars, writing instruments, leather and imitations of leather, and goods made of these materials, suitcases, bags, attaché cases, haversacks, hat boxes, briefcases, belts, handbags, key cases, leather laces, music cases, wallets and purses, satchels, wheeled shopping bags, trunks, game bags, harnesses, collars, leads and muzzles, fur and articles made from fur, umbrellas, parasols, walking sticks, furniture, mirrors, picture frames, drinking straws, works of art and ornaments made of wood, wax, bamboo, cork, reed, cane, wicker, horn, bone, ivory, whalebone, shell, amber, mother-of-pearl, meerschaum, plaster and substitutes for all these materials or of plastics, sleeping bags, ladders, barrels, air mattresses, cushions and pillows, curtains, beds, bedding, (except linen) and non-metallic bed fittings and materials, display boards, cots and cradles, cushions, non-metallic door and window fittings, kennels for household pets, animal and pet carriers, slatted indoor blinds, coat hangers and coat hooks, non-metallic infant walkers, inflatable publicity objects, non-metallic jewellery cases, plastic key cards, non-metallic number plates, playpens for babies, household or kitchen utensils and containers, combs and sponges, brushes (except paintbrushes), articles for cleaning purposes, glass, glassware, porcelain and earthenware, baby baths, portable baths, candlesticks, gloves for household purposes, non-electric whisks, blenders, presses, grinders, polishers, pressure cookers, mills for household purposes, shoe appliances, toothbrushes, presses and stretchers, vanity cases, watering devices, non-metallic piggy banks, cash boxes, animal and pet cages, animal and pet litter trays and boxes, containers for household pets, animal and pet accessories, indoor terraria, textiles and textile goods, bed and table covers, plastic coverings for furniture, pillow or cushion covers, plastic or textile or net curtains, upholstery fabrics, woollen fabric, eiderdowns, clothing, footwear, headgear, lace and embroidery, ribbons and braid, buttons, hooks and eyes, pins and needles, artificial flowers, hair ornaments, false hair, badges to wear, bags (zip fasteners for), hat ornaments, hair bands, knitting needles, needle cases, pin cushions, sewing boxes and sewing needles, sewing thimbles, shoe fasteners, shoe laces, shoe ornaments, shoulder pads (for clothing), tapes for curtain headings, trouser clips for cyclists, toupees, wigs, zippers, floor coverings, carpets, carpets for vehicles, bath mats, rugs, mats, matting, linoleum, wall hangings (non-textile), wallpaper, artificial turf, games and playthings, playing cards, gymnastic and sporting articles, decorations for Christmas trees, childrens' toy bicyc-

les, toys and dolls, artificial snow for Christmas marionettes, confetti, sports equipment, toy scooters, in-line skates and roller skates.

(260) AM 2013 67048 A

(800) 1104378

(731) KENDAL ELEKTRİK AYDINLATMA
ELEKTRONİK İNŞAAT SANAYİ VE DİS
TİCARET LİMİTED SİRKETİ
Buyukhendek Cad. No.14, Karakoy –
Beyoglu, Istanbul, Turkey

(540)

(591) Black, white

(511)

9 – Measurement tools, instruments and indicators including the ones for scientific purposes and for laboratory use; laboratory apparatus and instruments for scientific use; apparatus for reproduction, recording and transmission of sound and images, including electronic tools, computer softwares and hardwares for data processing, communicating, and duplicating; magnetic and optical recorders or recorders in the form of exposed films; antennas, satellite antennas, amplifiers and parts thereof; vending machines, ticket dispensers, ATMs; electrical and electronic components used at machines and equipments; meters and timers to get consuming amount for a specific period of time; controlling instruments and tools for conduction, conversion, storage of electrical energy (including cables and power sources used in electricity and electronics); warning instruments and alarms, (except vehicle alarms), electric alarm bells; electric flat irons; electric steam irons; electronic signalling apparatus and instruments, signalling devices as traffic-light devices; fire extinguishing apparatus and devices including vehicles for fire extinguishing purposes; electric welding apparatus (including welding electrodes); radar apparatus, sonars, apparatus and devices for the improvement of night sighting; electric devices for attracting and killing insects; automatic doors for buildings, automatic turnstiles, electric, electronic or remote control door closers/openers of buildings and vehicles; apparatus for electrolysis and galvanizing purposes; anodes, cathodes; magnets, decorative magnets.

11 – Illuminating equipment (illuminating armatures for vehicles, indoor and outdoor spaces); apparatus for heating and steam generating (including stoves and kitchen stoves functioning with coal, fuel, electricity and gas); air conditioning and ventilation apparatus; refrigerators and freezers; electric and gas apparatus, machines and instruments for cooking, drying and boiling purposes (including

the ones for personal care); water installations, sanitary ware; water softening apparatus, water purification apparatus, water purification system, waste treatment system; instruments including hand drying apparatus for washrooms (included in this class) used in beauty saloons; mattress and blankets, electric, other than medical use, heating pillows, electric or non-electric foot warmers; filters and filter-motor combinations for aquariums; Industry type cooking, drying and cooling installation; pasteurizers and sterilizers.

(260) AM 2013 67050 A

(800) 1040112

(731) ZENTIVA, K.S.

U Kabelovny 130, CZ-102 37 Praha
10 – Dolní Měcholupy, Czech Republic

(540)

KAPIDIN

(591) Black, white

(511)

5 – Antihypertensive pharmaceutical preparations containing the active substance lercanidipini HCL (preparation for reduction of the blood pressure), not applied intravenously or by injection.

(260) AM 2013 67051 A

(800) 1072650

(731) CACHE-CACHE "Société par actions
simplifiée"

ZAC de la Moinerie, 10 impasse du Grand
Jardin, F-35400 Saint-Malo, France

(540)

(591) Yellow and gray

(511)

3 – Toiletries; tissues impregnated with cosmetic lotions; cleansing milks; antiperspirants, soaps, cakes of toilet soap, personal deodorants; deodorant soaps; oils for cosmetic use; perfumery oils; toiletry oils; perfumery goods, eaux de toilette, scented water, perfumes, cologne; essential oils; ethereal oils; flower extracts (perfumery); cosmetics, cosmetic preparations for skin, body and facial care; cosmetic creams; cosmetic lotions; sun-tanning preparations (cosmetics); beauty masks; cosmetic bath preparations; bath salts, not for medical use; aromatics (essential oils); cosmetic kits; cosmetic preparations for slimming purposes; cotton buds for cosmetic use; after-shave lotions; cosmetic creams, cotton wool for cosmetic use; depilatories; depilatory preparations; nail care preparations; dentifrices; make-up and make-up removing preparations, lipsticks, mascara, make-up, nail polish; cosmetic preparations for eyelashes; eyebrow cosmetics;

eyebrow pencils; make-up powder; cosmetic pencils; cosmetic hair care preparations; hair lotions; hair dyes; hair styling waxes; oil for hair; hair gel; hair spray; bleaching agents for cosmetic use, shampoos, hair spray; decorative transfers for cosmetic use; false nails; false eyelashes; incense; sachets for perfuming linen; potpourris.

9 – Optical goods; spectacles (optics); sunglasses; spectacle frames; spectacle cases; spectacle lenses; sound and video recordings; compact discs and CD-ROMs; pre-recorded compact discs and CD-ROMs containing information relating to fashion, and/or entertainment, and/or music, and/or videos, and/or films, and/or books, and/or television, games and/or sports; optical data media; music jukeboxes; apparatus, instruments and media for recording, reproducing, storing, processing, manipulating, transmitting, broadcasting, retrieving, downloading and reproducing music, sound, images, texts, data; computer software for transmitting sound, images, texts and data on communication networks; transmitters and receivers (audio, video); tapes; cassettes, audio cassettes, video cassettes; magnetic cards; memory or microchip cards; compact discs and other data media; optical and magnetic devices, all containing or designed to contain audio and/or video recordings; audio and/or video recordings; headphones; cases for mobile telephones; cases for apparatus, instruments and media for recording, reproducing, storing, processing, manipulating, transmitting, broadcasting, retrieving, downloading and reproducing music, sound, images, text, data; downloadable electronic publications; protective helmets for sports.

14 – Precious metals and their alloys other than for dental use, jewelry, precious stones, horological and chronometric instruments; watches, watch cases, watch bands, alarm clocks, clocks; bands, rings (jewelry), earrings, bracelets, brooches (jewelry), necklaces, fashion jewelry, charms, tie clips, tie pins, caskets made of precious metal; boxes of precious metal; jewelry cases (of precious metal); statues of precious metal.

16 – Paper, cardboard (unprocessed, semi-processed or for stationery purposes); printed matter; stationery articles; pencils; pens; electric or non-electric pencil sharpeners; transfers (decalcomanias); paper clasps; sets; bookmarks; page markers; bookmarks; note clips; bookends; non-textile labels; plastic packaging materials, namely plastic bags, sachets, films and sheets for packaging purposes; sachets (envelopes, small bags) for packaging (made of paper); packaging packets of paper or cardboard; packaging cartons; posters; advertisement boards of paper or cardboard; albums; stickers (stationery); pads (stationery); calendars; notebooks; booklets; files (office requisites); document folders; catalogs; printed matter; newspapers; prospectuses;

publications, particularly publications in the fashion field; bookbindings; bookbinding articles; indexes; journals (periodicals); postcards; office requisites, except furniture; cardboard or paper boxes.

18 – Leather and imitation leather, goods made thereof (leather and imitation leather) not included in other classes, namely travel chests, bags and sets, vanity cases, trunks, small cases, school satchels, attaché cases and briefcases, suitcases, card holders, purses and wallets (not made of precious materials), backpacks, handbags; umbrellas, parasols, sunshades and walking sticks; whips, harness and saddlery; key cases (leather goods); spectacle cases (leather goods); school bags; money pouches; business cases; backpacks; school book bags; beach bags; shopping bags; wheeled bags; garment bags (for travel); sports bags other than those adapted for their contents; boxes of leather or imitation leather; strips of leather or imitation leather; straps of leather or imitation leather; animal collars of leather or imitation leather; clothing for animals; leashes; muzzles; animal skins, pelts and hides; leather or imitation leather goods (excluding cases adapted to the goods for which they are intended, gloves and belts).

24 – Fabrics for textile use, bed and table covers, lingerie fabric, table and household linen (except paper table linen), upholstery fabrics, bed covers, bedspreads, sheets, mattress covers, textile hand towels, cushion cases, covers for comforters, tablecloths (not of paper), rugs, pillowcases, textile or plastic curtains, table napkins of textile, face towels of textile; bath linen (except clothing); bath towels; washcloths; cotton fabrics, cotton cloths; sleeping bags (sheeting); textile blinds; stickable adhesive fabric; elastic fabrics; fabric labels, fabrics, fiberglass fabrics for textile use; textile filtering materials, calico fabrics; jersey fabrics; jute fabric; woollen fabric; woollen cloths; linen cloth; bed linen; fabric of imitation animal skins; textile wall hangings, eiderdowns (down coverlets).

25 – Clothing, clothing for men, clothing for women, clothing for children; suits, overalls (clothing); leather and imitation leather clothing; dresses, skirts, underskirts, slacks, Bermuda shorts, shorts; shirts, short-sleeved shirts, blouses, singlets, tee-shirts, tank tops; vests, sweaters, pullovers, knitwear; jackets, gabardines, raincoats, coats, overcoats, parkas, pea jackets; sports clothing, sports footwear, cycling shorts; bathing caps, swimming trunks, bathing suits; bathrobes, bath sandals, bath slippers; pajamas, nightgowns, dressing gowns; suspenders, belts (clothing); socks, tights; collar protectors, sashes for wear, scarves, furs, hand-warmers, mittens, gloves (clothing); shawls, ponchos; underclothing, body wear, intimate apparel, underclothing, briefs, panties, slips (underclothing), bodysuits (leotards), crop tops, briefs, brassieres; layet-

tes; headgear; headbands (clothing), berets, caps, baseball caps, hats, ear muffs, hoods, visors (headgear); footwear (excluding orthopedic footwear); sandals, boots, espadrilles, slippers, booties.

35 – Retail sale of clothing, underclothing, footwear, headgear, fashion accessories, home accessories (namely ornamental art objects, candle holders, table linen, dishware, lamps, vases), household linen, jewelry, cosmetics, perfumery, luggage; wholesaling in clothing, underclothing, footwear, headgear, fashion accessories, home accessories (namely ornamental art objects, candle holders, table linen, dishware, lamps, vases), household linen, jewelry, cosmetics, perfumery, luggage; commercial information and advice for consumers; import-export services in clothing, underclothing, footwear, headgear, fashion accessories, home accessories, household linen, jewelry, cosmetics, perfumery, luggage; advertising; services for distributing advertisements, advertising publications, sales promotion for third parties, bill-posting; services for updating advertising literature; distribution and dissemination of advertising materials namely samples; product demonstration services; modeling for advertising or sales promotion; advertising, namely preparation of media plans; services relating to exhibition planning for commercial or promotional purposes; advertising sponsorship services; business management; business administration; office functions; data recording and processing services namely data input, compilation and systemization; computer file management services; collection of data in a central file; systemization of information into a central file; business management assistance services; business management and organization consultancy; management assistance services for commercial or industrial companies; retail sale in the field of entertainment, namely pre-recorded audiovisual and musical works; retail sale of entertainment products, namely pre-recorded audiovisual and musical works.

41 – Entertainment, radio entertainment, television entertainment, entertainment information; providing of training; videotape recording (filming), providing on-line electronic publications (not downloadable); editing and publishing of texts, illustrations, books, magazines, newspapers, periodicals and more generally all types of publication other than advertising texts, including electronic and digital publications; publishing of texts, images, audio and/or video works, particularly via communication networks; organization of lotteries and games of all kinds; organization of exhibitions for cultural or educational purposes; organization of competitions (education or entertainment); organization of sports competitions; production of films, production of shows, particularly concerts, musical shows; videotape film production; music production; practical training (demonstration); on-line game services (via a computer network); leisure services; organization of beauty contests; organization of shows (impre-

sario services), organization of events in the fashion field; organization and conducting of training workshops, organization and conducting of colloquiums, conventions, seminars, symposiums; photography, photographic reporting; party planning (entertainment); music publishing services; entertainment, via communication networks; editing of multimedia content in the field of fashion, music, video, films, entertainment, games, sports.

42 – Computer system installation analysis; graphic arts design services, packaging design services, fashion design services, styling; database reconstitution; computer systems design, development (design) of computer software, installation of computer software, updating of computer software, rental of computer software; quality control; cosmetic research; creation and maintenance of web sites for third parties, hosting of web sites.

(260) AM 2013 67052 A

(800) 1072990

(731) COMSERV (NO.3036) PTY LIMITED

Unit 2, 4 Warringah Close, Somersby NSW
2250, Australia

(540)

WHITELINE

(591) Black, white

(511)

12 – Motor vehicle spare parts; fittings and accessories for motor vehicles, namely, coil springs for vehicle suspension, suspension springs, suspension dampers, suspension shock absorbers, air pumps (vehicle accessories), struts, strut and chassis bracing, sway bars, torsion bars, anti-roll bars for vehicles in this class; steering apparatus, camber and caster correction products, casters (wheels) for vehicles, polyurethane bushings, adjustable suspension.

(260) AM 2013 67053 A

(800) 1076518

(731) F. HOFFMANN-LA ROCHE AG

Grenzacherstrasse 124, CH-4070 Basel,
Switzerland

(540)

IQAYLA

(591) Black, white

(511)

5 – Pharmaceutical preparations.

(260) AM 2013 67054 A

(800) 1089303

(731) MEDICE ARZNEIMITTEL PÜTTER

GMBH & CO. KG

Kuhloweg 37, 58638 Iserlohn, Germany

(540)

MEDYN

(591) Black, white

(511)

5 – Veterinary and sanitary preparations, except the aforesaid goods with analgesic and anti-bacterial properties; pharmaceutical preparations for lowering homocysteine levels; food supplements for medical purposes; vitamin preparations, all the aforesaid goods other than with analgesic and anti-bacterial properties, also except pharmaceutical preparations for treating infertility and sanitary preparations for treating infertility, except preparations for treating tumours and urological medicines.

(260) AM 2013 67080 A

(800) 1111548

(731) Pearl Luxury Group SA

102B, rue de Mamer, L-8081 Bertrange,
Luxembourg

(540)



(591) Black, white

(511)

14 – Precious metals and their alloys and goods in precious metals or coated therewith, not included in other classes; jewelry; jewelry; precious stones; horological and chronometric instruments; jewelry; necklaces; bracelets; rings; charms; jewel pendants; earrings; cuff links; medallions; watches; watch bands; jewelry articles; necktie pins; ornamental pins; jewelry cases (caskets); jewelry cases; diamonds; precious stones; precious stones; keyrings (trinkets or fobs), statues or figurines (statuettes) of precious metal; boxes and cases for timepieces and jewellery; medals.

18 – Leather and imitations of leather, and goods made of these materials and not included in other classes; animal skins; trunks and travelling bags; umbrellas, parasols and walking sticks; whips, harness and saddlery; vanity cases (not fitted); leatherware (not included in other classes); bags not included in other classes; saddlebags; school bags; suitcases; trunks; valises; travelling trunks; key cases; travelling sets; wallets; briefcases; purses; card cases (notecases); straps of leather; shoulder belts of leather.

35 – Advertising; business management; business administration; office functions; presentation of goods on communication media, for retail purposes; commercial administration of the licensing of the

goods and services of others; organization of exhibitions for commercial or advertising purposes; administrative and commercial management of the retail sale of jewelry goods and leatherware; wholesale services for jewelry goods and leatherware; retail services for jewelry goods and leatherware.

(260) AM 2013 67081 A

(800) 1111589

(731) DR. CORNELIA CLAUDIUS

Jakobsgasse 26, 72070 Tübingen, Germany

(540)

Otoglobe

(591) Black, white

(511)

5 – Pharmaceutical and veterinary products.

10 – Medical devices.

(260) AM 2013 67082 A

(800) 1111600

(731) KRKA, tovarna zdravil, d.d., Novo mesto

Šmarješka cesta 6, SI-8501 Novo mesto,
Slovenia

(540)

BALUTAR

(591) Black, white

(511)

5 – Pharmaceutical preparations.

(260) AM 2013 67083 A

(800) 1111601

(731) KRKA, tovarna zdravil, d.d., Novo mesto

Šmarješka cesta 6, SI-8501 Novo mesto,
Slovenia

(540)

БАЛУТАР

(591) Black, white

(511)

5 – Pharmaceutical preparations.

(260) AM 2013 67084 A

(800) 1111602

(731) Russkaya Upravlyayushchaya Kompaniya, OOO

Novomytishchenskiy prospekt, 41, korp. 1,
Mytishchi, RU-141018 Moskovskaya Oblast,
Russian Federation

(540)

SLOBODA

(591) Black, white

(511)
33 – Aperitifs; brandy; wines; piquette; whisky; vodka; gin; digesters [liqueurs and spirits]; cocktails; liqueurs; alcoholic beverages, except beer; alcoholic beverages containing fruit; spirits [beverages]; distilled beverages; mead [hydromel]; peppermint liqueurs; bitters; rum; sake; cider; rice alcohol; alcoholic extracts; fruit extracts, alcoholic; alcoholic essences.

(260) AM 2013 67085 A
(800) 1111608
(731) KLYMENKO SERGII LEONIDOVYCH
Narodnogo Opolchennya str., 7, apt. 90, Kyiv
03151, Ukraine

(540)



(591) Black, white
(511)
25 – Pants, drawers (clothing), tights, slips (undergarments), bodices (lingerie), corsets (underclothing), bathing suits; swimsuits, brassieres; camisoles; singlets; underclothing, underwear; teddies (undergarments); tips for footwear; clothing for gymnastics; hosiery; stockings; pyjamas; beach clothes; shirts, skirts; petticoats; frocks; knitwear (clothing); underpants; sports shirts; dressing gowns; bath robes; socks.

35 – Sales promotion for others.

(260) AM 2013 67087 A
(800) 1111635
(731) WELFAR İLAÇ TIC. LTD. STİ.
Atatürk Hava Alani, Serbest Bölgesi Plaza
N° 319, Vesilköy, Istanbul, Turkey

(540)



(591) Black, white
(511)
5 – Pharmaceutical and veterinary preparations; sanitary preparations for medical purposes; dietetic substances adapted for medical use, food for babies; plasters, materials for dressings; material for stopping teeth, dental wax; disinfectants; preparations for destroying vermin; fungicides, herbicides.

(260) AM 2013 67088 A
(800) 1111693
(731) Medice Arzneimittel Pütter GmbH & Co. KG
Kuhloweg 37, 58638 Iserlohn, Germany
(540)



(591) Black, white
(511)
5 – Pharmaceutical, veterinary and sanitary preparations; pharmaceutical preparations for food supplements, included in this class, except pharmaceutical active substances per se, dietetic substances adapted for medical use, food for babies; plasters, materials for dressings; material for stopping teeth, dental wax.

(260) AM 2013 67090 A
(800) 1111724
(731) Obshchestvo s ogranichennoy
otvetstvennostju "KREPMARKET"
11, Timiryazevskaya street, RU-127422
Moscow, Russian Federation

(540)



(591) White, red and black
(511)
6 – Bolts of metal; eye bolts; screws of metal; sleeves (metal hardware); nuts of metal; nails; horseshoe nails; brads; crampons of metal; rivets of metal; tension links; knobs of metal; lintels of metal; collars of metal included in this class; hinges of metal.

16 – Posters; forms (printed); booklets; packing paper; signboards of paper or cardboard; bags (envelopes, pouches) of paper or plastics, for packaging; cardboard articles; calendars; tear-off calendars; boxes of cardboard or paper; viscose sheets for wrapping; plastic bubble packs for wrapping or packaging; sheets of reclaimed cellulose for wrapping; stickers (stationery); sealing wafers; plastic cling film, extensible, for palletization; plastic film for wrapping; prospectuses; placards of paper or cardboard; advertisement boards of paper or cardboard; labels, not of textile.

35 – Accounting; efficiency experts; demonstration of goods; opinion polling; marketing studies; personnel recruitment; organization of exhibitions for commercial or advertising purposes; organization of trade fairs for commercial or advertising purposes; shop window dressing; payroll preparation; commercial or industrial management assistance;

auctioneering; sales promotion for others; distribution of samples; procurement services for others (purchasing goods and services for other businesses); drawing up of statements of accounts; import-export agencies; rental of advertising space; on-line advertising on a computer network; business information; updating of advertising material; radio advertising; dissemination of advertising matter; advertising; advertising by mail order; television advertising; systemization of information into computer databases; business inquiries.

(260) AM 2013 67091 A

(800) 1111738

(731) VILLEROY & BOCH AG

Postfach 11 20, 66693 Mettlach, Germany

(540)

O.novo

(591) Black, white

(511)

11 – Apparatus and instruments for lighting, heating, steam generating, cooking, refrigerating, drying, ventilating and water supply; sanitary apparatus and installations; fittings for wash basins, sinks, bath tubs, showers; light apparatus; light fixtures; bath tubs; bath installations; bath fittings; bidets; showers; shower cubicles (enclosures); shower trays; electric lamps; water taps; pipe line cocks (spigots); lamps; spa baths; hand-operated valves and mixer valves for sanitary water supply; regulating accessories for water apparatus and for water pipes; sauna installations; siphons; bath tubs for sitz baths; shower basins, sinks; water closets; toilet bowls; toilet seats; water flushing installations; flushing tanks; urinals (sanitary fixtures); urinal covers; mixer taps for water pipes; water conduits installations; water supply installations; water distribution installations; whirlpools; wash-hand basins (parts of sanitary installations); parts and accessories for the aforesaid goods, included in this class; wall lamps.

20 – Furniture; mirrors; picture frames; goods (not included in other classes) of wood, cork, reed, cane, wicker, horn, bone, ivory, whalebone, shell, amber, mother-of-pearl, meerschaum and substitutes for all these materials, or of plastics; benches (furniture); cases of wood or plastic; holders and units for bath and toilet utensils; chests of drawers; wickerwork; fixed towel dispensers, not of metal; stools; racks; mirror tiles; mirror cabinets; dressing tables; wall plaques made of plastic or wood; washstands (furniture).

21 – Household and kitchen utensils and containers; unworked or semi-worked glass (except glass used in building); glassware, porcelain and earthenware, not included in other classes; towel holders; cera-

mics for household purposes; baskets, for domestic use; works of art, of porcelain, terra-cotta or glass; soap boxes; soap holders, soap dishes; soap dispensers.

(260) AM 2013 67092 A

(800) 1111748

(731) TU ER XUN JIANG – YI MA MU AI SHAN

N401, Unit 1, Building 1, Heba Erxiang, Shengli Road, Wulumuqi City, 830002 Xinjiang, China

(540)



(591) Black, white

(511)

7 – Saw benches (parts of machines); woodworking machines; paring machines; saw blades (parts of hand tools); saws (machines); whip stitching machines; wrapping machines; packing machines; truck lifts; lifters; metalworking machines; hydraulic engines and motors; generate electricity apparatus of wind power; shears, electric; knives, electric; electric hand drills; glue guns, electric; electric screwdrivers; electric spanners; grinding wheel machines, electric; hydraulic hand-held tools; hand-held machines of hydraulic pressure; hand-held tools of wind power; pneumatic pin guns; angle burnishing machines; painting machines; spray guns for paint; spray machines for paint; electric hammers.

(260) AM 2013 67095 A

(800) 386068

(731) Boehringer Ingelheim Pharma GmbH & Co. KG

55218 Ingelheim, Germany

(540)

BERODUAL

(591) Black, white

(511)

5 – Pharmaceutical and veterinary preparations and preparations for sanitary applications; dietetic preparations for children and the sick; plasters, materials for dressings; materials for dental fillings and dental impressions; disinfectants.

(260) AM 2013 67096 A

(800) 433381

(731) W.L. Gore & Associates GmbH

Hermann-Oberth-Strasse 22, 85640 Putzbrunn, Germany

(540)

GORE-TEX

(591) Black, white

(511)

1 – Chemical products for use in industry, science and photography made of polytetrafluoroethylene (excluding products for water treatment and preparation, rust removers and anticorrosive products, as well as agents for coating metal surfaces); unexposed films, impregnating products for textiles, felt pens and paper; synthetic materials of fluorocarbon polymers in a plastic state; filtering and separating materials of plastic.

5 – Materials for dressings of synthetic fibers for injuries for humans and animals, especially for burns.

9 – Insulated electrical cables and conduits, water-repellent and/or flame retardant outerclotting for protection against accidents or for rescue teams.

10 – Veins, arteries, lungs, kidneys and other human body parts of plastic materials.

12 – Boat hulls and coatings for boats of plastic materials.

16 – Plastic packaging materials; plastic sheets for packaging purposes.

17 – Joints, sealing tapes, insulating materials, insulating tapes for cables, flexible tubes and sheaths, fittings for valves and for flanges, all the aforementioned parts of plastic; filtering and separating materials of plastic or plastic sheets, insulating fabrics of plastic materials.

18 – Handbags of plastic; net bags for shopping.

19 – Building materials, panels, all of plastic materials.

20 – Plastic containers.

21 – Plastic containers.

22 – Binding wire and cables of plastic materials, nets, i.e. catching nets and fishing nets, tents, tarpaulins and awnings, all of synthetic fibers; weather protective fabrics made of plastic materials.

23 – Synthetic threads and yarns.

24 – Synthetic fiber fabrics; bed and table covers of synthetic materials, waterproof textiles, fabrics for rainproof clothing and clothing for protecting against adverse weather conditions of synthetic materials or synthetic fibers; filtering nets of synthetic fibers.

25 – Woven or knitted garments and underwear made of synthetic fibres (excluding elastic stockings and trousers for medical purposes, as well as sanitary pads, menstruation knickers and belts for

sanitary towels), footwear, soles for footwear and heel pieces, of plastic.

26 – Plastic tapes; hair nets of synthetic fibers.

27 – Carpets and mats of synthetic fibers, coverings for floors and drapes of synthetic materials in strip, plate or sheet form.

28 – Children's toys and ski overclotting of synthetic materials; tennis nets of synthetic fibers.

(260) AM 2013 67097 A

(800) 511209

(731) LABORATOIRES DE BIOLOGIE
VEGETALE YVES ROCHER, Société
anonyme F-56201 LA GACILLY, France

(540)

HYDRAVEGETAL

(591) Black, white

(511)

3 – Perfumery; cosmetics; toilet soaps; creams; hair lotions, gels, sprays, dyes and shampoos; dentifrices.

(260) AM 2013 67098 A

(800) 668634

(731) W.L. Gore & Associates GmbH
Hermann-Oberth-Strasse 22, 85640
Putzbrunn, Germany

(540)



(591) Black, white

(511)

9 – Clothing for protection including for accidents.

24 – Textiles and textile laminates included in this class.

25 – Clothing, shoes, boots, headgear, gloves.

(260) AM 2013 67099 A

(800) 771294

(731) BARILLA G. E. R. FRATELLI - SOCIETÀ
PER AZIONI
Via Mantova, 166, I-43100 PARMA, Italy

(540)



(591) Blue, red, white and yellow

(511)

29 – Meat, fish, poultry and game; meat extracts; preserved, dried and cooked fruit and vegetables; jellies, jams; compotes; eggs, milk and dairy products; edible oils and fats.

30 – Coffee, tea, cocoa; sugar; rice; tapioca; sago; coffee substitutes; flour and preparations made from cereals, bread, pasta, biscuits, pastry and confectionery, edible ice; honey, treacle; yeast, baking powder; salt, mustard; vinegar, sauces (condiments); spices; ice for refreshment.

(260) AM 2013 67100 A

(800) 830388

(731) IDEMITSU KOSAN CO., LTD.

1-1, 3-chome, Marunouchi, Chiyoda-ku,
Tokyo 100-8321, Japan

(540)

IDEMITSU

(591) Black, white

(511)

4 – Fuels; industrial oils (including lubricating oils); non-mineral oils and greases for industrial purposes (not for fuel); wax; grease for shoes and boots; solid lubricants; leather preserving oils and greases; lamp wicks; candles.

(260) AM 2013 67127 A

(800) 1111947

(731) THE MCKENZIE CORPORATION
LIMITED

The Old Rectory, 1 North Road, Ponteland
Village, Northumberland NE20 9UH,
United Kingdom

(540)

MCKENZIE

(591) Black, white

(511)

25 – Clothing; footwear; shoes, boots and sandals; headgear; hats.

(260) AM 2013 67140 A

(800) 1112109

(731) ZAKRYTOE AKTSIONERNOE
OBCHTCHESTVO "GROUPPA EITI"
str.2, 14, oul. B. Novodmitrovskaya,

RU-127015 Moskva, Russian Federation

(540)



(591) White, turquoise blue and light turquoise blue

(511)

9 – Magnetic tape units for computers; computer memory devices; magnetic data media; optical data media; distance recording apparatus; connections for electric lines; electric installations for the remote control of industrial operations; steering apparatus, automatic, for vehicles; balancing apparatus; video recorders; sound reproduction apparatus; invoicing machines; readers (data processing equipment); bar code readers.

35 – Cost/price analysis; auditing; computerized file management; invoicing; transcription; opinion polling; marketing studies; business information; commercial information and advice for consumers; business research; marketing research; personnel recruitment; business management and organization consultancy; personnel management consultancy; business organization consultancy; business management consultancy; professional business consultancy; business appraisals; data search in computer files for others; business management assistance; commercial or industrial management assistance; economic forecasting; sales promotion for others; compilation of information into computer databases; systemization of information into computer databases; outsourcing services (business assistance); efficiency experts.

37 – Electric appliance installation and repair; installation, maintenance and repair of computer hardware; office machines and equipment installation, maintenance and repair; machinery installation, maintenance and repair; interference suppression in electrical apparatus.

38 – Electronic bulletin board services (telecommunications services); information about telecommunication; telecommunications routing and junction services; providing access to databases; computer aided transmission of messages and images; electronic mail; rental of telecommunication equipment; communications by computer terminals.

42 – Computer system analysis; recovery of computer data; computer virus protection services; technical project studies; engineering; installation of computer software; technical research; consultancy in the design and development of computer hardware; computer software consultancy; updating of computer software; maintenance of computer soft-

ware; conversion of data or documents from physical to electronic media; data conversion of computer programs and data [not physical conversion]; computer system design; rental of web servers; computer rental; rental of computer software; duplication of computer programs; computer software design; creating and maintaining web sites for others; computer programming; surveying.

(260) AM 2013 67141 A

(800) 1112116

(731) HENKEL AG & CO. KGAA

Henkelstraße 67, 40589 Düsseldorf,
Germany

(540)



(591) Black, white

(511)

3 – Preparations for conditioning, cleaning, tinting, dyeing, bleaching, setting and perming hair, hair lotions and shampoos for cosmetic purposes.

(260) AM 2013 67142 A

(800) 1112117

(731) "DOSUG PROBA" Limited Liability
Company

Shchelkovskoye shosse 98/57, RU-10552
Moscow, Russian Federation

(540)



(591) Red and black

(511)

12 – Motor buses; automobiles; sports cars; concrete mixing vehicles; refrigerated vehicles; casings for pneumatic tires [tyres]; suspension shock absorbers for vehicles; space vehicles; luggage carriers for vehicles; bumpers for automobiles; vehicle bumpers; transmission shafts for land vehicles; bicycles; valves for vehicle tires [tyres]; automobile hoods; hoods for vehicles; trucks; horns for vehicles; treads for vehicles [tractor type]; doors for vehicles; engines for land vehicles; rearview mirrors;

inner tubes for bicycles, cycles; inner tubes for pneumatic tires [tyres]; hoods for vehicle engines; crankcases for land vehicle components, other than for engines; vehicle wheels; wheels for bicycles, cycles; brake shoes for vehicles; hub caps; side cars; baskets adapted for cycles; panniers adapted for cycles; gear boxes for land vehicles; bands for wheel hubs; caps for vehicle petrol [gas] tanks; bodies for vehicles; traction engines; tailboard lifts [parts of land vehicles]; propulsion mechanisms for land vehicles; mopeds; motorcycles; freewheels for land vehicles; clutches for land vehicles; repair outfits for inner tubes; air pumps [vehicle accessories]; pumps for bicycles, cycles; upholstery for vehicles; rims for vehicle wheels; windows for vehicles; axles for vehicles; pedals for cycles; gearing for land vehicles; carts; head-rests for vehicle seats; vehicle running boards; air bags [safety devices for automobiles]; vehicle covers [shaped]; anti-glare devices for vehicles; anti-theft devices for vehicles; sun-blinds adapted for automobiles; non-skid devices for vehicle tires [tyres]; balance weights for vehicle wheels; shock absorbing springs for vehicles; frames for bicycles, cycles; security harness for vehicle seats; vehicle suspension springs; rudders; handle bars for bicycles, cycles; cranks for cycles; bicycle saddles; saddles for bicycles, cycles or motorcycles; luggage nets for vehicles; dress guards for bicycles, cycles; anti-theft alarms for vehicles; reversing alarms for vehicles; vehicle seats; safety seats for children, for vehicles; scooters [vehicles]; vehicle wheel spokes; undercarriages for vehicles; cycle cars; electric vehicles; remote control vehicles, other than toys; tri-cycles; windscreens; windshield wipers; cycle stands; hubs for vehicle wheels; trailer hitches for vehicles; couplings for land vehicles; brakes for vehicles; brakes for bicycles, cycles; torsion bars for vehicles; transmissions, for land vehicles; caravans; stands for bicycles, cycles [parts of bicycles, cycles]; vans [vehicles]; automobile chains; chains for bicycles, cycles; covers for vehicle steering wheels; saddle covers for bicycles or motorcycles; seat covers for vehicles; vehicle chassis; automobile chassis; connecting rods for land vehicles, other than parts of motors and engines; axle journals; gears for cycles; tubeless tires [tyres] for bicycles, cycles; bicycle tires [tyres]; automobile tires [tyres]; tires for vehicle wheels; vehicle wheel tires [tyres]; pneumatic tires [tyres]; spikes for tires [tyres]; mudguards; motors, electric, for land vehicles; brake linings for vehicles; shock absorbers for automobiles.

35 – Advertising agencies; demonstration of goods; opinion polling; marketing studies; business information; commercial information and advice for consumers [consumer advice shop]; business investigations; marketing research; business management consultancy; business organization consultancy; bu-

business management and organization consultancy; professional business consultancy; organization of exhibitions for commercial or advertising purposes; organization of trade fairs for advertising purposes; business appraisals; business management assistance; commercial or industrial management assistance; presentation of goods on communication media, for retail purposes; sales promotion for others; publication of publicity texts; distribution of samples; dissemination of advertising matter; advertising; business inquiries; commercial administration of the licensing of the goods and services of others; administrative processing of purchase orders; public relations; relocation services for businesses; price comparison services; procurement services for others [purchasing goods and services for other businesses]; outsourcing services [business assistance]; efficiency experts.

42 – Research and development for others; vehicle roadworthiness testing.

(260) AM 2013 67145 A
(800) 1112134
(731) Liability Limited Company "Elfa laboratory"
vul. Simi Sosninykh, 9, m. Kyiv 03148,
Ukraine

(540)

Baby Born

(591) Black, white

(511)

3 – Bleaching preparations and other substances for laundry use; cleaning, polishing preparations, degreasers, abrasives; soap; perfumes, ethereal oils, cosmetics, hair lotions; dentifrices.

5 – Pharmaceutical and veterinary preparations; sanitary preparations for medical purposes; dietetic food and substances adapted for medical or veterinary use, food for babies; plasters, materials for dressings; material for stopping teeth and dental wax; disinfectants; preparations for destroying vermin; fungicides, herbicides.

(260) AM 2013 67146 A
(800) 1112162
(731) UCB PHARMA S.A.
Allée de la Recherche 60, 1070
BRUXELLES, Belgium

(540)

SYNVOXA

(591) Black, white

(511)

5 – Pharmaceutical and veterinary preparations; sanitary preparations for medical purposes; dietetic

substances adapted for medical use; food for babies; plasters, materials for dressings; material for dental fillings and dental impressions; disinfectants; pesticides; fungicides and herbicides.

(260) AM 2013 67147 A
(800) 1112163
(731) UCB PHARMA S.A.
Allée de la Recherche 60, 1070
BRUXELLES, Belgium

(540)

MONAVRI

(591) Black, white

(511)

5 – Pharmaceutical preparations and substances which act on the central nervous system.

(260) AM 2013 67148 A
(800) 1112164
(731) UCB PHARMA S.A.
Allée de la Recherche 60, 1070
BRUXELLES, Belgium

(540)

BRIVIACT

(591) Black, white

(511)

5 – Pharmaceutical and veterinary preparations; sanitary preparations for medical purposes; dietetic substances adapted for medical use; food for babies; plasters, materials for dressings; material for dental fillings and dental impressions; disinfectants; pesticides; fungicides and herbicides.

(260) AM 2013 67149 A
(800) 1112170
(731) NOVAGALI PHARMA SA
1, rue Pierre Fontaine, Bâtiment Genavenir
IV, F-91000 EVRY, France

(540)

KATIOHOPM

(591) Black, white

(511)

5 – Pharmaceutical and veterinary preparations; sanitary preparations for medical purposes; chemical preparations for medical or pharmaceutical purposes; eye-washes; lotions for pharmaceutical purposes; tissues impregnated with pharmaceutical lotions; medicines for human purposes; medicines for veterinary purposes; serums; collyriums; ophthalmic emulsions; chemico-pharmaceutical preparations.

(260) AM 2013 67150 A
 (800) 583969
 (731) FILOPUR AG
 83, Seestrasse, CH-8700 KÜSNACHT,
 Switzerland

(540)

FILOPUR

(591) Black, white
 (511)
 11 – Filters and filtering utensils for purifying liquids, particularly drinking water.

(260) AM 2013 67152 A
 (800) 808667
 (731) ÖNDER AYAKKABI SANAYİ VE
 TİCARET LİMİTED ŞİRKETİ
 Merkez Mahallesi, Merkez Sanayi
 Sitesi Billur, Sokak No: 9 Yenibosna,
 İstanbul, Turkey

(540)



(591) Black, white
 (511)
 25 – Footwear.

(260) AM 2013 67153 A
 (800) 830719
 (731) SOPHARMA AD
 16, Iliensko shaussee Str. BG-1220 SOFIA,
 Bulgaria

(540)

SPASMIL

(591) Black, white
 (511)
 5 – Pharmaceutical and veterinary preparations; sanitary preparations for medical purposes; dietetic substances adapted for medical use, food for babies; plasters, materials for dressings; material for stopping teeth and dental wax; disinfectants; preparations for destroying vermin.

(260) AM 2013 67209 A
 (800) 1112392
 (731) Administration des Biens de SAS Le Prince
 Souverain
 Palais Princier, MC-98000 Monaco, Monaco

(540)

GRACE KELLY

(591) Black, white

(511)
 3 – Soap; perfumery, essential oils, cosmetics, hair lotions.

9 – Eyeglasses; sunglasses; spectacle frames.

14 – Precious metals and their alloys and goods in precious metals or coated therewith, not included in other classes; jewelry, precious stones; horological and chronometric instruments.

16 – Paper, cardboard and goods made from these materials, not included in other classes; printed matter; bookbinding material; photographs; stationery; writing instruments; artists' materials; paintbrushes; printing blocks.

18 – Leather and imitations of leather, and goods made of these materials and not included in other classes; animal skins; trunks and travelling bags; umbrellas, parasols and walking sticks.

25 – Clothing, footwear, headgear.

(260) AM 2013 67222 A
 (800) 1112606
 (731) Société des Produits Nestlé S.A.
 CH-1800 Vevey, Switzerland

(540)

Maestria

(591) Black, white
 (511)

11 – Apparatus for heating milk and for foaming milk; electric apparatus for preparing beverages; electric coffee machines, coffee makers and percolators; parts and components for all of the aforementioned goods.

(260) AM 2013 67223 A
 (800) 1112609
 (731) IMPERIAL S.p.A.
 Via dei Lanaioli, 42 Blocco 11, Centergross
 I-40050 Funo Di Argelato (Bologna), Italy

(540)



(591) Black, white
 (511)
 25 – Clothing, namely, pants, shorts and skirts.

(260) AM 2013 67224 A
 (800) 1112618
 (731) Barilla G. e R. Fratelli – Società per Azioni
 Via Mantova, 166, I-43100 Parma (PR), Italy
 (540)



(591) Black, white
 (511)
 32 – Beers; mineral and aerated waters and other non-alcoholic beverages; fruit beverages and fruit juices; syrups and other preparations for making beverages.

(260) AM 2013 67225 A
 (800) 1112627
 (731) PROBIONOV
 Rue des Frères Lumière, F-15130 ARPAJON
 SUR CERRE, France
 (540)

RESTITUO

(591) Black, white
 (511)
 5 – Pharmaceuticals used to boost the body's immune system or for treating gynecological disorders, gastroenterological disorders, ear, nose and throat disorders, skin disorders; medical preparations, namely freeze-dried bacteria in the composition of biological pharmaceuticals for treating gynecological disorders, intestinal disorders, gastroenterological disorders, disorders linked to imbalances in the intestinal flora, the vaginal flora, skin disorders, disorders of the immune system, autoimmune and inflammatory disorders, ear, nose and throat disorders; sanitary preparations for medical purposes, namely freeze-dried bacteria used for producing biological preparations for treating bowel disorders, gynecological disorders; biological or chemical preparations for pharmaceutical, medical and sanitary purposes, namely probiotics, tribiotics, for treating gastroenterological, gynecological, ear, nose and throat, and skin disorders as well as allergies, immune system disorders and inflammatory disorders; preparations for medical purposes, namely antifungals, antimycotics, antiflatulent agents, antidiarrheic agents, antispasmodics, antiinflammatories or antibiotics; preparations to regulate bowel movements, for medical use; probiotic substances in capsules, for pharmaceutical purposes, for treating disorders linked to imbalances in the vaginal and intestinal flora, flatulence, spasms, and for improving the regularity of bowel movements; vaginal capsules for treating gynecological disorders; disinfectants for use in the sanitary follow-up of patients suffering from gastroenterological disorders, imbalances in the intestinal flora, gynecological disorders,

imbalances in the vaginal flora; nutritional additives for medical purposes; dietetic supplements, foodstuffs, beverages and substances adapted for medical use; vitamin preparations; medical preparations for slimming purposes; mineral food supplements.

(260) AM 2013 67227 A
 (800) 1112681
 (731) OÜ FRIENDS TEXTILE
 Narva mnt 7, EE-10117 Tallinn, Estonia
 (540)

FRIENDS

(591) Black, white
 (511)
 25 – Clothing, footwear, headgear.

(260) AM 2013 67228 A
 (800) 1112688
 (731) BERLUTI
 31 rue Marbeuf, F-75008 PARIS, France
 (540)

BERLUTI

(591) Black, white
 (511)
 18 – Boxes of leather or imitations of leather; travelling bags, travelling sets (leatherware), valises, garment bags for travel; vanity cases (not fitted); bags, rucksacks, handbags; attaché cases (leatherware), pocket wallets, coin holders, briefcases, small suitcases; key cases (leatherware); umbrellas.
 25 – Clothing and underclothing such as shirts, t-shirts, jumpers, vests, skirts, frocks, trousers, coats, jackets, belts (clothing), scarves, sashes for wear, gloves, neckties, socks, lingerie, bathing suits, pajamas; footwear; headgear for wear.

(260) AM 2013 67229 A
 (800) 1112691
 (731) KALISTO BUSINESS CORP.
 P.O. Box 3321, Road Town, Tortola,
 British Virgin Islands
 (540)



(591) Black, brown, red, violet, light blue, beige, yellow, orange, blue, green, light green, pink, white and grey
 (511)
 18 – Purses; card cases (notecases); chamois leather, other than for cleaning purposes; umbrellas;

parasols; briefcases; imitation leather; leather, unworked or semi-worked; cases, of leather or leatherboard; pocket wallets; chain mesh purses; bags (envelopes, pouches) of leather, for packaging; vanity cases, not fitted; music cases; bandoliers; backpacks; leather straps; travelling bags; travelling sets (leatherware); sling bags for carrying infants; garment bags for travel; handbags; wheeled shopping bags; beach bags; bags for sports; bags for campers; shopping bags; net bags for shopping; school bags; travelling trunks; walking sticks; umbrella sticks; walking stick seats; key cases (leatherware); valises; suitcases; attache cases; umbrella covers.

25 – Bandanas (neckerchiefs); underwear; blouses; boas (necklets); breeches for wear; half-boots; trousers; brassieres; galoshes; neckties; boot uppers; waistcoats; knitwear (clothing); heels; pants; tights; combinations (clothing); bodices (lingerie); suits; swimsuits; jackets (clothing); sports jerseys; cuffs; sleep masks; heelpieces for boots and shoes; ear muffs (clothing); socks; bath slippers; beach shoes; boots for sports; footwear; outerclothing; ready-made clothing; clothing of imitations of leather; clothing of leather; clothing; fittings of metal for shoes and boots; overcoats; gloves (clothing); pyjamas; bathing trunks; scarfs; frocks; coats; waterproof clothing; headbands (clothing); garters; soles for footwear; braces for clothing (suspenders); lace boots; belts (clothing); money belts (clothing); non-slipping devices for boots and shoes; pullovers; welts for boots and shoes; wooden shoes; shirts; sandals; boots; sweaters; footwear uppers; inner soles; underpants; gymnastic shoes; slippers; shoes; headgear for wear; dressing gowns; tips for footwear; shower caps; stockings; shawls; caps (headwear); sashes for wear; esparto shoes or sandals; skirts.

35 – Business management; business administration; office functions; demonstration of goods; marketing studies; business research; marketing research; advisory services for business management; business management consultancy; business management and organization consultancy; business organization consultancy; organization of exhibitions for commercial or advertising purposes; organization of trade fairs for commercial or advertising purposes; shop window dressing; business management assistance; auctioneering; sales promotion for others of goods, including sales through stores of goods of 3, 9, 14, 16, 18, 20, 21, 25, 26, 28 classes; distribution of samples; advertising; commercial administration of the licensing of the goods and services of others; public relations; procurement services for others (purchasing goods and services for other businesses); outsourcing services (business assistance); efficiency experts.

(260) AM 2013 67230 A
(800) 1112692
(731) XYLEM WATER SOLUTIONS AB
SE-361 80 Emmaboda, Sweden
(540)

SMARTRUN

(591) Black, white
(511)
7 – Centrifugal pumping systems comprised of electric motor driven centrifugal pumps and electric motors incorporating pre-programmed and programmable variable frequency drive control system for controlling the operation of the electric motor driven centrifugal pumps.

9 – Pre-programmed and programmable variable frequency drive control system for controlling the operation of an electric motor driven centrifugal pump.

(260) AM 2013 67231 A
(800) 1112699
(731) ENTE AUTONOMO FIERA DEL
LEVANTE
Lungomare Starita, 4, I-70123 BARI, Italy
(540)



(591) Blue and white
(511)
35 – Organization of fairs and exhibitions for commercial, promotional and advertising purposes, in relation to the gas industry; public relations; market research; organization of events for advertising purposes.
41 – Education services, namely, conducting classes, seminars, conferences, workshops in the field of gas industry; education services namely providing tutoring in the field of transportation, delivery, supply, distribution and storage of gas.

(260) AM 2013 67232 A
(800) 1112710
(731) ODINTSOVO CONFECTIONERY PLANT,
LTD.
20, Maliye Vyazemy, Odintsovo District,
RU-143040 Moscow Region, Russian
Federation
(540)

VALENZO

(591) Black, white
(511)
30 – Aromatic preparations for food; flavorings for beverages, other than essential oils; star aniseed;

cookies; pancakes; buns; bread rolls; vanillin [vanilla substitute]; vanilla [flavoring]; waffles; vermicelli [noodles]; coffee flavorings; natural sweeteners; sausage binding materials; binding agents for ice cream [edible ices]; sea water for cooking; glucose for food; mustard; baking powder; thickening agents for cooking foodstuffs; rice-based snack food; cereal-based snack food; artificial coffee; vegetal preparations for use as coffee substitutes; pastries; confectionery; confectionery for decorating Christmas trees; fruit jellies [confectionery]; cakes; flour confectionery; peanut confectionery; almond confectionery; pasta; pasty; frozen yoghurt; cocoa; cocoa products; capers; caramels [candy]; gruel, with a milk base, for food; quiches; gluten for food; sweetmeats [candy]; liquorice [confectionery]; peppermint sweets; coffee; unroasted coffee; starch for food; crackers; crushed barley; hominy grits; milled corn; roasted corn; meat pies; turmeric for food; couscous [semolina]; farinaceous foods; noodles; ice for refreshment; ice, natural or artificial; edible ices; candy for food; rice cakes; maltose; hominy; marzipan; custard; honey; royal jelly for human consumption, not for medical purposes; ice cream; sherbets [ices]; corn flour; muesli; mint for confectionery; cocoa beverages with milk; coffee beverages with milk; coffee-based beverages; tea-based beverages; chocolate beverages with milk; chocolate-based beverages; cocoa-based beverages; infusions, not medicinal; crushed oats; husked oats; nutmegs; lozenges [confectionery]; golden syrup; pepper; petits fours [cakes]; biscuits; pies; pizzas; fondants [confectionery]; popcorn; powders for ice cream; pralines; condiments; meat tenderizers, for household purposes; cereal preparations; flour-milling products; oat-based food; propolis [bee glue] for human consumption; gingerbread; spices; puddings; cake powder; ravioli; chewing gum, not for medical purposes; rice; spring rolls; sugar; aniseed; cake paste; malt for human consumption; baking soda [bicarbonate of soda for cooking purposes]; salt for preserving foodstuffs; cooking salt; celery salt; spaghetti; seasonings; preparations for stiffening whipped cream; rusks; breadcrumbs; sushi; sandwiches; yeast extracts for food; tabbouleh; tacos; tapioca; soya bean paste [condiment]; almond paste; tortillas; tarts; garden herbs, preserved [seasonings]; candy decorations for cakes; vinegar; ferments for pastes; halvah; bread; unleavened bread; corn flakes; chicory [coffee substitute]; tea; iced tea; chocolate; malt extract for food; essences for foodstuffs, except etheric essences and essential oils.

(260) AM 2013 67233 A
(800) 539504
(731) DR. WILLMAR SCHWABE
GMBH & Co. KG

Willmar-Schwabe-Strasse 4, 76227
Karlsruhe, Germany

(540)

TEBOKAN

(591) Black, white

(511)

5 – Pharmaceutical, veterinary and sanitary products.

(260) AM 2013 67234 A

(800) 848504

(731) Barilla G.e R. Fratelli – Società per Azioni

Via Mantova, 166, I-43100 Parma, Italy

(540)

PICCOLINI

(591) Black, white

(511)

30 – Coffee, tea, cocoa, sugar, rice, tapioca, sago, artificial coffee; flour and preparations made from cereals, bread, pasta, biscuits, pastry and confectionery, ices; honey, treacle; yeast, baking-powder; salt, mustard; vinegar, sauces (condiments); spices; ice.

(260) AM 2013 67264 A

(800) 1112759

(731) Novartis AG

CH-4002 Basel, Switzerland

(540)

EQISTEM

(591) Black, white

(511)

5 – Pharmaceutical preparations.

(260) AM 2013 67265 A

(800) 1112774

(731) SOPHARMA AD

16, Iliensko shaussee Str. BG-1220 SOFIA,
Bulgaria

(540)

PRINOPRIL ПРИНОПРИЛ

(591) Black, white

(511)

5 – Pharmaceutical and veterinary preparations; sanitary preparations for medical purposes; dietetic substances adapted for medical use, food for babies; plasters, materials for dressings.

(260) AM 2013 67266 A

(800) 1112785

(731) ZHEJIANG CONSTANT ENGINE

MADING CO., LTD.

Intersection of Yueying Road and Mashan Road, Paojiang Industrial Zone, Shaoxing, Zhejiang, China

(540)

CONSTANT

(591) Black, white

(511)

7 – Mowing and reaping machines; atomisers [machines]; internal combustion engines (other than for automobiles, tractors, grain combine harvesters, motorcycles, chain saws, steam locomotives); diesel engine (other than for land vehicles); gas engines; petrol engines (other than for land vehicles); alternators; dynamos; generators of electricity.

(260) AM 2013 67267 A

(800) 1112805

(731) PPHU TESPOL Tadeusz Koralewski
ul. Łódzka 27/29, PL-95-050 Konstancin
Łódzki, Poland

(540)

SPAIO

(591) Black, white

(511)

25 – Clothing, underwear, headgear, socks, tights, knee socks.

(260) AM 2013 67268 A

(800) 1112819

(731) AVON PRODUCTS, INC.
World Headquarters, 777 Third Avenue,
New York, NY 10017, USA

(540)



(591) Black, white

(511)

1 – Non-medicated toilet preparations; toiletries; skin care preparations; skin moisturizers; body and beauty care preparations; powders, creams and lotions, all for the face, hands and body; cosmetic suntan preparations; soaps; shower and bath preparations; beauty masks; talcum powder; nail polish; nail polish remover; enamel for nails; false nails; adhesives for cosmetic purposes; cosmetics; eye makeup remover, eye shadow, eye liner, mascara, lipstick, lip liner, lipgloss; make-up foundation; blusher; tissues impregnated with cosmetic lotions; cotton sticks for cosmetic purposes; cotton wool for cosmetic purposes; preparations for cleaning, moisturising, colouring and styling the hair; preparations for cleaning the teeth; shaving and aftershave preparations; perfumes, fragrance, toilet waters, eau de colognes; deodorants and anti-perspirants for personal use; essential oils (cosmetic); all the aforesaid

being alone, in combination and/or in gift sets comprised of some or all of these items.

(260) AM 2013 67269 A

(800) 1112820

(731) AVON PRODUCTS, INC.
World Headquarters, 777 Third Avenue,
New York, NY 10017, USA

(540)

AVON ULTRA COLOR RICH BRILLIANCE

(591) Black, white

(511)

3 – Non-medicated toilet preparations; toiletries; skin care preparations; skin moisturizers; body and beauty care preparations; powders, creams and lotions, all for the face, hands and body; cosmetic suntan preparations; soaps; shower and bath preparations; beauty masks; talcum powder; nail polish; nail polish remover; enamel for nails; false nails; adhesives for cosmetic purposes; cosmetics; eye makeup remover, eye shadow, eye liner, mascara, lipstick, lip liner, lipgloss; make-up foundation; blusher; tissues impregnated with cosmetic lotions; cotton sticks for cosmetic purposes; cotton wool for cosmetic purposes; preparations for cleaning, moisturising, colouring and styling the hair; preparations for cleaning the teeth; shaving and aftershave preparations; perfumes, fragrance, toilet waters, eau de colognes; deodorants and anti-perspirants for personal use; essential oils (cosmetic); all the aforesaid being alone, in combination and/or in gift sets comprised of some or all of these items.

(260) AM 2013 67270 A

(800) 1112836

(731) DEUTSCHE TELEKOM AG
Friedrich-Ebert-Allee 140, 53113 Bonn,
Germany

(540)

TelematicOne

(591) Black, white

(511)

9 – Scientific, nautical, surveying, photographic, cinematographic, optical, weighing, measuring, signalling, checking (supervision), life-saving and teaching apparatus and instruments; apparatus and instruments for conducting, switching, transforming, accumulating, regulating or controlling electricity; apparatus for recording, transmission, processing and reproduction of sound or images; magnetic data carriers; automatic vending machines and mechanisms for coin-operated apparatus; calculating machines, data processing equipment and computers; recorded and unrecorded data carriers (as far as included in this class); computer programs

recorded; electronically recorded data (downloadable); electronic publications (downloadable).

35 – Advertising; business management; business administration; collection, systematization, compilation and analysis of business data and information stored in computer databases; retail services (also via Internet and other communication networks), concerning goods of class 9.

38 – Telecommunications; press agencies; rental of telecommunications equipment; information on telecommunications.

42 – Scientific and technological services and research and design relating thereto; industrial analysis and research services; design and development of computer hardware, software and data bases; maintenance of software; technical consultancy related to services included in this class; computer services concerning electronic data storage; rental of computer hardware and software; Website design for others.

(260) AM 2013 67272 A

(800) 1112850

(731) AUTODESK, INC.

111 McInnis Parkway, San Rafael CA
94903, USA

(540)

AUTODESK

(591) Black, white

(511)

9 – Computer programs and instructional manuals in electronic format used therewith sold as a unit.

41 – Computer education training; education services, namely, providing live and online seminars and programs in the fields of computer aided design, graphics, constructions management, architectural design and computer software usage; training in the use of computer software; training services in the field of software for project management, civil engineering, graphics, multimedia and computer aided design.

42 – Providing temporary use of on-line non-downloadable operating software for accessing and using a cloud computing network for use by architects, interior designers, civil engineers, construction managers, computer aided designers, and graphics professionals; computer aided graphic design; computer project management services; computer services, namely, interactive hosting services which allow the user to publish and share their own content and images on-line; providing a secure electronic online system featuring technology which allows users to create, publish, modify, share and produce personalized things from digital content, models and designs; providing a web site featuring

technology that enables users to design their own home layouts, three dimensional objects and construction projects; providing a website featuring on-line non-downloadable software tools for image editing; providing an Internet website portal offering information in the field of computer aided design; providing on-line non-downloadable software for construction projects, home design, object design and computer graphics.

(260) AM 2013 67273 A

(800) 1112883

(731) RENAULT s.a.s.

13/15, quai Alphonse le Gallo, F-92100
Boulogne-Billancourt, France

(540)

DJEYO

(591) Black, white

(511)

12 – Automobiles, spare parts for automobiles, automobile accessories, namely arm rests for automobiles, anti-theft devices for automobiles, head restraints for automobiles, sun shields and visors for automobiles, luggage carriers for automobiles, safety seats for children for automobiles, covers for automobiles, seat covers for automobiles.

(260) AM 2013 67274 A

(800) 1112899

(731) BEAUTE PRESTIGE INTERNATIONAL

28-32, avenue Victor Hugo, F-75116 PARIS,
France

(540)



(591) Black, white

(511)

3 – Perfumes, toilet water; deodorants for personal use (perfumery); essential oils for personal use; oils for cosmetic purposes; liquid soaps for personal use; cleansing milk for toilet purposes; cosmetic creams, lotions and products for face care; cosmetic creams, lotions and products for body care; make-up removing lotions; cosmetic products and preparations for skin care, for slimming, for the bath, for suntanning; beauty masks; bath and shower gels; bath foam; hair lotions and preparations for hair care; shampoos.

(260) AM 2013 67275 A
 (800) 1112914
 (731) POMELLATO S.P.A.
 Via Neera, 37, I-20141 MILANO, Italy
 (540)

NUDO

(591) Black, white
 (511)

3 – Cosmetics in general, including perfumes, perfumes in solid form; deodorants for personal use; soap, liquid soap; cakes of toilet soap; foaming bath products; dentifrices; shampoos; essential oils; hair lotions; preparations for permanent hair waves and for setting hair; gels; hair dyes; face creams for cosmetic use; mascara; eyeliner; eyeshadow; make-up pencils; face powders; lipsticks; foundation; cosmetic body creams; nail polish; nail strengtheners; suntanning oils and creams; cleansers; laundry preparations; fabric softeners.

(260) AM 2013 67276 A
 (800) 1112920
 (731) Obshchestvo s ogranichennoj
 otvetstvennost'ju "BANK FININVEST"
 ul. Krasnoprudnaja, 3-5,1, RU-107140
 Moscow, Russian Federation
 (540)

 **БАНК ФИНИНВЕСТ**

(591) White, red and blue
 (511)

35 – Commercial information agencies; cost price analysis; auditing; computerized file management; accounting; invoicing; marketing studies; business information; commercial information and advice for consumers [consumer advice shop]; business investigations; marketing research; business management and organization consultancy; personnel management consultancy; business organization consultancy; business management consultancy; professional business consultancy; organization of exhibitions for commercial or advertising purposes; business appraisals; payroll preparation; data search in computer files for others; sponsorship search; business management assistance; commercial or industrial management assistance; economic forecasting; document reproduction; compilation of statistics; compilation of information into computer databases; business inquiries; systemization of information into computer databases; tax preparation; drawing up of statements of accounts; commercial administration of the licensing of the goods and services of others; administrative processing of purchase orders; price comparison services; outsour-

cing services [business assistance]; efficiency experts.

36 – Credit bureaux; debt collection agencies; real estate agencies; financial analysis; hire-purchase financing; savings bank; rent collection; issuing of travellers' checks [cheques]; issuance of credit cards; issue of tokens of value; capital investments; insurance information; financial information; clearing, financial; insurance consultancy; financial consultancy; stock exchange quotations; financial management; exchanging money; debit card services; credit card services; home banking; factoring; organization of collections; antique appraisal; jewellery appraisal; stamp appraisal; real estate appraisal; numismatic appraisal; art appraisal; financial evaluation [insurance, banking, real estate]; repair costs evaluation [financial appraisal]; electronic funds transfer; bail-bonding; stocks and bonds brokerage; real estate brokers; insurance brokerage; loans [financing]; lending against security; check [cheque] verification; charitable fund raising; financial sponsorship; mortgage banking; instalment loans; accident insurance underwriting; fire insurance underwriting; health insurance underwriting; insurance underwriting; life insurance underwriting; marine insurance underwriting; actuarial services; banking; retirement payment services; fiduciary; mutual funds; financing services; safe deposit services; deposits of valuables; fiscal assessments.

(260) AM 2013 67283 A
 (800) 1112924
 (731) OPEL SPECIAL VEHICLES GMBH
 Mainzer Str. (Adam Opel AG – M55), 65428
 Rüsselsheim, Germany
 (540)

ADAM GLAM

(591) Black, white
 (511)
 12 – Motor cars; their parts and spare parts; seat belt pads for automobiles; bicycles and parts thereof; all the aforesaid goods included in this class.

(260) AM 2013 67284 A
 (800) 1112947
 (731) OÜ FRIENDS TEXTILE
 Narva mnt 7, EE-10117 Tallinn, Estonia
 (540)



(591) Black, white
 (511)
 25 – Clothing, footwear, headgear.

(260) AM 2013 67285 A
 (800) 1112952
 (731) BATA BRANDS S.à r.l.
 B.P. 1638, L-1016 Luxembourg,
 Luxembourg

(540)

AMBASSADOR

(591) Black, white

(511)

14 – Keychains.

18 – Bags, wallets; belts of leather (saddlery).

25 – Footwear; belts (clothing).

(260) AM 2013 67286 A
 (800) 1112996
 (731) Mars, Incorporated
 6885 Elm Street, McLean, Virginia
 22101-3883, USA

(540)

ЛЮБИМЫЕ СЕМЕЙНЫЕ РЕЦЕПТЫ

(591) Black, white

(511)

31 – Foodstuffs for animals, birds and fish; cuttle bone for birds; bone and edible chews for animals.

(260) AM 2013 67289 A
 (800) 1113004
 (731) Proizvodstvenno-torgovoe respublikanskoe
 unitarnoe predpriyatie "MINSK
 KRISTALL" RUP
 "MINSK KRISTALL"
 d.15, ul. Oktyabrskaya, 220030 Minsk,
 Belarus

(540)



(591) White, light-yellow, light-brown, brown and bronze

(511)

33 – Vodka.

(260) AM 2013 67291 A
 (800) 1113072
 (731) SWATCH AG (SWATCH SA) (SWATCH
 LTD)

Jakob-Stämpfli-Strasse 94, CH-2502
 Biel/Bienne, Switzerland

(540)

SWATCH COLOUR CODES

(591) Black, white

(511)

14 – Precious metals and their alloys and goods in precious metals or coated therewith, included in this class; jewellery, precious stones; horological and chronometric instruments.

(260) AM 2013 67350 A
 (800) 1113472
 (731) Zhejiang Constant Engine Mading Co., Ltd.
 Intersection of Yueying Road and Mashan
 Road, Paojiang Industrial Zone, Shaoxing,
 Zhejiang, China

(540)



(591) Black, white

(511)

7 – Agricultural machines; mowing and reaping machines; drainage machines; atomisers [machines]; weeding machines; sowers [machines]; internal combustion engines (other than for automobiles, tractors, grain combine harvesters, motorcycles, chain saws, steam engines); diesel engines (other than for land vehicles), gas engines, petrol engines (other than for land vehicles); alternators; dynamos; generators of electricity; emergency power generators; aeroplane engines; centrifugal pumps; pumps [machines]; engines, other than for land vehicles; welding machines, electric.

(260) AM 2013 67351 A
 (800) 1113474
 (731) SARAR GİYİM TEKSTİL ENERJİ
 SANAYİ VE TİCARET ANONİM ŞİRKETİ
 Organize Sanayi Bölgesi, TR-26110
 Eskişehir, Turkey

(540)



(591) Black, white

(511)

14 – Jewellery and imitation jewellery, namely, bracelets, rings, charms for necklaces and bracelets, necklaces, ear clips, cuff-links, earrings, ornamental pins, tie pins, brooches, ornaments of precious metal in the nature of jewelry; wrist watches made

of precious metals or coated therewith, wall clocks, table clocks, cases for watches and clocks.

18 – Goods made of leather, imitation leather or synthetic materials, namely, briefcases, business card cases, handbags for ladies, handbags for men, travel bags, valises, wallets, make-up cases sold empty, toiletry bags sold empty; umbrellas.

25 – Clothing, namely, trousers, jackets, overcoats, coats, skirts, suits, jerseys, waistcoats, shirts, T-shirts, sweatshirts, dresses, Bermuda shorts, shorts, pajamas, pullovers, jeans, tracksuits, rainwear, beachwear, bathing suits, swimming suits; clothing for sports (for exclusive use for sports); underclothing, namely, boxer shorts, brassieres, briefs, pants, socks; footwear, namely, shoes excluding orthopedic shoes, sandals, waterproof boots, walking boots, bootees, sporting shoes, slippers; headgear, namely, caps, skull caps, sports caps, hats, berets; gloves (clothing), stockings, belts (clothing), camisoles, sarongs, scarves, neck scarves, shawls, collars, neckties, ties, suspender belts.

35 – The bringing together, for the benefit of others, of cosmetics and cosmetic products, perfumes, sunglasses, jewellery and imitation jewellery, wrist watches, pens, pen cases, clothing, footwear, headgear (excluding the transport thereof), enabling customers to conveniently view and purchase those goods; such services may be provided by retail stores, wholesale outlets, through mail order catalogues or by means of electronic media, for example, through web sites or television shopping programmes.

(260) AM 2013 67352 A

(800) 1113482

(731) INVENTIO AG

Postfach, CH-6052 Hergiswil, Switzerland

(540)

SCHINDLER AWARD

(591) Black, white

(511)

7 – Elevators and goods lifts and the parts and components thereof (included in this category); escalators, moving walkways and the parts and components thereof (included in this category).

41 – Providing information on cultural activities, online from computer databases or provided on the Internet; organization and implementation of cultural events as well as competitions for students relating to the topic of universal architecture (with awarding of prizes).

(260) AM 2013 67353 A

(800) 1113490

(731) FTE automotive GmbH

2, Andreas-Humann-Strasse, 96106 Ebern, Germany

(540)



(591) Light grey, red, dark grey and white

(511)

7 – Pressure relieve valves; brake bleed and fill devices; belt tightening devices; hydraulic control systems; hydraulic valves; hydraulic pumps; spring brakes; hydraulically actuated acceleration devices (except those for land vehicles); electro-hydraulic actuation units; electromechanical actuators; hydraulic pressure and volume input devices (except those for land vehicles).

9 – Brake pressure testing devices; chassis dynamic control systems for vehicles; electrical position and travel sensors.

12 – Brake systems for vehicles; brake master cylinders; brake boosters; disc brakes; brake linings; brake discs; brake hoses; brake lines; wheel brake cylinders; drum brakes; brake shoes; brake drums; parking brake cables; brake power limiters; built in units consisting of pedals and brake boosters; brake calipers; brake fittings; brake power distributors; pressure regulating valves; clutch systems for vehicles; clutches; clutch master cylinders; clutch slave cylinders; clutch hoses; clutch lines; master cylinders for clutch actuation; automated and non-automated clutch actuation systems; clutch boosters; built in units consisting of pedals and actuation cylinders; clutch cables; electromechanical actuators for clutches; vibration and pulsation damping devices for hydraulic clutch actuation systems; anti-lock/skid brake systems (ABS) for vehicles; servo-steering hoses; hydraulic steering devices; hydraulically actuated acceleration devices for land vehicles; electro hydraulic actuation units; hydraulic pressure and volume input devices for land vehicles; automated gear shift arrangements for vehicles; hydraulic gear actuators.

(260) AM 2013 67354 A

(800) 1113504

(731) MIDAC S.P.A

Via A. Volta, 2, I-37038 Soave (VR), Italy

(540)



(591) Black, white
(511)
9 – Batteries; storage batteries.

(260) AM 2013 67355 A
(800) 1113515
(731) PRO BONO BIO ENTREPRENEUR
LIMITED
4th floor, Reading Bridge House, George
Street, Reading, Berkshire RG1 8LS,
United Kingdom

(540)

FLEKSISÈK

(591) Black, white
(511)
5 – Pharmaceutical preparations and substances; veterinary and sanitary preparations and substances; chemical preparations for pharmaceutical purposes; diagnostic preparations and substances, all for in vivo use; pharmaceuticals in the field of osteoarthritis, oncology, cardiovascular disease, respiratory disease, inflammation, infection, gastrointestinal diseases and central nervous system diseases; diagnostic preparations for medical and veterinary use; topical and parenteral preparations of vesicles; chemical preparations in the form of vesicles for medical and veterinary purposes; chemical membranes and chemical aggregates for medical and veterinary purposes; preparations of arachidonic acids; cosmeceutical preparations for medical use; local anaesthetics; steroids; anti-inflammatory drugs; pharmaceuticals for the treatment of nail fungal infections; vaccines; immunotherapeutic vaccines; lipids for topical and parenteral use; creams, dispersions, lotions, ointments, gels, solutions, sprays, lacquers and film forming solution for the treatment of pain or inflammation; surfactants for use in the treatment of or prevention of cancer, infectious disease, fungal diseases, disease caused by parasites, eye disease, diseases of the central and peripheral nervous systems, cardiovascular disease, diseases affecting the immune system, inflammatory diseases, inherited disease, single gene disorders, diseases of the mouth, teeth, skin, hair and ear, bone and blood diseases and reproductive system disorders, the treatment of inflammation, asthma, atopic eczema, dishydrotic hand eczema, plaque type psoriasis, seborrhoeic eczema, acne vulgaris, bronchospasm, atherothrombotic cardiovascular disorders, venous thrombotic disorders, pain, dysmenorrhea hypercholesterolemia, mia, fatty acid metabolism, metal or other toxicity, Alzheimer's disease, gout or macular degeneration, such as AMD, or fungal infection and disorders related to fatty acid deficiencies.

10 – Medical devices for topical use in the treatment of pain; molecular filtering devices for medi-

cal use; medical, veterinary and surgical apparatus, instruments and devices; inhalers; injection apparatus, instruments and devices; apparatus, instruments and devices for dispensing medical, surgical and veterinary preparations, dispersions, creams, powders, tablets and pills; instruments and devices for the administration of pain relief therapy and prophylaxis preparations and substances; parts and fittings for all of the aforesaid.

(260) AM 2013 67356 A
(800) 1113555
(731) OPEN-TYPE JOINT STOCK COMPANY
"CONFECTIONARY CONCERN
BABAEVSKY"
ul. Malaya Krasnoselskaya, d. 7, RU-107140
Moscow, Russian Federation

(540)

DARX

(591) Black, white
(511)
30 – Confectionery; Turkish delight, pastilla, marshmallow, caramels, candy, sweets, chocolate, praline, waffles; cocoa products; pastries; waffle cake; marzipan; chocolate beverages; coffee-based beverages; coffee; tea; ice cream; bread.

(260) AM 2013 67357 A
(800) 1113560
(731) Limited Liability Company GK GFD
Limited
Agiou Pavlou Street, 15 Ledra House, Agios
Andreas, CY-1105 Nicosia, Cyprus

(540)

e-on

(591) Black, white
(511)
32 – Non-alcoholic beverages, including energy drinks; aerated water; preparations for making aerated water.

(260) AM 2013 67362 A
(800) 1113563
(731) LIMITED LIABILITY COMPANY "MIND
LABS."
Str. 8, D. 34, Ul. B. Pochtovaya,
Ru-105082 Moscow, Russian
Federation

(540)

MIND

(591) Black, white

(511)

9 – Scientific, nautical, surveying, photographic, cinematographic, optical, weighing, measuring, signalling, checking (supervision), life-saving and teaching apparatus and instruments; apparatus and instruments for conducting, switching, transforming, accumulating, regulating or controlling electricity; apparatus for recording, transmission or reproduction of sound or images; magnetic data carriers, recording discs; automatic vending machines and mechanisms for coin-operated apparatus; cash registers, calculating machines, data processing equipment and computers; fire-extinguishing apparatus.

28 – Games and playthings; gymnastic and sporting articles not included in other classes; decorations for Christmas trees.

32 – Mineral and aerated waters and other non-alcoholic drinks; fruit drinks and fruit juices; syrups and other preparations for making beverages.

38 – Telecommunications.

41 – Education; providing of training; entertainment; sporting and cultural activities.

42 – Scientific and technological services and research and design relating thereto; industrial analysis and research services; design and development of computer hardware and software.

45 – Legal services; security services for the protection of property and individuals; mediation.

(260) AM 2013 67364 A

(800) 1113610

(731) KİLİKYA ŞALGAM İÇECEK SANAYİ VE
TİCARET ANONİM ŞİRKETİ

Adana Hacı Sabancı Organize Sanayi
Bölgesi, AOSB, Suluca Caddesi No: 2,
Sarıçam-Adana, Turkey

(540)



(591) Red, white

(511)

29 – Meat, fish, poultry, game, meat extracts, broth, shellfish not live, namely, shrimp (not live), lobster (not live), clams (not live), processed meat, frozen meat, dried meat, fried meat, meat jellies, meat juices; pulses for food, namely, preserved or processed beans, chickpeas, lentil, soy beans; instant or pre-cooked soups, bouillon; processed olives, olive pastes, pickles; milk and milk products, namely milk, cheese, yoghurt, ayran (drink based on yoghurt), cream, milk powder, milk based beverages containing fruits; edible oils and fats, butter,

margarine; dried, preserved, canned, frozen or processed fruits and vegetables; tomato puree, tomato paste; processed and roasted chickpeas, nuts, peanuts, walnuts, pistachio; peanut butter, hazelnut paste, tahini (sesame seed paste); jams, marmalades, fruit jellies; eggs, powdered eggs; processed bee pollen for food purposes, edible proteins for use as food additives; potato chips.

30 – Coffee, cocoa, artificial coffee, vegetal preparations for use as coffee substitutes, cocoa-based beverages, coffee-based beverages; tapioca, sago; noodles, macaroni, ravioli; bakery products, namely sweet bakery goods, namely, pies, cakes, donuts, muffins; pastries, flour-based products, namely chips, pasta; dough products, namely, pizza dough, cake dough, bread dough; tarts, cakes, bread, pizzas, sandwiches, puddings, ready cake mixes; honey, royal jelly for human consumption, propolis for human consumption; ketchups, mayonnaises, mustards, flavorings, sauces, namely, soy sauce, hot sauce, spaghetti sauce, cheese sauce; salad dressings, spices, namely, pepper, ginger (spice), cinnamon powder, curry powder; yeast, baking powder; flour for food, semolina, starch for food; granulated sugar, cube sugar, powdered sugar; teas, ice teas; chocolate for confectionery, confectionery for decorating Christmas trees, biscuits, waffles, crackers, chocolates, candies; chewing gums not for medical purposes; ice, ice creams, edible fruit ices, sorbets; salt; processed cereals and cereal products; snacks made of cereals, namely, corn flakes, oatmeal.

32 – Beers; preparations for use in the production of beer, namely, beer wort, extracts of hops; mineral water, spring water, table water, soda water, tonic water; fruit drinks and fruit juices, namely, apple juice, grape juice; vegetable juices, namely, turnip juice, tomato juice; concentrates syrups or powders used in the preparation of fruit drinks; soft drinks, carbonated soft drinks, soda pops.

(260) AM 2013 67366 A

(800) 1113654

(731) LOCKTON, INC.

Suite 900, 444 West 47th Street, Kansas
City MO 64112, USA

(540)

LOCKTON GLOBAL

(591) Black, white

(511)

36 – Financial risk management; Insurance agencies; Insurance brokerage services; Insurance information and consultancy.

(260) AM 2013 67367 A

(800) 1113658

(731) ZAKRITOE AKTSIONERNOE

OBSHCHESTVO "EDIM DOMA"
stroenie 1, 15, Naprudny pereulok,
RU-129110 Moskva, Russian Federation

(540)

(591) Red, white

(511)

16 – Printed matter; printed publications, including magazines [periodicals], newspapers.

29 – Charcuterie; caviar; meat; meat, preserved; liver pastes; liver; milk products; food products made from fish; poultry, not live; fish, not live; fish, preserved; salted fish; vegetable salads; fruit salads; herrings; sausages in batter; cheese; potato flakes; potato chips.

30 – Bread; pastry and confectionery; ice-cream; mustard; vinegar; condiments.

35 – Advertising; television advertising; advertising agencies; sales promotion for others; organization of exhibitions for commercial or advertising purposes; procurement services for others [purchasing goods and services for other businesses].

38 – Telecommunications; news agencies; television broadcasting; cable television broadcasting; providing user access to a global computer network [service providers]; radio broadcasting; communications by fiber [fibre] optic networks; telecomferencing services.

41 – Entertainment; organization of sports competitions; videotaping; dubbing; movie studios; microfilming; videotape editing; production of radio and television programmes; music-halls; providing on-line electronic publications, not downloadable; organization of exhibitions for cultural or educational purposes; arranging and conducting of workshops [training]; arranging of beauty contests; operating lotteries; television entertainment; presentation of live performances; theatre productions; videotape film production; rental of sound recordings.

(260) AM 2013 67368 A

(800) 1113680

(731) SGL CARBON SE

Rheingastr. 182, 65203 Wiesbaden,
Germany

(540)

ECOPHIT

(591) Black, white

(511)

1 – Graphite salts, graphite intercalation compounds for industrial purposes in particular for ma-

king expanded graphite; expanded graphite, in particular for processing graphite foils, graphite laminates, heat insulating materials, heat conducting substances and composite materials; composite material consisting of a phase change material and carbon.

11 – Heat or cold accumulators consisting of, or containing, carbon, natural graphite, expanded graphite and phase change materials; parts and spare parts for heating, steam generating, cooking, refrigerating, drying, ventilating and water supply apparatus, floor, wall and ceiling heating systems, ventilating and air conditioning apparatus, equipment and installations, air cooling apparatus, ovens, heat pumps, heat recovery systems, heat exchangers, water heaters, water coolers and water intake apparatus, consisting of, or containing, carbon, natural graphite, expanded graphite and phase change material.

12 – Parts and spare parts for heat accumulation, insulation and conduction, for vehicles, consisting of, or containing, carbon, natural graphite, expanded graphite.

17 – Graphite foils, graphite laminates and graphite granules made from expanded graphite, other than for packaging; laminates containing graphite foils; semi-finished products of graphite foils, graphite laminates, graphite granules and laminates containing graphite foils, graphite granules, in particular for manufacturing material for conducting and accumulating electricity and heat, and thermal shields and linings; plastic materials containing expanded graphite.

19 – Building materials for absorbing electromagnetic radiation, sound-absorbing building materials of expanded graphite, of graphite foils, graphite laminates and laminates containing graphite foils; building materials (non-metallic), building boards, mortar, coatings (building materials), building stone, heat accumulator stones; composite boards of plasterboard and of expanded graphite, composite boards of inorganic materials and of expanded graphite, of graphite foils, graphite laminates and laminates containing graphite foils; building materials, mainly non-metallic, for protection from noise, heat, fire and electromagnetic radiation, for the accumulation and conduction of heat, wholly or partly of expanded graphite, of graphite foils, graphite laminates and laminates containing graphite foils.

(260) AM 2013 67369 A

(800) 1113704

(731) Shenzhen Gongjin Electronics Co., Ltd.
B116, B118, A211-A213, B201-B213,
A311-313 and B411-413, Nanshan
Medical Instrument Industry Park,
1019 Nanhai Road, Nanshan District,

518067 Shenzhen City, Guangdong Province,
China

(540)

T&W

(591) Black, white

(511)

9 – Computer peripheral devices; computer software [recorded]; couplers [data processing equipment]; computer programs [downloadable software]; antennas; transmitters of electronic signals; intercommunication apparatus; modems; optical communication apparatus; network communication apparatus; plugs, sockets and other contacts [electric connections].

(260) AM 2013 67374 A

(800) 1113746

(731) KPM-Königliche Porzellan-Manufaktur
Berlin GmbH

Wegelystrasse 1, 10623 Berlin, Germany

(540)



**KÖNIGLICHE
PORZELLAN-MANUFAKTUR
BERLIN**

(591) Black, white

(511)

8 – Cutlery, forks and spoons; sugar tongs.

11 – Lamps for domestic use; lamp stands.

14 – Goods made of precious metals and their alloys or coated therewith (included in this class); jewelry, in particular jewelry made of glass, porcelain and earthenware; horological and chronometric instruments; cuff-links; tie pins; key rings (fantasy jewelry); medallions (jewelry).

21 – Glassware, porcelain and earthenware (included in this class); porcelain ware including services (tableware); cups, butter dishes, egg cups, coffee service, tableware, salt and pepper shakers; dishes, tea services, sugar bowls; drinking glasses and drinking vessels; containers for household and kitchen use; figurines (statuettes) of porcelain, painted glassware; candlesticks; napkin rings.

24 – Textiles and textile goods, included in this class; bed and table covers; textile napkins, place mats (sets) not of paper; table linen, not of paper; handkerchiefs of textiles; bed linen, bed spreads; bed covers; damask; textile materials; flags, pennants (not of paper), household linen; curtains of textile or plastics; pillow shams; furniture coverings of plastics, towels of textile.

(260) AM 2013 67419 A

(800) 1114409

(731) AYAKS AYAKKABI VE SATIŞ
HİZMETLERİ LİMİTED ŞİRKETİ

Keresteciler Sitesi Zakkum, Sokak No:18

Merter, TR-34173 Güngören / Istanbul,

Turkey

(540)

TRAVELSOFT 24hs

(591) Green, red, white

(511)

10 – Medical, dental, veterinary and surgical apparatus and instruments, namely, injection needles, surgical thread, apparatus for artificial respiration, blood pressure measuring apparatus, hearing aids, medical X-ray apparatus; furniture adapted for medical treatment purposes; heat beds and electric blankets for medical purposes, air pillows for medical purposes, water beds for medical purposes; electrically-heated cushions for medical purposes; massage apparatus for medical purposes; implants consisting of artificial materials, namely, artificial breasts, artificial cartilage, artificial eyes, artificial jaws, artificial joints, artificial limbs, artificial skin for surgical purposes, artificial teeth; medical orthopedic materials, namely, orthopedic support bandage, orthopedic belts, orthopedic braces, orthopedic footwear, abdominal corsets, plaster casts for orthopedic purposes, templates for orthopedic purposes, vertebral orthopedic apparatus, orthopedic soles; clothing especially for operating rooms; bone implants made from artificial materials; foot retractors for use in podiatric surgery, surgical gloves, surgical mask, surgical shoe covers, incontinence sheets; instruments for contraception purposes, namely, condom; feeding bottles, baby bottle nipples, pacifiers for babies.

18 – Goods made of leather and imitations of leather, namely travel bags, valises, wallets, backpacks for carrying babies, leather and stout leather boxes for storing greeting cards, and leather hat boxes for travel; make-up cases sold empty, toiletry bags sold empty, vanity cases sold empty, tool bags sold empty, book bags; carrying cases for documents, wallets, briefcases, backpacks, school bags, leather shopping bags; and notecases, namely business card cases; umbrellas, parasols and walking sticks.

25 – Clothing, namely, trousers, jackets, overcoats, coats, skirts, suits, jerseys, waistcoats, shirts, t-shirts, sweatshirts, dresses, bermuda shorts, shorts, pajamas, pullovers, jeans, tracksuits, rainwear, beachwear, bathing suits, swimming suits; articles of clothing made from cotton denim, namely, trousers, jackets, overcoats, coats, skirts, suits, waistcoats, shirts, T-shirts, sweatshirts, dresses, shorts, articles of clothing made from knitted fabrics, namely, trousers, jackets, overcoats, coats, skirts, jerseys, dresses, pullovers; underclothing, namely, boxer shorts,

brassieres, briefs, pants, socks, footwear, namely shoes, excluding orthopedic shoes, sandals, waterproof boots, walking boots, bootees, sporting shoes, slippers; shoe parts namely heelpieces, insoles for footwear, footwear uppers, headgear, namely caps, skull caps, sports caps, hats, berets; gloves, stockings, belts, camisoles, sarongs, scarves, neck scarves, shawls, collars, mufflers, neckties, ties, suspender belts.

(260) AM 2013 67420 A

(800) 1114441

(731) PHILIP MORRIS PRODUCTS S.A.

Quai Jeanrenaud 3, CH-2000 Neuchâtel,
Switzerland

(540)

PORPORA

(591) Black, white

(511)

34 – Tobacco, raw or manufactured; tobacco products, including cigars, cigarettes, cigarillos, tobacco for roll-your-own cigarettes, pipe tobacco, chewing tobacco, snuff tobacco, kretek; snus; tobacco substitutes (not for medical purposes); smokers' articles, including cigarette paper and tubes, cigarette filters, tobacco tins, cigarette cases and ashtrays, pipes, pocket apparatus for rolling cigarettes, lighters; matches.

(260) AM 2013 67421 A

(800) 1114447

(731) OPEL SPECIAL VEHICLES GMBH

Mainzer Str. (Adam Opel AG – M55), 65428
Rüsselsheim, Germany

(540)

ADAM JAM

(591) Black, white

(511)

12 – Motor cars; their parts and spare parts; seat belt pads for automobiles; bicycles and parts thereof; all the aforesaid goods included in this class.

(260) AM 2013 67425 A

(800) 1114468

(731) Obshchestvo s ogranichennoy

otvetstvennostyu "Izdatelstvo Spets-Adres"
d. 15/1, ul. Selskokhozyaystvennaya,
RU-129226 Moskva, Russian Federation

(540)

ЛУЧШИЕ ЛЮДИ

(591) Black, white

(511)

16 – Paper, cardboard and goods made from these materials, not included in other classes; printed matter; bookbinding material; photographs; stationery; adhesives for stationery or household purposes; artists' materials; paint brushes; typewriters and office requisites (except furniture); instructional and teaching material (except apparatus); plastic materials for packaging (not included in other classes); printers' type; printing blocks; fountain pens; aquarelles; albums; almanacs; document laminators for office use; atlases; posters; paper bows; table napkins of paper; tickets; forms, printed; note books; drawing pads; pads [stationery]; loose-leaf binders; wristbands for the retention of writing instruments; pamphlets; booklets; paper sheets [stationery]; waxed paper; paper for recording machines; paper for radiograms; electrocardiograph paper; drawer liners of paper, perfumed or not; wood pulp paper; carbon paper; parchment paper; writing paper; luminous paper; hygienic paper; packing paper; xuan paper for Chinese painting and calligraphy; paper; blotters; newsletters; rollers for typewriters; house painters' rollers; composing sticks; modelling wax, not for dental purposes; signboards of paper or cardboard; patterns for dressmaking; newspapers; electrotypes; hectographs; shields [paper seals]; terrestrial globes; engravings; slate pencils; pencil leads; pencil holders; chalk holders; holders for stamps [seals]; holders for checkbooks [cheque books]; diagrams; engraving plates; writing slates; blackboards; galley racks [printing]; drawing boards; punches [office requisites]; cream containers of paper; money clips; tags for index cards; pen clips; bookmarkers; etching needles; tracing needles for drawing purposes; printed publications; bags [envelopes, pouches] of paper or plastics, for packaging; cardboard articles; paper shredders for office use; graphic representations; graining combs; calendars; tear-off calendars; tracing paper; tracing cloth; tracing patterns; gums [adhesives] for stationery or household purposes; lithographic stones; pencils; pencil lead holders; charcoal pencils; pictures; decalcomanias; paintings [pictures], framed or unframed; wood pulp board [stationery]; cardboard; hat boxes of cardboard; document files [stationery]; files [office requisites]; cards; index cards [stationery]; credit card imprinters, non-electric; geographical maps; paper tapes and cards for the recordal of computer programmes; perforated cards for jacquard looms; catalogues; spools for inking ribbons; covers of paper for flower pots; paintbrushes; painters' brushes; writing brushes; typewriter keys; glue for stationery or household purposes; isinglass for stationery or household purposes; starch paste [adhesive] for stationery or household purposes; printing blocks; books; ledgers [books]; manifolds [stationery]; comic books; drawing pins; cigar bands; envelopes [stationery]; cases for stamps [seals]; boxes of cardboard or paper; paint boxes [articles for use in school]; correcting fluids [office requisites]; french curves; paper ribbons; typewriter ribbons; adhesive bands for stationery or

household purposes; gummed tape [stationery]; inking ribbons; inking ribbons for computer printers; square rulers; viscose sheets for wrapping; plastic bubble packs for wrapping or packaging; sheets of reclaimed cellulose for wrapping; steel letters; letters [type]; numbers [type]; lithographic works of art; architects' models; postage stamps; graphic prints; modelling clay; teaching materials [except apparatus]; bookbinding cloth; sealing compounds for stationery purposes; adhesives [glues] for stationery or household purposes; packaging material made of starches; filter paper; addressng machines; bookbinding apparatus and machines [office equipment]; typewriters, electric or non-electric; folders [stationery]; franking machines [stamping machines]; chalk for lithography; writing chalk; steatite [tailor's chalk]; marking chalk; garbage bags of paper or of plastics; painters' easels; hand-rests for painters; writing instruments; writing cases [stationery]; printing sets, portable [office requisites]; bibs of paper; stickers [stationery]; finger-stalls [office requisites]; bookbinding cords; paper cutters [office requisites]; numbering apparatus; bottle envelopes of cardboard or paper; sealing wafers; covers [stationery]; passport holders; plastic cling film, extensible, for palletization; embroidery designs [patterns]; handwriting specimens for copying; oleographs; musical greeting cards; greeting cards; postcards; etchings; conical paper bags; bags for microwave cooking; palettes for painters; ink sticks; folders for papers; papier mâché; pastels [crayons]; babies' diapers of paper and cellulose, disposable; boxes for pens; bookbindings; magazines [periodicals]; pen wipers; office perforators; nibs; nibs of gold; steel pens; drawing pens; song books; seals [stamps]; sealing stamps; announcement cards [stationery]; clipboards; address plates for addressing machines; handkerchiefs of paper; plastic film for wrapping; babies' napkin-pants [diaper-pants] of paper and cellulose, disposable; letter trays; trays for sorting and counting money; coasters of paper; bookends; stamp stands; mats for beer glasses; stands for pens and pencils; photograph stands; inking pads; binding strips [bookbinding]; towels of paper; gummed cloth for stationery purposes; printers' blankets, not of textile; inking sheets for document reproducing machines; inking sheets for duplicators; portraits; paperweights; inkstands; compasses for drawing; erasing shields; office requisites, except furniture; writing materials; school supplies [stationery]; adhesive tape dispensers [office requisites]; hand labelling appliances; paper clasps; pencil sharpeners, electric or non-electric; prospectuses; printed timetables; printers' reglets; indexes; elastic bands for offices; graphic reproductions; duplicators; penholders; pens [office requisites]; napkins of paper for removing make-up; face towels of paper; scrapers [erasers] for offices; clips for offices; erasing products;

biological samples for use in microscopy [teaching materials]; histological sections for teaching purposes; figurines [statuettes] of papier mâché; writing board erasers; composing frames [printing]; sealing wax; arithmetical tables; placards of paper or cardboard; writing or drawing books; transparencies [stationery]; stencil plates; cardboard tubes; indian inks; moisteners [office requisites]; moisteners for gummed surfaces [office requisites]; chart pointers, non-electronic; bottle wrappers of cardboard or paper; envelope sealing machines, for offices; sealing machines for offices; vignetting apparatus; apparatus for mounting photographs; stapling presses [office requisites]; handbooks [manuals]; paper coffee filters; flags of paper; silver paper; molds for modelling clays [artists' materials]; photo-engravings; stencil cases; canvas for painting; chromolithographs [chromos]; artists' watercolor [watercolour] saucers; correcting ink [heliography]; ink; ink stones [ink reservoirs]; blueprints; chaplets; balls for ball-point pens; cabinets for stationery [office requisites]; printing type; address stamps; stamps prints [engravings]; labels, not of textile.

18 – Leather and imitations of leather, and goods made of these materials and not included in other classes; animal skins, hides; trunks and travelling bags; umbrellas, parasols and walking sticks; whips, harness and saddlery, including, alpenstocks; pocket wallets; card cases [notecases]; reins; harness fittings; parts of rubber for stirrups; chamois leather, other than for cleaning purposes; umbrellas; parasols; briefcases; saddlery; frames for umbrellas or parasols; handbag frames; valves of leather; whips; imitation leather; leather, unworked or semi-worked; leatherboard; casings, of leather, for springs; umbrella rings; hat boxes of leather; boxes of leather or leather board; boxes of vulcanised fibre; purses; chain mesh purses; fastenings for saddles; butts [parts of hides]; saddle trees; envelopes, of leather, for packaging; moleskin [imitation of leather]; knee-pads for horses; muzzles; halters; vanity cases, not fitted; leather thread; furniture coverings of leather; gut for making sausages; clothing for pets; trimmings of leather for furniture; collars for animals; dog collars; music cases; slings for carrying infants; gold beaters' skin; cat o' nine tails; pads for horse saddles; horseshoes; bands of leather; coverings of skins [furs]; horse blankets; bandoliers; fur; haversacks; leather straps; straps for soldiers' equipment; harness straps; straps for skates; straps of leather [saddlery]; chin straps, of leather; stirrup leathers; umbrella handles; walking cane handles; suitcase handles; backpacks; travelling bags; riding saddles; net bags for shopping; umbrella or parasol ribs; stirrups; bags for climbers; travelling sets [leatherware]; sling bags for carrying infants; garment bags for travel; handbags; tool bags of leather, empty; wheeled shopping bags; be-

ach bags; bags for sports; bags for campers; shopping bags; school bags; travelling trunks; cases, of leather or leatherboard; nose bags [feed bags]; bridoons; canes; umbrella sticks; walking stick seats; bits for animals [harness]; bridles [harness]; harness for animals; key cases [leatherware]; horse collars; valises; suitcases; attache cases; covers for horse-saddles; umbrella covers; kid; curried skins; animal skins; cattle skins; leather leads; blinders [harness]; game bags [hunting accessories].

19 – Building materials (non-metallic); non-metallic rigid pipes for building; asphalt, pitch and bitumen; non-metallic transportable buildings; monuments, not of metal, including, aquaria [structures]; alabaster; door casings, not of metal; window frames, not of metal; asbestos cement; asphalt; beams, not of metal; balustrading; huts; swimming pools [structures, not of metal]; arbours [structures]; concrete; bitumen; telephone booths, not of metal; beacons, not of metal, non-luminous; building paper; busts of stone, concrete or marble; bird baths [structures, not of metal]; binding agents for making briquettes; binding material for road repair; stained-glass windows; felt for building; aviaries, not of metal [structures]; gates, not of metal; diving boards, not of metal; geotextiles; gypsum; plaster; potters' clay; potters' clay [raw material]; earth for bricks; clay; gravel; aquarium gravel; granite; folding doors, not of metal; doors, not of metal; coal tar; chimney cowls, not of metal; memorial plaques, not of metal; shingle; worked timber; veneer wood; moldable wood; chimney shafts, not of metal; jalousies, not of metal; gutters, not of metal; agglomerated bagasses of cane [building material]; signs, non-luminous and non-mechanical, not of metal, for roads; non-luminous and non-mechanical signs, not of metal; calcareous stone; lime; works of stonemasonry; works of art of stone, concrete or marble; cabanas not of metal; building stone; rubble; artificial stone; gravestones; reeds, for building; framework, not of metal, for building; greenhouse frames, not of metal; cornices, not of metal; building cardboard [asphalted]; wood pulp board, for building; building cardboard; skating rinks [structures, not of metal]; quartz; caissons for construction work under water; bricks; fire burrs; water-pipe valves, not of metal or plastic; drain traps [valves], not of metal or plastic; cask wood; mooring bollards, not of metal; cement posts; mantlepieces; chimney pots, not of metal; buildings, not of metal; buildings, transportable, not of metal; poles, not of metal, for electric power lines; stringers [parts of staircases], not of metal; roofing, not of metal; manhole covers, not of metal; xylolith; chicken-houses, not of metal; paint spraying booths, not of metal; fair huts; building timber; manufactured timber; sawn timber; wood, semi-worked; staircases, not of metal; stair-treads [steps], not of metal; reinforcing materials, not of metal, for building; bituminous

products for building; tar; planks [wood for building]; road coating materials; materials for making and coating roads; fireclay; building materials, not of metal; pitch; refractory construction materials, not of metal; raw chalk; calcareous marl; mosaics for building; marble; slate powder; porches, not of metal, for building; roof flashing, not of metal; perches; duckboards, not of metal; wall claddings, not of metal, for building; moldings, not of metal, for building; coatings [building materials]; tomb or grave enclosures, not of metal; laths, not of metal; scantlings [carpentry]; floor boards; wall linings, not of metal, for building; fences, not of metal; crash barriers, not of metal, for roads; latticework, not of metal; windows, not of metal; olivine for building; shuttering, not of metal, for concrete; greenhouses, transportable, not of metal; branching pipes, not of metal; monuments, not of metal; tombs, not of metal; wainscotting, not of metal; signalling panels, non-luminous and non-mechanical, not of metal; parquet flooring; partitions, not of metal; floors, not of metal; ceilings, not of metal; lintels, not of metal; casement windows, not of metal; sand, except foundry sand; aquarium sand; silver sand; sandstone for building; rocket launching platforms, not of metal; platforms, prefabricated, not of metal; tiles, not of metal, for building; floor tiles, not of metal; paving slabs, not of metal; cement slabs; gravestone slabs, not of metal; roofing, not of metal, incorporating solar cells; cladding, not of metal, for building; asphalt paving; wood paving; lighting slabs; macadam; fireproof cement coatings; paving blocks, not of metal; roof coverings, not of metal; bituminous coatings for roofing; vinyl siding; tarred strips, for building; road marking sheets and strips of synthetic material; sills, not of metal; floating docks, not of metal, for mooring boats; cork [compressed]; props, not of metal; grout; asbestos mortar; tanks of masonry; furrings of wood; pilings, not of metal; insect screens not of metal; vaults, not of metal [burial]; bicycle parking installations, not of metal; shutters, not of metal; statues of stone, concrete or marble; figurines [statuettes] of stone, concrete or marble; building glass; alabaster glass; safety glass; glass granules for road marking; insulating glass [building]; window glass, except glass for vehicle windows; plate glass [windows], for building; tombstone stelae, not of metal; advertisement columns, not of metal; telegraph posts, not of metal; hips for roofing; terra cotta; penstock pipes, not of metal; water-pipes, not of metal; gutter pipes, not of metal; ducts, not of metal, for ventilating and air-conditioning installations; drain pipes, not of metal; chimneys, not of metal; rigid pipes, not of metal [building]; sandstone tubes; tufa; angle irons, not of metal; lengthening pieces, not of metal, for chimneys; plywood; door panels, not of metal; foundry molds [moulds], not of metal; parquet floor boards; pigsties; silos,

not of metal; silica [quartz]; cement for blast furnaces; cement for furnaces; magnesia cement; cement; pantiles; schists; roofing slates; slag [building material]; clinker stone; railroad ties, not of metal; veneers; blinds [outdoor], not of metal and not of textile; clinker ballast; building panels, not of metal; masts [poles], not of metal; flashing, not of metal, for masonry.

20 – Furniture, mirrors, picture frames; goods not included in other classes of wood, cork, reed, cane, wicker, horn, bone, ivory, whalebone, shell, amber, mother-of-pearl, meerschaum and substitutes for all these materials, or of plastics, including, reels, not of metal, non-mechanical, for flexible hoses; pulleys of plastics for blinds; cork bands; casks of wood for decanting wine; mooring buoys, not of metal; casks, not of metal; barrels, not of metal; identification bracelets, not of metal, for hospitals; sideboards; busts of wood, wax, plaster or plastic; costume stands; bolsters; fans for personal use, non-electric; work benches; vice benches, not of metal; coatstands; coat hangers; shoulder poles [yokes]; display stands; showcases [furniture]; newspaper display stands; artificial honeycombs; signboards of wood or plastics; loading gauge rods, not of metal, for railway waggons [wagons]; nuts, not of metal; nesting boxes; coffins; doors for furniture; curtain holders, not of textile material; bolts, not of metal; divans; keyboards for hanging keys; display boards; flagpoles; containers, not of metal, for liquid fuel; packaging containers of plastic; flowerstands [furniture]; curtain tie-backs; wall plugs, not of metal; binding screws, not of metal, for cables; cable or pipe clips of plastics; rivets, not of metal; tortoiseshell imitation; locks, other than electric, not of metal; locks, not of metal, for vehicles; bead curtains for decoration; bottle closures, not of metal; closures, not of metal, for containers; mirrors [looking glasses]; hand-held mirrors [toilet mirrors]; bamboo; scratching posts for cats; animal claws; animal hooves; coral; meerschaum; whalebone, unworked or semi-worked; stag antlers; tortoiseshell; shells; horn, unworked or semi-worked; animal horns; rattan; ivory, unworked or semi-worked; corozo; plaited straw, except matting; wickerwork; works of art, of wood, wax, plaster or plastic; cabinet work; reeds [plaiting materials]; settees; curtain rods; reels of wood for yarn, silk, cord; valves, not of metal, other than parts of machines; water-pipe valves of plastic; drain traps [valves] of plastic; staves of wood; plastic key cards, not encoded; mats for infant playpens; saw horses; bed casters, not of metal; furniture casters, not of metal; brush mountings; wind chimes [decoration]; bassinets; tent pegs, not of metal; curtain rings; chests of drawers; containers, not of metal [storage, transport]; floating containers, not of metal; lecterns; dog kennels; baskets, not of metal; hampers [baskets]; bakers' bread baskets; trays, not of metal;

bottle casings of wood; taps for casks, not of metal; armchairs; hairdressers' chairs; hospital beds; bedsteads of wood; beds; table tops; coathooks, not of metal; curtain hooks; clothes hooks, not of metal; ladders of wood or plastics; playpens for babies; dressmakers' dummies; air mattresses, not for medical purposes; spring mattresses; mattresses; hydrotatic beds, not for medical purposes; furniture of metal; office furniture; school furniture; sleeping bags for camping; mobiles [decoration]; curtain rails; house numbers, not of metal, non-luminous; index cabinets [furniture]; barrel hoops, not of metal; furniture; furniture partitions of wood; mother-of-pearl, unworked or semi-worked; mirror tiles; ambroid plates; numberplates, not of metal; identity plates, not of metal; loading pallets, not of metal; transport pallets, not of metal; handling pallets, not of metal; head-rests [furniture]; stakes for plants or trees; trestles [furniture]; magazine racks; book rests [furniture]; stands for calculating machines; flower-pot pedestals; pet cushions; pillows; cushions; air cushions, not for medical purposes; mats, removable, for sinks; racks [furniture]; library shelves; shelves for filing-cabinets [furniture]; furniture shelves; foundations for beehives; shelves for storage; wood ribbon; straw edgings; towel closets [furniture]; hat stands; cask stands, not of metal; inflatable publicity objects; beds for household pets; bedding, except linen; latches, not of metal; bungs, not of metal; corks for bottles; corks; stair rods; desks; embroidery frames; picture frames; sections of wood for beehives; reservoirs, not of metal nor of masonry; fodder racks; curtain rollers; tool handles, not of metal; knife handles, not of metal; door handles, not of metal; scythe handles, not of metal; broom handles, not of metal; fishing baskets; writing desks; seats of metal; benches [furniture]; drinking straws; vats, not of metal; honeycombs; sofas; sealing caps, not of metal; bottle caps, not of metal; statues of wood, wax, plaster or plastic; statuettes of wood, wax, plaster or plastic; oyster shells; silvered glass [mirrors]; filing cabinets; ambroid bars; counters [tables]; umbrella stands; gun racks; carts for computers [furniture]; dressing tables; shelves for typewriters; draughtman's tables; chopping blocks [tables]; massage tables; tables of metal; desks [furniture]; tea carts; dinner wagons [furniture]; tables; steps [ladders], not of metal; chairs [seats]; high chairs for babies; bins, not of metal; placards of wood or plastics; footstools; crates; troughs, not of metal, for mixing mortar; trolleys [furniture]; straw plaits; boarding stairs, not of metal, mobile, for passengers; straw mattresses; edgings of plastic for furniture; decorations of plastic for foodstuffs; beehives; washstands [furniture]; funerary urns; wax figures; door fittings, not of metal; coffin fittings, not of metal; bed fittings, not of metal; moldings for picture frames; furniture fittings, not of metal;

window fittings, not of metal; infant walkers; garment covers [storage]; stuffed animals; stuffed birds; hinges, not of metal; deck chairs; poles, not of metal; screens [furniture]; cupboards; medicine cabinets; meat chests, not of metal; plate racks; bamboo curtains; slatted indoor blinds; woven timber blinds [furniture]; indoor window blinds [shades] [furniture]; fire screens, domestic; yellow amber; lockers; bins of wood or plastic; chests for toys; letter boxes, not of metal or masonry; bottle racks; towel dispensers, fixed, not of metal.

25 – Clothing, footwear, headgear, including wimples; bandanas [neckerchiefs]; corselets; sweat-absorbent underclothing [underwear]; overalls; stuff jackets [clothing]; boas [necklets]; teddies [undergarments]; half-boots; breeches for wear; trousers; football boots; brassieres; shoulder wraps; detachable collars; shirt yokes; veils [clothing]; galoshes; neckties; ascots; leggings; gaiters; boot uppers; vests; singlets; hosiery; heels; pants; hoods [clothing]; hat frames [skeletons]; pocket squares; pockets for clothing; collar protectors; cap peaks; tights; combinations [clothing]; wet suits for water-skiing; bodices [lingerie]; suits; bathing suits; masquerade costumes; beach clothes; jackets [clothing]; fishing vests; liveries; camisoles; tee-shirts; cuffs; chemisettes [shirt fronts]; mantillas; coats; sleep masks; furs [clothing]; mittens; miters [hats]; muffs [clothing]; not electrically heated footmuffs; heel-pieces for boots and shoes; bibs, not of paper; fur stoles; ear muffs [clothing]; socks; bath sandals; beach shoes; ski boots; footwear; paper clothing; outerclothing; ready-made clothing; motorists' clothing; cyclists' clothing; clothing for gymnastics; gabardines [clothing]; jerseys [clothing]; clothing of imitations of leather; clothing of leather; knitwear [clothing]; uniforms; clothing; fittings of metal for shoes and boots; maniples; overcoats; parkas; babies' diapers of textile; pelerines; gloves [clothing]; pyjamas; bathing trunks; scarfs; frocks; waterproof clothing; headbands [clothing]; garters; sock suspenders; stocking suspenders; ready-made linings [parts of clothing]; dress shields; soles for footwear; suspenders; lace boots; belts [clothing]; money belts [clothing]; layettes [clothing]; non-slipping devices for boots and shoes; pullovers; heelpieces for stockings; welts for boots and shoes; chasubles; shirts; wooden shoes; sandals; boots; saris; sweaters; footwear uppers; inner soles; togas; underpants; gymnastic shoes; slippers; shoes; turbans; berets; aprons [clothing]; bath robes; tips for footwear; shower caps; stockings; sweat-absorbent stockings; shawls; paper hats [clothing]; skull caps; bathing caps; sashes for wear; studs for football boots [shoes]; babies' pants; gaiter straps; pelisses; esparto shoes or sandals; skirts; petticoats.

26 – Lace and embroidery, ribbons and braid; buttons, hooks and eyes, pins and needles; artificial

flowers, including fringes; hair curlers, other than hand implements, non-electric; mica spangles; shoe eyelets; false beards; expanding bands for holding sleeves; brooches [clothing accessories]; pins, other than jewellery [jewelry (am.)]; wreaths of artificial flowers; reins for guiding children; false hair; artificial garlands; tea cosies; frills [lacework]; trouser clips for cyclists; slides [hair grips]; heat adhesive patches for repairing textile articles; blouse fasteners; shoe fasteners; dress fastenings; fastenings for suspenders; belt clasps; hook and pile fastening tapes; zip fasteners; slide locks for bags; competitors' numbers; badges for wear, not of precious metal; darning needles; needles for wool combing machines; binding needles; saddlers' needles; boxes for needles; lace trimmings; embroidery; silver embroidery; haberdashery, except thread; hair ornaments; heat adhesive patches for decoration of textile articles [haberdashery]; braids; gold embroidery; thread of metal for embroidery; tassels [haberdashery]; snap fasteners; sewing boxes; plaited hair; false hems; picot [lace]; hooks [haberdashery]; embroidering crochet hooks; rug hooks; shoe hooks; ribbons [haberdashery]; prize ribbons; elastic ribbons; letters for marking linen; orsedew [trimmings for clothing]; toupees; sewing thimbles; skirt flounces; bows for the hair; hair curling papers; wigs; feathers [clothing accessories]; ostrich feathers [clothing accessories]; eyelets for clothing; corset busks; hair bands; brassards; shoulder pads for clothing; pin cushions; needle cushions; top-knots [pompoms]; buckles [clothing accessories]; shoe buckles; buttons; ornamental novelty badges [buttons]; rosettes [haberdashery]; frills for clothing; hair nets; chenille [passementerie]; knitting needles; shoe ornaments, not of precious metal; trimmings for clothing; hat ornaments, not of precious metal; false moustaches; festoons [embroidery]; artificial fruit; artificial flowers; shuttles for making fishing nets; hair coloring caps; darning lasts; bodkins; shoe laces; tapes for curtain headings; cords for clothing; woollen laces; hair pins; collar supports.

35 – Advertising; business management; business administration; office functions, namely, arranging subscriptions to telecommunication services for others; import-export agencies; commercial information agencies; advertising agencies; cost price analysis; rental of advertising space; auditing; employment agencies; computerized file management; accounting; invoicing; demonstration of goods; transcription; opinion polling; marketing studies; business information; commercial information and advice for consumers [consumer advice shop]; business investigations; marketing research; personnel recruitment; business management and organization consultancy; personnel management consultancy; business organization consultancy; business management consultancy; professional business consul-

tancy; layout services for advertising purposes; business management of performing artists; news clipping services; updating of advertising material; word processing; secretarial services; shorthand; organization of exhibitions for commercial or advertising purposes; arranging newspaper subscriptions for others; organization of trade fairs for commercial or advertising purposes; shop window dressing; business appraisals; evaluation of standing timber; evaluation of wool; payroll preparation; data search in computer files for others; sponsorship search; business management assistance; commercial or industrial management assistance; presentation of goods on communication media, for retail purposes; economic forecasting; auctioneering; sales promotion for others; office machines and equipment rental; rental of advertising time on communication media; publicity material rental; rental of vending machines; rental of photocopying machines; publication of publicity texts; typing; radio advertising; bill-posting; distribution of samples; direct mail advertising; writing of publicity texts; on-line advertising on a computer network; advertising by mail order; television advertising; document reproduction; compilation of statistics; compilation of information into computer databases; business inquiries; systemization of information into computer databases; tax preparation; drawing up of statements of accounts; publicity columns preparation; psychological testing for the selection of personnel; business management of hotels; commercial administration of the licensing of the goods and services of others; administrative processing of purchase orders; public relations; modelling for advertising or sales promotion; relocation services for businesses; price comparison services; procurement services for others [purchasing goods and services for other businesses]; outsourcing services [business assistance]; telephone answering for unavailable subscribers; photocopying; efficiency experts.

36 – Insurance; financial affairs; monetary affairs; real estate affairs, including, credit bureaux; debt collection agencies; real estate agencies; customs brokerage; financial analysis; leasing of farms; hire-purchase financing; savings banks; accommodation bureaux [apartments]; rent collection; issuing of travellers' checks [cheques]; issuance of credit cards; issue of tokens of value; capital investments; insurance information; financial information; clearing, financial; insurance consultancy; financial consultancy; stock exchange quotations; business liquidation services, financial; brokerage; financial management; exchanging money; debit card services; credit card services; home banking; factoring; organization of collections; antique appraisal; jewellery appraisal; stamp appraisal; real estate appraisal; numismatic appraisal; art appraisal; financial evaluation [insurance, banking, real estate]; repair

costs evaluation [financial appraisal]; electronic funds transfer; bail-bonding; securities brokerage; housing agents; insurance brokerage; loans [financing]; lending against security; check [cheque] verification; charitable fund raising; leasing of real estate; rental of offices [real estate]; renting of apartments; financial sponsorship; mortgage banking; instalment loans; accident insurance underwriting; apartment house management; real estate management; actuarial services; banking; retirement payment services; fiduciary; mutual funds; financing services; safe deposit services; deposits of valuables; fiscal assessments.

38 – Telecommunications, including, news agencies; television broadcasting; cable television broadcasting; electronic bulletin board services [telecommunications services]; information about telecommunication; telecommunications routing and junction services; providing internet chatrooms; providing user access to a global computer network [service providers]; providing access to databases; providing telecommunications connections to a global computer network; providing telecommunication channels for teleshopping services; message sending; computer aided transmission of messages and images; sending of telegrams; transmission of telegrams; electronic mail; rental of message sending apparatus; rental of access time to global computer networks; rental of modems; rental of telecommunication equipment; rental of telephones; rental of facsimile apparatus; radio broadcasting; communications by fiber [fibre] optic networks; cellular telephone communication; communications by computer terminals; satellite transmission; communications by telegrams; communications by telephone; facsimile transmission; paging services [radio, telephone or other means of electronic communication]; teleconferencing services; telex services; voice mail services; telegraph services; telephone services.

39 – Transport; packaging and storage of goods; travel arrangement, including, air transport; boat rental; parking place rental; booking of seats for travel; travel reservation; transport reservation; towing; vehicle towing; water distribution; delivery of newspapers; message delivery; parcel delivery; delivery of goods; delivery of goods by mail order; flower delivery; launching of satellites for others; traffic information; transportation information; storage information; arranging of cruises; arranging of tours; hauling; carting; transport and storage of trash; transporting furniture; removal services; barge transport; ferry-boat transport; transport of travellers; freight [shipping of goods]; armored-car transport; bus transport; car transport; boat transport; railway transport; marine transport; passenger transport; river transport; portage; refloating of ships; shipbrokerage; transport brokerage; freight

brokerage; operating canal locks; car rental; truck rental; rental of diving bells; rental of diving suits; rental of motor racing cars; rental of wheelchairs; rental of storage containers; horse rental; coach rental; frozen-food locker rental; vehicle rental; stevedoring; unloading cargo; electricity distribution; distribution of energy; packaging of goods; ambulance transport; garage rental; rental of vehicle roof racks; rental of warehouses; ice-breaking; piloting; water supplying; escorting of travellers; underwater salvage; salvage of ships; taxi transport; streetcar transport; transport by pipeline; rescue operations [transport]; wrapping of goods; car parking; chauffeur services; pleasure boat transport; courier services [messages or merchandise]; salvaging; franking of mail; freighting; physical storage of electronically-stored data or documents; boat storage; storage of goods; storage; sightseeing [tourism]; freight forwarding.

41 – Education; providing of training; entertainment; sporting and cultural activities, including, modeling for artists; academies [education]; rental of tennis courts; lending libraries; booking of seats for shows; videotaping; nursery schools; physical education; discotheque services; animal training; dubbing; gaming; publication of books; education information; recreation information; entertainment information; movie studios; health club services; club services [entertainment or education]; night clubs; layout services, other than for advertising purposes; microfilming; videotape editing; production of radio and television programmes; music-halls; game services provided on-line from a computer network; providing on-line electronic publications, not downloadable; religious education; gymnastic instruction; correspondence courses; practical training [demonstration]; organization of balls; organization of exhibitions for cultural or educational purposes; providing recreation facilities; arranging and conducting of colloquiums; arranging and conducting of congresses; arranging and conducting of conferences; arranging and conducting of concerts; arranging and conducting of workshops [training]; arranging and conducting of seminars; arranging and conducting of symposiums; arranging of beauty contests; organization of competitions [education or entertainment]; operating lotteries; holiday camp services [entertainment]; organization of shows [impresario services]; organization of sports competitions; vocational guidance [education or training advice]; amusement parks; sign language interpretation; television entertainment; bookmobile services; providing karaoke services; providing golf facilities; providing sports facilities; providing amusement arcade services; cinema presentations; presentation of live performances; theatre productions; educational examination; timing of sports events; videotape film production; film production; rental of sound recordings; rental

of audio equipment; rental of camcorders; rental of video cassette recorders; rental of videotapes; rental of show scenery; rental of movie projectors and accessories; rental of cine-films; rental of stadium facilities; rental of lighting apparatus for theatrical sets or television studios; rental of radio and television sets; rental of skin diving equipment; rental of sports equipment, except vehicles; rental of stage scenery; electronic desktop publishing; publication of electronic books and journals on-line; publication of texts, other than publicity texts; radio entertainment; entertainer services; amusements; writing of texts, other than publicity texts; zoological gardens; news reporters services; party planning [entertainment]; music composition services; sport camp services; subtitling; providing casino facilities [gambling]; calligraphy services; providing museum facilities [presentation, exhibitions]; educational services; orchestra services; translation; scriptwriting services; ticket agency services [entertainment]; recording studio services; digital imaging services; photography; photographic reporting; circuses; boarding schools; production of shows.

42 – Scientific and technological services and research and design relating thereto; industrial analysis and research services; design and development of computer hardware and software, including, computer systems analysis; chemical analysis; architecture; authenticating works of art; recovery of computer data; graphic arts designing; computer virus protection services; technical project studies; engineering; installation of computer software; weather forecasting; material testing; textile testing; bacteriological research; biological research; geological research; research in the field of environmental protection; cosmetic research; mechanical research; physics [research]; chemical research; research and development for others; analysis for oil-field exploitation; underwater exploration; technical research; calibration [measuring]; consultancy in the field of computer hardware; computer software consultancy; architectural consultation; oil-well testing; quality control; vehicle roadworthiness testing; land surveying; dress designing; updating of computer software; geological surveys; oil-field surveys; maintenance of computer software; design of interior decor; conversion of data or documents from physical to electronic media; urban planning; providing search engines for the internet; data conversion of computer programs and data [not physical conversion]; computer system design; rental of web servers; computer rental; rental of computer software; geological prospecting; oil prospecting; hosting computer sites [web sites]; duplication of computer programs; construction drafting; computer software design; cloud seeding; consultancy in the field of energy-saving; creating and maintaining web sites for others; computer programming;

industrial design; chemistry services; packaging design; surveying.

(260) AM 2013 67426 A
 (800) 1114478
 (731) EGIS GYOGYSZERGYÁR Nyilvánosan
 Működő Részvénytársaság
 Kereszturi ut 30-38, H-1106 Budapest,
 Hungary

(540)

FECOMBREN

(591) Black, white
 (511)
 5 – Pharmaceutical preparations for human use.

(260) AM 2013 67430 A
 (800) 1114527
 (731) OKYANUS KİMYA HIRDAVAT
 ELEKTRİKLİ EL ALETLERİ VE
 ELEKTRONİK MALZEMELERİ
 İTHALAT İHRACAT SANAYİ
 TİCARET LİMİTED ŞİRKETİ
 Hadimköy Mahallesi, Arpaslan Sokagi
 No: 10, Arnavutköy-İstanbul, Turkey

(540)

STALLION

(591) Black, white
 (511)
 1 – Chemicals used in industry, science and photography, as well as in agriculture, horticulture and forestry; unprocessed artificial resins, unprocessed plastics; manures; fire extinguishing compositions; tempering and soldering preparations; chemical substances for preserving foodstuffs; tanning substances; adhesives used in industry.

17 – Rubber; gutta-percha; gum; asbestos; mica and goods made from these materials; insulating materials; rubber stoppers; fillers for expansion joints; chemical compositions for repairing leaks; flexible plumbing pipes of plastic, rubber or natural rubber, canvas hose pipes, fire hoses, flexible compressed air pipe fittings, not of metal, pipe fittings, vehicle radiator connecting hoses.

(260) AM 2013 67437 A
 (800) 1114557
 (731) ZAMBAITI PARATI S.P.A
 VIA ALESSANDRO PERTINI, 2, I-24021
 ALBINO (BG), Italy

(540)

VITALII

(591) Black, white
 (511)

27 – Wall hangings (non-textile), wallpapers.

(260) AM 2013 67438 A
 (800) 1114588
 (731) Millennium Pharmaceuticals, Inc.
 40 Landsdowne Street, Cambridge,
 MA 02139, USA

(540)

AUROQUEST

(591) Black, white
 (511) 5 – Pharmaceutical preparations for human use, including for the treatment of cancer, autoimmune diseases and disorders and inflammatory diseases and disorders; pharmaceutical preparations for the treatment and prevention of cancer.

(260) AM 2013 67476 A
 (800) 1114766
 (731) WERZALIT GMBH + CO. KG
 Gronauer Strasse 70, 71720 Oberstenfeld,
 Germany

(540)

expona

(591) Black, white
 (511)
 6 – Building materials made of metal, in particular window ledges made of metal.

19 – Building materials not made of metal; in particular building and construction materials derived from timber, wood plastic composites, from wood polymer composites or from paper plastic composites; chipboard; plywood; laminated wood; trimmed timber; veneers and veneer wood; building timber and lumber; shaped wood, compressible wood, semi-worked wood, wood pulp board for building purposes; linings, not of metal, for building; lining for garage doors and balconies; wall linings, not of metal; wall claddings, not of metal; ceiling linings, not of metal; slabs, in particular for lining exterior and interior walls and ceilings, not of metal; tiles, not of metal; wall and ceiling paneling, not of metal; laths, not of metal; moldings, not of metal; wainscotting, not of metal; furrings, not of metal; balconies and parts of balconies, not of metal; floors, not of metal; terrace floors, not of metal; terrace coverings, not of metal; terrace slabs, not of metal; terrace profiles, not of metal; terrace tiles, not of metal; tiles and tile floorings, not of metal; parts for the assembly of floors, not of metal; floor tiles, not of metal; skirting boards, not of metal; formwork elements and shuttering for concrete buildings, not of metal; roller shutter casings and parts for this, not of metal; cornices, in particular window sills, not of metal; window frames, not of metal; window ledges, not of metal; doors and gates, not of metal; door frames and posts, not of metal; door casings, not of metal, door

leaves, not of metal; frames and middle layers for the manufacture of door leaves, not of metal; walls, not of metal; prefabricated parts of walls, not of metal; partitions, not of metal; ceilings, not of metal; lighting grids for ceiling lighting, not of metal; middle layers for the manufacture of wall parts, not of metal; balustrades and balustrading, not of metal; railing and railing components, not of metal; duckboards, not of metal.

20 – Furniture and parts thereof insofar as contained in this class; bedsteads and parts thereof insofar as contained in this class; slatted bed bases (parts of beds); slats for slatted bed bases; tables and table-tops; seating furniture and parts thereof, insofar as contained in this class, in particular chair carcasses, cushion supports, seat shells and frames for seat cushions; office furniture and parts thereof, insofar as contained in this class; garden furniture and parts thereof, in particular tabletops; furniture for catering businesses and parts thereof, in particular tabletops; furniture shelves, in particular for racks; shelves for storage; countertops; hard covers as panels for kitchen furniture, made of wood plastic composites and wood polymer composites, for example for refrigerators, washing machines and dishwashers; coffins; coffin parts; burial urns; mirrors, picture frames; moldings for frames, insofar as contained in this class; frame borders, insofar as contained in this class; packaging containers, not of metal as far as included in this class; containers, not of metal; boxes, cases and crates, not of metal, insofar as contained in this class; barrels, casks, not of metal; pallets, insofar as contained in this class, in particular handling, loading and transport pallets, not of metal; storage containers, not of metal as far as included in this class; transport containers, not of metal; cask stands, not of metal; tanks, not of metal and not of masonry; plugs, not of metal, for the transport and protection of rolls, for example, paper or cling film rolls; goods, insofar as they are not contained in other classes, made of wood, derived timber products, wood plastic composites, wood polymer composites, paper plastic composites, cork, reeds, rushes, willow, horn, bone, ivory, whalebone, tortoiseshell, yellow amber, mother-of-pearl, meerscham and their substitutes or made of plastics.

(260) AM 2013 67477 A
(800) 1114775
(731) ZENTIVA, K.S.
U Kabelovny 130, CZ-102 37 Praha
10 – Dolní Měcholupy , Czech Republic
(540)

TROMBEXDUO

(591) Black, white
(511)
5 – Medicines, pharmaceutical preparations for human use.

(260) AM 2013 67478 A
(800) 1114776
(731) ZENTIVA, K.S.
U Kabelovny 130, CZ-102 37 Praha
10 – Dolní Měcholupy , Czech Republic
(540)

DUOTROMBEX

(591) Black, white
(511)
5 – Medicines, pharmaceutical preparations for human use.

(260) AM 2013 67484 A
(800) 1114780
(731) ZENTIVA, K.S.
U Kabelovny 130, CZ-102 37 Praha
10 – Dolní Měcholupy , Czech Republic
(540)

SIDRETANA

(591) Black, white
(511)
5 – Medicines, pharmaceutical preparations for human use.

(260) AM 2013 67485 A
(800) 1114781
(731) ZENTIVA, K.S.
U Kabelovny 130, CZ-102 37 Praha
10 – Dolní Měcholupy , Czech Republic
(540)

SIDRENATA

(591) Black, white
(511)
5 – Medicines, pharmaceutical preparations for human use.

(260) AM 2013 67486 A
(800) 1114802
(731) The Absolut Company Aktiebolag
SE-117 97 Stockholm, Sweden
(540)



(591) Black, white

(511)
33 – Alcoholic beverages (except beers).

(260) AM 2013 67488 A
(800) 1114831
(731) PHILIP MORRIS BRANDS SÀRL
Quai Jeanrenaud 3, CH-2000 Neuchâtel,
Switzerland

(540)

EASY LIFT

(591) Black, white
(511)
34 – Tobacco, raw or manufactured; tobacco products, including cigars, cigarettes, cigarillos, tobacco for roll-your-own cigarettes, pipe tobacco, chewing tobacco, snuff tobacco, kretek; snus; tobacco substitutes (not for medical purposes); smokers' articles, including cigarette paper and tubes, cigarette filters, tobacco tins, cigarette cases and ashtrays, pipes, pocket apparatus for rolling cigarettes, lighters; matches.

(260) AM 2013 67489 A
(800) 1114832
(731) PHILIP MORRIS BRANDS SÀRL
Quai Jeanrenaud 3, CH-2000 Neuchâtel,
Switzerland

(540)

PARLIAMENT A CUT ABOVE

(591) Black, white
(511)
34 – Tobacco, raw or manufactured; tobacco products, including cigars, cigarettes, cigarillos, tobacco for roll-your-own cigarettes, pipe tobacco, chewing tobacco, snuff tobacco, kretek; snus; tobacco substitutes (not for medical purposes); smokers' articles, including cigarette paper and tubes, cigarette filters, tobacco tins, cigarette cases and ashtrays, pipes, pocket apparatus for rolling cigarettes, lighters; matches.

(260) AM 2013 67490 A
(800) 1114837
(731) X-Trade Brokers Dom Maklerski S.A.
ul. Ogrodowa 58, PL-00-876 Warszawa,
Poland

(540)



(591) Orange, white and black
(511)
36 – Brokerage.

(260) AM 2013 67492 A
(800) 1114917
(731) MOSCOVSKIY OBLASTNOI BANK
ul. Solianka 3, str. 2, RU-109028 Moscow,
Russian Federation

(540)



(591) Red, white, gold
(511)
36 – Credit agencies, savings bank services, issuing of travellers' checks, issuing of credit cards, capital investment, financial information, currency exchange services, financial consulting, financial management, foreign exchange services, debit card services, credit card services, direct banking, organizing collections, electronic funds transfer, guarantees (credit guarantees), loans (financing), pledge loans, check verification, charitable fundraising, financial sponsorship, mortgage banking, payment in installments, monetary affairs, retirement payment services, fiduciary services, raising of capital, financing services, safe-deposit services, deposits of valuables.

(260) AM 2013 67494 A
(800) 1114966
(731) RHODIA OPERATIONS
40 rue de la Haie-Coq, F-93306
AUBERVILLIERS, France

(540)



(591) Black, white
(511)
1 – Chemicals for industrial use; chemicals used in the perfumery, cosmetics, additives, food and plastics industries; active principles and chemical intermediates used in the perfumery, cosmetics, additives, food and plastics industries; chemicals containing vanillin used in the perfumery, cosmetics, additives, food and plastics industries.

5 – Chemicals used in the pharmaceutical industries; active principles and chemical intermediates used in the pharmaceuticals industries; chemicals containing vanillin used in the pharmaceuticals industries.

(260) AM 2013 67556 A
(800) 1115396
(731) OPEL SPECIAL VEHICLES GMBH

Mainzer Str. (Adam Opel AG – M55), 65428
Rüsselsheim, Germany

(540)

ADAM SLAM

(591) Black, white

(511)

12 – Motor vehicles, except motor scooters (vehicles); parts and spare parts therefor, except parts and spare parts for motor scooters (vehicles); seat belt pads for motor vehicles; all the aforesaid goods included in this class.

(260) AM 2013 67624 A

(800) 1115848

(731) YMIR ENTERTAINMENT Co., Ltd.
6F, Donggung Bldg, 9 Teheranro 20-gil,
Gangnam-Gu (Yeoksam-Dong), Seoul,
Republic of Korea

(540)



(591) Goldenrod and firebrick red

(511)

9 – Downloadable computer game software; recorded computer software; downloadable computer programs (software); downloadable digital music; recorded computer game programs; pre-recorded electronic media of music; downloadable electronic publications; video game cartridges; musical juke boxes; apparatus for recording and reproduction of sound and images; computer software for wireless content delivery; pre-recorded electronic media of non-music excluding computer software; animated cartoons.

41 – Game services provided on-line from a computer network; rental of videotapes; television entertainment; publication of electronic books and journals on-line; providing amusement arcade services; provision of on-line information in the field of computer games entertainment; rental of recorded magnetic audio tapes.

(260) AM 2013 67626 A

(800) 1115884

(731) ETAM (société par actions simplifiée)
57-59 rue Henri Barbusse, F-92110 Clichy,
France

(540)



(591) Black, white

(511)

3 – Cosmetics, cosmetic creams, make-up powder, cosmetic lotions, milks and lotions for removing

make-up; make-up preparations, make-up foundation, blushes, lipsticks, mascara, pencils for the eyes and eyelids, nail polish, nail polish removers; cosmetic preparations for use in the bath or shower, shower gels, bath foams, cosmetic milks, body care oils and lotions for cosmetic use, fluid body glitter, deodorants for personal use, eaux de toilette, perfumes, scented water; tanning and after-sun milks, gels and oils (cosmetics), sunscreen preparations (cosmetic sun-tanning preparations); cosmetic sun-tanning preparations; decorative transfers for cosmetic use.

18 – Leather and imitation leather; animal skins, pelts and hides, trunks and suitcases, travel chests; boxes of leather, boxes of leatherboard, small leather bags (envelopes, pouches) for packing purposes, handbags, travel bags, backpacks, beach bags, wheeled bags, school satchels, belt bags, garment bags, travel and make-up sets sold empty, leather bands, carrying cases; purses, briefcases, wallets, change purses, card cases (wallets), key cases (leather goods), umbrellas, parasols and walking sticks.

25 – Clothing, footwear, headgear; clothing for men, women and children, dresses, skirts, underskirts, pant skirts, suits, slacks, shorts, Bermuda shorts, undershorts, shirts, blouses, bodices, tee-shirts, sweat-shirts, vests, coats, gabardines, raincoats, furs, stoles, sashes for wear, shawls, scarves, gloves (clothing), neckties, belts (clothing), socks, stockings, tights, underclothing, pajamas, dressing gowns, bathing suits, bathrobes; shoes, sandals, boots, ankle boots, booties, slippers; headgear, hats, berets, caps.

(260) AM 2013 67628 A

(800) 1115938

(731) MOS MOBILITY OUTSOURCING
SERVICE GmbH + Co. KG
Balcke-Dürr-Allee 3, 40882 Ratingen,
Germany

(540)

MOS Toll Box

(591) Black, white

(511)

4 – Industrial oils and greases; liquid and gaseous fuels; all the aforesaid goods being motor vehicle fuels.

7 – Motor vehicle accessories, included in this class, namely catalytic converters, starters for engine, driving chain, except for farm vehicles, main engines, except for farm vehicles, drive shafts, except for farm vehicles, exhaust manifold for engines, mufflers for engines, gaskets, speed regulators for machines and engines, decompression valves, pressure controllers, pressure valves, injectors for engines, springs, blowers for compressing, suc-

tion and for the transportation of gas, bodies for machines and engines, gears, except for farm vehicles, glow plugs for diesel engines, hydraulic engines, hydraulic actuators for machines and engines, hydraulic door openers and door closers, pistons for engines, piston rings, compressors, fuel saving device for engines, clutches, except for farm vehicles, crankshafts, turbocharger, air filter for engines, connecting rod for machines and engines, pneumatic actuators for machines and engines, pneumatic door openers and door closers, shifting clutches, except for farm vehicles, control devices for machines or engines, control cable for machines or engines, transmission chain, except for farm vehicles, drive belts for engines, engines for vehicles, except for farm vehicles, turbo compressors, step-up gear unit for vehicles, except for farm vehicles, step-up gear unit for machines, reduction gear unit, except for farm vehicles, fans for engines, valves, carburetor, apparatus for transmission, except for farm vehicles, car-jack, shaft coupling, ignition plugs for combustion engines, cylinders for engines, cylinder pistons, barrel head for engines.

9 – Satellite navigational instruments; aerials; distance recording apparatus; steering apparatus, automatic, for vehicles; accounting machines; integrated-circuit chips; magnetic encoders; encoded identification cards; encoded service cards; data-processing apparatus; receiving apparatus; distance measuring apparatus; speed checking apparatus for vehicles; high-frequency apparatus; interfaces (for computers); surveying instruments; meters; radar apparatus; transmitters for telecommunications and for electronic signals; remote control of signals; simulators for the steering and control of vehicles; bar code readers; checkers; time recording apparatus; on-board units for use in toll lanes.

12 – Motor vehicle accessories, included in this class.

35 – Billing (office functions) based mainly on customer-oriented and developed software programs, computer-aided billing and billing management for fuel, ferry fees, motorway fees, toll fees and/or value-added tax as services in the field of the cashless in-transit provisioning of nationally and internationally active businesses involved in Industrial goods and passenger transport, of commercial vehicles fleets of passenger vehicle and/or lorries, in the transport sector; station services and sales and servicing relating thereto, namely computer aided billing of border clearance fees; computer aided billing of freight and freight brokerage costs; border clearance and ferry services, namely providing access authorization for toll lanes and tunnels through the input of data processing equipment; computer-aided billing of tunnel fees; computer-aided billing of repair services; business management services; business administration; offi-

ce functions; advertising; logging a person and vehicle-related data; computer-aided logging, evaluation and analysis of vehicle master data, tank data calculations, vehicle costs and revenues, computer-aided order planning, including systematic logging and organizational and professional business planning of motor vehicles and orders, coordination and updating of order planning; provision of contracts for mobile phone services.

36 – Issuing of service cards with payment functions to commercial goods and passenger transport operations, for cashless in-transit supplying of lorries, buses and their drivers; computer-aided handling of financial transactions, monetary transactions, namely with service cards with payment functions; refunding of foreign value-added tax; customs clearance services; border clearance and ferry services, namely providing access authorization for toll lanes and tunnels through the issuing of car windscreen stickers (permits); financial guarantee services for the reimbursement of expenses incurred as a result of vehicle accident or breakdown.

37 – Motor vehicle repair workshop services, namely maintenance and repair of motor vehicles; service station services and sales and servicing relating thereto, namely cleaning of motor vehicles, repairing of motor vehicles; breakdown assistance, namely repair of motor vehicles by the roadside and in motor vehicle repair workshops; rental services, namely rental of construction vehicles; motor vehicle maintenance; repair and maintenance of tyres and motor vehicle cooling systems; installation services; installation and maintenance of toll logging and toll billing apparatus.

38 – Transmission of information on emergency breakdown services by electronic communications networks; information services for nationally and internationally-active commercial goods and passenger transport operations, namely transmission of information via the Internet, via radio and printed matter relating to road conditions, traffic situations, the location of service stations, the location of vehicles and technical vehicle matters, transmission of price information relating to the price of fuel at home and abroad.

39 – Breakdown assistance, namely towing and recovery services; rental services, namely rental of buses, freight-forwarding vehicles; transport of vehicles by rail; accident services, namely organizing replacement vehicles, tow vehicles and towing services; vehicle fleet management, namely vehicle fleet administration; packaging and storage of goods; travel arrangement; transshipment of transport goods; freight forwarding, excluding customs clearance, for others; locating broken-down vehicles through computer-aided map systems.

41 – Language interpretation services; publication of printed matter other than publicity texts also in electronic form in relation to road conditions, traffic situations, location of service stations, location of vehicles and technical vehicle matters, transmission of price information relating to the price of fuel at home and abroad.

42 – Installation and maintenance of software for toll logging and toll billing apparatus.

44 – Medical care related to accident.

45 – Consultancy with regard to intellectual and industrial property rights; licensing of intellectual property rights and copyright; industrial property rights, including in the field of copyright; legal consultancy relating to intellectual property rights; legal representation of others in tax matters.

(260) AM 2013 67629 A

(800) 1115948

(731) H&M Hennes & Mauritz AB
SE-106 38 Stockholm, Sweden

(540)

MTWTFSS WEEKDAY

(591) Black, white

(511)

25 – Clothing, footwear, headgear.

35 – Advertising and business advertising; business management; business administration; office functions; online consumer information; retailer services regarding: soaps, perfumery, essential oils, cosmetics, hair lotions, dentifrices, eyewear cases, spectacles, sunglasses, eye-glass frames, glasses cases, spectacle chains, precious metals and their alloys, and goods in precious metals or coated therewith, not included in other classes, jewellery, precious stones, horological and chronometric instruments, paper, cardboard and goods made from these materials, not included in other classes, printed matter, bookbinding material, photographs, stationery, adhesives for stationery or household purposes, artists' materials, paint brushes, typewriters and office requisites (except furniture), instructional and teaching material (except apparatus), plastic materials for packaging (not included in other classes), printers' type, printing blocks, printed publications, loaders and books, leather and imitations of leather, and all goods made of these materials and not included in other classes, skins, hides, trunks and travelling bags; umbrellas, parasols and walking sticks, whips, harness and saddlery, clothing, footwear, headwear.

(260) AM 2013 67630 A

(800) 1115951

(731) Manufacturing Private Unitary Enterprise

"Svetopribor" of the Public Association
"Belorussian Association of the Visually
Handicapped"
d. 52, ul. Yakubovskogo, 220018 Minsk,
Belarus

(540)

Bylectrica

(591) Black, white

(511)

9 – Apparatus and instruments for conducting, switching, transforming, accumulating, regulating or controlling electricity; blocks of switches and sockets combined; switches, electric plug connectors (plugs, sockets), extension cords, mounting boxes for wires arrangement and for installation of switches and sockets; apparatus for recording, transmission and reproduction of sound and images; phone jacks; television jacks; electric cords.

11 – Searchlights; lamps; lamp holders; threaded sockets for electric lamps.

20 – Goods of plastics not included in other classes, including dummy receptacles.

(260) AM 2013 67631 A

(800) 1116018

(731) Compagnie des Montres Longines, Francillon
S.A. (Longines Watch Co., Francillon Ltd.)
CH-2610 Saint-Imier, Switzerland

(540)

THE LONGINES AVIGATION WATCH TYPE A-7

(591) Black, white

(511)

14 – Precious metals and their alloys and goods in precious metals or coated therewith, included in this class; jewellery, precious stones; horological and chronometric instruments.

(260) AM 2013 67633 A

(800) 1116023

(731) ZAKRYTOE AKTSIONERNOE
OBSHESTVO "ATLANT"

61, Pobeditelei Av., 220035 Minsk, Belarus

(540)

ATLANT

(591) Grey

(511)

7 – Compressors for refrigerators and freezers; dishwashing machines; washing machines (laundry); vacuum cleaners; injection plastic moulding machines and parts thereof including drying devices, mixers, devices for material delivery, devices for finished products transporting; devices and con-

veyor for plastic crushing; conveyor lines for moulding porcelain and faience products; conveyor lines for working edges of porcelain or faience products; drying equipment and vacuum crushers used in the production of porcelain or faience; transporting systems, chain conveyors, roller conveyors, elevators for continuous operation; automated machines for warehousing; cutting tools (parts of machines).

11 – Boilers, other than parts of machines; refrigerators and freezers with compressors; thermoelectric refrigeration units; showcase refrigerators; cookers; cooker hob panels; electric kettles.

37 – Household and kitchen appliances repair; repair and modernization of metal-cutting, press-forging, transport and lifting, woodworking equipment; plastering, interior and exterior painting, wallpapering; heating equipment installation and repair; masonry, roofing services; electric appliance installation and repair; rebuilding machines that have been worn or partially destroyed.

(260) AM 2013 67634 A

(800) 1116048

(731) FU BENZHU

22C, 15 Haiyuehuayuan, Shekou, Nanshan Disc., Shenzhen City, Guangdong Prov, China

(540)

JOINUS

(591) Black, white

(511)

9 – Pocket calculators.

(260) AM 2013 67636 A

(800) 1116072

(731) ZHONGSHAN VATTI GAS APPLIANCE STOCK CO., LTD.

No.1, Huayuan Street, Xiaolan South Industry Road, Zhongshan, Guangdong, China

(540)

vatti

(591) Black, white

(511)

7 – Dishwashers; mills for household purposes other than hand-operated; fruit presses, electric, for household purposes; household bean juice makers; grinders and crushers, electric, for household purposes; blenders, electric, for household purposes; electric kitchen machines; meat choppers, electric; tin openers electric; whisks, electric, for household purposes.

11 – Lighters; methane kitchen ranges; electrical water heaters; bakers' ovens; induction cookers; el-

ectric cookers; electrical water heaters; lanterns; gas burners; gas water heaters; refrigerating appliances and installations; gas ovens; gas cookers; air conditioning apparatus; electric woks; exhaust fans; friction lighters for igniting gas; electric kettles; hot air apparatus; hydrants; electric radiators; polymerisation installations; sterilization units; sun energy water heaters; desiccating apparatus; extractor hoods for kitchens; microwave ovens cooking apparatus; bath installations.

20 – Furniture; cabinets; display stands; sideboards; dressing tables; furniture of metal; beds; pillows; bolsters; sleeping bags for camping.

(260) AM 2013 67640 A

(800) 1116115

(731) BIOFARMA

50 rue Carnot, F-92284 SURESNES
CEDEX, France

(540)

IZUVAL

(591) Black, white

(511)

5 – Pharmaceutical and veterinary preparations; sanitary preparations for medical purposes; dietetic preparations for medical use, food for babies; plasters, materials for dressings; material for dental fillings and dental impressions; disinfectants; pesticides; fungicides, herbicides.

(260) AM 2013 67642 A

(800) 1116128

(731) Industria de Diseño Textil, S.A.

(Inditex S.A.)

Avenida de la Diputación, Edificio Inditex, E-15142 Arteixo (A Coruña), Spain

(540)

PULL & BEAR SHOT

(591) Black, white

(511)

3 – Bleaching preparations and other substances for laundry use; cleaning, polishing, degreasing and abrasive preparations; soap; perfumery, essential oils, cosmetics, hair lotions; dentifrices; shoe waxes, shoe creams and pitch for shoes; tailors' wax; shoemakers' wax; waxes for leather; depilatory wax; laundry wax; parquet floor wax; shampoos; cosmetic kits; depilatory preparations; make-up removing preparations; deodorants for human beings or for animals; lipsticks; cosmetic pencils; hair and nail sprays; lacquer-removing preparations; tissues impregnated with cosmetic lotions; cloths impregnated with a detergent for cleaning; after-shave lotions; lotions for cosmetic purposes; make-up preparations; pomades for cosmetic purposes;

stain removers; sachets for perfuming linen; preparations for nail care; bleaching preparations [decolorants] for cosmetic purposes; extracts of flowers (perfumes); incense; scented wood; decorative transfers for cosmetic purposes; false nails and eyelashes; pumice stone; potpourris; cosmetic preparations for slimming purposes; cosmetic preparations for baths; hair waving preparations; laundry detergents; toiletries; articles for oral hygiene, not for medical purposes; bath salts, not for medical purposes; oils for toilet purposes; eau de Cologne; deodorant soap; talcum powder for toiletry use; adhesives for cosmetic purposes; greases for cosmetic purposes; abrasives; shaving preparations; color-brightening chemicals for domestic use (laundry); cotton sticks for cosmetic purposes; beauty masks; mustache wax; laundry bleach; hair dyes; eyebrow cosmetics; cleaning chalk; shampoos for pets; cosmetics for animals; cosmetic creams; disinfectant soap; cakes of toilet soap; soap for foot perspiration; detergents other than for use in manufacturing operations and for medical purposes; laundry starch; cleansing milk for toilet purposes; Javelle water; dry-cleaning preparations; scented water; perfumes; cosmetic preparations for eyelashes; cosmetic preparations for skin care; make-up powder; adhesives for affixing false hair; laundry softener; cosmetic dyes; preparations for removal of dyes; toilet water.

(260) AM 2013 67874 A

(800) 1117596

(731) MILLENNIUM PHARMACEUTICALS, INC.

40 Landsdowne Street, Cambridge,
MA 02139, USA

(540)

AUROQUEST

(591) Black, white

(511)

5 – Pharmaceutical preparations for human use, including for the treatment of cancer, auto-immune diseases and disorders and inflammatory diseases and disorders; pharmaceutical preparations for the treatment and prevention of cancer.

(260) AM 64291 A*

(800) 885779

(731) MARKS AND SPENCER PLC

Waterside House, 35 North Wharf Road,
London W2 NW, United Kingdom

(540)

M&S

(591) Black, white

(511)

3 – Cosmetics; perfumes; deodorants for personal use; antiperspirants; eau de cologne; soaps; detergents (not for use in industrial or manufacturing processes or for medical use); washing powders; washing up liquid; preparations for laundry use; fabric softener; cleansing and polishing preparations; household bleach; shampoos; preparations for the hair; dentifrices; depilatory preparations; potpourri; false nails; toilet preparations, preparations for the care of the skin, preparations for use in the bath, aftershave lotions and shaving creams, all being non-medicated.

25 – Complete articles of clothing.

30 – Coffee, coffee substitutes, coffee essences and coffee extracts, tea, cocoa, rice, tapioca, sago, flour and preparations made from cereals or from flour; bread, biscuits (other than biscuits for animals), cakes, pastry, pasta, pasta products and pastry products, water ices, honey, treacle, yeast, baking powder, salt, mustard, pepper, vinegar, sauces, salad dressing, spices, beverages included in this class and preparations therefor, puddings, desserts, prepared meals and chocolate spread.

35 – The bringing together, for the benefit of others, of a variety of goods and services, enabling customers to conveniently view and purchase those goods and services, in a department store, in a supermarket, in a food retail store, in a retail clothing store, in a retail home furnishing store, from a general merchandise store (including food and drink, telephones and accessories), clothing, food, home furnishings or supermarket catalogue by mail order or by means of telecommunications, or from a general merchandise store (including food and drink, telephones and accessories), department store, clothing, food, home furnishings or supermarket internet website; advertising; business management; business administration; office functions.

(260) AM 64411 A*

(800) 643517

(731) Total Petrochemicals & Refining SA/NV
Rue de l'Industrie 52, B-1040 Bruxelles,
Belgium

(540)



(591) Red, blue, white

(511)

4 – Industrial oils and greases; lubricants; raw petroleum, petroleum jelly for industrial purposes, products derived from petroleum included in this class; fuels, such as gas and liquefied gas; petroleum cokes; lighting fuel.

(260) AM 65025 A*

(800) 1095605

(731) GUESS, INC.

1444 South Alameda Street, Los Angeles
CA 90021, USA

(540)

GUESS. ONE WORLD ONE BRAND

(591) Black, white

(511)

25 – Men's, women's, boys', girls', and infants' apparel, namely, underwear, footwear, swimwear, caps, headwear, robes, sleep wear, pajamas, hosiery, gloves, suspenders, belts, neckties, undershirts, socks, shorts, t-shirts, sweatpants, sweatshirts, knit tops, skirts, pants, trousers, shorts, sweaters, jeans, dungarees, vests, coats, jackets, overalls, blazers, dresses, scarves, blouses, cardigans, gowns, golf shirts, jogging suits, turtlenecks, suits and polo shirts; women's panties, bras, lingerie, tank tops, crop tops, bustiers, camisoles, tap pants, rompers and teddies; men's briefs and boxer shorts; infants' coveralls and diaper covers.

(260) AM 65843 A*

(800) 1102084

(731) PAK GIDA ÜRETİM VE PAZARLAMA
ANONİM SİRKETİ

Prof.Dr. Bülent Tarcan Sk. No:5, Pak Is
Merkezi, Istanbul, Turkey

(540)



(591) Black, white, red

(511)

30 – Yeasts, natural substances for improving shape and color of bread and retarding its period of getting stale, natural additive substances for improving shape and color of bakery products and retarding its period of getting stale, baking powder, vanilin (vanilla substitute), vanilla (flavoring).

INTERNATIONAL TRADEMARKS PROTECTED IN GEORGIA

(260) AM 2013 62532 A
(800) 1074458
(151) 2011 03 18
(181) 2021 03 18
(511) 05

(260) AM 2013 63525 A
(800) 1083698
(151) 2011 04 08
(181) 2021 04 08
(511) 03

(260) AM 2013 64394 A
(800) 1090544
(151) 2011 04 07
(181) 2021 04 07
(511) 16, 41, 42, 43

(260) AM 2013 64676 A
(800) 1092815
(151) 2011 09 02
(181) 2021 09 02
(511) 04

(260) AM 2013 64879 A
(800) 1094443
(151) 2011 09 23
(181) 2021 09 23
(511) 05

(260) AM 2013 64880 A
(800) 1094486
(151) 2011 09 16
(181) 2021 09 16
(511) 39

(260) AM 2013 64881 A
(800) 1094534
(151) 2011 05 06
(181) 2021 05 06
(511) 03, 05, 44

(260) AM 2013 64882 A
(800) 1094582
(151) 2011 08 17
(181) 2021 08 17
(511) 30

(260) AM 2013 64883 A
(800) 1094593
(151) 2011 08 29
(181) 2021 08 29
(511) 38, 45

(260) AM 2013 64884 A
(800) 1094609
(151) 2011 09 09
(181) 2021 09 09
(511) 04

(260) AM 2013 64885 A
(800) 1094618
(151) 2011 09 02
(181) 2021 09 02
(511) 03

(260) AM 2013 64886 A
(800) 1094633
(151) 2011 10 04
(181) 2021 10 04
(511) 25, 35

(260) AM 2013 64887 A
(800) 1094641
(151) 2011 10 07
(181) 2021 10 07
(511) 01, 05

(260) AM 2013 64888 A
(800) 620405
(151) 2004 06 16
(181) 2014 06 16
(511) 05

(260) AM 2013 64889 A
(800) 675893
(151) 2007 06 24
(181) 2017 06 24
(511) 05

(260) AM 2013 64890 A
(800) 726931
(151) 2009 12 22
(181) 2019 12 22
(511) 05

(260) AM 2013 64891 A
(800) 768987
(151) 2001 10 11
(181) 2011 10 11
(511) 37, 39

(260) AM 2013 64893 A
(800) 817434
(151) 2003 11 27
(181) 2013 11 27
(511) 05

(260) AM 2013 64894 A
(800) 898561
(151) 2006 08 21
(181) 2016 08 21
(511) 04

(260) AM 2013 64895 A
(800) 1007868
(151) 2009 06 23
(181) 2019 06 23
(511) 29, 30, 32

(260) AM 2013 64971 A
(800) 1095225
(151) 2011 09 05
(181) 2021 09 05
(511) 30

(260) AM 2013 64975 A
(800) 1095260
(151) 2011 08 09
(181) 2021 08 09
(511) 36

(260) AM 2013 64976 A
(800) 1095300
(151) 2011 09 02
(181) 2021 09 02
(511) 03

(260) AM 2013 64979 A
(800) 923198
(151) 2006 12 23
(181) 2016 12 23
(511) 03, 16, 26, 31

(260) AM 2013 64980 A
(800) 943315
(151) 2007 09 03

(181) 2017 09 03
(511) 14

(260) AM 2013 65005 A
(800) 1095340
(151) 2011 09 13
(181) 2021 09 13
(511) 34

(260) AM 2013 65006 A
(800) 1095341
(151) 2011 10 10
(181) 2021 10 10
(511) 09

(260) AM 2013 65011 A
(800) 1095376
(151) 2011 09 05
(181) 2021 09 05
(511) 29

(260) AM 2013 65012 A
(800) 1095391
(151) 2011 02 03
(181) 2021 02 03
(511) 03, 09, 14, 18, 25

(260) AM 2013 65105 A
(800) 721725
(151) 2009 10 02
(181) 2019 10 02
(511) 05

(260) AM 2013 65106 A
(800) 734004
(151) 2010 03 17
(181) 2020 03 17
(511) 39

(260) AM 2013 65107 A
(800) 767767
(151) 2011 09 07
(181) 2021 09 07
(511) 14

(260) AM 2013 65109 A
(800) 799799
(151) 2002 09 09
(181) 2012 09 09
(511) 25

(260) AM 2013 65110 A
(800) 804963
(151) 2003 06 24
(181) 2013 06 24
(511) 20

(260) AM 2013 65111 A
(800) 809164
(151) 2003 03 11
(181) 2013 03 11
(511) 05, 29, 30, 32

(260) AM 2013 65125 A
(800) 1096103
(151) 2011 10 04
(181) 2021 10 04
(511) 03, 05

(260) AM 2013 65126 A
(800) 1096111
(151) 2011 03 28
(181) 2021 03 28
(511) 04, 09, 12

(260) AM 2013 65127 A
(800) 1096119
(151) 2011 05 24
(181) 2021 05 24
(511) 03, 05, 08, 10, 16, 21, 29, 30, 31, 32, 33

(260) AM 2013 65129 A
(800) 1096136
(151) 2011 07 25
(181) 2021 07 25
(511) 21, 32

(260) AM 2013 65132 A
(800) 1096264
(151) 2011 09 30
(181) 2021 09 30
(511) 29, 30, 32

(260) AM 2013 65133 A
(800) 1096298
(151) 2011 09 21
(181) 2021 09 21
(511) 14

(260) AM 2013 65135 A
(800) 1096343
(151) 2011 09 28

(181) 2021 09 28
(511) 04

(260) AM 2013 65136 A
(800) 1096364
(151) 2011 10 19
(181) 2021 10 19
(511) 18, 25

(260) AM 2013 65137 A
(800) 1096380
(151) 2011 10 10
(181) 2021 10 10
(511) 18, 20, 22, 25

(260) AM 2013 65138 A
(800) 1096394
(151) 2011 06 22
(181) 2021 06 22
(511) 03, 18, 25

(260) AM 2013 65140 A
(800) 1096409
(151) 2011 08 22
(181) 2021 08 22
(511) 06, 07, 09

(260) AM 2013 65163 A
(800) 1096701
(151) 2011 05 26
(181) 2021 05 26
(511) 05, 44

(260) AM 2013 65182 A
(800) 729036
(151) 2009 12 23
(181) 2019 12 23
(511) 01, 09, 11

(260) AM 2013 65183 A
(800) 748395
(151) 2010 07 27
(181) 2020 07 27
(511) 01, 03, 04, 05, 06, 07, 08, 09, 11, 12, 17, 18,
21, 25, 27, 31, 36, 37, 41, 42

(260) AM 2013 65190 A
(800) 775475
(151) 2001 12 20
(181) 2011 12 20

(511) 17, 19, 20

(260) AM 2013 65191 A
(800) 781923
(151) 2002 03 29
(181) 2012 03 29
(511) 05, 30, 31

(260) AM 2013 65261 A
(800) 1097180
(151) 2011 09 20
(181) 2021 09 20
(511) 05

(260) AM 2013 65293 A
(800) 1097426
(151) 2011 05 05
(181) 2021 05 05
(511) 05, 35, 41, 42, 44, 45

(260) AM 2013 65294 A
(800) 1097427
(151) 2011 05 05
(181) 2021 05 05
(511) 05, 35, 41, 42, 44, 45

(260) AM 2013 65295 A
(800) 353100
(151) 2008 12 20
(181) 2018 12 20
(511) 05

(260) AM 2013 65296 A
(800) 367739
(151) 2010 04 24
(181) 2020 04 24
(511) 01, 05, 31

(260) AM 2013 65303 A
(800) 558709
(151) 2010 09 11
(181) 2020 09 11
(511) 06, 07, 09, 11, 17, 19

(260) AM 2013 65340 A
(800) 1097631
(151) 2011 10 10
(181) 2021 10 10
(511) 03

(260) AM 2013 65341 A
(800) 1097653
(151) 2011 10 28
(181) 2021 10 28
(511) 35

(260) AM 2013 65342 A
(800) 1097656
(151) 2011 08 06
(181) 2021 08 06
(511) 09

(260) AM 2013 65344 A
(800) 1097671
(151) 2011 09 21
(181) 2021 09 21
(511) 36

(260) AM 2013 65345 A
(800) 1097672
(151) 2011 08 17
(181) 2021 08 17
(511) 09, 18, 25, 28

(260) AM 2013 65347 A
(800) 1097705
(151) 2011 05 27
(181) 2021 05 27
(511) 07

(260) AM 2013 65348 A
(800) 1097722
(151) 2011 10 31
(181) 2021 10 31
(511) 34

(260) AM 2013 65349 A
(800) 1097732
(151) 2011 09 14
(181) 2021 09 14
(511) 05

(260) AM 2013 65352 A
(800) 1097738
(151) 2011 10 19
(181) 2021 10 19
(511) 07

(260) AM 2013 65353 A
(800) 1097757
(151) 2011 02 21

(181) 2021 02 21
(511) 01, 06, 07, 09, 12, 17, 18, 19, 20, 24, 25, 28,
35, 37

(260) AM 2013 65354 A
(800) 1097765
(151) 2011 07 08
(181) 2021 07 08
(511) 16

(260) AM 2013 65355 A
(800) 1097789
(151) 2011 07 27
(181) 2021 07 27
(511) 09, 12, 38, 42

(260) AM 2013 65356 A
(800) 1097804
(151) 2011 08 24
(181) 2021 08 24
(511) 09, 18, 25, 28

(260) AM 2013 65357 A
(800) 1097805
(151) 2011 09 07
(181) 2021 09 07
(511) 42

(260) AM 2013 65359 A
(800) 1097814
(151) 2011 09 30
(181) 2021 09 30
(511) 35, 36

(260) AM 2013 65360 A
(800) 1097867
(151) 2011 10 18
(181) 2021 10 18
(511) 30

(260) AM 2013 65361 A
(800) 1097889
(151) 2011 06 29
(181) 2021 06 29
(511) 01, 02, 21

(260) AM 2013 65362 A
(800) 1097890
(151) 2011 06 06
(181) 2021 06 06
(511) 06

(260) AM 2013 65364 A
(800) 1097948
(151) 2011 08 09
(181) 2021 08 09
(511) 04, 06, 16, 21, 28

(260) AM 2013 65365 A
(800) 1097959
(151) 2011 08 09
(181) 2021 08 09
(511) 33

(260) AM 2013 65366 A
(800) 1097964
(151) 2011 07 22
(181) 2021 07 22
(511) 30

(260) AM 2013 65367 A
(800) 1098008
(151) 2011 09 23
(181) 2021 09 23
(511) 35, 36, 40

(260) AM 2013 65457 A
(800) 921431
(151) 2007 02 12
(181) 2017 02 12
(511) 25

(260) AM 2013 65458 A
(800) 923379
(151) 2007 01 19
(181) 2017 01 19
(511) 21

(260) AM 2013 65460 A
(800) 984946
(151) 2008 09 09
(181) 2018 09 09
(511) 25

(260) AM 2013 65461 A
(800) 1005192
(151) 2009 01 27
(181) 2019 01 27
(511) 18, 25, 28

(260) AM 2013 65481 A
(800) 1098546
(151) 2011 09 08
(181) 2021 09 08
(511) 42

(260) AM 2013 65482 A
(800) 1098564
(151) 2011 10 07
(181) 2021 10 07
(511) 01, 05, 31

(260) AM 2013 65483 A
(800) 1098590
(151) 2011 09 02
(181) 2021 09 02
(511) 09, 18, 25, 28

(260) AM 2013 65485 A
(800) 1098634
(151) 2011 07 24
(181) 2021 07 24
(511) 06, 09

(260) AM 2013 65486 A
(800) 1098638
(151) 2011 09 30
(181) 2021 09 30
(511) 30

(260) AM 2013 65487 A
(800) 1098651
(151) 2011 10 20
(181) 2021 10 20
(511) 05

(260) AM 2013 65508 A
(800) 1098795
(151) 2011 09 29
(181) 2021 09 29
(511) 03, 05, 10

(260) AM 2013 65511 A
(800) 1098796
(151) 2011 10 14
(181) 2021 10 14
(511) 05, 41, 42, 44

(260) AM 2013 65512 A
(800) 1098797
(151) 2011 10 17

(181) 2021 10 17
(511) 05, 41, 42, 44

(260) AM 2013 65518 A
(800) 1098840
(151) 2011 11 16
(181) 2021 11 16
(511) 03, 14, 18, 25, 35

(260) AM 2013 65525 A
(800) 1098971
(151) 2011 07 20
(181) 2021 07 20
(511) 03, 05

(260) AM 2013 65526 A
(800) 1098975
(151) 2011 07 25
(181) 2021 07 25
(511) 01, 02, 03, 17, 19

(260) AM 2013 65532 A
(800) 1099006
(151) 2011 10 06
(181) 2021 10 06
(511) 03

(260) AM 2013 65534 A
(800) 1099021
(151) 2011 10 31
(181) 2021 10 31
(511) 34

(260) AM 2013 65535 A
(800) 1099023
(151) 2011 09 20
(181) 2021 09 20
(511) 05

(260) AM 2013 65536 A
(800) 1099055
(151) 2011 11 01
(181) 2021 11 01
(511) 33

(260) AM 2013 65537 A
(800) 1099069
(151) 2011 11 07
(181) 2021 11 07
(511) 03, 05

(260) AM 2013 65538 A
(800) 1099070
(151) 2011 11 07
(181) 2021 11 07
(511) 03, 05

(260) AM 2013 65539 A
(800) 1099083
(151) 2011 10 26
(181) 2021 10 26
(511) 25

(260) AM 2013 65591 A
(800) 778372
(151) 2001 12 27
(181) 2011 12 27
(511) 01, 03, 05, 29, 30, 31, 32, 33

(260) AM 2013 65596 A
(800) 883664
(151) 2006 03 01
(181) 2016 03 01
(511) 05, 10

(260) AM 2013 65651 A
(800) 1100081
(151) 2011 10 07
(181) 2021 10 07
(511) 01, 05, 31

(260) AM 2013 65654 A
(800) 1100113
(151) 2011 10 20
(181) 2021 10 20
(511) 30

(260) AM 2013 65674 A
(800) 1100244
(151) 2011 03 04
(181) 2021 03 04
(511) 06

(260) AM 2013 65680 A
(800) 1100360
(151) 2011 11 24
(181) 2021 11 24
(511) 11

(260) AM 2013 65681 A
(800) 1100381
(151) 2011 05 25

(181) 2021 05 25
(511) 32, 33, 35, 36, 39, 42

(260) AM 2013 65682 A
(800) 1100383
(151) 2011 07 08
(181) 2021 07 08
(511) 10, 25

(260) AM 2013 65685 A
(800) 1100405
(151) 2011 08 20
(181) 2021 08 20
(511) 21

(260) AM 2013 65703 A
(800) 1100723
(151) 2011 08 24
(181) 2021 08 24
(511) 09

(260) AM 2013 65706 A
(800) 670395
(151) 2007 03 11
(181) 2017 03 11
(511) 18, 25

(260) AM 2013 65712 A
(800) 1027041
(151) 2009 10 08
(181) 2019 10 08
(511) 06, 09, 11, 19, 20, 22

(260) AM 2013 65713 A
(800) 1027237
(151) 2009 10 19
(181) 2019 10 19
(511) 06, 09, 11, 19, 20, 22

(260) AM 2013 65714 A
(800) 1074088
(151) 2011 03 28
(181) 2021 03 28
(511) 09, 16, 41

(260) AM 2013 65715 A
(800) 1083292
(151) 2011 06 07
(181) 2021 06 07
(511) 36

(260) AM 2013 65720 A
(800) 1100845
(151) 2011 05 27
(181) 2021 05 27
(511) 06, 07, 11

(260) AM 2013 65721 A
(800) 1100854
(151) 2011 10 03
(181) 2021 10 03
(511) 05

(260) AM 2013 65723 A
(800) 1100855
(151) 2011 10 03
(181) 2021 10 03
(511) 05

(260) AM 2013 65725 A
(800) 1100857
(151) 2011 10 06
(181) 2021 10 06
(511) 05

(260) AM 2013 65726 A
(800) 1100867
(151) 2011 11 25
(181) 2021 11 25
(511) 05

(260) AM 2013 65727 A
(800) 1100875
(151) 2011 09 20
(181) 2021 09 20
(511) 03, 05

(260) AM 2013 65732 A
(800) 1100926
(151) 2011 07 08
(181) 2021 07 08
(511) 01, 02, 03, 06, 11, 17, 19, 24, 27, 37

(260) AM 2013 65733 A
(800) 1100932
(151) 2011 08 16
(181) 2021 08 16
(511) 11

(260) AM 2013 65778 A
(800) 1101431
(151) 2011 10 19

(181) 2021 10 19
(511) 06, 17

(260) AM 2013 65780 A
(800) 1101459
(151) 2011 11 16
(181) 2021 11 16
(511) 30

(260) AM 2013 65782 A
(800) 1101497
(151) 2011 12 01
(181) 2021 12 01
(511) 14

(260) AM 2013 65783 A
(800) 1101498
(151) 2011 12 01
(181) 2021 12 01
(511) 14

(260) AM 2013 65784 A
(800) 1101499
(151) 2011 12 01
(181) 2021 12 01
(511) 14

(260) AM 2013 65786 A
(800) 1101533
(151) 2011 11 25
(181) 2021 11 25
(511) 35

(260) AM 2013 65788 A
(800) 1101552
(151) 2011 11 18
(181) 2021 11 18
(511) 05

(260) AM 2013 65789 A
(800) 1101553
(151) 2011 11 18
(181) 2021 11 18
(511) 05

(260) AM 2013 65790 A
(800) 1101568
(151) 2011 11 22
(181) 2021 11 22
(511) 03

(260) AM 2013 65791 A
(800) 1101583
(151) 2011 11 18
(181) 2021 11 18
(511) 05

(260) AM 2013 65792 A
(800) 1101591
(151) 2011 11 15
(181) 2021 11 15
(511) 04

(260) AM 2013 65793 A
(800) 1101657
(151) 2011 10 20
(181) 2021 10 20
(511) 31

(260) AM 2013 65794 A
(800) 1101711
(151) 2011 11 30
(181) 2021 11 30
(511) 09

(260) AM 2013 65795 A
(800) 1101719
(151) 2011 11 23
(181) 2021 11 23
(511) 14

(260) AM 2013 65798 A
(800) 1101768
(151) 2011 10 24
(181) 2021 10 24
(511) 11, 35, 37

(260) AM 2013 65799 A
(800) 1101771
(151) 2011 11 21
(181) 2021 11 21
(511) 10

(260) AM 2013 65801 A
(800) 773195
(151) 2011 12 07
(181) 2021 12 07
(511) 05, 30

(260) AM 2013 65802 A
(800) 811905
(151) 2003 07 01

(181) 2013 07 01
(511) 07, 11

(260) AM 2013 65807 A
(800) 1001502
(151) 2009 03 06
(181) 2019 03 06
(511) 33

(260) AM 2013 65813 A
(800) 1051920
(151) 2010 08 25
(181) 2020 08 25
(511) 43

(260) AM 2013 65848 A
(800) 1102183
(151) 2011 10 27
(181) 2021 10 27
(511) 07, 09, 12

(260) AM 2013 65849 A
(800) 1102202
(151) 2011 11 22
(181) 2021 11 22
(511) 05

(260) AM 2013 65852 A
(800) 1102265
(151) 2011 11 16
(181) 2021 11 16
(511) 05

(260) AM 2013 65855 A
(800) 772712
(151) 2001 11 16
(181) 2011 11 16
(511) 10

(260) AM 2013 65856 A
(800) 901211
(151) 2006 08 08
(181) 2016 08 08
(511) 07

(260) AM 2013 65857 A
(800) 1065039
(151) 2011 01 18
(181) 2021 01 18
(511) 14, 18

(260) AM 2013 65858 A
(800) 1068840
(151) 2011 01 26
(181) 2021 01 26
(511) 05

(260) AM 2013 65912 A
(800) 1102709
(151) 2011 12 05
(181) 2021 12 05
(511) 30

(260) AM 2013 65913 A
(800) 1102711
(151) 2011 11 08
(181) 2021 11 08
(511) 32

(260) AM 2013 65916 A
(800) 1102758
(151) 2011 08 23
(181) 2021 08 23
(511) 29

(260) AM 2013 65918 A
(800) 1102769
(151) 2011 11 21
(181) 2021 11 21
(511) 05

(260) AM 2013 65919 A
(800) 1102777
(151) 2011 09 09
(181) 2021 09 09
(511) 19, 20, 35

(260) AM 2013 65921 A
(800) 1102788
(151) 2011 06 24
(181) 2021 06 24
(511) 06, 09, 11

(260) AM 2013 65923 A
(800) 1102849
(151) 2011 10 27
(181) 2021 10 27
(511) 19

(260) AM 2013 65948 A
(800) 1103023
(151) 2011 10 25

(181) 2021 10 25
(511) 30

(260) AM 2013 65949 A
(800) 1103035
(151) 2011 11 11
(181) 2021 11 11
(511) 01

(260) AM 2013 65951 A
(800) 1103062
(151) 2011 11 14
(181) 2021 11 14
(511) 20, 35

(260) AM 2013 65952 A
(800) 1103063
(151) 2011 12 06
(181) 2021 12 06
(511) 07, 08, 35

(260) AM 2013 65953 A
(800) 1103071
(151) 2011 05 27
(181) 2021 05 27
(511) 18, 21, 24

(260) AM 2013 65954 A
(800) 1103136
(151) 2011 12 19
(181) 2021 12 19
(511) 32

(260) AM 2013 65955 A
(800) 1103153
(151) 2011 08 11
(181) 2021 08 11
(511) 01, 03, 04, 06, 07, 08, 09, 11, 14, 16, 18, 20,
21, 22, 24, 25, 26, 28, 29, 30, 33, 35, 42, 43

(260) AM 2013 65962 A
(800) 1103188
(151) 2011 12 01
(181) 2021 12 01
(511) 35, 36, 38, 41

(260) AM 2013 65966 A
(800) 1103205
(151) 2011 12 09
(181) 2021 12 09
(511) 04

(260) AM 2013 65974 A
(800) 1103206
(151) 2011 12 09
(181) 2021 12 09
(511) 04

(260) AM 2013 65975 A
(800) 1103207
(151) 2011 12 09
(181) 2021 12 09
(511) 04

(260) AM 2013 65976 A
(800) 1103208
(151) 2011 12 09
(181) 2021 12 09
(511) 04

(260) AM 2013 65978 A
(800) 1103247
(151) 2011 11 16
(181) 2021 11 16
(511) 05

(260) AM 2013 65985 A
(800) 1103249
(151) 2011 09 20
(181) 2021 09 20
(511) 05

(260) AM 2013 65986 A
(800) 1103251
(151) 2011 09 20
(181) 2021 09 20
(511) 05

(260) AM 2013 65987 A
(800) 1103266
(151) 2011 07 19
(181) 2021 07 19
(511) 06, 07, 09, 11, 19, 20, 21, 37, 41, 42

(260) AM 2013 66017 A
(800) 1103397
(151) 2011 04 22
(181) 2021 04 22
(511) 03, 05, 09, 12, 16, 24, 26, 28, 30, 31, 32, 35,
39, 41, 42, 43, 44, 45

(260) AM 2013 66027 A
(800) 1103412
(151) 2011 10 14
(181) 2021 10 14
(511) 33

(260) AM 2013 66051 A
(800) 1103577
(151) 2011 09 30
(181) 2021 09 30
(511) 09

(260) AM 2013 66052 A
(800) 1103589
(151) 2011 11 22
(181) 2021 11 22
(511) 05, 10

(260) AM 2013 66101 A
(800) 1103917
(151) 2011 11 17
(181) 2021 11 17
(511) 30

(260) AM 2013 66102 A
(800) 1103923
(151) 2011 12 19
(181) 2021 12 19
(511) 28

(260) AM 2013 66103 A
(800) 820178
(151) 2003 12 23
(181) 2013 12 23
(511) 25, 35

(260) AM 2013 66105 A
(800) 922988
(151) 2006 08 16
(181) 2016 08 16
(511) 21

(260) AM 2013 66106 A
(800) 935888
(151) 2007 07 26
(181) 2017 07 26
(511) 05

(260) AM 2013 66107 A
(800) 964057
(151) 2008 04 29
(181) 2018 04 29
(511) 05

(260) AM 2013 66108 A
(800) 1049473
(151) 2010 05 27
(181) 2020 05 27
(511) 06, 35

(260) AM 2013 66140 A
(800) 1104103
(151) 2011 09 28
(181) 2021 09 28
(511) 18, 25

(260) AM 2013 66143 A
(800) 1104227
(151) 2011 06 17
(181) 2021 06 17
(511) 09, 16, 18

(260) AM 2013 66144 A
(800) 1104228
(151) 2011 06 20
(181) 2021 06 20
(511) 05

(260) AM 2013 66145 A
(800) 1104230
(151) 2011 07 12
(181) 2021 07 12
(511) 07, 11, 21, 35

(260) AM 2013 66146 A
(800) 1104237
(151) 2011 09 29
(181) 2021 09 29
(511) 01, 02

(260) AM 2013 66147 A
(800) 1104245
(151) 2011 09 01
(181) 2021 09 01
(511) 16

(260) AM 2013 66148 A
(800) 1104254
(151) 2011 10 26

(181) 2021 10 26
(511) 17

(260) AM 2013 66153 A
(800) 1104314
(151) 2011 07 20
(181) 2021 07 20
(511) 38

(260) AM 2013 66155 A
(800) 1104392
(151) 2011 08 30
(181) 2021 08 30
(511) 29

(260) AM 2013 66156 A
(800) 1104399
(151) 2011 12 20
(181) 2021 12 20
(511) 09

(260) AM 2013 66157 A
(800) 1104409
(151) 2011 10 24
(181) 2021 10 24
(511) 25

(260) AM 2013 66158 A
(800) 1104424
(151) 2011 08 19
(181) 2021 08 19
(511) 08, 09, 11, 21

(260) AM 2013 66159 A
(800) 1104459
(151) 2011 11 18
(181) 2021 11 18
(511) 03

(260) AM 2013 66160 A
(800) 1104501
(151) 2011 12 16
(181) 2021 12 16
(511) 19

(260) AM 2013 61410 A
(800) 1064489
(151) 2010 12 02
(181) 2020 12 02
(511) 05, 32

(260) AM 2013 61411 A
(800) 1064490
(151) 2010 12 14
(181) 2020 12 14
(511) 05

(260) AM 2013 61412 A
(800) 1064499
(151) 2010 08 13
(181) 2020 08 13
(511) 02, 07, 19, 35, 37, 39, 42

(260) AM 2013 61413 A
(800) 1064524
(151) 2010 10 20
(181) 2020 10 20
(511) 01, 40

(260) AM 2013 61414 A
(800) 1064529
(151) 2010 11 12
(181) 2020 11 12
(511) 30

(260) AM 2013 61458 A
(800) 1064916
(151) 2010 10 29
(181) 2020 10 29
(511) 05

(260) AM 2013 61459 A
(800) 1064935
(151) 2010 10 26
(181) 2020 10 26
(511) 05

(260) AM 2013 61460 A
(800) 1064971
(151) 2011 01 06
(181) 2021 01 06
(511) 34

(260) AM 2013 61461 A
(800) 1064972
(151) 2011 01 06
(181) 2021 01 06
(511) 34

(260) AM 2013 61462 A
(800) 1064973
(151) 2011 01 06
(181) 2021 01 06
(511) 34

(260) AM 2013 61557 A
(800) 1066096
(151) 2011 01 10
(181) 2021 01 10
(511) 32, 33, 34

(260) AM 2013 61558 A
(800) 1066099
(151) 2010 12 07
(181) 2020 12 07
(511) 34

(260) AM 2013 61559 A
(800) 1066113
(151) 2010 12 15
(181) 2020 12 15
(511) 33

(260) AM 2013 61560 A
(800) 1066124
(151) 2010 10 21
(181) 2020 10 21
(511) 05

(260) AM 2013 61561 A
(800) 1066147
(151) 2010 10 12
(181) 2020 10 12
(511) 09

(260) AM 2013 61638 A
(800) 1066963
(151) 2011 01 14
(181) 2021 01 14
(511) 11

(260) AM 2013 61644 A
(800) 1067047
(151) 2010 12 29
(181) 2020 12 29
(511) 09

(260) AM 2013 61721 A
(800) 1067875
(151) 2010 11 18
(181) 2020 11 18
(511) 36

(260) AM 2013 61980 A
(800) 1069687
(151) 2011 01 31
(181) 2021 01 31
(511) 05

(260) AM 2013 61794 A
(800) 1068268
(151) 2010 06 16
(181) 2020 06 16
(511) 39

(260) AM 2013 61982 A
(800) 1069703
(151) 2010 12 16
(181) 2020 12 16
(511) 03, 09, 14, 18, 20, 22, 24, 25

(260) AM 2013 61796 A
(800) 1068274
(151) 2010 08 23
(181) 2020 08 23
(511) 07, 09, 37, 42

(260) AM 2013 61983 A
(800) 1069704
(151) 2011 02 24
(181) 2021 02 24
(511) 05

(260) AM 2013 61798 A
(800) 1068326
(151) 2011 01 05
(181) 2021 01 05
(511) 05

(260) AM 2013 61801 A
(800) 1068373
(151) 2010 12 28
(181) 2020 12 28
(511) 07, 11

(260) AM 2013 61976 A
(800) 1069639
(151) 2010 10 29
(181) 2020 10 29
(511) 07, 09, 35, 37, 42

(260) AM 2013 61977 A
(800) 1069660
(151) 2010 12 31
(181) 2020 12 31
(511) 14

(260) AM 2013 61979 A
(800) 1069686
(151) 2011 01 31
(181) 2021 01 31
(511) 05

APPELLATIONS OF ORIGIN AND GEOGRAPHICAL INDICATIONS OF GOODS

APPELLATIONS OF ORIGIN OF GOODS FILED IN GEORGIA FOR EXAMINATION UNDER LISBON AGREEMENT, ON THE BASIS OF THE INTERNATIONAL REGISTRATION

The decision can be appealed at the Chamber of Appeal of Sakpatenti within 3 months from the publication or at the Mtskheta District Court Administrative Cases Board (Address: №17, Samkhedro str., Mtskheta), within 1 month following the publication.

NUMBER OF IDENTIFICATION: 1091/06

NUMBER OF INTERNATIONAL REGISTRATION: 906

DATE OF INTERNATIONAL REGISTRATION: 2012 09 24

DATE OF FILING OF THE APPLICATION: 2012 11 29

APPELLATIONS OF ORIGIN: **PROSECCO**

NAMES OF THE GOODS, FOR WHICH THE REGISTRATION OF APPELLATION OF ORIGIN
IS REQUIRED:

33 – Wine

NAME AND ADDRESS OF APPLICANT: Consorzio di Tutela della Denominazione d'Origine Controllata
Prosecco
Piazza della Borsa 3/B, 31100, Treviso, Italy

THE RIGHT TO USE OF REGISTERED APPELLATIONS OF ORIGIN OF GOODS

Registered Appellations of Origin of Goods: **MANAVI**

The Right to Use: LTD "MEGVINEOBA KHAREBA"

Davit Agmasheneblis Kheivani me-6 km., 0131, Tbilisi, Georgia

Number of Registration: 788/2-13

Valid: 2014 04 03

OFFICIAL NOTIFICATIONS
TRADEMARKS
RENEWAL OF REGISTRATIONS

(111) M 2002 14614 R1
(156) 2013 02 06
(186) 2022 09 13
(732) INTERSUN HOLDING FZCO
P.O. Box: 61051, Jebel Ali Free Zone,
Dubai, United Arab Emirates

(111) M 2003 15109 R1
(156) 2013 04 30
(186) 2023 04 30
(732) YKK CORPORATION
1, Kanda Izumi-Cho, Chiyoda-Ku, Tokyo,
Japan

(111) M 2002 14786 R1
(156) 2013 02 08
(186) 2022 11 15
(732) LTD "ILIONI"
Takaishvilis q. 80, 6000, Batumi, Georgia

(111) M 2003 15134 R1
(156) 2013 05 19
(186) 2023 05 19
(732) DIAGEO BRANDS B.V.
Molenwerf 10-12, 1014 BG Amsterdam,
Netherlands

(111) M 2003 15003 R1
(156) 2013 03 04
(186) 2023 03 04
(732) TAMAZ SHILAKADZE
Bakhtrionis q., 6, b. 24, 0160, Tbilisi,
Georgia

(111) M 2003 15004 R1
(156) 2013 03 04
(186) 2023 03 04
(732) TAMAZ SHILAKADZE
Bakhtrionis q., 6, b. 24, 0160, Tbilisi,
Georgia

(111) M 2003 15026 R1
(156) 2013 03 28
(186) 2023 03 28
(732) UNITED PARCEL SERVICE OF
AMERICA, INC.
55 Glenlake Parkway, NE Atlanta, Georgia,
USA

(111) M 2003 15080 R1
(156) 2013 04 16
(186) 2023 04 16
(732) NISSAN JIDOSHA KABUSHIKI KAISHA
(also trading as Nissan Motor Co., Ltd.)
No.2 Takaracho, Kanagawa-ku, Yokohama-
shi, Kanagawa-ken, Japan

CHANGES IN NAMES AND/OR ADDRESSES OF OWNERS

(111) M 1998 010885 R1
(732) GEORGIAN GLASS & MINERAL WATER
CO. N.V.
Pareraweg 45, Curacao, Netherlands Antilles
(770) GEORGIAN GLASS & MINERAL WATER
CO., N.V.
Landhuis Joonchi, Kaya Richard J. Beaujon
z/n, Curacao, Netherlands Antilles
(580) 2013 03 12

(111) M 1998 010885 R1
(732) IDS Borjomi Beverages Co. N.V.
Pareraweg 45, Curacao, Netherlands Antilles
(770) GEORGIAN GLASS & MINERAL WATER
CO. N.V.
Pareraweg 45, Curacao, Netherlands Antilles
(580) 2013 03 12

(111) M 1998 010886 R1
(732) GEORGIAN GLASS & MINERAL WATER
CO. N.V.
Pareraweg 45, Curacao, Netherlands Antilles
(770) GEORGIAN GLASS & MINERAL WATER
CO., N.V.
Landhuis Joonchi, Kaya Richard J. Beaujon
z/n, Curacao, Netherlands Antilles
(580) 2013 03 12

(111) M 1998 010886 R1
(732) IDS Borjomi Beverages Co. N.V.
Pareraweg 45, Curacao, Netherlands Antilles
(770) GEORGIAN GLASS & MINERAL WATER
CO. N.V.
Pareraweg 45, Curacao, Netherlands Antilles
(580) 2013 03 12

(111) M 1998 010887 R1
(732) GEORGIAN GLASS & MINERAL WATER
CO. N.V.
Pareraweg 45, Curacao, Netherlands Antilles
(770) GEORGIAN GLASS & MINERAL WATER
CO., N.V.
Landhuis Joonchi, Kaya Richard J. Beaujon
z/n, Curacao, Netherlands Antilles
(580) 2013 03 12

(111) M 1998 010887 R1
(732) IDS Borjomi Beverages Co. N.V.
Pareraweg 45, Curacao, Netherlands Antilles

(770) GEORGIAN GLASS & MINERAL WATER
CO. N.V.
Pareraweg 45, Curacao, Netherlands Antilles
(580) 2013 03 12

(111) M 1998 010888 R1
(732) GEORGIAN GLASS & MINERAL WATER
CO. N.V.
Pareraweg 45, Curacao, Netherlands Antilles
(770) GEORGIAN GLASS & MINERAL WATER
CO., N.V.
Landhuis Joonchi, Kaya Richard J. Beaujon
z/n, Curacao, Netherlands Antilles
(580) 2013 03 12

(111) M 1998 010888 R1
(732) IDS Borjomi Beverages Co. N.V.
Pareraweg 45, Curacao, Netherlands Antilles
(770) GEORGIAN GLASS & MINERAL WATER
CO. N.V.
Pareraweg 45, Curacao, Netherlands Antilles
(580) 2013 03 12

(111) M 1998 010889 R1
(732) GEORGIAN GLASS & MINERAL WATER
CO. N.V.
Pareraweg 45, Curacao, Netherlands Antilles
(770) GEORGIAN GLASS & MINERAL WATER
CO., N.V.
Landhuis Joonchi, Kaya Richard J. Beaujon
z/n, Curacao, Netherlands Antilles
(580) 2013 03 12

(111) M 1998 010889 R1
(732) IDS Borjomi Beverages Co. N.V.,
Pareraweg 45, Curacao, Netherlands Antilles
(770) GEORGIAN GLASS & MINERAL WATER
CO. N.V.
Pareraweg 45, Curacao, Netherlands Antilles
(580) 2013 03 12

(111) M 1998 010905 R1
(732) GEORGIAN GLASS & MINERAL WATER
CO. N.V.
Pareraweg 45, Curacao, Netherlands Antilles
(770) GEORGIAN GLASS & MINERAL WATER
CO. N.V.
Landhuis Joonchi, Kaya Richard J. Beaujon
z/n, Curacao, Netherlands Antilles

(580) 2013 03 12

(111) M 1998 010905 R1
 (732) IDS Borjomi Beverages Co. N.V.
 Pareraweg 45, Curacao, Netherlands Antilles
 (770) GEORGIAN GLASS & MINERAL WATER
 CO. N.V.
 Pareraweg 45, Curacao, Netherlands Antilles
 (580) 2013 03 12

(111) M 1998 010906 R1
 (732) GEORGIAN GLASS & MINERAL WATER
 CO. N.V.
 Pareraweg 45, Curacao, Netherlands Antilles
 (770) GEORGIAN GLASS & MINERAL WATER
 CO. N.V.
 Landhuis Joonchi, Kaya Richard J. Beaujon
 z/n, Curacao, Netherlands Antilles
 (580) 2013 03 12

(111) M 1998 010906 R1
 (732) IDS Borjomi Beverages Co. N.V.
 Pareraweg 45, Curacao, Netherlands Antilles
 (770) GEORGIAN GLASS & MINERAL WATER
 CO. N.V.
 Pareraweg 45, Curacao, Netherlands Antilles
 (580) 2013 03 12

(111) M 1998 010907 R1
 (732) GEORGIAN GLASS & MINERAL WATER
 CO. N.V.
 Pareraweg 45, Curacao, Netherlands Antilles
 (770) GEORGIAN GLASS & MINERAL WATER
 CO. N.V.
 Landhuis Joonchi, Kaya Richard J. Beaujon
 z/n, Curacao, Netherlands Antilles
 (580) 2013 03 12

(111) M 1998 010907 R1
 (732) IDS Borjomi Beverages Co. N.V.
 Pareraweg 45, Curacao, Netherlands Antilles
 (770) GEORGIAN GLASS & MINERAL WATER
 CO. N.V.
 Pareraweg 45, Curacao, Netherlands Antilles
 (580) 2013 03 12

(111) M 1998 010908 R1
 (732) GEORGIAN GLASS & MINERAL WATER
 CO. N.V.
 Pareraweg 45, Curacao, Netherlands Antilles
 (770) GEORGIAN GLASS & MINERAL WATER
 CO., N.V.,
 Landhuis Joonchi, Kaya Richard J. Beaujon
 z/n, Curacao, Netherlands Antilles

(580) 2013 03 12

(111) M 1998 010908 R1
 (732) IDS Borjomi Beverages Co. N.V.
 Pareraweg 45, Curacao, Netherlands Antilles
 (770) GEORGIAN GLASS & MINERAL WATER
 CO. N.V.
 Pareraweg 45, Curacao, Netherlands Antilles
 (580) 2013 03 12

(111) M 1998 010909 R1
 (732) GEORGIAN GLASS & MINERAL WATER
 CO. N.V.
 Pareraweg 45, Curacao, Netherlands Antilles
 (770) GEORGIAN GLASS & MINERAL WATER
 CO., N.V.
 Landhuis Joonchi, Kaya Richard J. Beaujon
 z/n, Curacao, Netherlands Antilles
 (580) 2013 03 12

(111) M 1998 010909 R1
 (732) IDS Borjomi Beverages Co. N.V.
 Pareraweg 45, Curacao, Netherlands Antilles
 (770) GEORGIAN GLASS & MINERAL WATER
 CO. N.V.
 Pareraweg 45, Curacao, Netherlands Antilles
 (580) 2013 03 12

(111) M 1998 010910 R1
 (732) GEORGIAN GLASS & MINERAL WATER
 CO. N.V.
 Pareraweg 45, Curacao, Netherlands Antilles
 (770) GEORGIAN GLASS & MINERAL WATER
 CO., N.V.
 Landhuis Joonchi, Kaya Richard J. Beaujon
 z/n, Curacao, Netherlands Antilles
 (580) 2013 03 12

(111) M 1998 010910 R1
 (732) IDS Borjomi Beverages Co. N.V.
 Pareraweg 45, Curacao, Netherlands Antilles
 (770) GEORGIAN GLASS & MINERAL WATER
 CO. N.V.
 Pareraweg 45, Curacao, Netherlands Antilles
 (580) 2013 03 12

(111) M 1999 011504 R1
 (732) GEORGIAN GLASS & MINERAL WATER
 CO. N.V.
 Pareraweg 45, Curacao, Netherlands Antilles
 (770) GEORGIAN GLASS & MINERAL WATER
 CO., N.V.
 Landhuis Joonchi, Kaya Richard J. Beaujon
 z/n, Curacao, Netherlands Antilles

(580) 2013 03 12

(111) M 1999 011504 R1
(732) IDS Borjomi Beverages Co. N.V.
Pareraweg 45, Curacao, Netherlands Antilles
(770) GEORGIAN GLASS & MINERAL WATER
CO. N.V.
Pareraweg 45, Curacao, Netherlands Antilles
(580) 2013 03 12

(111) M 1999 011505 R1
(732) GEORGIAN GLASS & MINERAL WATER
CO. N.V.
Pareraweg 45, Curacao, Netherlands Antilles
(770) GEORGIAN GLASS & MINERAL WATER
CO., N.V.
Landhuis Joonchi, Kaya Richard J. Beaujon
z/n, Curacao, Netherlands Antilles
(580) 2013 03 12

(111) M 1999 011505 R1
(732) IDS Borjomi Beverages Co. N.V.,
Pareraweg 45, Curacao, Netherlands Antilles
(770) GEORGIAN GLASS & MINERAL WATER
CO. N.V.
Pareraweg 45, Curacao, Netherlands Antilles
(580) 2013 03 12

(111) M 2003 015108 R
(732) NARCISO RODRIGUES CORPORATION
30 Irving Place, 9th Floor, New York,
New York 10003, USA
(770) NARCISO RODRIGUES CORPORATION
50 Bond Street, New York, New York
10012, USA
(580) 2013 03 06

(111) M 2008 018793 R
(732) IDS Borjomi Beverages Co. N.V.
Pareraweg 45, Curacao, Netherlands Antilles
(770) LTD "JORJIAN GLAS END MINERAL
VOTERS KOMPANI"
Toris q.39, 1200, Borjomi, Georgia
(580) 2013 03 12

(111) M 2008 018798 R
(732) IDS Borjomi Beverages Co. N.V.,
Pareraweg 45, Curacao, Netherlands Antilles
(770) LTD "JORJIAN GLAS END MINERAL
VOTERS KOMPANI"
Toris q.39, 1200, Borjomi, Georgia
(580) 2013 03 12

(111) M 2009 020043 R
(732) IDS Borjomi Beverages Co. N.V.
Pareraweg 45, Curacao, Netherlands Antilles
(770) LTD "JORJIAN GLAS END MINERAL
VOTERS KOMPANI"
Toris q.39, 1200, Borjomi, Georgia
(580) 2013 03 12

(111) M 2009 020044 R
(732) IDS Borjomi Beverages Co. N.V.
Pareraweg 45, Curacao, Netherlands Antilles
(770) LTD "JORJIAN GLAS END MINERAL
VOTERS KOMPANI"
Toris q.39, 1200, Borjomi, Georgia
(580) 2013 03 12

(111) M 2009 020045 R
(732) IDS Borjomi Beverages Co. N.V.
Pareraweg 45, Curacao, Netherlands Antilles
(770) LTD "JORJIAN GLAS END MINERAL
VOTERS KOMPANI"
Toris q.39, 1200, Borjomi, Georgia
(580) 2013 03 12

LICENSE AGREEMENTS

(111) 13620
(732) LTD "AVERSI PHARMA"
 Davit Agmashenebeli Av. 148/2, 0112,
 Tbilisi, Georgia
(791) LTD "AVERSI KLINIKA"
 Vazha-Pshavela 27b, Tbilisi, Georgia
(580) 2011 02 03
(793) A SIMPLE LICENSE
(793) 786
(793) 2011 01 01
(793) 2016 01 01
(511) 42

CLASSIFICATION INDEXES

INVENTIONS

CONCORDANCE TABLE OF INTERNATIONAL CLASSIFICATION INDEX AND PUBLICATION NUMBERS

| INTERNATIONAL CLASSIFICATION INDEXES (51) | NUMBER OF PUBLISHED APPLICATION (10) |
|--|--|
| A 01 D 46/26 | AP 2013 12683 A |
| A 47 G 19/22 | AP 2013 12528 A |
| A 61 K 31/216; A 61 K 31/513; A 61 P 35/00; A 61 P 35/04 | AP 2013 12190 A |
| A 61 K 35/56 | AP 2013 12509 A |
| A 61 K 36/00; A 61 K 35/64; A 61 K 35/54 | AP 2013 12325 A |
| A 61 K 36/00; A 61 K 35/64 | AP 2013 12326 A |
| B 01 J 20/18; C 02 F 1/28, 1/64 | AP 2013 12156 A |
| B 21 C 23/14; B 21 C 25/02 | AP 2013 12068 A |
| B 60 G 21/06 | AP 2013 11955 A |
| C 02 F 1/00 | AP 2013 12171 A |
| C 05 C 1/02 | AP 2013 10866 A |
| C 07 D 231/56; C 07 F 3/02 | AP 2013 12610 A |
| C 07 D 231/56; C 07 F 3/02 | AP 2013 12611 A |
| C 07 D 475/04; A 61 K 31/519 | AP 2013 11921 A |
| E 05 B 35/00 | AP 2013 12164 A |
| F 01 B 17/02; F 02 G 1/04; F 01 K 25/08 | AP 2013 11075 A |
| F 16 H 1/00 | AP 2013 12173 A |
| H 01 S 3/20 | AP 2013 12246 A |

CONCORDANCE TABLE OF PUBLICATION NUMBERS AND INTERNATIONAL CLASSIFICATION INDEX

| NUMBER OF PUBLISHED APPLICATION (10) | INTERNATIONAL CLASSIFICATION INDEXES (51) |
|--|--|
| AP 2013 10866 A | C 05 C 1/02 |
| AP 2013 11075 A | F 01 B 17/02; F 02 G 1/04; F 01 K 25/08 |
| AP 2013 11921 A | C 07 D 475/04; A 61 K 31/519 |
| AP 2013 11955 A | B 60 G 21/06 |
| AP 2013 12068 A | B 21 C 23/14; B 21 C 25/02 |
| AP 2013 12156 A | B 01 J 20/18; C 02 F 1/28, 1/64 |
| AP 2013 12164 A | E 05 B 35/00 |
| AP 2013 12171 A | C 02 F 1/00 |
| AP 2013 12173 A | F 16 H 1/00 |
| AP 2013 12190 A | A 61 K 31/216; A 61 K 31/513; A 61 P 35/00; A 61 P 35/04 |
| AP 2013 12246 A | H 01 S 3/20 |
| AP 2013 12325 A | A 61 K 36/00; A 61 K 35/64; A 61 K 35/54 |
| AP 2013 12326 A | A 61 K 36/00; A 61 K 35/64 |
| AP 2013 12509 A | A 61 K 35/56 |
| AP 2013 12528 A | A 47 G 19/22 |
| AP 2013 12610 A | C 07 D 231/56; C 07 F 3/02 |
| AP 2013 12611 A | C 07 D 231/56; C 07 F 3/02 |
| AP 2013 12683 A | A 01 D 46/26 |

**CONCORDANCE TABLE OF INTERNATIONAL CLASSIFICATION INDEX,
PATENT NUMBERS AND PUBLICATION NUMBERS**

| INTERNATIONAL CLASSIFICATION INDEX (51) | NUMBER OF PATENT (11) | NUMBER OF PUBLISHED APPLICATION (10) |
|--|-----------------------------|---|
| A 61 K 31/437; A 61 K 31/4709; A 61 K 31/496; A 61 K 31/573; A 61 K 38/08; A 61 P 19/02 | P 2013 5792 B | AP 2012 12055 A |
| A 61 K 31/513; A 61 K 31/44; A 61 K 31/131; A 61 P 3/10 | P 2013 5791 B | AP 2012 10608 A |
| B 65 G 27/00 | P 2013 5794 B | AP 2012 12175 A |
| C 07 D 231/40; C 07 D 401/12; C 07 D 403/12; C 07 D 513/04; A 61 K 31/4427; A 61 K 31/4155; A 61 K 31/4178; A 61 K 31/506; A 61 K 31/497; A 61 P 3/00 | P 2013 5793 B | AP 2012 12135 A |
| F 03 B 13/14; F 03 B 13/22 | P 2013 5795 B | AP 2012 12176 A |

**CONCORDANCE TABLE OF PATENT NUMBERS,
PUBLICATION NUMBERS AND INTERNATIONAL CLASSIFICATION INDEX**

| NUMBER OF PATENT (11) | NUMBER OF PUBLISHED APPLICATION (10) | INTERNATIONAL CLASSIFICATION INDEX (51) |
|-----------------------------|---|--|
| P 2013 5791 B | AP 2012 10608 A | A 61 K 31/513; A 61 K 31/44; A 61 K 31/131; A 61 P 3/10 |
| P 2013 5792 B | AP 2012 12055 A | A 61 K 31/437; A 61 K 31/4709; A 61 K 31/496; A 61 K 31/573; A 61 K 38/08; A 61 P 19/02 |
| P 2013 5793 B | AP 2012 12135 A | C 07 D 231/40; C 07 D 401/12; C 07 D 403/12; C 07 D 513/04; A 61 K 31/4427; A 61 K 31/4155; A 61 K 31/4178; A 61 K 31/506; A 61 K 31/497; A 61 P 3/00 |
| P 2013 5794 B | AP 2012 12175 A | B 65 G 27/00 |
| P 2013 5795 B | AP 2012 12176 A | F 03 B 13/14; F 03 B 13/22 |

**CONCORDANCE TABLE OF APPLICATION NUMBERS, PUBLICATION NUMBERS
AND PATENTS**

| NUMBER OF APPLICATION (21) | NUMBER OF PUBLISHED APPLICATION (10) | NUMBER OF PATENT (11) |
|----------------------------------|--|--------------------------|
| AP 2006 010608 | AP 2012 10608 A | P 2013 5791 B |
| AP 2009 012055 | AP 2012 12055 A | P 2013 5792 B |
| AP 2009 012135 | AP 2012 12135 A | P 2013 5793 B |
| AP 2011 012175 | AP 2012 12175 A | P 2013 5794 B |
| AP 2011 012176 | AP 2012 12176 A | P 2013 5795 B |

UTILITY MODELS

CONCORDANCE TABLE OF INTERNATIONAL CLASSIFICATION INDEX AND PUBLICATION NUMBERS

| INTERNATIONAL CLASSIFICATION INDEXES (51) | NUMBER OF PUBLISHED APPLICATION (10) |
|--|---|
| A 61 K 36/00 | AU 2013 12070 U |
| A 61 M 3/00 | AU 2013 12659 U |
| B 67 D 1/04 | AU 2013 12571 U |
| C 12 N 7/00; A 61 K 35/76 | AU 2013 12016 U |
| E 05 F 1/00 | AU 2013 12695 U |

CONCORDANCE TABLE OF PUBLICATION NUMBERS AND INTERNATIONAL CLASSIFICATION INDEX

| NUMBER OF PUBLISHED APPLICATION (10) | INTERNATIONAL CLASSIFICATION INDEXES (51) |
|---|--|
| AU 2013 12016 U | C 12 N 7/00; A 61 K 35/76 |
| AU 2013 12070 U | A 61 K 36/00 |
| AU 2013 12571 U | B 67 D 1/04 |
| AU 2013 12659 U | A 61 M 3/00 |
| AU 2013 12695 U | E 05 F 1/00 |

CONCORDANCE TABLE OF INTERNATIONAL CLASSIFICATION INDEX, PATENT NUMBERS AND PUBLICATION NUMBERS

| INTERNATIONAL CLASSIFICATION INDEX (51) | NUMBER OF PATENT (11) | NUMBER OF PUBLISHED APPLICATION (10) |
|--|-----------------------------|---|
| A 61 K 8/97 | U 2013 1760 Y | AU 2012 12317 U |
| A 61 K 9/02 | U 2013 1761 Y | AU 2012 12492 U |
| A 61 K 9/02 | U 2013 1762 Y | AU 2012 12493 U |
| A 61 N 5/06 | U 2013 1763 Y | AU 2012 12650 U |

CONCORDANCE TABLE OF PATENT NUMBERS, PUBLICATION NUMBERS AND INTERNATIONAL CLASSIFICATION INDEX

| NUMBER OF PATENT (11) | NUMBER OF PUBLISHED APPLICATION (10) | INTERNATIONAL CLASSIFICATION INDEX (51) |
|-----------------------------|---|--|
| U 2013 1760 Y | AU 2012 12317 U | A 61 K 8/97 |
| U 2013 1761 Y | AU 2012 12492 U | A 61 K 9/02 |
| U 2013 1762 Y | AU 2012 12493 U | A 61 K 9/02 |
| U 2013 1763 Y | AU 2012 12650 U | A 61 N 5/06 |

**CONCORDANCE TABLE OF APPLICATION NUMBERS, PUBLICATION NUMBERS
AND PATENTS**

| NUMBER OF APPLICATION (21) | NUMBER OF PUBLISHED APPLICATION (10) | NUMBER OF PATENT (11) |
|-------------------------------|---|--------------------------|
| AU 2011 012317 | AU 2012 12317 U | U 2013 1760 Y |
| AU 2011 012492 | AU 2012 12492 U | U 2013 1761 Y |
| AU 2011 012493 | AU 2012 12493 U | U 2013 1762 Y |
| AU 2012 012650 | AU 2012 12650 U | U 2013 1763 Y |

DESIGNS

**CONCORDANCE TABLE OF INTERNATIONAL CLASSIFICATION INDEX
AND PUBLICATION NUMBERS**

| INTERNATIONAL CLASSIFICATION INDEXES (51) | NUMBER OF PUBLISHED APPLICATION (10) |
|--|---|
| 32-00 | AD 2013 726 S |
| 32-00 | AD 2013 727 S |
| 32-00 | AD 2013 728 S |

**CONCORDANCE TABLE OF PUBLICATION NUMBERS
AND INTERNATIONAL CLASSIFICATION INDEX**

| NUMBER OF PUBLISHED APPLICATION (10) | INTERNATIONAL CLASSIFICATION INDEXES (51) |
|---|--|
| AD 2013 726 S | 32-00 |
| AD 2013 727 S | 32-00 |
| AD 2013 728 S | 32-00 |

**CONCORDANCE TABLE OF INTERNATIONAL CLASSIFICATION INDEX,
PATENT NUMBERS AND PUBLICATION NUMBERS**

| INTERNATIONAL CLASSIFICATION INDEX (51) | NUMBER OF PATENT (11) | NUMBER OF PUBLISHED APPLICATION (10) |
|--|--------------------------|---|
| 09-01 | D 2013 535 S | AD 2012 709 S |

CONCORDANCE TABLE OF PATENT NUMBERS,
PUBLICATION NUMBERS AND INTERNATIONAL CLASSIFICATION INDEX

| NUMBER OF PATENT (11) | NUMBER OF PUBLISHED APPLICATION (10) | INTERNATIONAL CLASSIFICATION INDEX (51) |
|-----------------------|--------------------------------------|---|
| D 2013 535 S | AD 2012 709 S | 09-01 |

CONCORDANCE TABLE OF APPLICATION NUMBERS, PUBLICATION NUMBERS
AND PATENTS

| NUMBER OF APPLICATION (21) | NUMBER OF PUBLISHED APPLICATION (10) | NUMBER OF PATENT (11) |
|----------------------------|--------------------------------------|-----------------------|
| AD 2012 000709 | AD 2012 709 S | D 2013 535 S |

TRADEMARKS

CONCORDANCE TABLE OF REGISTRATION NUMBERS, APPLICATION NUMBERS, PUBLICATION NUMBERS AND BULLETIN NUMBERS

| NUMBER OF REGISTRATION (111) | NUMBER OF APPLICATION (210) | NUMBER OF PUBLISHED APPLICATION (260) | NUMBER OF BULLETIN |
|------------------------------------|-----------------------------------|--|-----------------------|
| 1 | 2 | 3 | 4 |
| M 2013 23413 R | AM 2013 70930 | - | 5(369) 2013 |
| M 2013 23414 R | AM 2013 70934 | - | 5(369) 2013 |
| M 2013 23415 R | AM 2013 70935 | - | 5(369) 2013 |
| M 2013 23416 R | AM 2013 70936 | - | 5(369) 2013 |
| M 2013 23417 R | AM 2013 70937 | - | 5(369) 2013 |
| M 2013 23418 R | AM 2013 71018 | - | 5(369) 2013 |
| M 2013 23419 R | AM 2013 70989 | - | 5(369) 2013 |
| M 2013 23420 R | AM 2011 63532 | AM 2012 63532 A | 16(356) 2012 |
| M 2013 23421 R | AM 2011 63533 | AM 2012 63533 A | 16(356) 2012 |
| M 2013 23422 R | AM 2011 64321 | AM 2012 64321 A | 15(355) 2012 |
| M 2013 23423 R | AM 2011 64375 | AM 2012 64375 A | 21(361) 2012 |
| M 2013 23424 R | AM 2011 64692 | AM 2012 64692 A | 15(355) 2012 |
| M 2013 23425 R | AM 2011 64806 | AM 2012 64806 A | 21(361) 2012 |
| M 2013 23426 R | AM 2011 64807 | AM 2012 64807 A | 21(361) 2012 |
| M 2013 23427 R | AM 2011 64808 | AM 2012 64808 A | 21(361) 2012 |
| M 2013 23428 R | AM 2011 64809 | AM 2012 64809 A | 21(361) 2012 |
| M 2013 23429 R | AM 2011 64810 | AM 2012 64810 A | 21(361) 2012 |
| M 2013 23430 R | AM 2011 64811 | AM 2012 64811 A | 21(361) 2012 |
| M 2013 23431 R | AM 2011 64830 | AM 2012 64830 A | 21(361) 2012 |
| M 2013 23432 R | AM 2011 64831 | AM 2012 64831 A | 21(361) 2012 |
| M 2013 23433 R | AM 2011 64832 | AM 2012 64832 A | 21(361) 2012 |
| M 2013 23434 R | AM 2011 64833 | AM 2012 64833 A | 21(361) 2012 |
| M 2013 23435 R | AM 2011 64838 | AM 2012 64838 A | 21(361) 2012 |
| M 2013 23436 R | AM 2011 64839 | AM 2012 64839 A | 21(361) 2012 |
| M 2013 23437 R | AM 2011 64840 | AM 2012 64840 A | 21(361) 2012 |
| M 2013 23438 R | AM 2011 64841 | AM 2012 64841 A | 21(361) 2012 |
| M 2013 23439 R | AM 2011 64918 | AM 2012 64918 A | 20(360) 2012 |
| M 2013 23440 R | AM 2011 64974 | AM 2012 64974 A | 18(358) 2012 |
| M 2013 23441 R | AM 2011 64996 | AM 2012 64996 A | 21(361) 2012 |
| M 2013 23442 R | AM 2011 65093 | AM 2012 65093 A | 21(361) 2012 |
| M 2013 23443 R | AM 2011 65378 | AM 2012 65378 A | 21(361) 2012 |
| M 2013 23444 R | AM 2011 65391 | AM 2012 65391 A | 21(361) 2012 |
| M 2013 23445 R | AM 2011 65412 | AM 2012 65412 A | 22(362) 2012 |
| M 2013 23446 R | AM 2011 65489 | AM 2012 65489 A | 21(361) 2012 |
| M 2013 23447 R | AM 2011 65490 | AM 2012 65490 A | 21(361) 2012 |
| M 2013 23448 R | AM 2011 65569 | AM 2012 65569 A | 22(362) 2012 |
| M 2013 23449 R | AM 2011 65584 | AM 2012 65584 A | 20(360) 2012 |
| M 2013 23450 R | AM 2012 65744 | AM 2012 65744 A | 21(361) 2012 |
| M 2013 23451 R | AM 2012 65835 | AM 2012 65835 A | 22(362) 2012 |
| M 2013 23452 R | AM 2012 65859 | AM 2012 65859 A | 22(362) 2012 |
| M 2013 23453 R | AM 2012 65861 | AM 2012 65861 A | 22(362) 2012 |
| M 2013 23454 R | AM 2012 65862 | AM 2012 65862 A | 22(362) 2012 |
| M 2013 23455 R | AM 2012 65874 | AM 2012 65874 A | 22(362) 2012 |
| M 2013 23456 R | AM 2012 65875 | AM 2012 65875 A | 22(362) 2012 |
| M 2013 23457 R | AM 2012 65944 | AM 2012 65944 A | 21(361) 2012 |

| 1 | 2 | 3 | 4 |
|----------------|---------------|-----------------|--------------|
| M 2013 23461 R | AM 2012 66009 | AM 2012 66009 A | 21(361) 2012 |
| M 2013 23462 R | AM 2012 66014 | AM 2012 66014 A | 21(361) 2012 |
| M 2013 23463 R | AM 2012 66125 | AM 2012 66125 A | 22(362) 2012 |
| M 2013 23464 R | AM 2012 66275 | AM 2012 66275 A | 22(362) 2012 |
| M 2013 23465 R | AM 2012 66276 | AM 2012 66276 A | 22(362) 2012 |
| M 2013 23466 R | AM 2013 71150 | - | 5(369) 2013 |
| M 2013 23467 R | AM 2013 71151 | - | 5(369) 2013 |
| M 2013 23468 R | AM 2013 71152 | - | 5(369) 2013 |
| M 2013 23469 R | AM 2013 71147 | - | 5(369) 2013 |
| M 2013 23470 R | AM 2013 71143 | - | 5(369) 2013 |
| M 2013 23471 R | AM 2013 71144 | - | 5(369) 2013 |
| M 2013 23472 R | AM 2013 71169 | - | 5(369) 2013 |
| M 2013 23473 R | AM 2013 71197 | - | 5(369) 2013 |
| M 2013 23474 R | AM 2013 71142 | - | 5(369) 2013 |

**CONCORDANCE TABLE OF PUBLICATION NUMBERS
AND APPLICATION NUMBERS**

| NUMBER OF PUBLISHED APPLICATION (260) | NUMBER OF APPLICATION (210) |
|--|--------------------------------|
| AM 2013 66278 A | AM 2012 66278 |
| AM 2013 66345 A | AM 2012 66345 |
| AM 2013 67175 A | AM 2012 67175 |
| AM 2013 67180 A | AM 2012 67180 |
| AM 2013 67181 A | AM 2012 67181 |
| AM 2013 67183 A | AM 2012 67183 |
| AM 2013 67184 A | AM 2012 67184 |
| AM 2013 67185 A | AM 2012 67185 |
| AM 2013 67198 A | AM 2012 67198 |
| AM 2013 67245 A | AM 2012 67245 |
| AM 2013 67288 A | AM 2012 67288 |
| AM 2013 67427 A | AM 2012 67427 |
| AM 2013 68504 A | AM 2012 68504 |
| AM 2013 68505 A | AM 2012 68505 |
| AM 2013 68551 A | AM 2012 68551 |
| AM 2013 68552 A | AM 2012 68552 |
| AM 2013 68553 A | AM 2012 68553 |
| AM 2013 68554 A | AM 2012 68554 |

**CONCORDANCE TABLE OF INDEX OF GOODS AND/OR SERVICES
AND APPLICATION NUMBERS**

| INDEX OF GOODS AND/OR SERVICES (511) | NUMBER OF PUBLISHED APPLICATION (260) | 1 | 2 |
|--|--|----|-----------------|
| 1 | 2 | | |
| 3 | AM 2013 67183 A | 30 | AM 2013 67185 A |
| 5 | AM 2013 68504 A | 33 | AM 2013 67180 A |
| 5 | AM 2013 68505 A | 33 | AM 2013 67181 A |
| 7 | AM 2013 67427 A | 35 | AM 2013 67183 A |
| 9 | AM 2013 67427 A | 35 | AM 2013 67198 A |
| 11 | AM 2013 67427 A | 35 | AM 2013 68551 A |
| 12 | AM 2013 67175 A | 35 | AM 2013 68552 A |
| 12 | AM 2013 67288 A | 35 | AM 2013 68553 A |
| 16 | AM 2013 67183 A | 35 | AM 2013 68554 A |
| 18 | AM 2013 67183 A | 36 | AM 2013 67183 A |
| 19 | AM 2013 67245 A | 36 | AM 2013 67184 A |
| 20 | AM 2013 67183 A | 36 | AM 2013 67185 A |
| 24 | AM 2013 67185 A | 41 | AM 2013 67183 A |
| 25 | AM 2013 67183 A | 43 | AM 2013 67183 A |
| 25 | AM 2013 67185 A | 43 | AM 2013 67184 A |
| 25 | AM 2013 67198 A | 43 | AM 2013 67185 A |
| 30 | AM 2013 66278 A | 43 | AM 2013 68552 A |
| 30 | AM 2013 66345 A | 44 | AM 2013 67183 A |
| 30 | AM 2013 67183 A | 45 | AM 2013 68551 A |
| | | 45 | AM 2013 68552 A |
| | | 45 | AM 2013 68553 A |
| | | 45 | AM 2013 68554 A |

**CONCORDANCE TABLE OF INDEX OF GOODS AND/OR SERVICES
AND NUMBERS OF TRADEMARKS REGISTERED ACCORDING
TO THE ACCELERATED PROCEDURE**

| INDEX OF GOODS AND/OR SERVICES (511) | NUMBER OF REGISTERED ACCORDING TO THE ACCELERATED PROCEDURE (111) |
|---|---|
| 1 | 2 |
| 9 | M 2013 23413 R |
| 25 | M 2013 23466 R |
| 25 | M 2013 23467 R |
| 25 | M 2013 23468 R |
| 29 | M 2013 23419 R |
| 30 | M 2013 23414 R |
| 30 | M 2013 23415 R |
| 30 | M 2013 23416 R |
| 30 | M 2013 23417 R |
| 30 | M 2013 23418 R |
| 32 | M 2013 23472 R |
| 33 | M 2013 23469 R |
| 35 | M 2013 23466 R |
| 35 | M 2013 23467 R |
| 35 | M 2013 23468 R |
| 35 | M 2013 23473 R |
| 36 | M 2013 23466 R |
| 36 | M 2013 23467 R |
| 36 | M 2013 23468 R |

| 1 | 2 |
|----|----------------|
| 36 | M 2013 23470 R |
| 36 | M 2013 23471 R |
| 36 | M 2013 23474 R |
| 37 | M 2013 23466 R |
| 37 | M 2013 23467 R |
| 37 | M 2013 23468 R |
| 38 | M 2013 23466 R |
| 38 | M 2013 23467 R |
| 38 | M 2013 23468 R |
| 38 | M 2013 23470 R |
| 38 | M 2013 23471 R |
| 38 | M 2013 23474 R |
| 39 | M 2013 23466 R |
| 39 | M 2013 23467 R |
| 39 | M 2013 23468 R |
| 39 | M 2013 23470 R |
| 39 | M 2013 23471 R |
| 39 | M 2013 23474 R |
| 41 | M 2013 23413 R |
| 41 | M 2013 23466 R |
| 41 | M 2013 23467 R |
| 41 | M 2013 23468 R |
| 41 | M 2013 23470 R |
| 41 | M 2013 23471 R |
| 41 | M 2013 23474 R |
| 43 | M 2013 23466 R |
| 43 | M 2013 23467 R |
| 43 | M 2013 23468 R |
| 45 | M 2013 23466 R |
| 45 | M 2013 23467 R |
| 45 | M 2013 23468 R |

OFFICIAL BULLETIN OF THE INDUSTRIAL PROPERTY

6(370)

EDITOR-IN-CHIEF: N. Bebrishvili

EDITORS-TRANSLATORS: E. Gabunia
G. Nadareishvili

PROOFREADER: L. Chanturia

COMPUTER LAYOUT: M. Ordenidze
K. Svanidze

www.sakpatenti.org.ge
E-mail: info@sakpatenti.org.ge