



**NATIONAL INTELLECTUAL PROPERTY CENTER OF GEORGIA  
SAKPATENTI**

**OFFICIAL BULLETIN  
OF THE INDUSTRIAL PROPERTY**

**9(397)**

**2014  
TBILISI**

**NATIONAL INTELLECTUAL PROPERTY CENTER OF GEORGIA  
SAKPATENTI**

**OFFICIAL BULLETIN  
OF THE INDUSTRIAL PROPERTY**

**ОФИЦИАЛЬНЫЙ БЮЛЛЕТЕНЬ  
ПРОМЫШЛЕННОЙ СОБСТВЕННОСТИ**

**9(397)**

**INVENTIONS  
UTILITY MODELS  
DESIGNS  
TRADEMARKS**

DATE OF PUBLICATION

2014 05 13

# INID CODES FOR IDENTIFICATION OF BIBLIOGRAPHIC DATA

## INVENTIONS, UTILITY MODELS

- (10) Number of publication for application, which has been examined
- (11) Number of patent and kind of document
- (21) Serial number of application
- (22) Date of filing of the application
- (23) Date of exhibition or the date of the earlier filing and the number of application, if any
- (24) Date from which patent may have effect
- (31) Number of priority application
- (32) Date of filing of priority application
- (33) Code of the country or regional organization allotting priority application number
- (44) Date of publication of application not granted, but examined and number of bulletin
- (45) Date of publication of registered document
- (51) International Patent Classification Index
- (54) Title of the invention
- (57) Abstract
- (60) Number of examined patent document granted by foreign patent office, date from which patent has effect and country code
- (62) Number of the earlier application and in case of divided application, date of filing an application
- (71) Name, surname and address of applicant (country code)
- (72) Name, surname of inventor (country code)
- (73) Name, surname and address of patent owner (country code)
- (74) Name, surname of representative or patent attorney
- (85) Date of commencement of the national phase of International Application
- (86) Number and date of filing of international application
- (87) Number and date of publication of international application

## DESIGNS

- (10) Number of publication for application
- (11) Number of patent and kind of document or number of registration
- (15) Date of registration/Date of patent renewal
- (18) Expected expiration date of patent or registration
- (21) Serial number of application
- (22) Date of filing of the application
- (23) Date of exhibition or the date of the earlier filing and the number of application, if any
- (24) Date from which patent may have effect
- (28) Number of designs included in the application
- (30) Data relating to priority (number of application, date of filing of application, two-letter code identifying the authority with whom the priority application was made)
- (31) Number of priority application
- (32) Date of filing of priority application
- (33) Code of the country or regional organization allotting priority application number
- (34) Two-letter code according to WIPO St.3 identifying the authority with which the priority application was made
- (44) Date of publication of design and number of bulletin (the first publication)
- (45) Date of publication of design registered by WIPO and number of bulletin
- (51) International Classification for designs (class and subclass of the Locarno Classification)
- (54) Title of the invention
- (55) Reproduction of the design
- (57) Description of characteristic features of the design including indication of colors
- (62) Number of the earlier application, registration and document number and if available the date of filing an application in case of divided application
- (71) Name, surname and address of applicant (country code)
- (72) Name, surname of creator (country code)
- (73) Name, surname and address of patent owner (country code)
- (74) Name, surname of representative or patent attorney
- (81) Contracting states concerned
  - II designated contracting states according to the 1960 Act
  - III designated contracting states according to the 1999 Act
- (85) Owner's permanent address
- (86) Owner's nationality
- (87) Owner's residence
- (88) State in which the owner has a real and effective industrial or commercial establishment

## TRADEMARKS

- (111) - Number of registration
- (151) - Date of registration
- (156) - Date of the renewal
- (181) - Expected expiration date of registration
- (186) - Renewal expiration date of registration
- (141) - Date of cancel of duration of the mark
- (210) - Serial number of application
- (220) - Date of filing of the application
- (230) - Data concerning exhibition
- (260) - Number of application, for which favorable decision of examination about registration has been taken (publication number)
- (310) - Number of the first application
- (320) - Date of filing of the first application
- (330) - Code, identifying national or regional Office where the first application was made
- (511) - International Classification of Goods and Services for the purposes of registration of trade marks and/or list of goods and/or services classified according thereto
- (526) - Disclaimer
- (531) - Description of figurative elements of Trade Marks according to the International Classification of the Figurative Elements of Marks
- (540) - Reproduction of Trade Mark
- (550) - Nature and kind of Trade Mark
- (580) - Date of recording of any kind changes in respect of applications or registrations
- (591) - Information concerning colors claimed
- (731) - Name and address of the applicant
- (732) - Name and address of the holder of the registration
- (740) - Name and address of the representative
- (750) - Address for correspondence
- (770) - Name and address of the previous applicant or holder in case of change in ownership
- (771) - Previous name and address of the applicant or holder in case of change in ownership
- (791) - Name and address of the licensee
- (793) - Indication of conditions and/or restrictions under the license (Type of license, number of license agreement, data of license, data of validity of license)
- (800) - Certain data relating to the international registration of Trade Marks under the Protocol Relating to Madrid Agreement (International registration number
- (891) - Date of subsequent designation

## CODES FOR PUBLICATION IN BULLETIN

- (21) AP 0000 000000 - serial number of application for invention
- (10) AP 0000 0000 A - number of published application for invention (first publication)
- (11) P 0000 0000 B - number of patent for invention (second publication)
- (21) API 0000 000000 - number of application for imported patent
- (11) PI 0000 0000 A - number of imported patent (first publication)
- (21) AU 0000 000000 - serial number of application for utility model
- (10) AU 0000 000 U - number of published application for utility model (first publication)
- (11) U 0000 000 Y - number of patent for utility model (second publication)
- (21) AD 0000 000000 - serial number of application for design
- (10) AD 0000 000 S - number of published application for design (first publication)
- (11) D 0000 000 S - number of patent for design (second publication)

## INTERNATIONAL PATENT CLASSIFICATION FOR INVENTIONS AND UTILITY MODELS

- SECTION A - HUMAN NECESSITIES
- SECTION B - PERFORMING OPERATIONS; TRANSPORTING
- SECTION C - CHEMISTRY; METALLURGY
- SECTION D - TEXTILES; PAPER
- SECTION E - FIXED CONSTRUCTIONS
- SECTION F - MECHANICAL ENGINEERING; LIGHTING; HEATING; WEAPONS; BLASTING
- SECTION G - PHYSICS
- SECTION H - ELECTRICITY

- 
- M - Trade Mark
  - (210) AM 0000 000000 - Serial number of application;
  - (260) AAM 0000 00000 A - Publication number of application;
  - (111) M 0000 00000 R - Number of registration;
  - (111) MMM0000 00000 Rn - Number of renewals, in which n=1,2,3;
  - (111) M 0000 00000 R(P) - Number of registration under partial assignment of rights
-

**LIST OF CODES, IN ALPHABETIC SEQUENCE, AND THE CORRESPONDING (SHORT) NAMES OF STATES, OTHER ENTITIES AND INTERGOVERNMENTAL ORGANIZATIONS**  
(WIPO STANDARD ST.3)

AD	Andorra				
AE	United Arab Emirates				
AF	Afghanistan				
AG	Antigua and Barbuda				
AI	Anguilla				
AL	Albania				
AM	Armenia				
AN	Netherlands Antilles				
AO	Angola				
AP	African Regional Intellectual Property Organization (ARIPO)				
AR	Argentina				
AT	Austria				
AU	Australia				
AW	Aruba				
AZ	Azerbaijan				
BA	Bosnia and Herzegovina				
BB	Barbados				
BD	Bangladesh				
BE	Belgium				
BF	Burkina Faso				
BG	Bulgaria				
BH	Bahrain				
BI	Burundi				
BJ	Benin				
BM	Bermuda				
BN	Brunei Darussalam				
BO	Bolivia				
BR	Brazil				
BS	Bahamas				
BT	Bhutan				
BV	Bouvet Island				
BW	Botswana				
BX	Benelux Office for Intellectual Property (BOIP)				
BY	Belarus				
BZ	Belize				
CA	Canada				
CD	Democratic Republic of the Congo				
CF	Central African Republic				
CG	Congo				
CH	Switzerland				
CI	Cote d'Ivoire				
CK	Cook Islands				
CL	Chile				
CM	Cameroon				
CN	China				
CO	Colombia				
CR	Costa Rica				
CU	Cuba				
CV	Cape Verde				
CY	Cyprus				
CZ	Czech Republic				
DE	Germany				
DJ	Djibouti				
DM	Dominica				
DO	Dominican Republic				
DZ	Algeria				
EA	Eurasian Patent Organization (EAPO)				
EC	Ecuador				
EE	Estonia				
EG	Egypt				
EH	Western Sahara				
EM	Office for Harmonization in the Internal Market (Trademarks and Designs)(OHIM)				
EP	European Patent Office (EPO)				
ER	Eritrea				
ES	Spain				
ET	Ethiopia				
FI	Finland				
FJ	Fiji				
FK	Falkland Islands (Malvinas)				
FO	Faroe Islands				
FR	France				
GA	Gabon				
GB	United Kingdom				
GC	Patent Office of the Cooperation Council for the Arab States of the Gulf (GCC)				
GD	Grenada				
GG	Guernsey				
GH	Ghana				
GI	Gibraltar				
GT	Guatemala				
GW	Guinea- Bissau				
GY	Guyana				
HK	The Hong Kong Special Administrative Region of the People's Republic of China				
HN	Honduras				
HR	Croatia				
HT	Haiti				
HU	Hungary				
IB	International Bureau of the World Intellectual Property Organization (WIPO)				
ID	Indonesia				
IE	Ireland				
IL	Israel				
IM	Isle of Man				
IN	India				
IQ	Iraq				
ID	Indonesia				
IE	Ireland				
IL	Israel				
IM	Isle of Man				
IN	India				
IQ	Iraq				
IR	Iran (Islamic Republic of)				
IS	Iceland				
IT	Italy				
JE	Jersey				
JM	Jamaica				
JO	Jordan				
JP	Japan				
KE	Kenya				
KG	Kyrgyzstan				
KH	Cambodia				
KI	Kiribati				
KM	Saint Kitts and Nevis				
KP	Democratic People's Republic of Korea				
KR	Republic of Korea				
KW	Kuwait				
KY	Cayman Islands				
KZ	Kazakhstan				
LA	Lao People's Democratic Republic				
LB	Lebanon				
LC	Saint Lucia				
LI	Liechtenstein				
LK	Sri Lanka				
LR	Liberia				
LS	Lesotho				
LT	Lithuania				
LU	Luxembourg				
LV	Latvia				
LY	Libyan Arab Jamahiriya				
MA	Morocco				
MC	Monaco				
MD	Republic of Moldova				
ME	Montenegro				
MG	Madagascar				
MK	The former Yugoslav Republic of Macedonia				
ML	Mali				
MM	Myanmar				
MN	Mongolia				
MO	Macao				
MP	Northern Mariana Islands				
MR	Mauritania				
MS	Montserrat				
MT	Malta				
MU	Mauritius				
MV	Maldives				
MW	Malawi				
MX	Mexico				
MY	Malaysia				
MZ	Mozambique				
NA	Namibia				
NE	Niger				
NG	Nigeria				
NI	Nicaragua				
NL	Netherlands				
NO	Norway				
NP	Nepal				
NR	Nauru				
NZ	New Zealand				
OA	African Intellectual Property Organization (OAPI)				
OM	Oman				
PA	Panama				
PE	Peru				
PG	Papua New Guinea				
PH	Philippines				
PK	Pakistan				
PL	Poland				
PT	Portugal				
PW	Palau				
PY	Paraguay				
QA	Qatar				
QZ	Community Plant Variety Office (European Community) (CPVO)				
RO	Romania				
RS	Serbia				
RU	Russian Federation				
RW	Rwanda				
SA	Saudi Arabia				
SB	Solomon Islands				
SC	Seychelles				
SD	Sudan				
SG	Singapore				
SH	Saint Helena				
SI	Slovenia				
SK	Slovakia				
SL	Sierra Leone				
SM	San Marino				
SN	Senegal				
SO	Somalia				
SR	Suriname				
ST	Sao Tome and Principe				
SV	El Salvador				
SY	Syrian Arab Republic				
SZ	Swaziland				
TC	Turks and Caicos Islands				
TD	Chad				
TG	Togo				
TH	Thailand				
TJ	Tajikistan				
TL	Timor-Leste				
TM	Turkmenistan				
TN	Tunisia				
TO	Tonga				
TR	Turkey				
SE	Sweden				
TT	Trinidad and Tobago				
TV	Tuvalu				
TW	Taiwan, Province of China				
TZ	United Republic of Tanzania				
UA	Ukraine				
UG	Uganda				
US	United States of America				
UY	Uruguay				
UZ	Uzbekistan				
VA	Holy See				
VC	Saint Vincent and the Grenadines				
VE	Venezuela				
VG	Virgin Islands (British)				
VN	Viet Nam				
VU	Vanuatu				
WO	World Intellectual Property Organization (WIPO)				
WS	Samoa				
XN	Nordic Patent Institute (NPI)				
YE	Yemen				
ZA	South Africa				
ZM	Zambia				
ZW	Zimbabwe				

# CONTENTS

<b>PUBLISHED TITLES OF PROTECTION .....</b>	<b>2</b>
<b>INVENTIONS</b>	
▪ APPLICATIONS APPROVED FOR GRANTING PATENTS .....	4
▪ PATENTED INVENTIONS .....	7
<b>UTILITY MODELS</b>	
▪ APPLICATIONS APPROVED FOR GRANTING PATENTS .....	9
▪ PATENTED UTILITY MODEL:.....	10
<b>DESIGNS</b>	
▪ APPLICATIONS APPROVED FOR REGISTRATION.....	11
▪ DESIGNS REGISTERED AT THE INTERNATIONAL BUREAU ON WHICH THE DECISION IS TAKEN CONCERNING THE EXTENSION OF REGISTRATION VALIDITY TO THE TERRITORY OF GEORGIA.....	12
<b>TRADEMARKS</b>	
▪ APPLICATIONS FILED UNDER THE NATIONAL PROCEDURE APPROVED FOR REGISTRATION .....	28
▪ REGISTERED TRADEMARKS.....	33
▪ TRADEMARKS REGISTERED ACCORDING TO THE ACCELERATED PROCEDURE .....	35
▪ INTERNATIONAL TRADEMARKS FOR WHICH A DECISION ON GRANTING PROTECTION IS TAKEN .....	36
▪ INTERNATIONAL TRADEMARKS PROTECTED IN GEORGIA .....	90
<b>OFFICIAL NOTIFICATIONS</b>	
<b>INVENTIONS</b>	
▪ REINSTATEMENT OF PATENTS.....	98
<b>TRADEMARKS</b>	
▪ RENEWAL OF REGISTRATIONS.....	99
<b>CLASSIFICATION INDEXES</b>	
INVENTIONS .....	100
UTILITY MODELS .....	101
DESIGNS .....	102
TRADEMARKS .....	103

## **PUBLISHED TITLES OF PROTECTION**

### **INVENTIONS**

- APPLICATIONS APPROVED FOR GRANTING PATENTS  
13145; 12340; 12982; 12834; 13194; 12949
- PATENTED INVENTIONS  
6084-6091

### **UTILITY MODELS**

- APPLICATIONS APPROVED FOR GRANTING PATENTS  
13112
- PATENTED UTILITY MODEL:  
1811-1812

### **DESIGNS**

- APPLICATIONS APPROVED FOR REGISTRATION  
776
- DESIGNS REGISTERED AT THE INTERNATIONAL BUREAU ON WHICH THE DECISION IS TAKEN CONCERNING THE EXTENSION OF REGISTRATION VALIDITY TO THE TERRITORY OF GEORGIA  
82734; 82760; 82795; 82815; 82840; 81812; 82901-82903; 83014

### **TRADEMARKS**

- APPLICATIONS FILED UNDER THE NATIONAL PROCEDURE APPROVED FOR REGISTRATION  
70116, 70117; 72525; 72644; 72678; 72750; 72807; 72877; 72927-72929; 72953; 72955; 73070; 73078;  
73083-73086; 73089; 73093, 73094; 73147; 73262; 73297; 73535; 73698; 73733
- REGISTERED TRADEMARKS  
24696-24715; 24717
- TRADEMARKS REGISTERED ACCORDING TO THE ACCELERATED PROCEDURE  
24695; 24716
- INTERNATIONAL TRADEMARKS FOR WHICH A DECISION ON GRANTING PROTECTION IS TAKEN  
70530; 70539; 70639, 70640; 70657; 70862; 70875; 71108; 71120; 71458; 71472-71478; 71480-71485; 71499-  
-71502; 71520; 72031; 72044; 72216; 72235; 72295- 72300; 72303-72305; 72318-72320; 72329-72335;  
72337--72340; 72342-72345; 72347-72350; 72419-72427; 72431; 72436; 72443-72448; 72450-72452; 72454;  
72461, 72462; 72608, 72609; 72612-72628; 72650; 72652-72658; 72705-72707; 72710; 72712-72714; 72718;  
72720; 72724 72728, 72729; 72890-72892; 72894-72896; 72899; 72900, 72901; 72904, 72905; 72907; 72910,  
72911; 72913-72917; 72919; 72921, 72922; 72924-72926; 73001; 73003, 73004; 73006; 73012; 73014-73016;  
73018; 73023; 73026; 73219; 73331; 73343; 73345; 73356; 69778\*; 70451\*; 65404\*
- INTERNATIONAL TRADEMARKS PROTECTED IN GEORGIA  
66364; 68654; 71005; 68095; 68283; 68755; 69782; 70415-70419; 70452; 70454, 70455; 70458, 70459;  
70466, 70467; 70469-70471; 70473-70479; 70485-70495; 70499; 70503; 70515; 70558; 70561-70566; 70570;  
70573-70578; 70580, 70581; 70583; 70587-70593; 70595, 70596; 70598-70606; 70610-70612; 70614-70624;  
70626-70628; 70664-70668; 70670-70676; 70678, 70679; 70681-70683; 70724; 70726-70728; 70771

# INVENTIONS

## APPLICATIONS APPROVED FOR GRANTING PATENTS

The decision can be appealed at the Chamber of Appeal of Sakpatenti within 3 months from the publication or at the Mtskheta District Court Administrative Cases Board (Address: №17, Samkhedro str., Mtskheta), within 1 month following the publication.

### PART A

#### A 47

(10) AP 2014 13145 A (51) Int. Cl. (2006)  
A 47 J 37/00

(21) AP 2013 013145 (22) 2013 06 27

(71) Kakhaber Dzodzuashvili (GE)

Barnovis q.133, b. 47, 0179 Tbilisi (GE)

(72) Kakhaber Dzodzuashvili (GE)

(54) **EQUIPMENT HEATING FOOD PRODUCTS**

(57) There is represented an equipment including installed on supporting means 7 the frame 1, whereon a lattice 2 is located. Metal tray 3 and heat energy source located under the lattice are executed as chutes with two sloping surfaces, which inclination angle to horizontal plane is 5-25°. Longitudinal channels 4 of fat extracted at heating food products are executed on the frame opposite sides.

Claims: 1 independent

10 dependent

Fig.: 5

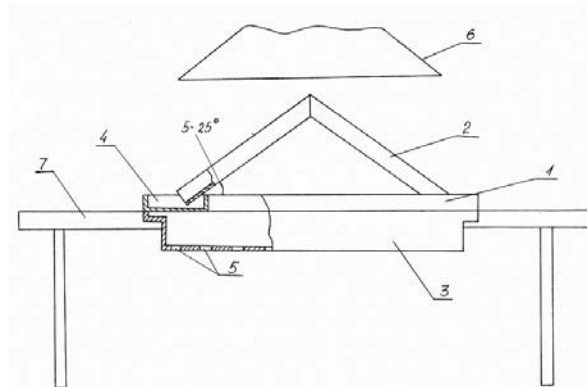

Fig. 1

#### A 61

(10) AP 2014 12340 A (51) Int. Cl. (2006)  
A 61 K 33/24

(21) AP 2011 012340 (22) 2011 08 16

(71) Tsiala Gabelia (GE)

Libanis q. 3, b. 58, 0189 Tbilisi (GE);

Spartak Urotadze (GE)

Nutsubidzis q. 77B, b. 54, 0177 Tbilisi (GE);

Leila Japaridze (GE)

Kurdianis q. 1/6, 0101 Tbilisi (GE);

Eter Salukvadze (GE)

Dolidzis q. korp. 26, b. 128, 0161 Tbilisi (GE)

(72) Tsiala Gabelia (GE);

Spartak Urotadze (GE);

Leila Japaridze (GE);

Eter Salukvadze (GE)

(54) **METHOD OF REMEDY PREPARATION WITH ASKANCLAY**

(57) Remedy preparation method with askanclay provides askanclay colloid solution preparation and modification with Co-fructose complex received by salt including Co interaction with fructose.

Claims: 1 independent

4 dependent

(10) AP 2014 12982 A (51) Int. Cl. (2006)  
A 61 M 5/50

(21) AP 2011 012982 (22) 2011 06 30

(31) 12/827548

(32) 2010 06 30

(33) US

(71) RETRACTABLE TECHNOLOGIES, INC. (US)

511 Lobo Lane Little Elm, TX 75068 (US);

SHAW, Thomas, J. (US)

5310 Buena Vista, Frisco, TX 75034 (US)

(72) SHAW, Thomas, J. (US);

ZHU, Ni (US)

(74) Alexander Gegechkori

(85) 2013 01 28

(86) PCT/US2011/042628, 2011 06 30

(54) **MEDICAL DEVICE WITH RETRACTABLE NEEDLE AND MOVEABLE PLUNGER SEAL**

(57) There is represented a medical device having a barrel 302, a retractable needle 314, a needle retraction assembly and a plunger 304. At that, the needle retraction assembly includes and holds inside the

barrel prior 336 to retraction at least in part by a retainer member 310 contacting the barrel. The plunger 304 comprises a plunger seal 316 with an body having at least a portion that is rearward moveable relative to the plunger and an elastomeric web 317 sealing a retraction cavity 330 inside the plunger prior to retraction of needle, the retainer member and the plunger seal, each cooperates with inside wall of barrel to provide a sealed liquid containment chamber 306 inside the device.

Claims: 1 independent  
41 dependent  
Fig.: 28

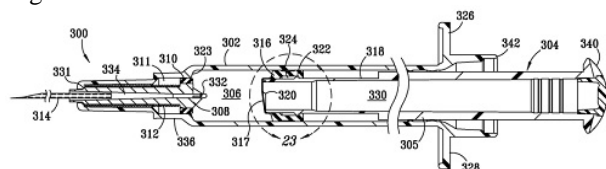
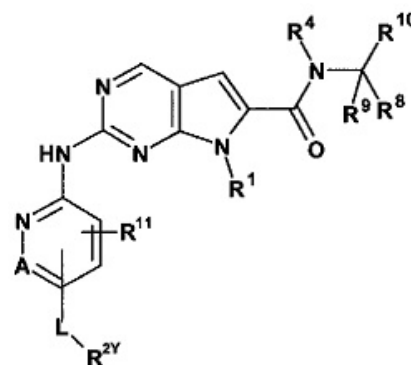

Fig. 18



(I)

and salts thereof, including pharmaceutically acceptable salts. Compounds of present invention are inhibitors of CDK4/6 useful at cancer treatment caused by CDK4/6. The invention relates to pharmaceutical compositions containing said compounds, as well.

Claims: 7 independent  
29 dependent

## PART C

### C 07

(10) AP 2014 12834 A (51) Int. Cl. (2006)  
C 07 D 487/04  
C 07 B 59/00  
A 61 K 31/519  
A 61 P 35/00  
C 07 D 519/00

(21) AP 2011 012834 (22) 2011 02 17

(31) 61/306248; 61/429372; 61/429997

(32) 2010 02 19; 2011 01 03; 2011 01 05

(33) US; US; US

(71) NOVARTIS AG (CH)

Lichtstrasse 35, CH-4056, Basel (CH)

(72) BRAIN, Christopher, Thomas (GB);

CHO, Young Shin (KR);

GIRALDES, John, William (US);

LAGU, Bharat (US);

LEVELL, Julian (GB);

LUZZIO, Michael (US);

PEREZ, Lawrence, Blas (US);

WANG, Yaping (CN);

YANG, Fan (CN)

(74) Alexander Kartvelishvili

(85) 2012 08 17

(86) PCT/EP2011/052353, 2011 02 17

(54) **PYRROLOPYRIMIDINE COMPOUNDS  
AS INHIBITORS OF CDK4/6**

(57) An invention relates to novel compounds of pyrolopyrimidine of formula (I),

## PART F

### F 42

(10) AP 2014 13194 A (51) Int. Cl. (2006)  
F 42 B 10/06

(21) AP 2013 013194 (22) 2013 08 14

(71) Vasil Kotorashvili (GE)

Sop. Gldani, 3304 Mtskheta (GE)

(72) Vasil Kotorashvili (GE)

(74) Gela Peradze

(54) **SPORTING AND HUNTING**

**SMOOTH TUBE GUN CARTRIDGE**

(57) There is represented a cartridge 1 with firing capsule 2 and gunpowder charge 3, and a bullet 4 with stabilizer 6. The stabilizer 6 is executed as set of threads made of flexible material, and in the cartridge the bullet is inserted directly or by means of container 9. In the part of bullet base the cavity is executed, wherein said set of threads is mounted; at that, cylindrical unit is inserted in the cavity so, that set of threads is uniformly allocated around the unit and overhanged from the clearance between cylindrical unit and cavity wall; furthermore, the threads are mounted inclined in one direction so, that inclination angle of each one relative to the plane parallel of bullet axis passed in threads mounting place is 25°, in preference.

Claims: 1 independent  
3 dependent

Fig.: 5



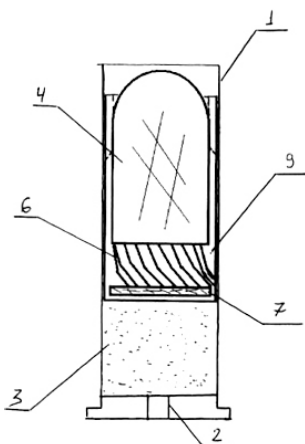

Fig. 2

## PART G

### G 07

(10) AP 2014 12949 A (51) Int. Cl. (2006)

G 07 D 7/20

G 06 Q 10/00

G 06 K 9/64

(21) AP 2008 012949 (22) 2008 10 14

(62) AP 2008 011975, 2008 10 14

(31) PI 0800754-3

(32) 2008 03 25

(33) BR

(71) SICPA HOLDING SA (CH)

Avenue de Florissant 41, CH-1008 Prilly (CH)

(72) SCHEID BUDZINSKI, João Augusto (BR);

AMON, Philippe (CH);

SETO, Myron (CH)

(74) Ketevan Tsakadze

(85) 2013 01 04

(86) PCT/IB2008/002713, 2008 10 14

(54) **METHOD AND SYSTEM FOR**

**ITEMS PRODUCTION CONTROL**

(57) There is represented control method of items production on production line, wherein digital image of each said item is processed so, as to obtain at least identified product type data and identified item data. Said data are further used for determining reliable production volume per product type and per associated item.

Claims: 2 independent

14 dependent

Fig.: 4

## PATENTED INVENTIONS

### PART A

#### A 61

- (11) P 2014 6091 B**      **(51) Int. Cl. (2006)**  
**A 61 F 2/16**  
 (10) AP 2014 13088 A (44) 2(390)/2014  
 (21) AP 2013 013088  
 (22) 2013 05 15  
 (24) 2013 05 15  
 (73) Merab Dvali (GE)  
 I.Abashidzis q. 31, 0179 Tbilisi (GE)  
 (72) Merab Dvali (GE)  
 (74) Tamaz Shilakadze  
**(54) INTRAOCULAR INTRAOCULAR LENS**

- (11) P 2014 6087 B**      **(51) Int. Cl. (2006)**  
**A 61 K 9/00**  
**A 61 K 31/13**  
**A 61 K 9/08**  
 (10) AP 2014 12468 A (44) 2(390)/2014  
 (21) AP 2010 012468  
 (22) 2010 04 12  
 (24) 2010 04 12  
 (31) 09290298.0  
 (32) 2009 04 21  
 (33) EP  
 (86) PCT/IB2010/051573, 2010 04 12  
 (73) PIERRE FABRE DERMO-  
 COSMETIQUE (FR)  
 45, Place Abel Gance F-92100 Boulogne  
 Billancourt (FR)  
 (72) CHAUMONT, Christine (FR);  
 CORDOLIANI, Jean-François (FR);  
 LEVERD, Elie (FR);  
 MUGUET, Valérie (FR)  
 (74) Tamar Kochlamazashvili  
**(54) PAEDIATRIC SOLUTION COMPRISING  
 BETA-BLOCKER**

- (11) P 2014 6088 B**      **(51) Int. Cl. (2006)**  
**A 61 K 9/107**  
**A 61 K 9/127**  
**A 61 K 31/232**  
**A 61 K 31/455**  
**A 61 K 47/14**  
**A 61 K 47/24**  
 (10) AP 2014 12619 A (44) 2(390)/2014  
 (21) AP 2010 012619  
 (22) 2010 08 11  
 (24) 2010 08 11  
 (31) 0955612  
 (32) 2009 08 11  
 (33) FR

- (86) PCT/EP2010/061701, 2010 08 11  
 (73) PIERRE FABRE MEDICAMENT (FR)  
 45, Place Abel Gance F-92100 Boulogne-  
 Billancourt (FR)  
 (72) LEVERD, Elie (FR);  
 VAN HOOGEVEST, Peter (NL);  
 KUNG, Elsa (GB);  
 LEIGH, Mathew (GB)  
 (74) Shalva Gvaramadze  
**(54) PHARMACEUTICAL COMPOSITION  
 INCLUDING DOCOSAHEXAENOIC  
 ACID (DHA) ESTER TO BE  
 ARENTERALLY ADMINISTERED**

### PART C

#### C 07

- (11) P 2014 6084 B**      **(51) Int. Cl. (2006)**  
**C 07 K 16/28**  
 (10) AP 2014 12211 A (44) 2(390)/2014  
 (21) AP 2009 012211  
 (22) 2009 10 01  
 (24) 2009 10 01  
 (31) 08305631.7; 61/136,772; 61/173,743  
 (32) 2008 10 01; 2008 10 01; 2009 04 29  
 (33) EP; US; US  
 (86) PCT/EP2009/062787, 2009 10 01  
 (73) PIERRE FABRE MEDICAMENT (FR)  
 45, Place Abel Gance F-92100 Boulogne-  
 Billancourt (FR)  
 (72) KLINGUER-HAMOUR, Christine (FR);  
 GRENIER-CAUSSANEL, Véronique (FR)  
 (74) Giorgi Meipariani  
**(54) ANTI-CXCR4 ANTIBODIES AND THEIR  
 USAGE FOR CANCER TREATMENT**

**PART E****E 01**

(11) P 2014 6085 B (51) Int. Cl. (2006)  
E 01 B 9/00

- (10) AP 2013 12427 A (44) 19(383)/2013  
 (21) AP 2011 012427  
 (22) 2011 10 26  
 (24) 2011 10 26  
 (73) Giorgi Tumanishvili (GE)  
 Didi Dighomi, III mkr., korp. 4, b. 65,  
 0131 Tbilisi (GE);  
 Tengiz Nadiradze (GE)  
 Bakhtrionis q. 7a, b. 33, 0194 Tbilisi (GE);  
 Tengiz Buchukuri (GE)  
 Vazha-Pshavelas VI kvart., korp. 37, b. 37,  
 0186 Tbilisi (GE);  
 Viktor Zviadauri (GE)  
 Vazha-Pshavelas V kvart., korp. 4, b. 79,  
 0186 Tbilisi (GE);  
 Giorgi Tumanishvili Jr (GE)  
 Didi Dighomi, III mkr., korp. 4, b. 65,  
 0131 Tbilisi (GE)  
 (72) Giorgi Tumanishvili (GE);  
 Tengiz Nadiradze (GE);  
 Tengiz Buchukuri (GE);  
 Viktor Zviadauri (GE);  
 Giorgi Tumanishvili Jr (GE)  
 (54) **BASEPLATE**

- (72) THESING, Robin (DE);  
 SILVA, James M. (US);  
 ANDERSEN, Robert L. (US)  
 (74) Pavle Meipariani  
 (54) **AUDIO DECODER AND DECODING  
 METHOD USING EFFICIENT  
 DOWNMIXING**

**PART H****H 02**

(11) P 2014 6089 B (51) Int. Cl. (2006)  
H 02 J 17/00

- (10) AP 2014 12731 A (44) 2(390)/2014  
 (21) AP 2012 012731  
 (22) 2012 06 01  
 (24) 2012 06 01  
 (73) GEORGIAN TECHNICAL UNIVERSITY (GE)  
 Kostavas q. 77, 0175 Tbilisi (GE)  
 (72) Merab Poladashvili (GE);  
 Zaal Azmaiparashvili (GE);  
 Nikoloz Meskhidze (GE)  
 (74) Givi Sibashvili  
 (54) **DEVICE FOR WIRELESS POWER  
 TRANSMISSION**

**PART G****G 10**

(11) P 2014 6086 B (51) Int. Cl. (2006)  
G 10 L 19/00  
H 04 S 3/00

- (10) AP 2014 12462 A (44) 2(390)/2014  
 (21) AP 2011 012462  
 (22) 2011 02 03  
 (24) 2011 02 03  
 (31) 61/305871; 61/359763  
 (32) 2010 02 18; 2010 06 29  
 (33) US; US  
 (86) PCT/US2011/023533, 2011 02 03  
 (73) DOLBY LABORATORIES LICENSING  
 CORPORATION (US)  
 100 Potrero Avenue San Francisco, CA 94103-  
 4813 (US)  
 DOLBY INTERNATIONAL AB (SE)  
 Apollo Building, 3E Herikerbergweg 1-35 NL-  
 1101 CN  
 Amsterdam Zuid-Oost (NL)

**H 04**

(11) P 2014 6090 B (51) Int. Cl. (2006)  
H 04 M 3/42  
H 04 M 3/487

- (10) AP 2014 13034 A (44) 2(390)/2014  
 (21) AP 2012 013034  
 (22) 2012 01 17  
 (24) 2012 01 17  
 (31) s20110195  
 (32) 2011 03 17  
 (33) MD  
 (86) PCT/MD2012/000001, 2012 01 17  
 (73) NICOLAESCU, Gheorghe (MD)  
 Str. Biruinta 4, kom. Lozova,  
 Strasen 3721 (MD)  
 (72) NICOLAESCU, Gheorghe (MD)  
 (74) Alexander Gegechkori  
 (54) **METHOD TO CARRY OUT  
 INFORMATIONAL PHONE CALLS**

# UTILITY MODELS

## APPLICATIONS APPROVED FOR GRANTING PATENT

The decision can be appealed at the Chamber of Appeal of Sakpatenti within 3 months from the publication or at the Mtskheta District Court Administrative Cases Board (Address: №17, Samkhedro str., Mtskheta), within 1 month following the publication.

### PART B

#### B 65

(10) AU 2014 13112 U (51) Int. Cl. (2006)

B 65 H 54/08

B 65 H 7/04

G 01 N 33/36

D 01 B 7/04

(21) AU 2013 013112 (22) 2013 06 06

(71) Elguja Shapakidze (GE)

Petriashvilis q. 13, 0179 Tbilisi (GE);

Vladimer Miruashvili (GE)

Dolidzis q. 132, 0115 Tbilisi (GE)

(72) Elguja Shapakidze (GE);

Vladimer Miruashvili (GE)

(54) **DEVICE REELING THREAD FROM COCOON**

(57) There is represented a device comprising a frame, a basin for cocoon allocation mounted thereon, water heating units allocated under the basin, the spindles, and the drivers. An engine of each driver is of low DC and switched into control box, wherein control rheostat and unit converting low voltage into the DC are located.

Claims: 1 independent

Fig.: 2

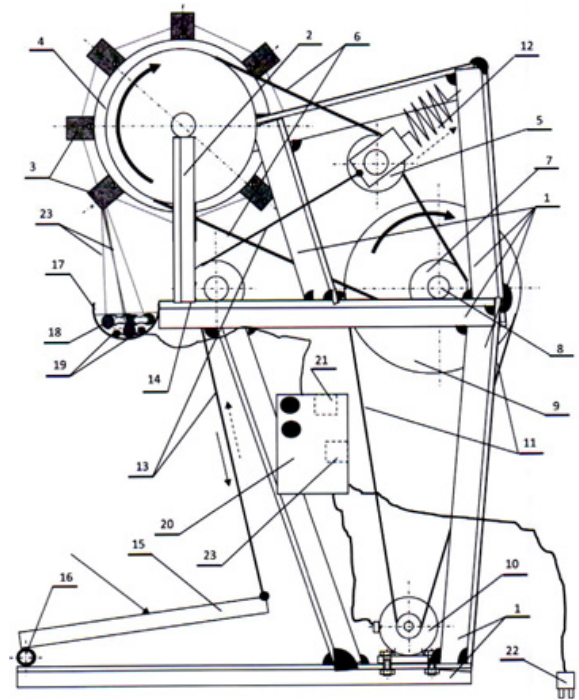

Fig. 2

## PATENTED UTILITY MODEL

### PART A

#### A 61

- (11) U 2014 1812 Y      (51) **Int. Cl. (2006)**  
                                  **A 61 K 36/481**  
                                  **A 61 K 135/00**
- (10) AU 2014 12969 U    (44) 2(390)/2014  
(21) AU 2013 012969  
(22) 2013 01 17  
(24) 2013 01 17  
(73) Meri Alania (GE)  
      Dolidzis q. 20, b. 20, 0171 Tbilisi (GE);  
      Eter Kemertelidze (GE)  
      Pekinis q. 33a, b. 40, 0160 Tbilisi (GE)  
(72) Meri Alania (GE);  
      Eter Kemertelidze (GE)  
(54) **METHOD FOR OBTAINING ROBININ**
- 

### PART E

#### E 05

- (11) U 2014 1811 Y      (51) **Int. Cl. (2006)**  
                                  **E 05 B 41/00**
- (10) AU 2014 12815 U    (44) 2(390)/2014  
(21) AU 2012 012815  
(22) 2012 08 02  
(24) 2012 08 02  
(73) Gocha Muzashvili (GE)  
      Akhtalis q. Gas. 4, 0104 Tbilisi (GE)  
(72) Gocha Muzashvili (GE)  
(74) Nugzar Ksovreli  
(54) **LOCKING ARRANGEMENT**
-

---

# DESIGNS

## APPLICATION APPROVED FOR REGISTRATION

The decision can be appealed at the Chamber of Appeal of Sakpatenti within 3 months from the publication or at the Mtskheta District Court Administrative Cases Board (Address: №17, Samkhedro str., Mtskheta), within 1 month following the publication.

(10) AD 2014 776 S (51) 09-01

(21) AD 2013 000776

(22) 2013 12 03

(28) 2

(71) Tamaz Kakhidze (GE)

Khelvachauri, Didacharis q. 17, 6400 (GE)

(72) Tamaz Kakhidze (GE)

(54) POLYETHYLENE CANS

(55)



1.1



1.2



1.3



2.1



2.2



2.3

**DESIGNS REGISTERED AT THE INTERNATIONAL BUREAU ON WHICH THE DECISION IS  
TAKEN CONCERNING THE EXTENSION OF REGISTRATION VALIDITY TO THE TERRITORY OF  
GEORGIA**

The decision can be appealed at the Chamber of Appeal of Sakpatenti within 3 months from the publication or at the Mtskheta District Court Administrative Cases Board (Address: №17, Samkhedro Str., Mtskheta), within 1 month following the publication.

**(11) DM/082734 (51) 10-07**

(15) 2013 11 18 (45) 2014/05 (2014 02 07)

(22) 2013 11 18 (28) 1

(73) HERMANN STAIB GMBH Grimmigweg 27, 75179 Pforzheim (DE)

(85) DE, EM

(86) DE, EM

(87) DE, EM

(88) DE, EM

(89) EM

(81) III. CH, EM, GE, NO, SG, TR, UA

(72) Uwe Staib, Grimmigweg 27, 75179 Pforzheim

(54) 1. Metal mesh stripe

(55)

1

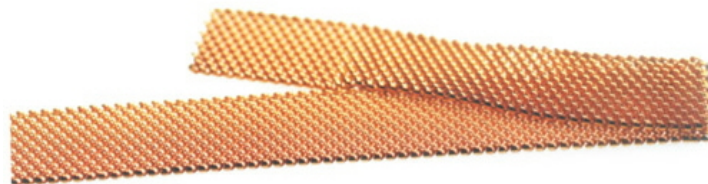
**(11) DM/082760 (51) 11-01**

(15) 2013 10 18 (45) 2014/06 (2014 02 14)

(22) 2013 10 18 (28) 11

(73) DE GRISOGONO SA 176bis route de Saint Julien, CH-1228 Plan-les-Ouates (CH)

(85) CH

(86) CH

(87) CH

(88) CH

(89) CH

(81) II. MA. III. EG, EM, GE, MC, OM, SG, TR, UA (30) 23.04.2013; 139881; CH

(72) 1-11: GRUOSI, Les Mèlèzes Chemin de Trembley 30, 1197 Prangins, Suisse

(54) 1.-3. Finger rings; 4. Earrings; 5. Finger ring; 6. Earrings; 7.-8. Pendants [jewelry]; 9. Finger ring; 10. Earrings; 11. Charm

(55)

1.1



1.2

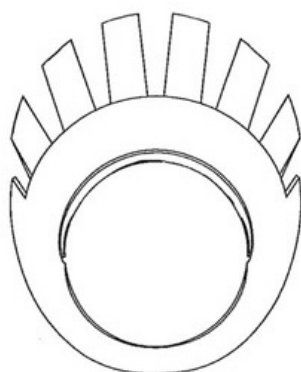

1.3

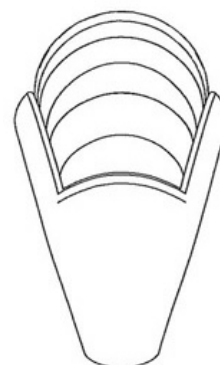

1.4

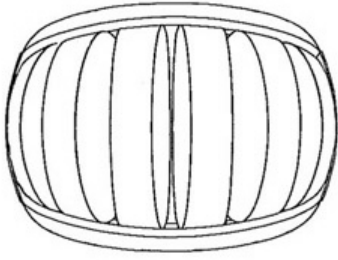

1.5

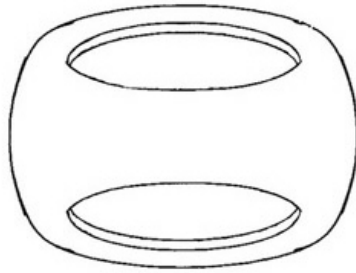

2.1

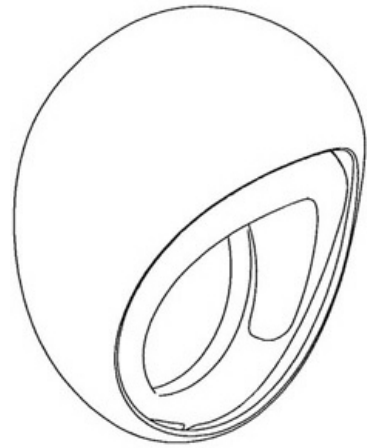

2.2

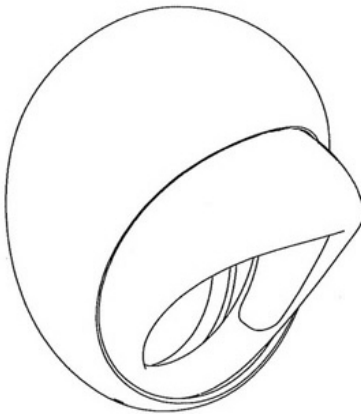

2.3

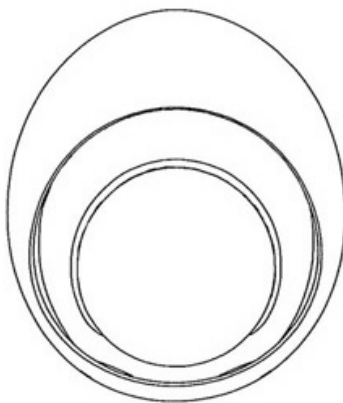

2.4

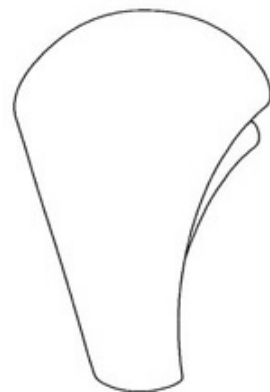

2.5

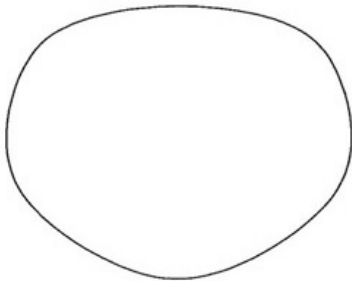

2.6

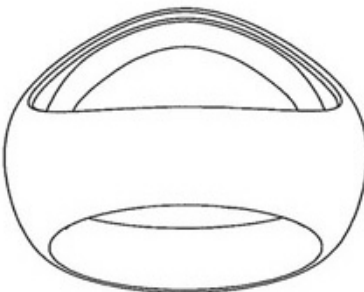

3.1



3.2



3.3



3.4





3.5



4.1



4.2



4.3



4.4



5.1



5.2



5.3



5.4



6.1



6.2



6.3



7.1



7.2



7.3



7.4



7.5



8.1



8.2



8.3



8.4



9.1



9.2



9.3



9.4



10.1



10.2



10.3



10.4



11.1

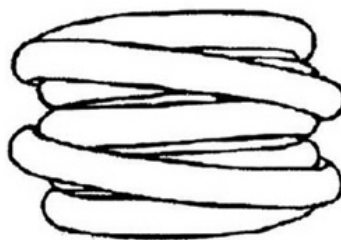

11.2



11.3

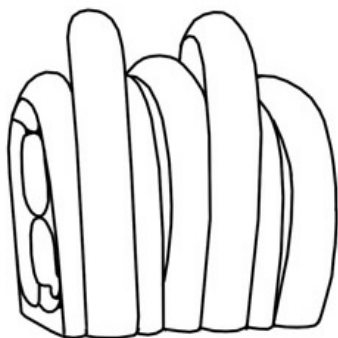

11.4

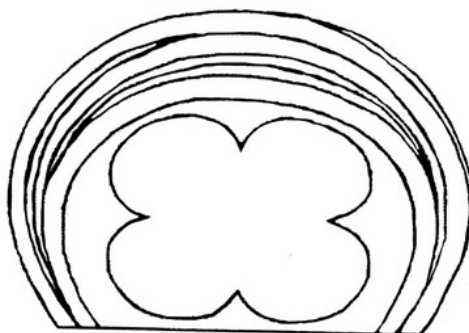

11.5

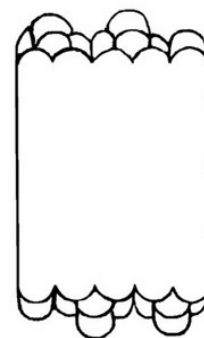
**(11) DM/082795 (51) 10-02**

(15) 2013 06 18 (45) 2014/07 (2014 02 21)

(22) 2013 06 18 (28) 4

(73) SWATCH AG (SWATCH SA) (SWATCH LTD.) Jakob-Stämpfli-Strasse 94, CH-2502 BIEL/BIENNE (CH)

(85) CH

(86) CH

(87) CH

(88) CH

(89) CH

(81) II. BZ, MA. III. AL, AM, AZ, BA, CH, EM, GE, KG, LI, MC, MD, ME, MK, MN, NO, OM, SG, TJ, TN, TR, UA

(72) 1-2: Rossana Boffi, Swatchlab, Via Archimede 6, 20129 Milano, Italie; 3: Patrizio VITA, Swatchlab, Via Archimede 6, 20129 Milano, Italie; 4: Ylenia AGATE, Swatchlab, Via Archimede 6, 20129 Milano, Italie

(54) 1.-4. Wristwatches

(55)

1



2



3



4



**(11) DM/082815 (51) 24-02**

(15) 2013 07 05 (45) 2014/07 (2014 02 21)

(22) 2013 07 05 (28) 2

(73) NIKOLAY PETROV SERDEV Layosh Koshut Str. 8, app. 24, Sofia (BG)

(85) BG, EM

(86) BG, EM

(87) BG, EM

(88) BG, EM

(89) BG

(81) III. AL, AM, BA, CH, EM, GE, LI, MD, ME, MK, RS, SG, TR, UA

(72) Nikolay Petrov Serdev, 8, Layosh Koshut Str., app. 24 BG-1606 Sofia

(54) 1.-2. Surgical needles

(55)

1.1



1.2



1.3



1.4



2.1



2.2



**(11) DM/082840 (51) 10-07**

(15) 2013 11 18 (45) 2014/07 (2014 02 21)

(22) 2013 11 18 (28) 1

(73) HERMANN STAIB GMBH Grimmigweg 27, 75179 Pforzheim (DE)

(85) DE, EM

(86) DE, EM

(87) DE, EM

(88) DE, EM

(89) EM

(81) III. CH, EM, GE, NO, SG, TR, UA

(72) Uwe Staib, Grimmigweg 27, 75179, Pforzheim

(54) 1. Metal mesh stripe

(55)

1



**(11) DM/081812 (51) Cl. 12-11**

(15) 2013 08 06 (45) 2014/08 (2014 02 28)

(22) 2013 08 06 (28) 3

(30) 27.02.2013; 002192518

(73) PIAGGIO & C.S.P.A. Viale Rinaldo Piaggio, 25, I-56025 PONTEDERA (PISA) (IT)

(85) --

(86) IT, EM

(87) IT, EM

(88) IT, EM

(89) EM

(81) II. MA. III. AL, BA, CH, EG, GE, ME, MK, RS, TN, TR

(72) Marco Lambri, c/o PIAGGIO & C. S.p.A., Viale Rinaldo Piaggio, 25, I-56025 Pontedera (PI);

Marco Canepa, c/o PIAGGIO & C. S.p.A.; Viale Rinaldo Piaggio, 25, I-56025 Pontedera (PI)

(54) 1.-3. Motor scooters

(55)

1.1

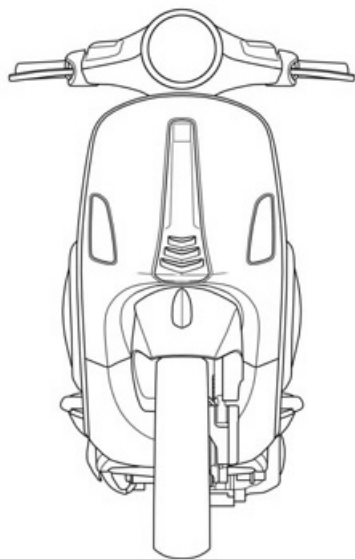

1.2

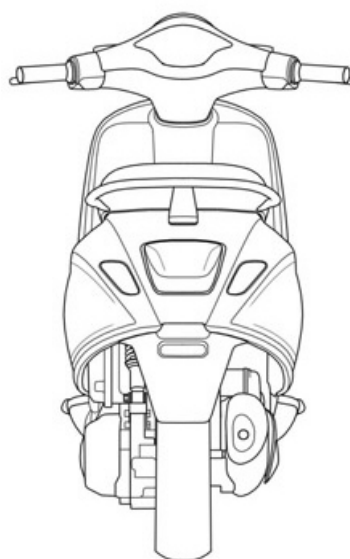

1.3

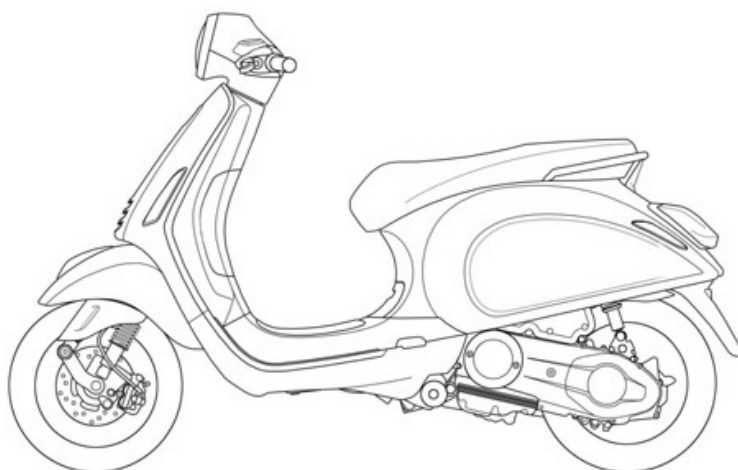

1.4

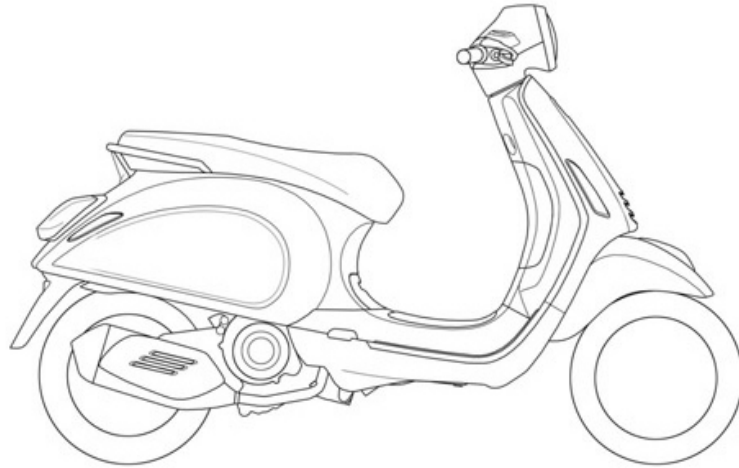

1.5

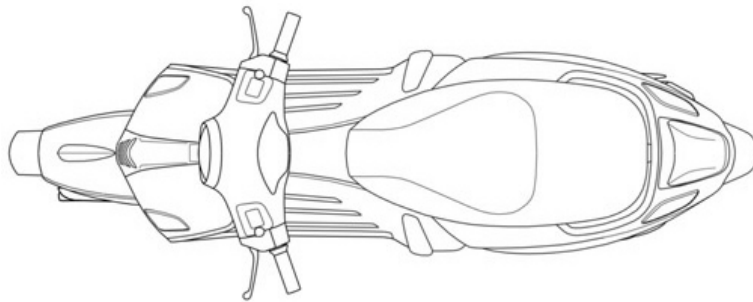

1.6

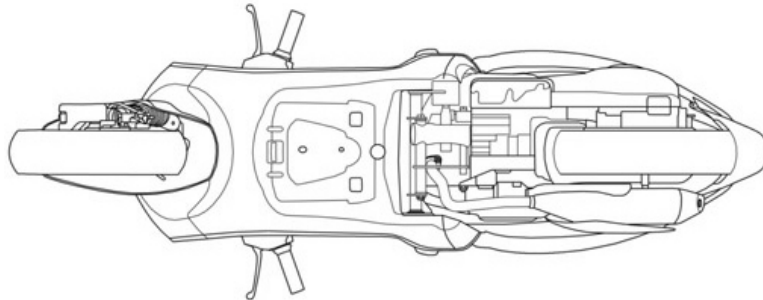

1.7

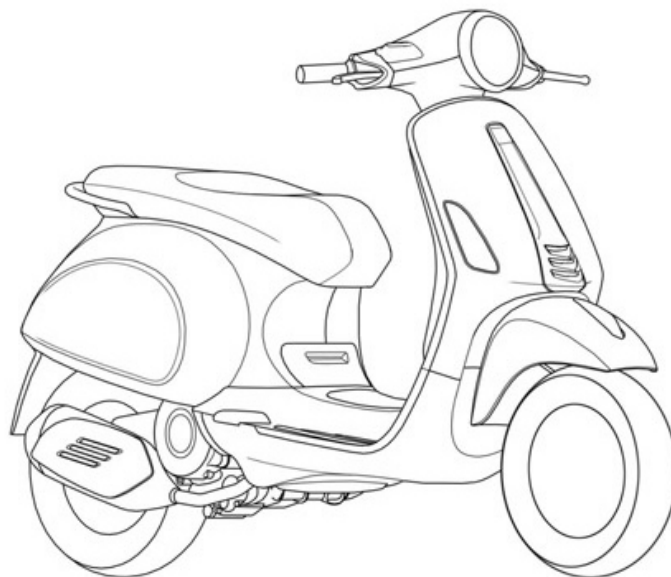

2.1

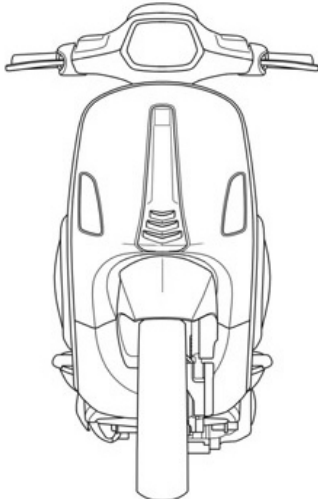

2.2

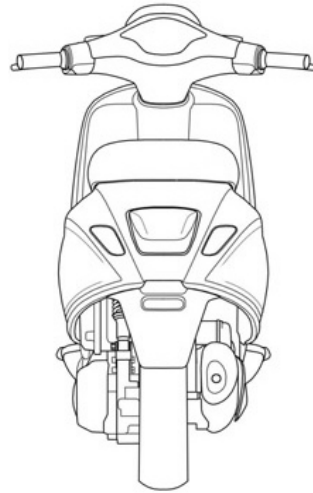

2.3

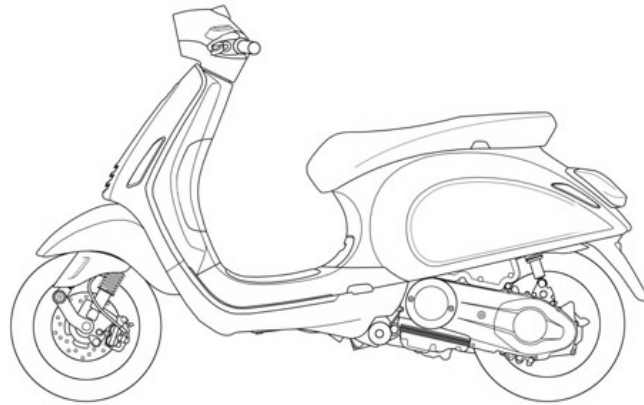

2.4

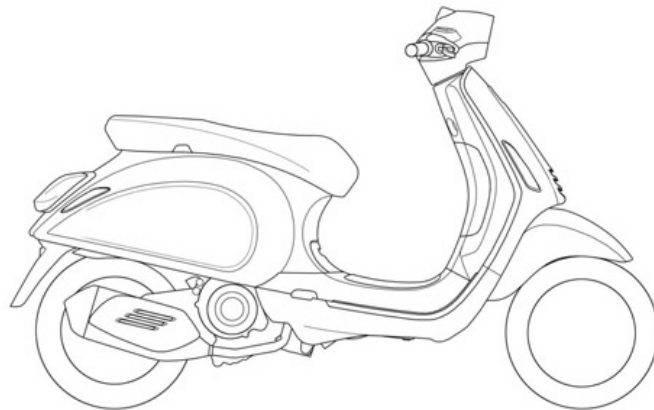

2.5

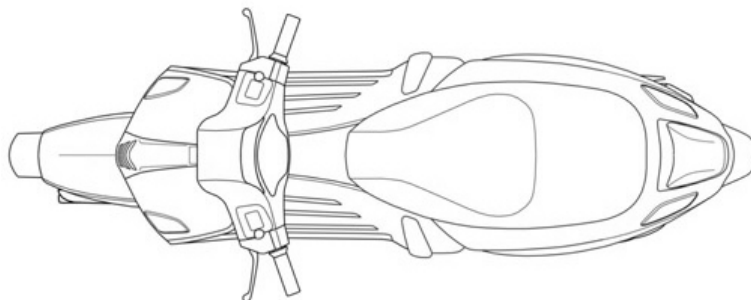



2.6

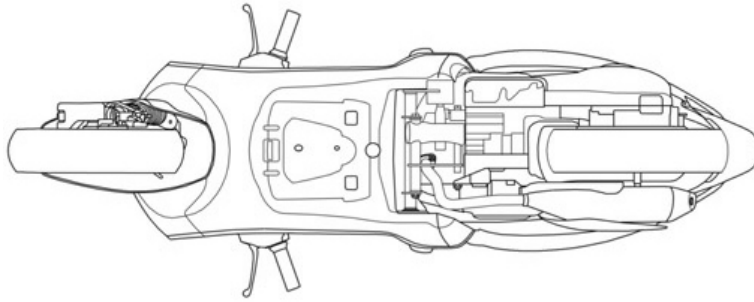

2.7



3.1

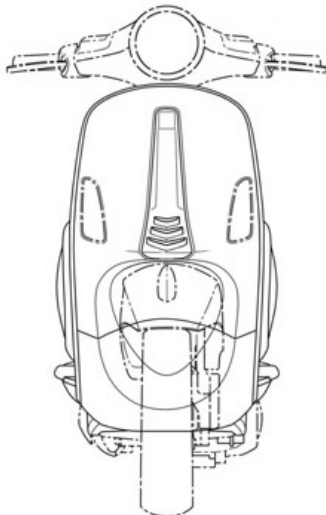

3.2

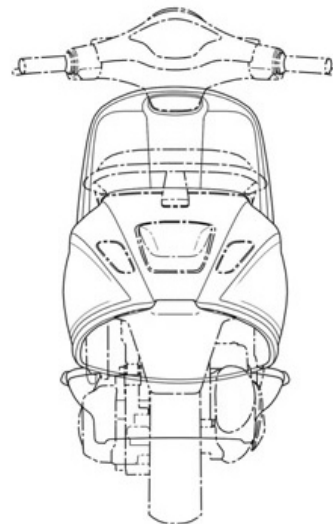

3.3

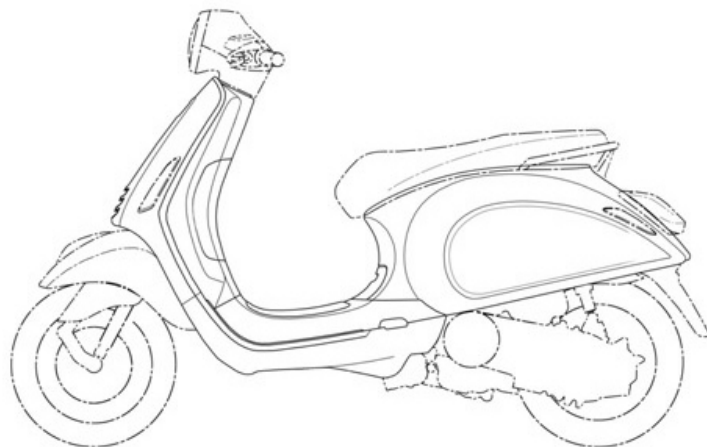

3.4

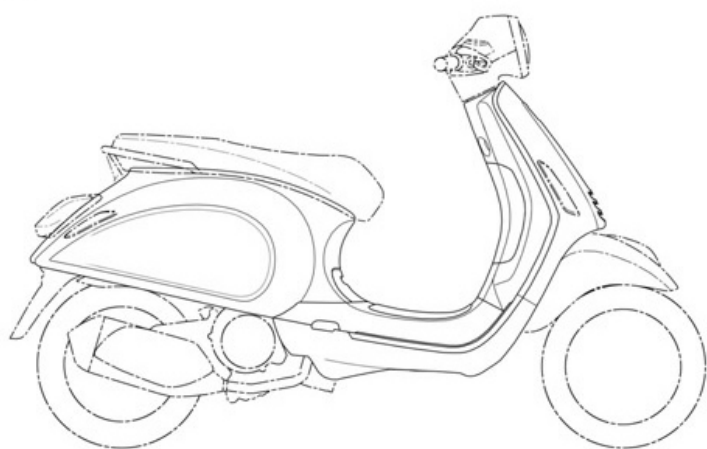

3.5

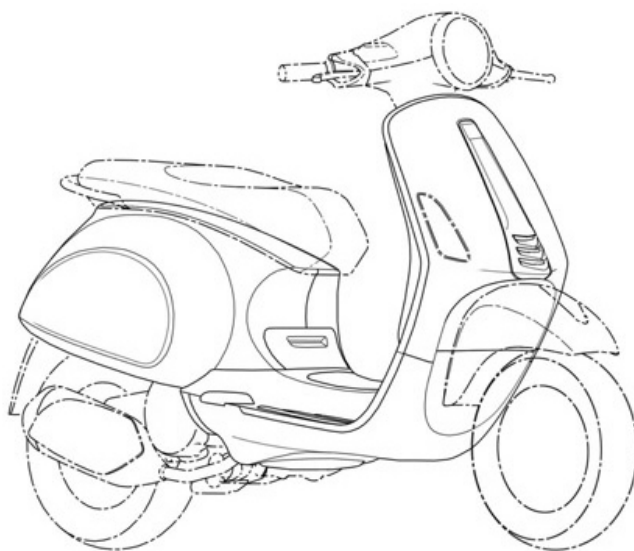

(11) DM/082901 (51) 06-04

(15) 2014 02 11 (45) 2014/08 (2014 02 28)

(22) 2014 02 11 (28) 1

(30) 07.02.2014; s201400259; UA

(73) JOINT UKRAINIAN-POLISH ENTERPRISE IN THE FORM OF THE COMPANY WITH LIMITED RESPONSIBILITY "MODERN-EXPO" Rivnenska Str., 4 Lutsk District Volyn Region, Strumivka 45603 (UA)

(85) --

(86) UA

(87) n/a

(88) n/a

(89) UA

(81) III. AM, AZ, CH, EG, EM, GE, MD, NO, TR, UA

(72) Oleg Semenyuk, vul. Grabovskogo, 7a/98, 43017 Lutsk, Ukraine

(54) 1. Shelving system

(55)

1.1

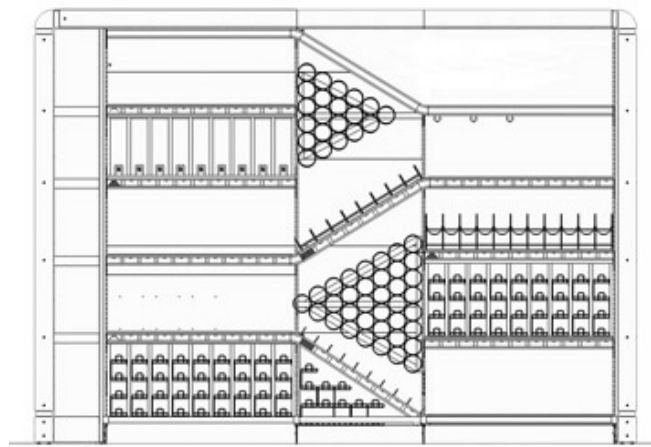

1.2

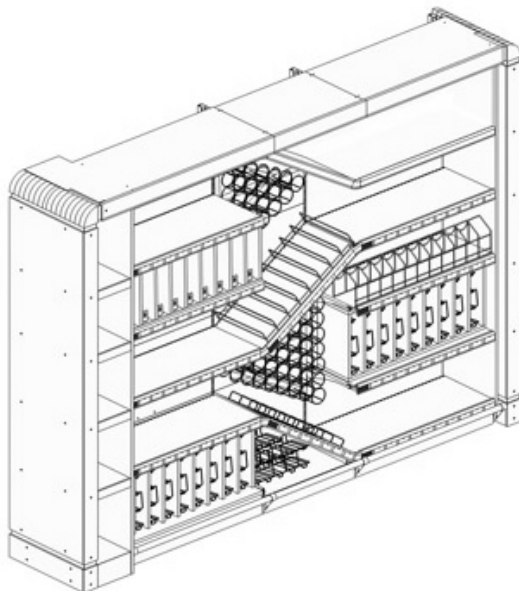

1.3



**(11) DM/082902 (51) 06-04**

(15) 2014 02 13 (45) 2014/08 (2014 02 28)

(22) 2014 02 13 (28) 3

(30) 07.02.2014; s201400262; UA

(73) JOINT UKRAINIAN-POLISH ENTERPRISE IN THE FORM OF THE COMPANY WITH LIMITED RESPONSIBILITY "MODERN-EXPO" Rivnenska Str., 4 Lutsk District Volyn Region, Strumivka 45603 (UA)

(85) --

(86) UA

(87) n/a

(88) n/a

(89) UA

(81) III. AM, AZ, CH, EG, EM, GE, MD, NO, TR

(72) Oleg Semenyuk, vul. Grabovskogo, 7a/98, 43017 Lutsk, Ukraine

(54) 1.-3. Racks for fruit and vegetables

(55)

1

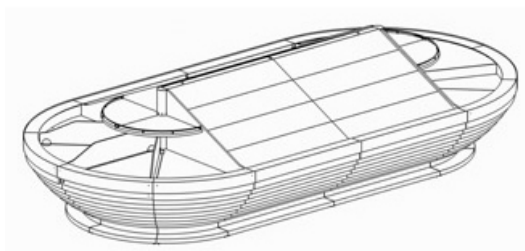

2

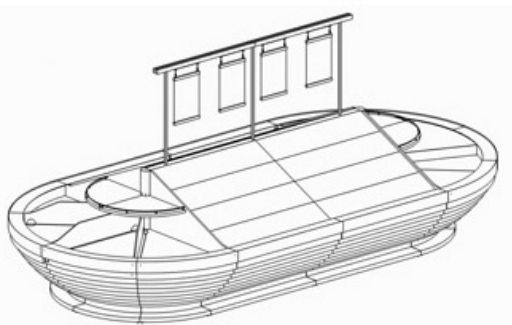

3

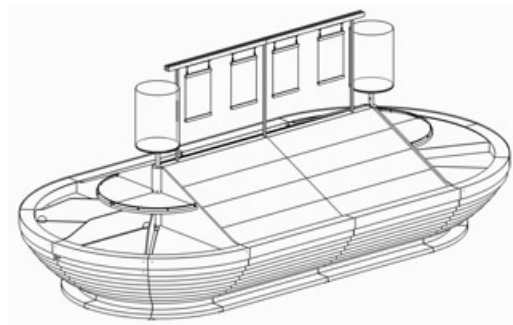
**(11) DM/082903 (51) 20-02**

(15) 2014 02 13 (45) 2014/08 (2014 02 28)

(22) 2014 02 13 (28) 6

(30) 07.02.2014; s201400261; UA

(73) JOINT UKRAINIAN-POLISH ENTERPRISE IN THE FORM OF THE COMPANY WITH LIMITED RESPONSIBILITY "MODERN-EXPO" Rivnenska Str., 4 Lutsk District Volyn Region, Strumivka 45603 (UA)

(85) --

(86) UA

(87) n/a

(88) n/a

(89) UA

(81) III. AZ, CH, EG, EM, GE, NO, TR

(72) Anatolii Kyrylyuk, vul. Rivnenska, 125/57, 45603 Lutsk (Volyn Region), Ukraine

(54) 1.-6. Counter desks

(55)

1.1

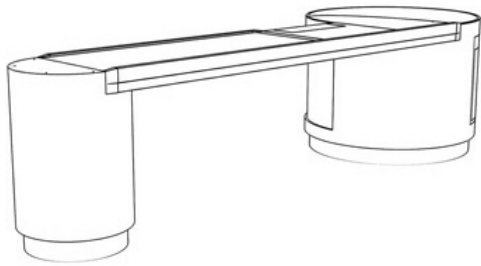

2.1

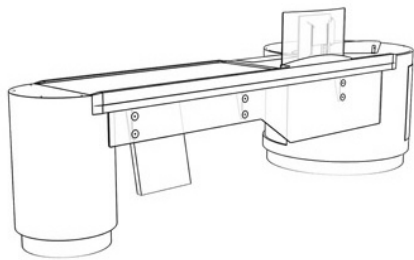

3.1



4.1



5.1

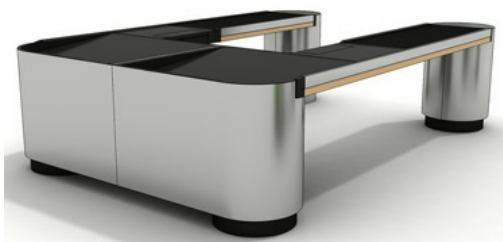

6.1



1.2

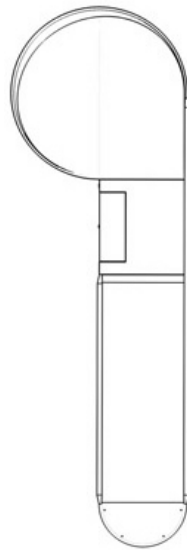

3.2



2.2



4.2



5.2

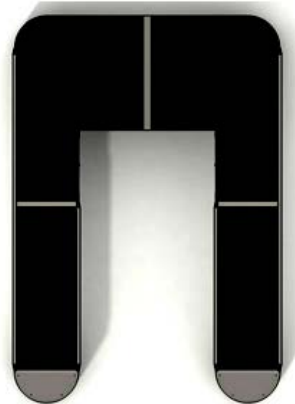

6.2



**(11) DM/083014 (51) 14-03**

(15) 2014 03 03 (45) 2014/10 (2014 03 14)

(22) 2014 03 03 (28) 1

(73) VERTU CORPORATION LIMITED Beacon Hill Road Church Crookham, Hampshire GU52 8DY (GB)

(85) --

(86) n/a

(87) EM

(88) n/a

(89) EM

(81) III. CH, EG, GE, LI, MC, NO, SG, TR, UA

(72) Nathan Bates, 63 Alexandra Drive, Se19 1an London, United Kingdom; Ignacio Germade, 38 Bridge Street, OX20BB Oxford, United Kingdom

(54) 1. Handset

(55)

1.1

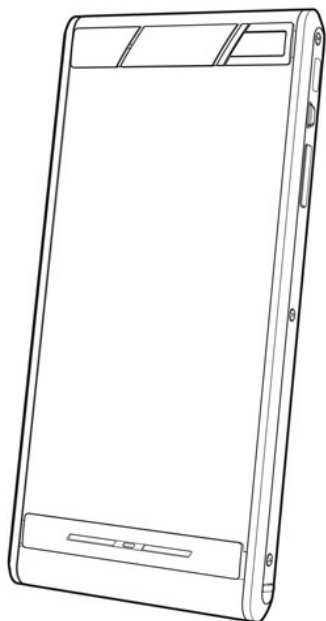

1.2

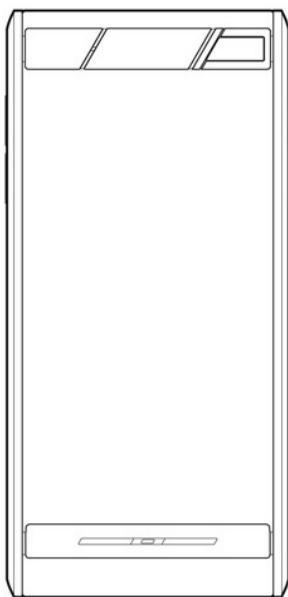

1.3

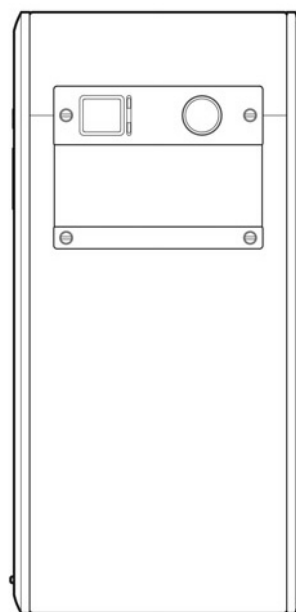

1.4



1.5



1.6



1.7



---

# TRADEMARKS

## APPLICATIONS FILED UNDER THE NATIONAL PROCEDURE APPROVED FOR REGISTRATION

The decision can be appealed at the Chamber of Appeal of Sakpatenti within 3 months from the publication or at the Mtskheta District Court Administrative Cases Board (Address: №17, Samkhedro str., Mtskheta), within 1 month following the publication.

(260) AM 2014 70116 A  
(210) AM 070116  
(220) 2012 12 20  
(731) B.S.A.  
33, Avenue du Main Tour Maine  
Montparnasse 75015 Paris, France  
(740) Tamaz Shilakadze  
(540)



(591) Red, white, tobacco yellow  
(531) 26.13.25-27.05.24-29.01.13-  
(511) 29

---

(260) AM 2014 70117 A  
(210) AM 070117  
(220) 2012 12 20  
(731) B.S.A.  
33, Avenue du Main Tour Maine  
Montparnasse 75015 Paris, France  
(740) Tamaz Shilakadze  
(540)



(591) Red, white, tobacco yellow, black  
(531) 19.03.01-26.13.25-27.05.24-29.01.13-  
(511) 29

---

(260) AM 2014 72525 A  
(210) AM 072525  
(731) LTD "MARNISKARI"  
Askuravas q. 17, 0101 Tbilisi, Georgia  
(540)

ორშიმო  
**ORSHIMO**  
ОРШИМО

(591) Black, white  
(511) 33, 35

---

(260) AM 2014 72644 A  
(210) AM 072644  
(220) 2013 06 12  
(731) LTD "WINEMAN LTD"  
Gudiashvilis q. 11, 0105 Tbilisi, Georgia  
(740) Shalva Gvaramadze  
(540)

სანთელი  
**SANTELI**

(591) Black, white  
(511) 33

---

(260) AM 2014 72678 A  
(210) AM 072678  
(220) 2013 06 13  
(731) AL-ZAWRA'A FOR TOBACCO END  
CIGARETETS TRADING  
P.O. Box 941936, Amman 11194, Jordan  
(740) Vakhtang Torotadze  
(540)

**BENTLY**

(591) Black, white  
(511) 34

---

(260) AM 2014 72750 A  
 (210) AM 072750  
 (220) 2013 06 18  
 (731) LTD "PRIMA-VITA"  
 Cross of Military Way of Georgia with  
 Akhmeteli St., 0159 Tbilisi, Georgia  
 (740) Alexander Amashukeli  
 (540)



(591) Various Color scale on green and sky blue  
 background: green, blue, orange, light green,  
 coral, yellow, dark red, red and white  
 (531) 02.05.17-06.19.11-28.05.00-  
 (511) 5

(260) AM 2014 72807 A  
 (210) AM 072807  
 (220) 2013 06 21  
 (731) LTD "GEORGIAN BEER COMPANY"  
 Sop. Saguramo, 3311 Mtskheta, Georgia  
 (740) Ana Vachadze  
 (540)



(591) Green, red  
 (531) 25.01.25-28.05.00-29.01.12-  
 (526) **DISCLAIMER** – The trademark is protected as a  
 whole, verbal sign "ЛИМОНАД" included therein shall  
 not be subject to independent legal protection.  
 (511) 32

(260) AM 2014 72877 A  
 (210) AM 072877  
 (220) 2013 06 28  
 (731) DOUBLE A (1991) PUBLIC COMPANY  
 LIMITED  
 1 Moo 2, Thatoom, Srimahaphote,  
 Prachinburi, Tayland  
 (740) Giorgi Meipariani  
 (540)

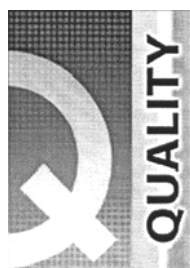

(591) Black, white  
 (531) 25.07.04-26.04.18-26.11.07-  
 (526) **DISCLAIMER** – The trademark is protected as a  
 whole, verbal sign "QUALITY" included therein shall  
 not be subject to independent legal protection.  
 (511) 16

(260) AM 2014 72927 A  
 (210) AM 072927  
 (220) 2013 07 02  
 (731) GENERAL MOTORS LLC  
 300 Renaissance Center, City of Detroit,  
 State of Michigan 48265-3000, USA  
 (740) Giorgi Taktakishvili  
 (540)

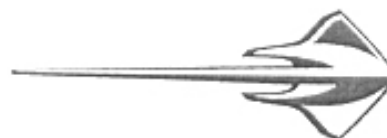

(591) Black, white  
 (531) 24.15.01-26.04.03-  
 (511) 12

(260) AM 2014 72928 A  
 (210) AM 072928  
 (220) 2013 07 02  
 (731) REINKE MANUFACTURING CO., INC.  
 101 Reinke Road, Deshler, Nebraska 68340,  
 USA  
 (740) Giorgi Taktakishvili  
 (540)

**REINKE**

(591) Black, white  
 (531) 27.05.01-  
 (511) 11

(260) AM 2014 72929 A  
 (210) AM 072929  
 (220) 2013 07 02  
 (731) STARBUCKS CORPORATION  
 D/B/A STARBUCKS COFFEE  
 COMPANY Washington Corporation  
 2401 Utah Avenue South, Seattle,  
 Washington 98134, USA  
 (740) Tamar Kochlamazashvili  
 (540)

**READY BREW**

(591) Black, white  
 (511) 30



(260) AM 2014 72953 A  
 (210) AM 072953  
 (220) 2013 07 03  
 (310) 2647950  
 (320) 2013 01 07  
 (330) GB  
 (731) BRITISH AMERICAN TOBACCO  
 (BRANDS) INC. (Delaware Corporation)  
 2711 Centerville Road, Suite 300,  
 Wilmington, DE 19808, USA

(740) Tamar Kochlamazashvili  
 (540)

## LUCKY STRIKE FRESH

(591) Black, white  
 (511) 34

(260) AM 2014 72955 A  
 (210) AM 072955  
 (220) 2013 07 03  
 (731) HARRINGTON DEVELOPMENT INC.  
 Elvira Mendez Street, Vallarino bldg.,  
 3<sup>rd</sup> Floor, Panama, Panama

(740) Givi Akopashvili  
 (540)

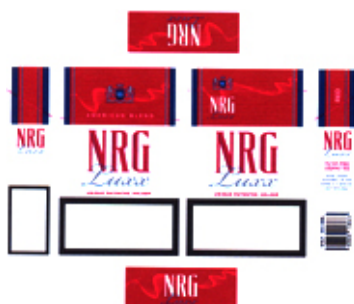

(591) White, red, light red, silver, black, blue  
 (531) 19.03.24-25.01.01-26.11.13-29.01.13-  
 (526) **DISCLAIMER** – The trademark is protected as a  
 whole, verbal sign "NRG LUXX" included therein shall  
 not be subject to independent legal protection.  
 (511) 34

(260) AM 2014 73070 A  
 (210) AM 073070  
 (220) 2013 07 10  
 (731) LTD "BMB"  
 Sop. Ratevani, 1100 Bolnisi R-ni, Georgia  
 (540)



(591) Green, dark green, red, dark red

(531) 05.01.06-05.01.16-25.01.01-28.19.00-  
 29.01.13-

(526) **DISCLAIMER** – The trademark is protected as a  
 whole, verbal sign „უბეჭდესი ტრადიციის თანამედ-  
 როვე მეთოდით“ included therein shall not be subject  
 to independent legal protection.

(511) 29

(260) AM 2014 73078 A  
 (210) AM 073078  
 (220) 2013 07 10  
 (310) 011840972  
 (320) 2013 05 23  
 (330) EM  
 (731) AUTUMNPAPER LIMITED  
 5<sup>th</sup> Floor Rear Suite, Oakfield House,  
 35 Perrymount Road, Haywards Heath,  
 West Sussex RH16 3BW, UK

(740) Liliana Darakhvelidze  
 (540)

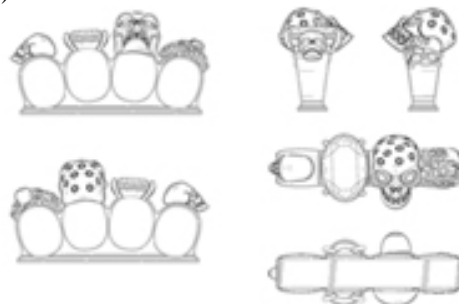

(591) Black, white  
 (531) 02.09.23-17.02.17-  
 (511) 14, 18

(260) AM 2014 73083 A  
 (210) AM 073083  
 (220) 2013 07 11  
 (731) JSC "INSURANCE COMPANY ALDAGI"  
 Old Tbilisi, Pushkinis q. 3, Tbilisi, Georgia  
 (740) Archil Kereselidze  
 (540)



(591) Combination of various green colors  
 (531) 26.04.06-29.01.03-  
 (511) 16, 36, 44

(260) AM 2014 73084 A  
 (210) AM 073084  
 (220) 2013 07 11  
 (731) JSC "INSURANCE COMPANY ALDAGI"  
 Old Tbilisi, Pushkinis q. 3, Tbilisi, Georgia  
 (740) Archil Kereselidze  
 (540)



(591) Various green colors, grey  
 (531) 26.04.06-29.01.03-  
 (511) 16, 36, 44

(260) AM 2014 73085 A  
 (210) AM 073085  
 (220) 2013 07 11  
 (731) JSC "INSURANCE COMPANY ALDAGI"  
 Old Tbilisi, Pushkinis q. 3, Tbilisi, Georgia  
 (740) Archil Kereselidze  
 (540)



(591) Grey  
 (531) 28.19.00-  
 (511) 16, 36, 44

(260) AM 2014 73086 A  
 (210) AM 073086  
 (220) 2013 07 11  
 (731) JSC "INSURANCE COMPANY ALDAGI"  
 Old Tbilisi, Pushkinis q. 3, Tbilisi, Georgia  
 (740) Archil Kereselidze  
 (540)



(591) Grey  
 (531) 27.05.17-  
 (511) 16, 36, 44

(260) AM 2014 73089 A  
 (210) AM 073089  
 (220) 2013 07 12  
 (731) STOKKE AS  
 Parkgata 6, N6003 Ålesund, Norway  
 (740) Shalva Gvaramadze  
 (540)

**TRIPP TRAPP**

(591) Black, white  
 (511) 20

(260) AM 2014 73093 A  
 (210) AM 073093  
 (220) 2013 07 12  
 (731) ATE MY HEART INC.  
 S/O GELFAND, RENNERT & FELDMAN,  
 LLP.  
 1880, Sancherry Park East, Suite 1600,  
 90067 Los-Angeles, CA, USA  
 (740) Shalva Gvaramadze  
 (540)

**LADY GAGA FAME**

(591) Black, white  
 (511) 3

(260) AM 2014 73094 A  
 (210) AM 073094  
 (220) 2013 07 12  
 (731) LTD "FORTUNE"  
 Gldani, Didi Tbis Mimdebared, 0167  
 Tbilisi, Georgia  
 (540)

**სოლარი**  
**solari**  
**солари**

(591) Black, white  
 (511) 29

(260) AM 2014 73147 A  
 (210) AM 073147  
 (220) 2013 07 22  
 (310) 2651917  
 (320) 2013 02 06  
 (330) GB  
 (731) BRITISH AMERICAN TOBACCO  
 (BRANDS) INC. (Delaware Corporation)  
 2711 Centerville Road, Suite 300,  
 Wilmington, DE 19808, USA  
 (740) Tamar Kochlamazashvili  
 (540)



(591) Beige, white, brown, dark brown, light brown,  
 dark yellow, golden  
 (531) 10.01.05-29.01.14-  
 (511) 34

(260) AM 2014 73262 A  
 (210) AM 073262  
 (220) 2013 07 30  
 (731) NIKAI GULF FZCO  
 P.O. Box 9200, Dubai, United Arab  
 Emirates  
 (740) Giorgi Taktakishvili  
 (540)

**NIKURA**

(591) Black, white  
 (511) 7, 11

(260) AM 2014 73297 A  
 (210) AM 073297  
 (220) 2013 07 31  
 (731) BYD COMPANY LIMITED  
 Yan'an Road, Kuichong Town, Longgang  
 District, Shenzhen, China  
 (740) Shalva Gvaramadze  
 (540)

**BYD ebus**

(591) Black, white  
 (511) 12

(260) AM 2014 73535 A  
 (210) AM 073535  
 (220) 2013 08 14  
 (731) LTD "LOIDLY"  
 Tseretlis Gamz. 87, 0119 Tbilisi, Georgia  
 (740) Davit Gugava  
 (540)



(591) White, wine red  
 (531) 26.01.20-26.04.10-26.07.05-28.19.00-  
 29.01.12-  
 (511) 29, 30, 31, 43

(260) AM 2014 73698 A  
 (210) AM 073698  
 (220) 2013 08 26  
 (731) LTD "GRAND CANDY"  
 Peikrebis q. 12, 0141 Tbilisi, Georgia  
 (740) Davit Zurabashvili  
 (540)



(591) White, golden, yellow, red, black, brown  
 (531) 07.01.01-07.01.03-07.05.06-06.01.01-  
 25.01.19-29.01.15-  
 (511) 30

(260) AM 2014 73733 A  
 (210) AM 073733  
 (220) 2013 08 29  
 (731) CANTERBURY LIMITED  
 8 Manchester Square, London, W1U 3PH, UK  
 (740) Davit Zurabishvili  
 (540)



(591) Black, white  
 (531) 03.07.24-26.01.15-27.05.17-  
 (511) 18, 25, 28

---

**REGISTERED TRADEMARKS**

(111) M 2014 024696 R

(151) 2014 04 23

(181) 2024 04 23

(260) AM 2013 70078 A

(220) 2012 12 17

(732) JSC "BEST CLEAN"

142700, Moskovskaya Obl., Leninskij R-n,  
Vidnoe, Severnaia Promzona Ter.,  
Proektiruemij Proezd 251 vl. 2, Russian  
Federation

---

(111) M 2014 024700 R

(151) 2014 04 23

(181) 2024 04 23

(260) AM 2013 70480 A

(220) 2013 01 22

(732) STARBUCKS CORPORATION

D/B/A STARBUCKS COFFEE  
COMPANY Washington Corporation  
2401 Utah Avenue South, Seattle, Washington  
98134, USA

---

(111) M 2014 024697 R

(151) 2014 04 23

(181) 2024 04 23

(260) AM 2013 70079 A

(220) 2012 12 17

(732) JSC "BEST CLEAN"

142700, Moskovskaya Obl., Leninskij R-n,  
Vidnoe, Severnaia Promzona Ter.,  
Proektiruemij Proezd 251 vl. 2, Russian  
Federation

---

(111) M 2014 024701 R

(151) 2014 04 23

(181) 2024 04 23

(260) AM 2013 70609 A

(220) 2013 01 29

(732) CELGENE CORPORATION

86 Morris Avenue, Summit, NJ 07901,  
USA

---

(111) M 2014 024698 R

(151) 2014 04 23

(181) 2024 04 23

(260) AM 2013 70081 A

(220) 2012 12 17

(732) OPEN ENGLISH LLC

Edificio Torres de las Amèricas, Torre "A",  
Piso 15, Punta pacifika, Apartado Postal  
0832-0588 Panama, Panama

---

(111) M 2014 024702 R

(151) 2014 04 23

(181) 2024 04 23

(260) AM 2013 70798 A

(220) 2013 02 08

(732) Giorgi Zautashvili

Jorjiashvilis q. 3, 4800 Kvareli, Georgia

---

(111) M 2014 024699 R

(151) 2014 04 23

(181) 2024 04 23

(260) AM 2013 70337 A

(220) 2013 01 15

(732) INDUSTRIAL DE VALVULAS, S.A.

DE C.V.  
Avenida de la Industria, Lote 16,  
Fraccionamiento Industrial El Trébol,  
Tepotzotlán, Estado de México 54600,  
Mexico

---

(111) M 2014 024703 R

(151) 2014 04 23

(181) 2024 04 23

(260) AM 2013 70866 A

(220) 2013 02 13

(732) BIOGEN IDEC MA INC.

Massachusetts Corporation  
14 Cambridge Center, Cambridge, MA 02142, USA

---

(111) M 2014 024704 R

(151) 2014 04 23

(181) 2024 04 23

(260) AM 2013 70961 A

(220) 2013 02 20

(732) PARAMOUNT BED KABUSHIKI

KAISHA (Also Trading as Paramount Bed  
Co., Ltd.)  
14-5, Higashi Suna 2-chome, Koto-ku, Tokyo,  
Japan

---

(111) M 2014 024705 R  
(151) 2014 04 23  
(181) 2024 04 23  
(260) AM 2013 71115 A  
(220) 2013 02 27  
(732) JSC "LOMISI"  
Sop. Natakhtari, 3308 Mtskheta, Georgia

---

(111) M 2014 024706 R  
(151) 2014 04 23  
(181) 2024 04 23  
(260) AM 2013 71116 A  
(220) 2013 02 27  
(732) JSC "LOMISI"  
Sop. Natakhtari, 3308 Mtskheta, Georgia

---

(111) M 2014 024707 R  
(151) 2014 04 23  
(181) 2024 04 23  
(260) AM 2013 71117 A  
(220) 2013 02 27  
(732) JSC "LOMISI"  
Sop. Natakhtari, 3308 Mtskheta, Georgia

---

(111) M 2014 024708 R  
(151) 2014 04 23  
(181) 2024 04 23  
(260) AM 2013 71305 A  
(220) 2013 03 12  
(732) STARBUCKS CORPORATION  
D/B/A STARBUCKS COFFEE  
COMPANY, Washington Corporation  
2401 Utah Avenue South, Seattle, Washington  
98134, USA

---

(111) M 2014 024709 R  
(151) 2014 04 23  
(181) 2024 04 23  
(260) AM 2013 71391 A  
(220) 2013 03 18  
(732) STARBUCKS CORPORATION  
D/B/A STARBUCKS COFFEE  
COMPANY, Washington Corporation  
2401 Utah Avenue South, Seattle, Washington  
98134, USA

---

(111) M 2014 024710 R  
(151) 2014 04 23  
(181) 2024 04 23  
(260) AM 2013 71479 A  
(220) 2013 03 22  
(732) ACCOR  
110 Avenue de France, 75013 Paris, France

---

(111) M 2014 024711 R  
(151) 2014 04 23  
(181) 2024 04 23  
(260) AM 2013 71486 A  
(220) 2013 03 22  
(732) ASTELLAS PHARMA EUROPE B.V.  
Sylviusweg 62, 2333 Be Leiden, Netherlands

---

(111) M 2014 024712 R  
(151) 2014 04 23  
(181) 2024 04 23  
(260) AM 2014 71790 A  
(220) 2013 04 11  
(732) LTD "BIBLUSI CO"  
Iosebisdzis q. 49, Kviris Palitris Redaktsia,  
0160 Tbilisi, Georgia

---

(111) M 2014 024713 R  
(151) 2014 04 23  
(181) 2024 04 23  
(260) AM 2013 72101 A  
(220) 2013 05 01  
(732) Zviad Gugava  
Davit Aghmasheneblis q. 1, 2900 Daba  
Lentekhi, Georgia

---

(111) M 2014 024714 R  
(151) 2014 04 23  
(181) 2024 04 23  
(260) AM 2014 72146 A  
(220) 2013 05 07  
(732) LTD "MISO GIRO CREDIT"  
Pekinis Gamz. 3, Microfinancial  
Organization "GIRO CREDIT", Tbilisi,  
Georgia

---

(111) M 2014 024715 R  
(151) 2014 04 23  
(181) 2024 04 23  
(260) AM 2013 72151 A  
(220) 2013 05 08  
(732) LTD "WATCH WORLD"  
Gudiashvilis q. 4, 0104 Tbilisi, Georgia

---

(111) M 2014 024717 R  
(151) 2014 04 25  
(181) 2024 04 25  
(260) AM 2013 71096 A  
(220) 2013 02 27  
(732) JSC "LVOVSKAYA TOBACHNAYA  
FABRIKA" (Lviv Tobacco Fabric)  
Ul. Promishlennaya, 50/52, k. 716, Lviv  
(Lvov) 79024, Ukraine

---

---

## TRADEMARKS REGISTERED ACCORDING TO THE ACCELERATED PROCEDURE

The decision can be appealed at the Chamber of Appeal of Sakpatenti within 3 months from the publication.

(111) M 2014 24695 R  
(151) 2014 04 22  
(181) 2024 04 22  
(210) AM 076497  
(220) 2014 03 31  
(732) LTD "PSP INSURANCE"  
Davit Agmasheneblis Gamz. 148, 0112  
Tbilisi, Georgia  
(740) Nugzar Ksovreli  
(540)



(591) Gray, dark green  
(531) 27.05.03-27.05.10-27.05.21-28.01.12-  
(526) **DISCLAIMER** – The trademark is protected as a  
whole, verbal sign "INSURANCE" included therein  
shall not be subject to independent legal protection.  
(511) 36

---

(111) M 2014 24716 R  
(151) 2014 04 24  
(181) 2024 04 24  
(210) AM 076536  
(220) 2014 04 02  
(732) LTD "ROYAL SERVICE"  
Cross of Ghvimmis Aghmarti and Dutu  
Megreli St-s, Plot 90/22, Tbilisi, Georgia  
(540)



(591) White, golden, black  
(531) 26.04.24-27.05.24-  
(511) 41

## INTERNATIONAL TRADEMARKS FOR WHICH A DECISION ON GRANTING PROTECTIONS IS TAKEN

The decision can be appealed at the Chamber of Appeal of Sakpatenti within 3 months from the publication or at the Mtskheta District Court Administrative Cases Board (Address: №17, Samkhedro str., Mtskheta), within 1 month following the publication.

(260) AM 2014 70530 A

(800) 1143634

(151) 2011 10 31

(731) WHITE ROSE MOTOR SANAYİ VE OTOMASYON TİCARET LİMİTED ŞİRKETİ

Büyükdere Cad. No. 62, Lale İshani Kat: 1, Mecidiyeköy/İSTANBUL, Turkey

(540)



(591) Dark blue, orange, white

(511)

6 – Non-precious metal ores; common metals and their alloys, and extruded semi-finished articles of metal or its alloys; metal plates and sheets, profiles, sheet iron, can, iron, construction iron, copper, zinc, tin, brass, aluminum; steel mats, stirrups for constructions; portable metal structures, metal floors, stairs, iron railing fittings, banisters, metal roofs, metal fences, portable metal platforms, metal telephone cabins, boxes of common metal, portable metal greenhouses, swimming pools, metal silos, metal barriers for roads; metal doors and windows, door and window cases; metal shutters, metal rolling shutters and metal exterior blinds, metallic slatted shutters; metal scaffolding and construction moulds made of metal; telescopic masts of metal for constructions; metal cables and wires not for electrical purposes, welding and soldering wires; metal ropes, metal hangers, cords, columns, strips, bands and ribbons for use in lifting and carrying loads; ironmongery (hardware) articles: metal screws, nails, bolts, nuts, pins, crampons (climbing irons), ice nails (climbing irons), chains, casters of metal for furniture; metal casters, hinges, non-electric locks, keys, rings of common metal for keys, reels, hoops, metal connections and connecting mechanisms for furniture; bells, church bells, small bells; tool handles made of metal; vehicle badges, metal numbers and letters, anchor irons for sea vehicles; door frames of metal; window frames of metal; ducts and pipes of metal for central heating installations, roof vents of metal for residential and commercial buildings, vent covers of metal, pipes, chimney cowls of metal; signs, non-luminous and non-mechanical, of metal; signaling panels, non-luminous and non-

mechanical, of metal; metal number plates; advertisement columns of metal; metal pallets for lifting, loading and transporting; containers, barrels, casks, tanks and depots for storing and transporting purposes; metal packaging materials, foils of metal for wrapping and packaging; pressure vessels, tubes of metal for LPG and gas transfer; metal pipes for liquid and gas transfer; drilling pipes; junctions of metal for pipes, flanges, T-connections, nipples, sleeves, elbows, reductions; metal valves (except for machine or motor parts), metal money safes, safe deposit boxes; metal tool boxes, boxes of common metal, mailboxes, vice benches of metal, and floors of metal.

7 – Machines for the processing of wood, metal, glass and plastics, machine tools: lathes, milling cutters, smoothing planes, saws, emery machines, industrial grinding machines, cutting machines, plastic injection machines, screw cutting machines; glass working machines; stone working machines; machines for metal working; construction machines: dozers, buckets for earth moving machines, excavators, road construction and coating machines, drilling machines, rock drilling machines, loaders, sweeping machines; rolling machines, molding machines, rolling cylinders; lifting and transferring machines: elevators for humans and for loads, mobile elevating work platforms, mobile lifting work platforms, loading platforms, lifts, cranes, elevators; milking machines, butter machines, cream/milk separators, incubators and incubators for eggs; agricultural instruments and machines: machine or motor operated agricultural instruments, agricultural machines, combine harvester-threshers, harvester-binders, ploughs, one-ways, baling machines, motor grass mowers, fertilizer spreading machines; power-operated sprayers for soil-sterilizing preparations; insecticide sprayers (machines); motors and propulsion mechanisms other than for land vehicles; jet engines other than for land vehicles, sealing joints (parts of engines), joints, gears, transmission chains and shafts, transmission shaft bearings, milling cutters (machine tools), pressure reducers as parts of machine and motor, pressure regulators, pressure valves; hydraulic and pneumatic controls, rollers, ball-bearings, motor pistons and jackets, speed reducing mechanisms, drive mechanisms, torque converters, coaster brakes, clutches, universal joints (Cardan joints), turbines; brake equipments and parts, brakes, brake linings and shoes; starters, dynamos, bicycle dyna-

mos, sparking plugs, igniters, injectors; exhausts, exhaust installations, silencers; belts used in engines and motors, V belts, dynamo belts, conveyor belts; bearings, ball and cop bearings; carburetors, feeders for carburetors; fuel economizers for motors, fuel conversion equipment for internal combustion engines (LPG conversion equipment); radiators for vehicles (motor coolers), fans, oil, fuel and air filters for engines and motors; hydraulic and pneumatic cylinders (pistons) other than those as motor parts, cylinder heads, electric motors (other than those for land transportation vehicles); wheel removing and mounting machines, alternators, generators, electricity generators, generators driven by solar energy, painting machines, paint injection guns, electric staple machines and guns, electric adhesive guns, pressured air or liquid atomizers (guns) for machines, electric hand drills; power-operated saws, hand-held, cutting machines, spiral binding machines for industrial use; robots used in manufacture, hair clipping machines for animals, air compressors, compressors; welding machines: electric welding machines, welding machines, electric, welding apparatus, gas-operated, printing machines and parts thereof, metal cutting machines, machining centers for metal working; packaging machines, filling-plugging and closing machines, labeling machines, sorting machines for industry; machines for the production of leather and fabric goods: sewing machines, embroidering machines, overlocking machines, buttonhole opening and sewing machines, cutting machines; textile machines: balers for industrial use, threshing-beating machines, carding machines, yarn twisting machines, weaving looms; pumps other than machine or motor parts: hydrophores, water pumps (electro pumps, motor pumps), diving pumps, pumps for heating installations; pumps as machine or motor parts (liquid and gas pumps), electric apparatus used in the kitchen for chopping, grinding, crushing, mixing and crumbling: mixers, blenders, kitchen robots, electric knives, meat-grinding machines, garbage disposal machines; dishwashers, washing machines and spin dryers, electrical or motor-operated floor polishing machines; electric vacuum cleaners and electric carpet washing machines and their bags, hoses and parts thereof; casting machines and parts thereof, converters for steel works, oil refining machines; vehicle washing machines, automatic dough kneading machines, dough-forming machines, conveyors (machines); dough cutting machines; separators; filtering machines; sorting machines for industry; sieving machines, electromagnetic machines (separating-sorting), blowing machines or fans for the compression, sucking and carrying of grain, vibrators (machines) for industrial use; hoppers (mechanical discharging); milling machines, grain processing machines, grain husking machines, bran brush machines, unpeeling and separating machines; sieves [machines or parts

of machines]; filters [parts of machines or engines]; starters for motor engines.

9 – Scientific, nautical, surveying, photographic, cinematographic, optical and measuring apparatus and instruments; laboratory apparatus and instruments; meteorological instruments; measuring devices, electric; material testing apparatus and instruments; barometers, ammeters, gas testing apparatus, sliding apparatus for measurement of thickness, humidity measuring apparatus, thermometers (air temperature measuring apparatus), voltmeters, microscopes, magnifying glasses, telescopes, periscopes; laboratory apparatus and instruments (test tubes, scales and other laboratory apparatus and instruments), laboratory experiment ovens and furniture especially made for laboratories; illuminated ads, illuminated ad billboards, illuminated sliding ads; apparatus for recording, transmission or reproduction of sound and images other than communication devices: radios, televisions, video players, video cameras, audio devices and parts thereof, amusement apparatus adapted for use with television receivers, cinematographic devices, remote control instruments, headphones, speakers, megaphones, diaphones, intercoms, picture and slide projection devices, data processing apparatus: computers, computer software and hardware; printers, laser printers, scanners, cash registers, calculators, barcode readers and parts and accessories thereof; navigation apparatus for vehicles in the nature of on-board computers; magnetic and optic record carriers: records, cassettes, discs, diskettes, CDs, exposed cinema films; all kinds of photograph machines, parts and accessories for photograph machines, magnifying devices; exposed films: cinema films ready for filming, photography films, X-ray films; antennas, satellite antennas, amplifiers and parts thereof; electric apparatus for remote ignition, automatic vending machines and mechanisms for coin, token or card operated apparatus: automatic vending machines, photographic machines and apparatus; picture projectors, ticket automates, electronic weighing scales, cash machines; electronic elements used in electronic apparatus: semi-conductors, electronic circuits, integrated circuits, chips, photocells, diodes, transistors, circuit cards, crystal oscillators, condensers, interface circuits, liquid crystal indicators, hybrid circuits, thermistors (heat sensors), converters, magnetic heads, magnetic deviators; telecommunication devices: telephones, faxes, facsimiles, telexes, telegraph machines, wireless telephones, telephone stations; electric copying and reproduction machines, photocopy machines, blue printing machines; counters: electric counters, water meters, gas meters, gas pumps for service stations (automatic), parking meters, timers, egg cooking timers (timers, hourglasses); integrated circuit cards and magnetically encoded cards, including pre-paid telephone calling cards, key cards; weighing apparatus and



devices: balances, weighing machines, weighing scales; detectors, display devices, X-ray apparatus not for medical purposes, radiological devices (X-ray) for industrial purposes; life saving and protecting equipments: life vests, swimming belts, water wings, respiratory devices for divers, diving suits, diving goggles; life belts, life nets; protective clothing, gloves and caps (helmets), signaling whistles and lanterns, signaling buoys; spectacle glasses and sun glasses and lenses, boxes, cases, parts and accessories therefor; electric plugs, electric sockets, electrical distribution boxes, electrical switches, switches, breakers, circuit breakers and disconnectors, fuses, ballasts, control panels (electricity), elevator control panels, electric connection pieces, electric cables, cable channels, push buttons, resistors, connection elements used for electric and electronic purposes, namely connectors and sockets; apparatus and instruments for conducting, switching, transforming, accumulating, regulating or controlling electricity; adapters; charging appliances for rechargeable equipment; electric bells, alarms other than vehicle alarms, sirens; cables, wires: all kinds of cables and wires used for electric and electronic purposes and for telephone lines, fiber optics, optical fibers, fiber optic cables, electrical power supplies; accumulators, solar batteries, electrical cells, batteries, uninterrupted power supplies; electric irons; electric irons and steam irons, press irons; indicators for vehicles: velocity, oil, fuel and heat indicators, tachometers, taximeters; rods (surveying instruments); vehicle breakdown warning triangles, illuminated and mechanical road indicators, electric-electronic or mechanically operated traffic signalization equipment, traffic-light apparatus (signalling devices), reflectors for traffic signal, fire engines, fire-extinguishing apparatus and devices; electrical welding apparatus; electric soldering coppers, electric welding torches, welding electrodes; radars, submarine sonars, night vision providing and increasing devices and apparatus; lightning arresters, static grounding systems and apparatus, set squares, water scales, measuring tapes, foldable meters, tape measures, plumb rules; dosage regulators; electric hair curlers, hair rollers; electric devices for destroying and repelling flies and insects; electric door openers and closers, electric or electronic door opening-closing installations for buildings; satellites for scientific purposes, apparatus for electrolysis and computers and televisions; anodes, cathodes; screen filters for computers and televisions; remote control opening-closing mechanisms for vehicle doors; magnets, decorative magnets; ear plugs; strength testing machines.

(260) AM 2014 70539 A  
(800) 724225  
(151) 1999 12 02  
(891) 2012 09 13  
(731) LABORATOIRE NUXE  
19 rue Péclet, F-75015 PARIS, France  
(540)

## PRODIGIEUSE

(591) Black, white  
(511)  
3 – Soaps; perfumery, essential oils, cosmetics, hair lotions.

(260) AM 2014 70639 A  
(800) 790510  
(151) 2002 07 05  
(891) 2012 11 05  
(731) EIDMINAS KASPAREVIČIUS  
Statybininkų g. 25, Garliava, Kauno r.,  
Lithuania  
(540)



(591) Blue, black, grey, white CMYK 100:0:0:0 (Cyan); CMYK 0:0:0:100 (black)  
(511)  
7 – Filters for cleaning cooling air (for engines); filters (parts of machines or engines).

(260) AM 2014 70640 A  
(800) 885211  
(151) 2006 03 31  
(891) 2012 10 05  
(731) Blagoi Dimitrov Bonev  
j.k. "Mladost 1", bl.15, vh.1, BG-1784  
SOFIA, Bulgaria;  
Anna Stoyanova TSANKOVA  
j.k. "Yavorov", bloc 4, vhod 1 BG-1124  
SOFIA, Bulgaria  
(540)

## MAJESTIC

(591) Black, white  
(511)  
34 – Cigarettes; tobacco; smokers' articles; matches.

(260) AM 2014 70657 A  
 (800) 1021490  
 (151) 2009 10 05  
 (891) 2012 12 17  
 (731) Obschestvo s ogranichennoy otvetstvennostyu  
 "Masloekstraktsionniy zavod Yug Rusi"  
 Tolstogo sq., 8, RU-344037 Rostov-on-Don,  
 Russian Federation

(540)



(591) Blue, sky-blue, yellow, red, brown and white  
 (511)  
 29 – Sunflower oil for food.

(260) AM 2014 70862 A  
 (800) 1146119  
 (151) 2012 12 13  
 (731) Henkel AG & Co. KGaA  
 Henkelstraße 67, 40589 Düsseldorf, Germany

(540)

## ROUGH RUBBER

(591) Black, white  
 (511)  
 3 – Preparations for the conditioning, cleaning, tinting, dyeing, bleaching, fixing and waving of hair, hair lotions and shampoos for cosmetic purposes.

(260) AM 2014 70875 A  
 (800) 1146317  
 (151) 2012 12 03  
 (731) OJSC SIBUR Holding  
 liter A, 5, ul. Galernaya, RU-190000  
 St. Petersburg, Russian Federation

(540)

## VEALAST

(591) Black, white  
 (511)  
 17 – Liquid rubber; synthetic rubber; rubber, raw or semi-worked; latex [rubber]; weatherstripping compositions; insulating materials; rubber material for recapping tires [tyres]; rubber solutions.  
 35 – Commercial information and advice for consumers [consumer advice shop]; distribution of samples; commercial administration of the licensing of the goods and services of others.  
 42 – Material testing; mechanical research; chemical research; research and development for others; chemistry services.

(260) AM 2014 71108 A  
 (800) 1148057  
 (151) 2012 12 21  
 (731) Japan Tobacco Inc.  
 2-2-1 Toranomom, Minato-ku, Tokyo, Japan

(540)

## H2O

(591) Black, white  
 (511)  
 34 – Tobacco, raw or manufactured; smoking tobacco, pipe tobacco, rolling tobacco, chewing tobacco, moist tobacco powder called "snus"; cigarettes, cigars, cigarillos; smoking substances sold separately or blended with tobacco for non-medical and non-therapeutic purposes; snuff; smokers' articles included in this class; cigarette paper, cigarette tubes and matches.

(260) AM 2014 71120 A  
 (800) 1148170  
 (151) 2012 12 24  
 (731) XINGQUAN (FUJIAN) SHOES PLASTICS  
 CO., LTD.  
 Houyang Gongyequ, Yanshang, Chendai  
 Zhen, Jinjiang, FUJIAN, China

(540)



(591) Black, white  
 (511)  
 25 – Clothing; ski boots; hats; mountain climbing shoes; leather belts for clothing; gloves (clothing); football shoes.

(260) AM 2014 71458 A  
 (800) 1151136  
 (151) 2013 01 15  
 (731) Astellas Pharma Inc.  
 5-1, Nihonbashi-Honcho 2-chome, Chuo-ku,  
 Tokyo 103-8411, Japan

(540)



(591) Yellow  
 (511)  
 5 – Pharmaceutical preparations and substances.

(260) AM 2014 71472 A

(800) 1151191

(151) 2012 11 07

(731) NEXTDOR.COM, INC.

101 Spear Street, suite 230, SAN  
FRANCISCO CA 94105, USA

(540)

**NEXTDOR**

(591) Black, white

(511)

9 – Computer software, namely, computer software for creating private networks and communities; computer software providing a communications platform enabling users to create private networks and online communities based on geographic locations; software to enable uploading, posting, showing, displaying, tagging, blogging, sharing or otherwise providing electronic media or information over the internet or other communications network; computer software development tools for social networking, building social networking applications and for allowing data retrieval, upload, access and management; computer software application programming interface (API) for third-party software and online services for social networking, building social networking applications and for allowing data retrieval, upload, access and management.

35 – Advertising services; advertising and information distribution services, namely, providing classified advertising space via the global computer network; promoting the goods and services of others over the internet; providing on-line computer databases and on-line searchable databases in the field of classifieds; online service for connecting social network users with retailers for the purpose of facilitating discounted purchases.

38 – Electronic transmission of instant messages and data; chat room services for social networking; providing on-line chat rooms for social networking; providing online chat rooms and electronic bulletin boards for registered users for transmission of messages concerning local communities, news, and events, topics of general interest, classifieds, virtual community, social networking, photo sharing, and transmission of photographic images; provision of on-line forums for the transmission of photographic images and audio/video content; provision of on-line forums for communications on topics of general interest; providing access to computer databases featuring pre-populated and user-generated information related to topics of general interest.

42 – Computer services, namely, online non-downloadable software which allows users to create online communities related to shared geographic boundaries, common interests, and local events and activities; computer services, namely, creating an online community; computer services, namely, hosting

online web facilities for others for organizing and conducting online meetings, gatherings, and interactive discussions; computer services in the nature of customized web pages featuring user-defined information, personal profiles and information; computer services, namely, creating an on-line community for registered users to participate in discussions, get feedback from their peers, form virtual communities, and engage in social networking; providing a website that gives users the ability to review various print, photographic, graphic image, and audio and video content and utilize a custom template to provide input, likes, dislikes, edits, changes, modifications, opinions, suggestions, and comments and engage in social and community networking; providing temporary use of non-downloadable software applications for classifieds, virtual community, social networking, photo sharing, and transmission of photographic images; computer services, namely, providing search platforms to allow users to request content from and receive content to a mobile device; providing customized on-line web pages featuring user-defined information, which includes blog posts, new media content, other on-line content, and on-line web links to other websites.

45 – Hosting an online community website featuring shared communications between community members; internet based introduction and social networking services; providing on-line computer databases and on-line searchable databases in the field of social, community and local networking.

(260) AM 2014 71473 A

(800) 1151199

(151) 2012 07 13

(731) Society with limited liability "AYAN"

M. Gashgay str., 7, Nasimi district, AZ-1000  
Baku, Azerbaijan

(540)

**ЗОЛОТОЙ КОЛОДЕЦ**  
**QIZIL QUYU**

(591) Black, white

(511)

32 – Beers; mineral and aerated waters and other non-alcoholic drinks; fruit drinks and fruit juices; syrups and other preparations for making beverages.

(260) AM 2014 71474 A  
 (800) 1151210  
 (151) 2012 07 30  
 (731) WORLD MEDICINE İLAÇLARI LİMİTED  
 ŞİRKETİ  
 Evren Mah., Camiyolu Cad. No.50 K.2,  
 GÜNEŞLİ/BAĞCILAR/İSTANBUL, Turkey  
 (540)

## VANCOMED

(591) Black, white  
 (511)  
 5 – Medicines for human purposes, medicines for veterinary purposes, chemical preparations for medical purposes, dietetic substances adapted for medical use; dietetic foods adapted for medical purposes; baby foods, medicinal herbs, herbal beverages adapted for medical purposes; medicines for dental purposes, hygienic products for medical purposes including pads, waddings for medical purposes, plasters for medical purposes, dressings for medical purposes, preparations for destroying noxious plants, preparations for destroying noxious animals, fungicides, deodorants other than for human beings or for animals, disinfectants for hygiene purposes, antiseptics, detergents for medical purposes.

(260) AM 2014 71475 A  
 (800) 1151211  
 (151) 2012 07 30  
 (731) WORLD MEDICINE İLAÇLARI LİMİTED  
 ŞİRKETİ  
 Evren Mah., Camiyolu Cad. No.50 K.2,  
 GÜNEŞLİ/BAĞCILAR/İSTANBUL, Turkey  
 (540)

## GALARA

(591) Black, white  
 (511)  
 5 – Medicines for human purposes, medicines for veterinary purposes, chemical preparations for medical purposes, dietetic substances adapted for medical use; dietetic foods adapted for medical purposes; baby foods, medicinal herbs, herbal beverages adapted for medical purposes; medicines for dental purposes, hygienic products for medical purposes including pads, waddings for medical purposes, plasters for medical purposes, dressings for medical purposes, preparations for destroying noxious plants, preparations for destroying noxious animals, fungicides, deodorants other than for human beings or for animals, disinfectants for hygiene purposes, antiseptics, detergents for medical purposes.

(260) AM 2014 71476 A  
 (800) 1151212  
 (151) 2012 07 30  
 (731) WORLD MEDICINE İLAÇLARI LİMİTED  
 ŞİRKETİ  
 Evren Mah., Camiyolu Cad. No.50 K.2,  
 GÜNEŞLİ/BAĞCILAR/İSTANBUL, Turkey  
 (540)

## Terbinorm

(591) Black, white  
 (511)  
 5 – Medicines for human purposes, medicines for veterinary purposes, chemical preparations for medical purposes, dietetic substances adapted for medical use; dietetic foods adapted for medical purposes; baby foods, medicinal herbs, herbal beverages adapted for medical purposes; medicines for dental purposes, hygienic products for medical purposes including pads, waddings for medical purposes, plasters for medical purposes, dressings for medical purposes, preparations for destroying noxious plants, preparations for destroying noxious animals, fungicides, deodorants other than for human beings or for animals, disinfectants for hygiene purposes, antiseptics, detergents for medical purposes.

(260) AM 2014 71477 A  
 (800) 1151226  
 (151) 2012 10 30  
 (731) Apple Inc.  
 1 Infinite Loop, Cupertino, CA 95014, USA  
 (540)



(591) Black, green, yellow and blue  
 (511)  
 9 – Software related to handheld digital devices; electronic and encoded gift cards; computer software; computer software for personal information management, and data synchronization software.

(260) AM 2014 71478 A  
 (800) 1151232  
 (151) 2012 10 26  
 (731) Abstragan Holding Limited  
 Intershore Suites Vernon House, Sicilian  
 Avenue, London WC1A 2QS, United  
 Kingdom

(540)

**ALCORECT**  
**AJKOPEKT**

(591) Black, white

(511)

5 – Pharmaceutical and veterinary preparations, excluding preparations for the treatment of alcoholism; sanitary preparations for medical purposes, excluding preparations for the treatment of alcoholism; dietetic substances adapted for medical use, excluding preparations for the treatment of alcoholism; food for babies; plasters, materials for dressings; material for stopping teeth, dental wax; disinfectants; preparations for destroying vermin; fungicides, herbicides; foods and beverages which are adapted for medical purposes, excluding preparations for the treatment of alcoholism; air deodorising preparations.

(260) AM 2014 71480 A  
 (800) 1151243  
 (151) 2012 11 13  
 (731) Signum International S.à.r.l. Luxembourg,  
 Luzern Branch  
 Haldenstrasse 4, CH-6006 Luzern,  
 Switzerland

(540)



(591) Black, white

(511)

39 – Passenger transport; booking of seats for travel; services provided by a travel guide and a tour guide, organization of outings, organization of trips and excursions, organization of cruises, reservation services, provision of information on travel and excursion destinations; organization of traveler transport.

41 – Provision of language training sessions, language proficiency examinations; provision of information on language teaching on a global computer network; computer-aided language education, teaching and training; on-line publication of teaching tools; organization of educational trips and exchange programs for students and teachers.

(260) AM 2014 71481 A  
 (800) 1151249  
 (151) 2012 12 24  
 (731) Zhejiang Huabang Machinery Co., Ltd.  
 Auto & Motor Industrial Zone, Yuhuan  
 County, 317600 Zhejiang Province, China

(540)



(591) Black, white

(511)

12 – Vehicle chassis; motorcycles; hydraulic circuits for vehicles; clutches for land vehicles; automobile shock absorbers; vehicle running boards; torque converters for land vehicles.

(260) AM 2014 71482 A  
 (800) 1151274  
 (151) 2012 11 19  
 (731) OĞUZCANLAR MAKİNA VE MOTOR  
 SANAYİ TİC. LTD. STİ.  
 Organize Sanayi Bölgesi, KARAMAN,  
 Turkey

(540)



(591) Green and orange

(511)

20 – Furniture, non-metal furniture casters, non-metal furniture fittings, furniture of metal, office furniture, partitions of wood for furniture, furniture shelves, mirrors, picture frames; goods (not included in other classes) of wood and substitutes for all these materials, or of plastics.

(260) AM 2014 71483 A  
 (800) 1151297  
 (151) 2013 01 15  
 (731) August Storck KG  
 Waldstrasse 27, 13403 Berlin, Germany

(540)



(591) Light brown, dark brown, green and white

(511)  
30 – Confectionery, chocolate, chocolate goods, pastries, preparations for making the aforementioned products, included in this class.

(260) AM 2014 71484 A

(800) 1151308

(151) 2013 01 22

(731) Tovarystvo z Obmezhenoiu Vidpovidalnistiu "Aromat"  
vul. Prymakova, 46, Kharkiv 61004, Ukraine

(540)



(591) Black, white

(511)

3 – Soap; perfumes; essential oils; cosmetics; hair lotions, dentifrices, breath freshening sprays, alum stones (astringents); amber (perfume); colorants for toilet purposes; bergamot oil, joss sticks, badian essence, beard dyes; shaving soap; shaving preparations, eyebrow cosmetics, eyebrow pencils, petroleum jelly for cosmetic purposes; cosmetic preparations for baths; bath salts, not for medical purposes; skin whitening creams; bleaching salts; dental bleaching gels; bleaching preparations (decolorants) for cosmetic purposes, decorative transfers for cosmetic purposes; cosmetic preparations for eyelashes; hair colorants; depilatory preparations; hair waving preparations; mustache wax; heliotropine, make-up; make-up removing preparations; make-up preparations; lipsticks; disinfectant soap, deodorants for human beings or for animals; deodorant soap; depilatory wax; scented water, extracts of flowers (perfumes), ethereal essences, greases for cosmetic purposes; aromatics (essential oils), bases for flower perfumes; essential oils of cedarwood; adhesives for cosmetic purposes; cosmetics for animals, make-up powder, beauty masks, cosmetic kits; cosmetic preparations for slimming purposes, tailors' wax, cosmetic creams, lavender water; lavender oil; hair spray; nail polish; essential oils of lemon, polishing wax, polishing preparations, medicated soap; lotions for cosmetic purposes; tissues impregnated with cosmetic lotions; after-shave lotions; almond oil; almond soap, almond milk for cosmetic purposes, detergents other than for use in manufacturing operations and for medical purposes; bleaching preparations (laundry); cakes of toilet soap, soap for foot perspiration; antiperspirant soap; cleansing milk for toilet purposes; musk (perfumery); mint for perfumery; mint essence (essential oil); flavorings (flavourings) for beverages (essential oils), ammonia (volatile alkali) (detergent); neutralizers for permanent waving, nail varnish, nail care preparations, fumigation preparations (perfumes); eau de cologne, cosmetic pencils; oils for perfumes and scents; oils for cosmetic purposes; oils for toilet purposes; oils

for cleaning purposes; oil of turpentine for degreasing; perfumery; hydrogen peroxide for cosmetic purposes; varnish-removing preparations; mouth washes, not for medical purposes; pomades for cosmetic purposes; antiperspirants (toiletries), leather preservatives (polishes); sachets for perfuming linen; turpentine, for degreasing; sun-tanning preparations (cosmetics); sunscreen preparations; pot-pourris (fragrances), talcum powder, for toilet use, cotton sticks for cosmetic purposes; terpenes (essential oils); cake flavourings (essential oils); rose oil, toiletries, toilet water; mascara; paint stripping preparations; hair dyes; cosmetic dyes; cleaning preparations; scouring solutions; preparations for cleaning dentures; shampoos; shampoos for pets; cosmetic preparations for skin care; creams for leather; false eyelashes; false nails.

(260) AM 2014 71485 A

(800) 1151332

(151) 2012 06 20

(731) NLSTAR LIMITED

Arch. Makariou III, 227 Doma Building, 3<sup>rd</sup>  
Floor, CY-3105 Limassol, Cyprus

(540)



(591) Black, white

(511)

3 – Soaps, perfumery, perfumes, eau de toilette, eau de parfum, scented waters, deodorants for personal use (perfumery), essential oils, oils for toilet purposes, cosmetics, cosmetic kits, cosmetic preparations for skincare, cosmetic creams, cosmetic milks, lotions for cosmetic purposes, cosmetic powders, cosmetic preparations for slimming purposes, tissues impregnated with cosmetic lotions, skin-tanning preparations (cosmetics), make-up preparations and make-up removing preparations, beauty creams, cleansing milk, beauty masks, creams and lotions for the face and body, cosmetic preparations for the bath, bath salts, not for medical purposes, oils for cosmetic purposes, shampoos, hair lotions, lotions for cosmetic purposes, aftershave preparations, shaving preparations, shaving soap, blusher, make-up powder, lipsticks, cosmetic preparations for the lips, mascara, cosmetic pencils.

5 – Sanitary preparations, dietetic substances adapted for medical use, dietetic foods for medical purposes, biological preparations for medical purposes, dietetic beverages for medical purposes, medicated confectionery, chemico-pharmaceutical preparations, chemical preparations for medical purposes, chemical preparations for pharmaceutical purposes, food supplements and substitutes for medical purposes, decoctions for pharmaceutical purposes, elixirs (pharmaceutical preparations), edible plant

fibres (non nutritive), smoking herbs for medical purposes, chewing gum for medical purposes, gum for medical purposes, medicinal herbs, medicinal oils, medicinal infusions, lotions for pharmaceutical purposes, medicines for human purposes, mineral water for medical purposes, narcotics, preparations of trace elements for human use, ointments for pharmaceutical purposes, medicinal drinks, medicinal roots, tonics (medicines), remedies for human purposes, tranquillizers, serums, syrups for pharmaceutical purposes, soporifics, sugar for medical purposes, mineral food supplements, medicinal tea, herbal teas, vitamin and mineral preparations, glycerine for medical purposes; dietetic foods, food supplements and meal replacements, not for medical purposes, in particular in the form of powders, made from meat, fish, poultry and game.

29 – Meat, fish, poultry and game, preserved, dried, cooked, dehydrated or freeze-dried meat, fish, poultry and game, preserved, dried, cooked, dehydrated or freeze-dried meat, fish, poultry and game extracts, preserved, dried, cooked, dehydrated or freeze-dried fruits and vegetables, jellies, jams, compotes, eggs, milk, milk products, edible oils and fats, weed extracts for food, ground almonds, processed peanuts, butter, milk beverages (milk predominating), bouillon, preparations for making bouillon, preserved mushrooms, desiccated coconut, bouillon concentrates, crystallised fruits, soups, cream (dairy products), fruit peel, preserved beans, cheese, gelatine for food, fruit jellies, fruit pulp, jellies for food, preserved soya beans for food, vegetable juices for cooking, whey, margarine, marmalade, prepared nuts, nut oils (food), preserved olives, fish (not live), pickles, pollen prepared as foodstuff, protein for human consumption, nutritive vegetable fibre for human consumption; raisins, salted meats, sausages, tofu, yoghurt; prepared meals and dishes of meat, fish, poultry, preserved, dried, cooked fruits; preserved dried, cooked vegetables; eggs, milk and milk products; canned fruits, vegetable preserves, fish preserves, meat preserves and soups; meat, fish, poultry and game extracts, preserved, dried, cooked, dehydrated or freeze-dried fruits and vegetables, fruit extracts, vegetable extracts for human consumption, vitamins, minerals, protein for human consumption, vegetable fibre for human consumption, jellies, eggs, milk, milk products, edible oils and fats, weed extracts for food, preserved peanuts, butter, preserved mushrooms, bouillon concentrates, crystallised fruits, crystallised fruits, fruit peel, preserved beans, gelatine for food, fruit pulp, preserved soya beans for food, vegetable juices for cooking, whey, margarine, fish (not live), pollen prepared as foodstuff, salted meats, tofu; cooked dishes and dietetic foodstuffs, not adapted for medical purposes, made from meat, fish, poultry, fruits, vegetables, eggs, milk and milk products.

30 – Flour and preparations made from cereals, salt, vinegar, spices, weeds (condiment), ices, pasta, almond confectionery, almond paste, starch for food, starch for foods, peanut confectionery, flavourings, other than essential oils, flavourings for cakes, other than essential oils, aromatic preparations for food, seasonings, oat-based food, oat flakes, stick liquorice (confectionery), flavourings, other than essential oils, for beverages, cocoa products, coffee, coffee flavourings, vegetal preparations for use as coffee substitutes, unroasted coffee, chips (cereal products), chicory (coffee substitute), cocoa, chocolate, condiments, confectionery, couscous (semolina), ice cream, natural sweeteners, thickening agents for cooking, essences for foodstuffs (except etheric essences and essential oils), malt extract for food, starch for food, ferments for pastes, bean meal, wheat flour, farinaceous foods, corn flakes, royal jelly for human consumption (not for medical purposes), glucose for food, sweetmeats (candy), chewing gum, not for medical purposes, lozenges (confectionery), fruit jellies (confectionery), gruel, with a milk base, for food, puddings, gluten for food, groats for human food, leaven, yeast, corn flour, roasted corn, popcorn, malt extract for food, malt for food, mayonnaise, molasses for food, treacle, infusions, not medicinal, honey, bread, unleavened bread, gingerbread, crackers, flour-milling products, mustard, noodles, barley meal, corn flakes, pepper, potato flour for food, cake powder, pralines, bee glue (propolis) for human consumption, liquorice (confectionery), rice, sauces (condiments), semolina, soya flour, sherbets (ices), sugar, candy for food, tapioca, tapioca flour for food, lea, frozen yoghurt (confectionery ices), rusks, biscuits, cocoa, coffee and chocolate-based beverages, garden herbs, preserved; cooked dishes and meals with a base of flour, cooked dishes and meals with a base of cereals; preparations made from cereals, pasta, rice, cocoa, chocolate, coffee or tea; dietetic foods, food supplements and meal replacements, not for medical purposes (in particular in the form of powders), made from flour and preparations made from cereals, cereal products, salt, vinegar, spices, weeds (condiment), paste, starch products for foods, flavorings, other than essential oils, aromatic preparations for food, seasonings, cocoa products, coffee, coffee flavourings, vegetal preparations for use as coffee substitutes, unroasted coffee, chicory (coffee substitute), cocoa, chocolate, condiments, confectionery, couscous (semolina), natural sweeteners, thickening agents for cooking, essences for foodstuffs (except etheric essences and essential oils), malt extract for food, starch for food, ferments for pastes, royal jelly for human consumption (not for medical purposes), glucose for food, gluten for food, groats for human food, leaven, yeast, corn (flour), malt extract for food, malt for food, molasses for food, honey, bread, flour-milling products, mustard, pepper, cake pow-

der, bee glue (propolis) for human consumption, rice, sauces (condiments), semolina, sugar, candy for food, tapioca, tea; cooked dishes and dietetic food-stuffs, not adapted for medical purposes, made from flour, cereals, preparations made from cereals, pasta, rice, cocoa, chocolate, cafe or tea; preserved garden herbs.

32 – Beers, mineral and aerated waters and other non-alcoholic drinks, fruit drinks and fruit juices, syrups and other preparations for making beverages, non-alcoholic aperitifs, essences for making beverages, pastilles for effervescing beverages, powders for beverages, isotonic drinks, syrup for beverages, non-alcoholic cocktails, table waters, preparations for making aerated water, non-alcoholic fruit extracts, vegetable juices (beverages), soda water, sorbets (beverages); dietetic beverages, not for medical purposes, made from cocoa, coffee and chocolate, dietetic rusks, not for medical purposes, dietetic biscuits, not for medical purposes, dietetic beverages not adapted for medical purposes; non alcoholic fruits extracts, non alcoholic vegetable extracts for human consumption.

---

(260) AM 2014 71499 A  
 (800) 1151364  
 (151) 2012 12 20  
 (731) ANONYMOS ETAIRIA TSIMENTON  
 TITAN.  
 22A Halkidos & Doxara Str., GR-111 43  
 ATHENS, Greece  
 (540)



(591) Blue  
 (511)  
 8 – Articles of cutlery; knives; forks; spoons; hand tools and instruments (hand operated).

---

(260) AM 2014 71500 A  
 (800) 1151418  
 (151) 2012 12 19  
 (731) Unitary Enterprise "Green plant"  
 Komnata No. 19, administrativnoe  
 pomeshchenie Pyatnitskogo A.L., rayon  
 derevni Uglyany, 223045 Minskiy rayon,  
 Minskaya oblast, Belarus  
 (540)

**Грин плант**

(591) Black, white  
 (511)  
 19 – Door casings, not of metal; beams, not of metal; joists, not of metal; doors, not of metal;

folding doors, not of metal; wood for making household utensils; veneer wood; moldable wood; framework, not of metal, for building; cornices, not of metal; buildings, not of metal; manufactured timber; sawn timber; wood, semi-worked; moldings, not of metal, for cornices; moldings, not of metal, for building; wood panelling; partitions, not of metal; lintels, not of metal; planks [wood for building]; tarred strips, for building; door panels, not of metal; sills, not of metal; scantlings [carpentry]; wood veneers.

20 – Wood ribbon; door fittings, not of metal.

35 – Demonstration of goods; commercial information and advice for consumers [consumer advice shop]; professional business consultancy; presentation of goods on communication media, for retail purposes; sales promotion for others; distribution of samples; dissemination of advertising matter.

---

(260) AM 2014 71501 A  
 (800) 1151432  
 (151) 2013 02 08  
 (731) EGIS GYÓGYSZERGYÁR Nyilvánosan  
 Működő Részvénytársaság  
 Kereszturi út 30-38, H-1106 Budapest,  
 Hungary  
 (540)

**LYNSPRO**

(591) Black, white  
 (511)  
 5 – Pharmaceutical preparations for human use.

---

(260) AM 2014 71502 A  
 (800) 1151434  
 (151) 2013 01 11  
 (731) Ferring B.V.  
 Polarisavenue 144, NL-2132 JX  
 HOOFFDORP, Netherlands  
 (540)

**PREPOPIK**

(591) Black, white  
 (511)  
 5 – Pharmaceutical preparations and substances.



- (260) AM 2014 71520 A  
 (800) 1127623  
 (151) 2012 05 16  
 (891) 2013 01 28  
 (731) Rita's Water Ice Franchise Company, LLC  
 1210 Northbrook Drive, Suite 310, Trevose  
 PA 19053, USA  
 (540)



- (591) Red, green, white and blue  
 (511)  
 30 – Frozen confections; flavored water ices; frozen custards.  
 35 – Retail store services featuring Italian ice, frozen custard and other frozen confections, for consumption on and off the premises; restaurant franchising, namely, offering business management assistance in the establishment and operation of restaurants.

- (260) AM 2014 72031 A  
 (800) 1154902  
 (151) 2012 08 22  
 (731) English Tea Shop (UK) Ltd  
 Suite G7-G8, Davina House, 137-149 Goswell  
 Road, London EC1V 7ET, United Kingdom  
 (540)



- (591) Black, white  
 (511)  
 30 – Flavourings for beverages, other than essential oils; beverages made from or containing tea; beverages made from or containing chocolate; beverages made from or containing cocoa; beverages made from or containing coffee; herbal preparations for making beverages; beverages made from or containing infusions; infusions; tea; instant tea; tea beverages; tea-flavoured beverages; iced tea; packaged tea; tea bags; tea leaves; tea products; tea substitutes; preparations for making tea or tea based drinks; tea extracts; tea essences; aromatic teas; herbal teas; herb tea (infusions); flavourings for tea; fruit and herbal flavoured tea; coffee; coffee essences; coffee extracts; artificial coffee; coffee preparations; drinks containing coffee; coffee substitutes; coffee-based beverages; cocoa; drinking chocolate; cocoa products; cocoa powder preparations for making chocolate or cocoa based drinks; sugar; bread; bread products; bakery products; pastry; pastries; ca-

kes; scones; tarts; tea cakes; pancakes; biscuits shortbread; gingerbread; cookies; prepared meals; puddings; snack food products; sandwiches; confectionery; chocolate; chocolate products; ice cream; ice cream confections; ices; water ices and frozen confections; aromatic preparations for food; carbonated tea.

32 – Mineral and aerated waters and other non-alcoholic drinks; fruit drinks and fruit juices; syrups and other preparations for making beverages; infusions for making beverages; carbonated drinks; fruit beverages; tisanes; herbal beverages; non-alcoholic beverages.

- (260) AM 2014 72044 A  
 (800) 1155110  
 (151) 2012 10 31  
 (731) Modern Times Group MTG AB  
 Box 2094, SE-103 13 Stockholm, Sweden  
 (540)

**like.tv**

- (591) Black, white  
 (511)  
 35 – Advertising and sales promotion services; business management; business consultancy; business management consultancy; business administration; rental of advertising space; provision of television advertising commercials, provision of radio advertising commercials and provision of mobile television advertising commercials; provision of advertising space/time for sponsors; rental of advertising space on the internet and via mobile telephones; production of filmed/graphic advertising material for use in marketing or sponsorship; provision of information, advisory and consultancy services relating to advertising and promotional services; provision of information, advisory and consultancy services relating to organization, operation and supervision of sales and promotional incentive schemes; provision of information, advisory and consultancy services relating to rental of advertising space, television advertising commercials, radio advertising commercials, mobile television advertising commercials, preparation and presentation of audio visual display for advertising purposes, dissemination of advertising matter and the arranging and conducting of trade shows and exhibitions; compilation of business statistics and commercial information; marketing studies; business planning, inspection, surveys and appraisal services; provision of business information; receipt, compilation of business statistics and commercial information, all relating to television, radio and satellite broadcasting; advisory and information services relating to the aforesaid.

38 – Transmission of audio, video and images by means of telecommunication devices including mobile telephones; cable, satellite and terrestrial

television broadcasting; television, internet and radio broadcasting; computer aided transmission of messages and images; satellite transmission; telecommunication; provision of information about telecommunication; rental of telecommunications, communications and broadcasting apparatus; provision of user access to telecommunication networks; provision of information about broadcasting via the Internet; professional consultancy services relating to television and radio broadcasting, transmission and communication services; provision of information, advisory and consultancy services relating to broadcasting and transmission of radio or television programs or computer aided transmission of messages and images; provision of information, advisory and consultancy services relating to communications services by satellite, television, mobile telephones and radio; provision of information, advisory and consultancy services relating to news agency services; provision of information, advisory and consultancy services relating to hiring, rental and leasing of communications apparatus and the provision of telecommunications links to computer databases and websites on the Internet; provision of information, advisory and consultancy services relating to telecommunications services dedicated to retailing goods through interactive communications with customers; provision of information, advisory and consultancy services relating to broadcasting and transmission of interactive television services; provision of information, advisory and consultancy services relating to broadcasting and transmission of interactive television, interactive entertainment and interactive competitions; provision of information services relating to the aforesaid; providing access to a photo and vide sharing portal.

41 – Amusement, education and entertainment services including television and radio entertainment; production and performing of shows, theatre and other amusement performances; film, radio and video production; provision of film studios; recording studio and recording studio services; production of radio and television programmes; information regarding amusement, education and entertainment services; rental of movies, videotapes, DVDs and radio and television programmes; provision of information, advisory and consultancy services relating to education and entertainment services; provision of information, advisory and consultancy services relating to education and entertainment provided on-line and/or via the Internet; provision of information, advisory and consultancy services relating to television and radio entertainment services; provision of information, advisory and consultancy services relating to entertainment and education services provided on-line and/or via an interactive television platform; provision of information, advisory and consultancy services relating to interactive games, interactive entertainment and interactive com-

petitions; provision of information, advisory and consultancy services relating to betting, gaming and gambling services; organization of conferences, lectures and symposiums relating to television and radio; provision of information, advisory and consultancy services relating to television viewing guide services; publication of electronic journals and web logs, electronic publishing services for others; providing entertainment information in the form of programme listings online; information services related to the aforesaid.

(260) AM 2014 72216 A

(800) 1156559

(151) 2013 01 15

(731) ARIAN TOOTOON SANAT COMPANY

No.29 Haghparast St., Sarafraz St. Dr.

Beheshti Ave. 1587693413 Tehran, Iran

(Islamic Republic of)

(540)

انیکس  
ONYX

(591) Black, white

(511)

34 – Cigarettes.

35 – Export agency services for cigarettes.

39 – Packaging services for cigarettes.

(260) AM 2014 72235 A

(800) 1156722

(151) 2012 11 28

(731) Wicom Germany GmbH

Liebigstr. 16, 64646 Heppenheim, Germany

(540)

**Carnegie Hero**

(591) Black, white

(511)

16 – Print matters (with the exception of print matters and newsletters in the field of financial services) in relation to fire protection, work protection, civil defense, emergency management and rescue from life-threatening situations.

35 – Business organization and managerial coordination of appeals for money; business advice, control and audit in respect of donation assignments; public relation services relating to charitable donations.

36 – Collection, financial administration and allocation of donations in relation to fire protection, work protection, civil defense, emergency management, rescue from life-threatening situations and promotion of international understanding.

41 – Conception, organization and holding of events for professional education, training courses, seminars, workshops, conventions and symposia; all before mentioned services in relation to fire protection, work protection, civil defense, emergency management and rescue from life-threatening situations; organization and holding of events, namely award ceremonies and decorations for life-savers, included in this class; arranging and conducting of educational seminars and workshops in the fields of fire protection, work protection, civil defense and emergency management.

42 – Scientific and technical research and consultancy in the fields of fire protection, work protection, civil defense and emergency management.

(260) AM 2014 72295 A

(800) 1157367

(151) 2013 02 12

(731) TELETRADE D.J. INTERNATIONAL  
CONSULTING LIMITED  
Commercial Center, 28 Shanghai Street,  
Kowloon, Hong Kong, China

(540)



(591) Blue and red

(511)

35 – Advertising; business management; business administration; office functions; advertising agency; opinion polling; business management and organization consultancy; compilation of information into computer databases; computerized file management; arranging newspaper subscriptions; newspaper and radio commercials; systemization and information into computer databases.

36 – Insurance; financial affairs; monetary affairs; real estate affairs; credit bureau; real estate agencies; real estate affairs; financial consultation; insurance consultancy; credit services; credit bureaus; insurance brokerage; loans.

41 – Teaching; providing of training; entertainment; sporting and cultural activities; vocational guidance (education or training advice); publication of newspapers and books.

(260) AM 2014 72296 A

(800) 1157382

(151) 2012 12 20

(731) GUANGZHOU NEAR MAP TRADING CO., LTD.

No.23 Store, 1st FL. No. 47, Dongguan Zhuang Road, Tianhe District, Guangzhou, Guangdong Province, China

(540)



(591) Black, white

(511)

6 – Ice nails [climbing irons]; crampons [climbing irons]; bolts of metal; plugs of metal; pulleys of metal [other than for machines]; pitons of metal [mountaineering equipment].

8 – Sharpening instruments; garden tools, hand-operated; harpoons; razors, electric or non-electric; hand tools, hand-operated; metal band stretchers [hand tools]; glaziers's diamonds [parts of hand tools]; knives; side arms; table cutlery [knives, forks and spoons].

20 – Furniture; containers, not of metal [storage, transport]; mirrors [looking glasses]; artware of wood and bamboo; horn, teeth and shell, unworked or semi-worked; furniture fittings, not of metal; cushions; pillows; sleeping bags for camping; bedding [except linen].

22 – Tents; ropes; car towing ropes; sails; hammocks; down [feathers]; textile fibers; tarpaulins; woven bags; nets.

(260) AM 2014 72297 A

(800) 1157422

(151) 2013 01 04

(731) VINERO BAGCILIK SANAYI VE  
TICARET ANONIM SIRKETI

Istinye Mahallesi, Balabandere Caddesi  
No.14, TR-34460 SARIYER/ISTANBUL,  
Turkey

(540)

**vinero**

(591) Black, white

(511)

32 – Beers; mineral and aerated waters and other non-alcoholic drinks; fruit drinks and fruit juices; syrups and other preparations for making beverages.

33 – Wines, alcoholic beverages (except beers).

(260) AM 2014 72298 A  
 (800) 1157473  
 (151) 2013 03 07  
 (731) FLAGMANTO LTD  
 Spyrou Kyprianou 61, SK House, CY-4003  
 Limassol, Cyprus

(540)

## NABEER

(591) Black, white  
 (511)  
 29 – Anchovy; peanuts, processed; weed extracts for food; toasted laver; nuts, prepared; fat-containing mixtures for bread slices; salted fish; caviar; processed fish spawn; potato flakes; potato chips; potato crisps; isinglass for food; clams (not live); charcuterie; shrimps, not live; prawns, not live; spiny lobsters, not live; salmon; meat; mussels, not live; shellfish, not live; sea-cucumbers, not live; processed sunflower seeds; lobsters, not live; herrings; crayfish, not live; crustaceans, not live; fish, presserved; fish, not live; fish meal for human consumption; fish fillets; fish, tinned (canned (Am.)); foods prepared from fish; pork; cheese; pickles; sausages; sausages in batter; tuna fish; oysters, not live; low-fat potato chips; ham.

30 – Farinaceous foods; cereal-based snack food; popcorn; corn flakes; maize flakes; rusks; petit-beurre biscuits; crackers.

31 – Peanuts, fresh; nuts (fruits); fish spawn; spiny lobsters, live; mussels, live; sea-cucumbers, live; crayfish, live; crustaceans, live; fish, live; oysters, live.

(260) AM 2014 72299 A  
 (800) 1157495  
 (151) 2013 03 19  
 (731) KRKA, tovarna zdravil, d.d., Novo mesto  
 Šmarješka cesta 6, SI-8501 Novo mesto,  
 Slovenia

(540)

## DILAXA

(591) Black, white  
 (511)  
 5 – Pharmaceutical preparations.

(260) AM 2014 72300 A  
 (800) 1157512  
 (151) 2013 03 08  
 (731) BIOFARMA  
 50 rue Carnot, F-92284 SURESNES CEDEX,  
 France

(540)

## PRESTALIA

(591) Black, white

(511)  
 5 – Pharmaceutical and veterinary products; sanitary products for medical purposes; dietetic substances for medical use, food for babies; plasters, materials for dressings; material for dental fillings and dental impressions; disinfectants; products for destroying vermin; fungicides, herbicides.

(260) AM 2014 72303 A  
 (800) 1157638  
 (151) 2013 03 07  
 (731) Bayer Aktiengesellschaft  
 Kaiser-Willhelm-Allee, 51373 Leverkusen,  
 Germany

(540)



(591) Black, white  
 (511)  
 5 – Pharmaceutical preparation for the reduction of subcutaneous fat.

(260) AM 2014 72304 A  
 (800) 1157688  
 (151) 2013 01 24  
 (731) ADEL KALEMCİLİK TİCARET VE  
 SANAYİ ANONİM ŞİRKETİ  
 Esentepe Mahallesi Anadolu Caddesi No.7,  
 Kartal, TR-34870 İstanbul, Turkey

(540)



(591) Orange, yellow, green, blue and purple  
 (511)  
 16 – Paper, cardboard and goods made from these materials, not included in other classes; packaging and wrapping materials made of plastic materials; printing sets, portable [office requisites], binding materials for books and papers; printed matter, printed publications, printed calendars, printed photograph, printed tables, stickers [stationery], posters; stationery, office requisites (except furniture) instructional and teaching material [except apparatus]; office machines; paint rollers and paintbrushes.

(260) AM 2014 72305 A

(800) 1157712

(151) 2012 08 28

(731) IŞIL TELEVIZYON YAYINCILIK,  
ANONİM ŞİRKETİ  
Ahi Evran Caddesi No.4, Maslak Şişli-  
İstanbul, Turkey

(540)

(591) White, grey, blue, black, brown, orange, violet  
(511)

38 – Radio and television broadcasting services, arrangement of the broadcasting flow of radio, television and other communication devices; communication services; communication services by cellular telephones, communication via satellite, communication services, namely, electronic transmission of data and documents among users of computers, communication via telegraph, communication via telephone, transmission of images and messages via computer, e-mail services, fax-sending services, telegraph services, telephone services, telex services, information services related to communication, consultancy services related to communication, providing access for users to global computer network (Internet) services, rental of communication instruments and devices; news agencies, namely, the transmission of news items to news reporting organizations.

41 – Educational services; organization of conferences, symposiums, seminars and congresses in relation to business and business management; sport services; entertainment services; publication of books, publication of periodicals; production of radio and television programs except commercials; production of cine-films, videotape film production, recording studio services, dubbing, rental of television and radio receivers, rental of cine-films and motion pictures; rental of movie projectors and accessories; news reporting services, photographic reporting services; photography services; translation services.

(260) AM 2014 72318 A

(800) 1157797

(151) 2013 03 18

(731) Société des Produits Nestlé S.A.  
CH-1800 Vevey, Switzerland

(540)

**OPTI-START**

(591) Black, white

(511)

5 – Dietetic foodstuffs and beverages for medical use, nutritional supplements; nutritional and dietetic supplements; vitamin preparations; mineral food supplements; concentrated nutritional supplements based on carbohydrates.

29 – Milk-based beverages and preparations; milk substitutes; cream and milk-based desserts; yogurts.

30 – Coffee, coffee extracts, coffee-based beverages and preparations; iced coffee; artificial coffee, artificial coffee extracts, artificial coffee-based beverages and preparations; chicory (coffee substitute); tea, tea extracts, tea-based beverages and preparations; iced tea; malt-based preparations for human consumption; cocoa and cocoa-based beverages and preparations; chocolate, chocolate products, chocolate-based beverages and preparations; breakfast cereals, cereal bars, ready-to-eat cereals; cereal preparations; confectionery products, sugar confectionery (candy); candy, biscuits and cookies; cakes, wafers; edible ices, water ices, sherbets, frozen confectionery, frozen cakes, frozen yogurts, powder and binding agents for preparing edible ices and/or water ices and/or sherbets and/or frozen confectionery and/or frozen cakes and/or frozen yogurts.

32 – Non-alcoholic beverages and preparations for making non-alcoholic beverages (excluding essential oils); non-alcoholic malt-based beverages; isotonic beverages.

(260) AM 2014 72319 A

(800) 1157816

(151) 2013 04 08

(731) DENK PHARMA GmbH & Co. KG  
Prinzregentenstr. 79, 81675 München,  
Germany

(540)

**ZOLEDRO-DENK**

(591) Black, white

(511)

5 – Pharmaceutical products and preparations; medicines; chemical products for medical purposes.

(260) AM 2014 72320 A

(800) 1157868

(151) 2012 08 06

(731) Bilfinger SE  
Carl-Reiss-Platz 1-5, 68165 Mannheim,  
Germany

(540)



(591) Black, white

(511)

1 – Chemicals used in industry, science and photography, as well as in agriculture, horticulture and forestry; unprocessed artificial resins, unprocessed plastics; manures; fire extinguishing compositions; tempering and soldering preparations; chemical substances for preserving foodstuffs; tanning substances; adhesives used in industry; oil separating chemicals; concrete-aeration chemicals; agglutinants for concrete.

6 – Metal building materials; transportable buildings of metal; materials of metal for railway tracks; non-electric cables and wires of common metal; ironmongery, small items of metal hardware; goods of common metal not included in other classes; metal containers; tanks and vats of metal; metal structures; common metals and their alloys; ores; pipework of metal; pipes and tubes of metal and pipeline systems consisting thereof; coated pipes and tubes of metal protected against corrosion and erosion; membrane walls of metal for building industry; closures of metal for containers; combustion grates.

7 – Machines namely driving motors (other than for land vehicles), mineworking machines, concrete mixers (machines), grinding machines, ore treating machines, earth moving machines, conveyors (machines), sizing machines, bitumen making machines, separators, sifters, road making machines, road sweeping machines, tarring machines and machine tools and parts thereof (included in this class); motors and engines (except for land vehicles); machine coupling and transmission components (except for land vehicles); agricultural implements other than hand-operated; automatic vending machines; machines and mechanical apparatus for crushing combustible materials and raw materials, in particular mills of all kinds; conveying installations; mechanical blowing machines; dust removing installations for cleaning purposes; powergenerating apparatus and machines, namely power generators; compressors; turbines, namely steam and gas turbines; steam condensers; super-heaters; pumps (machines); controls for machines, motors and engines, namely electric and process control installations for operating power plant, waste incineration and industrial installations and individual components therefor; separators, in particular wet scrubbers (hydrocyclone installations) and electrostatic separators; machines and mechanical apparatus and installations consisting thereof and individual parts thereof for separating, sorting, conveying, pressing and comminuting fuels and raw kinds.

9 – Scientific, nautical, surveying, photographic, cinematographic, optical, weighing, measuring, signalling, checking (supervision), life-saving and teaching apparatus and instruments; apparatus and

instruments for conducting, switching, transforming, accumulating, regulating or controlling electricity; apparatus for recording, transmission or reproduction of sound or images; magnetic data carriers, recording discs; compact discs, DVDs and other digital recording media; mechanisms for coin-operated apparatus; cash registers, calculating machines; data processing hardware, computers; computer software; fire-extinguishing apparatus; data-processing equipment and computers; alarm apparatus; electromechanical and electronic controls; computer operating programs (recorded); magnetic and optical data carriers; devices for protection against accidents for personal use.

11 – Apparatus for lighting, heating, steam generating, cooking, refrigerating, drying, ventilating, water supply and sanitary purposes; purification installations for sewage; watering machines for agriculture; desalination units; air ionizing apparatus; water purification installations; burners, air valves for steam heating installations; furnaces being parts of heating systems or stoves [heating apparatus]; hot gas generators being parts of heating systems or stoves [heating apparatus], filters (parts of industrial installations); waste heat boilers being parts of heating systems or stoves [heating apparatus], pre-heaters being parts of heating systems or stoves [heating apparatus], rotary air heaters being parts of heating systems or stoves [heating apparatus]; heating surfaces; heating boilers; gas condensers except machine parts; refrigeration installations; refrigerating apparatus; nuclear reactors; airconditioning fans; firing technology machines for solid, liquid and gaseous fuels; burner valves; preheating apparatus being parts of heating systems or stoves [heating apparatus]; gas reduction apparatus being parts of heating systems or stoves [heating apparatus]; gas-oil combined burners or gas surface burners, flue gas cleaning installations; water and waste water treatment installations, water and waste water conditioning installations and parts therefor for clarifying waste water; generators for gasses to be used in industry.

19 – Building materials (non-metallic); fixed and transportable buildings (not of metal); asphalt, pitch or bitumen; non-metallic rigid pipes for building; monuments, not of metal; materials for making and coating roads (not of metal); coverings, not of metal, for building, roof coverings and roofs not of metal, docks (not of metal); scaffolding, not of metal; road marking materials (not of metal); crash barriers, not of metal, for roads.

35 – Advertising; business management; business administration; office functions; business organizational preparation of building projects; business organisation consultancy; business organizational project management; office machines and equipment rental; office personnel placement; layout services

for advertising purposes; arranging and conducting of commercial exhibitions; collating of data in computer databases; development of marketing strategies and concepts for real estate; business management and organization of vehicle fleets; business organization consultancy; maintenance of data in computer data bases; business organization consultancy in the field of the management of a building (facility services) also via subcontractors and cooperation partners; document copying services; personal management services, namely recruiting and placement of subcontractors; commercial management assistance in relation to building projects, including area management, contract management, in particular the arranging of contracts for the rental of real estate including house rental.

36 – Insurance; financial affairs; real estate affairs; monetary affairs; real estate management, in particular management of properties/land, buildings including their equipment; evaluation of real estate taking into account both the requirements of owners/users and the subsequent optimal costs operation of real estate, in particular by operating and managing real estate, in particular by operating and management real estate during the usage phase, including the financial evaluation of ancillary costs and consumption costs; building management (infrastructure); financial preparation of building projects; rental and leasing of offices and land (real estate); property and building management; rental of office space; brokerage services.

37 – Building construction; installation services; exterior and interior cleaning of buildings, windows, vehicles, textiles; repair and servicing of real estate; maintenance services, in particular servicing; maintenance of technical building installations; caretaker services, namely carrying out minor repairs; construction information; management and supervision of construction works; conducting building projects; demolition of buildings; rental of construction machinery; domestic and building maintenance, repair and cleaning (caretaker services); assembly services relating to the installation of, and maintenance and repair of computer hardware, office equipment and electrical equipment; mining extraction; road paving.

39 – Transport; transportation by land, sea and by air, of documents and parcels; packaging, storage and delivery of goods; courier services; freighting; transport and sending of freight; customs brokerage in connection with the transport and shipment of goods; collection and delivery services (transport), logistical services, namely the acceptance, packaging, thermal bonding, labelling, storing, managing, sending, commissioning and arranging of goods; distribution and collection of post, rental of vehicles; transport and storage of waste; car parking; distribution of electricity, energy and water.

40 – Treatment of materials; water treating; electroplating; metal tempering; soldering; metal treatment; waste processing services; sorting of waste and recyclable material; destruction of waste and rubbish; recycling of waste and rubbish, in particular treatment of building rubble and incineration of waste and trash in incineration installations; printing services; generation of energy; air freshening; air purification; rental of room heaters.

42 – Scientific and technological services and research and design relating thereto; industrial analysis and research services; computer software design; architecture; architectural consultancy; consultancy in the field of computers; installing, duplication, updating, rental of computer software; rental of and maintenance for computer hardware; engineering; industrial design and interior design; measurement evaluations; consultancy relating to the conservation of energy; providing of geological expertise and surveying; design and maintenance of websites for third parties; construction drafting; land surveying; urban planning; research and development (for others); preparation of reports relating to technical project studies for construction projects; technical project studies in the field of real estate; development of energy management systems for optimising energy consumption; structural and civil engineering; inspection of technical building installations for quality control.

---

(260) AM 2014 72329 A

(800) 1157925

(151) 2013 03 19

(731) KRKA, tovarna zdravil, d.d., Novo mesto  
Šmarješka cesta 6, SI-8501 Novo mesto,  
Slovenia

(540)

**ДИЛАКСА**

(591) Black, white

(511)

5 – Pharmaceutical preparations.

---

(260) AM 2014 72330 A

(800) 1157936

(151) 2013 01 14

(731) OMV PETROL OFISI ANONIM SIRKETI  
Eski Büyükdere Caddesi No: 33/37 Maslak.  
Istanbul, Turkey

(540)

**maxima**<sup>®</sup>

(591) Black, white

(511)

4 – Industrial oils, industrial greases, industrial lubricants, engine oil, motor oil, grease for machines,

automotive greases, cutting fluids, dust absorbing, wetting and binding compositions; solid fuels, namely, coal, briquettes of coal, coke, lignite, charcoal briquettes; gaseous and liquid fuels, non-chemical additives for gaseous and liquid fuels; fuel for motor vehicles, namely, gasoline, diesel, fuel oil; kerosene, non-chemical additives for engine oils, gasoline and diesel fuels; candles for lighting, wicks for oil lamps, illuminating wax, paraffin wax.

(260) AM 2014 72331 A

(800) 1157956

(151) 2013 02 26

(731) Richter Gedeon Nyrt.

Gyömroi út 19-21, H-1103 Budapest,  
Hungary

(540)

**Эквaмep**

(591) Black, white

(511)

5 – Pharmaceutical preparations.

(260) AM 2014 72332 A

(800) 1157958

(151) 2013 02 26

(731) Richter Gedeon Nyrt.

Gyömroi út 19-21, H-1103 Budapest,  
Hungary

(540)

**EKVAMER**

(591) Black, white

(511)

5 – Pharmaceutical preparations.

(260) AM 2014 72333 A

(800) 1157962

(151) 2013 03 08

(731) EGIS GYÓGYSZERGYÁR Nyilvánosan

Működő Részvénytársaság  
Keresztúri út 30-38, H-1106 Budapest,  
Hungary

(540)

**RUBESSA**

(591) Black, white

(511)

5 – Pharmaceutical preparations for human use.

(260) AM 2014 72334 A

(800) 1157963

(151) 2013 03 08

(731) EGIS GYÓGYSZERGYÁR Nyilvánosan

Működő Részvénytársaság  
Keresztúri út 30-38, H-1106 Budapest,  
Hungary

(540)

**GENTILION**

(591) Black, white

(511)

5 – Pharmaceutical preparations for human use.

(260) AM 2014 72335 A

(800) 1157975

(151) 2013 02 19

(731) GRUPO BIMBO, S.A.B. DE C.V.

Prol. Paseo de la Reforma #1000, 01210 Col.  
Peña Blanca Santa Fe, Mexico

(540)



(591) Red PMS 185, blue PMS 286 and white

(511)

29 – Meat, fish, poultry and game; meat extracts; preserved, dried and cooked fruit and vegetables; jellies, jams, compotes; eggs, milk and dairy products; edible oils and fats.

30 – Coffee, tea, cocoa, sugar, rice, tapioca, sago, artificial coffee; flours and preparations made from cereals; bread, cakes and confectionery; edible ices; honey, treacle; yeast, baking powder; salt; mustard; vinegar, sauces (condiments); spices; ice; biscuits, cookies, corn tortilla chips and wheat tortilla chips.

(260) AM 2014 72337 A

(800) 1157998

(151) 2012 11 02

(731) BERİMPEKS DIŞ TİCARET LİMİTED

ŞİRKETİ

Karayollari Mahallesi, Kadir Akdoğan  
Caddesi, No.3, Küçükköy, Gaziosmanpaşa-  
Istanbul, Turkey

(540)

**ecober**

(591) Red and dark blue



(511)

1 – Chemicals used in industry, science and photography, as well as in agriculture, horticulture and forestry; unprocessed artificial resins, unprocessed plastics; manures; fire extinguishing compositions; glues, other than for stationery or household purposes.

3 – Bleaching preparations and other substances for laundry use; cleaning, polishing, scouring and abrasive preparations; soaps; perfumery, essential oils, cosmetics, hair lotions; dentifrices; emery paper, abrasive paste, pumice stones for personal use; leather polishes, polishes for metallic items, furniture polishes, floor polishes.

35 – Advertising agencies services, marketing and publicity bureaus services including commercial or advertisement exhibition and trade fair organization services; providing office functions; business management; business administration; import and export agencies; business investigations, evaluations, expert business appraisals; auctioneering; the bringing together, for the benefit of others, of chemicals used in industry, science and photography, as well as in agriculture, horticulture and forestry; unprocessed artificial resins, unprocessed plastics; manures; fire extinguishing compositions; glues, other than for stationery or household purposes; bleaching preparations and other substances for laundry use; cleaning, polishing, scouring and abrasive preparations; soaps; perfumery, essential oils, cosmetics, hair lotions; dentifrices; emery paper, abrasive paste, pumice stones for personal use; leather polishes, polishes for metallic items, furniture polishes, floor polishes (excluding the transport thereof), enabling customers to conveniently view and purchase those goods; all of the aforementioned services may be provided by retail stores, wholesale outlets, through mail order catalogues or by means of electronic media, for example, through web sites or television shopping programmes.

37 – Construction services; rental of construction and building equipment, cleaning services; disinfecting; rental of street cleaning machines, rental of cleaning equipment; rental of cleaning machines; disinfection of equipment and linen; vermin extermination services other than for agriculture; vehicle repair and maintenance; repair or maintenance of vessels; aircraft repair and maintenance; upholstering services, upholstery repair services, furniture restoration, repair and maintenance; installation, repair and maintenance of heating equipment, repair or maintenance of air-conditioning apparatus for industrial purposes; clothing repair; laundry services for cloth, clothing, fabric, linen, textiles washing of cloth, clothing, fabric, linen, textiles; repair or maintenance of movie projectors, repair or maintenance of photographic machines and apparatus, repair or maintenance of office machines and apparatus,

installation and maintenance of burglar and/or fire alarms, repair or maintenance of elevators and lifts, clock and watch repair or maintenance, wallpaper hanging; mining extraction, repair or maintenance of mining machines and apparatus, floor sanding services, knife sharpening services, safe maintenance or repair; umbrella repair services, shoe repair services.

(260) AM 2014 72338 A

(800) 1158030

(151) 2013 02 11

(731) RUBUN GLOBAL CORP.

33 Porter Road, P.O. Box 3169 PMB103

Road Town Tortola, British Virgin Islands

(540)



(591) Black, white

(511)

3 – Bleaching preparations and other substances for laundry use; cleaning, polishing, scouring and abrasive preparations; soaps; perfumery, essential oils, cosmetics, hair lotions; dentifrices.

(260) AM 2014 72339 A

(800) 409593

(151) 1974 07 30

(891) 2012 07 18

(731) GELDERMANN Privatsektellerei

Gesellschaft mit beschränkter Haftung

1, Am Schloßberg, 79206 Breisach am

Rhein, Germany

(540)

## GELDERMANN

(591) Black, white

(511)

33 – Wines, Champagne wines and sparkling wines.

(260) AM 2014 72340 A

(800) 470941

(151) 1982 08 13

(891) 2013 03 14

(731) GORENJE gospodinjski aparati, d.d.

Partizanska 12, SI-3503 VELENJE, Slovenia

(540)



(591) Black, white

(511)

7 – Machines for working metal and plastic, machines for processing of metal and plastic, bottling machines, machines for public works, welding machines, grinding machines, dredgers, bulldozers, machine tools; motors and engines (except for land vehicles); transmission couplings and belts (except for land vehicles); large agricultural implements; incubators; electric motors and engines (except for land vehicles), welding rectifier units, spot-welding machines and semi automatic machines for welding; dishwashers, washing machines, drying machines; small electric utensils for household purposes, namely mixers, kitchen machines, bread slicing machines, electric knives, electric tin openers, bread toasters, ice makers.

9 – Kitchen scales, including electric scales; electro-technical and electronic apparatus and instruments (not included in other classes), particularly aeri-als and aerial accessories, namely aerial cables, aerial connector plugs, aerial boxes, aerial adaptors, aerial boosters, aerial pointers and distributors; systems for domestic television, mainly consisting of television broadcast receiving sets, television cameras, television monitors, video recording machines, television cables, television broadcast receiving sets designed for cable television; musical receiver chains, particularly consisting of radio and television apparatus, installation parts for radio reception (Tuner), electro-acoustic amplifiers, equalizers, sound recording and sound reproduction apparatus, stereophonic and quadrasonic installations, including parts thereof (not included in other classes) as well as those in compact form, cassette recorders, loudspeakers, headstrap earphones, microphones, sound mixers (mixing consoles), record players and juke boxes; electronic control and measuring apparatus for industrial purposes, protection transformers.

11 – Apparatus for lighting, heating, steam generating, cooking, refrigerating, drying, ventilating, water supply and sanitary purposes; cookers, including microwave ranges, built-in cooking plates, electric apparatus for grilling, roasting and cooking, refrigerators, deep freezers (cabinets and chests), hair dryers, fans, blast heaters, electric fireplace furnishings, lamps and lighting fixtures, drier units, heating elements of steel and aluminium, boilers for central heating purposes, mobile boiler containers for heating purposes, gas and electric water heaters, domestic gas furnaces; drying machines; apparatus for tanning the skin.

(260) AM 2014 72342 A

(800) 597895

(151) 1993 01 28

(891) 2013 02 25

(731) MEDIOLANUM FARMACEUTICI S.P.A.  
Via S.G. Cottolengo, 31, I-20143 MILANO,  
Italy

(540)

## MEDIOLANUM

(591) Black, white

(511)

5 – Pharmaceutical products and, in particular, a proprietary medicine.

(260) AM 2014 72343 A

(800) 670762

(151) 1997 03 26

(891) 2012 12 17

(731) INTERNATIONAL PAPER S.A.  
Boulevard des Chênes – 4, parc Ariane  
Immeuble Pluton, F-78280 GUYANCOURT,  
France

(540)

## TECNIS

(591) Black, white

(511)

16 – Paper, cardboard, printing and writing paper, paper for stationery and printing purposes, printing products, stationery, cardboard articles, printed matter.

(260) AM 2014 72344 A

(800) 671163

(151) 1997 03 26

(891) 2013 02 25

(731) CONSORZIO PER LA TUTELA DEL  
FORMAGGIO GRANA PADANO  
Via XXIV Giugno 8, Frazione S. Martino  
della Battaglia, I-25015 DESENZANO DEL  
GARDA (Brescia), Italy

(540)



(591) Black, white

(511)

29 – Cheeses.

(260) AM 2014 72345 A  
 (800) 862414  
 (151) 2005 08 15  
 (891) 2013 02 05  
 (731) Farmaprim S.R.L.  
 Str. Crinilor, nr. 5, MD-4829 Porumbeni,  
 Criuleni, Republic of Moldova

(540)

**PRIMAFUNGIN**  
**ПРИМАФУНГИН**

(591) Black, white  
 (511)  
 5 – Chemico-pharmaceutical products; pharmaceutical products; medicines, medicines for human use.

(260) AM 2014 72347 A  
 (800) 912895  
 (151) 2006 07 12  
 (891) 2013 03 27  
 (731) Gold's Gym Licensing LLC  
 4001 Maple Avenue, Suite 200, Dallas  
 TX 75219, USA

(540)

**GOLD'S GYM**

(591) Black, white  
 (511)  
 25 – Sweat bands and hats; athletic clothing, namely, shirts, shorts, tank tops, warm-up suits, including pants and jackets, and posing trunks.  
 28 – Weight lifting belts, weight lifting gloves, weight belt straps and wrist straps; gymnasium equipment, namely, multi-purpose exercise unit, free standing cross over cable, long pull and pull down combo, double pull down station, long pull apparatus, pull down machine, bench press, barbell incline bench with spotters platform, olympic plate holder, seated calf machine, standing calf machine, rowing machine, combination squat rack and bench press, adjustable flat bench, adjustable low-seated incline bench, behind the neck press bench, hyper-extension bench, leg extension apparatus, leg curl apparatus, hyper-extension machine, sit-up bench, standing curl bench, seated incline bench, and free standing lying leg press.  
 41 – Gymnasium services.

(260) AM 2014 72348 A  
 (800) 913494  
 (151) 2006 09 09  
 (891) 2013 03 27  
 (731) Gold's Gym Licensing LLC  
 4001 Maple Avenue, Suite 200, Dallas  
 TX 75219, USA

(540)



(591) Black, white  
 (511)  
 25 – Clothing, namely shirts, tank tops, shorts, trunks, warm-up suits, pants, jackets, shoes, sweat bands and hats.  
 28 – Exercise machines and exercise equipment, namely, multi-purpose exercise unit, free standing crossover cable, long pull and pull down combo, double pull down station, long pull apparatus, pull down machine, bench press, barbell incline bench with spotters platform, weight plate holder, seated calf machine, standing calf machine, rowing machine, combination squat rack and bench press, adjustable flat bench, adjustable low-seated incline bench, behind the neck press bench, hyper-extension bench, leg extension apparatus, leg curl apparatus, hyper-extension machine, sit-up bench, standing curl bench, seated incline bench, and free standing lying leg press; weight lifting belts, weight lifting gloves, weight belt straps and wrist straps.  
 41 – Gymnasium services.

(260) AM 2014 72349 A  
 (800) 1043404  
 (151) 2010 06 12  
 (891) 2013 02 20  
 (731) Glaxo Group Limited  
 980 Great West Road, Brentford, Middlesex  
 TW8 9GS, United Kingdom

(540)

**ESPANDA**

(591) Black, white  
 (511)  
 5 – Pharmaceutical and medicinal preparations and substances; vaccines.

(260) AM 2014 72350 A

(800) 1148989

(151) 2012 10 09

(891) 2013 03 06

(731) Sport Retail LTD

Offices of Aleman, Cordero, Galindo and Lee  
Trust (BVI) Limited, P.O. Box 3175, Road  
Town, Tortola, British Virgin Islands

(540)



(591) White, green-gray, black and red

(511)

28 – Roller skates and protective accessories thereto;  
ice skates.

(260) AM 2014 72419 A

(800) 868014

(151) 2005 10 03

(891) 2013 05 16

(731) I.P. CREATIONS ENTERPRISES LIMITED

Agiou Pavlou, 15 Ledra House, Agios  
Andreas, CY-1105 Nicosia, Cyprus

(540)



(591) White, black, red, yellow, green, dark green,  
blue, dark blue, beige

(511)

43 – Services for providing food and drink; restau-  
rants (meals), self-service restaurants, fast food res-  
taurants and snack bars, cafés, cafeterias; arranging  
of dinners and weddings; temporary accommoda-  
tion.

(260) AM 2014 72420 A

(800) 939396

(151) 2007 09 12

(891) 2013 02 12

(731) GROUPEMENT DES LABORATOIRES  
FRANCAIS/SORAS, (société par Actions  
Simplifiée)

16 rue Danton, F-92130 ISSY LES  
MOULINEAUX, France

(540)

## EMBRYOLISSE

(591) Black, white

(511)

3 – Soaps, perfumery, perfumes, essential oils, cos-  
metics, non-medical preparatons for skin care and  
embellishment, make-up removing preparations, ma-  
ke-up preparations, deodorants for personal use, pre-  
shave and after-shave preparations, hair lotions,  
dentifrices.

(260) AM 2014 72421 A

(800) 961228

(151) 2008 01 10

(891) 2013 02 19

(731) Novartis AG

CH-4002 Basel, Switzerland

(540)

## YENRILA

(591) Black, white

(511)

5 – Pharmaceutical preparations.

(260) AM 2014 72422 A

(800) 981295

(151) 2008 07 31

(891) 2013 03 04

(731) Mitas a.s.

Svehlova 1900/3, Záběhlice, CZ-106 00 Praha  
10, Czech Republic

(540)

## CULTOR

(591) Black, white

(511)

12 – Car tyres and tyres for agricultural vehicles.

(260) AM 2014 72423 A

(800) 1044923

(151) 2010 06 25

(891) 2013 02 13

(731) LUIS CALVO SANZ, S.A.

Ctra. Coruña-Finisterre, Km. 34,5, E-15100  
CARBALLO – LA CORUÑA, Spain

(540)



(591) Yellow, blue, white

(511)

29 – Meat, fish, poultry and game; meat extracts;  
preserved, frozen, dried and cooked fruit and  
vegetables; jellies, jams, compotes; eggs, milk and  
milk products; edible oils and fats.

(260) AM 2014 72424 A  
 (800) 1065210  
 (151) 2011 01 11  
 (891) 2013 03 12  
 (731) Budo-Sport AG  
 Rosenweg 34, CH-3007 Bern, Switzerland  
 (540)

**HIKU®**

(591) Black, white  
 (511)  
 18 – Bags for sports.  
 25 – Clothing for gymnastics and sports.  
 28 – Gymnastic and sporting articles.

(260) AM 2014 72425 A  
 (800) 1065212  
 (151) 2011 01 11  
 (891) 2013 03 12  
 (731) Budo-Sport AG  
 Rosenweg 34, CH-3007 Bern, Switzerland  
 (540)

**ヒク**

(591) Black, white  
 (511)  
 18 – Bags for sports.  
 25 – Clothing for gymnastics and sports.  
 28 – Gymnastic and sporting articles.

(260) AM 2014 72426 A  
 (800) 1085838  
 (151) 2011 07 04  
 (891) 2013 03 11  
 (731) Frères Rochat SA  
 Route du Campe 15 CH-1348 Le Brassus,  
 Switzerland  
 (540)

**Frères Rochat**

(591) Black, white  
 (511)  
 9 – Coin-operated musical automata.  
 14 – Timepieces, jewelry.  
 15 – Musical instruments.

(260) AM 2014 72427 A  
 (800) 1107974  
 (151) 2012 02 10  
 (891) 2013 03 01  
 (731) Novartis AG  
 CH-4002 Basel, Switzerland  
 (540)

**REASANZ**

(591) Black, white  
 (511)  
 5 – Pharmaceutical preparations.

(260) AM 2014 72431 A  
 (800) 1159008  
 (151) 2012 11 12  
 (731) Sol Mate AG  
 5, rue Heienhaff, L-1736 Senningerberg,  
 Luxembourg  
 (540)



(591) Black, white  
 (511)  
 30 – Tea; tea-based beverages; iced tea.  
 32 – Mineral and aerated waters and other non-alcoholic beverages; fruit beverages and fruit juices; syrups and other preparations for making beverages.

(260) AM 2014 72436 A  
 (800) 1159080  
 (151) 2013 03 15  
 (731) SIXTY INTERNATIONAL S.A.  
 29, avenue Monterey L-2163 Luxembourg,  
 Luxembourg  
 (540)

**ENERGIE**

(591) Black, white  
 (511)  
 9 – Optical apparatus; optical goods, spectacles, sunglasses, spectacle frames, spectacle cases, mobile phones.  
 14 – Jewellery (including custom jewellery) in particular rings, earrings, cuff links, bracelets, trinkets, brooches, chains, necklaces, key rings, jewellery cases, watches, wrist watches, alarm clocks, cases for watches.  
 18 – Boxes of leather or imitation of leather, suitcases, travelling bags, trunks, garment bags for travel, vanity cases, toiletry cases, backpacks, handbags, attaché cases, leather document holders, wallets,

purses, shopping bags, umbrellas, walking sticks, beach bags, harness for animals, pouches, sport bags.

25 – Clothing, underwear, shirts, t-shirts, pullovers, skirts, dresses, trousers, coats, jackets, belts, scarves, neckties, socks, swimsuits, shoes, headgear.

(260) AM 2014 72443 A

(800) 1159229

(151) 2012 12 03

(731) Fujian Xinghui Baby Supplies CO., LTD.  
North Area, Zhaoan Industrial Park,  
Zhangzhou Fujian, China

(540)



**RastarBaby**

(591) Black, white

(511)

12 – Strollers; pushchair hoods; pushchair covers; handcarts; shopping trolleys [carts (Am.)]; cycles; moped; casings for pneumatic tires [tyres]; repair outfits for inner tubes; cars.

20 – Bassinettes; cradles; playpens for babies; infant walkers; high chairs for babies, cushions; mats for infant playpens; baby changing mats; pillows; fans for personal use, non-electric.

25 – Clothing; children's clothing; layettes [clothing]; bathing suits; waterproof clothing; shoes; hats; socks; shawls.

(260) AM 2014 72444 A

(800) 1159236

(151) 2013 02 07

(731) Obchtchestvo s ogranichennoi  
otvetstvennostyuu "Olimp"  
oul. 4-ya Promychnennaya, 1, g. Vladikavkaz,  
RU-362013 Respublika Severnaya Osetia –  
Alania, Russian Federation

(540)

**ОСИНКА**

(591) Black, white

(511)

33 – Alcoholic beverages (except beers).

(260) AM 2014 72445 A

(800) 1159237

(151) 2013 02 07

(731) Obchtchestvo s ogranichennoi  
otvetstvennostyuu "Olimp"  
oul. 4-ya Promychnennaya, 1, g. Vladikavkaz,  
RU-362013 Respublika Severnaya Osetia –  
Alania, Russian Federation

(540)

**ЗАБАВА**

(591) Black, white

(511)

33 – Alcoholic beverages (except beers).

(260) AM 2014 72446 A

(800) 1159238

(151) 2013 02 07

(731) Obchtchestvo s ogranichennoi  
otvetstvennostyuu "Olimp"  
oul. 4-ya Promychnennaya, 1, g. Vladikavkaz,  
RU-362013 Respublika Severnaya Osetia –  
Alania, Russian Federation

(540)

**ДОБРЫЙ ЛОСЬ**

(591) Black, white

(511)

33 – Alcoholic beverages (except beers).

(260) AM 2014 72447 A

(800) 1159239

(151) 2012 11 18

(891) 2012 12 18

(731) Obshchestvo s ogranichennoy  
otvetstvennostyuu "Tonus-slub"  
ul. Cherniakhovskogo 33, litera A,  
pomeshenie 2-H, RU-191119 gorod Saint-  
Petersburg, Russian Federation

(540)



(591) Black, white, light – green, dark – green,  
yellow

(511)

5 – Nutritional supplements; pharmaceutical preparations.

10 – Physical exercise apparatus, for medical purposes; body rehabilitation apparatus for medical purposes; physiotherapy apparatus; vibromassage apparatus; lasers for medical purposes; esthetic massage apparatus; pulse meters; massage apparatus.

25 – Clothing, including disposable clothing for fitness training.

28 – Body-training apparatus; body-building apparatus.

41 – Physical education; health club services [health and fitness training]; organization of sports competitions; providing sports facilities; conducting fitness classes; personal trainer services [fitness trainer].

(260) AM 2014 72448 A  
 (800) 1159240  
 (151) 2013 02 12  
 (731) KOPOS KOLÍN a.s.  
 Havlíčkova 432, CZ-280 94 Kolín, Czech  
 Republic

(540)

**KOPODUR**

(591) Black, white  
 (511)  
 9 – Ducting for electric cables.

17 – Non-metallic flexible tubes especially for underground sewerage and drainage purposes, flexible plastic tubes especially for underground sewerage and drainage purposes.

(260) AM 2014 72450 A  
 (800) 1159283  
 (151) 2013 03 19  
 (731) Henkel AG & Co. KGaA  
 Henkelstrasse 67, 40589 Düsseldorf, Germany



(591) Black, white  
 (511)  
 3 – Soaps, perfumery goods, essential oils, cosmetics, deodorants for human beings, cosmetic foam bath preparations and shower gels, cosmetic preparations for hair care and treatment; dentifrices.

(260) AM 2014 72451 A  
 (800) 1159291  
 (151) 2013 03 12  
 (731) VENCHI S.P.A.  
 Via Venchi, 1, I-12040 Castelletto Stura (CN),  
 Italy

(540)

**VENCHI**

(591) Black, white  
 (511)  
 43 – Services for providing food and drink, coffee, cafeterias, ice cream parlors.

(260) AM 2014 72452 A  
 (800) 1159293  
 (151) 2013 04 19  
 (731) Cloud Microphones  
 45 West Ventura Street Tucson, AZ 85705,  
 USA

(540)

**CLOUDLIFTER**

(591) Black, white  
 (511)  
 9 – Pre-amplifiers.

(260) AM 2014 72454 A  
 (800) 1159342  
 (151) 2013 04 08  
 (731) Obschestvo s ogranichennoy otvetstvennostyu  
 "Laboratoriya sovremennogo zdorovya"  
 ul. Khimzavodskaya, 11/20, Berdsk,  
 RU-633004 Novosibirskaya oblast', Russian  
 Federation

(540)

**FITNESSCATALYST**

(591) Black, white  
 (511)  
 5 – Albuminous foodstuffs for medical purposes; albuminous preparations for medical purposes; anti-septics; bacterial preparations for medical and veterinary use; balms for medical purposes; biocides; biological preparations for medical purposes; dietetic beverages adapted for medical purposes; diabetic bread adapted for medical use; dietetic foods adapted for medical purposes; dietetic substances adapted for medical use; digestives for pharmaceutical purposes; disinfectants for hygiene purposes; ferments for pharmaceutical purposes; fumigating sticks; germicides; herbal teas for medicinal purposes; liniments; lotions for pharmaceutical purposes; medicinal herbs; medicinal infusions; medicinal mud; medicinal oils; medicinal roots; mineral food supplements; mouthwashes for medical purposes; nervines; opotherapy preparations; pharmaceutical preparations for treating dandruff; pharmaceutical preparations for skin care; preparations of trace elements for human and animal use; remedies for perspiration; sea water for medicinal bathing; serums; styptic preparations; therapeutic preparations for the bath; tissues impregnated with pharmaceutical lotions; tonics [medicines]; vitamin preparations.

(260) AM 2014 72461 A  
 (800) 1159374  
 (151) 2012 07 07  
 (731) Spey Medical Limited  
 Lynton House, 7-12 Tavistock Square,  
 London WC1H 9LT, United Kingdom

(540)

**ANDERIM**  
**АНДЕРИМ**

(591) Black, white  
 (511)  
 5 – Pharmaceutical and veterinary preparations; sanitary preparations for medical purposes; dietetic

substances adapted for medical use, food for babies; plasters, materials for dressings; material for stopping teeth, dental wax; disinfectants; preparations for destroying vermin; fungicides, herbicides; foods and beverages which are adapted for medical purposes; air deodorising preparations.

(260) AM 2014 72462 A

(800) 1159380

(151) 2013 03 15

(731) Zakrytoe akcionerhoe obschestvo

"Market Logistik"

of. 2, h. 11, st. Druzhinnikov, RU-394026

Voronezh, Russian Federation

(540)

## МАПЕНГО MARENGO

(591) Black, white

(511)

5 – Protein for human consumption.

29 – Beans, preserved; soya beans, preserved, for food; bouillon; broth; peas, preserved; mushrooms, preserved; game, not live; yolk of eggs; charcuterie; sausages; raisins; caviar; black pudding; blood sausage; meat, tinned; vegetables, tinned; fish, tinned; fruits, tinned; bouillon concentrates; broth concentrates; gherkins; prawns, not live; shrimps, not live; salmon; onions, preserved; margarine; piccalilli; coconut oil; coconut butter; chocolate nut butter; cocoa butter; butter; milk; soya milk [milk substitute]; cream [dairy products]; kefir [milk beverage]; kephir [milk beverage]; kumys [kumyss]; milk beverages, milk predominating; milk products; whey; yoghurt; yogurt; fish meal for human consumption; fruit pulp; meat; meat, preserved; vegetables, preserved; vegetables, dried; vegetables, cooked; olives, preserved; coconut, desiccated; nuts, prepared; tomato puree; liver pastes; pectin for culinary purposes; liver; ham; foods prepared from fish; salted fish; curd; poultry, not live; crayfish, not live; crustaceans, not live; fish, not live; fish, preserved; vegetable salads; fruit salads; bacon; sardines; pork; herrings; vegetable juices for cooking; salted meats; sausages in batter; preparations for making bouillon; preparations for making soup; tripe; soups; vegetable soup preparations; cheese; tofu; sea-cucumbers, not live; truffles, preserved; tuna fish; oysters, not live; rennet; fish fillets; dates; frozen fruits; fruit, preserved; fruit preserved in alcohol; fruit, stewed; weed extracts for food; meat extracts; snail eggs for consumption; eggs.

32 – Kvass [non-alcoholic beverage]; cocktails, non-alcoholic; lemonades; non-alcoholic beverages; isotonic beverages; non-alcoholic honey-based beverages; whey beverages; non-alcoholic fruit juice beverages; milk of almonds [beverage]; fruit nectars,

non-alcoholic; powders for effervescing beverages; syrups for lemonade; syrups for beverages; tomato juice [beverage]; cider, non-alcoholic; vegetable juices [beverages]; fruit juices; preparations for making aerated water; preparations for making mineral water.

(260) AM 2014 72608 A

(800) 1160460

(151) 2013 04 16

(731) BASF SE

Carl-Bosch-Strasse 38, 67063 Ludwigshafen  
am Rhein, Germany

(540)

## CLERASUS

(591) Black, white

(511)

5 – Preparations for destroying and combating vermin, insecticides, fungicides, herbicides, pesticides.

(260) AM 2014 72609 A

(800) 1160467

(151) 2013 03 27

(731) De Rigo S.p.A.

Zona Industriale Villanova, 12, I-32013  
Longarone (BL), Italy

(540)

## POLICEYES

(591) Black, white

(511)

9 – Glasses, and their parts and accessories, in particular sun glasses, eyeglasses, correcting lenses, sun lenses, swimming goggles, contact lenses, frames, bars (parts of frames), eyeglass cases, eyeglass containers, helmets.

(260) AM 2014 72612 A

(800) 1160469

(151) 2013 04 16

(731) BASF SE

Carl-Bosch-Strasse 38, 67063 Ludwigshafen  
am Rhein, Germany

(540)

## CLEMAVOR

(591) Black, white

(511)

5 – Preparations for destroying and combating vermin, insecticides, fungicides, herbicides, pesticides.



(260) AM 2014 72613 A

(800) 1160470

(151) 2013 04 16

(731) BASF SE

Carl-Bosch-Strasse 38, 67063 Ludwigshafen  
am Rhein, Germany

(540)

## CLESURA

(591) Black, white

(511)

5 – Preparations for destroying and combating ver-  
min, insecticides, fungicides, herbicides, pesticides.

(260) AM 2014 72614 A

(800) 471878

(151) 1982 09 24

(891) 2013 04 04

(731) Vifor SA

Route de Moncor, CH-1752 Villars-sur-  
Glâne, Switzerland

(540)

## PERSKINDOL

(591) Black, white

(511)

5 – Oil-free hemodynamic liniment against pain and  
sports injuries.

(260) AM 2014 72615 A

(800) 614586

(151) 1994 01 19

(891) 2013 04 03

(731) VIFOR S.A.

10, route de Moncor, CH-1752 VILLARS-  
SUR-GLÂNE, Switzerland

(540)

## TRIOFAN

(591) Black, white

(511)

5 – Pharmaceutical products.

(260) AM 2014 72616 A

(800) 744588

(151) 2000 09 20

(891) 2012 11 23

(731) ISTITUTO GANASSINI S.P.A.

DI RICERCHE BIOCHIMICHE

Via P. Gaggia, 16, I-20139 MILANO (MI),  
Italy

(540)

## BIOCLIN

(591) Black, white

(511)

3 – Bleaching preparations and other substances for  
laundry use; cleaning, polishing, scouring and ab-

rasive preparations, soaps, perfumery, essential oils,  
cosmetics, hair lotions, dentifrices.

(260) AM 2014 72617 A

(800) 787005

(151) 2002 06 13

(891) 2013 04 22

(731) K+S KALI GmbH

Bertha-von-Suttner-Straße 7, 34131 Kassel,  
Germany

(540)



(591) Red (HKS 15; euroscala 10 % cyan, 100 %  
magenta, 80 % yellow), blue (HKS 47;  
euroscala 100 % cyan)

(511)

1 – Potassium salts, in particular potassium chloride,  
potassium sulphate; magnesium salts, in particular  
magnesium chloride and magnesium hydroxide, kie-  
serite, magnesium sulphate; magnesium oxide; so-  
dium salts, in particular rock salt, sodium chloride,  
all the aforesaid goods being chemical preparations  
for industrial purposes; mineral fertilising prepa-  
rations, in particular potassium fertilising salt also  
derived from recycling products, potassium ferti-  
lising salt containing straight or compound fertiliser,  
organic fertiliser, and also from recycling products,  
as compost, pulp and liquid manure; mixture of  
mineral and organic fertiliser as aforesaid.

(260) AM 2014 72618 A

(800) 981105

(151) 2008 06 11

(891) 2013 05 02

(731) Tricobiotos S.p.A.

Via Di Spicciano 11, I-59021 VAIANO  
(Prato), Italy

(540)



(591) Black, white

(511)

3 – Soaps, perfumery, essential oils, cosmetics, cos-  
metic creams, hair lotions, hair dyes, hair spray, hair  
waving preparations, shampoos.

(260) AM 2014 72619 A

(800) 1085769

(151) 2011 04 08

(891) 2013 03 26

(731) Yara International ASA

Bygdøy allé 2, P.O. Box 2464 Solli, N-0202

Oslo, Norway

(540)



(591) Black, white

(511)

1 – Chemical products for use in industry, agriculture, horticulture and forestry; fertilizers; industrial chemicals, namely nitrogen based chemicals, including ammonia, ammonium bicarbonate, ammonium nitrate, dinitrogen tetroxide, nitric acid, hydrochloric acid, phosphoric acid, urea, calcium carbonate, calcium nitrate, potassium nitrate and sodium nitrate; formic acid and salts thereof; flocculants: industrial gases, specialty gases and welding gases, including acetylene, methyl acetylene, oxygen, nitrogen, argon, carbon dioxide, carbon monoxide, helium, hydrogen, neon, krypton, xenon, methane, deuterium and mixtures of said gases, all in gaseous, liquid or solid state; catalysts; cryogenic preparations.

13 – Ammonium nitrate for the production of emulsion explosives, including Ammonium Nitrate Fuel Oil explosives (ANFO), all for civil purposes.

44 – Rental of farming equipment; professional consultancy and advisory services in the field of agriculture, horticulture and forestry.

(260) AM 2014 72620 A

(800) 1089599

(151) 2011 06 10

(891) 2013 04 08

(731) Obchtchestvo s ogranitchennoi

otvetstvennostiou "Laboratoria sovremennogo zdorovia"

ul. Khimzavodskaia, 11/20, RU-633004

Berdsk, Novosibirskaia obl., Russian

Federation

(540)

## PANTORAL

(591) Black, white

(511)

5 – Albuminous foodstuffs for medical purposes; albuminous preparations for medical purposes; antiseptics; antiparasitic preparations; bacterial preparations for medical and veterinary use; balms for medical purposes; biocides; biological preparations for medical purposes; diabetic bread; dietetic beverages adapted for medical purposes; dietetic foods

adapted for medical purposes; dietetic substances adapted for medical use; digestives for pharmaceutical purposes; elixirs [pharmaceutical preparations]; ferments for pharmaceutical purposes; food for babies; germicides; haematogen; herbs teas for medicinal purposes; lacteal flour for babies; liniments; lotions for pharmaceutical purposes; medicinal herbs; medicinal infusions; medicinal oils; medicinal roots; mineral food-supplements; nervines; nutritional additives for medical purposes; opotherapy preparations; preparations of trace elements for human use; sea water for medicinal bathing; serums; styptic preparations; therapeutic preparations for the bath; tonics [medicines]; vitamin preparations.

(260) AM 2014 72621 A

(800) 1089600

(151) 2011 06 10

(891) 2013 04 08

(731) Obchtchestvo s ogranitchennoi

otvetstvennostiou "Laboratoria sovremennogo zdorovia"

ul. Khimzavodskaia, 11/20, RU-633004

Berdsk, Novosibirskaia obl., Russian

Federation

(540)

## HEALTHY RHYTHMS

(591) Black, white

(511)

5 – Albuminous foodstuffs for medical purposes; albuminous preparations for medical purposes; antiseptics; bacterial preparations for medical and veterinary use; balms for medical purposes; biocides; biological preparations for medical purposes; diabetic bread; dietetic beverages adapted for medical purposes; dietetic foods adapted for medical purposes; dietetic substances adapted for medical use; digestives for pharmaceutical purposes; disinfectants for hygiene purposes; ferments for pharmaceutical purposes; food for babies; fumigating sticks; germicides; herbs teas for medicinal purposes; lacteal flour [for babies]; liniments; lotions for pharmaceutical purposes; medicinal herbs; medicinal infusions; medicinal mud; medicinal oils; medicinal roots; mineral food-supplements; mouthwashes for medical purposes; nervines; nutritional additives for medical purposes; organotherapy preparations; pharmaceutical preparations for skin care; pharmaceutical preparations for treating dandruff; preparations of trace elements for human and animal use; remedies for perspiration; sanitary towels; sea water for medicinal bathing; serums; styptic preparations; therapeutic preparations for the bath; tissues impregnated with pharmaceutical lotions; tonics [medicines]; vitamin preparations.

(260) AM 2014 72622 A  
 (800) 1089601  
 (151) 2011 06 10  
 (891) 2013 04 08  
 (731) Obchtchestvo s ogranitchennoi  
 otvetstvennostiou "Laboratoria sovremennogo  
 zdorovia"  
 ul. Khimzavodskaia, 11/20, RU-633004  
 Berdsk, Novosibirskaia obl., Russian  
 Federation

(540)

**SYNCHROVITALS**

(591) Black, white

(511)

5 – Albuminous foodstuffs for medical purposes; albuminous preparations for medical purposes; antiseptics; bacterial preparations for medical and veterinary use; balms for medical purposes; biocides; biological preparations for medical purposes; diabetic bread; dietetic beverages adapted for medical purposes; dietetic foods adapted for medical purposes; dietetic substances adapted for medical use; digestives for pharmaceutical purposes; disinfectants for hygiene purposes; ferments for pharmaceutical purposes; food for babies; fumigating sticks; germicides; herbs teas for medicinal purposes; lacteal flour for babies; liniments; lotions for pharmaceutical purposes; medicinal herbs; medicinal infusions; medicinal mud; medicinal oils; medicinal roots; mineral food-supplements; mouthwashes for medical purposes; nervines; nutritional additives for medical purposes; ootherapy preparations; pharmaceutical preparations for skin care; pharmaceutical preparations for treating dandruff; preparations of trace elements for human and animal use; remedies for perspiration; sanitary napkins; sea water for medicinal bathing; serums; styptic preparations; therapeutic preparations for the bath; tissues impregnated with pharmaceutical lotions; tonics [medicines]; vitamin preparations.

(260) AM 2014 72623 A

(800) 1098874

(151) 2011 11 21

(891) 2013 04 08

(731) F. Hoffmann-La Roche AG  
 Grenzachstrasse 124, CH-4070 Basel,  
 Switzerland

(540)

**GAZYVA**

(591) Black, white

(511)

5 – Pharmaceutical preparations.

(260) AM 2014 72624 A

(800) 1100174

(151) 2011 09 12

(891) 2013 03 12

(731) İNMODA MOBİLYA KOLTUK  
 DEKORASYON İNŞAAT DAYANIKLI  
 TÜKETİM MALLARI SANAYİ VE  
 TICARET LIMITED SİRKETİ  
 İnegöl Bursa Karayolu Üzeri 5.Km No.  
 Bila İnegöl Bursa, Turkey

(540)

**inmoda**

(591) Black, white

(511)

20 – Furniture made of any kind of substance or material; beds, bed mattresses, pillows, non-medical air beds and pillows, sleeping bags for camping.

35 – Advertising; business management; business administration; office functions; the bringing together, for the benefit of others, of a variety of goods (excluding the transport thereof), enabling customers to conveniently view and purchase those goods; such services may be provided by retail stores, wholesale outlets, through mail order catalogues or by means of electronic media, for example, through web sites or television shopping programmes.

(260) AM 2014 72625 A

(800) 1117506

(151) 2012 05 10

(891) 2013 03 04

(731) MEDICE Arzneimittel GmbH  
 Römerstr. 14, A-5400 Hallein, Austria

(540)

**ФерМед**

(591) Black, white

(511)

5 – Pharmaceutical and veterinary preparations; sanitary preparations for medical purposes; dietetic food and substances adapted for medical or veterinary use, food for babies; dietary supplements for humans and animals; plasters, materials for dressings; material for stopping teeth, dental wax; disinfectants; preparations for destroying vermin; fungicides, herbicides.

(260) AM 2014 72626 A

(800) 1123153

(151) 2012 03 02

(891) 2013 04 08

(731) Obschestvo s ogranichennoy otvetstvennostyu "Laboratoriya sovremennogo zdorovya" ul. Khimzavodskaya, 11/20, Berdsk, RU-633004 Novosibirskaya oblast', Russian Federation

(540)

## UYAN NOMO

(591) Black, white

(511)

5 – Albuminous foodstuffs for medical purposes; albuminous preparations for medical purposes; antiseptics; antiparasitic preparations; bacterial preparations for medical and veterinary use; balms for medical purposes [including balms for treatment of joints]; biocides; biological preparations for medical purposes [including biologically active nutritional supplements]; diabetic bread; dietetic beverages adapted for medical purposes; dietetic foods adapted for medical purposes; dietetic substances adapted for medical use; digestives for pharmaceutical purposes; elixirs [pharmaceutical preparations]; ferments for pharmaceutical purposes; food for babies; germicides; herbal teas for medicinal purposes; lacteal flour for babies; liniments; lotions for pharmaceutical purposes; medicinal herbs; medicinal infusions; medicinal oils; medicinal roots; mineral food supplements [including biologically active nutritional supplements]; nervines; nutritional additives for medical purposes [including biologically active nutritional additives]; ootherapy preparations; preparations of trace elements for human use [including biologically active nutritional supplements]; sea water for medicinal bathing; serums; styptic preparations; therapeutic preparations for the bath; tonics [medicines]; vitamin preparations.

30 – Artificial coffee; iced tea; infusions, not medicinal; tea; tea-based beverages.

(260) AM 2014 72627 A

(800) 1137551

(151) 2012 04 25

(891) 2013 04 08

(731) Gorokhovskaya Tatyana Germanovna Krasnyi prospekt, d. 49, kv. 58, RU-630091 Novosibirsk, Russian Federation

(540)



(591) Black, white

(511)

3 – After-shave lotions; antiperspirants [toiletries]; aromatics [essential oils]; bath salts, not for medical purposes; beauty masks; breath freshening sprays; cleansing milk for toilet purposes; cosmetics; cosmetic creams; cosmetic dyes; cosmetic kits; cosmetic pencils; cosmetic preparations for baths; cosmetic preparations for eyelashes; cosmetic preparations for skin care; cosmetic preparations for slimming purposes; cotton sticks for cosmetic purposes; cotton wool for cosmetic purposes; dental bleaching gels; dentifrices; depilatories; deodorants for personal use; eau de cologne; eyebrow cosmetics; hair colorants; hair lotions; hair spray; hair waving preparations; lotions for cosmetic purposes; make-up removing preparations; make-up powder; mascara; mouth washes, not for medical purposes; nail care preparations; nail polish; oils for cosmetic purposes; oils for toilet purposes; perfumes; perfumery; pomades for cosmetic purposes; potpourris [fragrances]; shampoos; shaving preparations; soap; tissues impregnated with cosmetic lotions; toiletries; toilet water.

5 – Albuminous foodstuffs for medical purposes; albuminous preparations for medical purposes; antiseptics; antiparasitic preparations; bacterial preparations for medical and veterinary use; balms for medical purposes; biocides; biological preparations for medical purposes; diabetic bread; dietetic beverages adapted for medical purposes; dietetic foods adapted for medical purposes; dietetic substances adapted for medical use; digestives for pharmaceutical purposes; elixirs [pharmaceutical preparations]; food for babies; germicides; herb teas for medicinal purposes; lacteal flour for babies; liniments; lotions for pharmaceutical purposes; medicinal herbs; medicinal infusions; medicinal oils; medicinal roots; mineral food-supplements, namely, biologically active supplements; nervines; nutritional additives for medical purposes, namely, biologically active additives; ootherapy preparations; preparations of trace elements for human use, namely, biologically active supplements; sea water for medicinal bathing; serums; styptic preparations; therapeutic preparations for the bath; tonics [medicines]; vitamin preparations.

16 – Albums; almanacs; bags [envelopes, pouches] of paper or plastics, for packaging; booklets; books; cardboard articles; calendars; catalogues; credit card imprinters, non-electric; envelopes [stationery]; forms, printed; graphic prints; greeting cards; handbooks [manuals]; labels, not of textile; newsletters; newspapers; note books; pamphlets; paper; posters; printed matter; prospectuses; stationery; signboards of paper or cardboard; stickers [stationery]; teaching materials [except apparatus]; writing cases [sets]; writing instruments.

21 – Abrasive sponges for scrubbing the skin; aerosol dispensers, not for medical purposes; appliances for removing make-up, non-electric; combs; comb cases; cosmetic utensils; deodorising apparatus for personal use; electric combs; eyebrow brushes; floss for dental purposes; nail brushes; water apparatus for cleaning teeth and gums; shaving brushes; soap boxes; toilet cases; toilet utensils; toothbrushes; toothbrushes, electric; toothpicks; toothpick holders.

25 – Bandanas [neckerchiefs]; boots; breeches for wear; clothing; combinations [clothing]; dressing gowns; footwear; dresses; furs [clothing]; headgear for wear; hosiery; jackets [clothing]; neckties; outer-clothing; overalls; overcoats; parkas; pelisses; pullovers; ready-made clothing; sandals; sashes for wear; shirts; shoes; skirts; socks; stockings; suits; sweaters; tee-shirts; tights; trousers; underwear; vests.

29 – Albumen for culinary purposes; bouillon; caviar; cheese; crystallized fruits; edible fats; edible oils; eggs; fat-containing mixtures for bread slices; fish, not live; fish, tinned; foods prepared from fish; fruit-based snack food; fruit chips; fruit jellies; fruit, preserved; fruit preserved in alcohol; fruit pulp; fruit salads; fruit, stewed; fruits, tinned [canned (Am.)]; frozen fruits; jams; jellies for food; marmalade; meat; meat extracts; meat, preserved; meat, tinned [canned (Am.)]; milk; milk products; mushrooms, preserved; mussels, not live; nuts, prepared; potato chips; potato flakes; poultry, not live; raisins; sausages; soups; suet for food; vegetables, dried; vegetables, cooked; vegetable juices for cooking; vegetables, preserved; vegetable salads; vegetables, tinned [canned (Am.)].

30 – Aromatic preparations for food; bee glue [propolis] for human consumption; bread; bread rolls; buns; cakes; cereal-based snack food; cereal preparations; cocoa; cocoa-based beverages; cocoa beverages with milk; cocoa products; coffee; coffee-based beverages; coffee beverages with milk; chewing gum, not for medical purposes; chips [cereal products]; chocolate; chocolate beverages with milk; chocolate-based beverages; condiments; confectionery; cooking salt; crackers; edible ices; farinaceous foods; ferments for pastes; flour for food; flour-milling products; fruit jellies [confectionery]; garden herbs, preserved [seasonings]; gingerbread; groats for human food; gruel, with a milk base, for food; honey; ice cream; infusions, not medicinal; malt for human consumption; muesli; oat-based food; pancakes; pastries; pasties; pizzas; popcorn; puddings; ravioli; rice-based snack food; rusks; sandwiches; seasonings; spices; starch for food; sugar; sushi; sweetmeats [candy]; tarts; tea; tea-based beverages; thickening agents for cooking foodstuffs; vinegar; yeast.

35 – Administrative processing of purchase orders; advertising; business information; business management and organization consultancy; business research; commercial administration of the licensing of the goods and services of others; commercial information and advice for consumers [consumer advice shop]; data search in computer files for others; demonstration of goods; distribution of samples; import-export agencies; marketing studies; on-line advertising on a computer network; organization of exhibitions for commercial or advertising purposes; organization of trade fairs for commercial or advertising purposes; presentation of goods on communication media, for retail purposes; procurement services for others [purchasing goods and services for other businesses]; professional business consultancy; rental of advertising time on communication media; sales promotion for others, namely, wholesale and retail services.

41 – Arranging and conducting of concerts; arranging and conducting of seminars; arranging and conducting of workshops [training]; club services [entertainment or education]; educational examination; education information; entertainment information; film production; game services provided on-line from a computer network; health club services; night clubs; organization of competitions [education or entertainment]; practical training [demonstration]; providing amusement arcade services; providing on-line electronic publications, not downloadable; providing recreation facilities; providing sports facilities; publication of books; publication of electronic books and journals on-line; publication of texts, other than publicity texts; recreation information; rental of sports equipment, except vehicles; videotape film production; vocational guidance [education or training advice].

---

(260) AM 2014 72628 A

(800) 1141037

(151) 2012 10 24

(891) 2013 04 08

(731) Obschestvo s ogranichennoy otvetstvennostyu  
"Laboratoriya sovremennogo zdorovya"  
ul. Khimzavodskaya, 11/20, Berdsk,  
RU-633004 Novosibirskaya oblast',  
Russian Federation

(540)

## LYMPHOSAN

(591) Black, white

(511)

5 – Albuminous foodstuffs for medical purposes; albuminous preparations for medical purposes; anti-parasitic preparations; antiseptics; bacterial preparations for medical and veterinary use; balms for medical purposes; biocides; biological preparations for medical purposes [including bioactive food

additives]; diabetic bread adapted for medical use; dietetic beverages adapted for medical purposes; dietetic foods adapted for medical purposes; dietetic substances adapted for medical use; digestives for pharmaceutical purposes; elixirs [pharmaceutical preparations]; ferments for pharmaceutical purposes; germicides; hematogen; herbal teas for medicinal purposes; liniments; lotions for pharmaceutical purposes; medicinal herbs; medicinal infusions; medicinal oils; medicinal roots; mineral food supplements [including bioactive food additives]; nervines; nutritional additives for medical purposes [including bioactive food additives]; organotherapy preparations; preparations of trace elements for human [including bioactive food additives]; sea water for medicinal bathing; serums; styptic preparations; therapeutic preparations for the bath; tonics [medicines]; vitamin preparations.

(260) AM 2014 72650 A  
 (800) 1160486  
 (151) 2013 03 22  
 (731) Nemiroff Intellectual Property Establishment  
 Städtle 31, FL-9490 Vaduz, Liechtenstein

(540)

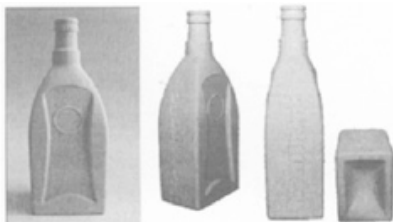

(591) Black, white  
 (511)  
 33 – Alcoholic beverages (except beers).

(260) AM 2014 72652 A  
 (800) 1160562  
 (151) 2013 01 18  
 (731) J. Floris Limited  
 89 Jermyn Street London SW1Y 6JH,  
 United Kingdom

(540)

## FLORIS

(591) Black, white  
 (511)  
 3 – Non-medicated toilet preparations, cosmetic preparations, depilatory preparations, perfumery, perfumes, eau de cologne, soaps, dentifrices, preparations for the hair, anti-perspirants, shampoos, deodorants, toilet articles, powders, creams and lotions, bath preparations and bath crystals, shaving soaps, shaving oils, shaving creams, aftershave lotions, aftershaves, aftershave balms, essential oils, fragrances, air freshening preparations, incense and incense sticks, fragrant sachets, pot pourri, paper and

fabric sachets for perfuming linen and lingerie; pomanders, non-medicated mouth washes; scented shoe stuffers.

4 – Candles and illuminants.

(260) AM 2014 72653 A  
 (800) 1160587  
 (151) 2013 03 14  
 (731) TA Hydronics SA (TA Hydronics AG)  
 (TA Hydronics Ltd)  
 Lake Geneva Business Park, Route de  
 Crassier 19, CH-1262 Eysins, Switzerland

(540)

## TA-FUSION

(591) Black, white  
 (511)  
 9 – Apparatus and instruments for measuring, weighing, signaling, automation, checking (supervision); apparatus, systems and instruments, including computer controlled apparatus for checking and monitoring as well as programming apparatus and systems (timers) and software, system software, printed circuits and recorded software, all the aforementioned goods for heating, cooling, ventilation, climate control, water supply, temperature adjustment, lighting, power supply, air conditioning and security in buildings; transformers, rheostats, fire fighting apparatus; fire-extinguishing apparatus; apparatus for controlling temperature and supplying electricity in buildings; parts and components of all the aforesaid goods.

11 – Apparatus for lighting, heating, cooling, drying, steam generating, cooking, ventilation, water supply, air conditioning, climate control and sanitary purposes installed in buildings; control valves included in this class; parts and components of all the aforesaid goods.

(260) AM 2014 72654 A  
 (800) 1160588  
 (151) 2013 03 14  
 (731) TA Hydronics SA (TA Hydronics AG)  
 (TA Hydronics Ltd)  
 Lake Geneva Business Park, Route de  
 Crassier 19, CH-1262 Eysins, Switzerland

(540)



(591) Black, white  
 (511)  
 9 – Apparatus and instruments for measuring, weighing, signaling, automation, checking (supervision); apparatus, systems and instruments, including computer controlled apparatus for checking and monitoring as well as programming apparatus and sys-

tems (timers) and software, system software, printed circuits and recorded software, all the aforementioned goods for heating, cooling, ventilation, climate control, water supply, temperature adjustment, lighting, power supply, air conditioning and security in buildings; transformers, rheostats, fire fighting apparatus; fire-extinguishing apparatus; apparatus for controlling temperature and supplying electricity in buildings; parts and components of all the aforesaid goods.

11 – Apparatus for lighting, heating, cooling, drying, steam generating, cooking, ventilation, water supply, air conditioning, climate control and sanitary purposes installed in buildings; control valves included in this class; parts and components of all the aforesaid goods.

(260) AM 2014 72655 A

(800) 1160629

(151) 2012 10 04

(731) CONG TY TRACH NHIEM HUU HAN

NHAT NHAT

So 3, ngo 189 Hoang Hoa Tham, phuong Lieu

Giai, quan Ba Dinh Ha Noi, Viet Nam

(540)

**TÂM TÂM**

(591) Black, white

(511)

5 – Pharmaceutical preparations; nutritive food stuff for medical purpose.

(260) AM 2014 72656 A

(800) 1160645

(151) 2013 02 04

(731) Zentiva Group, a.s.

U kabelovny 130, CZ-102 37 Praha

10 – dolní Měcholupy, Czech Republic

(540)

**FORBONE**

(591) Black, white

(511)

5 – Medicines, pharmaceutical preparations for human use.

(260) AM 2014 72657 A

(800) 1160646

(151) 2013 01 10

(731) Zentiva Group, a.s.

U kabelovny 130, CZ-102 37 Praha

10 – dolní Měcholupy, Czech Republic

(540)

**TAXIER**

(591) Black, white

(511)

5 – Medicines, pharmaceutical preparations for human use.

(260) AM 2014 72658 A

(800) 1160647

(151) 2013 01 10

(731) Zentiva Group, a.s.

U kabelovny 130, CZ-102 37 Praha

10 – dolní Měcholupy, Czech Republic

(540)

**CABENDE**

(591) Black, white

(511)

5 – Medicines, pharmaceutical preparations for human use.

(260) AM 2014 72705 A

(800) 1161202

(151) 2012 06 22

(731) WORLD MEDICINE İLAÇLARI LİMİTED

ŞİRKETİ

Evren Mah., Camiyolu Cad. No.50 K.2,

GÜNEŞLİ/BAĞCILAR/İSTANBUL, Turkey

(540)



(591) Black, white, red

(511)

3 – Bleaching preparations and other substances for laundry use; perfumery, cosmetics, essential oils for personal use, soaps, dental care products, abrasive products; emery cloth, emery papers, emery powders and pastes, pumice stones and abrasive pastes.

5 – Medicines for human purposes, medicines for veterinary purposes, chemical preparations for medical purposes, dietetic substances adapted for medical use; dietetic foods adapted for medical purposes; amino acids for medical purposes, nutritional substances, pollen dietary substances, mineral food substances, protein dietary supplements, baby foods, medicinal herbs, herbal beverages adapted for medical purposes; medicines for dental purposes, hygienic products for medical purposes including pads, waddings for medical purposes, plasters for medical purposes, dressings for medical purposes, preparations for destroying noxious plants, preparations for destroying noxious animals, fungicides, deodorants other than for personal use, disinfectants

for hygiene purposes, antiseptics, detergents for medical purposes.

8 – Goods such as forks, spoons, knives and non-electric cutter, kitchen appliances used for cutting, mincing, peeling; side arms and cutting tools (hand tools) used as provoking weapons; tools and implements for personal care, used in shaving, depilation, manicure, pedicure and beauty, included in this class (including scissors); hand-operated (non-motor) tools related to the reparation of machine, device, vehicle and to the construction, agriculture, horticulture and forestry.

10 – Surgical, medical, dental and veterinary apparatus and instruments; artificial limbs, eyes and teeth and prosthesis; orthopedic articles; suture materials and surgical sterile sheets; devices and equipments for sexual purposes; contraceptive devices; feeding bottles, baby bottles, teethingers for babies.

16 – Paper, cardboard and goods made from these materials (except goods used for stationery); packaging and wrapping materials made of plastic materials; printed matter and bookbinding materials; printed documents; printed publications, calendars, posters, photographs, notices, charts, stickers, stamps; stationery, office requisites, educational and teaching materials (except furniture and devices); office machines, included in this class; whitewashing and painting brushes and rolls.

21 – Non-electric cleaning tools and appliances (brushes except for painting brushes, including steel wool for cleaning, sponges, steel wool, cleaning wool, cleaning and wiping clothes made of textile, dishwashing gloves, non-electric polishing machines, carpet brooms, mops); toothbrushes, electrical toothbrushes, dental floss, shaving brushes, hair brushes, combs; non-electrical tools and utensils for household and kitchen use; ironing boards, ironing board covers, laundry-drying racks, clothes drying hangers; cages and litter boxes for pets, indoor terrariums for plants; indoor terrariums for animals; decorative articles, statues, knickknacks (ornamental plates), vases, cups given during sports competitions made of glass, porcelain, ceramic, clay; mousetraps, insect traps, fly catchers, fly swatters; perfume burners (burners giving off scents when lit), perfume sprays and vaporizers (atomizers), non-electric devices made of sponges for removing makeup, powder puffs, boxes for toilet articles; sprinklers for watering garden flowers and plants, wrought glass, partially wrought glass, glass mosaics and glass powder for decorative purposes (except for building), glass wool (not for insulation and textile purposes).

29 – Meat, fish, meat of poultry and game and all kinds of processed meat products; dried beans; dried peas; ready-made soups, bouillions; olives, olive paste; milk and milk products (including butter);

edible vegetable oils; dried, preserved, frozen, cooked, smoked, pickled fruits and vegetables; purée of hazelnut and peanut, tahini (sesame seed paste); eggs, powdered eggs; nutrient-dense foods, containing pollen, proteins with added carbohydrates), potato chips.

30 – Coffee, cocoa, coffee or cocoa-based beverages, chocolate-based beverages; pasta, raviolis, home made pasta; bakery products, confectionery, honey, royal jelly, propolis; food flavorings other than essential oils; yeasts, baking powder, all kinds of flour, semolina, corn starch; granulated sugar, cubed sugar, powdered sugar; teas, iced teas; chocolates, biscuits, crackers, waffles; chewing gums; ice creams, edible ice; salt; processed grains; processed cereals; grain products.

35 – Services related to advertising, marketing and public relations including organization of exhibitions and fairs for commercial or advertising purposes, office services, business management and administration, consultancy for business management and administration including accountancy services, import export agency services, commercial and industrial management expertise services, organization of auctioneering services and auctioneering, the bringing together of a variety of goods enabling customers to conveniently view and purchase those goods (the mentioned services can be provided by wholesale outlets, retail stores, by means of electronic media or through mail order catalogues and other similar methods).

44 – Medical services; hygienic and beauty care for human beings; veterinary services, agriculture, horticulture and forestry services, services of a nursing home.

(260) AM 2014 72706 A

(800) 1161209

(151) 2013 01 28

(731) SIPADAN-MABUL RESORT (SABAH)  
SDN. BHD.

Lot A-1-G, Block A, Signature Office, KK  
Times Square, Off Coastal Highway, 88100  
Kota Kinabalu, Sabah, Malaysia

(540)



(591) Black, white

(511)

43 – Services for providing food and drink; temporary accommodation including provision of holiday accommodation; provision of food and drinks in



restaurants, cafes, cafeterias and takeaway food and drink services; hotel and resort hotel services; catering services; providing facilities for conventions, conferences and exhibitions; provision of changing room facilities (incorporating shower and toilet facilities); provision of information about services for providing food, drink and temporary accommodation via all means of communication, including online from a computer database or the global communications network; provision of information, advisory and consultancy services in respect of all of the aforesaid services.

(260) AM 2014 72707 A  
 (800) 1161260  
 (151) 2013 03 07  
 (731) L'OREAL (Société Anonyme)  
 14, rue Royale, F-75008 Paris, France  
 (540)



(591) Black, white  
 (511)  
 3 – Perfumed soaps; perfumery; perfumes; eau de toilette; eau de cologne; perfumed shower and bath gels; perfumed shower and bath salts; deodorants for personal use; non-medicated skincare preparations; cosmetics, in particular creams, milks, lotions, gels and powders for the face, body, hair and hands; non-medicated sun care preparations; suntanning preparations; sunscreens preparations; make-up preparations; hair care preparations; shampoos; hair styling preparations; hair-colouring preparations; essential oils for personal use.  
 8 – Eyelash curlers; tweezers; nail files.  
 18 – Vanity cases sold empty; toiletry cases sold empty; toiletry bags; beauty cases [not fitted]; make-up cases; make-up bags.  
 21 – Fitted toiletry cases; powder compacts [cases]; cases adapted for cosmetic utensils; nail brushes; eyebrow brushes; cosmetic brushes; make-up brushes; skin cleansing brushes; mascara brushes; eyelash combs; combs and sponges for cosmetic use.

(260) AM 2014 72710 A  
 (800) 1161287  
 (151) 2013 04 08  
 (731) BESPOKE SERVICES GROUP SA  
 Rue Philippe-Plantamour 20, CH-1201  
 Genève, Switzerland



(591) Black, white  
 (511)  
 35 – Advertising; business management; business administration; office functions.  
 36 – Insurance underwriting; financial affairs; monetary affairs; real estate affairs.  
 37 – Building construction; repair; installation services.  
 38 – Telecommunications.  
 39 – Transport; packaging and storage of goods; travel arrangement.  
 41 – Education; training; entertainment; sporting and cultural activities.  
 42 – Scientific and technological services and research and design relating thereto; industrial analysis and research services; design and development of computers and software.  
 43 – Services for providing food and drink; temporary accommodation.  
 44 – Medical services; veterinary services; hygienic and beauty care for human beings or animals; agriculture, horticulture and forestry services.  
 45 – Legal services; security services for the protection of property and individuals; detective agencies; baby sitting; escorting in society (chaperoning), mediation; marriage agencies, dating services; horoscope casting; undertaking, cremation, organization of religious meetings; clothing rental.

(260) AM 2014 72712 A  
 (800) 1161307  
 (151) 2013 04 09  
 (731) Messe München GmbH  
 Am Messesee 2, 81829 München, Germany  
 (540)



(591) Green and brown  
 (511)  
 16 – Printed matter.

35 – Organisation of exhibitions and trade fairs for commercial and advertising purposes; publication and issuance of advertising texts.

41 – Arranging of exhibitions for cultural and teaching purposes; organisation and arranging of congresses and meetings; publication and issuance of printed matter (except for advertising purposes).

(260) AM 2014 72713 A

(800) 876190

(151) 2005 02 16

(891) 2013 05 10

(731) KİMAR KİMYASAL ARA MADDELERİ  
SANAYİ VE TİCARET ANONİM ŞİRKETİ  
Gosb 700 Sokak Gebze KOCAELİ, Turkey

(540)



(591) Black, white, red, blue, orange

(511)

1 – Chemicals used in industry, science and photography, as well as in agriculture, horticulture and forestry; unprocessed artificial resins, unprocessed plastics; manures; fire extinguishing compositions; tempering and soldering preparations; chemical substances for preserving foodstuffs; tanning substances; adhesives used in industry.

2 – Paints, varnishes, lacquers; preservatives against rust and against deterioration of wood; colorants; mordants; raw natural resins; metals in foil and powder form for painters, decorators, printers and artists.

17 – Rubber, gutta-percha, gum, asbestos, mica and goods made from these materials and not included in other classes; plastics in extruded form for use in manufacture; packing, stopping and insulating materials; flexible pipes, not of metal.

(260) AM 2014 72714 A

(800) 696669

(151) 1998 06 29

(891) 2013 02 26

(731) Mitas a.s.  
Svehlova 1900/3, Záběhlice, CZ-106 00  
Praha 10, Czech Republic

(540)

**MITAS**

(591) Black, white

(511)

12 – Tyres.

17 – Mix for casing retreading, rubber material for recapping tyres.

(260) AM 2014 72718 A

(800) 933987

(151) 2007 08 06

(891) 2013 05 07

(731) SJEC CORPORATION

718 Fengting Avenue, Suzhou Industrial  
Park Suzhou, China

(540)

**SJEC**

(591) Black, white

(511)

7 – Elevators; elevating apparatus; hoists; moving stair cases (escalators).

(260) AM 2014 72720 A

(800) 959878

(151) 2007 12 19

(891) 2013 04 04

(731) Nilfisk-Advance A/S

Sognevej 25, DK-2605 Brøndby, Denmark

(540)

**VIPER**

(591) Black, white

(511)

7 – Machines and machine tools, cleaning machines, including vacuum cleaners, central vacuum cleaning installations, suction apparatus (vacuum cleaners) for the removal of dust, wet and dry vacuum cleaners, vacuum cleaners for liquids, soot removers, dust separators, special vacuum cleaners for industrial purposes, vacuum application equipment for complex machines, pneumatic transporters (machines), vacuum cleaners for household purposes, fixed vacuum equipment, floor cleaning machines, complex machines for washing and drying surfaces, carpet cleaning machines, industrial floor-polishers, floor sweepers, monophase and three-phase blowers; vacuum cleaner bags, vacuum cleaner hoses, vacuum cleaner attachments for disseminating perfumes and disinfectants, parts and accessories for the mentioned goods (not included in other classes), including filters for vacuum cleaners and cleaning machines (not included in other classes).

(260) AM 2014 72724 A

(800) 981198

(151) 2008 04 18

(891) 2013 02 08

(731) YPS İÇ VE DIŞ TİCARET LİMİTED

ŞİRKETİ

Ankara Yolu Üzeri, Konsan Özel Organize

Sanayi Bölgesi, Hilal Sokak No.30-32

KONYA, Turkey

(540)



(591) Black, gray and red

(511)

7 – Machine tools to process wood, metal, glass and plastic materials; lathes, milling machines, planing machines, saw blades, sanding machines, industrial grinding machines, cutting machines, plastic injection machines, threading machines, working machines, construction machines; bulldozers, excavators, road making machines, drainage machines, rock drilling machines, loaders, road sweeping machines (self propelled), rolling mills, rams, molding machines, rolling mill cylinders, lifting and hoisting machines; elevators for people and material, moving pavements, ramps, lifts, cranes, moving staircases (escalators), belt conveyors, elevators; milking machines, churns, dairy machines, incubators for eggs and brooding machines, bale machines, pulverizing machines; engines and motors, segments, transmission chains and shafts, transmission shaft bearings, crank shafts, pressure reducers, pressure regulators, pressure valves, hydraulic and pneumatic controls, pulleys, bobbins included in this class, pistons for engines and sleeves, speed governors, driving mechanisms, torque transformers (converters), counter pedals, clutches, cardan joints (universal joints), turbines, other than for land vehicles (for working machines and water and air vehicles), brake mechanisms and segments, brakes, brake linings and shoes, brake repair sets, starters, dynamos, bicycle dynamos, spark plugs, igniting devices, injectors, exhausts, exhaust installations, mufflers, belts, V-belts, dynamo belts, conveyor belts for engines and motors, bearings, ball or roller bearings, carburetors, carburetor feeders, fuel economizers for engines, fuel conversion apparatus for internal combustion engines (LPG conversion apparatus); radiators (engine cooling) for vehicles, fans, oil, fuel and air filters for engines and motors, hydraulic and pneumatic cylinders (pistons), cylinder heads other than engine parts, electric engines (other than for land transportation vehicles), rack and pinion jacks for tires, alternators, generators; electrical generators, painting machines, spray guns for paint, electric punching machines and guns, glue guns (electric),

pressurized air or liquid spray guns, electric hand drills, chain saws, spirals, robots used in production, shearing machines for animals, compressed air machines, compressors; welding machines, electric welding machines, point welding machines, printing machines and apparatus, mine working machines for crumbling and breaking, packaging machines, filling-tapping and covering machines, labelers, classifiers, machines for manufacturing of leather and fabric goods; sewing machines, embroidery machines, edging machines, button looping and sewing machines, cutting machines, textile machines; weaving machines, thresher machines, reed machines, thread bending machines (ring machines), weaving looms, pumps other than parts of machines, engines or motors; pressure tanks, water pumps (electro pumps, motor pumps), diver pumps, pumps for heating installations, pumps (parts of machines, engines or motors) (liquid and gas pumps), electric kitchen machines used for chopping, grinding, crushing, trimming and crumbling; mixers, blenders, kitchen robots, electric knives, meat grinders, garbage grinding machines, dishwasher machines, washing machines, electric ground polishing machines, vacuum cleaners, carpet washing machines and their bags, hoses and parts; casting machines and their parts, crucibles (converters) for casting, refining crucibles, vehicle washing installations, automatic kneading machines, dough shaping machines, drying machines for setting dough aside, dough cutting machines, annealing machines, machines for separating foreign bodies, sieving machines, electro magnetizing (separator) machines, milling machines, grain processors, grain breaking machines, wheat brushing machines, peeling and separating machines; electromechanical controls for vehicle windows.

12 – Automobiles, trucks, buses, tow trucks, tractors, refrigerated vehicles, vehicles mixing and transporting concrete, military vehicles for transport purposes, ambulances, watering trucks, hose trucks, sports cars, golf carts, garbage trucks, mobile funeral service vehicles, mobile kitchens, forklifts, sewage trucks, engines, chassis, axles, axletrees, connecting rods for land vehicles, gearboxes (transmissions), clutches, engine cylinders (pistons), engine sleeves (piston sleeves), jet engines, transmission chains, gears, vehicle tires, rims of land vehicles, pushrods, bodies, bumpers, vehicle doors, hoods, fenders, mudguards of bicycles and motorbikes, bicycles, motorbikes, mopeds and similar vehicles, and their bodies, handlebars, vehicle trunks, dump body trunks, tractor trailers, refrigerated trucks, dump bodies, shock absorbers; hydraulic, pneumatic, electric or mechanical suspension springs, cylinders and parts for shock absorbers, brake repair sets and parts for vehicles, brakes, brake linings and shoes, vehicle seats, head supports for seats, safety seats for children in vehicles, direction signals, tires, inner

tubes and tubeless tires for vehicles, tire-fixing sets, patches for vehicle tires, adhesive rubber patches for repairing inner tubes; valves for vehicle tires, windows for vehicles, safe windows for vehicles, windshield wipers for vehicles, wiper arms, fuel tanks for vehicles, tire chains, wedges for land vehicles, bicycle and ski carriers, saddles for vehicles, tire inflating pumps, anti-theft alarms, horns for vehicles, safety belts, airbags for vehicles, seat covers, vehicle covers (fitted, shaped), sunshades, trailer hitches for vehicles, profile bars made of metal or synthetic materials for vehicles (for decoration purposes), rearview mirrors and side mirrors for vehicles, strollers, wheelchairs, baby carriages, hand cars, shopping carts, single or multi-cycle hand cars, carrier tricycles, and household goods handling carts; aerial conveyor vehicles: telfer railways (cable cars), lifts for skies; railway vehicles: locomotives, trains, tramways, wagon cars; water vehicles and parts (other than their engines and motors): rowboats, motorboats, ships, yachts, cutter boats, boats, ferryboats, canoes; steering gears, rudders, spars, timbers, fenders, screws (propellers), funnels, hulls for water vehicles; air vehicles and parts.

17 – Goods made of rubber, natural rubber, plastic and similar materials namely rubber and natural rubber pads (shock absorbers), expansion bellows, rubber stoppers, sealing plugs made primarily from rubber, billets of rubber, sleeves and brackets of rubber, foam rubber for protecting parts of machinery, rings of rubber for use as pipe connection seals, washers of rubber, metal engine gaskets for vehicles, gasket sealer for use in plumbing, gasket rings.

(260) AM 2014 72728 A

(800) 1039594

(151) 2010 04 21

(891) 2013 04 10

(731) KIM, Yee Haeng

332-1 Suseong 3ga, Suseong-gu, Daegu

706-833, Republic of Korea

(540)



(591) Black, white

(511)

6 – Flashing of metal, for building; metal roofing tiles; gutters of metal; tile floorings of metal; floor boards of metal; tiles of metal; metal sheets for floor boards; metal sheets for wall boards; metal sheets for roofing; metal sheets for ceiling decorations.

(260) AM 2014 72729 A

(800) 1133530

(151) 2012 05 17

(891) 2013 03 25

(731) ISHIHARA SANGYO KAISHA, LTD.

3-15, Edobori, 1-Chome, Nishi-Ku,

Osaka-Shi, Osaka 550-0002, Japan

(540)



(591) Black, white

(511)

5 – Herbicides; insecticides; nematocides; fungicides; preparations for destroying vermin and weeds; pesticides.

(260) AM 2014 72890 A

(800) 1162751

(151) 2013 04 12

(731) Dr. Theiss Naturwaren GmbH

Michelinstrasse 10, 66424 Homburg,

Germany

(540)

DR.THEISS  
HEILQUELLEN-KOSMETIK



(591) Blue and grey

(511)

3 – Bleaching preparations and other substances for laundry use; cleaning, polishing, scouring and abrasive preparations; soaps; perfumery, ethereal oils, cosmetics, including non-medicated preparations for cleaning and caring for the skin, and hair care preparations; hair lotions; dentifrices.

5 – Pharmaceutical and veterinary preparations; medicines for human or veterinary purposes; sanitary preparations for medical purposes; food and dietetic substances adapted for medical use, food for babies; nutritional supplements; vitamin preparations, including beauty capsules; plasters, materials for dressings; material for stopping teeth, dental wax; disinfectants.

(260) AM 2014 72891 A  
 (800) 1162781  
 (151) 2013 03 18  
 (731) AYT KUMAŞÇILIK SANAYİ VE DIŞ  
 TİCARET LIMITED ŞİRKETİ  
 Aksaray Mahallesi Küçüklanga, Aralığı Cad.  
 No.19 K:1 Fatih İstanbul, Turkey

(540)



(591) Black, white and brown  
 (511)

24 – Non-woven fabrics; woven fabrics; household linen; cloth pennants; handkerchiefs; fabric flags.

35 – Advertising, marketing and publicity services; organization of exhibitions and trade fairs for commercial or advertising purposes; office functions; advisory services for business management; business accounts management; import-export agencies; efficiency experts; auction and reverse auction services; the bringing together, for the benefit of others of "non-woven fabrics, woven fabrics, household linen, cloth pennants, handkerchiefs, fabric flags" (excluding the transport thereof), enabling customers to conveniently view and purchase those goods from wholesale outlets, retail outlets and from a general merchandise catalogue by mail order or by means of telecommunications.

(260) AM 2014 72892 A  
 (800) 1162783  
 (151) 2013 04 22  
 (731) GIORGIO ARMANI S.P.A.  
 Milan, Swiss Branch Mendrisio; Via Penate  
 4, CH-6850 Mendrisio, Switzerland

(540)



(591) Black, white  
 (511)

25 – Clothing, footwear, headgear.

(260) AM 2014 72894 A  
 (800) 1162791  
 (151) 2013 01 24  
 (731) QUARMAX LIMITE  
 Artisan House, 7 Queensbridge Northampton  
 NN4 7BF, United Kingdom

(540)

# Anamint

(591) Black, white

(511)

5 – Pharmaceutical preparations.

(260) AM 2014 72895 A  
 (800) 1162806  
 (151) 2012 10 22  
 (731) EVYAP SABUN YAĞ GLİSERİN SANAYİ  
 VE TİCARET ANONİM ŞİRKETİ  
 Ayazağa Cendere Yolu No.10, Levent  
 İstanbul, Turkey

(540)

# EVY BABY

(591) Black, white

(511)

3 – Preparations used for bleaching and cleaning purposes; perfumery; cosmetic products; deodorants used for personal purposes (including deodorants for human beings and for animals), soaps, cosmetic preparations for the care of mouth and teeth, abrasive products, emery cloth, emery paper, emery powders and pastes, pumice stones, pastes, polishes and care products (used for leather, vinyl, metal and wood).

5 – Medication for human and animal health, chemical products for medical purposes, dietetic substances for medical purposes; diet foods, baby foods; medical herbs and herbal drinks; dietetic supplements for humans and animals (including dietetic preparations for non medical purposes, pollen for using dietetic supplement, animal feed supplements for non medical purposes), products for dentistry (other than apparatus/devices), hygienic products (pads, tampons, fever blister treatment preparations, plasters, bandages, bandaging materials for medical purposes, diapers including made of paper and textile) substances for destroying weeds, vermin and fungus, deodorants other than for human beings and for animals, odor repellents for rooms, disinfectants, antiseptics (bacteria killers), detergents for medical purposes.

10 – Feeding bottles, feeding bottle nipples, babies' pacifiers, teething rings.

16 – Paper, cardboard, paperboard and products made of them; packaging materials made of paper, cardboard and plastic not included in other classes;

printed matter and bookbinding materials; printed matter; printed publications, calendars, posters, pictures, notices, charts, stickers, (stamps) stationery, office, educational and teaching materials (except furniture and apparatus); typewriters and office requisites (except furniture); paint brushes and paint rollers.

(260) AM 2014 72896 A

(800) 1162816

(151) 2013 05 07

(731) HOPERISE TEXTILES CO., LTD.

QUANZHOU

Economic Development Zone, Quanzhou,

Fujian, China

(540)

**HÔPERISE**

(591) Black, white

(511)

33 – Fruit extracts, alcoholic; spirits [beverages]; wine; brandy; rice alcohol; aperitifs; cocktails; distilled beverages; alcoholic beverages, except beer; alcoholic beverages containing fruit.

(260) AM 2014 72899 A

(800) 1162849

(151) 2013 03 15

(731) Hawle Armaturen AG

Mattenrainstrasse 9-11, CH-8370 Sirmach,

Switzerland

(540)

 hawido

(591) Blue, black and white

(511)

6 – Valves of metal for water pipes, metal valves controlled by a membrane.

9 – Electric or electronic controls for hydraulic installations; electric or electronic controls for energy use in hydraulic installations.

11 – Regulating and safety accessories for water apparatus, namely automatic and manually-operated regulation valves for water supply and for regulation of fluids in the industrial sector.

37 – Assembly of hydraulic installations with valves.

42 – Construction work planning for hydraulic installations equipped with valves; construction work planning regarding control apparatus for controlling and regulating hydraulic installations; construction work planning regarding control apparatus for the use of energy in hydraulic installations.

(260) AM 2014 72900 A

(800) 1162893

(151) 2013 03 05

(731) DİMES GIDA SANAYİ VE TİCARET ANONİM ŞİRKETİ

Gıda Sanayi Sitesi No.1 TOKAT, Turkey

(540)

**DİREN**

(591) Black, white

(511)

33 – Alcoholic beverages excluding beers, namely, wines, liqueurs, brandies, whiskeys, sake (Japanese traditional alcoholic beverage), raki (Turkish traditional anise flavored alcoholic beverage), cocktails, milk based alcoholic beverages, anise flavored alcoholic beverages, alcoholic preparations for use in the production of alcoholic beverages.

(260) AM 2014 72901 A

(800) 1162914

(151) 2013 03 13

(731) VIENNA INSURANCE GROUP AG Wiener

Versicherung Gruppe

Schottenring 30, A-1010 Vienna, Austria

(540)

 WIENER OSIGURANJE  
VIENNA INSURANCE GROUP

(591) Red, white and black

(511)

36 – Insurance; financial affairs; monetary affairs; real estate affairs.

(260) AM 2014 72904 A

(800) 1162998

(151) 2013 04 25

(731) ASK Chemicals GmbH

Reisholzstr. 16-18, 40721 Hilden, Germany

(540)

**UDICELL**

(591) Black, white

(511)

7 – Fireproof filters for foundry engineering (parts for engines); fireproof filters for foundry machines or casting equipment (machines), in particular to prevent the penetration of contaminants when casting; fireproof filters being parts of machines, included in this class, in particular for grey cast iron, nodular graphite iron, cast steel and aluminium; feeder sleeves for use in foundries (parts of machines); feeders (parts of machines) being parts of

casting equipment, in particular exothermic and insulating push-in feeders and insulating feeder sleeves.

(260) AM 2014 72905 A

(800) 1163008

(151) 2013 04 15

(731) WISEN INTERNATIONAL INDUSTRIES LTD

Suite 1112, 11/F, Ocean Centre, 5 Canton Road, Harbour City, Tsimshatsui Kowloon, Hong Kong, China

(540)



(591) Black, white

(511)

4 – Fuel gas; fuel; mineral fuel; fuel with an alcoholic base.

11 – Burners; lighters; gas lighters.

34 – Gas containers for cigar lighters; lighters for smokers; firestones.

35 – Import-export agencies; computerized file management; demonstration of goods; marketing studies; Organization of exhibitions for commercial or advertising purposes; sales promotion for others; distribution of samples; publicity; compilation of information into computer databases; procurement services for others [purchasing goods and services for other businesses]; systemization of information into computer databases.

(260) AM 2014 72907 A

(800) 1163014

(151) 2013 03 19

(731) ZF Friedrichshafen AG

Graf-von-Soden-Platz 1, 88046 Friedrichshafen, Germany

(540)

**TRAKSON**

(591) Black, white

(511)

12 – Transmissions for motor vehicles.

37 – Maintenance and repair of transmissions for motor vehicles.

(260) AM 2014 72910 A

(800) 1163039

(151) 2013 05 07

(731) Rolled Alloys, Inc.

125 W.Sterns Road, Temperance MI 48182, USA

(540)

**AFP**

(591) Black, white

(511)

6 – Stainless steel.

(260) AM 2014 72911 A

(800) 1163058

(151) 2013 05 08

(731) Mouser Electronics, Inc.

1000 North Main Street, Mansfield Tx 76063, USA

(540)

**MOUSER**

(591) Black, white

(511)

35 – Distributorship services in the field of electronic components; catalog ordering service featuring electronic components; electronic catalog services featuring electronic components; electronic commerce services, namely, providing information about products via telecommunication networks for advertising and sales purposes; mail order catalog services featuring electronic components.

(260) AM 2014 72913 A

(800) 1163117

(151) 2013 03 21

(731) Eurofish Trading AG

Route des Arsenaux 41, CH-1700 Fribourg, Switzerland

(540)



(591) Black, white

(511)

29 – Fish, salted fish, preserved fish, fish fillets, food products made from fish, canned fish, isinglass for food, fish meal for human consumption, fish mousse, preserved fish spawn, tuna fish; all these goods are of European origin.

31 – Live fish, fish meal for animal consumption, fish spawn; all these goods are of European origin.

35 – Provision of business information, advice for conducting business, retail sale and wholesale services, assistance and conducting of business for others, arranging and concluding commercial transactions for others.

(260) AM 2014 72914 A

(800) 1163120

(151) 2013 03 26

(731) VILMORIN

Route du Manoir, F-49250 LA MENITRE,  
France

(540)

## SEED GENERATION

(591) Black, white

(511)

1 – Chemical products for use in industry, agriculture, horticulture and forestry.

16 – Printed matter (printing products); bookbinding material; photographs; stationery; adhesives for stationery or household purposes; artists' materials; paintbrushes; instructional or teaching material (except apparatus); printing blocks; paper; cardboard; boxes of cardboard or paper; posters; albums; cards; books; newspapers; prospectuses; pamphlets; calendars; writing instruments; engravings or lithographic works of art; framed or unframed paintings (pictures); watercolors [paintings]; patterns for dressmaking; graphic prints; drawing instruments; handkerchiefs of paper; face towels of paper; table linen of paper; toilet paper; bags, sachets, envelopes, small bags for packaging (of paper or plastic) for agriculture and gardening; garbage bags of paper or of plastics.

31 – Agricultural, horticultural and forestry products, neither prepared, nor processed; live animals; fresh fruit and vegetables; plant seeds (grains), natural plants and flowers; foodstuffs for animals; malt; natural turf; live crustaceans; live bait for fishing; unprocessed cereal seeds; shrubs; plants; seedlings; trees (plants); citrus fruit; unsawn timber; fodder; germ seed for botanical purposes; wheat germ for animal consumption; grains for animal consumption; grains (cereals), bulbs, seedlings and particularly vegetable seedlings.

35 – Advertising; business management; business administration; office functions; direct mail advertising (leaflets, prospectuses, printed matter, samples); arranging newspaper subscriptions (for others); arranging of telecommunication service subscriptions for others; presentation of goods on all communication media for retail sale; business management and organization consultancy; accounting; document reproduction; employment agencies; computerized file management; organization of exhibitions for commercial or advertising purposes; on-line advertising on a computer network; rental of advertising time on all communication media; publication of advertising texts; rental of advertising space; dissemination of advertisements; public relations; retail sale service for agricultural, horticultural and forestry products; wholesale service for agricultural, horticultural and forestry products.

42 – Evaluations, assessments and research in the fields of science and technology provided by engineers; design and development of computers and software; research and development of new products for others; technical project studies; architecture; design of interior decor; surveying (engineering work); biological research; research in the field of environmental protection.

44 – Agricultural, horticultural and forestry services; veterinary services; gardening; landscape gardening services; consultancy in relation to agriculture, horticulture and forestry; rental of farming equipment; vermin exterminating for agriculture, horticulture and forestry; weed killing; animal breeding; landscape design; lawn maintenance services; plant nurseries; tree planting for carbon offsetting purposes.

(260) AM 2014 72915 A

(800) 1163133

(151) 2013 04 09

(731) PEUGEOT S.A.

75, Avenue de la Grande-Armée, F-75116  
PARIS, France

(540)



(591) Black, white, blue, red

(511)

12 – Vehicles, apparatus for locomotion by land, motor vehicles, particularly trucks; vans; vans (vehicles); motorcycles; mopeds; cycles, bicycles; electric power-assisted bicycles; their component parts, namely suspension shock absorbers for vehicles; shock absorbers (springs) for vehicles; motors and engines for land vehicles; gear boxes for land vehicles; vehicle chassis; bodies for vehicles; transmission shafts for land vehicles; hydraulic circuits for vehicles; torque converters for land vehicles; clutches; axles; brakes for vehicles; vehicle wheels; rims for vehicle wheels; hub caps for wheels; hubs for vehicle wheels; tires, solid, for vehicle wheels; steering wheels; vehicle seats; headrests for vehicle seats; security devices for vehicles such as safety belts and air bags; rearview mirrors; windshield wipers; torsion bars; bumpers; protective molding rods; deflectors; spoilers; windshields; sunroofs; windows for vehicles; caps for gas tanks; luggage carriers; saddles for cycles, bicycles and motorcycles; stands for cycles, bicycles and motorcycles; frames for cycles, bicycles and motorcycles; anti-theft devices.

35 – Bringing together (excluding the transport thereof) of vehicles and second-hand vehicles, their



parts and accessories, enabling customers to conveniently view and purchase said goods; presentation of vehicles and second-hand vehicles, their parts and accessories on all communication media for retail purposes; organization of exhibitions for commercial or advertising purposes.

36 – Insurance underwriting; banking and financial services, lending, credit and lease-purchasing services particularly for the purchase of new and second-hand vehicles; vehicle insurance underwriting; life assurance underwriting; accident insurance underwriting; insurance brokerage; insurance consultancy, information and advice; services provided using credit cards and other electronic means of payment for buying fuels and lubricants and for carrying out vehicle maintenance and repair; financial services in the field of lease-purchasing and rental of vehicles; financial loans for vehicle repair; guarantee (surety) services for vehicles; financial appraisals relating to land vehicle fleets and car fleets.

(260) AM 2014 72916 A  
(800) 1163171  
(151) 2013 05 07  
(731) Trippe Manufacturing Company  
1111 35th Street Chicago, IL 60632, USA  
(540)

## SmartRack

(591) Black, white  
(511)  
9 – Mounting racks and enclosures for computer hardware.

(260) AM 2014 72917 A  
(800) 1163190  
(151) 2013 04 12  
(731) LACHIFARMA SRL; S.S.  
16 – Zona Industriale, I-73010 ZOLLINO  
(LE), Italy  
(540)

## NEOGLOBIN

(591) Black, white  
(511)  
5 – Pharmaceutical and veterinary preparations; sanitary preparations for medical purposes; dietetic food and substances adapted for medical or veterinary use, food for babies; dietary supplements for humans and animals; plasters, materials for dressings; material for stopping teeth, dental wax; disinfectants; preparations for destroying vermin; fungicides, herbicides.

(260) AM 2014 72919 A  
(800) 1163210  
(151) 2013 05 24  
(731) OneTwoTrip Ltd.  
ZA Little Denmark Complex, 147 Main St.,  
Road Town, Tortola VG 1110, British Virgin  
Islands

(540)



(591) Black, white  
(511)  
35 – auctioneering; business inquiries; business management of hotels; compilation of information into computer databases; compilation of statistics; on-line advertising on a computer network; price comparison services; systemization of information into computer databases.

36 – accident insurance underwriting; credit card services; debit card services; health insurance underwriting; insurance brokerage; insurance underwriting; life insurance underwriting.

42 – computer programming; creating and maintaining web sites for others; providing search engines for the internet.

(260) AM 2014 72921 A  
(800) 580990  
(151) 1991 12 18  
(891) 2013 05 21  
(731) SOCIETE DES PRODUITS D'ARMAGNAC  
Route de Cazaubon, F-32800 EAUZE, France  
(540)

## MARQUIS DE MONTESQUIOU

(591) Black, white  
(511)  
33 – Wines, sparkling wines, ciders, alcohols and eaux-de-vie (brandy), liqueurs and spirits.

(260) AM 2014 72922 A  
(800) 717432  
(151) 1999 07 23  
(891) 2013 04 03  
(731) S.A.S.I.C. S.A. SANTUCCI SICFA REUNIS  
6, rue Pierre Curie, F-92400 COURBEVOIE,  
France  
(540)

## SASIC

(591) Black, white

(511)

12 – Vehicles; apparatus for locomotion by land, air or water; automobiles including industrial vehicles, lorries and trailers, automobile spare parts (excluding component parts of engines other than for land vehicles, of the engines other than for land vehicles, electric locks, systems for heating, air-conditioning and lighting, non-metal and non-electric locks); complete steering systems and parts thereof; ball joints; shock-absorption mechanisms and shock absorbers and parts thereof, transmission shafts and parts for transmissions, clutch stops and parts for clutches, brake drums; brake disks and brake systems, mechanic parts for automobiles, metal and non-metal vehicle parts.

(260) AM 2014 72924 A

(800) 1000559

(151) 2008 06 19

(891) 2013 05 02

(731) Glutolin Renovierungsprodukte GmbH

Im Schedetal 1, 34346 Hann. Münden,  
Germany

(540)

## GLUTOCLEAN

(591) Black, white

(511)

1 – Chemical products for use in industry; products for removing oil; water-repellent products and products for impregnating floors, walls, ceilings as well as for coverings for floors, walls or ceilings; water-repellent products and products for impregnating parquet flooring, laminates, linoleum, linings of PVC, cork, natural and artificial stones, stoneware or tiles; chemical products for anti-mould sealers.

2 – Rust-proofing agents; preparations for protecting wood; preparations for protecting metals; products against metal oxidation.

3 – Laundry products; bleaching products; cleaning products; oil stain removers; polishing preparations; rust removing preparations; grease removing preparations; preparations for abrasive purposes; cleaning agents; products for cleaning floors, walls, ceilings, coverings for floors, walls or ceilings; products for cleaning parquet flooring, laminates, linoleum, linings of PVC, cork, natural or artificial stones, stoneware and tiles; products for cleaning joints; products for cleaning metals, glass, wood, plastics, porcelain ware, leather and textile articles; maintenance and cleaning products in the sanitary sector or for damp rooms; products for removing mould; decalcifying preparations and scale-removing preparations for household or professional purposes; products for removing limestone deposits; stain removing products; strippers for household or professional use for removing wallpaper or glues; wax-removing products; cleaning agents used for pipes

and closet augers; clearing tools for pipes and other sanitary installations; grease removing preparations for kitchens; products for removing mosses and algae; mould removing products; products for cleaning floors, walls, ceilings, coatings for floors, walls or ceilings; cleaning products for parquet flooring, laminates, linoleum, linings of PVC, cork, natural or artificial stones, stoneware and tiles; products for intensifying tints and colours of natural or artificial stones; cleaning products for metals, glass, wood, plastics, porcelain ware, leather and textile articles; polishing products; oil for teak; skin cleaning preparations; cleaning products used for hands in paste form; products for skin hygiene; preparations for skin protection (all products listed which are included in this class).

5 – Disinfecting preparations; fungicides; herbicides (included in this class).

(260) AM 2014 72925 A

(800) 1118325

(151) 2012 03 27

(891) 2013 03 07

(731) COSENTINO, S.A.U.

Carretera A-334, Km 59, E-04850

CANTORIA (Almeria), Spain

(540)

## SILESTONE

(591) Black, white

(511)

19 – Marble and stones for building, stone agglomerated materials, coatings not of metal for building, precast concrete and ceramic tiles, building materials not of metal.

(260) AM 2014 72926 A

(800) 1151234

(151) 2012 10 16

(891) 2013 04 15

(731) Takeda Pharmaceutical Company Limited

1-1, Doshomachi 4-chome, Chuo-ku,

OSAKA, Japan

(540)

## VIPIDIA

(591) Black, white

(511)

5 – Pharmaceutical preparations.

(260) AM 2014 73001 A  
 (800) 1164130  
 (151) 2012 12 21  
 (731) HOLA, S.L.  
 Miguel Angel, 1, E-28010 MADRID, Spain  
 (540)



(591) Red and white  
 (511)  
 38 – Telecommunications.

(260) AM 2014 73003 A  
 (800) 1164145  
 (151) 2013 05 07  
 (731) YOULIAN (SHISHI) SHOES CO., LTD  
 No.1, Xueshang, District 1, Shishi, Fujian  
 Province, China  
 (540)



(591) Black, white  
 (511)  
 25 – Shoes.

(260) AM 2014 73004 A  
 (800) 1164181  
 (151) 2012 12 11  
 (731) ADIPHARM EAD  
 Simeonovsko shose 130, BG-1700 SOFIA,  
 Bulgaria  
 (540)



(591) Black, white  
 (511)  
 5 – Chemico-pharmaceutical preparations; chemical preparations for medical purposes; chemical preparations for pharmaceutical purposes; adjuvants for medical purposes; dietetic food preparations adapted for medical purposes; medicinal herbs; medicines for human purposes; biological preparations for medical purposes; dietetic substances adapted for medical use; nutritional supplements.

(260) AM 2014 73006 A  
 (800) 1164235  
 (151) 2013 03 11  
 (731) TOVARYSTVO Z OBMEZHENOIU  
 VIDPOVIDALNISTIU "NATSIONALNA  
 HORILCHANA KOMPANIJA"  
 Smilianske shose, 8-i kilometer, bud. 2,  
 s. Stepanky, Cherkaskyi raion, Cherkaska  
 oblast 19632, Ukraine  
 (540)



(591) Green  
 (511)  
 32 – Beers; mineral and aerated waters and other non-alcoholic beverages; fruit beverages and fruit juices; syrups and other preparations for making beverages; soft drinks.

33 – Alcoholic beverages, except beers; aperitifs; arak (arrack); brandy; wine; whisky; vermouth; vodka; anisette (liqueur); anise (liqueur); hydromel (mead); kirsch; Perry; gin; cocktails; curacao; liqueurs; peppermint liqueurs; distilled beverages; alcoholic beverages containing fruit; bitters; piquette; rice alcohol; rum; sake; cider; spirits (beverages); alcoholic extracts; alcoholic essences; digesters (liqueurs and spirits) fruit extracts, alcoholic; champagne.

35 – Advertising; business management; business administration; office functions.

(260) AM 2014 73012 A  
 (800) 1164300  
 (151) 2013 05 14  
 (731) Tovarystvo z obmezhenoiu vidpovidalnistiu  
 "Almira"  
 vul. Budka, 47, Hadiach, Hadiatskyi r-n  
 Poltavaska obl. 37300, Ukraine  
 (540)



(591) White, light blue and dark blue  
 (511)  
 29 – Butter; butter cream; cheese; chocolate nut butter; cocoa butter; coconut butter; condensed milk; curd; kefir [milk beverage]; koumiss [kumiss] [milk beverage]; milk beverages, milk predominating; milk products; milk shakes; milk; peanut butter; rennet; whey.

(260) AM 2014 73014 A  
 (800) 1164309  
 (151) 2013 05 29  
 (731) Peking University Founder Group Co., Ltd.  
 9th Floor, ZhongGuancun Founder Building,  
 No.298 Chengfu Road, Haidian District,  
 100871 Beijing, China

(540)



(591) Black, white

(511)

9 – Computers; computer operating programs, recorded; computer peripheral devices; computer software, recorded; electronic publications, downloadable; computer programs (downloadable software); telephone apparatus; DVD players; cameras (photography); compact discs.

36 – Insurance underwriting; fund investments; art appraisal; real estate agencies; brokerage; surety services; charitable fund raising; trusteeship; pawn brokerage; financial sponsorship.

44 – Nursing, medical; convalescent homes; beauty salons; veterinary assistance; gardening; opticians' services; rental of sanitation facilities; medical clinic services; hospitals.

(260) AM 2014 73015 A  
 (800) 1164318  
 (151) 2013 04 19  
 (731) BBK Dairy Export AG  
 c/o Reichlin&Hess, Hofstrasse 1A, CH-6300  
 Zug, Switzerland

(540)



(591) Black, white, dark blue, gray, dark gray

(511)

5 – Food for babies.

29 – Milk; milk products.

35 – Import-export agencies; sales promotion for others of goods of classes 5 and 29.

39 – Packaging and storage of classes 5 and 29.

(260) AM 2014 73016 A  
 (800) 813873  
 (151) 2003 10 07  
 (891) 2013 03 28  
 (731) Salvatore Ferragamo S.p.A.  
 Via dei Tornabuoni, 2, I-50123 Firenze, Italy

(540)

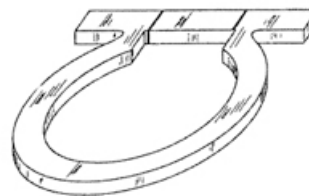

(591) Black, white

(511)

9 – Eyeglasses, sunglasses, eyeglass frames, eyeglass cases, eyeglass chains.

18 – Leather and imitations of leather, and goods made of these materials and not included in other classes; animal skins, hides; trunks and travelling bags; umbrellas, parasols and walking sticks; whips, harness and saddlery; bags, namely shoulder bags, travelling bags, handbags, Boston bags, waist packs, sling bags for carrying infants, leather and canvas shopping bags, duffle bags, tote bags, clutch bags, trunks, wallets, purses, briefcases, attaché cases, pouches of leather or textile, school bags, suitcases, garment bags for travel, key cases made of leather, backpacks, rucksacks, vanity cases sold empty, carry-on bags, beach bags, umbrellas.

25 – Clothing, footwear, headgear; pullovers, cardigans, sweaters, jerseys, jumpers, jackets, sweatshirts, parkas, bathing suits, blouses, shirts, trousers, jeans, waistcoats, skirts, shorts, T-shirts, dresses, men's suits, coats, half coats, down jackets, anoraks, raincoats, overcoats, fur coats and jackets, overalls, underwear, vests, hosiery and panty hose, bathrobes, neckerchiefs, bandannas, shawls, scarves, neckties, gloves for clothing, belts for clothing, shoes, boots, sandals, slippers, clogs, hats and caps.

(260) AM 2014 73018 A  
 (800) 926670  
 (151) 2007 05 09  
 (891) 2013 04 09  
 (731) Vifor SA  
 Route de Moncor 10, CH-1752 Villars-sur-  
 Glâne, Switzerland

(540)



(591) Black, white

(511)

5 – Pharmaceutical preparations and substances; dietetic substances adapted for medical use; infants' and invalids' foods; vitamin preparations; veterinary preparations and substances.

29 – Non-medicated food supplements; dietary and nutritional supplements; edible oils and fats; fish oil; evening primrose oil; thyme oil.

31 – Plants and seeds; foodstuffs for animals; dietary and nutritional supplements for animals; additives to fodder.

(260) AM 2014 73023 A

(800) 1117291

(151) 2012 03 11

(891) 2013 03 20

(731) RUBUN GLOBAL CORP.

33 Porter Road, P.O. Box 3169, P.O.

Box 3169, PMB103 Road Town, British

Virgin Islands

(540)



(591) Black, white

(511)

25 – Wimples; bandanas [neckerchiefs]; underwear; sweat-absorbent underclothing [underwear]; overalls; smocks; boas [necklets]; half-boots; breeches for wear; trousers; football boots; brassieres; detachable collars; shirt yokes; veils [clothing]; neckties; ascots; leg warmers; gaiters; boot uppers; vests; singlets; hosiery; heels; drawers [clothing]; hoods [clothing]; hat frames [skeletons]; pockets for clothing; collar protectors; cap peaks; tights; combinations [clothing]; wet suits for water-skiing; suits; suits for men; bathing suits; masquerade costumes; beach clothes; jackets [clothing]; fishing vests; liveries; camisoles; cuffs; short-sleeve shirts; mantillas; coats; furs [clothing]; mittens; miters [hats]; muffs [clothing]; footmuffs, not electrically heated; heel-pieces for footwear; bibs, not of paper; fur stoles; ear muffs [clothing]; socks; beach shoes; sports shoes; footwear; paper clothing; outerclothing; ready-made clothing; motorists' clothing; cyclists' clothing; clothing for gymnastics; clothing of imitations of leather; clothing of leather; uniforms; clothing; fittings of metal for footwear; maniples; overcoats; parkas; pelerines; gloves [clothing]; pyjamas; bathing drawers; scarfs; dresses; waterproof clothing; headbands [clothing]; sock suspenders; stocking suspenders; ready-made linings [parts of clothing]; soles for footwear; suspenders; lace boots; belts [clothing];

hing]; money belts [clothing]; layettes [clothing]; non-slipping devices for footwear; pullovers; heel-pieces for stockings; welts for footwear; chasubles; shirts; wooden shoes; sandals; boots; saris; sweaters; footwear uppers; inner soles; togas; knitwear [clothing]; underpants; gymnastic shoes; slippers; turbans; headgear for wear; aprons [clothing]; tee-shirts; dressing gowns; tips for footwear; stockings; sweat-absorbent stockings; caps [headwear]; shower caps; bathing caps; sashes for wear; studs for football boots; babies' pants [clothing]; gaiter straps; pelisses; esparto shoes or sandals; skirts; clothes for children.

26 – Fringes; mica spangles; shoe eyelets; false beards; brooches [clothing accessories]; pins, other than jewellery [jewelry (am.)]; wreaths of artificial flowers; reins for guiding children; false hair; artificial garlands; expanding bands for holding sleeves; frills [lacework]; trouser clips; hair grips [slides]; heat adhesive patches for repairing textile articles; blouse fasteners; shoe fasteners; dress fastenings; fastenings for suspenders; belt clasps; hook and pile fastening tapes; slide fasteners [zippers]; slide locks for bags; competitors' numbers; needles for wool combing machines; binding needles; saddlers' needles; boxes for needles; lace trimmings; embroidery; haberdashery, except thread; hair ornaments; decoration of textile articles (heat adhesive patches for haberdashery; silver embroidery; tassels [haberdashery]; snap fasteners; sewing boxes; plaited hair; false hems; hooks [haberdashery]; embroidering crochet hooks; rug hooks; shoe hooks; ribbons [haberdashery]; prize ribbons; elastic ribbons; letters for marking linen; numerals for marking linen; orsedew [trimmings for clothing]; toupees; sewing thimbles; skirt flounces; bows for the hair; hair curling papers; wigs; feathers [clothing accessories]; birds' feathers [clothing accessories]; eyelets for clothing; corset busks; hair bands; brassards; shoulder pads for clothing; pin cushions; needle cushions; top-knots [pompoms]; buckles [clothing accessories]; shoe buckles; buttons; ornamental novelty badges [buttons]; rosettes [haberdashery]; frills for clothing; hair nets; chenille [passementerie]; knitting needles; shoe ornaments, not of precious metal; trimmings for clothing; hat ornaments, not of precious metal; false moustaches; festoons [embroidery]; artificial fruit; artificial flowers; shuttles for making fishing nets; hair coloring caps; shoe laces; cords for clothing; woollen laces; hair pins; collar supports.

(260) AM 2014 73026 A

(800) 1148430

(151) 2012 12 22

(891) 2013 04 26

(731) Merck KGaA

Frankfurter Strasse 250, 64293 Darmstadt,  
Germany

(540)



(591) Black, white

(511)

5 – Pharmaceutical preparations; dietetic preparations and food supplements for medical use.

29 – Dietetic preparations and food supplements not for medical use, included in this class.

30 – Dietetic preparations and food supplements not for medical use, included in this class.

(260) AM 2014 73219 A

(800) 1166352

(151) 2013 05 15

(731) NIPPON KAYAKU KABUSHIKI KAISHA

11-2, Fujimi 1-chome, Chiyoda-ku, Tokyo  
102-8172, Japan

(540)



(591) Black, white

(511)

5 – Pharmaceutical preparations; drugs for medical purposes; medicines for human purposes; tumor suppressing agents; diagnostic preparations for medical purposes; biocides; insecticides; pesticides.

(260) AM 2014 73331 A

(800) 1167678

(151) 2013 03 27

(731) Metsä Tissue Oyj

Revontulenpuisto 2, FI-02100 Espoo, Finland

(540)



(591) Black, white

(511)

3 – Cleaning preparations; soaps; perfumery, essential oils, cosmetics, in particular moistened wipes for sanitary and cosmetic purposes; hair lotions.

4 – Candles and wicks for lighting.

5 – Babies' diapers (of paper and cellulose).

16 – Paper, cardboard and goods made from these materials, not included in other classes; in particular soft paper products, paper for drying and cleaning for use in service installations and in industry, napkins, table cloths, wrapping and packaging material, face towels, wipes, handkerchiefs; printed matter; plastic materials for packaging (not included in other classes).

21 – Household or kitchen utensils and containers, in particular disposable tableware (other than knives, forks and spoons), holders, containers and dispensers for kitchen rolls, toilet paper, napkins and hand towels; articles for cleaning purposes, in particular soap dishes, soap boxes and soap dispensers, cloths for cleaning.

28 – Games and playthings; decorations, in particular paper party hats.

(260) AM 2014 73343 A

(800) 1167831

(151) 2013 05 02

(731) YENTUR TEKSTİL SANAYİ VE TİCARET  
LİMİTED ŞİRKETİ

3. Organize Sanayi Bölgesi, 2 Nolu  
Cadde, Şehitkamil – Başpınar – Gaziantep,  
Turkey

(540)



(591) Black, gold and white

(511)

24 – Woven textiles, namely, fabrics for use in the manufacture of clothing, towels, table linen, bed linen, household linen; non-woven textiles, namely, fabrics for use in the manufacture of clothing, towels, table linen, bed linen, household linen; fiberglass fabrics for textile use; fabric impervious to gases for aeronautical balloons; waterproof fabrics, namely, waterproof fabric for manufacturing clothing, furniture, luggage and automobile upholstery; gummed waterproof cloth; fabric of imitation animal skins; textile linings, namely, linen lining fabric for shoes, unfinished textile for the manufacture of li-

nings for garments, textile used as lining for clothing; buckram; filtering materials of textile, namely, chemical fiber fabrics, synthetic fiber fabrics, inorganic fiber mixed fabrics all for use in filtering liquids and powders; quilts of textile, blankets; washing mitts, bath linen, hand towels, face towels of textile, bathing towels; tapestries of textile, traveling rugs, namely, lap rugs; curtains of textile, shower curtains of textile, shower curtains of plastics; oilcloth for use as table cloths; bed blankets, bed sheets, bedspreads, bed linen, diapered linen, pillowcases, quilt covers; furniture coverings of textile, namely, unfitted fabric furniture covers; upholstery fabrics; table napkins of textile; bed covers of paper; banners of textile, namely, cloth banners; flags not of paper, namely, cloth flags, fabric flags; cloth labels.

27 – Carpets, rugs, mats; prayer rug of textile; linoleum for covering existing floors; other material for covering existing floors, namely, rubber bath mats, rubber door mats, cork for use as a floor covering, cork mats, vinyl floor coverings, textile floor mats for use in the home; mats for gymnastic and wrestling; non-textile wall coverings, non-textile wall hangings, wall coverings of paper.

(260) AM 2014 73345 A

(800) 1167867

(151) 2013 03 29

(731) Joint Stock Company Gazprom neft  
Galemaya ul, 5, lit A, RU-190000  
St-Petersburg, Russian Federation

(540)



(591) Blue, light-blue, white, grey, orange, yellow, brown and black

(511)

1 – Acetate of cellulose, unprocessed; acetates [chemicals]; acetic anhydride; acetone; acetylene tetrachloride; acetylene; acid proof chemical compositions; acids; acidulated water for recharging accumulators; acidulated water for recharging batteries; anti-frothing solutions for batteries; acrylic resins, unprocessed; actinium; activated carbons; additives, chemical, to drilling muds; additives, chemical, to fungicides; additives, chemical, to insecticides; additives, chemical, to motor fuel; adhesive preparations for surgical bandages; adhesives for billposting; adhesives for industrial purposes; adhesives for paperhanging; adhesives for wall tiles; adhesives for

wallpaper; agar-agar; agglutinants for concrete; agricultural chemicals, except fungicides, weedkillers, herbicides, insecticides and parasiticides; albumin [animal or vegetable, raw material]; albuminized paper; alcohol; aldehydes; alginates for industrial purposes; alginates for the food industry; alkalies; alkaline iodides for industrial purposes; alkaline metals; alkaline-earth metals; alkaloids; alum; alumina; aluminium acetate; aluminium alum; aluminium chloride; aluminium hydrate; aluminium iodide; aluminium silicate; americium; ammonia [volatile alkali] for industrial purposes; ammonia; ammonia alum; ammoniacal salts; ammonium aldehyde; ammonium salts; amyl acetate; amyl alcohol; anhydrides; anhydrous ammonia; animal albumen [raw material]; animal carbon preparations; animal carbon; animal charcoal; blood charcoal; bone charcoal; anti-boil preparations for engine coolants; anti-frothing solutions for accumulators; anti-incrustants; anti-knock substances for internal combustion engines; anti-sprouting preparations for vegetables; anti-tarnishing chemicals for windows; antifreeze; antimony oxide; antimony sulphide; antimony; antistatic preparations, other than for household purposes; antranilic acid; argon; arsenic; arsenious acid; artificial resins, unprocessed; artificial sweeteners [chemical preparations]; astatine; automobile body fillers; auxiliary fluids for use with abrasives; bacterial preparations other than for medical and veterinary use; bacteriological preparations for acetification; bacteriological preparations other than for medical and veterinary use; balm of gurgun [gurgun, gurjan] for making varnish; barium compounds; barium sulphate; barium; baryta paper; baryta; barytes; bases [chemical preparations]; basic gallate of bismuth; bate for dressing skins; baths for galvanizing; bauxite; beer preserving agents; beer-clarifying and preserving agents; bentonite; benzene derivatives; benzene-based acids; benzoic acid; benzoic sulphinide; berkelium; bicarbonate of soda for chemical purposes; bichloride of tin; bichromate of potassium; bichromate of soda; biochemical catalysts; biological preparations, other than for medical or veterinary purposes; biological tissue cultures other than for medical or veterinary purposes; birdlime; bismuth nitrite for chemical purposes; bismuth; bleaching preparations [decolorants] for industrial purposes; blueprint cloth; blueprint paper; borax; boric acid for industrial purposes; brake fluid; brake fluids; brazing fluxes; brazing preparations; brickwork preservatives, except paints and oils; bromine for chemical purposes; by-products of the processing of cereals for industrial purposes; caesium; calcined soda; calcium carbide; calcium cyanamide [fertilizer]; calcium salts; californium; camphor, for industrial purposes; car body fillers; carbide; carbolineum for the protection of plants; carbon black for industrial purposes; carbon for filters; carbon sulphide; carbon tetrachloride; carbon; carbonates;

carbonic acid; carbonic hydrates; casein for Industrial purposes; casein for the food industry; cassio-pium [lutetium]; catalysts; catechu; caustic alkali; caustic soda for industrial purposes; caustics for industrial purposes; cellulose; cement [metallurgy]; cement for pneumatic tires [tyres]; cement presser-vatives, except paints and oils; cement-waterproofing preparations, except paints; ceramic composi-tions for sintering [granules and powders]; ceramic glazings; ceramic materials in particulate form, for use as filtering media; cerium; chemical additives for oils; chemical additives to drilling muds; chemi-cal additives to fungicides; chemical additives to motor fuel; chemical condensation preparations; chemical intensifiers for paper; chemical intensifiers for rubber; chemical preparations for analyses in laboratories, other than for medical or veterinary purposes; chemical preparations for decarbonising engines; chemical preparations for facilitating the alloying of metals; chemical preparations for protection against wheat blight [smut]; chemical preparations for scientific purposes, other than for medical or veterinary use; chemical preparations for smoking meat; chemical preparations for the manufacture of paints; chemical preparations for the manufacture of pigments; chemical preparations for use in photography; chemical preparations to pre-vent mildew; chemical preparations to prevent wheat smut; chemical preparations, except pigments, for the manufacture of enamel; chemical reagents, other than for medical or veterinary purposes; chemical substances for analyses in laboratories, other than for medical or veterinary purposes; chemical sub-stances for preserving foodstuffs; cement for foot-wear; chemicals for forestry, except fungicides, herbicides, insecticides and parasiticides; chemicals used in fermenting wine; chimney cleaners, chemi-cal; china clay; china slip; chlorates; chlorides; chlo-rine; cholic acid; chromates; chrome alum; chrome salts; chromic acid; chromic salts; chromium oxide; cinematographic film, sensitized but not exposed; cinematographic films, sensitized but not exposed; citric acid for industrial purposes; clarification pre-parations; coal saving preparations; cobalt oxide for industrial purposes; collodion; color-brightening chemicals for industrial purposes; colour-brigh-tening chemicals for industrial purposes; combusting preparations [chemical additives to motor fuel]; compositions for repairing inner tubes of tires [ty-res]; chemical additives to insecticides; composi-tions for repairing tires [tyres]; compositions for the manufacture of phonograph records; compositions for the manufacture of technical ceramics; com-positions for threading; compost; concrete presser-vatives, except paints and oils; concrete-aeration chemicals; condensation-preventing chemicals; cool-ants for vehicle engines; copper sulphate [vitriol]; corrosive preparations; creosote for chemical pur-poses; crotonic aldehyde; cryogenic preparations;

cultures of microorganisms other than for medical and veterinary use; curium; currying preparations for leather; currying preparations for skins; cyanides [prussiates]; cymene; damp proofing preparations, except paints, for masonry; decolorants for industrial purposes; defoliants; degreasing preparations for use in manufacturing processes; degumming prepara-tions; dehydrating preparations for industrial purpo-ses; detergent additives to gasoline [petrol]; deter-gent additives to gasoline; detergent additives to petrol [gasoline]; detergents for use in manufac-turing processes; dextrine size; diagnostic prepara-tions, other than for medical or veterinary purposes; diastase for industrial purposes; diatomaceous earth; diazo paper; diazo papers; dioxide of hydrogen; disincrustants; dispersions of plastics; distilled wa-ter; dolomite for industrial purposes; dressing and finishing preparations for textiles; dressing, except oils, for skins; drilling muds; dry ice [carbon di-oxide]; dysprosium; earth for growing; electrophore-sis gels, other than for medical or veterinary pur-poses; emollients for industrial purposes; emulsi-fiers; enamel and glass-staining-chemicals; enamel-staining chemicals; engine-decarbonising chemicals; enzyme preparations for industrial purposes; enzyme preparations for the food industry; enzymes for industrial purposes; enzymes for the food industry; epoxy resins, unprocessed; erbium; esters; ethane; ethers; ethyl alcohol; ethyl ether; europium; expan-ded-clay for hydroponic plant growing [substrate]; fat-bleaching chemicals; fatty acids; ferments for chemical purposes; fermium; ferrocyanides; ferroty-pe plates [photography]; fertilizers; fertilizing prepa-rations; fillers for automobile bodies; fillers for car bodies; filtering materials [chemical preparations]; filtering materials [mineral substances]; filtering materials [unprocessed plastics]; filtering materials [vegetable substances]; filtering preparations for the beverages industry; finishing preparations for use in the manufacture of steel; fire extinguishing compo-sitions; fireproofing preparations; fish meal fertili-zers; fissionable chemical elements; fissionable ma-terial for nuclear energy; fixing baths [photography]; fixing solutions [photography]; flashlight prepara-tions; flocculants; flour for industrial purposes; flo-wer preservatives; flowers of sulphur for chemical purposes; fluids for hydraulic circuits; fluorine; fluorspar compounds; formic acid; formic aldehyde for chemical purposes; foundry binding substances; foundry molding [moulding] preparations; foundry molding preparations; foundry moulding prepara-tions; foundry sand; francium; fuel for atomic piles; fuel-saving preparations; fuller's earth for use in textile industry; fulling preparations for use in textile industry; fulling preparations; gadolinium; gall nuts; gallic acid for the manufacture of ink; gallium; gallnuts; gallotannic acid; galvanizing baths; galva-nizing preparations; gambier; gas propellents for aerosols; gas purifying preparations; gelatine for



industrial purposes; gelatine for photographic purposes; genes of seeds for agricultural production; getters [chemically active substances]; glass-frosting chemicals; glass-staining chemicals; glaziers' putty; glucose for industrial purposes; glucose for the food industry; glucosides; glue for industrial purposes; gluten [glue], other than for stationery or household purposes; gluten for industrial purposes; gluten for the food industry; glutinous preparations for tree-banding; glutinous tree-banding preparations; glutinous tree-grafting preparations; glycerides; glycerine for industrial purposes; glycol ether; glycol; gold salts; grafting mastic for trees; grafting wax for trees; graphite for industrial purposes; grease-removing preparations for use in manufacturing processes; guano; gum arabic for industrial purposes; gum solvents; gums [adhesives], other than for stationery or household purposes; heavy water; helium; holmium; hormones for hastening the ripening of fruit; horticulture chemicals, except fungicides, herbicides, insecticides and parasiticides; humus top dressing; humus; hydrates; hydrazine; hydrochlorates; hydrochloric acid; hydrofluoric acid; hydrogen peroxide; hydrogen; hypochlorite of soda; hyposulphites; industrial chemicals; iodic acid; iodine for chemical purposes; iodine for industrial purposes; iodised albumen; malt albumen; iodised salts; ion exchangers [chemicals]; ion exchangers [chemical preparations]; iron salts; isinglass other than for stationery, household or alimentary purposes; isotopes for industrial purposes; kainite; kaolin; ketones; kieselgur; krypton; lactic acid; lactose [raw material]; lactose for industrial purposes; lactose for the food industry; lamp black for industrial purposes; lanthanum; lead acetate; lead arsenate; lead oxide; leather glues; leather-dressing chemicals; leather-impregnating chemicals; leather-renovating chemicals; leather-waterproofing chemicals; lecithin [raw material]; lecithin for industrial purposes; lecithin for the food industry; lime acetate; lime carbonate; lime chloride; limestone hardening substances; liquids for hydraulic circuits; liquids for removing sulphates from accumulators; liquids for removing sulphates from batteries; lithia [lithium oxide]; lithium; litmus paper; loam; lutetium [cassioium]; magnesite; magnesium carbonate; magnesium chloride; magnetic fluid for industrial purposes; manganate; manganese dioxide; mangrove bark for industrial purposes; manure for agriculture; masonry preservatives, except paints and oils; mastic for leather; mastic for tires [tyres]; mastic for tires; mastic for tyres; meat tenderizers for industrial purposes; mercuric oxide; mercury salts; mercury; metal annealing preparations; metal earths; rare earths; metal hardening preparations; metal tempering preparations; metalloids; methane; methyl benzene; methyl benzol; methyl ether; milk ferments for chemical purposes; milk ferments for industrial

purposes; milk ferments for the food industry; mineral acids; moderating materials for nuclear reactors; moistening [wetting] preparations for use in bleaching; moistening [wetting] preparations for use in dyeing; moistening [wetting] preparations for use in the textile industry; mold-release preparations; mordants for metals; mould-release preparations; must-fining preparations; naphthalene; neodymium; neon; neptunium; nitrate of uranium; nitrate paper; nitrates; nitric acid; nitric monoxide; nitrogen; nitrogenous fertilisers; nitrogenous lime [manure]; nitrous oxide; oenological bactericides [chemical preparations used in wine making]; oil cement [putty]; oil dispersants; oil-bleaching chemicals; oil-purifying chemicals; oil-separating chemicals; oils for currying leather; oils for preparing leather in the course of manufacture; oils for tanning leather; oils for the preservation of food; oleic acid; olivine [chemical preparations]; opacifiers for enamel; opacifiers for enamel or glass; opacifiers for glass; organic-bleaching chemicals; oxalates; oxalic acid; oxygen; palladious chlorides; paper pulp; wood pulp; peat [fertiliser]; peat pots for horticulture; pectin [photography]; pectin for industrial purposes; pectin for the food industry; perborate of soda; percarbonates; perchlorates; persulphates; persulphuric acid; petroleum dispersants; phenol for industrial purposes; phosphates [fertilisers]; phosphatides; phosphoric acid; phosphorus; photographic developers; photographic emulsions; photographic paper; photographic sensitizers; photometric paper; photosensitive plates; sensitized photographic plates; picric acid; plant growth regulating preparations; plasticizers; plastics, unprocessed; plastisols; Plutonium; polish removing substances; polonium; potash water; potash; potassium dioxalate; potassium; potato flour for industrial purposes; potting soil; power steering fluid; praseodymium; preparations for preventing the tarnishing of glass; preparations for preventing the tarnishing of lenses; preparations for stimulating cooking for industrial purposes; preparations for the purification of gas; preparations for the separation of greases; preparations of microorganisms other than for medical and veterinary use; preparations of the distillation of wood alcohol; preservatives for pharmaceutical preparations; preservatives for tiles, except paints and oils; promethium; protactinium; protective gases for welding; protein [raw material]; prussiates; purification preparations; pyrogalllic acid; pyroligneous acid [wood vinegar]; quebracho for industrial purposes; radiator flushing chemicals; radioactive elements for scientific purposes; radium for scientific purposes; radon; reducing agents for use in photography; refrigerants; refrigerating preparations; renovating preparations for phonograph records; rhenium; rock salt; rubber preservatives; rubidium; saccharin; sal ammoniac spirits; sal ammoniac; salicylic acid; salpetre; salt for preserving, other than for foodstuffs;

salt, raw; saltpeter; salts [chemical preparations]; salts [fertilisers]; salts for coloring [colouring] metal; salts for coloring metal; salts for colouring metal; salts for galvanic batteries; salts for galvanic cells; salts for industrial purposes; salts from rare earth metals; salts of alkaline metals; salts of precious metals for industrial purposes; sauce for preparing tobacco; scale removing preparations, other than for household purposes; scandium; sea water for industrial purposes; seaweeds [fertilizers]; sebacic acid; seed preserving substances; selenium; self-toning paper [photography]; sensitized cloth for photography; sensitized films, unexposed; sensitized paper; sensitized plates for offset printing; separating and unsticking [ungluing] preparations; silicates; silicon; silicones; silver nitrate; silver salt solutions for silvering; size for finishing and priming; sizing preparations; slag [fertilisers]; soap [metallic] for industrial purposes; soda ash; sodium salts [chemical preparations]; sodium; soil conditioning preparations; soldering chemicals; soldering fluxes; solidified gases for industrial purposes; solutions for cyanotyping; solvents for varnishes; soot for industrial or agricultural purposes; sorrel salt; spinel [chemical preparations]; spirits of salt; spirits of vinegar [dilute acetic acid]; stain-preventing chemicals for use on fabrics; starch for industrial purposes; starch paste [adhesive], other than for stationery or household purposes; starch size [chemical preparations]; starch-liquifying chemicals [ungluing agents]; stearic acid; stem cells other than for medical or veterinary purposes; strontium; substances for preventing runs in stockings; substances for removing polish; substrates for soil-free growing [agriculture]; sulphates; sulphides; sulphonic acids; sulphur; sulphuric acid; sulphuric ether; sulphurous acid; sumac for use in tanning; superphosphates [fertilisers]; surface-active chemical agents; synthetic materials for absorbing oil; synthetic resins, unprocessed; talc [magnesium silicate]; tan-wood; tan; tannic acid; tannin; tanning substances; tapioca flour for industrial purposes; tartar other than for pharmaceutical purposes; tartaric acid; technetium; tellurium; tensio-active agents; terbium; test paper, chemical; tetrachlorides; textile-brightening chemicals; textile-impregnating chemicals; textile-waterproofing chemicals; thallium; thiocarbonyl; thorium; thulium; tire repairing compositions; titanite; titanium dioxide for industrial purposes; toluene; toluol; toning baths [photography]; toning salts [photography]; toxic gas neutralizers; tragacanth gum for use in manufactures; transmission fluid; tree cavity fillers [forestry]; tungstic acid; tyre repairing compositions; ungluing agents [chemical preparations for liquifying starch]; ungluing preparations; unsticking and separating preparations; uranium oxide; uranium; vine disease preventing chemicals; vinic alcohol; viscose; vitriol; volatile alkali [ammonia] for industrial purposes; vulcanisation accelera-

tors; vulcanising preparations; wallpaper removing preparations; water glass [soluble glass]; water purifying chemicals; water-softening preparations; wax-bleaching chemicals; welding chemicals; wetting preparations for use in bleaching; wetting preparations for use in dyeing; wetting preparations for use in the textile industry; wine finings; witherite; wood alcohol; wood vinegar [pyroligneous acid]; x-ray films, sensitized but not exposed; xenon; ytterbium; yttrium; zirconia.

4 – Additives, non-chemical, to motor fuel; alcohol [fuel]; anthracite; beeswax; belting wax; benzene; benzine; benzol; blocks of peat [fuel]; bone oil for industrial purposes; candles; carburants; carnauba wax; castor oil for technical purposes; ceresine; charcoal [fuel]; Christmas tree candles; perfumed candles; coal briquettes; coal dust [fuel]; coal naphtha; coal tar oil; coal; coke; combustible oil; cutting fluids; diesel oil; dust binding compositions for sweeping; dust laying compositions; dust removing preparations; electrical energy; ethanol [fuel]; fire-lighters; firewood; fish oil, not edible; fuel gas; fuel oil; fuel with an alcoholic base; fuel; gas for lighting; gasoline; grease for arms [weapons]; grease for belts; non-slipping preparations for belts; grease for boots; combustible briquettes; grease for leather; grease for shoes; illuminating grease; illuminating wax; industrial grease; industrial oil; industrial wax; kerosene; lamp wicks; lanolin; lighting fuel; lignite; ligroin; lubricants; lubricating graphite; lubricating grease; lubricating oil; mazut; methylated spirit; mineral fuel; moistening oil; motor fuel; motor oil; naphtha; nightlights [candles]; oil for the preservation of leather; oil for the preservation of masonry; oil-gas; oils for paints; oils for releasing form work [building]; oleine; ozocerite [ozokerite]; paper spills for lighting; wood spills for lighting; paraffin; peat [fuel]; peat briquettes [fuel]; petrol; petroleum ether; petroleum jelly for industrial purposes; petroleum, raw or refined; preservatives for leather [oils and greases]; producer gas; rape oil for industrial purposes; solidified gas [fuel]; solidified gases [fuel]; soya bean oil preparations for non-stick treatment of cooking utensils; stearine; sunflower oil for industrial purposes; tallow; tapers; textile oil; tinder; vaporized fuel mixtures; wax [raw material]; wicks for candles; wood briquettes; wool grease; xylene; xylo.

37 – Airplane maintenance and repair; anti-rust treatment for vehicles; artificial snow-making services; asphaltting; boiler cleaning and repair; bricklaying; building construction supervision; building insulating; building of fair stalls and shops; building sealing; vehicle service stations [refuelling and maintenance]; burglar alarm installation and repair; burner maintenance and repair; cabinet making [repair]; car wash; carpentry services; chimney sweeping; cleaning of buildings [exterior surface]; cleaning of

buildings [interior]; cleaning of clothing; clock and watch repair; installation, maintenance and repair of computer hardware; construction consultation; construction information; construction; damp-proofing [building]; demolition of buildings; diaper cleaning; disinfecting; drilling of deep oil or gas-wells; drilling of wells; dry cleaning; electric appliance installation and repair; interference suppression in electrical apparatus; elevator installation and repair; factory construction; film projector repair and maintenance; fire alarm installation and repair; freezing equipment installation and repair; fur care, cleaning and repair; furnace installation and repair; furniture maintenance; furniture restoration; harbour construction; heating equipment installation and repair; installation of doors and windows; irrigation devices installation and repair; kitchen equipment installation; knife sharpening; laundering; leather care, cleaning and repair; lift installation and repair; linen ironing; machinery installation, maintenance and repair; clothing repair; masonry; mending clothing; mining extraction; motor vehicle maintenance and repair; motor vehicle wash; installation, maintenance and repair of office machines and equipment; painting or repair of signs; paper hanging; parasol repair; photographic apparatus repair; pier breakwater building; pipeline construction and maintenance; plastering; plumbing; pressing of clothing; pumicing; pump repair; quarrying services; rat exterminating; re-tinning; rebuilding engines that have been worn or partially destroyed; rebuilding machines that have been worn or partially destroyed; refilling of toner cartridges; renovation of clothing; rental of bulldozers; rental of cleaning machines; rental of construction equipment; rental of cranes [construction equipment]; rental of excavators; rental of road sweeping machines; repair information; repair of security locks; restoration of musical instruments; restoration of works of art; retreading of tires [tyres]; riveting; road paving; roofing services; rustproofing; safe maintenance and repair; sanding; scaffolding; shipbuilding; shoe repair; street cleaning; strong-room maintenance and repair; swimming-pool maintenance; telephone installation and repair; umbrella repair; underwater construction; underwater repair; upholstery; upholstery repair; varnishing; vehicle breakdown assistance [repair]; vehicle cleaning; vehicle greasing; vehicle lubrication [greasing]; vehicle maintenance; vehicle polishing; vehicle wash; vermin exterminating, other than for agriculture; vulcanization of tires [repair]; wallpapering; warehouse construction and repair; washing of linen; washing; window cleaning.

(260) AM 2014 73356 A  
 (800) 1168262  
 (151) 2013 03 12  
 (731) VARTA Microbattery GmbH  
 Daimlerstr. 1, 73479 Ellwangen, Germany  
 (540)



(591) Black, white  
 (511)  
 9 – Passive electric elements, in particular capacitors, super capacitors, double layer capacitors, pseudo-capacitors, hybrid capacitors, resistors, memristors, inductors, coils, chokes, magnetic cores, ferrites, potentiometers, electric trimmers (capacitors), oscillators, crystal oscillators and sensors; parts for the aforesaid goods, included in this class.

(260) AM 69778 A \*  
 (800) 1135117  
 (731) Meda AB  
 Pipers väg 2 A, Box 906, SE-170 09 Solna,  
 Sweden  
 (540)

**HEPOHOJI**

(591) Black, white  
 (511)  
 5 – Pharmaceutical and veterinary preparations; sanitary preparations for medical purposes; dietetic food and substances adapted for medical or veterinary use, food for babies; dietary supplements for humans and animals; plasters, materials for dressings; material for stopping teeth, dental wax; disinfectants; preparations for destroying vermin; fungicides, herbicides; analgesic remedies, anti-epileptic remedies, preparations for the treatment of the nervous system.

(260) AM 70451 A \*  
 (800) 1142453  
 (731) José EISENBERG  
 24, avenue Princesse Grace, MC-98000  
 Monaco, Monaco  
 (540)

**EISENBERG  
 PARIS**

(591) Black, white  
 (511)  
 3 – Bleaching preparations and other substances for laundry use; cleaning, polishing, degreasing and abrasive preparations; soaps, and more specifically

shower gels, bath gels, shower creams, bath creams, shampoos; perfumery, and more specifically perfumes, fragrances, deodorants; essential oils; cosmetics, and more specifically cosmetic preparations for slimming purposes, beauty masks, skin whitening creams, make-up removing products, oils for cosmetic use; make-up products and more specifically lipsticks, lip gloss, pencils for cosmetic use, make-up, mascara, nail polish, make-up powders, make-up foundation; hair lotions; hair sprays; dentifrices. All aforesaid goods are made in France.

25 – Clothing, underwear, footwear, headgear, tights, stockings, bodysuits, t-shirts, scarves, pareos. All aforesaid goods are made in France.

---

(260) AM 65404 A \*\*

(800) 1098167

(731) KAO KABUSHIKI KAISHA

(Kao Corporation)

14-10, Nihonbashi Kayabacho 1-chome,

Chuo-ku, Tokyo 103-8210, Japan

(540)

**SENSAI**

(591) Black, white

(511)

21 – Cosmetic and toilet utensils, other than electric toothbrushes; perfume containers; perfume sprayers; cosmetic brushes; eyebrow brushes; hair brushes; nail brushes; shaving brushes; combs; powder compacts; soap dispensers; soap holders; sponge holders; powder puffs; cosmetic sponges.

---

**INTERNATIONAL TRADEMARKS PROTECTED IN GEORGIA**

(260) AM 2013 66364 A  
(800) 1106013  
(151) 2011 06 17  
(181) 2021 06 17  
(511) 03, 08, 09, 11, 14, 16, 18, 20, 21, 24, 25, 28,  
35, 36, 39, 41, 42, 45

---

(260) AM 2013 68654 A  
(800) 925322  
(151) 2007 03 16  
(891) 2012 06 20  
(181) 2017 03 16  
(511) 12, 16, 35, 37, 41, 42

---

(260) AM 2013 71005 A  
(800) 1147215  
(151) 2012 09 13  
(181) 2022 09 13  
(511) 05

---

(260) AM 2014 68095 A  
(800) 1119541  
(151) 2012 04 10  
(181) 2022 04 10  
(511) 34

---

(260) AM 2014 68283 A  
(800) 1034142  
(151) 2010 02 10  
(891) 2012 06 12  
(181) 2020 02 10  
(511) 09

---

(260) AM 2014 68755 A  
(800) 411955A  
(151) 1974 10 16  
(891) 2012 06 28  
(181) 2014 10 16  
(511) 05

---

(260) AM 2014 69782 A  
(800) 886695  
(151) 2006 02 07  
(891) 2012 08 22  
(181) 2016 02 07  
(511) 05

---

(260) AM 2014 70415 A  
(800) 1141871  
(151) 2012 04 28  
(181) 2022 04 28  
(511) 35, 38, 41

---

(260) AM 2014 70416 A  
(800) 1141897  
(151) 2012 08 23  
(181) 2022 08 23  
(511) 09

---

(260) AM 2014 70417 A  
(800) 1141899  
(151) 2012 08 23  
(181) 2022 08 23  
(511) 11, 20, 21

---

(260) AM 2014 70418 A  
(800) 1141905  
(151) 2012 06 25  
(181) 2022 06 25  
(511) 06, 07, 09, 11, 12, 17

---

(260) AM 2014 70419 A  
(800) 1141909  
(151) 2012 05 31  
(181) 2022 05 31  
(511) 25

---

(260) AM 2014 70452 A  
(800) 1142489  
(151) 2012 07 18  
(181) 2022 07 18  
(511) 20

---

(260) AM 2014 70454 A  
(800) 1142499  
(151) 2012 08 02  
(181) 2022 08 02  
(511) 30

---

(260) AM 2014 70455 A  
(800) 1142524  
(151) 2012 08 20  
(181) 2022 08 20  
(511) 29, 30

---

(260) AM 2014 70458 A  
(800) 1142586  
(151) 2012 10 11  
(181) 2022 10 11  
(511) 29

---

(260) AM 2014 70459 A  
(800) 1142598  
(151) 2012 09 18  
(181) 2022 09 18  
(511) 05, 32

---

(260) AM 2014 70466 A  
(800) 613853  
(151) 1994 02 05  
(891) 2012 09 19  
(181) 2014 02 05  
(511) 06, 07, 19

---

(260) AM 2014 70467 A  
(800) 1142667  
(151) 2012 11 13  
(181) 2022 11 13  
(511) 34

---

(260) AM 2014 70469 A  
(800) 1142705  
(151) 2012 05 02  
(181) 2022 05 02  
(511) 01, 19

---

(260) AM 2014 70470 A  
(800) 1142712  
(151) 2012 10 24  
(181) 2022 10 24  
(511) 11

---

(260) AM 2014 70471 A  
(800) 1142723  
(151) 2012 10 08  
(181) 2022 10 08  
(511) 31

---

(260) AM 2014 70473 A  
(800) 1142742  
(151) 2012 10 23  
(181) 2022 10 23  
(511) 29, 30

---

(260) AM 2014 70474 A  
(800) 1142767  
(151) 2012 10 09  
(181) 2022 10 09  
(511) 03

---

(260) AM 2014 70475 A  
(800) 1142792  
(151) 2012 11 19  
(181) 2022 11 19  
(511) 34

---

(260) AM 2014 70476 A  
(800) 1142819  
(151) 2012 06 18  
(181) 2022 06 18  
(511) 03, 14, 18, 35

---

(260) AM 2014 70477 A  
(800) 1142822  
(151) 2012 08 02  
(181) 2022 08 02  
(511) 09

---

(260) AM 2014 70478 A  
(800) 1142843  
(151) 2011 12 13  
(181) 2021 12 13  
(511) 25, 28, 35

---

(260) AM 2014 70479 A  
(800) 1142845  
(151) 2012 02 20  
(181) 2022 02 20  
(511) 03, 05, 09, 10, 12, 14, 16, 18, 25, 28, 29, 30,  
32, 35, 36, 38, 39, 41, 42, 43

---

(260) AM 2014 70485 A  
(800) 1142847  
(151) 2012 03 19  
(181) 2022 03 19  
(511) 01, 06, 17, 23, 37, 40, 42

---

(260) AM 2014 70486 A  
(800) 1142877  
(151) 2012 07 20  
(181) 2022 07 20  
(511) 05

---

(260) AM 2014 70487 A  
(800) 1142885  
(151) 2012 07 25  
(181) 2022 07 25  
(511) 29, 30

---

(260) AM 2014 70488 A  
(800) 1142907  
(151) 2012 08 28  
(181) 2022 08 28  
(511) 25, 35, 42

---

(260) AM 2014 70489 A  
(800) 1142945  
(151) 2012 09 10  
(181) 2022 09 10  
(511) 03, 05, 35

---

(260) AM 2014 70490 A  
(800) 1142955  
(151) 2012 10 02  
(181) 2022 10 02  
(511) 03, 21

---

(260) AM 2014 70491 A  
(800) 1142990  
(151) 2012 10 22  
(181) 2022 10 22  
(511) 03

---

(260) AM 2014 70492 A  
(800) 1142912  
(151) 2012 09 05  
(181) 2022 09 05  
(511) 36

---

(260) AM 2014 70493 A  
(800) 1142952  
(151) 2012 10 04  
(181) 2022 10 04  
(511) 32, 33

---

(260) AM 2014 70494 A  
(800) 1142959  
(151) 2012 10 24  
(181) 2022 10 24  
(511) 25

---

(260) AM 2014 70495 A  
(800) 1143020  
(151) 2012 10 04  
(181) 2022 10 04  
(511) 05

---

(260) AM 2014 70499 A  
(800) 1143111  
(151) 2012 05 05  
(181) 2022 05 05  
(511) 03, 05

---

(260) AM 2014 70503 A  
(800) 1143253  
(151) 2012 09 26  
(181) 2022 09 26  
(511) 03

---

(260) AM 2014 70515 A  
(800) 1143466  
(151) 2012 10 31  
(181) 2022 10 31  
(511) 01, 02, 03, 04, 05

---

(260) AM 2014 70558 A  
(800) 1143940  
(151) 2012 05 02  
(181) 2022 05 02  
(511) 01, 09, 11, 21, 37, 39, 40, 41, 42, 43

---

(260) AM 2014 70561 A  
(800) 1144040  
(151) 2012 10 24  
(181) 2022 10 24  
(511) 01, 02, 03

---

(260) AM 2014 70562 A  
(800) 1144048  
(151) 2012 11 27  
(181) 2022 11 27  
(511) 09

---

(260) AM 2014 70563 A  
(800) 1144073  
(151) 2012 10 26  
(181) 2022 10 26  
(511) 42

---

(260) AM 2014 70576 A  
(800) 1144316  
(151) 2012 12 07  
(181) 2022 12 07  
(511) 34

---

(260) AM 2014 70564 A  
(800) 1144089  
(151) 2012 10 24  
(181) 2022 10 24  
(511) 10

---

(260) AM 2014 70577 A  
(800) 1144342  
(151) 2012 11 09  
(181) 2022 11 09  
(511) 05

---

(260) AM 2014 70565 A  
(800) 1144104  
(151) 2012 11 27  
(181) 2022 11 27  
(511) 35

---

(260) AM 2014 70578 A  
(800) 1144343  
(151) 2012 11 09  
(181) 2022 11 09  
(511) 05

---

(260) AM 2014 70566 A  
(800) 1144180  
(151) 2012 11 05  
(181) 2022 11 05  
(511) 09, 14

---

(260) AM 2014 70580 A  
(800) 1144365  
(151) 2012 12 06  
(181) 2022 12 06  
(511) 03

---

(260) AM 2014 70570 A  
(800) 1144209  
(151) 2012 10 16  
(181) 2022 10 16  
(511) 18, 25

---

(260) AM 2014 70581 A  
(800) 1144367  
(151) 2012 08 14  
(181) 2022 08 14  
(511) 09

---

(260) AM 2014 70573 A  
(800) 1144226  
(151) 2012 12 04  
(181) 2022 12 04  
(511) 05

---

(260) AM 2014 70583 A  
(800) 1144402  
(151) 2012 11 09  
(181) 2022 11 09  
(511) 05

---

(260) AM 2014 70574 A  
(800) 1144228  
(151) 2012 12 04  
(181) 2022 12 04  
(511) 05

---

(260) AM 2014 70587 A  
(800) 1144405  
(151) 2012 11 09  
(181) 2022 11 09  
(511) 41

---

(260) AM 2014 70575 A  
(800) 1144238  
(151) 2012 11 30  
(181) 2022 11 30  
(511) 20

---

(260) AM 2014 70588 A  
(800) 1144408  
(151) 2012 11 30  
(181) 2022 11 30  
(511) 05

---



(260) AM 2014 70589 A  
(800) 1144410  
(151) 2012 11 19  
(181) 2022 11 19  
(511) 33, 35

---

(260) AM 2014 70599 A  
(800) 1144559  
(151) 2012 06 15  
(181) 2022 06 15  
(511) 04, 06, 07, 09, 12, 16, 17, 35, 37, 38, 41

---

(260) AM 2014 70590 A  
(800) 1144414  
(151) 2012 12 03  
(181) 2022 12 03  
(511) 05, 29

---

(260) AM 2014 70600 A  
(800) 1144566  
(151) 2012 08 02  
(181) 2022 08 02  
(511) 02

---

(260) AM 2014 70591 A  
(800) 1144437  
(151) 2012 04 27  
(181) 2022 04 27  
(511) 03, 05

---

(260) AM 2014 70601 A  
(800) 1144567  
(151) 2012 07 16  
(181) 2022 07 16  
(511) 02

---

(260) AM 2014 70592 A  
(800) 1144470  
(151) 2012 07 20  
(181) 2022 07 20  
(511) 29, 35, 39, 43

---

(260) AM 2014 70602 A  
(800) 1144571  
(151) 2012 07 20  
(181) 2022 07 20  
(511) 33

---

(260) AM 2014 70593 A  
(800) 1144475  
(151) 2012 07 31  
(181) 2022 07 31  
(511) 05

---

(260) AM 2014 70603 A  
(800) 1144577  
(151) 2012 08 20  
(181) 2022 08 20  
(511) 05, 16, 35

---

(260) AM 2014 70595 A  
(800) 1144480  
(151) 2012 08 21  
(181) 2022 08 21  
(511) 03

---

(260) AM 2014 70604 A  
(800) 1144578  
(151) 2012 08 27  
(181) 2022 08 27  
(511) 01, 17, 19

---

(260) AM 2014 70596 A  
(800) 1144489  
(151) 2012 11 09  
(181) 2022 11 09  
(511) 05

---

(260) AM 2014 70605 A  
(800) 1144585  
(151) 2012 10 04  
(181) 2022 10 04  
(511) 35

---

(260) AM 2014 70598 A  
(800) 1144557  
(151) 2012 06 16  
(181) 2022 06 16  
(511) 04, 06, 07, 09, 12, 16, 17, 35, 37, 38, 41

---

(260) AM 2014 70606 A  
(800) 1144592  
(151) 2012 10 21  
(181) 2022 10 21  
(511) 29, 30

---

(260) AM 2014 70610 A  
(800) 1144613  
(151) 2012 09 21  
(181) 2022 09 21  
(511) 09

---

(260) AM 2014 70611 A  
(800) 1144627  
(151) 2012 11 09  
(181) 2022 11 09  
(511) 44

---

(260) AM 2014 70612 A  
(800) 1144633  
(151) 2012 11 27  
(181) 2022 11 27  
(511) 09

---

(260) AM 2014 70614 A  
(800) 1144637  
(151) 2012 11 13  
(181) 2022 11 13  
(511) 01, 06, 07, 09, 19

---

(260) AM 2014 70615 A  
(800) 1144640  
(151) 2012 11 19  
(181) 2022 11 19  
(511) 01, 06, 07, 09, 19

---

(260) AM 2014 70616 A  
(800) 1144641  
(151) 2012 11 20  
(181) 2022 11 20  
(511) 02, 12, 25, 37

---

(260) AM 2014 70617 A  
(800) 1144644  
(151) 2012 11 14  
(181) 2022 11 14  
(511) 18, 25

---

(260) AM 2014 70618 A  
(800) 1144655  
(151) 2012 11 13  
(181) 2022 11 13  
(511) 30

---

(260) AM 2014 70619 A  
(800) 1144660  
(151) 2012 11 19  
(181) 2022 11 19  
(511) 33, 35

---

(260) AM 2014 70620 A  
(800) 1144771  
(151) 2012 03 12  
(181) 2022 03 12  
(511) 06, 07, 12

---

(260) AM 2014 70621 A  
(800) 1144674  
(151) 2012 11 15  
(181) 2022 11 15  
(511) 12

---

(260) AM 2014 70622 A  
(800) 1144702  
(151) 2012 12 10  
(181) 2022 12 10  
(511) 18

---

(260) AM 2014 70623 A  
(800) 1144713  
(151) 2012 12 12  
(181) 2022 12 12  
(511) 09

---

(260) AM 2014 70624 A  
(800) 1144717  
(151) 2012 12 12  
(181) 2022 12 12  
(511) 09

---

(260) AM 2014 70626 A  
(800) 1144722  
(151) 2012 12 03  
(181) 2022 12 03  
(511) 17, 35, 42

---

(260) AM 2014 70627 A  
(800) 1144723  
(151) 2012 12 03  
(181) 2022 12 03  
(511) 17, 35, 42

---

(260) AM 2014 70628 A  
(800) 1144724  
(151) 2012 12 03  
(181) 2022 12 03  
(511) 01, 17, 35, 42

---

(260) AM 2014 70664 A  
(800) 1144853  
(151) 2012 11 14  
(181) 2022 11 14  
(511) 09, 35

---

(260) AM 2014 70665 A  
(800) 1144862  
(151) 2012 10 11  
(181) 2022 10 11  
(511) 12, 25, 37

---

(260) AM 2014 70666 A  
(800) 1144871  
(151) 2012 11 14  
(181) 2022 11 14  
(511) 12, 25, 37

---

(260) AM 2014 70667 A  
(800) 1144884  
(151) 2012 12 11  
(181) 2022 12 11  
(511) 25

---

(260) AM 2014 70668 A  
(800) 1144886  
(151) 2012 12 11  
(181) 2022 12 11  
(511) 07

---

(260) AM 2014 70670 A  
(800) 1144935  
(151) 2012 12 01  
(181) 2022 12 01  
(511) 34, 35, 39

---

(260) AM 2014 70671 A  
(800) 1144944  
(151) 2012 12 10  
(181) 2022 12 10  
(511) 03, 05

---

(260) AM 2014 70672 A  
(800) 1144947  
(151) 2012 11 26  
(181) 2022 11 26  
(511) 06

---

(260) AM 2014 70673 A  
(800) 1144948  
(151) 2012 11 26  
(181) 2022 11 26  
(511) 06

---

(260) AM 2014 70674 A  
(800) 1144980  
(151) 2012 12 05  
(181) 2022 12 05  
(511) 03

---

(260) AM 2014 70675 A  
(800) 1144986  
(151) 2012 08 01  
(181) 2022 08 01  
(511) 05

---

(260) AM 2014 70676 A  
(800) 1144987  
(151) 2012 08 01  
(181) 2022 08 01  
(511) 05

---

(260) AM 2014 70678 A  
(800) 1145027  
(151) 2012 07 26  
(181) 2022 07 26  
(511) 09, 28, 41

---

(260) AM 2014 70679 A  
(800) 1145033  
(151) 2012 08 15  
(181) 2022 08 15  
(511) 14, 24, 28, 30

---

(260) AM 2014 70681 A  
(800) 1145046  
(151) 2012 11 14  
(181) 2022 11 14  
(511) 01, 04, 29, 30, 31, 35, 37, 39, 40, 42, 44

---

(260) AM 2014 70682 A  
(800) 1145122  
(151) 2012 11 29  
(181) 2022 11 29  
(511) 05, 29, 30

---

(260) AM 2014 70683 A  
(800) 1145149  
(151) 2012 09 19  
(181) 2022 09 19  
(511) 05

---

(260) AM 2014 70724 A  
(800) 1085532  
(151) 2011 07 13  
(891) 2012 11 02  
(181) 2021 07 13  
(511) 05

---

(260) AM 2014 70726 A  
(800) 1088678  
(151) 2011 03 28  
(891) 2012 10 09  
(181) 2021 03 28  
(511) 12, 37, 41

---

(260) AM 2014 70727 A  
(800) 1089099  
(151) 2011 08 12  
(891) 2012 10 15  
(181) 2021 08 12  
(511) 33

---

(260) AM 2014 70728 A  
(800) 1092045  
(151) 2011 07 13  
(891) 2012 11 19  
(181) 2021 07 13  
(511) 25

---

(260) AM 2014 70761 A  
(800) 1145667  
(151) 2012 12 11  
(181) 2022 12 11  
(511) 03

---

---

# OFFICIAL NOTIFICATIONS

## REINSTATEMENT OF PATENTS

### INVENTIONS

**(11) P 2012 5620 B**

(73) Archil Prangishvili (GE);

Levan Imnaishvili (GE);

Maguli Bedineishvili (GE)

(54) **BIOMETRIC IDENTIFICATION AND REGISTRATION SYSTEM FOR PEDAGOGUES**

Date of Patent Reinstatement: 2014 05 13

---

**(11) P 2011 5338 B**

(73) Lali Ghurchumelia (GE)

(54) **FIRE-EXTINGUISHING POWDERS ON BASIS OF ZEOLITES, PERLITES AND CLAY-SLATES**

Date of Patent Reinstatement: 2014 05 13

---

---

# TRADEMARKS

## RENEWAL OF REGISTRATIONS

(111) M 1994 113 R2  
(156) 2014 10 27  
(186) 2024 10 27  
(732) PERFETTI VAN MELLE BENELUX B.V.  
Zoete Inval 20, 4815 HK Breda,  
Netherlands

---

(111) M 2004 15462 R1  
(156) 2014 03 25  
(186) 2024 03 15  
(732) BASF AGRO B.V., ARNHEM (NL)  
ZWEIGNIEDERLASSUNG ZÜRICH  
Im Tiergarten 7, 8055 Zürich, Switzerland

---

(111) M 2004 15463 R1  
(156) 2014 03 25  
(186) 2024 03 15  
(732) BASF AGRO B.V., ARNHEM (NL)  
ZWEIGNIEDERLASSUNG ZÜRICH  
Im Tiergarten 7, 8055 Zürich, Switzerland

---

(111) M 2004 15485 R1  
(156) 2014 03 31  
(186) 2024 03 31  
(732) WYBOROWA S.A.  
Ul. Komandoria 5, 61-023 Poznań, Poland

---

(111) M 2004 15508 R1  
(156) 2014 04 16  
(186) 2024 04 16  
(732) NORDMARK ARZNEIMITTEL GMBH &  
CO. KG  
Pinnauallee 4, D-25436 Uetersen, Germany

---

(111) M 2004 15516 R1  
(156) 2014 04 16  
(186) 2024 04 16  
(732) ROTTAPHARM LTD  
Damastown Industrial Park, Mulhuddart,  
Dublin 15, Irland

---

(111) M 2004 15555 R1  
(156) 2014 06 15  
(186) 2024 06 15  
(732) BENQ CORPORATION  
16, Jihu Road, Neihu Dist., Taipei 114,  
Taiwan, Province of China

---

(111) M 2004 15565 R1  
(156) 2014 06 15  
(186) 2024 06 15  
(732) COLGATE-PALMOLIVE COMPANY  
300 Park Avenue, New York, NY 10022,  
USA

---

(111) M 2004 15570 R1  
(156) 2014 06 15  
(186) 2024 06 15  
(732) Wyeth LLC  
Five Giralda Farms, Madison, NJ 07940,  
USA

---

(111) M 2004 15631 R1  
(156) 2014 08 13  
(186) 2024 08 13  
(732) BENQ CORPORATION  
16, Jihu Road, Neihu Dist., Taipei 114,  
Taiwan, Province of China

---

(111) M 2004 15671 R1  
(156) 2014 10 05  
(186) 2024 10 05  
(732) UNDERBERG GMBH & CO. KG  
Underbergstr.1-3, D-47495, Rainberg, Germany

---

(111) M 2005 15855 R1  
(156) 2015 02 14  
(186) 2025 02 14  
(732) GILEAD SCIENCES, INC. DELAWARE  
CORPORATION  
333 Lakeside Drive, Foster City, CA 94404,  
USA

---

(111) M 1994 186 R2  
(156) 2014 10 31  
(186) 2024 10 31  
(732) PERFETTI VAN MELLE BENELUX B.V.  
Zoete Inval 20, 4815 HK Breda, Netherlands

---

---

# CLASSIFICATION INDEXES

## INVENTIONS

### CONCORDANCE TABLE OF INTERNATIONAL CLASSIFICATION INDEX AND PUBLICATION NUMBERS

INTERNATIONAL CLASSIFICATION INDEXES (51)	NUMBER OF PUBLISHED APPLICATION (10)
A 47 J 37/00	AP 2014 13145 A
A 61 K 33/24	AP 2014 12340 A
A 61 M 5/50	AP 2014 12982 A
C 07 D 487/04; C 07 B 59/00; A 61 K 31/519; A 61 P 35/00; C 07 D 519/00	AP 2014 12834 A
F 42 B 10/06	AP 2014 13194 A
G 07 D 7/20; G 06 Q 10/00; G 06 K 9/64	AP 2014 12949 A

### CONCORDANCE TABLE OF APPLICATION APPLICATION PUBLICATION NUMBERS AND INTERNATIONAL CLASSIFICATION INDEXES

NUMBER OF PUBLISHED APPLICATION (10)	INTERNATIONAL CLASSIFICATION INDEXES (51)
AP 2014 13145 A	A 47 J 37/00
AP 2014 12340 A	A 61 K 33/24
AP 2014 12982 A	A 61 M 5/50
AP 2014 12834 A	C 07 D 487/04; C 07 B 59/00; A 61 K 31/519; A 61 P 35/00; C 07 D 519/00
AP 2014 13194 A	F 42 B 10/06
AP 2014 12949 A	G 07 D 7/20; G 06 Q 10/00; G 06 K 9/64

### CONCORDANCE TABLE OF INTERNATIONAL CLASSIFICATION INDEXES, PATENT NUMBERS AND PUBLICATION NUMBERS

INTERNATIONAL CLASSIFICATION INDEX (51)	NUMBER OF PATENT (11)	NUMBER OF PUBLISHED APPLICATION (10)
A 61 F 2/16	P 2014 6091 B	AP 2014 13088 A
A 61 K 9/00; A 61 K 31/13; A 61 K 9/08	P 2014 6087 B	AP 2014 12468 A
A 61 K 9/107; A 61 K 9/127; A 61 K 31/232; A 61 K 31/455; A 61 K 47/14; A 61 K 47/24	P 2014 6088 B	AP 2014 12619 A
C 07 K 16/28	P 2014 6084 B	AP 2014 12211 A
E 01 B 9/00	P 2014 6085 B	AP 2013 12427 A
G 10 L 19/00; H 04 S 3/00	P 2014 6086 B	AP 2014 12462 A
H 02 J 17/00	P 2014 6089 B	AP 2014 12731 A
H 04 M 3/42; H 04 M 3/487	P 2014 6090 B	AP 2014 13034 A

**CONCORDANCE TABLE OF PATENT NUMBERS,  
PUBLICATION NUMBERS AND INTERNATIONAL CLASSIFICATION INDEXES**

NUMBER OF PATENT (11)	NUMBER OF PUBLISHED APPLICATION (10)	INTERNATIONAL CLASSIFICATION INDEX (51)
1	2	3
P 2014 6084 B	AP 2014 12211 A	C 07 K 16/28
P 2014 6085 B	AP 2013 12427 A	E 01 B 9/00
P 2014 6086 B	AP 2014 12462 A	G 10 L 19/00; H 04 S 3/00
P 2014 6087 B	AP 2014 12468 A	A 61 K 9/00; A 61 K 31/13; A 61 K 9/08
P 2014 6088 B	AP 2014 12619 A	A 61 K 9/107; A 61 K 9/127; A 61 K 31/232; A 61 K 31/455; A 61 K 47/14; A 61 K 47/24
P 2014 6089 B	AP 2014 12731 A	H 02 J 17/00
P 2014 6090 B	AP 2014 13034 A	H 04 M 3/42; H 04 M 3/487
P 2014 6091 B	AP 2014 13088 A	A 61 F 2/16

**CONCORDANCE TABLE OF APPLICATION NUMBERS, APPLICATION  
PUBLICATION NUMBERS AND PATENT NUMBERS**

NUMBER OF APPLICATION (21)	NUMBER OF PUBLISHED APPLICATION (10)	NUMBER OF PATENT (11)
AP 2009 012211	AP 2014 12211 A	P 2014 6084 B
AP 2010 012468	AP 2014 12468 A	P 2014 6087 B
AP 2010 012619	AP 2014 12619 A	P 2014 6088 B
AP 2011 012427	AP 2013 12427 A	P 2014 6085 B
AP 2011 012462	AP 2014 12462 A	P 2014 6086 B
AP 2012 012731	AP 2014 12731 A	P 2014 6089 B
AP 2012 013034	AP 2014 13034 A	P 2014 6090 B
AP 2013 013088	AP 2014 13088 A	P 2014 6091 B

## UTILITY MODELS

**CONCORDANCE TABLE OF INTERNATIONAL CLASSIFICATION INDEXES  
AND PUBLICATION NUMBERS**

INTERNATIONAL CLASSIFICATION INDEXES (51)	NUMBER OF PUBLISHED APPLICATION (10)
B 65 H 54/08, 7/04; G 01 N 33/36; D 01 B 7/04	AU 2014 13112 U

**CONCORDANCE TABLE OF PUBLICATION NUMBERS  
AND INTERNATIONAL CLASSIFICATION INDEX**

NUMBER OF PUBLISHED APPLICATION (10)	INTERNATIONAL CLASSIFICATION INDEXES (51)
AU 2014 13112 U	B 65 H 54/08, 7/04; G 01 N 33/36; D 01 B 7/04



**CONCORDANCE TABLE OF INTERNATIONAL CLASSIFICATION INDEX,  
PATENT NUMBERS AND PUBLICATION NUMBERS**

INTERNATIONAL CLASSIFICATION INDEX (51)	NUMBER OF PATENT (11)	NUMBER OF PUBLISHED APPLICATION (10)
A 61 K 36/481; A 61 K 135/00	U 2014 1812 Y	AU 2014 12969 U
E 05 B 41/00	U 2014 1811 Y	AU 2014 12815 U

**CONCORDANCE TABLE OF PATENT NUMBERS,  
PUBLICATION NUMBERS AND INTERNATIONAL CLASSIFICATION INDEX**

NUMBER OF PATENT (11)	NUMBER OF PUBLISHED APPLICATION (10)	INTERNATIONAL CLASSIFICATION INDEX (51)
U 2014 1811 Y	AU 2014 12815 U	E 05 B 41/00
U 2014 1812 Y	AU 2014 12969 U	A 61 K 36/481; A 61 K 135/00

**CONCORDANCE TABLE OF APPLICATION NUMBERS, PUBLICATION NUMBERS  
AND PATENTS**

NUMBER OF APPLICATION (21)	NUMBER OF PUBLISHED APPLICATION (10)	NUMBER OF PATENT (11)
AU 2012 012815	AU 2014 12815 U	U 2014 1811 Y
AU 2013 012969	AU 2014 12969 U	U 2014 1812 Y

## DESIGNS

**CONCORDANCE TABLE OF INTERNATIONAL CLASSIFICATION INDEXES  
AND PUBLICATION NUMBERS**

INTERNATIONAL CLASSIFICATION INDEX (51)	NUMBER OF PUBLISHED APPLICATION (10)
09-01	AD 2014 776 S

**CONCORDANCE TABLE OF PUBLICATION NUMBERS  
AND INTERNATIONAL CLASSIFICATION INDEX**

NUMBER OF PUBLISHED APPLICATION (10)	INTERNATIONAL CLASSIFICATION INDEXES (51)
AD 2014 776 S	09-01

## TRADEMARKS

### CONCORDANCE TABLE OF REGISTRATION NUMBERS, APPLICATION NUMBERS, PUBLICATION NUMBERS AND BULLETIN NUMBERS

NUMBER OF REGISTRATION (111)	NUMBER OF APPLICATION (210)	NUMBER OF PUBLISHED APPLICATION (260)	NUMBER OF BULLETIN
M 2014 24695 R	AM 2014 76497	-	9(397) 2014
M 2014 24696 R	AM 2012 70078	AM 2013 70078 A	19(383) 2013
M 2014 24697 R	AM 2012 70079	AM 2013 70079 A	19(383) 2013
M 2014 24698 R	AM 2012 70081	AM 2013 70081 A	19(383) 2013
M 2014 24699 R	AM 2013 70337	AM 2013 70337 A	19(383) 2013
M 2014 24700 R	AM 2013 70480	AM 2013 70480 A	24(388) 2013
M 2014 24701 R	AM 2013 70609	AM 2013 70609 A	22(386) 2013
M 2014 24702 R	AM 2013 70798	AM 2013 70798 A	24(388) 2013
M 2014 24703 R	AM 2013 70866	AM 2013 70866 A	20(384) 2013
M 2014 24704 R	AM 2013 70961	AM 2013 70961 A	24(388) 2013
M 2014 24705 R	AM 2013 71115	AM 2013 71115 A	24(388) 2013
M 2014 24706 R	AM 2013 71116	AM 2013 71116 A	24(388) 2013
M 2014 24707 R	AM 2013 71117	AM 2013 71117 A	24(388) 2013
M 2014 24708 R	AM 2013 71305	AM 2013 71305 A	24(388) 2013
M 2014 24709 R	AM 2013 71391	AM 2013 71391 A	24(388) 2013
M 2014 24710 R	AM 2013 71479	AM 2013 71479 A	24(388) 2013
M 2014 24711 R	AM 2013 71486	AM 2013 71486 A	24(388) 2013
M 2014 24712 R	AM 2013 71790	AM 2014 71790 A	1(389) 2014
M 2014 24713 R	AM 2013 72101	AM 2013 72101 A	24(388) 2013
M 2014 24714 R	AM 2013 72146	AM 2014 72146 A	1(389) 2014
M 2014 24715 R	AM 2013 72151	AM 2013 72151 A	24(388) 2013
M 2014 24716 R	AM 2014 76536	-	9(397) 2014
M 2014 24717 R	AM 2013 71096	AM 2013 71096 A	24(388) 2013

### CONCORDANCE TABLE OF PUBLICATION NUMBERS AND APPLICATION NUMBERS

NUMBER OF PUBLISHED APPLICATION (260)	NUMBER OF APPLICATION (210)	1	2
1	2	AM 2014 72955 A	AM 2013 72955
AM 2014 70116 A	AM 2012 70116	AM 2014 73070 A	AM 2013 73070
AM 2014 70117 A	AM 2012 70117	AM 2014 73078 A	AM 2013 73078
AM 2014 72525 A	AM 2013 72525	AM 2014 73083 A	AM 2013 73083
AM 2014 72644 A	AM 2013 72644	AM 2014 73084 A	AM 2013 73084
AM 2014 72678 A	AM 2013 72678	AM 2014 73085 A	AM 2013 73085
AM 2014 72750 A	AM 2013 72750	AM 2014 73086 A	AM 2013 73086
AM 2014 72807 A	AM 2013 72807	AM 2014 73089 A	AM 2013 73089
AM 2014 72877 A	AM 2013 72877	AM 2014 73093 A	AM 2013 73093
AM 2014 72927 A	AM 2013 72927	AM 2014 73094 A	AM 2013 73094
AM 2014 72928 A	AM 2013 72928	AM 2014 73147 A	AM 2013 73147
AM 2014 72929 A	AM 2013 72929	AM 2014 73262 A	AM 2013 73262
AM 2014 72953 A	AM 2013 72953	AM 2014 73297 A	AM 2013 73297
		AM 2014 73535 A	AM 2013 73535
		AM 2014 73698 A	AM 2013 73698
		AM 2014 73733 A	AM 2013 73733

**CONCORDANCE TABLE OF INDEX OF GOODS AND/OR SERVICES  
AND APPLICATION NUMBERS**

INDEX OF GOODS AND/OR SERVICES (511)	NUMBER OF PUBLISHED APPLICATION (260)	1	2
1	2	29	AM 2014 73070 A
3	AM 2014 73093 A	29	AM 2014 73094 A
5	AM 2014 72750 A	29	AM 2014 73535 A
7	AM 2014 73262 A	30	AM 2014 72929 A
11	AM 2014 72928 A	30	AM 2014 73535 A
11	AM 2014 73262 A	30	AM 2014 73698 A
12	AM 2014 72927 A	31	AM 2014 73535 A
12	AM 2014 73297 A	32	AM 2014 72807 A
14	AM 2014 73078 A	33	AM 2014 72525 A
16	AM 2014 72877 A	33	AM 2014 72644 A
16	AM 2014 73083 A	34	AM 2014 72678 A
16	AM 2014 73084 A	34	AM 2014 72953 A
16	AM 2014 73085 A	34	AM 2014 72955 A
16	AM 2014 73086 A	34	AM 2014 73147 A
18	AM 2014 73078 A	35	AM 2014 72525 A
18	AM 2014 73733 A	36	AM 2014 73083 A
20	AM 2014 73089 A	36	AM 2014 73084 A
25	AM 2014 73733 A	36	AM 2014 73085 A
28	AM 2014 73733 A	36	AM 2014 73086 A
29	AM 2014 70116 A	43	AM 2014 73535 A
29	AM 2014 70117 A	44	AM 2014 73083 A
		44	AM 2014 73084 A
		44	AM 2014 73085 A
		44	AM 2014 73086 A

**CONCORDANCE TABLE OF INDEX OF GOODS AND/OR SERVICES  
AND NUMBERS OF TRADEMARKS REGISTERED ACCORDING  
TO THE ACCELERATED PROCEDURE**

INDEX OF GOODS AND/OR SERVICES (511)	NUMBER OF REGISTERED ACCORDING TO THE ACCELERATED PROCEDURE (111)
36	M 2014 24695 R
41	M 2014 24716 R

# OFFICIAL BULLETIN OF THE INDUSTRIAL PROPERTY

## 9(397)

EDITOR-IN-CHIEF: N. Bebrishvili

EDITORS-TRANSLATORS: E. Gabunia  
G. Nadareishvili

COMPUTER LAYOUT: K. Svanidze