



**NATIONAL INTELLECTUAL PROPERTY CENTER OF GEORGIA
SAKPATENTI**

**OFFICIAL BULLETIN
OF THE INDUSTRIAL PROPERTY**

3(463)

**2017
TBILISI**

INID CODES FOR IDENTIFICATION OF BIBLIOGRAPHIC DATA

INVENTIONS, UTILITY MODELS

- (10) Number of publication for application, which has been examined
- (11) Number of patent and kind of document
- (21) Serial number of application
- (22) Date of filing of the application
- (23) Date of exhibition or the date of the earlier filing and the number of application, if any
- (24) Date from which patent may have effect
- (31) Number of priority application
- (32) Date of filing of priority application
- (33) Code of the country or regional organization allotting priority application number
- (44) Date of publication of application not granted, but examined and number of bulletin
- (45) Date of publication of registered document
- (51) International Patent Classification Index
- (54) Title of the invention
- (57) Abstract
- (60) Number of examined patent document granted by foreign patent office, date from which patent has effect and country code
- (62) Number of the earlier application and in case of divided application, date of filing an application
- (71) Name, surname and address of applicant (country code)
- (72) Name, surname of inventor (country code)
- (73) Name, surname and address of patent owner (country code)
- (74) Name, surname of representative or patent attorney
- (85) Date of commencement of the national phase of International Application
- (86) Number and date of filing of international application
- (87) Number and date of publication of international application

DESIGNS

- (10) Number of publication for application
- (11) Number of patent and kind of document or number of registration
- (15) Date of registration/Date of patent renewal
- (18) Expected expiration date of patent or registration
- (21) Serial number of application
- (22) Date of filing of the application
- (23) Date of exhibition or the date of the earlier filing and the number of application, if any
- (24) Date from which patent may have effect
- (28) Number of designs included in the application
- (30) Data relating to priority (number of application, date of filing of application, two-letter code identifying the authority with whom the priority application was made)
- (31) Number of priority application
- (32) Date of filing of priority application
- (33) Code of the country or regional organization allotting priority application number
- (34) Two-letter code according to WIPO St.3 identifying the authority with which the priority application was made
- (44) Date of publication of design and number of bulletin (the first publication)
- (45) Date of publication of design registered by WIPO and number of bulletin
- (51) International Classification for designs (class and subclass of the Locarno Classification)
- (54) Title of the invention
- (55) Reproduction of the design
- (57) Description of characteristic features of the design including indication of colors
- (58) Date of recording of any kind of amendment in the Register
- (62) Number of the earlier application, registration and document number and if available the date of filing an application in case of divided application
- (71) Name, surname and address of applicant (country code)
- (72) Name, surname of creator (country code)
- (73) Name, surname and address of patent owner (country code)
- (74) Name, surname of representative or patent attorney
- (81) Contracting states concerned
 - II designated contracting states according to the 1960 Act
 - III designated contracting states according to the 1999 Act
- (85) Owner's permanent address
- (86) Owner's nationality
- (87) Owner's residence
- (88) State in which the owner has a real and effective industrial or commercial establishment

TRADEMARKS

- (111) – Number of registration
- (151) – Date of registration
- (156) – Date of the renewal
- (181) – Expected expiration date of registration
- (186) – Renewal expiration date of registration
- (141) – Date of cancel of duration of the mark
- (210) – Serial number of application
- (220) – Date of filing of the application
- (230) – Data concerning exhibition
- (260) – Number of application, for which favorable decision of examination about registration has been taken (publication number)
- (310) – Number of the first application
- (320) – Date of filing of the first application
- (330) – Code, identifying national or regional Office where the first application was made
- (511) – International Classification of Goods and Services for the purposes of registration of trade marks and/or list of goods and/or services classified according thereto
- (531) – Description of figurative elements of Trade Marks according to the International Classification of the Figurative Elements of Marks
- (540) – Reproduction of Trade Mark
- (550) – Nature and kind of Trade Mark
- (580) – Date of recording of any kind changes in respect of applications or registrations
- (591) – Information concerning colors claimed
- (731) – Name and address of the applicant
- (732) – Name and address of the holder of the registration
- (740) – Name and address of the representative
- (750) – Address for correspondence
- (770) – Name and address of the previous applicant or holder in case of change in ownership
- (771) – Previous name and address of the applicant or holder in case of change in ownership
- (791) – Name and address of the licensee
- (793) – Indication of conditions and/or restrictions under the license (Type of license, number of license agreement, data of license, data of validity of license)
- (800) – Certain data relating to the international registration of Trade Marks under the Protocol Relating to Madrid Agreement (International registration number)

CODES FOR PUBLICATION IN BULLETIN

- (21) AP 0000 000000 – serial number of application for invention
- (10) AP 0000 0000 A – number of published application for invention (first publication)
- (11) P 0000 0000 B – number of patent for invention (second publication)
- (21) API 0000 000000 – number of application for imported patent
- (11) PI 0000 0000 A – number of imported patent (first publication)
- (21) AU 0000 000000 – serial number of application for utility model
- (10) AU 0000 000 U – number of published application for utility model (first publication)
- (11) U 0000 000 Y – number of patent for utility model (second publication)
- (21) AD 0000 000000 – serial number of application for design
- (10) AD 0000 000 S – number of published application for design (first publication)
- (11) D 0000 000 S – number of patent for design (second publication)

INTERNATIONAL PATENT CLASSIFICATION FOR INVENTIONS AND UTILITY MODELS

- SECTION A – HUMAN NECESSITIES
- SECTION B – PERFORMING OPERATIONS; TRANSPORTING
- SECTION C – CHEMISTRY; METALLURGY
- SECTION D – TEXTILES; PAPER
- SECTION E – FIXED CONSTRUCTIONS
- SECTION F – MECHANICAL ENGINEERING; LIGHTING; HEATING; WEAPONS; BLASTING
- SECTION G – PHYSICS
- SECTION H – ELECTRICITY

-
- M – Trade Mark
 - (210) AM 0000 000000 – Serial number of application;
 - (260) AAM 0000 00000 A – Publication number of application;
 - (111) M 0000 00000 R – Number of registration;
 - (111) MMM0000 00000 Rn – Number of renewals, in which n=1,2,3;
 - (111) M 0000 00000 R(P) – Number of registration under partial assignment of rights
-

LIST OF CODES, IN ALPHABETIC SEQUENCE, AND THE CORRESPONDING (SHORT) NAMES OF STATES, OTHER ENTITIES AND INTERGOVERNMENTAL ORGANIZATIONS (WIPO STANDARD ST.3)

AD	Andorra		for the Arab States of the Gulf (GCC)	NE	Niger
AE	United Arab Emirates	GD	Grenada	NG	Nigeria
AF	Afghanistan	GG	Guernsey	NI	Nicaragua
AG	Antigua and Barbuda	GH	Ghana	NL	Netherlands
AI	Anguilla	GI	Gibraltar	NO	Norway
AL	Albania	GT	Guatemala	NP	Nepal
AM	Armenia	GW	Guinea- Bissau	NR	Nauru
AN	Netherlands Antilles	GY	Guyana	NZ	New Zealand
AO	Angola	HK	The Hong Kong Special Administrative Region of the People's Republic of China	OA	African Intellectual Property Organization (OAPI)
AP	African Regional Intellectual Property Organization (ARIPO)	HN	Honduras	OM	Oman
AR	Argentina	HR	Croatia	PA	Panama
AT	Austria	HT	Haiti	PE	Peru
AU	Australia	HU	Hungary	PG	Papua New Guinea
AW	Aruba	IB	International Bureau of the World Intellectual Property Organization (WIPO)	PH	Philippines
AZ	Azerbaijan	ID	Indonesia	PK	Pakistan
BA	Bosnia and Herzegovina	IE	Ireland	PL	Poland
BB	Barbados	IL	Israel	PT	Portugal
BD	Bangladesh	IM	Isle of Man	PW	Palau
BE	Belgium	IN	India	PY	Paraguay
BF	Burkina Faso	IQ	Iraq	QA	Qatar
BG	Bulgaria	ID	Indonesia	QZ	Community Plant Variety Office (European Community) (CPVO)
BH	Bahrain	IE	Ireland	RO	Romania
BI	Burundi	IL	Israel	RS	Serbia
BJ	Benin	IM	Isle of Man	RU	Russian Federation
BM	Bermuda	IN	India	RW	Rwanda
BN	Brunei Darussalam	IQ	Iraq	SA	Saudi Arabia
BO	Bolivia	IR	Iran (Islamic Republic of)	SB	Solomon Islands
BR	Brazil	IS	Iceland	SC	Seychelles
BS	Bahamas	IT	Italy	SD	Sudan
BT	Bhutan	JE	Jersey	SG	Singapore
BV	Bouvet Island	JM	Jamaica	SH	Saint Helena
BW	Botswana	JO	Jordan	SI	Slovenia
BX	Benelux Office for Intellectual Property (BOIP)	JP	Japan	SK	Slovakia
BY	Belarus	KE	Kenya	SL	Sierra Leone
BZ	Belize	KG	Kyrgyzstan	SM	San Marino
CA	Canada	KH	Cambodia	SN	Senegal
CD	Democratic Republic of the Congo	KI	Kiribati	SO	Somalia
CF	Central African Republic	KM	Saint Kitts and Nevis	SR	Suriname
CG	Congo	KP	Democratic People's Republic of Korea	ST	Sao Tome and Principe
CH	Switzerland	KR	Republic of Korea	SV	El Salvador
CI	Cote d'Ivoire	KW	Kuwait	SY	Syrian Arab Republic
CK	Cook Islands	KY	Cayman Islands	SZ	Swaziland
CL	Chile	KZ	Kazakhstan	TC	Turks and Caicos Islands
CM	Cameroon	LA	Lao People's Democratic Republic	TD	Chad
CN	China	LB	Lebanon	TG	Togo
CO	Colombia	LC	Saint Lucia	TH	Thailand
CR	Costa Rica	LI	Liechtenstein	TJ	Tajikistan
CU	Cuba	LK	Sri Lanka	TL	Timor-Leste
CV	Cape Verde	LR	Liberia	TM	Turkmenistan
CY	Cyprus	LS	Lesotho	TN	Tunisia
CZ	Czech Republic	LT	Lithuania	TO	Tonga
DE	Germany	LU	Luxembourg	TR	Turkey
DJ	Djibouti	LV	Latvia	SE	Sweden
DM	Dominica	LY	Libyan Arab Jamahiriya	TT	Trinidad and Tobago
DO	Dominican Republic	MA	Morocco	TV	Tuvalu
DZ	Algeria	MC	Monaco	TW	Taiwan, Province of China
EA	Eurasian Patent Organization (EAPO)	MD	Republic of Moldova	TZ	United Republic of Tanzania
EC	Ecuador	ME	Montenegro	UA	Ukraine
EE	Estonia	MG	Madagascar	UG	Uganda
EG	Egypt	MK	The former Yugoslav Republic of Macedonia	US	United States of America
EH	Western Sahara			UY	Uruguay
EM	Office for Harmonization in the Internal Market (Trademarks and Designs)(OHIM)	ML	Mali	UZ	Uzbekistan
EP	European Patent Office (EPO)	MM	Myanmar	VA	Holy See
ER	Eritrea	MN	Mongolia	VC	Saint Vincent and the Grenadines
ES	Spain	MO	Macao	VE	Venezuela
ET	Ethiopia	MP	Northern Mariana Islands	VG	Virgin Islands (British)
FI	Finland	MR	Mauritania	VN	Viet Nam
FJ	Fiji	MS	Montserrat	VU	Vanuatu
FK	Falkland Islands (Malvinas)	MT	Malta	WO	World Intellectual Property Organization (WIPO)
FO	Faroe Islands	MU	Mauritius	WS	Samoa
FR	France	MV	Maldives	XN	Nordic Patent Institute (NPI)
GA	Gabon	MW	Malawi	YE	Yemen
GB	United Kingdom	MX	Mexico	ZA	South Africa
GC	Patent Office of the Cooperation Council	MY	Malaysia	ZM	Zambia
		MZ	Mozambique	ZW	Zimbabwe
		NA	Namibia		

**NATIONAL INTELLECTUAL PROPERTY CENTER OF GEORGIA
SAKPATENTI**

**OFFICIAL BULLETIN
OF THE INDUSTRIAL PROPERTY**

3(463)

INVENTIONS

UTILITY MODELS

DESIGNS

TRADEMARKS

**APPELLATIONS OF ORIGIN AND GEOGRAPHICAL
INDICATION OF GOODS**

DATE OF PUBLICATION

2017 02 10

CONTENTS

PUBLISHED TITLES OF PROTECTION	2
INVENTIONS	
▪ APPLICATIONS APPROVED FOR GRANTING PATENTS	4
▪ PATENTED INVENTIONS	9
UTILITY MODELS	
▪ PATENTED UTILITY MODEL	14
DESIGNS	
▪ REGISTERED DESIGNS	15
▪ DESIGNS REGISTERED WITH THE INTERNATIONAL BUREAU CLAIMING PRIORITY ON THE TERRITORY OF GEORGIA	16
TRADEMARKS	
▪ APPLICATIONS FILED UNDER THE NATIONAL PROCEDURE APPROVED FOR REGISTRATION	38
▪ REGISTERED TRADEMARKS	48
▪ TRADEMARKS REGISTERED ACCORDING TO THE ACCELERATED PROCEDURE	54
▪ INTERNATIONAL TRADEMARKS FOR WHICH A DECISION ON GANTING PROTECTION IS TAKEN	57
▪ INTERNATIONAL TRADEMARKS PROTECTED IN GEORGIA	81
APPELLATIONS OF ORIGIN AND GEOGRAPHICAL INDICATION OF GOODS	
▪ REGISTERED APPELLATIONS OF ORIGIN OF GOODS	94
▪ REGISTERED GEOGRAPHICAL INDICATION	98
OFFICIAL NOTIFICATIONS	
INVENTIONS	
▪ RENEWAL OF A PATENTS	99
UTILITY MODELS	
▪ RENEWAL OF A PATENTS	100
TRADEMARKS	
▪ RENEWAL OF REGISTRATIONS	101
▪ COMPLETE TRANSFER OF RIGHTS	107
▪ CHANGES IN NAMES AND/OR ADDRESSES OF OWNERS	117
CLASSIFICATION INDEXES	
INVENTIONS	119
UTILITY MODELS	122
DESIGNS	123
TRADEMARKS	124

PUBLISHED TITLES OF PROTECTION

INVENTIONS

- **APPLICATIONS APPROVED FOR GRANTING PATENTS:**
13715; 13894; 13384; 14026; 13515; 13895; 13595; 13979; 13362; 13796; 13347; 13536; 14037
- **PATENTED INVENTIONS:**
6611-6626

UTILITY MODELS

- **PATENTED UTILITY MODEL:**
1926

DESIGNS

- **REGISTERED DESIGNS:**
697, 696
- **DESIGNS REGISTERED WITH THE INTERNATIONAL BUREAU CLAIMING PRIORITY ON THE TERRITORY OF GEORGIA:**
91895; 93594; 93674, 93675; 93724, 93725; 93786; 93807; 93880

TRADEMARKS

- **APPLICATIONS FILED UNDER THE NATIONAL PROCEDURE APPROVED FOR REGISTRATION:**
83830; 85027; 86681; 86881; 86895, 86896; 86928; 86966; 87075; 87159; 87195; 87213; 87338; 87366; 87388; 87415; 87444, 87445; 87486; 87498; 87504; 87510; 87512; 87528; 87533; 87557; 87569; 87588, 87589; 87620, 87621; 87624; 87677; 87748; 87751; 87762; 87776; 87778, 87779; 87784-87786; 87788; 87792; 87794; 87799; 87834; 87874; 87883; 87885; 87887; 87892; 87909; 87965; 87971; 88071
- **REGISTERED TRADEMARKS:**
28091-28112; 28114-28155
- **TRADEMARKS REGISTERED ACCORDING TO THE ACCELERATED PROCEDURE:**
28078-28090; 28113
- **INTERNATIONAL TRADEMARKS FOR WHICH A DECISION ON GRANTING PROTECTIONS IS TAKEN:**
80883*; 84186*; 84424*; 85460; 86024; 86178; 86449; 86474-86476; 86480; 86485; 86489; 86493; 86501-6503; 86505; 86507, 86508; 86510, 86511; 86520; 86522; 86562; 86567; 86570; 86572-86574; 86580; 86706; 86710-86712; 86714; 86791, 86792; 86810; 86816; 86819; 86917; 86919; 86961; 87039, 87040; 87042; 87062; 87064; 87109; 87171; 87178; 87180; 87197, 87198; 87200; 87207
- **INTERNATIONAL TRADEMARKS PROTECTED IN GEORGIA:**
73612; 73711; 70162; 80660; 82339; 84585; 84596; 84601; 84612; 84614; 84745; 85069; 85146; 85148, 85149; 85152-85156; 85158; 85161; 85166, 85167; 85172; 85174; 85176, 85177; 85179, 85180; 85184; 85198; 85203; 85206; 85208; 85210; 85212; 85214-85216; 85239; 85244; 85250, 85251; 85257; 85261, 85262; 85267, 85268; 85278; 85284; 85292; 85296, 85297; 85323; 85330; 85333; 85337; 85339; 85342; 85344; 85348, 85349; 85356; 85358; 85362; 85368-85370; 85377; 85381-85383; 85386-85390; 85397-85399; 85412-85414; 85428, 85429; 85436; 85439; 85442; 85454; 85465, 85466; 85470; 85472; 85474-85480; 85484, 85485; 85507; 85511-85513; 85515-85521; 85537; 85539, 85540; 85547; 85549-85551; 85562; 85566; 85571; 85575; 85582; 85584-85586; 85588-85590; 85595-85599; 85601; 85603; 85605; 85607-85609; 85611-85613; 85615-85617; 85632; 85635; 85637; 85643; 85647, 85648; 85651; 85654, 85655; 85680; 85683; 85779; 85782; 85785-85788; 85935; 85941-85943; 85946; 86013; 86016-86018; 86022, 86023; 86160; 86163; 86165, 86166; 86282; 86319, 86320; 86595

APPELLATIONS OF ORIGIN AND GEOGRAPHICAL INDICATIONS OF GOODS

- **REGISTERED APPELLATIONS OF ORIGIN OF GOODS:**
822-824; 831-844
- **REGISTERED GEOGRAPHICAL INDICATION:**
17-20

INVENTIONS

APPLICATIONS APPROVED FOR GRANTING PATENTS

The decision can be appealed at the Chamber of Appeal of Sakpatenti within 3 months from the publication or at the Mtskheta District Court Administrative Cases Board (Address: №17, Samkhedro str., Mtskheta), within 1 month following the publication.

PART A

A 61

(10) AP 2017 13715 A **(51) Int. Cl. (2006)**
A 61 K 9/00
A 61 K 9/14
A 61 K 31/40
A 61 K 31/439
A 61 K 31/4704
A 61 K 31/33

(21) AP 2013 013715 (22) 2013 06 24
(31) 2012/07842; 2012/10438; 2013/00194
(32) 2012 07 05; 2012 09 12; 2013 01 07
(33) TR; TR; TR
(71) ARVEN ILAC SANAYI VE TICARET
A.S. (TR)
Balabandere Cad. Ilac Sanayi Yolu, No:14
Istinye, 34460 Istanbul (TR)
(72) CIFTER, Umit (TR);
TURKYILMAZ, Ali (TR);
MUTLU, Onur (TR);
RAMAZANOGLU, Gaye (TR)

(74) Shalva Gvaramadze
(85) 2015 02 03
(86) PCT/TR2013/000193, 2013 06 24
(54) **DRY POWDER INHALER**
COMPOSITIONS COMPRISING LONG
ACTING MUSCORINIC ANTAGONISTS
(57) Composition contains muscarinic receptor antagonists of prolong action in the form of dry powder and pharmaceutically acceptable carrier; at that, the carrier is represented in the form of mixture of small and big particles.
Claims: 3 independent
25 dependent

(10) AP 2017 13894 A **(51) Int. Cl. (2006)**
A 61 K 38/06
A 61 K 38/48
A 61 K 31/737
C 08 B 37/00
C 12 N 9/50
C 12 P 13/12
A 61 P 29/00

(21) AP 2014 013894 (22) 2014 01 23
(31) MI2013A000117

(32) 2013 01 25
(33) IT
(71) GNOSIS S.P.A. (IT)
Piazza del Carmine 4, I-20121 Milano (IT)
(72) MIRAGLIA, Niccolò (IT);
ROSSINI, Mauro (IT);
BIANCHI, Davide (IT);
TRENTIN, Antonella (IT)

(74) Shalva Gvaramadze
(85) 2015 07 23
(86) PCT/EP2014/051308, 2014 01 23
(54) **COMPOSITIONS CONTAINING**
CHONDROITIN SULPHATE,
PROTEOLYTIC ENZYMES AND
SULPHYDRYL COMPOUNDS FOR
IMPROVING THE BIOAVAILABILITY
OF CHONDROITIN SULPHATE

(57) Composition contains chondroitin sulphate, nattokinase and sulphhydryl compound.
Claims: 2 independent
13 dependent
Fig.: 1

(10) AP 2017 13384 A **(51) Int. Cl. (2006)**
A 61 K 39/125

(21) AP 2012 013384 (22) 2012 07 11
(31) 61/506,447
(32) 2011 07 11
(33) US
(71) TAKEDA VACCINES, INC (US)
2155 Analysis Drive, Bozeman, Montana
59718 (US)
(72) RICHARDSON, Charles (US);
BARGATZE, Robert, F. (US);
MENDELMAN, Paul, M. (US)

(74) Larisa Amirkhanyan
(85) 2014 02 11
(86) PCT/US2012/046222, 2012 07 11
(54) **PARENTERAL NOROVIRUS**
VACCINE FORMULATIONS
(57) Present invention relates to single dose vaccine compositions containing mixtures of univalent virus-like particles of norovirus. There is disclosed the methods providing protective immunity against norovirus infections, in human, as well.
Claims: 2 independent
12 dependent

PART B

B 01

(10) AP 2017 14026 A (51) Int. Cl. (2006)

B 01 J 20/18

C 02 F 1/28

C 02 F 1/64

(21) AP 2015 014026 (22) 2015 12 28

(71) Jemal Shengelia (GE)

Nutsubidzis q. 2, b.9, 0186, Tbilisi (GE);

Vakhtang Tediashvili (GE)

Vazha-Pshavelas III kv., 24 korp., b. 1, 0186, Tbilisi (GE);

Tamar Tkeshelashvili (GE)

XV k., II chikhi 4, 1008, sop. Persati,

Baghdatis r-ni (GE);

Irakli Suladze (GE)

Al. Kazbegis gamz. 49a, b. 15, 0177,

Tbilisi (GE);

Levan Beriashvili (GE)

Vazisubani, Tsulukidzis III shes., korp. 9,

b. 24, 0190, Tbilisi (GE);

Shalva Kikabidze (GE)

me-20 mkr, korp. 15, b. 96, 3700,

Rustavi (GE)

(72) Jemal Shengelia (GE);

Vakhtang Tediashvili (GE);

Tamar Tkeshelashvili (GE);

Irakli Suladze (GE);

Levan Beriashvili (GE);

Shalva Kikabidze (GE)

(54) **METHOD FOR RECEIVING
FILTERING MATERIAL FOR Mn^{+2}
IONS REMOVAL FROM WATER**

(57) A method for receiving filtering material for Mn^{+2} ions removal from water including treatment of solid back with Mn (II) salts water solutions and oxidizing in electrolysis of Mn^{+2} ions in MnO_2 in interstitial in solid back structure, wherein electrolysis of NaCl water solution is 50-100 g/l, is received oxidizing NaClO, with 4-6 g/l amount; at that, zeolite porous ceramic received from charge consisting of zeolite 40.7-42.3%, red clay 33.4-34.6% and sawdust 23.1-25.9% and burned at 800-850°C is used as solid back, when oxidizing process is executed by means of equipment connected to electrolyzer which united system of solution circulation.

Claims: 1 independent

Table: 2

B 61

(10) AP 2017 13515 A (51) Int. Cl. (2006)

B 61 F 3/02

(21) AP 2014 013515 (22) 2014 07 04

(71) Givi Kuprashvili (GE)

V. Bochorishvilis q. 1, b. 39, 0171,

Tbilisi (GE)

(72) Givi Kuprashvili (GE)

(54) **FRAMELESS TWO-AXLE BOGIE
OF EXPRESS CARRIAGE**

(57) A body is rested on spring 5 center by means of resting equipment 1. The spring includes two-component sheets 7 and 8, and with its ends, by means of nodes 9, is connected to double springs 11 and 12 disposed between boxes 10 and consisting of ternary sheetes 31 and 32. Flat silentblocks 18 are fastened on each blacket 14 of spring 11 yoke, a roller 17 with calculated clearance is passed in lower part of extreme sheet relative to the ends. Springs 11 and 12 with boxes 10 are connected to each other by means of nodes 23 and 24. Pressurized in suspension brackets 28 upper staples the silentblocks 29 are vertical antivibration means, and the silentblocks 33 except crosscut antivibration function perform crosscut dynamic force softening function. Lower extreme sheets 31 in springs 11 and 12 relateve to upper sheets 32 samely as in spring 5 have incommensurate thickness. The width of sheetes 7 and 8 of spring 5 is linearly decreasing, thickness is constant, and height is linearly decreasing. Each couple of boxes 10 are connected to each other with a bar 34 by means of rubber-metal hinge nodes 36 of box 10 of wheel couple 38 directed to central part of carriage are connected to body disposed in horizontal plane and have double-arm lever 41 of lever-bar system. Each wheel couple 38 is connected to the body with in cross-vertical plane by means of twisting-bar equipment, which creates substantially only angle connection between said parts of carriage. The spring 5 is connected to the body with hainge nodes 56 equipped with longitudinal bars 57. The springs 11 and 12 are connected to the body with cross rigid bars 63.

Claims: 1 independent

3 dependent

Fig.: 15

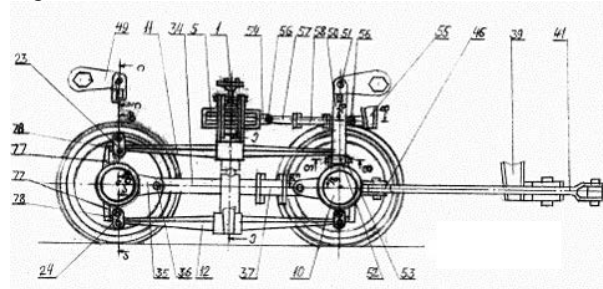

Fig. 1

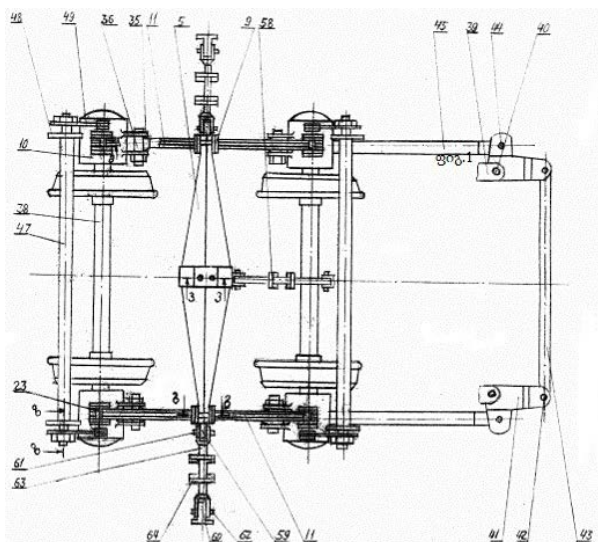

Fig. 2

PART C

C 07

(10) AP 2017 13895 A (51) Int. Cl. (2006)
C 07 C 273/042
B 01 J 19/24

- (21) AP 2013 013895 (22) 2013 12 27
(31) 12199631.8
(32) 2012 12 28
(33) EP
(71) STAMICARBON B.V. (NL)
Mercator 3, NL-6135 KW Sittard (NL)
(72) BUITINK, Fredericus Henricus Maria (NL);
DIELTJENS, Luc Louis Maria (NL)
(74) Liliana Darakhvelidze
(85) 2015 07 27
(86) PCT/NL2013/050961, 2013 12 27
(54) **UREA SYNTHESIS PROCESS AND PLANT**

(57) Urea plant comprises recovery section and high pressure carbamate condenser, additionally, a reactor positioned between the recovery section and high pressure carbamate condenser. The invention also relates to a process for synthesis of urea providing an additional reaction step converting at earlier stage than conventional, recovered carbamate into urea.

Claims: 2 independent
6 dependent

Fig.: 4

(10) AP 2017 13595 A (51) Int. Cl. (2006)
C 07 D 471/04

- (21) AP 2013 013595 (22) 2013 03 11
(31) 288/KOL/2012
(32) 2012 03 14
(33) IN
(71) LUPIN LIMITED (IN)
159 CST Road, Kalina, Santacruz (East),
State of Maharashtra, Mumbai 400 098 (IN)
(72) DAVE, Bhavesh (IN);
BANERJEE, Rakesh, Kumar (IN);
PHUKAN, Samiron (IN);
KHOJE, Abhijit, Datta (IN);
HANGARGE, Rajkumar (IN);
JADHAV, Jitendra, Sambhaji (IN);
PALLE, Venkata, P. (IN);
KAMBOJ, Rajender, Kumar (IN)

- (74) Larisa Amirkhanyan
(85) 2014 10 13
(86) PCT/IB2013/051908, 2013 03 11
(54) **HETEROCYCLYL COMPOUNDS AS MEK INHIBITORS**
(57) Present invention relates to heteroaryl compounds of formula (I),

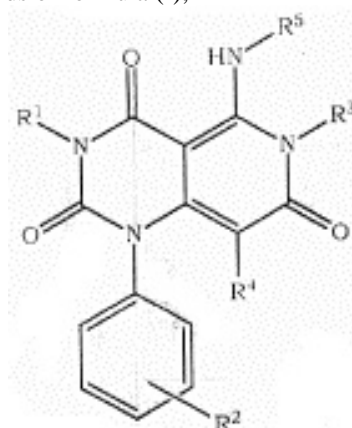

pharmaceutically acceptable salts thereof, and pharmaceutical compositions containing said compounds capable be used as MEK inhibitors for tumor effective regression.

Claims: 2 independent
16 dependent

(10) AP 2017 13979 A (51) Int. Cl. (2006)
C 07 D 487/04
A 61 K 31/53
A 61 P 25/18

- (21) AP 2014 013979 (22) 2014 04 23
(31) 61/818,650
(32) 2013 05 02
(33) US
(71) PFIZER INC. (US)
235 East 42nd Str., New York, NY 10017 (US)
(72) CHAPPIE, Thomas, Allen (US);
HELAL, Christopher, John (US);
KORMOS, Bethany, Lyn (US);

TUTTLE, Jamison, Bryce (US);
VERHOEST, Patrick, Robert (US)

(74) Shalva Gvaramadze

(85) 2015 10 29

(86) PCT/IB2014/060945, 2014 04 23

(54) **IMIDAZO-TRIAZINE DERIVATIVES
AS PDE10 INHIBITORS**

(57) Present invention relates to derivatives of formula (I),

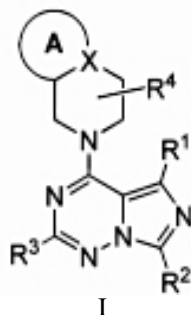

pharmaceutically acceptable salts thereof, pharmaceutical compositions containing them, and their usage as PDE10 inhibitors, as well.

Claims: 4 independent

17 dependent

(10) **AP 2017 13362 A** (51) **Int. Cl. (2006)
C 07 K 16/28**

(21) AP 2012 013362 (22) 2012 06 28

(31) 61/502,167; PCT/US2012/044451

(32) 2011 06 28; 2012 06 27

(33) US; US

(71) OXFORD BIOTHERAPEUTICS LTD. (GB)
94a Milton Park, Arbingdon,
Oxon OX14 4RY (GB)

(72) ROHLFF, Christian (GB);
TERRETT, Jonathan, Alexander (US)

(74) Tamar Kochlamazashvili

(85) 2014 01 27

(86) PCT/US2012/044703, 2012 06 28

(54) **ANTIBODIES TO ADP-RIBOSYL
CYCLASE 2**

(57) Present invention provides antibodies which bind to the ADP-ribosyl cyclase 2, nucleic acid molecules encoding the antibodies, expression vectors, and host cells coding nucleic acids and methods for expressing antibodies, as well. Antibodies may be used for the treatment of human cancers, including acute myeloid leukemia (AML), B-cell chronic lymphocytic leukemia, breast cancer, colorectal cancer, ovarian carcinoma pancreatic cancer and human inflammatory diseases, including asthma, gout, crohns, lupus, multiple sclerosis, rheumatoid arthritis, psoriasis, diabetes and atherosclerotic.

Claims: 10 independent

13 dependent

Fig.: 6

C 22

(10) **AP 2017 13796 A** (51) **Int. Cl. (2006)
C 22 B 5/04
C 22 C 33/00
B 22 F 3/23**

(21) AP 2015 013796 (22) 2015 04 15

(71) Garegin Zakharov (GE)

Ertsos q. 11, b. 9, 0192, Tbilisi (GE);

Zurab Aslamazashvili (GE)

Davit Tavkheldidzis q. 1, b. 58, 0186,

Tbilisi (GE);

Giorgi Tavadze (GE)

D. Uznadzis q. 4, b. 77, 0102, Tbilisi (GE);

Giorgi Oniashvili (GE)

Bazaletis q. 7, b. 6, 0179, Tbilisi (GE);

Archil Chirakadze (GE)

Paliashvilis q. 31, b. 2, 0179, Tbilisi (GE);

Avtandil Khvadagiani (GE)

Kandelakis q. 6, b. 10, 0160, Tbilisi (GE);

Giorgi Mikaberidze (GE)

Gamsakhurdias gamz. 14, b. 34, 0171,

Tbilisi (GE)

(72) Garegin Zakharov (GE);

Zurab Aslamazashvili (GE);

Giorgi Tavadze (GE);

Giorgi Oniashvili (GE);

Archil Chirakadze (GE);

Avtandil Khvadagiani (GE);

Giorgi Mikaberidze (GE)

(54) **METHOD AND EQUIPMENT FOR
RECEIVING CAST ALLOYS**

(57) Reaction mixture is prepared with initial powders, placed into fireproof form from inside covered with functional protective layer made of inorganic compounds, than it is placed into centrifuge, which is four insulated CBC reactors disposed as minimum on two horizontal levels, and rotating around vertical axis is executed initiating process and synthesis in burning regime under influence of centrifugal forces – overload value is reached by changing rotary speed, and shifting reactors from rotating axis – changing side from cast alloys are separated from synthetic products, one from componentry of reaction mixture is a salvage of manganese concentrates called as a dirt in enrich form – including manganese oxides 60-80 mass%, having dispersion up to 200 mkm, which is preliminarily thermally treated on the air at 700-750°K during 30 min; at that, reaction mixture can contain oxides of following metals: Ti, V, Cr, Fe, Co, Ni, Cu, Nb, Mo, Ta, W, which are d and f elements of IV, V and VI periods, and aluminium and aluminium-manganese alloy can be used as metal-restorative.

Claims: 2 independent

Fig.: 1

Table: 1

PART E**E 01**

(10) AP 2017 13347 A (51) Int. Cl. (2006)
E 01 H 1/08

(21) AP 2012 013347 (22) 2012 12 19

(71) CRYSTAL LAGOONS (CURACAO)

B.V. (NL)

Curacao Kaya W.F.G. (Jombi) Mensing 14,
Curacao, Antilles Islands (NL)

(72) FISCHMANN, Fernando Benjamin (CL)

(74) Tamar Kochlamazashvili

(85) 2014 01 09

(86) PCT/EP2012/076170, 2012 12 19

(54) **LOCALIZED DISINFECTION**

SYSTEM FOR LARGE WATER BODIES

(57) The present invention relates to a method for controlling the microbiological properties of a portion of water within a large body of water by treating such zone with chemical agents, according to the temperature of water, its salinity, its dilution power and the diffusion of chemicals.

Claims: 1 independent

16 dependent

Fig. 4

E 04

(10) AP 2017 13536 A (51) Int. Cl. (2006)
E 04 B 1/34

(21) AP 2014 013536 (22) 2014 07 25

(71) Elguja Medzmariashvili (GE)

M. Burdzglas q. 108, 0194, Tbilisi (GE);

Nikoloz Medzmariashvili (GE)

M. Burdzglas q. 108, 0194, Tbilisi (GE)

(72) Elguja Medzmariashvili (GE);

Nikoloz Medzmariashvili (GE)

(74) Tina Chalauri

(54) **FLYING SAUCER-SHAPED**

CONSTRUCTION

(57) A construction 1 includes a disc-shaped case having arched roof 8 and bedding 8', box-shaped entrance holl 3 disposed on rocky slope 2 and supporting buildings. The case is attached to the holl cantilever and has cylindrical hinges 7 connected thereto rotating around cross axles 6 and its immovable fixing componentry in design position. The case with roof is rested on the holl before its transfer into design position. Counterbalance block for resting on the slope is attached to the holl. The holl and supporting buildings are loaded with counterbalance ballast.

Claims: 1 independent

4 dependent

Fig.: 6

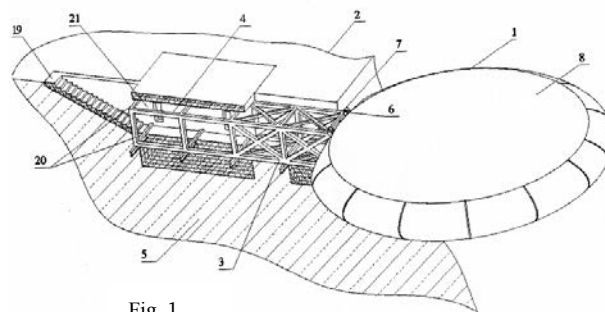

Fig. 1

PART H**H 02**

(10) AP 2017 14037 A (51) Int. Cl. (2006)
H 02 P 27/00

(21) AP 2016 014037 (22) 2016 01 15

(71) LEPL RAPHIEL DVALI INSTITUTE
OF MASHINE MECHANICS (GE)

Mindelisi q. 10, 0186, Tbilisi (GE)

(72) Tamaz Natriashvili (GE);

Vladimer Kldiashvili (GE);

Slava Mebonia (GE);

Aleksandre Shermazanashvili (GE)

(54) **FREQUENCY-CONTROLLED**
ASYNCHRONOUS MOTOR

(57) frequency-controlled asynchronous motor includes cylindrical stator core executed with sheets, in which inner surface grooves the stator winding is placed. The motor is executed controllable speed by means of feeding supplied from frequency converter. Stator winding is made of rectangular wires covered with thermos persistent glass cloth or polyamide or another like that insulation. Winding cooling is executed with independent ventilation.

Claims: 1 independent

Fig.: 1

PATENTED INVENTIONS

PART B

B 01

- (11) P 2017 6625 B** (51) **Int. Cl. (2006)**
B 01 D 1/00
A 23 L 1/06
A 23 L 2/00
- (10) AP 2016 13943 A (44) 20(456)/2016
 (21) AP 2015 013943
 (22) 2015 09 24
 (24) 2015 09 24
 (73) LEPL SCIENTIFIC-RESEARCH
 CENTER OF AGRICULTURE (GE)
 Marshal Gelovanis gamz. 6, 0159, Tbilisi (GE)
 (72) Ekaterine Katsitadze (GE);
 Vladimer Miruashvili (GE)
 (54) **AGGREGATE FOR JUICE**
EVAPORATION

PART C

C 03

- (11) P 2017 6617 B** (51) **Int. Cl. (2006)**
C 03 B 37/09
- (10) AP 2016 13533 A (44) 11(447)/2016
 (21) AP 2014 013533
 (22) 2014 07 24
 (24) 2014 07 24
 (73) Roman Verulashvili (GE)
 Arakishvilis q. I chikhi 13, 0179,
 Tbilisi (GE);
 Izolda Kamushadze (GE)
 Nutsbidzis perdob, IV mkr, korp. 28, b. 21,
 0183, Tbilisi (GE);
 Davit Verulashvili (GE)
 Arakishvilis q. I chikhi 13, 0179, Tbilisi (GE)
 (72) Roman Verulashvili (GE);
 Izolda Kamushadze (GE);
 Davit Verulashvili (GE)
 (54) **PLATINUM-RHODIUM FILLER FOR**
FIBER GLASS CONTINUOUS PRODUC-
TION WITH IRON-CONTAINING
ROCKS

C 07

- (11) P 2017 6611 B** (51) **Int. Cl. (2006)**
C 07 D 221/00
C 07 D 223/02
C 07 D 223/04
C 07 D 231/04
- (10) AP 2016 9736 A (44) 20(456)/2016
 (21) AP 2005 009736
 (22) 2005 05 04
 (24) 2005 05 04
 (31) 60/569,273; 60/602,051; 60/602,791;
 60/638,803
 (32) 2004 05 07; 2004 08 17; 2004 08 19;
 2004 12 22
 (33) US; US; US; US
 (86) PCT/US2005/015559, 2005 05 04
 (73) INCYTE CORPORATION (US)
 Experimental Station, Building 336,
 Route 141 & Henry Clay Road,
 Wilmington, DE 19880 (US)
 (72) YAO, Wenqing (US);
 ZHUO, Jincong (CN);
 XU, Meizhong (CN);
 ZHANG, Colin (CN);
 METCALF, Brian (US);
 HE, Chunhong (CN);
 QIAN, Ding-Quan (CN)
 (74) Shalva Gvaramadze
 (54) **AMIDO COMPOUNDS AND THEIR**
USE AS PHARMACEUTICALS

- (11) P 2017 6621 B** (51) **Int. Cl. (2006)**
C 07 D 239/26
C 07 D 231/12
C 07 D 233/64
C 07 D 401/06
C 07 D 403/04
C 07 D 403/06
C 07 D 237/08
C 07 D 405/04
C 07 D 239/26
C 07 C 233/66
C 07 C 233/73
C 07 C 233/78
C 07 D 211/26
C 07 D 213/40
C 07 D 213/61
- (10) AP 2016 13785 A (44) 20(456)/2016
 (21) AP 2013 013785
 (22) 2013 10 11
 (24) 2013 10 11
 (31) 61/713,113
 (32) 2012 10 12

(33) US
 (86) PCT/EP2013/071247, 2013 10 11
 (73) H. LUNDBECK A/S (DK)
 Ottliavej 9 DK-2500 Valby (DK)
 (72) KILBURN, John Paul (DK);
 RASMUSSEN, Lars Kyhn (DK);
 JESSING, Mikkel (DK);
 ELDEMENKY, Eman Mohammed (US);
 CHEN, Bin (US);
 JIANG, Yu (US);
 HOPPER, Allen T. (US)
 (74) Tamaz Shilakadze
 (54) **BENZAMIDES**

(11) P 2017 6616 B **(51) Int. Cl. (2006)**
C 07 D 249/08
C 07 D 401/12
C 07 D 403/12
C 07 D 409/12
A 61 K 31/497
A 61 K 31/4439
A 61 K 31/506
A 61 K 31/498
A 61 K 31/55
A 61 K 31/5377
A 61 P 35/00
A 61 P 31/12
A 61 P 29/00
A 61 P 27/02

(10) AP 2016 13396 A (44) 20(456)/2016
 (21) AP 2012 013396
 (22) 2012 07 26
 (24) 2012 07 26
 (31) 61/654,651; 61/653,588; 61/610,178;
 61/513,432; 61/513,428
 (32) 2012 06 01; 2012 05 31; 2012 03 13;
 2011 07 29; 2011 07 29
 (33) US; US; US; US; US
 (86) PCT/US2012/048319, 2012 07 26
 (73) KARYOPHARM THERAPEUTICS,
 INC. (US)
 2 Mercer Road Natick, MA 01760 (US)
 (72) SANDANAYAKA, Vincent, P. (US);
 SHACHAM, Sharon (IL);
 MCCAULEY, Dilara (US);
 SHECHTER, Sharon (IL)
 (74) Tamaz Shilakadze
 (54) **HYDRAZIDE CONTAINING NUCLEAR**
TRANSPORT MODULATORS AND
USAGE THEREOF

(11) P 2017 6626 B **(51) Int. Cl. (2006)**
C 07 D 413/12
A 61 K 31/422
A 61 P 33/00
A 61 P 31/00

(10) AP 2016 13967 A (44) 20(456)/2016

(21) AP 2013 013967
 (22) 2013 03 13
 (24) 2013 03 13
 (62) 12167640.7 2012 05 11 (EP)
 (31) 12167640.7
 (32) 2012 05 11
 (33) EP
 (86) PCT/EP2013/055078, 2013 03 13
 (73) POLICHEM SA (LU)
 50, Val Fleuri L-1526 Luxembourg (LU)
 (72) GAGLIARDI, Stefania (IT);
 CONSONNI, Alessandra (IT);
 MAILLAND, Federico (IT);
 BULGHERONI, Anna (IT)
 (74) Aleksandre gegechkori
 (54) **SYNTHESIS OF (S)-NIFURATEL**

(11) P 2017 6620 B **(51) Int. Cl. (2006)**
C 07 D 487/04
C 07 D 519/00

(10) AP 2016 13675 A (44) 20(456)/2016
 (21) AP 2013 013675
 (22) 2013 06 19
 (24) 2013 06 19
 (31) 61/820,828; 61/666,299
 (32) 2013 05 08; 2012 06 29
 (33) US; US
 (86) PCT/IB2013/055039, 2013 06 19
 (73) PFIZER INC. (US)
 235 East 42nd Street New York,
 NY 10017 (US)
 (72) GALATSIS, Paul (US);
 HAYWARD, Matthew Merrill (US);
 HENDERSON, Jaclyn (GB);
 KORMOS, Bethany Lyn (US);
 KURUMBAIL, Ravi G. (US);
 STEPAN, Antonia Friederike (GB);
 VERHOEST, Patrick Robert (US);
 WAGER, Travis T. (US);
 ZHANG, Lei (US)
 (74) Shalva Gvaramadze
 (54) **NOVEL 4-(SUBSTITUTED-AMINO)-**
7H-PYRROLO[2,3-d]PYRIMIDINES
AS LRRK2 INHIBITORS

(11) P 2017 6624 B **(51) Int. Cl. (2006)**
C 07 D 487/04
C 07 D 519/00
A 61 K 31/4985
A 61 K 31/519
A 61 K 31/5377
A 61 K 31/501
A 61 P 35/00

(10) AP 2016 13859 A (44) 20(456)/2016
 (21) AP 2013 013859
 (22) 2013 11 15
 (24) 2013 11 15

- (31) 12192987.1
 (32) 2012 11 16
 (33) EP
 (86) PCT/EP2013/073946, 2013 11 15
 (73) BOEHRINGER INGELHEIM
 INTERNATIONAL GMBH (DE)
 Binger Strasse 173 55216 Ingelheim
 Am Rhein (DE)
- (72) ENGELHARDT, Harald (DE);
 SMETHURST, Christian (GB);
 GIANNI, Davide (IT)
- (74) Tamar Kochlamazashvili
- (54) **TRIAZOLOPYRAZINE AS BRD4
 INHIBITORS AND USAGE THEREOF
 FOR CANCER TREATMENT**
-
- (11) P 2017 6623 B** **(51) Int. Cl. (2006)**
C 07 D 487/04
C 07 D 519/00
A 61 K 31/53
A 61 P 11/00
A 61 P 9/00
A 61 P 25/00
A 61 P 31/12
- (10) AP 2016 13828 A (44) 20(456)/2016
 (21) AP 2013 013828
 (22) 2013 10 15
 (24) 2013 10 15
 (31) 61/718,782; 123822399.9
 (32) 2012 10 26; 2012 10 16
 (33) US; US
 (86) PCT/EP2013/071551, 2013 10 15
 (73) ALMIRALL, S.A. (ES)
 Ronda del General Mitre 151 E-08022
 Barcelona (ES)
- (72) ERRA SOLA, Montserrat (ES);
 CARRASCAL RIERA, Marta (ES);
 TALTAVULL MOLL, Joan (ES);
 CATURLA JAVALOYES, Juan
 Francisco (ES);
 BERNAL ANCHUELA, Francisco
 Javier (ES);
 PAGES SANTACANA, Lluís Miquel (ES);
 MIR CEPEDA, Marta (ES);
 COLL Gaspar Casals (ES);
 OLASAGARRE Maria Begona
 Hernandez (ES)
- (74) Tamar Kochlamazashvili
- (54) **PYRROLOTRIAZINONE
 DERIVATIVES AS PI3K INHIBITORS**
-
- (11) P 2017 6619 B** **(51) Int. Cl. (2006)**
C 07 D 495/04
A 61 K 31/519
A 61 P 35/00
A 61 P 37/00
- (10) AP 2016 13667 A (44) 20(456)/2016
 (21) AP 2014 013667
 (22) 2014 12 19
 (24) 2014 12 19
 (31) 13,63500
 (32) 2013 12 23
 (33) FR
 (73) LES LABORATOIRES SERVIER (FR)
 35 rue de Verdun 92284 Suresnes
 Cedex (FR);
 VERNALIS (R&D) LTD. (GB)
 100 Berkshire Plays Warfdale Rd., Winners
 Berkshire RG41 5RD (GB)
- (72) KOTSCHY Andras (HU);
 SZLAVIK Zoltán (HU);
 CZEKEI Márton (HU);
 PACZAL Attila (HU);
 SZABO Zoltan (HU);
 SIPOS Szaboles (HU);
 RADICS Gábor (HU);
 PROSZENYAK Agnes (HU);
 BALINT Balázs (HU);
 BRUNO Alain (FR);
 GENESTE Olivier (FR);
 DAVIDSON James Edward Paul (GB);
 MURRAY James Brooke (GB);
 CHEN I-Jen (GB);
 PERRON-SIERRA Françoise (FR)
- (74) Tamaz Shilakadze
- (54) **NEW THIENOPYRIMIDINE
 DERIVATIVES, A PROCESS FOR
 THEIR PREPARATION AND
 PHARMACEUTICAL COMPOSITION
 CONTAINING THEM**
-
- C 08**
- (11) P 2017 6614 B** **(51) Int. Cl. (2006)**
C 08 G 73/06
C 08 L 79/06
A 61 P 41/00
C 07 D 401/04
- (10) AP 2016 13326 A (44) 20(456)/2016
 (21) AP 2012 013326
 (22) 2012 05 17
 (24) 2012 05 17
 (31) RU2011119848; RU2011153043
 (32) 2011 05 17; 2011 12 26
 (33) RU; RU
 (86) PCT/IB2012/052483, 2012 05 17
 (73) JOINT STOCK COMPANY
 "PHARMASYNTEZ" (RU)
 Office 3, dom 23, ul. Krasnogvardeyskaya,
 Irkutsk, 664007 (RU)
- (72) SHURYGIN, Mikhail Gennadievich (RU);
 SHURYGINA, Irina Aleksandrovna (RU)
- (74) Khatuna Imnadze

(54) **COMPOUNDS, PHARMACEUTICAL COMPOSITIONS AND A METHOD FOR THE PROPHYLAXIS AND TREATMENT OF THE ADHESION PROCESS**

C 11

(11) **P 2017 6613 B** (51) **Int. Cl. (2006)**
C 11 D 1/37
C 11 D 3/50
C 11 D 17/00
E 03 D 9/02
C 11 D 3/48

(10) AP 2016 13113 A (44) 20(456)/2016
 (21) AP 2011 013113
 (22) 2011 11 11
 (24) 2011 11 11
 (31) 10 2010 043 848.0
 (32) 2010 11 12
 (33) DE
 (86) PCT/EP2011/069965, 2011 11 11
 (73) HENKEL AG & CO. KGAA (DE)
 Henkelstr. 67 40589 Düsseldorf (DE)
 (72) SCHIEDEL, Marc-Steffen (DE);
 GIESEN, Brigitte (DE);
 ERNST, Anke (DE);
 REICHERT, Christian (DE);
 CAPPLEMAN, Robert Stephen (DE);
 HORN, Michael (DE)
 (74) Shalva Gvaramadze
 (54) **BALL-SHAPED TOILET BLOCKS
 BASED ON ANIONIC SURFACTANTS**

C 12

(11) **P 2017 6612 B** (51) **Int. Cl. (2006)**
C 12 N 15/09

(10) AP 2016 12972 A (44) 18(454)/2016
 (21) AP 2012 012972
 (22) 2012 08 31
 (24) 2012 08 31
 (31) US61/530,873; US61/532,534;
 US61/628,999; US61/568,110
 (32) 2011 09 02; 2011 09 08; 2011 11 12;
 2011 12 07
 (33) US; US; US; US
 (86) PCT/US2012/053551, 2012 08 31
 (73) NOVAMEDICA LIMITED LIABILITY
 COMPANY (RU)
 Prem. VII, Sokolnicheskaya Wall Street 38,
 107113, Moscow (RU)
 (72) GOODENOW, Robert (US);
 ORDENTLICH, Peter (US)
 (74) Khatuna Imnadze
 (54) **METHODS FOR THE TREATMENT
 OF BREAST CANCER**

(11) **P 2017 6618 B** (51) **Int. Cl. (2006)**
C 12 P 13/00
C 12 P 13/02
C 12 P 41/00
C 07 C 227/02
C 07 C 229/28

(10) AP 2016 13598 A (44) 20(456)/2016
 (21) AP 2014 013598
 (22) 2014 10 15
 (24) 2014 10 15
 (31) P-13-154
 (32) 2013 10 15
 (33) LV
 (73) JSC "OLAINFARM" (LV)
 Rūpnīcu Iela 5, Olaine Nov. LV- 2114 (LV)
 (72) LIEPINS, Vilnis (LV);
 LIVDANE, Albine (LV);
 REVUCA, Ekaterina (LV)
 (74) Aleksandre Gegechkori
 (54) **METHOD FOR SEMIPRODUCTS OF
 PHENIBUT PRODUCTION**

C 13

(11) **P 2017 6615 B** (51) **Int. Cl. (2006)**
C 13 K 13/00
C 10 L 1/182
C 13 K 1/02
D 21 C 1/02

(10) AP 2016 13363 A (44) 20(456)/2016
 (21) AP 2012 013363
 (22) 2012 07 12
 (24) 2012 07 12
 (31) 61/508,407
 (32) 2011 07 15
 (33) US
 (86) PCT/CA2012/050481, 2012 07 12
 (73) GREENFIELD SPECIALTY
 ALCOHOLS INC. (CA)
 20 Toronto Street, Suite 1400 Toronto,
 Ontario M5C 2B8 (CA)
 (72) DOTTORI, Frank, A. (CA);
 BENSON, Robert, Ashley, Cooper (CA);
 BENECH, Régis-Olivier (CA)
 (74) Shalva Gvaramadze
 (54) **CONDITIONING OF BIOMASS FOR
 IMPROVED C5/C6 SUGAR RELEASE
 PRIOR TO FERMENTATION**

C 22

(11) **P 2017 6622 B** (51) **Int. Cl. (2006)**
C 22 B 5/04
C 22 C 33/00
B 22 F 3/23

(10) AP 2016 13797 A (44) 20(456)/2016
 (21) AP 2015 013797

(22) 2015 04 15

(24) 2015 04 15

(73) LEPL FERDINAND TAVADZE
INSTITUTE OF METALLURGY AND
MATERIALS SCIENCE (GE)
Al. Kazbegis gamz. 15, 0160, Tbilisi (GE)

(72) Garegin Zakharov (GE);
Zurab Aslamazashvili (GE);
Giorgi Tavadze (GE);
Giorgi Oniashvili (GE);
Archil Chirakadze (GE);
Avtandil Khvadagiani (GE);
Lali Ghurchumelia (GE);
Zakaria Buachidze (GE);
Giorgi Mikaberidze (GE);
Gulnara Urushadze (GE);
Mikhael Chikhradze (GE);
Merab Poladashvili (GE)

(54) **METHOD FOR FERROMANGA-
NESE PRODUCTION**

DESIGNS

REGISTERED DESIGNS

(11) D 2017 697 S **(51) 09-03**
(10) AD 2016 916 S (44) 20(456)/2016
(21) AD 2016 000916
(22) 2016 07 04
(24) 2016 07 04
(28) 1
(18) 2021 07 04
(73) LTD "Fruit Master Group" (GE)
 Varketili 3, mkr. 3a, korp. 340, b. 5, 0163, Tbilisi (GE)
(72) Meral Shamoyan (GE)
(54) **BOX**

(11) D 2017 696 S **(51) 12-99**
(10) AD 2016 915 S (44) 20(456)/2016
(21) AD 2016 000915
(22) 2016 07 04
(24) 2016 07 04
(28) 1
(18) 2021 07 04
(73) Nika Alavidze (GE)
 Kavtiskhevis q. 14, 0180, Tbilisi (GE)
(72) Nika Alavidze (GE)
(54) **PARKING BOOKING SYSTEM**

DESIGNS, WHICH HAVE BEEN REGISTERED WITH THE INTERNATIONAL BUREAU CLAIMING PRIORITY ON THE TERRITORY OF GEORGIA

The decision can be appealed at the Chamber of Appeal of Sakpatenti within 3 months from the publication or at the Mtskheta District Court Administrative Cases Board (Address: №17, Samkhedro Str., Mtskheta), within 1 month following the publication.

(11) DM/091895

(15) 2016 06 07

(22) 2016 06 07

(28) 1

(30) 08.12.2015; 29/547,900; US

(73) CUTTING EDGE PRODUCTS LLC

120 Newport Center Drive, Newport Beach CA 92660 (US)

(85) US

(86) US

(87) US

(88) US

(89) US

(81) III. AL, AM, AZ, BA, BN, BW, CH, EG, EM, GE, GH, IS, JP, KG, KR, LI, MC, MD, ME, MK, MN, NA, NO, OA, OM, RS, RW, SG, ST, SY, TJ, TM, TN, TR, UA

(72) Babek Khamenian

14 Lewis, Irvine CA 92620, US;

Jason Ivey

41 Nightshade, Irvine CA 92603, US;

Daniel Bryan Laird Edney

4790 Irvine Blvd. Ste 105. N118, Irvine CA 92620, US

(54) 1. Two-wheeled scooter

(55)

(51) 12-11

(45) 2016/49 (2016 12 09)

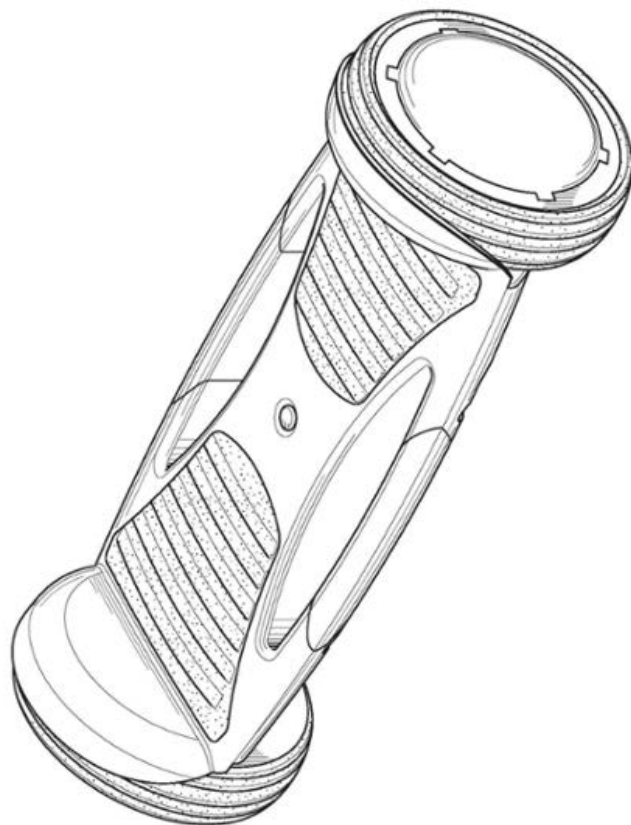

1.1

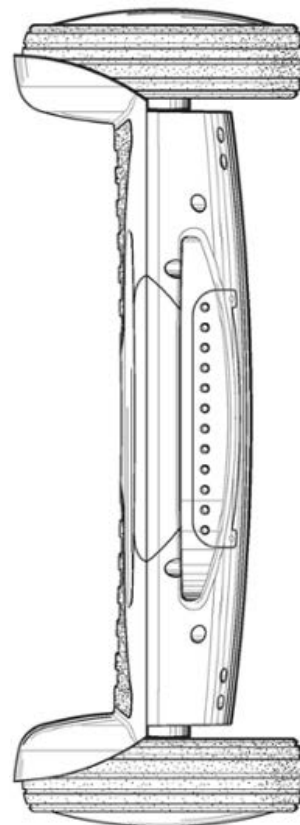

1.2

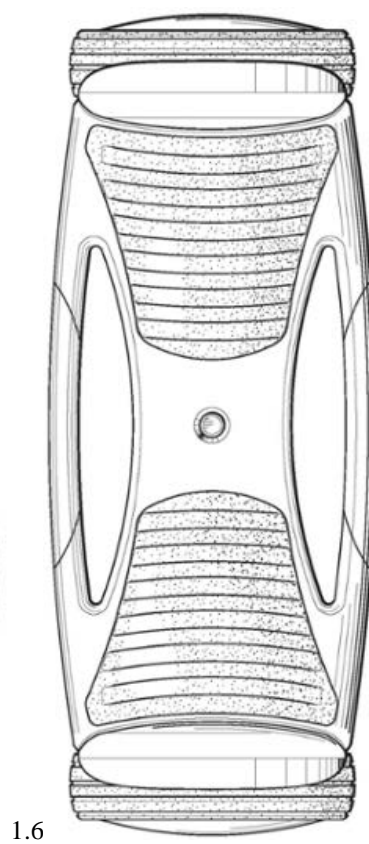
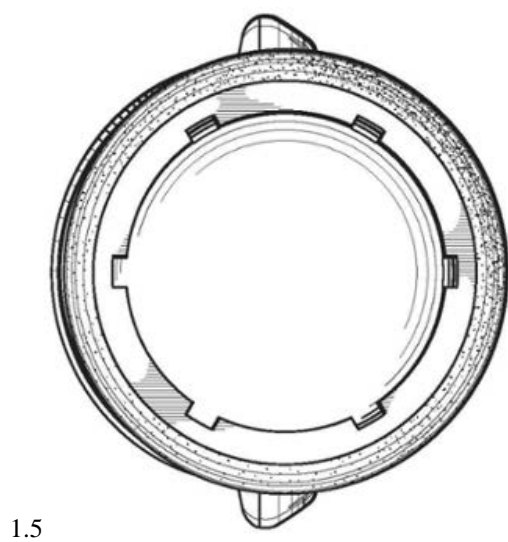
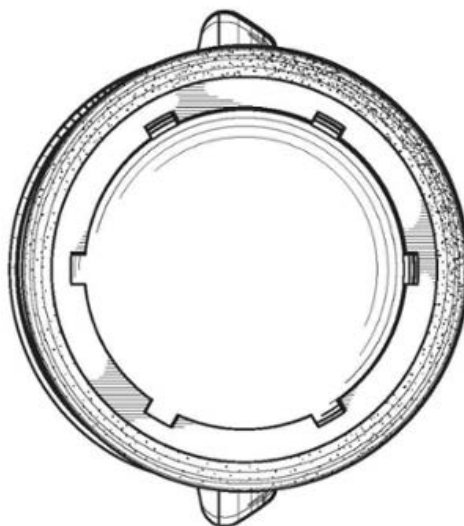
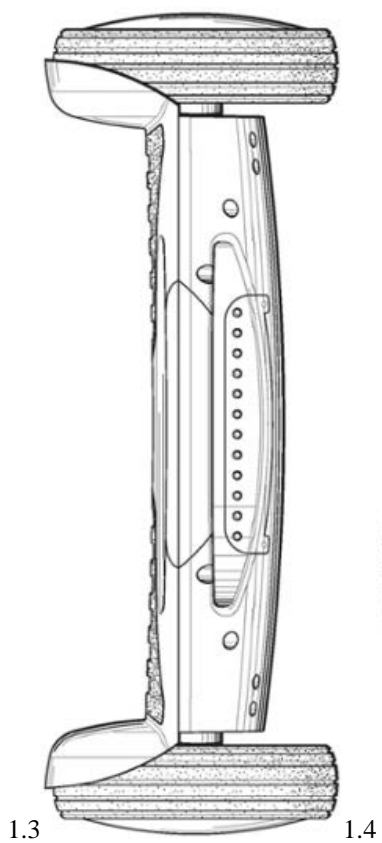

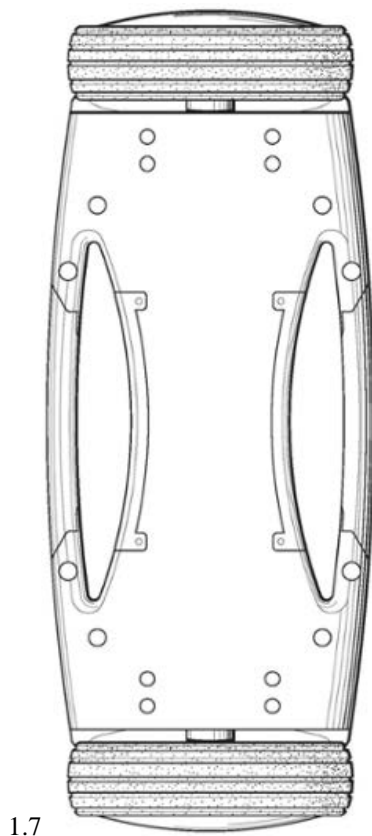

1.7

(11) DM/093594

(15) 2016 11 22

(22) 2016 11 22

(28) 1

(73) SAVERGLASS

3 rue de la Gare, F-60960 FEUQUIERES (FR)

(85) FR, EM

(86) FR, EM

(87) FR, EM

(88) FR, EM

(89) FR

(81) III. AM, AZ, BA, CH, EG, GE, JP, KR, MC, MD, ME, MK, NO, RS, SG, TR, UA

(54) 1. Bottle

(55)

(51) 09-01

(45) 2016/49 (2016 12 09)

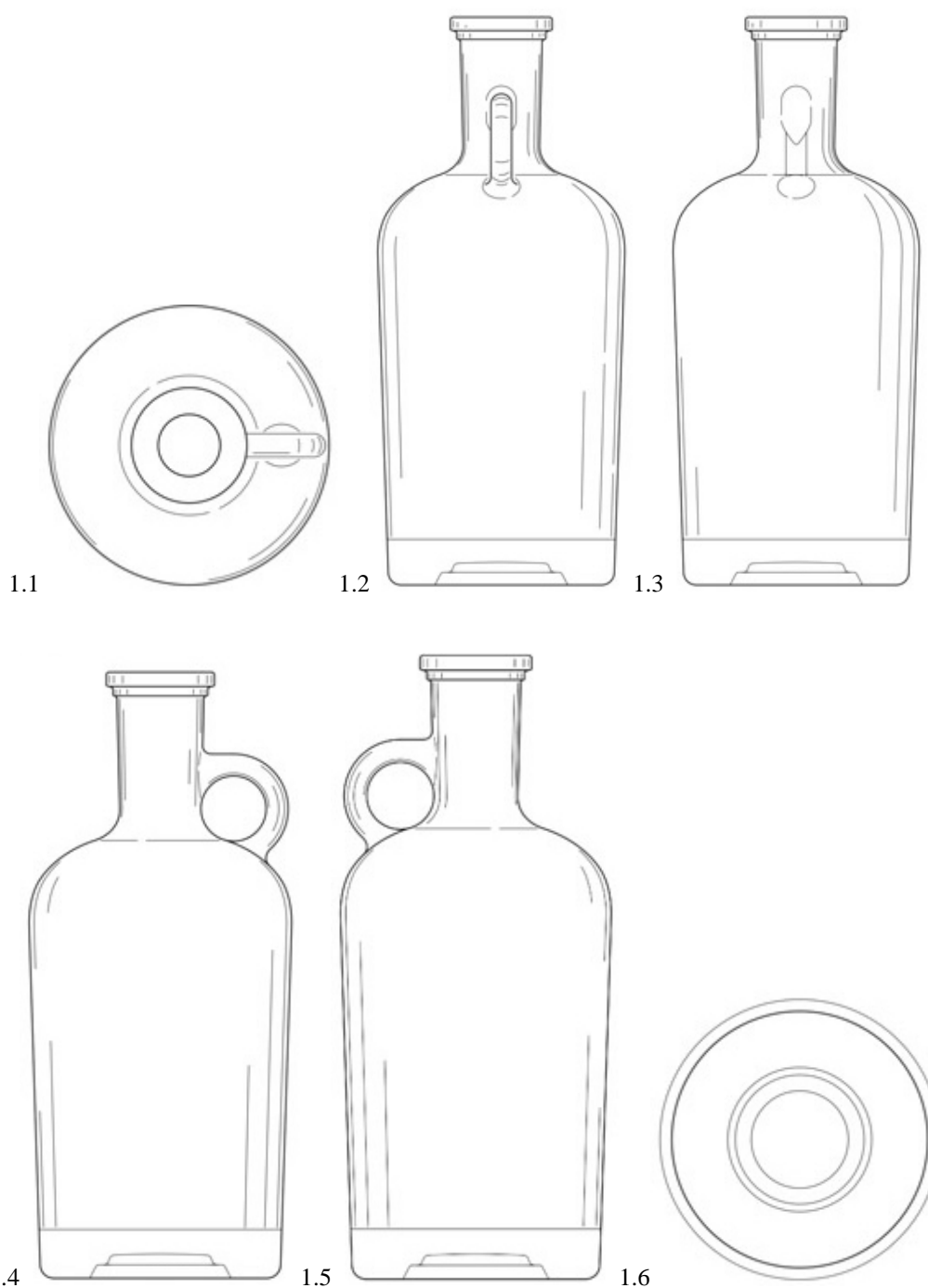

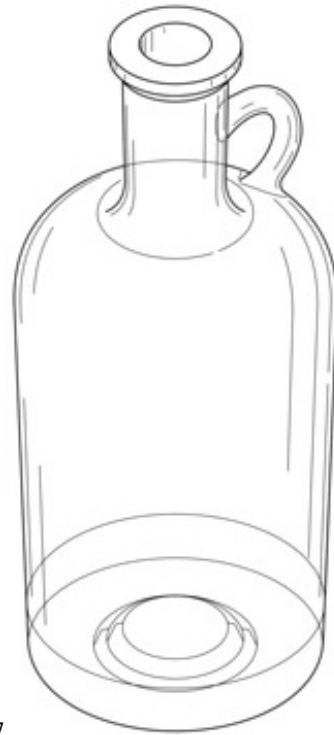

1.7

(11) DM/093674

(15) 2016 04 24

(22) 2016 04 24

(28) 5

(73) PATROIS GUILLAUME

55 avenue Marceau, F-75016 Paris (FR)

(85) FR

(86) FR

(87) FR

(88) FR

(89) FR

(81) II. BX, BZ, GR, KP, MA, SR III. AL, AM, AZ, BA, BN, BW, CH, EG, EM, GE, GH, IS, KG, LI, LV, MC, MD, ME, MK, MN, NA, NO, OA, OM, RS, RW, SG, ST, SY, TJ, TN, TR, UA

(72) Patrois Guillaume

55 Avenue Marceau, F-75016 PARIS, France

(54) 1.-2. Protection cabs for scooters and two-wheel vehicles; 3.-5. stabilizers for two-wheel vehicles

(55)

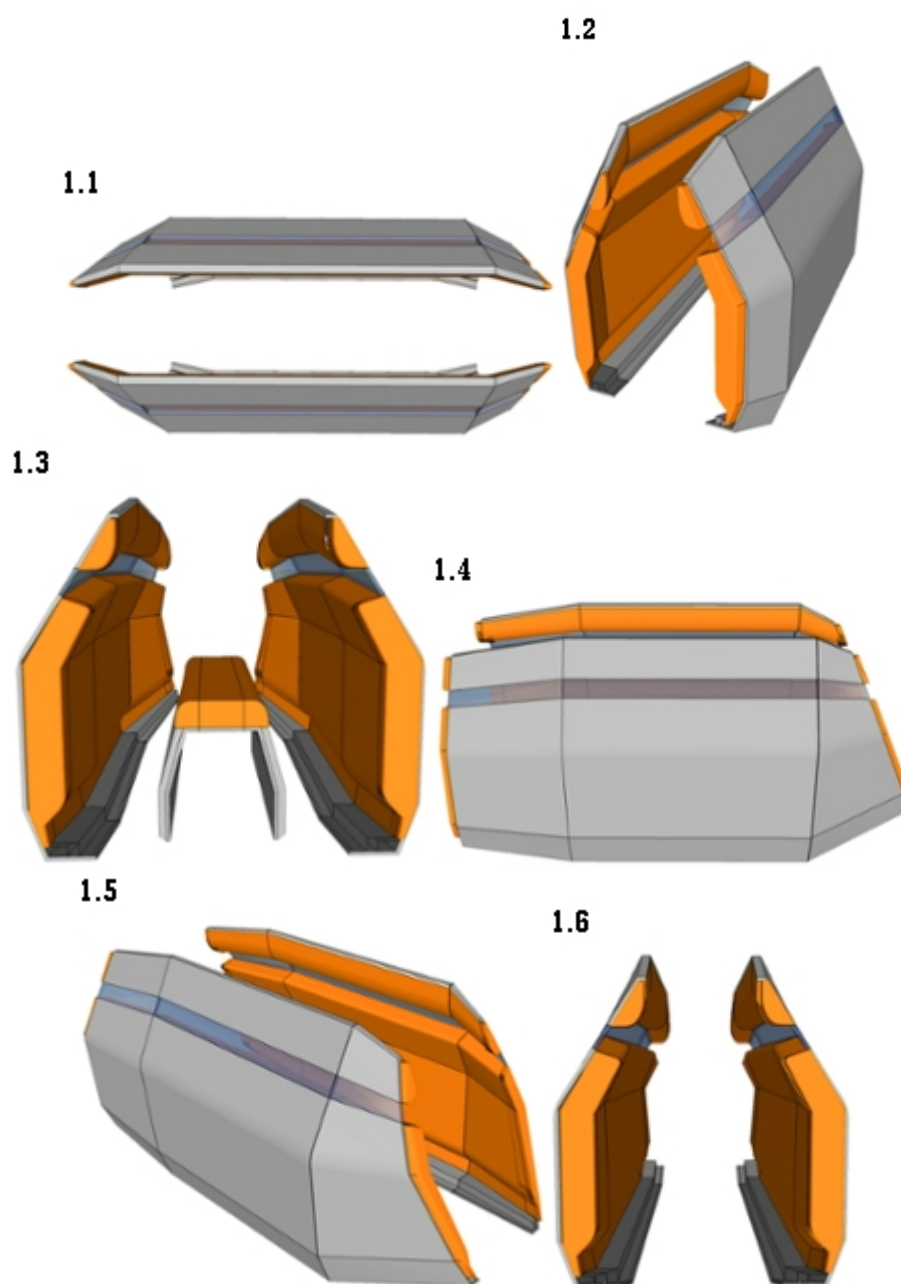

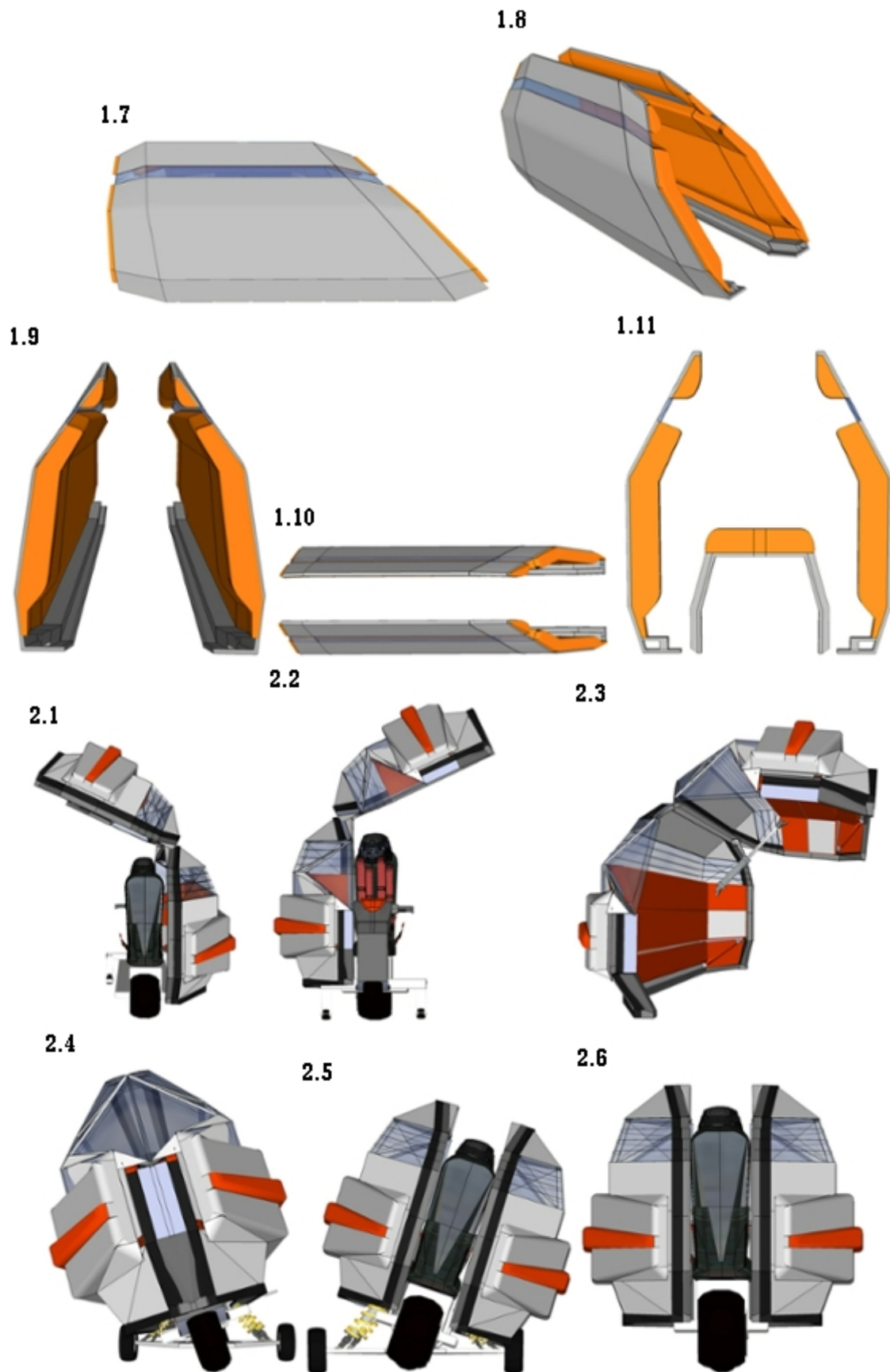

2.7

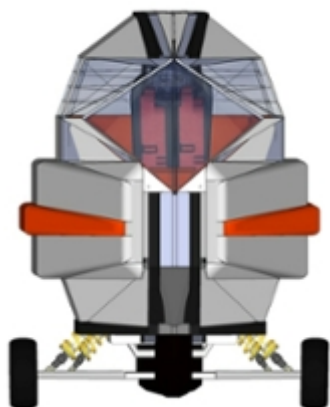

2.8



2.9



2.10



2.11

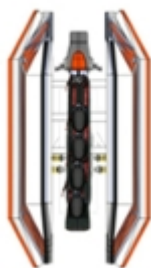

2.12



2.13



3.1



3.2



3.3



3.4



4.1

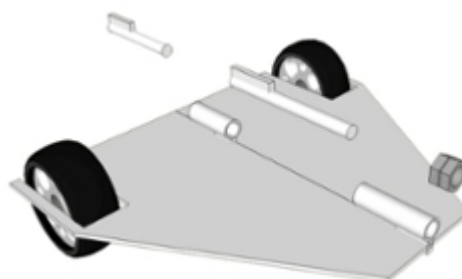

4.2

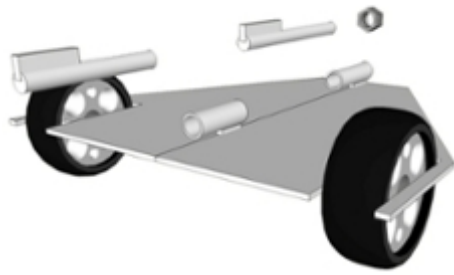

4.3

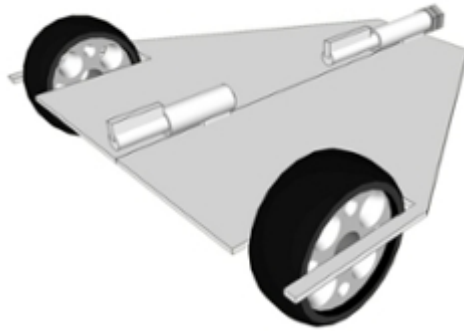

5.1

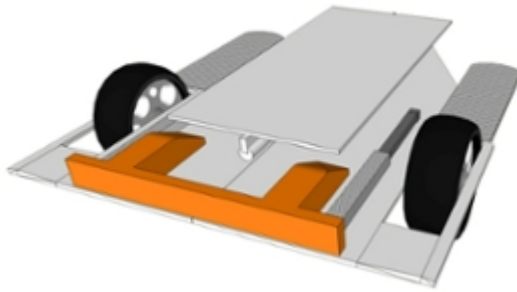

5.2

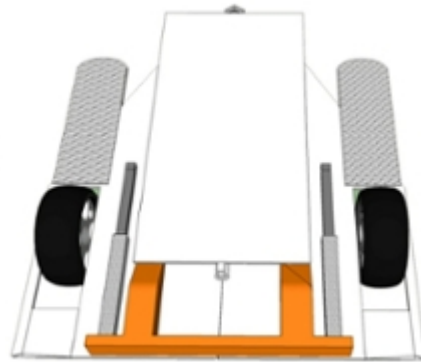

5.3

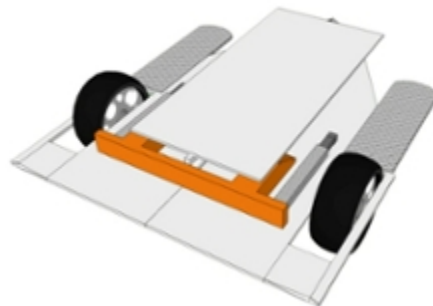

(11) DM/093675**(51) 25-02**

(15) 2016 04 24

(45) 2016/49 (2016 12 09)

(22) 2016 04 24

(28) 1

(73) PATROIS GUILLAUME

55 avenue Marceau, F-75016 Paris (FR)

(85) FR, EM

(86) FR, EM

(87) FR, EM

(88) FR, EM

(89) FR

(81) II. BX, BZ, GR, KP, MA, SR III. AL, AM, AZ, BA, BN, BW, CH, EG, EM, GE, GH, IS, KG, LI, LV, MC, MD, ME, MK, MN, NA, NO, OA, OM, RS, RW, SG, ST, SY, TJ, TN, TR, UA

(72) Guillaume Patrois

55 Avenue Marceau, Paris, France

(54) 1. Modular structure

(55)

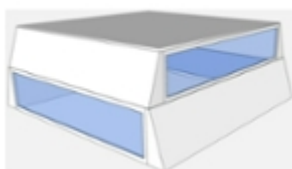
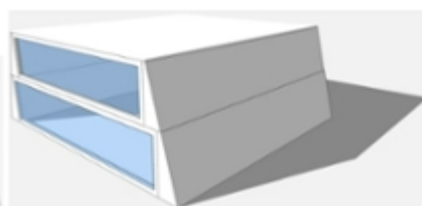
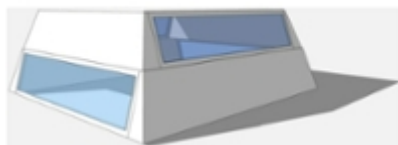
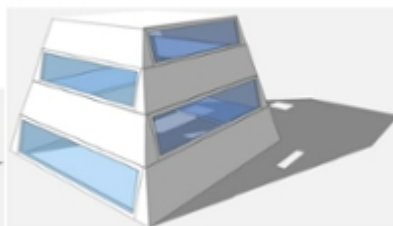
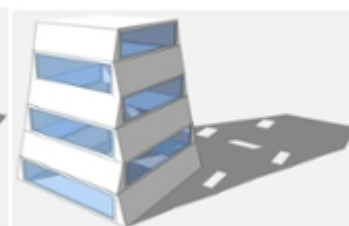
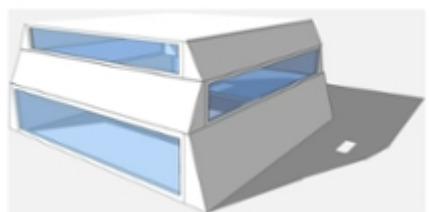
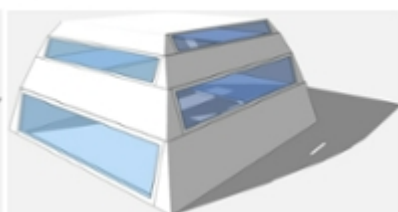
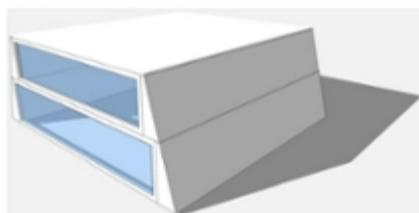
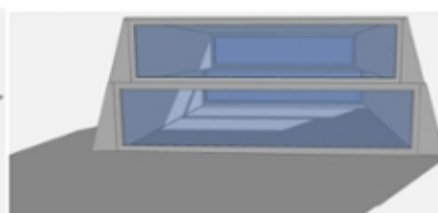
1.1**1.2****1.3****1.4****1.5****1.6****1.7****1.8****1.9****1.10****1.11**

1.12

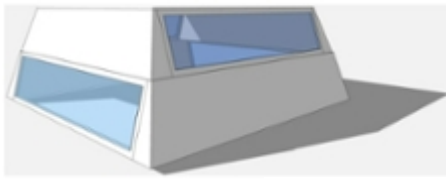

1.13

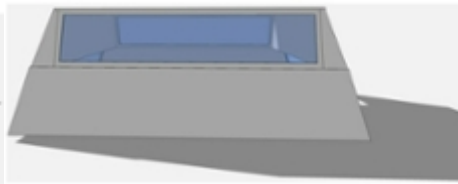

1.14

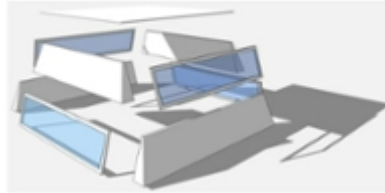

(11) DM/093724

(15) 2016 07 19

(22) 2016 07 19

(28) 2

(73) VALENTINO S.P.A.

Via Turati, 16/18, I-20121 MILANO (IT)

(85) -

(86) EM, IT

(87) EM, IT

(88) EM, IT

(89) EM

(81) III. AZ, EM, GE, JP, KG, KR, TJ, TR, UA

(72) SASSI Stefano

c/o VALENTINO S.p.A. Via Turati, 16/18,I-20121 Milano, Italy

(54) 1.-2. Shoes

(55)

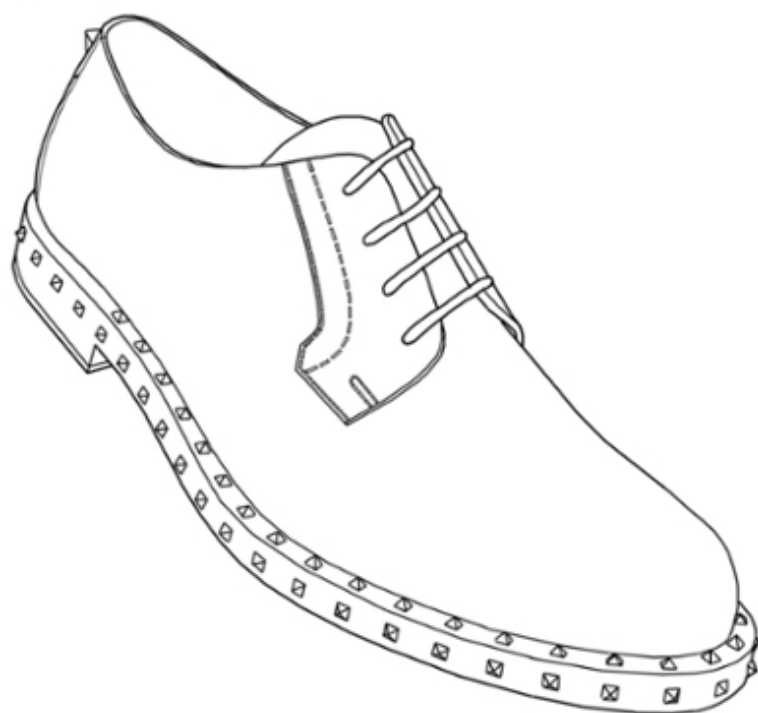
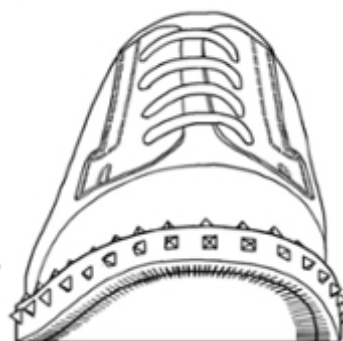
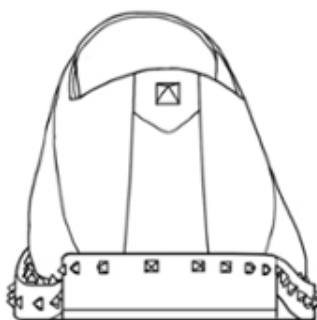
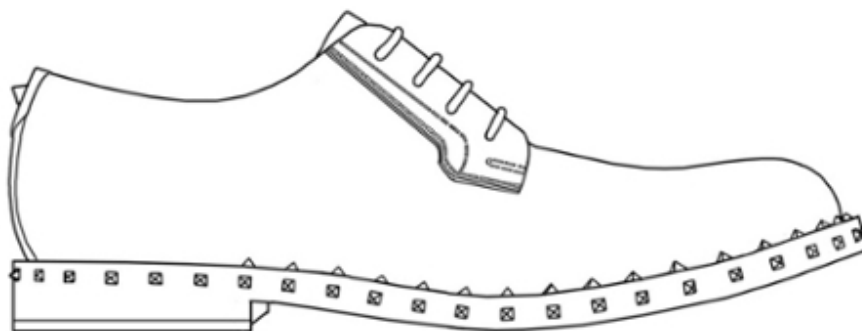
1.1**1.2****1.3****1.4**

1.5

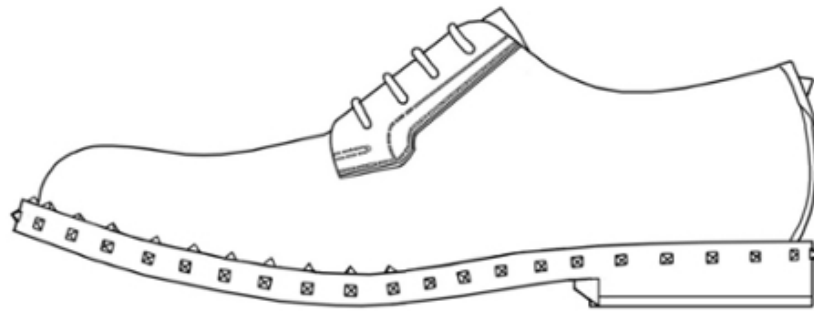

1.6

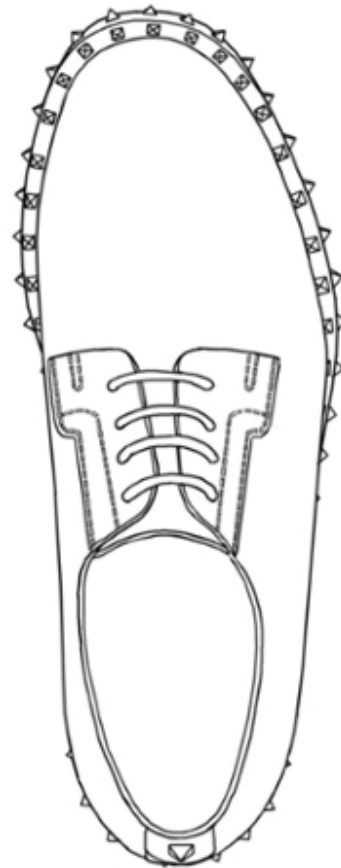

1.7

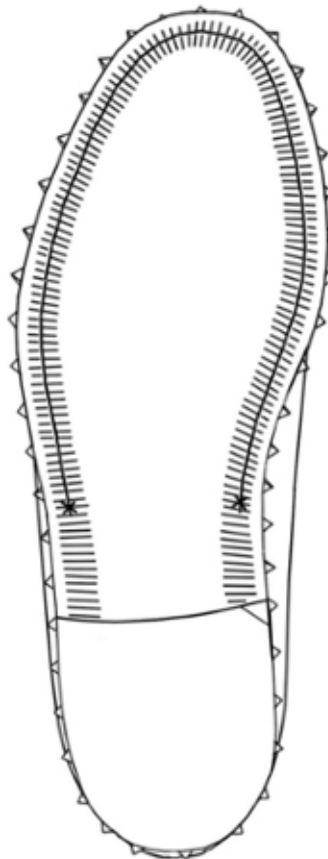

2.1



2.2



2.3



2.4

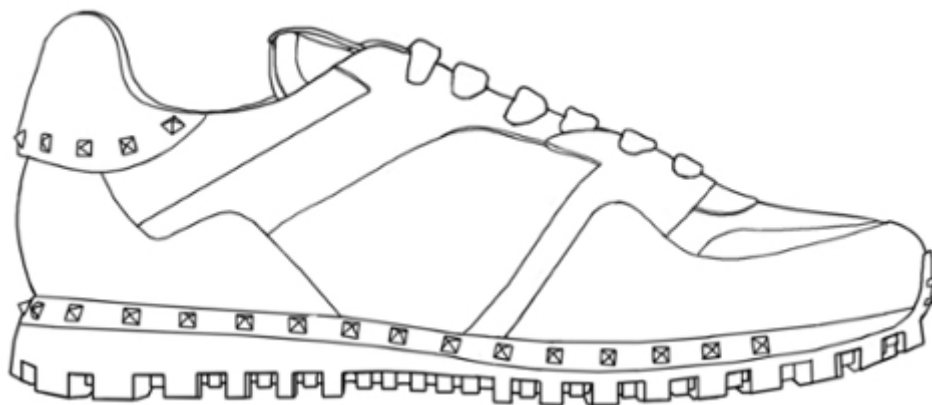

2.5

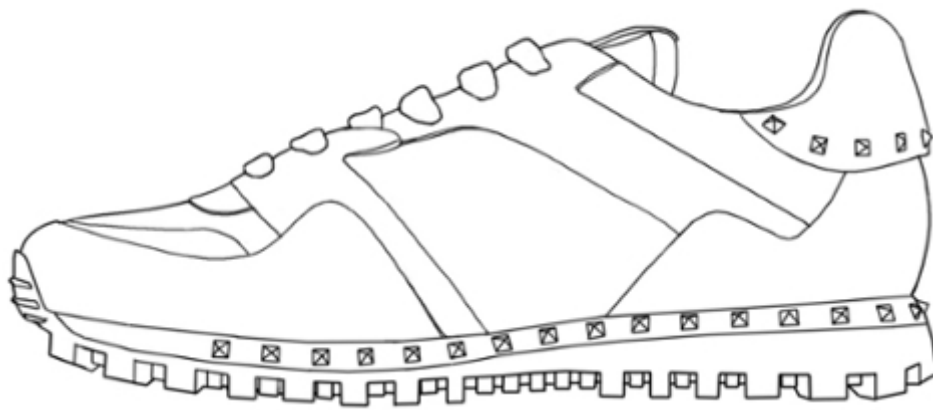

2.6



2.7

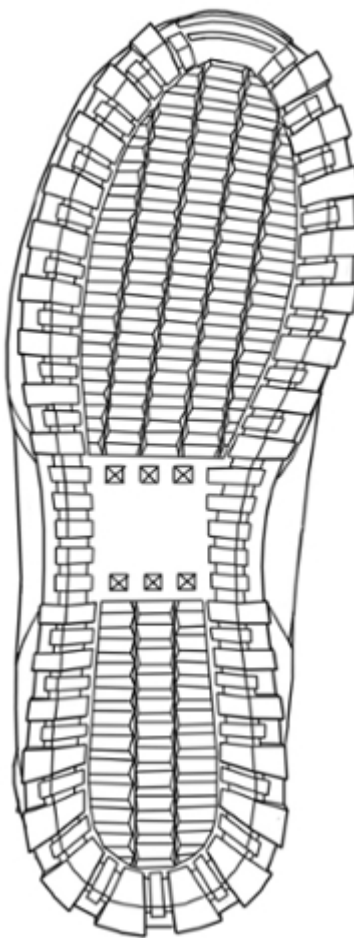

(11) DM/093725**(51) 03-01**

(15) 2016 07 19

(45) 2016/50 (2016 12 16)

(22) 2016 07 19

(28) 1

(73) VALENTINO S.P.A.

Via Turati, 16/18, I-20121 MILANO (IT)

(85) -

(86) EM, IT

(87) EM, IT

(88) EM, IT

(89) EM

(81) III. AZ, EM, GE, JP, KG, KR, TJ, TR, UA, US

(72) SASSI Stefano

c/o VALENTINO S.p.A. Via Turati, 16/18,I-20121 Milano, Italy

(54) 1. Bag

(55)



1.1



1.2

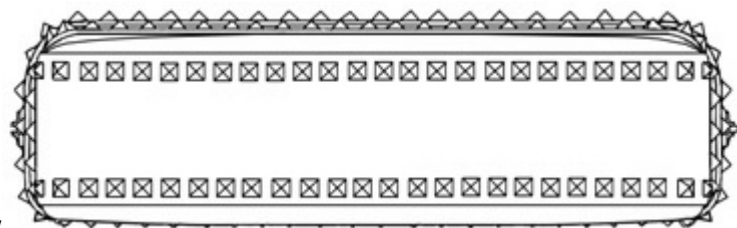
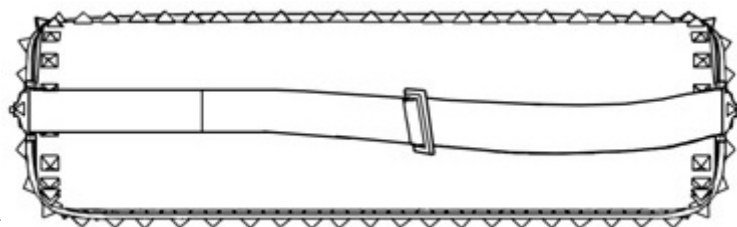
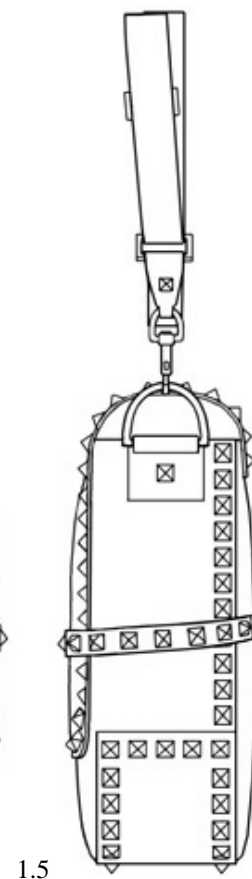
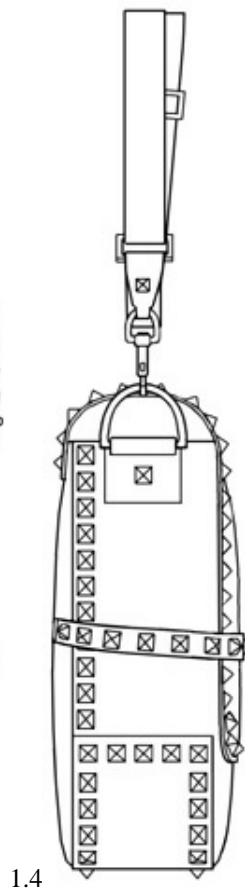
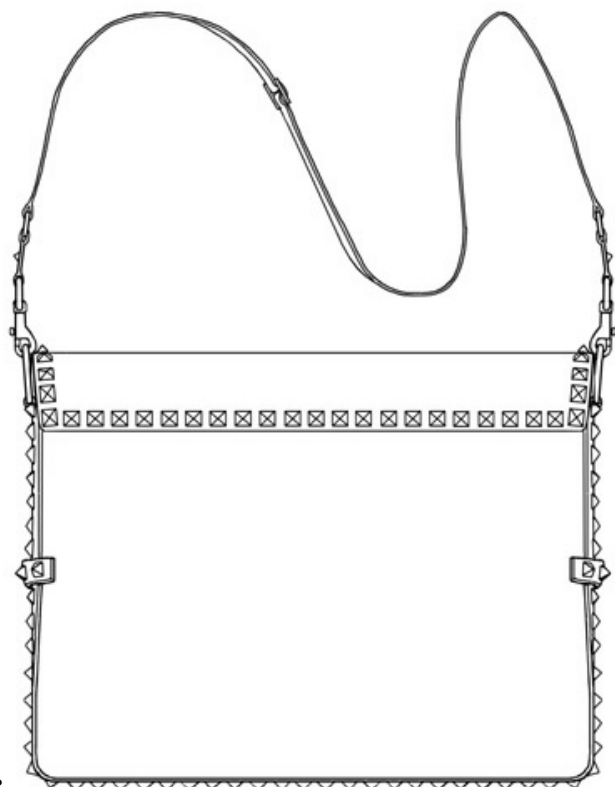

(11) DM/093786

(15) 2016 10 13

(22) 2016 10 13

(28) 1

(73) WOODSKINE SWITZERLAND SNC

Place Charles-David 2, CH-1290 Versoix (CH)

(85) CH

(86) CH

(87) CH

(88) CH

(89) CH

(81) II. BJ, BX, BZ, CI, GA, GR, IT, MA, ML, NE, SN, SR III. AL, AM, AZ, BA, BG, BN, BW, CH, DE, DK, EE, EG, EM, ES, FI, FR, GE, GH, HR, HU, IS, JP, KG, KP, KR, LI, LT, LV, MC, MD, ME, MK, MN, NA, NO, OA, OM, PL, RO, RS, RW, SG, SI, ST, SY, TJ, TM, TN, TR, UA, US

(72) Alaix Balada Miriam

Route de Gland 3, 1268 Begnins, Suisse

(54) 1. Handbag

(55)

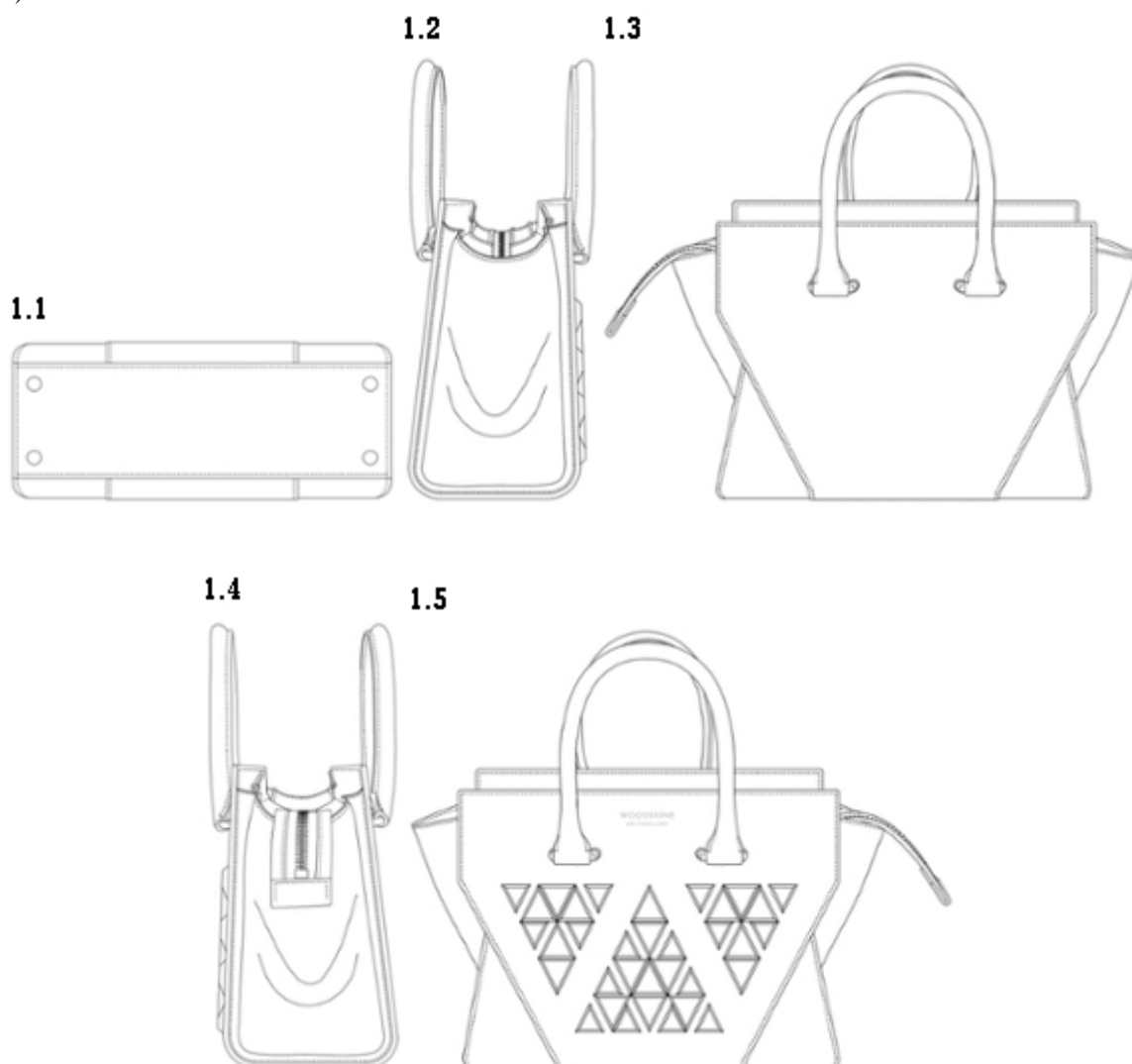

1.6

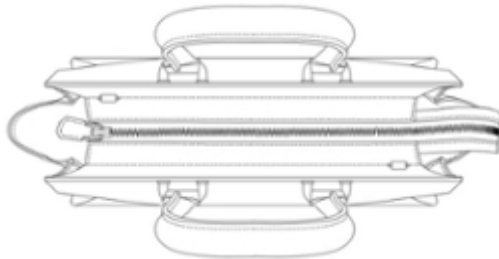

1.7



1.8



(11) DM/093807

(15) 2016 08 24

(22) 2016 08 24

(28) 2

(30) Nos. 1, 2: 23.05.2016; 402016000052539; IT

(73) VALTER TARQUINI V

ia Carlo Galeffi, 46, I-00128 Rome (IT)

(85) EM

(86) IT, EM

(87) IT, EM

(88) IT, EM

(89) EM

(81) II. CI, GR, KP, MA, ML, SN III. AL, BA, BG, BN, CH, DE, DK, EG, EM, ES, FR, GE, HR, HU, IS, JP, KR, LI, MC, MD, ME, MK, MN, NO, OA, OM, PL, RO, SG, SI, TN, TR, UA, US

(72) Valter Tarquini

Via Carlo Galeffi 46, 00128 ROME, Italie

(54) 1. Wafer cup; 2. Ice cream cornet

(55)

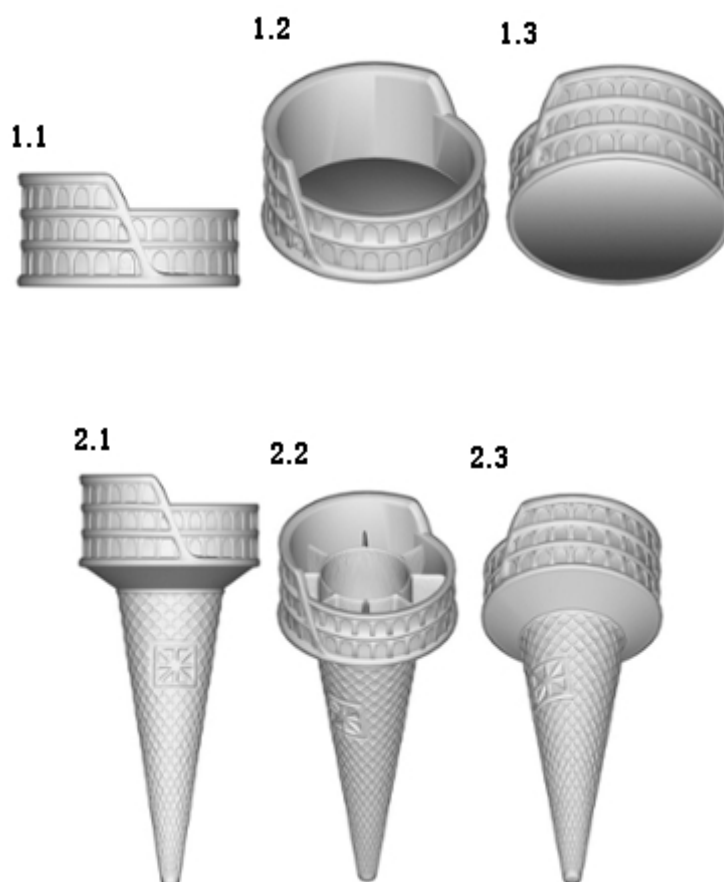

(11) DM/093880

(51) 22-01

(15) 2016 09 15

(45) 2016/51 (2016 12 23)

(22) 2016 09 15

(28) 2

(30) 31.03.2016; D-2016/0028; RS

(73) ZDRAVKO ŠPIRIĆ

Šaljapinova 2, 21000 Novi Sad (RS)

(85) RS

(86) RS

(87) RS

(88) RS

(89) RS

(81) III. AZ, BA, BG, GE, HR, HU

(72) Zdravko Spiric

Saljapinova 2, 21000 Novi Sad, Serbia;

Dragan Macura

Majke Jugovica 7, 78250 Laktasi, Serbia

(54) 1.-2. Launchers for anti-hail rockets with a protective container

(55)

1.1



1.2



1.3

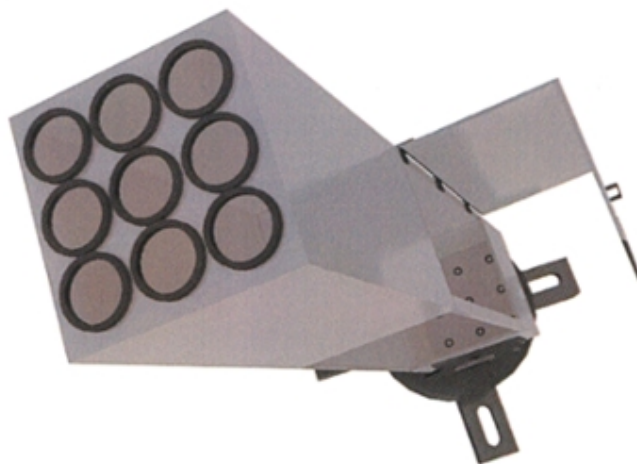

2.1



2.2



TRADEMARKS

APPLICATIONS FILED UNDER THE NATIONAL PROCEDURE APPROVED FOR REGISTRATION

The decision can be appealed at the Chamber of Appeal of Sakpatenti within 3 months from the publication or at the Mtskheta District Court Administrative Cases Board (Address: №17, Samkhedro St., Mtskheta), within 1 month following the publication.

(260) AM 2017 83830 A

(210) AM 83830

(220) 2015 09 17

(330) GE

(731) The Young Georgian Musicians Association
Pasteris q. 0102, Tbilisi, Georgia

(740) Shoren Tsintsadze

(540)

Music International Summer Academy



მუსიკის საერთაშორისო საზაფხულო აკადემია

(591) Black, white and red

(531) 24.17.14, 27.05.05, 28.19, 29.01.12, 24.17.12

(511) 39, 41

(260) AM 2017 85027 A

(210) AM 85027

(220) 2015 12 04

(731) JSC "CORPORATION KINDZMARAU LI"
Ilia Chavchavadzis q. 55, 4800, Kvareli,
Georgia

(540)

ვერდი
Вердзи
Verdzi

(511) 33

(260) AM 2017 86681 A

(210) AM 86681

(220) 2016 03 21

(731) N(N)LE"GEORGIAN RUGBI UNION"
I. Chavchavadzis gamz. 49a, 0179, Tbilisi,
Georgia

(740) Eduard Natchkebia

(540)



(591) Red and black

(531) 01.15.23, 26.01.02, 26.01.18, 26.11.12,
29.01.12

(511) 5, 29, 30, 32, 33, 35

(260) AM 2017 86881 A

(210) AM 86881

(220) 2016 04 04

(731) VALEANT PHARMACEUTICALS
INTERNATIONAL

a Delaware corporation

400 Somerset Corporate Blvd., Bridgewater,
New Jersey 08807, USA

(740) Tamar Kochlamazashvili

(540)



(591) Black, white

(531) 26.04.09, 27.05.21

(511) 5

(260) AM 2017 86895 A

(210) AM 86895

(220) 2016 04 05

(731) LTD "PASANAURI 2016"
26 Maisis moedani 2, 0171, Tbilisi,
Georgia

(540)



(591) Black, white
 (531) 24.13.01, 26.04.03, 26.04.09, 26.11.09
 (511) 43

(260) AM 2017 86896 A
 (210) AM 86896
 (220) 2016 04 05
 (731) LTD "RESHENAL SOLUSHENSI"
 Iosebisdzis q. 49, (nakv. 17/1)/ Kutatelis g. 3,
 Saburtalos raioni, 0160, Tbilisi, Georgia

(740) Ana Samsonia
 (540)



(591) Red, pink, purple, sky-blue, yellow, green,
 orange, grey
 (531) 01.03.07, 04.05.02, 27.05.17, 28.19, 29.01.15
 (511) 16, 35, 38, 45

(260) AM 2017 86928 A
 (210) AM 86928
 (220) 2016 04 08
 (731) XIAMEN GOLDEN DRAGON BUS CO.,
 LTD.
 No.69 Huli Street, Huli Industry Zone,
 Xiamen 361000, Fujian, China

(740) Giorgi Meipariani
 (540)



(591) Black, white
 (531) 26.01.10, 26.03.23
 (511) 12

(260) AM 2017 86966 A
 (210) AM 86966
 (220) 2016 04 11
 (731) LTD "AGROCONSORTSIUM TSEROVANI"
 Sop. Tserovani, 3300, Mtskheta, Georgia
 (740) Vakhtang Torotadze
 (540)



(591) Golden, light brown, green, sky-blue, blue,
 white
 (531) 06.19.11, 26.01.21, 29.01.15
 (511) 29

(260) AM 2017 87075 A
 (210) AM 87075
 (220) 2016 04 19
 (731) LTD "Q M C VAINSI"
 Dighmis mas., me-3 kv., korp. 31, b. 57,
 0159, Tbilisi, Georgia
 (540)

SHNO
შნო
SHHO

(511) 33, 35

(260) AM 2017 87159 A
 (210) AM 87159
 (220) 2016 05 04
 (731) IONGGANG CHEN
 Avtomsheneblis 88, 4600, Kutaisi, Georgia
 (540)

Casalina

(591) Black, white
 (531) 27.05.17
 (511) 6, 11, 19, 35

(260) AM 2017 87195 A
 (210) AM 87195
 (220) 2016 05 06
 (731) LTD "JEOSLI"
 Gotuas q.3, 0160, Tbilisi, Georgia
 (740) Mariam Ghubianuri

(540)



(591) Lilac
 (531) 03.07.05, 14.05.19, 15.07.01, 20.01.03,
 27.05.05, 28.19, 29.01.05
 (511) 16, 38, 41, 42

(260) AM 2017 87213 A
 (210) AM 87213
 (220) 2016 05 11
 (731) LTD "GEOMAR - MARITIME
 CONSULTANTS & SURVEYORS"
 I. Gogebashvilis q. 32, b. 13, 6003, Batumi,
 Georgia
 (740) Mirza Dolidze
 (540)



(591) White, blue, sky-blue, green and yellow
 (531) 24.03.07, 26.01.11, 26.01.18, 26.01.21,
 27.05.24, 29.01.15
 (511) 42

(260) AM 2017 87338 A
 (210) AM 87338
 (220) 2016 05 20
 (731) LTD "CHALIKUSHU"
 M. Khimshiashvilis q. 37, b. 19, 6000,
 Batumi, Georgia
 (740) Roman Ghorjmelidze
 (540)



(591) Black, yellow
 (531) 26.04.24, 26.11.13, 27.05.24, 29.01.12
 (511) 43

(260) AM 2017 87366 A
 (210) AM 87366
 (220) 2016 05 24
 (731) BANK PASARGAD
 No.430, Mirdamad Boulevard, Teheran, Iran
 (Islamic Republic of)
 (740) Davit Zurabishvili
 (540)



(591) Black, white, grey
 (531) 03.01.02, 27.05.22, 28.01, 29.01.13
 (511) 36

(260) AM 2017 87388 A
 (210) AM 87388
 (220) 2016 05 25
 (731) EMBRIA HEALTH SCIENCES, LLC
 a limited liability company of the
 State of Iowa, 2105 SE Creekview
 Drive, Ankeny, Iowa 50021, USA
 (740) Tamar Kochlamazashvili
 (540)

EPICOR

(511) 5, 30

(260) AM 2017 87415 A
 (210) AM 87415
 (220) 2016 05 28
 (731) DIAGEO MEXICO
 COMERCIALIZADORA, S.A. DE C.V.
 Avenida Ejercito Nacional No. 843-B,
 Torre Paseo 2o Piso, Col. Granada Del.
 Miguel Hidalgo, C.P., Mexico, 11520,
 Mexico
 (740) Tamar Kochlamazashvili
 (540)

DON JULIO

(511) 33

(260) AM 2017 87444 A
 (210) AM 87444
 (220) 2016 05 30
 (731) KIAN BASPAR KARAN CO.
 No.229, North Baghestan St., 2nd Phase of
 Baharestan Industrial Town, 5th Km of

Karaj-Ghazvin Road, 3197935551 Karaj,
Iran, (Islamic Republic of)
(740) Giorgi Taktakishvili
(540)



(554) Three-dimensional
(591) White, yellow, red, blue, grey, black
(531) 04.05.02, 08.01.23, 29.01.15
(511) 28, 30

(260) AM 2017 87445 A
(210) AM 87445
(220) 2016 05 30
(731) KIAN BASPAR KARAN CO.
No.229, North Baghestan St., 2nd Phase of
Baharestan Industrial Town, 5th Km of
Karaj-Ghazvin Road, 3197935551 Karaj,
Iran, (Islamic Republic of)
(740) Giorgi Taktakishvili
(540)



(554) Three-dimensional
(591) White, yellow, red, blue, maroon, black
(531) 04.05.02, 08.01.23, 29.01.15
(511) 28, 30

(260) AM 2017 87486 A
(210) AM 87486
(220) 2016 06 01
(731) JSC "TELAVI WINE CELLAR"
Sop. Kurdghelauri, 2200, Telavis raioni,
Georgia
(740) Aleksandre Kvernadze

(540)



MARANI

(591) Black, white
(531) 19.09.01, 02.01.13, 27.05.05
(511) 33

(260) AM 2017 87498 A
(210) AM 87498
(220) 2016 06 03
(731) LTD "R.B.J."
Z. Paliashvilis q. 49, b. 10, 0179, Tbilisi,
Georgia
(540)



(591) Black, white
(531) 26.04.24, 27.07.24, 28.19
(511) 38

(260) AM 2017 87504 A
(210) AM 87504
(220) 2016 06 03
(731) ROHTO PHARMACEUTICAL CO., LTD.
8-1, Tatsuminishi 1-chome, Ikuno-ku, Osaka-shi,
Osaka 544-8666, Japan
(740) Merab Kvimsadze
(540)

ROHTO

(591) Black-white
(531) 27.05.05
(511) 5

(260) AM 2017 87510 A
(210) AM 87510
(220) 2016 06 06
(731) Closed Joint-Stock Company
"TIERRAS DE ARMENIA"
1st Blind Alley, M. Khorenatsi str., Building
8, Apartment A2, Yerevan, Armenia

(740) Giorgi Meipariani

(540)



(591) Yellow, white, blue, red, green, black

(531) 05.03.14, 26.04.08, 27.05.11, 28.19, 29.01.15

(511) 33

(260) AM 2017 87512 A

(210) AM 87512

(220) 2016 06 06

(731) INDIVIDUAL ENTREPRENEURIALCHIN FARZALIEVI

L. Gudiashevili q.42, 30000, Marneuli, Georgia

(740) Yalchin Parzaliev

(540)



(591) White, green

(531) 05.07.06, 27.03.11, 29.01.12

(511) 29

(260) AM 2017 87528 A

(210) AM 87528

(220) 2016 06 07

(731) Pharmaceutical Chemical Cosmetic industry ALKALOID AD - Skopje

Bul. Aleksandar Makedonski, 12, 1000, The Former Yugoslav Republic of Macedonia

(740) Vakhtang Torotadze

(540)

BlokMax

(511) 5

(260) AM 2017 87533 A

(210) AM 87533

(220) 2016 06 07

(731) Pharmaceutical Chemical Cosmetic industry ALKALOID AD - Skopje

Bul. Aleksandar Makedonski, 12, 1000, The Former Yugoslav Republic of Macedonia

(740) Vakhtang Torotadze

(540)

TOND SR

(511) 5

(260) AM 2017 87557 A

(210) AM 87557

(220) 2016 06 09

(310) 30284

(320) 2015 12 11

(330) AD

(731) BRITISH AMERICAN TOBACCO (BRANDS) INC.

(a Delaware corporation)

2711 Centerville Road, Suite 300, Wilmington, Delaware 19808, USA

(740) Tamar Kochlamazashvili

(540)

TASTE + 
IMPROVED AFTER TASTE

(591) Black, white .

(531) 24.17.06, 26.01.12, 26.11.12, 27.05.10

(511) 34

(260) AM 2017 87569 A

(210) AM 87569

(220) 2016 06 10

(731) DEHA MAGAZACILIK EV TEKSTILI URUNLERI SANAYI VE TICARET

ANONIM SIRKETI

GULBAHAR MAH. AVNI DILLIGIL SK.

CELIK IS MERKEZI B/BLOK NO:9 G. KAT

MECIDIYEKOY SISLI ISTANBUL, Turkey

(740) Merab Kvimsadze

(540)

MADAMECOCO

(591) Black, white

(531) 27.05.05

(511) 8, 21, 24, 27, 35

(260) AM 2017 87588 A

(210) AM 87588

(220) 2016 06 13

(731) LTD "EFL CITY"

Pekinis gamz. 13, 0171, Tbilisi, Georgia

(740) Alexandre Revazishvili

(540)

სოპოპო
iCity
айСити

(511) 35

(260) AM 2017 87589 A
 (210) AM 87589
 (220) 2016 06 13
 (731) LTD "CITY SPORT GEORGIA"
 I. Chavchavadzis gamz. 19, 0179, Tbilisi,
 Georgia
 (740) Aleksandre Revazishvili
 (540)

სიტი სპორტი
City Sport
 Сити Спорт

(511) 35

(260) AM 2017 87620 A
 (210) AM 87620
 (220) 2016 06 16
 (731) LTD "LERMONT"
 Vazha-Pshavelas gamz. 71, korp. C, b. 27,
 0186, Tbilisi, Georgia
 (740) Ekaterine Kuprashvili
 (540)



(591) Black, white
 (531) 26.04.24, 27.05.05, 28.07
 (511) 43

(260) AM 2017 87621 A
 (210) AM 87621
 (220) 2016 06 16
 (731) LTD "LERMONT"
 Vazha-Pshavelas gamz. 71, korp.C, b.27,
 0186, Tbilisi, Georgia
 (740) Ekaterine Kuprashvili
 (540)



(591) Black, white
 (531) 26.04.24, 28.07, 28.19
 (511) 43

(260) AM 2017 87624 A
 (210) AM 87624
 (220) 2016 06 17
 (731) GENERAL PETROLEUM GMBH
 Friedrich-Ebert-Anlage 49, 60308 Frankfurt
 Am Main, Messeturm-Frankfurt, 25 Etage,
 Germany
 (740) Khatuna Imnadze
 (540)



(591) Black, white
 (531) 25.05.02, 26.01.12, 26.01.18, 27.05.01,
 27.05.21
 (511) 4

(260) AM 2017 87677 A
 (210) AM 87677
 (220) 2016 06 22
 (731) IRAKLI ARCHVADZE
 G. Brtskinvales q. 19, b. 3, 0131, Tbilisi,
 Georgia
 (740) Irakli Archvadze
 (540)

ავტომობილ
Autopia
 Аутопия

(511) 35, 37

(260) AM 2017 87748 A
 (210) AM 87748
 (220) 2016 06 28
 (731) LTD "LABORATORY KOLKHIKA"
 Sanapiros q. 10, 0108, Tbilisi, Georgia
 (740) Salome Jeladze
 (540)



(591) Grey, stoney

(531) 03.04.02, 03.04.12
(511) 35, 44

(260) AM 2017 87751 A
(210) AM 87751
(220) 2016 06 28
(731) LTD "LABORATORY KOLKHIKA"
Sanapiros q. 10, 0108, Tbilisi, Georgia
(740) Salome Jeladze
(540)

COLCHICA
კოლხიკა

(511) 35, 44

(260) AM 2017 87762 A
(210) AM 87762
(220) 2016 06 28
(731) Tamar Tevdorashvili
Varketilis me-4 mkr.-ni, me-2 rigi, me-6 korp.
me-7 sad. b.143, 0182, Tbilisi, Georgia
(740) Tamar Tevdorashvili
(540)



(591) Black, white
(531) 02.09.01, 26.11.12
(511) 25

(260) AM 2017 87776 A
(210) AM 87776
(220) 2016 06 29
(731) DISCOVER FINANCIAL SERVICES
2500 Lake Cook Road, Riverwoods, IL 60015,
USA
(740) Shalva Gvaramadze
(540)

DISCOVER
GLOBAL NETWORK

(591) Black, white
(531) 26.15.01, 27.01.06
(511) 36

(260) AM 2017 87778 A
(210) AM 87778
(220) 2016 06 29

(731) WESTERN DIGITAL TECHNOLOGIES,
INC. a Delaware corporation
3355 Michelson Drive, Suite 100 Irvin
California 92612, USA
(740) Tamar Kochlamazashvili
(540)

WD GOLD

(511) 9, 42

(260) AM 2017 87779 A
(210) AM 87779
(220) 2016 06 29
(731) P.K. OVERSEAS (P) LTD.
4039/3, Naya Bazar, Lahori Gate, Delhi-110
006, India
(740) Tamaz Shilakadze
(540)



(591) White, brown, straw
(531) 25.01.10, 27.05.24, 29.01.07, 29.01.13
(511) 30

(260) AM 2017 87784 A
(210) AM 87784
(220) 2016 06 30
(731) NISSAN JIDOSHA KABUSHIKI KAISHA
(also trading as Nissan Motor Co., Ltd.)
No.2, Takara-cho, Kanagawa-ku, Yokohama-shi,
Kanagawa-ken, Japan
(740) Shalva Gvaramadze
(540)



(591) Black, white
(531) 24.11.25, 25.03.03, 26.05.22, 27.05.24
(511) 1, 2, 3, 4, 5, 7, 11, 27, 36, 38, 39, 41

(260) AM 2017 87785 A
(210) AM 87785
(220) 2016 06 30
(731) NISSAN JIDOSHA KABUSHIKI KAISHA
(also trading as Nissan Motor Co., Ltd.)
No.2, Takara-cho, Kanagawa-ku, Yokohama-shi,
Kanagawa-ken, Japan

(740) Shalva Gvaramadze
(540)

on-DO

(511) 9, 19

(260) AM 2017 87786 A
(210) AM 87786
(220) 2016 06 30
(731) NISSAN JIDOSHA KABUSHIKI KAISHA
(also trading as Nissan Motor Co., Ltd.)
No.2, Takara-cho, Kanagawa-ku, Yokohama-shi,
Kanagawa-ken, Japan
(740) Shalva Gvaramadze
(540)

mi-DO

(511) 9, 16

(260) AM 2017 87788 A
(210) AM 87788
(220) 2016 06 30
(731) NISSAN JIDOSHA KABUSHIKI KAISHA
(also trading as Nissan Motor Co., Ltd.)
No.2, Takara-cho, Kanagawa-ku, Yokohama-shi,
Kanagawa-ken, Japan
(740) Shalva Gvaramadze
(540)

დასუნი

(591) Black, white
(531) 28.19
(511) 9, 12, 16, 24, 36, 37

(260) AM 2017 87792 A
(210) AM 87792
(220) 2016 06 30
(731) NISSAN JIDOSHA KABUSHIKI KAISHA
(also trading as Nissan Motor Co., Ltd.)
No.2, Takara-cho, Kanagawa-ku, Yokohama-shi,
Kanagawa-ken, Japan
(740) Shalva Gvaramadze
(540)



(591) Black, white
(531) 24.11.25, 25.03.03, 26.05.22, 27.05.22
(511) 6, 8, 14, 18, 21, 25, 28

(260) AM 2017 87794 A
(210) AM 87794
(220) 2016 06 30
(731) LTD "NUTRIMAKSI"
Rustavis gzat.68a, 0165, Tbilisi, Georgia
(740) Giorgi Kartvelishvili
(540)



ნუტრიმაქსი
NUTRIMAX

(591) Green, white, dark yellow, dark brown,
cornelian-red
(531) 26.04.09, 26.04.12, 26.11.11, 27.05.05, 28.19,
29.01.15
(511) 31

(260) AM 2017 87799 A
(210) AM 87799
(220) 2016 07 01
(731) LTD "BORAN LIGHT"
Marneulis q. 44, Kvemo Ponitchala, 0165,
Tbilisi, Georgia
(740) Nino Kaplanishvili
(540)

LINUS

(511) 11

(260) AM 2017 87834 A
(210) AM 87834
(220) 2016 07 06
(731) SOFBEY SÁRL
rue de Graman 25, 1241 Puplinge (Geneva),
Switzerland
(740) Konstantine Meipariani
(540)

ბლეკჯეკო

(511) 1

(260) AM 2017 87874 A
(210) AM 87874
(220) 2016 07 07
(731) LEPL "GEORGIAN TRAINING
CENTER OF JUSTICE"
Sandro Eulis q. 3a, 0186, Tbilisi,
Georgia
(740) Simona Tsalani

(540)



(591) White, orange, brown
 (531) 05.01.16, 26.01.15, 26.04.10, 29.01.13
 (511) 41

(260) AM 2017 87883 A
 (210) AM 87883
 (220) 2016 07 08
 (731) NOVARTIS AG
 4002 Basel, Switzerland
 (740) Pavle Meipariani
 (540)

ტეკოპრილი

(591) Black, white
 (531) 28.19
 (511) 5

(260) AM 2017 87885 A
 (210) AM 87885
 (220) 2016 07 08
 (731) LTD "ASB"
 F. Khalvashis gamz. 235, 6000, Batumi,
 Georgia
 (740) Pavle Meipariani
 (540)

DESTAŞ

(511) 9

(260) AM 2017 87887 A
 (210) AM 87887
 (220) 2016 07 08
 (731) GENZYME CORPORATION
 500 Kendall Street, Cambridge, Massachusetts
 02142, USA
 (740) Shalva Gvaramadze
 (540)

XENPOZYME

(511) 5

(260) AM 2017 87892 A
 (210) AM 87892
 (220) 2016 07 11
 (731) LTD "POSEIDON"
 Kakhetis gzat. 14, 3800, Sagarejo, Georgia

(540)

პლანეტა
PLANETA

(511) 34

(260) AM 2017 87909 A
 (210) AM 87909
 (220) 2016 07 12
 (731) THE SECOND CUP COFFEE
 COMPANY INC.
 6303 Airport Road, Suite 103, Mississauga,
 Ontario, L4V 1R8, Canada
 (740) Giorgi Taktakishvili
 (540)



(591) White, grey, black
 (531) 01.15.11, 05.03.04, 11.03.04, 25.01.01,
 27.05.10
 (511) 30, 35, 43

(260) AM 2017 87965 A
 (210) AM 87965
 (220) 2016 07 15
 (731) ABBOTT BIOLOGICALS B.V.
 C.J. van Houtenlaan 36, WEESP 1381 CP,
 Netherlands
 (740) Tamar Kochlamazashvili
 (540)

INFLUVAC TETRA

(511) 5

(260) AM 2017 87971 A
 (210) AM 87971
 (220) 2016 07 15
 (731) ABBOTT BIOLOGICALS B.V.
 C.J. van Houtenlaan 36, WEESP 1381 CP,
 Netherlands
 (740) Tamar Kochlamazashvili
 (540)

ИНФЛЮВАК ТЕТРА

(511) 5

(260) AM 2017 88071 A

(210) AM 88071

(220) 2016 07 27

(731) LTD "GEORGIAN BRANDS COMPANY"

Kakhetis gzat. 110a, 0198, Tbilisi, Georgia

(740) Khatia Khatiashvili

(540)

გლენშერი
ГЛЕНШЕР
GLENSHER

(511) 33

REGISTERED TRADEMARKS

(111) M 2017 28091 R
(151) 2017 02 01
(181) 2027 02 01
(260) AM 2016 82583 A
(220) 2015 06 17
(732) LTD "GEODISTRIBUTSIION"
G. Nadareishvilis q.5a, 0120, Tbilisi, Georgia

(111) M 2017 28092 R
(151) 2017 02 01
(181) 2027 02 01
(260) AM 2016 83579 A
(220) 2015 08 27
(732) LTD "KARTU-UNIVERSAL"
Kakhetis gzat. me-2 chikhi 11, 0190, Tbilisi,
Georgia

(111) M 2017 28093 R
(151) 2017 02 01
(181) 2027 02 01
(260) AM 2016 83580 A
(220) 2015 08 27
(732) LTD "KARTU-UNIVERSAL"
Kakhetis gzat. me-2 chikhi 11, 0190, Tbilisi,
Georgia

(111) M 2017 28094 R
(151) 2017 02 01
(181) 2027 02 01
(260) AM 2016 83581 A
(220) 2015 08 27
(732) LTD "KARTU-UNIVERSAL"
Kakhetis gzat. me-2 chikhi 11, 0190, Tbilisi,
Georgia

(111) M 2017 28095 R
(151) 2017 02 01
(181) 2027 02 01
(260) AM 2016 83582 A
(220) 2015 08 27
(732) LTD "KARTU-UNIVERSALI"
Kakhetis gzat. me-2 chikhi 11, 0190, Tbilisi,
Georgia

(111) M 2017 28096 R
(151) 2017 02 01
(181) 2027 02 01
(260) AM 2016 83583 A
(220) 2015 08 27
(732) LTD "KARTU-UNIVERSAL"
Kakhetis gzat. me-2 chikhi 11, 0190, Tbilisi,
Georgia

(111) M 2017 28097 R
(151) 2017 02 01
(181) 2027 02 01
(260) AM 2016 83724 A
(220) 2015 09 07
(732) UNICHARM GULF HYGIENIC INDUSTRIES
LTD.
P.O. Box 99883, Riyadh 11625, Saudi Arabia

(111) M 2017 28098 R
(151) 2017 02 01
(181) 2027 02 01
(260) AM 2016 83725 A
(220) 2015 09 07
(732) UNICHARM GULF HYGIENIC INDUSTRIES
LTD.
P.O. Box 99883, Riyadh 11625, Saudi Arabia

(111) M 2017 28099 R
(151) 2017 02 01
(181) 2027 02 01
(260) AM 2016 83726 A
(220) 2015 09 07
(732) UNICHARM GULF HYGIENIC INDUSTRIES
LTD.
P.O. Box 99883, Riyadh 11625, Saudi Arabia

(111) M 2017 28100 R
(151) 2017 02 02
(181) 2027 02 02
(260) AM 2016 83993 A
(220) 2015 09 28
(732) Tovarystvo z Obmegenuju Vidpovidalnistu
"PROMYSLOVO-TORGOVELNA
KOMPANIJA SHABO"
Vul. Dzergynskogo 10, S. Shabo, Bilgorod-
Dnistovskij r-n Odessa obl. 67770, Ukraine;
ELDAR IUKURIDZE
Vul. Dzergynskogo 19, b. 9, Odessa, Ukraine

(111) M 2017 28101 R
(151) 2017 02 02
(181) 2027 02 02
(260) AM 2016 83994 A
(220) 2015 09 28
(732) Tovarystvo z Obmegenuju Vidpovidalnistu
"PROMYSLOVO-TORGOVELNA
KOMPANIJA SHABO"
Vul. Dzergynskogo 10, S. Shabo, Bilgorod-
Dnistovskij r-n Odessa obl. 67770, Ukraine;
ELDAR IUKURIDZE
Vul. Dzergynskogo 19, b. 9, Odessa, Ukraine

(111) M 2017 28102 R
 (151) 2017 02 02
 (181) 2027 02 02
 (260) AM 2016 84254 A
 (220) 2015 10 19

(732) INFINIX TECHNOLOGY LIMITED
 RMS 05-15, 13A/F SOUTH TOWER
 WORLD FINANCE CTR HARBOUR CITY
 17 CANTON RD TST KLN HONG KONG,
 The Hong Kong Special Administrative
 Region of the peoples republic of China

(111) M 2017 28103 R
 (151) 2017 02 02
 (181) 2027 02 02
 (260) AM 2016 84404 A
 (220) 2015 10 30

(732) IRINA TCHELIDZE
 L. Ssatianis q. 44, 0105, Tbilisi, Georgia

(111) M 2017 28104 R
 (151) 2017 02 02
 (181) 2027 02 02
 (260) AM 2016 84453 A
 (220) 2015 11 03

(732) LTD "RUMBI"
 Jikias q. 9a, (savatchro saofise farti 1),0186,
 Tbilisi, Georgia

(111) M 2017 28105 R
 (151) 2017 02 02
 (181) 2027 02 02
 (260) AM 2016 84592 A
 (220) 2015 11 09

(732) LUBA TSIREKIDZE
 Gldani, pirveli mikro r-ni, me-9 korp., me-5
 sad., b. 98, 0167, Tbilisi, Georgia

(111) M 2017 28106 R
 (151) 2017 02 02
 (181) 2027 02 02
 (260) AM 2016 84675 A
 (220) 2015 11 13

(732) BLUE DIAMOND GROWERS
 1802 C Street, Sacramento,
 California 95811, USA

(111) M 2017 28107 R
 (151) 2017 02 02
 (181) 2027 02 02
 (260) AM 2016 84699 A
 (220) 2015 11 16

(732) MAHS INVESTMENT HOLDING LTD.
 P.O.Box: (309), Agland House,
 Grand Cayman KY1-1104, Cayman Islands

(111) M 2017 28108 R
 (151) 2017 02 02
 (181) 2027 02 02
 (260) AM 2016 84827 A
 (220) 2015 11 25

(732) LTD "BRANDING.GE"
 Nutsbidzis q. 179, korp.2, b.10, Tbilisi,
 Georgia

(111) M 2017 28109 R
 (151) 2017 02 02
 (181) 2027 02 02
 (260) AM 2016 84872 A
 (220) 2015 11 27

(732) ANESTASS EL MURR
 El Murr Residence - Haret El Deir, Kfarchima –
 Baabda, Lebanon

(111) M 2017 28110 R
 (151) 2017 02 02
 (181) 2027 02 02
 (260) AM 2016 84933 A
 (220) 2015 11 30

(732) PHILIP MORRIS BRANDS SÀRL
 Quai Jeanrenaud 3, 2000 Neuchâtel, Switzerland

(111) M 2017 28111 R
 (151) 2017 02 02
 (181) 2027 02 02
 (260) AM 2016 85142 A
 (220) 2015 12 14

(732) LTD "IMPERVETI"
 Ak. Tseretlis gamz. 142, me-2 sart., 0119,
 Tbilisi, Georgia

(111) M 2017 28112 R
 (151) 2017 02 02
 (181) 2027 02 02
 (260) AM 2016 85235 A
 (220) 2015 12 17

(732) TOYOTA JIDOSHA KABUSHIKI KAISHA
 (also trading as Toyota Motor Corporation)
 1, Toyota-cho, Toyota-shi, Aichi-ken, Japan

(111) M 2017 28114 R
 (151) 2017 02 03
 (186) 2027 02 03
 (260) AM 2016 64923 A

(220) 2011 11 16
(732) LTD "AGROCHEMISTRY"
Gumathesis q. 4, b. 46, Tbilisi, Georgia

(111) M 2017 28115 R
(151) 2017 02 03
(186) 2027 02 03
(260) AM 2016 64922 A
(220) 2011 11 16
(732) LTD "AGROCHEMISTRY"
Gumathesis q. 4, b. 46, Tbilisi, Georgia

(111) M 2017 28116 R
(151) 2017 02 03
(186) 2027 02 03
(260) AM 2016 64924 A
(220) 2011 11 16
(732) LTD "AGROCHEMISTRY"
Gumathesis q. 4, b. 46, Tbilisi, Georgia

(111) M 2017 28117 R
(151) 2017 02 03
(186) 2027 02 03
(260) AM 2016 64925 A
(220) 2011 11 16
(732) LTD "AGROCHEMISTRY"
Gumathesis q. 4, b. 46, Tbilisi, Georgia

(111) M 2017 28118 R
(151) 2017 02 03
(186) 2027 02 03
(260) AM 2016 64926 A
(220) 2011 11 16
(732) LTD "AGROCHEMISTRY"
Gumathesis q. 4, b. 46, Tbilisi, Georgia

(111) M 2017 28119 R
(151) 2017 02 03
(186) 2027 02 03
(260) AM 2016 64927 A
(220) 2011 11 16
(732) LTD "AGROCHEMISTRY"
Gumathesis q. 4, b. 46, Tbilisi, Georgia

(111) M 2017 28120 R
(151) 2017 02 03
(186) 2027 02 03
(260) AM 2016 64930 A
(220) 2011 11 16
(732) LTD "AGROCHEMISTRY"
Gumathesis q. 4, b. 46, Tbilisi, Georgia

(111) M 2017 28121 R
(151) 2017 02 03
(186) 2027 02 03
(260) AM 2016 64931 A
(220) 2011 11 16
(732) LTD "AGROCHEMISTRY"
Gumathesis q. 4, b. 46, Tbilisi, Georgia

(111) M 2017 28122 R
(151) 2017 02 03
(181) 2027 02 03
(260) AM 2016 85236 A
(220) 2015 12 17
(732) BRITISH AMERICAN TOBACCO (BRANDS)
INC (a Delaware corporation).
2711 Centerville Road, Suite 300,
Wilmington, Delaware 19808, USA

(111) M 2017 28123 R
(151) 2017 02 03
(181) 2027 02 03
(260) AM 2016 85237 A
(220) 2015 12 17
(732) BRITISH AMERICAN TOBACCO (BRANDS)
INC (a Delaware corporation).
2711 Centerville Road, Suite 300,
Wilmington, Delaware 19808, USA

(111) M 2017 28124 R
(151) 2017 02 03
(181) 2027 02 03
(260) AM 2016 85393 A
(220) 2015 12 23
(732) AMSTEL BROUWERIJ B.V.
Tweede Weteringplantsoen 21, 1017 ZD
AMSTERDAM, Netherlands

(111) M 2017 28125 R
(151) 2017 02 06
(181) 2027 02 06
(260) AM 2016 85444 A
(220) 2015 12 25
(732) JSC "PHARMFIRMA "SOTEKS"
Pos. Belikovo, d. 11, Selskoe Poselenie
Bereznikovskoe, 141345, Moskovskaya
Oblast, Sergievo-Posadskiy Municipalniy
raion, Russian Federation

(111) M 2017 28126 R
(151) 2017 02 06
(181) 2027 02 06
(260) AM 2016 85445 A
(220) 2015 12 25

(732) JSC "PHARMFIRMA "SOTEKS"
Pos. Belikovo, d. 11, Selskoe Poselenie
Berezhnykovskoe, 141345, Moskovskaya
Oblast, Sergievo-Posadskiy Municipalny
raion, Russian Federation

(111) M 2017 28127 R
(151) 2017 02 06
(181) 2027 02 06
(260) AM 2016 85646 A
(220) 2016 01 08

(732) LTD "KINDZMARAU LI KVARELI"
Sairmis q., korp. 4, b.18, 0194, Tbilisi, Georgia

(111) M 2017 28128 R
(151) 2017 02 06
(181) 2027 02 06
(260) AM 2016 85720 A
(220) 2016 01 13

(732) PHILIP MORRIS BRANDS SÀRL
Quai Jeanrenaud 3, 2000 Neuchâtel, Switzerland

(111) M 2017 28129 R
(151) 2017 02 06
(181) 2027 02 06
(260) AM 2016 85738 A
(220) 2016 01 13

(732) ALFRED KÄRCHER GMBH & CO. KG.
Alfred-Kärcher-Strasse 28-40, 71364
Winnenden, Germany

(111) M 2017 28130 R
(151) 2017 02 06
(181) 2027 02 06
(260) AM 2016 85748 A
(220) 2016 01 14

(732) DABUR INDIA LIMITED
8/3, Asaf Ali Road, New Delhi 110 002, India

(111) M 2017 28131 R
(151) 2017 02 06
(181) 2027 02 06
(260) AM 2016 85758 A
(220) 2016 01 14

(732) DABUR INDIA LIMITED
8/3, Asaf Ali Road, New Delhi 110 002, India

(111) M 2017 28132 R
(151) 2017 02 06
(181) 2027 02 06
(260) AM 2016 85763 A
(220) 2016 01 14

(732) LTD "TIFLISSKI VINNI POGREB"
Iumashevis q. 27, 0198, Tbilisi, Georgia

(111) M 2017 28133 R
(151) 2017 02 06
(181) 2027 02 06
(260) AM 2016 85765 A
(220) 2016 01 14

(732) LTD "TIFLISSKI VINNI POGREB"
Iumashevis q. 27, 0198, Tbilisi, Georgia

(111) M 2017 28134 R
(151) 2017 02 06
(181) 2027 02 06
(260) AM 2016 85792 A
(220) 2016 01 20

(732) LTD "ELVA-2"
Shevchenkos q.8, Kutaisi, Georgia

(111) M 2017 28135 R
(151) 2017 02 06
(181) 2027 02 06
(260) AM 2016 85799 A
(220) 2016 01 20

(732) YILDIZ HOLDİNG A.Ş.
Kısıklı Mahallesi, Çeşme Çıkma zı Sokak,
No:6/1 Üsküdar İstanbul, Turkey

(111) M 2017 28136 R
(151) 2017 02 06
(181) 2027 02 06
(260) AM 2016 85815 A
(220) 2016 01 21

(732) YILDIZ HOLDİNG A.Ş.
Kısıklı Mahallesi, Çeşme Çıkma zı Sokak,
No:6/1 Üsküdar İstanbul, Turkey

(111) M 2017 28137 R
(151) 2017 02 06
(181) 2027 02 06
(260) AM 2016 85820 A
(220) 2016 01 21

(732) LTD "FAVOURITE STILE"
Chubinashvilis q. 50, 0164, Tbilisi, Georgia

(111) M 2017 28138 R
(151) 2017 02 06
(181) 2027 02 06
(260) AM 2016 85821 A
(220) 2016 01 21

(732) LTD "KAMBECHOVANI"
Chubinashvilis q. 50, 0164, Tbilisi, Georgia

(111) M 2017 28139 R
(151) 2017 02 06
(181) 2027 02 06
(260) AM 2016 85831 A
(220) 2016 01 25
(732) TIANJIN LOVOL HEAVY INDUSTRY
GROUP CO., LTD.
No.77, Gaoxin Road, Beichen Science and
Technology Park, Tianjin, P.R. China

(111) M 2017 28140 R
(151) 2017 02 06
(181) 2027 02 06
(260) AM 2016 85835 A
(220) 2016 01 25
(732) IVYBRIDGE VENTURES LIMITED.
Lampousas 1, P.C. 1095, Nicosia, Cyprus

(111) M 2017 28141 R
(151) 2017 02 06
(181) 2027 02 06
(260) AM 2016 85882 A
(220) 2016 01 27
(732) MONSTER ENERGY COMPANY
(a Delaware corporation)
1 Monster Way, Corona, California 92879,
USA

(111) M 2017 28142 R
(151) 2017 02 06
(181) 2027 02 06
(260) AM 2016 85884 A
(220) 2016 01 27
(732) MONSTER ENERGY COMPANY
(a Delaware corporation)
1 Monster Way, Corona, California 92879,
USA

(111) M 2017 28143 R
(151) 2017 02 06
(181) 2027 02 06
(260) AM 2016 85887 A
(220) 2016 01 27
(732) GIA AGIRBA
I. Gordezianis q. 12, Batumi, Georgia

(111) M 2017 28144 R
(151) 2017 02 06
(181) 2027 02 06
(260) AM 2016 85892 A
(220) 2016 01 28
(732) IVYBRIDGE VENTURES LIMITED
Lampousas 1, P.C. 1095, Nicosia, Cyprus

(111) M 2017 28145 R
(151) 2017 02 06
(181) 2027 02 06
(260) AM 2016 85896 A
(220) 2016 01 29
(732) AUTOMATIC SWITCH COMPANY
50-60 Hanover Road, Florham Park, NJ 07932,
USA

(111) M 2017 28146 R
(151) 2017 02 06
(181) 2027 02 06
(260) AM 2016 86007 A
(220) 2016 02 05
(732) LTD "AFLOPHARM PHARMACY
POLSKA"
Partizanska street N133/151, 95-200
Pabianitse, Poland

(111) M 2017 28147 R
(151) 2017 02 06
(181) 2027 02 06
(260) AM 2016 86010 A
(220) 2016 02 05
(732) JSC "GEORGIAN BEER COMPANY"
Sop. Saguramo, 3311, Mtskheta, Georgia

(111) M 2017 28148 R
(151) 2017 02 06
(181) 2027 02 06
(260) AM 2016 86109 A
(220) 2016 02 10
(732) JSC "GEORGIAN BEER COMPANY"
Sop. Saguramo, 3311, Mtskheta, Georgia

(111) M 2017 28149 R
(151) 2017 02 06
(181) 2027 02 06
(260) AM 2016 86128 A
(220) 2016 02 11
(732) WORLDWIDE FRANCHISE SYSTEMS, INC.
One StarPoint, Stamford, Connecticut 06902, USA

(111) M 2017 28150 R
(151) 2017 02 06
(181) 2027 02 06
(260) AM 2016 86130 A
(220) 2016 02 11
(732) WORLDWIDE FRANCHISE SYSTEMS, INC.
One StarPoint, Stamford, Connecticut 06902,
USA

(111) M 2017 28151 R
(151) 2017 02 06
(181) 2027 02 06
(260) AM 2016 86132 A
(220) 2016 02 12
(732) LTD "GLOBALPHARMI"
Almasianis q. 13a/ Berbutis q.8, 0171, Tbilisi,
Georgia

(111) M 2017 28152 R
(151) 2017 02 06
(181) 2027 02 06
(260) AM 2016 86364 A
(220) 2016 02 29
(732) MERCK SHARP & DOHME CORP.
One Merck Drive, Whitehouse Station,
New Jersey, 08889, USA

(111) M 2017 28153 R
(151) 2017 02 06
(181) 2027 02 06
(260) AM 2016 86365 A
(220) 2016 02 29
(732) MERCK SHARP & DOHME CORP.
One Merck Drive, Whitehouse Station,
New Jersey, 08889, USA

(111) M 2017 28154 R
(151) 2017 02 06
(181) 2027 02 06
(260) AM 2016 86366 A
(220) 2016 02 29
(732) MERCK SHARP & DOHME CORP.
One Merck Drive, Whitehouse Station,
New Jersey, 08889, USA

(111) M 2017 28155 R
(151) 2017 02 06
(181) 2027 02 06
(220) 2016 08 08
(732) REEMTSMA CIGARETTENFABRIKEN
GMBH
Max-Born Strasse 4, 22761 Hamburg, Germany

TRADEMARKS REGISTERED ACCORDING TO THE ACCELERATED PROCEDURE

The decision can be appealed at the Chamber of Appeal of Sakpatenti within 3 months from the publication.

(111) M 2017 28078 R
(151) 2017 01 23
(181) 2027 01 23
(210) AM 89789
(220) 2016 12 02
(732) LTD "GEORGIAN WINES AND SPIRITS
COMPANY"
Sop. Achinebuli, 2200 Telavi, Georgia
(740) Elene Totibadze
(540)

ახალი თბილისი

(526) The trademark is protected as a whole.
"თბილისი" shall not be subject to independent
legal protection.
(511) 33

(111) M 2017 28079 R
(151) 2017 01 25
(181) 2027 01 25
(210) AM 89946
(220) 2016 12 13
(732) HENKEL AG & Co. KGaA
Henkelstrasse 67, D-40589 Dusseldorf,
Germany
(740) Shalva Gvaramadze
(540)



(591) Black, white
(531) 02.01.01, 02.03.01
(511) 3, 5, 11, 21

(111) M 2017 28080 R
(151) 2017 01 25
(181) 2027 01 25
(210) AM 89948
(220) 2016 12 13

(732) HENKEL AG & Co. KGaA
Henkelstrasse 67, D-40589 Dusseldorf,
Germany
(740) Shalva Gvaramadze
(540)

SCHWARZKOPF

(511) 3, 5, 11, 21

(111) M 2017 28081 R
(151) 2017 01 25
(181) 2027 01 25
(210) AM 90349
(220) 2017 01 10
(732) LTD "ZETI"
Tsknetis gzat. 39, b. 99, 0162, Tbilisi, Georgia
(740) Giorgi Gvazava
(540)



Narratoria

(591) Black, white
(531) 24.15.07, 24.15.11, 27.05.17
(511) 9

(111) M 2017 28082 R
(151) 2017 01 26
(181) 2027 01 26
(210) AM 90301
(220) 2017 01 06
(732) JAPAN TOBACCO INC.
2-2-1 Toranomom, Minato-Ku, Tokyo, Japan
(740) Shalva Gvaramadze
(540)

IMPULSE

(511) 34

(111) M 2017 28083 R
(151) 2017 01 26
(181) 2027 01 26
(210) AM 90484
(220) 2017 01 18
(732) JAPAN TOBACCO INC.
2-2-1 Toranomom, Minato-Ku, Tokyo, Japan

(740) Shalva Gvaramadze
(540)



(591) White, different tone of blue
(531) 19.03.24, 27.05.19, 27.05.24, 29.01.12
(511) 34

(111) M 2017 28084 R
(151) 2017 01 26
(181) 2027 01 26
(210) AM 90486
(220) 2017 01 18
(732) JAPAN TOBACCO INC.
2-2-1 Toranomon, Minato-Ku, Tokyo, Japan
(740) Shalva Gvaramadze
(540)



(591) Red, white, blue
(531) 19.03.24, 27.05.19, 27.05.24, 29.01.13
(511) 34

(111) M 2017 28085 R
(151) 2017 01 26
(181) 2027 01 26
(210) AM 87583

(220) 2016 06 13
(732) Gocha Pipia
Budapeshtis q. 11, b. 55, 0160, Tbilisi,
Georgia

(740) Aleksandre Kvernadze
(540)

GEORGIAN STANDARD

(526) GEORGIAN
(511) 33

(111) M 2017 28086 R
(151) 2017 01 26
(181) 2027 01 26
(210) AM 88502
(220) 2016 09 06
(732) LTD "TERMINAL WEST TRADING"
Tvaltchrelidzis q. 2, 0182, Tbilisi, Georgia
(740) Nino Dighmelashvili
(540)



(591) White, green, black
(531) 26.04.03, 26.04.09, 25.01.01, 29.01.13
(511) 19

(111) M 2017 28087 R
(151) 2017 01 30
(181) 2027 01 30
(210) AM 90411
(220) 2017 01 12
(732) LTD "MALTICOMI"
Oniashvilis q. 67, 0160, Tbilisi, Georgia
(740) Zura Lutidze
(540)



(591) Grey, red, white
(531) 26.04.24, 27.05.24, 29.01.13
(511) 38

(111) M 2017 28088 R
 (151) 2017 01 30
 (181) 2027 01 30
 (210) AM 90153
 (220) 2016 12 28
 (732) LTD "DIPLOMAT GEORGIA"
 Tengiz Chantladzis q., I shesak. 10,
 Tblisi, Georgia
 (740) Giorgi Sarajishvili
 (540)

დიპლომატ ჯორჯია

(526) The trademark is protected as a whole.
 "ჯორჯია" shall not be subject to independent legal
 protection.

(511) 35

(111) M 2017 28089 R
 (151) 2017 01 31
 (181) 2027 01 31
 (210) AM 90421
 (220) 2017 01 13
 (732) LTD "VAZIANI COMPANY"
 Mshvidobis q. 42. 2200, Telavi, Georgia
 (740) Aleksandre Kvernadze
 (540)

ТАЈАВЕРИ

(511) 33

(111) M 2017 28090 R
 (151) 2017 02 01
 (181) 2027 02 01
 (210) AM 87542
 (220) 2016 06 08
 (732) LTD "EVITBILISI"
 Kakhetis gzat. 110a, 0151, Tbilisi, Georgia
 (740) Gia Barbakadze
 (540)

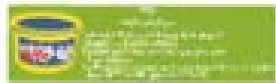

Alfa



Alfa



(591) Red, yellow, green
 (531) 02.09.15, 11.03.09, 19.01.04, 25.01.01,
 27.05.17, 29.01.13
 (511) 21

(111) M 2017 28113 R
 (151) 2017 02 03
 (181) 2027 02 03
 (210) AM 90560
 (220) 2017 01 23
 (732) BADRI BAGATELIA
 I. Abashidzis q. 24, b. 26, 0179, Tbilisi,
 Georgia
 (740) Badri Bagatelia
 (540)

მოკო

**MOKO
 MOKO**

(511) 43

INTERNATIONAL TRADEMARKS FOR WHICH A DECISION ON GRANTING PROTECTIONS IS TAKEN

The decision can be appealed at the Chamber of Appeal of Sakpatenti within 3 months from the publication or at the Mtskheta District Court Administrative Cases Board (Address: №17, Samkhedro str., Mtskheta), within 1 month following the publication.

(260) AM 2017 80883 A*

(800) 1234986

(891) 2014 04 29

(731) KONINKLIJKE PHILIPS N.V.

High Tech Campus 5, NL-5656 AE

Eindhoven, Netherlands

(540)

AVENT

(511)

3 – Bleaching preparations and other substances for laundry use; cleaning, polishing, scouring and abrasive preparations; soaps; perfumery, essential oils, cosmetics, hair lotions; dentifrices; toothpaste; non-medicated toilet preparations; cosmetics; shampoos, talcum powder; baby wipes, disposable wipes impregnated with scented water, facial wipes impregnated with cosmetics, moist wipes for sanitary and cosmetic purposes, moist wipes impregnated with cosmetic lotions, pre-moistened cosmetic wipes, wipes impregnated with a skin cleanser, wipes incorporating cleaning preparations; non-medicated preparations, creams and lotions for the body, skin and hair; non-medicated massage creams, oils and gels; liquid talc for babies; non-medicated nipple cream; descaling preparations for household use; pre-moistened or impregnated pads, tissues or wipes for cosmetic use; disposable wipes impregnated with cleansing chemicals or compounds for personal hygiene; baby bottom balm, baby cream; non-medicated body cream for mothers; non-medicated bath and shower, moisturizing and cleansing foam for mothers; non-medicated moisturizing oil for mothers, body wash for babies, shampoo for babies.

5 – Dietetic food and substances adapted for medical or veterinary use, food for babies; nutritional supplements for humans and animals; plasters, materials for dressings; material for stopping teeth, dental wax for dentists; disinfectants; preparations for destroying vermin; fungicides and herbicides; baby food, vitamin and mineral preparations; impregnated anti-septic or medicated wipes, moist wipes impregnated with pharmaceutical lotions, disinfectant wipes, wipes for medical use; nursing pads for breast-feeding; tissues and wipes impregnated with pharmaceutical lotions and creams, milk powder for babies; breast pads.

7 – Electrical appliances for household purposes not included in other classes, electric blenders, can openers, food processors, fruit presses, mills and mixers,

electric knives; kitchen machines, electric, for food preparation; parts of the aforesaid goods.

8 – Hand tools and implements, hand-operated; razors; table cutlery made of plastic, for babies and children; apparatus for making holes in teats; cutlery; cutlery for babies, infants and children; spoons, forks and knives; electric hair clippers, hair trimmers, scissors for cutting hair, nail clippers for babies; electric and non-electric depilation apparatus, electric and non-electric hair clippers for personal use, hair-removing tweezers, electric or non-electric nail clippers, electric or non-electric nail files; manicure and pedicure sets, nail files and cardboard nail files, electric or non-electric; tongs for picking up teats and other objects from a sterilizer; tongs to pick up hot objects; parts of the aforesaid goods.

9 – Scientific, nautical, surveying, photographic, cinematographic, optical, weighing, measuring, signaling, checking (supervision), life-saving and teaching apparatus and instruments; apparatus and instruments for conducting, switching, transforming, accumulating, regulating or controlling electricity; apparatus for recording, transmission or reproduction of sound or images; magnetic data carriers, recording discs, compact discs, DVDs and other digital storage media; data processing equipment, computers; computer software; scales for babies; digital photo frames, DECT monitors, thermometers and electronic thermometers, other than for medical purposes; anti-radiation garment; electronic publications provided online from databases or on the Internet; storage media; interactive compact discs and CD-ROMs; records, tapes, disks, cassettes, cartridges, cards and other carriers, all containing or for recording sound, video, data, images, games, text, programs or information; all the aforesaid goods for or in relation to babies, young children, pregnant women, breast-feeding mothers and young mothers; computer software programs and software applications for mobile phones and other handheld mobile digital electronic devices; application software for mobile devices, computer programs for accessing, browsing and searching online databases; computer software and firmware, namely, operating system programs, data synchronization programs and application software for personal and handheld computers; spectacle frames, eyeglasses, sunglasses; fridge magnets; parts for all the aforesaid goods, except hearing aids and related goods; electrical monitoring

devices; baby monitors; digital video monitors; monitors (hardware); chargers for electric batteries, battery chargers; batteries and rechargeable batteries; central processing units for baby monitors, electrical connections for baby monitors; power cord; charging stations for baby monitors; parts for baby monitors; thermometers in the form of teat, not for medical purposes; bath and room thermometers; digital photo frames; stress gauges.

10 – Surgical, medical, dental and veterinary apparatus and instruments, artificial limbs, eyes and teeth; orthopedic articles; suture materials; instruments, clothes, lights and lamps for medical, curative, surgical, dental and veterinary use; feeding bottles, handles for baby bottles; teats, soothers, pacifiers and teething rings; spoons and medical feeders for administering medicines; breast shells; incubators; po chairs; apparatus for the treatment and correction of inverted nipples; nipple protectors, breasts cooling pads, breasts heating pads; thermometers for medical use; parts for all the aforesaid goods; condoms; massage apparatus, electric or non-electric; body and breast massagers; gloves for massage, thermal massage pads; vibration generating apparatus for massage; pregnancy support belts; baby bottles; disposable feeding bottles; disposable baby bottles; parts of feeding bottles and baby bottles; breast pumps, including manual breast pumps, electric breast pumps, battery-operated breast pumps; parts for breast pumps; nipple shells; ice packs for medical purposes; parts and fittings for cups and goblets, namely drinking straw, handles, valve, drinking spouts and lids; pacifier chains, namely clips and holders for pacifiers; ear and forehead thermometers for medical purposes; instruments for the removing nasal mucus, namely external nostril dilation devices and nasal cleansing pumps; parts of the aforesaid goods; cups adapted for feeding babies and children.

11 – Apparatus for lighting, heating, steam generating, cooking, refrigerating, drying, ventilating, water supply and sanitary purposes; apparatus and instruments for sterilizing, heating, lighting, cooking, refrigerating, drying or for sanitary purposes; multi-function sterilizers (sterilizer with integrated milk and food preparer and dryer); fans, heaters and warmers for feeding bottles, foodstuffs, liquids and solids; electrical cooking apparatus for the preparation of 'congee'; kettles of both glass and stainless steel; air purifiers, humidifiers, wake up lights; guide lights and soothing lights; parts of all aforesaid goods; hot water pitchers and bottles; sterilizers; steam sterilizers; sterilizers for feeding bottles and baby bottles, including microwave steam sterilizers and electric steam sterilizers; disposable sterilization pouches; bags suitable for cooking in microwave; plastic bags for cooking in an oven; microwave sterilization pouches; parts for sterilizers; steamers for food and meal preparation; parts for all the aforesaid goods.

12 – apparatus for locomotion by air or water; baby buggies; baby carriages, pushchairs, prams; covers and hoods for baby carriages.

14 – Precious metals and their alloys and goods in precious metals or coated therewith, not included in other classes; bracelets for babies and young children; jewellery, precious stones; horological and chronometric instruments; jewellery; clocks, alarm clocks, watches, sleep trainers [watches]; parts for all the aforesaid goods.

16 – Paper, cardboard and goods made from these materials not included in other classes; printed matter; bookbinding materials; photographs; stationery; adhesives for stationery or household purposes; artists' materials; instructional and teaching material (except apparatus); plastic materials for packaging, not included in other classes; printers' type; printing blocks; printed matter, newspapers, newsletters, printed publications and magazines; disposable napkins made of paper or cellulose for infants and babies; paper wipes for the cleaning of babies and toddlers; disposable bibs made of paper; napkins of paper; ice cube bags; bibs of paper, handkerchiefs of paper.

18 – Leather and imitations of leather, and goods made of these materials and not included in other classes; trunks and travelling bags; umbrellas and parasols; harnesses; baby slings; baby harnesses; bags; baby changing bags; diaper bags; baby slings and baby carriers for wearing babies and infants; parts of all the aforesaid goods.

20 – Furniture, including walking chairs for babies and young children; mirrors, picture frames; goods (not included in other classes) of wood, cork, reed, cane, wicker, horn, bone, ivory, whalebone, shell, amber, mother-of-pearl, meerschaum and substitutes for all these materials, or of plastics; locks and safety latches, not of metal; corner protectors, not of metal; doorstops, not of metal; chimney screens; bed rails, high chairs; cots for babies and young children; pillows; changing mats; support pillows for use in baby car safety seats and baby car safety seats; baby head support cushions; breast feeding pillows; parts for all the aforesaid goods; storage boxes, not of metal; stair gates for babies and children.

21 – Household or kitchen utensils and containers; combs and sponges; brushes (except paint brushes); toothbrushes, finger toothbrushes; brush-making materials; cellulose cleansing wipes; cleaning material; glassware, porcelain and earthenware not included in other classes; small domestic utensils and containers (not of precious metals or coated therewith); containers for use in the sterilization of babies' feeding bottles and closures for such containers; combs, sponges (not for surgical purposes), heat insulated containers; milk powder dispensers; heat insulated containers and carriers for baby feeding bottles; brushes; utensils and containers for kitchen and

household use; baby food containers, cups, non-spill valves for use with cups, spouts for cups; baths and potties for babies; bowls and buckets; drinking utensils; cleaning articles and materials; money boxes; closures for aforesaid domestic utensils and containers; bags and containers for household use, namely, containers for storing and preserving of breast milk; bottles of glass; cups; closures for cups; brushes for cleaning (parts of) bottles, teats, containers; thermal and isothermic bags to keep bottles and cups warm or cool, including insulated pockets; portable baths for babies; plates and divider plates; travel feeding set with suction mat to prevent spills; drinking straws for drinking; blenders, non-electric, for household purposes; insulated flasks; bottle drying rack; bottle openers; sleeves for protecting cups, bottles and containers; parts for all the aforesaid goods.

24 – Textiles and textile goods, not included in other classes; bed and table covers; bed linen; pram and cot linen; wipes [textile] other than impregnated with cosmetics; napkins made of textile; place mats not of paper; cloth; corduroy fabric; felt; towels of textile; bed linen of textile; covers [loose] for furniture; washing mitts; banners.

25 – Clothing, footwear, headgear; scarves; disposable bibs made of plastic.

39 – Transport; packaging and storage of goods; travel arrangement; delivery [distribution] of goods intended for mothers, babies and young children; delivery [distribution] of gift packaging and gifts; delivery [distribution] of disposable napkins and diapers; the aforesaid services also provided via Internet.

41 – Education; providing information about the education of babies, infants, children and mothers; training; entertainment; sporting and cultural activities; educational services; educational services, tutorials and workshops; the aforesaid services also provided via Internet; the aforesaid services also related to breast-feeding and well-being of babies, infants, children and mothers.

42 – Scientific and technological services and research and design relating thereto; industrial analysis and research services; design and development of computers and software; design and development of computer hardware and software.

44 – Medical Services; veterinary services; hygienic and beauty care for human beings or animals; providing breast-feeding information; providing of health and beauty treatments; hygienic and beauty care services; nursery; nursing home services; temporary shelter; providing information related to well-being of babies, infants, children and mothers; rental of medical equipment, namely breast pumps, parts for breast pumps, bags for carrying breast pumps.

(260) AM 2017 84186 A*

(800) 1267332

(891) 2015 05 28

(731) FRUIT SHIPPERS LIMITED

3rd Floor, Charlotte House, Charlotte Street,
P.O. Box N-10051 Nassau, Belgium

(540)

BONITA

(511)

29 – Meat, fish, poultry and game; meat extracts; preserved, dried, baked and cooked fruits and vegetables; jellies, jams, compotes; eggs, milk and milk products; fruit salads; fruit-based snack food.

30 – Cocoa and preparations having a base of cocoa, chocolate, chocolate products, confectionery, sweets; sugar; natural sweeteners; bakery products, bread, yeast, pastries; biscuits, cakes, desserts of vegetable origin and other desserts based on cereals (cereals predominating); pasta, baking-powder, flour, spices, and flavourings; puddings; edible ices, products for making edible ices; honey and honey substitutes; breakfast cereals, rice, pasta, food products based on rice, flour or cereals, also in the form of cooked dishes; fruit sauces; coffee; coffee extracts and coffee-based preparations; coffee substitutes and extracts of coffee substitutes; coffee beans; unroasted coffee; ground coffee; decaffeinated coffee; instant coffee; coffee drinks; coffee beverages; coffee mixtures; flavoured coffee; roasted coffee beans; ground coffee beans; prepared coffee and coffee-based beverages; coffee based drinks; coffee in brewed form; coffee in ground form; coffee beverages with milk; ice beverages with a coffee base; filters in the form of paper bags filled with coffee; tea, tea extracts and tea-based preparations.

31 – Fresh fruits and vegetables; live animals; seeds; foodstuffs for animals, malt; agricultural, horticultural and forestry products and grains not included in other classes and excluding natural plants and flowers.

(260) AM 2017 84424 A*

(800) 865908A

(891) 2015 09 30

(731) Schweizerische Eidgenossenschaft v.d.

armasuisse

Eidg. Departement für Verteidigung,

Bevölkerungsschutz und Sport

Kasernenstrasse 19 CH-3003 Bern,

Switzerland

(540)

SWISS MILITARY
HANOWA

(591) Black, white
 (511)
 14 – Clocks and other chronometric instruments as well as parts thereof, of Swiss origin.

(260) AM 2017 85460 A
 (800) 1279826
 (891) 2015 07 01
 (731) AKTSIONERNO DROUJESTVO
 "BULGARTABAC-HOLDING"
 Graf Ignatiev Str. 62, BG-1000 SOFIA,
 Bulgaria

(540)



(591) black and white
 (511)
 34 – Tobacco; smokers' articles; matches; cigarettes; cigars; cigarillos; lighters for smokers; tobacco, raw or manufactured; tobacco products; cigarette filters; cigarette paper; ashtrays for smokers.

(260) AM 2017 86024 A
 (800) 1285343
 (891) 2015 07 10
 (731) PLZEŇSKÝ PRAZDROJ, A.S.
 U Prazdroje 7, CZ-304 97 Plzeň, Czech
 Republic

(540)



(591) Green, white, red, gold and black
 (511)
 32 – Beer; non-alcoholic beverages.
 35 – Advertising activities, advertising.

(260) AM 2017 86178 A
 (800) 1286891
 (891) 2015 10 08
 (731) BAYADERA MANAGEMENT LIMITED
 Karpenisiou, 30, P.C. CY-1660 Nicosia,
 Cyprus

(540)



(591) Black, white
 (554) Three-dimensional
 (511)
 33 – Alcoholic beverages [except beer]; alcoholic beverages [except beer] containing vodka; alcoholic beverages [except beer] on the basis of vodka; aperitifs; arak (arrak); brandy; baijiu [chinese distilled alcoholic beverage]; wines; flavored wines; white wines; table grape wines; dessert wines; sparkling wines; zestful wines; liqueur wines; strong wines; muscat wines; semi-sweet wines; semi-dry wines; foaming wines, including carbonated wines; fruit wines; rose wines; table wines; dry wines; red wines; whisky; vermouths; anisette; anise [liqueur]; hydromel [mead]; kirsch; perry; gin; cocktails; cocktails containing vodka; curacao; liqueurs; peppermint liqueurs; distilled beverages; pre-mixed alcoholic beverages, other than beer-based; alcoholic beverages containing fruit; bitters; nira [sugarcane-based alcoholic beverage]; piquette; rice alcohol; rum; sake; cider; spirits [beverages]; alcoholic extracts; alcoholic essences; digesters [liqueurs and spirits]; fruit extracts, alcoholic; low-alcohol beverages, except beers, containing not more than 1.2% by volume of alcohol.

(260) AM 2017 86449 A
 (800) 1289234
 (891) 2015 11 30
 (731) KATUSHA IP AG
 c/o MOORE STEPHENS ZUG AG,
 Alpenstrasse 15, CH-6300 Zug, Switzerland
 (540)

KATЮША

(591) black and white
 (511)
 9 – Electronic agendas; decorative magnets; downloadable computer software applications; videotapes; directional compasses; magnetic identification bracelets; digital photo frames; protective helmets for sports; video cassettes; footwear for protection against accidents; clothing for protection against acci-

dents or injury for cyclists; USB flash drives; cell phone straps; sound recording disks; compact disks [audio-video]; telephone receivers; time recording apparatus; distance recording apparatus; kilometer recorders for vehicles; spectacle cases; downloadable music files; downloadable image files; frequency meters; gloves for protection against accidents; covers for laptop computers; speed indicators; temperature indicators; slope indicators; binoculars; game software; software [recorded programs]; optical goods; spectacles [optics]; sunglasses; anti-glare glasses; goggles for sports; spectacle frames; hands-free kits for telephones; notebook computers; computer programs [downloadable software]; bells [warning apparatus]; mouse pads; computer peripheral devices.

12 – Vehicles; apparatus for locomotion by land, air or water; anti-theft devices for vehicles; tyres for bicycles, cycles; tires for cycles; bicycles, cycles; tubeless tires for cycles; frames for cycles; chains for bicycles, cycles; inner tubes for cycles; gears for cycles; bicycle brakes; handle bars for bicycles, cycles; saddle covers for cycles; direction indicators for cycles; bicycle rims; cranks for cycles; cycle hubs; special baskets for cycles and bicycles; pedals for cycles; bicycle pumps; bicycle spokes; adhesive rubber patches for repairing inner tubes; wheels for cycles and bicycles; saddlebags adapted for cycles; cycle saddles; bicycle bells; spoke clips for wheels; tricycles; delivery tricycles; repair outfits for inner tubes.

21 – Works of art of porcelain, ceramic, earthenware or glass; figurines [statuettes] of porcelain, ceramic, earthenware or glass; statuettes of porcelain, ceramic, earthenware or glass; insulating flasks; refrigerating bottles; bottles; fitted picnic baskets, including dishes; isothermal bags; tableware; toilet utensils.

25 – Clothing, footwear, headgear; thermal protection clothing; caps (bonnets); barrettes [headgear]; caps; headwear; cap peaks; headbands [clothing]; stockings; boxer shorts; belts [clothing]; money belts [clothing]; socks; tights; combinations [clothing]; ear muffs [clothing]; sports tank tops; underclothing; underwear; sock suspenders; ankle garters; gloves [clothing]; cyclists' clothing; sports singlets; cuffs [clothing]; mittens; mittens; waterproof clothing; non-slipping devices for footwear; footwear for sports.

28 – Games, toys; gymnastic and sporting articles not included in other classes; decorations for Christmas trees; stationary exercise bicycles; rollers for stationary exercise bicycles; snow globes; figurines [toys]; scale model vehicles; scale model kits [toys]; body protectors for sports; shin guards for sports.

41 – Education; training; entertainment; sporting and cultural activities; publication of books; electronic publication of books and periodicals on-line; pro-

vision of non-downloadable online electronic publications; ticket agency services [entertainment]; organization of competitions [education or entertainment]; holiday camp services [entertainment]; entertainment information; game services provided online from a computer network; provision of non-downloadable music online; provision of non-downloadable videos online; providing museum facilities [presentation, exhibitions]; organization of exhibitions for cultural or educational purposes; sports camp services; organization of sports competitions; practical training [demonstration]; organization and conducting of training workshops.

(260) AM 2017 86474 A

(800) 1290746

(891) 2015 11 16

(731) KAYALAR TEKSTİL KOFEKSİYON
İTHALAT İHRACAT SANAYİ VE
TİCARET LIMITED SİRKETİ
Ceyhan Yolu Üzeri 6.KM.,
İNCİRLİK/ADANA, Turkey

(540)



(591) Black, white

(511)

25 – Clothing, including underwear and outer clothing, other than special purpose protective clothing; socks, mufflers [clothing], shawls, bandanas, scarves, belts [clothing]; footwear, shoes, slippers, sandals; headgear, hats, caps with visors, berets, caps [headwear], skull caps.

35 – Advertising, marketing and public relations; organization of exhibitions and trade fairs for commercial or advertising purposes; office functions; secretarial services; arranging newspaper subscriptions for others; compilation of statistics; rental of office machines; systemization of information into computer databases; telephone answering for unavailable subscribers; business management, business administration and business consultancy; accounting; commercial consultancy services; personnel recruitment, personnel placement, employment agencies, import-export agencies; temporary personnel placement services; auctioneering; the bringing together, for the benefit of others, clothing, including under-

wear and outerclothing, other than special purpose protective clothing; socks, mufflers [clothing], shawls, bandanas, scarves, belts [clothing], footwear, shoes, slippers, sandals headgear, hats, caps with visors, berets, caps [headwear], skull caps, enabling customers to conveniently view and purchase those goods, such services may be provided by retail stores, wholesale outlets, by means of electronic media or through mail order catalogues.

(260) AM 2017 86475 A

(800) 1290761

(891) 2015 11 18

(731) Limited Liability Company

"ELFA LABORATORY"

vul. Simi Sosninykh, 9, Kyiv 03148, Ukraine

(540)

LadyCaramel

(591) Black, white

(511)

3 – Breath freshening sprays; amber [perfume]; anti-static preparations for household purposes; balms other than for medical purposes; beard dyes; hair dyes; colorants for toilet purposes; bergamot oil; joss sticks; lip glosses; nail varnish; badian essence; petroleum jelly for cosmetic purposes; cotton wool for cosmetic purposes; cotton sticks for cosmetic purposes; decorative transfers for cosmetic purposes; mustache wax; astringents for cosmetic purposes; gaultheria oil; dental bleaching gels; heliotropine; geraniol; make-up; lipsticks; disinfectant soap; deodorants for human beings or for animals; deodorant soap; depilatory preparations; depilatory wax; scented water; scented wood; ethereal essences; essential oils; essential oils of cedarwood; Javelle water; jasmine oil; greases for cosmetic purposes; aromatics [essential oils]; lacquer-removing preparations; ionone [perfumery]; extracts of flowers [perfumes]; adhesives for affixing false hair; adhesives for affixing false eyelashes; adhesives for cosmetic purposes; hair conditioners; cosmetics; eyebrow cosmetics; cosmetic preparations for eyelashes; cosmetics for animals; make-up powder; beauty masks; cosmetic kits; hair straightening preparations; cosmetic preparations for skin care; sun-tanning preparations [cosmetics]; cosmetic preparations for slimming purposes; cosmetic preparations for baths; cosmetic creams; cakes of toilet soap; lavender water; lavender oil; incense; hair spray; essential oils of lemon; medicated soap; hair lotions; lotions for cosmetic purposes; after-shave lotions; massage gels other than for medical purposes; almond oil; almond soap; almond milk for cosmetic purposes; soap; shaving soap; soap for foot perspiration; musk [perfumery]; mint for perfumery; mint essence [essential oil]; nail art stickers; neutralizers for permanent waving; fu-

migation preparations [perfumes]; eau de Cologne; eyebrow pencils; cosmetic pencils; oils for perfumes and scents; oils for cosmetic purposes; oils for toilet purposes; bases for flower perfumes; cleansing milk for toilet purposes; perfumery; perfumes; hydrogen peroxide for cosmetic purposes; pomades for cosmetic purposes; air fragrancing preparations; shaving preparations; make-up preparations; nail care preparations; make-up removing preparations; hair waving preparations; bath preparations, not for medical purposes; aloe vera preparations for cosmetic purposes; antiperspirants [toiletries]; antiperspirant soap; toiletries; saffrol; sachets for perfuming linen; tissues impregnated with cosmetic lotions; tissues impregnated with make-up removing preparations; breath freshening strips; bath salts, not for medical purposes; sunscreen preparations; douching preparations for personal sanitary or deodorant purposes [toiletries]; potpourris [fragrances]; dry shampoos; talcum powder, for toilet use; terpenes [essential oils]; rose oil; toilet water; mascara; cosmetic dyes; lipstick cases; henna [cosmetic dye]; essential oils of citron; shampoos; shampoos for pets; false eyelashes; false nails.

(260) AM 2017 86476 A

(800) 1290778

(891) 2015 12 14

(731) FRIESLANDCAMPINA NEDERLAND B.V.

Stationsplein 4, NL-3818 LE Amersfoort,

Netherlands

(540)



(591) Black, white

(511)

5 – Pharmaceutical and veterinary preparations; dietetic and fortifying substances for medical use; food for babies; food supplements, not included in other classes; vitamin preparations; foods and beverages for dietetic use, adapted for medical use, with or without the addition of vitamins, minerals and proteins and/or carbohydrates, whether or not intended for sportsmen; foods, dietary supplements and fortifying substances to animals for veterinary use; nutritional supplements, namely prebiotics and probiotics; calcium preparations (dietary or nutritional supplements).

29 – Meat, fish, poultry and game; meat extracts; meal substitutes included in this class; soups; potato products included in this class; preserved, dried and

cooked fruits and vegetables; jellies, jams; eggs; dairy products; dairy-based beverages, the dairy component predominating; dairy products for dietetic purposes (not for medical purposes); preserved dairy products; spreads included in this class; milk and milk products, including skimmed and low-calorie milk and milk products and substitutes therefor, included in this class; milk powder, whether or not sweetened evaporated (condensed) milk; milkshakes; fermented dairy products; buttermilk; yoghurt and yoghurt products; cottage cheese, quark; cheese and cheese products; cream, whipped cream, sour cream, crème fraîche, coffee milk and cream and substitutes therefor, including creamers; dairy-based desserts and mousses included in this class; aforementioned dairy products both natural and with added fruit, juices, flavourings, nuts, seeds, tea, herbs, spices, mustard, coffee, cocoa, honey, vitamins, minerals and other additives; edible oils and fats and mixtures thereof, with or without a reduced fat and/or reduced caloric value; butter, butter oil (ghee butter); ready-made meals, semi-prepared meals, breakfast drinks, sweet and savoury snacks included in this class; all the aforesaid goods for human consumption.

30 – Chocolate and coffee beverages, including low-calorie chocolate beverages containing milk and coffee beverages, and preparations for making these, not included in other classes; products (mainly) made from honey (not included in other classes); beverages containing tea, chocolate, cocoa or coffee and also containing honey and preparations for making these, not included in other classes; flour and preparations made from cereals and goods made therefrom, including meal bars; porridge containing milk or milk products; spreads, not included in other classes; pudding, Bavarian cream, mousses included in this class, with or without the addition of fruits, juices, nuts or other additives or flavourings, milk predominating; bakery goods, not included in other classes; glucose syrup and powder for food; ice cream; sauces; powders for ice cream; binding agents for ice cream; ice cream mix in liquid and powder form for making ice-cream; seasonings in powder form for the preparation of meals, ready-made meals, semi-prepared meals, included in this class; custard.

(260) AM 2017 86480 A
(800) 1290029
(891) 2016 01 22
(731) SOREMARTEC SA
Findel Business Center, Complexe B,
Rue de Treves, L-2632 Findel,
Luxembourg

(540)

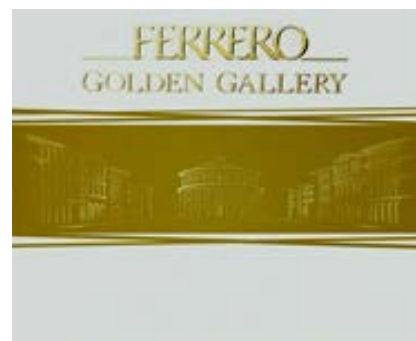

(591) Gold and white

(511)

30 – Pastry and confectionery, chocolate and chocolate-based products, cocoa and cocoa-based products, filled wafers, wafers coated with chocolate, pralines, sweets, edible ices.

(260) AM 2017 86485 A

(800) 1290132

(891) 2016 02 04

(731) ISISPHARMA FRANCE

29 Avenue de la Marne, Parc des 3 Chênes,
F-59290 WASQUEHAL, France

(540)

RUBORIL

(511)

3 – Perfumery, essential oils, cosmetics, hair lotions.

5 – Pharmaceutical and veterinary products.

(260) AM 2017 86489 A

(800) 1290279

(891) 2015 11 24

(731) Publichne aktsionerne tovarystvo

"KHARKIVSKA BISKVITNA FABRYKA"
vul. Lozivska, 8, Kharkiv 61017, Ukraine

(540)

ЯНТАРНИЙ

(591) black and white

(511)

30 – Pastries; confectionery; biscuits.

(260) AM 2017 86493 A

(800) 1290349

(891) 2015 03 30

(731) DUN & BRADSTREET INTERNATIONAL,

LTD.
103 JFK Parkway, Short Hills, NJ 07078,
USA

(540)

D&B FATCA CLASSIFIER

(511)

35 – Providing data for categorizing business entities for tax purposes, provided through an on-line computer database; preparation of business reports for categorizing business entities for tax purposes, provided through an on-line computer database.

(260) AM 2017 86501 A

(800) 1290493

(891) 2016 01 08

(731) CLOSURELOGIC GMBH

Mainzer Straße 185, 67547 Worms, Germany

(540)

AQUA STAR

(511)

6 – Sealing caps, bottle closures and individual parts thereof of metal, in particular for vessels of metal, glass, plastic, porcelain, ceramic and wood.

(260) AM 2017 86502 A

(800) 1290550

(891) 2015 12 04

(731) LABO COSPROPHAR AG

St. Jakobs Strasse 17, CH-4052 Basel, Switzerland

(540)

LABO TRANSDERMIC

(511)

3 – Cleaning and polishing preparations; soaps; perfumery, essential oils, cosmetics, cosmetic products for skin care, hair lotions; dentifrices.

(260) AM 2017 86503 A

(800) 1290552

(891) 2015 12 04

(731) KADOOGLU YAĞ SANAYİ VE TİCARET NONİM ŞİRKETİ

4. Organize Sanayi Bölgesi, Nolu Cadde No:11, TR-83422 Şehitkamil Gaziantep, Turkey

(540)



(591) dark blue, green

(511)

29 – Meat, fish, poultry and game; processed meat products; dried pulses; soups, bouillon; processed olives, olive paste; milk and milk products, butter; edible oils; dried, preserved, frozen, cooked, smoked or salted fruits and vegetables; tomato paste; prepared nuts and dried fruits as snacks; hazelnut spreads and peanut butter; tahini (sesame seed paste); eggs and powdered eggs; potato chips.

30 – Coffee, cocoa; coffee or cocoa based beverages, chocolate based beverages; pasta, stuffed dumplings, noodles; pastries and bakery products based on flour; desserts based on flour and chocolate; bread, simit [Turkish ring-shaped bagel covered with sesame seeds], pogaca [Turkish bagel], pita, sandwiches, katmer [Turkish pastry], pies, cakes, baklava [Turkish dessert based on dough coated with syrup], kadayif [Turkish dessert based on dough]; desserts based on dough coated with syrup; puddings, custard, kazandibi [Turkish pudding], rice pudding, keskul [Turkish pudding]; honey, bee glue for human consumption, propolis for food purposes; condiments for foodstuff, vanilla (flavoring), spices, sauces (condiments), tomato sauce; yeast, baking powder; flour, semolina, starch for food; sugar, cube sugar, powdered sugar; tea, ice tea; confectionery, chocolate, biscuits, crackers, wafers; chewing gums; ice-cream, edible ices; salt; cereal-based snack food, popcorn, crushed oats, corn chips, breakfast cereals, processed wheat for human consumption, crushed barley for human consumption, processed oats for human consumption, processed rye for human consumption, rice; molasses for food.

(260) AM 2017 86505 A

(800) 1290558

(891) 2015 11 18

(731) TUGİ ÇOCUK GİYİM VE TEKSTİL SANAYİ VE TİCARET LİMİTED ŞİRKETİ

Meşrutiyet Caddesi Şair, Nigar Sokak No:23/25, ŞİŞLİİSTANBUL, Turkey

(540)



(591) red, pink and black

(511)

25 – Clothing, footwear, headgear.

(260) AM 2017 86507 A

(800) 1290807

(891) 2015 12 30

(731) GILBARCO INC.

7300 West Friendly Avenue, Greensboro
NC 27410, USA

(540)



(591) Red, green, blue

(511)

6 – Swivels, adapters, breakaway couplings, and vapor/liquid splitter intake manifolds all made primarily of metal and all to be attached to fuel supply hoses for fuel dispensing systems.

7 – Fuel dispensers, and parts therefor, for service stations and fueling stations; vacuum assist vapor recovery system for fuel dispensers comprised of a vapor pump, fuel dispensing nozzle, fuel dispenser hose, and an electronic controller to recover vapors that are emitted from a vehicle's gas tank during fueling; submersible pumps; pumps for pumping vehicle fuel from fuel storage tanks; intake screens for submersible pumps for blocking particles in fuel storage tanks from entering the pumps; vapor vacuum pumps for use in vapor recovery systems for fuel dispensing sites; non-automatic fueling nozzles; vacuum breakers, namely, pressure relief valves used with fuel dispensing systems; automatic fuel dispensing nozzles; automatic fueling nozzles; electronic proportioning valves for vapor recovery from fuel dispensers.

9 – Flow meters for use with fuel dispensers; point-of-sale terminals; point-of-sale systems for service stations and convenience stores consisting of computer hardware, printers, display screens and computer software for controlling and monitoring fuel dispensing systems, payment authorization terminals, electronic cash registers, underground fuel storage containers, car wash machinery, video security systems, lottery terminals, and electronic safes; computer software for convenience store point-of-sale systems for monitoring transactions, providing predictive analytics, and promoting to customers the sale of convenience store products and services; radio-frequency identification (RFID) readers; electronic personal identification number (PIN) pads; electronic payment terminals for fuel dispensers; electronic card readers; bar code readers; electronic apparatus, namely, cash acceptors for making payments at fuel dispensers; contactless electronic payment terminals; media server with software for use with fuel dispensers, which enables fueling stations

to advertise and merchandise products and services, and enables customers to order products and services and access the internet from fuel dispensers; computer software for selling lottery tickets and lottery games at fuel dispensers; electronic display screens for fuel dispensers; printers for fuel dispensers; software for fuel retailers and fuel servicing organizations for controlling, programming, and interacting with fuel dispensers; software for fuel retailers for allowing fuel dispenser payments to be made via mobile devices and tablet computers; software for fuel retailers for managing advertising on fuel dispensers; software for fuel retailers for managing loyalty programs via fuel dispensers; software for fuel retailers for managing lottery or gaming services via fuel dispensers; software for fuel retailers for managing portable payment terminals used to control fuel dispensers; computer software; self-service electronic food ordering systems consisting primarily of electronic display screens, printers, and interactive kiosks for ordering food; electronic control apparatus for controlling and authorizing the operation of fuel dispensers, and for fuel management analysis and reporting; vehicle identification systems for authorizing and tracking vehicle refueling; computer software for vehicle fueling station operators, for fuel inventory management, for creating fuel data reports, for authorizing fueling transactions, for monitoring fuel status alarms, and for scheduling vehicle maintenance; automatic tank gauges; electronic control apparatus for submersible pumps; computer software for use with submersible pumps for optimizing pump fuel flow; sensors for fuel line leak detection; leak detectors for fuel lines; liquid level sensors; measuring probes for measuring inventory levels in fuel storage tanks; measuring probes for measuring fuel density in fuel storage tanks; float assembly for use with fuel storage tank electronic probes, for detection of water and ethanol phase separation in gasoline storage tanks; sensors for measuring water and/or fuel in fuel dispenser pans and containment sumps; sensors for detecting leaks in fuel dispenser pans and containment pans; sensors for detecting leaks in fuel storage tanks; sensors for detecting hydrocarbons in the water table; sensors for detecting hydrocarbon vapors in dry monitoring wells; electronic devices for wirelessly transmitting data from automatic tank gauges using radio frequency technology; vapor flow sensors; vapor pressure sensors; electronic vapor recovery controllers; vapor flow meters; computer software for fuel vapor recovery monitoring; computer software for use in connection with automatic tank gauges that are connected to fuel storage tanks at vehicle fueling stations, such software for the provision of fuel inventory data, leak detection and diagnostic information, and for providing web-based access to all of the foregoing functions; electronic meter register displays; computer software for monitoring, reporting,

transmitting, and organizing meter register data; interconnect boxes for electronic meter register systems, namely, an electronic device consisting primarily of a circuit board, operational software, and wire connectors for power and data; meter registers for use with fluid flow meters; gasoline pump computers; electric pulse transmitters.

42 – Providing online, non-downloadable software for fuel retailers and fuel servicing organizations for controlling, programming, and interacting with fuel dispensers; providing online, non-downloadable software for managing and processing payments made via fuel dispensers; providing online, non-downloadable software for mobile device users for interacting remotely with fuel dispensers; providing online, non-downloadable software for transmitting advertising to and managing advertising on fuel dispensers; providing online, non-downloadable software for lottery and gaming organizations for dispatching, displaying and managing tickets and games via fuel dispensers; providing online, non-downloadable software for managing loyalty programs on fuel dispensers; providing online, non-downloadable software; testing of fuel dispensing equipment, fueling station equipment, and fuel management equipment; monitoring fuel storage tanks and fuel lines to ensure proper functioning, and reporting performance.

(260) AM 2017 86508 A

(800) 1290564

(891) 2016 01 29

(731) FERRING B.V.

Polarisavenue 144, NL-2132 JX Hoofddorp,
Netherlands

(540)

RECOVELLE

(511)

5 – Pharmaceutical preparations and substances in the therapeutic area of fertility and/or reproductive health.

10 – Surgical and medical instruments, apparatus and devices in the therapeutic area of fertility and/or reproductive health.

(260) AM 2017 86510 A

(800) 1290623

(891) 2016 01 21

(731) SEHAT INDUSTRIAL AND
COMMERCIAL CO.

No.9, Zadmehr Alley, 14th Ave, Khajeh
Abdollah Ansari Street, TEHRAN, Iran
(Islamic Republic of)

(540)

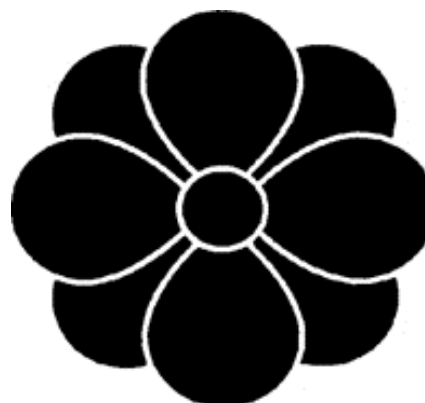

(591) black and white

(511)

3 – Bleaching preparations and other substances for laundry use; cleaning, polishing, scouring and abrasive preparations; soaps; perfumery, essential oils, cosmetics, hair lotions; dentifrices.

5 – Pharmaceutical and veterinary preparations; sanitary preparations for medical purposes; food for babies; plasters, materials for dressings; material for stopping teeth, dental wax; disinfectants; preparations for destroying vermin, weeds, fungicides, herbicides.

35 – Advertising; export, retail, wholesale services of bleaching preparations and other substances for laundry use, cleaning, polishing, scouring and abrasive preparations, soaps, perfumery, essential oils, cosmetics, hair lotions, dentifrices, pharmaceutical and veterinary preparations, sanitary preparations for medical purposes, food for babies, plasters, materials for dressings, material for stopping teeth, dental wax, disinfectants, preparations for destroying vermin, weeds, fungicides, herbicides.

39 – Transport; packaging and distribution (delivery) of bleaching preparations and other substances for laundry use, cleaning, polishing, scouring and abrasive preparations, soaps, perfumery, essential oils, cosmetics, hair lotions, dentifrices, pharmaceutical and veterinary preparations, sanitary preparations for medical purposes, food for babies, plasters, materials for dressings, material for stopping teeth, dental wax, disinfectants, preparations for destroying vermin, weeds, fungicides, herbicides.

(260) AM 2017 86511 A

(800) 1290822

(891) 2015 12 23

(731) BULGARI S.P.A.

Lungotevere Marzio, 11, I-00186 ROMA
(RM), Italy

(540)

BVLGARI

(511)

9 – Apparatus and instruments for the recording, transmission, processing, storage and exchange of data, sound or images; computer software; computer software applications, downloadable; computer software for application and database integration; computer chipsets for use in transmitting data to and from a central processing unit; programs for encrypting and decrypting computer data; circuits for encrypting and decrypting computer data; computer communication interfaces; communication interface cards; communication interface modules; integrated circuits; integrated circuit chips; micro-circuits; printed circuits; electronic labels; chip cards; memory cards; electronic payment cards and readers for electronic labels; access control cards; apparatus and instruments for controlling access and the identification and authentication of people and goods; remote control apparatus; chip card readers; electronic and online manuals; encoded electronic chips; data storage devices; antennas; antennas for wireless communications apparatus; application software; application software for mobile phones; application software for wireless devices; application software for cloud computing services; encoded identification bracelets; electronic components; programs for computers; microprocessors; electronically encoded identity bracelets.

35 – Retail, wholesale, mail order, on-line sale of apparatus and instruments for the recording, transmission, processing, storage and exchange of data, sound or images; retail services in relation to bags; retail services in relation to jewelry; retail services in relation to toiletries; retail services in relation to clothing and accessories; retail services in relation to luggage; retail services in relation to computer software; retail services in relation to works of art; retail services in relation to beauty implements for humans; retail services in relation to chocolate; on-line advertising on computer communication networks; on-line retail store services featuring jewelry, cosmetic and beauty products, clothing and accessories; on-line data processing services; computerized on-line ordering services; provision of on-line business and commercial information; data processing management; data processing services; business promotion administration of the business affairs of retail stores; advertising; advertising through all public communication means; presentation of goods on communications media, for retail purposes; computerised point-of-sale data collection services for retailers.

38 – Telecommunications and communications services; communications services via computer networks; providing telecommunications networks; data transmission; providing access to databases; transmission of information contained within databases; streaming of audio, visual and audiovisual material

via a global computer network; information services, assistance, consultancy and advice in the field of telecommunications; interactive telecommunication services.

42 – Engineering services; design, development and maintenance of computer programs and applications; design of programs for computers and microprocessors; computer programming services for electronic data security; design, development and updating of computer software and programs; data security services; computer services concerning electronic data storage; design services relating to data processing tools; programming of software for importing and managing data; computer programming for data processing and communication systems; design and development of electronic data security systems; design of software for multimedia data storing and recalling; encryption, decryption and authentication of information, messages and data; design and development of systems for data input, output, processing, display and storage; providing use of a non-downloadable computer interface in order to provide information concerning a wide range of text, electronic documents, databases, graphics and audiovisual information; application services provider (asp), namely, hosting computer software applications of others; providing temporary use of non-downloadable software.

(260) AM 2017 86520 A

(800) 1290978

(891) 2015 11 30

(731) KATUSHA IP AG

c/o MOORE STEPHENS ZUG AG,

Alpenstrasse 15, CH-6300 Zug, Switzerland

(540)

KATUSHA

(511)

9 – Electronic agendas; decorative magnets; downloadable computer software applications; videotapes; directional compasses; magnetic identification bracelets; digital photo frames; protective helmets for sports; video cassettes; footwear for protection against accidents; clothing for protection against accidents or injury for cyclists; USB flash drives; cell phone straps; sound recording disks; compact disks [audio-video]; telephone receivers; time recording apparatus; distance recording apparatus; kilometer recorders for vehicles; spectacle cases; downloadable music files; downloadable image files; frequency meters; gloves for protection against accidents; covers for laptop computers; speed indicators; temperature indicators; slope indicators; binoculars; game software; software [recorded programs]; optical goods; spectacles [optics]; sunglasses; anti-glare glasses; goggles for sports; spectacle frames; hands-free kits for telephones; notebook computers; com-

puter programs [downloadable software]; bells [warning apparatus]; mouse pads; computer peripheral devices.

12 – Vehicles; apparatus for locomotion by land, air or water; anti-theft devices for vehicles; tyres for bicycles, cycles; tires for cycles; bicycles, cycles; tubeless tires for cycles; frames for cycles; chains for bicycles, cycles; inner tubes for cycles; gears for cycles; bicycle brakes; handle bars for bicycles, cycles; saddle covers for cycles; direction indicators for cycles; bicycle rims; cranks for cycles; cycle hubs; special baskets for cycles and bicycles; pedals for cycles; bicycle pumps; bicycle spokes; adhesive rubber patches for repairing inner tubes; wheels for cycles and bicycles; saddlebags adapted for cycles; cycle saddles; bicycle bells; spoke clips for wheels; tricycles; delivery tricycles; repair outfits for inner tubes.

21 – Works of art of porcelain, ceramic, earthenware or glass; figurines [statuettes] of porcelain, ceramic, earthenware or glass; statuettes of porcelain, ceramic, earthenware or glass; insulating flasks; refrigerating bottles; bottles; fitted picnic baskets, including dishes; isothermal bags; tableware; toilet utensils.

25 – Clothing, footwear, headgear; thermal protection clothing; caps (bonnets); barrettes [headgear]; caps; headwear; cap peaks; headbands [clothing]; stockings; boxer shorts; belts [clothing]; money belts [clothing]; socks; tights; combinations [clothing]; ear muffs [clothing]; sports tank tops; underclothing; underwear; sock suspenders; ankle garters; gloves [clothing]; cyclists' clothing; sports singlets; cuffs [clothing]; mittens; mittens; waterproof clothing; non-slipping devices for footwear; footwear for sports.

28 – Games, toys; gymnastic and sporting articles not included in other classes; decorations for Christmas trees; stationary exercise bicycles; rollers for stationary exercise bicycles; snow globes; figurines [toys]; scale model vehicles; scale model kits [toys]; body protectors for sports; shin guards for sports.

41 – Education; training; entertainment; sporting and cultural activities; publication of books; electronic publication of books and periodicals on-line; provision of non-downloadable online electronic publications; ticket agency services [entertainment]; organization of competitions [education or entertainment]; holiday camp services [entertainment]; entertainment information; game services provided on-line from a computer network; provision of non-downloadable music online; provision of non-downloadable videos online; providing museum facilities [presentation, exhibitions]; organization of exhibitions for cultural or educational purposes; sports camp services; organization of sports competitions; practical training [demonstration]; organization and conducting of training workshops.

(260) AM 2017 86522 A

(800) 1291044

(891) 2015 11 12

(731) GUCCIO GUCCI S.P.A.

Via Tornabuoni, 73/R, I-50123 FIRENZE,
Italy

(540)

GG MARMONT

(511)

18 – Leather and imitations of leather; animal skins, hides; trunks and travelling bags; umbrellas and parasols; walking sticks; whips, harness and saddle; bags; shoulder bags; handbags; Boston bags; waist packs; sling bags for carrying infants; shopping bags; duffle bags; tote bags; evening handbags; clutch bags; wallets; purses; leather credit card cases and holders; business card cases; travelling cases of leather; shoe bags for travel; briefcases; attaché cases; pouches of leather; carrying cases made of leather; school bags and satchels; suitcases; sports bags; bags and holdalls for sports clothing; key cases made of leather; backpacks; rucksacks; carry-on bags; vanity cases sold empty; shaving bags sold empty; beach bags.

(260) AM 2017 86562 A

(800) 1291913

(891) 2015 12 04

(731) SUPERSTATION, INC.

One CNN Center, Atlanta GA 30303, USA

(540)



(591) Black, white

(511)

38 – Television broadcasting services; wireless communications, namely, transmission of text, data, audio, video and graphics to wireless devices; streaming of audio and video materials via the Internet; providing streaming of audio and video material in the nature of entertainment and editorial content and information on the Internet.

41 – Entertainment services, namely, production of motion picture films, on going television programs featuring dramas, comedies, romances, documentaries, news, comedy performances and talk shows; motion picture film distribution services rendered through the medium of cable television, satellite television, broadcast television and the Internet; entertainment services, namely, providing multimedia program series via various platforms across multiple forms of transmission media.

(260) AM 2017 86567 A

(800) 1292026

(891) 2015 10 14

(731) WORLD MEDICINE İLAÇ SANAYİ VE
TİCARET ANONİM ŞİRKETİ
Evren Mah. Camiyolu Cad. No.50, Kat 1
B Zemin 4-5-6, Güneşli / Bağcılar / İstanbul,
Turkey

(540)

RECHALÖZ
РЕХАЛОЗ

(591) Black, white

(511)

5 – Medicines for human purposes, medicines for veterinary purposes, vitamin preparations, chemical preparations for medical purposes, dietetic substances adapted for medical use; dietetic foods adapted for medical purposes; baby foods, medicinal herbs, herbal beverages adapted for medical purposes, nutritional supplements, pollen dietary supplements, mineral food supplements, protein dietary supplements; dietary supplements for animals; fodder supplements for veterinary purposes; medicines for dental purposes, hygienic products for medical purposes including sanitary pads, breast-nursing pads and bu-nion pads, waddings for medical purposes, plasters for medical purposes, dressings for medical purposes, babies' napkins, preparations for destroying noxious plants, preparations for destroying noxious animals, fungicides, deodorants other than for human beings or for animals, air deodorising preparations, disinfectants for hygiene purposes, antiseptics, detergents for medical purposes.

(260) AM 2017 86570 A

(800) 1292087

(891) 2016 01 22

(731) IBSA Institut Biochimique SA
Via al Ponte 13, CH-6900 Massagno,
Switzerland

(540)

ALIXIN

3 – Bleaching preparations and other substances for laundry use; cleaning, polishing, degreasing and ab-rasive preparations; soaps; perfumery; essential oils, cosmetics, hair lotions; dentifrices.

5 – Pharmaceutical products.

10 – Surgical, medical, dental and veterinary appa-ratus and instruments; artificial limbs, eyes and teeth; orthopedic articles, suture materials.

(260) AM 2017 86572 A

(800) 1292103

(891) 2015 12 28

(731) SANOFI BIOTECHNOLOGY, Société par
actions simplifiée

54 rue La Boétie, F-75008 PARIS, France

(540)

SELPRESIO

(591) Black, white

(511)

5 – Pharmaceutical products.

(260) AM 2017 86573 A

(800) 1292110

(891) 2016 01 06

(731) L'OREAL

14 rue Royale, F-75008 PARIS, France

(540)

VICHY SLOW AGE

(511)

3 – Bath and shower gels and salts for non-medical use; toilet soaps; body deodorants; cosmetics, parti-cularly face, body and hand creams, milks, lotions, gels and powders; tanning and after-sun milks, gels and oils (cosmetics); make-up products; essential oils.

(260) AM 2017 86574 A

(800) 659080

(891) 2016 01 20

(731) IMPERA GESMBH

58, Oberhart, A-4641 Steinhaus, Austria

(540)

impera

(591) Black, white

(511)

9 – Automatic electronic games, games machines and electric video game installations; video game apparatus and their parts; remote control program-ming and/or electronic installations and apparatus for the processing, preparation and transmission of data and their peripheral devices, printers, input key-boards, display apparatus, screens, magnetic tape ap-paratus, disk and diskette stations; data memories, display apparatus, apparatus for data input and out-put and installations consisting thereof; magnetic disks and/or diskettes, floppy disks and cassettes, electronic building parts, mechanical and electro-mechanical machines for data and word processing, remote data processing apparatus, multiplex chan-nels, modulators, demodulators, file and output sta-tions and/or input and output apparatus, interface apparatus for data transmission and line adjustment devices thereof; electronic, electromechanical and

electrophysical apparatus for the optical and acoustic presentation, recording, reception and transmission of data; computers, computer installations, computer peripheral devices and their accessories not included in other classes, video game computers, computers for playing chess, microcomputers and their parts, especially keyboards, processors, adapters, adaptation apparatus, printers, screens, connection cables, carriers; computer memories, especially semiconductor memories, diskette memories, fixed magnetic disk units and cassette memories, computer programs recorded on disks, diskettes or magnetic tapes, chips, computer programs recorded on data carriers; magnetic data carriers, automatic vending machines and mechanisms for coin-operated apparatus, cash registers, calculating machines, operating devices, electronic apparatus, instruments and installations, office machines not included in other classes; apparatus for receiving and dispensing money, electronic copying machines, anti-theft and fire alarm apparatus; punching and reading apparatus for data carriers, control devices for data processing installations and data transmission devices and their peripheral devices; central processor installations and apparatus, parts and accessories not included in other classes for all the aforesaid products; programmed and non-programmed data carriers; electrical and/or electronic installations for customer records, devices for counting money, controlling input, dispensing money and giving warnings, money changing machines, master computers for control, administration and security installations in banks, all the aforesaid machines and devices being activated by magnetic cards, chip cards or tokens, calculators, sorting machines and devices for the delivery of punched cards; copying machines, digital video turntables, microprocessors, integrated circuits, hybrid integrated circuits, inverters, film hybrid integrated circuits, silicon controlled amplifiers, diodes, transistors, circuit boards and integrated circuit boards; software for all the aforesaid apparatus, instruments, machines, devices, controls or installations; video games designed for use with television receivers and their parts alone; computer cards.

28 – Non-coin-operated automatic games machines, except those designed for use with television receivers alone, electronic games, including video games, except those designed for use with television receivers alone.

36 – Leasing of computers and computer installations and their parts; rental and leasing of automatic games machines, games machines and video game, automatic game and electronic game installations, including video games; leasing of games arcades and games rooms.

41 – Entertainment; training, teaching, further training and works relating to data processing; management seminars; training and teaching relating to

the planning, development, installation, use, maintenance and repair of computers and computer programs; arranging and conducting of meetings, conferences, practical work, seminars and symposiums relating to computers, operation and rental of video game arcades and games rooms; organization and conducting of conferences for commercial purposes relating to computers.

42 – Development of computer programs, technical consultancy relating to electronic data processing; development and maintenance of software; rental and installation of computer programs; provision of computing time and storage space on computers; organization, planning and development of installations for data and word processing, computer installations, installations for the transmission of data, voice and images and installations for the collection, handling, production and presentation of data; programming of automatic games machines, games machines and video game, automatic and electronic game installations, including video games; operation of systems for the transmission of data, voice and images and reticulated or decentralized computer installations; design and development of electronic games, including video games; operation of industrial property rights relating to games arcades and games rooms.

(260) AM 2017 86580 A

(800) 1272397

(891) 2015 08 05

(731) CONTENUR, S.L.

Torneros, 3, P.I. Los Angeles, E-28906 Getafe (Madrid), Spain

(540)



(591) black, white, yellow, green, brown, blue

(511)

6 – Metal containers; metal garbage containers; metal refuse containers; metal waste containers; metal composting bins; metal waste bins for industrial purposes; metal manure compost bins.

20 – Non metal containers and bins; plastic bins; plastic compost bins; plastic bins (large) for industrial use; plastic garden furniture; non metal recycling waste paper bins for commercial use; packaging containers made of plastic; compost bins made of plastic; non metal portable containers.

21 – Garbage containers; trash cans; plastic bins; wastepaper baskets; metal waste paper bins.

28 – Games; gymnastic and sporting articles not included in other classes; apparatus for playgrounds; see saws; swings; slides; playground equipment.

37 – Provision of cleaning services; waste disposal (cleaning services); servicing, maintenance and repair of children's playgrounds; repair of playground equipment and gardens.

39 – Handling of garbage; garbage and waste removal; transportation of garbage and urban waste; transfer of garbage and waste.

40 – Waste management; destruction of garbage and waste; incineration of garbage and waste; recycling and treatment of waste; recycling of garbage, refuse and waste.

(260) AM 2017 86706 A
(800) 1292621
(891) 2016 01 20
(731) HYUNDAI MOTOR COMPANY
12, Heolleung-ro, Seocho-gu, Seoul, Republic of Korea

(540)

GC84

(591) black and white

(511)

12 – Automobiles; passenger cars; trucks; vans; parts and accessories for automobiles; shock absorbers for automobiles; brake systems for vehicles; engines for land vehicles; transmissions for land vehicles; locomotives; sports cars; wagons.

(260) AM 2017 86710 A
(800) 1292152
(891) 2015 11 13
(731) MATRIZE Handels-GmbH
Ferdinandstr. 25-27, 20095 Hamburg, Germany

(540)



(591) Black, white and red.

(511)

9 – Gloves for protection against accidents; gloves for protection against X-rays for industrial purposes; asbestos gloves for protection against accidents.

18 – Shopping bags; wheeled bags.

20 – Furniture; garden furniture; scythe handles, not of metal; broom handles, not of metal; tool handles of wood or plastic; benches [furniture]; steps [lad-

ders], not of metal; stools; trolleys [furniture]; easy chairs; ladders of wood or plastics; furniture for camping; furniture for gardening; flower-pot pedestals; containers, not of metal [storage, transport]; folding tables; folding chairs.

22 – Hammocks; tents; awnings.

25 – Gloves [clothing].

(260) AM 2017 86711 A
(800) 1292180
(891) 2015 12 15
(731) RICHTER GEDEON NYRT.
Gyömrői út 19-21, H-1103 Budapest, Hungary

(540)

EFGRATIN

(591) Black, white

(511)

5 – Pharmaceutical preparations.

(260) AM 2017 86712 A
(800) 1292194
(891) 2016 02 02
(731) CAROLINA HERRERA LTD
501 Seventh Avenue, 17th Floor, New York, New York 10018, USA

(540)

GOOD BOY

(511)

3 – Soaps; perfumery products; essential oils; cosmetics; hair lotions; dentifrices; toiletries; perfumery and fragrances; eau de Cologne; perfumes; scented preparations; mouth wash products; preparations for cleaning and care of the body; deodorants and antiperspirants; soaps and gels for personal use; bath preparations; preparations for skin care; exfoliants; talcum powders; wet wipes, cotton balls and hand wipes for sanitary, cosmetic and perfume purposes; cosmetics, toiletries and perfumery products for the care and beauty of eyelashes, eyebrows, eyes, lips and nails; lip balm (non-medicated); nail polish; adhesives for cosmetic use; cosmetic preparations for slimming; hair preparations and treatments; make-up products; make-up removing products; products for hair removal and shaving; pre-shave preparations; after-shave preparations; non-medicated beauty preparations; cosmetic tanning and self-tanning preparations; cosmetic kits; preparations for perfuming; fragrances for the home; sachets for perfuming linen; aromatic extracts; products for the care and cleaning of animals.

(260) AM 2017 86714 A
 (800) 1292217
 (891) 2016 01 21
 (731) RIGO TRADING S.A.
 6, route de Trèves, EBBC Building E,
 L-2633 Senningerberg; Luxembourg

(540)

COLOR POPS

(511)
 30 – Confectionery.

(260) AM 2017 86791 A
 (800) 1294009
 (891) 2016 02 05
 (731) SHAN DONG HONGSHENG RUBBER CO.,
 LTD
 Dongzhangzhuang Village, Dawang Town,
 Guangrao County, Dongying City, 257335
 Shandong Province, China

(540)

KAPSEN

(591) Black, white
 (511)
 12 – Vehicle tires [tyres]; inner tubes for automobile; bicycle tires [tyres]; ATV tyre; automobile tires [tyres]; vehicle solid tires [tyres]; aero tires [tyres]; casings for pneumatic tires [tyres]; inner tubes for bicycles, cycles; treads for retreading tires [tyres].

(260) AM 2017 86792 A
 (800) 1294045
 (891) 2016 02 16
 (731) Train Like A Freak Apparel LLC
 Suite 225, 5901 Broken Sound Parkway NW,
 Boca Raton FL 33487, USA

(540)

TLF

(591) Black, white
 (511)
 18 – Gym bags.
 25 – Apparel, namely, active wear including t-shirts, shorts, pants, jackets, socks, hats, beanis, gloves, long-sleeved shirts, fleece-pullovers and pull-overs, sports bras, tank tops, capris, leggings and hoodies.

(260) AM 2017 86810 A
 (800) 1293604
 (891) 2015 12 31
 (731) FG DİĞİTAL TEKNOLOJİLER
 ELECTRONİK, YAZILIM GELİŞTİRME
 BİLGİSAYAR VE DANIŞMANLIK

SANAYİ VE TİCARET LİMİTED ŞİRKETİ
 Rızapaşa Mahallesi, Karakol Sokak No:19,
 D:11 Moda, Kadıköy İSTANBUL, Turkey
 (540)



(591) Red, black and white
 (526) The trademark is protected as a whole.
 "TV" shall not be subject to independent legal protection.

(511)
 9 – Measurement apparatus and equipment including those for scientific, nautical, topographic, meteorologic, industrial and laboratory purposes, thermometers, not for medical purposes, barometers, ammeters, voltmeters, hygrometers, testing apparatus not for medical purposes, telescopes, periscopes, directional compasses, speed indicators, laboratory apparatus, microscopes, magnifying glasses, stills, ovens and furnaces for laboratory experiments; apparatus for recording, transmission or reproduction of sound or images, cameras, photographic cameras, television apparatus, video recorders, CD and DVD players and recorders, MP3 players, computers, desktop computers, tablet computers, microphones, loudspeakers, earphones, telecommunications apparatus, apparatus for the reproduction of sound or images, computer peripheral devices, cell phones, covers for cell phones, telephone apparatus, computer printers, scanners [data processing equipment], photocopiers; magnetic and optic data carriers and computer software and programmes recorded thereto, downloadable and recordable electronic publications, encoded magnetic and optic cards; antennas, satellite antennas, amplifiers for antennas, parts of the aforementioned goods; ticket dispensers, automatic teller machines (ATM); electronic components used in the electronic parts or machines and apparatus, semiconductors, electronic circuits, integrated circuits, chips [integrated circuits], diodes, transistors [electronic], magnetic heads for electronic apparatus, electronic locks, photocells, remote control apparatus for opening and closing doors, optical sensors; counters and quantity indicators for measuring the quantity of consumption, automatic time switches; clothing for protection against accidents, irradiation and fire, safety vests and life-saving apparatus and equipment; eyeglasses, sunglasses, optical lenses and cases, containers, parts and components thereof; apparatus and instruments for conducting, transforming, accumulating or controlling electricity, electric plugs, junction boxes [electricity], electric swit-

ches, circuit breakers, fuses, lighting ballasts, battery starter cables, electrical circuit boards, electric resistances, electric sockets, transformers [electricity], electrical adapters, battery chargers, electric door bells, electric and electronic cables, batteries, electric accumulators; alarms and anti-theft alarms, other than for vehicles, electric bells; signalling apparatus and instruments, luminous or mechanical signs for traffic use; fire extinguishing apparatus, fire engines, fire hose and fire hose nozzles; radar apparatus, sonars, night vision apparatus and instruments; decorative magnets; metronomes.

38 – Radio and television broadcasting services, broadcasting of radio and television programming to communication devices; communication services; communication services by cellular telephones, communication via satellite, communication services, namely, electronic transmission of data and documents among users of computers, communication via telegraph, communication via telephone, transmission of images and messages via computer, e-mail services, fax sending services, telegraph services, telephone services, telex services, consultancy services related to communication, providing access for users to global computer network (Internet) services, rental of communication instruments and devices; news agencies, namely, transmission of news items to news reporting organizations.

41 – Education and training; arranging and conducting of conferences, congresses and seminars; sporting and cultural activities; entertainment; ticket reservation and booking services for entertainment, sporting and cultural events, including ticket reservation and booking services for theatres, cinemas, museums and concerts; publication and editing of printed matter, including magazines, books, newspapers, other than publicity texts; electronic publication services; production of movie films, radio and television programmes; news reporters services; photographic reporting services; photography; translation.

(260) AM 2017 86816 A

(800) 1293681

(891) 2016 01 28

(731) MERCK KGAA

Frankfurter Strasse 250, 64293 Darmstadt,
Germany

(540)

TIVMA

(511)

5 – Pharmaceutical preparations for human use.

(260) AM 2017 86819 A

(800) 1293732

(891) 2016 01 31

(731) APPLIED DATA FINANCE, LLC
15373 Innovation Drive, Suite 250,
San Diego CA 92128, USA

(540)



591) Black,white

(511)

36 – Financial services, namely, originating, arranging, financing and servicing of loans; financial intermediary services, namely, facilitating the channeling of funds between lenders and borrowers by connecting those with a financial surplus with those having a financial deficit.

(260) AM 2017 86917 A

(800) 1294478

(891) 2015 11 02

(731) ETKİN KOZMETİK VİTRİFİYE İMALAT
SANAYİ VE TİCARET LİMİTED ŞİRKETİ
Dikilitaş Mh. Eren Sk., Özsoy Plaza No:10
D.10 Beşiktaş/İstanbul, Turkey

(540)



(591) Black and blue.

(511)

11 – Lighting installations; lights for vehicles and interior-exterior spaces; heating and steam generating installations; stoves for heating purposes using solid, liquid or gas fuels; electric stoves for heating purposes; kitchen stoves; installations for air-conditioning and ventilating; cooling installations and freezers; electric and gas-powered devices, installations and apparatus for cooking, drying and boiling; electric laundry driers; hair driers; hand drying apparatus; sanitary installations; taps (faucets); shower installations; toilets (water-closets); shower and bathing cubicles; bath tubs; sinks; wash-hand basins (parts of sanitary installations); water softening apparatus; water purification apparatus; water purification installations; waste water purification installations; electric bed warmers and electric blankets, not for medical use; electric pillow warmers; electric or non-electric footwarmers; hot water bottles; filters for aquariums and aquarium filtration apparatus; industrial type installations for cooking, drying and cooling purposes; pasteurizers and sterilizers.

(260) AM 2017 86919 A
 (800) 1294516
 (891) 2015 12 15
 (731) KOCEL CELIK ESYA SANAYI VE
 TICARET LIMITED SIRKETI
 Mahmutbey mah., Kopru cad., No:12 Istanbul,
 Turkey

(540)

(591) zed,Black

(511)
 20 – Office cabinets of metal; lockers of metal; workbenches of metal; shelf systems of metal; galvanized shelf systems; storage cabinets of metal; industrial cabinets of metal; CNC tool cabinets of metal; cabinets of metal with drawers; cabinets of metal with sliding doors; storage bin cabinets of metal; computer cabinets with working table; cabinets of metal for storage of chemical substance; cabinets of metal.

(260) AM 2017 86961 A
 (800) 1294984
 (891) 2016 02 17
 (731) Obshchestvo s ogranichennoi
 otvetstvennostyu "INTEL"
 Varshavskoye shosse, d. 75, korp. 1,
 RU-117556 Moscow; Russian Federation

(540)

(591) Black, white

(511)
 33 – Alcoholic beverages (except beers).

(260) AM 2017 87039 A
 (800) 1295170
 (891) 2015 12 30
 (731) Tovarichtchestvo s ogranichennoy
 otvetstvennostyu "ASIA SU
 KOMPANIYASY"
 ul. Knuaeva, 130/31, Almaty (Kazakhstan),
 Kazakstan

(540)

(591) black and white

(511)
 32 – Non-alcoholic beverages.
 33 – Alcoholic beverages.

(260) AM 2017 87040 A
 (800) 1295458
 (891) 2015 11 09
 (731) NOVARESE S.r.l.
 Via Lorenzo Lotto, 1 I-62014 CORRIDONIA
 (MC), Italy

(540)

(591) Black,white

(511)
 18 – Leather; leather and imitations of leather, and goods made of these materials and not included in other classes; skins and hides; leather for shoes; valises; leather suitcases; pullman cases; small suitcases; gladstone bags; trunks [luggage]; footlockers; travelling trunks; trunks and travelling bags; haversacks; duffle bags; leather bags, suitcases and wallets; bags; leather bags; bags of leather, eco-leather, imitation leather, jewellery bags of textile material [empty], including bags, handbags, shoulder bags, overnight bags, key cases, holdalls, gentlemen's handbags, make-up bags sold empty, travelling bags, shopping bags, wheeled shopping bags, travelling sets (leatherware); chain mesh purses, not of precious metal; chain mesh purses of precious metal; purses [handbags] of precious metal; chain mesh purses, not of precious metal; wheeled bags; leather bags and wallets; handbags for ladies; reticules; evening purses [handbags]; travelling sets [leatherware]; garment bags for travel made of leather; jewelry bags of textile material [empty]; bags for sports clothing; beach bags; barrel bags; bags [envelopes, pouches] of leather, for merchandise packaging; purses; small purses [handbags]; purses [handbags], not of precious metal; small clutch purses [handbags]; felt pouches; drawstring pouches; small bags for men; gentlemen's handbags; cosmetic bags sold empty; clutch bags; travelling bags [leatherware]; leather shopping bags; multi-purpose purses [handbags]; leather purses [handbags]; shingen-bukuro [Japanese utility pouches]; flexible bags for garments; hip bags; slings for carrying infants; rucksacks; sports packs; hiking rucksacks; small backpacks; rucksacks for mountaineers; vanity cases sold empty; garment carriers for suits, shirts and dresses; tie cases for travel; credit card cases of leather; key cases of leather or imitation leather; credit card cases and holders [leatherware]; cosmetic cases sold empty; leather cases; travelling cases of leather; key cases of leather; coin purses of precious metal; coin holders in the nature of wallets; wrist-mounted money purses; coin purses, not of precious metal; pocket wallets; wallets of precious metal; leather wallets; credit card cases [wallets]; card wallets [leatherware]; leather briefcases; folding briefcases; business card cases; hat boxes of leather; hat boxes for travel; carrying cases

for documents; pouches for holding make-up, keys and other personal items; shoe bags for travel.

25 – Clothing for men, women and children of any kind of textile or material, including skirts, trousers, shorts, jeans, shirts, blouses, jerseys, sweaters, tee-shirts, vests, suits, tracksuits, coats, overcoats, coats, bomber jackets, jackets, wind-resistant jackets, waterproof clothing, parkas, stockings, tights, socks, tights, shawls, sashes for wear, scarves, gloves, ties, underwear, nightgowns, nightshirts, pajamas (am.), baby doll pajamas, bath robes and bathing costumes; articles of clothing, footwear and headgear for babies and toddlers; footwear; footwear for men and women; infants' footwear; baby shoes; infants' shoes and boots; footwear for men, women and children of textile, leather, imitations of leather and any other material, including sandals, bath sandals, bath slippers, boots, riding boots, winter boots, rain boots, functional boots and boots for everyday wear, moccasins and slippers, slippers, boots for sports, deck shoes, esparto shoes or sandals, dance shoes, work shoes, mountaineering shoes, dress shoes, leisure footwear; riding shoes; driving shoes; ballroom dancing shoes; dance slippers; pumps [footwear]; jikatabi [Japanese split-toed work footwear]; waraji [Japanese footwear made of rice straw]; athletic footwear; athletic shoes; training shoes; tennis shoes; gymnastic shoes; sneakers; volleyball shoes; golf shoes; running shoes; rugby boots; football boots; field hockey shoes; boxing shoes; cycling shoes; handball shoes; bowling shoes; basketball sneakers; baseball shoes; anglers' shoes; wooden shoes; footwear, not for sports; footwear made of wood; shoe straps; toe caps [parts of footwear]; welts for footwear; fittings of metal for footwear; fittings of metal for shoes and boots; non-slipping devices for footwear; insoles for footwear; golf spikes; cleats for attachment to sports shoes; studs for football boots; tips for footwear; galoshes; tongues or pullstraps for shoes and boots; shoe soles; shoe soles for repair; protective metal fittings for shoes and boots; boot uppers; overshoes; hats; tuques; party hats [clothing]; rain hats; bucket caps; bobble hats; ski hats; hats for infants, babies, toddlers and children; top hats; headgear for wear; visors [headwear]; visor caps; cap peaks; berets; knot caps; nightcaps; knitted caps; caps with visors; golf caps; waistbands [parts of clothing]; leather belts [clothing]; belts made of cloth [clothing]; belts made from imitation leather; metal fittings for Japanese-style wooden clogs.

35 – Business administration consultancy; advertising; advertising services provided via the Internet; advertising on the Internet for others; help in the management of business affairs or commercial functions of an industrial or commercial enterprise; online advertising and marketing services; retail or wholesale services, including via the internet, for spectacles [optics], eyeglasses for reading, corrective

eyeglasses, eyeglasses for children, sunglasses, polarizing spectacles, goggles for sports, snow goggles, ski goggles, protective eyewear, goggles for motorcyclists, diving goggles, dust goggles, spectacle frames made of plastic, spectacle frames made of metal, spectacle frames made of a combination of metal and plastics, frames for sunglasses, eyewear cases, cases for sunglasses and protective eyewear, spectacle cases, cases for spectacles and sunglasses, cases for children's eyeglasses, spectacle holders, chains and cords for glasses chains and cords for sunglasses, straps for sunglasses, chains for sunglasses, parts and accessories for eyeglasses, spectacle lenses, lenses for sunglasses, side shields for eyeglasses; retail or wholesale services, including via the internet, for leather, leather and imitations of leather, and goods made of these materials and not included in other classes, skins and hides, leather for shoes, valises, leather suitcases, pullman cases, small suitcases, gladstone bags, trunks [luggage], footlockers, travelling trunks, trunks and travelling bags, haversacks, duffle bags, leather bags, suitcases and wallets, bags, leather bags, bags of leather, eco-leather, imitation leather, plastic or textile, including bags, handbags, shoulder bags, overnight bags, key cases, holdalls, gentlemen's handbags, make-up bags sold empty, travelling bags, shopping bags, wheeled shopping bags, travelling sets (leatherware), chain mesh purses, not of precious metal, chain mesh purses of precious metal, purses [handbags] of precious metal, wheeled bags, leather bags and wallets, handbags for ladies, reticules, evening purses [handbags], travelling sets [leatherware], garment bags for travel made of leather, jewelry bags of textile material [empty], bags for sports clothing, beach bags, barrel bags, bags [envelopes, pouches] of leather, for merchandise packaging, purses, small purses [handbags], purses [handbags], not of precious metal, small clutch purses [handbags], felt pouches, drawstring pouches, small bags for men, gentlemen's handbags, cosmetic bags sold empty, clutch bags, leather shopping bags; retail or wholesale services, including via the internet, for multi-purpose purses [handbags], leather purses [handbags], leather bags, suitcases and wallets, shingen-bukuro [Japanese utility pouches, flexible bags for garments, haversacks, haversacks for shoes, hip bags, slings for carrying infants, rucksacks, sports packs, hiking rucksacks, small backpacks, rucksacks for mountaineers, vanity cases sold empty; retail or wholesale services, including via the internet, for garment carriers for suits, shirts and dresses, tie cases for travel, credit card cases of leather, key cases of leather or imitation leather, credit card cases and holders [leatherware], cosmetic cases sold empty, leather cases, travelling cases of leather, key cases of leather, coin purses of precious metal, coin holders in the nature of wallets, wrist-mounted money purses, coin purses, not of precious metal, pocket wallets, wallets of precious metal, leather wal-

lets, credit card cases [wallets], card wallets [leatherware], leather briefcases, folding briefcases, business card cases; retail or wholesale services, including via the internet, for hat boxes of leather, hat boxes for travel, carrying cases for documents, pouches for holding make-up, keys and other personal items, shoe bags for travel; retail or wholesale services, including via the internet, for clothing for men, women and children of any kind of textile or material, including skirts, trousers, shorts, jeans, shirts, blouses, jerseys, sweaters, tee-shirts, vests, suits, tracksuits, coats, overcoats, coats, bomber jackets, jackets, wind-resistant jackets, waterproof clothing, parkas, stockings, tights, socks, tights, shawls, sashes for wear, scarves, gloves, ties, underwear, nightgowns, nightshirts, pajamas (Am.), baby doll pajamas, bath robes and bathing costumes, articles of clothing, footwear and headgear for babies and toddlers, footwear, footwear for men and women, infants' footwear, baby shoes, infants' shoes and boots; retail or wholesale services, including via the Internet, for footwear for men, women and children of textile, leather, imitations of leather and any other material, including sandals, bath sandals, bath slippers, boots, riding boots, winter boots, rain boots, functional boots and boots for everyday wear, moccasins and slippers, slippers, boots for sports, deck shoes, esparto shoes or sandals, dance shoes, work shoes, mountaineering shoes, dress shoes, leisure footwear; retail or wholesale services, including via the Internet, for riding shoes, driving shoes, ballroom dancing shoes, dance slippers, pumps [footwear], jikatabi [Japanese split-toed work footwear], waraji [Japanese footwear made of rice straw], athletic footwear, athletic shoes, training shoes, tennis shoes, gymnastic shoes, sneakers, volleyball shoes, golf shoes, running shoes, rugby boots, football boots, field hockey shoes, boxing shoes, cycling shoes, handball shoes, bowling shoes, basketball sneakers, baseball shoes, anglers' shoes, wooden shoes, footwear, not for sports, footwear made of wood; retail or wholesale services, including via the Internet, for shoe straps, toe caps [parts of footwear], welts for footwear, fittings of metal for footwear, fittings of metal for shoes and boots, non-slipping devices for footwear, insoles for footwear, golf spikes, cleats for attachment to sports shoes, studs for football boots, tips for footwear, galoshes, tongues or pullstraps for shoes and boots, shoe soles, shoe soles for repair, protective metal fittings for shoes and boots, boot uppers, overshoes; retail or wholesale services, including via the Internet, for hats, tuques, party hats [clothing], rain hats, bucket caps, bobble hats, ski hats, hats for infants, babies, toddlers and children, top hats, headgear for wear, visors [headwear], visor caps, cap peaks, berets, knot caps, nightcaps, knitted caps, caps with visors, golf caps, waistbands [parts of clothing], leather belts [clothing], belts made of cloth [clothing], belts made from imitation leather,

metal fittings for Japanese-style wooden clogs; electronic commerce services, namely, providing information about products via telecommunication networks for advertising and sales purposes; marketing services provided via the Internet; auctioneering provided on the Internet; business administration; business management advisory services relating to franchising; services rendered by a franchisor, namely, assistance in the running or management of industrial or commercial enterprises; transcription of communications [office functions].

(260) AM 2017 87042 A

(800) 1295182

(891) 2015 12 31

(731) VALERII HARIIOVYCH KLEINBERH

vul. Chervonoho Kozatstva, 27, kv.131

m. Dnipropetrovsk 49125, Ukraine;

ANDRII IVANOVYCH LISETSKYI

zh/m Komunar, 5p, kv.31 m. Dnipropetrovsk

49128, Ukraine;

SERHII HENNADIIOVYCH KHRAPACHOV

vul. Lisna 38 m. Dnipropetrovsk 49008,

Ukraine

(540)

WALLER

(591) black and white

(511)

17 – Packing, stopping and insulating materials; acrylic resins (semi-finished products); lute; gaskets; sealant compounds for joints; draught excluder strips; insulating refractory materials; insulating materials; insulating tape and band; insulating fabrics; rubber, raw or semi-worked; rubber solutions; self-adhesive tapes, other than stationery and not for medical or household purposes; caulking materials; latex (rubber); adhesive bands, other than stationery and not for medical or household purposes; weather-stripping compositions; compositions to prevent the radiation of heat; padding materials of rubber or plastics; substances for insulating buildings against moisture; liquid rubber; synthetic rubber; artificial resins (semi-finished products); non-conducting materials for retaining heat; chemical compositions for repairing leaks; cords of rubber.

35 – Administrative processing of purchase orders; presentation of goods of class 17 on communication media, for retail purpose; sales promotion for others of goods of class 17; demonstration of goods of class 17; distribution of samples; the bringing together, for the benefit of others, of a variety of goods of class 17, excluding the transport thereof, enabling customers to conveniently view and purchase those goods by means of general catalogs of the goods, in wholesale and retail outlets; procurement services for others (purchasing goods and services for other businesses).

(260) AM 2017 87062 A
 (800) 1295506
 (891) 2015 11 04
 (731) KIKU Srl-GmbH
 Via Lamm, 23/c, I-39057
 APPIANO/CORNAIANO (Bolzano), Italy
 (540)



(591) Black, white
 (511)
 31 – Fruit fresh; fruit trees; seedlings; scions for fruit tree grafting; rootstocks for fruit tree grafting.

(260) AM 2017 87064 A
 (800) 1295510
 (891) 2015 12 30
 (731) ROSNEFT OIL COMPANY
 Sofiyskaya nab., 26/1 RU-115035 Moscow,
 Russian Federation
 (540)



(591) Yellow, orange, light red, red.
 (511)
 1 – Ammonia, including anhydrous ammonia; sulfur; alcohol; chemical products, including chemicals derived from gas and petroleum processing, for use in industry; anti-knock substances for internal combustion engines; antifreeze; solidified gases for industrial purposes; chemical additives for oils; chemical additives to motor fuel; oil dispersants; petroleum dispersants; detergent additives to gasoline [petrol]; combusting preparations [chemical additives to motor fuel]; fuel-saving preparations.

4 – Industrial oils and greases; lubricants; dust absorbing, wetting and binding compositions; fuels (including motor spirit) and illuminants; fuel oil; lubricating oil; motor oil; benzene; benzol; industrial wax; wax [raw material], including paraffin wax; ozocerite [ozokerite]; oil-gas; liquefied petroleum gas (LPG); fuel gas; liquefied natural gas (LNG); gas condensate; gasoline; solidified gases [fuel]; fuel; non-chemical additives to motor fuel; cutting fluids; gas for lighting; kerosene; mazut;

lubricating grease; coal dust [fuel]; diesel fuel; aviation fuel, including aviation kerosene, tar oil; lighting fuel; motor fuel; ethanol [fuel]; petroleum, raw or refined; petroleum products and petroleum based fuel; liquid fuel, solid fuel and gaseous fuel; naphtha; paraffin; vaporized fuel mixtures; lubricating graphite; ligroin; xylol; oleine; petroleum ether; alcohol [fuel]; methylated spirit; fuel with an alcoholic base; stearine; ceresine.

19 – Asphalt; concrete; bitumen; binding material for road repair; bituminous products for building; road coating materials; materials for making and coating roads; asphalt paving.

35 – Sales promotion for others; retail and wholesale services for petroleum, gas, liquefied natural gas (LNG), gas and petroleum products, including benzene, diesel fuel, aviation fuel, industrial oils and greases, fuel oil, lubricating oil, motor oil, paraffin, wax; auctioneering; demonstration of goods.

39 – Hauling, including tanker truck transport; transport and storage of trash; ferry-boat transport; barge transport; boat transport; railway transport; marine transport; river transport; portorage; stevedoring; transport by pipeline; wrapping and storage of goods; storage of petroleum, gas and gas and petroleum products, including benzene, diesel fuel, aviation fuel.

(260) AM 2017 87109 A
 (800) 1295988
 (891) 2016 01 27
 (731) INTELEMATICS AUSTRALIA PTY LTD
 250 Swan Street, Richmond VIC 3121,
 Australia
 (540)

INTELEMATICS

(511)
 9 – Computer hardware; security hardware for use with computer software; communications equipment in this class; wireless communication apparatus; computer software; application software, communication software, traffic monitoring and reporting software, navigational software; electronic publications, including instructional manuals in electronic format for computer software (including such manuals incorporated in the software); satellite based tracking and global positioning systems; satellite based vehicle tracking devices; global positioning systems; electronic navigational hardware and devices; passive and remote immobilisers; monitors in this class including low battery voltage monitors; remote door unlock systems; electronic security devices and alarms.

38 – Transmission and reception of information by electronic means; rental of information transmitting and receiving equipment; vehicle communications

services; provision of information on a variety of topics by electronic means to and from vehicles.

39 – Traffic and transport monitoring and information services; traffic and transport information services; parking monitoring and information services; parking information services; navigation and navigation information services.

42 – Computer software and hardware design, engineering, development, advisory and consultancy services; design, engineering and development of software and hardware used for transmission or reception of information by electronic means, for vehicle communication services and for remote vehicle monitoring services, and advisory and consultancy services in relation to the foregoing.

45 – Monitoring security, location and information systems, namely remote vehicle monitoring services; vehicle security, tracking and recovery services; security and emergency information services; emergency alert services.

(260) AM 2017 87171 A
(800) 1296178
(891) 2015 11 02
(731) ETİ GIDA SANAYİ VE TİCARET ANONİM ŞİRKETİ
Organize Sanayi Bölgesi 11. Cadde,
ESKİŞEHİR, Turkey

(540)



(591) Brown, light brown, red, white, black, yellow, beige, lilac, blue and green

(511)

30 – Biscuits, chocolates, pastries, crackers, wafers, cakes, tarts; bakery desserts, desserts based on flour and chocolate, mousse desserts, ice desserts; ice creams, edible ices.

(260) AM 2017 87178 A
(800) 1296211
(891) 2016 03 18
(731) KINIKA PHARMACEUTICALS, LTD.
Clarendon House, 2 Church Street, Hamilton
HM 11, Bermuda

(540)

KINIKA

(591) black and white

(511)

5 – Pharmaceutical preparations.

(260) AM 2017 87180 A

(800) 1296221

(891) 2016 03 16

(731) TELA BIO, INC.

1 Great Valley Parkway, Suite 24, Malvern
PA 19355, USA

(540)

OVITEX

(511)

10 – Natural and biocompatible materials comprised of non-living tissue for implantation or application in a surgical site to restore, repair, or treat organ, tissue, and body structures.

(260) AM 2017 87197 A

(800) 1296740

(891) 2016 03 17

(731) ALLIANCE LAUNDRY SYSTEMS LLC

Shepard Street Ripon, WI 54971-0990, USA

(540)

QUANTUM

(511)

9 – Computer software for commercial laundry room management services.

(260) AM 2017 87198 A

(800) 1296742

(891) 2016 03 21

(731) BECTON, DICKINSON AND COMPANY

1 Becton Dr., MC 090, Franklin Lakes
NJ 07417, USA

(540)

BD FACSMelody

(511)

9 – Flow cytometers for research purposes.

(260) AM 2017 87200 A

(800) 1296510

(891) 2016 02 08

(731) GAGAGUGU s. r. o.

Dvořákovo nábřezie 4A, SK-811 02
Bratislava, Slovakia

(540)

GAGAGUGU

(511)

9 – Holograms; data processing apparatus; intercommunication apparatus; computers; recorded computer programs; automatic steering apparatus for vehicles; software (recorded programs); downloadable electronic publications; computer programs (downloadable software); game software; downloadable music files; downloadable image files; downloadable computer software applications; application software for social networking services via the Internet; application software.

35 – Business management assistance; business inquiries; dissemination of advertisements; business management and organization consultancy; consulting services relating to personnel management; business management consultancy; demonstration of goods; market study; commercial business appraisal; business investigations; business organization consultancy; advertising; business investigations; public relations; advisory services for business management; market studies; computerized file management; professional business consultancy; business information; opinion polling; rental of advertising space; sales promotion for others; compilation of information into computer databases; systematization of information in computer databases; online advertising on a computer network; data search in computer files for others; rental of advertising time on all communication media; news clipping services; presentation of goods on all communication media, for retail sale; commercial information and advice for consumers (consumer advice shop); commercial administration of the licensing of the goods and services of others; compilation of statistics; sponsorship search; information relating to commercial and business contacts; web site traffic optimization; postpaid per click advertising services; update and maintenance of data in computer databases; commercial information via websites; provision of on-line sales areas for sellers and buyers of goods and services; provision of business information in the field of social networking; provision of marketing advice in the field of social networking.

36 – Real estate brokers; insurance brokerage; insurance underwriting; organization of collections; financial evaluation (insurance, banking, real estate); financial management; real property management; housing agencies (real estate); financial consultancy; insurance consultancy; financial information; insurance information; rental of offices (real estate); debt advice; organization of financing for construction projects; financial information by means of websites.

38 – Communications via computer terminals; computer-aided transmission of messages and images; electronic messaging; information relating to telecommunications; connection by telecommunications to a global computer network; telecommunications routing and junction services; teleconferencing ser-

vices; provision of user access to global computer networks; rental of access time to global computer networks; provision of telecommunication channels for teleshopping services; provision of chat rooms on the Internet; provision of access to databases; transmission of greeting cards online; transmission of digital files; wireless broadcasting services; video teleconferencing services; provision of on-line forums; provision of online chat rooms for social networking; chat room services for social networking purposes.

41 – Academies (education); entertainment services; organization of competitions (education or entertainment); rental of sound recordings; rental of motion pictures; online publication of specialized electronic books and journals; game services provided on-line from a computer network; provision of non-downloadable online electronic publications; provision of non-downloadable music online; provision of non-downloadable videos online.

42 – Technical research; programming for computers; software development (design); updating of software; rental of computer software; recovery of computer data; maintenance of computer software; computer system analysis; design of computer systems; duplication of computer programs; creation and maintenance of web sites for others; hosting of computer sites (web sites); installation of software; conversion of computer programs and data, other than physical conversion; software consultancy; rental of web servers; provision of search engines for the Internet; website design consultancy; software as a service (SaaS); information technology (IT) consultancy; hosting of servers; electronic data storage; information relating to information technology and programming by means of websites; cloud computing.

45 – Dating services; on-line social networking services; dating services through social networking.

(260) AM 2017 87207 A

(800) 1170510

(891) 2016 02 22

(731) SAIC MOTOR CORPORATION LIMITED
Room 509, Building 1, 563 Songtao Road,
Zhangjiang High-tech Park, 201203 Shanghai,
China

(540)



(591) Black, white

(511)

7 – Pistons [parts of machines or engines]; cylinders for motors and engines; igniting devices for internal

combustion engines; bearings [parts of machines]; pumps [machines]; compressors [machines]; universal joints [cardan joints]; valves [parts of machines]; truck lifts; hand-held tools, other than hand-operated.

37 – Repair information; construction; machinery installation, maintenance and repair; electric appliance installation and repair; motor vehicle maintenance and repair; vehicle service stations [refuelling and maintenance]; vehicle breakdown assistance [repair]; rustproofing; retreading of tires [tyres]; leather care, cleaning and repair.

INTERNATIONAL TRADEMARKS PROTECTED IN GEORGIA

(260) AM 2017 73612 A
(800) 1170656
(151) 2013 06 12
(891) 2013 06 12
(181) 2023 06 12
(511) 05

(260) AM 2017 84601 A
(800) 1271738
(151) 2015 09 29
(181) 2025 09 29
(891) 2015 09 29
(511) 05

(260) AM 2017 73711 A
(800) 1171698
(151) 2013 04 18
(891) 2013 04 18
(181) 2023 04 18
(511) 01, 05

(260) AM 2017 84612 A
(800) 1087297
(151) 2011 07 28
(181) 2021 07 28
(891) 2015 10 16
(511) 03, 05

(260) AM 2017 70162 A
(800) 1139121
(151) 2012 10 31
(891) 2012 10 31
(181) 2022 10 31
(511) 12

(260) AM 2017 84614 A
(800) 1145970
(151) 2012 12 11
(181) 2022 12 11
(891) 2015 09 09
(511) 25

(260) AM 2017 80660 A
(800) 1232679
(151) 2014 10 17
(181) 2024 10 17
(891) 2014 10 17
(511) 16

(260) AM 2017 84745 A
(800) 1273047
(151) 2015 06 30
(181) 2025 06 30
(891) 2015 06 30
(511) 30

(260) AM 2017 82339 A
(800) 1155367
(151) 2012 05 16
(181) 2022 05 16
(891) 2015 04 17
(511) 19, 35

(260) AM 2017 85069 A
(800) 1275500
(151) 2015 09 29
(181) 2025 09 29
(891) 2015 09 29
(511) 30

(260) AM 2017 84585 A
(800) 1271625
(151) 2015 08 12
(181) 2025 08 12
(891) 2015 08 12
(511) 09

(260) AM 2017 85146 A
(800) 1275914
(151) 2015 09 03
(181) 2025 09 03
(891) 2015 09 03
(511) 03, 05

(260) AM 2017 84596 A
(800) 1272458
(151) 2015 06 30
(181) 2025 06 30
(891) 2015 06 30
(511) 30

(260) AM 2017 85148 A
(800) 1276276
(151) 2015 08 28
(181) 2025 08 28
(891) 2015 08 28
(511) 05

(260) AM 2017 85149 A
(800) 1275930
(151) 2015 07 31
(181) 2025 07 31
(891) 2015 07 31
(511) 03

(260) AM 2017 85152 A
(800) 1275934
(151) 2015 08 25
(181) 2025 08 25
(891) 2015 08 25
(511) 05

(260) AM 2017 85153 A
(800) 1275949
(151) 2015 09 09
(181) 2025 09 09
(891) 2015 09 09
(511) 09, 16, 35, 36, 41

(260) AM 2017 85154 A
(800) 1276289
(151) 2015 09 01
(181) 2025 09 01
(891) 2015 09 01
(511) 05

(260) AM 2017 85155 A
(800) 1275966
(151) 2015 03 13
(181) 2025 03 13
(891) 2015 03 13
(511) 06, 07, 35, 37

(260) AM 2017 85156 A
(800) 1275982
(151) 2015 09 14
(181) 2025 09 14
(891) 2015 09 14
(511) 01

(260) AM 2017 85158 A
(800) 1276012
(151) 2015 07 01
(181) 2025 07 01
(891) 2015 07 01
(511) 05, 09, 10

(260) AM 2017 85161 A
(800) 1276587
(151) 2015 09 23

(181) 2025 09 23
(891) 2015 09 23
(511) 03

(260) AM 2017 85166 A
(800) 1276071
(151) 2015 09 23
(181) 2025 09 23
(891) 2015 09 23
(511) 05, 16

(260) AM 2017 85167 A
(800) 1276086
(151) 2015 10 01
(181) 2025 10 01
(891) 2015 10 01
(511) 34

(260) AM 2017 85172 A
(800) 1276115
(151) 2015 10 29
(181) 2025 10 29
(891) 2015 10 29
(511) 34

(260) AM 2017 85174 A
(800) 1276147
(151) 2015 10 05
(181) 2025 10 05
(891) 2015 10 05
(511) 09

(260) AM 2017 85176 A
(800) 1276160
(151) 2015 09 22
(181) 2025 09 22
(891) 2015 09 22
(511) 09

(260) AM 2017 85177 A
(800) 1276164
(151) 2015 07 22
(181) 2025 07 22
(891) 2015 07 22
(511) 32

(260) AM 2017 85179 A
(800) 1276185
(151) 2014 12 12
(181) 2024 12 12
(891) 2014 12 12
(511) 01, 02, 03, 04, 06, 07, 08, 09, 10, 11, 12, 13,

16, 17, 18, 19, 20, 21, 22, 23, 24, 25, 26, 27, 28, 31	(260) AM 2017 85212 A (800) 978128 (151) 2008 08 14 (181) 2018 08 14 (891) 2015 08 18 (511) 09
(260) AM 2017 85180 A (800) 1276664 (151) 2015 03 25 (181) 2025 03 25 (891) 2015 03 25 (511) 06	(260) AM 2017 85214 A (800) 1081543 (151) 2011 05 03 (181) 2021 05 03 (891) 2015 05 29 (511) 35
(260) AM 2017 85184 A (800) 1276672 (151) 2015 04 16 (181) 2025 04 16 (891) 2015 04 16 (511) 06, 09, 11, 17, 19	(260) AM 2017 85215 A (800) 1223311 (151) 2014 09 11 (181) 2024 09 11 (891) 2015 08 21 (511) 03
(260) AM 2017 85198 A (800) 1276827 (151) 2015 10 12 (181) 2025 10 12 (891) 2015 10 12 (511) 08	(260) AM 2017 85216 A (800) 1276586 (151) 2015 09 18 (181) 2025 09 18 (891) 2015 09 18 (511) 05
(260) AM 2017 85203 A (800) 1250747 (151) 2015 02 06 (181) 2025 02 06 (891) 2015 10 01 (511) 30	(260) AM 2017 85239 A (800) 1277001 (151) 2015 04 28 (181) 2025 04 28 (891) 2015 04 28 (511) 18, 25, 28
(260) AM 2017 85206 A (800) 1264965 (151) 2015 03 09 (181) 2025 03 09 (891) 2015 10 05 (511) 30	(260) AM 2017 85244 A (800) 1277041 (151) 2015 06 11 (181) 2025 06 11 (891) 2015 06 11 (511) 14, 35
(260) AM 2017 85208 A (800) 1276519 (151) 2015 10 12 (181) 2025 10 12 (891) 2015 10 12 (511) 05	(260) AM 2017 85250 A (800) 1277905 (151) 2015 09 22 (181) 2025 09 22 (891) 2015 09 22 (511) 30
(260) AM 2017 85210 A (800) 951417 (151) 2007 12 11 (181) 2027 12 11 (891) 2015 11 13 (511) 30, 43	(260) AM 2017 85251 A (800) 1277119 (151) 2015 08 31

(181) 2025 08 31
(891) 2015 08 31
(511) 41, 44

(260) AM 2017 85257 A
(800) 1277984
(151) 2015 10 07
(181) 2025 10 07
(891) 2015 10 07
(511) 29, 30, 31, 32, 33, 35, 43

(260) AM 2017 85261 A
(800) 1278031
(151) 2015 10 31
(181) 2025 10 31
(891) 2015 10 31
(511) 14

(260) AM 2017 85262 A
(800) 1278037
(151) 2015 11 05
(181) 2025 11 05
(891) 2015 11 05
(511) 09

(260) AM 2017 85267 A
(800) 1278087
(151) 2015 09 22
(181) 2025 09 22
(891) 2015 09 22
(511) 30

(260) AM 2017 85268 A
(800) 1278091
(151) 2015 09 22
(181) 2025 09 22
(891) 2015 09 22
(511) 30

(260) AM 2017 85278 A
(800) 1277229
(151) 2015 10 26
(181) 2025 10 26
(891) 2015 10 26
(511) 05

(260) AM 2017 85284 A
(800) 1277260
(151) 2015 07 31
(181) 2025 07 31
(891) 2015 07 31
(511) 02

(260) AM 2017 85292 A
(800) 1277350
(151) 2015 10 12
(181) 2025 10 12
(891) 2015 10 12
(511) 05

(260) AM 2017 85296 A
(800) 1068018
(151) 2010 08 20
(181) 2020 08 20
(891) 2015 11 13
(511) 05

(260) AM 2017 85297 A
(800) 1277379
(151) 2015 07 28
(181) 2025 07 28
(891) 2015 07 28
(511) 15

(260) AM 2017 85323 A
(800) 1277716
(151) 2015 11 11
(181) 2025 11 11
(891) 2015 11 11
(511) 30

(260) AM 2017 85330 A
(800) 1277890
(151) 2015 11 11
(181) 2025 11 11
(891) 2015 11 11
(511) 30

(260) AM 2017 85333 A
(800) 1277896
(151) 2015 11 05
(181) 2025 11 05
(891) 2015 11 05
(511) 30

(260) AM 2017 85337 A
(800) 1277900
(151) 2015 11 05
(181) 2025 11 05
(891) 2015 11 05
(511) 30

(260) AM 2017 85339 A
(800) 1277903
(151) 2015 09 22

(181) 2025 09 22
(891) 2015 09 22
(511) 30

(260) AM 2017 85342 A
(800) 1279348
(151) 2015 11 06
(181) 2025 11 06
(891) 2015 11 06
(511) 34

(260) AM 2017 85344 A
(800) 1279389
(151) 2015 07 01
(181) 2025 07 01
(891) 2015 07 01
(511) 03, 09, 14, 18, 24, 25, 30, 35, 43

(260) AM 2017 85348 A
(800) 1279552
(151) 2015 09 09
(181) 2025 09 09
(891) 2015 09 09
(511) 03, 10

(260) AM 2017 85349 A
(800) 1279587
(151) 2015 08 28
(181) 2025 08 28
(891) 2015 08 28
(511) 09

(260) AM 2017 85356 A
(800) 1278138
(151) 2015 09 28
(181) 2025 09 28
(891) 2015 09 28
(511) 30

(260) AM 2017 85358 A
(800) 1278139
(151) 2015 09 21
(181) 2025 09 21
(891) 2015 09 21
(511) 09, 16, 35, 38, 41

(260) AM 2017 85362 A
(800) 1279723
(151) 2015 11 13
(181) 2025 11 13
(891) 2015 11 13
(511) 25

(260) AM 2017 85368 A
(800) 1278277
(151) 2015 08 10
(181) 2025 08 10
(891) 2015 08 10
(511) 03, 18

(260) AM 2017 85369 A
(800) 1278319
(151) 2015 08 05
(181) 2025 08 05
(891) 2015 08 05
(511) 36

(260) AM 2017 85370 A
(800) 1278376
(151) 2015 09 08
(181) 2025 09 08
(891) 2015 09 08
(511) 30

(260) AM 2017 85377 A
(800) 1279744
(151) 2015 11 05
(181) 2025 11 05
(891) 2015 11 05
(511) 30

(260) AM 2017 85381 A
(800) 1279757
(151) 2015 11 02
(181) 2025 11 02
(891) 2015 11 02
(511) 14

(260) AM 2017 85382 A
(800) 1279759
(151) 2015 11 02
(181) 2025 11 02
(891) 2015 11 02
(511) 05

(260) AM 2017 85383 A
(800) 1279761
(151) 2015 11 19
(181) 2025 11 19
(891) 2015 11 19
(511) 14

(260) AM 2017 85386 A
(800) 732404
(151) 2000 01 24

(181) 2020 01 24
(891) 2015 08 21
(511) 05

(260) AM 2017 85387 A
(800) 734174
(151) 2000 02 28
(181) 2020 02 28
(891) 2015 08 21
(511) 05

(260) AM 2017 85388 A
(800) 741906
(151) 2000 09 07
(181) 2020 09 07
(891) 2015 10 08
(511) 12

(260) AM 2017 85389 A
(800) 766457
(151) 2001 10 09
(181) 2021 10 09
(891) 2015 08 21
(511) 05

(260) AM 2017 85390 A
(800) 839429
(151) 2004 09 25
(181) 2024 09 25
(891) 2015 10 29
(511) 14

(260) AM 2017 85397 A
(800) 960305
(151) 2008 02 13
(181) 2018 02 13
(891) 2015 08 21
(511) 05

(260) AM 2017 85398 A
(800) 1071853
(151) 2011 03 07
(181) 2021 03 07
(891) 2015 10 29
(511) 29, 30, 32

(260) AM 2017 85399 A
(800) 1095631
(151) 2011 09 15
(181) 2021 09 15
(891) 2015 10 20
(511) 12

(260) AM 2017 85412 A
(800) 1278775
(151) 2015 10 20
(181) 2025 10 20
(891) 2015 10 20
(511) 09, 11

(260) AM 2017 85413 A
(800) 1227843
(151) 2014 11 06
(181) 2024 11 06
(891) 2015 12 01
(511) 25

(260) AM 2017 85414 A
(800) 1261406
(151) 2015 06 09
(181) 2025 06 09
(891) 2015 11 26
(511) 30

(260) AM 2017 85428 A
(800) 1278923
(151) 2015 08 26
(181) 2025 08 26
(891) 2015 08 26
(511) 03, 05, 10, 35

(260) AM 2017 85429 A
(800) 1278937
(151) 2015 07 10
(181) 2025 07 10
(891) 2015 07 10
(511) 35, 39

(260) AM 2017 85436 A
(800) 1278950
(151) 2015 01 16
(181) 2025 01 16
(891) 2015 01 16
(511) 37

(260) AM 2017 85439 A
(800) 1279099
(151) 2015 10 12
(181) 2025 10 12
(891) 2015 10 12
(511) 29, 30

(260) AM 2017 85442 A
(800) 1279146
(151) 2015 10 07

(181) 2025 10 07
(891) 2015 10 07
(511) 29, 30, 31, 32, 33, 35, 43

(260) AM 2017 85454 A
(800) 1279235
(151) 2015 08 24
(181) 2025 08 24
(891) 2015 08 24
(511) 38, 41

(260) AM 2017 85465 A
(800) 1279956
(151) 2015 11 13
(181) 2025 11 13
(891) 2015 11 13
(511) 19

(260) AM 2017 85466 A
(800) 1279965
(151) 2015 11 12
(181) 2025 11 12
(891) 2015 11 12
(511) 03

(260) AM 2017 85470 A
(800) 1280001
(151) 2015 11 20
(181) 2025 11 20
(891) 2015 11 20
(511) 10

(260) AM 2017 85472 A
(800) 1280004
(151) 2015 11 24
(181) 2025 11 24
(891) 2015 11 24
(511) 05

(260) AM 2017 85474 A
(800) 1280045
(151) 2015 01 12
(181) 2025 01 12
(891) 2015 01 12
(511) 09, 16, 35, 36, 38, 39, 42

(260) AM 2017 85475 A
(800) 1280054
(151) 2015 03 19
(181) 2025 03 19
(891) 2015 03 19
(511) 29, 30

(260) AM 2017 85476 A
(800) 1280059
(151) 2015 03 30
(181) 2025 03 30
(891) 2015 03 30
(511) 01, 02, 03, 04, 16, 17, 19, 35

(260) AM 2017 85477 A
(800) 1280076
(151) 2015 05 25
(181) 2025 05 25
(891) 2015 05 25
(511) 07, 09, 11

(260) AM 2017 85478 A
(800) 1280107
(151) 2015 07 10
(181) 2025 07 10
(891) 2015 07 10
(511) 35, 36, 39

(260) AM 2017 85479 A
(800) 1280136
(151) 2015 09 29
(181) 2025 09 29
(891) 2015 09 29
(511) 09, 28, 41

(260) AM 2017 85480 A
(800) 1280138
(151) 2015 09 17
(181) 2025 09 17
(891) 2015 09 17
(511) 18, 25

(260) AM 2017 85484 A
(800) 1280213
(151) 2015 11 04
(181) 2025 11 04
(891) 2015 11 04
(511) 09

(260) AM 2017 85485 A
(800) 1280217
(151) 2015 10 13
(181) 2025 10 13
(891) 2015 10 13
(511) 29, 30, 31, 32, 33, 35, 43

(260) AM 2017 85507 A
(800) 1280722
(151) 2015 10 28

(181) 2025 10 28
(891) 2015 10 28
(511) 42

(260) AM 2017 85511 A
(800) 1280820
(151) 2015 11 16
(181) 2025 11 16
(891) 2015 11 16
(511) 30, 35

(260) AM 2017 85512 A
(800) 1280843
(151) 2015 11 02
(181) 2025 11 02
(891) 2015 11 02
(511) 09

(260) AM 2017 85513 A
(800) 1280871
(151) 2015 08 05
(181) 2025 08 05
(891) 2015 08 05
(511) 45

(260) AM 2017 85515 A
(800) 1280897
(151) 2015 10 15
(181) 2025 10 15
(891) 2015 10 15
(511) 32

(260) AM 2017 85516 A
(800) 779046
(151) 2001 12 27
(181) 2021 12 27
(891) 2015 11 12
(511) 07

(260) AM 2017 85517 A
(800) 1280292
(151) 2015 11 02
(181) 2025 11 02
(891) 2015 11 02
(511) 05

(260) AM 2017 85518 A
(800) 1280326
(151) 2015 07 24
(181) 2025 07 24
(891) 2015 07 24
(511) 06, 07, 09, 11, 37, 39, 42

(260) AM 2017 85519 A
(800) 362934
(151) 1969 12 09
(181) 2019 12 09
(891) 2015 11 06
(511) 37, 40

(260) AM 2017 85520 A
(800) 1280328
(151) 2015 10 08
(181) 2025 10 08
(891) 2015 10 08
(511) 05, 31

(260) AM 2017 85521 A
(800) 1280343
(151) 2015 11 13
(181) 2025 11 13
(891) 2015 11 13
(511) 09

(260) AM 2017 85537 A
(800) 1226018
(151) 2014 08 14
(181) 2024 08 14
(891) 2015 11 05
(511) 30

(260) AM 2017 85539 A
(800) 1280592
(151) 2015 11 25
(181) 2025 11 25
(891) 2015 11 25
(511) 09

(260) AM 2017 85540 A
(800) 1280593
(151) 2015 11 25
(181) 2025 11 25
(891) 2015 11 25
(511) 09

(260) AM 2017 85547 A
(800) 1280623
(151) 2015 10 13
(181) 2025 10 13
(891) 2015 10 13
(511) 38, 41, 44

(260) AM 2017 85549 A
(800) 1280645
(151) 2015 05 28

(181) 2025 05 28
(891) 2015 05 28
(511) 25

(260) AM 2017 85550 A
(800) 1280649
(151) 2015 07 24
(181) 2025 07 24
(891) 2015 07 24
(511) 09

(260) AM 2017 85551 A
(800) 1280653
(151) 2015 08 10
(181) 2025 08 10
(891) 2015 08 10
(511) 06, 07, 08, 19

(260) AM 2017 85562 A
(800) 1281932
(151) 2015 12 04
(181) 2025 12 04
(891) 2015 12 04
(511) 34

(260) AM 2017 85566 A
(800) 1280939
(151) 2015 11 04
(181) 2025 11 04
(891) 2015 11 04
(511) 05

(260) AM 2017 85571 A
(800) 1280983
(151) 2015 10 02
(181) 2025 10 02
(891) 2015 10 02
(511) 41

(260) AM 2017 85575 A
(800) 1280994
(151) 2015 10 13
(181) 2025 10 13
(891) 2015 10 13
(511) 03

(260) AM 2017 85582 A
(800) 1282110
(151) 2015 11 13
(181) 2025 11 13
(891) 2015 11 13
(511) 42

(260) AM 2017 85584 A
(800) 1282165
(151) 2015 12 01
(181) 2025 12 01
(891) 2015 12 01
(511) 35, 36, 41, 45

(260) AM 2017 85585 A
(800) 1282167
(151) 2015 12 08
(181) 2025 12 08
(891) 2015 12 08
(511) 29, 30

(260) AM 2017 85586 A
(800) 1282168
(151) 2015 12 08
(181) 2025 12 08
(891) 2015 12 08
(511) 29, 30

(260) AM 2017 85588 A
(800) 1281130
(151) 2015 10 12
(181) 2025 10 12
(891) 2015 10 12
(511) 34

(260) AM 2017 85589 A
(800) 1281132
(151) 2015 10 12
(181) 2025 10 12
(891) 2015 10 12
(511) 34

(260) AM 2017 85590 A
(800) 1281133
(151) 2015 10 12
(181) 2025 10 12
(891) 2015 10 12
(511) 34

(260) AM 2017 85595 A
(800) 1281229
(151) 2015 11 26
(181) 2025 11 26
(891) 2015 11 26
(511) 30

(260) AM 2017 85596 A
(800) 1281239
(151) 2015 12 03

(181) 2025 12 03
(891) 2015 12 03
(511) 12

(260) AM 2017 85597 A
(800) 1282169
(151) 2015 12 08
(181) 2025 12 08
(891) 2015 12 08
(511) 29, 30

(260) AM 2017 85598 A
(800) 1281240
(151) 2015 12 03
(181) 2025 12 03
(891) 2015 12 03
(511) 05

(260) AM 2017 85599 A
(800) 1281247
(151) 2015 12 04
(181) 2025 12 04
(891) 2015 12 04
(511) 05

(260) AM 2017 85601 A
(800) 1282170
(151) 2015 12 08
(181) 2025 12 08
(891) 2015 12 08
(511) 29, 30

(260) AM 2017 85603 A
(800) 596951
(151) 1992 12 11
(181) 2022 12 11
(891) 2015 12 04
(511) 14

(260) AM 2017 85605 A
(800) 1281249
(151) 2015 12 02
(181) 2025 12 02
(891) 2015 12 02
(511) 09

(260) AM 2017 85607 A
(800) 1281252
(151) 2015 12 04
(181) 2025 12 04
(891) 2015 12 04
(511) 34

(260) AM 2017 85608 A
(800) 1281253
(151) 2015 11 25
(181) 2025 11 25
(891) 2015 11 25
(511) 05

(260) AM 2017 85609 A
(800) 1281254
(151) 2015 11 25
(181) 2025 11 25
(891) 2015 11 25
(511) 05

(260) AM 2017 85611 A
(800) 1281274
(151) 2015 10 16
(181) 2025 10 16
(891) 2015 10 16
(511) 31

(260) AM 2017 85612 A
(800) 1281300
(151) 2015 04 16
(181) 2025 04 16
(891) 2015 04 16
(511) 09, 11, 16, 21, 35, 42

(260) AM 2017 85613 A
(800) 1281313
(151) 2015 08 06
(181) 2025 08 06
(891) 2015 08 06
(511) 07

(260) AM 2017 85615 A
(800) 1281354
(151) 2015 10 14
(181) 2025 10 14
(891) 2015 10 14
(511) 06, 37, 39, 42, 43, 44

(260) AM 2017 85616 A
(800) 707634
(151) 1999 02 11
(181) 2019 02 11
(891) 2015 11 18
(511) 12

(260) AM 2017 85617 A
(800) 752545
(151) 2001 03 02

(181) 2021 03 02
(891) 2015 11 13
(511) 05

(260) AM 2017 85632 A
(800) 1281643
(151) 2015 09 14
(181) 2025 09 14
(891) 2015 09 14
(511) 09, 10, 14

(260) AM 2017 85635 A
(800) 1281660
(151) 2015 10 12
(181) 2025 10 12
(891) 2015 10 12
(511) 35, 41

(260) AM 2017 85637 A
(800) 1281670
(151) 2015 10 08
(181) 2025 10 08
(891) 2015 10 08
(511) 16, 25, 35, 40, 42

(260) AM 2017 85643 A
(800) 1281752
(151) 2015 11 27
(181) 2025 11 27
(891) 2015 11 27
(511) 14

(260) AM 2017 85647 A
(800) 1281826
(151) 2015 08 21
(181) 2025 08 21
(891) 2015 08 21
(511) 05, 29, 32

(260) AM 2017 85648 A
(800) 1281827
(151) 2015 08 21
(181) 2025 08 21
(891) 2015 08 21
(511) 05, 29, 32

(260) AM 2017 85651 A
(800) 1281830
(151) 2015 08 24
(181) 2025 08 24
(891) 2015 08 24
(511) 06, 07, 35

(260) AM 2017 85654 A
(800) 1281902
(151) 2015 11 26
(181) 2025 11 26
(891) 2015 11 26
(511) 11

(260) AM 2017 85655 A
(800) 1281924
(151) 2015 11 17
(181) 2025 11 17
(891) 2015 11 17
(511) 03

(260) AM 2017 85680 A
(800) 1282520
(151) 2015 11 27
(181) 2025 11 27
(891) 2015 11 27
(511) 25

(260) AM 2017 85683 A
(800) 1282979
(151) 2015 11 09
(181) 2025 11 09
(891) 2015 11 09
(511) 05, 31

(260) AM 2017 85779 A
(800) 1283637
(151) 2015 11 19
(181) 2025 11 19
(891) 2015 11 19
(511) 29, 30

(260) AM 2017 85782 A
(800) 1283297
(151) 2015 10 14
(181) 2025 10 14
(891) 2015 10 14
(511) 05

(260) AM 2017 85785 A
(800) 1283656
(151) 2015 12 03
(181) 2025 12 03
(891) 2015 12 03
(511) 05

(260) AM 2017 85786 A
(800) 1283396
(151) 2015 08 03

(181) 2025 08 03
(891) 2015 08 03
(511) 38, 41

(260) AM 2017 85787 A
(800) 1283405
(151) 2015 08 05
(181) 2025 08 05
(891) 2015 08 05
(511) 38, 41

(260) AM 2017 85788 A
(800) 1283418
(151) 2015 08 06
(181) 2025 08 06
(891) 2015 08 06
(511) 03, 05

(260) AM 2017 85935 A
(800) 1285002
(151) 2015 11 22
(181) 2025 11 22
(891) 2015 11 22
(511) 38, 41

(260) AM 2017 85941 A
(800) 1284418
(151) 2015 10 09
(181) 2025 10 09
(891) 2015 10 09
(511) 01, 04

(260) AM 2017 85942 A
(800) 1284506
(151) 2015 10 24
(181) 2025 10 24
(891) 2015 10 24
(511) 05

(260) AM 2017 85943 A
(800) 1285074
(151) 2015 08 24
(181) 2025 08 24
(891) 2015 08 24
(511) 09, 35, 37, 42

(260) AM 2017 85946 A
(800) 1284518
(151) 2015 11 16
(181) 2025 11 16
(891) 2015 11 16
(511) 16, 35, 41

(260) AM 2017 86013 A
(800) 1286185
(151) 2015 10 06
(181) 2025 10 06
(891) 2015 10 06
(511) 35, 36, 37, 38, 39, 40, 41, 42, 43, 44, 45

(260) AM 2017 86016 A
(800) 1285265
(151) 2015 12 18
(181) 2025 12 18
(891) 2015 12 18
(511) 05

(260) AM 2017 86017 A
(800) 1286186
(151) 2015 10 06
(181) 2025 10 06
(891) 2015 10 06
(511) 35, 36, 37, 38, 39, 40, 41, 42, 43, 44, 45

(260) AM 2017 86018 A
(800) 1285267
(151) 2015 12 18
(181) 2025 12 18
(891) 2015 12 18
(511) 05

(260) AM 2017 86022 A
(800) 1285278
(151) 2015 07 15
(181) 2025 07 15
(891) 2015 07 15
(511) 06, 11, 19, 21, 35, 37

(260) AM 2017 86023 A
(800) 1285310
(151) 2015 12 17
(181) 2025 12 17
(891) 2015 12 17
(511) 03, 05, 09, 10, 16, 35, 36, 38, 41, 42, 44

(260) AM 2017 86160 A
(800) 1287361
(151) 2015 07 10
(181) 2025 07 10
(891) 2015 07 10
(511) 03, 09, 14, 18, 25, 35

(260) AM 2017 86163 A
(800) 1286736
(151) 2015 12 02

(181) 2025 12 02
(891) 2015 12 02
(511) 10

(260) AM 2017 86165 A
(800) 1286764
(151) 2015 12 15
(181) 2025 12 15
(891) 2015 12 15
(511) 05

(260) AM 2017 86166 A
(800) 1286795
(151) 2015 12 03
(181) 2025 12 03
(891) 2015 12 03
(511) 09, 35, 39, 42

(260) AM 2017 86282 A
(800) 1288563
(151) 2015 12 22
(181) 2025 12 22
(891) 2015 12 22
(511) 05, 42

(260) AM 2017 86319 A
(800) 1287946
(151) 2015 12 15
(181) 2025 12 15
(891) 2015 12 15
(511) 03

(260) AM 2017 86320 A
(800) 1287948
(151) 2015 12 15
(181) 2025 12 15
(891) 2015 12 15
(511) 03

(260) AM 2017 86595 A
(800) 1291270
(151) 2015 10 02
(181) 2025 10 02
(891) 2015 10 02
(511) 38

APPELLATIONS OF ORIGIN AND GEOGRAPHICAL INDICATION OF GOODS

REGISTERED APPELLATIONS OF ORIGIN OF GOODS

Number of National Registration: 822

Data of National Registration: 2011 12 13

Number of Indication: 966

Data of Application: 2011 08 03

Name and Address of Applicant: Agriculture Ministry of Georgia
Marshal Gelovani Ave. №6, 0159, Tbilisi (GE)

Appellation of Origin of Good: **NABEGHLAVI**

The Goods for which the Registration of Appellation of Origin is Required: 32 – Natural Mineral Water.

Number of National Registration: 823

Data of National Registration: 2011 12 21

Number of Indication: 964

Data of Application: 2011 08 03

Name and Address of Applicant: Agriculture Ministry of Georgia
Marshal Gelovani Ave. №6, 0159, Tbilisi (GE)

Appellation of Origin of Good: **SAIRME**

The Goods for which the Registration of Appellation of Origin is Required: 32 – Natural Mineral Water.

Number of National Registration: 824

Data of National Registration: 2012 02 22

Number of Indication: 965

Data of Application: 2011 08 03

Name and Address of Applicant: Agriculture Ministry of Georgia
Marshal Gelovani Ave. №6, 0159, Tbilisi (GE)

Appellation of Origin of Good: **BORJOMI**

The Goods for which the Registration of Appellation of Origin is Required: 32 – Natural Mineral Water.

Number of National Registration: 831

Data of National Registration: 2013 05 15

Data of Interational Registration: 904

Data of International Registration: 2012 03 09

Appellation of Origin of Good: **ЈЕСКОВАЧКИ ДОМАЊИ АЈВАР-LESKOVAČKI
DOMAĆI AJVAR**

Country Code: RS Serbia

Goods: 29 – Ajvar produced in a traditional way (agricultural food product by peppers).

Number of National Registration: 832
Data of National Registration: 2013 05 15
Data of Interational Registration: 905
Data of International Registration: 2012 06 12
Appellation of Origin of Good: **ARROZ DEL ESTADO DE MORELOS**
Country Code: MX Mexico

Goods: 31 – This covers the plant, seed and grain of the "ARROZ DEL ESTADO DE MORELOS" plant, especially "Arroz del Estado de Morelos" varieties Morelos A-92, Morelos A-98 and Morelos A-2010, created at the Zacatepec Experimental Field of the National Institute for Research into Forestry, Agriculture and Fisheries (INIFAP). In particular, the finished product or products covered by the appellation of origin are: a) Palay "Arroz del Estado de Morelos". b) Brown or wholemeal "Arroz del Estado de Morelos". c) Refined "Arroz del Estado de Morelos". d) By-products of "Arroz del Estado de Morelos": husk, half grain, three quarter grain, small grain, middling and flour.

Number of National Registration: 833
Data of National Registration: 2013 07 22
Data of Interational Registration: 906
Data of International Registration: 2012 09 24
Appellation of Origin of Good: **PROSECCO**
Country Code: IT Italy
Goods: 33 – Wine.

Number of National Registration: 834
Data of National Registration: 2013 09 17
Data of Interational Registration: 907
Data of International Registration: 2012 10 30
Appellation of Origin of Good: **MONOI DE TAHITI**
Country Code: FR France
Good: 3 – Cosmetic product obtained by macerating Tiare flowers in refined copra oil, extracted from coconuts.

Number of National Registration: 835
Data of National Registration: 2013 09 17
Data of Interational Registration: 908
Data of International Registration: 2012 11 12
Appellation of Origin of Good: **ACETO BALSAMICO DI MODENA**
Country Code: IT Italy
Good: 30 – Vinegar.

Number of National Registration: 836
Data of National Registration: 2014 06 05
Data of Interational Registration: 910
Data of International Registration: 2013 01 27
Appellation of Origin of Good: **FARSH E DASTBAFT E HERIS - FARSH E DASTBAFT E HERIZ**
Country Code: IR Islamic Republic of Iran
Good: 27 – Handmade Rug, Handmade carpet.

Number of National Registration: 837
Data of National Registration: 2014 06 05
Data of Interational Registration: 911
Data of International Registration: 2013 01 27
Appellation of Origin of Good: **FARSH E DASTBAFT E ISFAHAN - FARSH E DASTBAFT E ESFAHAN**
Country Code: IR Islamic Republic of Iran
Good: 27 – Handmade Carpet, Handmade rug.

Number of National Registration: 838
Data of National Registration: 2014 06 05
Data of Interational Registration: 912
Data of International Registration: 2013 01 27
Appellation of Origin of Good: **FARSH E DASTBAFT E MAHI E KHOY**
Country Code: IR Islamic Republic of Iran
Goods: 27 – Handmade Carpet, Handmade Rug.

Number of National Registration: 839
Data of National Registration: 2014 06 05
Data of Interational Registration: 913
Data of International Registration: 2013 01 27
Appellation of Origin of Good: **FARSH E DASTBAFT E QOM, FARSH E DASTBAFT E QUM,
FARSH E DASTBAFT E GHOM**
Appellation of Origin of Good:
Country Code: IR Islamic Republic of Iran
Good: 27 – Handmade Carpet, Handmade rug.

Number of National Registration: 840
Data of National Registration: 2014 06 05
Data of Interational Registration: 914
Data of International Registration: 2013 01 27
Appellation of Origin of Good: **FARSH E DASTBAFT E TABRIZ**
Country Code: IR Islamic Republic of Iran
Good: 27 – Handmade Carpet, Handmade rug.

Number of National Registration: 841
Data of National Registration: 2014 10 23
Data of Interational Registration: 922
Data of International Registration: 2014 01 20
Appellation of Origin of Good: **TALEGGIO**
Country Code: IT Italy
Good: 29 – Cheese.

Number of National Registration: 842
Data of National Registration: 2014 10 23
Data of Interational Registration: 923

Data of International Registration: 2014 01 20
Appellation of Origin of Good: **QUARTIROLO LOMBARDO**
Appellation of Origin of Good:
Country Code: IT Italy
Good: 29 – Cheese.

Number of National Registration: 843
Data of National Registration: 2014 10 23
Data of International Registration: 924
Data of International Registration: 2014 03 11
Appellation of Origin of Good: **ASIAGO**
Country Code: IT Italy
Good: 29 – Cheese.

Number of National Registration: 844
Data of National Registration: 2014 12 12
Number of Indication: 1176
Data of Application: 2014 05 29
Name and Address of Applicant: Agriculture Ministry of Georgia
Marshal Gelovani Ave. №6, 0159, Tbilisi (GE)
Appellation of Origin of Good: **MITARBI**
The Goods for which the Registration of Appellation of Origin is Required: 32 – Natural Mineral Water.

REGISTERED GEORGRAPHICAL INDICATIONS

Number of National Registration: 17
Data of National Registration: 2016 03 02
Number of Indication: 4713
Data of Application: 2015 01 26
Name and Address of Applicant: Association "**MACHAKHELA HONEY**"
Didadjaris q. №17, Sop. Chkhutuneti, Khelvachauri, Georgia
Geographical Indication: **MACHAKHELA HONEY**
The Goods for which the Registration of Appellation of Origin is Required: 30 – Honey.

Number of National Registration: 18
Data of National Registration: 2016 03 02
Number of Indication: 4714
Data of Application: 2015 01 29
Name and Address of Applicant: Association "**AKHALKALAKI POTATO** "
D. Aghmasheneblis q., II shesakhvevi №4, b. 6, 0700, Akhalkalaki, Georgia
Geographical Indication: **AKHALKALAKI POTATO**
The Goods for which the Registration of Appellation of Origin is Required: 31 – Potato.

Number of National Registration: 19
Data of National Registration: 2016 03 02
Number of Indication: 4715
Data of Application: 2015 01 29
Name and Address of Applicant: Association "**TKIBULI MOUNTAIN TEA**"
Gr. Gabriadzis q. №20, 4300, Tkibuli, Georgia
Geographical Indication: **TKIBULI MOUNTAIN TEA**
The Goods for which the Registration of Appellation of Origin is Required: 30 – Tea.

Number of National Registration: 20
Data of National Registration: 2016 04 01
Number of Indication: 4716
Data of Application: 2015 01 29
Name and Address of Applicant: Association "**KUTAISI GREENS**"
Sop. Patriketi, 5416, Tskaltubos r-ni, Georgia
Geographical Indication: **KUTAISI GREENS**
The Goods for which the Registration of Appellation of Origin is Required: 31 – Greens.

OFFICIAL NOTIFICATIONS

INVENTIONS

RENEWAL OF A PATENTS

(11) P 2009 4663 B

(73) Giorgi Ioramashvili (GE);
Marine Beroshvili (GE)

(54) **METHOD FOR SEPARATION OF FLUID INTRUSION**
DATE OF RENEWAL: 10 02 2017

(11) P 2007 4235 B

(73) Mariam Mchedlishvili (GE)

(54) **METHOD FOR BIODESTRUCTION OF OIL AND/OR OIL PRODUCTS, INCUBATING
NUTRIENT MEDIUM FOR MICROORGANISMS-OIL DESTRUCTORS AND METHOD FOR ITS
INCUBATION**

DATE OF RENEWAL: 10 02 2017

(11) P 2011 5273 B

(73) Tengiz Gelashvili (GE)

(54) **CLINKER-FREE CEMENT**

DATE OF RENEWAL: 10 02 2017

(11) P 2011 5274 B

(73) Tengiz Gelashvili (GE)

(54) **LOW-CLINKER CEMENT**

DATE OF RENEWAL: 10 02 2017

(11) P 2014 6210 B

(73) SAIPEM S.P.A. (IT)

(54) **PROCESS FOR RECOVERY OF AMMONIA FROM GASEOUS STREAM**

DATE OF RENEWAL: 10 02 2017

(11) P 2016 6453 B

(73) Akaki Peikrishvili (GE);
Elguja Chagelishvili (GE);
Irakli Bairamashvili (GE);
Merab Tsiklauri (GE);
Bagrat Godibadze (GE);
Avtandil Dgebuadze (GE)

(54) **CONTAINER FOR TRANSPORTING AND KEEPING RADIOACTIVE MATERIALS AND
METHOD OF MAKING THEREOF**

DATE OF RENEWAL: 10 02 2017

UTILITY MODELS

RENEWAL OF A PATENT

(11) U 2014 1824 Y

(73) Liana Gventsadze (GE);

Elguja Kutelia (GE);

Davit Gventsadze (GE)

(54) **COMPOSITE MATERIAL OF FRICTION PLATE**

DATE OF RENEWAL: 10 02 2017

TRADEMARKS

RENEWAL OF REGISTRATIONS

(111) M 2007 17252 R1
(156) 2017 01 30
(186) 2027 01 30
(732) PEPSICO, INC.
a North Carolina Corporation
700 Anderson Hill Road, Purchase,
New York 10577, USA

(111) M 2007 17253 R1
(156) 2017 01 30
(186) 2027 01 30
(732) PEPSICO, INC.
a North Carolina Corporation
700 Anderson Hill Road, Purchase,
New York 10577, USA

(111) M 2007 17320 R1
(156) 2017 02 27
(186) 2027 02 27
(732) KIMBERLY-CLARK WORLDWIDE, INC.
NEENAH, WI 54956, USA

(111) M 2007 17365 R1
(156) 2017 03 26
(186) 2027 03 26
(732) PFIZER ENTERPRISES SARL
Rond Point du Kirchberg 51, Avenue JF
Kennedy, L-1855, Luxembourg

(111) M 2007 17717 R1
(156) 2017 07 30
(186) 2027 07 30
(732) UNILEVER N.V.
Weena 455, 3013 AL Rotterdam, Netherlands

(111) M 2007 17856 R1
(156) 2017 09 18
(186) 2027 09 18
(732) VLAKTOR TRADING LIMITED
Zinonos Kitieos, 8, Kato Lakatamia,
P.C. 2322 Nicosia, Cyprus

(111) M 2007 17904 R1
(156) 2017 10 10
(186) 2027 10 10
(732) VLAKTOR TRADING LIMITED
Zinonos Kitieos, 8, Kato Lakatamia,
P.C. 2322 Nicosia, Cyprus

(111) M 2007 17985 R1
(156) 2017 11 13
(186) 2027 11 13
(732) VLAKTOR TRADING LIMITED
Arch. Makariou III, 134, Yiota Court,
Flat/Office 102, P.C. 3021, Limassol, Cyprus

(111) M 2007 17986 R1
(156) 2017 11 13
(186) 2027 11 13
(732) VLAKTOR TRADING LIMITED
Zinonos Kitieos, 8, Kato Lakatamia,
P.C. 2322 Nicosia, Cyprus

(111) M 2007 17987 R1
(156) 2017 11 13
(186) 2027 11 13
(732) VLAKTOR TRADING LIMITED
Zinonos Kitieos, 8, Kato Lakatamia,
P.C. 2322 Nicosia, Cyprus

(111) M 2007 17988 R1
(156) 2017 11 13
(186) 2027 11 13
(732) VLAKTOR TRADING LIMITED
Zinonos Kitieos, 8, Kato Lakatamia,
P.C. 2322 Nicosia, Cyprus

(111) M 2007 18063 R1
(156) 2017 11 13
(186) 2027 11 13
(732) Pierre Balmain S.A.;
44, rue Francois 1er, 75008 Paris, France

(111) M 1996 2563 R2
(156) 2016 07 02
(186) 2026 07 02
(732) GIORGIO ARMANI S.p.A., Milan, Swiss
Branch Mendrisio
Via Penate 4, 6850 Mendrisio, Switzerland

(111) M 1996 2984 R2
(156) 2016 09 10
(186) 2026 09 10
(732) SAFILO - SOCIETÀ AZIONARIA
FABBRICA ITALIANA LAVORAZIONE
OCCHIALI - S.P.A.
Piazza Tiziano 8, Pieve di Cadore (BL), Italy

(111) M 1996 3814 R2
(156) 2016 11 01
(186) 2026 11 01
(732) MANITOU B.F.
Ancenis, France

(111) M 1996 3815 R2
(156) 2016 11 01
(186) 2026 11 01
(732) MANITOU B.F.
Ancenis, France

(111) M 1996 3892 R2
(156) 2016 11 08
(186) 2026 11 08
(732) RITMEESTER B. V.
Vijftien morgen 4, 3901 HA Veenendaal,
Netherlands

(111) M 1996 3927 R2
(156) 2016 11 12
(186) 2026 11 12
(732) LUCAS INDUSTRIES LIMITED
Stratford Road, Solihull, West Midlands
B90 4 AX, United Kingdom

(111) M 1996 3928 R2
(156) 2016 11 12
(186) 2026 11 12
(732) LUCAS INDUSTRIES LIMITED
Stratford Road, Solihull, West Midlands
B90 4 AX, United Kingdom

(111) M 1996 3929 R2
(156) 2016 11 12
(186) 2026 11 12
(732) LUCAS INDUSTRIES LIMITED
Stratford Road, Solihull, West Midlands
B90 4 AX, United Kingdom

(111) M 1996 3939 R2
(156) 2016 11 13
(186) 2026 11 13
(732) ARJOWIGGINS RIVES
10 Rue Jean-Arnaud, Zone Artisanale
Champfeuillet, 38500 VOIRON, France

(111) M 1996 3940 R2
(156) 2016 11 13
(186) 2026 11 13
(732) MONKSJÖ ARCHES

48 ROUTE de Remiremont, 88380
ARCHES, France

(111) M 1996 3941 R2
(156) 2016 11 13
(186) 2026 11 13
(732) MONKSJÖ ARCHES
48 ROUTE de Remiremont, 88380
ARCHES, France

(111) M 1996 4073 R2
(156) 2016 11 22
(186) 2026 11 22
(732) BODEGAS FUNDADOR S.L.
Avenida Del Prezidente Carmona No.10,
28020 Madrid, Spain

(111) M 1996 4112 R2
(156) 2016 12 03
(186) 2026 12 03
(732) CONVATEC INC.
200 Headquarters Park Drive, Skillman,
NJ 08558, USA

(111) M 1996 4113 R2
(156) 2016 12 03
(732) CONVATEC INC.
200 Headquarters Park Drive, Skillman,
NJ 08558, USA

(111) M 1996 4114 R2
(156) 2016 12 03
(186) 2026 12 03
(732) CONVATEC INC.
200 Headquarters Park Drive, Skillman,
NJ 08558, USA

(111) M 1996 4124 R2
(156) 2016 12 03
(186) 2026 12 03
(732) ARRIS GLOBAL LTD
Victoria Road, Saltaire, Shipley, West
Yorkshire, BD 18 3LF, United Kingdom

(111) M 1996 4145 R2
(156) 2016 12 04
(186) 2026 12 04
(732) IVECO MAGIRUS AG;
Nicolaus-Otto-Strasse 27, D 89079 ULM,
Germany

(111) M 1996 4258 R2
 (156) 2016 12 19
 (186) 2026 12 19
 (732) MONCLER S.P.A.
 Via Stendhal 47, 20144 Milano, Italy

(111) M 1996 4268 R2
 (156) 2016 12 19
 (186) 2026 12 19
 (732) TRADALL S.A.
 Route de Meyrin 267, 1217 Meyrin, Switzerland

(111) M 1997 4309 R2
 (156) 2017 01 05
 (186) 2027 01 05
 (732) BODEGAS FUNDADOR S.L.
 Avenida Del Prezidente Carmona No.10,
 28020 Madrid, Spain

(111) M 1997 4321 R2
 (156) 2017 01 08
 (186) 2027 01 08
 (732) BODEGAS FUNDADOR S.L.
 Avenida Del Prezidente Carmona No.10,
 28020 Madrid, Spain

(111) M 1997 4335 R2
 (156) 2017 01 09
 (186) 2027 01 09
 (732) ELLESSE INTERNATIONAL S.p.A.
 ia Mario Angeloni, 80/A, 06124 Perugia,
 Italy

(111) M 1997 4384 R2
 (156) 2017 01 21
 (186) 2027 01 21
 (732) GERD PETRIK
 Via Collina 43, 6612 Ascona, Switzerland

(111) M 1997 4396 R2
 (156) 2017 01 24
 (186) 2027 01 24
 (732) THE PROCTER & GAMBLE COMPANY
 One Procter & Gamble Plaza, Cincinnati,
 Ohio, USA

(111) M 1997 4423 R2
 (156) 2017 01 28
 (186) 2027 01 28
 (732) THE PROCTER & GAMBLE COMPANY
 One Procter & Gamble Plaza, Cincinnati,
 Ohio, USA

(111) M 1997 4424 R2
 (156) 2017 01 28
 (186) 2027 01 28
 (732) THE PROCTER & GAMBLE COMPANY
 One Procter & Gamble Plaza, Cincinnati,
 Ohio, USA

(111) M 1997 4429 R2
 (156) 2017 01 29
 (186) 2027 01 29
 (732) DRAKA KABEL B.V.
 2-4 Hamerstraat, NL-1021 JV Amsterdam,
 Netherlands

(111) M 1997 4430 R2
 (156) 2017 01 29
 (186) 2027 01 29
 (732) DAIKIN INDUSTRIES, LTD
 Umeda Center Bldg, 4-12 Nakazaki-Nishi,
 2-chome, Kita-ku, Osaka, Japan

(111) M 1997 4431 R2
 (156) 2017 01 29
 (186) 2027 01 29
 (732) MERZ PHARMA GmbH & CO. KGaA
 Eckenheimer Landstrasse 100, 60318
 Frankfurt am Main, Germany

(111) M 1997 4433 R2
 (156) 2017 01 30
 (186) 2027 01 30
 (732) MERZ PHARMA GmbH & CO. KGaA
 Eckenheimer Landstrasse 100, 60318
 Frankfurt am Main, Germany

(111) M 1997 4434 R2
 (156) 2017 01 30
 (186) 2027 01 30
 (732) MERZ PHARMA GmbH & CO. KGaA
 Eckenheimer Landstrasse 100, 60318
 Frankfurt am Main, Germany

(111) M 1997 4435 R2
 (156) 2017 01 30
 (186) 2027 01 30
 (732) COATINGS FOREIGN IP CO. LLC
 c/o The Corporation Trust Company,
 Corporation Trust Center, 1209 Orange
 Street, Wilmington, Delaware 19801, USA

(111) M 1997 4463 R2
 (156) 2017 02 03
 (186) 2027 02 03

(732) DAIMLER AG
Mercedesstrasse 137, 70327 Stuttgart,
Germany

200 Vesey St., 49-12, New York, N.Y.
10285, USA

(111) M 1997 4498 R2
(156) 2017 02 04
(186) 2027 02 04
(732) CONVATEC INC.
200 Headquarters Park Drive, Skillman,
NJ 08558, USA

(111) M 1997 4989 R2
(156) 2017 04 07
(186) 2027 04 07
(732) PALL CORPORATION
25 Harbor Park Drive, Port Washington,
NY 11050-4630, USA

(111) M 1997 4598 R2
(156) 2017 02 10
(186) 2027 02 10
(732) BAYER CONSUMER CARE AG
Peter Merian-Strasse 84, 4002 Basel,
Switzerland

(111) M 1997 4990 R2
(156) 2017 04 07
(186) 2027 04 07
(732) PALL CORPORATION
25 Harbor Park Drive, Port Washington,
NY 11050-4630, USA

(111) M 1997 4618 R2
(156) 2017 02 12
(186) 2027 02 12
(732) BAYER AG
D-51368 Leverkusen, Germany

(111) M 1997 5036 R2
(156) 2017 04 14
(186) 2027 04 14
(732) UNILEVER N.V.
Weena 455, NL-3013 AL Rotterdam, Netherlands

(111) M 1997 4748 R2
(156) 2017 03 19
(186) 2027 03 19
(732) DOLLE FOOD COMPANY, INC.
(a Delaware Corporation)
One Dole Drive, Westlake Village,
California 91362-7300, USA

(111) M 1997 5089 R2
(156) 2017 04 15
(186) 2027 04 15
(732) UNILEVER N.V.
Weena 455, Rotterdam, 3013 AL,
Netherlands

(111) M 1997 4749 R2
(156) 2017 03 19
(186) 2027 03 19
(732) DOLLE FOOD COMPANY, INC.
(a Delaware Corporation)
One Dole Drive, Westlake Village,
California 91362-7300, USA

(111) M 1997 5090 R2
(156) 2017 04 15
(186) 2027 04 15
(732) UNILEVER N.V.
Weena 455, Rotterdam, 3013 AL,
Netherlands

(111) M 1997 4845 R2
(156) 2017 03 28
(186) 2027 03 28
(732) MATTEL, INCORPORATED
333 Continental Boulevard, El Segundo,
California 90245, USA

(111) M 1997 5091 R2
(156) 2017 04 15
(186) 2027 04 15
(732) UNILEVER N.V.
Weena 455, Rotterdam, 3013 AL,
Netherlands

(111) M 1997 4924 R2
(156) 2017 04 03
(186) 2027 04 03
(732) AMERICAN EXPRESS MARKETING &
DEVELOPMENT CORP.

(111) M 1997 5146 R2
(156) 2017 04 18
(186) 2027 04 18
(732) KABUSHIKI KAISHA HITACHI
SEISAKUSHO
6-6, Marunouchi 1-chome, Chiyoda-ku,
Tokio, Japan

(111) M 1997 5189 R2
 (156) 2017 04 25
 (186) 2027 04 25
 (732) UHU GmbH & Co. KG
 Herrmanstrasse 7, D-77815 Buhl (Baden),
 Germany

(111) M 1997 5394 R2
 (156) 2017 05 28
 (186) 2027 05 28
 (732) UNILEVER N.V.
 Weena 455, NL-3013 AL Rotterdam,
 Netherlands

(111) M 1997 5752 R2
 (156) 2017 06 26
 (186) 2027 06 26
 (732) MATTEL, INC.
 333 Continental Boulevard, El Segundo,
 California 90245, USA

(111) M 1997 5816 R2
 (156) 2017 07 04
 (186) 2027 07 04
 (732) UNILEVER N.V.
 Weena 455, NL-3013 AL Rotterdam,
 Netherlands

(111) M 1997 5866 R2
 (156) 2017 07 09
 (186) 2027 07 09
 (732) HYUNDAI MOTOR COMPANY
 140-2, Kye-Dong, Jongro-ku, Seoul,
 Republic of Korea

(111) M 1997 6030 R2
 (156) 2017 07 23
 (186) 2027 07 23
 (732) CONOPCO INC.
 700 Sylvan Avenue, Englewood Cliffs,
 NJ 07632, USA

(111) M 1997 6031 R2
 (156) 2017 07 23
 (186) 2027 07 23
 (732) CONOPCO INC.
 700 Sylvan Avenue, Englewood Cliffs,
 NJ 07632, USA

(111) M 1997 6032 R2
 (156) 2017 07 23
 (186) 2027 07 23

(732) CONOPCO INC.
 700 Sylvan Avenue, Englewood Cliffs,
 NJ 07632, USA

(111) M 1997 6304 R2
 (156) 2017 08 11
 (186) 2027 08 11
 (732) CONOPCO INC.
 700 Sylvan Avenue, Englewood Cliffs,
 NJ 07632, USA

(111) M 1997 6305 R2
 (156) 2017 08 11
 (186) 2027 08 11
 (732) CONOPCO INC.
 700 Sylvan Avenue, Englewood Cliffs,
 NJ 07632, USA

(111) M 1997 6557 R2
 (156) 2017 08 29
 (186) 2027 08 29
 (732) MATTEL, INC.
 a Delaware corporation
 333 Continental Boulevard, El Segundo,
 California 90245, USA

(111) M 1997 6594 R2
 (156) 2017 09 02
 (186) 2027 09 02
 (732) MATTEL, INC.
 a Delaware corporation
 333 Continental Boulevard, El Segundo,
 California 90245, USA

(111) M 1997 6785 R2
 (156) 2017 09 15
 (186) 2027 09 15
 (732) UNILEVER N.V.
 Weena 455, NL-3013 AL Rotterdam,
 Netherlands

(111) M 1997 6792 R2
 (156) 2017 09 15
 (186) 2027 09 15
 (732) UNILEVER N.V.
 Weena 455, NL-3013 AL Rotterdam,
 Netherlands

(111) M 1997 7004 R2
 (156) 2017 09 30
 (186) 2027 09 30
 (732) UNILEVER N.V.

Weena 455, NL-3013 AL Rotterdam,
Netherlands

(111) M 1997 7006 R2
(156) 2017 09 30
(186) 2027 09 30
(732) UNILEVER N.V.

Weena 455, NL-3013 AL Rotterdam,
Netherlands

(111) M 1997 7007 R2
(156) 2017 09 30
(186) 2027 09 30
(732) UNILEVER N.V.

Weena 455, NL-3013 AL Rotterdam,
Netherlands

(111) M 1997 7112 R2
(156) 2017 10 09
(186) 2027 10 09

(732) GUERLAIN SOCIETE ANONYME
68, Avenue de Champs-Elysees, F-75008
Paris, France

(111) M 1997 7113 R2
(156) 2017 10 09
(186) 2027 10 09

(732) GUERLAIN SOCIETE ANONYME
68, Avenue de Champs-Elysees, F-75008
Paris, France

(111) M 1997 7114 R2
(156) 2017 10 09
(186) 2027 10 09

(732) GUERLAIN SOCIETE ANONYME
68, Avenue de Champs-Elysees, F-75008
Paris, France

(111) M 1997 7329 R2
(156) 2017 10 28
(186) 2027 10 28

(732) GUERLAIN SOCIETE ANONYME
68, Avenue de Champs-Elysees, F-75008
Paris, France

(111) M 1997 7450 R2
(156) 2017 11 11
(186) 2027 11 11

(732) GUERLAIN SOCIETE ANONYME
68, Avenue de Champs-Elysees, F-75008
Paris, France

(111) M 1997 7581 R2

(156) 2017 11 18

(186) 2027 11 18

(732) CONOPCO INC.;

700 Sylvan Avenue, Englewood Cliffs,
NJ 07632, USA

(111) M 1997 7582 R2

(156) 2017 11 18

(186) 2027 11 18

(732) CONOPCO INC.

700 Sylvan Avenue, Englewood Cliffs,
NJ 07632, USA

(111) M 1997 7821 R2

(156) 2017 12 11

(186) 2027 12 11

(732) UNILEVER N.V.

Weena 455, NL-3013 AL Rotterdam,
Netherlands

COMPLETE TRANSFER OF RIGHTS

(111) M 1995 001026 R2
 (732) GLAXOSMITHKLINE CONSUMER
 HEALTHCARE (UK) IP LIMITED
 980 Great West Road, Brentford, Middlesex
 TW8 9GS, United Kingdom
 (770) GLAXO GROUP LIMITED
 980 Great West Road, Brentford, Middlesex
 TW8 9GS, United Kingdom
 (580) 2017 01 31

(111) M 1995 001027 R2
 (732) GLAXOSMITHKLINE CONSUMER
 HEALTHCARE (UK) IP LIMITED
 980 Great West Road, Brentford, Middlesex
 TW8 9GS, United Kingdom
 (770) GLAXO GROUP LIMITED
 980 Great West Road, Brentford, Middlesex
 TW8 9GS, United Kingdom
 (580) 2017 01 18

(111) M 1995 001028 R2
 (732) GLAXOSMITHKLINE CONSUMER
 HEALTHCARE (UK) IP LIMITED
 980 Great West Road, Brentford, Middlesex
 TW8 9GS, United Kingdom
 (770) GLAXO GROUP LIMITED
 980 Great West Road, Brentford, Middlesex
 TW8 9GS, United Kingdom
 (580) 2017 01 18

(111) M 1995 001033 R2
 (732) GLAXOSMITHKLINE CONSUMER
 HEALTHCARE (UK) IP LIMITED
 980 Great West Road, Brentford, Middlesex
 TW8 9GS, United Kingdom
 (770) GLAXO GROUP LIMITED
 980 Great West Road, Brentford, Middlesex
 TW8 9GS, United Kingdom
 (580) 2017 01 18

(111) M 1998 010389 R1
 (732) GLAXOSMITHKLINE CONSUMER
 HEALTHCARE (UK) IP LIMITED
 980 Great West Road, Brentford, Middlesex
 TW8 9GS, United Kingdom
 (770) GLAXO GROUP LIMITED
 980 Great West Road, Brentford, Middlesex
 TW8 9GS, United Kingdom
 (580) 2017 01 31

(111) M 1998 010795 R1
 (732) GLAXOSMITHKLINE CONSUMER
 HEALTHCARE (UK) IP LIMITED

980 Great West Road, Brentford, Middlesex
 TW8 9GS, United Kingdom
 (770) SMITHKLINE BEECHAM LIMITED
 980 Great West Road, Brentford, Middlesex
 TW8 9GS, United Kingdom
 (580) 2017 01 10

(111) M 1998 010962 R1
 (732) GLAXOSMITHKLINE CONSUMER
 HEALTHCARE (UK) IP LIMITED
 980 Great West Road, Brentford, Middlesex
 TW8 9GS, United Kingdom
 (770) SMITHKLINE BEECHAM LIMITED
 980 Great West Road, Brentford, Middlesex
 TW8 9GS, United Kingdom
 (580) 2017 01 10

(111) M 1998 010985 R1
 (732) GLAXOSMITHKLINE CONSUMER
 HEALTHCARE (UK) IP LIMITED
 980 Great West Road, Brentford, Middlesex
 TW8 9GS, United Kingdom
 (770) GLAXO GROUP LIMITED
 980 Great West Road, Brentford, Middlesex
 TW8 9GS, United Kingdom
 (580) 2017 01 18

(111) M 1998 010986 R1
 (732) GLAXOSMITHKLINE CONSUMER
 HEALTHCARE (UK) IP LIMITED
 980 Great West Road, Brentford, Middlesex
 TW8 9GS, United Kingdom
 (770) GLAXO GROUP LIMITED
 980 Great West Road, Brentford, Middlesex
 TW8 9GS, United Kingdom
 (580) 2017 01 18

(111) M 1998 010987 R1
 (732) GLAXOSMITHKLINE CONSUMER
 HEALTHCARE (UK) IP LIMITED
 980 Great West Road, Brentford, Middlesex
 TW8 9GS, United Kingdom
 (770) GLAXO GROUP LIMITED
 980 Great West Road, Brentford, Middlesex
 TW8 9GS, United Kingdom
 (580) 2017 01 18

(111) M 1998 010988 R1
 (732) GLAXOSMITHKLINE CONSUMER
 HEALTHCARE (UK) IP LIMITED
 980 Great West Road, Brentford, Middlesex
 TW8 9GS, United Kingdom

(770) GLAXO GROUP LIMITED
980 Great West Road, Brentford, Middlesex
TW8 9GS, United Kingdom
(580) 2017 01 18

(111) M 1998 011019 R1
(732) GLAXOSMITHKLINE CONSUMER
HEALTHCARE (UK) IP LIMITED
980 Great West Road, Brentford, Middlesex
TW8 9GS, United Kingdom
(770) GLAXO GROUP LIMITED
980 Great West Road, Brentford, Middlesex
TW8 9GS, United Kingdom
(580) 2017 01 18

(111) M 1998 011029 R1
(732) GLAXOSMITHKLINE CONSUMER
HEALTHCARE (UK) IP LIMITED
980 Great West Road, Brentford, Middlesex
TW8 9GS, United Kingdom
(770) GlaxoSmithKline LLC, Corporation Service
Company
2711 Centerville Road, Suite 400,
Wilmington, Delaware 19808, USA
(580) 2017 01 11

(111) M 1998 011069 R1
(732) GLAXOSMITHKLINE CONSUMER
HEALTHCARE (UK) IP LIMITED
980 Great West Road, Brentford, Middlesex
TW8 9GS, United Kingdom
(770) GlaxoSmithKline LLC, Corporation Service
Company
2711 Centerville Road, Suite 400,
Wilmington, Delaware 19808, USA
(580) 2017 01 11

(111) M 1999 011582 R1
(732) NOVARTIS CONSUMER HEALTH S.A.
Route de L'Etlaz, 1197 Prangins, Switzerland
(770) NOVARTIS AG
CH-4002 Basel, Switzerland
(580) 2017 01 13

(111) M 1999 011612 R1
(732) HENKEL IP & HOLDING GmbH
Henkelstrasse 67, 40589 Dusseldorf,
Germany
(770) HENKEL CORPORATION
One Henkel Way, Rocky Hill, Connecticut,
06067, USA
(580) 2017 01 11

(111) M 1999 012422 R1
(732) GLAXOSMITHKLINE CONSUMER
HEALTHCARE (UK) IP LIMITED
980 Great West Road, Brentford, Middlesex
TW8 9GS, United Kingdom
(770) GlaxoSmithKline LLC, Corporation Service
Company
2711 Centerville Road, Suite 400,
Wilmington, Delaware 19808, USA
(580) 2017 01 11

(111) M 1999 012423 R1
(732) GLAXOSMITHKLINE CONSUMER
HEALTHCARE (UK) IP LIMITED
980 Great West Road, Brentford, Middlesex
TW8 9GS, United Kingdom
(770) GlaxoSmithKline LLC, Corporation Service
Company
2711 Centerville Road, Suite 400,
Wilmington, Delaware 19808, USA
(580) 2017 01 11

(111) M 1999 012447 R1
(732) GLAXOSMITHKLINE CONSUMER
HEALTHCARE (UK) IP LIMITED
980 Great West Road, Brentford, Middlesex
TW8 9GS, United Kingdom
(770) GlaxoSmithKline LLC, Corporation Service
Company
2711 Centerville Road, Suite 400,
Wilmington, Delaware 19808, USA
(580) 2017 01 10

(111) M 1999 012448 R1
(732) GLAXOSMITHKLINE CONSUMER
HEALTHCARE (UK) IP LIMITED
980 Great West Road, Brentford, Middlesex
TW8 9GS, United Kingdom
(770) GlaxoSmithKline LLC, Corporation Service
Company
2711 Centerville Road, Suite 400,
Wilmington, Delaware 19808, USA
(580) 2017 01 11

(111) M 1999 012449 R1
(732) GLAXOSMITHKLINE CONSUMER
HEALTHCARE (UK) IP LIMITED
980 Great West Road, Brentford, Middlesex
TW8 9GS, United Kingdom
(770) GlaxoSmithKline LLC, Corporation Service
Company
2711 Centerville Road, Suite 400,
Wilmington, Delaware 19808, USA
(580) 2017 01 11

(111) M 1999 012452 R1
(732) GLAXOSMITHKLINE CONSUMER
HEALTHCARE (UK) IP LIMITED
980 Great West Road, Brentford, Middlesex
TW8 9GS, United Kingdom

(770) GlaxoSmithKline LLC, Corporation Service
Company
2711 Centerville Road, Suite 400,
Wilmington, Delaware 19808, USA
(580) 2017 01 11

(111) M 1999 012453 R1
(732) GLAXOSMITHKLINE CONSUMER
HEALTHCARE (UK) IP LIMITED
980 Great West Road, Brentford, Middlesex
TW8 9GS, United Kingdom

(770) GlaxoSmithKline LLC, Corporation Service
Company
2711 Centerville Road, Suite 400,
Wilmington, Delaware 19808, USA
(580) 2017 01 11

(111) M 1999 012825 R1
(732) GLAXOSMITHKLINE CONSUMER
HEALTHCARE (UK) IP LIMITED
980 Great West Road, Brentford, Middlesex
TW8 9GS, United Kingdom

(770) SMITHKLINE BEECHAM LIMITED
980 Great West Road, Brentford, Middlesex
TW8 9GS, United Kingdom
(580) 2017 01 10

(111) M 2000 013174 R1
(732) RECKITT BENCKISER VANISH B.V.
Siriusdreef 14, 2132 WT, Hoofddorp,
Netherlands

(770) RECKITT BENCKISER N.V.
Siriusdreef 14, 2132 WT, Hoofddorp,
Netherlands (580) 2017 01 25

(111) M 2000 013244 R1
(732) GLAXOSMITHKLINE CONSUMER
HEALTHCARE (UK) IP LIMITED
980 Great West Road, Brentford, Middlesex
TW8 9GS, United Kingdom

(770) GLAXO GROUP LIMITED
980 Great West Road, Brentford, Middlesex
TW8 9GS, United Kingdom
(580) 2017 01 18

(111) M 1996 001458 R2
(732) COORS BREWING COMPANY
1801 California Street, Suite 4600, Denver,
Colorado 80202, USA

(770) MILLER BREWING INTERNATIONAL,
INC.

3939 West Highland Boulevard, Milwaukee,
Wisconsin 53208, USA
(580) 2017 01 13

(111) M 2003 015255 R1
(732) GLAXOSMITHKLINE CONSUMER
HEALTHCARE (UK) IP LIMITED
980 Great West Road, Brentford, Middlesex
TW8 9GS, United Kingdom

(770) GLAXO GROUP LIMITED
980 Great West Road, Brentford, Middlesex
TW8 9GS, United Kingdom
(580) 2017 01 18

(111) M 2005 016217 R1
(732) GLAXOSMITHKLINE CONSUMER
HEALTHCARE (UK) IP LIMITED
980 Great West Road, Brentford, Middlesex
TW8 9GS, United Kingdom

(770) GLAXO GROUP LIMITED
980 Great West Road, Brentford, Middlesex
TW8 9GS, United Kingdom
(580) 2017 01 31

(111) M 2007 017640 R
(732) NOVARTIS CONSUMER HEALTH S.A.
Route de L'Etlaz, 1197 Prangins, Switzerland
(770) NOVARTIS AG
4002 Basel, Switzerland
(580) 2017 01 13

(111) M 2007 017641 R
(732) NOVARTIS CONSUMER HEALTH S.A.
Route de L'Etlaz, 1197 Prangins, Switzerland
(770) NOVARTIS AG
4002 Basel, Switzerland
(580) 2017 01 13

(111) M 2007 017643 R
(732) NOVARTIS CONSUMER HEALTH S.A.
Route de L'Etlaz, 1197 Prangins, Switzerland
(770) NOVARTIS AG
4002 Basel, Switzerland
(580) 2017 01 13

(111) M 2007 017644 R
(732) NOVARTIS CONSUMER HEALTH S.A.
Route de L'Etlaz, 1197 Prangins, Switzerland
(770) NOVARTIS AG
4002 Basel, Switzerland
(580) 2017 01 13

(111) M 2007 017645 R
(732) NOVARTIS CONSUMER HEALTH S.A.
Route de L'Etlaz, 1197 Prangins, Switzerland
(770) NOVARTIS AG
4002 Basel, Switzerland
(580) 2017 01 16

(111) M 2007 017646 R
(732) NOVARTIS CONSUMER HEALTH S.A.
Route de L'Etlaz, 1197 Prangins, Switzerland
(770) NOVARTIS AG
4002 Basel, Switzerland
(580) 2017 01 13

(111) M 2007 017648 R
(732) NOVARTIS CONSUMER HEALTH S.A.
Route de L'Etlaz, 1197 Prangins, Switzerland
(770) NOVARTIS AG
4002 Basel, Switzerland
(580) 2017 01 16

(111) M 2007 018045 R
(732) NOVARTIS CONSUMER HEALTH S.A.
Route de L'Etlaz, 1197 Prangins, Switzerland
(770) NOVARTIS AG
4002 Basel, Switzerland
(580) 2017 01 13

(111) M 2007 018048 R
(732) NOVARTIS CONSUMER HEALTH S.A.
Route de L'Etlaz, 1197 Prangins, Switzerland
(770) NOVARTIS AG
4002 Basel, Switzerland
(580) 2017 01 13

(111) M 2007 018049 R
(732) NOVARTIS CONSUMER HEALTH S.A.
Route de L'Etlaz, 1197 Prangins, Switzerland
(770) NOVARTIS AG
4002 Basel, Switzerland
(580) 2017 01 13

(111) M 2007 018089 R
(732) NOVARTIS CONSUMER HEALTH S.A.
Route de L'Etlaz, 1197 Prangins, Switzerland
(770) NOVARTIS AG
4002 Basel, Switzerland
(580) 2017 01 13

(111) M 2007 018090 R
(732) NOVARTIS CONSUMER HEALTH S.A.
Route de L'Etlaz, 1197 Prangins, Switzerland
(770) NOVARTIS AG

4002 Basel, Switzerland
(580) 2017 01 13

(111) M 2007 018091 R
(732) NOVARTIS CONSUMER HEALTH S.A.
Route de L'Etlaz, 1197 Prangins, Switzerland
(770) NOVARTIS AG
4002 Basel, Switzerland
(580) 2017 01 13

(111) M 2008 018552 R
(732) NOVARTIS CONSUMER HEALTH S.A.
Route de L'Etlaz, 1197 Prangins, Switzerland
(770) NOVARTIS AG
4002 Basel, Switzerland
(580) 2017 01 13

(111) M 2008 018741 R
(732) NOVARTIS CONSUMER HEALTH S.A.
Route de L'Etlaz, 1197 Prangins, Switzerland
(770) NOVARTIS AG
4002 Basel, Switzerland
(580) 2017 01 13

(111) M 2008 018742 R
(732) NOVARTIS CONSUMER HEALTH S.A.
Route de L'Etlaz, 1197 Prangins, Switzerland
(770) NOVARTIS AG
4002 Basel, Switzerland
(580) 2017 01 13

(111) M 2009 019498 R
(732) NOVARTIS CONSUMER HEALTH S.A.
Route de L'Etlaz, 1197 Prangins, Switzerland
(770) NOVARTIS AG
4002 Basel, Switzerland
(580) 2017 01 16

(111) M 2009 019689 R
(732) H.J. HEINZ COMPANY BRANDS LLC
One PPG PPlace, Suite 3100, Pittsburgh,
PA 15222, USA
(770) H. J. HEINZ COMPANY
One PPG Place, Suite 3100, Pittsburgh,
PA 15222, USA
(580) 2017 01 30

(111) M 2009 019691 R
(732) H.J. HEINZ COMPANY BRANDS LLC
One PPG PPlace, Suite 3100, Pittsburgh,
PA 15222, USA
(770) H. J. HEINZ COMPANY

One PPG Place, Suite 3100, Pittsburgh,
PA 15222, USA
(580) 2017 01 30

(111) M 2009 019693 R
(732) H.J. HEINZ COMPANY BRANDS LLC
One PPG PPlace, Suite 3100, Pittsburgh,
PA 15222, USA
(770) H. J. HEINZ COMPANY
One PPG Place, Suite 3100, Pittsburgh,
PA 15222, USA
(580) 2017 01 30

(111) M 2009 019694 R
(732) H.J. HEINZ COMPANY BRANDS LLC
One PPG PPlace, Suite 3100, Pittsburgh,
PA 15222, USA
(770) H. J. HEINZ COMPANY
One PPG Place, Suite 3100, Pittsburgh,
PA 15222, USA
(580) 2017 01 30

(111) M 2009 019820 R
(732) NOVARTIS CONSUMER HEALTH S.A.
Route de L'Etlaz, 1197 Prangins, Switzerland
(770) NOVARTIS AG
4002 Basel, Switzerland
(580) 2017 01 16

(111) M 2009 019931 R
(732) GLAXOSMITHKLINE CONSUMER
HEALTHCARE (UK) IP LIMITED
980 Great West Road, Brentford, Middlesex
TW8 9GS, United Kingdom
(770) GLAXO GROUP LIMITED
980 Great West Road, Brentford, Middlesex
TW8 9GS, United Kingdom
(580) 2017 01 18

(111) M 2010 020255 R
(732) GLAXOSMITHKLINE CONSUMER
HEALTHCARE (UK) IP LIMITED
980 Great West Road, Brentford, Middlesex
TW8 9GS, United Kingdom
(770) GLAXO GROUP LIMITED
980 Great West Road, Brentford, Middlesex
TW8 9GS, United Kingdom
(580) 2017 01 31

(111) M 2010 020256 R
(732) GLAXOSMITHKLINE CONSUMER
HEALTHCARE (UK) IP LIMITED
980 Great West Road, Brentford, Middlesex
TW8 9GS, United Kingdom
(770) GLAXO GROUP LIMITED

980 Great West Road, Brentford, Middlesex
TW8 9GS, United Kingdom
(580) 2017 01 31

(111) M 2010 020310 R
(732) GLAXOSMITHKLINE CONSUMER
HEALTHCARE (UK) IP LIMITED
980 Great West Road, Brentford, Middlesex
TW8 9GS, United Kingdom
(770) GLAXO GROUP LIMITED
980 Great West Road, Brentford, Middlesex
TW8 9GS, United Kingdom
(580) 2017 01 31

(111) M 2011 021263 R
(732) LTD "NARINJISFERI FARMATSENTRI"
Nutsubidzis III mkr., II kv., korp.I, b. 37,
0186, Tbilisi, Georgia
(770) LTD "FARMA SERVISI"
Guramishvilis gamz.30, korp.I, bina 8, 0192,
Tbilisi, Georgia
(580) 2010 12 24

(111) M 2012 022566 R
(732) GLAXOSMITHKLINE CONSUMER
HEALTHCARE (UK) IP LIMITED
980 Great West Road, Brentford, Middlesex
TW8 9GS, United Kingdom
(770) GlaxoSmithKline LLC Corporation Service
Company
2711 Centerville Road, Suite 400,
Wilmington, 19808 Delaware, USA
(580) 2017 01 11

(111) M 2012 023145 R
(732) NESTLE SKIN HEALTH S.A.
Avenue Gratta-Paille 2, CH-1018 Lausanne,
France
(770) GALDERMA S.A.
Zugerstrasse 8, CH-6330 CHAM, Switzerland
(580) 2017 01 05

(111) M 2013 023323 R
(732) SWEDISH ORPHAN BIOVITRUM AB
(PUBL)
SE-112 76 Stockholm, Sweden
(770) BIOGEN MA INC., a Massachusetts
Corporation
250 Binney Street, Cambridge, Massachusetts
02142, USA
(580) 2017 01 25

(111) M 2013 023484 R
(732) H.J. HEINZ COMPANY BRANDS LLC
One PPG PPlace, Suite 3100, Pittsburgh,
PA 15222, USA
(770) H.J. HEINZ COMPANY
One PPG PPlace, Suite 3100, Pittsburgh,
PA 15222, USA
(580) 2017 01 30

(111) M 2013 024029 R
(732) ZELMER SPOLKA AKCYJNA
ul. Hofmanowej 19, 35-016 Rzeszow, Poland
(770) ZELMER PRO Sp. z o.o.
ul. Hofmanowej 19, 35-016 Rzeszow, Poland
(580) 2017 01 27

(111) M 2013 024029 R
(732) BSH HAUSGERÄTE GMBH
Carl - Wery - Straße 34, 81739 München,
Germany
(770) ZELMER SPOLKA AKCYJNA
ul. Hofmanowej 19, 35-016 Rzeszow, Poland
(580) 2017 01 27

(111) M 2013 024109 R
(732) NESTLE SKIN HEALTH S.A.
Avenue Gratta-Paille 2, CH-1018 Lausanne,
France
(770) GALDERMA S.A.
Zugerstrasse 8, CH-6330 CHAM,
Switzerland
(580) 2017 01 05

(111) M 2013 024110 R
(732) NESTLE SKIN HEALTH S.A.
Avenue Gratta-Paille 2, CH-1018 Lausanne,
France
(770) GALDERMA S.A.
Zugerstrasse 8, CH-6330 CHAM, Switzerland
(580) 2017 01 05

(111) M 2014 024498 R
(732) NESTLE SKIN HEALTH S.A.
Avenue Gratta-Paille 2, CH-1018 Lausanne,
France
(770) GALDERMA S.A.
Zugerstrasse 8, CH-6330 CHAM,
Switzerland
(580) 2017 01 05

(111) M 2014 024499 R
(732) NESTLE SKIN HEALTH S.A.
Avenue Gratta-Paille 2, CH-1018 Lausanne,
France

(770) GALDERMA S.A.
Zugerstrasse 8, CH-6330 CHAM,
Switzerland
(580) 2017 01 05

(111) M 2014 024861 R
(732) NESTLE SKIN HEALTH S.A.
Avenue Gratta-Paille 2, CH-1018 Lausanne,
France
(770) GALDERMA S.A.
Zugerstrasse 8, CH-6330 CHAM,
Switzerland
(580) 2017 01 05

(111) M 2014 025025 R
(732) HANJIN KAL Corp.
88, Sogong-ro, Jung-gu, Seoul, Republic of
Korea
(770) HANJIN SHIPPING CO., LTD.
25, Gukjegeumyung-ro 2-gil,
Youngdeungpo-gu, Seoul, Republic of
Korea
(580) 2017 02 01

(111) M 2014 025026 R
(732) HANJIN KAL Corp.
88, Sogong-ro, Jung-gu, Seoul, Republic of
Korea
(770) HANJIN SHIPPING CO., LTD.,
25, Gukjegeumyung-ro 2-gil,
Youngdeungpo-gu, Seoul, Republic of
Korea
(580) 2017 02 01

(111) M 2015 025588 R
(732) LUTOSA
Zone Industrielle du Vieux-Pont, 7900
Leuze-en-Hainaut, Belgium
(770) LTD "JEO-KOOP"
A. Tvalchrelidzis q. 2, 0182, Tbilisi, Georgia
(580) 2017 01 24

(111) M 1996 002984 R2
(732) PROGRAMMA 2002 S.P.A.
Piazza Tiziano 8, Pieve di Cadore (BL), Italy
(770) Safilo Società Azionaria Fabbrica Italiana
Lavorazione Occhiali S.p.A.
Piazza Tiziano, 8-32044 Pieve di Cadore,
Belluno, Italy
(580) 2017 01 24

(111) M 1996 002984 R2
(732) PROGRAMMA 2001 S.P.A.
Piazza Tiziano 8, Pieve di Cadore (BL), Italy

(770) Safilo - Società Azionaria Fabbrica Italiana
Lavorazione Occhiali - S.p.A.
Piazza Tiziano 8, Pieve di Cadore (BL), Italy
(580) 2017 01 24

(111) M 1996 002989 R2
(732) COORS BREWING COMPANY
1801 California Street, Suite 4600, Denver,
Colorado 80202, USA
(770) MILLER BREWING INTERNATIONAL,
INC.
3939 West Highland Boulevard, Milwaukee,
Wisconsin 53208, USA
(580) 2017 01 13

(111) M 1996 004073 R2
(732) BODEGAS FUNDADOR S.L.
Avenida Del Prezidente Carmona No.10,
28020 Madrid, Spain
(770) BEAM SPAIN, S.L.
Calle Mahonia No.2, Madrid, Spain
(580) 2017 01 27

(111) M 1997 004309 R2
(732) BODEGAS FUNDADOR S.L.
Avenida Del Prezidente Carmona No.10,
28020 Madrid, Spain
(770) BEAM SPAIN, S.L.
Calle Mahonia No.2, Madrid, Spain
(580) 2017 01 27

(111) M 1997 004321 R2
(732) BODEGAS FUNDADOR S.L.
Avenida Del Prezidente Carmona No.10,
28020 Madrid, Spain
(770) BEAM SPAIN, S.L.
Calle Mahonia No.2, Madrid, Spain
(580) 2017 01 27

(111) M 1997 004441 R1
(732) GLAXOSMITHKLINE CONSUMER
HEALTHCARE (UK) IP LLC
CORPORATION SERVICE COMPANY
2711 Centerville Road, Suite 400,
Wilmington, Delaware, 19808, USA
(770) GlaxoSmithKline LLC, Corporation Service
Company
2711 Centerville Road, Suite 400,
Wilmington, Delaware 19808, USA
(580) 2017 01 10

(111) M 1997 004912 R2
(732) HENKEL IP & HOLDING GmbH
Henkelstrasse 67, 40589 Dusseldorf,
Germany

(770) HENKEL CORPORATION
One Henkel Way, Rocky Hill, Connecticut,
06067, USA
(580) 2017 01 11

(111) M 1997 005196 R1
(732) NESTLE SKIN HEALTH S.A.
Avenue Gratta-Paille 2, CH-1018 Lausanne,
France
(770) GALDERMA S.A.
CH-6330 Cham, Switzerland
(580) 2017 01 05

(111) M 1997 005323 R1
(732) LIVELLE
243-425, rue Jean Jaures - 59650
VILLENEUVE d'ASCQ, France
(770) 3 SUISSSES FRANCE SAS
12, rue de la Centenaire 59170 Croix, France
(580) 2017 01 24

(111) M 1997 005422 R1
(732) GLAXOSMITHKLINE CONSUMER
HEALTHCARE (UK) IP LIMITED
980 Great West Road, Brentford, Middlesex
TW8 9GS, United Kingdom
(770) GlaxoSmithKline LLC, Corporation Service
Company
2711 Centerville Road, Suite 400,
Wilmington, Delaware 19808, USA
(580) 2017 01 10

(111) M 1997 005615 R1
(732) NOVARTIS CONSUMER HEALTH S.A.
Route de L'Etlaz, 1197 Prangins, Switzerland
(770) NOVARTIS AG
4002 Basel, Switzerland
(580) 2017 01 16

(111) M 1997 005924 R1
(732) GLAXOSMITHKLINE CONSUMER
HEALTHCARE (UK) IP LIMITED
980 Great West Road, Brentford, Middlesex
TW8 9GS, United Kingdom
(770) GLAXO GROUP LIMITED
980 Great West Road, Brentford, Middlesex
TW8 9GS, United Kingdom
(580) 2017 01 18

(111) M 1997 005925 R1
(732) GLAXOSMITHKLINE CONSUMER
HEALTHCARE (UK) IP LIMITED
980 Great West Road, Brentford, Middlesex
TW8 9GS, United Kingdom

(770) GLAXO GROUP LIMITED
980 Great West Road, Brentford, Middlesex
TW8 9GS, United Kingdom
(580) 2017 01 18

(111) M 1997 006088 R1
(732) NOVARTIS CONSUMER HEALTH S.A.
Route de L'Etlaz, 1197 Prangins, Switzerland
(770) NOVARTIS AG
4002 Basel, Switzerland
(580) 2017 01 13

(111) M 1997 006220 R1
(732) AVENTISUB II INC.
3711 Kennett Pike, Suite 200, Greenville,
Delaware 19807, USA
(770) AVENTIS HOLDINGS INC.
3711 Kennett Pike, Suite 200, Greenville DE
19807, USA
(580) 2017 01 24

(111) M 1997 006220 R1
(732) AVENTIS HOLDINGS INC.
3711 Kennett Pike, Suite 200, Greenville,
Delaware, 19807, USA
(770) AVENTISUB II INC.
3711 Kennett Pike, Suite 200, Greenville,
Delaware 19807, USA
(580) 2017 01 24

(111) M 1997 006220 R1
(732) AVENTISUB INC.
3711 Kennett Pike, Suite 200, Greenville,
Delaware 19807, USA
(770) AVENTIS HOLDINGS INC.
3711 Kennett Pike, Suite 200, Greenville,
Delaware, 19807, USA
(580) 2017 01 24

(111) M 1997 006221 R1
(732) AVENTISUB II INC.
3711 Kennett Pike, Suite 200, Greenville,
Delaware 19807, USA
(770) AVENTIS HOLDINGS INC.
3711 Kennett Pike, Suite 200, Greenville
DE 19807, USA
(580) 2017 01 24

(111) M 1997 006221 R1
(732) AVENTIS HOLDINGS INC.
3711 Kennett Pike, Suite 200, Greenville,
Delaware, 19807, USA
(770) AVENTISUB II INC.

3711 Kennett Pike, Suite 200, Greenville,
Delaware 19807, USA
(580) 2017 01 24

(111) M 1997 006221 R1
(732) AVENTISUB INC.
3711 Kennett Pike, Suite 200, Greenville,
Delaware 19807, USA
(770) AVENTIS HOLDINGS INC.
3711 Kennett Pike, Suite 200, Greenville,
Delaware, 19807, USA
(580) 2017 01 24

(111) M 1995 000646 R2
(732) GLAXOSMITHKLINE CONSUMER
HEALTHCARE (UK) IP LIMITED
980 Great West Road, Brentford, Middlesex
TW8 9GS, United Kingdom
(770) GLAXO GROUP LIMITED
980 Great West Road, Brentford, Middlesex
TW8 9GS, United Kingdom
(580) 2017 01 18

(111) M 1995 000648 R2
(732) GLAXOSMITHKLINE CONSUMER
HEALTHCARE (UK) IP LIMITED
980 Great West Road, Brentford, Middlesex
TW8 9GS, United Kingdom
(770) GLAXO GROUP LIMITED
980 Great West Road, Brentford, Middlesex
TW8 9GS, United Kingdom
(580) 2017 01 31

(111) M 1997 006752 R1
(732) HENKEL IP & HOLDING GmbH
Henkelstrasse 67, 40589 Dusseldorf,
Germany
(770) HENKEL CORPORATION
One Henkel Way, Rocky Hill, Connecticut,
06067, USA
(580) 2017 01 11

(111) M 1997 006753 R1
(732) HENKEL IP & HOLDING GmbH
Henkelstrasse 67, 40589 Dusseldorf,
Germany
(770) HENKEL CORPORATION
One Henkel Way, Rocky Hill, Connecticut,
06067, USA
(580) 2017 01 11

(111) M 1997 006756 R2
 (732) HENKEL IP & HOLDING GmbH
 Henkelstrasse 67, 40589 Dusseldorf,
 Germany
 (770) HENKEL CORPORATION
 One Henkel Way, Rocky Hill, Connecticut,
 06067, USA
 (580) 2017 01 11

(111) M 1997 007298 R1
 (732) NESTLE SKIN HEALTH S.A.
 Avenue Gratta-Paille 2, CH-1018 Lausanne,
 France
 (770) GALDERMA S.A.
 CH-6330 Cham, Switzerland
 (580) 2017 01 05

(111) M 1997 007645 R1
 (732) H.J. HEINZ COMPANY BRANDS LLC
 One PPG PPlace, Suite 3100, Pittsburgh,
 PA 15222, USA
 (770) H.J. HEINZ COMPANY
 One PPG PPlace, Suite 3100, Pittsburgh,
 PA 15222, USA
 (580) 2017 01 30

(111) M 1997 007684 R1
 (732) GLAXOSMITHKLINE CONSUMER
 HEALTHCARE (UK) IP LIMITED
 980 Great West Road, Brentford, Middlesex
 TW8 9GS, United Kingdom
 (770) GLAXO GROUP LIMITED
 980 Great West Road, Brentford, Middlesex
 TW8 9GS, United Kingdom
 (580) 2017 01 31

(111) M 1997 007879 R1
 (732) SABMILLER INTERNATIONAL BRANDS
 LIMITED
 Church Street West, Woking, Surrey
 GU21 6HS, United Kingdom
 (770) PERONI NASTRO AZZURRO LIMITED
 IOMA House, Hope Street Douglas, Isle
 of Man, 1M1 1AP, United Kingdom
 (580) 2017 01 27

(111) M 1997 007880 R1
 (732) SABMILLER INTERNATIONAL BRANDS
 LIMITED
 Church Street West, Woking, Surrey
 GU21 6HS, United Kingdom
 (770) PERONI NASTRO AZZURRO LIMITED
 IOMA House, Hope Street Douglas, Isle
 of Man, 1M1 1AP, United Kingdom

(580) 2017 01 27

(111) M 1998 009082 R1
 (732) GLAXOSMITHKLINE CONSUMER
 HEALTHCARE (UK) IP LIMITED
 980 Great West Road, Brentford, Middlesex
 TW8 9GS, United Kingdom
 (770) GLAXO GROUP LIMITED
 980 Great West Road, Brentford, Middlesex
 TW8 9GS, United Kingdom
 (580) 2017 01 18

(111) M 1998 009455 R1
 (732) VELCRO BVBA
 Industrielaan 16, 9800 Deinze, Belgium
 (770) VELCRO INDUSTRIES B.V.
 Castorweg 22-24, Curacao, Netherlands
 (580) 2017 02 01

(111) M 1998 009495 R1
 (732) H.J. HEINZ COMPANY BRANDS LLC
 One PPG PPlace, Suite 3100, Pittsburgh,
 PA 15222, USA
 (770) H.J. HEINZ COMPANY
 One PPG PPlace, Suite 3100, Pittsburgh,
 PA 15222, USA
 (580) 2017 01 30

(111) M 1998 009797 R1
 (732) GlaxoSmithKline LLC Corporation Service
 Company
 2711 Centerville Road, Suite 400,
 Wilmington, Delaware, 19808, USA
 (770) GLAXOSMITHKLINE LLC
 Corporation Service Company, 2711
 Centerville Road, Suite 400, Wilmington,
 Country of New Castle, Delaware 19808, USA
 (580) 2017 01 10

(111) M 1998 009833 R1
 (732) GLAXOSMITHKLINE CONSUMER
 HEALTHCARE (UK) IP LIMITED
 980 Great West Road, Brentford, Middlesex
 TW8 9GS, United Kingdom
 (770) GLAXO GROUP LIMITED
 980 Great West Road, Brentford, Middlesex
 TW8 9GS, United Kingdom
 (580) 2017 01 18

(111) M 1998 009834 R1
 (732) GLAXOSMITHKLINE CONSUMER
 HEALTHCARE (UK) IP LIMITED
 980 Great West Road, Brentford, Middlesex
 TW8 9GS, United Kingdom

(770) GLAXO GROUP LIMITED
980 Great West Road, Brentford, Middlesex
TW8 9GS, United Kingdom
(580) 2017 01 18

(111) M 1998 009835 R1
(732) GLAXOSMITHKLINE CONSUMER
HEALTHCARE (UK) IP LIMITED
980 Great West Road, Brentford, Middlesex
TW8 9GS, United Kingdom
(770) GLAXO GROUP LIMITED
980 Great West Road, Brentford, Middlesex
TW8 9GS, United Kingdom
(580) 2017 01 18

(111) M 1998 009890 R1
(732) H.J. HEINZ COMPANY BRANDS LLC
One PPG PPlace, Suite 3100, Pittsburgh,
PA 15222, USA
(770) H.J. HEINZ COMPANY,
One PPG PPlace, Suite 3100, Pittsburgh,
PA 15222, USA
(580) 2017 01 30

(111) M 1998 009891 R1
(732) H.J. HEINZ COMPANY BRANDS LLC
One PPG PPlace, Suite 3100, Pittsburgh,
PA 15222, USA
(770) H.J. HEINZ COMPANY
One PPG PPlace, Suite 3100, Pittsburgh,
PA 15222, USA
(580) 2017 01 30

(111) M 1998 009892 R1
(732) H.J. HEINZ COMPANY BRANDS LLC
One PPG PPlace, Suite 3100, Pittsburgh,
PA 15222, USA
(770) H.J. HEINZ COMPANY
One PPG PPlace, Suite 3100, Pittsburgh,
PA 15222, USA
(580) 2017 01 30

(111) M 1998 009893 R1
(732) H.J. HEINZ COMPANY BRANDS LLC
One PPG PPlace, Suite 3100, Pittsburgh,
PA 15222, USA
(770) H.J. HEINZ COMPANY
One PPG PPlace, Suite 3100, Pittsburgh,
PA 15222, USA
(580) 2017 01 30

(111) M 1998 009894 R1
(732) H.J. HEINZ COMPANY BRANDS LLC
One PPG PPlace, Suite 3100, Pittsburgh, PA
15222, USA
(770) H.J. HEINZ COMPANY
One PPG PPlace, Suite 3100, Pittsburgh,
PA 15222, USA
(580) 2017 01 30

(111) M 1998 009921 R1
(732) GLAXOSMITHKLINE CONSUMER
HEALTHCARE (UK) IP LIMITED
980 Great West Road, Brentford, Middlesex
TW8 9GS, United Kingdom
(770) GlaxoSmithKline LLC, Corporation Service
Company
2711 Centerville Road, Suite 400,
Wilmington, Delaware 19808, USA
(580) 2017 01 11

CHANGES IN NAMES AND/OR ADDRESSES OF OWNERS

- (111) M 2004 015439 R1
 (732) AFFINITY PETCARE, S.A.
 Plaza Euripa 54-56, 08902 L'Hospitalet
 de Llobregat, Barcelona, Spain
 (770) AFFINITY PETCARE, S.A.
 Plaça Xavier Cugat, numero 2 Edificio D,
 3a planta, 08174 Sant Cugat del Valles
 (Barcelona), Spain
 (580) 2017 01 24
-
- (111) M 2004 015674 R1
 (732) STARWOOD HOTELS & RESORTS
 WORLDWIDE, LLC
 10400 Fernwood Road, Dept. 955.23,
 Bethesda, Maryland 20817, USA
 (770) STARWOOD HOTELS & RESORTS
 WORLDWIDE, INC.
 One StarPoint, Stamford, Connecticut 06902,
 USA
 (580) 2017 01 24
-
- (111) M 2010 020627 R
 (732) LTD "BADAGONI"
 Sofeli Zemo Khodasheni, 0910, Akhmetis
 raioni, Georgia
 (770) LTD "BADAGONI"
 Tavisuflebis moedani 4, 0105, Tbilisi,
 Georgia
 (580) 2017 01 27
-
- (111) M 2012 022447 R
 (732) LTD "BADAGONI"
 Sof. Zemo Khodasheni, 0910, Akhmetis
 raioni, Georgia
 (770) LTD "BADAGONI"
 Tavisuflebis moedani 4, 0105, Tbilisi,
 Georgia
 (580) 2017 01 27
-
- (111) M 1996 002984 R2
 (732) SAFILO - SOCIETÀ AZIONARIA
 FABBRICA ITALIANA LAVORAZIONE
 OCCHIALI - S.P.A.
 Piazza Tiziano 8, Pieve di Cadore (BL), Italy
 (770) PROGRAMMA 2002 S.P.A.
 Piazza Tiziano 8, Pieve di Cadore (BL), Italy
 (580) 2017 01 24
-
- (111) M 1996 003939 R2
 (732) ARJOWIGGINS RIVES
 10 Rue Jean-Arnaud, Zone Artisanale
 Champfeuillet, 38500 VOIRON, France
- (770) ARJOWIGGINS RIVES
 Usine de Rives, 38140 Rives, France
 (580) 2017 02 01
-
- (111) M 1996 004124 R2
 (732) PACE PLC
 Victoria Road, Saltaire, Shipley, West
 Yorkshire, BD 18 3LF, United Kingdom
 (770) PACE MICRO TECHNOLOGY PLC
 Victoria Road, Saltaire, Shipley, West
 Yorkshire, BD 18 3LF, United Kingdom
 (580) 2017 01 24
-
- (111) M 1996 004124 R2
 (732) PACE LIMITED
 Victoria Road, Saltaire, Shipley, West
 Yorkshire, BD 18 3LF, United Kingdom
 (770) PACE PLC
 Victoria Road, Saltaire, Shipley, West
 Yorkshire, BD 18 3LF, United Kingdom
 (580) 2017 01 24
-
- (111) M 1997 004335 R2
 (732) ELLESSE INTERNATIONAL S.P.A.
 Via Mario Angeloni, 80/A, 06124 Perugia,
 Italy
 (770) ELLESSE INTERNATIONAL S.P.A.
 32, Via Filippo Turati, I-06074 CORCIANO
 Perugia, Italy
 (580) 2017 02 01
-
- (111) M 1997 004384 R2
 (732) GERD PETRIK
 Via Collina 43, 6612 Ascona, Switzerland
 (770) GERD PETRIK
 1538 North Casey Key Road, Osprey, FL
 34229, USA
 (580) 2017 01 27
-
- (111) M 1997 004989 R2
 (732) PALL CORPORATION
 25 Harbor Park Drive, Port Washington,
 NY 11050-4630, USA
 (770) PALL CORPORATION, a NEW YORK
 CORPORATION
 2200 Northern Boulevard, East Hills, New
 York 11548, USA
 (580) 2017 02 01
-

(111) M 1997 004990 R2
(732) PALL CORPORATION
25 Harbor Park Drive, Port Washington,
NY 11050-4630, USA
(770) PALL CORPORATION, a NEW YORK
CORPORATION
2200 Northern Boulevard, East Hills,
New York 11548, USA
(580) 2017 02 01

(111) M 1997 005146 R2
(732) KABUSHIKI KAISHA HITACHI
SEISAKUSHO
6-6, Marunouchi 1-chome, Chiyoda-ku,
Tokio, Japan
(770) KABUSHIKI KAISHA HITACHI
SEISAKUSHO
6, Kanda-Surugadai, 4-chome, Chiyoda-ku,
Tokyo, Japan
(580) 2017 02 01

(111) M 1997 005323 R1
(732) 3 SUISSES FRANCE SAS
12, rue de la Centenaire 59170 Croix, France
(770) 3 SUISSES FRANCE S.A.
4, Place de la Republique, 59170 Croix,
France
(580) 2017 01 24

(111) M 1997 006220 R1
(732) AVENTISUB LLC
3711 Kennett Pike, Suite 200, Greenville,
Delaware 19807, USA
(770) AVENTISUB INC.
3711 Kennett Pike, Suite 200, Greenville,
Delaware 19807, USA
(580) 2017 01 24

(111) M 1997 006221 R1
(732) AVENTISUB LLC
3711 Kennett Pike, Suite 200, Greenville,
Delaware 19807, USA
(770) AVENTISUB INC.
3711 Kennett Pike, Suite 200, Greenville,
Delaware 19807, USA
(580) 2017 01 24

(111) M 1998 009455 R1
(732) VELCRO INDUSTRIES B.V.
Castorweg 22-24, Curacao, Netherlands
(770) VELCRO INDUSTRIES B.V.
Castorweg 22-24, Curacao, Netherlands
Antilles, Netherlands
(580) 2017 02 01

CLASSIFICATION INDEXES

INVENTIONS

CONCORDANCE TABLE OF INTERNATIONAL CLASSIFICATION INDEX AND PUBLICATION NUMBERS

INTERNATIONAL CLASSIFICATION INDEXES (51)	NUMBER OF PUBLISHED APPLICATION (10)
A 61 K 9/00; A 61 K 9/14; A 61 K 31/40; A 61 K 31/439; A 61 K 31/4704; A 61 K 31/33	AP 2017 13715 A
A 61 K 38/06; A 61 K 38/48; A 61 K 31/737; C 08 B 37/00; C 12 N 9/50; C 12 P 13/12; A 61 P 29/00	AP 2017 13894 A
A 61 K 39/125	AP 2017 13384 A
B 01 J 20/18; C 02 F 1/28; C 02 F 1/64	AP 2017 14026 A
B 61 F 3/02	AP 2017 13515 A
C 07 C 273/042; B 01 J 19/24	AP 2017 13895 A
C 07 D 471/04	AP 2017 13595 A
C 07 D 487/04; A 61 K 31/53; A 61 P 25/18	AP 2017 13979 A
C 07 K 16/28	AP 2017 13362 A
C 22 B 5/04; C 22 C 33/00; B 22 F 3/23	AP 2017 13796 A
E 01 H 1/08	AP 2017 13347 A
E 04 B 1/34	AP 2017 13536 A
H 02 P 27/00	AP 2017 14037 A

CONCORDANCE TABLE OF PUBLICATION NUMBERS AND INTERNATIONAL CLASSIFICATION INDEX

NUMBER OF PUBLISHED APPLICATION (10)	INTERNATIONAL CLASSIFICATION INDEXES (51)
AP 2017 13347 A	E 01 H 1/08
AP 2017 13362 A	C 07 K 16/28
AP 2017 13384 A	A 61 K 39/125
AP 2017 13515 A	B 61 F 3/02
AP 2017 13536 A	E 04 B 1/34
AP 2017 13595 A	C 07 D 471/04
AP 2017 13715 A	A 61 K 9/00; A 61 K 9/14; A 61 K 31/40; A 61 K 31/439; A 61 K 31/4704; A 61 K 31/33
AP 2017 13796 A	C 22 B 5/04; C 22 C 33/00; B 22 F 3/23;
AP 2017 13894 A	A 61 K 38/06; A 61 K 38/48; A 61 K 31/737; C 08 B 37/00; C 12 N 9/50; C 12 P 13/12; A 61 P 29/00
AP 2017 13895 A	C 07 C 273/042; B 01 J 19/24
AP 2017 13979 A	C 07 D 487/04; A 61 K 31/53; A 61 P 25/18
AP 2017 14026 A	B 01 J 20/18; C 02 F 1/28; C 02 F 1/64
AP 2017 14037 A	H 02 P 27/00

**CONCORDANCE TABLE OF INTERNATIONAL CLASSIFICATION INDEX,
PATENT NUMBERS AND PUBLICATION NUMBERS**

INTERNATIONAL CLASSIFICATION INDEX (51)	NUMBER OF PATENT (11)	NUMBER OF PUBLISHED APPLICATION (10)
B 01 D 1/00; A 23 L 1/06; A 23 L 2/00	P 2017 6625 B	AP 2016 13943 A
C 03 B 37/09	P 2017 6617 B	AP 2016 13533 A
C 07 D 221/00, 223/02, 223/04, 231/04	P 2017 6611 B	AP 2016 9736 A
C 07 D 239/26; C 07 D 231/12; C 07 D 233/64; C 07 D 401/06; C 07 D 403/04; C 07 D 403/06; C 07 D 237/08; C 07 D 405/04; C 07 D 239/26; C 07 C 233/66; C 07 C 233/73; C 07 C 233/78; C 07 D 211/26; C 07 D 213/40; C 07 D 213/61	P 2017 6621 B	AP 2016 13785 A
C 07 D 249/08; C 07 D 401/12; C 07 D 403/12; C 07 D 409/12; A 61 K 31/497; A 61 K 31/4439; A 61 K 31/506; A 61 K 31/498; A 61 K 31/55; A 61 K 31/5377; A 61 P 35/00; A 61 P 31/12; A 61 P 29/00; A 61 P 27/02	P 2017 6616 B	AP 2016 13396 A
C 07 D 413/12; A 61 K 31/422; A 61 P 33/00; A 61 P 31/00	P 2017 6626 B	AP 2016 13967 A
C 07 D 487/04; C 07 D 519/00	P 2017 6620 B	AP 2016 13675 A
C 07 D 487/04; C 07 D 519/00; A 61 K 31/4985; A 61 K 31/519; A 61 K 31/5377; A 61 K 31/501; A 61 P 35/00	P 2017 6624 B	AP 2016 13859 A
C 07 D 487/04; C 07 D 519/00; A 61 K 31/53; A 61 P 11/00; A 61 P 9/00; A 61 P 25/00; A 61 P 31/12	P 2017 6623 B	AP 2016 13828 A
C 07 D 495/04; A 61 K 31/519; A 61 P 35/00; A 61 P 37/00	P 2017 6619 B	AP 2016 13667 A
C 08 G 73/06; C 08 L 79/06; A 61 P 41/00; C 07 D 401/04	P 2017 6614 B	AP 2016 13326 A
C 11 D 1/37; C 11 D 3/50; C 11 D 17/00; E 03 D 9/02; C 11 D 3/48	P 2017 6613 B	AP 2016 13113 A
C 12 N 15/09	P 2017 6612 B	AP 2016 12972 A
C 12 P 13/00, 13/02, 41/00; C 07 C 227/02, 229/28	P 2017 6618 B	AP 2016 13598 A
C 13 K 13/00; C 10 L 1/182; C 13 K 1/02; D 21 C 1/02	P 2017 6615 B	AP 2016 13363 A
C 22 B 5/04; C 22 C 33/00; B 22 F 3/23	P 2017 6622 B	AP 2016 13797 A

**CONCORDANCE TABLE OF PATENT NUMBERS,
PUBLICATION NUMBERS AND INTERNATIONAL CLASSIFICATION INDEX**

NUMBER OF PATENT (11)	NUMBER OF PUBLISHED APPLICATION (10)	INTERNATIONAL CLASSIFICATION INDEX (51)
P 2017 6611 B	AP 2016 9736 A	C 07 D 221/00, 223/02, 223/04, 231/04
P 2017 6612 B	AP 2016 12972 A	C 12 N 15/09
P 2017 6613 B	AP 2016 13113 A	C 11 D 1/37; C 11 D 3/50; C 11 D 17/00; E 03 D 9/02; C 11 D 3/48
P 2017 6614 B	AP 2016 13326 A	C 08 G 73/06; C 08 L 79/06; A 61 P 41/00; C 07 D 401/04
P 2017 6615 B	AP 2016 13363 A	C 13 K 13/00; C 10 L 1/182; C 13 K 1/02; D 21 C 1/02
P 2017 6616 B	AP 2016 13396 A	C 07 D 249/08; C 07 D 401/12; C 07 D 403/12; C 07 D 409/12; A 61 K 31/497; A 61 K 31/4439; A 61 K 31/506; A 61 K 31/498; A 61 K 31/55; A 61 K 31/5377; A 61 P 35/00; A 61 P 31/12; A 61 P 29/00; A 61 P 27/02
P 2017 6617 B	AP 2016 13533 A	C 03 B 37/09
P 2017 6618 B	AP 2016 13598 A	C 12 P 13/00, 13/02, 41/00; C 07 C 227/02, 229/28
P 2017 6619 B	AP 2016 13667 A	C 07 D 495/04; A 61 K 31/519; A 61 P 35/00; A 61 P 37/00
P 2017 6620 B	AP 2016 13675 A	C 07 D 487/04; C 07 D 519/00
P 2017 6621 B	AP 2016 13785 A	C 07 D 239/26; C 07 D 231/12; C 07 D 233/64; C 07 D 401/06; C 07 D 403/04; C 07 D 403/06; C 07 D 237/08; C 07 D 405/04; C 07 D 239/26; C 07 C 233/66; C 07 C 233/73; C 07 C 233/78; C 07 D 211/26; C 07 D 213/40; C 07 D 213/61
P 2017 6622 B	AP 2016 13797 A	C 22 B 5/04; C 22 C 33/00; B 22 F 3/23
P 2017 6623 B	AP 2016 13828 A	C 07 D 487/04; C 07 D 519/00; A 61 K 31/53; A 61 P 11/00; A 61 P 9/00; A 61 P 25/00; A 61 P 31/12
P 2017 6624 B	AP 2016 13859 A	C 07 D 487/04; C 07 D 519/00; A 61 K 31/4985; A 61 K 31/519; A 61 K 31/5377; A 61 K 31/501; A 61 P 35/00
P 2017 6625 B	AP 2016 13943 A	B 01 D 1/00; A 23 L 1/06; A 23 L 2/00
P 2017 6626 B	AP 2016 13967 A	C 07 D 413/12; A 61 K 31/422; A 61 P 33/00; A 61 P 31/00

**CONCORDANCE TABLE OF APPLICATION NUMBERS, PUBLICATION NUMBERS
AND PATENTS**

NUMBER OF APPLICATION (21)	NUMBER OF PUBLISHED APPLICATION (10)	NUMBER OF PATENT (11)
AP 2005 009736	AP 2016 9736 A	P 2017 6611 B
AP 2012 012972	AP 2016 12972 A	P 2017 6612 B
AP 2011 013113	AP 2016 13113 A	P 2017 6613 B
AP 2012 013326	AP 2016 13326 A	P 2017 6614 B
AP 2012 013363	AP 2016 13363 A	P 2017 6615 B
AP 2012 013396	AP 2016 13396 A	P 2017 6616 B
AP 2014 013533	AP 2016 13533 A	P 2017 6617 B
AP 2014 013598	AP 2016 13598 A	P 2017 6618 B
AP 2014 013667	AP 2016 13667 A	P 2017 6619 B
AP 2013 013675	AP 2016 13675 A	P 2017 6620 B
AP 2013 013785	AP 2016 13785 A	P 2017 6621 B
AP 2015 013797	AP 2016 13797 A	P 2017 6622 B
AP 2013 013828	AP 2016 13828 A	P 2017 6623 B
AP 2013 013859	AP 2016 13859 A	P 2017 6624 B
AP 2015 013943	AP 2016 13943 A	P 2017 6625 B
AP 2013 013967	AP 2016 13967 A	P 2017 6626 B

UTILITY MODELS

**CONCORDANCE TABLE OF INTERNATIONAL CLASSIFICATION INDEX,
PATENT NUMBERS AND PUBLICATION NUMBERS**

INTERNATIONAL CLASSIFICATION INDEX (51)	NUMBER OF PATENT (11)	NUMBER OF PUBLISHED APPLICATION (10)
H 02 K 17/00	U 2017 1926 Y	AU 2016 14085 U

**CONCORDANCE TABLE OF PATENT NUMBERS,
PUBLICATION NUMBERS AND INTERNATIONAL CLASSIFICATION INDEX**

NUMBER OF PATENT (11)	NUMBER OF PUBLISHED APPLICATION (10)	INTERNATIONAL CLASSIFICATION INDEX (51)
U 2017 1926 Y	AU 2016 14085 U	H 02 K 17/00

**CONCORDANCE TABLE OF APPLICATION NUMBERS, PUBLICATION NUMBERS
AND PATENTS**

NUMBER OF APPLICATION (21)	NUMBER OF PUBLISHED APPLICATION (10)	NUMBER OF PATENT (11)
AU 2016 014085	AU 2016 14085 U	U 2016 1926 Y

DESIGNS**CONCORDANCE TABLE OF INTERNATIONAL CLASSIFICATION INDEX,
PATENT NUMBERS AND PUBLICATION NUMBERS**

INTERNATIONAL CLASSIFICATION INDEX (51)	NUMBER OF PATENT (11)	NUMBER OF PUBLISHED APPLICATION (10)
09-03	D 2017 697 S	AD 2016 916 S
12-99	D 2017 696 S	AD 2016 915 S

**CONCORDANCE TABLE OF PATENT NUMBERS,
PUBLICATION NUMBERS AND INTERNATIONAL CLASSIFICATION INDEX**

NUMBER OF PATENT (11)	NUMBER OF PUBLISHED APPLICATION (10)	INTERNATIONAL CLASSIFICATION INDEX (51)
D 2017 696 S	AD 2016 915 S	12-99
D 2017 697 S	AD 2016 916 S	09-03

**CONCORDANCE TABLE OF APPLICATION NUMBERS, PUBLICATION NUMBERS
AND PATENTS**

NUMBER OF APPLICATION (21)	NUMBER OF PUBLISHED APPLICATION (10)	NUMBER OF PATENT (11)
AD 2016 000915	AD 2016 915 S	D 2017 696 S
AD 2016 000916	AD 2016 916 S	D 2017 697 S

TRADEMARKS

CONCORDANCE TABLE OF REGISTRATION NUMBERS, APPLICATION NUMBERS, PUBLICATION NUMBERS AND BULLETIN NUMBERS

NUMBER OF REGISTRATION (111)	NUMBER OF APPLICATIONS (210)	NUMBER OF PUBLISHED APPLICATIONS (260)	NUMBER OF BULLETIN
M 2017 28078 R	AM 89789	-	3(463)2017
M 2017 28079 R	AM 89946	-	3(463)2017
M 2017 28080 R	AM 89948	-	3(463)2017
M 2017 28081 R	AM 90349	-	3(463)2017
M 2017 28082 R	AM 90301	-	3(463)2017
M 2017 28083 R	AM 90484	-	3(463)2017
M 2017 28084 R	AM 90486	-	3(463)2017
M 2017 28085 R	AM 87583	-	3(463)2017
M 2017 28086 R	AM 88502	-	3(463)2017
M 2017 28087 R	AM 90411	-	3(463)2017
M 2017 28088 R	AM 90153	-	3(463)2017
M 2017 28089 R	AM 90421	-	3(463)2017
M 2017 28090 R	AM 87542	-	3(463)2017
M 2017 28091 R	AM 82583	AM 2016 82583 A	10(446)2016
M 2017 28092 R	AM 83579	AM 2016 83579 A	11(447)2016
M 2017 28093 R	AM 83580	AM 2016 83580 A	12(448)2016
M 2017 28094 R	AM 83581	AM 2016 83581 A	11(447)2016
M 2017 28095 R	AM 83582	AM 2016 83582 A	11(447)2016
M 2017 28096 R	AM 83583	AM 2016 83583 A	11(447)2016
M 2017 28097 R	AM 83724	AM 2016 83724 A	12(448)2016
M 2017 28098 R	AM 83725	AM 2016 83725 A	12(448)2016
M 2017 28099 R	AM 83726	AM 2016 83726 A	12(448)2016
M 2017 28100 R	AM 83993	AM 2016 83993 A	12(448)2016
M 2017 28101 R	AM 83994	AM 2016 83994 A	12(448)2016
M 2017 28102 R	AM 84254	AM 2016 84254 A	12(448)2016
M 2017 28103 R	AM 84404	AM 2016 84404 A	14(450)2016
M 2017 28104 R	AM 84453	AM 2016 84453 A	14(450)2016
M 2017 28105 R	AM 84592	AM 2016 84592 A	11(447)2016
M 2017 28106 R	AM 84675	AM 2016 84675 A	15(451)2016
M 2017 28107 R	AM 84699	AM 2016 84699 A	14(450)2016
M 2017 28108 R	AM 84827	AM 2016 84827 A	14(450)2016
M 2017 28109 R	AM 84872	AM 2016 84872 A	12(448)2016
M 2017 28110 R	AM 84933	AM 2016 84933 A	17(453)2016
M 2017 28111 R	AM 85142	AM 2016 85142 A	15(451)2016
M 2017 28112 R	AM 85235	AM 2016 85235 A	1(451)2016
M 2017 28113 R	AM 90560	-	3(463)2017
M 2017 28114 R	AM 6423	AM 2016 64923 A**	4(440)2016
M 2017 28115 R	AM 6422	AM 2016 64922 A**	4(440)2016
M 2017 28116 R	AM 6424	AM 2016 64924 A**	4(440)2016
M 2017 28117 R	AM 6425	AM 2016 64925 A**	4(440)2016
M 2017 28118 R	AM 6426	AM 2016 64926 A**	4(440)2016
M 2017 28119 R	AM 6427	AM 2016 64927 A**	4(440)2016
M 2017 28120 R	AM 6430	AM 2016 64930 A**	4(440)2016
M 2017 28121 R	AM 6431	AM 2016 64931 A**	4(440)2016
M 2017 28122 R	AM 85236	AM 2016 85236 A	18(454)2016
M 2017 28123 R	AM 85237	AM 2016 85237 A	18(454)2016
M 2017 28124 R	AM 85393	AM 2016 85393 A	15(451)2016

1	2	3	4
M 2017 28125 R	AM 85444	AM 2016 85444 A	15(451)2016
M 2017 28126 R	AM 85445	AM 2016 85445 A	15(451)2016
M 2017 28127 R	AM 85646	AM 2016 85646 A	17(453)2016
M 2017 28128 R	AM 85720	AM 2016 85720 A	17(453)2016
M 2017 28129 R	AM 85738	AM 2016 85738 A	17(453)2016
M 2017 28130 R	AM 85748	AM 2016 85748 A	16(452)2016
M 2017 28131 R	AM 85758	AM 2016 85758 A	15(451)2016
M 2017 28132 R	AM 85763	AM 2016 85763 A	18(454)2016
M 2017 28133 R	AM 85765	AM 2016 85765 A	18(454)2016
M 2017 28134 R	AM 85792	AM 2016 85792 A	16(452)2016
M 2017 28135 R	AM 85799	AM 2016 85799 A	17(453)2016
M 2017 28136 R	AM 85815	AM 2016 85815 A	17(453)2016
M 2017 28137 R	AM 85820	AM 2016 85820 A	17(453)2016
M 2017 28138 R	AM 85821	AM 2016 85821 A	17(453)2016
M 2017 28139 R	AM 85831	AM 2016 85831 A	17(453)2016
M 2017 28140 R	AM 85835	AM 2016 85835 A	17(453)2016
M 2017 28141 R	AM 85882	AM 2016 85882 A	17(453)2016
M 2017 28142 R	AM 85884	AM 2016 85884 A	17(453)2016
M 2017 28143 R	AM 85887	AM 2016 85887 A	18(454)2016
M 2017 28144 R	AM 85892	AM 2016 85892 A	18(454)2016
M 2017 28145 R	AM 85896	AM 2016 85896 A	17(453)2016
M 2017 28146 R	AM 86007	AM 2016 86007 A	19(455)2016
M 2017 28147 R	AM 86010	AM 2016 86010 A	17(453)2016
M 2017 28148 R	AM 86109	AM 2016 86109 A	17(453)2016
M 2017 28149 R	AM 86128	AM 2016 86128 A	17(453)2016
M 2017 28150 R	AM 86130	AM 2016 86130 A	18(454)2016
M 2017 28151 R	AM 86132	AM 2016 86132 A	17(453)2016
M 2017 28152 R	AM 86364	AM 2016 86364 A	17(453)2016
M 2017 28153 R	AM 86365	AM 2016 86365 A	17(453)2016
M 2017 28154 R	AM 86366	AM 2016 86366 A	17(453)2016
M 2017 28155 R	AM 86366	AM 2016 86366 A	17(453)2016

**CONCORDANCE TABLE OF PUBLICATION NUMBERS
AND APPLICATION NUMBERS**

NUMBER OF PUBLISHED APPLICATION (260)	NUMBER OF APPLICATION (210)	1	2
		1	2
AM 2017 83830 A	AM 83830 A	AM 2017 87528 A	AM 87528 A
AM 2017 85027 A	AM 85027 A	AM 2017 87533 A	AM 87533 A
AM 2017 86681 A	AM 86681 A	AM 2017 87557 A	AM 87557 A
AM 2017 86881 A	AM 86881 A	AM 2017 87569 A	AM 87569 A
AM 2017 86895 A	AM 86895 A	AM 2017 87588 A	AM 87588 A
AM 2017 86896 A	AM 86896 A	AM 2017 87589 A	AM 87589 A
AM 2017 86928 A	AM 86928 A	AM 2017 87620 A	AM 87620 A
AM 2017 86966 A	AM 86966 A	AM 2017 87621 A	AM 87621 A
AM 2017 87075 A	AM 87075 A	AM 2017 87624 A	AM 87624 A
AM 2017 87159 A	AM 87159 A	AM 2017 87677 A	AM 87677 A
AM 2017 87195 A	AM 87195 A	AM 2017 87748 A	AM 87748 A
AM 2017 87213 A	AM 87213 A	AM 2017 87751 A	AM 87751 A
AM 2017 87338 A	AM 87338 A	AM 2017 87762 A	AM 87762 A
		AM 2017 87776 A	AM 87776 A
		AM 2017 87778 A	AM 87778 A
		AM 2017 87779 A	AM 87779 A
		AM 2017 87784 A	AM 87784 A
		AM 2017 87785 A	AM 87785 A

1	2
AM 2017 87366 A	AM 87366 A
AM 2017 87388 A	AM 87388 A
AM 2017 87415 A	AM 87415 A
AM 2017 87444 A	AM 87444 A
AM 2017 87445 A	AM 87445 A
AM 2017 87486 A	AM 87486 A
AM 2017 87498 A	AM 87498 A
AM 2017 87504 A	AM 87504 A
AM 2017 87510 A	AM 87510 A
AM 2017 87512 A	AM 87512 A
AM 2017 87892 A	AM 87892 A
AM 2017 87909 A	AM 87909 A
AM 2017 87965 A	AM 87965 A

1	2
AM 2017 87786 A	AM 87786 A
AM 2017 87788 A	AM 87788 A
AM 2017 87792 A	AM 87792 A
AM 2017 87794 A	AM 87794 A
AM 2017 87799 A	AM 87799 A
AM 2017 87834 A	AM 87834 A
AM 2017 87874 A	AM 87874 A
AM 2017 87883 A	AM 87883 A
AM 2017 87885 A	AM 87885 A
AM 2017 87887 A	AM 87887 A
AM 2017 87971 A	AM 87971 A
AM 2017 88071 A	AM 88071 A

**CONCORDANCE TABLE OF INDEX OF GOODS AND/OR SERVICES
AND APPLICATION NUMBERS**

INDEX OF GOODS AND/OR SERVICES (511)	NUMBER OF PUBLISHED APPLICATIONS (26)
1	2
1	AM 2017 87784 A
1	AM 2017 87834 A
2	AM 2017 87784 A
3	AM 2017 87784 A
4	AM 2017 87624 A
4	AM 2017 87784 A
5	AM 2017 86681 A
5	AM 2017 86881 A
5	AM 2017 87388 A
5	AM 2017 87504 A
5	AM 2017 87528 A
5	AM 2017 87533 A
5	AM 2017 87784 A
5	AM 2017 87883 A
5	AM 2017 87887 A
5	AM 2017 87965 A
5	AM 2017 87971 A
6	AM 2017 87159 A
6	AM 2017 87792 A
7	AM 2017 87784 A
8	AM 2017 87569 A
8	AM 2017 87792 A
9	AM 2017 87778 A
9	AM 2017 87785 A
9	AM 2017 87786 A
9	AM 2017 87788 A
9	AM 2017 87885 A
11	AM 2017 87159 A
11	AM 2017 87784 A
11	AM 2017 87799 A

1	2
21	AM 2017 87792 A
24	AM 2017 87569 A
24	AM 2017 87788 A
25	AM 2017 87762 A
25	AM 2017 87792 A
27	AM 2017 87569 A
27	AM 2017 87784 A
28	AM 2017 87444 A
28	AM 2017 87445 A
28	AM 2017 87792 A
29	AM 2017 86681 A
29	AM 2017 86966 A
29	AM 2017 87512 A
30	AM 2017 86681 A
30	AM 2017 87388 A
30	AM 2017 87444 A
30	AM 2017 87445 A
30	AM 2017 87779 A
30	AM 2017 87909 A
31	AM 2017 87794 A
32	AM 2017 86681 A
33	AM 2017 85027 A
33	AM 2017 86681 A
33	AM 2017 87075 A
33	AM 2017 87415 A
33	AM 2017 87486 A
33	AM 2017 87510 A
33	AM 2017 88071 A
34	AM 2017 87557 A
34	AM 2017 87892 A
35	AM 2017 86681 A
35	AM 2017 86896 A
35	AM 2017 87075 A
35	AM 2017 87159 A
35	AM 2017 87569 A

1	2	1	2
12	AM 2017 86928 A	35	AM 2017 87588 A
12	AM 2017 87788 A	35	AM 2017 87589 A
14	AM 2017 87792 A	35	AM 2017 87677 A
16	AM 2017 86896 A	35	AM 2017 87748 A
16	AM 2017 87195 A	35	AM 2017 87751 A
16	AM 2017 87785 A	35	AM 2017 87909 A
16	AM 2017 87786 A	36	AM 2017 87366 A
16	AM 2017 87788 A	36	AM 2017 87776 A
19	AM 2017 87159 A	36	AM 2017 87784 A
21	AM 2017 87569 A	36	AM 2017 87788 A
37	AM 2017 87677 A	42	AM 2017 87195 A
37	AM 2017 87788 A	42	AM 2017 87213 A
38	AM 2017 86896 A	42	AM 2017 87778 A
38	AM 2017 87195 A	43	AM 2017 86895 A
38	AM 2017 87498 A	43	AM 2017 87338 A
38	AM 2017 87784 A	43	AM 2017 87620 A
39	AM 2017 83830 A	43	AM 2017 87621 A
39	AM 2017 87784 A	43	AM 2017 87909 A
41	AM 2017 83830 A	44	AM 2017 87748 A
41	AM 2017 87195 A	44	AM 2017 87751 A
41	AM 2017 87784 A	45	AM 2017 86896 A
41	AM 2017 87874 A		

**CONCORDANCE TABLE OF INDEX OF GOODS AND/OR SERVICES
AND NUMBERS OF TRADEMARKS REGISTERED ACCORDING
TO THE ACCELERATED PROCEDURE**

INDEX OF GOODS AND/OR SERVICES (511)	NUMBERS OF REGISTERED ACCORDING TO THE ACCELERATED PROCEDURE (111)
3	M 2017 28079 R
3	M 2017 28080 R
5	M 2017 28079 R
5	M 2017 28080 R
9	M 2017 28081 R
11	M 2017 28079 R
11	M 2017 28080 R
19	M 2017 28086 R
21	M 2017 28090 R
21	M 2017 28079 R
21	M 2017 28080 R
33	M 2017 28085 R
33	M 2017 28078 R
33	M 2017 28089 R
34	M 2017 28082 R
34	M 2017 28083 R
34	M 2017 28084 R
35	M 2017 28088 R
38	M 2017 28087 R
43	M 2017 28113 R

OFFICIAL BULLETIN OF THE INDUSTRIAL PROPERTY

3(463)

EDITOR-IN-CHIEF: N. Bebrishvili

EDITORS-TRANSLATORS: E. Gabunia

PROOFREADER: A. Shikhashvili

COMPUTER LAYOUT: M. Ordenidze
K. Svanidze

www.sakpatenti.org.ge

E-mail: info@sakpatenti.org.ge