



**NATIONAL INTELLECTUAL PROPERTY CENTER OF GEORGIA  
SAKPATENTI**

**OFFICIAL BULLETIN  
OF THE INDUSTRIAL PROPERTY**

**11(495)**

**2018  
TBILISI**

# INID CODES FOR IDENTIFICATION OF BIBLIOGRAPHIC DATA

## INVENTIONS, UTILITY MODELS

- (10) Number of publication for application, which has been examined
- (11) Number of patent and kind of document
- (21) Serial number of application
- (22) Date of filing of the application
- (23) Date of exhibition or the date of the earlier filing and the number of application, if any
- (24) Date from which patent may have effect
- (31) Number of priority application
- (32) Date of filing of priority application
- (33) Code of the country or regional organization allotting priority application number
- (44) Date of publication of application not granted, but examined and number of bulletin
- (45) Date of publication of registered document
- (51) International Patent Classification Index
- (54) Title of the invention
- (57) Abstract
- (60) Number of examined patent document granted by foreign patent office, date from which patent has effect and country code
- (62) Number of the earlier application and in case of divided application, date of filing an application
- (71) Name, surname and address of applicant (country code)
- (72) Name, surname of inventor (country code)
- (73) Name, surname and address of patent owner (country code)
- (74) Name, surname of representative or patent attorney
- (85) Date of commencement of the national phase of International Application
- (86) Number and date of filing of international application
- (87) Number and date of publication of international application

## DESIGNS

- (10) Number of publication for application
- (11) Number of patent and kind of document or number of registration
- (15) Date of registration/Date of patent renewal
- (18) Expected expiration date of patent or registration
- (21) Serial number of application
- (22) Date of filing of the application
- (23) Date of exhibition or the date of the earlier filing and the number of application, if any
- (24) Date from which patent may have effect
- (28) Number of designs included in the application
- (30) Data relating to priority (number of application, date of filing of application, two-letter code identifying the authority with whom the priority application was made)
- (31) Number of priority application
- (32) Date of filing of priority application
- (33) Code of the country or regional organization allotting priority application number
- (34) Two-letter code according to WIPO St.3 identifying the authority with which the priority application was made
- (44) Date of publication of design and number of bulletin (the first publication)
- (45) Date of publication of design registered by WIPO and number of bulletin
- (51) International Classification for designs (class and subclass of the Locarno Classification)
- (54) Title of the invention
- (55) Reproduction of the design
- (57) Description of characteristic features of the design including indication of colors
- (58) Date of recording of any kind of amendment in the Register
- (62) Number of the earlier application, registration and document number and if available the date of filing an application in case of divided application
- (71) Name, surname and address of applicant (country code)
- (72) Name, surname of creator (country code)
- (73) Name, surname and address of patent owner (country code)
- (74) Name, surname of representative or patent attorney
- (81) Contracting states concerned
  - II designated contracting states according to the 1960 Act
  - III designated contracting states according to the 1999 Act
- (85) Owner's permanent address
- (86) Owner's nationality
- (87) Owner's residence
- (88) State in which the owner has a real and effective industrial or commercial establishment

## TRADEMARKS

- (111) – Number of registration
- (151) – Date of registration
- (156) – Date of the renewal
- (181) – Expected expiration date of registration
- (186) – Renewal expiration date of registration
- (141) – Date of cancel of duration of the mark
- (210) – Serial number of application
- (220) – Date of filing of the application
- (230) – Date concerning exhibition
- (260) – Number of application, for which favorable decision of examination about registration has been taken (publication number)
- (310) – Number of the first application
- (320) – Date of filing of the first application
- (330) – Code, identifying national or regional Office where the first application was made
- (511) – International Classification of Goods and Services for the purposes of registration of trade marks and/or list of goods and/or services classified according thereto
- (531) – Description of figurative elements of Trade Marks according to the International Classification of the Figurative Elements of Marks
- (540) – Reproduction of Trade Mark
- (550) – Nature and kind of Trade Mark
- (580) – Date of recording of any kind changes in respect of applications or registrations
- (591) – Information concerning colors claimed
- (731) – Name and address of the applicant
- (732) – Name and address of the holder of the registration
- (740) – Name and address of the representative
- (750) – Address for correspondence
- (770) – Name and address of the previous applicant or holder in case of change in ownership
- (771) – Previous name and address of the applicant or holder in case of change in ownership
- (791) – Name and address of the licensee
- (793) – Indication of conditions and/or restrictions under the license (Type of license, number of license agreement, data of license, data of validity of license)
- (800) – Certain data relating to the international registration of Trade Marks under the Protocol Relating to Madrid Agreement (International registration number)

## CODES FOR PUBLICATION IN BULLETIN

- (21) AP 0000 000000 – serial number of application for invention
- (10) AP 0000 0000 A – number of published application for invention (first publication)
- (11) P 0000 0000 B – number of patent for invention (second publication)
- (21) API 0000 000000 – number of application for imported patent
- (11) PI 0000 0000 A – number of imported patent (first publication)
- (21) AU 0000 000000 – serial number of application for utility model
- (10) AU 0000 000 U – number of published application for utility model (first publication)
- (11) U 0000 000 Y – number of patent for utility model (second publication)
- (21) AD 0000 000000 – serial number of application for design
- (10) AD 0000 000 S – number of published application for design (first publication)
- (11) D 0000 000 S – number of patent for design (second publication)

## INTERNATIONAL PATENT CLASSIFICATION FOR INVENTIONS AND UTILITY MODELS

- SECTION A – HUMAN NECESSITIES
- SECTION B – PERFORMING OPERATIONS; TRANSPORTING
- SECTION C – CHEMISTRY; METALLURGY
- SECTION D – TEXTILES; PAPER
- SECTION E – FIXED CONSTRUCTIONS
- SECTION F – MECHANICAL ENGINEERING; LIGHTING; HEATING; WEAPONS; BLASTING
- SECTION G – PHYSICS
- SECTION H – ELECTRICITY

- 
- M – Trade Mark
  - (210) AM 0000 000000 – Serial number of application;
  - (260) AAM 0000 00000 A – Publication number of application;
  - (111) M 0000 00000 R – Number of registration;
  - (111) MMM0000 00000 Rn – Number of renewals, in which n=1,2,3;
  - (111) M 0000 00000 R(P) – Number of registration under partial assignment of rights
-

**LIST OF CODES, IN ALPHABETIC SEQUENCE, AND THE CORRESPONDING (SHORT) NAMES OF STATES, OTHER ENTITIES AND INTERGOVERNMENTAL ORGANIZATIONS**  
(WIPO STANDARD ST.3)

AD	Andorra				
AE	United Arab Emirates				
AF	Afghanistan				
AG	Antigua and Barbuda				
AI	Anguilla				
AL	Albania				
AM	Armenia				
AN	Netherlands Antilles				
AO	Angola				
AP	African Regional Intellectual Property Organization (ARIPO)				
AR	Argentina				
AT	Austria				
AU	Australia				
AW	Aruba				
AZ	Azerbaijan				
BA	Bosnia and Herzegovina				
BB	Barbados				
BD	Bangladesh				
BE	Belgium				
BF	Burkina Faso				
BG	Bulgaria				
BH	Bahrain				
BI	Burundi				
BJ	Benin				
BM	Bermuda				
BN	Brunei Darussalam				
BO	Bolivia				
BR	Brazil				
BS	Bahamas				
BT	Bhutan				
BV	Bouvet Island				
BW	Botswana				
BX	Benelux Office for Intellectual Property (BOIP)				
BY	Belarus				
BZ	Belize				
CA	Canada				
CD	Democratic Republic of the Congo				
CF	Central African Republic				
CG	Congo				
CH	Switzerland				
CI	Cote d'Ivoire				
CK	Cook Islands				
CL	Chile				
CM	Cameroon				
CN	China				
CO	Colombia				
CR	Costa Rica				
CU	Cuba				
CV	Cape Verde				
CY	Cyprus				
CZ	Czech Republic				
DE	Germany				
DJ	Djibouti				
DM	Dominica				
DO	Dominican Republic				
DZ	Algeria				
EA	Eurasian Patent Organization (EAPO)				
EC	Ecuador				
EE	Estonia				
EG	Egypt				
EH	Western Sahara				
EM	Office for Harmonization in the Internal Market (Trademarks and Designs)(OHIM)				
EP	European Patent Office (EPO)				
ER	Eritrea				
ES	Spain				
ET	Ethiopia				
FI	Finland				
FJ	Fiji				
FK	Falkland Islands (Malvinas)				
FO	Faroe Islands				
FR	France				
GA	Gabon				
GB	United Kingdom				
GC	Patent Office of the Cooperation Council for the Arab States of the Gulf (GCC)				
GD	Grenada				
GG	Guernsey				
GH	Ghana				
GI	Gibraltar				
GT	Guatemala				
GW	Guinea- Bissau				
GY	Guyana				
HK	The Hong Kong Special Administrative Region of the People's Republic of China				
HN	Honduras				
HR	Croatia				
HT	Haiti				
HU	Hungary				
IB	International Bureau of the World Intellectual Property Organization (WIPO)				
ID	Indonesia				
IE	Ireland				
IL	Israel				
IM	Isle of Man				
IN	India				
IQ	Iraq				
ID	Indonesia				
IE	Ireland				
IL	Israel				
IM	Isle of Man				
IN	India				
IQ	Iraq				
IR	Iran (Islamic Republic of)				
IS	Iceland				
IT	Italy				
JE	Jersey				
JM	Jamaica				
JO	Jordan				
JP	Japan				
KE	Kenya				
KG	Kyrgyzstan				
KH	Cambodia				
KI	Kiribati				
KM	Saint Kitts and Nevis				
KP	Democratic People's Republic of Korea				
KR	Republic of Korea				
KW	Kuwait				
KY	Cayman Islands				
KZ	Kazakhstan				
LA	Lao People's Democratic Republic				
LB	Lebanon				
LC	Saint Lucia				
LI	Liechtenstein				
LK	Sri Lanka				
LR	Liberia				
LS	Lesotho				
LT	Lithuania				
LU	Luxembourg				
LV	Latvia				
LY	Libyan Arab Jamahiriya				
MA	Morocco				
MC	Monaco				
MD	Republic of Moldova				
ME	Montenegro				
MG	Madagascar				
MK	The former Yugoslav Republic of Macedonia				
ML	Mali				
MM	Myanmar				
MN	Mongolia				
MO	Macao				
MP	Northern Mariana Islands				
MR	Mauritania				
MS	Montserrat				
MT	Malta				
MU	Mauritius				
MV	Maldives				
MW	Malawi				
MX	Mexico				
MY	Malaysia				
MZ	Mozambique				
NA	Namibia				
NE	Niger				
NG	Nigeria				
NI	Nicaragua				
NL	Netherlands				
NO	Norway				
NP	Nepal				
NR	Nauru				
NZ	New Zealand				
OA	African Intellectual Property Organization (OAPI)				
OM	Oman				
PA	Panama				
PE	Peru				
PG	Papua New Guinea				
PH	Philippines				
PK	Pakistan				
PL	Poland				
PT	Portugal				
PW	Palau				
PY	Paraguay				
QA	Qatar				
QZ	Community Plant Variety Office (European Community) (CPVO)				
RO	Romania				
RS	Serbia				
RU	Russian Federation				
RW	Rwanda				
SA	Saudi Arabia				
SB	Solomon Islands				
SC	Seychelles				
SD	Sudan				
SG	Singapore				
SH	Saint Helena				
SI	Slovenia				
SK	Slovakia				
SL	Sierra Leone				
SM	San Marino				
SN	Senegal				
SO	Somalia				
SR	Suriname				
ST	Sao Tome and Principe				
SV	El Salvador				
SY	Syrian Arab Republic				
SZ	Swaziland				
TC	Turks and Caicos Islands				
TD	Chad				
TG	Togo				
TH	Thailand				
TJ	Tajikistan				
TL	Timor-Leste				
TM	Turkmenistan				
TN	Tunisia				
TO	Tonga				
TR	Turkey				
SE	Sweden				
TT	Trinidad and Tobago				
TV	Tuvalu				
TW	Taiwan, Province of China				
TZ	United Republic of Tanzania				
UA	Ukraine				
UG	Uganda				
US	United States of America				
UY	Uruguay				
UZ	Uzbekistan				
VA	Holy See				
VC	Saint Vincent and the Grenadines				
VE	Venezuela				
VG	Virgin Islands (British)				
VN	Viet Nam				
VU	Vanuatu				
WO	World Intellectual Property Organization (WIPO)				
WS	Samoa				
XN	Nordic Patent Institute (NPI)				
YE	Yemen				
ZA	South Africa				
ZM	Zambia				
ZW	Zimbabwe				

**NATIONAL INTELLECTUAL PROPERTY CENTER OF GEORGIA  
SAKPATENTI**

**OFFICIAL BULLETIN  
OF THE INDUSTRIAL PROPERTY**

**11(495)**

**INVENTIONS  
UTILITY MODELS  
DESIGNS  
TRADEMARKS**

**DATE OF PUBLICATION  
2018 06 11**

# CONTENTS

<b>PUBLISHED TITLES OF PROTECTION</b> .....	3
<b>INVENTIONS</b>	
▪ APPLICATIONS APPROVED FOR GRANTING PATENTS .....	4
▪ PATENTED INVENTIONS .....	7
<b>UTILITY MODELS</b>	
▪ APPLICATIONS APPROVED FOR GRANTING PATENT .....	9
<b>DESIGNS</b>	
▪ REGISTERED DESIGN .....	10
▪ DESIGN REGISTERED ACCORDING TO THE ACCELERATED PROCEDURE .....	11
▪ DESIGNS, WHICH HAVE BEEN REGISTERED WITH THE INTERNATIONAL BUREAU CLAIMING PRIORITY ON THE TERRITORY OF GEORGIA .....	14
<b>TRADEMARKS</b>	
▪ APPLICATIONS FILED UNDER THE NATIONAL PROCEDURE APPROVED FOR REGISTRATION .....	76
▪ REGISTERED TRADEMARKS .....	84
▪ TRADEMARKS REGISTERED ACCORDING TO THE ACCELERATED PROCEDURE .....	88
▪ INTERNATIONAL TRADEMARKS FOR WHICH A DECISION ON GRANTING PROTECTION IS TAKEN .....	90
▪ INTERNATIONAL TRADEMARKS PROTECTED IN GEORGIA .....	91
<b>OFFICIAL NOTIFICATIONS</b>	
<b>INVENTIONS</b>	
▪ RENEWAL OF PATENTS .....	103
▪ CANCELLING OF PATENTS .....	103
▪ CHANGE ADDRESS OF PATENTOWNER .....	110
<b>UTILITY MODELS</b>	
▪ CANCELLING OF PATENTS .....	110
▪ CHANGE ADDRESS OF PATENTOWNER .....	111
<b>TRADEMARKS</b>	
▪ RENEWAL OF REGISTRATIONS .....	112
▪ COMPLETE TRANSFER OF RIGHTS .....	115
▪ CHANGES IN NAMES AND/OR ADDRESSES OF OWNERS .....	116
▪ INVALIDATION OF TRADEMARKS REGISTRATIONS .....	117
<b>CLASSIFICATION INDEXES</b>	
INVENTIONS .....	125
UTILITY MODELS .....	126
DESIGNS .....	127
TRADEMARKS .....	128

## PUBLISHED TITLES OF PROTECTION

### INVENTIONS

- **APPLICATIONS APPROVED FOR GRANTING PATENT:**  
14452; 14088; 14255; 14286; 14103; 13978
- **PATENTED INVENTIONS:**  
6857-6863

### UTILITY MODELS

- **APPLICATIONS APPROVED FOR GRANTING PATENT:**  
14511; 14053

### DESIGNS

- **REGISTERED DESIGN:**  
764
- **DESIGN REGISTERED ACCORDING TO THE ACCELERATED PROCEDURE:**  
763
- **DESIGNS WHICH HAVE BEEN REGISTERED WITH THE INTERNATIONAL BUREAU CLAIMING PRIORITY ON THE TERRITORY OF GEORGIA:**  
97537; 99828; 99846; 99875; 99894; 99990; 100022; 100241; 95557; 97878; 99148; 100332; 98231; 100432

### TRADEMARKS

- **APPLICATIONS FILED UNDER THE NATIONAL PROCEDURE APPROVED FOR REGISTRATION:**  
90304; 90882\*; 91479; 91520; 92020; 92445; 92739; 93198; 93533; 93559; 94193; 94255; 94263; 94268, 94269; 94435; 94439, 94440; 94452; 94533; 94543; 94582; 94587-94589; 94681, 94682; 94684; 94691; 94694; 94701; 94709; 94718; 94720; 94787-94789; 94793; 94883; 94980; 95034; 95036; 95038; 95079, 95080; 95186; 95223; 95227
- **REGISTERED TRADEMARKS:**  
29717, 29718; 29721-29757
- **TRADEMARKS REGISTERED ACCORDING TO THE ACCELERATED PROCEDURE:**  
29710-29716; 29719, 29720
- **INTERNATIONAL TRADEMARKS FOR WHICH A DECISION ON GRANTING PROTECTIONS IS TAKEN:**  
78980\*; 89812\*
- **INTERNATIONAL TRADEMARKS PROTECTED IN GEORGIA:**  
85075; 86307; 87459; 88083; 88213; 88655; 88838; 88869; 88880; 88900; 88908, 88909; 88953; 89281; 89743; 89806; 90449; 90708, 90709; 90715; 91117; 91269; 91271, 91272; 91274; 91294; 91324; 91335; 91339; 91345; 91450; 91589; 91604; 91647; 91649, 91650; 91655; 91668; 91673; 91675, 91676; 91679; 91683-91689; 91691, 91692; 91695, 91696; 91698- 91703; 91708; 91710, 91711; 91726; 91741-91748; 91750, 91751; 91753; 91768; 91787, 91788; 91790, 91791; 91793; 91796-91801; 91808, 91809; 91823, 91824; 91827; 91880; 91895; 91899-91902; 91908-91911; 91914; 91916- 91919; 91922, 91923; 91925; 91927, 91928; 91931-91934; 91943-91945; 91947-91950; 91952; 91964, 91965; 91967; 91970; 91972; 91974, 91975; 91982; 91987; 91990, 91991; 91993, 91994; 91998; 92000; 92005; 92010-92014; 92019; 92021; 92023, 92024; 92029, 92030; 92032, 92033; 92037, 92038; 92042-92046; 92048, 92049; 92063, 92064; 92072; 92078-92081; 92083-92085; 92087

# INVENTIONS

## APPLICATIONS APPROVED FOR GRANTING PATENTS

The decision can be appealed at the Chamber of Appeal of Sakpatenti within 3 months from the publication or at the Mtskheta District Court Administrative Cases Board (Address: №17, Samkhedro str., Mtskheta), within 1 month following the publication.

### PART B

#### B 23

(10) AP 2018 14452 A (51) Int. Cl. (2006)

B 23 C 3/32

(21) AP 2017 014452 (22) 2017 03 16

(71) Raul Turmanidze (GE)

Panaskertelis q. 19, b. 134, 0194,

Tbilisi (GE);

Giorgi Popkhadze (GE)

Kazbegis q. 14a, b. 12, 0177, Tbilisi (GE);

Vasil Bachanadze (GE)

Varketili, Kaloubnis q. 35, b. 22, 0182,

Tbilisi (GE)

(72) Raul Turmanidze (GE);

Giorgi Popkhadze (GE);

Vasil Bachanadze (GE)

(54) **FACILITY TO GRINDING MACHINE FOR SPIRAL OR SCREW GROOVES WITH VARIABLE INCLINATION TREATMENT**

(57) A facility includes wobble plate 2 capable to be disposed on grinding machine table 1. Wobble plate with one end is set on a finger 3 placed on the same table and rotatable around it; and on another end thereof the componentry 4 providing motion on arched track 5 are executed. A case 6, wherein couple of kinematic chains switched through reducer with one general motor are disposed, is installed on wobble plate. One of kinematic chains is destined to give a workpiece 7 fastened in a stock uniform rotation, and another – to provide rotation of, disposed opposite of stock with workpiece, the torsion cam 8 being in contact with a roller 9 set on wobble plate. Torsion cam is executed so that its cutout, depending on rotation angle, would be changed in accordance with progressive tangential rule.

Claims: 1 independent

4 dependent

Fig.: 5

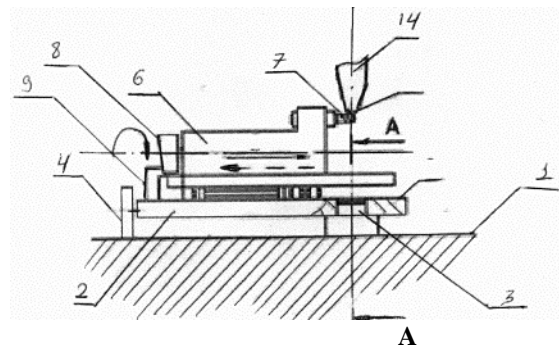

Fig. 1

### PART C

#### C 02

(10) AP 2018 14088 A (51) Int. Cl. (2006)

C 02 F 9/00

E 04 H 4/00

C 02 F 1/44

(21) AP 2014 014088 (22) 2014 11 04

(31) 14/531,395; 61/900,308

(32) 2014 11 03; 2013 11 05

(33) US; US

(71) CRYSTAL LAGOONS (CURACAO)

B.V. (NL)

Kaya W.F.G. (Jombi) Mensing,

14 Curacao (NL)

(72) FISCHMANN, Fernando, Benjamin (CL)

(74) Shalva Gvaramadze

(85) 2016 03 14

(86) PCT/IB2014/002991, 2014 11 04

(54) **FLOATING LAKE AND METHODS OF TREATING WATER WITHIN THE FLOATING LAKE**

(57) Present invention relates to floating artificial lakes and water treatment in such lakes. It is executed with floating capability in big basin, and even if improve water conditions, that are unsuitable for recreational uses. Floating lake can be provided with chemical 30 application system; pump recirculation system, filtration 40 system including mobile suctioning device 42, skimmer

system 60 to return filtered water from filtration system back to artificial lake 76, and optionally coordination system 20.

Claims: 3 independent  
41 dependent

Fig.: 12

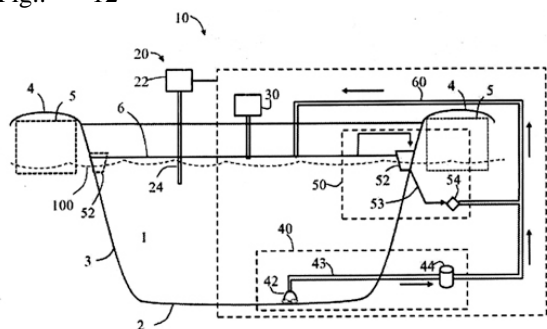

Fig. 5

## C 07

(10) AP 2018 14255 A (51) Int. Cl. (2006)  
C 07 D 401/06  
C 07 C 275/06  
C 07 C 275/26  
C 07 D 401/12  
C 07 D 211/58  
C 07 D 211/60  
C 07 D 211/94  
C 07 D 211/96  
C 07 D 213/00

(21) AP 2015 014255 (22) 2015 03 06

(31) 61/949,664

(32) 2014 03 07

(33) US

(71) HELSINN HEALTHCARE SA (CH)  
Via Pian Scairolo 9 6912 Lugano /  
Pazzallo (CH)

(72) GIULIANO, Claudio (IT);  
GARCIA RUBIO, Silvina (US);  
DAINA, Antoine (CH);  
GUAINAZZI, Angelo (CH);  
PIETRA, Claudio (IT)

(74) Shalva Gvaramadze

(85) 2016 09 01

(86) PCT/US2015/019112, 2015 03 06

(54) **P-SUBSTITUTED ASYMMETRIC**

**UREAS AND MEDICAL USES THEREOF**

(57) Compound of formula (I),

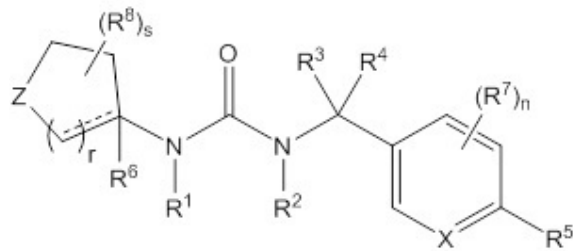

(I)

pharmaceutical compositions on basis thereof and usage thereat the treatment of diseases pathologically caused by Ghrelin receptor.

Claims: 6 independent  
19 dependent

Table: 2

Fig.: 12

(10) AP 2018 14286 A (51) Int. Cl. (2006)  
C 07 D 403/12  
A 61 K 31/506  
A 61 P 25/00

(21) AP 2015 014286 (22) 2015 03 27

(31) PA 2014 00194

(32) 2014 04 04

(33) DK

(71) H. LUNDBECK A/S (DK)

Ottiliavej 9 DK-2500 Valby (DK)

(72) KEHLER, Jan (DK);

RASMUSSEN, Lars Kyhn (DK);

LANGGÅRD, Morten (DK)

(74) Tamaz Shilakadze

(85) 2016 09 30

(86) PCT/EP2015/056713, 2015 03 27

(54) **HALOGENATED QUINAZOLIN-  
THF-AMINES AS PDE1 INHIBITORS**

(57) An invention relates to halogenised chinazolin-THF-amines of formula (I)

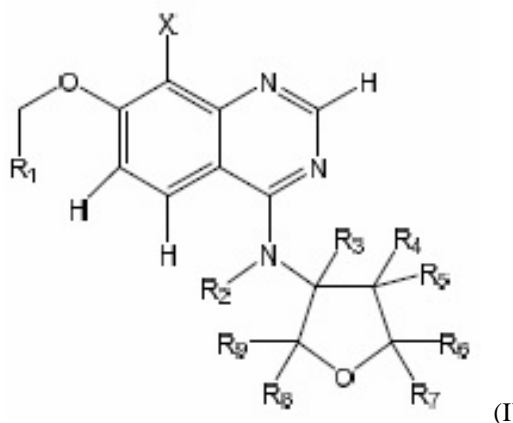

(I)

as PDE1 inhibitors, and usage thereat the treatment of neurodegenerative disorders and mental insanities.

Claims: 4 independent

9 dependent

(10) AP 2018 14103 A (51) Int. Cl. (2006)  
C 07 K 16/28  
A 61 P 35/00  
A 61 K 39/395

(21) AP 2014 014103 (22) 2014 08 18

(31) 61/867,976

(32) 2013 08 20

(33) US



(71) MERCK SHARP & DOHME CORP. US;  
126 East Lincoln Avenue Rahway, New Jersey  
07065-0907 (US)

(72) GU, Danling (US);  
BEEBE, Amy, M. (US)

(74) Shalva Gvaramadze

(85) 2016 03 25

(86) PCT/US2014/051402, 2014 08 18

(54) **MODULATION OF TUMOR IMMUNITY**

(57) There is provided usage of GITR agonist and PD-1 antagonist combination at tumor treatment.

Claims: 3 independent

21 dependent

Fig.: 15

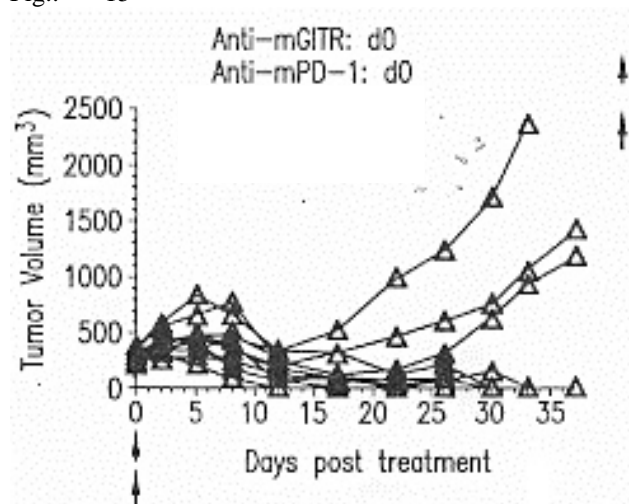

Fig. 1A

regenerant – ammonium chloride; and getting metallic manganese by manganese hydroxide electrolysis in sulfuric acid.

Claims: 1 independent

Fig.: 1

## C 22

(10) AP 2018 13978 A (51) Int. Cl. (2006)

C 22 B 47/00

C 22 B 1/02

C 22 B 1/08

C 22 B 3/04

(21) AP 2015 013978 (22) 2015 10 28

(71) GEORGIAN TECHNICAL  
UNIVERSITY (GE)

M. Kostavas q. 77, 0175, Tbilisi (GE)

(72) Lali Ghurtchumelia (GE);

Akaki Gigineishvili (GE);

Zakaria Buachidze (GE);

Archil Tchirakadze (GE);

Giorgi Oniashvili (GE);

Garegin Zakharov (GE);

Zurab Aslamazashvili (GE)

(74) Givi Sibashvili

(54) **METHOD FOR GETTING  
METALLIC MANGANESE  
FROM LOW-GRADE  
MANGANESE ORES**

(57) A method provides burning manganese ore and slimes in a microwave, at 400-500 °C; received concentrate enrichment by dry method, usage of

# PATENTED INVENTIONS

## PART A

### A 61

- (11) **P 2018 6863 B** (51) **Int. Cl. (2006)**  
**A 61 K 31/355**  
**A 61 K 9/00**  
**A 61 K 47/44**  
**A 61 P 11/02**
- (10) AP 2018 14463 A (44) 3(487)/2018  
(21) AP 2015 014463  
(22) 2015 10 02  
(24) 2015 10 02  
(31) MI2014A001819  
(32) 2014 10 22  
(33) IT  
(86) PCT/EP2015/072796, 2015 10 02  
(73) **BIO.LO.GA. S.R.L. (IT)**  
Via Giuseppe Lazzarin, 66 I-31015  
Conegliano (TV) (IT)  
(72) PANIN, Giorgio (IT);  
TESTA, Domenico (IT);  
GUERRA, Germano (IT)  
(74) Nugzar Ksovreli  
(85) 2017 04 03  
(86) PCT/EP2015/072796, 2015 10 02  
(54) **PHARMACEUTICAL COMPOSITION  
FOR USE IN INCREASING THE  
TROPHISM OF NASAL MUCOSA**

## PART B

### B 21

- (11) **P 2018 6862 B** (51) **Int. Cl. (2006)**  
**B 21 J 7/16**  
**B 21 C 5/00**
- (10) AP 2018 14364 A (44) 3(487)/2018  
(21) AP 2016 014364  
(22) 2016 12 27  
(24) 2016 12 27  
(73) **LEPL RAPHIEL DVALI INSTITUTE  
OF MASHINE MECHANICS (GE)**  
Mindelis q. 10, 0186, Tbilisi (GE)  
(72) Slava Mebonia (GE);  
Tamaz Natriashvili (GE);  
Merab Mikautadze (GE)  
(54) **RADIAL-SQUEEZING MACHINE**

## B 28

- (11) **P 2018 6859 B** (51) **Int. Cl. (2006)**  
**B 28 B 1/093**  
**B 28 B 11/00**  
**B 28 B 19/00**
- (10) AP 2018 14033 A (44) 3(487)/2018  
(21) AP 2013 014033  
(22) 2013 06 26  
(24) 2013 06 26  
(86) PCT/EP2013/063349, 2013 06 26  
(73) **KNAUF GIPS KG (DE)**  
Am Bahnhof 7 97346 Iphofen (DE)  
(72) KNAUF, Carlo (DE);  
KARAKOUSSIS, Stergios (DE);  
HARTMANN, Alexander (DE)  
(74) Shalva Gvaramadze  
(85) 2016 01 08  
(86) PCT/EP2013/063349, 2013 06 26  
(54) **GYPSUM PLASTERBOARD  
PRODUCTION PLANT AND METHOD  
FOR PRODUCING A GYPSUM  
PLASTERBOARD**

## PART C

### C 07

- (11) **P 2018 6857 B** (51) **Int. Cl. (2006)**  
**C 07 D 211/16**  
**C 07 D 211/18**  
**C 07 D 211/22**  
**C 07 D 295/185**  
**C 07 D 401/04**  
**C 07 D 207/08**  
**A 61 K 31/451**  
**A 61 K 31/495**  
**A 61 P 31/04**
- (10) AP 2018 13844 A (44) 3(487)/2018  
(21) AP 2013 013844  
(22) 2013 12 20  
(24) 2013 12 20  
(31) 12/03548  
(32) 2012 12 21  
(33) FR  
(86) PCT/EP2013/077732, 2013 12 20  
(73) **UNIVERSITE DE DROIT ET DE LA SANTE  
DE LILLE 2 (FR)**  
42 rue Paul Duez F-59800 Lille (FR)  
(72) WILLAND, Nicolas (FR);

DEPREZ, Benoit (FR);  
 BAULARD, Alain (BE);  
 BRODIN, Priscille (FR);  
 FLIPO, Marion (FR);  
 MAINGOT, Lucie (GB)

(74) Shalva Gvaramadze  
 (85) 2015 06 03  
 (86) PCT/EP2013/077732, 2013 12 20  
 (54) **SATURATED NITROGEN AND  
 N-ACYLATED HETEROCYCLES  
 POTENTIATING THE ACTIVITY  
 OF AN ACTIVE ANTIBIOTIC AGAINST  
 MYCOBACTERIA**

---

## C 10

(11) P 2018 6860 B (51) Int. Cl. (2006)  
 C 10 G 1/04

(10) AP 2018 14071 A (44) 4(488)/2018  
 (21) AP 2014 014071  
 (22) 2014 07 28  
 (24) 2014 07 28  
 (31) 61/859,679  
 (32) 2013 07 29  
 (33) US  
 (86) PCT/US2014/048474, 2014 07 28  
 (73) RED LEAF RESOURCES, INC. (US)  
 10808 South River Front Parkway, Suite 200  
 South Jordan, UT 84095 (US)  
 (72) PATTEN, James, W. (US)  
 (74) Shalva Gvaramadze  
 (85) 2016 02 26  
 (86) PCT/US 2014/048474, 2014 07 28  
 (54) **COMPOSITE FEEDSTOCK FOR  
 RECOVERY OF HYDROCARBONS  
 FROM HYDROCARBONACEOUS  
 MATERIAL**

---

## C 25

(11) P 2018 6858 B (51) Int. Cl. (2006)  
 C 25 C 3/12  
 C 25 C 3/04  
 C 25 C 3/22  
 C 25 C 7/02

(10) AP 2018 13932 A (44) 4(488)/2018  
 (21) AP 2014 013932  
 (22) 2014 02 14  
 (24) 2014 02 14  
 (31) 61/764,711  
 (32) 2013 02 14  
 (33) US  
 (86) PCT/CA2014/050102, 2014 02 14  
 (73) ALLIANCE MAGNÉSIUM (CA)  
 Office 410 9160 Leduc Blvd. Quartier  
 DIX30 Brossard, Québec J4Y 0E3 (CA)

(72) FOURNIER, Joël (CA);  
 RU, Lionel (CA);  
 EL, Sébastien (CA)

(74) Tamaz Shilakadze  
 (85) 2015 09 10  
 (86) PCT/CA2014/050102, 2014 02 14  
 (54) **HYDROGEN GAS DIFFUSION  
 ANODE ARRANGEMENT PRODUCING  
 HCL**

---

## PART E

### E 04

(11) P 2018 6861 B (51) Int. Cl. (2006)  
 E 04 C 1/40  
 E 04 C 1/41

(10) AP 2018 14238 A (44) 2(486)/2018  
 (21) AP 2016 014238  
 (22) 2016 08 09  
 (24) 2016 08 09  
 (73) Maia Gorgodze (GE)  
 Bakhtrionis q. 29, b. 76, Tbilisi (GE)  
 (72) Tamaz Mushkudiani (GE);  
 Levan Mushkudiani (GE);  
 Lasha Mushkudiani (GE)  
 (54) **WALL HEAT-INSULATING BLOCK**

---

# UTILITY MODELS

## APPLICATIONS APPROVED FOR GRANTING PATENT

The decision can be appealed at the Chamber of Appeal of Sakpatenti within 3 months from the publication or at the Mtskheta District Court Administrative Cases Board (Address: №17, Samkhedro str., Mtskheta), within 1 month following the publication.

### PART A

#### A 01

(10) AU 2018 14511 U (51) Int. Cl. (2006)  
A 01 G 17/06

(21) AU 2017 14511 (22) 2017 06 08  
(71) Zaur Kacharava (GE)  
Gldanis mas., VIII mkr., korp. 12, b. 141,  
0107, Tbilisi (GE)

(72) Zaur Kacharava (GE)

(54) **SUPPORTING DEVICE  
FOR AGRICULTURAL PLANTS  
DISPOSED ON TRELLIS WIRES**

(57) A device includes 1 the posts vertically driven into a soil and having the cramps 2 to fasten trellis wires 3. The cramps are rigid onto the posts from both sides from symmetry axes thereof, on perpendicular relative to rows of posts side surfaces. Trellis wires are tightened between the cramps of neighboring posts.

Claims: 1 independent

Fig.: 2

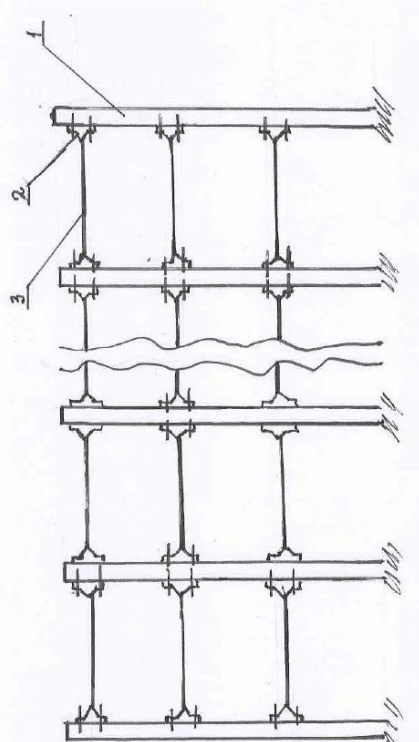

Fig. 1

#### A 61

(10) AU 2018 14053 U (51) Int. Cl. (2006)  
A 61 K 35/50  
A 61 K 47/46

(21) AU 2016 014053 (22) 2016 02 08

(71) Alesha Bakuridze (GE)

L. Sharashidzis q. 2/4, b. 41, 0179,  
Tbilisi (GE);

Zurab Kakabadze (GE)

Al. Kazbegis gamz. 6, b. 31, 0160,

Tbilisi (GE)

(72) Alesha Bakuridze (GE);

Zurab Kakabadze (GE)

(54) **BIO-DIFFUSE MATRIX  
FOR DRUGS TRANSDERMAL  
DELIVERY**

(57) A preparation includes sublimationally dried plate, whereon the ointment or liniment or gel is applied.

Claims: 1 independent

---

---

# DESIGNS

## REGISTERED DESIGN

**(11) D 2018 764 S**                      **(51) 09-05**  
(10) AD 2018 993 S                      (44) 4(488)/ 2018  
(21) AD 2017 993  
(22) 2017 09 22  
(24) 2017 09 22  
(28) 1  
(18) 2022 09 22  
(73) Simon Kharkhelauri (GE)  
    Temka, IV mkr., korp. 11, b. 85, 0197, Tbilisi, Georgia (GE)  
(72) Simon Kharkhelauri (GE)  
(54) **SUNFLOWER SEEDS PACKING BAG WITH POCKET**

---

## DESIGN REGISTERED ACCORDING TO THE ACCELERATED PROCEDURE

The decision can be appealed at the Chamber of Appeal of Sakpatenti within 3 months from the publication.

- (11) D 2018 763 S (51) 09-03; 09-05  
 (21) AD 2018 1036 (22) 2018 05 07  
 (24) 2018 05 07  
 (28) 15  
 (18) 2023 05 07  
 (73) LTD "CHERIE" (GE)  
 Didi Lilo, Nakveti 726, 0198, Tbilisi, Georgia (GE)  
 (72) Ivane Saginashvili (GE);  
 Gvantsa Chijavadze (GE);  
 Sopo Guraspashvili (GE)  
 (74) Tinatin Lomtaditdze (GE)  
 (54) 1.-15. PACKING  
 (55)



1.1



2.1



3.1



4.1



5.1



6.1

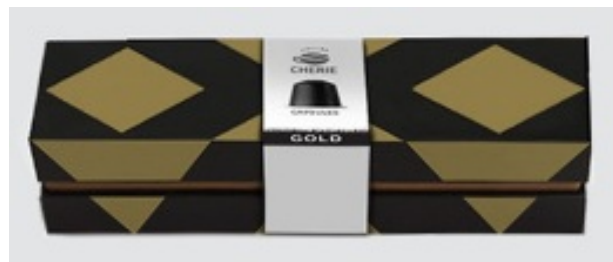

7.1



8.1



9.1



10.1



11.1



12.1



13.1



14.1



15.1



## DESIGNS, WHICH HAVE BEEN REGISTERED WITH THE INTERNATIONAL BUREAU CLAIMING PRIORITY ON THE TERRITORY OF GEORGIA

The decision can be appealed at the Chamber of Appeal of Sakpatenti within 3 months from the publication or at the Mtskheta District Court Administrative Cases Board (Address: №17, Samkhedro Str., Mtskheta), within 1 month following the publication.

**(11) DM/097537**

(15) 2017 08 29

(22) 2017 08 29

(28) 9

(73) TISSOT SA (TISSOT AG) (TISSOT LTD)

Chemin des Tourelles 17, CH-2400 Le Locle (CH)

(85) CH

(86) CH

(87) CH

(88) CH

(89) CH

(81) II. BZ, MA III. AL, AM, AZ, BA, CH, EM, GE, KG, LI, MC, MD, ME, MK, MN, NO, OM, SG, TN, TR, UA

(72) 2,9: Gilles HABEGGER

Rue de l'Oratoire 1, 2000 Neuchâtel, Suisse;

6-9: Laurie SAUNDERS

Ruelle des Vignerons 22, 1787 Môtier, Suisse;

9: Jérémie SENGGEN

Avenue de Montchoisi 25, 1006 Lausanne, Suisse;

1: Fiona MATTHEY

Rue Neuve 3, 2300 La Chaux-de-Fonds, Suisse;

1,3: David QUINCHE

Rue Jaquet Droz 5, 2300 La Chaux-de-Fonds, Suisse;

3-5: Benoît VIANIN

Promenade le Corbusier 11, 2300 La Chaux-de-Fonds, Suisse;

6-8: Laurent AUBERSON

Im Hessengüetli 1, 8406 Winterthur, Suisse

(54) 1. Watch case with strap; 2. Watch case; 3.-6. Watch dials; 7. Watch flange; 8. Watch case;

9. Watch case with strap

(55)

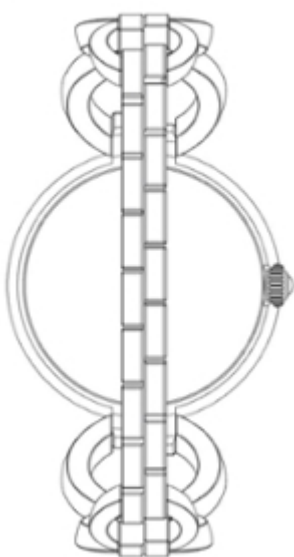
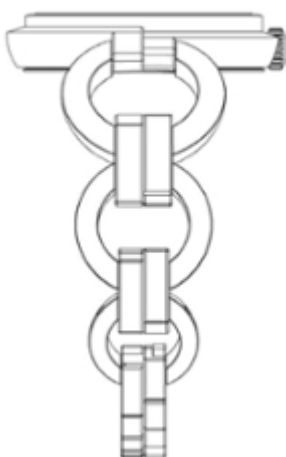
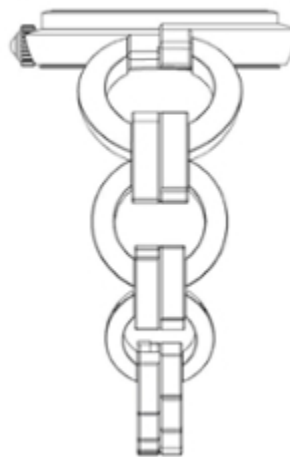
**1.1****1.2****1.3****1.4**

1.5

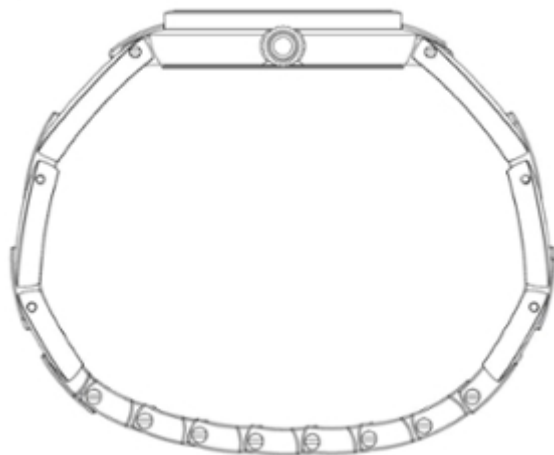

1.6

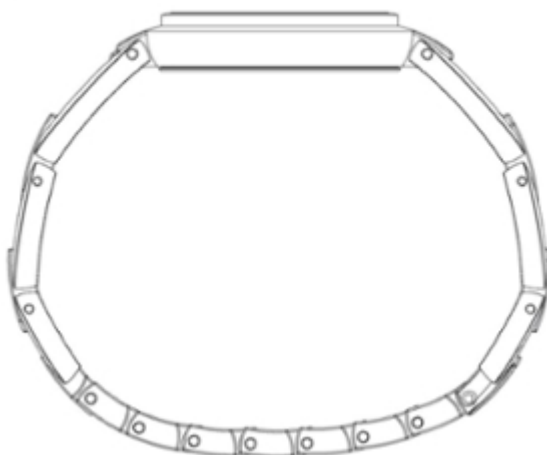

1.7



2.1

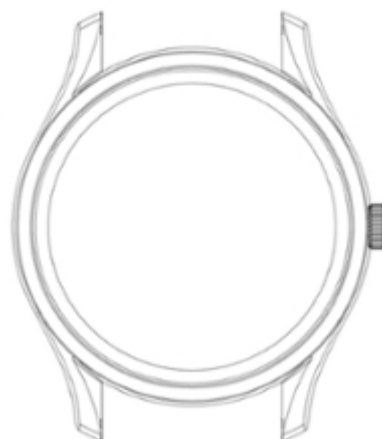

2.2

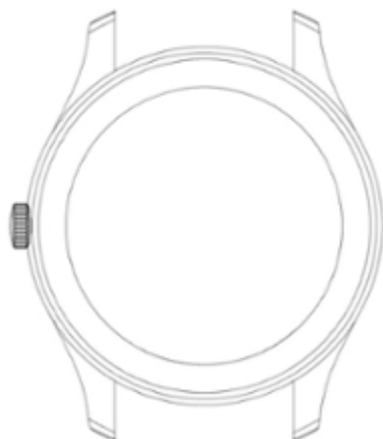

2.3



2.4



2.5

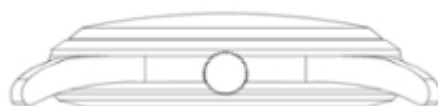

2.6



2.7



3.1

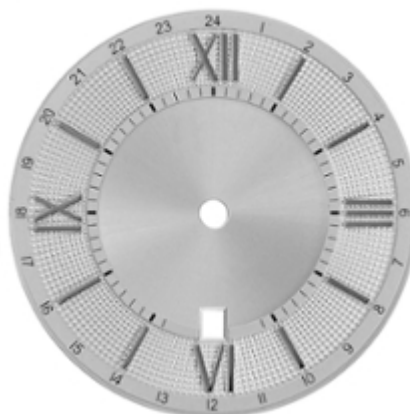

3.2

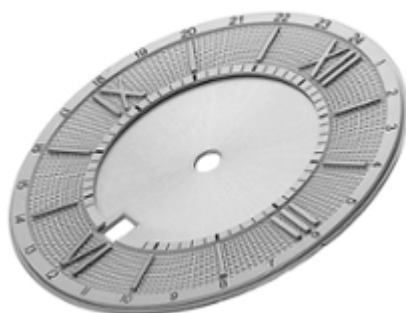

4.1



4.2



5.1

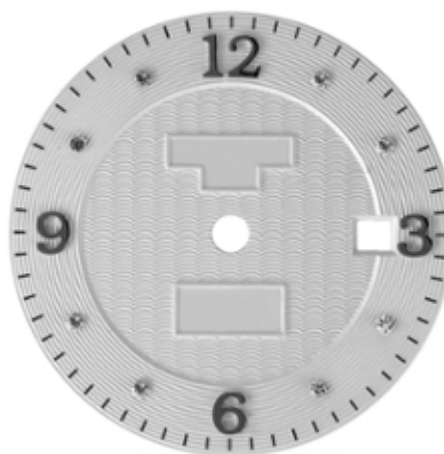

6.1



5.2



6.2

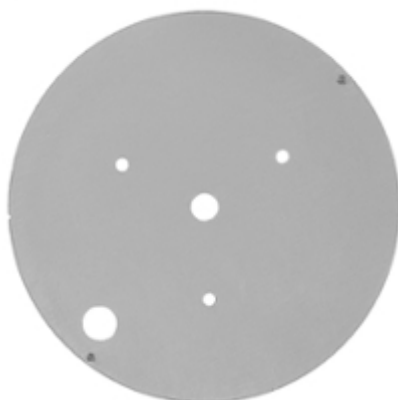

6.3



7.1



7.2



7.3



8.1



8.2



8.3



8.4



8.6

8.5



9.1



9.2



9.3



9.4



## 9.5

**(11) DM/099828**

(15) 2017 12 19

(22) 2017 12 19

(28) 19

(30) Nos. 1, 2, 3, 4, 5, 6, 7, 8, 9, 10, 11, 12, 13, 14, 15, 16, 17, 18, 19: 19.06.2017; 2017/04269; TR

(73) HAYAT KIMYA SAN. A.S.

Sepetlipinar Mh. Hayat Cd. No: 2, Basiskele, TR-41275 Kocaeli (TR)

(85) TR

(86) TR

(87) TR

(88) TR

(89) TR

(81) III. AL, AM, AZ, BA, CH, EG, EM, GE, GH, JP, KG, KH, KR, MD, ME, MK, MN, NA, NO, OA, OM, RS, RW, SG, SY, TJ, TM, TN, UA, US

(72) FIKRET KOC

Hayat Kimya Sanayi Anonim Sirketi, Sepetlipinar Mah. Osman Senol Cad. No: 26 Basiskele, 41250 Kocaeli, Turkey;

ARZU KARATEKİN

Hayat Kimya Sanayi Anonim Sirketi, Sepetlipinar Mah. Osman Senol Cad. No: 26 Basiskele, 41250 Kocaeli, Turkey;

ERHAN BİLGİN

Hayat Kimya Sanayi Anonim Sirketi, Sepetlipinar Mah. Osman Senol Cad. No: 26 Basiskele, 41250 KOCAELI, Turkey;

ARİF AKAYTAY, Hayat Kimya Sanayi Anonim Sirketi, Sepetlipinar Mah. Osman Senol Cad. No: 26 Basiskele, 41250 KOCAELI, Turkey;

BULENT ÇAKMAK

Hayat Kimya Sanayi Anonim Sirketi, Sepetlipinar Mah. Osman Senol Cad. No: 26 Basiskele, 41250 KOCAELI, Turkey;

EZGİ YENİCE, Hayat Kimya Sanayi Anonim Sirketi, Sepetlipinar Mah. Osman Senol Cad. No: 26 Basiskele, 41250 KOCELI, Turkey;

CIHAT YASAR

Hayat Kimya Sanayi Anonim Sirketi, Sepetlipinar Mah. Osman Senol Cad. No: 26 Basiskele/Kocaeli 41250, 41250 KOCAELI, Turkey;

DENİZ AYDIN

Hayat Kimya Sanayi Anonim Sirketi, Sepetlipinar Mah. Osman Senol Cad. No: 26 Basiskele, 41250 KOCAELI, Turkey;

HALUK ÖZGÜR ACAR

Sepetlipinar Mah. Hayat Cad. Osman Senol Sok. No:26 Yeniköy Basiskele/KOCAELİ, KOCAELI, Turkey;

İBRAHİM GÜLER

Hayat Kimya Sanayi Anonim Sirketi, Sepetlipinar Mah. Osman Senol Cad. No: 26 Basiskele/Kocaeli 41250, 41250 KOCAELI, Turkey

(54) 1.-19. Babies' diapers

(55)

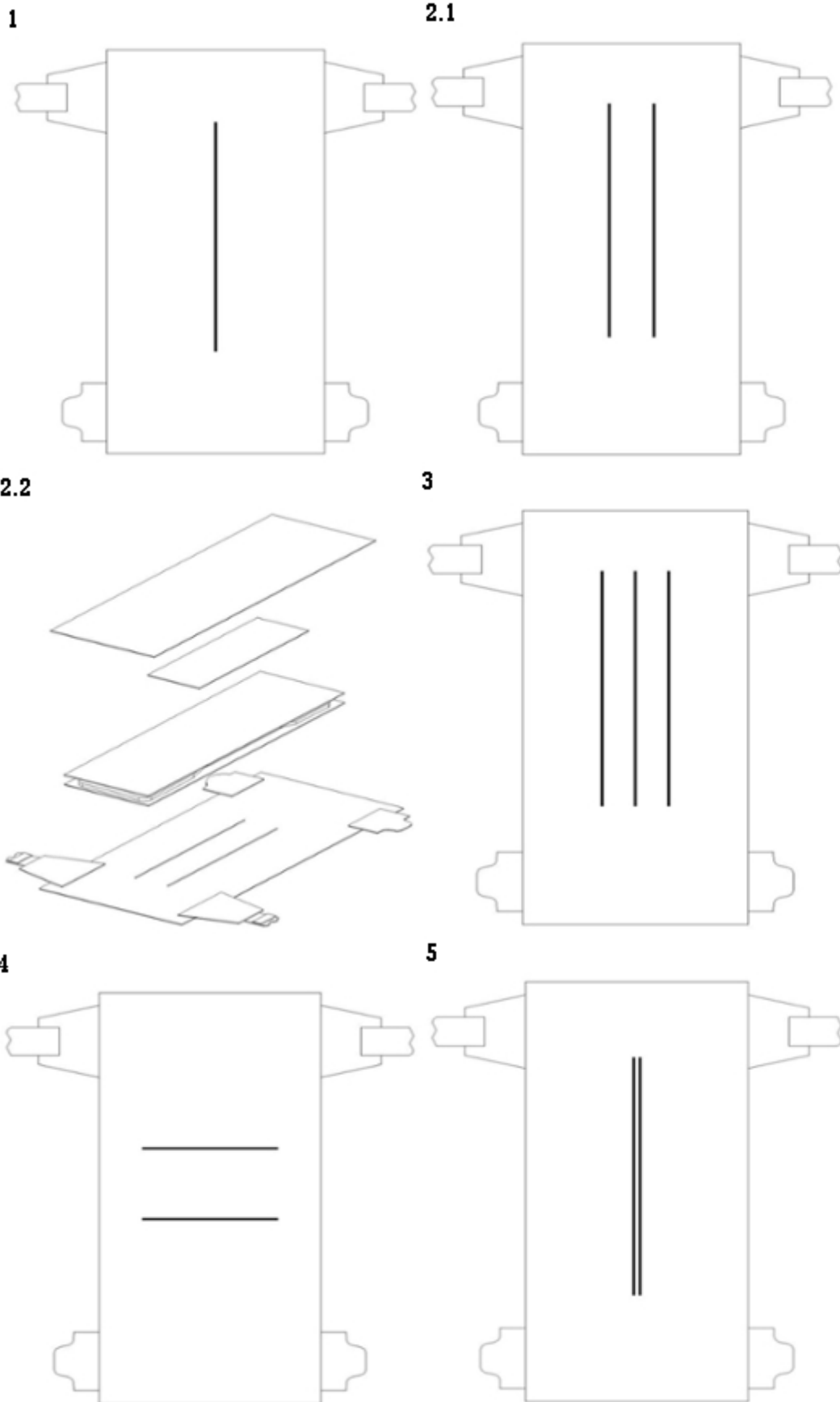

6.1

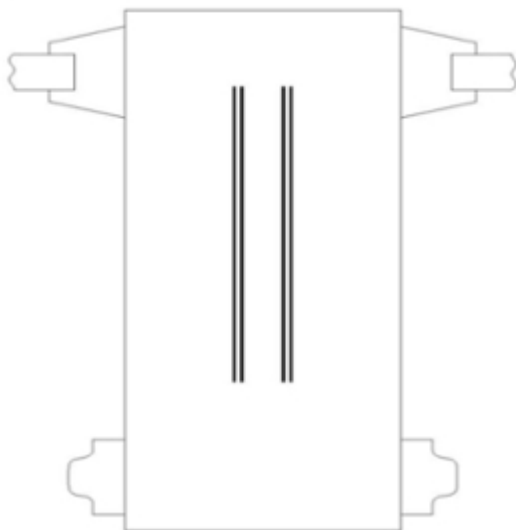

6.2

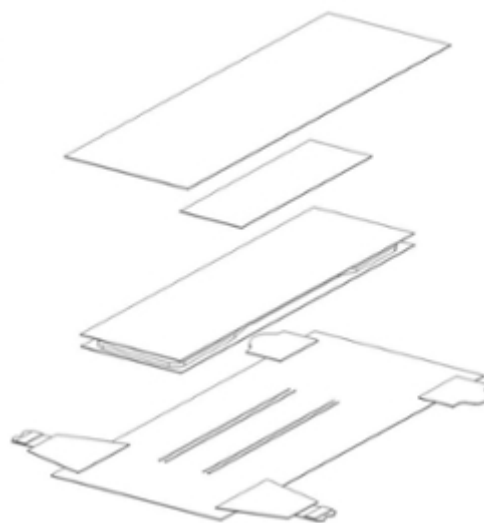

7

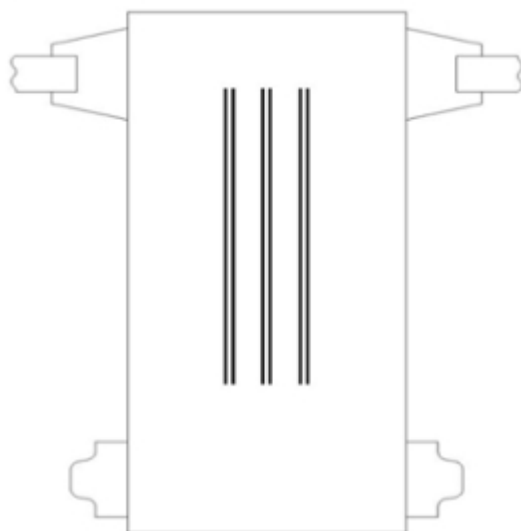

8

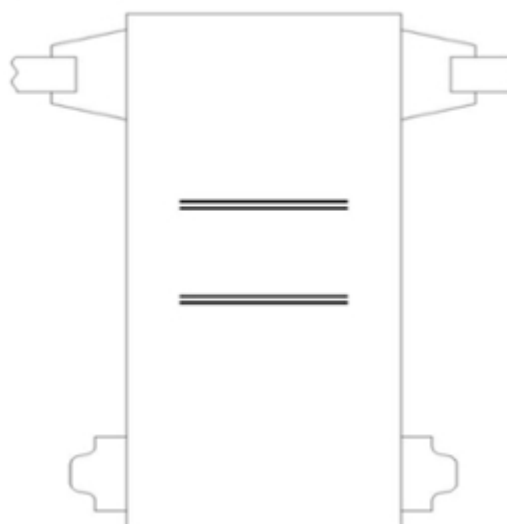

9

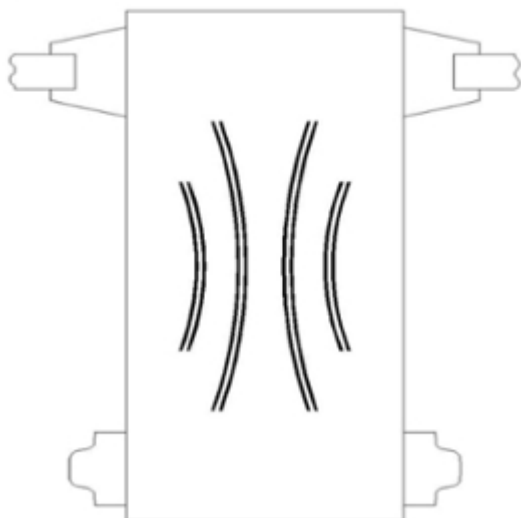

10

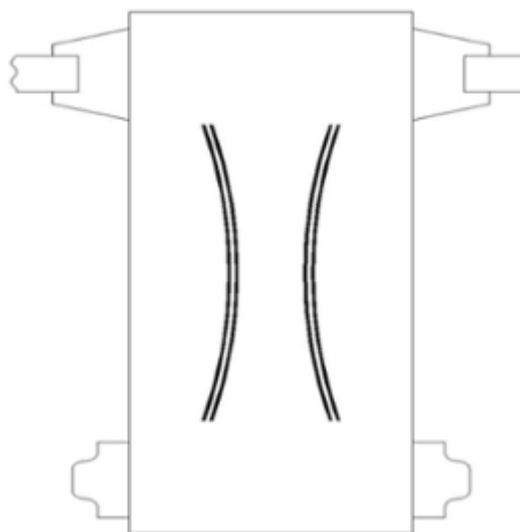



11

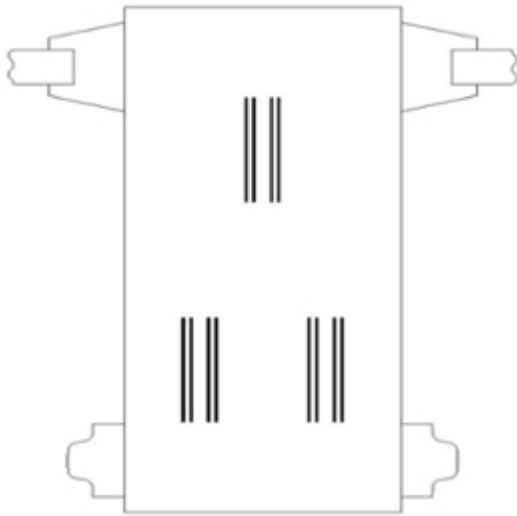

12

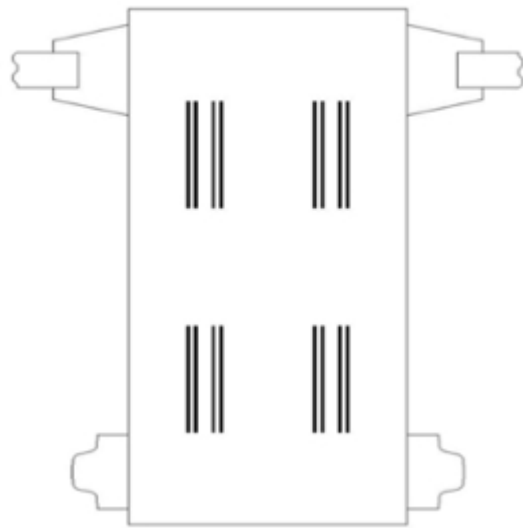

13

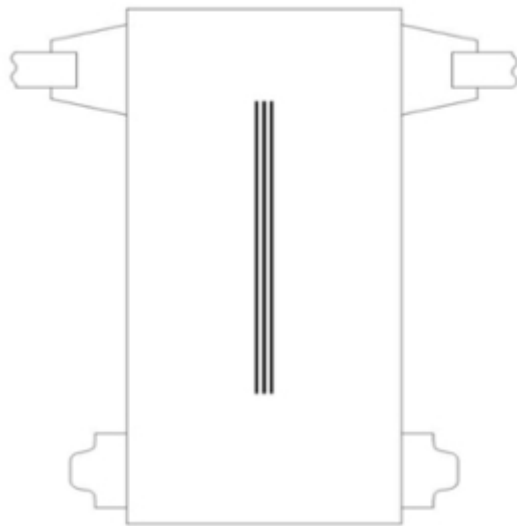

14.1

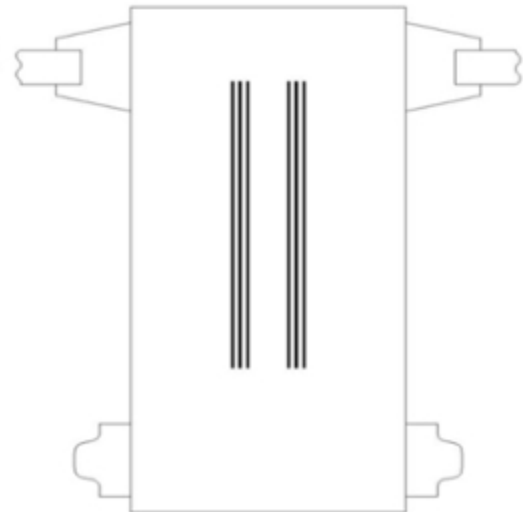

14.2

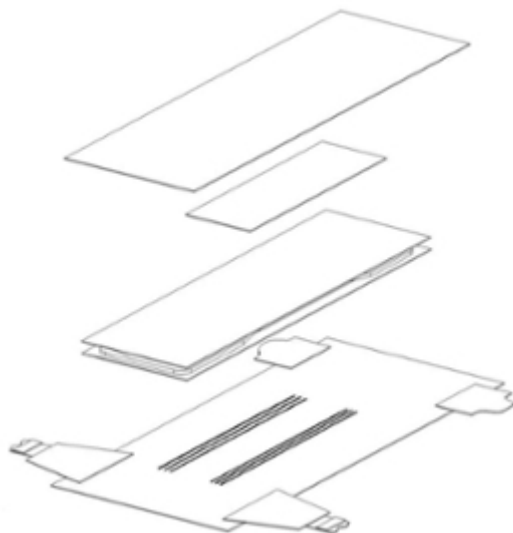

15

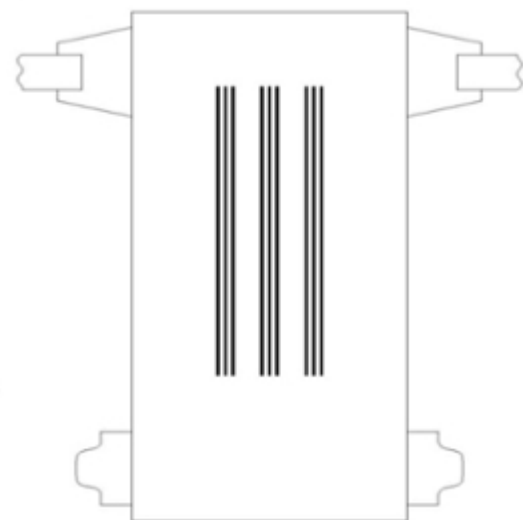

16

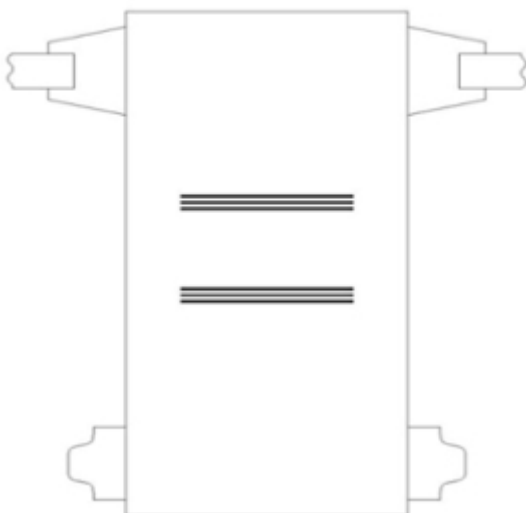

17

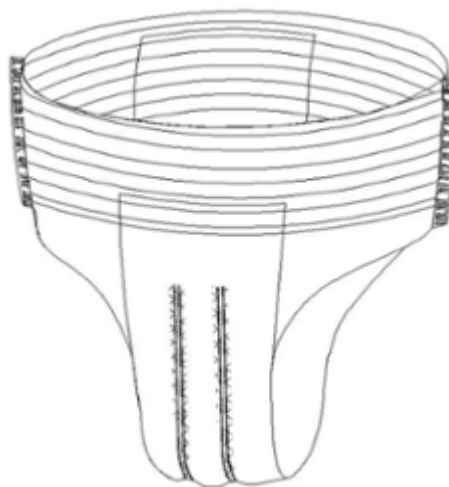

18

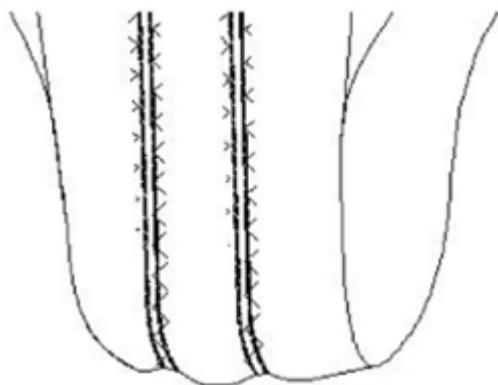

19.1



19.2



19.3



- (11) **DM/099846** (51) **14-04**  
 (15) 2017 06 16 (45) 2018/08 (2018 03 02)  
 (22) 2017 06 16  
 (28) 4  
 (30) Nos. 1, 2, 3, 4, 5: 20.12.2016; 62/436947; US; Nos. 1, 2, 3, 4, 5: 28.02.2017; 15/445752; US; Nos. 1, 2, 3, 4, 5: 28.02.2017; 29/595587; US  
 (73) ORIG3N, INC.  
 27 Drydock Ave., 6th Floor, Boston MA 02210 (US)  
 (85) US  
 (86) US  
 (87) US  
 (88) US  
 (89) US  
 (81) III. AL, AM, AZ, BA, BN, BW, CH, EG, EM, GE, GH, IS, JP, KG, KH, KP, KR, LI, MC, MD, ME, MK, MN, NA, NO, OA, OM, RS, RW, SG, ST, SY, TJ, TM, TN, TR, UA  
 (72) Robin Y. Smith  
 27 Drydock Ave., 6th Floor, 02210 Boston, United States of America;  
 Kate Blanchard  
 27 Drydock Ave., 6th Floor, 02210 Boston, United States of America;  
 Sunil Anant Gupta  
 27 Drydock Ave., 6th Floor, 02210 Boston, United States of America;  
 Edward Joseph Coffey  
 27 Drydock Ave., 6th Floor, 02210 Boston, United States of America;  
 Marcie A. Glicksman  
 27 Drydock Ave., 6th Floor, 02210 Boston, United States of America;  
 Brian Phillips, 27 Drydock Ave., 6th Floor, 02210 Boston, United States of America  
 (54) 1.-4. Graphical user interfaces for a display screen or portion thereof  
 (55)

1.1



2.1



2.2



3



4



**(11) DM/099875**

(15) 2018 02 05

(22) 2018 02 05

(28) 1

(73) LABORATOIRES LA PRAIRIE SA

Industriestrasse 8, CH-8604 Volketswil (CH)

(85) CH

(86) CH

(87) CH

(88) CH

(89) CH

(81) II. BJ, BZ, CI, GA, MA, ML, NE, SN, SR III. AL, AM, AZ, BA, BN, BW, CH, EG, EM, GE, JP, KG, KH, KR, LI, MC, MD, ME, MK, MN, NA, NO, OA, OM, RS, RW, SG, ST, TJ, TM, TN, TR, UA

(72) Davide Bordogna

Industriestrasse 8, 8604 Volketswil, Switzerland; Tobias Fricker, Industriestrasse 8, 8604 Volketswil, Switzerland

(54) 1. Container for cosmetic products

(55)

1.1



1.2



1.3

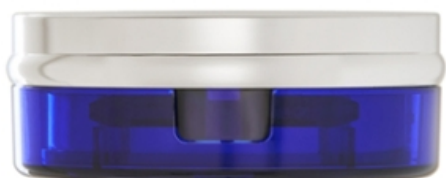

1.4



1.5



1.6



1.7



1.8



1.10

1.9



1.11



1.12



1.13

**(11) DM/099894**

(15) 2018 02 06

(22) 2018 02 06

(28) 1

(73) PATROIS GUILLAUME

55 avenue Marceau, F-75016 Paris (FR)

(85) FR, EM

(86) FR, EM

(87) FR, EM

(88) FR, EM

(89) FR

(81) II. BX, BZ, GR, MA, SR III. AL, AM, AZ, BA, BN, BW, CH, EG, EM, GE, GH, IS, KG, KP, LI, LV, MC, MD, ME, MK, MN, NA, NO, OA, OM, RS, RW, SG, ST, SY, TJ, TN, TR, UA

(72) Guillaume patrois

55 ave Marceau, Paris, France

(54) 1. Electric three wheeler

(55)

**(51) 12-11**

(45) 2018/09 (2018 03 09)

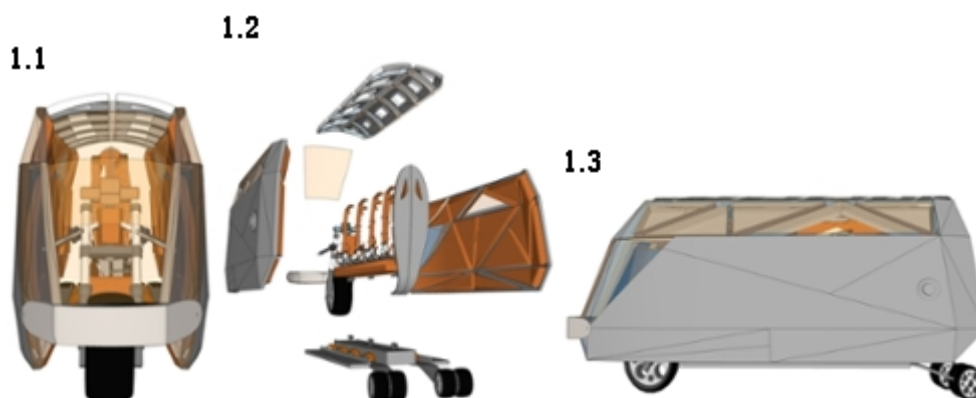

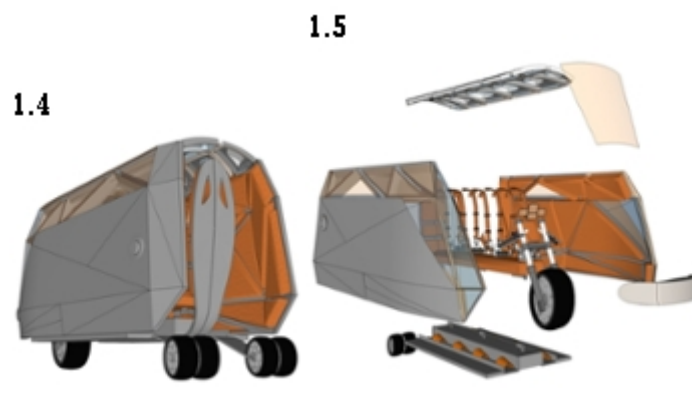

**(11) DM/099990**

(15) 2018 02 22

(22) 2018 02 22

(28) 6

(73) CHANEL SARL

Quai du Général-Guisan 24, CH-1204 Genève (CH)

(85) CH

(86) CH

(87) CH

(88) CH

(89) CH

(81) II. GR, MA III. AZ, BG, DK, EG, FI, GE, NO, PL, TN, TR, UA

(72) Marianna NITSCH

135 Avenue Charles de Gaulle, 92200 Neuilly-sur-Seine, France

(54) 1.-5. Handbags; 6. Shopping bag

(55)

**(51) 03-01**

(45) 2018/09 (2018 03 09)

**1.1**



1.2



1.3





1.4

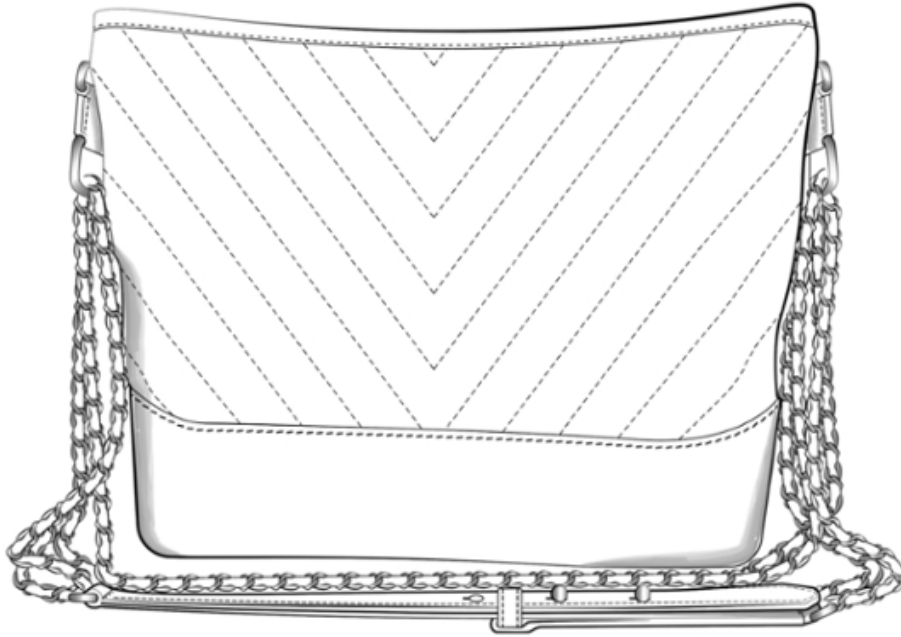

1.5

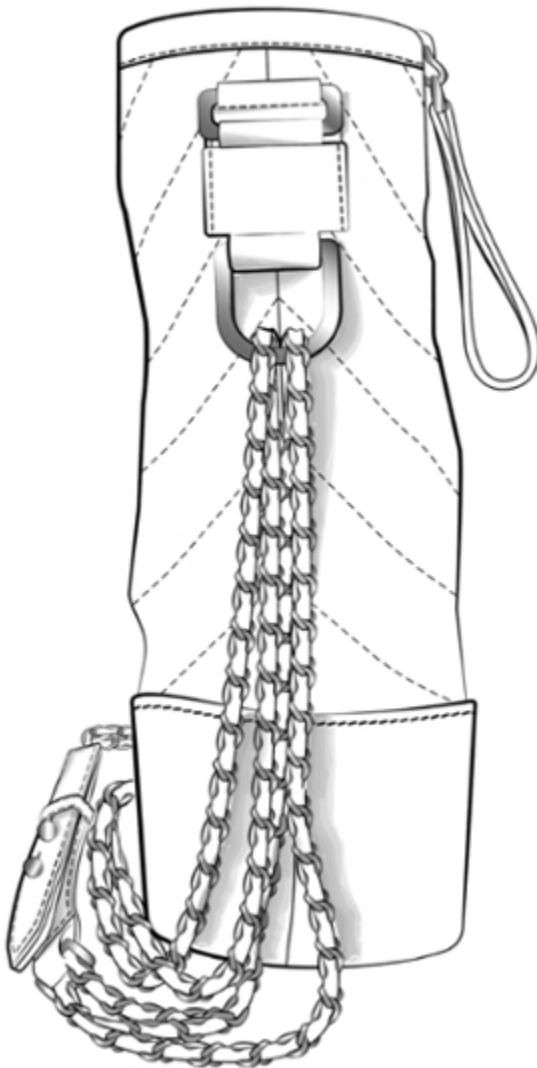

1.6

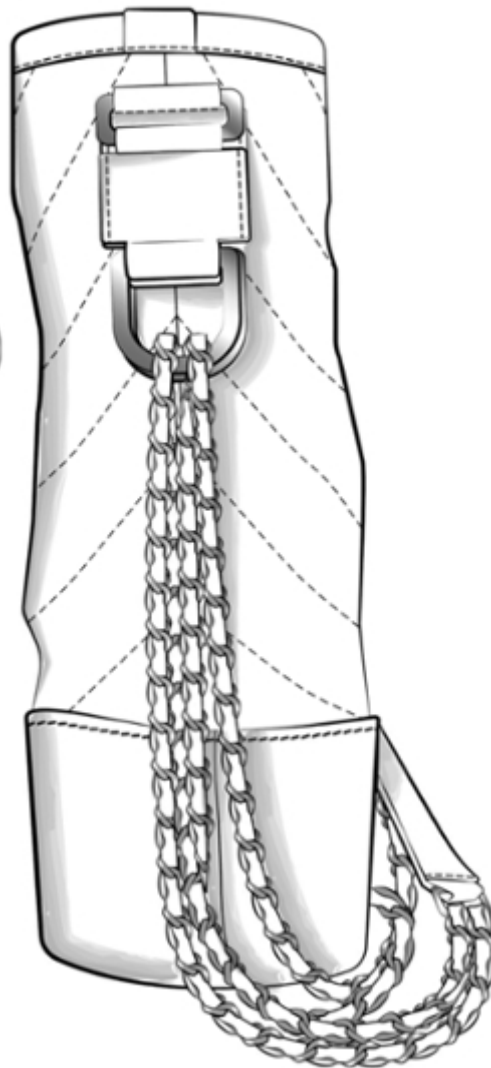

1.7

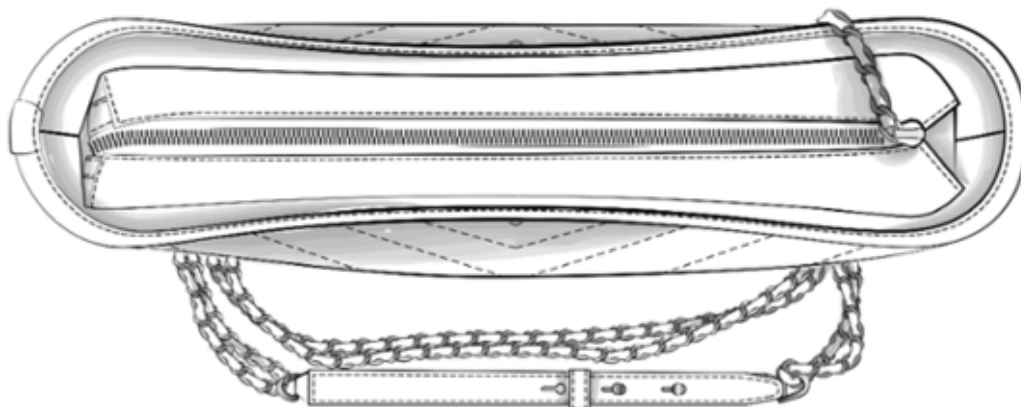

1.8

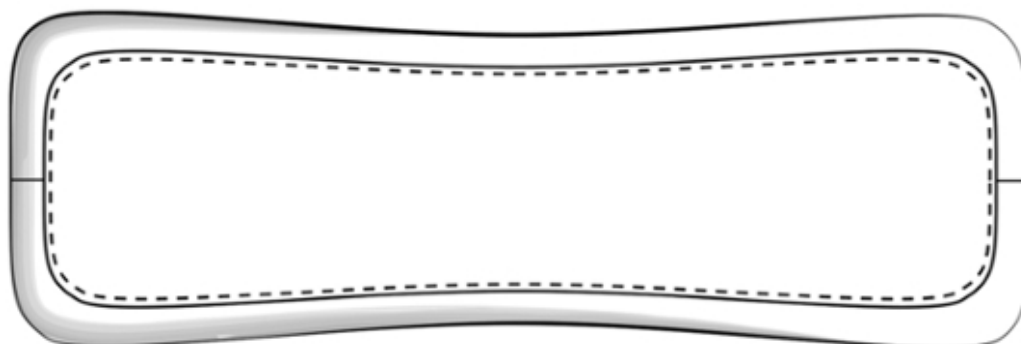

2.1

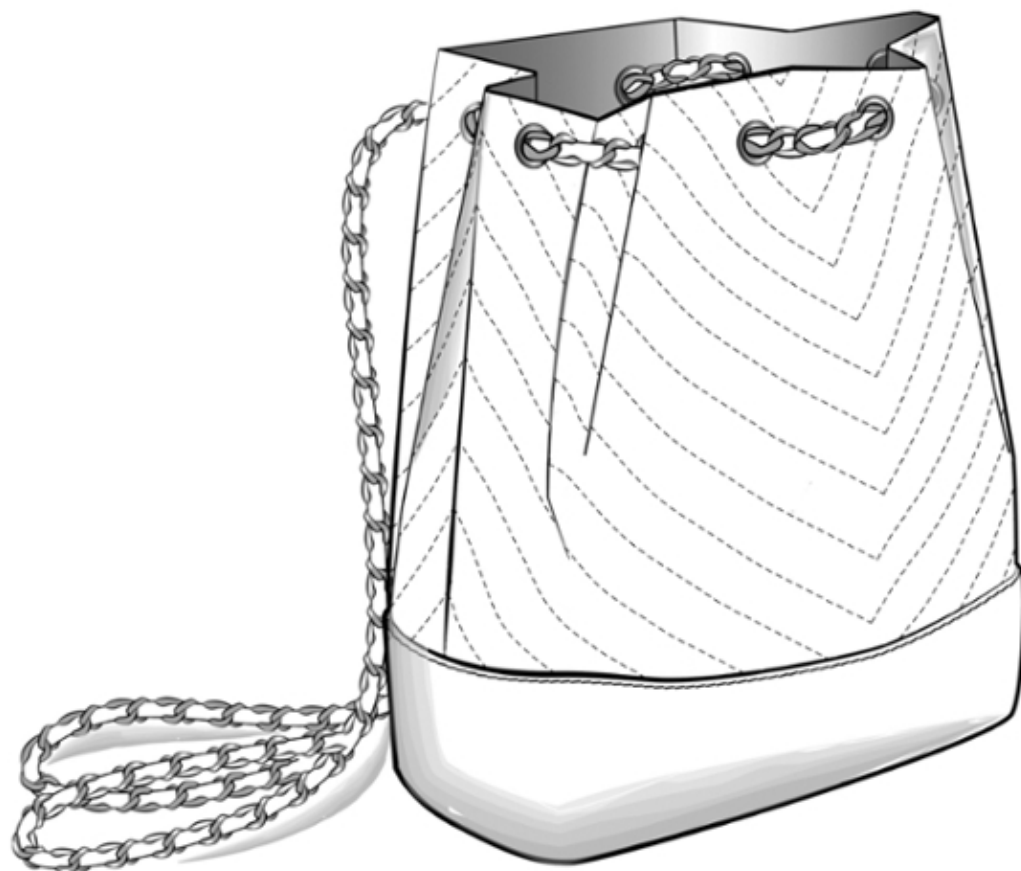

2.2



2.3



2.4

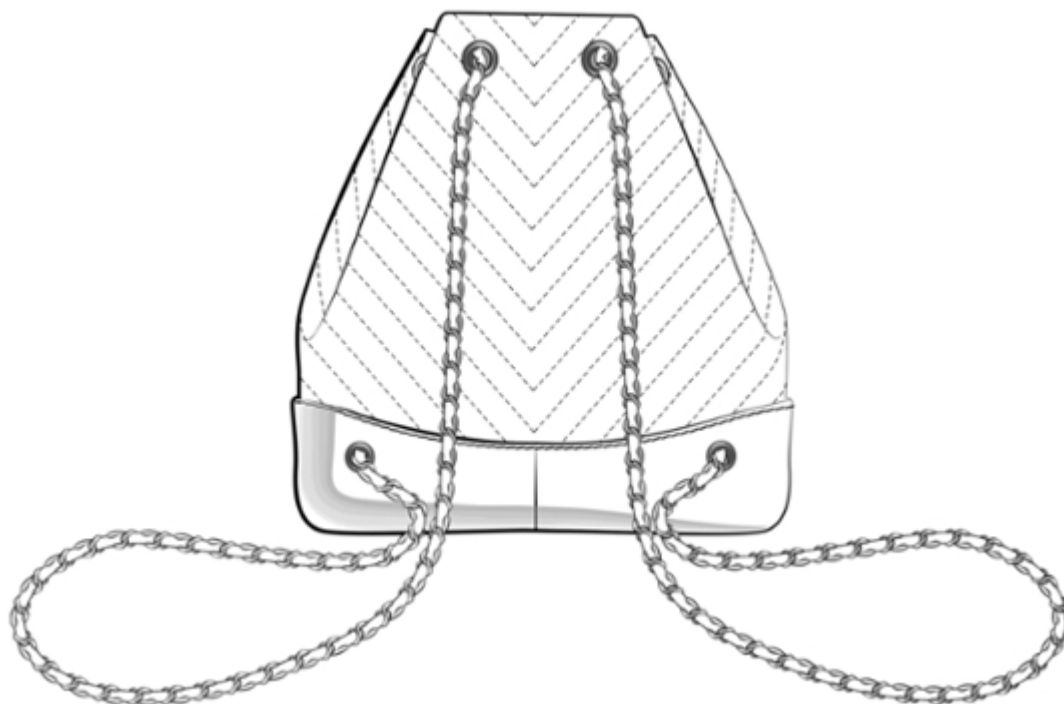

2.5

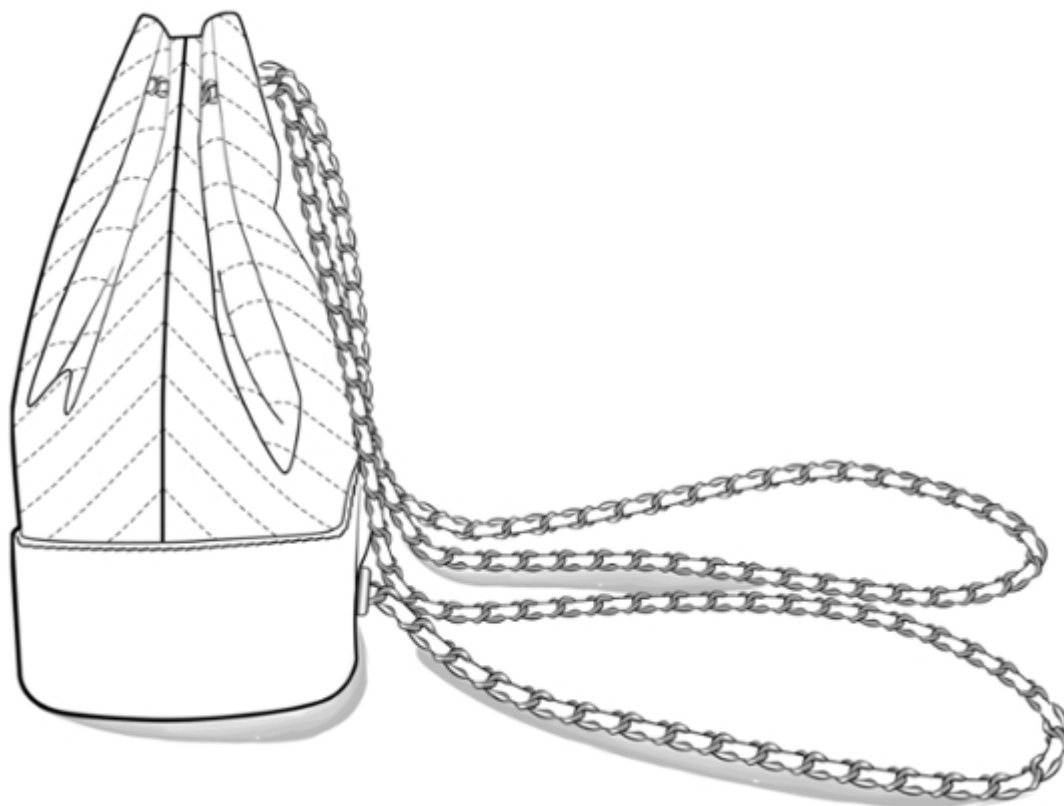

2.6

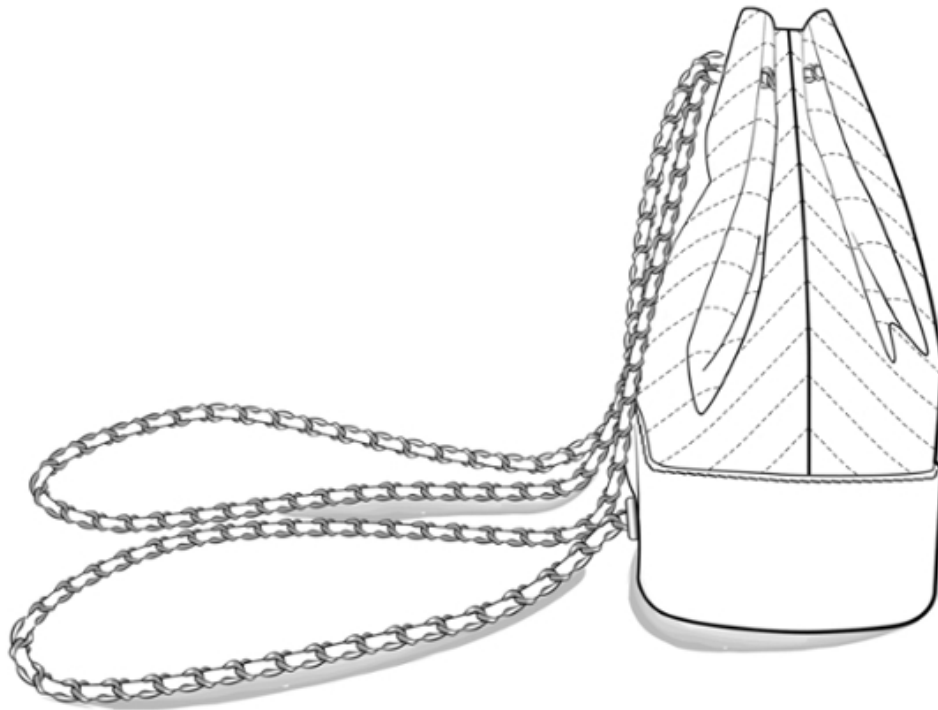

2.7

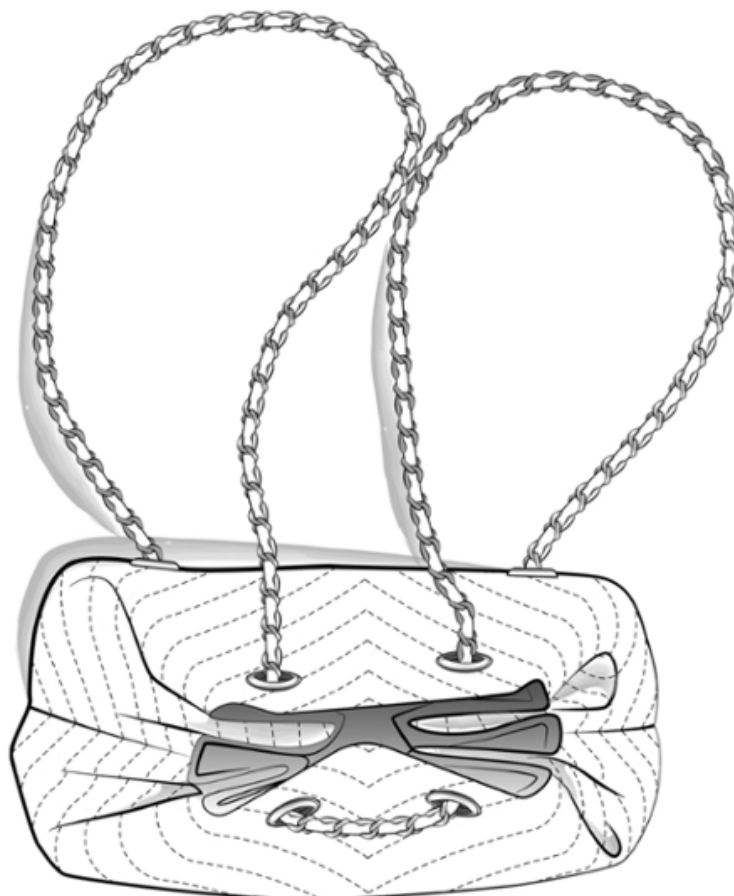

2.8

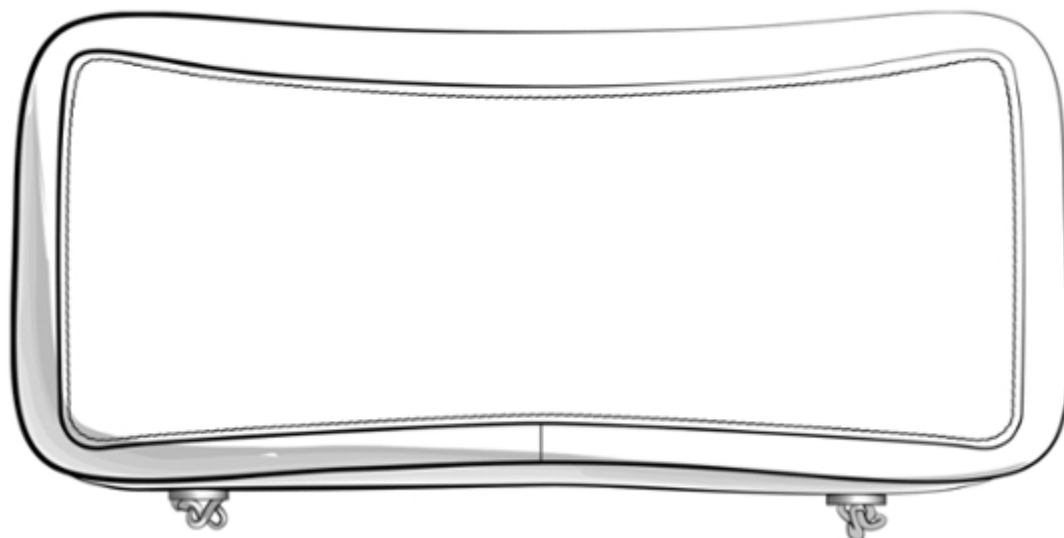

3.1



3.2

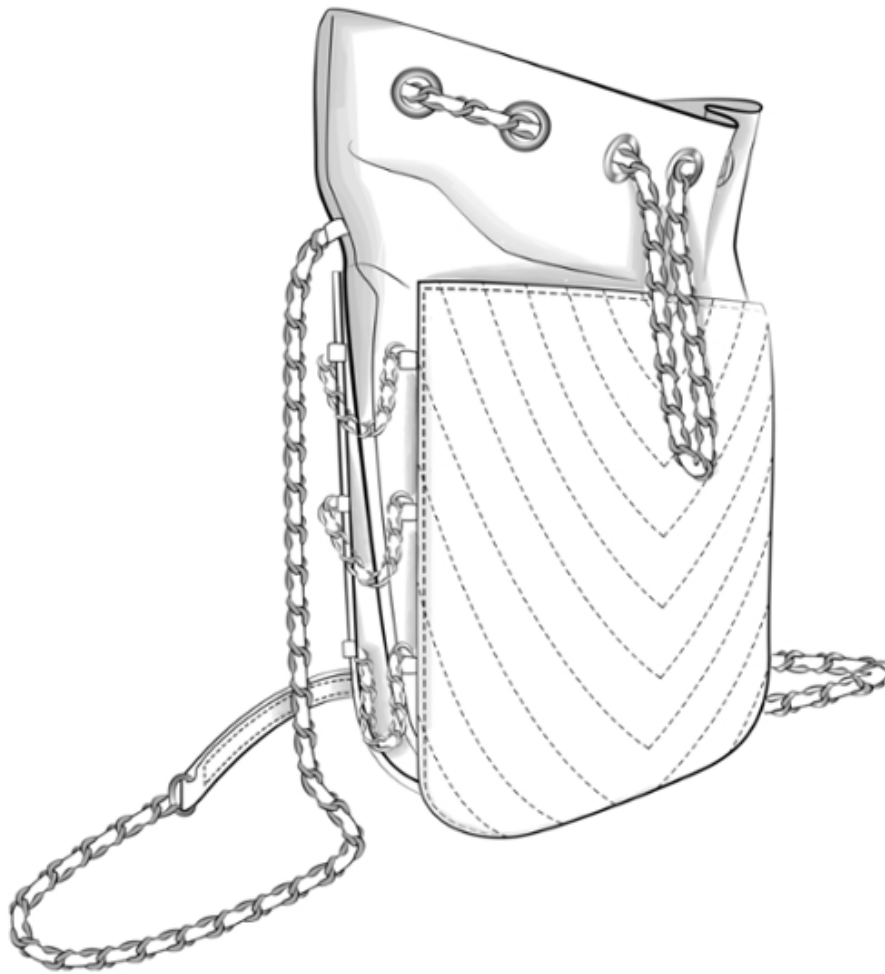

3.3



3.4

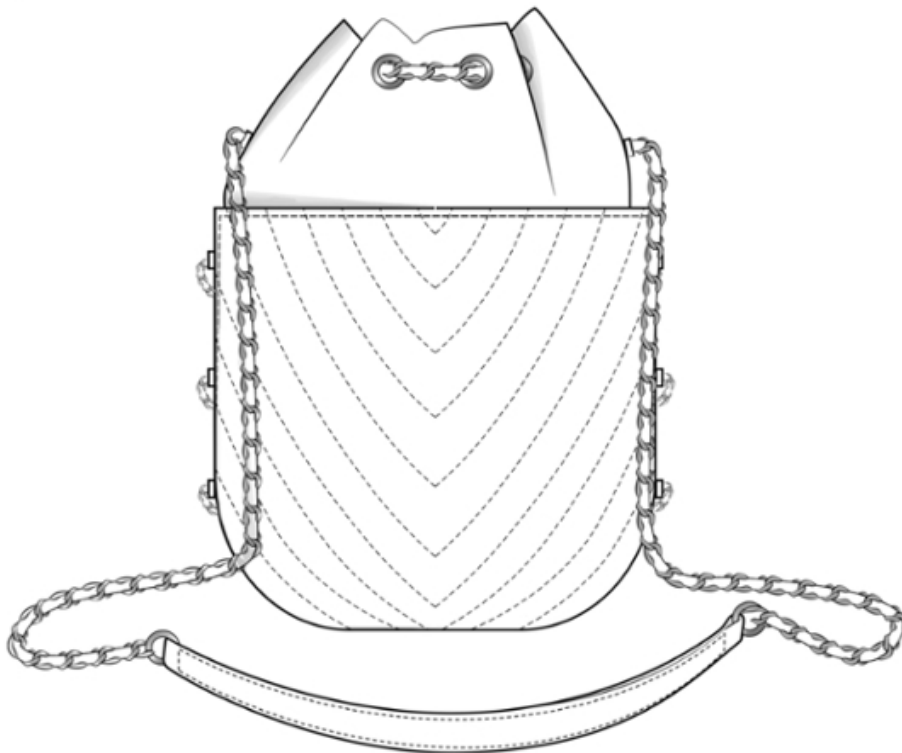

3.5

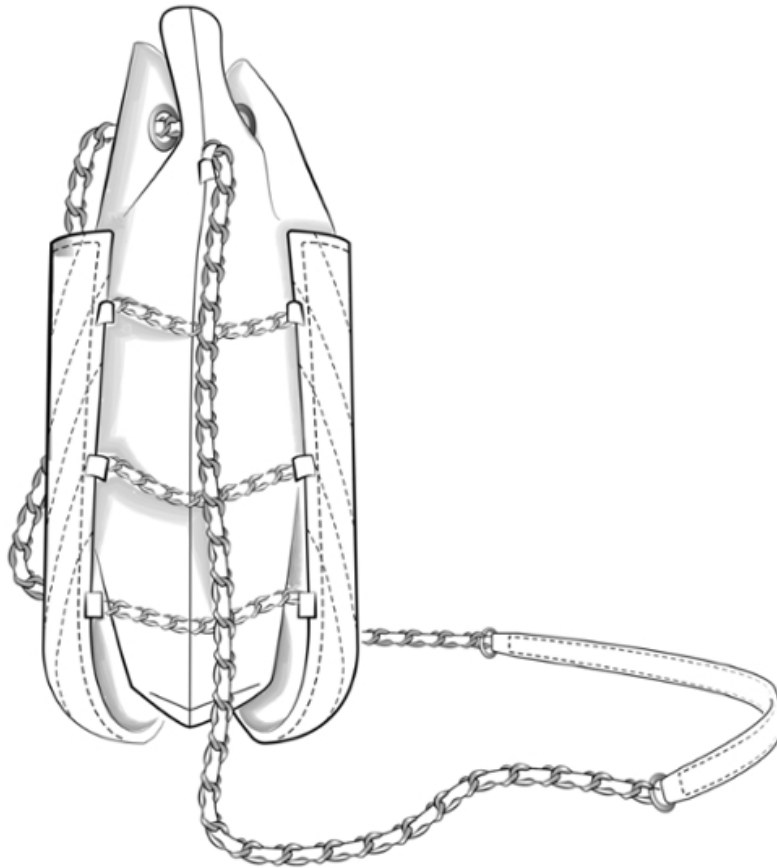

3.6

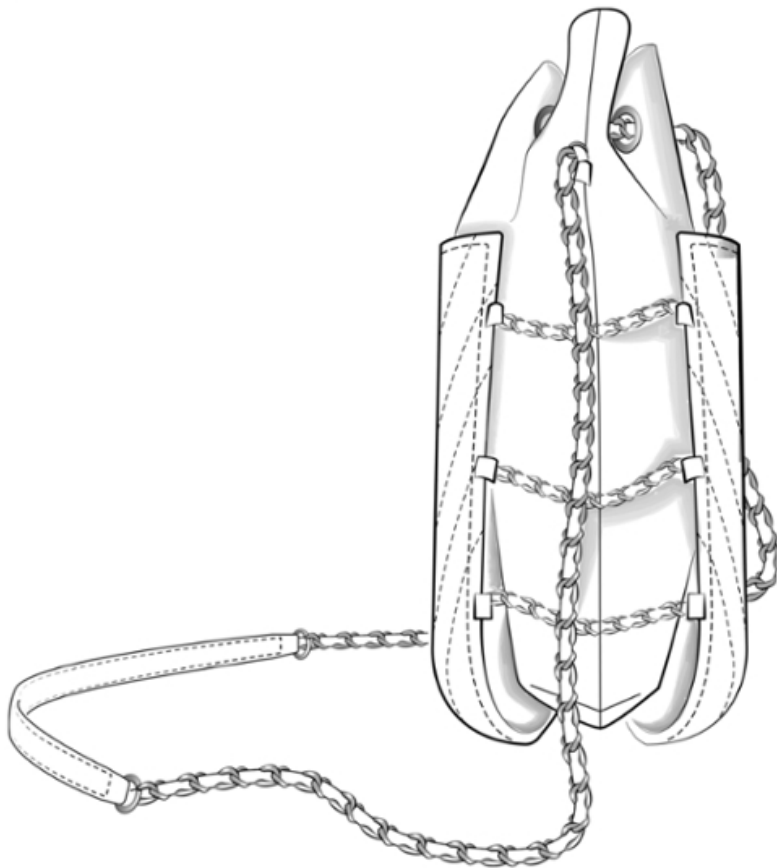



3.7

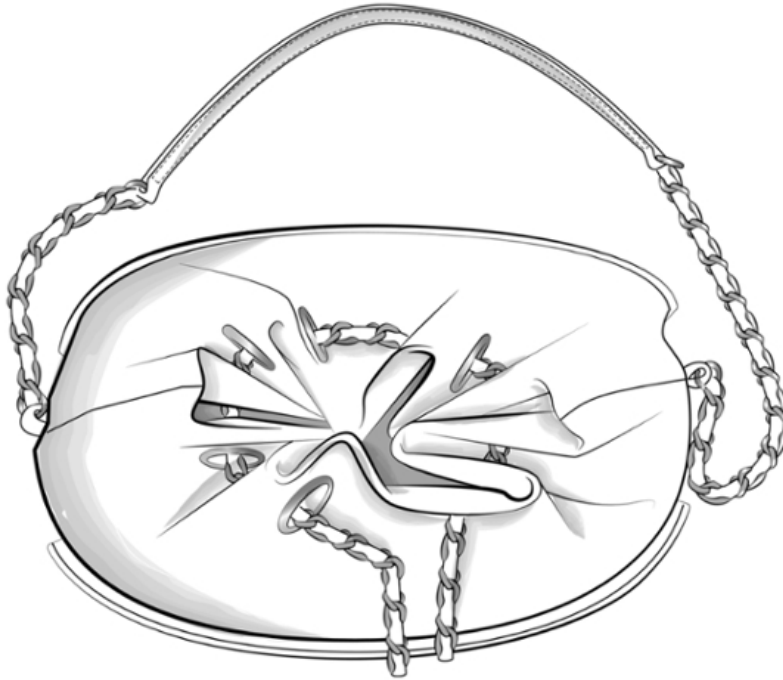

3.8

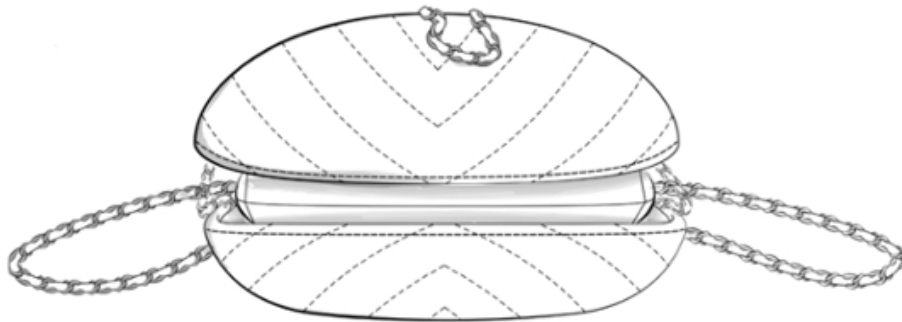

4.1

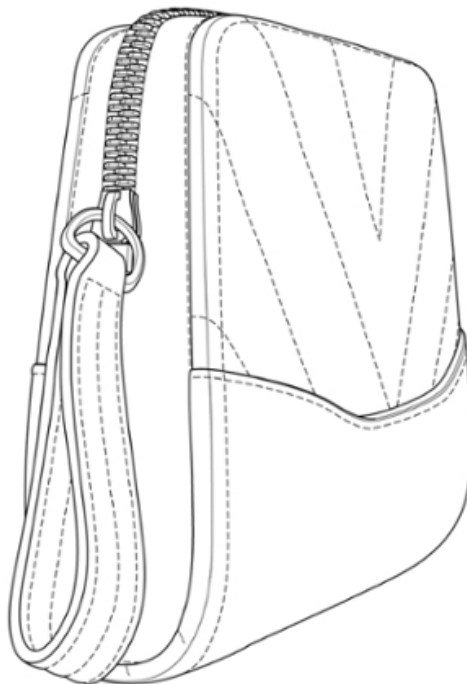

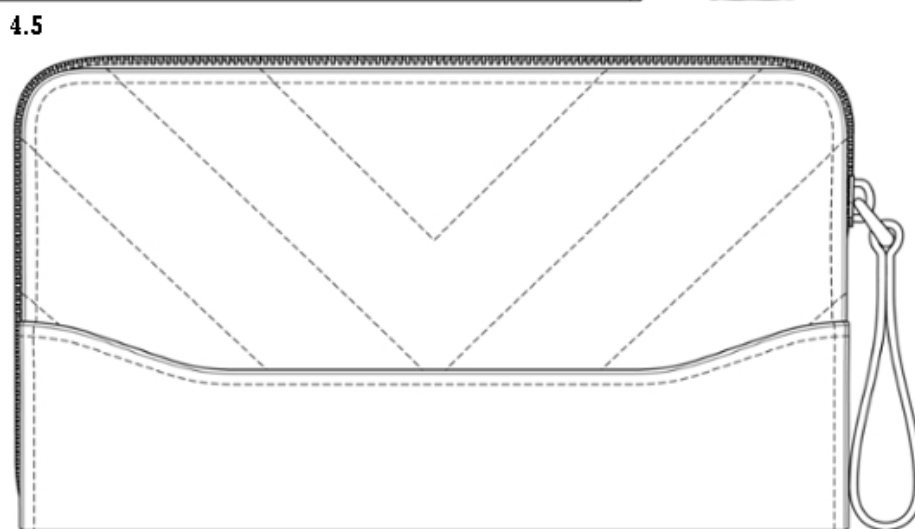
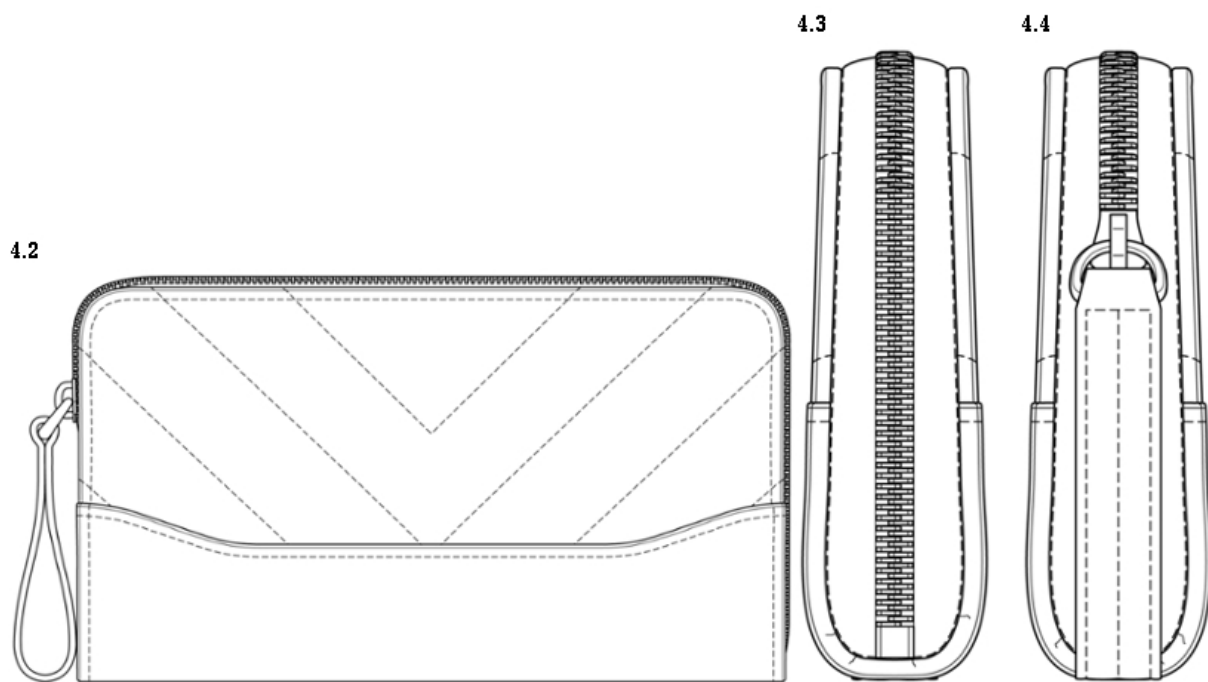

5.1



5.2



5.3



5.4



5.5



5.6

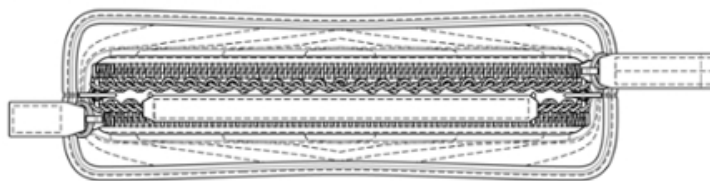

5.7

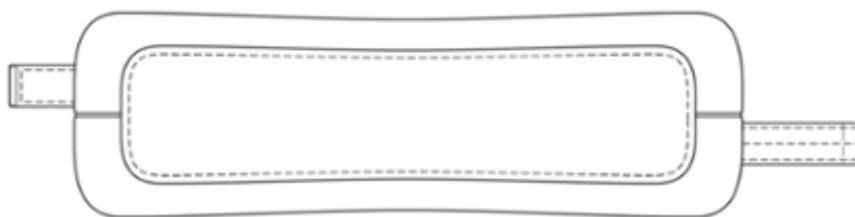

6



(11) DM/100022

(51) 25-03

(15) 2018 02 06

(45) 2018/10 (2018 03 16)

(22) 2018 02 06

(28) 1

(73) PATROIS GUILLAUME

55 avenue Marceau, F-75016 Paris (FR)

(85) FR, EM

(86) FR, EM

(87) FR, EM

(88) FR, EM

(89) FR

(81) II. BX, BZ, GR, MA, SR III. AL, AM, AZ, BA, BN, BW, CH, EG, EM, GE, GH, IS, KG, KP, LI, LV, MC, MD, ME, MK, MN, NA, NO, OA, OM, RS, RW, SG, ST, SY, TJ, TN, TR, UA

(72) Guillaume patrois

55 ave marceau, Paris, France

(54) 1. Modular house

(55)

1.1



1.2



**(11) DM/100241****(51) 09-03**

(15) 2017 10 23

(45) 2018/12 (2018 03 30)

(22) 2017 10 23

(28) 2

(30) No. 2: 25.07.2017; s201701335; UA; No. 1: 25.07.2017; s201701336; UA

(73) VOLOSHYN SERGII

vul. Akademika Tupoleva, 17, kv. 27, Kyiv 04128 (UA)

(85) UA

(86) UA

(87) UA

(88) UA

(89) UA

(81) II. BX III. BA, CH, EG, EM, GE, IS, LI, MC, MD, ME, NO, RS, TR

(72) VOLOSHYN SERGII

vul. Akademika Tupoleva, 17, kv. 27, 04128 Kyiv, Ukraine

(54) 1.-2. Boxes [packaging]

(55)

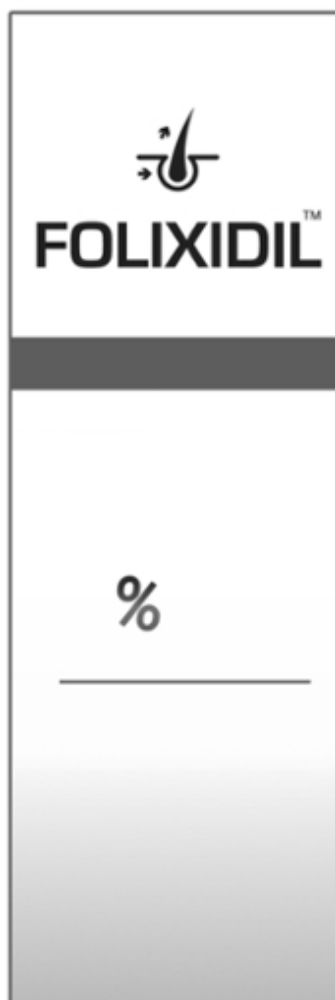
**1.1****1.2****1.3**

2.1



2.2

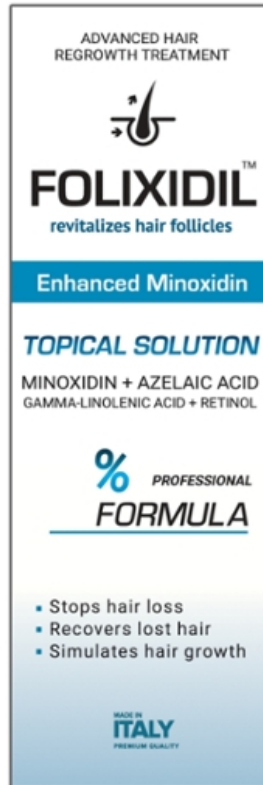

2.3

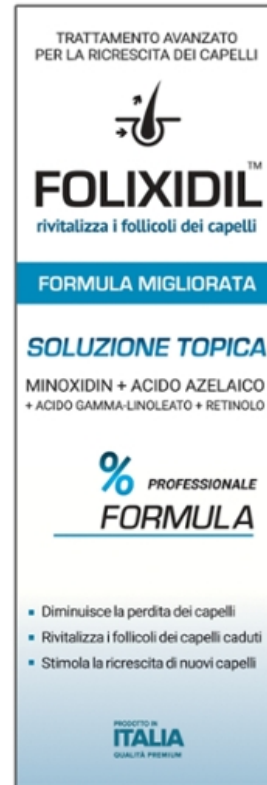

2.4



2.5

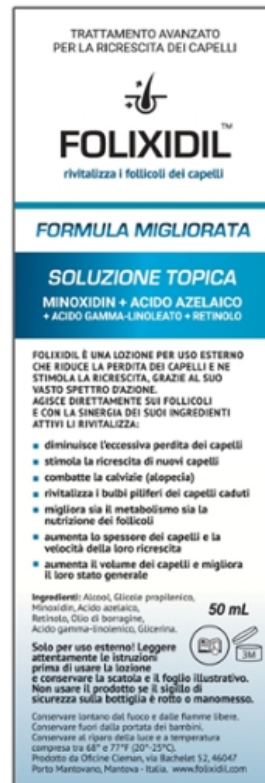

**(11) DM/095557****(51) 09-03, 05**

(15) 2017 03 30

(45) 2018/13 (2018 04 06)

(22) 2017 03 30

(28) 13

(73) SOREMARTEC SA

Rue de Trèves (FBC)-Complexe B, L-2632 Findel (LU)

(85) –

(86) BX, EM

(87) BX, EM

(88) EM

(89) EM

(81) IL, MA III, AL, CH, EM, GE, HR, ME, MK, OA, RS, TR

(72) Giuseppe TERRASI

Frazione Manera, 14, I-12050 Benevello (CN), Italy

(54) 1.-9. Shaped wrappings [packaging]; 10.-11. Bags [packaging]; 12.-13. Packagings for foodstuffs

(55)

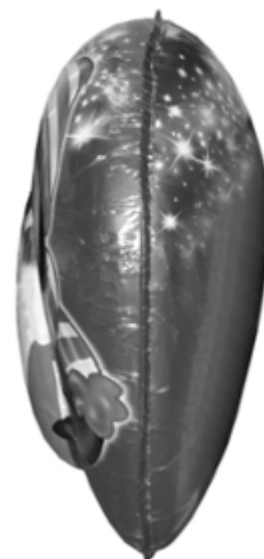
**1.1****1.2****1.3****1.4****1.5**



1.6

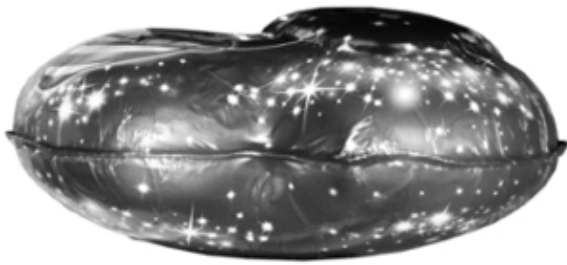

1.7

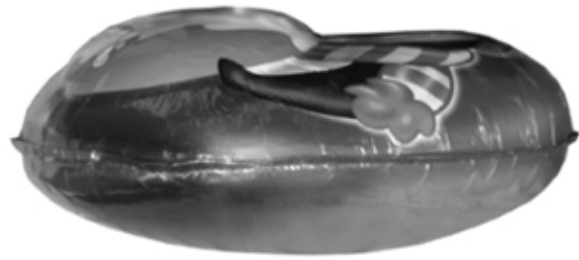

2.1



2.2



2.3



2.4



2.5



2.6

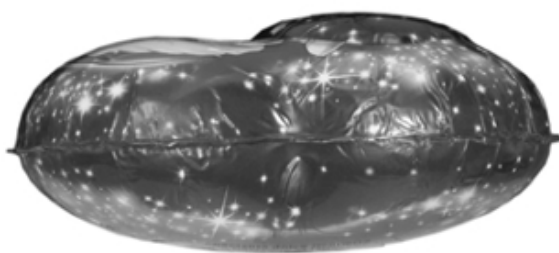

2.7

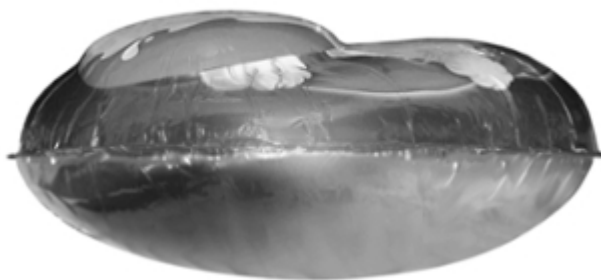

3.1



3.2



3.3



3.4



3.5



3.6

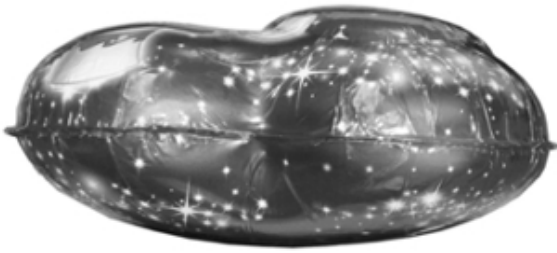

3.7

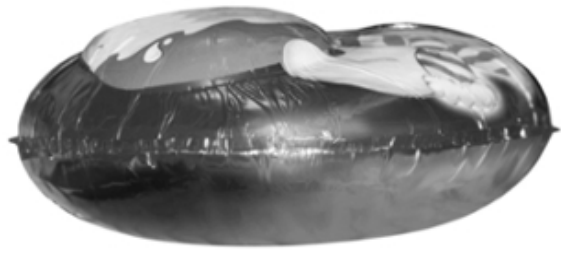

4.1



4.2



4.3



4.4



4.5



4.6

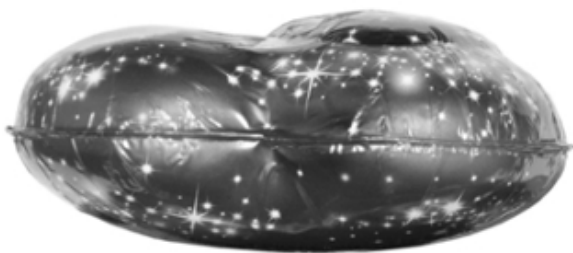

4.7

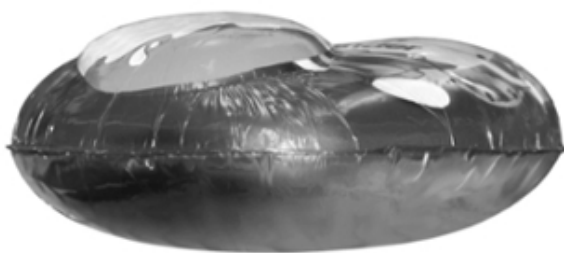

5.1



5.2



5.3



5.4



5.5



5.6



5.7



6.1



6.2



6.3



6.4



6.5



6.6

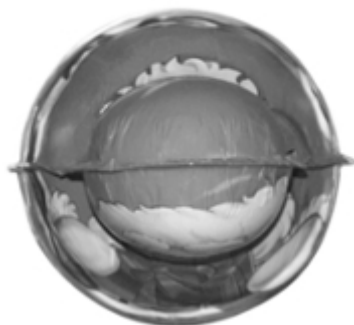

6.7



7.1



7.2



7.3



7.4



7.5



7.6

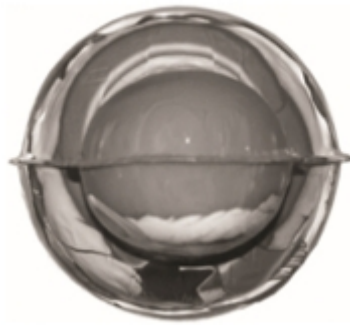

7.7



8.1



8.2



8.3



8.4



8.5



8.6

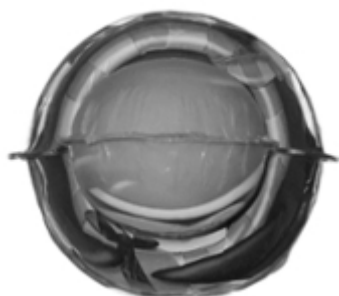

8.7



9.1



9.2



9.3



9.4



9.5





9.6

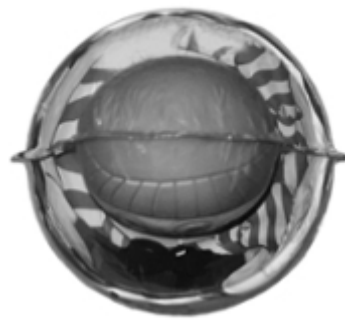

9.7



10



11



12.1



12.2



12.3



13.1

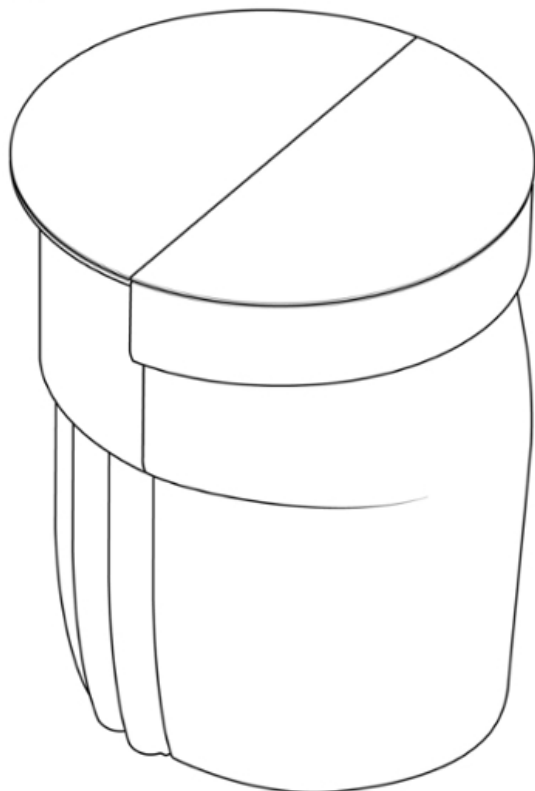

13.2

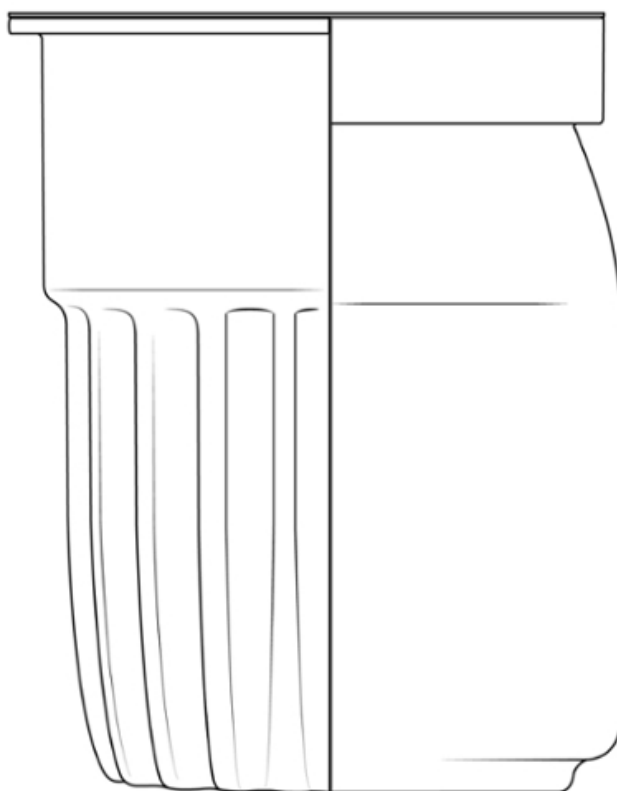

13.3

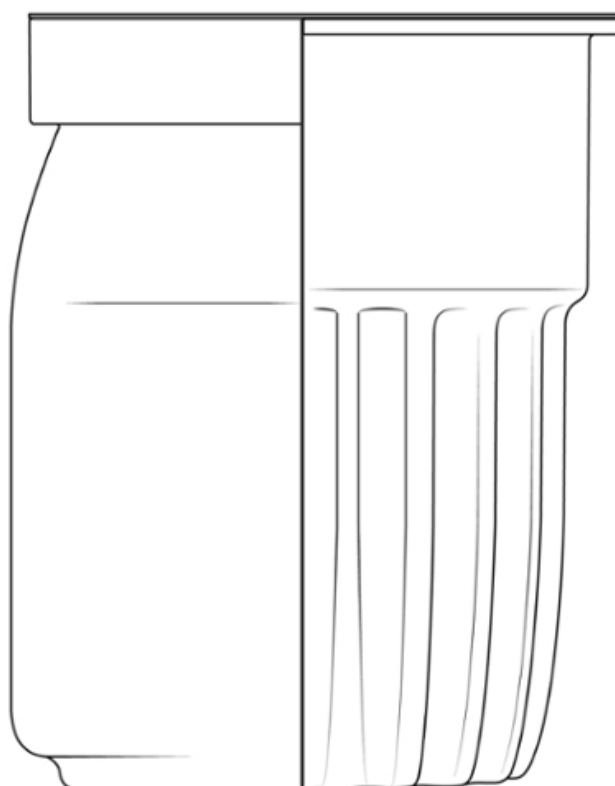

13.4

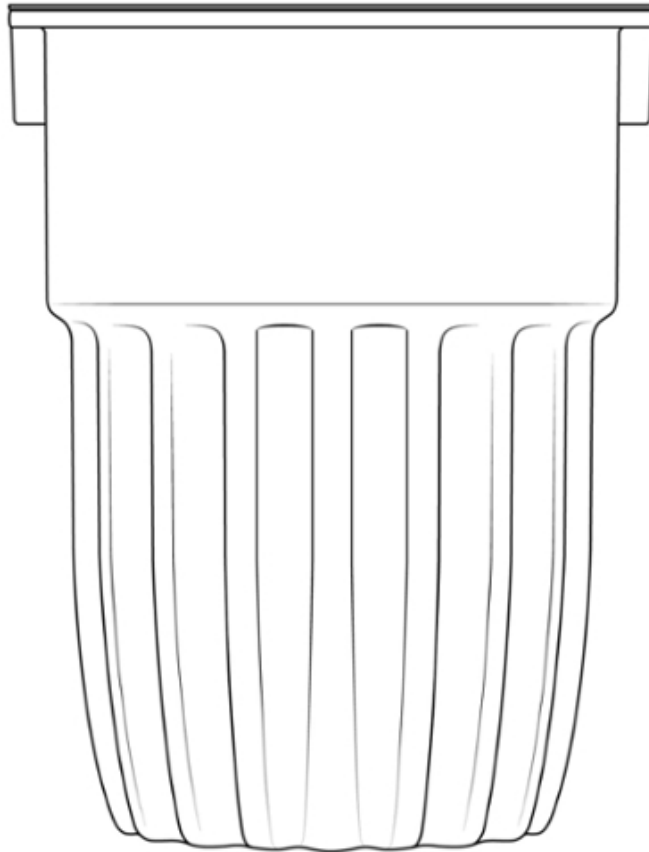

13.5

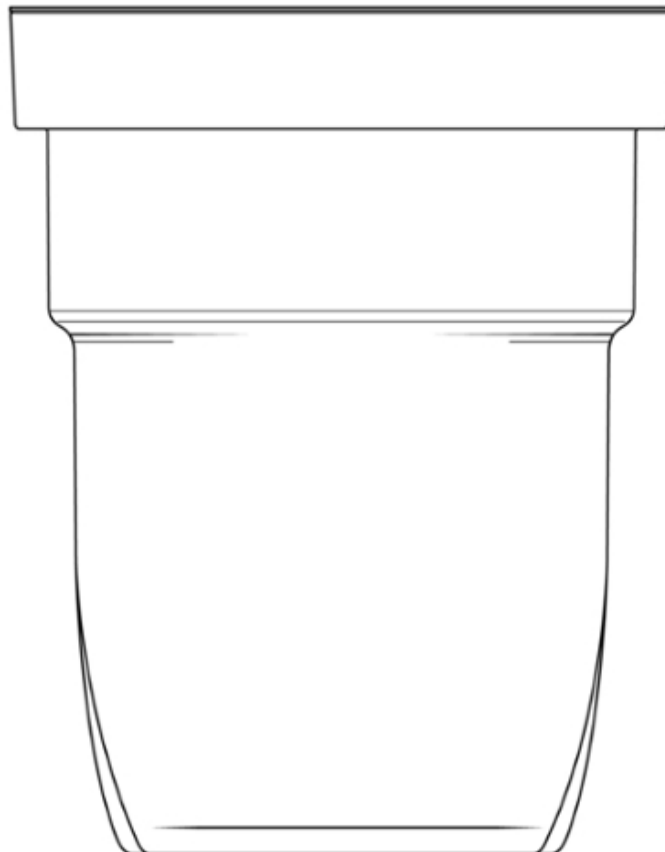

13.6

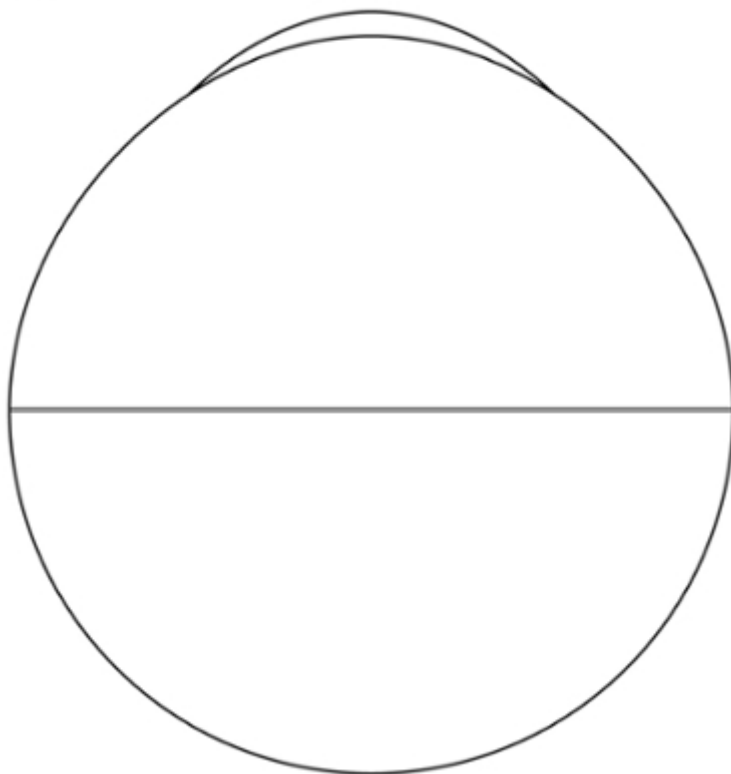

13.7

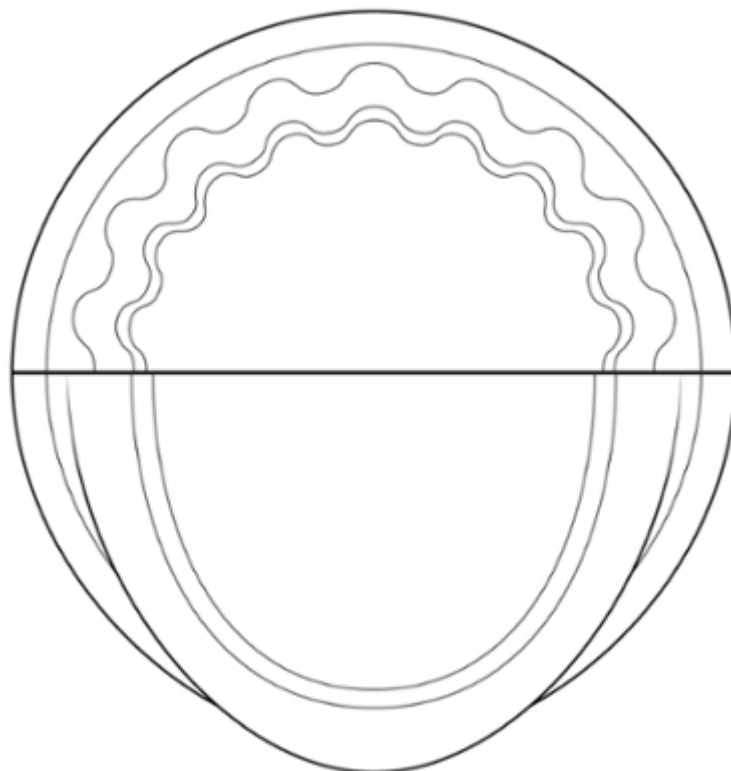

(11) DM/097878

(51) 10-07

(15) 2017 10 02

(45) 2018/13 (2018 04 06)

(22) 2017 10 02

(28) 1

(73) HAMILTON INTERNATIONAL AG (HAMILTON INTERNATIONAL SA)

(HAMILTON INTERNATIONAL LTD

Mattenstrasse 149, CH-2503 Biel/Bienne (CH)

(85) CH

(86) CH

(87) CH

(88) CH

(89) CH

(81) IL, BZ, MA III, AL, AM, AZ, BA, CH, EM, GE, KG, LI, MC, MD, ME, MK, MN, NO, OM, SG, TN, TR, UA

(72) Fabrice DUPORT

4, avenue de la Gare, 2000 Neuchâtel, Suisse

(54) 1. Dial with hands

(55)

1



**(11) DM/099148****(51) 09-03**

(15) 2017 10 02

(45) 2018/13 (2018 04 06)

(22) 2017 10 02

(28) 2

(30) Nos. 1, 2: 04.04.2017; 003840644; EM

(73) MAGIC PRODUCTION GROUP (M.P.G.) S.A.

Findel Business Center, complexe B, rue de Trèves, L-2632 Findel (LU)

(85) BX, EM

(86) BX, EM

(87) BX, EM

(88) EM

(89) EM

(81) II. MA III. AL, CH, EM, GE, HR, JP, KR, ME, MK, OA, RS, TR, UA

(72) Paolo VACCARELLA

Strada Pino Torinese 22/9, I-10020 BALDISSERO TORINESE (Torino), Italy;

Sergio MAIANDI

Via Pisa 41, I-10153 TORINO, Italy

(54) 1.-2. Gift containers

(55)

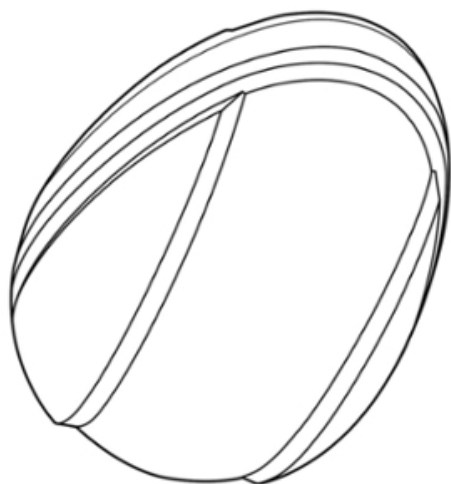
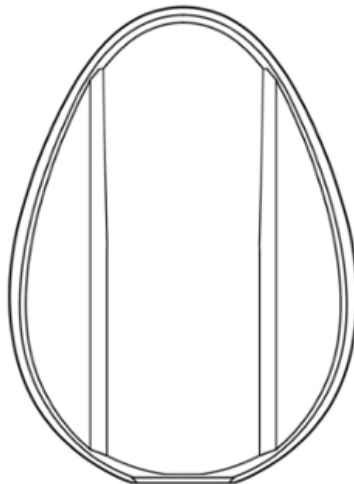
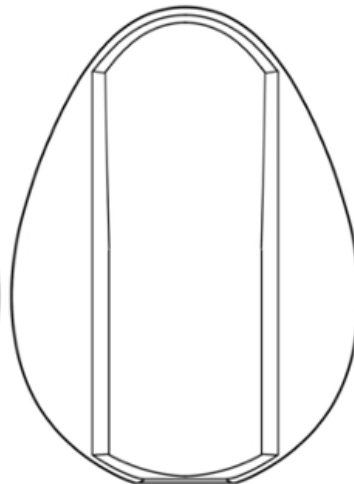
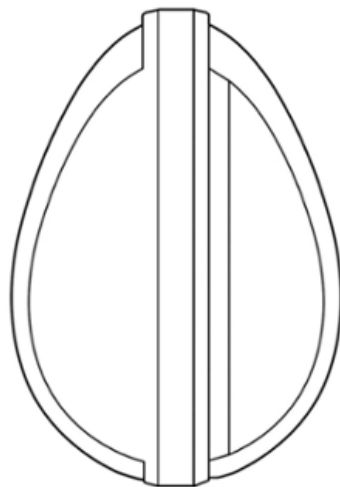
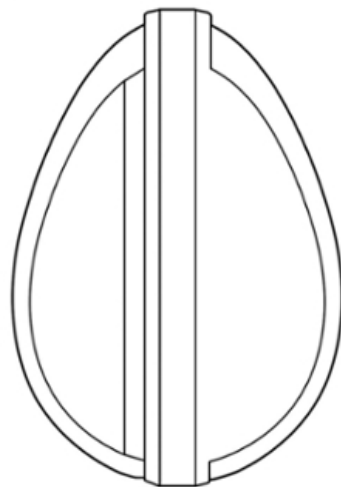
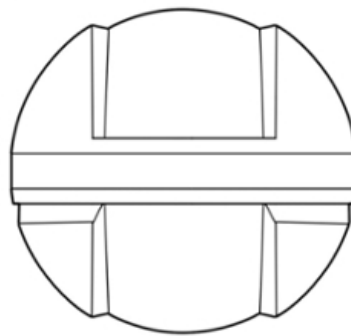
**1.1****1.2****1.3****1.4****1.5****1.6**

1.7

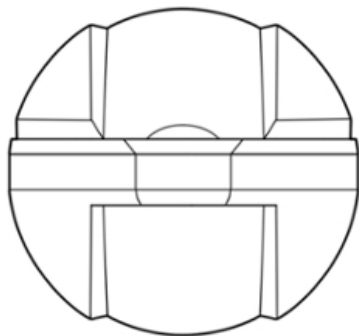

2.1



2.2

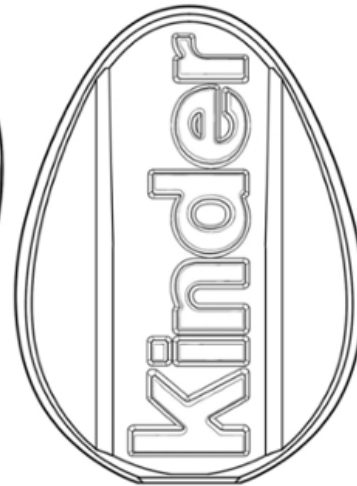

2.3

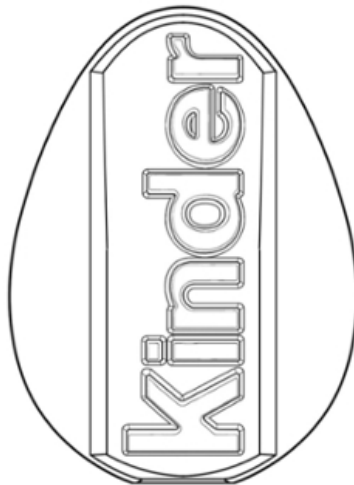

2.4

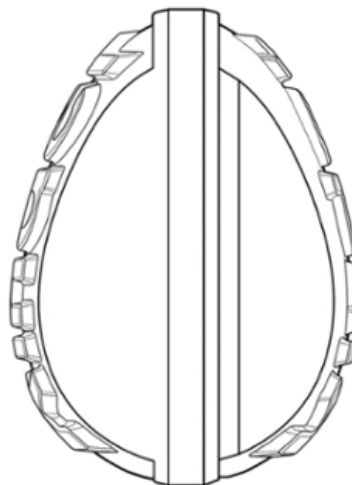

2.5

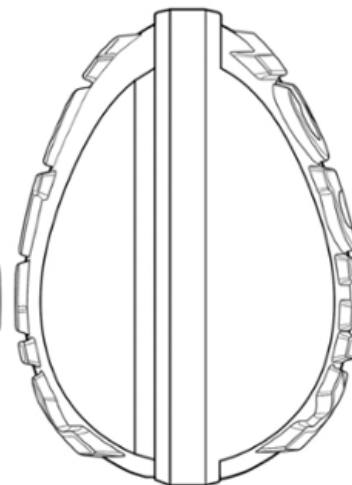

2.6

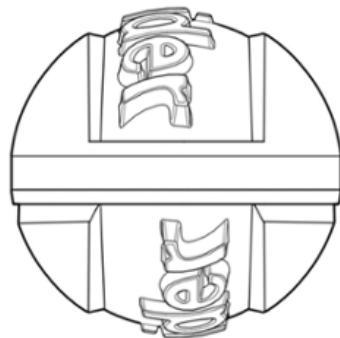

2.7

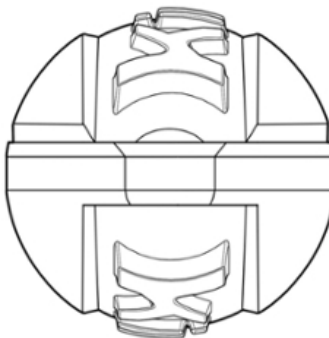

- (11) DM/100332 (51) 09-03  
 (15) 2017 12 18 (45) 2018/13 (2018 04 06)  
 (22) 2017 12 18  
 (28) 8  
 (30) Nos. 1, 2, 3, 4, 5, 6, 7: 20.07.2017; 004111763; EM  
 (73) ARC HOLDINGS  
 104 avenue du Général de Gaulle, F-62510 ARQUES (FR)  
 (85) FR, EM  
 (86) FR, EM  
 (87) FR, EM  
 (88) FR, EM  
 (89) FR  
 (81) III. EG, GE, TR, UA  
 (54) 1.-9. Cardboard boxes for packaging  
 (55)

1.1

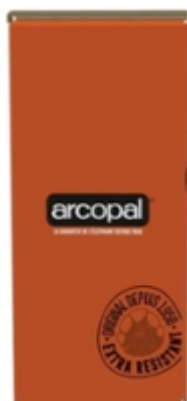

1.2



1.3

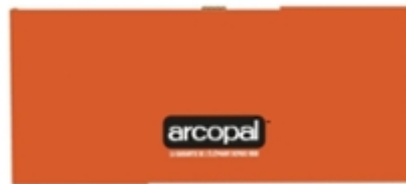

1.4



1.5



1.6



1.7



2.1



2.2





2.3



2.4

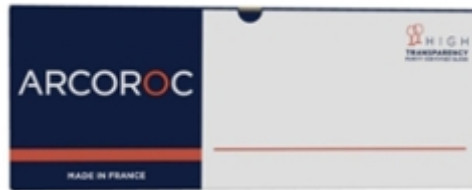

2.5



3.1



3.2

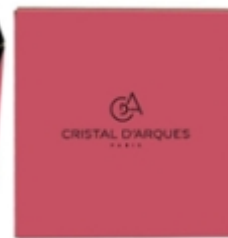

3.3



3.4



3.5



3.6



4.1



4.2



4.3



4.4

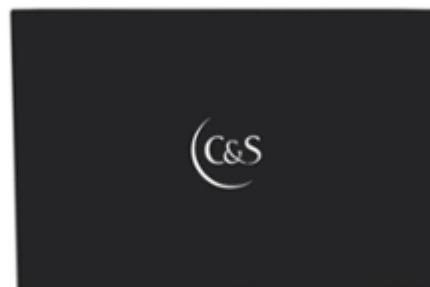



7.1



6.6



7.2



7.3

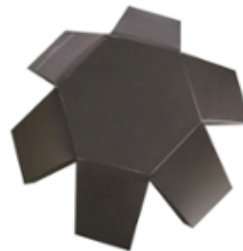

7.4



9

8

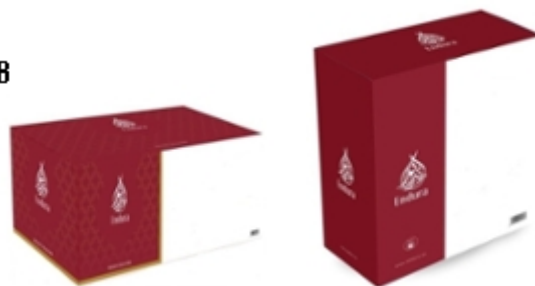

**(11) DM/098231****(51) 10-02, 07**

(15) 2017 10 13

(45) 2018/14 (2018 04 13)

(22) 2017 10 13

(28) 18

(73) THE SWATCH GROUP MANAGEMENT SERVICES AG  
 (THE SWATCH GROUP MANAGEMENT SERVICES SA)  
 (THE SWATCH GROUP MANAGEMENT SERVICES LTD)  
 rstadt 6, CH-2502 Biel/Bienne (CH)

(85) CH

(86) CH

(87) CH

(88) CH

(89) CH

(81) II. BZ, MA III. AL, AM, AZ, BA, CH, EM, GE, KG, LI, MC, MD, ME, MK, MN, NO, OM, SG, TN, TR, UA

(72) 2-5,8-12,14: Fernando SOARES

5 rue Fleury, 2000 Neuchâtel, Suisse;

1,6-7,13,15,18: Fabrice DUPORT

4 Avenue de la Gare, 2000 Neuchâtel, Suisse;

16-17: Jérémie SENNGEN

Le Château 3, 2028 Vaumarcus, Suisse

(54) 1. Watch cases with bracelets; 2.-3. Wristwatches; 4.-5. Watches; 6.-7. Watch cases with bracelets;  
 8.-9. Watches; 10. Watch case; 11.-12. Watches; 13. Watch dial; 14.-15. Watch cases with bracelets;  
 16.-17. Watches; 18. Watch dial

(55)

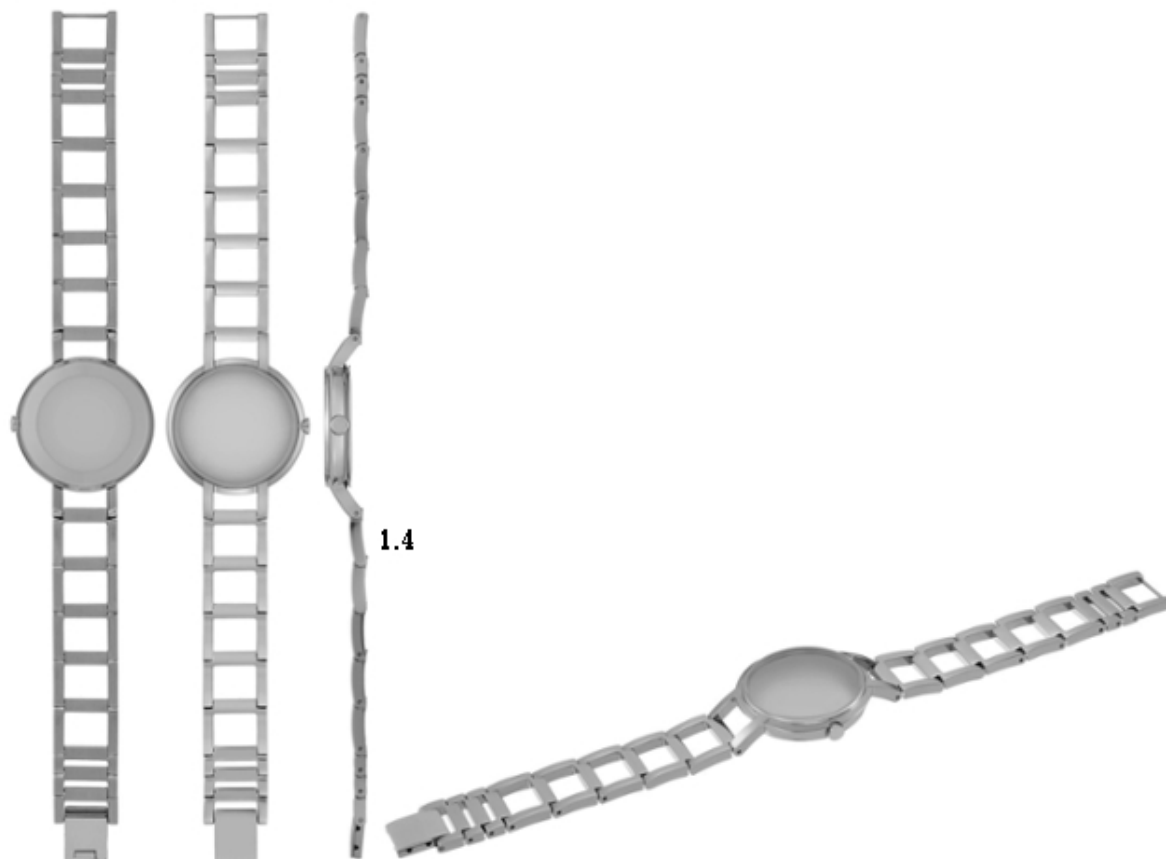
**1.1****1.2****1.3**

2.1



2.2



2.3



2.4



3.1



3.2



3.3



3.4



4.1



4.2



4.3



4.4



4.5



5.1



5.2



5.3



5.4



6.1



6.2



6.3



5.5



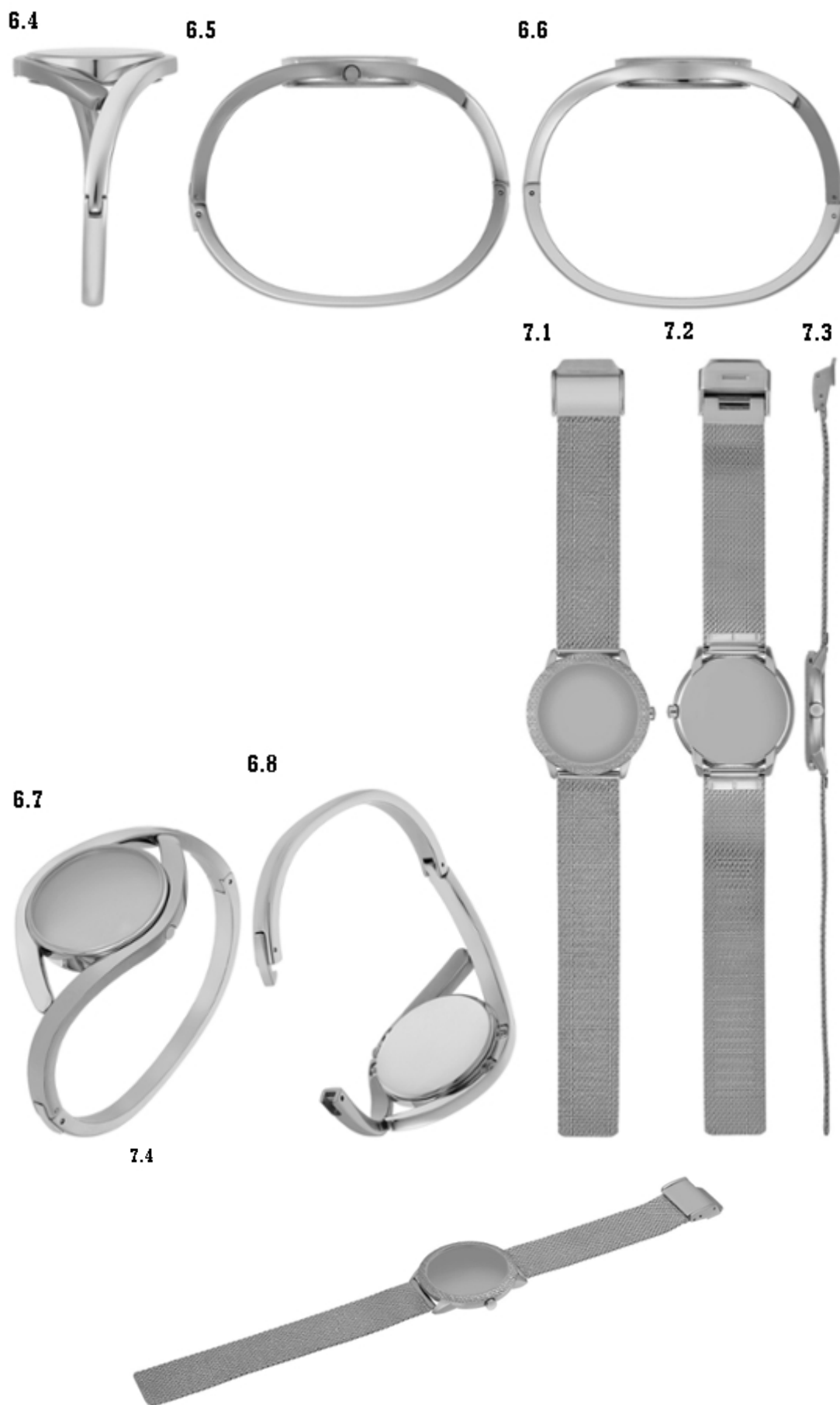

8.1



8.2



8.3



9.1

8.5



8.4



9.2



9.3



9.4



10.1



10.2



9.5





10.3



10.4



10.5



10.6



10.7



11.1



11.2



11.3



11.4



11.5



12.1



12.2



12.3



12.5



12.4



13.2

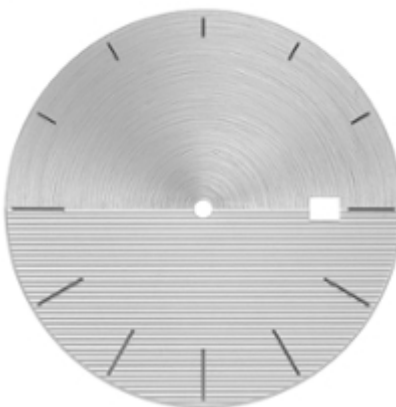

14.1



13.1



14.2



14.3



14.4



14.6



14.7



14.5



15.1



15.2



15.3



15.4



15.6



15.7



15.5



16.1



16.2



16.3



16.4



16.5



16.6



16.7



17.1



17.2



18.1



18.2

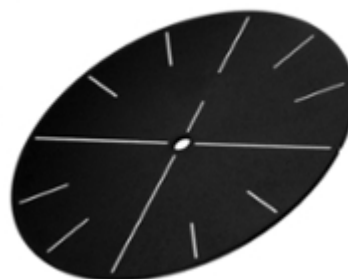

(11) DM/100432

(51) 21-03

(15) 2018 03 13

(45) 2018/14 (2018 04 13)

(22) 2018 03 13

(28) 1

(30) No. 1: 25.09.2017; 004370401-0001; EM

(73) EAGLE INVESTMENT SICAV PLC, ACTING ON BEHALF OF ITT FUND

Alpine House, Naxxar Road, San Gwann SGN9032 (MT)

(85) MT

(86) MT

(87) MT

(88) MT

(89) MT

(81) III. BA, CH, GE, IS, LI, MK, OA, RS, RW, US (30) No. 1: 25.09.2017; 004370401-0001; EM

(72) Jan Zelinka

Pritkovská 1645, 41501 Teplice, Czech Republic

(54) 1. Automatic machine for games of chance

(55)

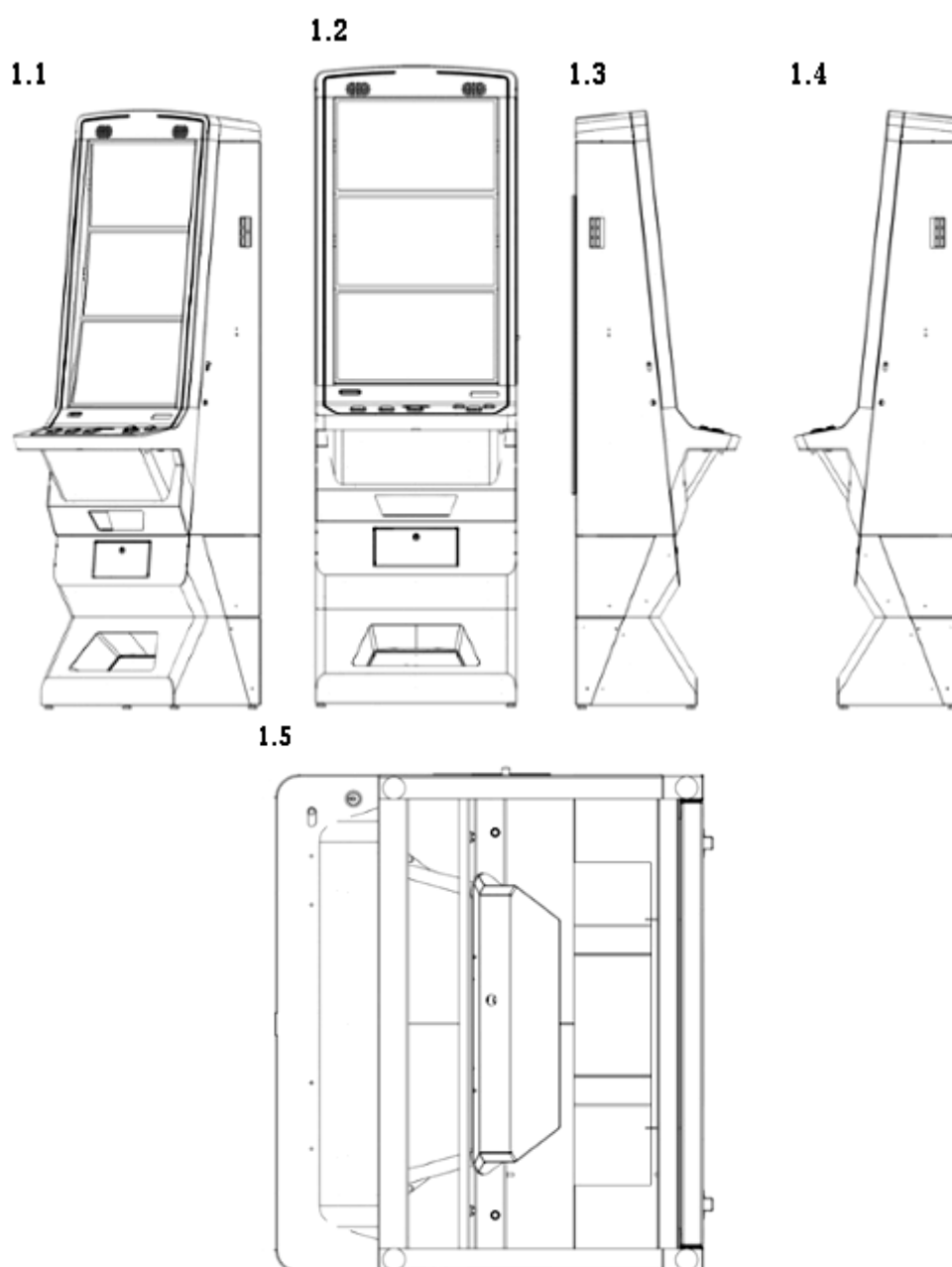

1.6

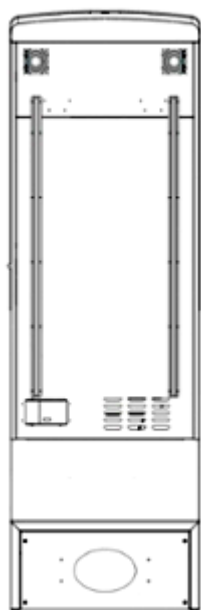

1.7

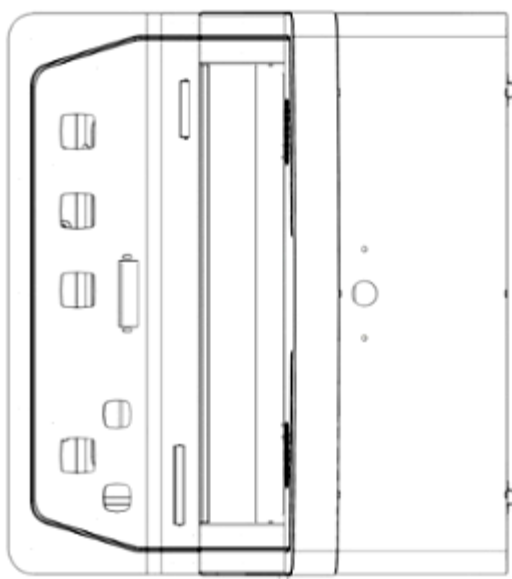

---

# TRADEMARKS

## APPLICATIONS FILED UNDER THE NATIONAL PROCEDURE APPROVED FOR REGISTRATION

The decision can be appealed at the Chamber of Appeal of Sakpatenti within 3 months from the publication or at the Mtskheta District Court Administrative Cases Board (Address: №17, Samkhedro St., Mtskheta), within 1 month following the publication.

(260) AM 2018 90304 A  
(210) AM 90304  
(220) 2017 01 06  
(731) LTD LABORATORY "KOLKHIKA"  
Sanapiros q. 10, 0105, Tbilisi, Georgia  
(740) Salome Jeladze  
(540)

### TAUROCINE

(511) 5

---

(260) AM 2018 90882 A\*  
(210) AM 90882  
(220) 2017 02 17  
(731) LTD "DI +"  
Gldani-Nadzaladevis r-ni, m/r 8, korp. 17,  
b. 46, Tbilisi, Georgia  
(740) Mariam Gogosashvili  
(540)



(591) Red, white  
(531) 26.04.09; 27.05.10; 29.01.01  
(511) 38

---

(260) AM 2018 91479 A  
(210) AM 91479  
(220) 2017 03 28  
(310) 571952  
(320) 2016 10 18  
(330) PT  
(731) FASHION TELEVISION LLC  
246 West Broadway, New York, NY 10013,  
USA  
(740) Khatuna Imnadze

(540)



(591) Black, white  
(531) 27.05.10; 27.05.17; 27.05.22  
(511) 38

---

(260) AM 2018 91520 A  
(210) AM 91520  
(220) 2017 03 30  
(731) LTD "TIFLISSKI VINNI POGREB"  
Umashevis q. 27, Tbilisi, Georgia  
(740) Irakli Gvilia  
(540)



(591) Black, white, grey  
(531) 01.03.07; 07.01.01; 25.01.17; 25.01.19; 28.05  
(511) 33

---

(260) AM 2018 92020 A  
 (210) AM 92020  
 (220) 2017 10 27  
 (731) LTD "FRANDY"  
 Sop. Dighomi, D. Aghmasheneblis q. 2a,  
 sart. 8, b. 23, 0131, Tbilisi, Georgia  
 (740) Giorgi Tsiskadze  
 (540)

**Frandy**  
**ფრენდი**

(511) 38

(260) AM 2018 92445 A  
 (210) AM 92445  
 (220) 2017 05 30  
 (731) LTD "4 BROS"  
 Sop. Velistsikhe, I q. 27, Gurjaani, Georgia  
 (740) Giorgi Taktakishvili  
 (540)



(591) White, pink, yellow, blue  
 (531) 03.04.02; 03.04.14; 26.02.07; 26.11.12;  
 27.07.01; 29.01.14  
 (526) გურჯაანი  
 (511) 30

(260) AM 2018 92739 A  
 (210) AM 92739  
 (220) 2017 06 12  
 (731) QURAMAX LIMITED U.K.  
 QURAMAX LIMITED  
 Artisans House, 7 Queensbridge  
 Northampton N4 7BF, United Kingdom  
 (740) Giorgi Taktakishvili  
 (540)

**NOLGRIPP**

(591) Black, white  
 (511) 5

(260) AM 2018 93198 A  
 (210) AM 93198  
 (220) 2017 07 06  
 (731) LTD "GEMOVANI"  
 Krtsanisis q. 22/24, b. 44, 0160,  
 Tbilisi, Georgia

(540)

**გემოვანი**  
**Gemovani**  
**ГЕМОВАНИ**

(511) 30, 31, 32, 35

(260) AM 2018 93533 A  
 (210) AM 93533  
 (220) 2017 07 28  
 (731) HIWIN TECHNOLOGIES CORP.  
 No.7, Jingke Road, Nantun District, Taichung  
 City, 40852, Taiwan, Province of China  
 (740) Shalva Gvaramadze  
 (540)

**HIWIN**

(591) Black, white  
 (531) 27.05.01; 27.05.17  
 (511) 7, 35

(260) AM 2018 93559 A  
 (210) AM 93559  
 (220) 2017 07 31  
 (731) JSC "KOTEKHI-GURJAANI WINE  
 FACTORY"  
 K. Koroghlishvilis q. 38, 1500, Gurjaani,  
 Georgia  
 (740) Dimitri Dzamukashvili  
 (540)

**vaznari**

(591) Black, white  
 (511) 33

(260) AM 2018 94193 A  
 (210) AM 94193  
 (220) 2017 09 15  
 (731) OPET PETROLCÜLÜK A.Ş.  
 Barbaros Mh. Gelincik Sk. N.4-A, Ataşehir,  
 Istanbul, Turkey  
 (740) Konstantine Meipariani  
 (540)



(591) Sky-blue, yellow  
 (531) 27.05.01; 27.05.17; 29.01.12  
 (511) 37



(260) AM 2018 94255 A  
 (210) AM 94255  
 (220) 2017 09 20  
 (731) HARRINGTON DEVELOPMENT INK.  
 Elvira Mendez Street, Vallarino Bldg,  
 3rd Floor, Panama, Republic of Panama  
 (740) Givi Akopashvili  
 (540)



(591) Black, white, red, silver  
 (531) 19.03.24; 25.01.01; 29.01.14  
 (511) 34

(260) AM 2018 94263 A  
 (210) AM 94263  
 (220) 2017 09 22  
 (731) JSC "TELIANI VALLEY"  
 Tbilisz gzatk. 3, Telavi, Georgia  
 (540)

## ღვინის მცველები

(511) 33

(260) AM 2018 94268 A  
 (210) AM 94268  
 (220) 2017 09 22  
 (731) CELGENE CORPORATION  
 86 Morris Avenue, Summit, New Jersey  
 07901, USA  
 (740) Tamaz Shilakadze  
 (540)

## ЗЕПОЗИЯ

(591) Black, white  
 (511) 5

(260) AM 2018 94269 A  
 (210) AM 94269  
 (220) 2017 09 22  
 (731) CELGENE CORPORATION

86 Morris Avenue, Summit, New Jersey  
 07901, USA  
 (740) Tamaz Shilakadze  
 (540)

## ОЗАВАНА

(591) Black, white  
 (511) 5

(260) AM 2018 94435 A  
 (210) AM 94435  
 (220) 2017 10 03  
 (731) LTD "GLOBALPHARM"  
 Almasianis g.13a/ Berbutis q. 8, 0171, Tbilisi,  
 Georgia  
 (540)

## ВАСТАЦИЛН БАКТАЦИЛИН ბაქტაცილინი

(591) Black, white  
 (511) 5

(260) AM 2018 94439 A  
 (210) AM 94439  
 (220) 2017 10 03  
 (731) DUNLOP INTERNATIONAL LIMITED  
 Thorncroft Manor, Thorncroft Drive, Dorking  
 Road, Leatherhead, Surrey, KT22 8JB,  
 United Kingdom  
 (740) Merab Kvimsadze  
 (540)

## DUNLOP

(591) Black, white  
 (531) 27.05.01  
 (511) 1

(260) AM 2018 94440 A  
 (210) AM 94440  
 (220) 2017 10 03  
 (731) DUNLOP INTERNATIONAL LIMITED  
 Thorncroft Manor, Thorncroft Drive, Dorking  
 Road, Leatherhead, Surrey, KT22 8JB,  
 United Kingdom  
 (740) Merab Kvimsadze  
 (540)



(591) Black, white  
 (531) 24.15.01; 26.01.01; 26.01.18; 27.05.21  
 (511) 1

(260) AM 2018 94452 A  
 (210) AM 94452  
 (220) 2017 10 04  
 (731) LTD "AGRO POWER"  
 Dedoplistskaros q. II Shesakh. I, (nakveti  
 52/17), C/S 1C, Tsiteltskaros I shesakh.,  
 kutkheshi, 0103, Tbilisi, Georgia

(540)

**SENCI**

(591) Black, white  
 (511) 7, 8

(260) AM 2018 94533 A  
 (210) AM 94533  
 (220) 2017 10 09  
 (731) LTD "MAGNETAR"  
 26 Maisis q. 53, b.19, Batumi, Georgia

(540)



**MAGNETAR**

(591) Black, white  
 (531) 26.13.25  
 (511) 9, 41, 42

(260) AM 2018 94543 A  
 (210) AM 94543  
 (220) 2017 10 10  
 (731) DAR AL ARKAN REAL ESTATE  
 DEVELOPMENT COMPANY  
 Khurais Road, P.O. Box 105633, Riyadh  
 11656, Saudi Arabia

(740) Merab Kvimsadze

(540)

**DAR  
 AL ARKAN  
 دار الأركان**

(591) Purple  
 (531) 27.05.01; 28.01; 29.01.04  
 (511) 36

(260) AM 2018 94582 A  
 (210) AM 94582  
 (220) 2017 10 13  
 (731) THE INTERNATIONAL ASSOCIATION OF  
 LIONS CLUBS  
 300 W. 22nd Street, Oak Brook, Illinois  
 60523, USA

(740) Giorgi Taktakishvili

(540)



(591) Black, white  
 (531) 03.01.01; 03.01.16; 26.01.18  
 (511) 36

(260) AM 2018 94587 A  
 (210) AM 94587  
 (220) 2017 10 13  
 (731) KAREN VARDANYAN  
 Baironis q. 3, b. 36, Yerevan, Armenia

(740) Giorgi Taktakishvili

(540)



(591) White, red, pink, beige, brown, yellow,  
 milken, orange, sky-blue, blue, green, peach,  
 golden, black, purple, lilac, khaki, gray  
 (531) 08.01.23; 24.01.10; 27.05.02; 27.05.24;  
 29.01.15  
 (511) 30

(260) AM 2018 94588 A  
 (210) AM 94588  
 (220) 2017 10 13  
 (731) KAREN VARDANYAN  
 Baironis q. 3, b. 36, Yerevan, Armenia

(740) Giorgi Taktakishvili  
(540)



(554) Three-dimensional  
(591) White, pink, red, brown, golden, black  
(531) 03.01.15; 29.01.15  
(511) 28, 30

(260) AM 2018 94589 A  
(210) AM 94589  
(220) 2017 10 13  
(731) LTD "X2"  
Lvovis q. 66, 0160, Tbilisi, Georgia  
(540)



(591) Black and blue  
(531) 27.05.10; 27.05.21; 29.01.12; 29.01.12  
(511) 36, 37

(260) AM 2018 94681 A  
(210) AM 94681  
(220) 2017 10 18  
(731) LTD "AVERSI-PHARMA"  
Davit Aghmashenebelis qamz. 148/2, 0112,  
Tbilisi, Georgia  
(540)

აქვირუბიცინი  
Аквирубицин  
Aqvirubicin

(591) Black, white  
(511) 5

(260) AM 2018 94682 A  
(210) AM 94682  
(220) 2017 10 18  
(731) LTD "AVERSI-PHARMA"  
Davit Aghmashenebelis qamz. 148/2, 0112,  
Tbilisi, Georgia

(540)

აქვიგრასტიმი  
Аквиграстим  
Aqvigrastim

(591) Black, white  
(511) 5

(260) AM 2018 94684 A  
(210) AM 94684  
(220) 2017 10 18  
(731) LTD "COFFEESHOP GEORGIA"  
Sop. Untsa, "Bagebi", Adigenis r-ni,  
Georgia  
(740) Giorgi Taktakishvili  
(540)



(591) Brown, white  
(531) 27.01.12; 27.05.01; 29.01.07  
(511) 43

(260) AM 2018 94691 A  
(210) AM 94691  
(220) 2017 10 18  
(731) LTD "NEW PHARM GROUP"  
D. Aghmasheneblis Kheiv. XII km., korp. 2,  
b.43, Vake-Saburtalos r-ni, 0131, Tbilisi,  
Georgia  
(540)

ნევილოლი  
Nevilol  
Невилол

(511) 5

(260) AM 2018 94694 A  
(210) AM 94694  
(220) 2017 10 18  
(731) LTD "NEW PHARM GROUP"  
D. Aghmasheneblis Kheiv. XII km., korp. 2,  
b.43, Vake-Saburtalos r-ni, 0131, Tbilisi,  
Georgia  
(540)

ტენზიპრილი  
Tenzipril  
Тензиприл

(511) 5

(260) AM 2018 94701 A  
 (210) AM 94701  
 (220) 2017 10 18  
 (731) LTD "NEW PHARM GROUP"  
 D. Aghmasheneblis Kheiv. XII km., korp. 2,  
 b.43, Vake-Saburtalos r-ni, 0131, Tbilisi,  
 Georgia

(540)

სარტიკორი  
**Sarticor**  
 Сартикор

(511) 5

(260) AM 2018 94709 A  
 (210) AM 94709  
 (220) 2017 10 19  
 (731) INTEL CORPORATION  
 2200 Mission College Boulevard, Santa Clara,  
 California 95052-8119, USA

(740) Tamaz Shilakadze

(540)

**INTEL MAX**

(591) Black, white

(511) 9

(260) AM 2018 94718 A  
 (210) AM 94718  
 (220) 2017 10 20  
 (731) AHLERS AG.  
 Elverdisser Strasse 313, Herford, 32052,  
 Germany

(740) Tamar Kochlamazashvili

(540)



**PIONIER**  
 JEANS & CASUALS

(591) Red, black, gray, white

(531) 26.01.18; 26.01.24; 27.05.10; 27.05.21;  
 27.05.24; 29.01.13

(511) 25

(260) AM 2018 94720 A  
 (210) AM 94720  
 (220) 2017 10 20  
 (731) AHLERS AG.  
 Elverdisser Strasse 313, Herford, 32052,  
 Germany

(740) Tamar Kochlamazashvili

(540)

**Pionier Jeans & Casuals**

(591) Black, white

(511) 25

(260) AM 2018 94787 A

(210) AM 94787

(220) 2017 10 27

(731) KAREN VARDANYAN

Baironis q. 3, b. 36, Yerevan, Armenia

(740) Giorgi Taktakishvili

(540)



(591) White, red, yellow, orange, gray, golden,  
 black

(531) 04.05.03; 04.05.05; 08.01.23; 27.05.01;  
 29.01.15

(511) 30

(260) AM 2018 94788 A

(210) AM 94788

(220) 2017 10 27

(731) KAREN VARDANYAN

Baironis q. 3, b. 36, Yerevan, Armenia

(740) Giorgi Taktakishvili

(540)



(591) White, red, golden, grey, black

(531) 02.09.01; 08.01.23; 24.01.10; 27.05.01;  
 29.01.15

(511) 30

(260) AM 2018 94789 A  
 (210) AM 94789  
 (220) 2017 10 27  
 (731) IALCHIN FARZALIEV  
 L. Gudiashvilis q. 42, 3000, Marneuli, Georgia  
 (540)



(591) White, green  
 (531) 05.07.06; 26.04.04; 29.01.15  
 (511) 29

(260) AM 2018 94793 A  
 (210) AM 94793  
 (220) 2017 10 30  
 (731) ASLANKAYA KIMYA VE SAGLIK  
 URUNLERI SANAYI ANONIM SIRKETI  
 Organize Sanayi Bolgesi, 83557 Nolu Cadde,  
 No:8 Baspinar Sehitkamil, Gaziantep, Turkey  
 (740) Giorgi Kartvelishvili  
 (540)

**Rojex**

(591) Black, white  
 (531) 27.05.01  
 (511) 3

(260) AM 2018 94883 A  
 (210) AM 94883  
 (220) 2017 11 01  
 (731) DP BEVERAGES LIMIT  
 Po Boqs 309 GT, Ugland Hauzi, Saut Cherch  
 Striti, Jorj Tauni, Didi Kaimani KY1-1104,  
 Cayman Islands  
 (740) Giorgi Taktakishvili  
 (540)



(591) Black, white  
 (531) 01.15.15; 05.03.14; 27.05.17; 27.05.24  
 (511) 30, 32

(260) AM 2018 94980 A  
 (210) AM 94980  
 (220) 2017 11 07  
 (731) SOFIO JINTCHARADZE  
 Leghva, 6200, Kobuleti, Georgia  
 (540)



(591) Black, red, white  
 (531) 26.03.23; 27.05.10; 27.05.21; 29.01.12  
 (511) 25

(260) AM 2018 95034 A  
 (210) AM 95034  
 (220) 2017 11 10  
 (731) CELINE  
 16 Riu Vivien, Parizi, 75002, France  
 (740) Shalva Gvaramadze  
 (540)

**CÉLINE**

(591) Black, white  
 (531) 27.05.01  
 (511) 3

(260) AM 2018 95036 A  
 (210) AM 95036  
 (220) 2017 11 10  
 (731) LABORATORIO KEMEX S.A.  
 Nazarre 3446, 1417 C.A.B.A., Argentina  
 (740) Merab Kvimsadze  
 (540)



(591) Black, sky-blue  
 (531) 27.05.01; 27.05.10; 27.05.25; 29.01.12  
 (511) 5

(260) AM 2018 95038 A  
 (210) AM 95038  
 (220) 2017 11 10  
 (731) ANHUI LIANGLIANG ELECTRONIC  
 TECHNOLOGY CO., LTD  
 Linqsi Ist Roudi, Kishan Nort Aveniu,  
 Ekonomik Development Zoun, Guangde  
 Qaunti, Siunchen Siti, Anhuish Provincia,  
 Siunchen Siti, China

(740) Khatuna Imnadze  
(540)

## Vallight

(591) Black, white  
(511) 11

---

(260) AM 2018 95079 A  
(210) AM 95079  
(220) 2017 11 15  
(731) EDUARD PUTKARADZE  
D. Aghmasheneblis q. 24, b. 24, 6000,  
Batumi, Georgia  
(540)

## LAMBADA

(591) Black, white  
(511) 30

---

(260) AM 2018 95080 A  
(210) AM 95080  
(220) 2017 11 15  
(731) EDUARD PUTKARADZE  
D. Aghmasheneblis q. 24, b. 24, 6000,  
Batumi, Georgia  
(540)

## INTEX

(591) Black, white  
(511) 20, 28

---

(260) AM 2018 95186 A  
(210) AM 95186  
(220) 2017 11 22  
(731) DOMPE' FARMACEUTICI SPA  
Via San Martino Dela Batalia, 12, Milano,  
20122, Italy  
(740) Khatuna Imnadze  
(540)

## OKI

(591) Black, white.  
(511) 5

---

(260) AM 2018 95223 A  
(210) AM 95223  
(220) 2017 11 29  
(731) Gilead Sciences Ireland UC  
IDA Business and Technology Park,  
Carrigtohill, Co.Cork, Ireland  
(740) Shalva Gvaramadze  
(540)

## BOCEBI

(511) 5

---

(260) AM 2018 95227 A  
(210) AM 95227  
(220) 2017 11 29  
(731) Gilead Sciences Ireland UC  
IDA Business and Technology Park,  
Carrigtohill, Co. Cork, Ireland  
(740) Shalva Gvaramadze  
(540)

## Биктарвы

(591) Black, white  
(531) 28.05  
(511) 5

---

**REGISTERED TRADEMARKS**

(111) M 2018 29717 R  
(151) 2018 05 31  
(181) 2028 05 31  
(260) AM 2017 90766 A  
(220) 2017 02 09

(732) PREMIUM TOBACCO FZ LTD  
P.O. Box: 31291, Al-Jazeera Al-Hamra,  
Ras Al Khaimah, United Arab Emirates

(111) M 2018 29718 R  
(151) 2018 05 31  
(181) 2028 05 31  
(260) AM 2017 90914 A  
(220) 2017 02 20

(732) PREMIUM TOBACCO FZ LTD  
P.O. Box: 31291, Al-Jazeera Al-Hamra,  
Ras Al Khaimah, United Arab Emirates

(111) M 2018 29721 R  
(151) 2018 06 04  
(181) 2028 06 04  
(260) AM 2017 90996 A  
(220) 2017 02 24

(732) LTD "ALGETI GEORGIA"  
Bolo Aghmartis q. 1, Tbilisi, Georgia

(111) M 2018 29722 R  
(151) 2018 06 04  
(181) 2028 06 04  
(260) AM 2017 91052 A  
(220) 2017 02 27

(732) LTD "K. BERIOSI"  
Tzagarelis q. 43, 0194, Tbilisi, Georgia

(111) M 2018 29723 R  
(151) 2018 06 04  
(181) 2028 06 04  
(260) AM 2017 90870 A  
(220) 2017 02 17

(732) JSC "JOKER CLUB 1927"  
Mazniashvilis q. 25, 3000, Narneuli, Georgia

(111) M 2018 29724 R  
(151) 2018 06 04  
(181) 2028 06 04  
(260) AM 2017 91160 A  
(220) 2017 03 07

(732) IRAKLI SEBISKVERADZE  
David Aghmasheneblis kheivani 12 km.,  
korp. 2, b. 47, 0131, Tbilisi, Georgia

(111) M 2018 29725 R  
(151) 2018 06 04  
(181) 2028 06 04  
(260) AM 2017 91093 A  
(220) 2017 03 01

(732) HOSEIN PAPEY  
Asuretis q. 31, 0101, Tbilisi, Georgia

(111) M 2018 29726 R  
(151) 2018 06 04  
(181) 2028 06 04  
(260) AM 2017 91226 A  
(220) 2017 03 13

(732) JSC "KOTEKHI-GURJAANI WINE FACTORY"  
K. Koroghlishvilis q. 38, 1500, Gurjaani,  
Georgia

(111) M 2018 29727 R  
(151) 2018 06 04  
(181) 2028 06 04  
(260) AM 2017 91282 A  
(220) 2017 03 16

(732) LTD "VINAGORA"  
G. Tabidzis q. 15, 0155, Tbilisi, Georgia

(111) M 2018 29728 R  
(151) 2018 06 04  
(181) 2028 06 04  
(260) AM 2017 91227 A  
(220) 2017 03 13

(732) AVON PRODUCTS INC.  
601 Midland Avenue, RI, New York,  
10580, USA

(111) M 2018 29729 R  
(151) 2018 06 04  
(181) 2028 06 04  
(260) AM 2017 91283 A  
(220) 2017 03 16

(732) LTD "VINAGORA"  
G. Tabidzis q. 15, 0155, Tbilisi, Georgia

(111) M 2018 29730 R  
(151) 2018 06 04  
(181) 2028 06 04  
(260) AM 2016 88244 A  
(220) 2016 08 11

(732) LTD "PHARMACEUTICAL HOUSE+"  
Lvovis q. 92, Tbilisi, Georgia

(111) M 2018 29731 R (151) 2018 06 04 (181) 2028 06 04 (260) AM 2017 91730 A (220) 2017 04 14 (732) DIAGEO SCOTLAND LIMITED Edinburgh Park, 5 Lochside Way, Edinburgh, EH12 9DT, Scotland	(260) AM 2017 92102 A (220) 2017 05 11 (732) Intersun Holding FZCO. P.O.Box 61051, Jebel Ali Fri Zon, Dubai, United Arab Emirates
(111) M 2018 29732 R (151) 2018 06 04 (181) 2028 06 04 (260) AM 2017 92135 A (220) 2017 05 16 (732) LTD "OUR FARMER" M. Kavtaradzis q. 11, 0180, Tbilisi, Georgia	(111) M 2018 29738 R (151) 2018 06 04 (181) 2028 06 04 (260) AM 2017 92480 A (220) 2017 05 30 (732) INMUSIC BRANDS, INC. 200 Scenic View Drive Cumberland, RI 02864, USA
(111) M 2018 29733 R (151) 2018 06 04 (181) 2028 06 04 (260) AM 2017 91866 A (220) 2017 04 27 (732) LTD "ARIC" S. Tsintsadzis q. 12, sart. 3, 0160, Tbilisi, Georgia	(111) M 2018 29739 R (151) 2018 06 04 (181) 2028 06 04 (260) AM 2017 92473 A (220) 2017 05 30 (732) INMUSIC BRANDS, INC. 200 Scenic View Drive Cumberland, RI 02864, USA
(111) M 2018 29734 R (151) 2018 06 04 (181) 2028 06 04 (260) AM 2017 91678 A (220) 2017 04 12 LTD "MANNA" I. Abashidzis q. 44, b. 32, 0179, Tbilisi, Georgia	(111) M 2018 29740 R (151) 2018 06 04 (181) 2028 06 04 (260) AM 2017 91803 A (220) 2017 04 21 (732) KAWASAKI KISEN KAISHA LTD 2-1-1 Uchisaiwaicho Chiyoda-Ku, Tokio-To 100-8540 Japan
(111) M 2018 29735 R (151) 2018 06 04 (181) 2028 06 04 (260) AM 2017 91230 A (220) 2017 03 14 (732) LTD "NUTRIMAX" Rustavis gzatk. 68a, 0165, Tbilisi, Georgia	(111) M 2018 29741 R (151) 2018 06 04 (181) 2028 06 04 (260) AM 2017 92124 A (220) 2017 05 15 (732) ASTRAZENECA AB SE-151 85 Södertälje, Sweden
(111) M 2018 29736 R (151) 2018 06 04 (181) 2028 06 04 (260) AM 2017 92187 A (220) 2017 05 17 (732) LEGO IURIS A/S Dk-7190 Bilundi, Denmark	(111) M 2018 29742 R (151) 2018 06 04 (181) 2028 06 04 (260) AM 2017 91942 A (220) 2017 05 03 (732) British American Tobacco (Brands) Limited Globe House, 4 Temple Place, London WC2R 2PG, London, United Kingdom
(111) M 2018 29737 R (151) 2018 06 04 (181) 2028 06 04	(111) M 2018 29743 R (151) 2018 06 04 (181) 2028 06 04



- (260) AM 2017 92729 A  
(220) 2017 06 09  
(732) JSC "PHARMFIRMA "SOTEKS"  
Pos. Belikovo, d. 11, Selskoe Poselenie  
Bereznykovskoe, 141345, Moskovskaya  
Oblast, Sergievo-Posadskiy Municipalniy  
raion, Russian Federation
- 
- (111) M 2018 29744 R  
(151) 2018 06 04  
(181) 2028 06 04  
(260) AM 2017 92724 A  
(220) 2017 06 09  
(732) JSC "PHARMFIRMA "SOTEKS"  
Pos. Belikovo, d. 11, Selskoe Poselenie  
Bereznykovskoe, 141345, Moskovskaya  
Oblast, Sergievo-Posadskiy Municipalniy  
raion, Russian Federation
- 
- (111) M 2018 29745 R  
(151) 2018 06 04  
(181) 2028 06 04  
(260) AM 2017 92180 A  
(220) 2017 05 17  
(732) LTD "REALTY AVLABAR"  
R. Chkhikvadzis q. 1, Commercial Space 4/2,  
4th fl., Blok II, Vake-Saburtalo district, 0101,  
Tbilisi, Georgia
- 
- (111) M 2018 29746 R  
(151) 2018 06 04  
(181) 2028 06 04  
(260) AM 2017 92773 A  
(220) 2017 06 13  
(732) Mapaex Consumer Healthcare Private  
Limited  
E-7, HIG-500, Arera Colony, Bhopal, Madhya  
Pradesh – 462016, India
- 
- (111) M 2018 29747 R  
(151) 2018 06 04  
(181) 2028 06 04  
(260) AM 2017 92772 A  
(220) 2017 06 13  
(732) Mapaex Consumer Healthcare Private  
Limited  
E-7, HIG-500, Arera Colony, Bhopal, Madhya  
Pradesh – 462016, India
- 
- (111) M 2018 29748 R  
(151) 2018 06 04  
(181) 2028 06 04  
(260) AM 2017 92796 A  
(220) 2017 06 16
- (732) APPLE INC.  
1, Infinite Loop, California, Cupertino,  
95014, USA
- 
- (111) M 2018 29749 R  
(151) 2018 06 04  
(181) 2028 06 04  
(260) AM 2017 92499 A  
(220) 2017 06 01  
(732) LTD "GLOBALPHARMI"  
Almasianis q. 13a / Berbutis q. 8, 0171, Tbilisi,  
Georgia
- 
- (111) M 2018 29750 R  
(151) 2018 06 04  
(181) 2028 06 04  
(260) AM 2017 92999 A  
(220) 2017 06 27  
(732) LTD "IIKLI"  
Evgeni Kharadzis q. 2a, 0153, Tbilisi, Georgia
- 
- (111) M 2018 29751 R  
(151) 2018 06 04  
(181) 2028 06 04  
(260) AM 2016 88501 A  
(220) 2016 09 06  
(732) Pharmanel Comercial Pharmaceutical S.A .  
106 Marathonos Ave. 15344 Gerekas, Athens  
Greece
- 
- (111) M 2018 29752 R  
(151) 2018 06 04  
(181) 2028 06 04  
(260) AM 2017 92088 A  
(220) 2017 05 10  
(732) Private Joint-Stock company  
"Cracow Biscuit Factory"  
Ul. Lazovskaya 8, Kharkov, 61017,  
Ukraine
- 
- (111) M 2018 29753 R  
(151) 2018 06 04  
(181) 2028 06 04  
(260) AM 2017 92937 A  
(220) 2017 06 23  
(732) LTD "AISI"  
Varketili 3, I mk/r, korp. 28, b. 26, 0163,  
Tbilisi, Georgia
- 
- (111) M 2018 29854 R  
(151) 2018 06 04  
(181) 2028 06 04  
(260) AM 2017 92989 A

(220) 2017 06 26  
(732) PHILIP MORRIS BRANDS SÀRL  
Quai Jeanrenaud 3, 2000 Neuchâtel,  
Switzerland

---

(111) M 2018 29755 R  
(151) 2018 06 04  
(181) 2028 06 04  
(260) AM 2017 92936 A  
(220) 2017 06 23  
(732) SERGO JAVAKHIDZE  
Khomlelis q. 4, b. 89, Tbilisi, Georgia

---

(111) M 2018 29756 R  
(151) 2018 06 04  
(181) 2028 06 04  
(260) AM 2017 93066 A  
(220) 2017 06 30  
(732) CHINA UNIONPAY CO. LTD  
NO. 498 GUOSHOUJING ROAD,  
PUDONG, SHANGHAI 201203, China

---

(111) M 2018 29757 R  
(151) 2018 06 04  
(181) 2028 06 04  
(260) AM 2017 93100 A  
(220) 2017 07 03  
(732) LTD "BEST"  
Uumashevis q. 8, 0151, Tbilisi, Georgia

---

## TRADEMARKS REGISTERED ACCORDING TO THE ACCELERATED PROCEDURE

The decision can be appealed at the Chamber of Appeal of Sakpatenti within 3 months from the publication.

(111) M 2018 29710 R  
(151) 2018 05 25  
(181) 2028 05 25  
(210) AM 97071  
(220) 2018 03 29  
(732) JSC "GEORGIAN EQUITY"  
Kazbegis q. 3-5, 0179, Tbilisi, Georgia  
(740) Giorgi Taktakishvili  
(540)



(591) Black, white  
(531) 03.01.01; 03.01.16; 26.01.01; 26.01.15; 28.05  
(526) საქართველოს  
(511) 36

(111) M 2018 29711 R  
(151) 2018 05 25  
(181) 2028 05 25  
(210) AM 97072  
(220) 2018 03 29  
(732) JSC "GEORGIAN EQUITY"  
Kazbegis q. 3-5, 0179, Tbilisi, Georgia  
(740) Giorgi Taktakishvili  
(540)



(591) Black, white  
(531) 03.01.01; 03.01.16; 26.01.15; 27.05.05  
(526) GEORGIA  
(511) 36

(111) M 2018 29712 R  
(151) 2018 05 25  
(181) 2028 05 25  
(210) AM 97485  
(220) 2018 05 10  
(732) BRITISH AMERICAN TOBACCO  
(BRANDS) INC.  
(a Delaware corporation)  
251 Little Falls Drive, Suite 100, Delaware,  
Wilmington, 19808-1674, USA  
(740) Tamar Kochlamazashvili

(540)  
**THE NEW EDGE OF TASTE**  
(591) Black, white  
(511) 34

(111) M 2018 29713 R  
(151) 2018 05 25  
(181) 2028 05 25  
(210) AM 97468  
(220) 2018 05 07  
(732) LEPL "GEORGIAN BAR ASSOCIATION"  
Dzmebi Zubalashvilebis q. 36, 0108, Tbilisi, Georgia  
(740) Giorgi Taktakishvili  
(540)



(591) Golden, blue  
(531) 05.03.08; 05.07.02; 24.01.10; 24.03.07;  
24.03.14; 26.01.21; 26.15.03; 29.01.12  
(511) 16, 41, 45

(111) M 2018 29714 R  
(151) 2018 05 28  
(181) 2028 05 28  
(210) AM 97221  
(220) 2018 04 12  
(732) TVG SHIPPING LIMITED  
140 B Franklin Roosevelt, CY-3011 Limassol,  
Cyprus  
(740) Shalva Gvaramadze  
(540)



(591) Black, white  
 (531) 03.04.13; 26.13.25; 27.05.17  
 (511) 25

(111) M 2018 29715 R  
 (151) 2018 05 28  
 (181) 2028 05 28  
 (210) AM 97706  
 (220) 2018 05 17  
 (732) LTD "GLOBAL BEER GEORGIA"  
 Vazisubnis IV M/r, I Kv. Kor. 21, b. 12,  
 Tbilisi, Georgia  
 (540)



(591) White, green  
 (531) 02.01.01; 02.01.02; 02.01.04; 26.01.21;  
 29.01.03  
 (511) 32

(111) M 2018 29716 R  
 (151) 2018 05 29  
 (181) 2028 05 29  
 (210) AM 97762  
 (220) 2018 05 18  
 (732) LTD "ADONIS HOLDING"  
 I. Chavchavadzis gamz. 11a, sartuli 2, b. 3,  
 Bloki "B", 0179, Tbilisi, Georgia  
 (540)



(591) Yellow, black, white  
 (531) 05.05.20; 26.01.01; 26.01.04; 26.01.15;  
 27.05.10; 29.01.13  
 (511) 36, 37

(111) M 2018 29719 R  
 (151) 2018 05 31  
 (181) 2028 05 31  
 (210) AM 97874  
 (220) 2018 05 25  
 (732) "GRAND CANDY" LLC  
 31 Masis Str., 0061, Yerevan, Armenia  
 (740) Giorgi Taktakishvili  
 (540)

**PATRIOT**  
**პატრიოტი**  
**ПАТРИОТ**

(591) Black, white  
 (511) 30

(111) M 2018 29720 R  
 (151) 2018 06 01  
 (181) 2028 06 01  
 (210) AM 97682  
 (220) 2018 05 11  
 (732) LTD "ILIA NARAKIDZE 777"  
 A. Abashidzis q. 7a, 6000, Batumi, Georgia  
 (740) Lela Memiadze  
 (540)



(591) Grey, yellow, white  
 (531) 26.04.02; 26.04.05; 26.04.22; 26.04.24;  
 27.07.17; 27.07.24; 28.19; 29.01.13  
 (511) 35, 37

## INTERNATIONAL TRADEMARKS FOR WHICH A DECISION ON GRANTING PROTECTIONS IS TAKEN

The decision can be appealed at the Chamber of Appeal of Sakpatenti within 3 months from the publication or at the Mtskheta District Court Administrative Cases Board (Address: №17, Samkhedro str., Mtskheta), within 1 month following the publication.

(260) AM 2018 78980 A\*

(800) 1217392

(151) 2014 07 24

(891) 2014 07 24

(731) OSRAM GMBH

Marcel-Breuer-Straße 6, 80807 München,  
Germany

(540)

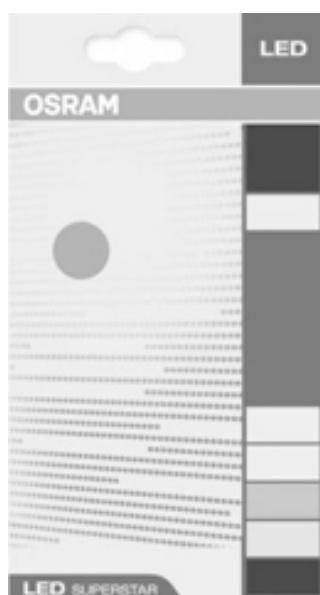

(591) Black, white

(531) 25.03.07; 25.03.13; 27.05.24

(511)

21 – cages for pets; household storage containers for pet food; litter trays for pets; litter boxes for pets.

---

(591) Black, white

(531) 25.01.01; 25.07.07; 26.01.24; 26.04.09;  
27.05.24

(511)

11 – Apparatus for lighting, especially electric lamps and lights; parts for the aforesaid goods, included in this class.

---

(260) AM 2018 89812 A\*

(800) 1321289

(151) 2016 06 26

(891) 2016 06 26

(731) CURVER Luxembourg sarl

Z.I. Haneboesch, L-4562 Niedercorn,  
Luxembourg

(540)



---

**INTERNATIONAL TRADEMARKS PROTECTED IN GEORGIA**

(260) AM 2018 85075 A  
(800) 999655  
(151) 2009 03 12  
(181) 2019 03 12  
(891) 2015 09 17  
(511) 05

---

(260) AM 2018 88869 A  
(800) 1311326  
(151) 2016 05 19  
(181) 2026 05 19  
(891) 2016 05 19  
(511) 05

---

(260) AM 2018 86307 A  
(800) 1287720  
(151) 2015 11 10  
(181) 2025 11 10  
(891) 2015 11 10  
(511) 16, 21, 25, 32

---

(260) AM 2018 88880 A  
(800) 1311623  
(151) 2016 02 19  
(181) 2026 02 19  
(891) 2016 02 19  
(511) 06, 20

---

(260) AM 2018 87459 A  
(800) 1297995  
(151) 2016 03 31  
(181) 2026 03 31  
(891) 2016 03 31  
(511) 36

---

(260) AM 2018 88900 A  
(800) 1083445  
(151) 2011 02 25  
(181) 2021 02 25  
(891) 2016 09 14  
(511) 07, 09, 37

---

(260) AM 2018 88083 A  
(800) 1303228  
(151) 2016 04 13  
(181) 2026 04 13  
(891) 2016 04 13  
(511) 30

---

(260) AM 2018 88908 A  
(800) 1310157  
(151) 2016 03 22  
(181) 2026 03 22  
(891) 2016 09 12  
(511) 35, 37

---

(260) AM 2018 88213 A  
(800) 1304111  
(151) 2016 04 01  
(181) 2026 04 01  
(891) 2016 04 01  
(511) 05

---

(260) AM 2018 88909 A  
(800) 1310158  
(151) 2016 03 22  
(181) 2026 03 22  
(891) 2016 09 12  
(511) 35, 37

---

(260) AM 2018 88655 A  
(800) 1308911  
(151) 2016 03 22  
(181) 2026 03 22  
(891) 2016 03 22  
(511) 35, 44

---

(260) AM 2018 88953 A  
(800) 1312254  
(151) 2016 04 06  
(181) 2026 04 06  
(891) 2016 04 06  
(511) 01, 05

---

(260) AM 2018 88838 A  
(800) 1310970  
(151) 2016 04 06  
(181) 2026 04 06  
(891) 2016 04 06  
(511) 01, 05

---

(260) AM 2018 89281 A  
(800) 1315546  
(151) 2016 08 04  
(181) 2026 08 04  
(891) 2016 08 04  
(511) 05

---

(260) AM 2018 89743 A  
(800) 1049700  
(151) 2010 06 16  
(181) 2020 06 16  
(891) 2016 06 16  
(511) 01, 02, 03, 05, 35

---

(260) AM 2018 89806 A  
(800) 1321770  
(151) 2016 06 02  
(181) 2026 06 02  
(891) 2016 06 02  
(511) 01

---

(260) AM 2018 90449 A  
(800) 1327296  
(151) 2016 09 15  
(181) 2026 09 15  
(891) 2016 09 15  
(511) 14

---

(260) AM 2018 90708 A  
(800) 1329417  
(151) 2016 06 14  
(181) 2026 06 14  
(891) 2016 06 14  
(511) 03, 09, 14, 18, 24, 25, 26, 35, 42

---

(260) AM 2018 90709 A  
(800) 1329879  
(151) 2016 08 03  
(181) 2026 08 03  
(891) 2016 08 03  
(511) 09, 16, 25, 35, 38, 41

---

(260) AM 2018 90715 A  
(800) 1329436  
(151) 2016 09 02  
(181) 2026 09 02  
(891) 2016 09 02  
(511) 30

---

(260) AM 2018 91117 A  
(800) 1332924  
(151) 2016 08 15  
(181) 2026 08 15  
(891) 2016 08 15  
(511) 30, 32

---

(260) AM 2018 91269 A  
(800) 1334248  
(151) 2016 09 06  
(181) 2026 09 06

(891) 2016 09 06  
(511) 35, 41

---

(260) AM 2018 91271 A  
(800) 1334303  
(151) 2016 11 01  
(181) 2026 11 01  
(891) 2016 11 01  
(511) 09

---

(260) AM 2018 91272 A  
(800) 1334345  
(151) 2016 04 06  
(181) 2026 04 06  
(891) 2016 04 06  
(511) 02, 07, 16, 19, 37

---

(260) AM 2018 91274 A  
(800) 1334346  
(151) 2016 04 06  
(181) 2026 04 06  
(891) 2016 04 06  
(511) 02, 07, 16, 19, 37

---

(260) AM 2018 91294 A  
(800) 1335302  
(151) 2016 11 22  
(181) 2026 11 22  
(891) 2016 11 22  
(511) 03

---

(260) AM 2018 91324 A  
(800) 1334749  
(151) 2016 06 27  
(181) 2026 06 27  
(891) 2016 06 27  
(511) 09, 10

---

(260) AM 2018 91335 A  
(800) 1334789  
(151) 2016 05 18  
(181) 2026 05 18  
(891) 2016 05 18  
(511) 01, 04, 07, 09, 11, 12

---

(260) AM 2018 91339 A  
(800) 1335089  
(151) 2016 07 25  
(181) 2026 07 25  
(891) 2016 07 25  
(511) 09, 35

---

(260) AM 2018 91345 A  
(800) 1334941  
(151) 2016 11 21  
(181) 2026 11 21  
(891) 2016 11 21  
(511) 09, 35, 42

---

(260) AM 2018 91450 A  
(800) 1335986  
(151) 2016 10 17  
(181) 2026 10 17  
(891) 2016 10 17  
(511) 30, 32

---

(260) AM 2018 91589 A  
(800) 1337240  
(151) 2016 12 19  
(181) 2026 12 19  
(891) 2016 12 19  
(511) 18, 24, 25, 28

---

(260) AM 2018 91604 A  
(800) 1336734  
(151) 2016 11 21  
(181) 2026 11 21  
(891) 2016 11 21  
(511) 25

---

(260) AM 2018 91647 A  
(800) 1337273  
(151) 2016 09 30  
(181) 2026 09 30  
(891) 2016 09 30  
(511) 30

---

(260) AM 2018 91649 A  
(800) 1337330  
(151) 2016 06 16  
(181) 2026 06 16  
(891) 2016 06 16  
(511) 09, 28

---

(260) AM 2018 91650 A  
(800) 1337405  
(151) 2016 11 29  
(181) 2026 11 29  
(891) 2016 11 29  
(511) 12, 35, 37

---

(260) AM 2018 91655 A  
(800) 1337504  
(151) 2016 12 21  
(181) 2026 12 21

(891) 2016 12 21  
(511) 10

---

(260) AM 2018 91668 A  
(800) 1337546  
(151) 2016 11 01  
(181) 2026 11 01  
(891) 2016 11 01  
(511) 06, 19, 20, 35

---

(260) AM 2018 91673 A  
(800) 1337625  
(151) 2016 02 23  
(181) 2026 02 23  
(891) 2016 02 23  
(511) 10, 35

---

(260) AM 2018 91675 A  
(800) 1338164  
(151) 2016 12 19  
(181) 2026 12 19  
(891) 2016 12 19  
(511) 03, 05

---

(260) AM 2018 91676 A  
(800) 1338179  
(151) 2016 11 21  
(181) 2026 11 21  
(891) 2016 11 21  
(511) 09

---

(260) AM 2018 91679 A  
(800) 1338213  
(151) 2016 07 28  
(181) 2026 07 28  
(891) 2016 07 28  
(511) 09, 28

---

(260) AM 2018 91683 A  
(800) 1338237  
(151) 2016 11 02  
(181) 2026 11 02  
(891) 2016 11 02  
(511) 09, 28

---

(260) AM 2018 91684 A  
(800) 1338240  
(151) 2016 11 03  
(181) 2026 11 03  
(891) 2016 11 03  
(511) 09, 28

---



(260) AM 2018 91685 A  
(800) 1338295  
(151) 2016 09 27  
(181) 2026 09 27  
(891) 2016 09 27  
(511) 09, 11, 34

---

(260) AM 2018 91686 A  
(800) 1338347  
(151) 2016 12 29  
(181) 2026 12 29  
(891) 2016 12 29  
(511) 29

---

(260) AM 2018 91687 A  
(800) 1338373  
(151) 2016 11 02  
(181) 2026 11 02  
(891) 2016 11 02  
(511) 09, 28

---

(260) AM 2018 91688 A  
(800) 1337659  
(151) 2016 12 22  
(181) 2026 12 22  
(891) 2016 12 22  
(511) 05

---

(260) AM 2018 91689 A  
(800) 1337666  
(151) 2016 12 23  
(181) 2026 12 23  
(891) 2016 12 23  
(511) 05, 10

---

(260) AM 2018 91691 A  
(800) 1338428  
(151) 2016 12 15  
(181) 2026 12 15  
(891) 2016 12 15  
(511) 05

---

(260) AM 2018 91692 A  
(800) 1338431  
(151) 2016 12 26  
(181) 2026 12 26  
(891) 2016 12 26  
(511) 03

---

(260) AM 2018 91695 A  
(800) 1045659  
(151) 2010 06 01  
(181) 2020 06 01

(891) 2017 03 17  
(511) 11

---

(260) AM 2018 91696 A  
(800) 1337784  
(151) 2016 12 19  
(181) 2026 12 19  
(891) 2016 12 19  
(511) 05

---

(260) AM 2018 91698 A  
(800) 1337785  
(151) 2016 12 19  
(181) 2026 12 19  
(891) 2016 12 19  
(511) 05

---

(260) AM 2018 91699 A  
(800) 1240640  
(151) 2014 10 17  
(181) 2024 10 17  
(891) 2017 03 10  
(511) 42

---

(260) AM 2018 91700 A  
(800) 1243349  
(151) 2015 01 20  
(181) 2025 01 20  
(891) 2016 11 29  
(511) 33

---

(260) AM 2018 91701 A  
(800) 1337793  
(151) 2016 12 14  
(181) 2026 12 14  
(891) 2016 12 14  
(511) 10

---

(260) AM 2018 91702 A  
(800) 1273463  
(151) 2015 07 07  
(181) 2025 07 07  
(891) 2016 11 16  
(511) 29, 30

---

(260) AM 2018 91703 A  
(800) 1337795  
(151) 2016 12 14  
(181) 2026 12 14  
(891) 2016 12 14  
(511) 30

---

(260) AM 2018 91708 A  
(800) 1337800  
(151) 2017 02 14  
(181) 2027 02 14  
(891) 2017 02 14  
(511) 43

---

(260) AM 2018 91710 A  
(800) 1337884  
(151) 2016 11 21  
(181) 2026 11 21  
(891) 2016 11 21  
(511) 12

---

(260) AM 2018 91711 A  
(800) 1337904  
(151) 2016 11 30  
(181) 2026 11 30  
(891) 2016 11 30  
(511) 33

---

(260) AM 2018 91726 A  
(800) 1337970  
(151) 2016 08 22  
(181) 2026 08 22  
(891) 2016 08 22  
(511) 29, 30, 31

---

(260) AM 2018 91741 A  
(800) 1338449  
(151) 2016 09 27  
(181) 2026 09 27  
(891) 2016 09 27  
(511) 30

---

(260) AM 2018 91742 A  
(800) 1338450  
(151) 2016 08 18  
(181) 2026 08 18  
(891) 2016 08 18  
(511) 32

---

(260) AM 2018 91743 A  
(800) 1338578  
(151) 2016 09 14  
(181) 2026 09 14  
(891) 2016 09 14  
(511) 09, 28

---

(260) AM 2018 91744 A  
(800) 1338604  
(151) 2016 11 08  
(181) 2026 11 08

(891) 2016 11 08  
(511) 29

---

(260) AM 2018 91745 A  
(800) 1338676  
(151) 2016 12 23  
(181) 2026 12 23  
(891) 2016 12 23  
(511) 18, 25, 35

---

(260) AM 2018 91746 A  
(800) 1338773  
(151) 2016 06 03  
(181) 2026 06 03  
(891) 2016 06 03  
(511) 03, 08, 35

---

(260) AM 2018 91747 A  
(800) 1338759  
(151) 2017 01 17  
(181) 2027 01 17  
(891) 2017 01 17  
(511) 05, 29, 30

---

(260) AM 2018 91748 A  
(800) 1338769  
(151) 2015 12 23  
(181) 2025 12 23  
(891) 2015 12 23  
(511) 06, 07, 08, 09, 16, 20, 21

---

(260) AM 2018 91750 A  
(800) 1338831  
(151) 2016 08 12  
(181) 2026 08 12  
(891) 2016 08 12  
(511) 25, 35

---

(260) AM 2018 91751 A  
(800) 1338837  
(151) 2016 09 08  
(181) 2026 09 08  
(891) 2016 09 08  
(511) 09, 42, 45

---

(260) AM 2018 91753 A  
(800) 1338896  
(151) 2016 06 02  
(181) 2026 06 02  
(891) 2016 06 02  
(511) 29, 35, 43

---

(260) AM 2018 91768 A  
(800) 1339008  
(151) 2016 02 18  
(181) 2026 02 18  
(891) 2016 02 18  
(511) 03, 07, 08, 09, 16, 17, 20

---

(260) AM 2018 91787 A  
(800) 1339170  
(151) 2016 12 26  
(181) 2026 12 26  
(891) 2016 12 26  
(511) 30

---

(260) AM 2018 91788 A  
(800) 1339175  
(151) 2016 12 21  
(181) 2026 12 21  
(891) 2016 12 21  
(511) 01, 04

---

(260) AM 2018 91790 A  
(800) 1339225  
(151) 2016 11 19  
(181) 2026 11 19  
(891) 2016 11 19  
(511) 09

---

(260) AM 2018 91791 A  
(800) 1339236  
(151) 2016 11 15  
(181) 2026 11 15  
(891) 2016 11 15  
(511) 33

---

(260) AM 2018 91793 A  
(800) 1339266  
(151) 2016 11 08  
(181) 2026 11 08  
(891) 2016 11 08  
(511) 05

---

(260) AM 2018 91796 A  
(800) 1339438  
(151) 2016 12 15  
(181) 2026 12 15  
(891) 2016 12 15  
(511) 36

---

(260) AM 2018 91797 A  
(800) 1339513  
(151) 2016 12 20  
(181) 2026 12 20

(891) 2016 12 20  
(511) 07

---

(260) AM 2018 91798 A  
(800) 1339530  
(151) 2017 01 24  
(181) 2027 01 24  
(891) 2017 01 24  
(511) 01, 05, 09, 10

---

(260) AM 2018 91799 A  
(800) 1339536  
(151) 2016 10 26  
(181) 2026 10 26  
(891) 2016 10 26  
(511) 33

---

(260) AM 2018 91800 A  
(800) 1339564  
(151) 2016 12 23  
(181) 2026 12 23  
(891) 2016 12 23  
(511) 18, 25

---

(260) AM 2018 91801 A  
(800) 1339586  
(151) 2017 01 16  
(181) 2027 01 16  
(891) 2017 01 16  
(511) 30

---

(260) AM 2018 91808 A  
(800) 1339595  
(151) 2016 09 26  
(181) 2026 09 26  
(891) 2016 09 26  
(511) 29, 30, 32, 33, 43

---

(260) AM 2018 91809 A  
(800) 1339631  
(151) 2016 12 02  
(181) 2026 12 02  
(891) 2016 12 02  
(511) 17, 19

---

(260) AM 2018 91823 A  
(800) 1339632  
(151) 2016 12 02  
(181) 2026 12 02  
(891) 2016 12 02  
(511) 05, 29, 30, 32

---

(260) AM 2018 91824 A  
(800) 1339633  
(151) 2016 12 02  
(181) 2026 12 02  
(891) 2016 12 02  
(511) 05, 29, 30, 32

---

(260) AM 2018 91827 A  
(800) 1339669  
(151) 2016 12 09  
(181) 2026 12 09  
(891) 2016 12 09  
(511) 09

---

(260) AM 2018 91880 A  
(800) 1340696  
(151) 2017 01 11  
(181) 2027 01 11  
(891) 2017 01 11  
(511) 09

---

(260) AM 2018 91895 A  
(800) 1339883  
(151) 2016 12 09  
(181) 2026 12 09  
(891) 2016 12 09  
(511) 09

---

(260) AM 2018 91899 A  
(800) 1339960  
(151) 2016 12 20  
(181) 2026 12 20  
(891) 2016 12 20  
(511) 11

---

(260) AM 2018 91900 A  
(800) 1339965  
(151) 2016 12 20  
(181) 2026 12 20  
(891) 2016 12 20  
(511) 01

---

(260) AM 2018 91901 A  
(800) 1340937  
(151) 2016 06 15  
(181) 2026 06 15  
(891) 2016 06 15  
(511) 09, 16, 18, 28, 29, 30, 32, 35, 41

---

(260) AM 2018 91902 A  
(800) 1339967  
(151) 2016 12 22  
(181) 2026 12 22

(891) 2016 12 22  
(511) 05

---

(260) AM 2018 91908 A  
(800) 1340994  
(151) 2017 02 16  
(181) 2027 02 16  
(891) 2017 02 16  
(511) 35, 39

---

(260) AM 2018 91909 A  
(800) 1340996  
(151) 2017 02 16  
(181) 2027 02 16  
(891) 2017 02 16  
(511) 35, 39

---

(260) AM 2018 91910 A  
(800) 1340011  
(151) 2016 06 24  
(181) 2026 06 24  
(891) 2016 06 24  
(511) 29, 30

---

(260) AM 2018 91911 A  
(800) 1341007  
(151) 2016 05 25  
(181) 2026 05 25  
(891) 2016 05 25  
(511) 05, 10, 35, 36, 37, 42, 43, 44, 45

---

(260) AM 2018 91914 A  
(800) 1340016  
(151) 2016 12 02  
(181) 2026 12 02  
(891) 2016 12 02  
(511) 05, 29, 30, 32

---

(260) AM 2018 91916 A  
(800) 1185067  
(151) 2013 06 26  
(181) 2023 06 26  
(891) 2016 11 30  
(511) 05

---

(260) AM 2018 91917 A  
(800) 1340048  
(151) 2016 12 23  
(181) 2026 12 23  
(891) 2016 12 23  
(511) 18, 25

---

(260) AM 2018 91918 A  
(800) 1213919  
(151) 2013 06 06  
(181) 2023 06 06  
(891) 2016 12 19  
(511) 12

---

(260) AM 2018 91919 A  
(800) 1340061  
(151) 2016 12 21  
(181) 2026 12 21  
(891) 2016 12 21  
(511) 01, 04

---

(260) AM 2018 91922 A  
(800) 1340062  
(151) 2016 12 21  
(181) 2026 12 21  
(891) 2016 12 21  
(511) 04, 37

---

(260) AM 2018 91923 A  
(800) 1340068  
(151) 2016 11 11  
(181) 2026 11 11  
(891) 2016 11 11  
(511) 32

---

(260) AM 2018 91925 A  
(800) 1340128  
(151) 2017 01 11  
(181) 2027 01 11  
(891) 2017 01 11  
(511) 09, 42

---

(260) AM 2018 91927 A  
(800) 1340130  
(151) 2016 11 17  
(181) 2026 11 17  
(891) 2016 11 17  
(511) 09

---

(260) AM 2018 91928 A  
(800) 1340134  
(151) 2016 12 21  
(181) 2026 12 21  
(891) 2016 12 21  
(511) 04, 37

---

(260) AM 2018 91931 A  
(800) 1340138  
(151) 2016 12 21  
(181) 2026 12 21

(891) 2016 12 21  
(511) 04, 37

---

(260) AM 2018 91932 A  
(800) 1277157  
(151) 2015 09 22  
(181) 2025 09 22  
(891) 2017 03 30  
(511) 07

---

(260) AM 2018 91933 A  
(800) 1340139  
(151) 2016 12 21  
(181) 2026 12 21  
(891) 2016 12 21  
(511) 41

---

(260) AM 2018 91934 A  
(800) 1301994  
(151) 2016 03 31  
(181) 2026 03 31  
(891) 2017 01 17  
(511) 03, 08

---

(260) AM 2018 91943 A  
(800) 1340237  
(151) 2016 12 14  
(181) 2026 12 14  
(891) 2016 12 14  
(511) 10

---

(260) AM 2018 91944 A  
(800) 1340238  
(151) 2016 12 14  
(181) 2026 12 14  
(891) 2016 12 14  
(511) 10

---

(260) AM 2018 91945 A  
(800) 1340239  
(151) 2016 12 14  
(181) 2026 12 14  
(891) 2016 12 14  
(511) 10

---

(260) AM 2018 91947 A  
(800) 1340240  
(151) 2016 12 14  
(181) 2026 12 14  
(891) 2016 12 14  
(511) 10

---

(260) AM 2018 91948 A  
(800) 1340334  
(151) 2017 02 16  
(181) 2027 02 16  
(891) 2017 02 16  
(511) 19, 20

---

(260) AM 2018 91949 A  
(800) 1340342  
(151) 2016 11 15  
(181) 2026 11 15  
(891) 2016 11 15  
(511) 09

---

(260) AM 2018 91950 A  
(800) 1340343  
(151) 2016 11 19  
(181) 2026 11 19  
(891) 2016 11 19  
(511) 42

---

(260) AM 2018 91952 A  
(800) 1340345  
(151) 2016 12 28  
(181) 2026 12 28  
(891) 2016 12 28  
(511) 29

---

(260) AM 2018 91964 A  
(800) 1340446  
(151) 2016 02 22  
(181) 2026 02 22  
(891) 2016 02 22  
(511) 17, 19

---

(260) AM 2018 91965 A  
(800) 1340475  
(151) 2016 07 22  
(181) 2026 07 22  
(891) 2016 07 22  
(511) 11

---

(260) AM 2018 91967 A  
(800) 1340502  
(151) 2016 09 02  
(181) 2026 09 02  
(891) 2016 09 02  
(511) 01, 05, 35, 40, 41, 42

---

(260) AM 2018 91970 A  
(800) 1340580  
(151) 2017 01 19  
(181) 2027 01 19

(891) 2017 01 19  
(511) 41

---

(260) AM 2018 91972 A  
(800) 1340602  
(151) 2017 02 24  
(181) 2027 02 24  
(891) 2017 02 24  
(511) 05, 30

---

(260) AM 2018 91974 A  
(800) 1340691  
(151) 2016 12 23  
(181) 2026 12 23  
(891) 2016 12 23  
(511) 29, 30

---

(260) AM 2018 91975 A  
(800) 1340695  
(151) 2017 02 08  
(181) 2027 02 08  
(891) 2017 02 08  
(511) 43

---

(260) AM 2018 91982 A  
(800) 1341905  
(151) 2016 11 03  
(181) 2026 11 03  
(891) 2016 11 03  
(511) 16, 21, 29, 30, 35, 43

---

(260) AM 2018 91987 A  
(800) 1341906  
(151) 2016 11 03  
(181) 2026 11 03  
(891) 2016 11 03  
(511) 16, 21, 29, 30, 35, 43

---

(260) AM 2018 91990 A  
(800) 1341064  
(151) 2017 02 23  
(181) 2027 02 23  
(891) 2017 02 23  
(511) 32, 33

---

(260) AM 2018 91991 A  
(800) 1341070  
(151) 2016 11 14  
(181) 2026 11 14  
(891) 2016 11 14  
(511) 30

---

(260) AM 2018 91993 A  
(800) 1341084  
(151) 2016 03 28  
(181) 2026 03 28  
(891) 2016 03 28  
(511) 09, 12, 28

---

(260) AM 2018 91994 A  
(800) 1341085  
(151) 2016 08 09  
(181) 2026 08 09  
(891) 2016 08 09  
(511) 03

---

(260) AM 2018 91998 A  
(800) 1341160  
(151) 2015 09 02  
(181) 2025 09 02  
(891) 2015 09 02  
(511) 01, 03, 04, 05, 06, 07, 09, 11, 17, 21, 35, 36,  
37, 40, 41, 42

---

(260) AM 2018 92000 A  
(800) 1341180  
(151) 2016 11 30  
(181) 2026 11 30  
(891) 2016 11 30  
(511) 09, 28

---

(260) AM 2018 92005 A  
(800) 1341488  
(151) 2017 01 17  
(181) 2027 01 17  
(891) 2017 01 17  
(511) 34

---

(260) AM 2018 92010 A  
(800) 1341533  
(151) 2016 11 23  
(181) 2026 11 23  
(891) 2016 11 23  
(511) 09

---

(260) AM 2018 92011 A  
(800) 1341907  
(151) 2016 11 03  
(181) 2026 11 03  
(891) 2016 11 03  
(511) 16, 21, 29, 30, 35, 43

---

(260) AM 2018 92012 A  
(800) 1341534  
(151) 2017 11 23  
(181) 2027 11 23

(891) 2016 11 23  
(511) 09

---

(260) AM 2018 92013 A  
(800) 1341908  
(151) 2016 11 10  
(181) 2026 11 10  
(891) 2016 11 10  
(511) 14, 18, 25

---

(260) AM 2018 92014 A  
(800) 1341535  
(151) 2016 11 23  
(181) 2026 11 23  
(891) 2016 11 23  
(511) 09

---

(260) AM 2018 92019 A  
(800) 1341536  
(151) 2016 11 23  
(181) 2026 11 23  
(891) 2016 11 23  
(511) 09

---

(260) AM 2018 92021 A  
(800) 1341537  
(151) 2016 11 23  
(181) 2026 11 23  
(891) 2016 11 23  
(511) 09

---

(260) AM 2018 92023 A  
(800) 1341623  
(151) 2016 10 24  
(181) 2026 10 24  
(891) 2016 10 24  
(511) 07

---

(260) AM 2018 92024 A  
(800) 1341676  
(151) 2016 12 20  
(181) 2026 12 20  
(891) 2016 12 20  
(511) 09

---

(260) AM 2018 92029 A  
(800) 1341692  
(151) 2016 12 16  
(181) 2026 12 16  
(891) 2016 12 16  
(511) 30

---

(260) AM 2018 92030 A  
(800) 1341698  
(151) 2017 01 16  
(181) 2027 01 16  
(891) 2017 01 16  
(511) 12

---

(260) AM 2018 92032 A  
(800) 1341712  
(151) 2017 01 04  
(181) 2027 01 04  
(891) 2017 01 04  
(511) 01, 02, 34

---

(260) AM 2018 92033 A  
(800) 1341714  
(151) 2017 01 17  
(181) 2027 01 17  
(891) 2017 01 17  
(511) 05, 29, 30

---

(260) AM 2018 92037 A  
(800) 1341234  
(151) 2016 08 15  
(181) 2026 08 15  
(891) 2016 08 15  
(511) 09, 16, 41, 45

---

(260) AM 2018 92038 A  
(800) 1341246  
(151) 2016 12 20  
(181) 2026 12 20  
(891) 2016 12 20  
(511) 08

---

(260) AM 2018 92042 A  
(800) 1341298  
(151) 2016 11 29  
(181) 2026 11 29  
(891) 2016 11 29  
(511) 09, 14, 35

---

(260) AM 2018 92043 A  
(800) 1341848  
(151) 2016 12 16  
(181) 2026 12 16  
(891) 2016 12 16  
(511) 30

---

(260) AM 2018 92044 A  
(800) 1341302  
(151) 2017 01 06  
(181) 2027 01 06

(891) 2017 01 06  
(511) 09, 35, 38

---

(260) AM 2018 92045 A  
(800) 1341860  
(151) 2016 09 30  
(181) 2026 09 30  
(891) 2016 09 30  
(511) 29, 35

---

(260) AM 2018 92046 A  
(800) 1341329  
(151) 2016 11 17  
(181) 2026 11 17  
(891) 2016 11 17  
(511) 09, 35, 36, 37, 38, 41, 42, 45

---

(260) AM 2018 92048 A  
(800) 1341866  
(151) 2016 12 20  
(181) 2026 12 20  
(891) 2016 12 20  
(511) 14, 35

---

(260) AM 2018 92049 A  
(800) 1341890  
(151) 2016 10 11  
(181) 2026 10 11  
(891) 2016 10 11  
(511) 36

---

(260) AM 2018 92063 A  
(800) 1342003  
(151) 2016 11 11  
(181) 2026 11 11  
(891) 2016 11 11  
(511) 09

---

(260) AM 2018 92064 A  
(800) 1342023  
(151) 2016 12 20  
(181) 2026 12 20  
(891) 2016 12 20  
(511) 05

---

(260) AM 2018 92072 A  
(800) 1342104  
(151) 2017 01 13  
(181) 2027 01 13  
(891) 2017 01 13  
(511) 29, 30, 32, 35, 43

---



(260) AM 2018 92078 A  
(800) 1342107  
(151) 2017 01 23  
(181) 2027 01 23  
(891) 2017 01 23  
(511) 01, 04, 35

---

(181) 2023 10 08  
(891) 2017 01 12  
(511) 07, 12

---

(260) AM 2018 92079 A  
(800) 1342135  
(151) 2016 05 25  
(181) 2026 05 27  
(891) 2016 05 25  
(511) 05, 10, 35, 36, 37, 42, 43, 44, 45

---

(260) AM 2018 92080 A  
(800) 1342136  
(151) 2016 07 22  
(181) 2026 07 22  
(891) 2016 07 22  
(511) 12, 14, 16, 18, 20, 21, 25, 28, 36

---

(260) AM 2018 92081 A  
(800) 1342147  
(151) 2016 10 11  
(181) 2026 10 11  
(891) 2016 10 11  
(511) 32

---

(260) AM 2018 92083 A  
(800) 896377  
(151) 2006 08 09  
(181) 2026 08 09  
(891) 2017 01 25  
(511) 05

---

(260) AM 2018 92084 A  
(800) 1031418  
(151) 2009 10 15  
(181) 2019 10 15  
(891) 2017 04 12  
(511) 18, 25, 35

---

(260) AM 2018 92085 A  
(800) 1055835  
(151) 2010 10 06  
(181) 2020 10 06  
(891) 2017 03 06  
(511) 25

---

(260) AM 2018 92087 A  
(800) 1188571  
(151) 2013 10 08

---

---

# OFFICIAL NOTIFICATIONS

## INVENTIONS

### RENEWAL OF PATENT

(21) AP 2009 11063

(11) P 2011 5223 B

(73) Devi Vasadze

(54) **REMOTELY-OPERATED SUBSCRIBER'S RECEIVING UNIT FOR WIRED RADIO BROADCASTING**

CANCELLATION DATE OF PATENT: 2018 01 15

DATE OF RENEWAL OF PATENT: 2018 06 11

---

### CANCELLING OF PATENTS

(21) AP 2007 10102

(11) P 2008 4429 B

(73) Giorgi Gureshidze

(54) **DEVICE FOR WEAVING LATERAL AND FACE MESH PANELS OF THE SPACE CARCASE**

CANCELLATION DATE OF PATENT: 2018 05 29

PATENT RESTORATION IS AVAILABLE: 2019 05 29

---

(21) AP 2006 10441

(11) P 2009 4738 B

(73) Aziende Chimiche Riunite Angelini Francesco A.C.R.A.F. S.p.A.

(54) **USE OF A BENZOYL DERIVATIVE OF 3-AMINOCARBAZOLE FOR THE TREATMENT OF A DISORDER ASSOCIATED WITH THE PRODUCTION OF PROSTAGLANDIN E2 (PGE2)**

CANCELLATION DATE OF PATENT: 2018 05 03

PATENT RESTORATION IS AVAILABLE: 2019 05 03

---

(21) AP 2008 10696

(11) P 2009 4739 B

(73) Leri Rukhadze;

Davit Kakhadze;

Shota Tsikhelashvili;

Ioseb Tsikhelashvili;

Giorgi Mikadze;

Merab Davitaia;

Giorgi Katsitadze;

Nodat Chkheidze;

Paata Giorgadze;

Ioseb Batsikadze;

Tamaz Batsikadze;

Archil Prangishvili;

Darejan Garuchava;

Zaur Tsikhelashvili

(54) **FLOATING DESIGN WITH DEVICE OF WAVES DAMPING**

CANCELLATION DATE OF PATENT: 2018 05 16

PATENT RESTORATION IS AVAILABLE: 2019 05 16

---

(21) AP 2009 11256  
(11) P 2011 5286 B  
(73) Devi Vasadze  
(54) **NOTIFICATION SYSTEM OF AIR-RAID PRECAUTIONS**  
CANCELLATION DATE OF PATENT: 2018 05 15  
PATENT RESTORATION IS AVAILABLE: 2019 05 15

---

(21) AP 2008 11569  
(11) P 2012 5582 B  
(73) NOVARTIS AG  
(54) **EXTENDED-RELEASE COMPOSITION COMPRISING SOMATOSTATIN DERIVATIVE  
IN MICROPARTICLES**  
CANCELLATION DATE OF PATENT: 2018 05 23  
PATENT RESTORATION IS AVAILABLE: 2019 05 23

---

(21) AP 2010 11766  
(11) P 2014 6023 B  
(73) Merab Rudadze  
(54) **ELECTROMAGNETIC ACTUATOR**  
CANCELLATION DATE OF PATENT: 2018 04 22  
PATENT RESTORATION IS AVAILABLE: 2019 04 22

---

(21) AP 2010 11815  
(11) P 2013 5759 B  
(73) Leila Getsadze;  
Anzor Getsadze  
(54) **THERAPEUTIC COLLECTION OF GASTRITS, COLITS AND CATAR**  
CANCELLATION DATE OF PATENT: 2018 05 28  
PATENT RESTORATION IS AVAILABLE: 2019 05 28

---

(21) AP 2009 12027  
(11) P 2014 6061 B  
(73) AYUMI Pharmaceutical Corporation  
(54) **GLUCOCORTICOID RECEPTOR AGONIST COMPOSED OF 2,2,4-TRIMETHYL-6-PHENYL-  
1,2-DIHYDROQUINOLINE DERIVATIVE HAVING SUBSTITUTED OXY GROUP**  
CANCELLATION DATE OF PATENT: 2018 05 12  
PATENT RESTORATION IS AVAILABLE: 2019 05 12

---

(21) AP 2009 12032  
(11) P 2012 5621 B  
(73) Aziende Chimiche Riunite Angelini Francesco A.C.R.A.F. S.p.A.  
(54) **3-AMINOCARBAZOLE COMPOUND, PHARMACEUTICAL COMPOSITION CONTAINING  
IT AND PREPARATION METHOD THEREFOR**  
CANCELLATION DATE OF PATENT: 2018 05 11  
PATENT RESTORATION IS AVAILABLE: 2019 05 11

---

---

(21) AP 2009 12038  
(11) P 2012 5622 B  
(73) David Murray Melrose  
(54) **METHOD OF HEADSPACE MODIFICATION FOR VACUUM PRESSURE REMOVAL AND APPARATUS FOR EMBODIMENT THEREOF**  
CANCELLATION DATE OF PATENT: 2018 05 18  
PATENT RESTORATION IS AVAILABLE: 2019 05 18

---

(21) AP 2010 12454  
(11) P 2014 6115 B  
(73) KATHOLIEKE UNIVERSITEIT LEUVEN  
(54) **THIENO [2,3-B] PYRIDINE DERIVATIVES AS VIRAL REPLICATION INHIBITORS**  
CANCELLATION DATE OF PATENT: 2018 05 17  
PATENT RESTORATION IS AVAILABLE: 2019 05 17

---

(21) AP 2009 12474  
(11) P 2013 5893 B  
(73) Jenő Csányi;  
Péter Szöllősi  
(54) **CIGARETTE FILTER**  
CANCELLATION DATE OF PATENT: 2018 04 30  
PATENT RESTORATION IS AVAILABLE: 2019 04 30

---

(21) AP 2013 13081  
(11) P 2014 6110 B  
(73) Vakhtang Aslanikashvili  
(54) **UNDERGROUND IRRIGATING UNIT**  
CANCELLATION DATE OF PATENT: 2018 05 07  
PATENT RESTORATION IS AVAILABLE: 2019 05 07

---

(21) AP 2013 13093  
(11) P 2015 6290 B  
(73) Givi Arabidze  
(54) **UNDERGROUND IRRIGATING UNIT**  
CANCELLATION DATE OF PATENT: 2018 05 22  
PATENT RESTORATION IS AVAILABLE: 2019 05 22

---

(21) AP 2013 13621  
(11) P 2016 6532 B  
(73) NOVARTIS AG  
(54) **BENZAMIDE DERIVATIVES FOR INHIBITING THE ACTIVITY OF ABL1, ABL2 AND BCR-ABL1**  
CANCELLATION DATE OF PATENT: 2018 05 09  
PATENT RESTORATION IS AVAILABLE: 2019 05 09

---

(21) AP 2014 13979  
(11) P 2017 6675 B  
(73) PFIZER INC.  
(54) **IMIDAZO-TRIAZINE DERIVATIVES AS PDE10 INHIBITORS**  
CANCELLATION DATE OF PATENT: 2018 04 23  
PATENT RESTORATION IS AVAILABLE: 2019 04 23

---

(21) AP 2000 5454  
(11) P 2002 2678 B  
(73) NOVARTIS AG  
(54) **BICYCLIC HETEROAROMATIC COMPOUNDS AS PROTEIN TYROSINE KINASE INHIBITORS, THEIR PHARMACEUTICAL COMPOSITIONS AND METHODS FOR TREATMENT**

CANCELLATION DATE OF PATENT: 2018 01 08  
PATENT RESTORATION IS AVAILABLE: 2019 01 08

---

(21) AP 2000 5600  
(11) P 2003 2966 B  
(73) Aziende Chimiche Riunite Angelini Francesco A.C.R.A.F. S.p.A.  
(54) **OPHTHALMIC SOLUTION COMPRISING GLYCOGEN**

CANCELLATION DATE OF PATENT: 2018 03 11  
PATENT RESTORATION IS AVAILABLE: 2019 03 11

---

(21) AP 2000 5614  
(11) P 2003 2974 B  
(73) AVENTIS PHARMA S.A.  
(54) **CRYSTALLINE FORMS OF 1S-[1ALPHA (2S\*, 3R\*), 9ALPHA]-6,10-DIOXO-N-(2-ETHOXY-5-OXO-TETRAHYDRO-3 -FURANYL)-9-[[1-(1-ISOQUINOLYL) CARBONYL]-AMINO] OCTAHYDRO-6H-PIRIDAZINO[1,2-A][1,2] DIAZEPIN-1-CARBOXAMIDE. METHOD FOR THEIR PRODUCTION AND PHARMACEUTICAL COMPOSITIONS CONTAINING THEM FOR TREATMENT OF DISEASES CAUSED BY ACTIVITY OF 1BETA INTERLEUKINE CONVERSION ENZYME**

CANCELLATION DATE OF PATENT: 2018 04 07  
PATENT RESTORATION IS AVAILABLE: 2019 04 07

---

(21) AP 2002 6551  
(11) P 2004 3236 B  
(73) WARNER LAMBERT COMPANY  
(54) **ASYMMETRIC SYNTHESIS OF PREGABALIN**

CANCELLATION DATE OF PATENT: 2018 01 11  
PATENT RESTORATION IS AVAILABLE: 2019 01 11

---

(21) AP 2002 6679  
(11) P 2006 3797 B  
(73) Les Laboratoires Servier  
(54) **METHOD FOR SYNTHESIS OF PERINDOPRIL AND ITS PHARMACEUTICALLY ACCEPTABLE SALTS**

CANCELLATION DATE OF PATENT: 2018 04 05  
PATENT RESTORATION IS AVAILABLE: 2019 04 05

---

(21) AP 2002 6688  
(11) P 2006 3798 B  
(73) Les Laboratoires Servier  
(54) **METHOD FOR SYNTHESIS OF N-[(S)-1-CARBOXYBUTYL]-(S)-ALANINE ESTERS AND USE IN SYNTHESIS OF PERINDOPRIL**

CANCELLATION DATE OF PATENT: 2018 04 10  
PATENT RESTORATION IS AVAILABLE: 2019 04 10

---

(21) AP 2003 7020  
(11) P 2008 4339 B  
(73) JANSSEN ALZHEIMER IMMUNOTHERAPY (IR), WYETH (USA)

---

**(54) HUMANIZED ANTIBODIES THAT RECOGNIZE BETA AMYLOID PEPTIDE**

CANCELLATION DATE OF PATENT: 2017 12 06

PATENT RESTORATION IS AVAILABLE: 2018 12 06

---

(21) AP 2003 7202

(11) P 2006 3804 B

(73) Euro-Celtique S.A.

**(54) ONCE-A-DAY OXYCODONE FORMULATIONS**

CANCELLATION DATE OF PATENT: 2018 05 02

PATENT RESTORATION IS AVAILABLE: 2019 05 02

---

(21) AP 2004 8200

(11) P 2006 3744 B

(73) Giorgi Kakhiani

**(54) Method for Production of Vaccine against Anthrax**

CANCELLATION DATE OF PATENT: 2018 05 10

PATENT RESTORATION IS AVAILABLE: 2019 05 10

---

(21) AP 2003 8363

(11) P 2006 3898 B

(73) SOCIETE DES PRODUITS NESTLE S.A.

**(54) CLOSED CAPSULE WITH OPENING MEAN**

CANCELLATION DATE OF PATENT: 2018 01 13

PATENT RESTORATION IS AVAILABLE: 2019 01 13

---

(21) AP 2003 8402

(11) P 2006 3822 B

(73) Aziende Chimiche Riunite Angelini Francesco A.C.R.A.F. S.p.A.

**(54) DICLOFENAC-BASED COMPOSITION FOR THE TOPICAL TREATMENT OF OROPHARYNGEAL CAVITY DISORDERS**

CANCELLATION DATE OF PATENT: 2018 04 16

PATENT RESTORATION IS AVAILABLE: 2019 04 16

---

(21) AP 2003 8411

(11) P 2007 4079 B

(73) TAKEDA Gmbh

**(54) ORAL DOSAGE FORM CONTAINING PHOSPHOR DIESTERASE INHIBITOR-4 AS AN ACTIVE INGREDIENT AND POLYVINYLPIRROLIDON AS EXCIPIENT**

CANCELLATION DATE OF PATENT: 2018 02 19

PATENT RESTORATION IS AVAILABLE: 2019 02 19

---

(21) AP 2003 8440

(11) P 2008 4474 B

(73) JANSSEN ALZHEIMER IMMUNOTHERAPY (IR), WYETH (USA)

**(54) HUMANIZED ANTIBODIES THAT RECOGNIZE BETA AMYLOID PEPTIDE**

CANCELLATION DATE OF PATENT: 2018 03 12

PATENT RESTORATION IS AVAILABLE: 2019 03 12

---

(21) AP 2003 8523

(11) P 2007 4149 B

(73) Interdigital Technology Corporation

(54) **METHOD AND SYSTEM FOR OPTIMIZING POWER RESOURCES IN WIRELESS DEVICES**

CANCELLATION DATE OF PATENT: 2018 04 29

PATENT RESTORATION IS AVAILABLE: 2019 04 29

---

(21) AP 2003 8534

(11) P 2007 4150 B

(73) Interdigital Technology Corporation

(54) **SYSTEM AND METHOD FOR PERMITTING CONTROL OF THE PURGING OF A NODE B BY THE SERVING RADIO NETWORK CONTROLLER**

CANCELLATION DATE OF PATENT: 2018 05 07

PATENT RESTORATION IS AVAILABLE: 2019 05 07

---

(21) AP 2003 8869

(11) P 2007 4225 B

(73) Otsuka Pharma Co., Ltd

(54) **USE OF CARBOSTYRIL DERIVATIVES AND SEROTONIN REUPTAKE INHIBITORS FOR TREATMENT OF MOOD DISORDERS**

CANCELLATION DATE OF PATENT: 2017 12 25

PATENT RESTORATION IS AVAILABLE: 2018 12 25

---

(21) AP 2004 8964

(11) P 2008 4390 B

(73) Strakan International Limited

(54) **STRAKAN International LIMITED**

CANCELLATION DATE OF PATENT: 2018 02 05

PATENT RESTORATION IS AVAILABLE: 2019 02 05

---

(21) AP 2004 8983

(11) P 2007 4075 B

(73) Aziende Chimiche Riunite Angelini Francesco A.C.R.A.F. S.p.A.

(54) **INDAZOLAMIDES WITH ANALGESIC ACTIVITY**

CANCELLATION DATE OF PATENT: 2018 01 26

PATENT RESTORATION IS AVAILABLE: 2019 01 26

---

(21) AP 2004 9031

(11) P 2009 4593 B

(73) Interdigital Technology Corporation

(54) **WIRELESS MULTI-CELL COMMUNICATION SYSTEM FOR MANAGING RESOURCE POWER TO PROVIDE HIGH SPEED DOWNLINK PACKET ACCESS SERVICES**

CANCELLATION DATE OF PATENT: 2018 03 23

PATENT RESTORATION IS AVAILABLE: 2019 03 23

---

(21) AP 2004 9046

(11) P 2007 4257 B

(73) Les Laboratoires Servier

(54) **NOVEL METHOD FOR THE SYNTHESIS OF S-INDOLINE-2-CARBOXYLIC ACID AND APPLICATION THEREOF IN THE SYNTHESIS OF PERINDOPRIL**

CANCELLATION DATE OF PATENT: 2018 04 07

PATENT RESTORATION IS AVAILABLE: 2019 04 07

---

---

(21) AP 2004 9088  
(11) P 2009 4714 B  
(73) Interdigital Technology Corporation  
(54) **METHOD AND ARCHITECTURE FOR ACCESSING AN INTERNET PROTOCOL  
MULTIMEDIA SUBSYSTEM (IMS) OVER A WIRELESS LOCAL AREA NETWORK (WLAN)**  
CANCELLATION DATE OF PATENT: 2018 04 30  
PATENT RESTORATION IS AVAILABLE: 2019 04 30

---

(21) AP 2004 9111  
(11) P 2007 4183 B  
(73) Aziende Chimiche Riunite Angelini Francesco A.C.R.A.F. S.p.A.  
(54) **INDAZOLE HAVING ANALGESIC ACTIVITY**  
CANCELLATION DATE OF PATENT: 2018 04 23  
PATENT RESTORATION IS AVAILABLE: 2019 04 23

---

(21) AP 2003 9300  
(11) P 2010 5068 B  
(73) Interdigital Technology Corporation  
(54) **GENERATION OF USER EQUIPMENT IDENTIFICATION SPECIFIC SCRAMBLING CODE  
FOR THE HIGH SPEED SHARED CONTROL CHANNEL**  
CANCELLATION DATE OF PATENT: 2018 05 05  
PATENT RESTORATION IS AVAILABLE: 2019 05 05

---

(21) AP 9999 9320  
(11) P 2010 5136 B  
(73) Interdigital Technology Corporation  
(54) **SYSTEM FOR PERMITTING CONTROL OF THE PURGING OF A NODE B BY THE  
SERVING RADIO NETWORK CONTROLLER**  
CANCELLATION DATE OF PATENT: 2018 05 07  
PATENT RESTORATION IS AVAILABLE: 2019 05 07

---

(21) AP 2005 9684  
(11) P 2010 4972 B  
(73) Interdigital Technology Corporation  
(54) **WIRELESS COMMUNICATION METHOD AND APPARATUS FOR REPORTING TRAFFIC  
VOLUME MEASUREMENT INFORMATION TO SUPPORT ENHANCED UPLINK DATA  
TRANSMISSIONS**  
CANCELLATION DATE OF PATENT: 2018 03 07  
PATENT RESTORATION IS AVAILABLE: 2019 03 07

---

(21) AP 2007 9964  
(11) P 2011 5197 B  
(73) Interdigital Technology Corporation  
(54) **GENERATION OF USER EQUIPMENT IDENTIFICATION SPECIFIC SCRAMBLING CODE  
FOR THE HIGH SPEED SHARED CONTROL CHANNEL**  
CANCELLATION DATE OF PATENT: 2018 05 05  
PATENT RESTORATION IS AVAILABLE: 2019 05 05

---



## CHANGES ADDRESS OF PATENTOWNERS

(21) AP 2013 13595

(11) P 2017 6671 B

(54) **HETEROCYCLYL COMPOUNDS AS MEK INHIBITORS**

**PATENTOWNER AND NEW ADDRESS:** LUPIN LIMITED (IN)

3rd floor Kalpataru Inspire, Off. W E Highway, Santacruz (East), Mumbai 400 055. (IN)

**PATENTOWNER AND FORMER ADDRESS:** LUPIN LIMITED (IN)

159 CST Road, Kalina, Santacruz (East), State of Maharashtra, Mumbai 400 098 (IN)

**DATE OF ENTRY TO THE REGISTRY:** 2018 05 23

---

## UTILITY MODELS

### CANCELLING OF PATENTS

(21) AU 2010 11779

(11) U 2012 1697 Y

(73) Nino Urushadze

(54) **METHOD OF MANUFACTURE OF MEDICAL AND MEDICAL-COSMETIC**

**APPLICATIONS WITH THE USE OF BENTONITIC (AQUAMARINE) CLAY EXTRACTED**

**IN ASKANA VILLAGE OF OZURGETI AREA**

CANCELLATION DATE OF PATENT: 2018 04 30

MODEL RESTORATION IS AVAILABLE: 2019 04 30

---

(21) AU 2010 11794

(11) U 2011 1674 Y

(73) Maka Kharchilava;

Levan Longurashvili

(54) **DEVICE FOR PREPARATION OF COFFEE**

CANCELLATION DATE OF PATENT: 2018 05 13

MODEL RESTORATION IS AVAILABLE: 2019 05 13

---

(21) AU 2011 12225

(11) U 2012 1714 Y

(73) Guram Beraia

(54) **STAND-ALONE CHARGING DEVICE FOR ACCUMULATOR**

CANCELLATION DATE OF PATENT: 2018 05 17

MODEL RESTORATION IS AVAILABLE: 2019 05 17

---

(21) AU 2012 12702

(11) U 2013 1759 Y

(73) Nugzar Meladze

(54) **SOLAR STATION SUPPLYING WITH HOT WATER**

CANCELLATION DATE OF PATENT: 2018 05 07

MODEL RESTORATION IS AVAILABLE: 2019 05 07

---

CHANGES ADDRESS OF PATENTOWNERS

(21) AU 2011 12227

(11) U 2012 1715 Y

(54) **METHOD FOR PREPARATION OF BOGVERADZE CAKE**

**PATENTOWNER AND NEW ADDRESS:** Valer Bogveradze (GE)

Ghvaladzis q. 6a, Tbilisi, Georgia (GE)

**PATENTOWNER AND FORMER ADDRESS:** Valer Bogveradze (GE)

Vazisubnis das., korp. 17, b. 13, 0152, Tbilisi, Georgia (GE)

**DATE OF ENTRY TO THE REGISTRY:** 2018 05 25

---

**TRADEMARKS****RENEWAL OF REGISTRATIONS**

(111) M 1998 9681 R2

(156) 1998 06 11

(186) 2028 06 11

(732) CARTIER INTERNATIONAL AG  
(CARTIER INTERNATIONAL LTD),  
(CARTIER INTERNATIONAL SA)  
Hinterbergstrasse 22, Postfach 61, 6312  
Steinhausen, Switzerland

---

(111) M 1998 9237 R2

(156) 1998 05 06

(186) 2028 05 06

(732) SEGA Games Co., Ltd.  
2-12, Haneda 1-chome, Ohta-ku, Tokyo 144,  
Japan

---

(111) M 1998 9238 R2

(156) 1998 05 06

(186) 2028 05 06

(732) SEGA Games Co., Ltd.  
2-12, Haneda 1-chome, Ohta-ku, Tokyo 144,  
Japan

---

(111) M 1998 9240 R2

(156) 1998 05 06

(186) 2028 05 06

(732) SEGA Games Co., Ltd.  
2-12, Haneda 1-chome, Ohta-ku, Tokyo 144,  
Japan

---

(111) M 1998 9242 R2

(156) 1998 05 06

(186) 2028 05 06

(732) SEGA Games Co., Ltd.  
2-12, Haneda 1-chome, Ohta-ku, Tokyo 144,  
Japan

---

(111) M 1998 9244 R2

(156) 1998 05 06

(186) 2028 05 06

(732) SEGA Games Co., Ltd.  
2-12, Haneda 1-chome, Ohta-ku, Tokyo 144,  
Japan

---

(111) M 1998 9161 R2

(156) 1998 05 04

(186) 2028 05 04

(732) TRESMONTES LUCCHETTI S.A.

Los Conquistadores 2345, Providencia,  
Santiago, Chile

---

(111) M 1998 9168 R2

(156) 1998 05 04

(186) 2028 05 04

(732) TRESMONTES LUCCHETTI S.A.  
Los Conquistadores 2345, Providencia,  
Santiago, Chile

---

(111) M 1998 9211 R2

(156) 1998 05 05

(732) AKTSIONERNO DRUZHESTVO  
"BULGARTABAK-HOLDING"  
(AD "BULGARTABAK-HOLDING")  
SOFIA 1000, UL. "GRAF IGNATIEV" 62,  
Bulgaria

---

(111) M 1998 9212 R2

(156) 1998 05 05

(186) 2028 05 05

(732) AKTSIONERNO DRUZHESTVO  
"BULGARTABAK-HOLDING"  
(AD "BULGARTABAK-HOLDING")  
SOFIA 1000, UL. "GRAF IGNATIEV" 62,  
Bulgaria

---

(111) M 1998 9215 R2

(156) 1998 05 05

(186) 2028 05 05

(732) AKTSIONERNO DRUZHESTVO  
"BULGARTABAK-HOLDING"  
(AD "BULGARTABAK-HOLDING")  
SOFIA 1000, UL. "GRAF IGNATIEV" 62,  
Bulgaria

---

(111) M 1998 9216 R2

(156) 1998 05 05

(186) 2028 05 05

(732) AKTSIONERNO DRUZHESTVO  
"BULGARTABAK-HOLDING"  
(AD "BULGARTABAK-HOLDING")  
SOFIA 1000, UL. "GRAF IGNATIEV" 62,  
Bulgaria

---

(111) M 1998 9024 R2  
 (156) 1998 04 28  
 (186) 2028 04 28  
 (732) DIAGEO NORTH AMERICA, INC.  
 801 Main Avenue, Norwalk CT 06851-1127,  
 USA

(111) M 1998 10460 R2  
 (156) 1998 08 20  
 (186) 2028 08 20  
 (732) VEKA AG  
 Dieselstrasse 8, D-48324 Sendenhorst,  
 Germany

(111) M 1998 9041 R2  
 (156) 1998 04 29  
 (186) 2028 04 29  
 (732) DIAGEO BRANDS B.V.  
 Molenwerf 10-12, 1014 BG Amsterdam,  
 Netherlands

(111) M 1998 10599 R2  
 (156) 1998 08 27  
 (186) 2028 08 27  
 (732) CEAT LIMITED  
 CEAT Mahal, 463 Dr. Annie Besant Road,  
 Worli, Mumbai 400030, India

(111) M 1998 9797 R2  
 (156) 1998 06 23  
 (186) 2028 06 23  
 (732) GlaxoSmithKline Consumer Healthcare (US)  
 IP LLC Corporation Service Company  
 2711 Centerville Road, Suite 400,  
 Wilmington, Delaware, 19808, USA

(111) M 1998 11019 R2  
 (156) 1998 10 28  
 (186) 2028 10 28  
 (732) GlaxoSmithKline Consumer Healthcare  
 (UK) IP Limited  
 980 Great West Road, Brentford, Middlesex  
 TW8 9GS, United Kingdom

(111) M 1998 9031 R2  
 (156) 1998 04 28  
 (186) 2028 04 28  
 (732) MEDA AB  
 Pipers Väg 2A, SE-17009 Solna, Sweden

(111) M 1998 10822 R2  
 (156) 1998 09 15  
 (186) 2028 09 15  
 (732) CARTIER INTERNATIONAL AG  
 (CARTIER INTERNATIONAL LTD),  
 (CARTIER INTERNATIONAL SA)  
 Hinterbergstrasse 22, Postfach 61, 6312  
 Steinhausen, Switzerland

(111) M 1998 9827 R2  
 (156) 1998 06 23  
 (186) 2028 06 23  
 (732) GlaxoSmithKline Consumer Healthcare  
 (UK) IP Limited  
 980 Great West Road, Brentford, Middlesex  
 TW8 9GS, United Kingdom

(111) M 1998 10565 R2  
 (156) 1998 08 26  
 (186) 2028 08 26  
 (732) TAKASAGO KORYO KOGYO  
 KABUSHIKI KAISHA  
 (also trading as Takasago International  
 Corporation)  
 5-37-1, Kamata, Ota-ku, Tokyo, Japan

(111) M 1998 10360 R2  
 (156) 1998 08 19  
 (186) 2028 08 19  
 (732) PFIZER INC.  
 235, East 42nd Street, New York 10017,  
 USA

(111) M 1998 10566 R2  
 (156) 1998 08 26  
 (186) 2028 08 26  
 (732) TAKASAGO KORYO KOGYO  
 KABUSHIKI KAISHA  
 (also trading as Takasago International  
 Corporation)  
 5-37-1, Kamata, Ota-ku, Tokyo, Japan

(111) M 1998 10459 R2  
 (156) 1998 08 20  
 (186) 2028 08 20  
 (732) VEKA AG  
 Dieselstrasse 8, D-48324 Sendenhorst,  
 Germany

(111) M 2008 18358 R1  
 (156) 2008 04 14  
 (186) 2028 04 14

(732) VIENNA INSURANCE GROUP AG  
 Wiener Versicherung Gruppe  
 Schottenring 30, 1010 Wien, Austria

(111) M 2009 19257 R1

(156) 2009 04 29

(186) 2029 04 29

(732) Inter AG  
 558 Te Rapa Road, Hamilton, New Zealand

(111) M 1998 9286 R2

(156) 1998 05 11

(186) 2028 05 11

(732) DIAGEO BRANDS B.V.  
 10-12 Molenwerf, 1014 BG Amsterdam,  
 Netherlands

(111) M 1998 9489 R2

(156) 1998 06 01

(186) 2028 06 01

(732) FMC CORPORATION,  
 a Delaware Corporation  
 1735 Market Street, Philadelphia,  
 Pennsylvania 19103, USA

(111) M 1998 9303 R2

(156) 1998 05 13

(186) 2028 05 13

(732) KRKA, tovarna zdravil, d.d., Novo mesto  
 Smarjeska cesta 6, 8501 Novo mesto,  
 Slovenia

(111) M 1998 10750 R2

(156) 1998 09 15

(186) 2028 09 15

(732) HASBRO, INC.  
 State of Rhode Island, USA

(111) M 1998 10751 R2

(156) 1998 09 15

(186) 2028 09 15

(732) HASBRO, INC.  
 State of Rhode Island, USA

(111) M 1998 10752 R2

(156) 1998 09 15

(186) 2028 09 15

(732) HASBRO, INC.  
 State of Rhode Island, USA

(111) M 1998 10753 R2

(156) 1998 09 15

(186) 2028 09 15

(732) HASBRO, INC.  
 State of Rhode Island, USA

(111) M 1998 9620 R2

(156) 1998 06 09

(186) 2028 06 09

(732) Salamander GmbH  
 Zur Schlenkhecke 4, 40764 Langenfeld,  
 Germany

(111) M 1998 9623 R2

(156) 1998 06 09

(186) 2028 06 09

(732) SALAMANDER GMBH  
 Zur Schlenkhecke 4, 40764 Langenfeld,  
 Germany

(111) M 1998 8763 R2

(156) 1998 03 30

(186) 2028 03 30

(732) DIAGEO BRANDS B.V.  
 10-12 Molenwerf, 1014 BG Amsterdam,  
 Netherlands

(111) M 1998 8772 R2

(156) 1998 04 03

(186) 2028 04 03

(732) DIAGEO BRANDS B.V.  
 Molenwerf 10-12, 1014 BG Amsterdam,  
 Netherlands

(111) M 1998 8774 R2

(156) 1998 04 03

(186) 2028 04 03

(732) DIAGEO BRANDS B.V.  
 10-12 Molenwerf, 1014 BG Amsterdam,  
 Netherlands

## COMPLETE TRANSFER OF RIGHTS

(111) M 1995 747 R  
(732) LTL PHARMA CO., LTD  
Nittochi Nishi-shinjuku Bldg 1F3, 6-10-1  
Nishi-shinjuku, Shinjuku-ku, Tokyo, Japan  
(770) ASTELLAS PHARMA INC.  
5-1, Nihonbashi-Honcho, 2-Chome, Chuo-ku,  
Tokyo, Japan  
(580) 2018 05 01

---

(111) M 2008 18409 R  
(732) SUN LABORATORIES FZE  
Saif Plus R5-30/B P.O.Box 7818 SHJ,  
United Arab Emirates  
(770) CONCEPT FOUNDATION LIMITED  
Room 1502, 15th Floor, Bonham Strand  
Road, Shueng Wan, Hong Kong SAR,  
Hong Kong  
(580) 2018 04 30

---

(111) M 2017 29203 R  
(732) LTD "SAMP KOMPANI"  
Akhvledianis q.26, Samgoris Raioni,  
Orkhevis Dasakhleba, Tbilisi, Georgia  
(770) LTD "POYRAZ GROUP"  
Tchirnakhulis q. 9, 0151, Tbilisi, Georgia  
(580) 2018 04 19

---

## CHANGES IN NAMES AND/OR ADDRESSES OF OWNERS

(111) M 1998 9087 R  
(732) OILINVEST (NETHERLANDS) B.V.  
WTS Building, Prinses Margrietplantsoen 92,  
595 BR The Hague, Netherlands  
(770) OILINVEST (NETHERLANDS) B.V.  
Wolweverstraat 23-25, 2984CE Ridderkerk,  
Netherlands  
(580) 2018 05 01

---

(111) M 1998 9623 R  
(732) SALAMANDER GMBH  
Zur Schlenkhecke 4, 40764 Langenfeld,  
Germany  
(770) SALAMANDER GMBH  
Kaiserstrasse 39-49, D-63065 Offenbach,  
Germany  
(580) 2018 05 01

---

(111) M 1998 9087 R  
(732) OILINVEST (NETHERLANDS) B.V.  
WTS Building, Prinses Margrietplantsoen 92,  
595 BR The Hague, Netherlands  
(770) OILINVEST (NETHERLANDS) B.V.  
Wolweverstraat 23-25, 2984CE Ridderkerk,  
Netherlands  
(580) 2018 05 01

---

(111) M 1995 747 R  
(732) LTL PHARMA CO., LTD  
Nittochi Nishi-shinjuku Bldg 1F3,  
6-10-1 Nishi-shinjuku, Shinjuku-ku,  
Tokyo, Japan  
(770) ASTELLAS PHARMA INC.  
5-1, Nihonbashi-Honcho, 2-Chome, Chuo-ku,  
Tokyo, Japan  
(580) 2018 05 01

---

(111) M 2008 18840 R  
(732) AQCIONERNOE OBSHCHESTVO  
"SINERGIA KAPITAL" (AO "SINERGIA  
KAPITAL")  
Ul. Pobedi, d.26, 143090 krasnoznamenski,  
moskovskaia obl., Russian Federation  
(770) OTKRITOE AKTSIONERNOE  
OBSHCHESTVO „SINERGIA KAPITAL“  
Ul. Pobedi, d.26, 143090 krasnoznamenski,  
moskovskaia obl., Russian Federation  
(580) 2018 04 20

---

(111) M 1998 8953 R  
(732) VANDERLANDE INDUSTRIES B.V.  
2, Vanderlandelaan, NL-5466 RB VEGHEL,  
Netherlands  
(770) VANDERLANDE INDUSTRIES  
NEDERLAND B.V.  
2, Vanderlandelaan, NL-5466 RB VEGHEL,  
Netherlands  
(580) 2018 04 24

---

## INVALIDATION OF TRADEMARKS REGISTRATION

(111) M 2007 17879 R (151) 2007 10 10 (181) 2018 04 10 (732) LTD "VAZI-1" Sop. Tserovani, 3318, Mtskhethis raioni, Georgia	Kakabadzebis q. 4a, Orkhevi, 0109, Tbilisi, Georgia
(111) M 2006 16936 R (151) 2006 10 26 (181) 2017 04 26 (732) LTD "GORGASALI" Leselidzis q. 44, 0105, Tbilisi, Georgia	(111) M 2006 17134 R (151) 2006 11 28 (181) 2017 05 28 (732) LTD "ELIT ELECTRONICS" Agladzis 7a, 0154, Tbilisi, Georgia
(111) M 2006 16937 R (151) 2006 10 26 (181) 2017 04 26 (732) LTD "GORGASALI" Leselidzis q. 44, 0105, Tbilisi, Georgia	(111) M 2007 17732 R (151) 2007 09 18 (181) 2018 03 18 (732) IE "LELA KALANDIA" Tsabadzis q.19, 0112, Tbilisi, Georgia
(111) M 2006 16938 R (151) 2006 10 26 (181) 2017 04 26 (732) LTD "GORGASALI" Leselidzis q., 44, 0105, Tbilisi, Georgia	(111) M 2007 17544 R (151) 2007 06 11 (181) 2017 12 11 (732) LTD "MITROPANE LAGHIDZE+" Dimitri Tavdadebulis q. I shesakhv. 17, 4600, Kutaisi, Georgia
(111) M 2007 17730 R (151) 2007 09 18 (181) 2018 03 18 (732) LTD "BEDIA" Khosharaulis q. 25, 0119, Tbilisi, Georgia	(111) M 2007 17410 R (151) 2007 04 13 (181) 2017 10 13 (732) LEVAN NIKOLISHVILI Aeroportis dasakh. 46, b. 32, 0158, Tbilisi, Georgia
(111) M 2006 16790 R (151) 2006 08 01 (181) 2017 02 01 (732) LTD "AVERSI-PHARMA" Davit Aghmasheneblis gamz. 148/2, 0112, Tbilisi, Georgia	(111) M 2007 17548 R (151) 2007 06 11 (181) 2017 12 11 (732) LTD "LONDON HAUS GEORGIA" Nutsubidzis II m/r, I kvart, VI korp., b. 6, 0183, Tbilisi, Georgia
(111) M 2007 17983 R (151) 2007 11 13 (181) 2018 05 13 (732) NODAR GIGINEISHVILI Kakabadzebis q. 4a, Orkhevi, 0109, Tbilisi, Georgia	(111) M 2007 17620 R (151) 2007 07 12 (181) 2018 01 12 (732) JSC "CORPORATION KINDZMARAULI" Ilia Chavchavadzis q. 55, 4800, Kvareli, Georgia
(111) M 2007 17984 R (151) 2007 11 13 (181) 2018 05 13 (732) NODAR GIGINEISHVILI	(111) M 2007 17550 R (151) 2007 06 11 (181) 2017 12 11 (732) ELCHIN VELIEV Shatberashvilis q. 4, II sad. b. 16, 0179, Tbilisi, Georgia



(111) M 2007 17586 R  
(151) 2007 06 15  
(181) 2017 12 15  
(732) LTD "A-B-C PHARMACEUTICALS"  
Lisis Tba 1, 0177, Tbilisi, Georgia

---

(111) M 2007 17574 R  
(151) 2007 06 15  
(181) 2017 12 15  
(732) LTD "SHROSHANI"  
Iosebidzis q. 53, b. 38, 0160, Tbilisi, Georgia

---

(111) M 2007 17552 R  
(151) 2007 06 11  
(181) 2017 12 11  
(732) NINO MUSASHVILI  
Al. Kazbegis gamz. 16, b. 21, 0160, Tbilisi,  
Tbilisi, Georgia

---

(111) M 2007 17590 R  
(151) 2007 06 28  
(181) 2017 12 28  
(732) LTD "KALASI"  
Kekelidzis q. 25, b.9, 0179, Tbilisi, Georgia

---

(111) M 2007 17591 R  
(151) 2007 06 28  
(181) 2017 12 28  
(732) LTD "PARADISI"  
S. Chikovanis q. 20/36, 0177, Tbilisi, Georgia

---

(111) M 2007 17592 R  
(151) 2007 06 28  
(181) 2017 12 28  
(732) LTD "PARADISI"  
S. Chikovanis q. 20/36, 0177, Tbilisi,  
Georgia

---

(111) M 2007 17593 R  
(151) 2007 06 28  
(181) 2017 12 28  
(732) LTD "PARADISI"  
S. Chikovanis q. 20/36, 0177, Tbilisi, Georgia

---

(111) M 2007 17738 R  
(151) 2007 09 18  
(181) 2018 03 18  
(732) DAVIT LORTQIFANIDZE  
Mitskevichis q.12, 0194, Tbilisi, Georgia;  
JEMAL INAISHVILI  
Kobuletis q. 32, 0179, Tbilisi, Georgia

---

(111) M 2007 17739 R  
(151) 2007 09 18  
(181) 2018 03 18  
(732) VLADIMER GURGENIDZE  
Ilia Chavchavadzis gamz. 39, b. 34, 0179,  
Tbilisi, Georgia

---

(111) M 2007 17665 R  
(151) 2007 07 25  
(181) 2018 01 25  
(732) LTD "G-M-C GROUP"  
Sanapiros q. 3, 0105, Tbilisi, Georgia

---

(111) M 2007 17666 R  
(151) 2007 07 25  
(181) 2018 01 25  
(732) LTD "G-M-C GROUP"  
Sanapiros q. 3, 0105, Tbilisi, Georgia

---

(111) M 2007 17667 R  
(151) 2007 07 25  
(181) 2018 01 25  
(732) LTD "G-M-C GROUP"  
Sanapiros q. 3, 0105, Tbilisi, Georgia

---

(111) M 2007 17668 R  
(151) 2007 07 25  
(181) 2018 01 25  
(732) LTD "G-M-C GROUP"  
Sanapiros q. 3, 0105, Tbilisi, Georgia

---

(111) M 2007 17670 R  
(151) 2007 07 25  
(181) 2018 01 25  
(732) LTD "LABIRINTI"  
Chkondidelis q. 10, 5800, Khobis raioni,  
Georgia

---

(111) M 2007 17671 R  
(151) 2007 07 25  
(181) 2018 01 25  
(732) LTD "LABIRINTI"  
Chkondidelis q. 10, 5800, Khobis raioni,  
Georgia

---

(111) M 2007 17558 R  
(151) 2007 06 11  
(181) 2017 12 11  
(732) LTD "ASPHARMA"  
Georgian Pharnaceutical Company  
Shevchenkos q. 12, 0108, Tbilisi, Georgia

---

(111) M 2007 17559 R  
 (151) 2007 06 11  
 (181) 2017 12 11  
 (732) LTD "ASPHARMA"  
 Georgian Pharnaceutical Company  
 Shevchenkos q. 12, 0108, Tbilisi, Georgia

(111) M 2007 17560 R  
 (151) 2007 06 11  
 (181) 2017 12 11  
 (732) LTD "ASPHARMA"  
 Georgian Pharnaceutical Company  
 Shevchenkos q. 12, 0108, Tbilisi, Georgia

(111) M 2007 17561 R  
 (151) 2007 06 11  
 (181) 2017 12 11  
 (732) LTD "ASPHARMA"  
 Georgian Pharnaceutical Company  
 Shevchenkos q. 12, 0108, Tbilisi, Georgia

(111) M 2007 17638 R  
 (151) 2007 07 12  
 (181) 2018 01 12  
 (732) LTD "ROSSOFT CONSALTING"  
 Shalva Nutsubidzis perdobi, IV mkr,  
 korp. 11, b. 90, Tbilisi, Georgia

(111) M 2007 17752 R  
 (151) 2007 09 18  
 (181) 2018 03 18  
 (732) LTD "G-M-C GROUP"  
 Sanapiros q. 3, 0105, Tbilisi, Georgia

(111) M 2007 17754 R  
 (151) 2007 09 18  
 (181) 2018 03 18  
 (732) MIKHEIL MCHEDLIDZE  
 Gogebashvilis q. 40, 0179, Tbilisi, Georgia

(111) M 2007 17729 R  
 (151) 2007 08 06  
 (181) 2018 02 06  
 (732) MIKHEIL MCHEDLIDZE  
 Gogebashvilis q. 40, 0179, Tbilisi, Georgia

(111) M 2007 17540 R  
 (151) 2007 06 08  
 (181) 2017 12 08  
 (732) LELA KALANDARISHVILI  
 Kazbegis gamz. 24a, b.42, 0177, Tbilisi,  
 Georgia

(111) M 2007 17569 R  
 (151) 2007 06 11  
 (181) 2017 12 11  
 (732) LTD "GANTIADI"  
 Leonidzis q.10, 0105, Tbilisi, Georgia

(111) M 2007 17756 R  
 (151) 2007 09 18  
 (181) 2018 03 18  
 (732) LTD "G-M-C GROUP"  
 Sanapiros q. 3, 0105, Tbilisi, Georgia

(111) M 2007 17757 R  
 (151) 2007 09 18  
 (181) 2018 03 18  
 (732) JSC "ARGO"  
 Lilo, Lochinis Khevi (nakv.05/001), 0151,  
 Tbilisi, Georgia

(111) M 2007 17758 R  
 (151) 2007 09 18  
 (181) 2018 03 18  
 (732) JSC "ARGO"  
 Lilo, Lochinis Khevi (nakv.05/001), 0151,  
 Tbilisi, Georgia

(111) M 2007 17759 R  
 (151) 2007 09 18  
 (181) 2018 03 18  
 (732) JSC "ARGO"  
 Lilo, Lochinis Khevi (nakv.05/001), 0151,  
 Tbilisi, Georgia

(111) M 2007 17760 R  
 (151) 2007 09 18  
 (181) 2018 03 18  
 (732) JSC "ARGO"  
 Lilo, Lochinis Khevi (nakv.05/001), 0151,  
 Tbilisi, Georgia

(111) M 2007 17761 R  
 (151) 2007 09 18  
 (181) 2018 03 18  
 (732) LTD "VAZI -1"  
 Sop. Tserovani, 3318, Mtskhetis raioni,  
 Georgia

(111) M 2007 17763 R  
 (151) 2007 09 18  
 (181) 2018 03 18  
 (732) LTD "A-B-C PHARMACEUTIKALS"  
 Lisis Tba 1, 0177, Tbilisi, Georgia

(111) M 2007 17584 R  
(151) 2007 06 15  
(181) 2017 12 15  
(732) LTD "G-T-C & COMPANY"  
Akaki Tseretlis q. 186, 4600, Kutaisi,  
Georgia

---

(111) M 2007 17538 R  
(151) 2007 06 08  
(181) 2017 12 08  
(732) ALEKSANDRE JAPARIDZE  
Galaqtion Tabidzis 4, 0105, Tbilisi,  
Georgia

---

(111) M 2007 17881 R  
(151) 2007 10 10  
(181) 2018 04 10  
(732) LTD "PIROSMANI"  
So. Arkhiloskalo, 1603, Dedoplistskaros  
raioni, Georgia

---

(111) M 2007 17603 R  
(151) 2007 06 28  
(181) 2017 12 28  
(732) LTD "MEGVINEOBA KHAREBA"  
Davit Aghmasheneblis kheivani me-6 km.,  
0131, Tbilisi, Georgia

---

(111) M 2007 17604 R  
(151) 2007 06 28  
(181) 2017 12 28  
(732) LTD "MEGVINEOBA KHAREBA"  
Davit Aghmasheneblis kheivani me-6 km.,  
0131, Tbilisi, Georgia

---

(111) M 2007 17605 R  
(151) 2007 06 28  
(181) 2017 12 28  
(732) LTD "MEGVINEOBA KHAREBA"  
Davit Aghmasheneblis kheivani me-6 km.,  
0131, Tbilisi, Georgia

---

(111) M 2007 17606 R  
(151) 2007 06 28  
(181) 2017 12 28  
(732) LTD "MEGVINEOBA KHAREBA"  
Davit Aghmasheneblis kheivani me-6 km.,  
0131, Tbilisi, Georgia

---

(111) M 2007 17772 R  
(151) 2007 09 18  
(181) 2018 03 18

(732) LTD "GEOPLASTIC"  
Paliashvilis q. 68, 0179, Tbilisi, Georgia

---

(111) M 2007 17570 R  
(151) 2007 06 11  
(181) 2017 12 11  
(732) LTD "AVITA"  
Tashkentis q. 31, 0160, Tbilisi, Georgia

---

(111) M 2007 17607 R  
(151) 2007 06 28  
(181) 2017 12 28  
(732) LTD "MEGVINEOBA KHAREBA"  
Davit Aghmasheneblis kheivani me-6 km.,  
0131, Tbilisi, Georgia

---

(111) M 2007 17779 R  
(151) 2007 09 18  
(181) 2018 03 18  
(732) LTD "A-B-C PHARMACEUTICALS"  
Lisis Tba 1, 0177, Tbilisi, Georgia

---

(111) M 2007 17927 R  
(151) 2007 10 29  
(181) 2018 04 29  
(732) LTD "SANTE G-M-T PRODUCT"  
Kakhetis gzat., 10 km., 0182, Tbilisi,  
Georgia

---

(111) M 2007 17928 R  
(151) 2007 10 29  
(181) 2018 04 29  
(732) LTD "SANTE G-M-T PRODUCT"  
Kakhetis gzat., 10 km., 0182, Tbilisi,  
Georgia

---

(111) M 2007 17780 R  
(151) 2007 09 18  
(181) 2018 03 18  
(732) LTD "SANTE G-M-T PRODUCT"  
Kakhetis gzat., 10 km., 0182, Tbilisi,  
Georgia

---

(111) M 2007 17781 R  
(151) 2007 09 18  
(181) 2018 03 18  
(732) LTD "SANTE G-M-T PRODUCT"  
Kakhetis gzat., 10 km., 0182, Tbilisi,  
Georgia

---

(111) M 2007 17585 R  
(151) 2007 06 15  
(181) 2017 12 15  
(732) LTD "GREEN CENTER"  
Davit Aghmasheneblis gamz. 154, 0112,  
Tbilisi, Georgia

---

(111) M 2007 17884 R  
(151) 2007 10 10  
(181) 2018 04 10  
(732) LTD "Georgian Vegetable Oil Company"  
Atonelis q. 31, 0105, Tbilisi, Georgia

---

(111) M 2007 17784 R  
(151) 2007 09 18  
(181) 2018 03 18  
(732) LTD "AVERSI-PHARMA"  
Davit Aghmasheneblis gamz. 148/2, 0112,  
Tbilisi, Georgia

---

(111) M 2007 17786 R  
(151) 2007 09 18  
(181) 2018 03 18  
(732) LTD "G-F-P" (GFP Ltd.)  
Didi Dighomi, IV mkr., korp. 25, 0131,  
Tbilisi, Georgia

---

(111) M 2007 17787 R  
(151) 2007 09 18  
(181) 2018 03 18  
(732) LTD "G-F-P" (GFP Ltd.)  
Didi Dighomi, IV mkr., korp. 25, 0131,  
Tbilisi, Georgia

---

(111) M 2007 17656 R  
(151) 2007 07 12  
(181) 2018 01 12  
(732) LTD "FENICS"  
Al. Kazbegis gamz. 12a, 0160, Tbilisi,  
Georgia

---

(111) M 2007 17657 R  
(151) 2007 07 12  
(181) 2018 01 12  
(732) LTD "IBERTEKI"  
Al. Kazbegis gamz. 12a, 0160, Tbilisi,  
Georgia

---

(111) M 2007 17929 R  
(151) 2007 10 29  
(181) 2018 04 29

(732) JUMBER BERADZE  
kutuzovis q. 10, b. 68, 0194, Tbilisi,  
Georgia

---

(111) M 2007 17797 R  
(151) 2007 09 18  
(181) 2018 03 18  
(732) LTD "BEST TOBACO"  
Peikrebis q. 4, 0141, Tbilisi, Georgia

---

(111) M 2007 17885 R  
(151) 2007 10 10  
(181) 2018 04 10  
(732) LTD "GEORGIAN KULTURAL WAVE"  
Marshal Gelovanis q. 2, 0159, Tbilisi, Georgia

---

(111) M 2007 17803 R  
(151) 2007 09 18  
(181) 2018 03 18  
(732) LTD "KALASI"  
Leselidzis q. 25, 0105, Tbilisi, Georgia

---

(111) M 2007 17804 R  
(151) 2007 09 18  
(181) 2018 03 18  
(732) LTD "KALASI"  
Leselidzis q. 25, 0105, Tbilisi, Georgia

---

(111) M 2007 17805 R  
(151) 2007 09 18  
(181) 2018 03 18  
(732) "NOBEL ILAC SANAYII VE TICARET  
ANONIM SIRKETI"-is tsarmomadgenloba  
saqartveloshi  
tavisuflebis moedani 4, 0105, Tbilisi, Georgia

---

(111) M 2007 17808 R  
(151) 2007 09 18  
(181) 2018 03 18  
(732) "NOBEL ILAC SANAYII VE TICARET  
ANONIM SIRKETI"-is tsarmomadgenloba  
saqartveloshi  
tavisuflebis moedani 4, 0105, Tbilisi, Georgia

---

(111) M 2007 17721 R  
(151) 2007 07 30  
(181) 2018 01 30  
(732) LTD "Georgian Distribution Marketing  
Company"  
Davit Agmaseneblis gamz.78, 0102, Tbilisi,  
Georgia

---

(111) M 2007 17888 R  
(151) 2007 10 10  
(181) 2018 04 10  
(732) JSC "ELMAVALMSHENE BELI"  
D. Guramishvilis gamz. 84, 0141, Tbilisi,  
Georgia

---

(111) M 2007 17889 R  
(151) 2007 10 10  
(181) 2018 04 10  
(732) JSC "ELMAVALMSHENE BELI"  
D. Guramishvilis gamz. 84, 0141, Tbilisi,  
Georgia

---

(111) M 2007 17890 R  
(151) 2007 10 10  
(181) 2018 04 10  
(732) JSC "ELMAVALMSHENE BELI"  
D. Guramishvilis gamz. 84, 0141, Tbilisi,  
Georgia

---

(111) M 2007 17722 R  
(151) 2007 07 30  
(181) 2018 01 30  
(732) CHICHIKO GOLETIANI  
Davit Aghmasheneblis gamz. 71, 0102,  
Tbilisi, Georgia

---

(111) M 2007 17659 R  
(151) 2007 07 12  
(181) 2018 01 12  
(732) JSC "INSURANCE COMPANI IMEDI-L"  
Kazbegis q. 3-5, 0179, Tbilisi, Georgia

---

(111) M 2007 17820 R  
(151) 2007 09 18  
(181) 2018 03 18  
(732) JSC "INSURANCE COMPANY B-C-I"  
Ilia Chavchavadzis gamz. 50, 0179, Tbilisi,  
Georgia

---

(111) M 2007 17834 R  
(151) 2007 09 18  
(181) 2018 03 18  
(732) LEPL Eliava Named Scientific Research  
Institute of Bacteriology, Microbiology  
and Virology  
Gotuas q. 3, 0160, Tbilisi, Georgia

---

(111) M 2007 17835 R  
(151) 2007 09 18  
(181) 2018 03 18

(732) LEPL Eliava Named Scientific Research  
Institute of Bacteriology, Microbiology  
and Virology  
Gotuas q. 3, 0160, Tbilisi, Georgia

---

(111) M 2007 17840 R  
(151) 2007 09 18  
(181) 2018 03 18  
(732) LTD "TONUS"  
Khvamlis q. 14, 0112, Tbilisi, Georgia

---

(111) M 2007 17857 R  
(151) 2007 09 18  
(181) 2018 03 18  
(732) LTD "NIKITA"  
Didi Dighomi, III mkr., korp. 3, b. 191, 0108,  
Tbilisi, Georgia

---

(111) M 2007 17858 R  
(151) 2007 09 18  
(181) 2018 03 18  
(732) LTD "NIKITA"  
Didi Dighomi, III mkr., korp. 3, b. 191, 0108,  
Tbilisi, Georgia

---

(111) M 2007 17859 R  
(151) 2007 09 18  
(181) 2018 03 18  
(732) JSC "LOMISI"  
Sanapiros q. 1, 0600, Daba Akh'algori,  
Georgia

---

(111) M 2007 17905 R  
(151) 2007 10 10  
(181) 2018 04 10  
(732) LTD "ASPHARMA"  
Georgian Pharnaceutical Company  
Shevchenkos q. 12, 0108, Tbilisi, Georgia

---

(111) M 2007 17906 R  
(151) 2007 10 10  
(181) 2018 04 10  
(732) LTD "ASPHARMA"  
Georgian Pharnaceutical Company  
Shevchenkos q. 12, 0108, Tbilisi, Georgia

---

(111) M 2007 17907 R  
(151) 2007 10 10  
(181) 2018 04 10  
(732) LTD "ASPHARMA"  
Georgian Pharnaceutical Company  
Shevchenkos q. 12, 0108, Tbilisi, Georgia

---

(111) M 2007 17908 R  
(151) 2007 10 10  
(181) 2018 04 10  
(732) LTD "ASPHARMA"  
Georgian Pharnaceutical Company  
Shevchenkos q. 12, 0108, Tbilisi, Georgia

---

(111) M 2007 17909 R  
(151) 2007 10 10  
(181) 2018 04 10  
(732) LTD "ASPHARMA"  
Georgian Pharnaceutical Company  
Shevchenkos q. 12, 0108, Tbilisi, Georgia

---

(111) M 2007 17910 R  
(151) 2007 10 10  
(181) 2018 04 10  
(732) LTD "ASPHARMA"  
Georgian Pharnaceutical Company  
Shevchenkos q. 12, 0108, Tbilisi,  
Georgia

---

(111) M 2007 17912 R  
(151) 2007 10 10  
(181) 2018 04 10  
(732) LTD "ASPHARMA"  
Georgian Pharnaceutical Company  
Shevchenkos q. 12, 0108, Tbilisi,  
Georgia

---

(111) M 2007 17913 R  
(151) 2007 10 10  
(181) 2018 04 10  
(732) ELCHINI VELIEVI  
Shatberashvilis q.4, II sad. b. 16, 0179,  
Tbilisi, Georgia

---

(111) M 2007 17914 R  
(151) 2007 10 10  
(181) 2018 04 10  
(732) Cefak KG  
Ostbahnhofstrasse 15, 87437 Kempten,  
Germany

---

(111) M 2007 17915 R  
(151) 2007 10 10  
(181) 2018 04 10  
(732) LTD "AVITA"  
Tashkentis q. 31, 0160, Tbilisi, Georgia

---

(111) M 2007 17916 R  
(151) 2007 10 10  
(181) 2018 04 10

(732) LTD "AVITA"  
Tashkentis q. 31, 0160, Tbilisi, Georgia

---

(111) M 2007 17862 R  
(151) 2007 09 18  
(181) 2018 03 18  
(732) LTD "PEPELA"  
Bakhtrionis q. 28, b. 66, 0194, Tbilisi,  
Georgia

---

(111) M 2007 17867 R  
(151) 2007 09 18  
(181) 2018 03 18  
(732) LTD "MGGS GEORGIA"  
Didi Dighomi, 4 mikroraioni, kor. 9, b. 81,  
0131, Tbilisi, Georgia

---

(111) M 2007 18010 R  
(151) 2007 11 13  
(181) 2018 05 13  
(732) FADI ASLI  
Nutsubidzis 1, 0177, Tbilisi, Georgia

---

(111) M 2007 17869 R  
(151) 2007 09 18  
(181) 2018 03 18  
(732) LTD "KAZINO ACHARA"  
26 maisis moedani 1, 0171, Tbilisi, Georgia

---

(111) M 2007 17876 R  
(151) 2007 09 18  
(181) 2018 03 18  
(732) LTD "KAZINO ACHARA"  
26 maisis moedani 1, 0171, Tbilisi, Georgia

---

(111) M 2007 17978 R  
(151) 2007 10 29  
(181) 2018 04 29  
(732) JSC BANK "REPUBLIC"  
Grigol Abashidzis q. 2, 0179, Tbilisi, Georgia

---

(111) M 2007 17918 R  
(151) 2007 10 10  
(181) 2018 04 10  
(732) LTD "GEORGIAN TELECOM"  
Rustavelis gamz. 31, 0108, Tbilisi, Georgia

---

(111) M 2007 17919 R  
(151) 2007 10 10  
(181) 2018 04 10  
(732) LTD "PRIZA"

Davit Aghmasheneblis kheivani, meotse km.,  
0131, Tbilisi, Georgia

---

(111) M 2007 17920 R

(151) 2007 10 10

(181) 2018 04 10

(732) LTD "KAMELINI"

Kindzmaraulis q.7, 0145, Tbilisi, Georgia

---

(111) M 2007 17952 R

(151) 2007 10 29

(181) 2018 04 29

(732) LTD "MONT"

Al. Kazbegis gamz.n12a, 0160, Tbilisi,  
Georgia

---

(111) M 2007 18027 R

(151) 2007 11 13

(181) 2018 05 13

(732) LTD "GORGASALI"

Leselidzis q. 44, 0105, Tbilisi, Georgia

---

(111) M 2007 18036 R

(151) 2007 11 13

(181) 2018 05 13

(732) LTD Mining Company "PARAVANPERLIT"

Ir. Abashidzis q. 29, , 0179, Tbilisi, Georgia

---

(111) M 2007 18037 R

(151) 2007 11 13

(181) 2018 05 13

(732) LTD "TEM&YOU"

Sop. Kvirike, 6206, Kobuleti, Georgia

---

(111) M 2007 17954 R

(151) 2007 10 29

(181) 2018 04 29

(732) NINO TKABLADZE

Chikovanis q. 24a, 0171, Tbilisi, Georgia

---

(111) M 2007 18050 R

(151) 2007 11 13

(181) 2018 05 13

(732) IE "INEZA PKHAKADZE"

Rustavelis gamz. 121, 4500, Kutaisi, Georgia

---

(111) M 2007 18064 R

(151) 2007 11 13

(181) 2018 05 13

(732) DAVIT RAMAZASHVILI

Llilo, II mkr., korp. 4, b. 77, 0198, Tbilisi,  
Georgia

---

---

# CLASSIFICATION INDEXES

## INVENTIONS

### CONCORDANCE TABLE OF INTERNATIONAL CLASSIFICATION INDEX AND PUBLICATION NUMBERS

INTERNATIONAL CLASSIFICATION INDEXES (51)	NUMBER OF PUBLISHED APPLICATION (10)
B 23 C 3/32	AP 2018 14452 A
C 02 F 9/00; E 04 H 4/00; C 02 F 1/44	AP 2018 14088 A
C 07 D 401/06; C 07 C 275/06; C 07 C 275/26; C 07 D 401/12; C 07 D 211/58; C 07 D 211/60; C 07 D 211/94; C 07 D 211/96; C 07 D 213/00	AP 2018 14255 A
C 07 D 403/12; A 61 K 31/506; A 61 P 25/00	AP 2018 14286 A
C 07 K 16/28; A 61 P 35/00; A 61 K 39/395	AP 2018 14103 A
C 22 B 47/00, 1/02, 1/08, 3/04	AP 2018 13978 A

### CONCORDANCE TABLE OF PUBLICATION NUMBERS AND INTERNATIONAL CLASSIFICATION INDEX

NUMBER OF PUBLISHED APPLICATION (10)	INTERNATIONAL CLASSIFICATION INDEXES (51)
AP 2018 13978 A	C 22 B 47/00, 1/02, 1/08, 3/04
AP 2018 14088 A	C 02 F 9/00; E 04 H 4/00; C 02 F 1/44
AP 2018 14103 A	C 07 K 16/28; A 61 P 35/00; A 61 K 39/395
AP 2018 14255 A	C 07 D 401/06; C 07 C 275/06; C 07 C 275/26; C 07 D 401/12; C 07 D 211/58; C 07 D 211/60; C 07 D 211/94; C 07 D 211/96; C 07 D 213/00
AP 2018 14286 A	C 07 D 403/12; A 61 K 31/506; A 61 P 25/00
AP 2018 14452 A	B 23 C 3/32

### CONCORDANCE TABLE OF INTERNATIONAL CLASSIFICATION INDEX, PATENT NUMBERS AND PUBLICATION NUMBERS

INTERNATIONAL CLASSIFICATION INDEX (51)	NUMBER OF PATENT (11)	NUMBER OF PUBLISHED APPLICATION (10)
A 61 K 31/355; A 61 K 9/00; A 61 K 47/44; A 61 P 11/02	P 2018 6863 B	AP 2018 14463 A
B 21 J 7/16; B 21 C 5/00	P 2018 6862 B	AP 2018 14364 A
B 28 B 1/093; B 28 B 11/00; B 28 B 19/00	P 2018 6859 B	AP 2018 14033 A
C 07 D 211/16; C 07 D 211/18; C 07 D 211/22; C 07 D 295/185; C 07 D 401/04; C 07 D 207/08; A 61 K 31/451; A 61 K 31/495; A 61 P 31/04	P 2018 6857 B	AP 2018 13844 A
C 10 G 1/04	P 2018 6860 B	AP 2018 14071 A
C 25 C 3/12; C 25 C 3/04; C 25 C 3/22; C 25 C 7/02	P 2018 6858 B	AP 2018 13932 A
E 04 C 1/40; E 04 C 1/41	P 2018 6861 B	AP 2018 14238 A



**CONCORDANCE TABLE OF PATENT NUMBERS,  
PUBLICATION NUMBERS AND INTERNATIONAL CLASSIFICATION INDEX**

NUMBER OF PATENT (11)	NUMBER OF PUBLISHED APPLICATION (10)	INTERNATIONAL CLASSIFICATION INDEX (51)
P 2018 6857 B	AP 2018 13844 A	C 07 D 211/16; C 07 D 211/18; C 07 D 211/22; C 07 D 295/185; C 07 D 401/04; C 07 D 207/08; A 61 K 31/451; A 61 K 31/495; A 61 P 31/04
P 2018 6858 B	AP 2018 13932 A	C 25 C 3/12; C 25 C 3/04; C 25 C 3/22; C 25 C 7/02
P 2018 6859 B	AP 2018 14033 A	B 28 B 1/093; B 28 B 11/00; B 28 B 19/00
P 2018 6860 B	AP 2018 14071 A	C 10 G 1/04
P 2018 6861 B	AP 2018 14238 A	E 04 C 1/40; E 04 C 1/41
P 2018 6862 B	AP 2018 14364 A	B 21 J 7/16; B 21 C 5/00
P 2018 6863 B	AP 2018 14463 A	A 61 K 31/355; A 61 K 9/00; A 61 K 47/44; A 61 P 11/02

**CONCORDANCE TABLE OF APPLICATION NUMBERS, PUBLICATION NUMBERS  
AND PATENTS**

NUMBER OF APPLICATION (21)	NUMBER OF PUBLISHED APPLICATION (10)	NUMBER OF PATENT (11)
AP 2013 013844	AP 2018 13844 A	P 2018 6857 B
AP 2014 013932	AP 2018 13932 A	P 2018 6858 B
AP 2013 014033	AP 2018 14033 A	P 2018 6859 B
AP 2014 014071	AP 2018 14071 A	P 2018 6860 B
AP 2016 014238	AP 2018 14238 A	P 2018 6861 B
AP 2016 014364	AP 2018 14364 A	P 2018 6862 B
AP 2015 014463	AP 2018 14463 A	P 2018 6863 B

## UTILITY MODELS

**CONCORDANCE TABLE OF INTERNATIONAL CLASSIFICATION INDEX  
AND PUBLICATION NUMBERS**

INTERNATIONAL CLASSIFICATION INDEXES (51)	NUMBER OF PUBLISHED APPLICATION (10)
A 01 G 17/06	AU 2018 14511 U
A 61 K 35/50; A 61 K 47/46	AU 2018 14053 U

**CONCORDANCE TABLE OF PUBLICATION NUMBERS  
AND INTERNATIONAL CLASSIFICATION INDEX**

NUMBER OF PUBLISHED APPLICATION (10)	INTERNATIONAL CLASSIFICATION INDEXES (51)
AU 2018 14053 U	A 61 K 35/50; A 61 K 47/46
AU 2018 14511 U	A 01 G 17/06

**DESIGNS****CONCORDANCE TABLE OF INTERNATIONAL CLASSIFICATION INDEX,  
PATENT NUMBERS AND PUBLICATION NUMBERS**

INTERNATIONAL CLASSIFICATION INDEX (51)	NUMBER OF PATENT (11)	NUMBER OF PUBLISHED APPLICATION (10)
09-05	D 2018 764 S	AD 2018 993 S

**CONCORDANCE TABLE OF PATENT NUMBERS,  
PUBLICATION NUMBERS AND INTERNATIONAL CLASSIFICATION INDEX**

NUMBER OF PATENT (11)	NUMBER OF PUBLISHED APPLICATION (10)	INTERNATIONAL CLASSIFICATION INDEX (51)
D 2018 764 S	AD 2018 993 S	09-05

**CONCORDANCE TABLE OF APPLICATION NUMBERS, PUBLICATION NUMBERS  
AND PATENTS**

NUMBER OF APPLICATION (21)	NUMBER OF PUBLISHED APPLICATION (10)	NUMBER OF PATENT (11)
AD 2017 993	AD 2018 993 S	D 2018 764 S

**DESIGN REGISTERED ACCORDING TO THE ACCELERATED  
PROCEDURE****CONCORDANCE TABLE OF INTERNATIONAL CLASSIFICATION INDEX  
AND PUBLICATION NUMBERS**

INTERNATIONAL CLASSIFICATION INDEXES (51)	NUMBER OF PUBLISHED APPLICATION (11)
09-03; 09-05	D 2018 763 S

**CONCORDANCE TABLE OF PUBLICATION NUMBERS  
AND INTERNATIONAL CLASSIFICATION INDEX**

NUMBER OF PUBLISHED APPLICATION (11)	INTERNATIONAL CLASSIFICATION INDEXES (51)
D 2018 763 S	09-03; 09-05

**CONCORDANCE TABLE OF APPLICATION NUMBERS,  
PUBLICATION NUMBERS AND PATENTS**

NUMBER OF APPLICATION (21)	NUMBER OF PATENT (11)
AD 2018 1036	D 2018 763 S

## TRADEMARKS

### CONCORDANCE TABLE OF REGISTRATION NUMBERS, APPLICATION NUMBERS, PUBLICATION NUMBERS AND BULLETIN NUMBERS

NUMBER OF REGISTRATION (111)	NUMBER OF APPLICATIONS (210)	NUMBER OF PUBLISHED APPLICATIONS (260)	NUMBER OF BULLETIN
M 2018 29710 R	AM 97071	-	11(495)2018
M 2018 29711 R	AM 97072	-	11(495)2018
M 2018 29712 R	AM 97485	-	11(495)2018
M 2018 29713 R	AM 97468	-	11(495)2018
M 2018 29714 R	AM 97221	-	11(495)2018
M 2018 29715 R	AM 97706	-	11(495)2018
M 2018 29716 R	AM 97762	-	11(495)2018
M 2018 29717 R	AM 90766	AM 2017 90766 A	19(479)2017
M 2018 29718 R	AM 90914	AM 2017 90914 A	21(481)2017
M 2018 29719 R	AM 97874	-	11(495)2018
M 2018 29720 R	AM 97682	-	11(495)2018
M 2018 29721 R	AM 90996	AM 2017 90996 A	21(481)2017
M 2018 29722 R	AM 91052	AM 2017 91052 A	19(479)2017
M 2018 29723 R	AM 90870	AM 2017 90870 A	21(481)2017
M 2018 29724 R	AM 91160	AM 2017 91160 A	21(481)2017
M 2018 29725 R	AM 91093	AM 2017 91093 A	22(482)2017
M 2018 29726 R	AM 91226	AM 2017 91226 A	21(481)2017
M 2018 29727 R	AM 91282	AM 2017 91282 A	20(480)2017
M 2018 29728 R	AM 91227	AM 2017 91227 A	22(482)2017
M 2018 29729 R	AM 91283	AM 2017 91283 A	20(480)2017
M 2018 29730 R	AM 88244	AM 2017 88244 A	7(467)2017
M 2018 29731 R	AM 91730	AM 2017 91730 A	24(484)2017
M 2018 29732 R	AM 92135	AM 2017 92135 A	24(484)2017
M 2018 29733 R	AM 91866	AM 2017 91866 A	24(484)2017
M 2018 29734 R	AM 91678	AM 2018 91678 A	2(486)2018
M 2018 29735 R	AM 91230	AM 2017 91230 A	24(484)2017
M 2018 29736 R	AM 92187	AM 2017 92187 A	24(484)2017
M 2018 29737 R	AM 92102	AM 2017 92102 A	24(484)2017
M 2018 29738 R	AM 92480	AM 2017 92480 A	24(484)2017
M 2018 29739 R	AM 92473	AM 2017 92473 A	24(484)2017
M 2018 29740 R	AM 91803	AM 2018 91803 A	1(485)2018
M 2018 29741 R	AM 92124	AM 2018 92124 A	2(486)2018
M 2018 29742 R	AM 91942	AM 2018 91942 A	2(486)2018
M 2018 29743 R	AM 92729	AM 2018 92729 A	2(486)2018
M 2018 29744 R	AM 92724	AM 2018 92724 A	2(486)2018
M 2018 29745 R	AM 92180	AM 2018 92180 A	2(486)2018
M 2018 29746 R	AM 92773	AM 2018 92773 A	2(486)2018
M 2018 29747 R	AM 92772	AM 2018 92772 A	2(486)2018
M 2018 29748 R	AM 92796	AM 2018 92796 A	3(487)2018
M 2018 29749 R	AM 92499	AM 2018 92499 A	2(486)2018
M 2018 29750 R	AM 92999	AM 2018 92999 A	3(487)2018
M 2018 29751 R	AM 88501	AM 2018 88501 A	3(487)2018
M 2018 29752 R	AM 92088	AM 2018 92088 A	3(487)2018
M 2018 29753 R	AM 92937	AM 2018 92937 A	3(487)2018
M 2018 29854 R	AM 92989	AM 2018 92989 A	3(487)2018
M 2018 29755 R	AM 92936	AM 2018 92936 A	3(487)2018

1	2	3	4
M 2018 29756 R	AM 93066	AM 2018 93066 A	3(487)2018
M 2018 29757 R	AM 93100	AM 2018 93100 A	5(489)2018

CONCORDANCE TABLE OF PUBLICATION NUMBERS  
AND APPLICATION NUMBERS

NUMBER OF PUBLISHED APPLICATION (260)	NUMBER OF APPLICATION (210)	1	2
		1	2
AM 2018 90304 A	AM 90304	AM 2018 94587 A	AM 94587
AM 2018 90882 A*	AM 90882	AM 2018 94588 A	AM 94588
AM 2018 91479 A	AM 91479	AM 2018 94589 A	AM 94589
AM 2018 91520 A	AM 91520	AM 2018 94681 A	AM 94681
AM 2018 92020 A	AM 92020	AM 2018 94682 A	AM 94682
AM 2018 92445 A	AM 92445	AM 2018 94684 A	AM 94684
AM 2018 92739 A	AM 92739	AM 2018 94691 A	AM 94691
AM 2018 93198 A	AM 93198	AM 2018 94694 A	AM 94694
AM 2018 93533 A	AM 93533	AM 2018 94701 A	AM 94701
AM 2018 93559 A	AM 93559	AM 2018 94709 A	AM 94709
AM 2018 94193 A	AM 94193	AM 2018 94718 A	AM 94718
AM 2018 94255 A	AM 94255	AM 2018 94720 A	AM 94720
AM 2018 94263 A	AM 94263	AM 2018 94787 A	AM 94787
AM 2018 94268 A	AM 94268	AM 2018 94788 A	AM 94788
AM 2018 94269 A	AM 94269	AM 2018 94789 A	AM 94789
AM 2018 94435 A	AM 94435	AM 2018 94793 A	AM 94793
AM 2018 94439 A	AM 94439	AM 2018 94883 A	AM 94883
AM 2018 94440 A	AM 94440	AM 2018 94980 A	AM 94980
AM 2018 94452 A	AM 94452	AM 2018 95034 A	AM 95034
AM 2018 94533 A	AM 94533	AM 2018 95036 A	AM 95036
AM 2018 94543 A	AM 94543	AM 2018 95038 A	AM 95038
AM 2018 94582 A	AM 94582	AM 2018 95079 A	AM 95079
		AM 2018 95080 A	AM 95080
		AM 2018 95186 A	AM 95186
		AM 2018 95223 A	AM 95223
		AM 2018 95227 A	AM 95227

**CONCORDANCE TABLE OF INDEX OF GOODS AND/OR SERVICES  
AND APPLICATION NUMBERS**

INDEX OF GOODS AND/OR SERVICES (511)	NUMBER OF PUBLISHED APPLICATIONS (26)	1	2
1	2		
1	AM 2018 94439 A	25	AM 2018 94980 A
1	AM 2018 94440 A	28	AM 2018 94588 A
3	AM 2018 94793 A	28	AM 2018 95080 A
3	AM 2018 95034 A	29	AM 2018 94789 A
5	AM 2018 90304 A	30	AM 2018 92445 A
5	AM 2018 92739 A	30	AM 2018 93198 A
5	AM 2018 94268 A	30	AM 2018 94587 A
5	AM 2018 94269 A	30	AM 2018 94588 A
5	AM 2018 94435 A	30	AM 2018 94787 A
5	AM 2018 94681 A	30	AM 2018 94788 A
5	AM 2018 94682 A	30	AM 2018 94883 A
5	AM 2018 94691 A	30	AM 2018 94883 A
5	AM 2018 94694 A	30	AM 2018 95079 A
5	AM 2018 94701 A	31	AM 2018 93198 A
5	AM 2018 95036 A	32	AM 2018 93198 A
5	AM 2018 95186 A	32	AM 2018 94883 A
5	AM 2018 95223 A	33	AM 2018 91520 A
5	AM 2018 95227 A	33	AM 2018 93559 A
7	AM 2018 93533 A	33	AM 2018 94263 A
7	AM 2018 94452 A	34	AM 2018 94255 A
8	AM 2018 94452 A	35	AM 2018 93198 A
9	AM 2018 94533 A	35	AM 2018 93533 A
9	AM 2018 94709 A	36	AM 2018 94543 A
11	AM 2018 95038 A	36	AM 2018 94582 A
20	AM 2018 95080 A	36	AM 2018 94589 A
25	AM 2018 94718 A	37	AM 2018 94193 A
25	AM 2018 94720 A	37	AM 2018 94589 A
		38	AM 2018 90882 A*
		38	AM 2018 91479 A
		38	AM 2018 92020 A
		41	AM 2018 94533 A
		42	AM 2018 94533 A
		43	AM 2018 94684 A

CONCORDANCE TABLE OF INDEX OF GOODS AND/OR SERVICES  
AND NUMBERS OF TRADEMARKS REGISTERED ACCORDING  
TO THE ACCELERATED PROCEDURE

INDEX OF GOODS AND/OR SERVICES (511)	NUMBERS OF REGISTERED ACCORDING TO THE ACCELERATED PROCEDURE (111)
1	2
1	M 2018 28492 R
16	M 2018 29713 R
25	M 2018 29714 R
30	M 2018 29719 R
32	M 2018 29715 R
34	M 2018 29712 R
35	M 2018 29720 R
36	M 2018 29710 R
36	M 2018 29711 R
36	M 2018 29716 R
37	M 2018 29716 R
37	M 2018 29720 R
41	M 2018 29713 R
45	M 2018 29713 R

# OFFICIAL BULLETIN OF THE INDUSTRIAL PROPERTY

INVENTIONS  
UTILITY MODELS  
DESIGNS  
TRADEMARKS

## 11(495)

EDITOR-IN-CHIEF: N. Bebrishvili

EDITOR-TRANSLATOR: E. Gabunia

PROOFREADER: A. Shikhashvili

COMPUTER LAYOUT: M. Ordenidze  
K. Svanidze

[www.sakpatenti.gov.ge](http://www.sakpatenti.gov.ge)

E-mail: [info@sakpatenti.org.ge](mailto:info@sakpatenti.org.ge)