



საქართველოს ინტელექტუალური საკუთრების ეროვნული ცენტრი
NATIONAL INTELLECTUAL PROPERTY CENTER OF GEORGIA

საქპატენტი
SAKPATENTI

**OFFICIAL BULLETIN
OF THE INDUSTRIAL PROPERTY**

11(519)

2019
TBILISI

INID CODES FOR IDENTIFICATION OF BIBLIOGRAPHIC DATA

INVENTIONS, UTILITY MODELS

- (10) Number of publication for application, which has been examined
- (11) Number of patent and kind of document
- (21) Serial number of application
- (22) Date of filing of the application
- (23) Date of exhibition or the date of the earlier filing and the number of application, if any
- (24) Date from which patent may have effect
- (31) Number of priority application
- (32) Date of filing of priority application
- (33) Code of the country or regional organization allotting priority application number
- (44) Date of publication of application not granted, but examined and number of bulletin
- (45) Date of publication of registered document
- (51) International Patent Classification Index
- (54) Title of the invention
- (57) Abstract
- (60) Number of examined patent document granted by foreign patent office, date from which patent has effect and country code
- (62) Number of the earlier application and in case of divided application, date of filing an application
- (71) Name, surname and address of applicant (country code)
- (72) Name, surname of inventor (country code)
- (73) Name, surname and address of patent owner (country code)
- (74) Name, surname of representative or patent attorney
- (85) Date of commencement of the national phase of International Application
- (86) Number and date of filing of international application
- (87) Number and date of publication of international application

DESIGNS

- (10) Number of publication for application
- (11) Number of patent and kind of document or number of registration
- (15) Date of registration/Date of patent renewal
- (18) Expected expiration date of patent or registration
- (21) Serial number of application
- (22) Date of filing of the application
- (23) Date of exhibition or the date of the earlier filing and the number of application, if any
- (24) Date from which patent may have effect
- (28) Number of designs included in the application
- (30) Data relating to priority (number of application, date of filing of application, two-letter code identifying the authority with whom the priority application was made)
- (31) Number of priority application
- (32) Date of filing of priority application
- (33) Code of the country or regional organization allotting priority application number
- (34) Two-letter code according to WIPO St.3 identifying the authority with which the priority application was made
- (44) Date of publication of design and number of bulletin (the first publication)
- (45) Date of publication of design registered by WIPO and number of bulletin
- (51) International Classification for designs (class and subclass of the Locarno Classification)
- (54) Title of the invention
- (55) Reproduction of the design
- (57) Description of characteristic features of the design including indication of colors
- (58) Date of recording of any kind of amendment in the Register
- (62) Number of the earlier application, registration and document number and if available the date of filing an application in case of divided application
- (71) Name, surname and address of applicant (country code)
- (72) Name, surname of creator (country code)
- (73) Name, surname and address of patent owner (country code)
- (74) Name, surname of representative or patent attorney
- (81) Contracting states concerned
 - II designated contracting states according to the 1960 Act
 - III designated contracting states according to the 1999 Act
- (85) Owner's permanent address
- (86) Owner's nationality
- (87) Owner's residence
- (88) State in which the owner has a real and effective industrial or commercial establishment

TRADEMARKS

- (111) – Number of registration
- (151) – Date of registration
- (156) – Date of the renewal
- (181) – Expected expiration date of registration
- (186) – Renewal expiration date of registration
- (141) – Date of cancel of duration of the mark
- (210) – Serial number of application
- (220) – Date of filing of the application
- (230) – Date concerning exhibition
- (260) – Number of application, for which favorable decision of examination about registration has been taken (publication number)
- (310) – Number of the first application
- (320) – Date of filing of the first application
- (330) – Code, identifying national or regional Office where the first application was made
- (511) – International Classification of Goods and Services for the purposes of registration of trade marks and/or list of goods and/or services classified according thereto
- (531) – Description of figurative elements of Trade Marks according to the International Classification of the Figurative Elements of Marks
- (540) – Reproduction of Trade Mark
- (550) – Nature and kind of Trade Mark
- (580) – Date of recording of any kind changes in respect of applications or registrations
- (591) – Information concerning colors claimed
- (731) – Name and address of the applicant
- (732) – Name and address of the holder of the registration
- (740) – Name and address of the representative
- (750) – Address for correspondence
- (770) – Name and address of the previous applicant or holder in case of change in ownership
- (771) – Previous name and address of the applicant or holder in case of change in ownership
- (791) – Name and address of the licensee
- (793) – Indication of conditions and/or restrictions under the license (Type of license, number of license agreement, data of license, data of validity of license)
- (800) – Certain data relating to the international registration of Trade Marks under the Protocol Relating to Madrid Agreement (International registration number)

CODES FOR PUBLICATION IN BULLETIN

- (21) AP 0000 000000 – serial number of application for invention
- (10) AP 0000 0000 A – number of published application for invention (first publication)
- (11) P 0000 0000 B – number of patent for invention (second publication)
- (21) API 0000 000000 – number of application for imported patent
- (11) PI 0000 0000 A – number of imported patent (first publication)
- (21) AU 0000 000000 – serial number of application for utility model
- (10) AU 0000 000 U – number of published application for utility model (first publication)
- (11) U 0000 000 Y – number of patent for utility model (second publication)
- (21) AD 0000 000000 – serial number of application for design
- (10) AD 0000 000 S – number of published application for design (first publication)
- (11) D 0000 000 S – number of patent for design (second publication)

INTERNATIONAL PATENT CLASSIFICATION FOR INVENTIONS AND UTILITY MODELS

- SECTION A – HUMAN NECESSITIES
- SECTION B – PERFORMING OPERATIONS; TRANSPORTING
- SECTION C – CHEMISTRY; METALLURGY
- SECTION D – TEXTILES; PAPER
- SECTION E – FIXED CONSTRUCTIONS
- SECTION F – MECHANICAL ENGINEERING; LIGHTING; HEATING; WEAPONS; BLASTING
- SECTION G – PHYSICS
- SECTION H – ELECTRICITY

-
- M – Trade Mark
 - (210) AM 0000 000000 – Serial number of application;
 - (260) AAM 0000 00000 A – Publication number of application;
 - (111) M 0000 00000 R – Number of registration;
 - (111) MMM0000 00000 Rn – Number of renewals, in which n=1,2,3;
 - (111) M 0000 00000 R(P) – Number of registration under partial assignment of rights
-

LIST OF CODES, IN ALPHABETIC SEQUENCE, AND THE CORRESPONDING (SHORT) NAMES OF STATES, OTHER ENTITIES AND INTERGOVERNMENTAL ORGANIZATIONS
(WIPO STANDARD ST.3)

AD	Andorra				
AE	United Arab Emirates				
AF	Afghanistan				
AG	Antigua and Barbuda				
AI	Anguilla				
AL	Albania				
AM	Armenia				
AN	Netherlands Antilles				
AO	Angola				
AP	African Regional Intellectual Property Organization (ARIPO)				
AR	Argentina				
AT	Austria				
AU	Australia				
AW	Aruba				
AZ	Azerbaijan				
BA	Bosnia and Herzegovina				
BB	Barbados				
BD	Bangladesh				
BE	Belgium				
BF	Burkina Faso				
BG	Bulgaria				
BH	Bahrain				
BI	Burundi				
BJ	Benin				
BM	Bermuda				
BN	Brunei Darussalam				
BO	Bolivia				
BR	Brazil				
BS	Bahamas				
BT	Bhutan				
BV	Bouvet Island				
BW	Botswana				
BX	Benelux Office for Intellectual Property (BOIP)				
BY	Belarus				
BZ	Belize				
CA	Canada				
CD	Democratic Republic of the Congo				
CF	Central African Republic				
CG	Congo				
CH	Switzerland				
CI	Cote d'Ivoire				
CK	Cook Islands				
CL	Chile				
CM	Cameroon				
CN	China				
CO	Colombia				
CR	Costa Rica				
CU	Cuba				
CV	Cape Verde				
CY	Cyprus				
CZ	Czech Republic				
DE	Germany				
DJ	Djibouti				
DM	Dominica				
DO	Dominican Republic				
DZ	Algeria				
EA	Eurasian Patent Organization (EAPO)				
EC	Ecuador				
EE	Estonia				
EG	Egypt				
EH	Western Sahara				
EM	Office for Harmonization in the Internal Market (Trademarks and Designs)(OHIM)				
EP	European Patent Office (EPO)				
ER	Eritrea				
ES	Spain				
ET	Ethiopia				
FI	Finland				
FJ	Fiji				
FK	Falkland Islands (Malvinas)				
FO	Faroe Islands				
FR	France				
GA	Gabon				
GB	United Kingdom				
GC	Patent Office of the Cooperation Council				
			for the Arab States of the Gulf (GCC)		
		GD	Grenada		
		GG	Guernsey		
		GH	Ghana		
		GI	Gibraltar		
		GT	Guatemala		
		GW	Guinea- Bissau		
		GY	Guyana		
		HK	The Hong Kong Special Administrative Region of the People's Republic of China		
		HN	Honduras		
		HR	Croatia		
		HT	Haiti		
		HU	Hungary		
		IB	International Bureau of the World Intellectual Property Organization (WIPO)		
		ID	Indonesia		
		IE	Ireland		
		IL	Israel		
		IM	Isle of Man		
		IN	India		
		IQ	Iraq		
		ID	Indonesia		
		IE	Ireland		
		IL	Israel		
		IM	Isle of Man		
		IN	India		
		IQ	Iraq		
		IR	Iran (Islamic Republic of)		
		IS	Iceland		
		IT	Italy		
		JE	Jersey		
		JM	Jamaica		
		JO	Jordan		
		JP	Japan		
		KE	Kenya		
		KG	Kyrgyzstan		
		KH	Cambodia		
		KI	Kiribati		
		KM	Saint Kitts and Nevis		
		KP	Democratic People's Republic of Korea		
		KR	Republic of Korea		
		KW	Kuwait		
		KY	Cayman Islands		
		KZ	Kazakhstan		
		LA	Lao People's Democratic Republic		
		LB	Lebanon		
		LC	Saint Lucia		
		LI	Liechtenstein		
		LK	Sri Lanka		
		LR	Liberia		
		LS	Lesotho		
		LT	Lithuania		
		LU	Luxembourg		
		LV	Latvia		
		LY	Libyan Arab Jamahiriya		
		MA	Morocco		
		MC	Monaco		
		MD	Republic of Moldova		
		ME	Montenegro		
		MG	Madagascar		
		MK	The former Yugoslav Republic of Macedonia		
		ML	Mali		
		MM	Myanmar		
		MN	Mongolia		
		MO	Macao		
		MP	Northern Mariana Islands		
		MR	Mauritania		
		MS	Montserrat		
		MT	Malta		
		MU	Mauritius		
		MV	Maldives		
		MW	Malawi		
		MX	Mexico		
		MY	Malaysia		
		MZ	Mozambique		
		NA	Namibia		
		NE	Niger		
		NG	Nigeria		
		NI	Nicaragua		
		NL	Netherlands		
		NO	Norway		
		NP	Nepal		
		NR	Nauru		
		NZ	New Zealand		
		OA	African Intellectual Property Organization (OAPI)		
		OM	Oman		
		PA	Panama		
		PE	Peru		
		PG	Papua New Guinea		
		PH	Philippines		
		PK	Pakistan		
		PL	Poland		
		PT	Portugal		
		PW	Palau		
		PY	Paraguay		
		QA	Qatar		
		QZ	Community Plant Variety Office (European Community) (CPVO)		
		RO	Romania		
		RS	Serbia		
		RU	Russian Federation		
		RW	Rwanda		
		SA	Saudi Arabia		
		SB	Solomon Islands		
		SC	Seychelles		
		SD	Sudan		
		SG	Singapore		
		SH	Saint Helena		
		SI	Slovenia		
		SK	Slovakia		
		SL	Sierra Leone		
		SM	San Marino		
		SN	Senegal		
		SO	Somalia		
		SR	Suriname		
		ST	Sao Tome and Principe		
		SV	El Salvador		
		SY	Syrian Arab Republic		
		SZ	Swaziland		
		TC	Turks and Caicos Islands		
		TD	Chad		
		TG	Togo		
		TH	Thailand		
		TJ	Tajikistan		
		TL	Timor-Leste		
		TM	Turkmenistan		
		TN	Tunisia		
		TO	Tonga		
		TR	Turkey		
		SE	Sweden		
		TT	Trinidad and Tobago		
		TV	Tuvalu		
		TW	Taiwan, Province of China		
		TZ	United Republic of Tanzania		
		UA	Ukraine		
		UG	Uganda		
		US	United States of America		
		UY	Uruguay		
		UZ	Uzbekistan		
		VA	Holy See		
		VC	Saint Vincent and the Grenadines		
		VE	Venezuela		
		VG	Virgin Islands (British)		
		VN	Viet Nam		
		VU	Vanuatu		
		WO	World Intellectual Property Organization (WIPO)		
		WS	Samoa		
		XN	Nordic Patent Institute (NPI)		
		YE	Yemen		
		ZA	South Africa		
		ZM	Zambia		
		ZW	Zimbabwe		

**OFFICIAL BULLETIN
OF THE INDUSTRIAL PROPERTY**

11(519)

**INVENTIONS
UTILITY MODELS
DESIGNS
TRADEMARKS**

DATE OF PUBLICATION
2019 06 10

CONTENTS

PUBLISHED TITLES OF PROTECTION	3
INVENTIONS	
▪ APPLICATIONS APPROVED FOR GRANTING PATENTS	4
▪ PATENTED INVENTIONS	6
UTILITY MODELS	
▪ APPLICATION APPROVED FOR GRANTING PATENT	8
DESIGNS	
▪ DESIGNS, WICH HAVE BEEN REGISTERED WITH THE INTERNATIONAL BUREAU CLAIMING PRIORITY ON THE TERRITORY OF GEORGIA	9
TRADEMARKS	
▪ APPLICATIONS FILED UNDER THE NATIONAL PROCEDURE APPROVED FOR REGISTRATION	38
▪ REGISTERED TRADEMARKS	51
▪ TRADEMARKS REGISTERED ACCORDING TO THE ACCELERATED PROCEDURE	56
▪ INTERNATIONAL TRADEMARKS FOR WHICH A DECISION ON GANTING PROTECTION IS TAKEN	60
▪ INTERNATIONAL TRADEMARKS PROTECTED IN GEORGIA	170
OFFICIAL NOTIFICATIONS	
INVENTIONS	
▪ RENEWAL OF PATENTS	178
▪ ABOLITION OF PATENTS WITH THE RIGHT TO RESTORE	178
▪ EXPIRATION OF TERM OF RESTORATION OF PATENTS	180
▪ ISSUING ADDITIONAL CERTIFICATE OF PROTECTION	182
UTILITY MODELS	
▪ RENEWAL OF PATENT	182
▪ ABOLITION OF PATENT WITH THE RIGHT TO RESTORE	182
▪ EXPIRATION OF TERM OF RESTORATION OF PATENTS	183
DESIGNS	
▪ CONTINUE THE PERIOD OF DESIGN REGISTRATION	184
▪ CANCELLATION OF DESIGNS REGISTRATIONS	184
TRADEMARKS	
▪ RENEWAL OF REGISTRATIONS	185
▪ COMPLET TRANSFER OF RIGHTS	191
▪ CHANGES OF NAMES AND/OR ADDRESSES OF OWNERS	194
▪ TERMINATION OF TRADEMARKS REGISTRATION	197
CLASSIFICATION INDEXES	
INVENTIONS	199
UTILITY MODELS	200
TRADEMARKS	201

PUBLISHED TITLES OF PROTECTION

INVENTIONS

- **APPLICATIONS APPROVED FOR GRANTING PATENT:**
14560; 14395; 14628; 14805
- **PATENTED INVENTION:**
6973-6980

UTILITY MODELS

- **APPLICATION APPROVED FOR GRANTING PATENT:**
14799

DESIGNS

- **DESIGNS WHICH HAVE BEEN REGISTERED WITH THE INTERNATIONAL BUREAU CLAIMING PRIORITY ON THE TERRITORY OF GEORGIA:**
103371; 200367; 200369; 200374; 103359; 103724

TRADEMARKS

- **APPLICATIONS FILED UNDER THE NATIONAL PROCEDURE APPROVED FOR REGISTRATION:**
100000-100004; 100006; 100008; 100019, 100020; 100042; 100051; 100074, 100075; 100080, 100081; 100086; 100091; 100093; 100097; 100368; 100379, 100380; 100387, 100388; 100391, 100392; 100396; 100398; 100400; 100411-100413; 100431; 100460; 100584, 100585; 100793; 100800, 100801; 95941; 98185; 99427; 99680; 99760; 99764, 99765; 99767, 99768; 99770; 99772; 99775; 99778, 99779; 99862; 99870, 99871; 99887; 99890, 99891; 99894; 99897; 99907-99909; 99912; 99914; 99939; 99955; 99963; 99965; 99977, 99978; 99985, 99986; 99988, 99989
- **REGISTERED TRADEMARKS:**
31246-31298
- **TRADEMARKS REGISTERED ACCORDING TO THE ACCELERATED PROCEDURE:**
31233-31245; 31299-31306
- **INTERNATIONAL TRADEMARKS FOR WHICH A DECISION ON GRANTING PROTECTIONS IS TAKEN:**
100112-100116; 100118-100121; 94379*, 94380*; 94403*; 95087*; 95263*; 95903; 96082*; 96328*; 96876; 96880*; 97617; 98361; 98465; 98508; 98525; 98532; 98648; 98651; 98704; 98716; 98723; 98809, 98810; 98812; 98818; 98837; 98839-98841; 98844-98846; 98853-98856; 98877-98879; 98882-98886; 98920, 98921; 98942; 98944; 98947; 98950; 98953; 98959; 99000; 99005-99007; 99011; 99020-99031; 99033, 99034; 99036-99041; 99089-99094; 99096; 99109; 99111, 99112; 99114; 99122-99124; 99133; 99139; 99148, 99149; 99151; 99156; 99172; 99203-99207; 99209-99213; 99222; 99225-99230; 99232-99234; 99245; 99247, 99248; 99285; 99288, 99289; 99292, 99293; 99369; 99371; 99373, 99374; 99378, 99379; 99396, 99397; 99405-99410; 99413, 99414; 99564; 99573; 99589-99592; 99610, 99611; 99613; 99625-99628; 99630, 99631; 99633, 99634; 99636- 99643; 99695-99704; 99821; 99826, 99827
- **INTERNATIONAL TRADEMARKS PROTECTED IN GEORGIA:**
92412; 93306; 93970; 94826; 95617; 95628; 95748; 97052; 97116; 97253-97262; 97341; 97354; 97356, 97357; 97359-97362; 97486; 97500; 97509, 97510; 97512; 97520, 97521; 97523, 97524; 97530, 97531; 97533-97538; 97540-97547; 97553; 97569; 97571; 97575; 97579-97588; 97597; 97609-976112, 97614-97616; 97622-97625; 97627; 97636-97640; 97661; 97665; 97671, 97672; 97674, 97675; 97716-97718; 97731, 97732; 97736, 97737; 97816; 97820; 97834, 97835; 97843, 97844; 97906; 97908; 97950; 98027, 98028; 98030; 98032; 98036; 98146; 98319; 98369, 98370

INVENTIONS

APPLICATIONS APPROVED FOR GRANTING PATENTS

The decision can be appealed at the Chamber of Appeal of Sakpatenti within 3 months from the publication or at the Mtskheta District Court Administrative Cases Board (Address: №17, Samkhedro str., Mtskheta), within 1 month following the publication.

PART A

A 61

(10) AP 2019 14560 A (51) Int. Cl. (2006)

A 61 B 18/02

A 61 B 18/00

A 61 B 18/14

(21) AP 2015 14560 (22) 2015 03 18

(31) MI20014A000467

(32) 2014 03 20

(33) IT

(71) ATRICATH S.P.A. (IT)

Viale Bianca Maria, 41 I-20122 Milano,
Italy (IT)

(72) PERFLER, Enrico (IT)

(74) Tamaz Shilakadze

(85) 2017 08 07

(86) PCT/IB2015/051998, 2015 03 18

(54) **ABLATION CATHETER AND
ABLATION APPARATUS**

(57) The present invention relates to an ablation catheter for the ablation of tissues comprising:- a telescopic tubular body 4 in turn comprising an external tubular body 4a and an internal tubular body 4b concentric with each other, and a rod-like guiding element 5 at least partly housed in the internal tubular body with at least one free end 5a protruding from the internal tubular body in correspondence with a distal end of the telescopic body; - a positioning head and an ablation head 3 in correspondence with the distal end of the telescopic body, the positioning head being situated in the proximity of the free end 5a of the rod-like guide, and the ablation head in the proximity of the positioning head, in a remote position with respect to the free end; - a control handpiece at a proximal end of the telescopic body coupled with the guiding element, the ablation head, the positioning head and the telescopic tubular body; wherein the ablation head comprises at least two ablation elements or petals 3a that can be moved from a rest position in which they are housed in the external tubular body and an operating position in which they protrude from the external tubular body like a petal; wherein each of the ablation elements or petals comprises: - a continuous ablation electrode which extends without interruption over a circumferential peripheral portion of each petal, substantially along an arc

of circumference having a longitudinal axis of the rod-like guiding element as its centre; - two side portions 3c of the petal, each connected to an end of the ablation electrode 3b, in correspondence with a curved section, the side portions and the ablation electrode being integral with each other, formed by means of the same folded metallic conductor, - each ablation petal being separate and distinct from another ablation petal of the ablation head, - all the ablation petals of the ablation head being separately connected to a distinct electric energy generator to cause a radiofrequency ablation in a powered ablation electrode condition.

Claims: 2 independent

12 dependent

Fig.: 21

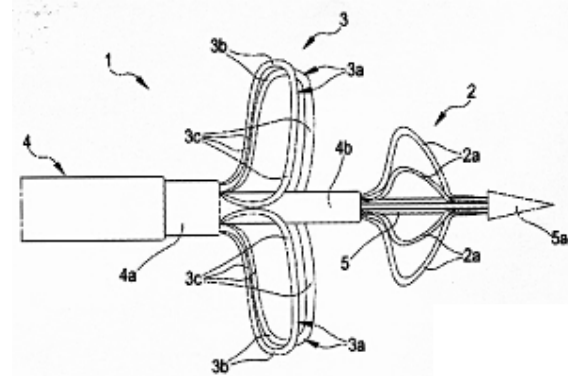

Fig. 2

(10) AP 2019 14395 A (51) Int. Cl. (2006)

A 61 K 31/44

A 61 K 3/506

C 07 D 239/24

(21) AP 2015 014395 (22) 2015 06 30

(31) 62/185,678; 62/019,756

(32) 2015 06 28; 2014 07 01

(33) US; US

(71) Millennium Pharmaceuticals Inc. (US)

40 Landsdowne Street Cambridge,
MA 02139 (US)

(72) DUFFEY, Matthew O. (US);

ENGLAND, Dylan (CA);

FREEZE, Scott (US);

HU, Zhigen (CN);

LANGSTON, Steven, P. (US);

MCINTYRE, Charles (US);

MIZUTANI, Hirotake (US);

ONO, Koji (JP);

XU, He (CN)

(74) Shalva Gvaramadze

(85) 2017 01 25

(86) PCT/US2015/038712, 2015 06 30

(54) **HETEROARYL COMPOUNDS**

USEFUL AS INHIBITORS OF SUMO

ACTIVATING ENZYME

(57) An invention relates to heteroaryl compositions of formula (I),

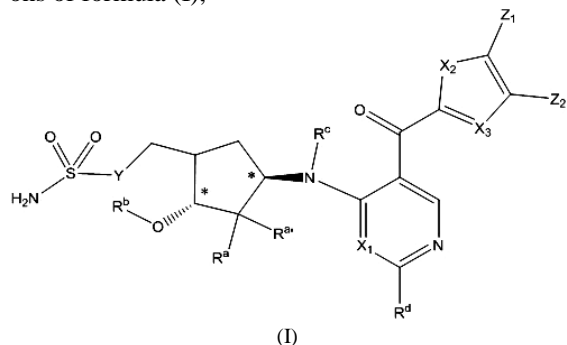

(I)

stereoisomers thereof, compositions containing them and their usage as inhibitors SUMO activating enzyme at proliferating, inflammatory, cardiovascular, and neurodegenerative diseases treatment.

Claims: 17 independent

50 dependent

Fig.: 17

PART B

B 42

(10) AP 2019 14628 A (51) Int. Cl. (2006)
B 42 D 25/00

(21) AP 2016 14628 (22) 2016 04 20

(31) 2014690

(32) 2015 04 22

(33) NL

(71) MORPHO B.V. (NL)

Oudeweg 32 2031 CC Haarlem (NL)

(72) WESSELINK, Wilhelmus Johannes (NL);

VAN DEN BERG, Jan (NL)

(74) Tamaz Shilakadze

(85) 2017 11 20

(86) PCT/NL2016/050277, 2016 04 20

(54) **SECURITY DOCUMENT AND
METHOD OF MANUFACTURING**

(57) Present invention relates to security document comprising image area repeating image pattern in image area of mutually spaced image elements at mutual distance D and a layer of plastics material overlying the image area and an array of lenses in the plastics material. The lenses are spaced at mutual distance L which maybe equal to D or

which may differ from D, the array of lenses overlying only a part of image area surface and are formed in the plastics material within image contour. Within the contour an image may be observed such as Moiré magnification or Moiré effect of light and dark stripes. The lenses may be formed for instance by laser ablation or by imprinting.

Claims: 3 independent

10 dependent

Fig.: 6

PART H

H 01

(10) AP 2019 14805 A (51) Int. Cl. (2006)
H 01 S 3/10

(21) AP 2018 14805 (22) 2018 06 11

(71) LEPL Ilia Vekua Sukhumi Institute of Physics and Technology (GE)

MIndelis q. 7, 0186, Tbilisi (GE)

(72) Vladimer Kuchukhidze (GE);

Guram Bokuchava (GE);

Zurab Vardosanidze (GE);

Anzor Inashvili (GE)

(74) Zurab Vardosanidze (GE)

(54) **METHOD AND DEVICE FOR
RECEIVING POWERFUL LASER PULSE**

(57) There are represented a method and device for receiving powerful lazer pulses. The method provides laser cavity Q-switching; at that, there is provided concentration of spatially separated, short-time, having inter-perpendicular polarization couple of lazer pulses in one point by means of double refringence crystal and collecting lens.

Claims: 2 independent

Fig.: 2

PATENTED INVENTIONS

PART A

A 47

(11) P 2019 6980 B **(51) Int. Cl. (2006)**
A 47 J 31/00
B 65 D 85/804
C 12 G 3/06

(10) AP 2019 14581 A (44) 4(512)/2019
 (21) AP 2016 14581
 (22) 2016 02 16
 (24) 2016 02 16
 (31) P201530209
 (32) 2015 02 16
 (33) ES
 (86) PCT/ES2016/070090, 2016 02 16
 (73) SMART SPIRITS, S.L. (ES)
 Poeta Querol, 1 1º 46002 Valencia (ES)
 (72) SANCHEZ BOU, Carlos (ES);
 SMART, Mark Francis Joseph (ES);
 SANCHEZ LLOPIS, Carlos (ES)
 (74) Shalva Gvaramadze
 (54) **INFUSER FOR ALCOHOLIC
 BEVERAGES**

A 61

(11) P 2019 6977 B **(51) Int. Cl. (2006)**
A 61 K 9/20
A 61 K 31/40

(10) AP 2019 14292 A (44) 3(511)/2019
 (21) AP 2015 14292
 (22) 2015 03 05
 (24) 2015 03 05
 (31) 2014/02685
 (32) 2014 03 06
 (33) TR
 (86) PCT/EP2015/054631, 2015 03 05
 (73) SANOVEL ILAC SANAYI VE TICARET
 A.S. (TR)
 Balabandere Cad. Ilac Sanayi Yolu
 No: 14 Istinye, Sariyer, 34460, Istanbul (TR)
 (72) TÜRKYILMAZ, Ali (TR);
 TURP, Ali Hasan (TR);
 SAYDAM, Mehtap (TR);
 ÜLGEN, Onur (TR)
 (74) Larisa Amirkhanyan
 (54) **PHARMACEUTICAL FORMULATIONS
 OF VILDAGLIPTIN**

(11) P 2019 6976 B **(51) Int. Cl. (2006)**
A 61 K 39/17
A 61 P 35/00
C 12 N 15/09

(10) AP 2019 13952 A (44) 3(511)/2019
 (21) AP 2014 013952
 (22) 2014 03 04
 (24) 2014 03 04
 (31) 61/782,994
 (32) 2013 03 14
 (33) US
 (86) PCT/US2014/020299, 2014 03 04
 (73) ICAHN SCHOOL OF MEDICINE AT
 MOUNT SINAI (US)
 One Gustave L. Levy Place New York,
 NY 10029 (US);
 MEMORIAL SLOAN KETTERING
 CANCER CENTER (US)
 1275 York Avenue New York,
 NY 10065 (US)
 (72) PALESE, Peter (US);
 GARCIA-SASTRE, Adolfo (US);
 ZAMARIN, Dmitriy (US);
 ALLISON, James (US);
 WOLCHOK, Jedd, D. (US)
 (74) Shalva Gvaramadze
 (54) **NEWCASTLE DISEASE VIRUSES
 AND USES THEREOF**

A 62

(11) P 2019 6979 B **(51) Int. Cl. (2006)**
A 62 C 13/66
A 62 C 13/74

(10) AP 2019 14393 A (44) 3(511)/2019
 (21) AP 2015 14393
 (22) 2015 06 22
 (24) 2015 06 22
 (31) 14/313,761; 14/704,820
 (32) 2014 06 24; 2015 05 05
 (33) US; US
 (86) PCT/US2015/036895, 2015 06 22
 (73) ROUSSEAU INC. (US)
 3925 N Hastingway, O-Claire, W1 54703 (US)
 (72) ROUSSEAU, Randy (US);
 ROUSSEAU, Hector (US);
 BARROWS, Ryan H. (US);
 SEYMOUR, Justun C. (US)
 (74) Tamaz Shilakadze
 (54) **FIRE EXTINGUISHER WITH
 INTERNAL MIXING AND GAS
 CARTRIDGE**

PART B**B 64**

- (11) P 2019 6973 B** (51) **Int. Cl. (2006)**
B 64 C 5/06
 (10) AP 2019 14489 A (44) 2(510)/2019
 (21) AP 2017 14489
 (22) 2017 05 11
 (24) 2017 05 11
 (73) Zurab Sordia (GE)
 Nutsubidzis Plato, II mkr., III Kv., korp. 5,
 b. 23, 0183, Tbilisi (GE)
 (72) Zurab Sordia (GE)
 (54) **AIRCRAFT VERTICAL EMPENNAGE**

B 66

- (11) P 2019 6975 B** (51) **Int. Cl. (2006)**
B 66 D 5/26
 (10) AP 2019 14509 A (44) 3(511)/2019
 (21) AP 2017 14509
 (22) 2017 06 05
 (24) 2017 06 05
 (73) Rusudan Bitsadze (GE)
 Pekinis q. 31g, b. 29, 0160, Tbilisi (GE);
 Simon Bitsadze (GE)
 Pekinis q. 31g, b. 29, 0160, Tbilisi (GE)
 (72) Rusudan Bitsadze (GE);
 Simon Bitsadze (GE)
 (54) **MAGNETIC PUSHER**

PART C**C 07**

- (11) P 2019 6978 B** (51) **Int. Cl. (2006)**
C 07 B 57/00
C 07 D 487/06
 (10) AP 2019 14340 A (44) 3(511)/2019
 (21) AP 2014 14340
 (22) 2014 05 09
 (24) 2014 05 09
 (86) PCT/PT2014/000027, 2014 05 09
 (73) TECNIMEDE SOCIEDADE TECNICO-
 MEDICINAL S.A. (PT)
 Rua Tapada Grande, Nº2 Abrunheira
 P-2710-089 Sintra (PT)
 (72) PARDAL FILIPE, Augusto Eugénio (PT);
 EUFRÁSIO PEDROSO, Pedro Filipe (PT);
 ALMEIDA PECORELLI, Susana
 Marques (PT);
 CASIMIRO CAIXADO, Carlos Alberto
 Eufrásio (PT);

LOPES, Ana Sofia da Conceição (PT);
 DAMIL, João Carlos Ramos (PT);
 E OLIVEIRA SANTOS, Pedro Paulo de
 Lacerda (PT)

- (74) Tamaz Shilakadze
 (54) **PROCESS FOR OBTAINING
 OPTICALLY ACTIVE PIRLINDOLE
 ENANTIOMERS AND SALTS THEREOF**

- (11) P 2019 6974 B** (51) **Int. Cl. (2006)**
C 07 D 235/04
C 07 D 235/06
C 07 D 407/12
 (10) AP 2019 14554 A (44) 2(510)/2019
 (21) AP 2015 14554
 (22) 2015 11 18
 (24) 2015 11 18
 (31) 10 2015 0009326
 (32) 2015 01 20
 (33) KR
 (86) PCT/KR2015/012385, 2015 11 18
 (73) CJ HEALTHCARE CORPORATION (KR)
 330, Dongho-ro, Jung-gu, Seoul 04560
 (72) HEO, Seung Pyeong (KR);
 KO, Dong Hyun (KR);
 LEE, Sung Ah (KR);
 LEE, Ji Yun (KR);
 KWEON, Jae Hong (KR);
 CHOI, Kwang Do (KR);
 LEE, Ji Yun (KR);
 KIM, Eun Sun (KR);
 KIM, Young Ju (KR)
 (74) Shalva Gvaramadze
 (54) **NOVEL CRYSTAL FORM OF
 BENZIMIDAZOLE DERIVATIVE AND
 PREPARATION METHOD THEREOF**

UTILITY MODEL

APPLICATION APPROVED FOR GRANTING PATENT

The decision can be appealed at the Chamber of Appeal of Sakpatenti within 3 months from the publication or at the Mtskheta District Court Administrative Cases Board (Address: №17, Samkhedro str., Mtskheta), within 1 month following the publication.

PART B

B 60

(10) AU 2019 14799 U (51) Int. Cl. (2006)

B 60 T 17/22

B 60 T 17/08

G 01 L 5/28

(21) AU 2018 14799

(22) 2018 05 29

(31) 2017119422

(32) 2017 06 02

(33) RU

(71) Konstantin Yurievich Dyomin (RU)

P. Andropova, kv. 151, ap. 30,
115487, Moscow (RU);

Aleksey Alekseevich Popkov (RU)

P. Nastavnikikova, kv. 504,
korp. 1, ap. 41, Sankt-Peterburg 195030 (RU);

Vyacheslav Nikolaevich Bochkaryov (RU)

Ul. Varatinskaya, kv. 17, ap. 5, 125466,
Moscow (RU);

Pavel Nikolaevich Bochkaryov (RU)

Bulvar Khadinskogo, kv. 21, ap. 13,
Moscow (RU)

(72) Konstantin Yurievich Dyomin (RU);

Aleksey Alekseevich Popkov (RU);

Vyacheslav Nikolaevich Bochkaryov (RU);

Pavel Nikolaevich Bochkaryov (RU)

(74) Aleksandr Gegechkori

(54) **DEVICE FOR PRESSURE CONTROL**

IN BRAKE CYLINDER

(57) A device includes a case with inlet socket, piston chamber, and a piston abutting with spring. Additionally, the device is equipped with indicator pistons of empty and loaded regimes, disposed in corresponding case chambers; each chamber is connected to chamber channel, and the points of channels connections to piston chamber are executed on various levels; at that, piston chamber is intercommunicated to chambers of empty and loaded regimes to the extent of piston motion therein.

Claims: 1 independent

6 dependent

Fig.: 1

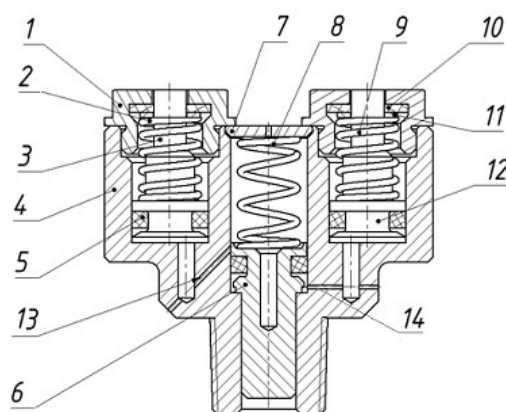
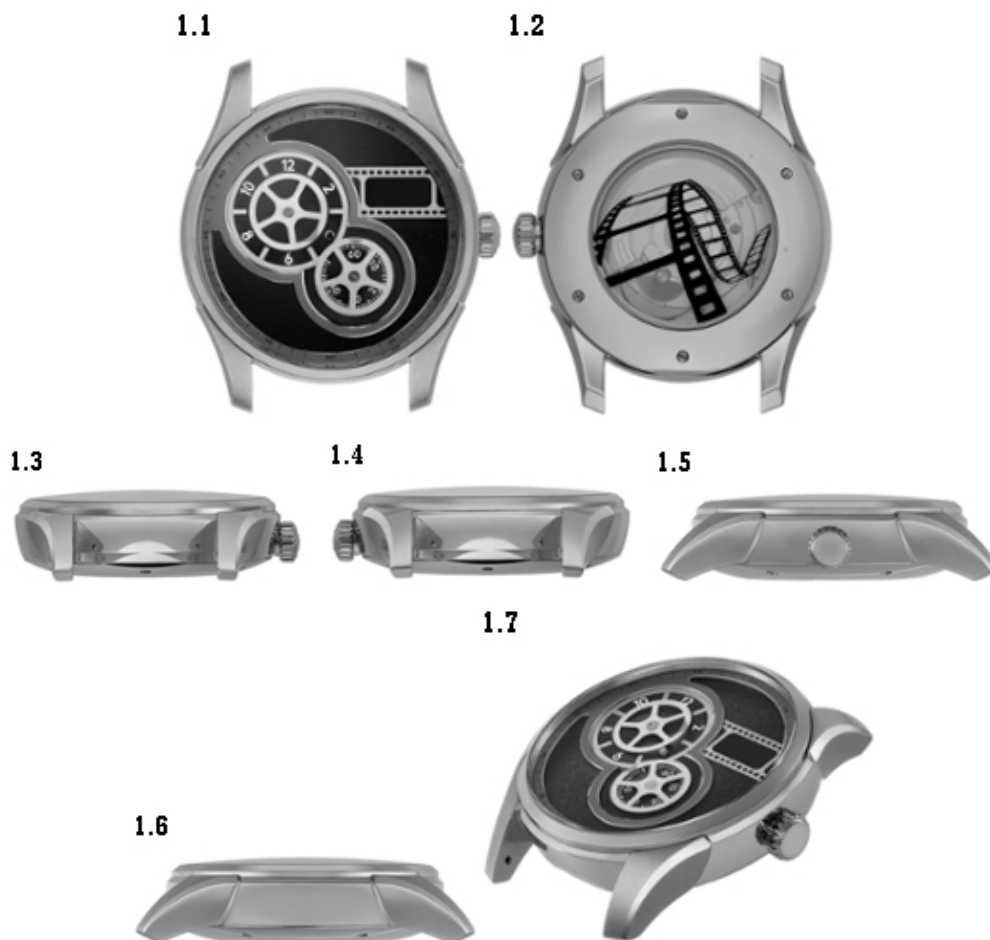

Fig. 1

DESIGNS, WHICH HAVE BEEN REGISTERED WITH THE INTERNATIONAL BUREAU CLAIMING PRIORITY ON THE TERRITORY OF GEORGIA

The decision can be appealed at the Chamber of Appeal of Sakpatenti within 3 months from the publication or at the Mtskheta District Court Administrative Cases Board (Address: №17, Samkhedro Str., Mtskheta), within 1 month following the publication.

- (11) **DM/103 371** (51) **10-02**
 (15) 2018 09 28 (44) 13/2019 (2019 03 29)
 (22) 2018 09 28
 (28) 1
 (73) Hamilton International AG (Hamilton International SA) (Hamilton International Ltd)
 Mattenstrasse 149 Biel/Bienne, CH-2503 (CH)
 (85) CH
 (86) CH
 (87) CH
 (88) CH
 (89) CH
 (81) II. BZ, MA III. UA, AM, AL, AZ, ME, MD, MC, SG, NO, MN, BA, TR, GE, OM, MK, LI, KG, TN,
 EM, JP, CH
 (72) Fabrice DUPORT
 4, Avenue De La Gare, 2000 Neuchâtel (CH)
 (74) The Swatch Group AG (The Swatch Group SA) (The Swatch Group Ltd.)
 Faubourg Du Lac 6 Biel/Bienne, CH-2501 (CH)
 (54) 1. Watch without hands
 (55)



(11) DM/200 367

(15) 2018 12 18

(22) 2018 12 18

(28) 5

(73) HARRY WINSTON SA

Chemin Du Tourbillon 8, 1228 Plan-Les-Ouates (CH)

(85) CH

(86) CH

(87) CH

(88) CH

(89) CH

(81) II. BZ, MA III. UA, AM, AL, AZ, ME, MD, MC, SG, NO, MN, BA, TR, MK, OM, GE, LI, KG, GB, TN, EM, CH

(72) Maurice GALLI

C/o Harry Winston Inc. 718 Fifth Avenue, 10019 New York (US)

(74) The Swatch Group AG (The Swatch Group SA) (The Swatch Group Ltd.)

Faubourg Du Lac 6, 2501 BIEL/BIENNE (CH)

(54) 1. Necklace, 2. Earring, 3.-5 Bracelet

(55)



1.1



1.2



1.3



2.1



2.2



2.3

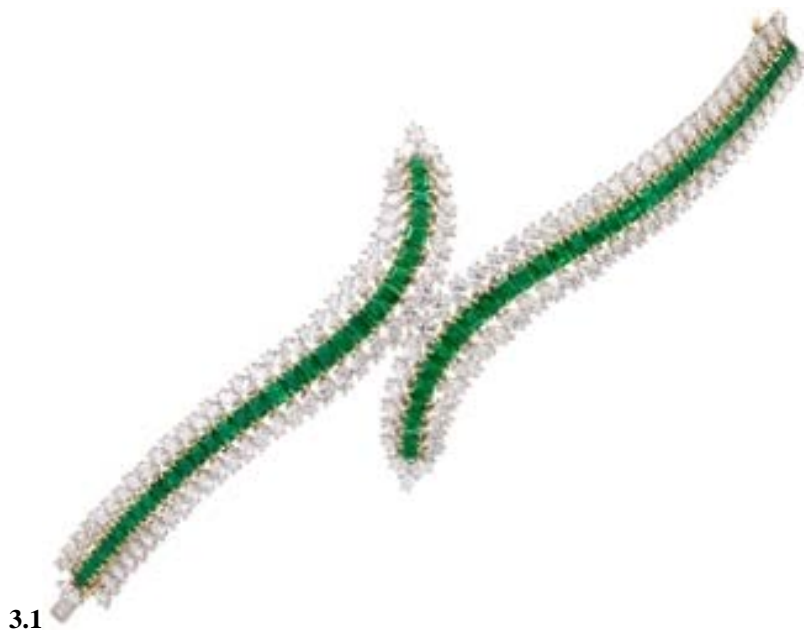

3.1



3.2



5.1



5.2



5.3



(11) DM/200 369

(51) 11-01

(15) 2018 11 16

(44) 13/2019 (2019 03 29)

(22) 2018 11 16

(28) 18

(73) HARRY WINSTON SA

Chemin Du Tourbillon 8, 1228 Plan-Les-Ouates (CH)

(85) CH

(86) CH

(87) CH

(88) CH

(89) CH

(81) II. BZ, MA III. AM, UA, AL, AZ, ME, MD, MC, SG, MN, NO, BA, TR, MK, GE, OM, LI, KG, GB, TN, EM, CH

(72) 1-4; 10-15 Delphine ABDOURAHIM

718 Fifth Avenue, 10019 New York (US);

5-9 Rie YATSUGI-KANG

718 Fifth Avenue, 10019 New York (US);

16-18 Dominique RIVIERE

718 Fifth Avenue, 10019 New York (US)

(74) The Swatch Group AG (The Swatch Group SA) (The Swatch Group Ltd.)

Faubourg Du Lac 6, 2501 BIEL/BIENNE (CH)

(54) 1. Earrings, 2.-3. Necklace, 4. Earrings, 5.-6. Bracelet, 7. Earrings, 8.-9. Finger ring, 10.-13. Earrings, 14. Bracelet, 15.-16. Necklace, 17. Earrings, 18. Finger ring,

(55)

1.1

1.2



1.3



2.1



2.2



2.3



3.1



3.2



3.3



4.1



4.2



4.3



5.1



5.2



5.3



6.1



6.2



6.3



7.1



7.2



7.3



8.1



8.2



8.3



9.1



9.2



10.1



10.2



9.3



10.3



11.1



11.2



11.3



12.1



12.2



12.3



13.1



13.2



13.3



14.1



14.2



14.3



15.1



15.3

15.2



16.1



16.2



16.3



17.1



17.2



17.3



18.1



18.2



18.3



(11) DM/200 374

(15) 2018 12 12

(22) 2018 12 12

(28) 3

(73) HARRY WINSTON SA

Chemin Du Tourbillon 8, 1228 Plan-Les-Ouates (CH)

(85) CH

(86) CH

(87) CH

(88) CH

(89) CH

(81) II. BZ, MA III. UA, AM, AL, AZ, ME, MD, MC, SG, NO, MN, BA, MK, OM, TR, GE, LI, KG, GB, TN, EM, CH

(72) 1. Delphine ABDOURAHIM

C/o Harry Winston Inc. 718 Fifth Avenue, 10019 New York (US);

2. Chaeree KWON

C/o Harry Winston Inc. 718 Fifth Avenue, 10019 New York (US);

3. Rie YATSUGI-KANG

C/o Harry Winston Inc. 718 Fifth Avenue, 10019 New York (US)

(74) The Swatch Group AG (The Swatch Group SA) (The Swatch Group Ltd.)

Faubourg Du Lac 6, 2501 BIEL/BIENNE (CH)

(54) 1.-3. Finger ring

(55)

(51) 11-01

(44) 13/2019 (2019 03 29)

1.1



1.2



1.3



1.4



1.5



1.6



1.7



1.8



2.1



2.2



2.3



2.4



2.5



2.6



2.7



2.8



3.1



3.2



3.3



3.4



3.5



3.6



(11) DM/103 359

(15) 2018 10 12

(22) 2018 10 12

(28) 4

(85) –

(86) JP

(87) –

(88) –

(89) JP

(81) III. ES, HU, IS, MN, PL, GB, LT, KR, FR, BN, AL, LV, HR, TM, MC, SG, NA, DE, BA, MK, LI, KG, FI, RU, EG, AM, MD, TJ, BW, GH, ST, TR, KH, TN, KP, CH, UA, AZ, ME, SI, OA, RS, NO, EE, GE, OM, RO, EM, DK, SY, BG, RW

(72) Kenzo MATSUMURA

C/o Hazuki Company Kabushiki Kaisha, 10-1, Roppongi 6-chome, Minato-ku, Tokyo (JP)

(74) Shuya KOHHARA

Acropolis 21 Bldg, 8th Floor, 4-10, Higashi Nihonbashi 3-chome, Chuo-Ku Tokyo (JP)

(54) 1.-4. Magnifying eyeglasses

(55)

(51) 16-06

(44) 15/2019 (2019 04 12)

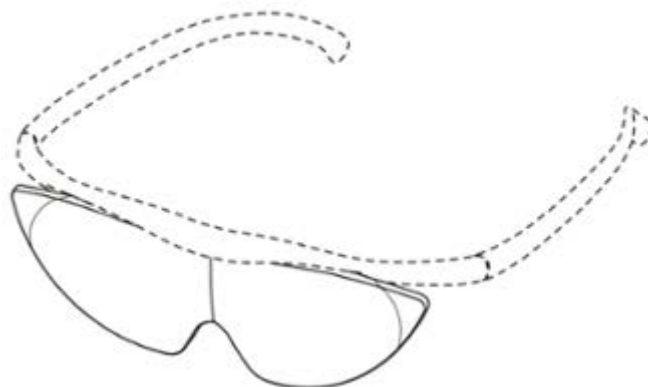
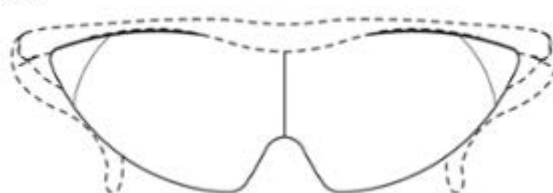
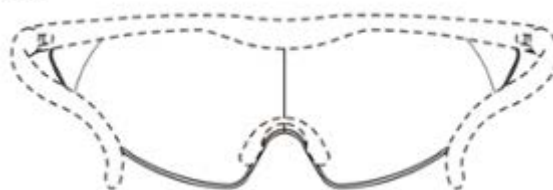
1.1**1.2****1.3**

1.4



1.5



1.6

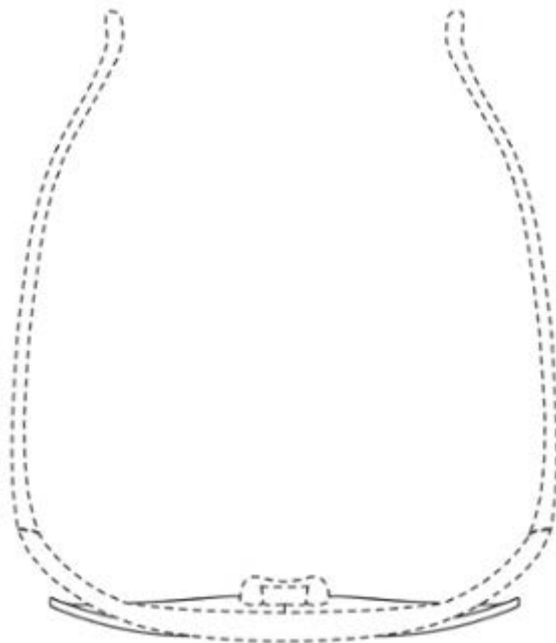

1.7

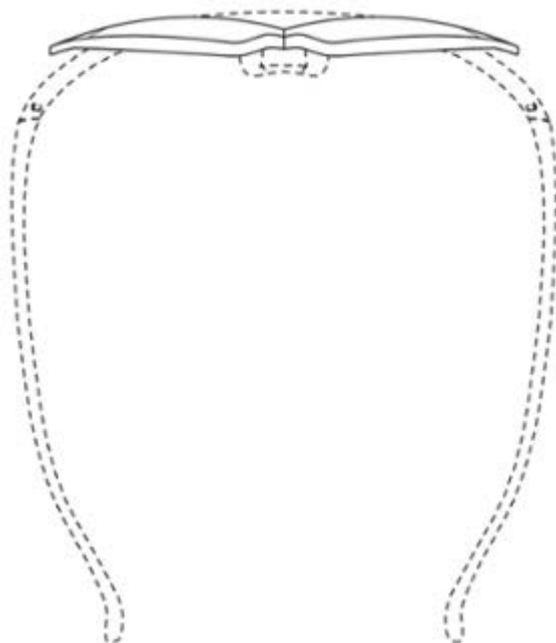

1.8

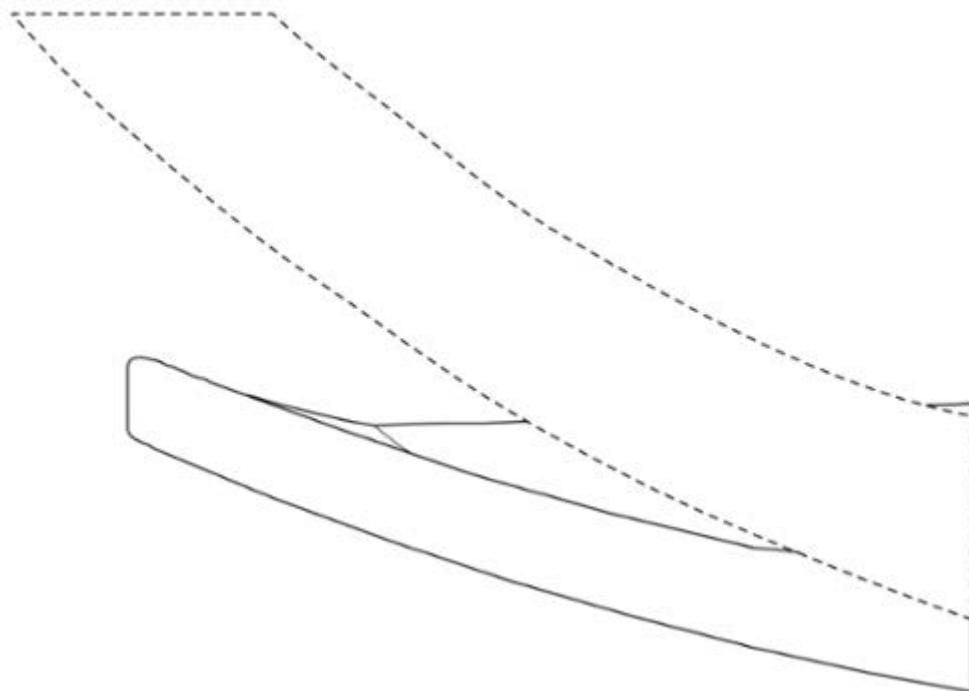

1.9

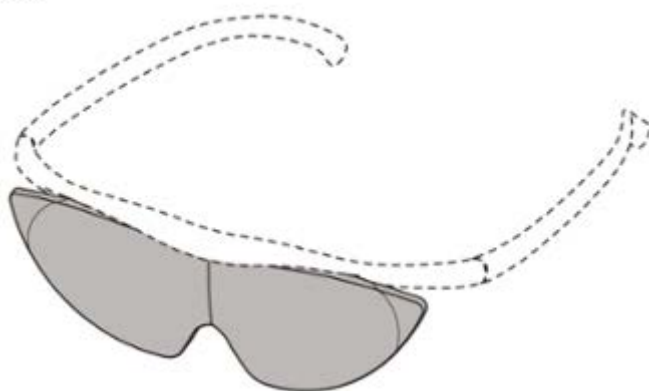

1.10

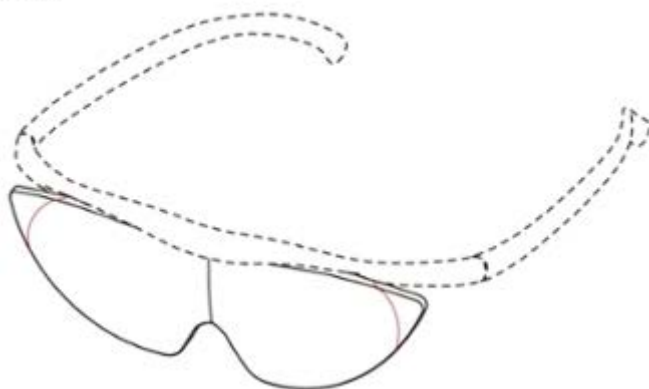

2.1

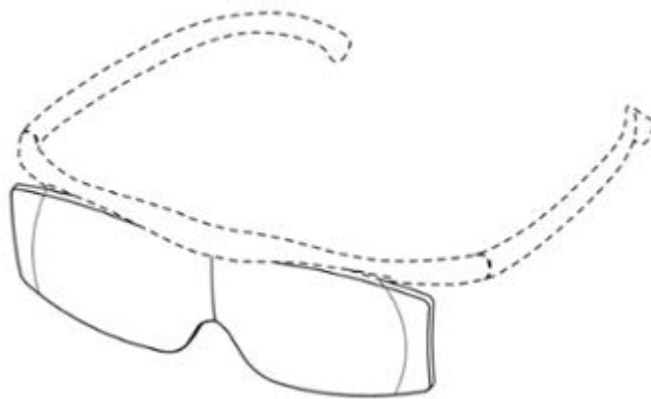

2.2

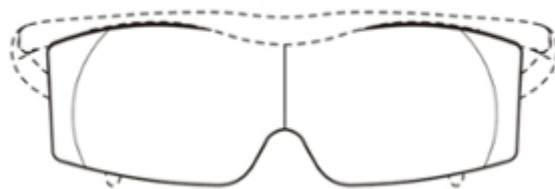

2.3

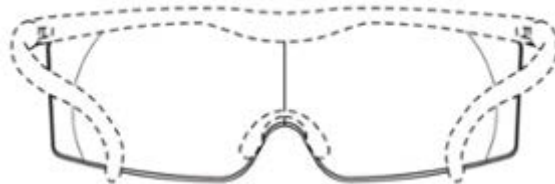

2.4



2.5



2.6

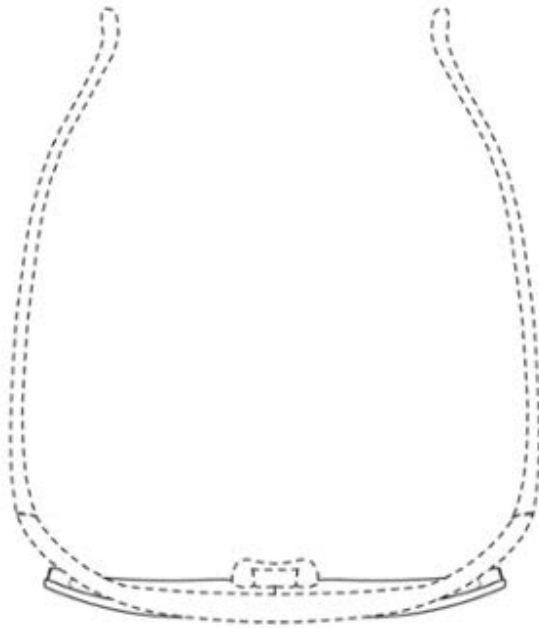

2.7

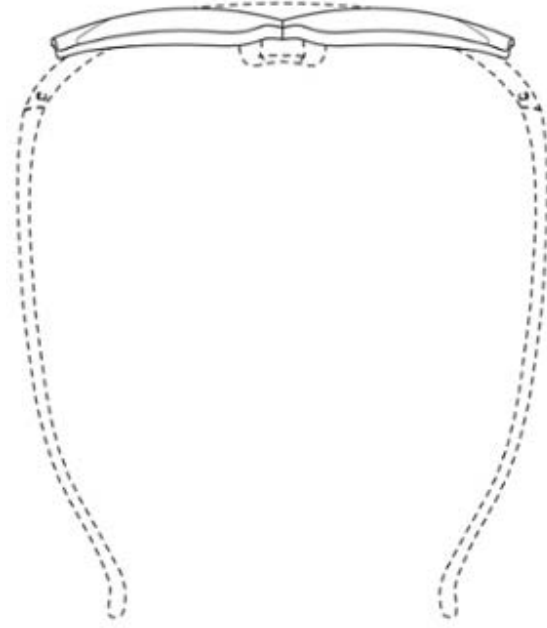

2.8

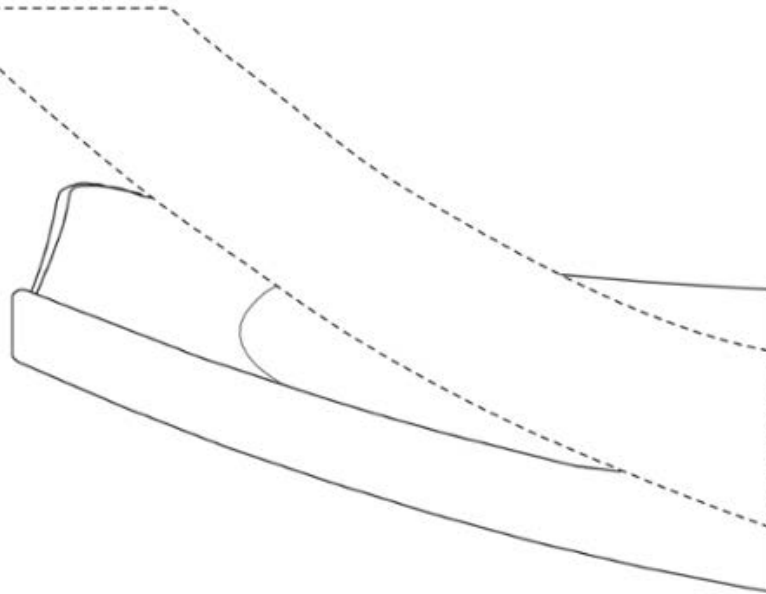

2.9

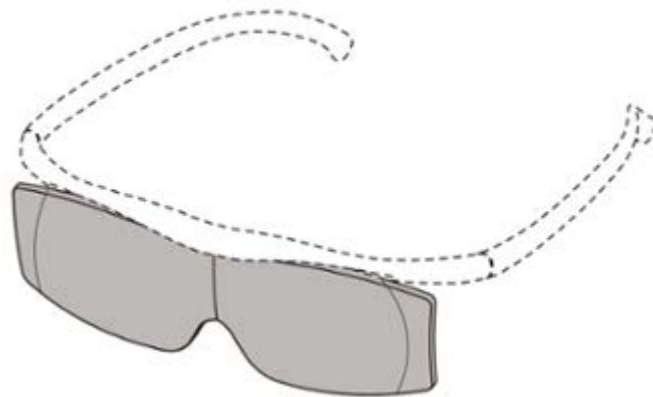

2.10

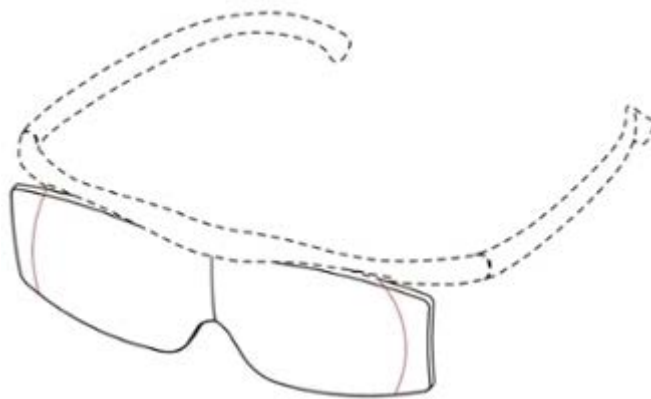

3.1

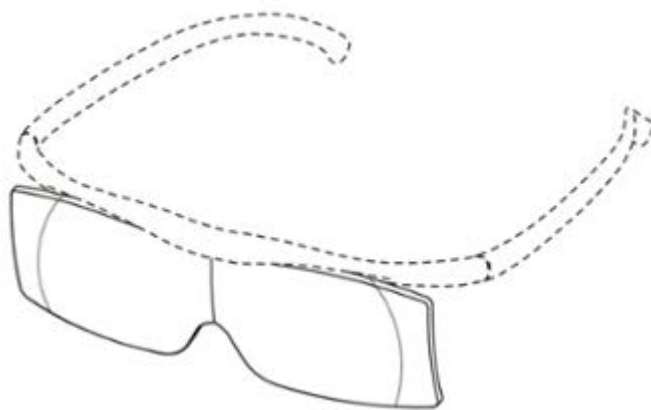

3.2

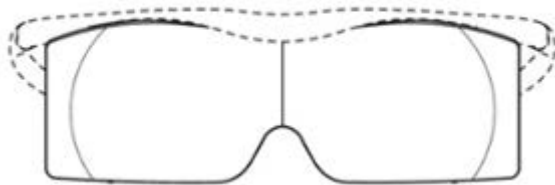

3.3

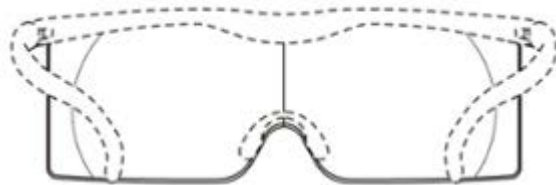

3.4



3.5



3.6

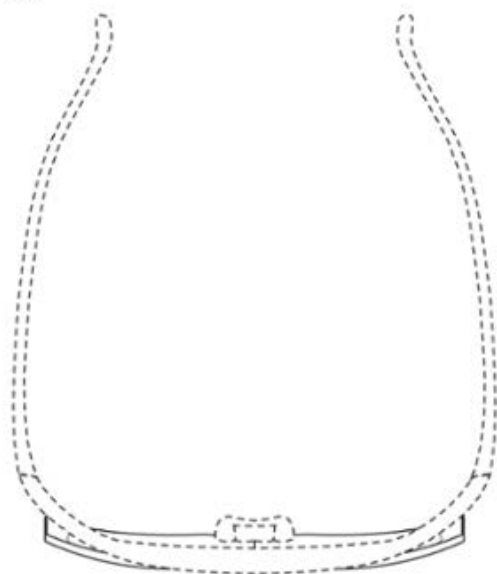

3.7

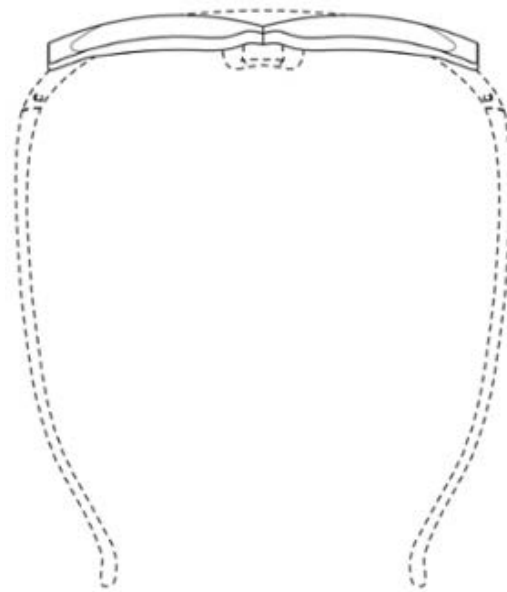

3.8

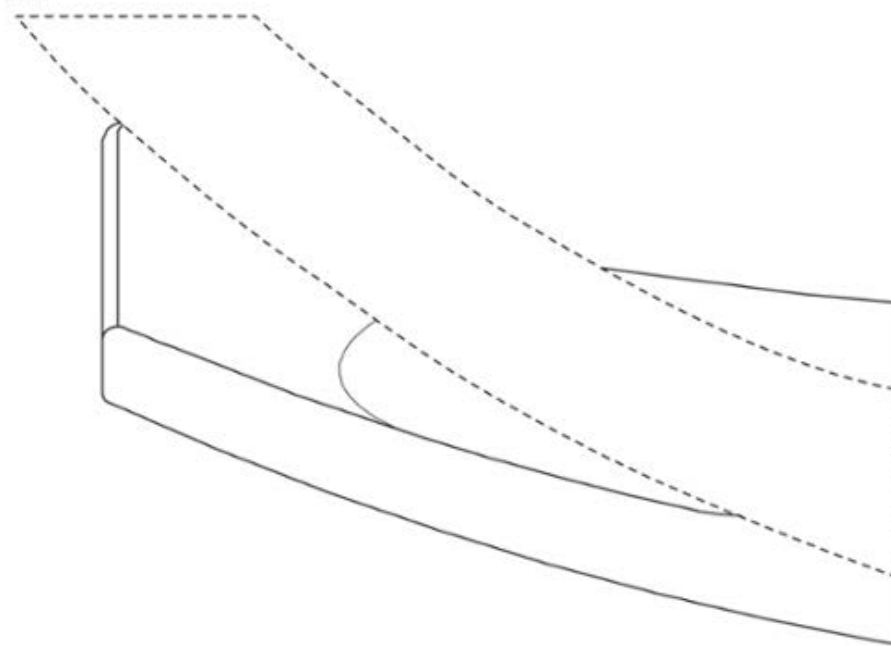

3.9

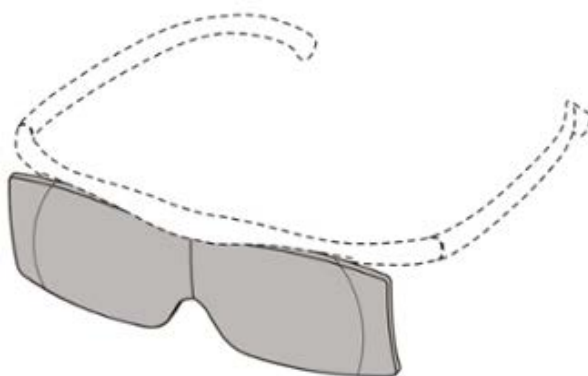

3.10

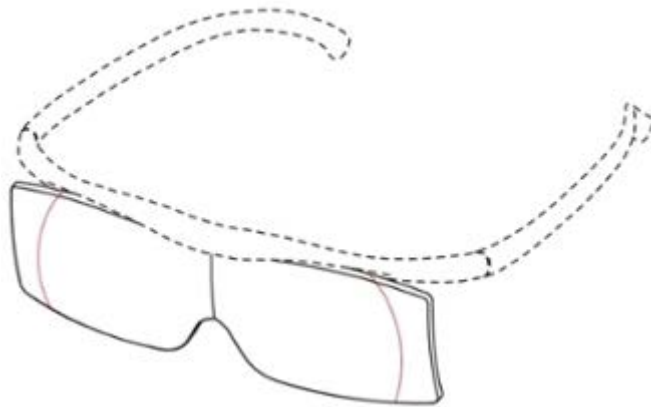

4.1

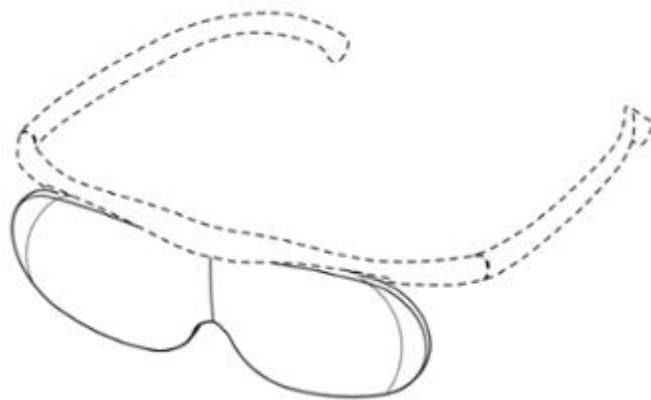

4.2

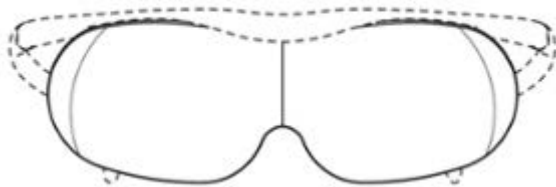

4.3

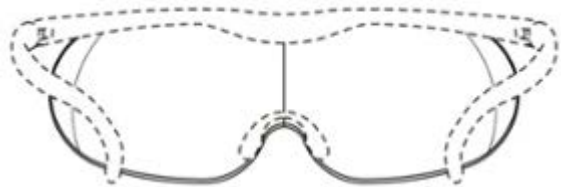

4.4



4.5



4.6

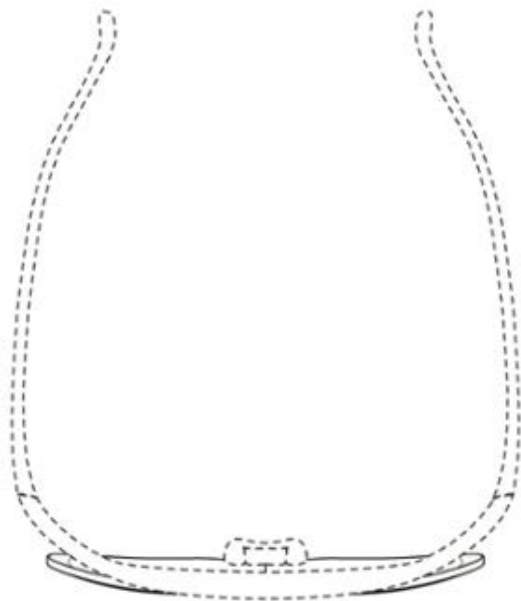

4.7

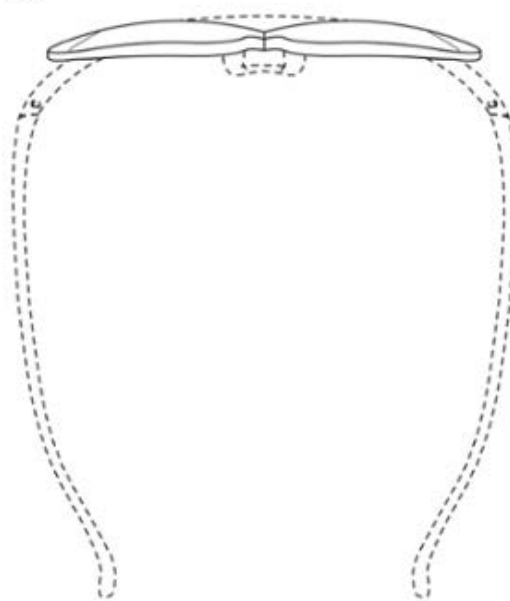

4.8

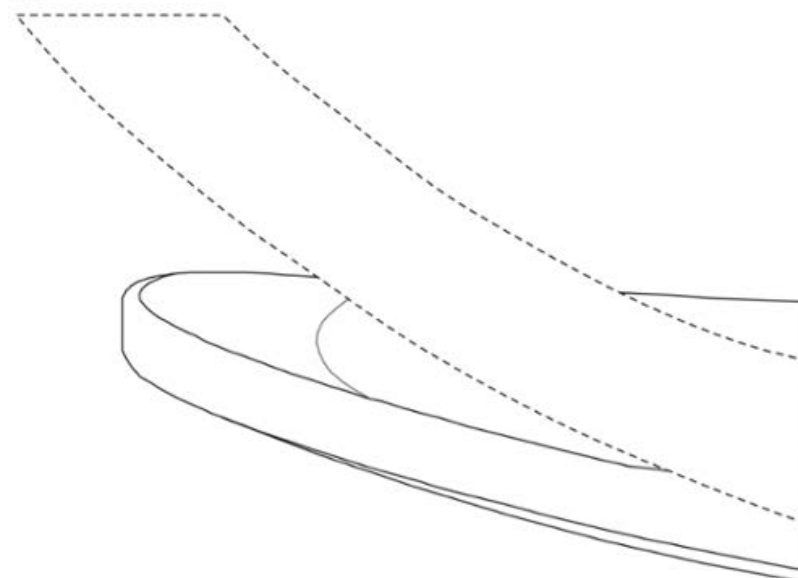

4.9

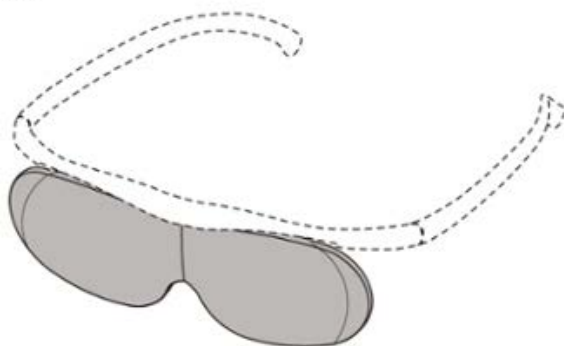

4.10

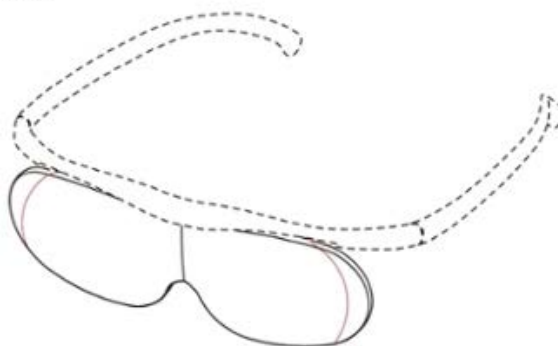

(11) DM/103 724

(15) 2018 10 12

(22) 2018 10 12

(28) 1

(73) Volka Entertainment Limited

Spyrou Kyprianou Ave 15, Mesa Geitonia Limassol, CY-4001 (EM)

(85) EM

(86) EM

(87) EM

(88) EM

(89) EM

(81) III. NO, TR, GE, UA, EM, KR, JP, CH, KP, SG, RU

(72) VOLKA ENTERTAINMENT LIMITED

15 Spyrou Kyprianou Ave, Mesa Geitonia, Limassol, 4001 Limasol (CY)

(54) 1. Cuddly toy

(55)

(51) 21-01

(44) 15/2019 (2019 04 12)

1.2

1.1



1.3



1.4



1.5



1.6



TRADEMARKS

APPLICATIONS FILED UNDER THE NATIONAL PROCEDURE APPROVED FOR REGISTRATION

The decision can be appealed at the Chamber of Appeal of Sakpatenti within 3 months from the publication or at the Mtskheta District Court Administrative Cases Board (Address: №17, Samkhedro St., Mtskheta), within 1 month following the publication.

(260) AM 2019 100000 A
(210) AM 100000
(220) 2018 10 23
(731) LTD "AVERSI-PHARMA"
D. Aghmashenebeli Av. 148/2, 0112,
Tbilisi, Georgia
(540)

ტრისენა
Трисена
Trisena

(591) Black, white
(511) 5

(260) AM 2019 100003 A
(210) AM 100003
(220) 2018 10 23
(731) LTD "AVERSI-PHARMA"
D. Aghmashenebeli Av. 148/2, 0112,
Tbilisi, Georgia
(540)

ტამერი
Тамер
Tamer

(591) Black, white
(511) 5

(260) AM 2019 100001 A
(210) AM 100001
(220) 2018 10 23
(731) LTD "Georgian Wine House"
Village Zegaani, 1500, Gurjaani district,
Georgia
(740) Sopio Vacheishvili
(540)

მიდიოთელი
MIDITELI
Мидители

(591) Black, white
(511) 33

(260) AM 2019 100004 A
(210) AM 100004
(220) 2018 10 23
(731) LTD "AVERSI-PHARMA"
D. Aghmashenebeli Av. 148/2, 0112,
Tbilisi, Georgia
(540)

ვილტარი
Вилтар
Viltar

(591) Black, white
(511) 5

(260) AM 2019 100002 A
(210) AM 100002
(220) 2018 10 23
(731) LTD "AVERSI-PHARMA"
D. Aghmashenebeli Av. 148/2, 0112,
Tbilisi, Georgia
(540)

პენემა
Пенема
Penema

(591) Black, white
(511) 5

(260) AM 2019 100006 A
(210) AM 100006
(220) 2018 10 23
(731) LTD "AVERSI-PHARMA"
D. Aghmashenebeli Av. 148/2, 0112,
Tbilisi, Georgia
(540)

ასტრილი
Астрил
Astril

(591) Black, white
(511) 5

(260) AM 2019 100008 A
 (210) AM 100008
 (220) 2018 10 23
 (731) LTD "AVERSI-PHARMA"
 D. Aghmashenebeli Av. 148/2, 0112,
 Tbilisi, Georgia
 (540)

გლორნიდი
Глорнид
Glornid

(591) Black, white
 (511) 5

(260) AM 2019 100019 A
 (210) AM 100019
 (220) 2018 10 23
 (731) LTD "AVERSI-PHARMA"
 D. Aghmashenebeli Av. 148/2, 0112,
 Tbilisi, Georgia
 (540)

აზბერგინი
Азбергин
Azbergin

(591) Black, white
 (511) 5

(260) AM 2019 100020 A
 (210) AM 100020
 (220) 2018 10 23
 (731) LTD "AVERSI-PHARMA"
 D. Aghmashenebeli Av. 148/2, 0112,
 Tbilisi, Georgia
 (540)

მადერინი
Мадерин
Maderin

(591) Black, white
 (511) 5

(260) AM 2019 100042 A
 (210) AM 100042
 (220) 2018 10 25
 (731) LTD "GMP"
 Village Ponitchala 65, 0165, Tbilisi,
 Georgia
 (740) Nugzar Ksovreli

(540)
კარდიოასმაგნე
КАРДИОАСМАГНЕ
CARDIOASMAGNE

(591) Black, white
 (511) 5

(260) AM 2019 100051 A
 (210) AM 100051
 (220) 2018 10 29
 (731) Royal Dutch Brands FZC
 Business Centre, Al Shmookh Building,
 UAQ Free Trade Zone, Umm Al Quwain,
 U.A.E., United Arab Emirates
 (740) Giorgi Taktakishvili
 (540)

CHELSEA 

(591) Black, white
 (531) 03.01.02; 26.04.03; 27.05.01
 (511) 33

(260) AM 2019 100074 A
 (210) AM 100074
 (220) 2018 11 02
 (731) LTD "Find Counseling"
 Petre Gamkrelidze St. 1b, Nadzaladevi
 district, 0178, Tbilisi, Georgia
 (540)



(591) Blue, white, yellow
 (531) 26.04.02; 26.04.05; 26.04.22; 26.04.24;
 26.11.08; 26.11.12; 27.05.10; 27.05.11;
 27.05.24; 29.01.13
 (526) FURNITURE & ACCESSORIES
 (511) 20, 21, 24

(260) AM 2019 100075 A
 (210) AM 100075
 (220) 2018 11 03

(731) LTD "AISI"
Varketili 3, I mkr., Bl. 28, ap. 26, 0163,
Tbilisi, Georgia

(540)

UNIX
ОУБОН
ЮНИКС

(511) 2

(260) AM 2019 100080 A
(210) AM 100080
(220) 2018 11 06
(731) Pharmacia & Upjohn Company LLC
7000 Portej Roud, Kalamazoo,
MI 49001, USA

(740) Shalva Gvaramadze

(540)

UPJOHN

(591) Black, white

(511) 5

(260) AM 2019 100081 A
(210) AM 100081
(220) 2018 11 06
(731) Pharmacia & Upjohn Company LLC
7000 Portej Roud, Kalamazoo,
MI 49001, USA

(740) Shalva Gvaramadze

(540)

UPJOHN

(591) Black, white

(511) 44

(260) AM 2019 100086 A
(210) AM 100086
(220) 2018 11 06
(731) Zenpia Co., Ltd
2F, Etang Bldg., Hakdong-ro 11-gil 6,
Gangnam-Gu, Seoul, Republic of Korea;
Jin Oh JOUNG
N105-2802, 12, Yeongdong-daero 138-gil,
Gangnam-gu, Seoul, Republic of Korea

(740) Giorgi Kartvelishvili

(540)

secret Key

(591) Black, white

(511) 3

(260) AM 2019 100091 A

(210) AM 100091

(220) 2018 11 07

(731) Kalesan Sağlık ve Hijyen Ürünleri Sanayi
ve Ticaret Limited Şirketi
3.Organize Sanayi Bölgesi, Kamil Şerbetçi
Bulvarı, No.46, Şehitkamil/Gaziantep,
Turkey

(740) Pavle Meipariani



(591) Blue, sky-blue, yellow, white

(531) 26.11.02; 26.11.12; 27.05.03; 29.01.13

(511) 3,5

(260) AM 2019 100093 A

(210) AM 100093

(220) 2018 11 07

(731) Kalesan Sağlık ve Hijyen Ürünleri Sanayi
ve Ticaret Limited Şirketi
3.Organize Sanayi Bölgesi, Kamil Şerbetçi
Bulvarı, No.46, Şehitkamil/Gaziantep,
Turkey

(740) Pavle Meipariani

(540)

SOFT LOVE

(591) Black, white

(511) 3

(260) AM 2019 100097 A

(210) AM 100097

(220) 2018 11 08

(731) Evrodrag Laboratoris B.v.
Regulusweg 11, 2516 AC The Hague,
The Netherlands

(740) Tamaz Shilakadze

(540)

DEFLACORTIN

(591) Black, white

(511) 5

(260) AM 2019 100368 A

(210) AM 100368

(220) 2018 11 09

(731) LTD "Tiflis Piazza"
Zurab and Teimuraz Zaldastanishvili St. 16,
0177, Tbilisi Georgia

(540)

ტიფლის პიაცა
tiflis piazza

(591) Black, white

(526) ტიფლის, tiflis

(511) 37, 43

(260) AM 2019 100379 A

(210) AM 100379

(220) 2018 11 12

(731) A&E Television Networks LLC
235 East 45th Street, New York, New York
10017, USA

(740) Natela Otariidze

(540)



(591) Yellow, golden, red, black

(531) 26.11.08; 27.05.11; 27.05.12; 27.05.21;
27.07.01; 27.07.03; 27.07.11; 29.01.14

(511) 38

(260) AM 2019 100380 A

(210) AM 100380

(220) 2018 11 12

(731) LTD "Bolero & Company"
Marshal Gelovani Av. 13, floor 9,
0159, Tbilisi, Georgia

(540)

ჩიორა
ЧИОРА
CHIORA

(591) Black, white

(511) 33

(260) AM 2019 100387 A

(210) AM 100387

(220) 2018 11 12

(731) LTD "Bolero & Company"
Marshal Gelovani Av. 13, floor 9,
0159, Tbilisi, Georgia

(540)

(591) Red, yellow, white, black, green, orange,
gray, pink, blue, sky-blue(531) 02.01.20; 02.01.21; 03.03.02; 06.07.01;
06.07.02; 06.07.04; 06.07.08; 06.07.25;
07.01.10; 07.01.12; 25.01.19; 28.05; 29.01.15

(511) 33

(260) AM 2019 100388 A

(210) AM 100388

(220) 2018 11 12

(731) LTD "Bolero & Company"
Marshal Gelovani Av. 13, floor 9,
0159, Tbilisi, Georgia

(540)



- (591) Red, yellow, white, black, green, orange,
gray, pink, blue, sky-blue
(531) 02.01.11; 02.01.23; 03.03.02; 06.07.01;
06.07.02; 06.07.04; 06.07.25; 07.01.09;
07.01.12; 25.01.19; 29.01.15
(511) 33

- (260) AM 2019 100391 A
(210) AM 100391
(220) 2018 11 13
(731) Vakhtang Pkhakadze
Il. Chavchavadze Av. 78, Bl. 1, ap.4,
0162, Tbilisi, Georgia
(740) Giorgi Taktakishvili
(540)



- (591) Golden, black
(531) 09.01.10; 24.09.07; 24.09.10; 27.05.24;
29.01.12
(511) 3, 35, 44

- (260) AM 2019 100392 A
(210) AM 100392
(220) 2018 11 13
(731) Vakhtang Pkhakadze
Il. Chavchavadze Av. 78, Bl. 1, ap.4,
0162, Tbilisi, Georgia
(740) Giorgi Taktakishvili
(540)

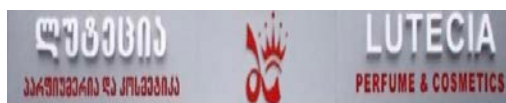

- (591) White, red, grey
(531) 09.01.10; 24.09.07; 24.09.10; 26.04.02;
26.04.22; 27.05.10; 27.05.21; 29.01.13
(511) 3, 35, 44

- (260) AM 2019 100396 A
(210) AM 100396
(220) 2018 11 14
(731) Giorgi Kikabidze
Il. Chavchavadze Av. 54a, 0179,
Tbilisi, Georgia
(740) Giorgi Taktakishvili

(540)



- (591) White, golden
(531) 05.07.10; 24.01.03; 24.01.10; 24.01.15;
25.01.05; 29.01.12
(511) 32, 33, 43

- (260) AM 2019 100398 A
(210) AM 100398
(220) 2018 11 14
(731) Facebook, Inc. (a Delaware corporation)
1601 Willow Road, Menlo Park California,
94025, USA
(740) Tamr Kochlamazashvili
(540)



- (591) Black, white
(531) 26.01.01; 26.01.03; 26.01.18
(511) 9, 35, 36, 38, 41, 42, 45

- (260) AM 2019 100400 A
(210) AM 100400
(220) 2018 11 14
(731) CORPORACION HABANOS S.A.
Carretera Vieja de Guanabacoa y Linea
del Ferrocarril Final, Guanabacoa,
La Habana, Cuba
(740) Tamaz Shilakadze
(540)



- (591) Black, brown, light brown, dark brown,
white, yellow, green, red

(531) 02.01.01; 02.01.19; 02.01.30; 05.01.12;
05.13.08; 06.01.02; 06.19.09; 06.19.16;
10.01.03; 24.01.18; 27.05.10; 29.01.14
(511) 34

(260) AM 2019 100411 A
(210) AM 100411
(220) 2018 11 16
(731) LTD "L COMPANY"
Gldani, VII mkr., Bl. 15, ap. 39, Tbilisi,
Georgia
(540)

UBICAR

(591) Black, white
(511) 5

(260) AM 2019 100412 A
(210) AM 100412
(220) 2018 11 16
(731) LTD "L COMPANY"
Gldani, VII mkr., Bl. 15, ap. 39, Tbilisi,
Georgia
(540)

DORADO

(591) Black, white
(511) 5

(260) AM 2019 100413 A
(210) AM 100413
(220) 2018 11 16
(731) LTD "L COMPANY"
Gldani, VII mkr., Bl. 15, ap. 39, Tbilisi,
Georgia
(540)

SERAZIN

(591) Black, white
(511) 5

(260) AM 2019 100431 A
(210) AM 100431
(220) 2018 11 20
(731) Chongqing Hwasdan Machinery
Manufacturing Co., Ltd
Xipeng Industrial Zone, Jiulongpo District,
Chongqing City, China
(740) Shalva Gvaramadze
(540)

HWA DAN

(591) Black, white, grey
(531) 26.11.13; 27.01.13; 27.05.09; 27.05.25

(511) 7

(260) AM 2019 100460 A
(210) AM 100460
(220) 2018 11 22
(731) NIPPON PISTON RING CO., LTD
5-12-10, Honmachi-Higashi, Chuo-ku,
Saitama City, Saitama, Japan
(740) Shalva Gvaramadze
(540)

NPR

(591) Black, white
(511) 7, 12

(260) AM 2019 100584 A
(210) AM 100584
(220) 2018 11 23
(731) LTD "Autotest Georgia"
Vil. Dighomi, Thirteen Asureli Fathers
St. 128, 0159, Tbilisi, Georgia
(540)

არ ავნო

(591) Black, white
(511) 37, 42

(260) AM 2019 100585 A
(210) AM 100585
(220) 2018 11 23
(731) LTD "Autotest Georgia"
Vil. Dighomi, Thirteen Asureli Fathers
St. 128, 0159, Tbilisi, Georgia
(540)

ar avno

(591) Black, white
(511) 37, 42

(260) AM 2019 100793 A
(210) AM 100793
(220) 2018 12 14
(731) LTD "Chigogidze Wine"
Jorbenadze St. 31, Isani-Samgori district,
0103, Tbilisi, Georgia
(540)



CHIGOGIDZE

GEORGIAN SPIRIT

(591) Black, golden, white

(260) AM 2019 99760 A
 (210) AM 99760
 (220) 2018 10 09
 (731) LTD "G-M-T Mtatsminda"
 Freedom Square 4, 0105, Tbilisi Georgia
 (740) Gocha Gogishvili;
 Rati Chantladze
 (540)



(591) Black, red, white
 (531) 02.01.01; 02.01.11; 11.01.02; 28.19; 29.01.13
 (511) 43

(260) AM 2019 99764 A
 (210) AM 99764
 (220) 2018 10 09
 (731) LTD "G-M-T Mtatsminda"
 Freedom Square 4, 0105, Tbilisi Georgia
 (740) Gocha Gogishvili;
 Rati Chantladze
 (540)



(591) Black, red, white
 (531) 02.01.01; 02.01.11; 11.01.02; 27.01.12;
 27.05.10; 29.01.13
 (511) 43

(260) AM 2019 99765 A
 (210) AM 99765
 (220) 2018 10 09
 (731) LTD "G-M-T Mtatsminda"
 Freedom Square 4, 0105, Tbilisi Georgia
 (740) Gocha Gogishvili;
 Rati Chantladze
 (540)



(591) Black, red, white
 (531) 27.05.10; 28.19; 29.01.12
 (511) 43

(260) AM 2019 99767 A
 (210) AM 99767
 (220) 2018 10 09
 (731) LTD "G-M-T Mtatsminda"
 Freedom Square 4, 0105, Tbilisi Georgia
 (740) Gocha Gogishvili;
 Rati Chantladze
 (540)



(591) Black, white
 (531) 28.05; 28.19
 (511) 30, 43

(260) AM 2019 99768 A
 (210) AM 99768
 (220) 2018 10 09
 (731) LTD "G-M-T Mtatsminda"
 Freedom Square 4, 0105, Tbilisi Georgia
 (740) Gocha Gogishvili;
 Rati Chantladze
 (540)



(591) Black, white
 (531) 27.05.01; 27.05.10
 (511) 30, 43

(260) AM 2019 99770 A
 (210) AM 99770
 (220) 2018 10 09
 (731) LTD "G-M-T Mtatsminda"
 Freedom Square 4, 0105, Tbilisi Georgia
 (740) Gocha Gogishvili;
 Rati Chantladze
 (540)

რიგო
RIGI

(591) Black, white
 (511) 43

(260) AM 2019 99772 A
 (210) AM 99772
 (220) 2018 10 09
 (731) LTD "G-M-T Mtatsminda"
 Freedom Square 4, 0105, Tbilisi Georgia
 (740) Gocha Gogishvili;
 Rati Chantladze
 (540)

გასტრონომიული
 ღუძენი რიგო
GASTRONOMIC DOUQAN RIGI

(591) Black, white
 (511) 43

(260) AM 2019 99775 A
 (210) AM 99775
 (220) 2018 10 10
 (731) Al Saidu Commerce & Industry Tobacco
 A Shoha bemelk Sobh Abu Alenien Abu
 Alenien Alfar, Mansoura Center,
 Al Dakahleya, Egypt
 (740) Merab Kvimsadze
 (540)



الأسطورة

(591) Red, golden, brown, black, white
 (531) 03.07.17; 03.07.19; 26.05.01; 26.05.22;
 26.05.24; 27.05.24; 28.01; 29.01.15
 (511) 34

(260) AM 2019 99778 A
 (210) AM 99778
 (220) 2019 03 25
 (731) LTD Georgian-American Center for

Reproductive Medicine "REPROART"
 Vazha-Pshavela Av. 32, ap. 3, Tbilisi, 0177,
 Georgia

(540)



(591) Blue, black, white
 (531) 27.05.15; 27.05.21; 28.19; 29.01.12
 (511) 44

(260) AM 2019 99779 A
 (210) AM 99779
 (220) 2018 10 11
 (731) JOHNSON & JOHNSON
 ONE JOHNSON & JOHNSON PLAZA
 New Brunswick, New Jersey
 08933, USA
 (740) Giorgi Taktakishvili
 (540)

ACUVUE

(591) Black, white
 (511) 5

(260) AM 2019 99862 A
 (210) AM 99862
 (220) 2018 10 12
 (731) LTD "ALTA"
 Akaki Beliashvili St. 104, 0159, Tbilisi
 Georgia
 (540)

ახსავშითი iSupport

(591) Lilac, black, white
 (531) 27.05.01; 28.19
 (511) 35, 37, 42

(260) AM 2019 99870 A
 (210) AM 99870
 (220) 2018 10 16
 (731) LTD "G-M-T Mtatsminda"
 Freedom Square 4, 0105, Tbilisi Georgia
 (740) Gocha Gogishvili;
 Rati Chantladze
 (540)



(591) Black, white
 (531) 07.01.01; 07.01.24; 07.03.04; 27.05.01;
 27.05.10
 (511) 43

(260) AM 2019 99871 A
 (210) AM 99871
 (220) 2018 10 16
 (731) LTD "G-M-T Mtatsminda"
 Freedom Square 4, 0105, Tbilisi Georgia
 (740) Gocha Gogishvili;
 Rati Chantladze
 (540)



(591) Black, white
 (531) 07.01.01; 07.01.24; 07.03.04; 28.19
 (511) 43

(260) AM 2019 99887 A
 (210) AM 99887
 (220) 2018 10 17
 (731) N(N)LE "Association IDS Borjomi"
 Thori St. 39, 1200, Borjomi, Georgia
 (540)



(554) Three-dimensional
 (591) Blue, gray, white, red, sky-blue
 (531) 02.03.01; 02.03.16; 06.01.02; 06.01.04;
 19.07.01; 29.01.14
 (526) ბაკურიანი
 (511) 5, 32, 35

(260) AM 2019 99890 A
 (210) AM 99890
 (220) 2018 10 17
 (731) LTD "G-M-P"
 Village Ponitchala 65, 0165, Tbilisi, Georgia
 (740) Nugzar Ksovreli
 (540)

პოლი სოლი
ПОЛИ СОЛ
POLY SOL

(591) Black, white
 (511) 5

(260) AM 2019 99891 A
 (210) AM 99891
 (731) LTD "G-M-P"
 Village Ponitchala 65, 0165, Tbilisi, Georgia
 (740) Nugzar Ksovreli
 (540)

მონსერა
МОНСЕРА
MONSERA

(591) Black, white
 (511) 5

(260) AM 2019 99894 A
 (210) AM 99894
 (220) 2018 10 18
 (731) PROTEOS BIOTECH S.L.
 Calle Almansa 14, Albacete, 02006, Spain
 (740) Khatuna Imnadze
 (540)

PB Serum

(591) Black, white
 (531) 27.05.04; 27.05.10
 (511) 3

(260) AM 2019 99897 A
 (210) AM 99897
 (220) 2018 10 18
 (731) ADAMA MAKHTESHIM LTD
 P.O. Box 60, Beer Sheva 8410001, Israel
 (740) Merab Kvimsadze
 (540)

AREVA GOLD

(591) Black, white
(511) 5

(260) AM 2019 99907 A
(210) AM 99907
(220) 2018 10 18

731) ADAMA MAKHTESHIM LTD
P.O. Box 60, Beer Sheva 8410001, Israel
(740) Merab Kvimsadze
(540)

BELVEDERE

(591) Black, white
(511) 5

(260) AM 2019 99908 A
(210) AM 99908
(220) 2018 10 18

731) ADAMA MAKHTESHIM LTD
P.O. Box 60, Beer Sheva 8410001, Israel
(740) Merab Kvimsadze
(540)

MISTRAL

(591) Black, white
(511) 5

(260) AM 2019 99909 A
(210) AM 99909
(220) 2018 10 18

731) ADAMA MAKHTESHIM LTD
P.O. Box 60, Beer Sheva 8410001, Israel
(740) Merab Kvimsadze
(540)

GALIGAN

(591) Black, white
(511) 5

(260) AM 2019 99912 A
(210) AM 99912
(220) 2018 10 19

(731) Pfizer Inc.
235 East 42nd Street, New York, New York
10017, USA
(740) Shalva Gvaramadze
(540)

STAQUIS

(591) Black, white
(511) 5

(260) AM 2019 99914 A
(210) AM 99914
(220) 2018 10 19
(731) LLC "EUROCHEKHOL"

1 Magistralny tupik, 5a, Pom. 6, Moscow,
123290, Russian Federation

(740) Tamr Kochlamazashvili
(540)



(591) White, crimson
(531) 12.01.09; 12.01.10; 26.13.25; 28.19; 29.01.12
(511) 24, 35

(260) AM 2019 99939 A
(210) AM 99939
(220) 2018 10 19

(731) Jinhua Kufiqstuls Ai&i Ko., Ltd
4/F, Building 1, No.98, Tangshan Road,
Economic Development Area, Yongkang
City, Zhejiang Province, China
(740) Giorgi Kartvelishvili
(540)



(591) Grey, black, white
(531) 15.07.01; 26.03.23; 26.05.01; 26.05.02;
27.03.15
(511) 7

(260) AM 2019 99955 A
(210) AM 99955
(220) 2018 10 22

(731) CORPORACION HABANOS S.A
Carretera Vieja de Guanabacoa y Linea del
Ferrocarril Final, Guanabacoa, La Habana,
Cuba
(740) Tamaz Shilakadze
(540)



(591) Red, light red, yellow, dark yellow, light green, green, sky-blue, brown, light brown, white, black, light and dark tobacco colors
 (531) 02.07.02; 05.01.12; 06.07.07; 06.07.08; 06.07.25; 07.01.09; 24.01.05; 24.05.07; 29.01.15
 (511) 34

(260) AM 2019 99963 A
 (210) AM 99963
 (220) 2018 10 22
 (731) (731) CORPORACION HABANOS S.A
 Carretera Vieja de Guanabacoa y Linea del Ferrocarril Final, Guanabacoa, La Habana, Cuba
 (740) Tamaz Shilakadze
 (540)



(591) Black, white, green
 (531) 05.03.14; 26.04.22; 27.05.01; 27.05.11; 27.05.21; 27.05.24
 (511) 34

(260) AM 2019 99965 A
 (210) AM 99965
 (220) 2018 10 22
 (731) (731) CORPORACION HABANOS S.A
 Carretera Vieja de Guanabacoa y Linea del Ferrocarril Final, Guanabacoa, La Habana, Cuba
 (740) Tamaz Shilakadze
 (540)

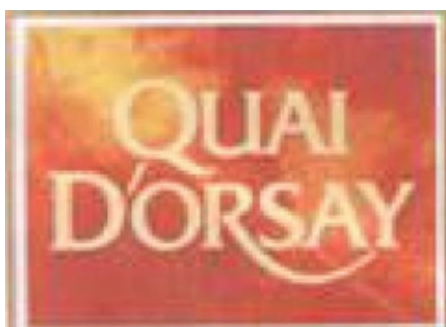

(591) Dark red, light red, dark yellow, light yellow, white
 (531) 25.01.10; 26.04.07; 26.04.24; 27.05.02; 27.05.24; 29.01.13
 (511) 34

(260) AM 2019 99977 A
 (210) AM 99977
 (220) 2018 10 23
 (731) LTD "AVERSI-PHARMA"
 D. Aghmashenebeli Av. 148/2, 0112, Tbilisi, Georgia
 (540)

უვერტისტი
Увертист
Uvertist

(591) Black, white
 (511) 5

(260) AM 2019 99978 A
 (210) AM 99978
 (220) 2018 10 23
 (731) LTD "AVERSI-PHARMA"
 D. Aghmashenebeli Av. 148/2, 0112, Tbilisi, Georgia
 (540)

ავიდენტი
Авидент
Avident

(591) Black, white
 (511) 5

(260) AM 2019 99985 A
 (210) AM 99985
 (220) 2018 10 23
 (731) LTD "AVERSI-PHARMA"
 D. Aghmashenebeli Av. 148/2, 0112, Tbilisi, Georgia
 (540)

პანტოზუმი
Пантозум
Pantozoom

(591) Black, white
 (511) 5

(260) AM 2019 99986 A
 (210) AM 99986
 (220) 2018 10 23
 (731) LTD "AVERSI-PHARMA"
 D. Aghmashenebeli Av. 148/2, 0112, Tbilisi, Georgia
 (540)

მონოკლი
Монокл
Monocl

(591) Black, white
(511) 5

(260) AM 2019 99988 A
(210) AM 99988
(220) 2018 10 23
(731) LTD "AVERSI-PHARMA"
D. Aghmashenebeli Av. 148/2, 0112,
Tbilisi, Georgia
(540)

ლიბინი
Либин
Libin

(591) Black, white
(511) 5

(260) AM 2019 99989 A
(210) AM 99989
(220) 2018 10 23
(731) LTD "AVERSI-PHARMA"
D. Aghmashenebeli Av. 148/2, 0112,
Tbilisi, Georgia
(540)

ლუპიტერი
Лупитер
Lupiter

(591) Black, white
(511) 5

REGISTERED TRADEMARKS

(111) M 2019 31246 R

(151) 2019 06 04

(181) 2029 06 04

(260) AM 2016 87132 A

(220) 2016 04 28

(732) MON'DELEZ RUS LLC

UL. Frantsa Shtolverka 10, Vladimirskaya
oblast, Petushinskiy rayon, G. Pokrov, 601123,
Russian Federation

(732) LTD "GEORGIAN WINE HOUSE"

S. Zegaani, 1514, Gurjaani, Georgia

(111) M 2019 31247 R

(151) 2019 06 04

(181) 2029 06 04

(260) AM 2016 87237 A

(220) 2016 05 16

(732) MON'DELEZ RUS LLC

UL. Frantsa Shtolverka 10, Vladimirskaya
oblast, Petushinskiy rayon, G. Pokrov, 601123,
Russian Federation

(111) M 2019 31252 R

(151) 2019 06 04

(181) 2029 06 04

(260) AM 2017 95173 A

(220) 2017 11 22

(732) LTD "GEORGIAN WINE HOUSE"

S. Zegaani, 1514, Gurjaani, Georgia

(111) M 2019 31253 R

(151) 2019 06 04

(181) 2029 06 04

(260) AM 2018 96764 A

(220) 2018 03 12

(732) HANKOOK TIRE CO., LTD

133, Teheran-ro (Yeoksam-dong), Gangnam-gu,
Seoul, Republic of Korea

(111) M 2019 31248 R

(151) 2019 06 04

(181) 2029 06 04

(260) AM 2017 92047 A

(220) 2017 05 08

(732) LTD "VANILA IVENT"

N. Zhvanias q. 10, b. 32, 0179, Tbilisi, Georgia

(111) M 2019 31254 R

(151) 2019 06 04

(181) 2029 06 04

(260) AM 2018 96916 A

(220) 2018 03 20

(732) LTD "AGRONOM"

L. Gotuas q. 12a, 0160, Tbilisi, Georgia

(111) M 2019 31249 R

(151) 2019 06 04

(181) 2029 06 04

(260) AM 2017 92065 A

(220) 2017 05 08

(732) LTD "KERA"

I. Chavchavadzis gamz. 49a, 0162, Tbilisi,
Georgia

(111) M 2019 31255 R

(151) 2019 06 04

(181) 2029 06 04

(260) AM 2018 97024 A

(220) 2018 03 27

(732) JSC "LAMARIA CAPITAL"

Sh. Nucubidzis perdobi, IV mkr., korp. 14,
b. 25, 0183, Tbilisi, Georgia

(111) M 2019 31250 R

(151) 2019 06 04

(181) 2029 06 04

(260) AM 2017 93532 A

(220) 2017 07 27

(732) LTD "VINIKO"

Kuchishvilis q. 9, b. 24, 0179, Tbilisi, Georgia

(111) M 2019 31256 R

(151) 2019 06 04

(181) 2029 06 04

(260) AM 2018 97183 A

(220) 2018 04 04

(732) JSC "TETRA PAK"

V. Piki St., Bl. 8, Moskow, 129226, Russian
Federation

(111) M 2019 31251 R

(151) 2019 06 04

(181) 2029 06 04

(260) AM 2017 95172 A

(220) 2017 11 22

(111) M 2019 31257 R

(151) 2019 06 04

(181) 2029 06 04

(260) AM 2018 97193 A

(220) 2018 04 09
(732) NOVARTIS AG
4002 Basel, Switzerland

I. Chavchavadzis gamz. 74, 0162, Tbilisi,
Georgia

(111) M 2019 31258 R
(151) 2019 06 04
(181) 2029 06 04
(260) AM 2018 97372 A
(220) 2018 04 19
(732) LTD "THE TWINS HOUSE IN NAPAREULI"
Sop. Napareuli, 2211, Telavis Municipality,
Georgia

(111) M 2019 31264 R
(151) 2019 06 04
(181) 2029 06 04
(260) AM 2018 97415 A
(220) 2018 04 26
(732) JSC "LIBERTY BANK"
I. Chavchavadzis gamz. 74, 0162, Tbilisi,
Georgia

(111) M 2019 31259 R
(151) 2019 06 04
(181) 2029 06 04
(260) AM 2018 97374 A
(220) 2018 04 19
(732) JSC "OPPA"
D. Uznadze St. 37, 0102, Tbilisi, Georgia

(111) M 2019 31265 R
(151) 2019 06 04
(181) 2029 06 04
(260) AM 2018 97460 A
(220) 2018 05 04
(732) LTD "AUTO GALLERY"
Shalva Nutsubidzis q. 201, 0186, Tbilisi,
Georgia

(111) M 2019 31260 R
(151) 2019 06 04
(181) 2029 06 04
(260) AM 2018 97375 A
(220) 2018 04 19
(732) JSC "OPPA"
D. Uznadze St. 37, 0102, Tbilisi, Georgia

(111) M 2019 31266 R
(151) 2019 06 04
(181) 2029 06 04
(260) AM 2018 97463 A
(220) 2018 05 04
(732) LTD "LUCKY"
Vazha-Pshavelas gamz. 36, 0177, Tbilisi,
Georgia

(111) M 2019 31261 R
(151) 2019 06 04
(181) 2029 06 04
(260) AM 2018 97412 A
(220) 2018 04 26
(732) JSC "LIBERTY BANK"
I. Chavchavadzis gamz. 74, 0162, Tbilisi,
Georgia

(111) M 2019 31267 R
(151) 2019 06 04
(181) 2029 06 04
(260) AM 2018 97678 A
(220) 2018 05 11
(732) LTD "TIFLIS TEKSTIL"
Gr. Lortkipanidzis q. 81a, 0145, Tbilisi, Georgia

(111) M 2019 31262 R
(151) 2019 06 04
(181) 2029 06 04
(260) AM 2018 97413 A
(220) 2018 04 26
(732) JSC "LIBERTY BANK"
I. Chavchavadzis gamz. 74, 0162, Tbilisi,
Georgia

(111) M 2019 31268 R
(151) 2019 06 04
(181) 2029 06 04
(260) AM 2018 97683 A
(220) 2018 05 13
(732) LTD "MUSEUMSHOP"
Ir. Abashidzis q. 72, b. 34, 0162, Tbilisi, Georgia

(111) M 2019 31263 R
(151) 2019 06 04
(181) 2029 06 04
(260) AM 2018 97414 A
(220) 2018 04 26
(732) JSC "LIBERTY BANK"

(111) M 2019 31269 R
(151) 2019 06 04
(181) 2029 06 04
(260) AM 2018 97877 A
(220) 2018 05 25
(732) NOVARTIS AG
4002 Basel, Switzerland

(111) M 2019 31270 R
 (151) 2019 06 04
 (181) 2029 06 04
 (260) AM 2018 97878 A
 (220) 2018 05 25
 (732) NOVARTIS AG
 4002 Basel, Switzerland

(111) M 2019 31276 R
 (151) 2019 06 04
 (181) 2029 06 04
 (260) AM 2018 98151 A
 (220) 2018 06 18
 (732) GENZYME CORPORATION
 50 Binney Street, Cambridge, MA 02142, USA

(111) M 2019 31271 R
 (151) 2019 06 04
 (181) 2029 06 04
 (260) AM 2018 97879 A
 (220) 2018 05 25
 (732) NOVARTIS AG
 4002 Basel, Switzerland

(111) M 2019 31277 R
 (151) 2019 06 04
 (181) 2029 06 04
 (260) AM 2018 98152 A
 (220) 2018 06 18
 (732) GENZYME CORPORATION
 50 Binney Street, Cambridge, MA 02142, USA

(111) M 2019 31272 R
 (151) 2019 06 04
 (181) 2029 06 04
 (260) AM 2018 97888 A
 (220) 2018 05 29
 (732) NOVARTIS AG
 4002 Basel, Switzerland

(111) M 2019 31278 R
 (151) 2019 06 04
 (181) 2029 06 04
 (260) AM 2018 98153 A
 (220) 2018 06 18
 (732) GENZYME CORPORATION
 50 Binney Street, Cambridge, MA 02142, USA

(111) M 2019 31273 R
 (151) 2019 06 04
 (181) 2029 06 04
 (260) AM 2018 97963 A
 (220) 2018 06 04
 (732) ABDI ÝBRAHİM ÝLAÇ SANAYİ VE
 TİCARET ANONİM ĐİRKETİ
 Rebitpaşa Mahallesi Eski Büyükdere Caddesi
 No:4 34467 Maslak Sarýyer Ýstanbul, Turkey

(111) M 2019 31279 R
 (151) 2019 06 04
 (181) 2029 06 04
 (260) AM 2018 98154 A
 (220) 2018 06 18
 (732) GENZYME CORPORATION
 50 Binney Street, Cambridge, MA 02142,
 USA

(111) M 2019 31274 R
 (151) 2019 06 04
 (181) 2029 06 04
 (260) AM 2018 97964 A
 (220) 2018 06 04
 (732) ABDI ÝBRAHİM ÝLAÇ SANAYİ VE
 TİCARET ANONİM ĐİRKETİ
 Rebitpaşa Mahallesi Eski Büyükdere Caddesi
 No:4 34467 Maslak Sarýyer Ýstanbul, Turkey

(111) M 2019 31280 R
 (151) 2019 06 04
 (181) 2029 06 04
 (260) AM 2018 98155 A
 (220) 2018 06 18
 (732) GENZYME CORPORATION
 50 Binney Street, Cambridge, MA 02142, USA

(111) M 2019 31275 R
 (151) 2019 06 04
 (181) 2029 06 04
 (260) AM 2018 97993 A
 (220) 2018 06 08
 (732) MANN+HUMMEL FT Poland Spółka
 z ograniczoną odpowiedzialnością Sp. k.
 Ul. Wroclawska 145, 63-800 Gostyn,
 Poland

(111) M 2019 31281 R
 (151) 2019 06 04
 (181) 2029 06 04
 (260) AM 2018 98156 A
 (220) 2018 06 18
 (732) JSC "LIBERTY BANK"
 I. Chavchavadze Av. 74, 0162, Tbilisi, Georgia

(111) M 2019 31282 R
 (151) 2019 06 04
 (181) 2029 06 04
 (260) AM 2018 98157 A

(220) 2018 06 18
(732) JSC "LIBERTY BANK"
I. Chavchavadze Av. 74, 0162, Tbilisi, Georgia

(111) M 2019 31283 R
(151) 2019 06 04
(181) 2029 06 04
(260) AM 2018 98162 A
(220) 2018 06 18
(732) N(N)LE International Standards Research
Center
M. Gorkis q. 2, Chughuretis raioni, 0102,
Tbilisi, Georgia

(111) M 2019 31284 R
(151) 2019 06 04
(181) 2029 06 04
(260) AM 2018 98169 A
(220) 2018 06 19
(732) JSC "LIBERTY BANK"
I. Chavchavadze Av. 74, 0162, Tbilisi, Georgia

(111) M 2019 31285 R
(151) 2019 06 04
(181) 2029 06 04
(260) AM 2018 98199 A
(220) 2018 06 22
(732) LTD "BASIC GROUP"
Kojris 1.1, b. 12, Dzveli Tbilisis raioni, Tbilisi,
Georgia

(111) M 2019 31286 R
(151) 2019 06 04
(181) 2029 06 04
(260) AM 2018 98222 A
(220) 2018 06 27
(732) BATA BRANDS SA
Avenue d'Ouchy 61, Lausanne, 1006,
Switzerland

(111) M 2019 31287 R
(151) 2019 06 04
(181) 2029 06 04
(260) AM 2018 98236 A
(220) 2018 06 28
(732) BINGGRAE CO., LTD.
45, Dasansunhwan-ro, Namyangju-si,
Gyeonggi-do, Republic of Korea

(111) M 2019 31288 R
(151) 2019 06 04
(181) 2029 06 04
(260) AM 2018 98241 A

(220) 2018 06 29
(732) UNIPHARM Inc.
350 Fifth Avenue, Suite 6701, New York,
N.Y. 10118, USA

(111) M 2019 31289 R
(151) 2019 06 04
(181) 2029 06 04
(260) AM 2018 98242 A
(220) 2018 06 29
(732) UNIPHARM Inc.
350 Fifth Avenue, Suite 6701, New York,
N.Y. 10118, USA

(111) M 2019 31290 R
(151) 2019 06 04
(181) 2029 06 04
(260) AM 2018 98243 A
(220) 2018 06 29
(732) UNIPHARM Inc.
350 Fifth Avenue, Suite 6701, New York,
N.Y. 10118, USA

(111) M 2019 31291 R
(151) 2019 06 04
(181) 2029 06 04
(260) AM 2018 98376 A
(220) 2018 07 04
(732) BINGGRAE CO., LTD.
45, Dasansunhwan-ro, Namyangju-si,
Gyeonggi-do, Republic of Korea

(111) M 2019 31292 R
(151) 2019 06 04
(181) 2029 06 04
(260) AM 2018 98437 A
(220) 2018 07 13
(732) LTD "IVERTA"
Sanapiro St. 10, 0108, Tbilisi, Georgia

(111) M 2019 31293 R
(151) 2019 06 04
(181) 2029 06 04
(260) AM 2018 98565 A
(220) 2018 07 19
(732) JOHNSON & JOHNSON
ONE JOHNSON & JOHNSON PLAZA,
NEW BRUNSWICK, NEW JERSEY 08933,
USA

(111) M 2019 31294 R
(151) 2019 06 04
(181) 2029 06 04

(260) AM 2018 98566 A
(220) 2018 07 19
(732) JOHNSON & JOHNSON
ONE JOHNSON & JOHNSON PLAZA,
NEW BRUNSWICK, NEW JERSEY 08933,
USA

(111) M 2019 31295 R
(151) 2019 06 04
(181) 2029 06 04
(260) AM 2018 98683 A
(220) 2018 07 24
(732) LTD "GLOBALPHARM"
Almasyan St. 13a/Berbuti St. 8, 0171,
Tbilisi, Georgia

(111) M 2019 31296 R
(151) 2019 06 04
(181) 2029 06 04
(260) AM 2018 98684 A
(220) 2018 07 25
(732) ARA RAZMIKOVICH ISPIRYAN
Ul. Khanjiyana, d. 45, Yerevan, Armenia

(111) M 2019 31297 R
(151) 2019 06 04
(181) 2029 06 04
(260) AM 2018 98685 A
(220) 2018 07 25
(732) ARA RAZMIKOVICH ISPIRYAN
Ul. Khanjiyana, d. 45, Yerevan, Armenia

(111) M 2019 31298 R
(151) 2019 06 04
(181) 2029 06 04
(260) AM 2018 98691 A
(220) 2018 07 26
(732) LTD "MACRO FOOD"
Rustaveli Av. 28/Al. Chavchavadze St. 2,
0108, Tbilisi, Georgia

TRADEMARKS REGISTERED ACCORDING TO THE ACCELERATED PROCEDURE

The decision can be appealed at the Chamber of Appeal of Sakpatenti within 3 months from the publication.

(111) M 2019 31233 R
 (151) 2019 05 21
 (181) 2029 05 21
 (210) AM 103002
 (220) 2019 05 03
 (732) JSC "Polyam Group"
 David Aghmashenebeli Av. 79, 0102,
 Tbilisi Georgia
 (740) Giorgi Taktakishvili
 (540)

area expo

(591) Black, white
 (511) 9, 35, 36

(111) M 2019 31234 R
 (151) 2019 05 22
 (181) 2029 05 22
 (210) AM 102728
 (220) 2019 04 17
 (732) JSC "LOMISI"
 Village Natakhtari, Mtskheta region,
 Georgia
 (740) Elguja Amozashvili
 (540)



(591) Golden, red, brown
 (531) 24.17.07; 24.17.09; 27.07.17; 28.19; 29.01.13
 (511) 32

(111) M 2019 31235 R
 (151) 2019 05 23
 (181) 2029 05 23
 (210) AM 103092
 (220) 2019 05 10
 (732) N(N) LE Georgian Copyright
 Rights Association - Property
 Rights on Collective Basis
 Managing Organization
 Kostava St. 63, where II, fl. 2, 0171,
 Tbilisi Georgia

(540)



საქართველოს
 საავტორო უფლებათა
 ეროვნული
 კომპიუტერიზებული მართვის ორგანიზაცია

(591) Green, black, white
 (526) საქართველო
 (511) 41, 45

(111) M 2019 31236 R
 (151) 2019 05 23
 (181) 2029 05 23
 (210) AM 103026
 (220) 2019 05 08
 (732) LTD "DENTAL"
 Tkibuli 1 deadlock, Kutaisi, Georgia
 (540)

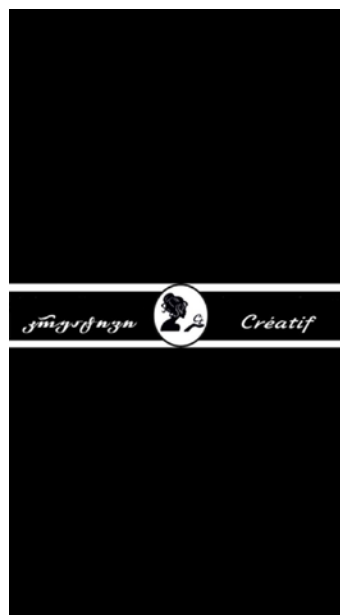

(591) Black, white
 (531) 02.03.01; 26.01.14; 26.04.10; 26.04.22;
 26.04.24; 27.05.01; 27.05.24; 28.19
 (511) 44

(111) M 2019 31237 R
 (151) 2019 05 23
 (181) 2029 05 23
 (210) AM 103110
 (220) 2019 05 15

(732) Sistem Teknik Sanayi Firinlari A.S.
Tosb Otomotiv Yan Sanayi Ihtisas
Osib 1. Cad. 15. Sok. No: 1 Cayirova
Kocaeli, Turkey
(740) Merab Kvimsadze
(540)

 **SISTEM TEKNİK**

(591) Black, red
(531) 27.05.01; 27.05.02; 27.05.22; 29.01.12
(511) 35

(111) M 2019 31238 R
(151) 2019 05 29
(181) 2029 05 29
(210) AM 103212
(220) 2019 05 23
(732) LTD "NEXTRA GROUP"
I. Evdoshvili St. 18, fl. 2,
Office space 3, Didube-Chughureti
district, 0154, Tbilisi, Georgia
(540)

პინომექსი
Pinomex
Пиномекс

(591) Black, white
(511) 5

(111) M 2019 31239 R
(151) 2019 05 29
(181) 2029 05 29
(210) AM 103215
(220) 2019 05 23
(732) LTD "NEXTRA GROUP"
I. Evdoshvili St. 18, fl. 2,
Office space 3, Didube-Chughureti
district, 0154, Tbilisi, Georgia
(540)

სოლუკამი
Solucam
Солукам

(591) Black, white
(511) 5

(111) M 2019 31240 R
(151) 2019 05 30
(181) 2029 05 30
(210) AM 103201

(220) 2019 05 22
(732) Japan Tobacco Inc.
2-2-1 Toranomom, Minato-ku, Tokyo, Japan
(740) Shalva Gvaramadze
(540)



**FLOWTECH
FILTER**

(591) Black, white
(531) 26.01.12; 26.11.03; 26.11.08; 26.11.13
(511) 34

(111) M 2019 31241 R
(151) 2019 05 30
(181) 2029 05 30
(210) AM 103214
(220) 2019 05 23
(732) Japan Tobacco Inc.
2-2-1 Toranomom, Minato-ku, Tokyo, Japan
(740) Shalva Gvaramadze
(540)



**3D
TIPPING**

(591) Black, white
(531) 10.01.01; 10.01.05; 10.01.25; 14.01.02;
26.01.01; 26.01.12; 26.11.08; 27.05.11;
27.05.15
(511) 34

(111) M 2019 31242 R
(151) 2019 05 30
(181) 2029 05 30
(210) AM 103220
(220) 2019 05 24
(732) JSC "NIKORA TRADE"
M. Kavtaradze St. 11, 0180, Tbilisi, Georgia
(540)



(591) Red, white
 (531) 26.01.01; 26.01.03; 26.01.17; 26.01.18;
 26.01.24; 27.05.21; 27.05.24; 27.07.01;
 27.07.24; 29.01.12
 (511) 16, 21, 29, 30, 32

(111) M 2019 31243 R
 (151) 2019 05 31
 (181) 2029 05 31
 (210) AM 103100
 (220) 2019 05 14
 (732) LTD "FEDS"
 Makharadze St. 4, ap. 17, Tbilisi, Georgia
 (740) Giorgi Kvaratskhelia
 (540)



(591) Red, white
 (531) 26.04.01; 26.04.04; 26.04.12; 26.11.03;
 26.11.06; 26.11.08; 29.01.12
 (511) 9

(111) M 2019 31244 R
 (151) 2019 05 31
 (181) 2029 05 31
 (210) AM 103305
 (220) 2019 05 27
 (732) შპს "Boshi - Group"
 Mitskevichi St. 24, b. 3, Tbilisi, Georgia
 (540)



(591) Green, black, white
 (531) 01.01.02; 01.01.09; 26.11.08; 27.05.07;
 27.05.08; 27.05.11; 27.05.17; 29.01.13
 (511) 7, 8

(111) M 2019 31245 R
 (151) 2019 06 03
 (181) 2029 06 03
 (210) AM 103321
 (220) 2019 05 29
 (732) LTD "NOVA"
 R. Agladze St. 45, 0119, Tbilisi, Georgia

(540)



(591) Aegean blue
 (531) 07.01.09; 26.03.01; 26.03.24; 28.19; 29.01.04
 (511) 35

(111) M 2019 31299 R
 (151) 2019 06 04
 (181) 2029 06 04
 (210) AM 103311
 (220) 2019 05 28
 (732) Vugar Japarov
 Village Kosalari, Tetrtskaro, Georgia
 (540)

JEV PARFUM & COSMETICS

(591) Black-white
 (511) 3

(111) M 2019 31300 R
 (151) 2019 06 04
 (181) 2029 06 04
 (210) AM 103190
 (220) 2019 05 21
 (732) LTD "ALGANI"
 Kutaisi St. 18, 0154, Tbilisi, Georgia
 (540)



(591) Red, dark golden, light golden, white, black
 (531) 03.01.01; 03.01.02; 03.01.16; 24.01.15;
 24.01.17; 24.01.20; 26.04.02; 26.04.16;
 26.04.22; 26.04.24; 27.05.24; 28.19; 29.01.14
 (526) დაცვის კომპანია, Security Company
 (511) 45

(111) M 2019 31301 R
 (151) 2019 06 05
 (181) 2029 06 05
 (210) AM 103445
 (220) 2019 06 03
 (732) LTD "BROTHERS"
 Gen. A. Abashidze St.. 14 and Bahrationi St.,
 Batumi, Georgia

(540)



(591) White, sky-blue
 (531) 05.05.20; 26.04.03; 26.04.15; 27.05.10;
 27.05.15; 29.01.12
 (511) 44

(111) M 2019 31302 R
 (151) 2019 06 05
 (181) 2029 06 05
 (210) AM 103181
 (220) 2019 05 20
 (732) The HAVI Group L.P.
 3500 Lacey Road, Suite 600 Downers Grove,
 ILLINOIS 60515, USA
 (740) Tamaz Shilakadze
 (540)



(591) Black, white, grey
 (531) 26.04.02; 26.04.03; 26.04.09; 27.05.17
 (511) 35, 39, 42

(111) M 2019 31303 R
 (151) 2019 06 05
 (181) 2029 06 05
 (210) AM 103195
 (220) 2019 05 22
 (732) LTD "EPG"
 Akhlagzrdoba Av. 84/24, Kutaisi, Georgia
 (540)

TONG YANG

(591) Black, white
 (511) 12

(111) M 2019 31304 R
 (151) 2019 06 05
 (181) 2029 06 05
 (210) AM 103196
 (220) 2019 05 22
 (732) LTD "EPG"
 Akhlagzrdoba Av. 84/24, Kutaisi, Georgia
 (540)

DA JUANE

(591) Black, white
 (511) 12

(111) M 2019 31305 R
 (151) 2019 06 05
 (181) 2029 06 05
 (210) AM 103197
 (220) 2019 05 22
 (732) LTD "EPG"
 Akhlagzrdoba Av. 84/24, Kutaisi, Georgia
 (540)

SIMYI

(591) Black, white
 (511) 12

(111) M 2019 31306 R
 (151) 2019 06 05
 (181) 2029 06 05
 (210) AM 103198
 (220) 2019 05 22
 (732) LTD "EPG"
 Akhlagzrdoba Av. 84/24, Kutaisi, Georgia
 (540)

YIH SHENG

(591) Black, white
 (511) 12

INTERNATIONAL TRADEMARKS FOR WHICH A DECISION ON GRANTING PROTECTIONS IS TAKEN

The decision can be appealed at the Chamber of Appeal of Sakpatenti within 3 months from the publication or at the Mtskheta District Court Administrative Cases Board (Address: №17, Samkhedro str., Mtskheta), within 1 month following the publication.

(260) AM 2019 100112 A
 (800) 1428757
 (151) 2018 05 21
 (891) 2018 05 21
 (731) LABORATORIOS NORMON, S.A.
 Ronda de Valdecarrizo, 6, E-28760 Tres
 Cantos (Madrid), Spain
 (540)

DILOCAIN

(591) Black, white
 (511)
 5 – Pharmaceutical products; preparations for medical use; anesthetics.

(260) AM 2019 100113 A
 (800) 1428797
 (151) 2018 06 26
 (891) 2018 06 26
 (731) ANADOLU BİRLİK HOLDİNG ANONİM
 ŞİRKETİ
 Dede Korkut Mh. Beyşehir Cd. No:9,
 Beyşehir, Konya, Turkey
 (540)

ÇATALHÖYÜK

(591) Black, white
 (531) 27.05.01
 (511)
 29 – Meat; meat, preserved; fish meal for human consumption; fish, not live; fish, tinned; poultry, not live; nuts, prepared; chocolate nut butter; soups; preparations for making soup; bouillon; olives, preserved; olive oil for food; milk; milk beverages, milk predominating; condensed milk; milk products; vegetables, dried; vegetables, cooked; vegetables, preserved; vegetables, tinned; frozen fruits; fruit jellies; fruit peel; fruit, stewed; fruit-based snack food; fruits, tinned; peanut butter; peanuts, prepared; tahini [sesame seed paste]; eggs; powdered eggs; potato chips; potato crisps; potato flakes; edible oils; hummus [chickpea paste].

30 – Coffee; cocoa; tea; coffee-based beverages; cocoa-based beverages; chocolate-based beverages; pasta; ravioli; noodles; bread; bagels; pastries; pastry dough; puddings; rice pudding; custard; honey; royal jelly; propolis; seasonings; condiments; sauces [con-

diments]; baking powder; flour; yeast; yeast extracts for human consumption; starch for food; semolina; sugar; granulated sugar; cube sugar; powdered sugar; iced tea; confectionery made of sugar; candy; chocolate; chocolate confections; biscuits; petit-beurre biscuits; crackers; waffles; chewing gum; edible ices; cooking salt; processed wheat for human consumption, crushed barley for human consumption, processed oats for human consumption, processed grains for human consumption; molasses for food; bulgur; rice; bean meal.

32 – Beer; beer wort; mineral water [beverages]; aerated mineral waters; carbonated mineral waters; soda water; table waters; spring water; fruit beverages and fruit juices; fruit-flavored beverages; non-alcoholic fruit juice beverages; vegetable juice beverages, non-alcoholic; vegetable juice drinks, non-alcoholic; soft drinks; non-carbonated soft drinks; non-alcoholic vegetable juice beverages; non-alcoholic vegetable juice drinks; fruit juices; fruit nectars, non-alcoholic; isotonic beverages; lemonades.

(260) AM 2019 100114 A
 (800) 1428818
 (151) 2018 04 10
 (891) 2018 04 10
 (731) ADP GAUSELMANN GMBH
 Merkur-Allee 1-15, 32339 Espelkamp,
 Germany
 (540)

Dino World

(591) Black, white
 (511)
 9 – Computer software; coin-operated mechanisms; computer and video games software; games software in particular for use on any computer platform, including electronic entertainment and games consoles; computer game programs; video games (software); computer games provided through a global computer network or supplied by means of multi-media electronic broadcast or through telecommunications or electronic transmission or via the internet; computer games, leisure and recreational software, video games and computer software, all being provided in the form of storage media; programs for operating electric and electronic apparatus for games, amusement and/or entertainment purposes; computer soft-

ware for computer games on the internet; online games (software), in particular for online betting games, online prize games, online gambling games, online games of skill and online casino games; computer software in the form of an app for mobile devices and computers; calculating apparatus in coin-operated machines and parts for the aforesaid goods; electric, electronic, optical or automatic apparatus, for identifying data carriers, identity cards and credit cards, bank notes and coins; software in particular for casino and/or amusement arcade games, for gaming machines and/or slot machines each one with or without prize payouts; gaming software that generates or displays wager outcomes of gaming machines; operational computer games software; computer software for managing of games (game collection); collection of video games (terms considered too vague by the International Bureau – rule 13.2.b) of the Common Regulations).

28 – Games; toys; gaming apparatus (including coin-operated apparatus); coin-operated arcade games (machines); games for amusement arcades (included in this class); coin-operated video gaming apparatus; video games adapted for use with external screens or monitors only (terms considered too vague by the International Bureau – rule 13.2.b) of the Common Regulations); casino fittings, namely roulette tables, roulette wheels; coin-operated automatic gaming machines and gaming machines, in particular for gaming arcades, with or without a prize payout; electronic or electrotechnical gaming apparatus, automatic gaming machines, gaming machines, slot machines operated by coins, tokens, banknotes, tickets or by means of electronic, magnetic or biometric storage media, in particular for commercial use in casinos and amusement arcades, with or without a prize payout; automatic gaming machines and gaming machines, in particular for commercial use in casinos and gaming arcades, with or without a prize payout; coin-operated gaming machines and/or electronic money-based gaming apparatus (machines), with or without prizes; housings adapted for gaming machines, gaming apparatus and automatic gaming machines, operated by means of coins, tokens, tickets or by means of electronic, magnetic or biometric storage media, in particular for commercial use in casinos and gaming arcades, with or without a prize payout; electronic games; electronic game entertainment apparatus and accessories (terms considered too vague by the International Bureau – rule 13.2.b) of the Common Regulations); video output game machines; drawing apparatus for prize games and lotteries, draws or raffles; housings of metal, plastic and/or wood for coin-operated automatic machines; apparatus for games (including video games), other than adapted for use with external screens or monitors only; electropneumatic and electric pulling machines (gaming machines) (terms considered too vague by the International Bureau – rule 13.2.b) of the

Common Regulations); gaming tables, in particular for table football, billiards, sliding games; flying discs (toys) and darts; electric, electronic or electro-mechanical apparatus for bingo games, lotteries or video lottery games and for betting offices, networked or unnetworked (terms considered too vague by the International Bureau – rule 13.2.b) of the Common Regulations); LCD games consoles; automatic gaming machines; including all the aforesaid automatic machines, machines and apparatus operating in networks (terms considered too vague by the International Bureau – rule 13.2.b) of the Common Regulations); apparatus and devices for accepting and storing money, being fittings for the aforesaid automatic machines, included in this class; automatic lottery machines.

(260) AM 2019 100115 A

(800) 1428889

(151) 2018 07 02

(891) 2018 07 02

(731) SHENZHEN YONGNUO PHOTOGRAPHIC EQUIPMENT CO., LTD
Building A, Shenfubao Modern Optics Factory, Kengzi Street, Pingshan District, Shenzhen, Guangdong, China

(540)

YONGNUO

(591) Black, white

(531) 27.05.01; 27.05.17

(511)

9 – Optical lenses; objectives [lenses] [optics]; cameras [photography]; flashlights [photography]; cellular phones; video recorders; cinematographic cameras; remote control apparatus; shutters [photography]; chargers for electric batteries.

(260) AM 2019 100116 A

(800) 1428922

(151) 2018 07 20

(891) 2018 07 20

(731) JAPAN TOBACCO INC.

2-2-1 Toranomom, Minato-ku, Tokyo, Japan

(540)

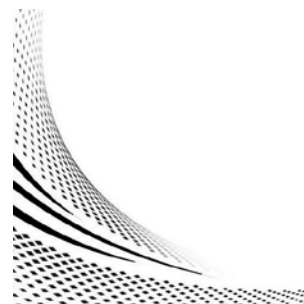

(591) Black, white

(531) 25.07.01; 25.07.02; 26.11.21

(511)

34 – Tobacco, raw or manufactured; smoking tobacco, pipe tobacco, rolling tobacco, chewing tobacco, snus; cigarettes, electronic cigarettes, cigars, cigarillos; snuff; smokers' articles; cigarette paper, cigarette tubes and matches.

(260) AM 2019 100118 A

(800) 1428964

(151) 2018 05 04

(891) 2018 05 04

(731) CORSINO CORSINI S.P.A.

Via del Sombolino, 62/64, I-52041

CIVITELLA VAL DI CHIANA (AR), Italy

(540)

CAFFÈ
CORSINI

1950

(591) Black, red and white

(531) 26.11.01; 26.11.08; 27.01.12; 27.05.09;

27.05.10; 27.05.11; 27.07.01; 29.01.13

(511)

30 – Coffee; caffeine-free coffee; espresso; iced coffee; ground coffee; instant coffee; unroasted coffee; coffee essences; coffee extracts; coffee-based beverages; roasted coffee beans.

(260) AM 2019 100119 A

(800) 1428998

(151) 2018 06 21

(891) 2018 06 21

(731) Carl Kühne KG (GmbH & Co.)

Kühnehöfe 11, 22761 Hamburg, Germany

(540)



(591) Black, white

(531) 23.05.05; 26.13.25; 27.05.01; 27.05.08;

27.05.24

(511)

29 – Jellies, jams, compotes, fruit and vegetable spreads; dairy products and dairy substitutes; dairy spreads; processed fruits, fungi and vegetables (including nuts and pulses); pickles; sauerkraut; fruit chips; vegetable chips; potato crisps; vegetable extracts for food; vegetable extracts for cooking; vegetables, tinned (canned (am.)); vegetables, preserved; processed chickpeas; soups and stocks, meat ext-

racts; soup concentrates; soup pastes; vegetable salads; dried fruit products; snack mixes consisting of dehydrated fruit and processed nuts; dried pulses; seaweed extracts for food; algae prepared for human foods; potato crisps in the form of snack foods; nut and seed-based snack bars; dried fruit-based snacks; vegetable-based snack foods; snack foods based on vegetables; snack foods based on legumes; snack foods based on nuts; prepared vegetable dishes; vegetable pate; vegetable-based spreads; processed, edible seaweed; vegetable pastes.

30 – Vinegar; fruit vinegar; mustard; seaweed (condiment); dried herbs; seasoning mixes; marinades; horseradish (relishes); relish (condiment); salad cream; sauce (edible); vegetable purees (sauces); cereals; snack food products consisting of cereal products; processed cereals for food for human consumption; corn chips; vegetable flavoured corn chips; savory pastries; ready to eat savory snack foods made from maize meal formed by extrusion; savory sauces; chutneys and pastes; spice preparations; condiments; tomato ketchup; mayonnaise and ketchup-based spreads; dressings for salad; tartare sauce; mayonnaise; vegan mayonnaise.

32 – Smoothies; mineral water (beverages); carbonated mineral water; vitamin enriched sparkling water (beverages); non-alcoholic sparkling fruit juice drinks; fruit juice beverages; syrups for beverages; non-alcoholic beverages; waters.

(260) AM 2019 100120 A

(800) 1429000

(151) 2018 05 31

(891) 2018 05 31

(731) DELI GROUP CO., LTD

Deli Industrial Park, Ninghai County, Ningbo, Zhejiang, China

(540)

Agnite

(591) Black, white

(531) 27.05.01; 27.05.17

(511)

9 – Goggles for sports; nose clips for divers and swimmers; mouth guards for sports; head guards for sports, diving suits; breathing apparatus for underwater swimming; lifebuoys; life jackets; divers' masks; gloves for divers.

21 – Isothermic bags; cups; jugs; pitchers; bottles; cups of paper or plastic; drinking bottles for sports; insulating flasks; vacuum bottles.

25 – Sports jerseys; sports singlets; cyclists' clothing; bathing caps; bathing trunks; bathing suits; ho-siery; sports shoes; football shoes; leggings [trousers].

27 – Yoga mats; artificial turf; gymnastic mats; vinyl floor coverings; mats of woven rope for ski slopes; bath mats; wallpaper; non-slip mats; floor mat.

28 – Shoulder guards [sports articles]; basketball; football; leg guards; goalkeeper's gloves; volleyball; ball net; badminton racket; shuttlecocks; pingpong bat; pingpong ball; tennis racket; tennis ball; skipping-rope; in-line roller skates; skateboards; targets; hand grippers for exercise; arm training device; polling force device; push-up stand; batting gloves [accessories for games]; boxing gloves; nunchakus; hula hoop; yoga ball; chess; go board games; chess or board games, playing cards; magic cube; waist guards; wrist guards; knee guards [sports articles]; elbow guards [sports articles]; ankle guards; machines for physical exercises; swimming kick boards; water wings; swimming belts.

(260) AM 2019 100121 A

(800) 1429018

(151) 2018 07 02

(891) 2018 07 02

(731) GREEN'S BIOENGINEERING

(SHENZHEN) CO., LTD

DongFang Road, DaTianyang Industrial Park, DongFang Village, SongGang Street, Baoan District, Shenzhen, China

(540)

CLASSY·KISS

(591) Black, white

(531) 27.05.01

(511)

29 – Meat; fish-based foodstuffs; fruit, preserved; fruit salads; vegetables, preserved; yogurt; milk products; edible fats; jellies for food; dry edible fungus.

(260) AM 2019 94379 A*

(800) 1366037

(151) 2017 04 26

(891) 2017 04 26

(731) SMESHARIKI GMBH

Hochbruckenstrasse 10, 80331 Munchen, Germany

(540)



(591) Yellow, dark yellow, blue, turquoise, light turquoise, dark turquoise, white, black, orange, grass green, light blue

(531) 04.05.03; 04.05.04; 04.05.05; 25.03.07; 28.05; 29.01.15

(511)

1 – Agar-agar; nitrogen; actinium; alkaloids; crotonic aldehyde; ammonium aldehyde; aldehydes; americium; amyl acetate; anhydrous ammonia; ammonia; acetic anhydride; anhydrides; anti-knock substances for internal combustion engines; antistatic preparations, other than for household purposes; antifreeze; argon; lead arsenate; astatine; aluminium acetate; lime acetate; lead acetate; acetate of cellulose, unprocessed; acetates [chemicals]; acetylene; acetone; oenological bactericides [chemical preparations for use in wine making]; balm of gurjun [gurjun, gurjan] for making varnish; barium; barytes; albumin [animal or vegetable, raw material]; animal albumen [raw material]; iodised albumen; malt albumen; bentonite; berkelium; bicarbonate of soda for chemical purposes; potassium dioxalate; bichromate of potassium; bichromate of soda; bauxite; bromine for chemical purposes; albumenized paper; baryta paper; diazo paper; blueprint paper; litmus paper; nitrate paper; sensitized paper; photometric paper; borax; agglutinants for concrete; gas purifying preparations; polish removing substances; preparations for the separation of greases; substances for preventing runs in stockings; water-softening preparations; limestone hardening substances; tanning substances; surface-active chemical agents; artificial sweeteners [chemical preparations]; fissionable material for nuclear energy; foundry binding substances; concrete-aeration chemicals; leather-dressing chemicals; chemicals for the manufacture of paints; chemical substances for preserving foodstuffs; starch-liquifying chemicals [ungluing agents]; flower preservatives; seed preserving substances; viscose; bismuth; bismuth subnitrate for chemical purposes; witherite; distilled water; seawater for industrial purposes; acidulated water for recharging accumulators; heavy water; hydrogen; seaweeds [fertilizers]; gadolinium; getters [chemically active substances]; protective gases for welding; basic gallate of bismuth; gallium; gambier; helium; aluminium hydrate; hydrates; hyposulfites; ceramic glazings; glycol; china slip; alumina; glycerides; glucosides; holmium; hormones for hastening the ripening of fruit; peat pots for horticulture; graphite for industrial purposes; guano; humus; defoliants; hydrazine; kieselgur; manganese dioxide; dry ice [carbon dioxide]; zirconia; oil dispersants; petroleum dispersants; dispersions of plastics; dysprosium; bichloride of tin; detergent additives to petrol [gasoline]; ceramic compositions for sintering [granules and powders]; additives, chemical, to drilling muds; additives, chemical, to insecticides; chemical additives for oils; additives, chemical, to motor fuel; additives, chemical, to fungicides;

tan-wood; europium; gelatine for photographic purposes; gelatine for industrial purposes; auxiliary fluids for use with abrasives; fluids for hydraulic circuits; liquids for removing sulfates from batteries; brake fluid; magnetic fluid for industrial purposes; transmission fluid; grafting wax for trees; tree cavity fillers [forestry]; glaziers' putty; moderating materials for nuclear reactors; diatomaceous earth; fuller's earth for use in the textile industry; lime chloride; isotopes for industrial purposes; ion exchangers [chemical preparations]; ytterbium; yttrium; iodine for chemical purposes; aluminium iodide; kainite; potassium; sorrel salt; californium; tartar, other than for pharmaceutical purposes; calcium carbide; carbide; lime carbonate; magnesium carbonate; carbonates; cement [metallurgy]; cassiopium [lutetium]; catalysts; biochemical catalysts; catechu; alum; ammonia alum; aluminium alum; chrome alum; ketones; cinematographic film, sensitized but not exposed; oxygen; nitric acid; anthranilic acid; benzoic acid; tartaric acid; tungstic acid; gallic acid for the manufacture of ink; gallotannic acid; tannic acid; iodic acid; lactic acid; formic acid; persulfuric acid; oleic acid; picric acid; pyrogallic acid; salicylic acid; sebacic acid; sulfuric acid; sulfurous acid; spirits of salt; stearic acid; carbonic acid; spirits of vinegar [dilute acetic acid]; phosphoric acid; hydrofluoric acid; cholic acid; chromic acid; oxalic acid; acids; benzene-based acids; fatty acids; arsenious acid; adhesives for billposting; leather glues; adhesives for wall tiles; adhesives for paperhanging; cement for mending broken articles; adhesives for industrial purposes; isinglass, other than for stationery, household or alimentary purposes; gluten [glue], other than for stationery or household purposes; collodion; compost; beer preserving agents; mangrove bark for industrial purposes; tan; starch paste [adhesive], other than for stationery or household purposes; silicon; creosote for chemical purposes; krypton; xenon; curium; lanthanum; lecithin [raw material]; lithium; magnesite; manganate; oils for tanning leather; oils for currying leather; oils for preparing leather in the course of manufacture; oils for the preservation of food; carbolineum for the protection of plants; paper pulp; wood pulp; grafting mastic for trees; mastic for leather; mastic for tires [tyres]; oil cement [putty]; synthetic materials for absorbing oil; ceramic materials in particulate form, for use as filtering media; filtering materials [unprocessed plastics]; filtering materials [mineral substances]; filtering materials [vegetable substances]; filtering materials [chemical preparations]; copper sulfate [blue vitriol]; metalloids; alkaline-earth metals; alkaline metals; methane; methyl benzol; flour for industrial purposes; potato flour for industrial purposes; arsenic; bate for dressing skins; sodium; hypochlorite of soda; naphthalene; sal ammoniac; toxic gas neutralizers; neodymium; neon; neptunium; uranium nitrate; nitrates; combusting preparations [chemical additives to mo-

tor fuel]; nitrous oxide; baryta; uranium oxide; oxalates; lithia [lithium oxide]; lead oxide; antimony oxide; chromium oxide; mercuric oxide; gallnuts; clarification preparations; wine finings; textile-brightening chemicals; beer-clarifying and preserving agents; reducing agents for use in photography; bases [chemical preparations]; wax-bleaching chemicals; fat-bleaching chemicals; pectin [photography]; perborate of soda; humus top dressing; percarbonates; persulfates; perchlorates; foundry sand; plastisols; sensitized plates for offset printing; plasticizers; X-ray films, sensitized but not exposed; plutonium; substrates for soil-free growing [agriculture]; polonium; potash; potash water; soil for growing; praseodymium; rubber preservatives; brickwork preservatives, except paints and oils; cement preservatives, except paints and oils; preservatives for tiles, except paints and oils; bacteriological preparations for acetification; vulcanising preparations; renovating preparations for phonograph records; currying preparations for leather; currying preparations for skins; metal hardening preparations; fixing baths [photography]; unsticking and separating preparations; preparations for preventing the tarnishing of lenses; preparations for preventing the tarnishing of glass; cement-waterproofing chemicals, except paints; plant growth regulating preparations; wallpaper removing preparations; anti-boil preparations for engine coolants; fulling preparations for use in the textile industry; descaling preparations, other than for household purposes; flashlight preparations; galvanizing preparations; finishing preparations for use in the manufacture of steel; sizing preparations; animal carbon preparations; corrosive preparations; cryogenic preparations; degreasing preparations for use in manufacturing processes; degumming preparations; oil-bleaching chemicals; bleaching preparations [decolorants] for industrial purposes; meat tenderizers for industrial purposes; preparations for stimulating cooking for industrial purposes; preparations of trace elements for plants; moistening [wetting] preparations for use in the textile industry; moistening [wetting] preparations for use in dyeing; moistening [wetting] preparations for use in bleaching; filtering preparations for the beverages industry; chemical preparations to prevent mildew; chemical preparations for protection against wheat blight [smut]; chemical condensation preparations; chemical preparations for smoking meat; chemical preparations for facilitating the alloying of metals; chemical preparations for decarbonising engines; fulling preparations; fuel-saving preparations; coal saving preparations; damp-proofing chemicals, except paints, for masonry; anti-sprouting preparations for vegetables; preparations of the distillation of wood alcohol; benzene derivatives; cellulose derivatives [chemicals]; promethium; protactinium; protein [raw material]; mordants for metals; radium for scientific purposes; radon; solvents for varnishes; anti-frothing solutions for accu-

mulators; solutions for cyanotyping; baths for galvanizing; silver salt solutions for silvering; toning baths [photography]; rhenium; mercury; rubidium; soot for industrial or agricultural purposes; samarium; saccharin; selenium; salpêtre; sulfur; silver nitrate; carbon disulfide; silicates; aluminium silicate; silicones; scandium; foundry molding [moulding] preparations; acrylic resins, unprocessed; artificial resins, unprocessed; epoxy resins, unprocessed; calcined soda; barium compounds; fluorspar compounds; salts [fertilisers]; salts [chemical preparations]; ammoniacal salts; ammonium salts; salts of precious metals for industrial purposes; salts for galvanic batteries; salt for preserving, other than for foodstuffs; salts for coloring [colouring] metal; iron salts; gold salts; iodised salts; calcium salts; salts from rare earth metals; mercury salts; toning salts [photography]; chrome salts; chromic salts; salts of alkaline metals; rock salt; mold-release preparations; fire extinguishing compositions; coolants for vehicle engines; compositions for the manufacture of phonograph records; compositions for the manufacture of technical ceramics; compositions for repairing inner tubes of tires [tyres]; compositions for repairing tires [tyres]; acid proof chemical compositions; glutinous tree-banding preparations; adhesive preparations for surgical bandages; fireproofing preparations; compositions for threading; sauce for preparing tobacco; amyl alcohol; vinic alcohol; wood alcohol; sal ammoniac spirits; ethyl alcohol; alcohol; cement for footwear; concrete preservatives, except paints and oils; water glass [soluble glass]; strontium; barium sulfate; sulfates; antimony sulfide; sulfides; benzoic sulfimide; sulfonic acids; sumac for use in tanning; superphosphates [fertilisers]; antimony; thallium; talc [magnesium silicate]; tannin; tellurium; terbium; tetrachlorides; carbon tetrachloride; acetylene tetrachloride; technetium; thiocarbanilide; titanite; sensitized cloth for photography; blueprint cloth; toluene; fuel for atomic piles; thorium; peat [fertiliser]; gum tragacanth for industrial purposes; thulium; carbonic hydrates; carbon; activated carbon; carbon for filters; animal carbon; bone charcoal; blood charcoal; nitrogenous fertilisers; pyroligneous acid [wood vinegar]; uranium; chemical intensifiers for paper; chemical intensifiers for rubber; vulcanisation accelerators; ferments for chemical purposes; milk ferments for chemical purposes; fermium; ferrocyanides; brazing fluxes; formic aldehyde for chemical purposes; phosphatides; phosphates [fertilisers]; phosphorus; photographic paper; photosensitive plates; sensitized photographic plates; sensitized films, unexposed; photographic developers; photographic sensitizers; chemical preparations for use in photography; photographic emulsions; francium; fluorine; chemicals for use in forestry, except fungicides, herbicides, insecticides and parasiticides; glass-frosting chemicals; leather-renovating chemicals; glass-staining chemicals; enamel-staining chemicals; oil-separating

chemicals; water-purifying chemicals; oil-purifying chemicals; radiator flushing chemicals; condensation-preventing chemicals; stain-preventing chemicals for use on fabrics; anti-tarnishing chemicals for windows; leather-waterproofing chemicals; textile-waterproofing chemicals; chemicals, except pigments, for the manufacture of enamel; leather-impregnating chemicals; textile-impregnating chemicals; horticultural chemicals, except fungicides, herbicides, insecticides and parasiticides; agricultural chemicals, except fungicides, herbicides, insecticides and parasiticides; soil conditioning preparations; chimney cleaners, chemical; color-brightening chemicals for industrial purposes; refrigerants; chlorine; chlorates; hydrochlorates; aluminium chloride; magnesium chloride; chlorides; palladium chloride; chromates; flowers of sulfur for chemical purposes; caesium; cellulose; cerium; cymene; loam; slag [fertilisers]; alkalies; caustic alkali; radioactive elements for scientific purposes; emulsifiers; erbium; ethane; methyl ether; sulfuric ether; ethyl ether; glycol ether; ethers; esters; benzene; xylene; xylol.

2 – Auramine; canada balsam; white lead; paper for dyeing easter eggs; glazes [paints, lacquers]; orange lead; primers; gamboge for painting; titanium dioxide [pigment]; indigo [colorant]; gum resins; colophony; caramel [food colorant]; carbonyl [wood preservative]; cochineal carmine; copal; alizarine dyes; aniline dyes; ink for leather; colorants for liqueurs; colorants for beverages; shoe dyes; colorants for beer; colorants for butter; ink for skin-dressing; dye-wood; malt colorants; food colorants; colorants; ink [toner] for photocopiers; aluminium paints; asbestos paints; bactericidal paints; wood stains; ceramic paints; marking ink for animals; distempers; fireproof paints; printing ink; engraving ink; enamels for painting; paints; creosote for wood preservation; turmeric [colorant]; bitumen varnish; bronzing lacquers; copal varnish; lacquers; anti-corrosive bands; anti-rust oils; oils for the preservation of wood; mastic [natural resin]; lime wash; zinc oxide [pigment]; silver paste; pigments; coatings [paints]; coatings for roofing felt [paints]; wood coatings [paints]; undercoating for vehicle chassis; varnishes; aluminium powder for painting; bronze powder for painting; silvering powders; metals in powder form for use in painting, decorating, printing and art; anti-corrosive preparations; protective preparations for metals; wood mordants; mordants for leather; mordants; thinners for paints; thinners for lacquers; whitewash; soot [colorant]; carbon black [pigment]; lamp black [pigment]; sandarac; anti-rust greases; natural resins, raw; malt caramel [food colorant]; badigeon; anti-tarnishing preparations for metals; anti-rust preparations; wood preservatives; sumac for varnishes; red lead; turpentine [thinner for paints]; fixatives [varnishes]; fixatives for watercolors [watercolours]; metal foil for use in painting, decorating, printing and art; yellowwood [colorant]; saffron [colorant];

gum-lac; wood dyestuffs; enamels [varnishes]; silver emulsions [pigments].

3 – Abrasives; amber [perfume]; descaling preparations for household purposes; antistatic preparations for household purposes; breath freshening sprays; canned pressurized air for cleaning and dusting purposes; polishing stones; abrasive paper; emery paper; polishing paper; petroleum jelly for cosmetic purposes; cotton wool for cosmetic purposes; aromatics [essential oils]; cake flavourings [essential oils]; flavorings for beverages [essential oils]; sachets for perfuming linen; scented water; potassium hypochloride; lavender water; toilet water; laundry wax; floor wax; non-slipping wax for floors; moustache wax; tailors' wax; polish for furniture and flooring; heliotropine; dental bleaching gels; geraniol; make-up; scented wood; perfumes; non-slipping liquids for floors; windscreen cleaning liquids; greases for cosmetic purposes; volcanic ash for cleaning; perfume-ry; decorative transfers for cosmetic purposes; ionone [perfumery]; smoothing stones; eyebrow pencils; cosmetic pencils; silicon carbide [abrasive]; carbides of metal [abrasives]; tripoli stone for polishing; adhesives for affixing false eyelashes; adhesives for affixing false hair; quillaia bark for washing; corundum [abrasive]; beard dyes; colorants for toilet purposes; cosmetic dyes; laundry starch; cosmetic creams; skin whitening creams; incense; nail polish; after-shave lotions; hair lotions; lotions for cosmetic purposes; beauty masks; oils for perfumes and scents; oils for cosmetic purposes; oils for toilet purposes; essential oils; essential oils of cedarwood; essential oils of lemon; oils for cleaning purposes; bergamot oil; gaultheria oil; jasmine oil; lavender oil; almond oil; rose oil; oil of turpentine for degreasing; adhesives for cosmetic purposes; whiting; cleaning chalk; almond milk for cosmetic purposes; cleansing milk for toilet purposes; musk [perfumery]; soap; deodorant soap; shaving soap; soap for brightening textile; cakes of toilet soap; antiperspirant soap; soap for foot perspiration; almond soap; mint for perfumery; cosmetic kits; emery; false nails; eau de cologne; bases for flower perfumes; joss sticks; pastes for razor strops; dentifrices; pumice stone; hydrogen peroxide for cosmetic purposes; abrasive cloth; glass cloth [abrasive cloth]; lipsticks; pomades for cosmetic purposes; shaving preparations; cosmetic preparations for baths; hair waving preparations; laundry soaking preparations; grinding preparations; leather bleaching preparations; denture polishes; mouthwashes, not for medical purposes; cosmetic preparations for slimming purposes; laundry glaze; fabric softeners for laundry use; laundry bleaching preparations; dry-cleaning preparations; make-up removing preparations; paint stripping preparations; lacquer-removing preparations; rust removing preparations; nail care preparations; cleaning preparations; preparations for cleaning dentures; wallpaper cleaning preparations; preparations for unb-

locking drain pipes; color-brightening chemicals for household purposes [laundry]; make-up powder; diamantine [abrasive]; scouring solutions; false eyelashes; tissues impregnated with cosmetic lotions; safrol; turpentine for degreasing; potpourris [fragrances]; bleaching soda; washing soda, for cleaning; bath salts, not for medical purposes; bleaching salts; ammonia [volatile alkali] [detergent]; astringents for cosmetic purposes; eyebrow cosmetics; stain removers; make-up preparations; sun-tanning preparations [cosmetics]; hair colorants; neutralizers for permanent waving; preparations to make shiny the leaves of plants; cosmetic preparations for eyelashes; depilatories; cosmetic preparations for skin care; cosmetics; cosmetics for animals; mascara; detergents, other than for use in manufacturing operations and for medical purposes; degreasers, other than for use in manufacturing processes; bleaching preparations [decolorants] for cosmetic purposes; talcum powder, for toilet use; terpenes [essential oils]; cloths impregnated with a detergent for cleaning; shampoos; glass paper; soda lye; extracts of flowers [perfumes]; ethereal essences; badian essence; mint essence [essential oil].

4 – Anthracite; benzine; wood briquettes; combustible briquettes; wax [raw material]; ozocerite [ozokerite]; illuminating wax; industrial wax; belting wax; carnauba wax; beeswax; gas for lighting; oil-gas; fuel gas; gasoline; producer gas; solidified gases [fuel]; carburants; lubricating graphite; additives, non-chemical, to motor fuel; firewood; cutting fluids; fish oil, not edible; lanolin; illuminating grease; grease for leather; grease for footwear; tallow; industrial grease; kerosene; coke; ligroin; mazut; combustible oil; oils for paints; oils for releasing form work [building]; oils for the preservation of masonry; textile oil; lubricating oil; industrial oil; moistening oil; coal tar oil; coal naphtha; castor oil for industrial purposes; bone oil for industrial purposes; motor oil; sunflower oil for industrial purposes; rape oil for industrial purposes; lubricants; naphtha; petroleum, raw or refined; nightlights [candles]; oleine; paraffin; dust removing preparations; soya bean oil preparations for non-stick treatment of cooking utensils; non-slipping preparations for belts; coal dust [fuel]; Christmas tree candles; candles; perfumed candles; grease for arms [weapons]; lubricating grease; grease for belts; vaporized fuel mixtures; dust laying compositions; alcohol [fuel]; methylated spirit; stearine; diesel oil; lighting fuel; mineral fuel; fuel with an alcoholic base; peat [fuel]; peat briquettes [fuel]; lignite; charcoal [fuel]; coal; coal briquettes; ceresine; electrical energy; petroleum ether; wax for skis.

8 – Apparatus for tattooing; razors, electric or non-electric; scythe stones; levers; table forks; harpoons; harpoons for fishing; whetstone holders; bushhammers; lifting jacks, hand-operated; bludgeons; chi-

sels; engraving needles; cutlery; numbering punches; depilation appliances, electric and non-electric; cattle marking tools; oyster openers; glazing irons; ear-piercing apparatus; tube cutting instruments; hand tools, hand-operated; knuckle dusters; daggers; pickaxes; blades [weapons]; annular screw plates; breast drills; lasts [shoemakers' hand tools]; scythe rings; instruments for punching tickets; scythes; hainault scythes; fire irons; emery grinding wheels; sledgehammers; ice picks; blades [hand tools]; razor blades; jig-saws; machetes; beard clippers; hair clippers for personal use, electric and non-electric; hair clippers for animals [hand instruments]; masons' hammers; mattocks; manicure sets; pedicure sets; needle files; hand pumps; shaving cases; cheese slicers, non-electric; scaling knives; molding irons; farriers' knives; budding knives; hunting knives; penknives; bill-hooks; knives; cattle shearers; border shears; scissors; sword scabbards; vegetable knives; side arms, other than firearms; stropping instruments; reamer sockets; nail files; nail files, electric; bow saws; tweezers; hair-removing tweezers; guns, hand-operated, for the extrusion of mastics; saw blades [parts of hand tools]; tool belts [holders]; table cutlery [knives, forks and spoons]; crimping irons; money scoops; pin punches; nail punches; syringes for spraying insecticides; reamers; saw holders; cutters; razor strops; planes; marline spikes; bits [parts of hand tools]; pruning scissors; sickles; drawing knives; mortise chisels; caulking irons; branding irons; hatchets; adzes [tools]; vices; axes; razor cases; scraping tools [hand tools]; cuticle nippers; eyelash curlers; scrapers for skis.

9 – Dvd players; ticket dispensers; juke boxes, musical; answering machines; accumulators, electric; accumulators, electric, for vehicles; actinometers; alidades; altimeters; ammeters; anemometers; anodes; aerials; anticathodes; apertometers [optics]; high-frequency apparatus; remote control apparatus; electrodynamic apparatus for the remote control of railway points; electro-dynamic apparatus for the remote control of signals; monitoring apparatus, electric; sound recording apparatus; distillation apparatus for scientific purposes; diffraction apparatus [microscopy]; air analysis apparatus; apparatus to check franking; sound transmitting apparatus; breathing apparatus for underwater swimming; cash registers; electric apparatus for commutation; intercommunication apparatus; stills for laboratory experiments; projection apparatus; radiological apparatus for industrial purposes; blueprint apparatus; blinkers [signalling lights]; stereoscopic apparatus; telephone apparatus; facsimile machines; phototelegraphy apparatus; igniting apparatus, electric, for igniting at a distance; salinometers; acidimeters for batteries; aerometers; barometers; anode batteries; galvanic batteries; batteries for lighting; solar batteries; batteries, electric; betatrons; binoculars; electronic tags for goods; fire hose nozzles; encoded identification bracelets, mag-

netic; safety tarpaulins; life buoys; marking buoys; directional compasses; vacuum gauges; electrolyzers; variometers; scales; letter scales; levelling staffs [surveying instruments]; camcorders; video cassettes; video telephones; video screens; micrometer screws for optical instruments; viscosimeters; circuit closers; wavemeters; voltmeters; mechanical signs; switchboxes [electricity]; current rectifiers; gas testing instruments; galvanometers; heliographic apparatus; hygrometers; hydrometers; weights; holograms; plotters; plumb bobs; range finders; densimeters; densitometers; optical goods; detectors; smoke detectors; counterfeit [false] coin detectors; slides [photography]; slide projectors; dictating machines; dynamometers; floppy disks; phonograph records; disks, magnetic; optical discs; disk drives for computers; dna chips; electronic notice boards; bullet-proof waistcoats [vests (am.)]; life jackets; identification threads for electric wires; nose clips for divers and swimmers; bells [warning devices]; alarm bells, electric; electric door bells; signal bells; acoustic conduits; mirrors for inspecting work; road signs, luminous or mechanical; signs, luminous; marine depth finders; probes for scientific purposes; buzzers; needles for record players; gauges; pressure measuring apparatus; simulators for the steering and control of vehicles; inverters [electricity]; temperature indicators; incubators for bacteria culture; measuring instruments; mathematical instruments; levelling instruments; surveying instruments; azimuth instruments; spark-guards; coaxial cables; fibre [fiber (am.)] optic cables; cables, electric; calipers; slide calipers; screw-tapping gauges; calculating machines; pocket calculators; decompression chambers; cinematographic cameras; electronic pens [visual display units]; holders for electric coils; identity cards, magnetic; video game cartridges; riding helmets; carriers for dark plates [photography]; automated teller machines [ATM]; cathodes; choking coils [impedance]; coils, electric; electromagnetic coils; cinematographic film, exposed; computer keyboards; solenoid valves [electromagnetic switches]; electronic agendas; push buttons for bells; magnetic encoders; anti-dazzle shades; collectors, electric; calibrating rings; protective suits for aviators; commutators; compact discs [audio-video]; comparators; marine compasses; computers; notebook computers; capacitors; contacts, electric; accumulator boxes; cabinets for loudspeakers; reflecting discs for wear, for the prevention of traffic accidents; covers for electric outlets; logs [measuring instruments]; lasers, not for medical purposes; lactodensimeters; lactometers; darkroom lamps [photography]; amplifying tubes; flashlights [photography]; head cleaning tapes [recording]; magnetic tapes; videotapes; surveying chains; fire escapes; slide-rules; contact lenses; optical lenses; optical condensers; sounding lines; electricity conduits; measuring spoons; thread counters; magnets; decorative magnets; resuscitation manne-

quins [teaching apparatus]; manometers; divers' masks; solderers' helmets; protective masks; voting machines; money counting and sorting machines; material testing instruments and machines; megaphones; diaphragms for scientific apparatus; metal detectors for industrial or military purposes; metro-nomes; rules [measuring instruments]; carpenters' rules; dressmakers' measures; coin-operated mechanisms for television sets; micrometer gauges; micro-processors; microscopes; microtomes; microphones; modems; lightning arresters; monitors [computer hardware]; animated cartoons; junction sleeves for electric cables; teeth protectors; knee-pads for workers; headphones; surveyors' levels; verniers; sound recording carriers; magnetic data media; optical data media; sheaths for electric cables; identification sheaths for electric wires; weighing machines; punched card machines for offices; lenses for astrophotography; egg-candlers; electrified fences; clothing for protection against accidents, irradiation and fire; clothing for protection against fire; clothing especially made for laboratories; ozonisers [ozonators]; octants; eyepieces; ohmmeters; spectacle frames; oscillographs; plumb lines; sunglasses; goggles for sports; signalling panels, luminous or mechanical; radio pagers; electronic pocket translators; transmitters [telecommunication]; transmitters of electronic signals; switches, electric; periscopes; gloves for divers; pipettes; pyrometers; planimeters; plane tables [surveying instruments]; plates for batteries; compact disc players; cassette players; sound recording strips; films, exposed; life-saving rafts; laboratory trays; semiconductors; polarimeters; measuring glassware; life belts; fuses; converters, electric; telerup-ters; food analysis apparatus; distance measuring ap-paratus; appliances for measuring the thickness of leather; speed checking apparatus for vehicles; teach-ing apparatus; time recording apparatus; apparatus and instruments for astronomy; surveying apparatus and instruments; weighing apparatus and instru-ments; optical apparatus and instruments; apparatus and instruments for physics; chemistry apparatus and instruments; measuring apparatus; measuring devices, electric; boiler control instruments; meteorolo-gical instruments; naval signalling apparatus; obser-vation instruments; navigation apparatus for vehicles [on-board computers]; satellite navigational appa-ratus; regulating apparatus, electric; precision measur-ing apparatus; apparatus for changing record player needles; retorts' stands; drainers for use in photog-raphy; cleaning apparatus for phonograph records; fire beaters; sighting telescopes for firearms; test tubes; pressure indicator plugs for valves; magnetic wires; telegraph wires; telephone wires; wires, elec-tric; conductors, electric; copper wire, insulated; fuse wire; computer programs [downloadable software]; record players; central processing units [processors]; rods for water diviners; radar apparatus; masts for wireless aerials; radios; vehicle radios; frames for

photographic transparencies; walkie-talkies; voltage regulators for vehicles; stage lighting regulators; speed regulators for record players; marking gauges [joinery]; relays, electric; rheostats; respirators for filtering air; retorts; refractometers; refractors; grids for batteries; horns for loudspeakers; saccharome-ters; dog whistles; sextants; life nets; fire alarms; signals, luminous or mechanical; sirens; scanners [data processing equipment]; connections for electric lines; connections, electric; sonars; sound locating instruments; lighting ballasts; resistances, electric; spectrograph apparatus; spectroscopes; speed indica-tors; alcoholmeters; satellites for scientific purposes; audiovisual teaching apparatus; radiotelegraphy sets; radiotelephony sets; fire boats; spherometers; integ-rated circuits; printed circuits; counters; parking me-ters; kilometer recorders for vehicles; revolution co-unters; abacuses; taximeters; ear plugs for divers; tachometers; television apparatus; telescopes; telep-rompters; teleprinters; theodolites; thermostats; ther-mostats for vehicles; crucibles [laboratory]; tone arms for record players; totalizators; transistors [el-ectronic]; protractors [measuring instruments]; ve-hicle breakdown warning triangles; starter cables for motors; capillary tubes; telephone receivers; quantity indicators; automatic indicators of low pressure in vehicle tires; gasoline gauges; water level indicators; light-emitting electronic pointers; clinometers; levels [instruments for determining the horizontal]; mercu-ry levels; spirit levels; urinometers; amplifiers; par-ticle accelerators; steering apparatus, automatic, for vehicles; balancing apparatus; video recorders; so-und reproduction apparatus; invoicing machines; railway traffic safety appliances; data processing ap-paratus; oxygen transvasing apparatus; film cutting apparatus; drying apparatus for photographic prints; optical character readers; centering apparatus for photographic transparencies; dosage dispensers; chargers for electric batteries; sounding apparatus and machines; editing appliances for cinematograp-hic films; cathodic anti-corrosion apparatus; coup-lers [data processing equipment]; computer periph-eral devices; demagnetizing apparatus for magnetic tapes; acoustic couplers; alarms; adding machines; readers [data processing equipment]; heat regulating apparatus; photocopiers [photographic, electrostatic, thermic]; bar code readers; filters for respiratory masks; filters for ultraviolet rays, for photography; magic lanterns; optical lamps; signal lanterns; cam-eras [photography]; glazing apparatus for photo-graphic prints; shutters [photography]; darkrooms [photography]; photometers; flash-bulbs [photograp-hy]; enlarging apparatus [photography]; photovoltaic cells; containers for contact lenses; spectacle cases; containers for microscope slides; cases especially made for photographic apparatus and instruments; chromatography apparatus for laboratory use; chro-nographs [time recording apparatus]; cyclotrons; fre-quency meters; egg timers [sandglasses]; fire blan-

kets; meteorological balloons; electrified rails for mounting spot lights; asbestos screens for firemen; protective helmets for sports; switchboards; workmen's protective face-shields; projection screens; radiology screens for industrial purposes; fluorescent screens; ducts [electricity]; galvanic cells; epidiascopes; ergometers.

14 – Agates; diamonds; bracelets [jewellery]; straps for wristwatches; charms [jewellery]; alarm clocks; ornamental pins; tie pins; pearls made of ambroid [pressed amber]; jet, unwrought or semi-wrought; copper tokens; tie clips; gold, unwrought or beaten; jewellery; jewellery of yellow amber; iridium; precious stones; semi-precious stones; spun silver [silver wire]; necklaces [jewellery]; rings [jewellery]; boxes of precious metal; watch cases; pendulums [clock and watch making]; medals; medallions [jewellery]; precious metals, unwrought or semi-wrought; clockworks; coins; threads of precious metal [jewellery]; gold thread [jewellery]; silver thread [jewellery]; olivine [gems]; osmium; palladium; platinum [metal]; watch springs; rhodium; ruthenium; stopwatches; silver, unwrought or beaten; earrings; ingots of precious metals; alloys of precious metal; statues of precious metal; figurines [statuettes] of precious metal; watch crystals; paste jewellery; shoe ornaments of precious metal; hat ornaments of precious metal; ornaments of jet; ivory [jewellery]; clock cases; presentation boxes for watches; chronographs [watches]; chronometers; chronoscopes; chains [jewellery]; watch chains; dials [clock and watch making]; clocks; watches; atomic clocks; sun dials; clocks and watches, electric; control clocks [master clocks]; wristwatches; spinel [precious stones].

16 – Fountain pens; aquarelles; albums; almanacs; document laminators for office use; atlases; posters; paper bows; tickets; forms, printed; note books; drawing pads; loose-leaf binders; wristbands for the retention of writing instruments; pamphlets; booklets; paper sheets [stationery]; waxed paper; paper for recording machines; paper for radiograms; electrocardiograph paper; drawer liners of paper, perfumed or not; wood pulp paper; carbon paper; parchment paper; writing paper; luminous paper; hygienic paper; packing paper; paper; blotters; newsletters; rollers for typewriters; house painters' rollers; composing sticks; modelling wax, not for dental purposes; signboards of paper or cardboard; newspapers; electrotypes; hectographs; terrestrial globes; engravings; slate pencils; pencil leads; pencil holders; chalk holders; holders for checkbooks [cheque books]; diagrams; engraving plates; writing slates; blackboards; galley racks [printing]; drawing boards; punches [office requisites]; cream containers of paper; money clips; tags for index cards; bookmarks; printed publications; graphic representations; graining combs; calendars; tracing paper; tracing pat-

terns; gums [adhesives] for stationery or household purposes; lithographic stones; pencils; pencil lead holders; charcoal pencils; pictures; decalcomanias; paintings [pictures], framed or unframed; wood pulp board [stationery]; cardboard; hat boxes of cardboard; files [office requisites]; cards; index cards [stationery]; geographical maps; paper tapes and cards for the recordal of computer programmes; perforated cards for jacquard looms; catalogues; covers of paper for flower pots; paintbrushes; painters' brushes; writing brushes; typewriter keys; glue for stationery or household purposes; starch paste [adhesive] for stationery or household purposes; printing blocks; books; manifolds [stationery]; comic books; drawing pins; cigar bands; envelopes [stationery]; boxes of paper or cardboard; paint boxes [articles for use in school]; correcting fluids [office requisites]; french curves; paper ribbons; typewriter ribbons; gummed tape [stationery]; viscose sheets for wrapping; plastic bubble packs for wrapping or packaging; steel letters; letters [type]; architects' models; postage stamps; graphic prints; teaching materials [except apparatus]; sealing compounds for stationery purposes; adhesives [glues] for stationery or household purposes; packaging material made of starches; addressing machines; bookbinding apparatus and machines [office equipment]; typewriters, electric or non-electric; folders [stationery]; chalk for lithography; writing chalk; marking chalk; garbage bags of paper or of plastics; painters' easels; hand-rests for painters; printing sets, portable [office requisites]; bibs of paper; stickers [stationery]; bookbinding cords; paper knives [cutters] [office requisites]; numbering apparatus; sealing wafers; covers [stationery]; passport holders; plastic cling film, extensible, for palletization; embroidery designs [patterns]; handwriting specimens for copying; oleographs; musical greeting cards; greeting cards; postcards; etchings; conical paper bags; bags for microwave cooking; palettes for painters; ink sticks; folders for papers; papier mâché; pastels [crayons]; boxes for pens; pen wipers; office perforators; nibs; nibs of gold; steel pens; drawing pens; song books; seals [stamps]; sealing stamps; clipboards; address plates for addressing machines; handkerchiefs of paper; plastic film for wrapping; letter trays; trays for sorting and counting money; coasters of paper; bookends; stamp stands; mats for beer glasses; stands for pens and pencils; photograph stands; stamp pads; towels of paper; gummed cloth for stationery purposes; printers' blankets, not of textile; portraits; paperweights; writing cases [sets]; office requisites, except furniture; writing materials; school supplies [stationery]; adhesive tape dispensers [office requisites]; hand labelling appliances; pencil sharpeners, electric or non-electric; printed matter; prospectuses; printed timetables; printers' galleys; indexes; graphic reproductions; face towels of paper; erasing products; writing board erasers; sealing wax; arithmetical tab-

les; placards of paper or cardboard; writing or drawing books; stationery; transparencies [stationery]; stencil plates; cardboard tubes; indian inks; moisteners for gummed surfaces [office requisites]; chart pointers, non-electronic; bottle wrappers of paper or cardboard; envelope sealing machines for offices; sealing machines for offices; vignetting apparatus; apparatus for mounting photographs; stapling presses [office requisites]; handbooks [manuals]; paper coffee filters; flags of paper; silver paper; molds for modelling clays [artists' materials]; photo-engravings; stencil cases; canvas for painting; chromolithographs [chromos]; artists' watercolor saucers; correcting ink [heliography]; ink; inkwells; blueprints; balls for ball-point pens; cabinets for stationery [office requisites]; printing type; address stamps; stamps [seals]; prints [engravings]; labels of paper or cardboard.

18 – Mountaineering sticks; pocket wallets; reins; harness fittings; parts of rubber for stirrups; chamois leather, other than for cleaning purposes; umbrellas; parasols; saddlery; frames for umbrellas or parasols; handbag frames; valves of leather; whips; imitation leather; leather, unworked or semi-worked; leatherboard; casings, of leather, for springs; umbrella rings; hat boxes of leather; boxes of leather or leatherboard; purses; chain mesh purses; fastenings for saddles; butts [parts of hides]; saddle trees; bags [envelopes, pouches] of leather, for packaging; moleskin [imitation of leather]; knee-pads for horses; muzzles; halters; leather thread; furniture coverings of leather; clothing for pets; trimmings of leather for furniture; collars for animals; dog collars; music cases; slings for carrying infants; goldbeaters' skin; cat o' nine tails; pads for horse saddles; horseshoes; girths of leather; coverings of skins [furs]; horse blankets; shoulder belts [straps] of leather; fur; haversacks; leather straps; straps for soldiers' equipment; harness straps; straps for skates; straps of leather [saddlery]; chin straps, of leather; stirrup leathers; umbrella handles; walking stick handles; suitcase handles; rucksacks; travelling bags; riding saddles; net bags for shopping; umbrella or parasol ribs; stirrups; bags for climbers; pouch baby carriers; garment bags for travel; handbags; beach bags; bags for sports; bags for campers; shopping bags; school satchels; travelling trunks; bridoons; walking sticks; umbrella sticks; walking stick seats; bits for animals [harness]; bridles [harness]; harness for animals; horse collars; suitcases.

19 – Aquaria [structures]; alabaster; door casings, not of metal; window frames, not of metal; asbestos cement; asphalt; beams, not of metal; balustrades, not of metal; huts; swimming pools [structures], not of metal; harbours [structures], not of metal; concrete; bitumen; telephone booths, not of metal; beacons, not of metal, non-luminous; busts of stone, concrete

or marble; binding material for road repair; stained-glass windows; gates, not of metal; geotextiles; gypsum; plaster; potters' clay; potters' clay [raw material]; earth for bricks; clay; gravel; aquarium gravel; granite; folding doors, not of metal; coal tar; wood for making household utensils; veneer wood; moldable wood; non-luminous and non-mechanical signs, not of metal; calcareous stone; lime; works of stonemasonry; works of art of stone, concrete or marble; rubble; artificial stone; greenhouse frames, not of metal; cornices, not of metal; paperboard for building; quartz; caissons for construction work under water; bricks; fire burrs; water-pipe valves, not of metal or plastic; drain traps [valves], not of metal or plastic; cask wood; mooring bollards, not of metal; buildings, transportable, not of metal; roofing, not of metal; manhole covers, not of metal; xylolith; chicken-houses, not of metal; manufactured timber; sawn timber; wood, semi-worked; staircases, not of metal; bituminous products for building; road coating materials; pitch; refractory construction materials, not of metal; raw chalk; calcareous marl; mosaics for building; marble; slate powder; roof flashing, not of metal; perches; duckboards, not of metal; moldings, not of metal, for cornices; laths, not of metal; wood panelling; latticework, not of metal; windows, not of metal; olivine for building; shuttering, not of metal, for concrete; branching pipes, not of metal; monuments, not of metal; wainscoting, not of metal; signalling panels, non-luminous and non-mechanical, not of metal; parquet flooring; partitions, not of metal; lintels, not of metal; casement windows, not of metal; sand, except foundry sand; aquarium sand; silver sand; platforms, prefabricated, not of metal; paving slabs, not of metal; cement slabs; roofing, not of metal, incorporating solar cells; asphalt paving; wood paving; macadam; roof coverings, not of metal; bituminous coatings for roofing; floating docks, not of metal, for mooring boats; grout; asbestos mortar; tanks of masonry; furrings of wood; pilings, not of metal; shutters, not of metal; statues of stone, concrete or marble; statuettes of stone, concrete or marble; alabaster glass; safety glass; glass granules for road marking; window glass, other than vehicle window glass; plate glass [windows] for building; advertisement columns, not of metal; telegraph posts, not of metal; hips for roofing; terra cotta; penstock pipes, not of metal; water-pipes, not of metal; gutter pipes, not of metal; ducts, not of metal, for ventilating and air-conditioning installations; drain pipes, not of metal; chimneys, not of metal; tufa; angle irons, not of metal; lengthening pieces, not of metal, for chimneys; plywood; door panels, not of metal; foundry molds [moulds], not of metal; cement for blast furnaces; cement for furnaces; magnesia cement; cement; roofing slates; slag [building material]; clinker stone; railroad ties, not of metal; veneers; clinker ballast; letter boxes of masonry.

20 – Pulleys of plastics for blinds; mooring buoys, not of metal; sideboards; busts of wood, wax, plaster or plastic; costume stands; bolsters; fans for personal use, non-electric; work benches; coatstands; coat hangers; display stands; showcases [furniture]; newspaper display stands; signboards of wood or plastics; nesting boxes; doors for furniture; curtain holders, not of textile material; divans; keyboards for hanging keys; display boards; containers, not of metal, for liquid fuel; packaging containers of plastic; curtain tie-backs; imitation tortoiseshell; locks, other than electric, not of metal; locks, not of metal, for vehicles; bead curtains for decoration; mirrors [looking glasses]; hand-held mirrors [toilet mirrors]; bamboo; animal claws; animal hooves; coral; meerscham; whalebone, unworked or semi-worked; stag antlers; tortoiseshell; shells; horn, unworked or semi-worked; animal horns; rattan; ivory, unworked or semi-worked; corozo; plaited straw, except matting; wickerwork; works of art of wood, wax, plaster or plastic; cabinet work; reeds [plaiting materials]; settees; curtain rods; reels of wood for yarn, silk, cord; staves of wood; mats for infant playpens; saw horses; bed casters, not of metal; furniture casters, not of metal; brush mountings; wind chimes [decoration]; cradles; curtain rings; chests of drawers; containers, not of metal [storage, transport]; floating containers, not of metal; lecterns; dog kennels; baskets, not of metal; bakers' bread baskets; bottle casings of wood; armchairs; hairdressers' chairs; hospital beds; bedsteads of wood; beds; table tops; curtain hooks; clothes hooks, not of metal; ladders of wood or plastics; playpens for babies; dressmakers' dummies; air mattresses, not for medical purposes; mattresses; hydrostatic beds, not for medical purposes; furniture of metal; office furniture; school furniture; curtain rails; furniture; furniture partitions of wood; mother-of-pearl, unworked or semi-worked; mirror tiles; ambroid plates; numberplates, not of metal; identity plates, not of metal; head-rests [furniture]; trestles [furniture]; magazine racks; book rests [furniture]; stands for calculating machines; flower-pot pedestals; pet cushions; pillows; cushions; mats, removable, for sinks; racks [furniture]; library shelves; shelves for file cabinets; furniture shelves; shelves for storage; wood ribbon; straw edgings; towel stands [furniture]; hat stands; inflatable publicity objects; bedding, except linen; corks for bottles; corks; standing desks; embroidery frames; picture frames; sections of wood for beehives; reservoirs, not of metal nor of masonry; curtain rollers; door handles, not of metal; fishing baskets; writing desks; seats of metal; benches [furniture]; honeycombs; sofas; statues of wood, wax, plaster or plastic; statuettes of wood, wax, plaster or plastic; oyster shells; ambroid bars; umbrella stands; gun racks; dressing tables; shelves for typewriters; drafting tables; massage tables; tables of metal; desks; tea carts; tables; high chairs for babies; placards of wood or plastics; stools;

crates; trolleys [furniture]; straw plaits; straw mattresses; decorations of plastic for foodstuffs; beehives; funerary urns; wax figures; door fittings, not of metal; bed fittings, not of metal; furniture fittings, not of metal; window fittings, not of metal; infant walkers; stuffed animals; stuffed birds; deck chairs; poles, not of metal; screens [furniture]; medicine cabinets; plate racks; bamboo curtains; slatted indoor blinds; indoor window blinds [shades] [furniture]; yellow amber; lockers; chests for toys; letter boxes, not of metal or masonry; bottle racks.

21 – Broom handles; drinking straws; indoor aquaria; buckets; china ornaments; dishes; paper plates; saucers; mugs; boxes for sweetmeats; sandwich boxes; bottles; carboys; busts of china, terra-cotta or glass; vases; epergnes; fruit cups; bird baths; baby baths, portable; plungers for clearing blocked drains; waffle irons, non-electric; ice buckets; buckets made of woven fabrics; hair for brushes; birdcages; funnels; carpet beaters [hand instruments]; signboards of porcelain or glass; candle extinguishers; flower pots; chamber pots; glue-pots; decanters; large-toothed combs for the hair; combs for animals; abrasive sponges for scrubbing the skin; sponges for household purposes; toilet sponges; sponge holders; toothpick holders; dishes for soap; holders for flowers and plants [flower arranging]; shaving brush stands; ironing boards; cutting boards for the kitchen; bread boards; washing boards; smoke absorbers for household purposes; containers for household or kitchen use; kitchen containers; heat-insulated containers for beverages; thermally insulated containers for food; frying pans; closures for pot lids; buckskin for cleaning; toothpicks; ceramics for household purposes; majolica; brush goods; cleaning instruments, hand-operated; stew-pans; shaving brushes; cages for household pets; polishing leather; napkin rings; baskets for household purposes; cookie jars; tea caddies; earthenware saucepans; mess-tins; cauldrons; coffee percolators, non-electric; coffeepots, non-electric; coffee grinders, hand-operated; fused silica [semi-worked product], other than for building; beer mugs; rat traps; pot lids; aquarium hoods; butter-dish covers; covers for dishes; cheese-dish covers; buttonhooks; jugs; perfume burners; watering cans; insect traps; mixing spoons [kitchen utensils]; pie servers; butter dishes; material for brush-making; noodle machines, hand-operated; polishing apparatus and machines, for household purposes, non-electric; pepper mills, hand-operated; feather-dusters; brooms; isothermic bags; basins [bowls]; mosaics of glass, not for building; saucepan scourers of metal; soap boxes; mouse traps; cooking pot sets; nozzles for watering cans; fitted picnic baskets, including dishes; toilet cases; floss for dental purposes; fiberglass thread, not for textile use; cookie [biscuit] cutters; pastry cutters; sprinklers; sprinklers for watering flowers and plants; cotton waste for cleaning; wool waste for cleaning; cleaning tow; chopsticks; cock-

tail stirrers; pepper pots; gloves for household purposes; polishing gloves; gardening gloves; plates to prevent milk boiling over; trays for household purposes; trays of paper, for household purposes; lazy susans; heaters for feeding bottles, non-electric; candleabra [candlesticks]; trivets [table utensils]; menu card holders; flat-iron stands; egg cups; gridiron supports; abrasive pads for kitchen purposes; pads for cleaning; drinking troughs; powdered glass for decoration; pottery; painted glassware; tableware, other than knives, forks and spoons; porcelain ware; crockery; cosmetic utensils; toilet utensils; trouser presses; spice sets; apparatus for wax-polishing, non-electric; glove stretchers; boot jacks; crumb trays; tie presses; clothes-pegs; glass caps; powder compacts; perfume sprayers; powder puffs; dusting apparatus, non-electric; combs; electric combs; drinking horns; shoe horns; salad bowls; sugar bowls; services [dishes]; liqueur sets; tea strainers; siphon bottles for carbonated water; rolling pins, domestic; steel wool for cleaning; currycombs; salt cellars; drinking vessels; vessels of metal for making ices and iced drinks; refrigerating bottles; cups of paper or plastic; glasses [receptacles]; drinking glasses; figurines [statuettes] of porcelain, terra-cotta or glass; glass for vehicle windows [semi-finished product]; plate glass [raw material]; opal glass; glass, unworked or semi-worked, except building glass; vitreous silica fibers [fibres], not for textile use; soup bowls; drying racks for laundry; table plates; disposable table plates; insulating flasks; indoor terrariums [plant cultivation]; indoor terrariums [vivariums]; cloth for washing floors; cloths for cleaning; dusting cloths [rags]; furniture dusters; urns; aerosol dispensers, not for medical purposes; water apparatus for cleaning teeth and gums; sprinkling devices; utensils for household purposes; kitchen utensils; flasks; molds [kitchen utensils]; ice cube molds [moulds]; deep fryers, non-electric; comb cases; bread bins; fly swatters; teapots; kettles, non-electric; cups; garlic presses [kitchen utensils]; ironing board covers, shaped; tea balls; glass bowls; mops; cocktail shakers; corkscrews, electric and non-electric; dishwashing brushes; brushes for cleaning tanks and containers; lamp-glass brushes; horse brushes; scrubbing brushes; toothbrushes; toothbrushes, electric; carpet sweepers; brushes for footwear; toilet brushes; electric brushes, except parts of machines; brushes; eyebrow brushes; nail brushes; nest eggs, artificial; dustbins; tea cosies; nutcrackers; sugar tongs.

24 – Sleeping bags for camping; frieze [cloth]; velvet; household linen; diapered linen; bath linen, except clothing; bed linen; table linen, not of paper; buckram; dimity; felt; jersey [fabric]; curtains of textile or plastic; net curtains; zephyr [cloth]; canvas for tapestry or embroidery; bolting cloth; crepe [fabric]; crepon; furniture coverings of textile; fabrics for textile use; filtering materials of textile; tapestry [wall hangings], of textile; non-woven textile fabrics; plas-

tic material [substitute for fabrics]; textile material; moleskin [fabric]; mattress covers; bed blankets; brocades; handkerchiefs of textile; travelling rugs [lap robes]; curtain holders of textile material; bed covers; coverings of plastic for furniture; towels of textile; hemp cloth; gummed cloth, other than for stationery purposes; printers' blankets of textile; cloth; door curtains; shrouds; face towels of textile; mosquito nets; tablecloths, not of paper; oilcloth for use as tablecloths; billiard cloth; taffeta [cloth]; tick [linen]; lingerie fabric; fabric, impervious to gases, for aeronautical balloons; jute fabric; fabric for footwear; ramie fabric; esparto fabric; rayon fabric; fiberglass fabrics for textile use; adhesive fabric for application by heat; linen cloth; upholstery fabrics; hemp fabric; lining fabric for footwear; traced cloths for embroidery; chenille fabric; printed calico cloth; knitted fabric; cotton fabrics; silk fabrics for printing patterns; woollen cloth; elastic woven material; fabric; fabric of imitation animal skins; cheese cloth; marabouts [cloth]; tulle; flannel [fabric]; trellis [cloth]; fitted toilet lid covers of fabric; covers [loose] for furniture; pillow shams; cheviots [cloth]; labels of textile.

25 – Wimples; bandanas [neckerchiefs]; underwear; sweat-absorbent underwear; smocks; boas [necklets]; teddies [underclothing]; breeches for wear; trousers; football shoes; brassieres; detachable collars; shirt yokes; veils [clothing]; galoshes; neckties; ascots; gaiters; boot uppers; vests; sports jerseys; hosiery; heels; hoods [clothing]; hat frames [skeletons]; pockets for clothing; tights; combinations [clothing]; wet suits for water-skiing; bodices [lingerie]; suits; bathing suits; masquerade costumes; beach clothes; jackets [clothing]; fishing vests; liveries; camisoles; cuffs; mantillas; coats; sleep masks; furs [clothing]; mittens; miters [hats]; muffs [clothing]; heelpieces for footwear; bibs, not of paper; fur stoles; ear muffs [clothing]; socks; beach shoes; sports shoes; footwear; paper clothing; outerclothing; ready-made clothing; motorists' clothing; cyclists' clothing; clothing for gymnastics; clothing of imitations of leather; clothing of leather; knitwear [clothing]; uniforms; clothing; fittings of metal for footwear; maniples; overcoats; parkas; swaddling clothes; peleries; gloves [clothing]; pyjamas; bathing drawers; scarves; dresses; garters; sock suspenders; stocking suspenders; ready-made linings [parts of clothing]; dress shields; soles for footwear; suspenders; lace boots; belts [clothing]; money belts [clothing]; layettes [clothing]; non-slipping devices for footwear; pullovers; heelpieces for stockings; welts for footwear; chasubles; shirts; wooden shoes; sandals; boots; saris; sweaters; footwear uppers; inner soles; togas; underpants; gymnastic shoes; slippers; shoes; turbans; headgear for wear; aprons [clothing]; dressing gowns; tips for footwear; stockings; sweat-absorbent stockings; shawls; paper hats [clothing]; bathing caps; sashes for wear; studs for football boots; ba-

bies' pants [underwear]; trouser straps; pelisses; esparto shoes or sandals; skirts; petticoats.

26 – Fringes; hair curlers, other than hand implements, non-electric; mica spangles; shoe eyelets; false beards; brooches [clothing accessories]; pins, other than jewellery [jewelry (am.)]; wreaths of artificial flowers; false hair; artificial garlands; frills [lacework]; shoe fasteners; fastenings for suspenders; belt clasps; hook and pile fastening tapes; zip fasteners; zip fasteners for bags; competitors' numbers; needles for wool combing machines; binding needles; embroidery; silver embroidery; haberdashery, except thread; decorative articles for the hair; heat adhesive patches for decoration of textile articles [haberdashery]; gold embroidery; snap fasteners; plaited hair; false hems; hooks [haberdashery]; crochet hooks; shoe hooks; ribbons [haberdashery]; elastic ribbons; toupees; sewing thimbles; skirt flourishes; bows for the hair; hair curling papers; wigs; feathers [clothing accessories]; birds' feathers [clothing accessories]; eyelets for clothing; corset busks; hair bands; brassards; shoulder pads for clothing; pin cushions; needle cushions; top-knots [pompoms]; buckles [clothing accessories]; shoe buckles; buttons; ornamental novelty badges [buttons]; rosettes [haberdashery]; frills for clothing; hair nets; chenille [passementerie]; knitting needles; trimmings for clothing; false moustaches; festoons [embroidery]; artificial fruit; artificial flowers; shuttles for making fishing nets; hair coloring caps; shoe laces; cords for clothing; woollen laces; collar supports; needle-threaders.

28 – Amusement machines, automatic and coin-operated; toy vehicles; swimming pools [play articles]; novelties for parties, dances [party favors, favours]; starting blocks for sports; skating boots with skates attached; dolls' feeding bottles; shuttlecocks; spinning tops [toys]; jigsaw puzzles; punching bags; hang gliders; flying discs [toys]; discuses for sports; dolls' houses; dominoes; spring boards [sports articles]; skateboards; sailboards; chessboards; checkerboards; darts; Christmas trees of synthetic material; cups for dice; kites; toys; toys for pets; plush toys; stuffed toys; wooden toys; plastic toys; rubber toys; inflatable toys; mobiles [toys]; practical jokes [novelties]; board games; ring games; games; kaleidoscopes; bladders of balls for games; rosin used by athletes; edges of skis; bingo cards; playing cards; fairground ride apparatus; rocking horses; swings; skittles; ninepins; billiard cues; golf clubs; hockey sticks; bells for Christmas trees; dolls' rooms; building games; confetti; ice skates; roller skates; dice; paintball guns [sports apparatus]; ski bindings; dolls' beds; roulette wheels; building blocks [toys]; dolls; flippers for swimming; bows for archery; skis; waterskis; surf skis; mah-jong; hunting game calls; marionettes; theatrical masks; fencing masks; masts for sailboards; chalk for billiard cues; targets; electronic

targets; scale model vehicles; balls for games; billiard table cushions; knee guards [sports articles]; billiard cue tips; elbow guards [sports articles]; dolls' clothes; fencing weapons; twirling batons; paragliders; toy pistols; toy air pistols; detonating caps [toys]; rattles [playthings]; horseshoe games; candle holders for Christmas trees; Christmas tree stands; sole coverings for skis; decoys for hunting or fishing; scent lures for hunting or fishing; archery implements; kite reels; soap bubbles [toys]; divot repair tools [golf accessories]; protective paddings [parts of sports suits]; bats for games; surfboard leashes; harness for sailboards; sling shots [sports articles]; rollers for stationary exercise bicycles; harpoon guns [sports articles]; scooters [toys]; sleighs [sports articles]; butterfly nets; nets for sports; appliances for gymnastics; quoits; bar-bells; climbers' harness; artificial snow for Christmas trees; snowshoes; clay pigeon traps; billiard tables; coin-operated billiard tables; tables for table tennis; cricket bags; golf bags, with or without wheels; slides [playthings]; remote-controlled toy vehicles; backgammon games; ornaments for Christmas trees, except illumination articles and confectionery; tennis ball throwing apparatus.

29 – Anchovy, not live; peanuts, prepared; white of eggs; beans, preserved; soya beans, preserved, for food; bouillon; ginger jam; fatty substances for the manufacture of edible fats; edible birds' nests; peas, preserved; mushrooms, preserved; game, not live; gelatine for food; meat jellies; jellies for food; fruit jellies; yolk of eggs; coconut fat; bone oil, edible; lard; suet for food; edible fats; fruit-based snack food; charcuterie; raisins; caviar; sauerkraut; isinglass for food; black pudding; meat, tinned [canned (am.)]; vegetables, tinned [canned (am.)]; fish, tinned [canned (am.)]; fruits, tinned [canned (am.)]; bouillon concentrates; gherkins; prawns, not live; buttercream; croquettes; silkworm chrysalis for human consumption; spiny lobsters, not live; salmon, not live; onions, preserved; margarine; marmalade; peanut butter; cocoa butter for food; coconut butter; butter; shellfish, not live; almonds, ground; animal marrow for food; mussels, not live; milk; soya milk [milk substitute]; fish meal for human consumption; fruit pulp; meat; meat, preserved; vegetables, preserved; vegetables, dried; vegetables, cooked; potato fritters; olives, preserved; lobsters, not live; coconut, desiccated; nuts, prepared; tomato purée; liver pâté; liver; pickles; jams; powdered eggs; milk products; fish-based foodstuffs; curd; poultry, not live; pollen prepared as foodstuff; cranberry sauce [compote]; apple purée; crayfish, not live; fish, not live; fish, preserved; vegetable salads; fruit salads; bacon; sardines, not live; pork; herrings, not live; whipped cream; fat-containing mixtures for bread slices; tomato juice for cooking; vegetable juices for cooking; salted meats; sausages in batter; preparations for making bouillon; preparations for making soup; tripe; soups; vegetable soup preparations; cheese;

tofu; sea-cucumbers, not live; truffles, preserved; tuna, not live; oysters, not live; rennet; fish fillets; dates; crystallized fruits; frozen fruits; fruit, preserved; fruit preserved in alcohol; fruit, stewed; potato flakes; fruit peel; lentils, preserved; potato chips; fruit chips; seaweed extracts for food; meat extracts; snail eggs for consumption; eggs; peanut milk-based beverages; almond milk-based beverages.

30 – Aromatic preparations for food; food flavorings, other than essential oils; star aniseed; pancakes; buns; bread rolls; vanillin [vanilla substitute]; waffles; vermicelli [noodles]; natural sweeteners; sausage binding materials; binding agents for edible ices; sea water for cooking; mustard; yeast; thickening agents for cooking foodstuffs; rice-based snack food; cereal-based snack food; artificial coffee; vegetal preparations for use as coffee substitutes; marshmallow; pastries; confectionery for decorating Christmas trees; fruit jellies [confectionery]; cakes; peanut confectionery; almond confectionery; pasta; pasties; frozen yoghurt [confectionery ices]; cocoa; cocoa products; capers; caramels [candy]; gruel, with a milk base, for food; instant porridge; quiches; gluten prepared as foodstuff; sweetmeats [candy]; liquorice [confectionery]; peppermint sweets; coffee; unroasted coffee; starch for food; crackers; hominy grits; groats for human food; corn, milled; corn, roasted; meat pies; turmeric; couscous [semolina]; noodles; ice for refreshment; ice, natural or artificial; edible ices; candy; rice cakes; maltose; hominy; marzipan; custard; honey; royal jelly for human consumption, not for medical purposes; ice cream; wheat flour; muesli; muesli bars; mint for confectionery; cocoa beverages with milk; coffee beverages with milk; coffee-based beverages; tea-based beverages; chocolate beverages with milk; chocolate-based beverages; cocoa-based beverages; infusions, not medicinal; crushed oats; husked oats; nutmegs; lozenges [confectionery]; golden syrup; pepper; petits fours [cakes]; biscuits; pies; pizzas; fondants [confectionery]; popcorn; powders for making ice cream; pralines; condiments; meat tenderizers for household purposes; cereal preparations; oat-based food; propolis; gingerbread; spices; puddings; cake powder; ravioli; chewing gum; rice; spring rolls; sugar; aniseed; cake dough; confectionery; baking soda [bicarbonate of soda for cooking purposes]; malt for human consumption; salt for preserving foodstuffs; cooking salt; celery salt; spaghetti; seasonings; preparations for stiffening whipped cream; rusks; bread-crumbs; sushi; sandwiches; tabbouleh; tacos; tapioca; almond paste; tortillas; garden herbs, preserved [seasonings]; candy decorations for cakes; vinegar; ferments for pastes; halvah; bread; unleavened bread; corn flakes; chicory [coffee substitute]; tea; iced tea; chocolate; chocolate bars; filled chocolates; chocolate eggs; malt extract for food; essences for foodstuffs, except etheric essences and essential oils.

32 – Aperitifs, non-alcoholic; waters [beverages]; kvass [non-alcoholic beverage]; cocktails, non-alcoholic; lemonades; non-alcoholic beverages; isotonic beverages; non-alcoholic honey-based beverages; whey beverages; non-alcoholic fruit juice beverages; fruit nectars, non-alcoholic; orgeat; beer; powders for effervescing beverages; sarsaparilla [non-alcoholic beverage]; syrups for lemonade; syrups for beverages; tomato juice [beverage]; cider, non-alcoholic; vegetable juices [beverages]; fruit juices; preparations for making aerated water; preparations for making liqueurs; preparations for making mineral water; preparations for making beverages; must; grape must, unfermented; beer wort; malt wort; pastilles for effervescing beverages; sherbets [beverages]; non-alcoholic fruit extracts; extracts of hops for making beer; essences for making beverages.

34 – Gas containers for cigar lighters; absorbent paper for tobacco pipes; cigarette paper; lighters for smokers; tobacco pouches; books of cigarette papers; humidors; matchboxes; firestones; cigar cutters; cigar holders; cigarette holders; mouthpieces for cigarette holders; tips of yellow amber for cigar and cigarette holders; ashtrays for smokers; spittoons for tobacco users; pipe racks for tobacco pipes; pipe cleaners for tobacco pipes; cigarettes; cigarettes containing tobacco substitutes, not for medical purposes; cigarillos; cigars; tobacco jars; match holders; matches; tobacco; chewing tobacco; snuff; snuff boxes; herbs for smoking; tobacco pipes; pocket machines for rolling cigarettes; cigarette filters; cigarette tips; cigar cases; cigarette cases.

38 – News agency services; television broadcasting; cable television broadcasting; electronic bulletin board services [telecommunications services]; information about telecommunication; telecommunication routing and junction services; providing access to databases; providing telecommunications connections to a global computer network; providing telecommunication channels for teleshopping services; message sending; computer aided transmission of messages and images; transmission of telegrams; rental of message sending apparatus; rental of access time to global computer networks; rental of modems; rental of telecommunication equipment; rental of telephones; rental of facsimile apparatus; radio broadcasting; communications by fibre optic networks; communications by cellular phones; communications by computer terminals; satellite transmission; communications by telegrams; communications by telephone; facsimile transmission; paging services [radio, telephone or other means of electronic communication]; telex services; telegraph services; telephone services.

41 – Modelling for artists; academies [education]; rental of tennis courts; lending library services; videotaping; nursery schools; physical education; disotheque services; animal training; dubbing; gamb-

ling services; publication of books; education information; recreation information; entertainment information; movie studio services; layout services, other than for advertising purposes; microfilming; videotape editing; production of radio and television programmes; game services provided on-line from a computer network; providing on-line electronic publications, not downloadable; religious education; gymnastic instruction; correspondence courses; practical training [demonstration]; organization of balls; organization of exhibitions for cultural or educational purposes; providing recreation facilities; arranging and conducting of colloquiums; arranging and conducting of congresses; arranging and conducting of conferences; arranging and conducting of concerts; arranging and conducting of workshops [training]; arranging and conducting of seminars; arranging and conducting of symposiums; arranging of beauty contests; organization of competitions [education or entertainment]; organization of lotteries; organization of shows [impresario services]; organization of sports competitions; vocational guidance [education or training advice]; amusement park services; sign language interpretation; television entertainment; mobile library services; providing golf facilities; providing sports facilities; providing amusement arcade services; cinema presentations; presentation of live performances; theatre productions; educational examination; film production, other than advertising films; rental of sound recordings; rental of audio equipment; rental of video cameras; rental of video cassette recorders; rental of videotapes; rental of show scenery; rental of cinematographic apparatus; rental of motion pictures; rental of stadium facilities; rental of lighting apparatus for theatrical sets or television studios; rental of radio and television sets; rental of skin diving equipment; rental of sports equipment, except vehicles; rental of stage scenery; electronic desktop publishing; on-line publication of electronic books and journals; publication of texts, other than publicity texts; radio entertainment; entertainer services; entertainment services; zoological garden services; news reporters services; party planning [entertainment]; music composition services; subtitling; providing casino facilities [gambling]; calligraphy services; providing museum facilities [presentation, exhibitions]; educational services; orchestra services; translation; scriptwriting, other than for advertising purposes; ticket agency services [entertainment]; recording studio services; photography; photographic reporting; presentation of circus performances; boarding school education; production of shows.

42 – Computer system analysis; chemical analysis; architectural services; authenticating works of art; graphic arts design; computer virus protection services; conducting technical project studies; engineering; installation of computer software; meteorological information; material testing; textile testing;

bacteriological research; biological research; geological research; research in the field of environmental protection; cosmetic research; mechanical research; physics [research]; chemical research; analysis for oil-field exploitation; underwater exploration; technical research; calibration [measuring]; computer software consultancy; architectural consultancy; oil-well testing; quality control; vehicle roadworthiness testing; land surveying; dress designing; updating of computer software; design of interior decor; conversion of data or documents from physical to electronic media; urban planning; providing search engines for the internet; computer system design; rental of web servers; computer rental; geological prospecting; oil prospecting; duplication of computer programs; construction drafting; computer software design; cloud seeding; consultancy in the field of energy-saving; creating and maintaining web sites for others; computer programming; chemistry services; packaging design; surveying.

43 – Accommodation bureau services [hotels, boarding houses]; rental of temporary accommodation; rental of meeting rooms; tourist home services; hotel reservations; boarding house bookings; temporary accommodation reservations; hotel services; retirement home services; snack-bar services; café services; cafeteria services; motel services; boarding house services; boarding for animals; rental of chairs, tables, table linen, glassware; rental of tents; rental of transportable buildings; restaurant services; self-service restaurant services; canteen services; holiday camp services [lodging]; bar services; providing campground facilities; food and drink catering; day-nursery [crèche] services.

45 – Marriage agency services; detective agency services; night guard services; adoption agency services; arbitration services; lost property return; intellectual property consultancy; licensing of intellectual property; licensing of computer software [legal services]; organization of religious meetings; opening of security locks; missing person investigations; baby sitting; pet sitting; inspection of factories for safety purposes; evening dress rental; rental of fire extinguishers; clothing rental; rental of fire alarms; registration of domain names [legal services]; fire-fighting; chaperoning; horoscope casting; copyright management; dating services; house sitting; personal body guarding.

(260) AM 2019 94380 A*

(800) 1366039

(151) 2017 04 26

(891) 2017 04 26

(731) SMESHARIKI GMBH

Hochbruckenstrasse 10, 80331 Munchen,
Germany

(540)



(591) Yellow, blue, dark pink, light pink, red, pink, dark red, black, white, light blue

(531) 03.04.18; 03.04.24; 25.03.13; 28.05; 29.01.15 (511)

3 – Perfumery and cosmetic preparations, namely petroleum jelly for cosmetic purposes; cotton wool for cosmetic purposes; cotton sticks for cosmetic purposes; scented water; lavender water; toilet water; make-up; deodorants for personal use; perfumes; perfumery; decorative transfers for cosmetic purposes; eyebrow pencils; cosmetic pencils; cosmetic creams; skin whitening creams; hair spray; nail polish; hair lotions; lotions for cosmetic purposes; beauty masks; oils for cosmetic purposes; cleansing milk for toilet purposes; soap; cakes of toilet soap; almond soap; cosmetic kits; dentifrices; pumice stone; lipsticks; cosmetic preparations for baths; toiletries; mouthwashes, not for medical purposes; make-up removing preparations; nail care preparations; make-up powder; tissues impregnated with cosmetic lotions; potpourris [fragrances]; bath salts, not for medical purposes; make-up preparations; sun-tanning preparations [cosmetics]; hair colorants; cosmetic preparations for skin care; cosmetics; talcum powder, for toilet use; shampoos.

14 – Amulets (jewellery); bijouterie made of imitation gold; bracelets (jewellery); straps for wristwatches; charms (jewellery); key rings (trinkets or fobs); brooches (jewellery); alarm clocks; pins (jewellery); ornamental pins; tie pins; tie clips; cufflinks; badges of precious metal; jewellery made of silver or gold; jewellery plated with precious metals; jewellery; jewellery of yellow amber; necklaces (jewellery); rings (jewellery); boxes of precious metal; watch cases; medallions (jewellery); earrings; figurines (statuettes) of precious metal; ornaments (jewellery); hat ornaments of precious metal; silver jewellery; ivory (jewellery); clock cases; presentation boxes for watches; jewel cases; watch chains; dials (clock- and watchmaking); clocks; watches; sundials; clocks and watches, electric; wristwatches; chaplets.

16 – Fountain pens; aquarelles; albums; atlases; posters; paper bows; table linen of paper; tickets; note books; drawing pads; pads (stationery); loose-leaf binders; pamphlets; booklets; writing paper; luminous paper; toilet paper; packing paper; paper; modelling wax, not for dental purposes; signboards of paper or cardboard; newspapers; pencil holders; cream containers of paper; bookmarkers; printed publications; bags (envelopes, pouches) of paper or plastics, for packaging; cardboard articles; graphic representations; calendars; tear-off calendars; pencils; pencil lead holders; pictures; transfers (decalcomanias); hat boxes of cardboard; charts; geographical maps; catalogues; covers of paper for flower pots; paintbrushes; glue for stationery or household purposes; books; comic books; drawing pins; envelopes (stationery); boxes of cardboard or paper; paint boxes (articles for use in school); correction fluids (office requisites); paper ribbons; square rulers; postage stamps; modelling materials; teaching materials (except apparatus); adhesives for stationery or household purposes; packaging material made of starches; writing chalk; writing sets; bibs of paper; stickers (stationery); bottle envelopes of cardboard or paper; covers (stationery); embroidery designs (patterns); musical greeting cards; greeting cards; postcards; conical paper bags; folders for papers; papier mâché; pastels (crayons); pen cases; periodicals; song books; seals; clipboards; handkerchiefs of paper; coasters of paper; bookends; mats for beer glasses; stands for pens and pencils; photograph stands; towels of paper; writing cases (sets); drawing materials; erasing products; writing materials; school supplies (stationery); adhesive tape dispensers (office requisites); paper clasps; pencil sharpening machines, electric or non-electric; printed matter; prospectuses; printed timetables; tissues of paper for removing make-up; face towels of paper; clips for offices; erasers; figurines (statuettes) of papier mâché; writing board erasers; arithmetical tables; placards of paper or cardboard; writing or drawing books; stationery; cardboard tubes; indian inks; bottle wrappers of cardboard or paper; stapling presses (office requisites); handbooks (manuals); flags of paper; silver paper; artists' watercolor (watercolour) saucers; ink; inkwells; printing types; stamps; labels, not of textile.

18 – Pocket wallets; card cases (notecases); umbrellas; parasols; hat boxes of leather; boxes of leather or leather board; boxes of vulcanised fibre; purses; bags (envelopes, covers, pouches) of leather, for packaging; vanity cases, not fitted; music cases; haversacks; leather straps; umbrella handles; walking stick handles; backpacks; travelling bags; net bags for shopping; travelling sets (leatherware); sling bags for carrying infants; handbags; wheeled shopping bags; beach bags; bags for campers; shopping bags; school satchels; travelling trunks; cases, of

leather or leatherboard; key cases (leatherware); suitcases; valises; attaché cases; umbrella covers.

20 – Furniture; mirrors [looking glasses]; picture frames; goods, not included in other classes, of wood, cork, reed, cane, wicker, horn, bone, ivory, whalebone, shell, amber, mother-of-pearl, meerschaum and substitutes for all these materials, or of plastics; metal furniture and furniture for camping; bedding, including mattresses, spring mattresses, pillows; furnishing or toilet mirrors; registration number plates not of metal; letter boxes not of metal or masonry; pulleys of plastics for blinds; cork bands; barrels, not of metal; sideboards; busts of wood, wax, plaster or plastic; costume stands; bolsters; fans for personal use, non-electric; coatstands; coat hangers; shoulder poles [yokes]; display stands; showcases [furniture]; newspaper display stands; signboards of wood or plastics; doors for furniture; curtain holders, not of textile material; dowels, not of metal; pegs [pins], not of metal; pins [pegs], not of metal; divans; keyboards for hanging keys; display boards; packaging containers of plastic; flower-stands [furniture]; curtain tie-backs; locks, other than electric, not of metal; bead curtains for decoration; closures, not of metal, for containers; bamboo; coral; rattan; plaited straw, except matting; wickerwork; works of art, of wood, wax, plaster or plastic; cabinet work; reeds [plaiting materials]; settees; curtain rods; reels of wood for yarn, silk, cord; plastic key cards, not encoded and not magnetic; bed casters, not of metal; furniture casters, not of metal; wind chimes [decoration]; cradles; curtain rings; chests of drawers; containers, not of metal [storage, transport]; floating containers, not of metal; lecterns; baskets, not of metal; hampers [baskets]; bakers' bread baskets; bottle casings of wood; armchairs; hairdressers' chairs; bedsteads of wood; beds; table tops; hooks, not of metal, for clothes rails; curtain hooks; clothes hooks, not of metal; playpens for babies; mannequins; tailors' dummies; air mattresses, not for medical purposes; spring mattresses; mattresses; hydrostatic beds, not for medical purposes; water beds, not for medical purposes; furniture of metal; office furniture; school furniture; mobiles [decoration]; curtain rails; house numbers, not of metal, non-luminous; index cabinets [furniture]; furniture partitions of wood; mother-of-pearl, unworked or semi-worked; mirror tiles; ambroid plates; head-rests [furniture]; stakes for plants or trees; trestles [furniture]; magazine racks; book rests [furniture]; flower-pot pedestals; pet cushions; pillows; cushions; air cushions, not for medical purposes; air pillows, not for medical purposes; racks [furniture]; library shelves; shelves for file cabinets; furniture shelves; shelves for storage; wood ribbon; straw edgings; hat stands; inflatable publicity objects; beds for household pets; nesting boxes for household pets; kennels for household pets; bedding, except linen; desks; embroidery frames; curtain rollers; writing desks; seats of metal;

benches [furniture]; vats, not of metal; sofas; statues of wood, wax, plaster or plastic; figurines [statuettes] of wood, wax, plaster or plastic; silvered glass [mirrors]; shelving units; ambroid bars; counters [tables]; umbrella stands; carts for computers [furniture]; dressing tables; drafting tables; tea carts; dinner wagons [furniture]; tables; steps [ladders], not of metal; chairs [seats]; high chairs for babies; chests, not of metal; placards of wood or plastics; footstools; trolleys [furniture]; straw plaits; straw mattresses; edgings of plastic for furniture; decorations of plastic for foodstuffs; washstands [furniture]; wax figures; door fittings, not of metal; bed fittings, not of metal; picture frame brackets; moldings for picture frames; picture rods [frames]; furniture fittings, not of metal; window fittings, not of metal; covers for clothing [wardrobe]; garment covers [storage]; hinges, not of metal; easy chairs; screens [furniture]; cupboards; meat chests, not of metal; plate racks; bamboo curtains; slatted indoor blinds; woven timber blinds [furniture]; indoor window blinds [shades] [furniture]; screens for fireplaces [furniture]; yellow amber; lockers; boxes of wood or plastic; chests for toys; towel dispensers, fixed, not of metal.

21 – China ornaments; dishes; paper plates; saucers; mugs; boxes for sweetmeats; candy boxes; sandwich boxes; bottles; busts of china, terra-cotta or glass; vases; epergnes; fruit cups; baby baths, portable; towel rails; trouser stretchers; clothing stretchers; shirt stretchers; signboards of porcelain or glass; flower pots; chamber pots; cruets; decanters; large-toothed combs for the hair; toilet sponges; sponge holders; toothpick holders; soap holders; ironing boards; cutting boards for the kitchen; bread boards; containers for household or kitchen use; kitchen containers; glass bulbs (receptacles); glass vials (receptacles); heat-insulated containers for beverages; thermally insulated containers for food; glass flasks (containers); toothpicks; ceramics for household purposes; majolica; works of art of porcelain, ceramic or glass; brush goods; covers, not of paper, for flower pots; napkin rings; piggy banks, not of metal; baskets for household purposes; cookie jars; tea caddies; coffee percolators, non-electric; coffee grinders, hand-operated; covers for dishes; jugs; watering cans; spatulas (kitchen utensils); butter dishes; pepper mills, hand-operated; bowls (basins); soap boxes; cooking pot sets; fitted picnic baskets, including dishes; toilet cases; fitted vanity cases; sprinklers; syringes for watering flowers and plants; cocktail stirrers; trays for household purposes; trays of paper, for household purposes; lazy susans; vegetable dishes; cabarets (trays); heaters for feeding bottles, non-electric; candelabra (candlesticks); menu card holders; egg cups; painted glassware; tableware (other than knives, forks and spoons); porcelain ware; crockery; crystal (glassware); cosmetic utensils; toilet utensils; appliances for removing makeup, non-electric; toilet paper dispensers; bottle ope-

ners; glass caps; glass stoppers; powder compacts; perfume sprayers; powder puffs; soap dispensers; combs; electric combs; salad bowls; sugar bowls; services (dishes); coffee services (tableware); liqueur sets; tea services (tableware); siphon bottles for carbonated water; fruit presses, non-electric, for household purposes; salt shakers; drinking vessels; vessels of metal for making ices and iced drinks; refrigerating bottles; cups of paper or plastic; glasses (receptacles); drinking glasses; statues of porcelain, ceramic or glass; figurines (statuettes) of porcelain, ceramic or glass; drying racks for washing; basins (receptacles); table plates; insulating flasks; vacuum bottles; kitchen grinders, non-electric; mills for household purposes, hand-operated; household utensils; cooking utensils, non-electric; kitchen utensils; flasks; drinking flasks for travelers; cake molds (moulds); comb cases; bread bins; teapots; kettles, non-electric; cups; ironing board covers, shaped; dishwashing brushes; toothbrushes; toothbrushes, electric; brushes; eyebrow brushes; nail brushes; towel holders; dishes of precious metal; saucers of precious metal; household containers; nutcrackers; drinking straws.

24 – Household linen; bath linen, except clothing; bed linen; table linen (not of paper); shower curtains of textile or plastic; curtains of textile or plastic; banners; sleeping bag liners; bed blankets; eiderdowns (down coverlets); handkerchiefs of textile; travelling rugs (lap robes); coasters for decanters (table linen); bed covers; bed covers of paper; furniture coverings of plastic; towels of textile; glass cloths (towels); cloths for removing make-up; face towels of textile; place mats, not of paper; tablecloths, not of paper; oilcloth for use as tablecloths; traced cloths for embroidery; flags of textile or plastic; fitted toilet lid covers of fabric; covers (loose) for furniture; pillow shams; labels of textile; sleeping bags for camping.

25 – Bandanas (neckerchiefs); underclothing; smocks; half-boots; breeches for wear; trousers; brassieres; neckties; gaiters; vests; sports jerseys; hosiery; hoods (clothing); neck scarfs (mufflers); cap peaks; tights; combinations (clothing); bodices (lingerie); suits; bathing suits; masquerade costumes; beach clothes; jackets (clothing); camisoles; tee-shirts; bibs, not of paper; fur stoles; ear muffs (clothing); socks; bath slippers; beach shoes; sports shoes; footwear; paper clothing; outerclothing; ready-made clothing; gabardines (clothing); jerseys (clothing); clothing of imitations of leather; clothing of leather; knitwear (clothing); uniforms; clothing; overcoats; parkas; swaddling clothes; gloves (clothing); pyjamas; bathing trunks; scarfs; frocks; waterproof coats; braces for clothing (suspenders); lace boots; belts (clothing); money belts (clothing); layettes (clothing); pullovers; shirts; wooden shoes; sandals; boots; sweaters; underpants; gymnastic shoes;

slippers; shoes; headgear for wear; aprons (clothing); dressing gowns; shower caps; stockings; shawls; bathing caps; sashes for wear; babies' pants; pelisses; skirts.

28 – Amusement machines, automatic and coin-operated; toy vehicles; swimming pools (play articles); novelties for parties, dances (party favors, favours); skating boots with skates attached; paintballs (ammunition for paintball guns) (sports apparatus); spinning tops (toys); jigsaw puzzles; flying discs (toys); dolls' houses; skateboards; kites; toys; plush toys; mobiles (toys); practical jokes (novelties); board games; games; bingo cards; playing cards; fairground ride apparatus; rocking horses; swings; bells for Christmas trees; dolls' rooms; building games; confetti; coxaques (toy fireworks); explosive bonbons (Christmas crackers); ice skates; roller skates; building blocks (toys); skis; puppets; toy masks; theatrical masks; balls for games; dolls' clothes; rattles (playthings); candle holders for Christmas trees; soap bubbles (toys); bats for games; rackets; scooters (toys); radio-controlled toy vehicles; ornaments for Christmas trees, except illumination articles and confectionery; apparatus for electronic games other than those adapted for use with television receivers only; counters (discs) for games; marbles for games; billiard balls; playing balls; snow globes.

29 – Peanuts, processed; fruit jellies; raisins; fruits, tinned [canned (Am.)]; buttercream; marmalade; peanut butter; milk; fruit pulp; jams; dairy products; cranberry sauce [compote]; apple puree; fruit salads; whipped cream; dates; crystallized fruits; frosted fruits; frozen fruits; fruit, preserved; fruits, stewed; potato crisps; fruit chips; peanut milk; almond milk.

30 – Cookies; pancakes; bread rolls; waffles; cakes; pastries; peanut confectionery; almond confectionery; pasties; frozen yoghurt [confectionery ices]; cocoa; cocoa products; caramels [candy]; gruel, with a milk base, for food; sweetmeats [candy]; liquorice [confectionery]; peppermint sweets; coffee; crackers; candy; fruit jellies [confectionery]; marzipan; custard; honey; ice cream; fruit ice cream; muesli; cocoa beverages with milk; coffee beverages with milk; coffee-based beverages; tea-based beverages; chocolate beverages with milk; chocolate-based beverages; cocoa-based beverages; infusions, not medicinal; pastilles [confectionery]; biscuits; pies; pizzas; fondants [confectionery]; popcorn; gingerbread; puddings; chewing gum; confectionery; tarts; candy decorations for cakes; halvah; bread; chips [cereal products]; tea; chocolate.

32 – Aperitifs, non-alcoholic; waters [beverages]; cocktails, non-alcoholic; lemonades; non-alcoholic beverages; whey beverages; fruit drinks; fruit nectars, non-alcoholic; powders for effervescing beverages; syrups for lemonade; syrups for beverages;

tomato juice [beverage]; apple juice; vegetable juices [beverages]; fruit juices.

38 – Television broadcasting; cable television broadcasting; computer aided transmission of messages and images; electronic mail; radio broadcasting; teleconferencing services.

41 – Nursery schools; discotheque services; gaming; publication of books; education information; recreation information; entertainment information; movie studio services; health club services; club services [entertainment or education]; night clubs; game services provided on-line from a computer network; providing on-line electronic publications, not downloadable; correspondence courses; organization of exhibitions for cultural or educational purposes; providing recreation facilities; arranging and conducting of conferences; arranging and conducting of workshops [training]; arranging and conducting of seminars; arranging of beauty contests; organization of competitions [education or entertainment]; operating lotteries; holiday camp services [entertainment]; organization of sports competitions; amusement parks; television entertainment; providing amusement arcade services; cinema presentations; presentation of live performances; theatre productions; videotape film production; film production; rental of sound recordings; rental of videotapes; rental of show scenery; rental of motion pictures; electronic desktop publishing; publication of electronic books and journals on-line; publication of texts, other than publicity texts; radio entertainment; amusements; entertainer services; sport camp services; providing casino facilities [gambling]; providing museum facilities [presentation, exhibitions]; educational services; translation services; scriptwriting services, other than for advertising purposes; recording studio services; boarding school education; production of shows.

42 – Graphic arts design; research and development of new products for others; quality control; dress designing; design of interior decor; hosting computer sites [web sites]; computer software design; creating and maintaining web sites for others; styling [industrial design]; packaging design.

43 – Accommodation bureau services [hotels, boarding houses]; tourist home services; hotel services; snack-bar services; café services; cafeteria services; restaurant services; self-service restaurant services; canteen services; holiday camp services [lodging]; bar services; day-nursery [crèche] services.

(260) AM 2019 94403 A*

(800) 1366421

(151) 2017 04 26

(891) 2017 04 26

(731) SMESHARIKI GMBH

Hochbruckenstrasse 10, 80331 Munchen,
Germany

(540)



(591) Yellow, blue, dark red, black, orange, brown, dark orange, grey, light grey, red, white

(531) 03.07.24; 03.07.25; 25.03.01; 25.03.07; 28.05; 29.01.15

(511)

3 – Perfumery and cosmetic preparations, namely petroleum jelly for cosmetic purposes; cotton wool for cosmetic purposes; cotton sticks for cosmetic purposes; scented water; lavender water; toilet water; make-up; deodorants for personal use; perfumes; perfumery; decorative transfers for cosmetic purposes; eyebrow pencils; cosmetic pencils; cosmetic creams; skin whitening creams; hair spray; nail polish; hair lotions; lotions for cosmetic purposes; beauty masks; oils for cosmetic purposes; cleansing milk for toilet purposes; soap; cakes of toilet soap; almond soap; cosmetic kits; dentifrices; pumice stone; lipsticks; cosmetic preparations for baths; toiletries; mouthwashes, not for medical purposes; make-up removing preparations; nail care preparations; make-up powder; tissues impregnated with cosmetic lotions; potpourris [fragrances]; bath salts, not for medical purposes; make-up preparations; sun-tanning preparations [cosmetics]; hair colorants; cosmetic preparations for skin care; cosmetics; talcum powder, for toilet use; shampoos.

14 – Amulets [jewellery]; bijouterie made of imitation gold; bracelets [jewellery]; straps for wristwatches; charms [jewellery]; key rings [trinkets or fobs]; brooches [jewellery]; alarm clocks; pins [jewellery]; ornamental pins; tie pins; tie clips; cuff links; badges of precious metal; jewellery made of silver or gold; jewellery plated with precious metals; jewellery; jewellery of yellow amber; necklaces [jewellery]; rings [jewellery]; boxes of precious metal; watch cases; medallions [jewellery]; earrings; figurines [statuettes] of precious metal; ornaments [jewellery]; hat ornaments of precious metal; silver jewellery; ivory [jewellery]; clock cases; presentation boxes for watches; jewel cases; watch chains; dials [clock- and watchmaking]; clocks; watches; sundials; clocks and watches, electric; wristwatches; chaplets.

16 – Fountain pens; aquarelles; albums; atlases; posters; paper bows; table linen of paper; tickets; note books; drawing pads; pads [stationery]; loose-leaf binders; pamphlets; booklets; writing paper; luminous paper; toilet paper; packing paper; paper; modelling wax, not for dental purposes; signboards of paper or cardboard; newspapers; pencil holders; cream containers of paper; bookmarkers; printed publications; bags [envelopes, pouches] of paper or plastics, for packaging; cardboard articles; graphic representations; calendars; tear-off calendars; pencils; pencil lead holders; pictures; transfers [decalcomanias]; hat boxes of cardboard; charts; geographical maps; catalogues; covers of paper for flower pots; paintbrushes; glue for stationery or household purposes; books; comic books; drawing pins; envelopes [stationery]; boxes of cardboard or paper; paint boxes [articles for use in school]; correction fluids [office requisites]; paper ribbons; square rulers; postage stamps; modelling materials; teaching materials [except apparatus]; adhesives for stationery or household purposes; packaging material made of starches; writing chalk; writing sets; bibs of paper; stickers [stationery]; bottle envelopes of cardboard or paper; covers [stationery]; embroidery designs [patterns]; musical greeting cards; greeting cards; postcards; conical paper bags; folders for papers; papier mâché; pastels [crayons]; pen cases; periodicals; song books; seals; clipboards; handkerchiefs of paper; coasters of paper; bookends; mats for beer glasses; stands for pens and pencils; photograph stands; towels of paper; writing cases [sets]; drawing materials; erasing products; writing materials; school supplies [stationery]; adhesive tape dispensers [office requisites]; paper clasps; pencil sharpening machines, electric or non-electric; printed matter; prospectuses; printed timetables; tissues of paper for removing make-up; face towels of paper; clips for offices; erasers; figurines [statuettes] of papier mâché; writing board erasers; arithmetical tables; placards of paper or cardboard; writing or drawing books; stationery; cardboard tubes; indian inks; bottle wrappers of cardboard or paper; stapling presses [office requisites]; handbooks [manuals]; flags of paper; silver paper; artists' watercolor [watercolour] saucers; ink; inkwells; printing types; stamps; labels, not of textile.

18 – Pocket wallets; card cases [notecases]; umbrellas; parasols; hat boxes of leather; boxes of leather or leather board; boxes of vulcanised fibre; purses; bags [envelopes, covers, pouches] of leather, for packaging; vanity cases, not fitted; music cases; haversacks; leather straps; umbrella handles; walking stick handles; backpacks; travelling bags; net bags for shopping; travelling sets [leatherware]; sling bags for carrying infants; handbags; wheeled shopping bags; beach bags; bags for campers; shopping bags; school satchels; travelling trunks; cases, of le-

ather or leatherboard; key cases [leatherware]; suitcases; valises; attaché cases; umbrella covers.

20 – Furniture; mirrors [looking glasses]; picture frames; goods, not included in other classes, of wood, cork, reed, cane, wicker, horn, bone, ivory, whalebone, shell, amber, mother-of-pearl, meerschaum and substitutes for all these materials, or of plastics; metal furniture and furniture for camping; bedding, including mattresses, spring mattresses, pillows; furnishing or toilet mirrors; registration number plates not of metal; letter boxes not of metal or masonry; pulleys of plastics for blinds; cork bands; barrels, not of metal; sideboards; busts of wood, wax, plaster or plastic; costume stands; bolsters; fans for personal use, non-electric; coatstands; coat hangers; shoulder poles [yokes]; display stands; showcases [furniture]; newspaper display stands; signboards of wood or plastics; doors for furniture; curtain holders, not of textile material; dowels, not of metal; pegs [pins], not of metal; pins [pegs], not of metal; divans; keyboards for hanging keys; display boards; packaging containers of plastic; flower-stands [furniture]; curtain tie-backs; locks, other than electric, not of metal, for containers; bamboo; coral; rattan; plaited straw, except matting; wickerwork; works of art, of wood, wax, plaster or plastic; cabinet work; reeds [plaiting materials]; settees; curtain rods; reels of wood for yarn, silk, cord; plastic key cards, not encoded and not magnetic; bed casters, not of metal; furniture casters, not of metal; wind chimes [decoration]; cradles; curtain rings; chests of drawers; containers, not of metal [storage, transport]; floating containers, not of metal; lecterns; baskets, not of metal; hampers [baskets]; bakers' bread baskets; bottle casings of wood; armchairs; hairdressers' chairs; bedsteads of wood; beds; table tops; hooks, not of metal, for clothes rails; curtain hooks; clothes hooks, not of metal; playpens for babies; mannequins; tailors' dummies; air mattresses, not for medical purposes; spring mattresses; mattresses; hydrostatic beds, not for medical purposes; water beds, not for medical purposes; furniture of metal; office furniture; school furniture; mobiles [decoration]; curtain rails; house numbers, not of metal, non-luminous; index cabinets [furniture]; furniture partitions of wood; mother-of-pearl, unworked or semi-worked; mirror tiles; ambroid plates; head-rests [furniture]; stakes for plants or trees; trestles [furniture]; magazine racks; book rests [furniture]; flower-pot pedestals; pet cushions; pillows; cushions; air cushions, not for medical purposes; air pillows, not for medical purposes; racks [furniture]; library shelves; shelves for file cabinets; furniture shelves; shelves for storage; wood ribbon; straw edgings; hat stands; inflatable publicity objects; beds for household pets; nesting boxes for household pets; kennels for household pets; bedding, except linen; desks; embroidery frames; curtain rollers; writing desks; seats of metal;

benches [furniture]; vats, not of metal; sofas; statues of wood, wax, plaster or plastic; figurines [statuettes] of wood, wax, plaster or plastic; silvered glass [mirrors]; shelving units; ambroid bars; counters [tables]; umbrella stands; carts for computers [furniture]; dressing tables; drafting tables; tea carts; dinner wagons [furniture]; tables; steps [ladders], not of metal; chairs [seats]; high chairs for babies; chests, not of metal; placards of wood or plastics; footstools; trolleys [furniture]; straw plaits; straw mattresses; edgings of plastic for furniture; decorations of plastic for foodstuffs; washstands [furniture]; wax figures; door fittings, not of metal; bed fittings, not of metal; picture frame brackets; moldings for picture frames; picture rods [frames]; furniture fittings, not of metal; window fittings, not of metal; covers for clothing [wardrobe]; garment covers [storage]; hinges, not of metal; easy chairs; screens [furniture]; cupboards; meat chests, not of metal; plate racks; bamboo curtains; slatted indoor blinds; woven timber blinds [furniture]; indoor window blinds [shades] [furniture]; screens for fireplaces [furniture]; yellow amber; lockers; boxes of wood or plastic; chests for toys; towel dispensers, fixed, not of metal.

21 – China ornaments; dishes; paper plates; saucers; mugs; boxes for sweetmeats; candy boxes; sandwich boxes; bottles; busts of china, terra-cotta or glass; vases; epergnes; fruit cups; baby baths, portable; towel rails; trouser stretchers; clothing stretchers; shirt stretchers; signboards of porcelain or glass; flower pots; chamber pots; cruets; decanters; large-toothed combs for the hair; toilet sponges; sponge holders; toothpick holders; soap holders; ironing boards; cutting boards for the kitchen; bread boards; containers for household or kitchen use; kitchen containers; glass bulbs [receptacles]; glass vials [receptacles]; heat-insulated containers for beverages; thermally insulated containers for food; glass flasks [containers]; toothpicks; ceramics for household purposes; majolica; works of art of porcelain, ceramic or glass; brush goods; covers, not of paper, for flower pots; napkin rings; piggy banks, not of metal; baskets for household purposes; cookie jars; tea caddies; coffee percolators, non-electric; coffee grinders, hand-operated; covers for dishes; jugs; watering cans; spatulas [kitchen utensils]; butter dishes; pepper mills, hand-operated; bowls [basins]; soap boxes; cooking pot sets; fitted picnic baskets, including dishes; toilet cases; fitted vanity cases; sprinklers; syringes for watering flowers and plants; cocktail stirrers; trays for household purposes; trays of paper, for household purposes; lazy susans; vegetable dishes; cabarets [trays]; heaters for feeding bottles, non-electric; candelabra [candlesticks]; menu card holders; egg cups; painted glassware; tableware [other than knives, forks and spoons]; porcelain ware; crockery; crystal [glassware]; cosmetic utensils; toilet utensils; appliances for removing make-up, non-electric; toilet paper dispensers; bottle openers;

glass caps; glass stoppers; powder compacts; perfume sprayers; powder puffs; soap dispensers; combs; electric combs; salad bowls; sugar bowls; services [dishes]; coffee services [tableware]; liqueur sets; tea services [tableware]; siphon bottles for carbonated water; fruit presses, non-electric, for household purposes; salt shakers; drinking vessels; vessels of metal for making ices and iced drinks; refrigerating bottles; cups of paper or plastic; glasses [receptacles]; drinking glasses; statues of porcelain, ceramic or glass; figurines [statuettes] of porcelain, ceramic or glass; drying racks for washing; basins [receptacles]; table plates; insulating flasks; vacuum bottles; kitchen grinders, non-electric; mills for household purposes, hand-operated; household utensils; cooking utensils, non-electric; kitchen utensils; flasks; drinking flasks for travelers; cake molds [moulds]; comb cases; bread bins; teapots; kettles, non-electric; cups; ironing board covers, shaped; dishwashing brushes; toothbrushes; toothbrushes, electric; brushes; eyebrow brushes; nail brushes; towel holders; dishes of precious metal; saucers of precious metal; household containers; nutcrackers; drinking straws.

24 – Household linen; bath linen, except clothing; bed linen; table linen [not of paper]; shower curtains of textile or plastic; curtains of textile or plastic; banners; sleeping bag liners; bed blankets; eiderdowns [down coverlets]; handkerchiefs of textile; travelling rugs [lap robes]; coasters for decanters [table linen]; bed covers; bed covers of paper; furniture coverings of plastic; towels of textile; glass cloths [towels]; cloths for removing make-up; face towels of textile; place mats, not of paper; tablecloths, not of paper; oilcloth for use as tablecloths; traced cloths for embroidery; flags of textile or plastic; fitted toilet lid covers of fabric; covers [loose] for furniture; pillow shams; labels of textile; sleeping bags for camping.

25 – Bandanas [neckerchiefs]; underclothing; smocks; half-boots; breeches for wear; trousers; brassieres; neckties; gaiters; vests; sports jerseys; hosiery; hoods [clothing]; neck scarfs [mufflers]; cap peaks; tights; combinations [clothing]; bodices [lingerie]; suits; bathing suits; masquerade costumes; beach clothes; jackets [clothing]; camisoles; t-shirts; bibs, not of paper; fur stoles; ear muffs [clothing]; socks; bath slippers; beach shoes; sports shoes; footwear; paper clothing; outerclothing; ready-made clothing; gabardines [clothing]; jerseys [clothing]; clothing of imitations of leather; clothing of leather; knitwear [clothing]; uniforms; clothing; overcoats; parkas; swaddling clothes; gloves [clothing]; pyjamas; bathing trunks; scarfs; frocks; waterproof coats; braces for clothing [suspenders]; lace boots; belts [clothing]; money belts [clothing]; layettes [clothing]; pullovers; shirts; wooden shoes; sandals; boots; sweaters; underpants; gymnastic shoes;

slippers; shoes; headgear for wear; aprons [clothing]; dressing gowns; shower caps; stockings; shawls; bathing caps; sashes for wear; babies' pants; pelisses; skirts.

28 – Amusement machines, automatic and coin-operated; toy vehicles; swimming pools [play articles]; novelties for parties, dances [party favors, favours]; skating boots with skates attached; paintballs [ammunition for paintball guns] [sports apparatus]; spinning tops [toys]; jigsaw puzzles; flying discs [toys]; dolls' houses; skateboards; kites; toys; plush toys; mobiles [toys]; practical jokes [novelties]; board games; games; bingo cards; playing cards; fairground ride apparatus; rocking horses; swings; bells for Christmas trees; dolls' rooms; building games; confetti; cosques [toy fireworks]; explosive bonbons [Christmas crackers]; ice skates; roller skates; building blocks [toys]; skis; puppets; toy masks; theatrical masks; balls for games; dolls' clothes; rattles [playthings]; candle holders for Christmas trees; soap bubbles [toys]; bats for games; rackets; scooters [toys]; radio-controlled toy vehicles; ornaments for Christmas trees, except illumination articles and confectionery; apparatus for electronic games other than those adapted for use with television receivers only; counters [discs] for games; marbles for games; billiard balls; playing balls; snow globes.

29 – Peanuts, processed; fruit jellies; raisins; fruits, tinned [canned (Am.)]; buttercream; marmalade; peanut butter; milk; fruit pulp; jams; dairy products; cranberry sauce [compote]; apple puree; fruit salads; whipped cream; dates; crystallized fruits; frosted fruits; frozen fruits; fruit, preserved; fruits, stewed; potato crisps; fruit chips; peanut milk; almond milk.

30 – Cookies; pancakes; bread rolls; waffles; cakes; pastries; peanut confectionery; almond confectionery; pasties; frozen yoghurt [confectionery ices]; cocoa; cocoa products; caramels [candy]; gruel, with a milk base, for food; sweetmeats [candy]; liquorice [confectionery]; peppermint sweets; coffee; crackers; candy; fruit jellies [confectionery]; marzipan; custard; honey; ice cream; fruit ice cream; muesli; cocoa beverages with milk; coffee beverages with milk; coffee-based beverages; tea-based beverages; chocolate beverages with milk; chocolate-based beverages; cocoa-based beverages; infusions, not medicinal; pastilles [confectionery]; biscuits; pies; pizzas; fondants [confectionery]; popcorn; gingerbread; puddings; chewing gum; confectionery; tarts; candy decorations for cakes; halvah; bread; chips [cereal products]; tea; chocolate.

32 – Aperitifs, non-alcoholic; waters [beverages]; cocktails, non-alcoholic; lemonades; non-alcoholic beverages; whey beverages; fruit drinks; fruit nectars, non-alcoholic; powders for effervescing beverages; syrups for lemonade; syrups for beverages; tomato juice [beverage]; apple juice; vegetable juices [beverages]; fruit juices.

42 – Quality control.

43 – Day-nursery [crèche] services.

(260) AM 2019 95087 A*

(800) 1373767

(151) 2017 04 26

(891) 2017 04 26

(731) SMESHARIKI GMBH

Hochbruckenstrasse 10, 80331 Munchen, Germany

(540)



(591) Yellow, blue, violet, dark pink, pink, dark violet, white, black

(531) 04.05.05; 25.03.01; 28.05; 29.01.14

(511)

3 – Perfumery and cosmetic preparations, namely petroleum jelly for cosmetic purposes; cotton wool for cosmetic purposes; cotton sticks for cosmetic purposes; scented water; lavender water; toilet water; make-up; deodorants for personal use; perfumes; perfumery; decorative transfers for cosmetic purposes; eyebrow pencils; cosmetic pencils; cosmetic creams; skin whitening creams; hair spray; nail polish; hair lotions; lotions for cosmetic purposes; beauty masks; oils for cosmetic purposes; cleansing milk for toilet purposes; soap; cakes of toilet soap; almond soap; cosmetic kits; dentifrices; pumice stone; lipsticks; cosmetic preparations for baths; toiletries; mouthwashes, not for medical purposes; make-up removing preparations; nail care preparations; make-up powder; tissues impregnated with cosmetic lotions; potpourris [fragrances]; bath salts, not for medical purposes; make-up preparations; sun-tanning preparations [cosmetics]; hair colorants; cosmetic preparations for skin care; cosmetics; talcum powder, for toilet use; shampoos.

14 – Amulets [jewellery]; bijouterie made of imitation gold; bracelets [jewellery]; straps for wrist-watches; charms [jewellery]; key rings [trinkets or fobs]; brooches [jewellery]; alarm clocks; pins [jewellery]; ornamental pins; tie pins; tie clips; cuff-links; badges of precious metal; jewellery made of silver or gold; jewellery plated with precious metals; jewellery; jewellery of yellow amber; necklaces

[jewellery]; rings [jewellery]; boxes of precious metal; watch cases; medallions [jewellery]; earrings; figurines [statuettes] of precious metal; ornaments [jewellery]; hat ornaments of precious metal; silver jewellery; ivory [jewellery]; clock cases; presentation boxes for watches; jewel cases; watch chains; dials [clock- and watchmaking]; clocks; watches; sundials; clocks and watches, electric; wristwatches; chaplets.

16 – Fountain pens; aquarelles; albums; atlases; posters; paper bows; table linen of paper; tickets; note books; drawing pads; pads [stationery]; loose-leaf binders; pamphlets; booklets; writing paper; luminous paper; toilet paper; packing paper; paper; modelling wax, not for dental purposes; signboards of paper or cardboard; newspapers; pencil holders; cream containers of paper; bookmarks; printed publications; bags [envelopes, pouches] of paper or plastics, for packaging; cardboard articles; graphic representations; calendars; tear-off calendars; pencils; pencil lead holders; pictures; transfers [decalcomanias]; hat boxes of cardboard; charts; geographical maps; catalogues; covers of paper for flower pots; paintbrushes; glue for stationery or household purposes; books; comic books; drawing pins; envelopes [stationery]; boxes of cardboard or paper; paint boxes [articles for use in school]; correction fluids [office requisites]; paper ribbons; square rulers; postage stamps; modelling materials; teaching materials [except apparatus]; adhesives for stationery or household purposes; packaging material made of starches; writing chalk; writing sets; bibs of paper; stickers [stationery]; bottle envelopes of cardboard or paper; covers [stationery]; embroidery designs [patterns]; musical greeting cards; greeting cards; postcards; conical paper bags; folders for papers; papier mâché; pastels [crayons]; pen cases; periodicals; song books; seals; clipboards; handkerchiefs of paper; coasters of paper; bookends; mats for beer glasses; stands for pens and pencils; photograph stands; towels of paper; writing cases [sets]; drawing materials; erasing products; writing materials; school supplies [stationery]; adhesive tape dispensers [office requisites]; paper clasps; pencil sharpening machines, electric or non-electric; printed matter; prospectuses; printed timetables; tissues of paper for removing make-up; face towels of paper; clips for offices; erasers; figurines [statuettes] of papier mâché; writing board erasers; arithmetical tables; placards of paper or cardboard; writing or drawing books; stationery; cardboard tubes; indian inks; bottle wrappers of cardboard or paper; stapling presses [office requisites]; handbooks [manuals]; flags of paper; silver paper; artists' watercolor [watercolour] saucers; ink; inkwells; printing types; stamps; labels, not of textile.

18 – Pocket wallets; card cases [notecases]; umbrellas; parasols; hat boxes of leather; boxes of leather or leather board; boxes of vulcanised fibre; purses;

bags [envelopes, covers, pouches] of leather, for packaging; vanity cases, not fitted; music cases; haversacks; leather straps; umbrella handles; walking stick handles; backpacks; travelling bags; net bags for shopping; travelling sets [leatherware]; sling bags for carrying infants; handbags; wheeled shopping bags; beach bags; bags for campers; shopping bags; school satchels; travelling trunks; cases, of leather or leatherboard; key cases [leatherware]; suitcases; valises; attaché cases; umbrella covers.

20 – Furniture; mirrors [looking glasses]; picture frames; goods, not included in other classes, of wood, cork, reed, cane, wicker, horn, bone, ivory, whalebone, shell, amber, mother-of-pearl, meerschaum and substitutes for all these materials, or of plastics; metal furniture and furniture for camping; bedding, including mattresses, spring mattresses, pillows; furnishing or toilet mirrors; registration number plates not of metal; letter boxes not of metal or masonry; pulleys of plastics for blinds; cork bands; barrels, not of metal; sideboards; busts of wood, wax, plaster or plastic; costume stands; bolsters; fans for personal use, non-electric; coatstands; coat hangers; shoulder poles [yokes]; display stands; showcases [furniture]; newspaper display stands; signboards of wood or plastics; doors for furniture; curtain holders, not of textile material; dowels, not of metal; pegs [pins], not of metal; pins [pegs], not of metal; divans; keyboards for hanging keys; display boards; packaging containers of plastic; flower-stands [furniture]; curtain tie-backs; locks, other than electric, not of metal; bead curtains for decoration; closures, not of metal, for containers; bamboo; coral; rattan; plaited straw, except matting; wickerwork; works of art, of wood, wax, plaster or plastic; cabinet work; reeds [plaiting materials]; settees; curtain rods; reels of wood for yarn, silk, cord; plastic key cards, not encoded and not magnetic; bed casters, not of metal; furniture casters, not of metal; wind chimes [decoration]; cradles; curtain rings; chests of drawers; containers, not of metal [storage, transport]; floating containers, not of metal; lecterns; baskets, not of metal; hampers [baskets]; bakers' bread baskets; bottle casings of wood; armchairs; hairdressers' chairs; bedsteads of wood; beds; table tops; hooks, not of metal, for clothes rails; curtain hooks; clothes hooks, not of metal; playpens for babies; mannequins; tailors' dummies; air mattresses, not for medical purposes; spring mattresses; mattresses; hydrostatic beds, not for medical purposes; water beds, not for medical purposes; furniture of metal; office furniture; school furniture; mobiles [decoration]; curtain rails; house numbers, not of metal, non-luminous; index cabinets [furniture]; furniture partitions of wood; mother-of-pearl, unworked or semi-worked; mirror tiles; ambroid plates; head-rests [furniture]; stakes for plants or trees; trestles [furniture]; magazine racks; book rests [furniture]; flower-pot pedestals; pet cushions; pillows; cushions; air cushions, not for

medical purposes; air pillows, not for medical purposes; racks [furniture]; library shelves; shelves for file cabinets; furniture shelves; shelves for storage; wood ribbon; straw edgings; hat stands; inflatable publicity objects; beds for household pets; nesting boxes for household pets; kennels for household pets; bedding, except linen; desks; embroidery frames; curtain rollers; writing desks; seats of metal; benches [furniture]; vats, not of metal; sofas; statues of wood, wax, plaster or plastic; figurines [statuettes] of wood, wax, plaster or plastic; silvered glass [mirrors]; shelving units; ambroid bars; counters [tables]; umbrella stands; carts for computers [furniture]; dressing tables; drafting tables; tea carts; dinner wagons [furniture]; tables; steps [ladders], not of metal; chairs [seats]; high chairs for babies; chests, not of metal; placards of wood or plastics; footstools; trolleys [furniture]; straw plaits; straw mattresses; edgings of plastic for furniture; decorations of plastic for foodstuffs; washstands [furniture]; wax figures; door fittings, not of metal; bed fittings, not of metal; picture frame brackets; moldings for picture frames; picture rods [frames]; furniture fittings, not of metal; window fittings, not of metal; covers for clothing [wardrobe]; garment covers [storage]; hinges, not of metal; easy chairs; screens [furniture]; cupboards; meat chests, not of metal; plate racks; bamboo curtains; slatted indoor blinds; woven timber blinds [furniture]; indoor window blinds [shades] [furniture]; screens for fireplaces [furniture]; yellow amber; lockers; boxes of wood or plastic; chests for toys; towel dispensers, fixed, not of metal.

21 – China ornaments; dishes; paper plates; saucers; mugs; boxes for sweetmeats; candy boxes; sandwich boxes; bottles; busts of china, terra-cotta or glass; vases; epergnes; fruit cups; baby baths, portable; towel rails; trouser stretchers; clothing stretchers; shirt stretchers; signboards of porcelain or glass; flower pots; chamber pots; cruets; decanters; large-toothed combs for the hair; toilet sponges; sponge holders; toothpick holders; soap holders; ironing boards; cutting boards for the kitchen; bread boards; containers for household or kitchen use; kitchen containers; glass bulbs [receptacles]; glass vials [receptacles]; heat-insulated containers for beverages; thermally insulated containers for food; glass flasks [containers]; toothpicks; ceramics for household purposes; majolica; works of art of porcelain, ceramic or glass; brush goods; covers, not of paper, for flower pots; napkin rings; piggy banks, not of metal; baskets for household purposes; cookie jars; tea caddies; coffee percolators, non-electric; coffee grinders, hand-operated; covers for dishes; jugs; watering cans; spatulas [kitchen utensils]; butter dishes; pepper mills, hand-operated; bowls [basins]; soap boxes; cooking pot sets; fitted picnic baskets, including dishes; toilet cases; fitted vanity cases; sprinklers; syringes for watering flowers and plants; cocktail stirrers; trays for household purposes; trays of

paper, for household purposes; lazy susans; vegetable dishes; cabarets [trays]; heaters for feeding bottles, non-electric; candelabra [candlesticks]; menu card holders; egg cups; painted glassware; tableware [other than knives, forks and spoons]; porcelain ware; crockery; crystal [glassware]; cosmetic utensils; toilet utensils; appliances for removing make-up, non-electric; toilet paper dispensers; bottle openers; glass caps; glass stoppers; powder compacts; perfume sprayers; powder puffs; soap dispensers; combs; electric combs; salad bowls; sugar bowls; services [dishes]; coffee services [tableware]; liqueur sets; tea services [tableware]; siphon bottles for carbonated water; fruit presses, non-electric, for household purposes; salt shakers; drinking vessels; vessels of metal for making ices and iced drinks; refrigerating bottles; cups of paper or plastic; glasses [receptacles]; drinking glasses; statues of porcelain, ceramic or glass; figurines [statuettes] of porcelain, ceramic or glass; drying racks for washing; basins [receptacles]; table plates; insulating flasks; vacuum bottles; kitchen grinders, non-electric; mills for household purposes, hand-operated; household utensils; cooking utensils, non-electric; kitchen utensils; flasks; drinking flasks for travelers; cake molds [moulds]; comb cases; bread bins; teapots; kettles, non-electric; cups; ironing board covers, shaped; dishwashing brushes; toothbrushes; toothbrushes, electric; brushes; eyebrow brushes; nail brushes; towel holders; dishes of precious metal; saucers of precious metal; household containers; nutcrackers; drinking straws.

24 – Household linen; bath linen, except clothing; bed linen; table linen [not of paper]; shower curtains of textile or plastic; curtains of textile or plastic; banners; sleeping bag liners; bed blankets; eiderdowns [down coverlets]; handkerchiefs of textile; travelling rugs [lap robes]; coasters for decanters [table linen]; bed covers; bed covers of paper; furniture coverings of plastic; towels of textile; glass cloths [towels]; cloths for removing make-up; face towels of textile; place mats, not of paper; tablecloths, not of paper; oilcloth for use as tablecloths; traced cloths for embroidery; flags of textile or plastic; fitted toilet lid covers of fabric; covers [loose] for furniture; pillow shams; labels of textile; sleeping bags for camping.

25 – Bandanas [neckerchiefs]; underclothing; smocks; half-boots; breeches for wear; trousers; brassieres; neckties; gaiters; vests; sports jerseys; hosiery; hoods [clothing]; neck scarfs [mufflers]; cap peaks; tights; combinations [clothing]; bodices [lingerie]; suits; bathing suits; masquerade costumes; beach clothes; jackets [clothing]; camisoles; teeshirts; bibs, not of paper; fur stoles; ear muffs [clothing]; socks; bath slippers; beach shoes; sports shoes; footwear; paper clothing; outerclothing; ready-made clothing; gabardines [clothing]; jerseys [clothing]; clothing of imitations of leather; clothing of

leather; knitwear [clothing]; uniforms; clothing; overcoats; parkas; swaddling clothes; gloves [clothing]; pyjamas; bathing trunks; scarfs; frocks; waterproof coats; braces for clothing [suspenders]; lace boots; belts [clothing]; money belts [clothing]; layettes [clothing]; pullovers; shirts; wooden shoes; sandals; boots; sweaters; underpants; gymnastic shoes; slippers; shoes; headgear for wear; aprons [clothing]; dressing gowns; shower caps; stockings; shawls; bathing caps; sashes for wear; babies' pants; pelisses; skirts.

28 – Amusement machines, automatic and coin-operated; toy vehicles; swimming pools [play articles]; novelties for parties, dances [party favors, favours]; skating boots with skates attached; paintballs [ammunition for paintball guns] [sports apparatus]; spinning tops [toys]; jigsaw puzzles; flying discs [toys]; dolls' houses; skateboards; kites; toys; plush toys; mobiles [toys]; practical jokes [novelties]; board games; games; bingo cards; playing cards; fairground ride apparatus; rocking horses; swings; bells for Christmas trees; dolls' rooms; building games; confetti; cosagues [toy fireworks]; explosive bonbons [Christmas crackers]; ice skates; roller skates; building blocks [toys]; skis; puppets; toy masks; theatrical masks; balls for games; dolls' clothes; rattles [playthings]; candle holders for Christmas trees; soap bubbles [toys]; bats for games; rackets; scooters [toys]; radio-controlled toy vehicles; ornaments for Christmas trees, except illumination articles and confectionery; apparatus for electronic games other than those adapted for use with television receivers only; counters [discs] for games; marbles for games; billiard balls; playing balls; snow globes.

29 – Peanuts, processed; fruit jellies; raisins; fruits, tinned [canned (Am.)]; buttercream; marmalade; peanut butter; milk; fruit pulp; jams; dairy products; cranberry sauce [compote]; apple puree; fruit salads; whipped cream; dates; crystallized fruits; frosted fruits; frozen fruits; fruit, preserved; fruits, stewed; potato crisps; fruit chips; peanut milk; almond milk.

30 – Cookies; pancakes; bread rolls; waffles; cakes; pastries; peanut confectionery; almond confectionery; pasties; frozen yoghurt [confectionery ices]; cocoa; cocoa products; caramels [candy]; gruel, with a milk base, for food; sweetmeats [candy]; liquorice [confectionery]; peppermint sweets; coffee; crackers; candy; fruit jellies [confectionery]; marzipan; custard; honey; ice cream; fruit ice cream; muesli; cocoa beverages with milk; coffee beverages with milk; coffee-based beverages; tea-based beverages; chocolate beverages with milk; chocolate-based beverages; cocoa-based beverages; infusions, not medicinal; pastilles [confectionery]; biscuits; pies; pizzas; fondants [confectionery]; popcorn; gingerbread; puddings; chewing gum; confectionery; tarts; candy decorations for cakes; halvah; bread; chips [cereal products]; tea; chocolate.

32 – Aperitifs, non-alcoholic; waters [beverages]; cocktails, non-alcoholic; lemonades; non-alcoholic beverages; whey beverages; fruit drinks; fruit nectars, non-alcoholic; powders for effervescing beverages; syrups for lemonade; syrups for beverages; tomato juice [beverage]; apple juice; vegetable juices [beverages]; fruit juices.

38 – Television broadcasting; cable television broadcasting; computer aided transmission of messages and images; electronic mail; radio broadcasting; teleconferencing services.

41 – Nursery schools; discotheque services; gaming; publication of books; education information; recreation information; entertainment information; movie studio services; health club services; club services [entertainment or education]; night clubs; game services provided on-line from a computer network; providing on-line electronic publications, not downloadable; correspondence courses; organization of exhibitions for cultural or educational purposes; providing recreation facilities; arranging and conducting of conferences; arranging and conducting of workshops [training]; arranging and conducting of seminars; arranging of beauty contests; organization of competitions [education or entertainment]; operating lotteries; holiday camp services [entertainment]; organization of sports competitions; amusement parks; television entertainment; providing amusement arcade services; cinema presentations; presentation of live performances; theatre productions; videotape film production; film production; rental of sound recordings; rental of videotapes; rental of show scenery; rental of motion pictures; electronic desktop publishing; publication of electronic books and journals on-line; publication of texts, other than publicity texts; radio entertainment; amusements; entertainer services; sport camp services; providing casino facilities [gambling]; providing museum facilities [presentation, exhibitions]; educational services; translation services; scriptwriting services, other than for advertising purposes; recording studio services; boarding school education; production of shows.

42 – Graphic arts design; research and development of new products for others; quality control; dress designing; design of interior decor; hosting computer sites [web sites]; computer software design; creating and maintaining web sites for others; styling [industrial design]; packaging design.

43 – Accommodation bureau services [hotels, boarding houses]; tourist home services; hotel services; snack-bar services; café services; cafeteria services; restaurant services; self-service restaurant services; canteen services; holiday camp services [lodging]; bar services; day-nursery [crèche] services.

(260) AM 2019 95263 A*

(800) 1375808

(151) 2017 04 26

(891) 2017 04 26

(731) SMESHARIKI GMBH

Hochbruckenstrasse 10, 80331 Munchen,
Germany

(540)



(591) Yellow, blue, violet, light pink, dark violet,
pink, dark pink, red, black, white

(531) 03.04.11; 04.05.12; 25.03.03; 25.03.07; 28.05;
29.01.15

(511)

3 – Perfumery and cosmetic preparations, namely petroleum jelly for cosmetic purposes; cotton wool for cosmetic purposes; cotton sticks for cosmetic purposes; scented water; lavender water; toilet water; make-up; deodorants for personal use; perfumes; perfumery; decorative transfers for cosmetic purposes; eyebrow pencils; cosmetic pencils; cosmetic creams; skin whitening creams; hair spray; nail polish; hair lotions; lotions for cosmetic purposes; beauty masks; oils for cosmetic purposes; cleansing milk for toilet purposes; soap; cakes of toilet soap; almond soap; cosmetic kits; dentifrices; pumice stone; lipsticks; cosmetic preparations for baths; toiletries; mouthwashes, not for medical purposes; make-up removing preparations; nail care preparations; make-up powder; tissues impregnated with cosmetic lotions; potpourris [fragrances]; bath salts, not for medical purposes; make-up preparations; sun-tanning preparations [cosmetics]; hair colorants; cosmetic preparations for skin care; cosmetics; talcum powder, for toilet use; shampoos.

14 – Amulets [jewellery]; bijouterie made of imitation gold; bracelets [jewellery]; straps for wristwatches; charms [jewellery]; key rings [trinkets or fobs]; brooches [jewellery]; alarm clocks; pins [jewellery]; ornamental pins; tie pins; tie clips; cuff links; badges of precious metal; jewellery made of silver or gold; jewellery plated with precious metals; jewellery; jewellery of yellow amber; necklaces [jewellery]; rings [jewellery]; boxes of precious metal; watch cases; medallions [jewellery]; earrings; figurines [statuettes] of precious metal; ornaments [jewellery]; hat ornaments of precious metal; silver jewe-

llery; ivory [jewellery]; clock cases; presentation boxes for watches; jewel cases; watch chains; dials [clock- and watchmaking]; clocks; watches; sundials; clocks and watches, electric; wristwatches; chaplets.

16 – Fountain pens; aquarelles; albums; atlases; posters; paper bows; table linen of paper; tickets; note books; drawing pads; pads [stationery]; loose-leaf binders; pamphlets; booklets; writing paper; luminous paper; toilet paper; packing paper; paper; modelling wax, not for dental purposes; signboards of paper or cardboard; newspapers; pencil holders; cream containers of paper; bookmarkers; printed publications; bags [envelopes, pouches] of paper or plastics, for packaging; cardboard articles; graphic representations; calendars; tear-off calendars; pencils; pencil lead holders; pictures; transfers [decalcomanias]; hat boxes of cardboard; charts; geographical maps; catalogues; covers of paper for flower pots; paintbrushes; glue for stationery or household purposes; books; comic books; drawing pins; envelopes [stationery]; boxes of cardboard or paper; paint boxes [articles for use in school]; correction fluids [office requisites]; paper ribbons; square rulers; postage stamps; modelling materials; teaching materials [except apparatus]; adhesives for stationery or household purposes; packaging material made of starches; writing chalk; writing sets; bibs of paper; stickers [stationery]; bottle envelopes of cardboard or paper; covers [stationery]; embroidery designs [patterns]; musical greeting cards; greeting cards; postcards; conical paper bags; folders for papers; papier mâché; pastels [crayons]; pen cases; periodicals; song books; seals; clipboards; handkerchiefs of paper; coasters of paper; bookends; mats for beer glasses; stands for pens and pencils; photograph stands; towels of paper; writing cases [sets]; drawing materials; erasing products; writing materials; school supplies [stationery]; adhesive tape dispensers [office requisites]; paper clasps; pencil sharpening machines, electric or non-electric; printed matter; prospectuses; printed timetables; tissues of paper for removing make-up; face towels of paper; clips for offices; erasers; figurines [statuettes] of papier mâché; writing board erasers; arithmetical tables; placards of paper or cardboard; writing or drawing books; stationery; cardboard tubes; indian inks; bottle wrappers of cardboard or paper; stapling presses [office requisites]; handbooks [manuals]; flags of paper; silver paper; artists' watercolor [watercolour] saucers; ink; inkwells; printing types; stamps; labels, not of textile.

18 – Pocket wallets; card cases [notecases]; umbrellas; parasols; hat boxes of leather; boxes of leather or leather board; boxes of vulcanised fibre; purses; bags [envelopes, covers, pouches] of leather, for packaging; vanity cases, not fitted; music cases; haversacks; leather straps; umbrella handles; walking

stick handles; backpacks; travelling bags; net bags for shopping; travelling sets [leatherware]; sling bags for carrying infants; handbags; wheeled shopping bags; beach bags; bags for campers; shopping bags; school satchels; travelling trunks; cases, of leather or leatherboard; key cases [leatherware]; suit-cases; valises; attaché cases; umbrella covers.

20 – Furniture; mirrors [looking glasses]; picture frames; goods, not included in other classes, of wood, cork, reed, cane, wicker, horn, bone, ivory, whalebone, shell, amber, mother-of-pearl, meerschaum and substitutes for all these materials, or of plastics; metal furniture and furniture for camping; bedding, including mattresses, spring mattresses, pillows; furnishing or toilet mirrors; registration number plates not of metal; letter boxes not of metal or masonry; pulleys of plastics for blinds; cork bands; barrels, not of metal; sideboards; busts of wood, wax, plaster or plastic; costume stands; bolsters; fans for personal use, non-electric; coatstands; coat hangers; shoulder poles [yokes]; display stands; showcases [furniture]; newspaper display stands; signboards of wood or plastics; doors for furniture; curtain holders, not of textile material; dowels, not of metal; pegs [pins], not of metal; pins [pegs], not of metal; divans; keyboards for hanging keys; display boards; packaging containers of plastic; flower-stands [furniture]; curtain tie-backs; locks, other than electric, not of metal; bead curtains for decoration; closures, not of metal, for containers; bamboo; coral; rattan; plaited straw, except matting; wickerwork; works of art, of wood, wax, plaster or plastic; cabinet work; reeds [plaiting materials]; settees; curtain rods; reels of wood for yarn, silk, cord; plastic key cards, not encoded and not magnetic; bed casters, not of metal; furniture casters, not of metal; wind chimes [decoration]; cradles; curtain rings; chests of drawers; containers, not of metal [storage, transport]; floating containers, not of metal; lecterns; baskets, not of metal; hampers [baskets]; bakers' bread baskets; bottle casings of wood; armchairs; hairdressers' chairs; bedsteads of wood; beds; table tops; hooks, not of metal, for clothes rails; curtain hooks; clothes hooks, not of metal; playpens for babies; mannequins; tailors' dummies; air mattresses, not for medical purposes; spring mattresses; mattresses; hydrostatic beds, not for medical purposes; water beds, not for medical purposes; furniture of metal; office furniture; school furniture; mobiles [decoration]; curtain rails; house numbers, not of metal, non-luminous; index cabinets [furniture]; furniture partitions of wood; mother-of-pearl, unworked or semi-worked; mirror tiles; ambroid plates; head-rests [furniture]; stakes for plants or trees; trestles [furniture]; magazine racks; book rests [furniture]; flower-pot pedestals; pet cushions; pillows; cushions; air cushions, not for medical purposes; air pillows, not for medical purposes; racks [furniture]; library shelves; shelves for file cabinets; furniture shelves; shelves for storage; wood

ribbon; straw edgings; hat stands; inflatable publicity objects; beds for household pets; nesting boxes for household pets; kennels for household pets; bedding, except linen; desks; embroidery frames; curtain rollers; writing desks; seats of metal; benches [furniture]; vats, not of metal; sofas; statues of wood, wax, plaster or plastic; figurines [statuettes] of wood, wax, plaster or plastic; silvered glass [mirrors]; shelving units; ambroid bars; counters [tables]; umbrella stands; carts for computers [furniture]; dressing tables; drafting tables; tea carts; dinner wagons [furniture]; tables; steps [ladders], not of metal; chairs [seats]; high chairs for babies; chests, not of metal; placards of wood or plastics; footstools; trolleys [furniture]; straw plaits; straw mattresses; edgings of plastic for furniture; decorations of plastic for foodstuffs; washstands [furniture]; wax figures; door fittings, not of metal; bed fittings, not of metal; picture frame brackets; moldings for picture frames; picture rods [frames]; furniture fittings, not of metal; window fittings, not of metal; covers for clothing [wardrobe]; garment covers [storage]; hinges, not of metal; easy chairs; screens [furniture]; cupboards; meat chests, not of metal; plate racks; bamboo curtains; slatted indoor blinds; woven timber blinds [furniture]; indoor window blinds [shades] [furniture]; screens for fireplaces [furniture]; yellow amber; lockers; boxes of wood or plastic; chests for toys; towel dispensers, fixed, not of metal.

21 – China ornaments; dishes; paper plates; saucers; mugs; boxes for sweetmeats; candy boxes; sandwich boxes; bottles; busts of china, terra-cotta or glass; vases; epergnes; fruit cups; baby baths, portable; towel rails; trouser stretchers; clothing stretchers; shirt stretchers; signboards of porcelain or glass; flower pots; chamber pots; cruets; decanters; large-toothed combs for the hair; toilet sponges; sponge holders; toothpick holders; soap holders; ironing boards; cutting boards for the kitchen; bread boards; containers for household or kitchen use; kitchen containers; glass bulbs [receptacles]; glass vials [receptacles]; heat-insulated containers for beverages; thermally insulated containers for food; glass flasks [containers]; toothpicks; ceramics for household purposes; majolica; works of art of porcelain, ceramic or glass; brush goods; covers, not of paper, for flower pots; napkin rings; piggy banks, not of metal; baskets for household purposes; cookie jars; tea caddies; coffee percolators, non-electric; coffee grinders, hand-operated; covers for dishes; jugs; watering cans; spatulas [kitchen utensils]; butter dishes; pepper mills, hand-operated; bowls [basins]; soap boxes; cooking pot sets; fitted picnic baskets, including dishes; toilet cases; fitted vanity cases; sprinklers; syringes for watering flowers and plants; cocktail stirrers; trays for household purposes; trays of paper, for household purposes; lazy susans; vegetable dishes; cabalets [trays]; heaters for feeding bottles, non-electric; candelabra [candlesticks]; menu card holders; egg

cups; painted glassware; tableware [other than knives, forks and spoons]; porcelain ware; crockery; crystal [glassware]; cosmetic utensils; toilet utensils; appliances for removing make-up, non-electric; toilet paper dispensers; bottle openers; glass caps; glass stoppers; powder compacts; perfume sprayers; powder puffs; soap dispensers; combs; electric combs; salad bowls; sugar bowls; services [dishes]; coffee services [tableware]; liqueur sets; tea services [tableware]; siphon bottles for carbonated water; fruit presses, non-electric, for household purposes; salt shakers; drinking vessels; vessels of metal for making ices and iced drinks; refrigerating bottles; cups of paper or plastic; glasses [receptacles]; drinking glasses; statues of porcelain, ceramic or glass; figurines [statuettes] of porcelain, ceramic or glass; drying racks for washing; basins [receptacles]; table plates; insulating flasks; vacuum bottles; kitchen grinders, non-electric; mills for household purposes, hand-operated; household utensils; cooking utensils, non-electric; kitchen utensils; flasks; drinking flasks for travelers; cake molds [moulds]; comb cases; bread bins; teapots; kettles, non-electric; cups; ironing board covers, shaped; dishwashing brushes; toothbrushes; toothbrushes, electric; brushes; eyebrow brushes; nail brushes; towel holders; dishes of precious metal; saucers of precious metal; household containers; nutcrackers; drinking straws.

24 – Household linen; bath linen, except clothing; bed linen; table linen [not of paper]; shower curtains of textile or plastic; curtains of textile or plastic; banners; sleeping bag liners; bed blankets; eiderdowns [down coverlets]; handkerchiefs of textile; travelling rugs [lap robes]; coasters for decanters [table linen]; bed covers; bed covers of paper; furniture coverings of plastic; towels of textile; glass cloths [towels]; cloths for removing make-up; face towels of textile; place mats, not of paper; tablecloths, not of paper; oilcloth for use as tablecloths; traced cloths for embroidery; flags of textile or plastic; fitted toilet lid covers of fabric; covers [loose] for furniture; pillow shams; labels of textile; sleeping bags for camping.

25 – Bandanas [neckerchiefs]; underclothing; smocks; half-boots; breeches for wear; trousers; brassieres; neckties; gaiters; vests; sports jerseys; hosiery; hoods [clothing]; neck scarfs [mufflers]; cap peaks; tights; combinations [clothing]; bodices [lingerie]; suits; bathing suits; masquerade costumes; beach clothes; jackets [clothing]; camisoles; tee-shirts; bibs, not of paper; fur stoles; ear muffs [clothing]; socks; bath slippers; beach shoes; sports shoes; footwear; paper clothing; outerclothing; ready-made clothing; gabardines [clothing]; jerseys [clothing]; clothing of imitations of leather; clothing of leather; knitwear [clothing]; uniforms; clothing; overcoats; parkas; swaddling clothes; gloves [clothing]; pyjamas; bathing trunks; scarfs; frocks; waterproof coats; braces for clothing [suspenders]; lace

boots; belts [clothing]; money belts [clothing]; layettes [clothing]; pullovers; shirts; wooden shoes; sandals; boots; sweaters; underpants; gymnastic shoes; slippers; shoes; headgear for wear; aprons [clothing]; dressing gowns; shower caps; stockings; shawls; bathing caps; sashes for wear; babies' pants; pelisses; skirts.

28 – Amusement machines, automatic and coin-operated; toy vehicles; swimming pools [play articles]; novelties for parties, dances [party favors, favours]; skating boots with skates attached; paintballs [ammunition for paintball guns] [sports apparatus]; spinning tops [toys]; jigsaw puzzles; flying discs [toys]; dolls' houses; skateboards; kites; toys; plush toys; mobiles [toys]; practical jokes [novelties]; board games; games; bingo cards; playing cards; fairground ride apparatus; rocking horses; swings; bells for Christmas trees; dolls' rooms; building games; confetti; cosques [toy fireworks]; explosive bonbons [Christmas crackers]; ice skates; roller skates; building blocks [toys]; skis; puppets; toy masks; theatrical masks; balls for games; dolls' clothes; rattles [playthings]; candle holders for Christmas trees; soap bubbles [toys]; bats for games; rackets; scooters [toys]; radio-controlled toy vehicles; ornaments for Christmas trees, except illumination articles and confectionery; apparatus for electronic games other than those adapted for use with television receivers only; counters [discs] for games; marbles for games; billiard balls; playing balls; snow globes.

29 – Peanuts, processed; fruit jellies; raisins; fruits, tinned [canned (Am.)]; buttercream; marmalade; peanut butter; milk; fruit pulp; jams; dairy products; cranberry sauce [compote]; apple puree; fruit salads; whipped cream; dates; crystallized fruits; frosted fruits; frozen fruits; fruit, preserved; fruits, stewed; potato crisps; fruit chips; peanut milk; almond milk.

30 – Cookies; pancakes; bread rolls; waffles; cakes; pastries; peanut confectionery; almond confectionery; pasties; frozen yoghurt [confectionery ices]; cocoa; cocoa products; caramels [candy]; gruel, with a milk base, for food; sweetmeats [candy]; liquorice [confectionery]; peppermint sweets; coffee; crackers; candy; fruit jellies [confectionery]; marzipan; custard; honey; ice cream; fruit ice cream; muesli; cocoa beverages with milk; coffee beverages with milk; coffee-based beverages; tea-based beverages; chocolate beverages with milk; chocolate-based beverages; cocoa-based beverages; infusions, not medicinal; pastilles [confectionery]; biscuits; pies; pizzas; fondants [confectionery]; popcorn; gingerbread; puddings; chewing gum; confectionery; tarts; candy decorations for cakes; halvah; bread; chips [cereal products]; tea; chocolate.

32 – Aperitifs, non-alcoholic; waters [beverages]; cocktails, non-alcoholic; lemonades; non-alcoholic beverages; whey beverages; fruit drinks; fruit nectars, non-alcoholic; powders for effervescing beve-

rages; syrups for lemonade; syrups for beverages; tomato juice [beverage]; apple juice; vegetable juices [beverages]; fruit juices.

38 – Television broadcasting; cable television broadcasting; computer aided transmission of messages and images; electronic mail; radio broadcasting; teleconferencing services.

41 – Nursery schools; discotheque services; gaming; publication of books; education information; recreation information; entertainment information; movie studio services; health club services; club services [entertainment or education]; night clubs; game services provided on-line from a computer network; providing on-line electronic publications, not downloadable; correspondence courses; organization of exhibitions for cultural or educational purposes; providing recreation facilities; arranging and conducting of conferences; arranging and conducting of workshops [training]; arranging and conducting of seminars; arranging of beauty contests; organization of competitions [education or entertainment]; operating lotteries; holiday camp services [entertainment]; organization of sports competitions; amusement parks; television entertainment; providing amusement arcade services; cinema presentations; presentation of live performances; theatre productions; videotape film production; film production; rental of sound recordings; rental of videotapes; rental of show scenery; rental of motion pictures; electronic desktop publishing; publication of electronic books and journals on-line; publication of texts, other than publicity texts; radio entertainment; amusements; entertainer services; sport camp services; providing casino facilities [gambling]; providing museum facilities [presentation, exhibitions]; educational services; translation services; scriptwriting services, other than for advertising purposes; recording studio services; boarding school education; production of shows.

42 – Graphic arts design; research and development of new products for others; quality control; dress designing; design of interior decor; hosting computer sites [web sites]; computer software design; creating and maintaining web sites for others; styling [industrial design]; packaging design.

43 – Accommodation bureau services [hotels, boarding houses]; tourist home services; hotel services; snack-bar services; café services; cafeteria services; restaurant services; self-service restaurant services; canteen services; holiday camp services [lodging]; bar services; day-nursery [crèche] services.

(260) AM 2019 95903 A
(800) 1382499
(151) 2017 10 17
(891) 2017 10 17
(731) GRINDEKS, AS

Krustpils iela 53 LV-1057 Rīga, Latvia

(540)

IVACOR ИВАКОР

(591) Black and white

(511)

5 – Pharmaceutical preparations.

(260) AM 2019 96082 A*

(800) 1384976

(151) 2017 02 03

(891) 2017 02 03

(731) OLGA NOVGORODTCEVA

Salumetsa Tee 2A, Viimsi Vald, EE-74001
Harjumaa, Estonia

(540)

**СИСТЕМА ДИЗАЙНА
ЧЕЛОВЕКА**

(591) Black, white

(511)

41 – Education; providing of training; entertainment; sporting and cultural activities; publishing of books; publication of educational books; providing on-line electronic publications, not downloadable; providing electronic publications, not downloadable; providing on-line videos, not downloadable; providing on-line music, not downloadable; education information; provision of information relating to training; interactive training and education; personal development training; religious education; distance learning services; distance learning services provided online; tutoring; arranging and conducting of tutorials; organisation and conducting of seminars; organisation and conducting of conferences; personal development courses; personal development training; self-awareness courses [instruction]; conducting workshops and seminars in self-awareness.

(260) AM 2019 96328 A*

(800) 1385947

(151) 2017 02 03

(891) 2017 02 03

(731) OLGA NOVGORODTCEVA

Salumetsa Tee 2A, Viimsi Vald, EE-74001
Harjumaa, Estonia

(540)

**HUMAN DESIGN
SYSTEM**

(591) Black, white

(511)

41 – Education; providing of training; entertainment; sporting and cultural activities; publishing of books; publication of educational books; providing on-line electronic publications, not downloadable; providing electronic publications, not downloadable; providing

on-line videos, not downloadable; providing on-line music, not downloadable; education information; provision of information relating to training; interactive training and education; personal development training; religious education; distance learning services; distance learning services provided online; tutoring; arranging and conducting of tutorials; organisation and conducting of seminars; organisation and conducting of conferences; personal development courses; personal development training; self-awareness courses [instruction]; conducting workshops and seminars in self-awareness

(260) AM 2019 96876 A
(800) 1392520
(151) 2017 11 02
(891) 2017 11 02
(731) RADATZ FLEISCHWAREN
VERTRIEBSGESELLSCHAFT M.B.H.
Erlaaer Strasse 187, A-1230 Wien, Austria
(540)



(591) Red, black and white
(531) 27.01.12; 27.05.01; 27.05.02; 27.05.03;
27.05.17; 29.01.12
(511)
29 – Meat, meat extracts, sausage products, oils for food, edible fats.
30 – Mustard, vinegar, sauces (condiments), salad dressings.
31 – Animal foodstuffs.
43 – Providing foods and drinks for guests.

(260) AM 2019 96880 A*
(800) 1392620
(151) 2017 10 05
(891) 2017 10 05
(731) EGIS GYÓGYSZERGYÁR ZRT.
Keresztúri út 30-38, H-1106 Budapest,
Hungary
(540)

SORBIFER

(591) Black, white
(511)
5 – Pharmaceutical preparations for human use; dietetic substances adapted for medical use; vitamin compositions, mineral food supplements, dietary supplements; sanitary preparations for medical purposes.

(260) AM 2019 97617 A
(800) 1400303
(151) 2018 02 12
(891) 2018 02 12
(731) SHANDONG HONGSHENG RUBBER
TECHNOLOGY CO., LTD
East of Shengli Road, West of Xinggong
Road, Dawang Town, Guangrao County,
Dongying City, 257336 Shandong Province,
China
(540)

МАХОВИК

(591) Black, white
(531) 28.05
(511)
12 – Tires for vehicle wheels; automobile tires; casings for pneumatic tires; spikes for tires; repair outfits for inner tubes; automobile wheels; automobiles; mopeds; trolleys; vehicle chassis.

(260) AM 2019 98361 A
(800) 1149398
(151) 2012 12 17
(891) 2018 04 11
(731) Colony AMC 2012 ADC, LLC
28001 Dorothy Drive, Agoura Hills CA
91301, USA
(540)

**brazilian
blowout**

(591) The mark consists of the wording "BRAZILIAN BLOWOUT" in stylized form in black
(531) 27.05.01
(511)
3 – Three-in-one hair conditioners; 3-in-1 hair shampoos; hair conditioner; hair gel; hair relaxers; hair relaxing preparations; hair shampoos and conditioners; hair sprays and hair gels.

(260) AM 2019 98465 A
(800) 1410545
(151) 2018 05 23
(891) 2018 05 23
(731) ANNICK GOUTAL
14 rue de Castiglione, F-75001 Paris, France
(540)

BELLE DU SOIR

(591) Black, white
(511)
3 – Soaps; perfumery products; aromatic extracts for cosmetic use; cosmetics; hair lotions; toiletry products; perfuming and cleaning preparations.

(260) AM 2019 98508 A

(800) 1411679

(151) 2017 11 23

(891) 2017 11 23

(731) USCO S.P.A.

VIA DELLE NAZIONI 65, I-41122

MODENA, Italy

(540)



(591) Black, white

(531) 26.11.03; 26.11.08; 26.11.12; 27.05.17

(511)

7 – Mechanical engine parts for land vehicles; mechanical components for engines for land vehicles, agricultural machines and earth moving machines; crawler machines; crawler-tracked loaders; crawler cranes; rubber tracks being parts of crawlers on agricultural machines; rubber tracks being parts of crawlers on construction machines; rubber tracks being parts of crawlers on mining machines; rubber tracks being parts of crawlers on loading-unloading machines and apparatus; power transmission belts for machines; bearings for transmission shafts; transmission gears for machines; transmissions for machines; transmission shafts, other than for land vehicles; transmission belts, other than for land vehicles; clutches and apparatus for power transmission, other than for land vehicles; transmissions, other than for land vehicles; bearings for transmission shafts, being parts of machines; clutches, other than for land vehicles; pressure reducers [parts of machines]; air-cooled condensers; pumps for cooling engines; radiators [cooling] for motors and engines; filters for cleaning cooling air, for engines; hydraulic pumps; clack valves [parts of machines]; hydraulic valve actuators; valves [parts of machines]; pneumatic controls for machines, motors and engines; pneumatic machines and apparatus; hydraulic controls for machines, motors and engines; backhoes [earth moving machines]; blades for earth moving machines; blades [parts of machines]; buckets for earth moving machines; graders [earth moving machines]; loaders [earth moving machines]; air cleaners [parts of engines]; oil filters for motors and engines; filters [parts of machines or engines]; driving chains, other than for land vehicles; transmission chains, other than for land vehicles; pressure rollers [parts of machines]; rollers [parts of machines]; roller bearings; roller bearings for machines; steamrollers; roller conveyors; driving motors, other than for land vehicles; machine wheels; gear wheels [parts of machines]; loading and unloading machines; shovel loaders

[machines]; loading ramps; crawler loaders; machines for loading; derricks; earth augers; earth compacting machines; grease rings [parts of machines]; axles for machines; transmission shafts, not for land vehicles; bulldozers; excavators; cranes [lifting and hoisting apparatus]; mobile cranes; extracting machines; milling-drilling machines; end mills [machines]; radial drills; drills for the mining industry; motors, other than for land vehicles; agricultural implements, other than hand-operated; belt conveyors; undercarriages for earth moving machines; undercarriage components for use in agriculture, construction, mine workings and earth moving machines; universal joints [Cardan joints]; shaft couplings [machines]; joints [parts of engines]; couplings, other than for land vehicles; machine tools; motors and engines [except for land vehicles]; machine coupling and transmission components [except for land vehicles]; agricultural implements, other than hand-operated.

12 – Vehicle chassis parts; transmission shafts for land vehicles; transmission belts for land vehicles; drive gears for land vehicles; transmissions for land vehicles; transmission components for land vehicles; transmission cases for land vehicles; transmission top covers for land vehicles; differential gears for land vehicles; clutches for land vehicles; clutch linings for land vehicles; clutch mechanisms for land vehicles; mine cart wheels; wheel sprockets; vehicle wheels; hubs for vehicle wheels; wheel bearings for land vehicles; lug nuts for vehicle wheels; gear wheels for land vehicles; freewheels for land vehicles; solid tires for vehicle wheels; tires for land vehicles; tire liners; driving chains for land vehicles; tire chains for land vehicles; transmission chains for land vehicles; driving motors for land vehicles; tipping bodies for lorries [trucks]; hub caps; tires for vehicle wheels; valves for vehicle tires [tyres]; non-skid devices for vehicle tires [tyres]; vehicle wheel hubs; undercarriages for motor vehicles, tractors, tracked tractors; undercarriage components for motor vehicles, tractors, tracked tractors; vehicles; apparatus for locomotion by land, air or water.

(260) AM 2019 98525 A

(800) 1412386

(151) 2018 04 26

(891) 2018 04 26

(731) CHAMPAGNE DEUTZ S.A.

16, rue Jeanson, F-51150 AY, France

(540)

WILLIAM DEUTZ

(591) Black, white

(511)

33 – Wines, sparkling wines, wines of French origin, namely, Champagne; aperitifs; spirits; liqueurs.

(260) AM 2019 98532 A
 (800) 1024290
 (151) 2009 11 10
 (891) 2018 06 26
 (731) DR. WILLMAR SCHWABE GMBH & CO.
 KG
 Willmar-Schwabe-Strasse 4, 76227 Karlsruhe,
 Germany

(540)

Klimaktoplan

(591) Black, white
 (511)
 5 – Pharmaceutical and veterinary preparations; san-
 itary preparations for medical purposes; dietetic
 substances adapted for medical use.

(260) AM 2019 98648 A
 (800) 1039497
 (151) 2010 01 05
 (891) 2018 05 09
 (731) SKEMA S.R.L.
 Via dell'Artigianato 8, I-31047 Ponte di Piave
 (Treviso), Italy

(540)

SKEMA

(591) Black, white
 (531) 27.05.01
 (511)
 6 – Floors of metal, metal wall coverings; common
 metals and their alloys; metal building materials;
 transportable buildings of metal; materials of metal
 for railway tracks; non-electric cables and wires of
 common metal; ironmongery and small items of
 metal hardware; pipes and tubes of metal; safes of
 metal; goods of common metal not included in other
 classes; ores.

19 – Wood flooring, ceramic and grès tiles for tile
 floors, non-metal floors, coverings made of non-met-
 allic materials (buildings), non-metallic wall panels
 (buildings), non-metal sound control materials, non-
 metallic building materials, non-metallic rigid pipes
 for building, asphalt, pitch and bitumen; non-met-
 allic transportable buildings, monuments not of met-
 al.

(260) AM 2019 98651 A
 (800) 1333059
 (151) 2016 09 26
 (891) 2018 06 07
 (731) NEXUS AUTOMOTIVE INTERNATIONAL
 SA
 Chemin du Château-Bloch 11, CH-1219 Le
 Lignon, Switzerland

(540)



(591) Charcoal (Pantone PMS 425) and orange
 (Pantone PMS 144)

(531) 24.17.04; 27.05.10; 27.05.21; 29.01.12
 (511)

9 – Downloadable electronic publications, including
 downloadable audio and video digital files, relating
 to training and education in the fields of trade and
 distribution of spare parts for land vehicles, mainte-
 nance and repair of land vehicles; pre-recorded mag-
 netic or optical data media, particularly compact
 discs, compact discs with read-only memory (CD-
 ROMs), pre-recorded digital versatile disks (DVDs)
 and optical discs, all relating to training and educa-
 tion in the fields of trade and distribution of spare
 parts for land vehicles, maintenance and repair of
 land vehicles; downloadable software in the form of
 software and firmware intended for computers, lap-
 tops, tablets and mobile telephones, all relating to
 training and education in the fields of trade and dis-
 tribution of spare parts for land vehicles, mainten-
 ance and repair of land vehicles.

16 – Instructional and teaching manuals, books, pub-
 lications, educational, informational, instructional
 and teaching material (excluding apparatus), softwa-
 re printed on paper, all relating to training and edu-
 cation in the fields of trade and distribution of spare
 parts for land vehicles, maintenance and repair of
 land vehicles.

41 – Education, teaching, distance learning (by cor-
 respondence), particularly via interactive or non-in-
 teractive electronic means of communication, train-
 ing, theoretical and practical courses in the fields of
 trade and distribution of spare parts for land vehi-
 cles, maintenance and repair of land vehicles.

(260) AM 2019 98704 A
 (800) 1414387
 (151) 2018 06 14
 (891) 2018 06 14
 (731) ANDRE JACQUES LEVY
 Strada di Fulmignano 21, CH-6977
 RUVIGLIANA, Switzerland

(540)

AFTER HOURS

(591) Black, white

(511)

33 – Alcoholic beverages except beers; distilled spirits; rum; whisky; vodka; gin; distilled beverages; liqueurs; cocktails.

34 – Tobacco; smokers' articles; cigarettes; cigars; matches; chemical flavors in liquid form used for refilling electronic cigarette cartridges; articles for use with tobacco; cartridges for electronic cigarettes; cigar cases; cigarette cases; electronic cigarette cases.

(260) AM 2019 98716 A

(800) 1414590

(151) 2018 01 29

(891) 2018 01 29

(731) SELECTIS – PRODUTOS PARA A AGRICULTURA, S.A.

Herdade das Praias, Apartado 11, E.C.

Bonfim, P-2901-877 SETÚBAL, Portugal

(540)

ASCENZA

(591) Black, white

(511)

1 – Culture media, manure and chemical products for use in agriculture, horticulture and forestry; fertilizers and chemical products for use in agriculture, horticulture and forestry; Chemical additives for use in agriculture; chemical additives for use in horticulture; chemical additives for use in forestry; fertilizers; fertilizers for the soil; Soil fertilizers; fertilizing preparations; chemical products for use in agriculture, horticulture and forestry; chemical products intended for herbicides; chemical products intended for pesticides; chemical products for use in horticulture; chemical products for use in forestry; plant growth regulating preparations; chemical products for use in agriculture.

5 – Preparations and articles for pest control; fungicides; herbicides; insecticides; pesticides for agricultural use; preparations for repelling vermin; products for destroying vermin; veterinary products; veterinary preparations.

44 – Agriculture, aquaculture, horticulture and forestry services; information services in the field of agriculture; agriculture, horticulture and forestry services; services provided by consultants regarding agriculture; Culture consultancy services in the field of agriculture; consulting services relating to agriculture, horticulture and forestry; consulting and assistance services relating to agriculture, horticulture and forestry.

(260) AM 2019 98723 A

(800) 1414743

(151) 2018 02 21

(891) 2018 02 21

(731) Aktsionernoe obshchestvo "EMOKSIFARM" ulitsa Alexandra Solzhenitsyna, dom 27, komnata 32, RU-109004 Moscow, Russian Federation

(540)

**ЭМОКСИПИН
EMOXIPIN**

(591) Black, white

(531) 28.05

(511)

5 – Pharmaceutical preparations.

(260) AM 2019 98809 A

(800) 1415377

(151) 2017 12 28

(891) 2017 12 28

(731) "ILYINSKY HOSPITAL" JSC

Vadkovsky lane, 12, of. 20, RU-127055

Moscow, Russian Federation

(540)

**ILYINSKY
HOSPITAL**

(591) White, light green and dark green

(531) 05.03.13; 05.03.14; 29.01.13

(511)

5 – Pharmaceuticals, medical and veterinary preparations; sanitary preparations for medical purposes; dietetic food and substances adapted for medical or veterinary use, food for babies; dietary supplements for humans and animals; plasters, materials for dressings; material for dental fillings and dental impressions; preparations for destroying noxious animals; aconitine; alkaloids for medical purposes; alginates for pharmaceutical purposes; algicides; aldehydes for pharmaceutical purposes; dental amalgams of gold; dental amalgams; amino acids for veterinary purposes; amino acids for medical purposes; analgesics; anaesthetics; antibiotics; antiseptics; medicine cases, portable, filled; first-aid boxes, filled; aluminium acetate for pharmaceutical purposes; acetates for pharmaceutical purposes; germicides; balms for medical purposes; bandages for dressings; diagnostic biomarker reagents for medical purposes; biocides; bromine for pharmaceutical purposes; paper for mustard plasters; fly catching paper; reagent pa-

per for veterinary purposes; reagent paper for medical purposes; mothproofing paper; petroleum jelly for medical purposes; vaccines; oxygen baths; antiseptic cotton; aseptic cotton; absorbent cotton; wadding for medical purposes; cotton for medical purposes; dietetic substances adapted for medical use; radiological contrast substances for medical purposes; nutritive substances for microorganisms; radioactive substances for medical purposes; melissa water for pharmaceutical purposes; sea water for medicinal bathing; mineral waters for medical purposes; thermal water; dietary fiber; molding wax for dentists; gases for medical purposes; guaiacol for pharmaceutical purposes; sexual stimulant gels; hemato-gen; hemoglobin; hydrastine; hydrastinine; glycerine for medical purposes; glycerophosphates; glucose for medical purposes; gentian for pharmaceutical purposes; hormones for medical purposes; mustard for pharmaceutical purposes; mustard plasters; mud for baths; medicinal mud; gamboge for medical purposes; gurjun [gurjon, gurjan] balsam for medical purposes; air deodorising preparations; deodorants, other than for human beings or for animals; deodorants for clothing and textiles; diastase for medical purposes; digitalin; mineral food supplements; nutritional supplements; albumin dietary supplements; dietary supplements for animals; yeast dietary supplements; alginate dietary supplements; glucose dietary supplements; casein dietary supplements; lecithin dietary supplements; linseed oil dietary supplements; propolis dietary supplements; protein dietary supplements; protein supplements for animals; royal jelly dietary supplements; pollen dietary supplements; wheat germ dietary supplements; linseed dietary supplements; enzyme dietary supplements; yeast for pharmaceutical purposes; gelatine for medical purposes; cod liver oil; isotopes for medical purposes; immunostimulants; insecticides; iodine for pharmaceutical purposes; iodides for pharmaceutical purposes; alkaline iodides for pharmaceutical purposes; iodoform; calomel [fungicide]; tartar for pharmaceutical purposes; camphor for medical purposes; capsules for medicines; cachets for pharmaceutical purposes; hemostatic pencils; wart pencils; caustic pencils; carbolineum [parasiticide]; caustics for pharmaceutical purposes; cachou for pharmaceutical purposes; quassia for medical purposes; quebracho for medical purposes; oxygen for medical purposes; gallic acid for pharmaceutical purposes; acids for pharmaceutical purposes; adhesives for dentures; surgical glues; stem cells for veterinary purposes; stem cells for medical purposes; cocaine; collagen for medical purposes; collodion for pharmaceutical purposes; corn rings for the feet; candy, medicated; angostura bark for medical purposes; barks for pharmaceutical purposes; cedar wood for use as an insect repellent; condurango bark for medical purposes; croton bark; mangrove bark for pharmaceutical purposes; myrobalan bark for pharmaceutical purposes;

quinquina for medical purposes; medicated animal feed; medicinal roots; rhubarb roots for pharmaceutical purposes; lint for medical purposes; starch for dietetic or pharmaceutical purposes; creosote for pharmaceutical purposes; blood for medical purposes; cultures of microorganisms for medical or veterinary use; curare; dental lacquer; liquorice for pharmaceutical purposes; lactose for pharmaceutical purposes; candy for medical purposes; adhesive plasters; medicines for alleviating constipation; lecithin for medical purposes; lotions for veterinary purposes; medicated hair lotions; lotions for pharmaceutical purposes; medicated after-shave lotions; personal sexual lubricants; lupulin for pharmaceutical purposes; magnesia for pharmaceutical purposes; liniments; ointments for pharmaceutical purposes; sunburn ointments; mercurial ointments; frostbite salve for pharmaceutical purposes; gauze for dressings; medicinal oils; mustard oil for medical purposes; camphor oil for medical purposes; castor oil for medical purposes; oil of turpentine for pharmaceutical purposes; dill oil for medical purposes; dental mastics; dental abrasives; dressings, medical; surgical dressings; drugs for medical purposes; medicines for veterinary purposes; serotherapeutic medicines; medicines for human purposes; medicines for dental purposes; menthol; medicinal drinks; moleskin for medical purposes; almond milk for pharmaceutical purposes; powdered milk for babies; royal jelly for pharmaceutical purposes; milk ferments for pharmaceutical purposes; Irish moss for medical purposes; flour for pharmaceutical purposes; linseed meal for pharmaceutical purposes; fish meal for pharmaceutical purposes; fly glue; antibacterial soap; disinfectant soap; medicated soap; freeze-dried meat adapted for medical purposes; mint for pharmaceutical purposes; dietetic beverages adapted for medical purposes; malted milk beverages for medical purposes; narcotics; medicinal infusions; tincture of iodine; eucalyptol for pharmaceutical purposes; tinctures for medical purposes; opium; opodeldoc; decoctions for pharmaceutical purposes; antiparasitic collars for animals; stick liquorice for pharmaceutical purposes; sulfur sticks [disinfectants]; medicated dentifrices; pectin for pharmaceutical purposes; pepsins for pharmaceutical purposes; peptones for pharmaceutical purposes; hydrogen peroxide for medical purposes; pesticides; food for babies; leeches for medical purposes; blood plasma; eyepatches for medical purposes; poultices; compresses; scapulars for surgical purposes; babies' diapers [napkins]; diapers for pets; diapers for incontinents; bunion pads; breast-nursing pads; pomades for medical purposes; powder of cantharides; pyrethrum powder; belts for sanitary napkins [towels]; anti-uric preparations; bacterial preparations for medical and veterinary use; bacteriological preparations for medical and veterinary use; balsamic preparations for medical purposes; albuminous preparations for medical purposes; biological

preparations for veterinary purposes; biological preparations for medical purposes; bismuth preparations for pharmaceutical purposes; vitamin preparations; diagnostic preparations for medical purposes; bath preparations for medical purposes; therapeutic preparations for the bath; hemorrhoid preparations; preparations for callouses; lice treatment preparations [pediculicides]; acne treatment preparations; preparations to facilitate teething; preparations for the treatment of burns; fumigation preparations for medical purposes; ootherapy preparations; air purifying preparations; bronchodilating preparations; preparations for reducing sexual activity; sterilising preparations; soil-sterilising preparations; corn remedies; pharmaceutical preparations for treating dandruff; herbicides; preparations for destroying dry rot fungus; larvae exterminating preparations; fly destroying preparations; preparations for destroying mice; slug exterminating preparations; vermin destroying preparations; pharmaceutical preparations for skin care; contact lens cleaning preparations; preparations of microorganisms for medical or veterinary use; lime-based pharmaceutical preparations; medicated eye-washes; medicinal hair growth preparations; nutraceutical preparations for therapeutic or medical purposes; opiates; anticryptogamic preparations; aloe vera preparations for pharmaceutical purposes; preparations of trace elements for human and animal use; sulfonamides [medicines]; pharmaceutical preparations; pharmaceutical preparations for treating sunburn; enzyme preparations for veterinary purposes; enzyme preparations for medical purposes; phytotherapy preparations for medical purposes; chemico-pharmaceutical preparations; chemical preparations for veterinary purposes; chemical preparations for the diagnosis of pregnancy; chemical preparations for medical purposes; chemical preparations to treat wheat blight [smut]; vine disease treating chemicals; chemical preparations to treat mildew; chemical preparations for treating phyloxera; chemical preparations for pharmaceutical purposes; chilblain preparations; mothproofing preparations; collyrium; lead water; chemical conductors for electrocardiograph electrodes; albuminous foodstuffs for medical purposes; dietetic foods adapted for medical purposes; by-products of the processing of cereals for dietetic or medical purposes; homogenized food adapted for medical purposes; freeze-dried food adapted for medical purposes; pharmaceuticals; sanitary towels; sanitary pads; panty liners [sanitary]; propolis for pharmaceutical purposes; pearl powder for medical purposes; radium for medical purposes; hydrated chloral for pharmaceutical purposes; solvents for removing adhesive plasters; vaginal washes for medical purposes; solutions for contact lenses; chemical reagents for medical or veterinary purposes; gum for medical purposes; rubber for dental purposes; chewing gum for medical purposes; insect repellents; insect repellent

incense; repellents for dogs; tissues impregnated with pharmaceutical lotions; sarsaparilla for medical purposes; sugar for medical purposes; asthmatic tea; fumigating sticks; linseed for pharmaceutical purposes; tobacco-free cigarettes for medical purposes; siccatives [drying agents] for medical purposes; syrups for pharmaceutical purposes; turpentine for pharmaceutical purposes; greases for veterinary purposes; greases for medical purposes; lacteal flour for babies; infant formula; soporifics; bicarbonate of soda for pharmaceutical purposes; bath salts for medical purposes; salts for mineral water baths; salts for medical purposes; potassium salts for medical purposes; sodium salts for medical purposes; smelling salts; mineral water salts; malt for pharmaceutical purposes; semen for artificial insemination; alcohol for pharmaceutical purposes; medicinal alcohol; alloys of precious metals for dental purposes; ergot for pharmaceutical purposes; cooling sprays for medical purposes; antibacterial handwashes; adjuvants for medical purposes; astringents for medical purposes; vermifuges; disinfectants for hygiene purposes; disinfectants for chemical toilets; douching preparations for medical purposes; appetite suppressants for medical purposes; medical preparations for slimming purposes; parasiticides; mouthwashes for medical purposes; febrifuges; depuratives; animal washes [insecticides]; detergents for medical purposes; cattle washes [insecticides]; dog washes [insecticides]; insecticidal veterinary washes; vesicants; purgatives; remedies for perspiration; remedies for foot perspiration; chemical contraceptives; antiparasitic preparations; laxatives; tonics [medicines]; medicated toiletry preparations; digestives for pharmaceutical purposes; nervines; media for bacteriological cultures; steroids; strychnine; serums; tanning pills; appetite suppressant pills; slimming pills; antioxidant pills; sanitary tampons; vulnerary sponges; thymol for pharmaceutical purposes; biological tissue cultures for veterinary purposes; biological tissue cultures for medical purposes; smoking herbs for medical purposes; medicinal herbs; surgical implants comprised of living tissues; pants, absorbent, for incontinents; sanitary panties; babies' napkin-pants [diaper-pants]; charcoal for pharmaceutical purposes; porcelain for dental prostheses; phenol for pharmaceutical purposes; enzymes for veterinary purposes; enzymes for medical purposes; ferments for pharmaceutical purposes; formic aldehyde for pharmaceutical purposes; phosphates for pharmaceutical purposes; quinine for medical purposes; chinoline for medical purposes; diabetic bread adapted for medical use; chloroform; flowers of sulfur for pharmaceutical purposes; cement for animal hooves; bone cement for surgical and orthopaedic purposes; dental cements; medicinal tea; herbal teas for medicinal purposes; insecticidal animal shampoo; medicated shampoos; medicated shampoos for pets; pediculicidal shampoos; medicated dry shampoos; pre-

filled syringes for medical purposes; eucalyptus for pharmaceutical purposes; herbal extracts for medical purposes; plant extracts for pharmaceutical purposes; tobacco extracts [insecticides]; extracts of hops for pharmaceutical purposes; elixirs [pharmaceutical preparations]; ethers for pharmaceutical purposes; esters for pharmaceutical purposes; cellulose esters for pharmaceutical purposes; cellulose ethers for pharmaceutical purposes; rat poison; poisons; bacterial poisons; jalap; fungicides, herbicides; acaricides; bismuth subnitrate for pharmaceutical purposes; disinfectants; cream of tartar for pharmaceutical purposes; adhesive tapes for medical purposes; cotton sticks for medical purposes; pastilles for pharmaceutical purposes; diagnostic preparations for veterinary purposes; styptic pencils; suppositories; milking grease; sedatives; jujube, medicated; transplants [living tissues]; fennel for medical purposes.

10 – Surgical, medical, dental and veterinary apparatus and instruments; artificial limbs, eyes and teeth; suture materials; therapeutic and assistive devices adapted for the disabled; massage apparatus; apparatus, devices and articles for nursing infants; blood testing apparatus; anaesthetic apparatus; galvanic therapeutic appliances; apparatus for artificial respiration; apparatus for the treatment of deafness; physical exercise apparatus for medical purposes; body rehabilitation apparatus for medical purposes; dental apparatus and instruments; surgical apparatus and instruments; resuscitation apparatus; dental apparatus, electric; physiotherapy apparatus; bed vibrators; hot air therapeutic apparatus; diagnostic apparatus for medical purposes; traction apparatus for medical purposes; radiotherapy apparatus; microdermabrasion apparatus; fumigation apparatus for medical purposes; apparatus for the regeneration of stem cells for medical purposes; apparatus for DNA and RNA exams for medical purposes; apparatus and installations for the production of X-rays, for medical purposes; radiological apparatus for medical purposes; X-ray apparatus for medical purposes; hearing aids; nasal aspirators; trusses; maternity belts; bandages, elastic; cupping glasses; dental burs; bracelets for medical purposes; anti-rheumatism bracelets; feeding bottles; vaporizers for medical purposes; hot air vibrators for medical purposes; vibromassage apparatus; gastroscopes; hemocytometers; lice combs; surgical sponges; defibrillators; dialyzers; containers especially made for medical waste; clips, surgical; mirrors for dentists; mirrors for surgeons; probes for medical purposes; urethral probes; artificial teeth; acupuncture needles; suture needles; needles for medical purposes; orthopedic articles; surgical implants comprised of artificial materials; inhalers; injectors for medical purposes; incubators for medical purposes; incubators for babies; obstetric apparatus; obstetric apparatus for cattle; electric acupuncture instruments; surgical cutlery; insufflators; endoscopy cameras for medical purposes; cannulae;

droppers for medical purposes; dropper bottles for medical purposes; heart pacemakers; heart rate monitoring apparatus; catheters; catgut; draw-sheets for sick beds; enema apparatus for medical purposes; artificial skin for surgical purposes; menstrual cups; teething rings; anti-rheumatism rings; compressors [surgical]; thermo-electric compresses [surgery]; abdominal corsets; corsets for medical purposes; crutches; dentists' armchairs; armchairs for medical or dental purposes; beds specially made for medical purposes; feeding bottle valves; love dolls [sex dolls]; lasers for medical purposes; lamps for medical purposes; quartz lamps for medical purposes; ultraviolet ray lamps for medical purposes; lancets; lenses [intraocular prostheses] for surgical implantation; spoons for administering medicine; masks for use by medical personnel; respiratory masks for artificial respiration; anaesthetic masks; childbirth mattresses; air mattresses for medical purposes; hydrotatic [water] beds for medical purposes; furniture especially made for medical purposes; water bags for medical purposes; douche bags; breast pumps; body fat monitors; body composition monitors; urinals [vessels]; teeth protectors for dental purposes; temperature indicator labels for medical purposes; knee bandages, orthopaedic; tips for crutches; finger guards for medical purposes; medical guidewires; pumps for medical purposes; thread, surgical; knives for surgical purposes; scissors for surgery; ambulance stretchers; stretchers, wheeled; boots for medical purposes; orthopaedic footwear; clothing especially for operating rooms; compression garments; blankets, electric, for medical purposes; supports for flat feet; ophthalmometers; ophthalmoscopes; slings [supporting bandages]; gloves for massage; gloves for medical purposes; pessaries; saws for surgical purposes; ear picks; spittoons for medical purposes; plaster bandages for orthopaedic purposes; supportive bandages; suspensory bandages; abdominal pads; cushions for medical purposes; pads [pouches] for preventing pressure sores on patient bodies; air pillows for medical purposes; soporific pillows for insomnia; heating cushions [pads], electric, for medical purposes; abdominal belts; galvanic belts for medical purposes; hypogastric belts; belts for medical purposes; orthopaedic belts; umbilical belts; belts, electric, for medical purposes; condoms; aerosol dispensers for medical purposes; sphygmomanometers; pulse meters; esthetic massage apparatus; urological apparatus and instruments; orthodontic appliances; nursing appliances; brushes for cleaning body cavities; invalids' hoists; appliances for washing body cavities; corn knives; incontinence sheets; sterile sheets, surgical; surgical drapes; hair prostheses; artificial breasts; artificial jaws; ice bags for medical purposes; toe separators for orthopaedic purposes; orthodontic rubber bands; X-ray photographs for medical purposes; respirators for artificial respiration; strait jackets; sex toys; scalpels; tongue scra-

pers; babies' pacifiers [teats]; feeding bottle teats; receptacles for applying medicines; spirometers [medical apparatus]; vaginal syringes; implantable subcutaneous drug delivery devices; hearing protectors; contraceptives, non-chemical; orthopaedic soles; stents; stethoscopes; operating tables; commode chairs; basins for medical purposes; bed pans; instrument cases for use by doctors; arch supports for footwear; ear plugs [ear protection devices]; thermometers for medical purposes; tomographs for medical purposes; trocars; drainage tubes for medical purposes; X-ray tubes for medical purposes; radium tubes for medical purposes; balling guns; protection devices against X-rays, for medical purposes; apparatus for acne treatment; filters for ultraviolet rays, for medical purposes; walking frames for disabled persons; cases fitted for medical instruments; elastic stockings for surgical purposes; stockings for varices; splints, surgical; tongue depressors for medical purposes; syringes for injections; syringes for medical purposes; hypodermic syringes; uterine syringes; urethral syringes; pins for artificial teeth; forceps; castrating pincers; radiology screens for medical purposes; electrodes for medical use; electrocardiographs; brain pacemakers; sexual activity apparatus, devices and articles; analysers for bacterial identification for medical purposes; testing apparatus for medical purposes; air cushions for medical purposes; biodegradable bone fixation implants; surgical bougies; ear trumpets; thermal packs for first aid purposes; quad canes for medical purposes.

35 – Advertising; business management; business administration; office functions; import-export agency services; commercial information agency services; advertising agency services; cost price analysis; rental of advertising space; business auditing; business intermediary services relating to the matching of potential private investors with entrepreneurs needing funding; employment agency services; computerized file management; book-keeping; invoicing; demonstration of goods; transcription of communications [office functions]; opinion polling; market studies; business information; commercial information and advice for consumers [consumer advice shop]; business investigations; business research; marketing research; personnel recruitment; business management and organization consultancy; business organization consultancy; consultancy regarding public relations communications strategy; business management consultancy; personnel management consultancy; professional business consultancy; consultancy regarding advertising communications strategy; layout services for advertising purposes; marketing; business management of performing artists; business management of sports people; writing of résumés for others; scriptwriting for advertising purposes; news clipping services; updating and maintenance of information in registries; updating and maintenance of data in computer databases; updating

of advertising material; word processing; organization of exhibitions for commercial or advertising purposes; arranging newspaper subscriptions for others; organization of fashion shows for promotional purposes; organization of trade fairs for commercial or advertising purposes; shop window dressing; design of advertising materials; business appraisals; payroll preparation; data search in computer files for others; sponsorship search; business management assistance; commercial or industrial management assistance; commercial intermediation services; providing business information via a web site; provision of commercial and business contact information; provision of an on-line marketplace for buyers and sellers of goods and services; web indexing for commercial or advertising purposes; economic forecasting; auctioneering; retail or wholesale services for pharmaceutical, veterinary and sanitary preparations and medical supplies; sales promotion for others; production of teleshopping programmes; production of advertising films; office machines and equipment rental; rental of advertising time on communication media; publicity material rental; rental of billboards [advertising boards]; rental of vending machines; rental of photocopying machines; publication of publicity texts; radio advertising; distribution of samples; dissemination of advertising matter; direct mail advertising; registration of written communications and data; writing of publicity texts; on-line advertising on a computer network; advertising by mail order; television advertising; document reproduction; compilation of statistics; compilation of information into computer databases; business inquiries; systemization of information into computer databases; advisory services for business management; negotiation of business contracts for others; negotiation and conclusion of commercial transactions for third parties; compiling indexes of information for commercial or advertising purposes; tax preparation; drawing up of statements of accounts; telemarketing services; psychological testing for the selection of personnel; business management of hotels; business project management services for construction projects; commercial administration of the licensing of the goods and services of others; business management of reimbursement programs for others; administration of consumer loyalty programs; administration of frequent flyer programs; administrative processing of purchase orders; public relations; modelling for advertising or sales promotion; typing; appointment reminder services [office functions]; relocation services for businesses; tax filing services; search engine optimization for sales promotion; appointment scheduling services [office functions]; price comparison services; secretarial services; procurement services for others [purchasing goods and services for other businesses]; shorthand; outsourcing services [business assistance]; telephone answering for unavailable subscribers; photocopying servi-

ces; business efficiency expert services; arranging subscriptions to telecommunication services for others; presentation of goods on communication media, for retail purposes; rental of sales stands; bill-posting; outsourced administrative management for companies; business management for freelance service providers; web site traffic optimization; pay per click advertising.

42 – Scientific and technological services and research and design relating thereto; industrial analysis and research services; water analysis; computer system analysis; handwriting analysis [graphology]; chemical analysis; energy auditing; recovery of computer data; industrial design; graphic arts design; computer virus protection services; engineering; installation of computer software; meteorological information; clinical trials; material testing; textile testing; bacteriological research; biological research; geological research; research in the field of environmental protection; cosmetic research; mechanical research; chemical research; research and development of new products for others; scientific research; analysis for oil-field exploitation; underwater exploration; technical research; calibration [measuring]; web site design consultancy; computer security consultancy; information technology [IT] consultancy; consultancy in the design and development of computer hardware; architectural consultancy; Internet security consultancy; computer software consultancy; data security consultancy; technological consultancy; oil-well testing; quality control; vehicle road-worthiness testing; land surveying; dress designing; updating of computer software; monitoring of computer systems to detect breakdowns; monitoring of computer systems for detecting unauthorized access or data breach; monitoring of computer systems by remote access; software as a service [SaaS]; maintenance of computer software; authenticating works of art; design of interior decor; quality evaluation of standing timber; quality evaluation of wool; digitization of documents [scanning]; conversion of data or documents from physical to electronic media; urban planning; providing information on computer technology and programming via a web site; providing search engines for the Internet; conversion of computer programs and data, other than physical conversion; conducting technical project studies; computer system design; rental of web servers; computer rental; rental of computer software; unlocking of mobile phones; geological prospecting; oil prospecting; hosting computer sites [web sites]; construction drafting; computer software design; cloud seeding; consultancy in the field of energy-saving; creating and designing website-based indexes of information for others [information technology services]; creating and maintaining web sites for others; computer programming; technical writing; copying of computer programs; cloud computing; architectural services; chemistry services; outsource service providers in

the field of information technology; packaging design; off-site data backup; computer technology consultancy; telecommunications technology consultancy; scientific laboratory services; weather forecasting; styling [industrial design]; cartography services; data encryption services; physics [research]; electronic data storage; surveying; electronic monitoring of credit card activity to detect fraud via the Internet; electronic monitoring of personally identifying information to detect identity theft via the Internet; design and development of computer hardware and software; interior design; oil-field surveys; geological surveys; provision of scientific information, advice and consultancy in relation to carbon offsetting; server hosting.

44 – Medical services; veterinary services; hygienic and beauty care for human beings or animals; Turkish bath services; hospital services; reforestation services; landscape design; nursing home services; wreath making; hair implantation; medical advice for individuals with disabilities; pharmacy advice; manicuring; chiropractic; massage; horticulture; artificial insemination services; palliative care; hairdressing; body piercing; midwife services; veterinary assistance; medical assistance; tree planting for carbon offsetting purposes; preparation of prescriptions by pharmacists; medical equipment rental; rental of sanitation facilities; farming equipment rental; aerial and surface spreading of fertilizers and other agricultural chemicals; animal breeding; gardening; landscape gardening; beauty salon services; sanatorium services; blood bank services; health care; health counselling; flower arranging; tattooing; weed killing; health spa services; human tissue bank services; aquaculture services; visagists' services; convalescent home services; rest home services; medical clinic services; alternative medicine services; opticians' services; plant nursery services; pest control services for agriculture, aquaculture, horticulture and forestry; services of a psychologist; sauna services; solarium services; telemedicine services; therapy services; nursing, medical; lawn care; animal grooming; pet grooming; physical therapy; plastic surgery; tree surgery; hospice services; depilatory waxing; public bath services for hygiene purposes; agriculture, horticulture and forestry services; health center services; rehabilitation for substance abuse patients; aromatherapy services; speech therapy; orthodontic services; dentistry services; vermin exterminating for agriculture, aquaculture, horticulture and forestry; in vitro fertilization services.

(260) AM 2019 98810 A
(800) 1415393
(151) 2018 03 13
(891) 2018 03 13
(731) Public joint-stock company "ZAVOD
CERAMICHESKIH IZDELIY"

1, ul. Okruzhnaya, Ekaterinburg, RU-620103
Sverdlovskaya oblast, Russian Federation

(540)



(591) Yellow, red, blue, green, white and black

(531) 26.03.04; 26.03.23; 27.01.01; 27.01.02;
27.01.05; 29.01.15

(511)

19 – Building stone, including pottery stone; building materials, not of metal; refractory construction materials, not of metal; mosaics for building; coatings [building materials]; wall claddings, not of metal, for building; wall linings, not of metal, for building; wainscoting, not of metal; building panels, not of metal; tiles, not of metal, for building, including ceramic tiles for walls, floors and ceilings, ceramic tiles for flooring and lining, ceramic tiles for flooring and facing, glazed ceramic tiles; floor tiles, not of metal, including tiles of ceramic granite, granite tiles; tile floorings, not of metal; wall tiles, not of metal; slabs, not of metal, for building; floors, not of metal; ceilings, not of metal; linings, not of metal, for building; sills, not of metal; mortar for building; angle irons, not of metal; foundry molds, not of metal.

(260) AM 2019 98812 A

(800) 1415438

(151) 2018 01 29

(891) 2018 01 29

(731) HUAWEI TECHNOLOGIES CO., LTD

Administration Building, Huawei Technologies Co., LTD, Bantian, Longgang District, Shenzhen, China

(540)

HONOR

(591) Black, white

(511)

36 – Providing financial information via a web site; electronic funds transfer; online banking; financing services; insurance brokerage; insurance information; currency trading; online real-time currency trading; processing of bill payments; trusteeship; providing stock market information; securities brokerage; financial information; financial analysis; financial management; financial consultancy; providing rebates at participating establishments of others through use of a membership card; processing of debit card payments; apartment house management; real estate management; credit loans; processing of electronic credit card transaction; providing bill payments via a web site; electronic remittance via prepaid cards; electronic funds transfer via telecommunications; electronic bank services (Internet bank) through a global computer network; financial management through Internet; capital transfer through electronic means; acceptance of electronic checks;

processing of credit card payments; financial appraisals in responding to calls for tenders.

(260) AM 2019 98818 A

(800) 1415483

(151) 2018 04 27

(891) 2018 04 27

(731) AUDEMARS PIGUET HOLDING SA

Route de France 16, CH-1348 Le Brassus, Switzerland

(540)

CODE 11.59 BY AUDEMARS PIGUET

(591) Black, white

(511)

14 – Jewelry, timepieces and chronometric instruments, precious metals and their alloys, jewelry, jewelry products, precious stones.

(260) AM 2019 98837 A

(800) 1415882

(151) 2017 11 08

(891) 2017 11 08

(731) HUZHOU LONGTONG CHEMICAL CO., LTD

No.1-3#, 969 Qingfang Road, Huzhou City, Zhejiang Province, China

(540)

The logo for VISBELLA features the word "VISBELLA" in a bold, sans-serif font. Above the letter "A" is a stylized orange and red graphic element resembling a flame or a mountain peak.

(591) Black and red

(531) 26.03.23; 27.05.01; 27.05.07; 29.01.12

(511)

1 – Adhesives for industrial purposes; viscose; chemical additives to insecticides; brake fluid; silicon; alcohol; metal annealing preparations; soldering fluxes; plasticizers; chemical additives for lubricants.

(260) AM 2019 98839 A

(800) 1415892

(151) 2018 03 06

(891) 2018 03 06

(731) DIMITAR HRISTOV BALEV

Bldv. Vitosha No. 137, apt. 17, BG-1408 Sofia, Bulgaria

(540)

AREON

(591) Black, white

(531) 27.05.01

(511)

3 – Soaps; perfumery; essential oils; aromatics [essential oils]; ionone [perfumery]; extracts of flowers [perfumes]; potpourris [fragrances]; air fragrancing

preparations; fragrances for household purposes; fragrances for automobiles; sachets for perfuming linen; scented wood; scented water; joss sticks; tissues impregnated with cosmetic lotions; cloths impregnated with a detergent for cleaning; cloths impregnated with polishing preparations for cleaning; vehicle cleaning preparations; bath salts, not for medical purposes.

5 – Salts for mineral water baths; air purifying preparations; air deodorizers; deodorants for clothing and textiles; air deodorising preparations; automobile deodorizers; deodorants, other than for human beings or for animals; moist wipes impregnated with a pharmaceutical lotion; disposable sanitizing wipes; sanitary napkins for household use.

(260) AM 2019 98840 A
(800) 1415899
(151) 2018 06 05
(891) 2018 06 05
(731) BEIERSDORF AG
Unnastr. 48, 20253 Hamburg, Germany
(540)



(591) Blue, white and yellow
(531) 26.01.04; 26.01.22; 26.01.24; 29.01.13
(511)
3 – Non-medicated cosmetics; non-medicated sun care preparations; non-medicated aftersun preparations.

(260) AM 2019 98841 A
(800) 1415937
(151) 2018 07 02
(891) 2018 07 02
(731) RADISSON HOTELS INTERNATIONAL, INC.
P.O. Box 59159, Carlson Parkway,
Minneapolis MN 55459, USA
(540)



(591) The color(s) red, black and white is/are claimed as a feature of the mark
(531) 26.04.24; 27.05.09; 27.05.10; 27.05.24; 29.01.13
(511)
43 – Hotel, bar and restaurant services; services for the reservation of rooms.

(260) AM 2019 98844 A
(800) 1416009
(151) 2018 03 09
(891) 2018 03 09
(731) EGIS GYÓGYSZERGYÁR ZRT.
Keresztúri út 30-38., H-1106 Budapest,
Hungary
(540)

MILURAD

(591) Black, white
(511)
5 – Pharmaceutical preparations for human use.

(260) AM 2019 98845 A
(800) 1416020
(151) 2018 05 15
(891) 2018 05 15
(731) Public Joint Stock Company "KRASNYY OCTYABR"
ul. Malaya Krasnoselskaya, d. 7, str. 24,
RU-107140 Moscow, Russian Federation
(540)

ХРУСТЯЩАЯ СКАЗКА

(591) Black, white
(531) 28.05
(511)
30 – Aromatic preparations for food; flavorings, other than essential oils, for cakes; flavorings, other than essential oils, for beverages; coffee flavorings; star aniseed; high-protein cereal bars; sponge cakes; pancakes; noodle-based prepared meals; buns; bread rolls; vanillin [vanilla substitute]; waffles; vermicelli [noodles]; natural sweeteners; sausage binding materials; binding agents for ice cream; sea water for cooking; seaweed [condiment]; malt biscuits; cloves [spice]; cake frosting [icing]; mustard; gluten additives for culinary purposes; yeast; thickening agents for cooking foodstuffs; leaven; rice-based snack food; cereal-based snack food; artificial coffee; vegetal preparations for use as coffee substitutes; dressings for salad; fruit jellies [confectionery]; confectionery for decorating Christmas trees; cakes; pastries; peanut confectionery; pasta; ginger [spice]; frozen yogurt [confectionery ices]; cocoa; capers; caramels [candy]; curry [spice]; ketchup [sauce]; quiches; gluten prepared as foodstuff; sweetmeats [candy]; liquorice [confectionery]; peppermint sweets; cinnamon

[spice]; coffee; unroasted coffee; starch for food; crackers; custard; groats for human food; corn, milled; corn, roasted; meat pies; turmeric for food; couscous [semolina]; noodles; ice for refreshment; candy; ice, natural or artificial; edible ices; rice cakes; mayonnaise; macaroons [pastry]; macaroni; maltose; hominy; marinades; marzipan; honey; royal jelly; ice cream; flour; dessert mousses [confectionery]; chocolate mousses; muesli; mint for confectionery; cocoa beverages with milk; coffee beverages with milk; coffee-based beverages; tea-based beverages; chocolate beverages with milk; chocolate-based beverages; cocoa-based beverages; infusions, not medicinal; crushed oats; husked oats; nutmegs; stick liquorice [confectionery]; soya bean paste [condiment]; pastilles [confectionery]; molasses for food; pepper; allspice; peppers [seasonings]; pesto [sauce]; cookies; petit-beurre biscuits; pies; pizzas; meat gravies; fondants [confectionery]; popcorn; powders for making ice cream; baking powder; mustard meal; pralines; condiments; meat tenderizers for household purposes; cereal preparations; oat-based food; propolis; gingerbread; spices; petits fours [cakes]; puddings; cake powder; fruit coulis [sauces]; ravioli; chewing gum; relish [condiment]; rice; wheat germ for human consumption; spring rolls; sago; sugar; aniseed; linseed for culinary purposes [seasoning]; golden syrup; confectionery; chocolate paste; baking soda [bicarbonate of soda for cooking purposes]; malt for human consumption; salt for preserving foodstuffs; cooking salt; celery salt; sherbets [ices]; ham glaze; soya sauce; tomato sauce; sauces [condiments]; spaghetti; seasonings; rusks; breadcrumbs; sushi; sandwiches; tabbouleh; tacos; tapioca; tarts; almond paste; tortillas; garden herbs, preserved [seasonings]; vinegar; beer vinegar; ferments for pastes; halvah; bread; unleavened bread; chips [cereal products]; corn flakes; oat flakes; chicory [coffee substitute]; tea; iced tea; chutneys [condiments]; cheeseburgers [sandwiches]; chow-chow [condiment]; saffron [seasoning]; chocolate; malt extract for food; essences for foodstuffs, except etheric essences and essential oils; husked barley.

(260) AM 2019 98846 A

(800) 1416022

(151) 2018 04 19

(891) 2018 04 19

(731) LTD "VALENTA-INTELLEKT"

str.2, d.18, ul. Generate Dorokhova,

RU-119530 Moscow, Russian Federation

(540)

ANTAREIT
АНТАРЕЙТ

(591) Black, white

(531) 27.05.01; 28.05

(511)

5 – Pharmaceutical preparations; dietetic substances adapted for medical use; nutritional supplements for medical purposes; mineral nutritional supplements; dietary supplements; chemico-pharmaceutical preparations; chemical preparations for medical purposes; chemical preparations for pharmaceutical purposes; medicines for human purposes; pharmaceutical preparations and substances for the treatment of gastrointestinal diseases; elixirs [pharmaceutical preparations].

(260) AM 2019 98853 A

(800) 1416089

(151) 2018 05 11

(891) 2018 05 11

(731) BITMAINTTECH PTE. LTD

26 ENG HOON STREET, SG-169776

SINGAPUR, Singapore

(540)



(591) Black, white

(531) 03.13.02; 03.13.24; 27.05.10

(511)

9 – Computer hardware; blank integrated circuit cards; calculating machines; computer peripheral devices; computers; information processing apparatus; data processing equipment, namely couplers; electronic chips for manufacturing integrated circuits; integrated circuits; printed circuit boards; printed circuits; silicon chips.

35 – Commercial business management; commercial administration; advertising and advertisement services; online advertising on a computer network; market research by means of a computer database; statistical evaluation of data derived from market studies; compilation of information into computer databases; systematization of information in computer databases; business information; marketing research; marketing; consulting services relating to personnel management; business management assistance; sales promotion for others.

36 – Insurance services; financial affairs; monetary affairs; real estate affairs; installment loans; credit agencies; debt collection agencies; banking operations; mutual funds; capital investment; fund investment; exchange operations; issuance of travelers' checks; clearing operations; clearing houses; organization of collections; financing loans; fiscal assessments; financial evaluation; financial evaluation (insurance, banking, real estate); financing services; financial management; mortgage banking operations;

savings bank services; lease-purchase operation financing services; lease-purchase financing; securities brokerage; stock and bonds brokerage; financial analyses; check verification; financial consultancy services; credit card services; debit card services; electronic funds transfer; financial information; rent collection; issuance of securities; deposit of valuables; stock exchange quotations; issuance of credit cards; retirement payment services; financial sponsorship; on-line banking services; financial company liquidation services; repair costs evaluation; brokerage of carbon credits; provident fund services.

42 – Industrial analysis and research services; design and development of computers and software; software as a service (SaaS); computer rental; computer programming; computer software design services; updating of computer software; services provided by consultants regarding computer hardware design and development; software rental; recovery of computer data; software maintenance; computer system analysis; computer system design; duplication of computer programs; conversion of data or documents from physical to electronic media; creating and maintaining web sites for others; hosting of computer sites [websites]; installation of computer software; conversion of computer programs and data [other than physical conversion]; software consultancy; rental of web servers; computer virus protection services; provision of search engines on the Internet; digitization of documents [electronic scanning]; monitoring of computer systems by remote access.

(260) AM 2019 98854 A
 (800) 1416100
 (151) 2018 05 07
 (891) 2018 05 07
 (731) SOUTH BEACH BEVERAGE COMPANY, INC. (a Delaware corporation)
 700 Anderson Hill Road, Purchase NY 10577, USA

(540)



(591) Black, red, gray and khaki
 (531) 03.11.10; 03.11.24; 25.01.15; 25.05.03; 27.03.03; 27.05.09; 27.05.10; 27.05.21; 28.05; 29.01.14

(511)
 32 – Aperitifs, non-alcoholic; cocktails, non-alcoholic; lemonades; non-alcoholic beverages; non-alcoholic fruit juice beverages; energy drinks; fruit nectars, non-alcoholic; smoothies; fruit juices; preparations for making beverages.

(260) AM 2019 98855 A
 (800) 1416166
 (151) 2018 05 03
 (891) 2018 05 03
 (731) XIE PINGPING
 Room 705, Qianshuiwan Taoyuan, No.1699
 Xiadian Road, Gongchen Street, Licheng
 District, Putian City, Fujian Province, China

(540)



(591) Black, white
 (531) 27.05.17; 27.05.25; 28.03
 (511)
 25 – Clothing; layettes [clothing]; clothing for gymnastics; shoes; hats; hosiery; neckties; scarfs; leather belts [clothing]; gloves [clothing].

(260) AM 2019 98856 A
 (800) 1416167
 (151) 2018 05 03
 (891) 2018 05 03
 (731) FUJIAN PROVINCE JINJIANG CITY
 SHENHUDALI CLOTHING AND
 KNITTING CO., LTD
 Shenhudongan, Jinjiang City, Quanzhou City,
 Fujian Province, China

(540)



(591) Black, white
 (531) 24.17.25; 28.03
 (511)
 25 – Clothing; layettes [clothing]; clothing for gymnastics; football boots; dance clothing; shoes; hats; hosiery; neckties; girdles.
 35 – Advertising; advertising planning services; commercial or industrial management assistance; sales promotion for others; personnel management consul-

tancy; relocation services for businesses; computerized file management; book-keeping; rental of vending machines.

(260) AM 2019 98877 A

(800) 1091591

(151) 2011 07 13

(891) 2018 04 09

(731) KAÇMAZLAR OTOMOTİV TİCARET VE SANAYİ LİMİTED ŞİRKETİ

3.Organize Sanayi Bölgesi, İhsandede Caddesi, 9 Nolu Sokak, No:25, KONYA, Turkey

(540)



(591) Red, white, grey

(531) 26.04.18; 27.05.11; 29.01.12

(511)

12 – Automobiles, trucks, buses, tow trucks, tractors, refrigerated vehicles, namely, trailers, trucks, vehicles mixing and transporting concrete, military vehicles for transport purposes, namely, boats, automobiles; ambulances, watering trucks, hose trucks, sports cars, motorized golf carts, garbage trucks, mobile funeral service vehicles, namely, hearses; trailers for transporting mobile kitchens, forklifts, namely, fork lift trucks, sewage trucks; brake cylinder repair kits, brakes for land vehicles, brake linings and shoes for land vehicles; tipping bodies for lorries, automobile engines, land vehicle tires, wheel rims for vehicles, automobile chassis, axles for land vehicles; automobile parts, namely, axletrees, connecting rods for land vehicles other than parts of motors and engines; transmissions gearboxes, parts for land vehicles, namely, clutches; vehicle parts, namely cylinders and parts, turbines for land vehicles, transmission chains for land vehicles.

(260) AM 2019 98878 A

(800) 1163740

(151) 2013 05 13

(891) 2018 06 28

(731) LAS IGUANAS LIMITED

113 Whiteladies Road, Clifton, Bristol
BS8 2PB, United Kingdom

(540)

LAS IGUANAS

(591) Black, white

(511)

43 – Restaurant, cafe, wine-bar, public house and catering services; provision of food and drink.

(260) AM 2019 98879 A

(800) 1331572

(151) 2016 11 23

(891) 2018 05 04

(731) CALIDAD PASCUAL, S.A.U.

Carretera de Palencia, s/n, E-09400 ARANDA DE DUERO (BURGOS), Spain

(540)



(591) Red and white

(531) 25.03.01; 27.05.01; 29.01.12

(511)

29 – Fresh meat; poultry; poultry meat; fish; canned fruits; preserved vegetables; dried pulses; dried vegetables; snacks based on dried fruits; meat extracts; game; cooked vegetables; gelatins; marmalade; compotes; eggs; milk; powdered milk; condensed milk; soy milk (milk substitute); beverages mainly consisting of milk; milk-based beverages containing fruit juice; milk beverages, milk predominating; milk beverages containing fruit; flavored milk drinks; milk shakes; dairy products; milk products and milk substitutes; fresh cream; whipped cream; buttercream; butter cream; buttercream; cream; whipped cream; cheeses; yogurts; flavored yogurts; yogurt drinks; preparations for making yogurt; low-fat yogurts; fruit-flavored yogurts; edible oils; dairy desserts.

(260) AM 2019 98882 A

(800) 1377848

(151) 2017 10 12

(891) 2018 07 12

(731) PARTNERS NETWORK HOLDING BV

Laan 21, NL-8071 JG Nunspeet, Netherlands

(540)



(591) Blue, grey and white
 (531) 02.05.01; 02.05.03; 26.01.02; 26.01.03;
 26.01.14; 27.01.06; 27.01.12; 27.05.04;
 27.05.07; 27.05.08; 27.05.17; 29.01.13

(511)
 31 – Bananas.

(260) AM 2019 98883 A
 (800) 1386267
 (151) 2017 10 12
 (891) 2018 07 12
 (731) PARTNERS NETWORK HOLDING BV
 Laan 21, NL-8071 JG Nunspeet, Netherlands
 (540)

NIKKI

(591) Black, white
 (511)
 31 – Bananas.

(260) AM 2019 98884 A
 (800) 1391448
 (151) 2017 11 29
 (891) 2018 07 16
 (731) LI YULIAN
 No.5, Lane 3, Fengxing Street, Tingtian
 Subdistrict, Ruian, Zhejiang, China
 (540)

MERRY'S

(591) Black, white
 (531) 27.05.01
 (511)
 9 – Sunglasses; spectacle frames; pince-nez; correcting lenses [optics]; contact lenses; eyeglass chains; spectacle cases; spectacle lenses; spectacles.

(260) AM 2019 98885 A
 (800) 1400079
 (151) 2017 10 09
 (891) 2018 07 18
 (731) KATRAN SERGEY VIKTOROVICH
 Kostyakova street, 6/5, apartment 163,
 RU-125422 Moscow, Russian Federation
 (540)

SUPERNOVA

(591) Black, white
 (511)
 3 – Abrasives; ambergris [perfume]; descaling preparations for household purposes; antistatic preparations for household purposes; aromatics [essential oils]; air fragrancing preparations; cake flavorings [essential oils]; flavorings for beverages [essential oils]; breath freshening sprays; canned pressurized air for cleaning and dusting purposes; balms, other than for medical purposes; lip glosses; polishing stone-

nes; abrasive paper; emery paper; polishing paper; petroleum jelly for cosmetic purposes; shoe wax; cobblers' wax; cotton wool for cosmetic purposes; sachets for perfuming linen; drying agents for dish-washing machines; adhesives for cosmetic purposes; scented water; Javelle water; lavender water; toilet water; laundry wax; floor wax; non-slipping wax for floors; depilatory wax; mustache wax; tailors' wax; polish for furniture and flooring; shoemakers' wax; polishing wax; massage gels, other than for medical purposes; heliotropine; dental bleaching gels; geraniol; make-up; deodorants for pets; deodorants for human beings or for animals; scented wood; perfumes; non-slipping liquids for floors; windshield cleaning liquids; greases for cosmetic purposes; volcanic ash for cleaning; perfumery; decorative transfers for cosmetic purposes; ionone [perfumery]; shaving stones [astringents]; smoothing stones; eyebrow pencils; cosmetic pencils; silicon carbide [abrasive]; carbides of metal [abrasives]; alum stones [astringents]; tripoli stone for polishing; adhesives for affixing false eyelashes; adhesives for affixing false hair; quillaia bark for washing; corundum [abrasive]; beard dyes; colorants for toilet purposes; cosmetic dyes; laundry starch; laundry glaze; creams for leather; polishing creams; cosmetic creams; skin whitening creams; polishing rouge; incense; hair spray; nail polish; hair lotions; lotions for cosmetic purposes; after-shave lotions; beauty masks; oils for perfumes and scents; oils for cosmetic purposes; oils for toilet purposes; essential oils; essential oils of cedarwood; essential oils of lemon; oils for cleaning purposes; bergamot oil; gaultheria oil; jasmine oil; lavender oil; almond oil; rose oil; oil of turpentine for degreasing; whitening; cleaning chalk; almond milk for cosmetic purposes; cleansing milk for toilet purposes; musk [perfumery]; soap; deodorant soap; shaving soap; soap for brightening textile; cakes of toilet soap; antiperspirant soap; soap for foot perspiration; almond soap; mint for perfumery; cosmetic kits; emery; nail art stickers; false nails; eau de Cologne; bases for flower perfumes; cotton sticks for cosmetic purposes; joss sticks; pastes for razor strops; toothpaste; dentifrices; pumice stone; hydrogen peroxide for cosmetic purposes; breath freshening strips; abrasive cloth; glass cloth [abrasive cloth]; lipsticks; pomades for cosmetic purposes; shaving preparations; cosmetic preparations for baths; toiletry preparations; hair waving preparations; laundry soaking preparations; grinding preparations; douching preparations for personal sanitary or deodorant purposes [toilettries]; smoothing preparations [starching]; color-removing preparations; leather bleaching preparations; polishing preparations; denture polishes; mouthwashes, not for medical purposes; cosmetic preparations for slimming purposes; starch glaze for laundry purposes; refurbishing preparations; fabric softeners for laundry use; laundry bleach; dry-cleaning preparations; paint stripping preparations; lacquer-

removing preparations; make-up removing preparations; floor wax removers [scouring preparations]; varnish-removing preparations; rust removing preparations; nail care preparations; cleaning preparations; preparations for cleaning dentures; wallpaper cleaning preparations; preparations for unblocking drain pipes; laundry preparations; aloe vera preparations for cosmetic purposes; sunscreen preparations; color- [colour-] brightening chemicals for household purposes [laundry]; shining preparations [polish]; make-up powder; diamantine [abrasive]; stain removers; scouring solutions; false eyelashes; tissues impregnated with cosmetic lotions; safrol; laundry blueing; turpentine for degreasing; potpourris [fragrances]; bleaching soda; washing soda, for cleaning; bath salts, not for medical purposes; bleaching salts; fumigation preparations [perfumes]; preservatives for leather [polishes]; ammonia [volatile alkali] [detergent]; astringents for cosmetic purposes; eyebrow cosmetics; make-up preparations; sun-tanning preparations [cosmetics]; hair dyes; neutralizers for permanent waving; preparations to make the leaves of plants shiny; cosmetic preparations for eyelashes; depilatory and exfoliating preparations; depilatory preparations; cosmetic preparations for skin care; shoe polish; cosmetics; cosmetics for animals; mascara; detergents, other than for use in manufacturing operations and for medical purposes; degreasers, other than for use in manufacturing processes; bleaching preparations [decolorants] for cosmetic purposes; antiperspirants [toilettries]; talcum powder, for toilet use; terpenes [essential oils]; emery cloth; cloths impregnated with a detergent for cleaning; shampoos; shampoos for pets; dry shampoos; sandpaper; soda lye; extracts of flowers [perfumes]; ethereal essences; badian essence; mint essence [essential oil].

5 – Dietetic substances adapted for medical use; nutritive substances for microorganisms; mud for baths; medicinal mud; mineral food supplements; lotions for veterinary purposes; dog lotions; lotions for pharmaceutical purposes; liniments; ointments for pharmaceutical purposes; sunburn ointments; dental mastics; dental abrasives; dental impression materials; teeth filling material; medicinal drinks; dietetic beverages adapted for medical purposes; biological preparations for veterinary purposes; biological preparations for medical purposes; veterinary preparations; therapeutic preparations for the bath; hemorrhoid preparations; preparations for callouses; preparations to facilitate teething; preparations for the treatment of burns; fumigation preparations for medical purposes; opotherapy preparations; air deodorising preparations; air purifying preparations; bronchodilating preparations; sterilising preparations; pharmaceutical preparations for skin care; chemical preparations for medical purposes; chemical preparations for pharmaceutical purposes; albuminous foodstuffs for medical purposes; food for babies; dietetic foods

adapted for medical purposes; milking grease; greases for veterinary purposes; greases for medical purposes; diabetic bread adapted for medical use; disinfectant soap; candy, medicated; candy for medical purposes.

(260) AM 2019 98886 A
 (800) 1407589
 (151) 2018 03 12
 (891) 2018 06 26
 (731) FERRER INTERNACIONAL, S.A.
 Gran Vía Carlos III, 94, E-08028 Barcelona,
 Spain
 (540)



(591) Blue (PANTONE 320 C); Green (Pantone 376 C)
 (531) 26.04.04; 26.04.18; 27.05.21; 29.01.12
 (511)
 3 – Cleaning, polishing, degreasing and abrasive preparations; soaps, perfumery products; essential oils; cosmetics, hair lotions and dentifrices; deodorants for personal use; creams for cosmetic use; sun-tanning creams; sunscreen creams and sun protection (cosmetics); dermatological creams and lotions (other than for medical use).

(260) AM 2019 98920 A
 (800) 1416567
 (151) 2018 06 18
 (891) 2018 06 18
 (731) NV Biscuits Delacre SA
 Avenue Emile van Becelaere 2, B-1170
 Watermael-Boitsfort, Belgium
 (540)

MARQUISSETTE

(591) Black, white
 (511)
 30 – Biscuits and cookies, cakes, pastry, confectionery, chocolate and chocolate-based products.

(260) AM 2019 98921 A
 (800) 1416581
 (151) 2018 06 15
 (891) 2018 06 15
 (731) NV Biscuits Delacre SA
 Avenue Emile van Becelaere 2, B-1170
 Watermael-Boitsfort, Belgium

(540)

DELICHOC

(591) Black, white

(511)

30 – Biscuits and cookies, cakes, pastry, confectionery, chocolate and chocolate-based products.

(260) AM 2019 98942 A

(800) 1417151

(151) 2018 02 19

(891) 2018 02 19

(731) Société anonyme "EXTRA M"

oul. 3-ya Rybinskaya, 22, RU-107113
Moscou, Russian Federation

(540)

Pasteroni

(591) Black, white

(531) 27.05.17

(511)

29 – Meat, fish, poultry and game; vegetable oils for food use; butter substitutes; oils for food; olive oil for food; sunflower oil for food; maize oil for food; linseed oil for food use; colza oil for food; pumpkin seed oil for food; vegetable concentrates for food; vegetable juices for cooking; fruit juices for cooking; vegetable extracts for cooking; minced meat, fish stuffing (pâté); poultry stuffing (pâté) including for composed prepared meals; processed vegetables including for composed prepared meals.

30 – Flour and preparations made from cereals; bread, pastry and confectionery products; pasta; vermicelli; noodles; macaroni; ravioli; spaghetti; meals made from pasta, from noodles; processed cereals; groats for human food; starch for food; ready-to-eat cereals; breakfast cereals; cereal-based snacks; corn flakes; dried cereal flakes; grain-based chips; tortilla chips made of whole wheat; breadcrumbs; instant porridge; wheat cakes; malt biscuits; crackers; biscuits, cookies; frozen dough; baking dough; phyllo dough; puff pastries; tortillas; gravy mixes; sauces [condiments]; pasta sauces.

35 – Advertising; online advertising on a computer network; presentation of goods on all communication media, for retail sale; sales promotion services for third parties including at the point of purchase or sale, including via the Internet; administrative processing of purchase orders.

(260) AM 2019 98944 A

(800) 1417194

(151) 2018 05 11

(891) 2018 05 11

(731) L&O HUNTING GROUP GMBH

Ziegelstadel 1, 88316 Isny, Germany

(540)

Cherokee

(591) Black, white

(511)

13 – Firearms; air and gas weapons; trigger guards for guns and rifles; hammers for guns and rifles, gun barrels, gunstocks; butt plates; muzzle brakes that screw onto a rifle barrel; swivels for gun slings; magazines for weapons; ammunition; accessories for the aforesaid goods, namely, rifle cases, gun bags, cartridge belts, gun slings; cartridge pouches; noise-suppressors for guns; cleaning brushes for firearms; breeches of firearms; bipods for firearms; sighting mirrors for guns and rifles; mounts for attaching telescopic sights to a firearm; sights, other than telescopic sights, for firearms.

(260) AM 2019 98947 A

(800) 1417298

(151) 2018 04 06

(891) 2018 04 06

(731) PARFUM FRANCIS KURKDJIAN

41 rue Etienne Marcel, F-75001 Paris, France

(540)



(591) Black, white

(531) 27.05.14; 27.05.22

(511)

3 – Soaps; perfumery products; perfumes; essential oils; cosmetics; hair lotions; deodorants for personal use (perfumery); dentifrices; room fragrances; perfumed substances for indoor perfume dispensers; scented water; lavender waters; eaux de toilette; extracts of flowers; bases for flower perfumes; oils as fragrances for the home; oils for perfumes and scents; air freshening products; amber (perfumery); musk (perfumery); patchouli; scented wood; pot-pourri and perfumed incense; bleaching preparations and other substances for laundry use; laundry detergents; cleaning, polishing, degreasing and abrasive preparations; perfumed soap bubbles (perfumes); sachets for perfuming linen.

4 – Candles and wicks for lighting, perfumed candles.

(260) AM 2019 98950 A

(800) 1417345

(151) 2018 05 22

(891) 2018 05 22

(731) GLOBAL VISION CORPORATION
Room 825, No.1 Building, Guo Ying Yuan,
Xi Zhi Men Nan Xiao Jie, Xi Cheng District,
Beijing, China

(540)

GAUSH

(591) Black, white

(531) 27.05.01; 27.05.17

(511)

10 – Radiological apparatus for medical purposes; diagnostic apparatus for medical purposes; medical apparatus and instruments; medical ultrasound apparatus; radiotherapy apparatus; ophthalmoscopes; dental apparatus and instruments; ophthalmic apparatus; orthopedic articles; suture materials.

(260) AM 2019 98953 A

(800) 1144398

(151) 2012 10 31

(891) 2018 07 26

(731) GROUPAUTO INTERNATIONAL
147 avenue Charles de Gaulle, F-92200
Neuilly sur Seine, France

(540)



(591) Blue, gray, red, yellow and white

(531) 18.01.07; 18.01.08; 24.15.13; 25.05.25;
26.04.06; 29.01.14

(511)

35 – Advertising, business management, business consulting, information or inquiries, and particularly business organization and management consulting, business management consultancy, cost price analysis, business management consulting services, market study, business investigations, market research, economic forecasts, public relations, research for business purposes, marketing studies, consulting and business studies for the creation, development and management of commercial networks and signs, commercial advice on defining commercial network policy regarding the selection of suppliers, supply, logistics and distribution, studies for business partnerships with others, recruitment; sales, retail sale, wholesale, Internet sales and mail-order sale of spare parts for cars and trucks, industrial oils and greases, lubricants, products for absorbing oil, fuels (including gasoline for motors) and illuminants, candles, wicks, and especially non-chemical additives for fu-

els, fuels containing alcohol, benzene, benzine, benzol, products for dusting, turbo injection systems, starters, diesel engine and gasoline engine injection systems, radiators, bearings, valves, winches, hydraulic presses, batteries, buzzers, alarms, alcohol meters, accumulators, suppressors, electric welding apparatus, beacons, electrical coils, junction boxes, enclosures for speakers, pressure indicator plugs for valves, fog signals, electric cables, circuit breakers, flashers, switches, meters, electrical conductors, connectors, electrical control apparatus, speed controllers for vehicles, diagnostic apparatus, dynamometers, kilometer recorders for vehicles, luminous signs, balancing devices, fire extinguishers, fuses, sheaths for electric cables, gas meters, loudspeakers, electrical indicators, gauges, batteries, revolution counters, warning triangles, radars, radios, apparatus for charging electrical devices, controllers, electric locks, signage products, anti-theft warning devices, control apparatus, scales for paint, stationary or mobile grease distribution apparatus, stationary or mobile oil distribution apparatus, oil recovery apparatus; accumulators, gas analyzers, programmable automated devices for testing and maintaining the functions of a vehicle, test benches, batteries and battery chargers, heat accumulators, acetylene apparatus, devices for cooling and conditioning air in vehicles, air filters, bulbs, anti-fog, anti-glare, antifreeze devices, automotive lights, headlights, radiator caps, heating installations for vehicles, vehicle air conditioning, defrosters, lighting equipment for vehicles, electric radiators, reflector lamps, heaters, air conditioning systems, vehicles, apparatus for locomotion by land, any accessories and spare parts for vehicles, namely shock absorbers (springs), shock absorbers, anti-slip, anti-glare, anti-theft devices, head rests, transmission shafts, trailer hitches, hoods, bodies for vehicles, chains, chassis, bumpers, blinds, alarms, valves for tires, treads for retreading tires, torsion bars, skip wheels, truck skips, gear boxes, plugs for tanks, windshields, hoods for vehicles, crankcases, safety belts, inner tubes, tracks, hydraulic circuits, torque converters, direction indicators, electric motors, clutches, gears, hub caps, tires, wheel balancing apparatus, axles, axle bearings, windshield wipers, brake linings, brake shoes, brake segments, brakes, bands for wheel hubs, covers, wheel rims, running boards, sun visors, propulsion mechanisms, trailers, tanks, rear-view mirrors, wheels, car trains, transmissions, turbines, balance weights for wheels, doors, seats, steering wheels, windows, alarms, alternators, carburetors, air compressors, capacitors, bearings, cylinder heads, cycles, spoilers, engine equipment, air pumps for vehicles, trucks, lifts, sunroofs; turbo injection systems, starters, fuel injection systems for diesel engines and gasoline engines, radiators, bearings, valves, winches, hydraulic presses, accumulators, buzzers, alarms, alcoholometers, batteries, suppressors, electric welding devices, beacons, electric

coils, connection boxes, speaker boxes, pressure indicator caps for valves, fog signals, electric cables, fuses, flashers, switches, meters, electrical conductors, connectors, electrical control apparatus, speed controllers for vehicles, diagnostic apparatus, dynamometers, kilometer recorders for vehicles, signs, balancing devices, fire extinguishers, fuses, sheaths for electric cables, gas meters, speakers, electrical indicators, gauges, batteries, revolution counters, warning triangles, radars, radios, chargers for electrical devices, controllers, electric locks, signage products, anti-theft warning devices, control apparatus, scales for paint, stationary or mobile grease distribution devices, stationary or mobile oil distribution devices, oil recovery devices; accumulators, gas analyzers, automated programmable devices for testing and maintaining the functions of a vehicle, test benches, batteries and battery chargers, joints.

37 – Construction services; repair of motor vehicles and of spare parts and accessories for motor vehicles; installation of spare parts and accessories for motor vehicles; retreading or vulcanization of tires; maintenance, cleaning, washing and repair of motor vehicles, rental of tools.

39 – Vehicle breakdown assistance, warehousing, rental of vehicle roof racks, vehicle rental, towing; vehicle rental.

(260) AM 2019 98959 A
(800) 1325729
(151) 2016 09 15
(891) 2018 06 28
(731) LTD "VALENTA-INTELLEKT"
ul. Generala Dorokhova, 18, str. 2,
RU-119530 Moscow, Russian Federation

(540)

Тримедат

(591) Black, white
(531) 28.05
(511)

5 – Drugs for medical purposes; medicines for human purposes; pharmaceutical preparations; chemico-pharmaceutical preparations.

(260) AM 2019 99000 A
(800) 1417525
(151) 2018 07 12
(891) 2018 07 12
(731) CONTINENTAL MATADOR RUBBER,
S.R.O.
Terézie Vansovej 1054, SK-020 01 Púchov,
Slovakia

(540)

VARIANT

(591) Black, white
(511)
12 – Tyres.

(260) AM 2019 99005 A
(800) 1417610
(151) 2018 01 23
(891) 2018 01 23
(731) EURO GAMES TECHNOLOGY LTD
"Maritsa" Str. 4, "Vranya-Lozen-Triugulnika",
BG-1151 Sofia, Bulgaria

(540)



(591) Yellow, brown, pink, white and cyclamen
(531) 27.05.09; 29.01.13
(511)

9 – Apparatus for recording, transmission or reproduction of sound or image; computer software, recorded; monitors, computer hardware.

28 – Games that are not included in other classes; gaming machines operating with coins, banknotes and cards; gaming machines for gambling.

(260) AM 2019 99006 A
(800) 1417615
(151) 2018 03 30
(891) 2018 03 30
(731) ASTELLAS PHARMA INC.
5-1, Nihonbashi-Honcho 2-chome, Chuo-ku,
Tokyo 103-8411, Japan

(540)

Кстанди

(591) Black, white
(531) 28.05
(511)

5 – Pharmaceutical preparations for the treatment of cancer.

(260) AM 2019 99007 A
(800) 1417616
(151) 2018 06 05
(891) 2018 06 05
(731) REMY COINTREAU LUXEMBOURG S.A.
7, rue de la Déportation, L-1415 Luxembourg,
Luxembourg

(540)



(591) Yellow, blue, gold coloured and white

(531) 01.01.05; 01.03.01; 01.03.12; 01.03.15;
02.01.04; 02.01.08; 19.07.09; 24.05.03;
24.05.07; 24.05.25; 25.01.17; 25.01.19;
26.01.04; 26.01.05; 26.01.06; 26.01.21;
27.05.08; 27.05.17; 27.05.19; 27.05.24;
27.05.25; 27.07.17; 27.07.24; 27.07.25;
29.01.15(526) All written elements apart from the words
"METAXA" and "S. METAXA".

(511)

33 – Alcoholic beverages, except beers; spirits and
liqueurs.

(260) AM 2019 99011 A

(800) 1417789

(151) 2018 06 05

(891) 2018 06 05

(731) REMY COINTREAU LUXEMBOURG S.A.
7, rue de la Déportation, L-1415 Luxembourg,
Luxembourg

(540)

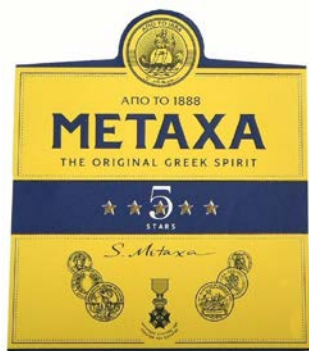

(591) Yellow, blue, gold coloured and white

(531) 01.01.05; 01.03.01; 01.03.12; 01.03.15;
02.01.04; 02.01.08; 24.05.03; 24.05.07;24.05.25; 25.01.19; 26.01.04; 26.01.05;
26.01.06; 26.01.21; 27.05.08; 27.05.17;
27.05.19; 27.05.24; 27.05.25; 27.07.17;
27.07.24; 27.07.25; 29.01.15(526) All written elements apart from the words
"METAXA" and "S. METAXA".

(511)

33 – Alcoholic beverages, except beers; spirits and
liqueurs.

(260) AM 2019 99020 A

(800) 1418034

(151) 2017 03 22

(891) 2017 03 22

(731) VEGAPHARM LLP

Astra House, Arklow Road, London SE14
6EB, United Kingdom

(540)

COCABENS

(591) Black, white

(511)

5 – Adhesive band for medical use; adhesive bands
for medical purposes; adhesive compositions for me-
dical use; adhesive plaster; adhesive tapes for me-
dical purposes; alcohol for pharmaceutical purposes;
allergy medications; allergy relief medication; anti-
allergic medicines; anti-bacterial soap; antibiotics;
antitussives; appetite stimulant preparations; baby
foods; balms for medical purposes; balsamic prepa-
rations for medical purposes; biological preparations
for medical purposes; cardiovascular preparations;
chemical preparations for medical purposes; chemi-
cal preparations for pharmaceutical purposes; chemi-
cal preparations for testing blood for medical pur-
poses; chemical preparations for the diagnosis of
diabetes; cotton for medical purposes; cough syrups;
court plaster; dietary supplemental drinks; dietary
supplements; dietary supplements for humans and
animals; dietary supplements for infants; dietary su-
pplements for medical use; dietetic beverages adap-
ted for medical purposes; dietetic confectionery
adapted for medical purposes; dietetic food and sub-
stances adapted for medical or veterinary use, food
for babies; dietetic foods adapted for infants; dietetic
foods adapted for invalids; dietetic foods adapted for
medical purposes; dietetic foods for medicinal pur-
poses; dietetic foodstuffs for medical purposes; die-
tetic infusions for medical use; dietetic preparations
adapted for medical use; dietetic products for medi-
cal purposes; dietetic substances adapted for medical
use; dietetic sugar for medical use; disinfectants; di-
sinfectants for hygiene purposes; disinfectants for
medical instruments; disinfectant soap; dragees [me-
dicines]; dressing retention materials; dressings, me-
dical; medicinal drinks; elixirs for preventing chills;
elixirs for preventing colds; elixirs for relieving asth-
ma; elixirs for relieving chills; elixirs for relieving
colds; elixirs [pharmaceutical preparations]; enzyme

dietary supplements; enzyme preparations for medical purposes; enzyme preparations for veterinary purposes; enzymes for medical purposes; enzymes for veterinary purposes; eye drops; eye lotions for medical use; eye ointment for medical use; eye pads for medical use; food for babies; food for diabetics; food for infants; food for invalids; food supplements for dietetic use; foodstuffs for diabetics [specially made for]; medicated foot balms; medicated foot creams; gastrointestinal preparations; glucose dietary supplements; glucose for medical purposes; glucose preparations for medical purposes; hemoglobin; herbal medicine; medicinal herbs; immunoassay reagents for medical use; immunomodulators; medical preparation for slimming purposes; medicated baby powders; medicated balms; medicated hand wash; medicated plasters; medicated shampoo; medicated shampoos; medicated soap; medicated skin lotions; medicated sugar; medicinal beverages; medicinal creams for skin care; medicinal herbal extracts for medical purposes; medicinal infusions; medicinal oils; medicinal preparations for stimulating hair growth; medicated mineral drinks; mineral food supplements; mineral salts for medical purposes; mineral water salts; mineral waters for medical purposes; nasal decongestants; nervines; nutritional supplements; ointments for pharmaceutical purposes; ophthalmologic preparations; pain relief medication; pharmaceutical and veterinary preparations; pharmaceutical compositions; pharmaceutical creams; pharmaceutical implants; pharmaceutical lipsalves; pharmaceutical preparations; pharmaceutical preparations for animal skincare; pharmaceutical preparations for animals; pharmaceutical preparations for skin care; pharmaceutical preparations for treating dandruff; pharmaceutical preparations for veterinary use; pharmaceutical preparations in strip form; pharmaceutical skin lotions; pharmaceutical sweets; pharmaceuticals for the treatment of erectile dysfunction; plasters [dressings]; plasters for medical purposes; plasters, materials for dressings; preparations for destroying pests; preparations for destroying vermin; preparations for ocular lubrication; preparations for use as additives to food for human consumption [medicated]; sanitary knickers; sanitary pads; sanitary panties; sanitary preparations for medical purposes; sanitary tampons; sanitary towels; sanitary wear; siccatives [drying agents] for medical purposes; styptic preparations; sugar for medical purposes; sugar substitutes for diabetics; tampons [sanitary]; therapeutic creams [medical]; tonics preparations for medical purposes; vitamins for animals.

(260) AM 2019 99021 A

(800) 1418037

(151) 2018 04 03

(891) 2018 04 03

(731) Sovmestnoe obschestvo s ogranichennoj

otvetstvennostyu "PP POLESIE"

ul. Sovetskaja, d. 141, Kobrin, Kobrinskij rajon, 225304 Brestskaja obl, Belarus

(540)



(591) Black, white

(531) 26.04.04; 26.04.05; 26.04.22; 26.04.24;

27.05.02; 27.05.24

(511)

28 – Games, toys and playthings; gymnastic and sporting articles; decorations for Christmas trees; amusement machines, automatic and coin-operated; toy vehicles; ride-on toys; children's tricycles [toys]; electric cars for children [toys]; swimming pools [play articles]; trampolines; novelty toys for parties; dolls' feeding bottles; paint filler for paintball guns; paintball guns [sports apparatus]; shuttlecocks; spinning tops [toys]; jigsaw puzzles; flying discs [toys]; discuses for sports; dolls' houses; dominoes; chessboards; checkerboards; darts; cups for dice; kites; piñata games; piñatas; toys for pets; stuffed toys; positionable toy figures or moving toys; toy mobiles; novelty toys for playing jokes; parlor games; automated games not for use with television receivers; forfeits, board games; ring games; bladders of balls for games; playing cards; building games; kaleidoscopes; fairground ride apparatus; rocking horses; swings; skittles; skittles [games]; bells for Christmas trees; dolls' rooms; toy construction sets; confetti; explosive bonbons [Christmas crackers] / cosaques [toy fireworks]; dice; dolls' beds; roulette wheels; building blocks [toys]; dolls; puppets; carnival masks; theatrical masks; targets; electronic targets; scale model kits [toys]; scale model vehicles; balls for games; dolls' clothes; twirling batons; toy pistols; toy air pistols; percussion caps [toys]; caps for pistols [toys]; rattles [playthings]; horseshoe games; candle holders for Christmas trees; Christmas tree stands; portable games with liquid crystal displays; kite reels; soap bubbles [toys]; rackets; sling shots [sports articles]; scooters [toys]; sleds [sports articles]; butterfly nets; nets for sports; quoits; bar-bells; artificial snow for Christmas trees; snowboards; snowshoes; clay pigeon traps; tables for table tennis; tables for table football; slides [playthings]; radio-controlled toy vehicles; backgammon games; tricrac games; ornaments for Christmas trees, except illumination articles and confectionery; conjuring apparatus; apparatus for games; units for playing electronic games, except those adapted for compulsory use with television receivers; bowling apparatus and machinery; counters [discs] for games; marbles for games; billiard balls; playing balls; snow globes; chess games; checkers [games].

35 – Wholesale and retail trade services relating to the goods of class 28, including the same via Internet

stores; procurement services for others [purchasing goods and services for other businesses]; sales promotion for others; advertising; organization and conducting of exhibitions for commercial or advertising purposes; demonstration of goods, including the same via the computer networks; business administration; commercial information and advice for consumers [consumer advice shop]; presentation of goods on communication media, for retail purposes.

(260) AM 2019 99022 A

(800) 1418144

(151) 2018 03 21

(891) 2018 03 21

(731) PALITRUMLAB LIMITED LIABILITY COMPANY

Nobelya 7, pom. 47, Skolkovo Innovation Center, RU-143026 Moscow, Russian Federation

(540)



(591) Gray, blue, green

(531) 26.01.02; 26.01.03; 26.01.24; 27.05.17; 27.05.22; 29.01.13

(511)

9 – Monitors [computer programs]; computer software, recorded; computer programs, recorded; computer programs [downloadable software]; computer operating programs, recorded; electronic publications, downloadable; data processing apparatus.

35 – Opinion polling; market studies; business investigations; business research; marketing research; data search in computer files for others; publication of publicity texts; on-line advertising on a computer network; compilation of information into computer databases; systemization of information into computer databases; public relations.

38 – Providing access to databases; transmission of digital files.

42 – Installation of computer software; computer software consultancy; information technology [IT] consultancy; scientific research; software as a service [SaaS]; maintenance of computer software; providing search engines for the internet; computer system design; rental of computer software; computer software design; computer programming.

(260) AM 2019 99023 A

(800) 1418164

(151) 2018 05 24

(891) 2018 05 24

(731) Ob'edinennaya spichechnaya kompaniya, Joint Stock Company

Kamyshinskaya str., h. 15, lit. D., RU-195043 Saint-Petersburg, Russian Federation

(540)



(591) White, blue and orange

(531) 18.05.01; 18.05.03; 26.04.05; 26.04.12; 26.04.16; 26.04.22; 26.04.24; 29.01.13

(526) SAFETY MATCHES

(511)

35 – business management.

(260) AM 2019 99024 A

(800) 1418176

(151) 2018 04 04

(891) 2018 04 04

(731) Closed Joint-Stock Company "BALTIC COAST"

Str. Centralnaya, 2G, village Peniki, Lomonosov district, RU-188530 Leningrad region, Russian Federation

(540)



(591) White, blue and light blue

(531) 03.07.16; 26.04.04; 26.04.06; 28.05; 29.01.12

(526) TM

(511)

29 – Ajvar [preserved peppers]; alginates for culinary purposes; anchovy; peanuts, prepared; albumen for culinary purposes; white of eggs; beans, preserved; bouillon; ginger jam; ham; fatty substances for the manufacture of edible fats; toasted laver; peas, preserved; mushrooms, preserved; game, not live; gelatin; meat jellies; jellies for food; fruit jellies; yolk of eggs; bone oil, edible; lard; suet for food; edible fats; fruit-based snack food; charcuterie; raisins; caviar; fish roe, prepared; yogurt; sauerkraut;

kephir [milk beverage]; kimchi [fermented vegetable dish]; isinglass for food; clams, not live; milk shakes; black pudding [blood sausage]; compotes; meat, tinned; vegetables, tinned; fish, tinned; fruits, tinned; bouillon concentrates; gherkins; shrimps, not live; prawns, not live; buttercream; croquettes; kumys [kumyss] [milk beverage]; spiny lobsters, not live; salmon; onions, preserved; margarine; marmalade; edible oils; shellfish, not live; almonds, ground; animal marrow for food; mussels, not live; milk; condensed milk; soya milk [milk substitute]; fish meal for human consumption; vegetable mousses; fish mousses; fruit pulp; meat; meat, preserved; milk beverages, milk predominating; vegetables, preserved; vegetables, dried; vegetables, cooked; potato fritters; olives, preserved; lobsters, not live; nuts, prepared; tomato paste; liver pastes; pectin for culinary purposes; liver; pickles; jams; powdered eggs; milk products; foods made from fish; prostokvasha [soured milk]; poultry, not live; pollen prepared as foodstuff; cranberry sauce [compote]; apple purée; crayfish, not live; crustaceans, not live; fish, preserved; fish, not live; salted fish; ryazhenka [fermented baked milk]; vegetable salads; fruit salads; bacon; sardines; pork; herrings; seeds, prepared; sunflower seeds, prepared; cream [dairy products]; whipped cream; fat-containing mixtures for bread slices; smetana [sour cream]; vegetable juices for cooking; salted meats; sausages; sausages in batter; preparations for making bouillon; preparations for making soup; tripe; soups; cheese; tofu; sea-cucumbers, not live; truffles, preserved; tuna fish; oysters, not live; milk ferments for culinary purposes; rennet; fish fillets; dates; crystallized fruits; frozen fruits; fruit, preserved; fruit, stewed; potato flakes; fruit peel; preserved garlic; lentils, preserved; potato chips; fruit chips; non-alcoholic eggnog; seaweed extracts for food; meat extracts; eggs.

31 – Oranges, fresh; peanuts, fresh; beans, fresh; grapes, fresh; algae for human or animal consumption; peas, fresh; mushrooms, fresh; cereal seeds, unprocessed; grains [cereals]; fish spawn; potatoes, fresh; roots for food; maize; spiny lobsters, live; lemons, fresh; vine plants; onions, fresh vegetables; olives, fresh; shellfish, live; mussels, live; fish meal for animal consumption; oats; vegetables, fresh; lobsters, live; nuts [fruits]; citrus fruit, fresh; poultry, live; wheat; crayfish, live; crustaceans, live; plants; rhubarb, fresh; rice, unprocessed; rye; fish, live; beet, fresh; grains [seeds]; garden herbs, fresh; truffles, fresh; oysters, live; fruit, fresh; hazelnuts; flowers, natural; spinach, fresh; berries, fresh fruits; live sea cucumbers.

(260) AM 2019 99025 A
(800) 1418179
(151) 2018 01 15
(891) 2018 01 15

(731) Obshchestvo s ogranichennoy otvetstvennost'yu "Koordiniroyushchy raspredelitel'ny tsentr "EFKO-Kaskad" ul. Frunze, 4, g. Alekseevka, RU-309850 Belgorodskaya obl., Russian Federation

(540)

Виват Россиянка

(591) Black, white

(531) 28.05

(511)

29 – tomato purée.

30 – Mustard, vinegar, condiments in particular dressings for salad based on tomato, sauces [condiments], including mayonnaise, ketchup.

(260) AM 2019 99026 A

(800) 1418185

(151) 2018 04 24

(891) 2018 04 24

(731) SHANDONG XINLONG GROUP CO., LTD
Wanggao Xinlong Industrial Garden,
Shouguang City, 262709 SHANDONG
PROVINCE, China

(540)



SHINLONG

(591) Black, white

(531) 01.05.02; 04.03.03

(511)

1 – Trichlorosilane; trichlorethylene; perchloroethylene; silicon tetrachloride; tetrafluoroethane; pentafluoroethane; aluminium chlorohydrate; calcined soda; aluminium chloride; tetrachlorides.

(260) AM 2019 99027 A

(800) 1418188

(151) 2018 01 15

(891) 2018 01 15

(731) Obshchestvo s ogranichennoy otvetstvennost'yu "Koordiniroyushchy raspredelitel'ny tsentr "EFKO-Kaskad" ul. Frunze, 4, g. Alekseevka, RU-309850 Belgorodskaya obl., Russian Federation

(540)

Виват

(591) Black, white

(531) 28.05

(511)
29 – Edible oils and fats, other than milk fat and its substitutes; tomato purée.

30 – Mustard, vinegar, condiments in particular dressings for salad based on tomato, sauces [condiments], including mayonnaise, ketchup.

(260) AM 2019 99028 A

(800) 1418191

(151) 2018 05 09

(891) 2018 05 09

(731) HEAD TECHNOLOGY GMBH

Wuhrkopfweg 1, A-6921 Kennelbach, Austria

(540)



(591) Black, white

(531) 24.17.02; 26.01.01; 26.01.03; 26.01.24;
26.11.01; 26.11.06; 26.11.12; 27.05.01

(511)

32 – Isotonic beverages; energy drinks; mineral water; fruit juices.

(260) AM 2019 99029 A

(800) 1418224

(151) 2018 01 25

(891) 2018 01 25

(731) EURO GAMES TECHNOLOGY LTD

"Maritsa" Str. 4, "Vranya-Lozen-Triugulnika",
BG-1151 Sofia, Bulgaria

(540)



(591) Blue, white and black

(531) 27.05.03; 29.01.13

(511)

9 – Apparatus for recording, transmission or reproduction of sound or image; computer software.

28 – Games; coin-operated slot machines; gaming machines adapted for use with an external screen or monitor.

(260) AM 2019 99030 A

(800) 1418226

(151) 2018 04 26

(891) 2018 04 26

(731) "WIELTON" SPÓLKA AKCYJNA

ul. Felicji Rymarkiewicz 6, PL-93-300
Wieluń, Poland

(540)



(591) Black, white

(531) 03.02.13; 03.02.24; 03.02.26; 27.05.01;
27.05.17

(511)

7 – Agricultural machines; horticultural machines; forestry machines; earth moving machines; construction machines; extracting machines; mineworking machines; handling machines; transporting machines; stamping machines; recycling machines; waste crushing machines; pumps [parts of machines, engines or motors]; pumps [machines]; compressors as parts of machines, motors and engines; moving and handling equipment; current generators; machines and machine tools for treatment of materials and for manufacturing; engines, other than for land vehicles; propulsion mechanisms and transmissions, other than for land vehicles; plasma cutting machines; laser cutting torches; lathes [machine tools]; milling machines; edgers [machines]; cutting machines; sanding machines; road rollers; road sweeping machines, self-propelled; brushing [sweeping] machines; road marking machines; road making machines; asphalt paving machines; machines for mixing asphalt; crack routers [machines]; jacks [machines]; cranes [lifting and hoisting apparatus]; excavators; loaders [machines]; feeders [parts of machines]; belt conveyors; ploughs; snow ploughs; sowers [machines]; harvesting machines; reapers; motor hoes [machines]; machine tools; machining centres; robots [machines].

12 – Vehicles; self-loading vehicles; dump trucks; electric vehicles; vehicles for the transport of specialized cargo including furniture, foodstuffs, boats and vehicles; refrigerated vehicles; cars; lorries; trucks; automobiles; tractors; semi-trailers; semi-trailers for vehicles for the transport of specialized cargo including furniture, foodstuffs, boats and vehicles; trailers [vehicles]; trailers for vehicles for the transport of specialized cargo including furniture, foodstuffs, boats and vehicles; bodies for vehicles; specialized bodies for vehicles; trailer hitches for vehicles; forklift trucks; motors for land vehicles.

39 – Transport; truck transport; road transport; railway transport; transport by water; packaging of goods; storage of goods and materials for recycling; storage of goods; transport brokerage.

40 – Treatment and processing of materials of metal, plastic and wood; waste treatment [transformation]; sorting of waste and recyclable material [transformation]; recycling services.

(260) AM 2019 99031 A

(800) 1418239

(151) 2018 06 13

(891) 2018 06 13

(731) ENIGMA LTD

Rojen Blvd 25V, BG-1220 Sofia, Bulgaria

(540)



(591) Red, blue, yellow, white and dark blue

(531) 01.01.04; 01.01.10; 01.01.15; 26.02.07;
26.11.12; 27.05.07; 29.01.15

(511)

13 – Signal rocket flares; pyrotechnics and pyrotechnic products; firecrackers; fireworks; Bengal lights.

(260) AM 2019 99033 A

(800) 1418278

(151) 2018 04 20

(891) 2018 04 20

(731) European Athletics association de droit suisse
16, avenue Louis-Ruchonnet, CH-1003
Lausanne, Switzerland

(540)

DNA Dynamic New Athletics

(591) Black, white

(511)

21 – Utensils and containers for household or kitchen use; combs and sponges; brushes, except paint brushes; brush-making materials; cleaning material; unworked or semi-worked glass, except glass used in building; glassware, porcelain and earthenware; table plates; disposable table plates; cocktail stirrers; glass jars [carboys]; boxes for dispensing paper towels; cookie jars; candy boxes; bottles; insulating flasks; refrigerating bottles; toothbrush; flower pot covers; coffee services; non-electric coffeepots; decanters; beer mugs; piggy banks; egg cups; table mats [table utensils]; signboards of porcelain or glass; figurines [statuettes] of porcelain, ceramic, earthenware or glass; non-electric portable coldboxes; cups of paper or plastic; drinking flasks for travelers; mugs; vanity cases; fitted picnic baskets, including dishes; bottle openers; combs; toothpick holders; soap holders; table napkin holders; pottery; thermally insulated bags; salad bowls; ice buckets / coolers; services [dishes]; tea services; teapots; corkscrews; money boxes; cosmetic utensils; kitchen utensils; toilet utensils; tableware; vases; glasses [receptacles]; drinking glasses.

28 – Games, toys; video game apparatus; gymnastic and sporting articles; decorations for Christmas trees; bows for archery; balls for games; play balloons; climbing harnesses; marbles for games; starting blocks for sports; playing cards; dice; discs for sports; flying disks [toys]; security blankets [plush toys]; machines for physical exercises; exercisers

[chest expanders] / chest expanders [exercisers]; horseshoe games; figurines [toys]; nets for sports; gloves [accessories for games]; cups for dice; gymnastics apparatus / physical training apparatus; barbells; dumbbells; toys; archery implements; shuttlecocks.

41 – Education; training; entertainment; sporting and cultural activities; academies [education]; timing of sports events; coaching [training]; organization and conducting of colloquiums, conferences, congresses and seminars; organization of sports competitions; organization of competitions [education or entertainment]; entertainment information; information relating to education; gymnastic instruction; rental of sports equipment except vehicles; rental of equipment for games; rental of stadium facilities; rental of sports grounds; provision of sports facilities; provision of recreational facilities; provision of non-downloadable films via video-on-demand services; provision of non-downloadable videos online; layout services, other than for advertising purposes; videotape editing; organization of exhibitions for cultural or educational purposes; operating lotteries; organization and conducting of workshops for cultural or educational purposes; organization and conducting of training workshops; organization and conducting of non-virtual educational forums; vocational guidance [education or training advice]; party planning [entertainment]; production of films other than advertising films; cinematographic film projection; publication of books; publication of texts other than advertising texts; online publication of specialized electronic books and journals; photographic reporting; lending library services; mobile library services; ticket agency services; holiday camp services [entertainment]; sports camp services; entertainment services; physical education services; educational services provided by schools; training services by means of simulators; game services provided on-line from a computer network; photography services; personal trainer services [fitness training]; providing museum facilities [presentation, exhibitions].

(260) AM 2019 99034 A

(800) 1418323

(151) 2018 01 09

(891) 2018 01 09

(731) EUPSPProvider s.r.o.

Kremencova 186/7, CZ-110 00 Prague, Czech
Republic

(540)



(591) Black, white

(531) 26.01.03; 26.01.12; 26.01.24; 26.11.01;
26.11.13

(511)
36 – Payment services, money remittance, merchant processing, cash money transfers, prepaid debit cards, mass payments.

(260) AM 2019 99036 A

(800) 1418494

(151) 2018 01 22

(891) 2018 01 22

(731) MISHCHENKO IVAN

OLEKSANDROVYCH

vul. Uralskaia, 5, kv. 44, m. Dnipro 49008,

Ukraine

(540)



(591) Black, white

(531) 05.05.20; 05.05.21; 27.05.01; 27.05.08

(511)

3 – Tissues impregnated with cosmetic lotions; beauty masks; breath freshening sprays; bleaching soda; bleaching salts; moustache wax; gaultheria oil; dental bleaching gels; make-up; lipsticks; deodorant soap; scented water; potassium hypochloride; jasmine oil; cosmetics; eyebrow cosmetics; cosmetic creams; lavender water; lavender oil; incense; hair spray; nail polish; almond oil; almond soap; washing soda, for cleaning; soap for foot perspiration; eau de Cologne; eyebrow pencils; cosmetic pencils; oils for perfumes and scents; oils for cleaning purposes; bases for flower perfumes; perfumery; perfumes; preparations for cleaning dentures; soda lye; rose oil; toilet water; cosmetic dyes; cleaning preparations; shoemakers' wax; cosmetic kits; cosmetic preparations for skin care; amber [perfume]; antistatic preparations for household purposes; hair dyes; joss sticks; nail polish; petroleum jelly for cosmetic purposes; cotton wool for cosmetic purposes; cotton swabs for cosmetic purposes; cream for whitening the skin; bleaching preparations [decolorants] for cosmetic purposes; decorative transfers for cosmetic purposes; false eyelashes; polishing wax; volcanic ash for cleaning; astringents for cosmetic purposes; cloths impregnated with a detergent for cleaning; depilatory preparations; scented wood; extracts of flowers [perfumes]; ethereal essences; essential oils of cedarwood; greases for cosmetic purposes; varnish-removing preparations; lacquer-removing preparations; color-removing preparations; degreasers, other than for use in manufacturing processes; ionone [perfumery]; shaving stones [astringents]; adhesives for affixing false eyelashes; adhesives for affixing false hair; adhesives for cosmetic purposes; make-up powder; sun-tanning preparations [cos-

metics]; cosmetic preparations for baths; cleaning chalk; cakes of toilet soap; essential oils of lemon; polishing stones; hair lotions; lotions for cosmetic purposes; after-shave lotions; almond milk for cosmetic purposes; deodorant soap; cakes of toilet soap; almond soap; shaving soap; soap; antiperspirant soap; cleansing milk for toilet purposes; musk [perfumery]; oils for toilet purposes; oils for cosmetic purposes; hydrogen peroxide for cosmetic purposes; pomades for cosmetic purposes; shaving preparations; stain removers; make-up; make-up preparations; paint stripping preparations; nail care preparations; neutralizers for permanent waving; mouthwashes, not for medical purposes; toilet water; bath salts, not for medical purposes; potpourris [fragrances]; talcum powder, for toilet use; cotton sticks for cosmetic purposes; mascara; cosmetic dyes; cleaning preparations; shampoos.

(260) AM 2019 99037 A

(800) 1418499

(151) 2018 03 02

(891) 2018 03 02

(731) ADP GAUSELMANN GMBH

Merkur-Allee 1-15, 32339 Espelkamp,

Germany

(540)

Western Pacific

(591) Black, white

(511)

9 – Computer software; coin-operated mechanisms; computer and video games software; games software in particular for use on any computer platform, including electronic entertainment and games consoles; computer game programs; video games (software); computer games provided through a global computer network or supplied by means of multi-media electronic broadcast or through telecommunications or electronic transmission or via the internet; computer games, leisure and recreational software, video games and computer software, all being provided in the form of storage media; programs for operating electric and electronic apparatus for games, amusement and/or entertainment purposes; computer software for computer games on the internet; online games (software), in particular for online betting games, online prize games, online gambling games, online games of skill and online casino games; computer software in the form of an app for mobile devices and computers; calculating apparatus in coin-operated machines and parts for the aforesaid goods; electric, electronic, optical or automatic apparatus, for identifying data carriers, identity cards and credit cards, bank notes and coins; software in particular for casino and/or amusement arcade games, for gaming machines and/or slot machines each one with or without prize payouts; gaming software that generates or displays wager outcomes of gaming ma-

chines; operational computer games software; computer software for managing of games (game collection); computer programs for video games.

28 – Games; toys; gaming apparatus (including coin-operated apparatus); coin-operated arcade games (machines); games for amusement arcades (included in this class); coin-operated video gaming apparatus; video games apparatus adapted for use with external screens or monitors only; casino fittings, namely roulette tables, roulette wheels; coin-operated automatic gaming machines and gaming machines, in particular for gaming arcades, with or without a prize payout; electronic or electrotechnical gaming apparatus, automatic gaming machines, gaming machines, slot machines operated by coins, tokens, banknotes, tickets or by means of electronic, magnetic or biometric storage media, in particular for commercial use in casinos and amusement arcades, with or without a prize payout; automatic gaming machines and gaming machines, in particular for commercial use in casinos and gaming arcades, with or without a prize payout; coin-operated gaming machines and/or electronic money-based gaming apparatus (machines), with or without prizes; housings adapted for gaming machines, gaming apparatus and automatic gaming machines, operated by means of coins, tokens, tickets or by means of electronic, magnetic or biometric storage media, in particular for commercial use in casinos and gaming arcades, with or without a prize payout; electronic games; electronic game entertainment apparatus and parts thereof; video output game machines; drawing apparatus for prize games and lotteries, draws or raffles; housings of metal, plastic and/or wood for coin-operated automatic machines; apparatus for games (including video games), other than adapted for use with external screens or monitors only; electropneumatic and electric slot machines with pulling handles (gaming machines); gaming tables, in particular for table football, billiards, sliding games; flying discs (toys) and darts; gaming machines, namely, electric, electronic or electromechanical apparatus for bingo games, lotteries or video lottery games and for betting offices, connected or unconnected to a computer network; LCD games consoles; automatic gaming machines; all the aforesaid automatic gaming machines operating in networks; apparatus and devices for accepting and storing money, being fittings for the aforesaid automatic machines, included in this class; automatic lottery machines.

(260) AM 2019 99038 A
(800) 605723
(151) 1993 06 16
(891) 2018 06 26
(731) VF INTERNATIONAL SAGL
Via Laveggio, 5, CH-6855 STABIO,
Switzerland

(540)



(591) Black, white
(531) 01.01.01; 26.01.01; 26.01.04; 26.01.21;
27.01.01

(511)

18 – Leather and imitation leather; animal skins; trunks and suitcases; shopping bags, handbags, traveling bags, satchels, backpacks, shoulder bags; key cases of textile materials; wallets and coin purses; umbrellas, parasols and walking sticks; whips, harness and saddlery.

(260) AM 2019 99039 A
(800) 634959
(151) 1995 03 22
(891) 2018 06 26
(731) VF INTERNATIONAL SAGL
Via Laveggio, 5, CH-6855 STABIO,
Switzerland

(540)



(591) Black, white
(531) 03.05.19; 27.05.01; 27.05.08

(511)

18 – All leather goods, luggage and accessories not included in other classes.

(260) AM 2019 99040 A
(800) 880861
(151) 2005 10 20
(891) 2018 05 22
(731) NEW MOBIL TECHNOLOGIES LLC
4a, bld.2, Chistova street, RU-109390
Moscow, Russian Federation

(540)

DOMINGO

(591) Black, white
(531) 27.05.17

(511)

3 – Bleaching preparations and other substances for laundry use; cleaning, polishing, scouring and abrasive preparations; soaps; perfumery, essential oils, cosmetics, hair lotions; dentifrices.

5 – Pharmaceutical and veterinary preparations; sanitary preparations for medical purposes; dietetic substances adapted for medical use, food for babies; plasters, materials for dressings; material for stopping teeth, dental wax; disinfectants; preparations for destroying vermin; fungicides, herbicides.

16 – Paper, cardboard and goods made from these materials, not included in other classes; printed matter; bookbinding material; photographs; stationery; adhesives for stationery or household purposes; artists' materials; paint brushes; typewriters and office requisites (except furniture); instructional and teaching material (except apparatus); plastic materials for packaging (not included in other classes); printers' type; printing blocks.

17 – Rubber, gutta-percha, gum, asbestos, mica and goods made from these materials and not included in other classes; plastics in extruded form for use in manufacture; packing, stopping and insulating materials; flexible pipes, not of metal.

21 – Household or kitchen utensils and containers (not of precious metal or coated therewith); combs and sponges; brushes (except paint brushes); brush-making materials; articles for cleaning purposes; steelwool; unworked or semi-worked glass (except glass used in building); glassware, porcelain and earthenware not included in other classes.

24 – Textiles and textile goods, not included in other classes; bed and table covers.

(260) AM 2019 99041 A

(800) 1071302

(151) 2010 12 13

(891) 2018 07 30

(731) WOLVER LAB GMBH

Im Zollhafen 24, 50678 Koeln, Germany

(540)



(591) Black, white

(531) 03.01.24; 26.04.24; 27.05.24

(511)

1 – Gas propellents for aerosols; chemical preparations for decarbonising engines; acidulated water for recharging accumulators; galvanizing baths; brake fluid; anti-knock substances for internal combustion engines; coolants for vehicle engines; anti-boil preparations for engine coolants; detergents for use in manufacturing processes; petroleum dispersants;

chemical additives for oils; detergent additives to gasoline (petrol); additives, chemical, to motor fuel; opacifiers for enamel; chemical preparations, except pigments, for the manufacture of enamel; emulsifiers; glaziers' putty; tree cavity fillers (forestry); degreasing preparations for use in manufacturing processes; catalysts; gum solvents; gums (adhesives), other than for stationery or household purposes; cement for shoes; cement for mending broken articles; leather glues; adhesives for wall tiles; mastic for tires; adhesives for wallpaper; adhesives for industrial purposes; glue for industrial purposes; flocculants; silicones; car body fillers; tire repairing compositions; foundry sand; compositions for threading; oil dispersants; oil-bleaching chemicals; oil-separating chemicals; oil-purifying chemicals; oils for tanning leather; oils for currying leather; oils for the preservation of food; oils for preparing leather in the course of manufacture; synthetic materials for absorbing oil; oil cement (putty); fuel-saving preparations; plastisols; plasticizers; dispersions of plastics; plastics, unprocessed; surface-active chemical agents; anti-frothing solutions for accumulators; radiator flushing chemicals; power steering fluid; fluids for hydraulic circuits; auxiliary fluids for use with abrasives; transmission fluid; drilling muds; chemical additives to drilling muds; solvents for varnishes; chemical preparations for the manufacture of paints; chemical intensifiers for rubber; refrigerating preparations; finishing preparations for use in the manufacture of steel; volatile alkali (ammonia) for industrial purposes.

2 – Asbestos paints; fixatives for watercolors (watercolours); alizarine dyes; aluminium paints; aniline dyes; black Japan; auramine; bactericidal paints; Canada balsam; dyes; dyestuffs; wood stains; colorants for butter; dyewood; white lead; whites (colorants or paints); bitumen varnish; bronze powder; bronzing lacquers; lime wash; shoe dyes; fireproof paints; litharge; primers; undercoating for vehicle chassis; dyewood extracts; preservative oils for wood; wood coatings (paints); wood preservatives; wood mordants; titanium dioxide (pigment); printers' pastes (ink); printing ink; enamels for painting; enamels (varnishes); silver emulsions (pigments); protective preparations for metals; thickeners for paints; colophony; carbonyl (wood preservative); ceramic paints; agglutinants for paints; badigeon; cobalt oxide (colorant); creosote for wood preservation; lacquers; thinners for lacquers; colorants for liqueurs; glossy platinum paint for ceramics; bright gold for ceramics; mastic (natural resin); anti-rust greases; zinc oxide (pigment); anti-rust oils; silver paste; pigments; coatings for roofing felt (paints); coatings (paints); glazes (paints, lacquers); varnishes; aluminium powder for painting; silvering powders; metals in powder form for painters, decorators, printers and artists; anti-fouling paints; anti-rust preparations for preservation; anti-corrosive preparations; anti-tarnis-

hing preparations for metals; mordants; thinners for paints; whitewash; red lead; siccatives (drying agents) for paints; blues (colorants or paints); silver paint for ceramics; anti-corrosive bands; paints; marking ink for animals; fixatives (varnishes); metal foil for painters, decorators, printers and artists; silver foil (leaf); blacks (colorants or paints).

3 – Abrasives; abrasive cloth; glass cloth; abrasive paper; diamantine (abrasive); alum stones (antiseptic); antistatic preparations for household purposes; laundry blueing; color (colour-) brightening chemicals for household purposes (laundry); preparations to make shiny the leaves of plants; laundry glaze; shining preparations (polish); bleaching soda; laundry preparations; tailors' wax; polishing wax; cobblers' wax; windscreen cleaning liquids; cloths impregnated with a detergent for cleaning; laundry soaking preparations; color-removing preparations; degreasers other than for use in manufacturing processes; scale removing preparations for household purposes; rust removing preparations; silicon carbide (abrasive); carbides of metal (abrasives); corundum (abrasive); parquet floor wax; non-slipping wax for floors; washing soda, for cleaning; detergents other than for use in manufacturing operations and for medical purposes; bleaching preparations (laundry); soap for brightening textile; oils for cleaning purposes; oil of turpentine for degreasing; laundry wax; parquet floor wax; non-slipping liquids for floors; floor wax removers (scouring preparations); stain removers; varnish-removing preparations; laundry bleach; laundry preparations; laundry starch; dry-cleaning preparations; turpentine, for degreasing; soda lye; canned pressurized air for cleaning and dusting purposes; preparations for cleaning waste pipes.

4 – Anthracite; perfumed candles; beeswax; benzene; benzine; benzol; wood briquettes; combustible briquettes; lignite; petroleum jelly for industrial purposes; grease for boots; wax (raw material); industrial wax; wool grease; producer gas; gas for lighting; solidified gases (fuel); diesel oil; gasoline; kerosene; lubricating graphite; lamp wicks; wicks for candles; methylated spirit; wood spills for lighting; charcoal (fuel); diesel oil; additives, non-chemical, to motor-fuel; firewood; electrical energy; petroleum ether; grease for leather; illuminating grease; tallow; preservatives for leather (oils and greases); oil for the preservation of masonry; grease for arms (weapons); moistening oil; coal; coal naphtha; coal tar oil; coal dust (fuel); coal briquettes; carnauba wax; castor oil for technical purposes; bone oil for industrial purposes; coke; xylene; xylol; wool grease; ligroin; mazut; grease for belts; lubricating grease; lubricants; lubricating oil; cutting fluids; mineral fuel; motor fuel; motor oil; naphtha; petroleum, raw or refined; oil-gas; nightlights (candles); ozocerite (ozokerite); oleine; oils for releasing form work (buil-

ding); oil for the preservation of leather; oils for paints; fuel gas; vaporized fuel mixtures; fuel; fuel with an alcoholic base; paper spills for lighting; paraffin; belting wax; non-slipping preparations for belts; dust laying compositions; dust removing preparations; dust binding compositions for sweeping; fish oil, not edible; rape oil for industrial purposes; firelighters; lighting fuel; illuminating wax; candles; Christmas tree candles; soya bean oil preparations for non-stick treatment of cooking utensils; sunflower oil for industrial purposes; alcohol (fuel); stearine; textile oil; industrial wax; industrial grease; industrial oil; peat (fuel); peat briquettes (fuel); cere-sine.

(260) AM 2019 99089 A

(800) 1418709

(151) 2018 06 18

(891) 2018 06 18

(731) LONDON DOLLAR LTD

Kemp House, 160 City Road, London EC1V
2NX, United Kingdom

(540)

MARHABA

(591) Black, white

(511)

34 – Cigarettes; cigarettes containing tobacco substitutes, not for medical purposes; cigarillos; cigars; chewing tobacco; any tobacco product; herbs for smoking; snuff; snuff boxes, tobacco, smokers' articles; molasses; molasses tobacco; shisha tobacco; hookah; hookah tobacco; matches.

(260) AM 2019 99090 A

(800) 1418725

(151) 2018 05 07

(891) 2018 05 07

(731) The Quaker Oats Company (a New Jersey corporation)

555 West Monroe Street, Chicago, Illinois
60661, USA

(540)



(591) White, grey, dark blue, blue, light blue, black, beige, pink and brown

(531) 02.01.01; 02.01.04; 27.01.01; 27.01.12;
27.05.10; 29.01; 29.01.15

(511)

5 – Food for babies.

29 – Jellies for food; fruit jellies; fruit-based snack food; yogurt; kefir [milk beverage]; milk shakes; compotes; butter; milk; milk beverages, milk predominating; nuts, prepared; jams; milk products; prostokvasha [soured milk]; cranberry compote; apple purée; ryazhenka [fermented baked milk]; seeds, prepared; whipped cream; cream [dairy products]; smetana [sour cream]; soups; whey; cheese; crystallized fruits; frozen fruits; fruit, preserved; fruit, stewed; potato flakes; fruit peel; potato chips; low-fat potato chips; fruit chips.

30 – High-protein cereal bars; cereal bars; rice-based snack food; cereal-based snack food; fruit jellies [confectionery]; frozen yogurt [confectionery ices]; instant porridge; gruel; gruel, with a milk base, for food; crackers; macarons [pastry]; ice cream; muesli; cookies; petit-beurre biscuits; pies; pizzas; fondants [confectionery]; powders for making ice cream; condiments; cereal preparations; oat-based food; gingerbread; rusks; sandwiches; tacos; tapioca; corn flakes; oat flakes; chips [cereal products]; cheeseburgers [sandwiches].

(260) AM 2019 99091 A

(800) 1418738

(151) 2018 05 22

(891) 2018 05 22

(731) SICHUAN JISHENGTANG

PHARMACEUTICAL CO., LTD

North Fanjiang Road, Pengzhou City,

Chengdu, Sichuan, China

(540)

(591) Black, white

(531) 28.03

(511)

5 – Chinese medicine nostrum; medicines for human purposes; chemico-pharmaceutical preparations; pharmaceutical preparations; active ingredient; biochemical drugs; chemical preparations for pharmaceutical purposes; nutritive substances for microorganisms.

(260) AM 2019 99092 A

(800) 1418838

(151) 2018 07 16

(891) 2018 07 16

(731) DR. THEISS NATURWAREN GMBH

Michelinstr. 10, 66424 Homburg, Germany

(540)

(591) Black, white

(511)

3 – Bleaching preparations and other substances for laundry use; cleaning, polishing, scouring and abrasive preparations; soaps; perfumery, ethereal oils, cosmetics, including non-medicated preparations for cleaning and caring for the skin, and hair care preparations; hair lotions; dentifrices.

5 – Pharmaceutical and veterinary preparations; medicines for human or veterinary purposes; sanitary preparations for medical purposes; dietetic foodstuffs and substances adapted for medical use; nutritional supplements; vitamin preparations, including beauty capsules; plasters, materials for dressings; disinfectants.

(260) AM 2019 99093 A

(800) 1418845

(151) 2018 04 03

(891) 2018 04 03

(731) FENER ULUSLARARASI NAKLİYAT
GIDA SANAYİ VE TİCARET LİMİTED
ŞİRKETİYusuf Paşa Mah. 886., Sok Dünya İş Merkezi
Kat:3 No:74, Eyyübiye, Şanlıurfa, Turkey

(540)

(591) Black, white

(531) 27.05.17

(511)

30 – Coffee, cocoa; coffee or cocoa based beverages, chocolate based beverages; tea, ice tea.

(260) AM 2019 99094 A

(800) 1418956

(151) 2018 05 22

(891) 2018 05 22

(731) OBSHESTVO S OGRANICHENNOY
OTVETSTVENNOSTYU "MAK FOOD
SERVIS"Dehkonobod street 1, Yunusabad District,
Tashkent, Uzbekistan

(540)



(591) Green, white and pistachio

(531) 25.03.01; 25.07.01; 26.01.18; 27.05.01;
29.01.12

(511)
43 – Services for providing food and drink; temporary accommodation.

(260) AM 2019 99096 A

(800) 1419005

(151) 2017 12 18

(891) 2017 12 18

(731) Assotsiatsiya "NATSIONALNIY KOORDI-NATSIONNIY TSESTR OBRABOTKI TRANZAKTSIY S PRAVAMI I OBJEK-TAMI INTELLEKTUALNOY SOBSTVENOSTI"

ul. Nobelya, 5, territoriya Skolkovo, innovatsionnogo tsentra, RU-143026 Moscow, Russian Federation

(540)

IPCHAIN

(591) Black, white

(531) 27.05.01

(511)

9 – Data processing equipment and computers; software; software and application software for computers, notebook computers, cellular phones, smartphones, mobile electronic devices; computer software for application and database integration; software and application software for conducting studies and management relating to intellectual property; software and application software for database management and providing access to databases; software and application software for e-commerce; software allowing users to perform business transactions via a global computer network; software for storage, transmission, listening and viewing audio and video files; software for statistical analysis and reporting; downloadable files; electronic publications, downloadable.

35 – Business management, business administration; business management relating to legal protection accounting and commercialization of intellectual property; commercial information agency services; business auditing; commercial intermediation services; commercial intermediation services relating to management of business operations relating to intellectual property; business management assistance; commercial or industrial management assistance; commercial or industrial management assistance, namely intangible assets management assistance of commercial or industrial enterprises; commercial intermediation services relation to intellectual property commercialization; provision of information and advisory services relating to e-commerce; intermediation services relating to e-commerce; business intermediary services relating to preparation, negotiation, conclusion and execution of transactions regarding intellectual property; computerized file management; compilation, systemization, updating and maintainan-

ce of data of information in computer databases and directories; business intermediary services relating to the matching of potential private investors with entrepreneurs needing funding; business intermediary services relating to the matching of potential acquirers of intellectual property; opinion polling; market studies; business information; business investigations; studies relating to commercial use of intellectual property; business research; marketing research; professional business consultancy; professional business consultancy relating to commercial use of intellectual property; marketing; business management of performing artists; updating and maintenance of information in registries; organization of exhibitions for commercial or advertising purposes; organization of trade fairs for commercial or advertising purposes; business appraisals; data search in computer files, databases and directories for others; providing business information via a web site; provision of commercial and business contact information; provision of an on-line marketplace for buyers and sellers of goods and services; provision of on-line marketplace for third parties for concluding commercial transactions relating to intellectual property; economic forecasting; sales promotion for others; advertising; on-line advertising on a computer network; compilation of statistics; business inquiries; negotiation of business contracts for others; negotiation and conclusion of commercial transactions for third parties; drawing up of statements of accounts; book-keeping; accounting consultancy relating to taxation; financial records management.

36 – Appraisal of intellectual property; financial evaluation and analysis; investment, financial operations relating to intellectual property; financial arrangement relating to intellectual property; financial affairs; insurance underwriting; monetary affairs; financial analysis; financial management; investment brokerage; art brokerage; financial services and financial consultancy relating to taxation; financial planning services relating to taxation; financial planning and advisory services relating to investment; investment of funds; organization of charitable collections; investment fund management; electronic funds transfer; surety services; securities brokerage; providing financial information via a web site; financial sponsorship; financial management of reimbursement payments for others; provident fund services; financing services; capital investment; exchange mediation; online brokerage relating to financial operations, financial evaluation, analysis, investment, financial arrangement and taxation regarding intellectual property; providing information and consultancy services relating to the aforementioned services.

38 – Telecommunications; providing access to databases; providing Internet chatrooms; providing telecommunication channels for providing information

about intellectual property; providing access to e-commerce platforms on the Internet; message sending; computer aided transmission of messages and images; transmission of digital files; providing online forums; radio broadcasting; wireless broadcasting; television broadcasting; video-on-demand and music-on-demand transmission; teleconferencing services; streaming of data.

41 – Education; providing of training; entertainment; sporting and cultural activities; production of music; providing on-line electronic publications, not downloadable; organization of public performance of music; organization of public performance of motion pictures, video records of stage shows, entertainment events and shows; production of television programmes; correspondence courses; organization of exhibitions for cultural or educational purposes; providing recreation facilities; arranging and conducting of colloquiums; arranging and conducting of congresses; arranging and conducting of conferences; arranging and conducting of concerts; arranging and conducting of workshops [training]; arranging and conducting of seminars; arranging and conducting of symposiums; organization of competitions [education or entertainment]; providing on-line videos, not downloadable; providing on-line music, not downloadable; providing television programs, not downloadable, via video-on-demand transmission services; providing films, not downloadable, via video-on-demand transmission services; cinema presentations; rental of sound recordings, motion pictures and videotapes; on-line publication of electronic books and journals; publication of texts, other than publicity texts; karaoke services; recording studio services; production of shows; movie studio services.

42 – Design and development of computer hardware and software; computer system analysis; installation of computer software; software as a service [SaaS]; software as a service [SaaS] for application and database integration, database management and providing access to databases; software as a service [SaaS] for conducting studies and management relating to intellectual property; software as a service [SaaS] for e-commerce; software as a service [SaaS], enabling users to perform electronic business transactions via a global computer network; software as a service [SaaS] for storage, transmission, listening and viewing audio and video files; software as a service [SaaS] for statistical analysis and reporting; maintenance of computer software; providing search engines for the Internet; conversion of computer programs and data, other than physical conversion; computer system design; rental of web servers; rental of computer software; hosting computer sites [web sites]; server hosting; computer software design; creating and designing website-based indexes of information for others [information technology services]; computer programming; off-site data backup; data encryption services; hosting e-commerce

platforms on the Internet; providing information and consultancy services relating to the aforementioned services.

45 – Legal services; arbitration services; legal research; monitoring intellectual property rights for legal advisory purposes; intellectual property consultancy; licensing of intellectual property; legal administration of licenses; litigation services; alternative dispute resolution services; mediation; copyright and ancillary rights management; industrial property rights management; intellectual property rights management; legal administration of intangible assets; legal services relating to preparing and concluding of contracts for others; providing information and consultancy services relating to the aforementioned services; legal services related to collective intellectual property rights management.

(260) AM 2019 99109 A
(800) 1419297
(151) 2018 05 12
(891) 2018 05 12
(731) RKW Agri GmbH & Co. KG
Nachtweideweg 1-7, 67227 Frankenthal, Germany
(540)



(591) Blue, white and grey
(531) 26.01.01; 26.01.05; 27.05.15; 29.01.13
(511)
16 – Films and sheets of plastic for packaging.

17 – Films and sheets of plastic for agricultural purposes; films and sheets for use in gardening and landscaping; silage films; flexible tubes of plastic for silage; bale stretch films; bale films and sheets; round bale films and sheets; harvest accelerating films; mulch films; stretch films for agricultural use; silo protecting films; greenhouse films.

22 – Sacks for silage.

(260) AM 2019 99111 A
(800) 1419336
(151) 2018 01 25
(891) 2018 01 25
(731) Euro Games Technology LTD
"Maritsa" Str. 4, "Vranya-Lozen-Triugulnika",
BG-1151 Sofia, Bulgaria
(540)



(591) Yellow, red, blue, purple, green, brown and black

(531) 25.01.10; 27.05.03; 27.05.04; 27.07.01; 29.01.15

(511)

9 – Apparatus for recording, transmission or reproduction of sound or image; computer software, recorded; monitors [computer hardware].

28 – Games, that are not included in other classes; gaming machines operating with coins, banknotes and cards; gaming machines for gambling.

(260) AM 2019 99112 A

(800) 1419395

(151) 2018 05 30

(891) 2018 05 30

(731) AVON PRODUCTS, INC.

601 Midland Avenue, Rye New York 10580, USA

(540)

AVON
SEGNO

(591) Black, white

(531) 27.05.10

(511)

3 – Non-medicated toilet preparations; toiletries; skin care preparations; skin moisturizers; body and beauty care preparations; powders, cleansers, creams and lotions, all for the face, hands and body; cosmetic suntan preparations; soaps; shower and bath preparations; beauty masks; talcum powder; nail polish; nail polish remover; false nails; adhesives for cosmetic purposes; cosmetics; eye cream; eye gels; eye lotions; eye make-up remover; eye shadow; eye liner; mascara; lipstick; lip liner; lip-gloss; make-up foundation; blusher; tissues impregnated with cosmetic lotions; cotton sticks for cosmetic purposes; cotton wool for cosmetic purposes; preparations for cleaning, moisturising, colouring and styling the hair; preparations for cleaning the teeth; shaving and aftershave preparations; perfumes; fragrances; toilet waters; cologne; deodorants for human beings; antiperspirants for personal use (toiletries); essential oils (cosmetic).

(260) AM 2019 99114 A

(800) 1419482

(151) 2018 06 25

(891) 2018 06 25

(731) SIEMENS AKTIENGESELLSCHAFT

Werner-von-Siemens-Str. 1, 80333 München, Germany

(540)

Sensformer

(591) Black, white

(511)

9 – Apparatus and instruments for conducting, switching, transforming, accumulating, regulating or controlling electricity; electricity transformers; parts for transformers, in particular coils, cables; electronic load indicating devices; electrotechnical, electronic and ceramic component parts and assemblies consisting thereof (included in class 09); apparatus for measuring, monitoring and analysing operating data from electric goods; data processing programs; mobile apps.

42 – Platform as a service (paas); development of data bases; development of computer database software; development and maintenance of computer database software; hosting platforms on the internet; electronic storage services for archiving databases; design of computer database software; installation and maintenance of database software.

(260) AM 2019 99122 A

(800) 1419864

(151) 2017 12 15

(891) 2017 12 15

(731) PUNTOBELLO YEMEK HİZMETLERİ VE DİŞ TİCARET ANONİM ŞİRKETİ

İstinye Park Alışveriş Merkezi, No:R 232-233, Sarıyer İstanbul, Turkey

(540)

PUNTO
FRESCO ITALIANO

(591) Black, Red, Green, White

(531) 26.01.01; 26.01.03; 26.01.24; 26.04.02; 26.04.09; 26.04.24; 27.05.10; 29.01.13

(526) ITALIANO

(511)

43 – Services for providing food and drink, temporary accommodation; reservation of temporary accommodation; rental of rooms for wedding ceremonies; providing rooms for conferences and various meetings, day nurseries (crèches)- boarding for animals.

(260) AM 2019 99123 A

(800) 1419868

(151) 2018 01 24

(891) 2018 01 24

(731) Malinauskas Andrius

ul. Aviakonstruktora Mikoyana, 14/3, 160, RU-125252 Moscow, Russian Federation

(540)



(591) Dark brown, light brown, white
 (531) 26.04.22; 27.05.24; 28.05; 29.01.12
 (526) "SOL' RESTORANNAYA PREMIYA", ®
 (511)
 35 – Advertising; business management; business administration.
 41 – Entertainment services; cultural activities.

(260) AM 2019 99124 A
 (800) 1419877
 (151) 2017 12 27
 (891) 2017 12 27
 (731) PEARSON PLC
 80 Strand, London WC2R 0RL, United Kingdom
 (540)



(591) Black, white
 (531) 24.17.01; 24.17.04; 26.01.18; 26.01.24;
 27.05.21
 (511)
 35 – Advertising; business management; business administration; office functions; personnel recruitment; recruitment services; employment agency services; personnel management consultancy; psychological testing for the selection of personnel; writing of curriculum vitae for others; human resources management; recruitment consultancy services; personnel placement; evaluation of personnel requirements; management advice relating to the recruitment of staff; management advice relating to the placement of staff; assessment of personnel's capacity for a particular work job or role; business auditing; business organization consultancy; business appraisal; marketing; price comparison services.
 36 – Insurance; financial affairs; monetary affairs; real estate affairs; financial management; financial consultancy; insurance brokerage; mortgage banking; mutual funds; real estate management; loans

[financing]; issuance of credit cards; banking; brokerage; capital investment; charitable fundraising; debt advisory services; corporate finance; consultancy in the field of private equity investment; private equity fund investment services; electronic funds transfer; financial underwriting and securities issuance (investment banking).

38 – Telecommunications; providing Internet chatrooms; message sending; satellite transmission; streaming of data; cable television broadcasting; providing telecommunications connections to a global computer network; television broadcasting; video on demand transmission; wireless communication; wireless broadcasting; stream data transmission; streaming of audio, visual and audiovisual material via a global computer network; electronic transmission and streaming of digital media content for others via global and local computer networks; video-on-demand transmission services; broadcasting of radio and television programmes; broadcasting of video and audio programming over the Internet; broadcasting services and provision of telecommunication access to video and audio content provided via a video-on-demand service via the Internet; telecommunication services, namely, transmission of voice, data, graphics, images, audio and video by means of telecommunications networks, wireless communication networks, and the Internet; telecommunication services, namely, transmission of podcasts; streaming of audio and video via the Internet featuring music, movies, news, and sports; streaming of television shows and movies via the Internet; broadcasting of radio and television programmes; subscription television broadcasting.

(260) AM 2019 99133 A
 (800) 1420003
 (151) 2018 01 25
 (891) 2018 01 25
 (731) Euro Games Technology LTD
 "Maritsa" Str. 4, "Vranya-Lozen-Triugulnika",
 BG-1151 Sofia, Bulgaria
 (540)



(591) Yellow, red and brown
 (531) 23.01.01; 27.05.02; 27.05.03; 27.05.12;
 29.01.13
 (511)
 9 – Apparatus for recording, transmission or reproduction of sound or image; computer software, recorded; monitors [computer hardware].
 28 – Games, that are not included in other classes; gaming machines operating with coins, banknotes and cards; gaming machines for gambling.

(260) AM 2019 99139 A

(800) 1420108

(151) 2018 01 18

(891) 2018 01 18

(731) ESPT GO LIMITED

9 Vasili Michaelides Street, CY-3026
Limassol, Cyprus

(540)



(591) Black, white

(531) 25.07.03; 26.04.18; 26.04.22; 26.04.24;

26.07.25; 26.15.09; 27.05.24

(511)

9 – Software; games software; process controlling software; cloud computing software; file sharing software; video game software; financial management software; computer software packages; electronic game software; computer telephony software; instant messaging software; data communications software; software for computers; network management software; embedded operating software; operating system software; computer software platforms; interactive entertainment software; children's educational software; application software for televisions; software for online messaging; computer video game software; software for mobile phones; computer software applications, downloadable; computer e-commerce software; computer programs [downloadable software]; programs (computer -) [downloadable software]; smartphone software applications, downloadable; virtual reality games software; downloadable computer software applications; application software for mobile phones; application software for smart phones; electronic mail and messaging software; software for optical character recognition; computer software for business purposes; augmented reality software for creating maps; computer software downloaded from the internet; computer software for wireless network communications; software for processing images, graphics and text; communication software for connecting computer network users; software for the processing of business transactions; software for the analysis of business data; software applications for use with mobile devices; computer programmes; illuminated advertising signs; computer software for advertising; software for embedding online advertising on websites; data storage devices; data storage discs; data loggers and recorders; digital data recording media; optical data storage drives; data protection backup units; computer software for creating searchable databases of information and data; memories for data processing equipment; computer networking and data communications equipment; computer software for database management; electronic databases recorded on computer media; electrical and electronic apparatus for

logging data; electrical and electronic instruments for storing data; computer software to enable retrieval of data; data processing equipment and accessories (electrical and mechanical); computer software for application and database integration; data carriers for computers having software recorded thereon; computer software for authorising access to data bases; computer software to enable the searching of data; memory devices for use with data processing apparatus; downloadable computer software for the management of data; downloadable computer software for the transmission of data; computer software to enable searching and retrieval of data; computer programs for accessing, browsing and searching online databases; central processing units for processing information, data, sound or images.

35 – Marketing; targeted marketing; direct marketing consulting; advertising and marketing; marketing advisory services; marketing consultation services; marketing research and analysis; search engine marketing services; providing business marketing information; estimations for marketing purposes; design of marketing surveys; analysis of marketing trends; conducting of marketing studies; advertising, marketing and promotional services; providing marketing information via websites; advice relating to marketing management; market research and marketing studies; advertising, marketing and promotion services; marketing (business advice relating to -); provision of information relating to marketing; distribution of advertising, marketing and promotional material; marketing the goods and services of others; video recordings for marketing purposes (production of -); business advice relating to marketing management consultations; consulting services in the field of internet marketing; advertising, marketing and promotional consultancy, advisory and assistance services; rental of all publicity and marketing presentation materials; marketing services provided by means of digital networks; marketing the goods and services of others by distributing coupons; advertising and marketing services provided by means of blogging; advertising; advertising research services; publicity and advertising; mail-order advertising; press advertising consultancy; classified advertising services; updating advertising material; advertising for others; production of advertising matter; design of advertising logos; consultancy relating to advertising; advertising and marketing consultancy; pay per click advertising; advertising and promotion services; radio and television advertising; advertising via the internet; advertising and marketing services; production of advertising films; advertising, including on-line advertising on a computer network; advertising services of a radio and television advertising agency; providing searchable online advertising guides; intermediary services relating to advertising; advisory services relating to advertising; arranging advertising contracts for others; production of visual

advertising matter; provision of information relating to advertising; advertising on the internet for others; advertising in periodicals, brochures and newspapers; modelling for advertising or sales promotion; arranging of presentations for advertising purposes; online advertising on a computer network; advertising services provided over the internet; compilation of statistics relating to advertising; provision of advertising space on electronic media; rental of advertising space on web sites; on-line advertising on computer networks; provision of advertising space, time and media; on-line advertising via a computer communications network; preparation of mailing lists for direct mail advertising services [other than selling]; advertising services to promote public awareness of the benefits of shopping locally; direct mail advertising to attract new customers and to maintain the existing customer base; consultancy regarding public relations communication strategies; rental of advertising time on communication media; data processing; data management; data entry and data processing; business management services relating to data processing; data file administration; administrative data processing; computerised data management; analysis of business data stored in computer databases; computer data processing; computerised data-base management; database management services; computer database management; data processing for businesses; compilation of business data; provision of business data; management of computer databases; analysis of market research data; preparation of business statistical data; data processing for the collection of data for business purposes; collection and systematization of business data; provision of computerised business information data; advertising services relating to data bases; computer databases (compilation of information into -); data search in computer files for others; provision of computerised data relating to business; services comprising the transcription of statistical data; services comprising the composition of statistical data; compilation and input of information into computer databases.

38 – Communications consultancy; radio communications; communications services; communication by computer; interactive communication services; electronic communication services; audiovisual communication services; electronic network communications; wireless communication services; computer communication and internet access; data communication services accessible by password; data communication services by electronic means; transmission of data by communications satellite; electronic communications services for the transmission of data; communication services for the transmission of information; communication of data by means of radio; data communication services accessible by access code; advisory and consultancy services relating to wireless communications and wireless communi-

cations equipment; provision of information relating to communications; transmission of messages, data and content via the internet and other communications networks; provision of communications facilities for the interchange of digital data; communication services for the transmission of information by electronic means; providing high speed access to computer and communication networks; data transmission and data broadcasting; transmission of data; e-mail data services; data bank interconnection services; electronic data interchange services; digital transmission of data; electronic transmission of data; transfer of data by radio; voice and data transmission services; data communication by electronic means; computer-aided transmission of data; data transmission by electronic mail; providing telecommunications connections to databases; packet transmission of data and images; consultancy services relating to data communications; arranging access to a computer database; provision of access to computer databases; electronic transmission of instant messages and data; leasing access time to a computer database; transmission of computerised data by means of cable; transmission of data, sound and images via satellites; cable transmission of sounds, images, signals and data; providing access to electronic communications networks and electronic databases; providing telecommunications connections to a global computer network or databases; provision of telecommunications links to computer databases and websites on the internet; transmission of data or audio visual images via a global computer network or the internet; transmission of data, audio, video and multimedia files, including downloadable files and files streamed over a global computer network.

41 – Entertainment provided via a global communication network; game services provided by means of communications by computer terminals or mobile telephone; provision of audio and visual media via communications networks; training in communication techniques; electronic data processing training; educational services relating to data processing; library services related to data stored and retrieved by electronic means.

42 – Programming of software for online advertising; designing websites for advertising purposes; hosting electronic memory space on the internet for advertising goods and services; development of software for communication systems; maintenance and updating of software for communication systems; online data storage; maintenance of database software; data security services; data migration services; data duplication and conversion services, data coding services; recovery of computer data; electronic data storage services; data back-up services; rental of data processing apparatus; design of data storage systems; creating programmes for data processing; rental of computer database software; research re-

lating to data processing; design and development of databases; design services relating to data processors; computer programming services for data warehousing; computer services concerning electronic data storage; development of programmes for data processing; engineering consultancy relating to data-processing; reconstruction of database systems for others; installation and maintenance of database software; programming of software for database management; temporary electronic storage of information and data; software engineering services for data processing programs; preparation of computer programs for data processing; design and development of computer database software; development of systems for the transmission of data; hosting of computerized data, files, applications and information; design and development of software for database management; design of software for data and multimedia content conversion from and to different protocols; design and development of computer software for evaluation and calculation of data; design and development of computer software for reading, transmitting and organising data; development of software for data and multimedia content conversion from and to different protocols; software creation; software design; computer software installation; software consultancy services; software engineering services; software development services; updating of software; software installation; computer software development; software as a service; software design and development; smartphone software design; computer software design; design of software; computer software maintenance; update of computer software; software (rental of computer -); leasing of computer software; installation of computer software; software development, programming and implementation; programming of video game software; software as a service [SaaS]; computer programming and software design; hosting services and software as a service and rental of software; computer and software consultancy services; rental of software for inventory management; updating and design of computer software; programming of software for internet platforms; support and maintenance services for computer software; services for the leasing of computer software; design of software for audio and video operators; consultancy and advice on computer software and the design and development of computer hardware; installation, maintenance, updating and upgrading of computer software; development of software solutions for internet providers and internet users; rental of computer software, data processing equipment and computer peripheral devices; analytical services relating to computer programmes; development and creation of computer programmes for data processing; services for the updating of computer programmes; duplicating computer programmes; installation of computer programmes.

(260) AM 2019 99148 A

(800) 1128167

(151) 2012 07 23

(891) 2018 08 09

(731) LABORATOIRE TRADIPHAR, Société Anonyme
176 rue de l'Arbrisseau, F-59000 LILLE,
France

(540)

CARBOLAX

(591) Black, white

(531) 27.05.01

(511)

5 – Products and preparations for medical and pharmaceutical purposes; sanitary preparations for medical purposes; food supplements for medical and pharmaceutical purposes; food supplements made from plants and vegetable charcoal for medical and pharmaceutical purposes.

(260) AM 2019 99149 A

(800) 1157415

(151) 2013 02 07

(891) 2018 08 02

(731) GLAMIRA INTERNET VE
KUYUMCULUK, SANAYI VE TICARET
ANONIM SIRKETI
Yenibosna Merkez Mah. 29 Ekim Cad.,
Vizyonpark Ofis Plazalari Vizyon 4, Kat 6,
Bahcelievler, TR-34197 Istanbul, Turkey

(540)

Glamira

(591) Black, white

(511)

14 – Precious metals and their alloys and goods in precious metals or coated therewith, not included in other classes; jewellery, precious stones; jewellery; horological and chronometric instruments; alarm clocks; wall clocks.

18 – Leather and imitations of leather, and goods made of these materials and not included in other classes; animal skins, hides; coverings of skins (furs); trunks and travelling bags; umbrellas and parasols; walking sticks; bags, all the aforesaid goods included in this class, in particular pocket wallets, tote bags, handbags, travelling bags, rucksacks, wheeled shopping bags, briefcases, documents wallets.

25 – Clothing, footwear, headgear; neckerchiefs; bandanas (scarves); dress handkerchiefs; belts (clothing); ties; ascots; gloves (clothing).

35 – Retailing, including via the internet, of precious metals and their alloys and goods in precious metals or coated therewith, jewellery, precious stones, horological and chronometric instruments, alarm clocks, wall clocks, leather and imitations of leather, and

goods made of these materials, animal skins, hides, coverings of skin (fur), trunks and travelling bags, umbrellas and parasols, walking sticks, bags, in particular pocket wallets, shopping bags, handbags, holdalls, rucksacks, wheeled shopping bags, briefcases, document wallets, clothing, footwear, headgear, scarves, bandanas (neckerchiefs), handkerchiefs, belts (clothing), neckties, ascots, gloves (clothing); advertising; rental of advertising space, including on the internet; arranging of commercial transactions, for others, including within the framework of e-commerce; arranging contracts for the buying and selling of goods and the provision of services, for others.

(260) AM 2019 99151 A

(800) 1377433

(151) 2017 10 19

(891) 2018 07 25

(731) AS HESBURGER

Uusaru 3, Saue city, EE-76505 Harju county, Estonia

(540)

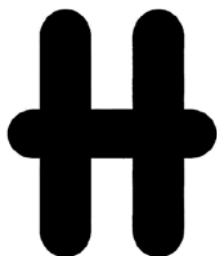

(591) Black, white

(531) 27.05.17; 27.05.21

(511)

37 – Building construction; repair; installation services.

(260) AM 2019 99156 A

(800) 1312626

(151) 2016 01 27

(891) 2017 09 13

(731) NUEVA ALAPLANA, S.L.

C/ El Pinet, 1 – P.I. Els Plans E-12592 Chilches (Castellón), Spain

(540)

alaplana.
CERÁMICA

(591) Black and red

(531) 27.05.01; 27.05.10; 29.01.12

(511)

19 – Non-metallic building materials, namely tiles, floor tiles, wall coverings, borders, ceramic tiles, stoneware for building (sandstone), natural stone, artificial stone, marble, granite, baked clay (terracotta), sand (with the exception of foundry sand), lime,

calcareous stones, bricks, slate, ceramics, parquet flooring; clay; luminous paving blocks, not of metal; mosaics (tiles) for construction; wainscoting not of metal.

(260) AM 2019 99172 A

(800) 1419406

(151) 2018 06 12

(891) 2018 06 12

(731) EMERGENT PAYMENTS, INC.

2445 Augustine Dr., Suite 460, Santa Clara CA 95054, USA

(540)



(591) Black, white

(531) 01.03.01; 01.03.02; 25.07.01; 25.07.07; 27.05.01; 27.05.10; 27.05.11; 27.05.17

(511)

36 – Accepting, processing, and reconciling financial and payment transactions; financial transaction services, namely, providing secure commercial transactions and payment and funds transfer options; tax calculation, collection, remittance and payment processing services.

(260) AM 2019 99203 A

(800) 1420219

(151) 2018 07 03

(891) 2018 07 03

(731) MBDA FRANCE

1 Avenue Réaumur F-92350 LE PLESSIS-ROBINSON, France

(540)

MISTRAL

(591) Black, white

(511)

13 – Missiles and corresponding weapon systems, excluding any such pyrotechnic products, objects, ammunition and fireworks.

(260) AM 2019 99204 A

(800) 1420232

(151) 2017 12 22

(891) 2017 12 22

(731) Autonomous nonprofit organization "TV-Novosti"

Borovaya street, 3, korp. 1, RU-111020 Moscow, Russian Federation

(540)

QUESTION MORE

(591) Black, white

(511)

9 – Facsimile machines; computer memory devices; floppy disks; optical discs; disk drives for computers; computers; notebook computers; monitors [computer hardware]; magnetic data media; optical data media; computer programs [downloadable software]; processors [central processing units]; scanners [data processing equipment]; data processing apparatus; computer peripheral devices; electrical communication machines and instruments; magnetic tape units for computers; juke boxes for computers; mouse [computer peripheral]; silicon wafers for integrated circuits; software and apparatus for downloading, receiving, providing, publishing, encoding, decoding, reading, organizing, carrying, storing, transmitting, retrieving music, sounds, images, text, signals, information and code; computer programmes [programs], recorded; interactive computer game programs.

35 – Arranging subscriptions to telecommunication services for others; import-export agency services; commercial information agency services; advertising agency services; cost price analysis; rental of advertising space; account auditing; employment agency services; computerized file management; invoicing; demonstration of goods; opinion polling; market studies; business information; business investigations; personnel recruitment; business management and organization consultancy; business organization consultancy; business management consultancy; professional business consultancy; layout services for advertising purposes; business management of performing artists; news clipping services; updating of advertising material; word processing; organization of exhibitions for commercial or advertising purposes; organization of trade fairs for commercial or advertising purposes; shop window dressing; business appraisals; payroll preparation; sponsorship search; business management assistance; commercial or industrial management assistance; economic forecasting; auctioneering; office machines and equipment rental; publicity material rental; rental of vending machines; rental of photocopying machines; publication of publicity texts; radio advertising; billposting; distribution of samples; dissemination of advertising matter; writing of publicity texts; advertising; on-line advertising on a computer network; advertising by mail order; television advertising; document reproduction; compilation of statistics; business inquiries; systemization of information into computer databases; tax preparation; drawing up of statements of accounts; commercial administration of the licensing of the goods and services of others; public relations; modelling for advertising or sales promotion; relocation services for businesses; price comparison services; procurement services for others [purchasing goods and services for other businesses]; book-keeping; compilation of information into computer databases; business efficiency expert

services; photocopying services; telephone answering for unavailable subscribers; administrative processing of purchase orders; business management of hotels; psychological testing for the selection of personnel; copy writing for advertising and promotional purposes; typing; rental of advertising time on communication media; presentation of goods on communication media, for retail purposes; data search in computer files for others; arranging newspaper subscriptions for others; secretarial services; business information and appraisal services; marketing; commercial information and advice for consumers [consumer advice shop]; transcription of communications [office functions]; sales promotions at point of purchase or sale, for others; arranging commercial transactions, for others, via on-line shops; retail services provided by means of mail order catalogs.

38 – News agency services; television broadcasting; cable television broadcasting; electronic bulletin board services [telecommunications services]; information about telecommunication; providing access to databases; providing telecommunications connections to a global computer network; message sending; computer aided transmission of messages and images; transmission of telegrams; rental of message sending apparatus; rental of modems; rental of telecommunication equipment; rental of telephones; rental of facsimile apparatus; radio broadcasting; communications by fiber optic networks; communications by cellular phones; communications by computer terminals; satellite transmission; communications by telegrams; communications by telephone; facsimile transmission; telex services; voice mail services; telegraph services; telephone services; telecommunications routing and junction services; providing Internet chatrooms; providing user access to the Internet [service providers]; providing telecommunication channels for teleshopping services; communication of data by electronic mail; rental of access time to global computer networks; teleconferencing services.

41 – Modelling for artists; academies [education]; videotaping; physical education; discotheque services; animal training; dubbing; gambling services; publication of books; education information; recreation information; entertainment information; entertainment in the nature of ongoing television programs in the field of news; production and distribution of television programs in the field of news; movie studio services; microfilming; videotape editing; production of radio and television programmes; religious education; gymnastic instruction; correspondence courses; practical training [demonstration]; organization of balls; arranging and conducting of colloquiums; arranging and conducting of congresses; arranging and conducting of conferences; arranging and conducting of concerts; arranging and conducting of workshops [training]; arranging and conduc-

ting of seminars; arranging and conducting of symposiums; arranging of beauty contests; organization of lotteries; organization of shows [impresario services]; organization of sports competitions; vocational guidance [education or training advice]; amusement park services; sign language interpretation; television entertainment; mobile library services; providing golf facilities; providing amusement arcade services; cinema presentations; presentation of live performances; theatre productions; educational examination; production of motion pictures; rental of audio equipment; rental of video cameras; rental of video cassette recorders; rental of videotapes; rental of show scenery; rental of motion pictures; rental of lighting apparatus for theatrical sets or television studios; rental of radio and television sets; electronic desktop publishing; on-line publication of electronic books and journals; radio entertainment; entertainer services; entertainment services; writing of texts; news reporters services; party planning [entertainment]; music composition services; subtitling; calligraphy services; teaching; orchestra services; translation; recording studio services; photography; photographic reporting; boarding school education; production of shows; booking of seats for shows; sport camp services; providing museum facilities [presentation, exhibitions]; scriptwriting, other than for advertising purposes; ticket agency services [entertainment]; publication of texts, other than publicity texts; rental of stadium facilities; rental of cinematographic apparatus; rental of sound recordings; videotape film production, other than advertising films; holiday camp services [entertainment]; organization of competitions [education or entertainment]; providing recreation facilities; organization of exhibitions for cultural or educational purposes; providing on-line electronic publications, not downloadable; game services provided online from a computer network; presentation of variety shows; layout services, other than for advertising purposes; nightclub services [entertainment]; entertainment club services; health club services [health and fitness training]; nursery schools.

42 – Computer system analysis; graphic arts design; computer virus protection services; installation of computer software; computer software consultancy; updating of computer software; design of interior decor; conversion of data or documents from physical to electronic media; computer system design; rental of web servers; computer rental; duplication of computer programs; computer software design; creating and maintaining web sites for others; computer programming; hosting web sites on the Internet; rental of computer software; conversion of computer programs and data, other than physical conversion; computer software support services; recovery of computer data.

(260) AM 2019 99205 A
 (800) 1420267
 (151) 2018 06 29
 (891) 2018 06 29
 (731) NOVARTIS AG
 CH-4002 Basel, Switzerland
 (540)

Precision 

(591) Black, white
 (531) 26.01.03; 26.01.17
 (511)
 9 – Contact lenses.

(260) AM 2019 99206 A
 (800) 1420269
 (151) 2018 03 28
 (891) 2018 03 28
 (731) KOVAL ALEKSANDR NIKOLAEVICH
 Fermerskoe shosse, 14, building 1, kv. 131,
 RU-197341 St. Petersburg, Russian Federation
 (540)

NiKA
kids

(591) Black, white
 (531) 27.05.10; 27.05.17; 27.05.19
 (511)
 12 – Bicycles; cycles; pushchairs; prams [baby carriages]; strollers; baby carriages; sleighs [vehicles]; sleds [vehicles]; kick sledges; sled-strollers; sled-pushchairs; push scooters [vehicles]; snowmobiles; snow scooters [vehicles]; tricycles; delivery tricycles; carrier tricycles; wheelbarrows; handling carts; shopping trolleys; stroller covers; pushchair covers; covers for baby carriages; seat covers for vehicles; vehicle covers [shaped].

16 – Writing slates; drawing boards; catalogues; graphic prints; painters' easels on metal frame made of bent pipes; printed matter; prospectuses; shields [paper seals]; labels, not of textile.

20 – Coatstands of metal; coat hangers of metal; clothes hangers of metal; furniture casters, not of metal; curtain hooks; metal furniture made of bent pipes; metal furniture for children, made of bent pipes; outdoor furniture on the metal frame for summer house; seats on metal frame; steps [ladders], not of metal; metal folding chairs for fisherman and summer visitor; stools on metal frame, including made of bent pipes; garment covers [storage]; easy chairs.

28 – Snow tubes; equipment for snow tubing; scooters [toys]; sleds [sport articles]; bob-sleighs; snow sleds for recreational use; slides [playthings].

(260) AM 2019 99207 A
 (800) 1420319
 (151) 2018 06 18
 (891) 2018 06 18
 (731) Davidoff & Cie SA
 Rue de Rive 2, CH-1200 Genève, Switzerland
 (540)



(591) Black, white
 (531) 26.07.25; 27.05.11; 27.05.19
 (511)
 34 – Tobacco, raw or manufactured; tobacco products; tobacco substitutes, for non-medicinal and non-curative use; cigarettes; electronic cigarettes; liquids for electronic cigarettes; smokers' articles, cigarette lighters; ashtrays; matches.

(260) AM 2019 99209 A
 (800) 1420327
 (151) 2018 06 22
 (891) 2018 06 22
 (731) SOCIÉTÉ DES PRODUITS NESTLÉ S.A.
 CH-1800 Vevey, Switzerland
 (540)

Вкус лета

(591) Black, white
 (531) 28.05
 (511)
 30 – Cocoa and cocoa-based beverages and preparations; chocolate, chocolate products, chocolate paste, chocolate spread, chocolate-based preparations and beverages; confectionery, sugar confectionery, candy; sugar confectionery, including fruit jellies; marshmallows; biscuits, cookies; cakes, cookies, wafers, caramels; ice cream, water ices, sherbets, frozen confectionery, frozen cakes, frozen desserts, frozen yogurts.

(260) AM 2019 99210 A
 (800) 1420332
 (151) 2018 06 12
 (891) 2018 06 12

(731) SOCIÉTÉ DES PRODUITS NESTLÉ S.A.
 CH-1800 Vevey, Switzerland

Забавный медвежонок

(591) Black, white
 (531) 28.05
 (511)
 30 – Chocolate, chocolate products, chocolate paste, chocolate spread, chocolate-based preparations and beverages; confectionery, sugar confectionery, candy; sugar confectionery, including fruit jellies; marshmallows; biscuits, cakes, cookies, wafers, caramels.

(260) AM 2019 99211 A
 (800) 1420338
 (151) 2018 06 18
 (891) 2018 06 18
 (731) DAVIDOFF & CIE SA
 Rue de Rive 2, CH-1200 Genève, Switzerland
 (540)



(591) Black, white
 (531) 26.07.25
 (511)
 34 – Tobacco, raw or manufactured; tobacco products; tobacco substitutes, for non-medicinal and non-curative use; cigarettes; electronic cigarettes; liquids for electronic cigarettes; smokers' articles, cigarette lighters; ashtrays; matches.

(260) AM 2019 99212 A
 (800) 1420342
 (151) 2018 03 30
 (891) 2018 03 30
 (731) ASTELLAS PHARMA INC.
 5-1, Nihonbashi-Honcho 2-chome, Chuo-ku,
 Tokyo 103-8411, Japan
 (540)

БЕТМИГА

(591) Black, white
 (531) 28.05
 (511)
 5 – Pharmaceutical preparations for the treatment of urinary diseases.

(260) AM 2019 99213 A
 (800) 1420364
 (151) 2018 04 18
 (891) 2018 04 18
 (731) "AnviLab" Company Limited
 Festivalnaya str. 10, Sergiev Posad, Urban
 settlement Sergiev Posad, Sergiev-Posad
 municipal district, RU-141302 Moscow,
 Russian Federation
 (540)

Sustaguard Artro

(591) Black, white
 (511)
 5 – Analgesics; antibiotics; first-aid boxes, filled; vaccines; dietetic substances adapted for medical use; nutritional supplements; capsules for medicines; cachets for pharmaceutical purposes; adhesive plasters; liniments; ointments for pharmaceutical purposes; medicinal oils; drugs for medical purposes; medicines for human purposes; medicines for veterinary purposes; dietetic beverages adapted for medical purposes; veterinary preparations; vitamin preparations; pharmaceutical preparations; chemico-pharmaceutical preparations; dietetic foods adapted for medical purposes; tissues impregnated with pharmaceutical lotions; suppositories; preparations of trace elements for human and animal use.

(260) AM 2019 99222 A
 (800) 1420565
 (151) 2018 08 01
 (891) 2018 08 01
 (731) JANSSEN PHARMACEUTICA NV
 Turnhoutseweg 30, B-2340 BEERSE,
 Belgium
 (540)

RYGLENTI

(591) Black, white
 (511)
 5 – Human pharmaceutical preparations.

(260) AM 2019 99225 A
 (800) 903087
 (151) 2006 09 01
 (891) 2018 07 13
 (731) TOYO TIRE CORPORATION
 2-2-13 Fujinoki, Itami-shi, Hyogo 664-0847,
 Japan
 (540)

OPEN COUNTRY

(591) Black, white
 (531) 27.05.01
 (511)
 12 – Tires (for automobiles); inner tubes (for automobile tires); wheels (of automobiles); automobiles

and their parts and fittings; vessels and their parts and fittings (other than air cushion vehicles); air-cushion vehicles; aircraft and their parts and fittings; railway rolling stock and their parts and fittings; two-wheeled motor vehicles, bicycles and their parts and fittings; baby carriages (prams); rickshaws; sleighs and sleds; wheelbarrows; carts; horse drawn carriages; bicycle trailers (riyakah); adhesive rubber patches for repairing tubes or tires.

(260) AM 2019 99226 A
 (800) 912339
 (151) 2006 12 28
 (891) 2018 08 10
 (731) HEINEKEN IRELAND LIMITED
 58 Leirim Street, Cork, Ireland
 (540)



(591) Gold, cream, white, brown, red, black and blue
 (531) 24.01.03; 24.01.09; 24.05.05; 25.01.15;
 29.01.13
 (511)
 32 – Beer, ale, porter and stout.

(260) AM 2019 99227 A
 (800) 969362
 (151) 2008 06 27
 (891) 2018 07 25
 (731) PLANTIN
 Usine de la Rolande, F-84350
 COURTHEZON, France
 (540)



(591) Blue (Pantone 288C), red (Pantone 193C on a white background)
 (531) 26.11.12; 27.05.07; 27.05.11; 29.01.12
 (511)
 1 – Organic-mineral compound fertilizers; mineral compound fertilizers; binary potassic fertilizers; superphosphates (fertilizers); soluble fertilizers; foliar fertilizers; preparation of trace elements for plants; organic soil improvers.

(260) AM 2019 99228 A

(800) 1309925

(151) 2015 12 09

(891) 2018 05 16

(731) ROMAN KHORUZHYY

vul. Novhorodska, 10, kv. 86, m. Kharkiv
61145, Ukraine

(540)



(591) Blue and black colours

(531) 26.05.01; 27.05.23; 29.01.12

(511)

17 – Acrylic resins (semi-finished products); adhesive bands, other than stationery and not for medical or household purposes; anti-dazzle films for windows; asbestos; asbestos cloth; asbestos coverings; asbestos fabrics; asbestos felt; asbestos fibers; asbestos millboards; asbestos packing; asbestos paper; asbestos safety curtains; asbestos sheets; asbestos slate; bags of rubber, for packaging; balata; bark coverings for sound insulation; boiler composition to prevent the radiation of heat; brake lining materials, partly processed; canvas hose pipes; carbon fibers, other than for textile use; caulking materials; cellulose acetate, semi-processed; chemical compositions for repairing leaks; clack valves of rubber; clutch linings; compositions to prevent the radiation of heat; compressed air pipe fittings, not of metal; connecting hose for vehicle radiators; cords of rubber; cotton wool for packing (caulking); cylinder jointings; dielectrics; ebonite; ebonite molds; elastic threads, not for use in textiles; expansion joint fillers; fiberglass fabrics, for insulation; fiberglass for insulation; filtering materials (semi-processed foams or films of plastic); flexible tubes, not of metal; floating anti-pollution barriers; foam supports for flower arrangements (semi-finished products); foils of metal for insulating; gaskets; glass wool for insulation; gum, raw or semi-worked; guttapercha; hoses of textile material; insulating fabrics; insulating felt; insulating gloves; insulating materials; insulating oil for transformers; insulating oils; insulating paints; insulating paper; insulating plaster; insulating refractory materials; insulating tape; insulating varnish; insulators; insulators for cables; insulators for electric mains; insulators for railway tracks; junctions, not of metal, for pipes; latex (rubber); liquid rubber; lute; mica, raw or partly processed; mineral wool (insulator); non-conducting materials for retaining heat; packing materials of rubber or plastics; padding materials of rubber or plastics; paper for electrical capacitors; pipe gaskets; pipe muffers, not of metal; plastic fibers, not for textile use; plastic film, not for wrapping; plastic sheeting for agricultural purposes; plastic substances, semi-processed; reinforcing materials, not of metal, for pipes; rings of rubber; rubber material for recapping tires; rubber, raw or

semi-worked; rubber seals for jars; rubber solutions; rubber stoppers; sealant compounds for joints; self-adhesive tapes, other than stationery and not for medical or household purposes; sheets of regenerated cellulose, other than for wrapping; shock-absorbing buffers of rubber; slag wool (insulator); sleeves of rubber for protecting parts of machines; soundproofing materials; stops of rubber; substances for insulating buildings against moisture; synthetic resins (semi-finished products); synthetic rubber; threads of plastic for soldering; threads of plastic materials, not for textile use; threads of rubber, not for use in textiles; valves of india-rubber or vulcanized fiber; viscose sheets, other than for wrapping; vulcanized fiber; washers of rubber or vulcanized fiber; watering hose; waterproof packings; water-tight rings; weatherstripping; weatherstripping compositions.

(260) AM 2019 99229 A

(800) 1328525

(151) 2016 10 13

(891) 2018 06 07

(731) NEXUS AUTOMOTIVE INTERNATIONAL SA

Chemin de Château Bloch 11, CH-1219 Le
Lignon – Genève, Switzerland

(540)

NEXUSTRUCK

(591) Black, white

(511)

12 – Vehicles; apparatus for locomotion by land, air or water, excluding bicycles, parts and components of bicycles as well as two-wheeled and three-wheeled motor vehicles.

37 – Maintenance and repair of motor vehicles; rebuilding of worn or partially destroyed engines; repair information; retreading of tires; rustproofing; wheel balancing services; vehicle lubrication [greasing]; vehicle washing; vehicle polishing; vehicle service stations [refueling and maintenance]; vehicle maintenance (servicing); vehicle cleaning; repair services in the case of vehicle breakdown; charging of vehicle batteries; vulcanization of tires [repair]; warehouse construction and repair.

(260) AM 2019 99230 A

(800) 1332182

(151) 2016 10 13

(891) 2018 06 07

(731) NEXUS AUTOMOTIVE INTERNATIONAL SA

Chemin du Château-Bloch 11, CH-1219 Le
Lignon, Switzerland

(540)



(591) Dark gray (Pantone PMS 425) and orange
(Pantone PMS 1505)

(531) 24.17.04; 25.03.03; 26.07.04; 26.07.11;
29.01.12

(511)

12 – Vehicles; apparatus for locomotion by land, air or water, excluding bicycles as well as parts and components of bicycles.

37 – Maintenance and repair of motor vehicles; re-building of worn or partially destroyed engines; repair information; retreading of tires; rustproofing; wheel balancing services; vehicle lubrication [greasing]; vehicle washing; vehicle polishing; vehicle service stations [refueling and maintenance]; vehicle maintenance (servicing); vehicle cleaning; repair services in the case of vehicle breakdown; charging of vehicle batteries; vulcanization of tires [repair]; warehouse construction and repair.

(260) AM 2019 99232 A

(800) 1365857

(151) 2017 03 07

(891) 2018 06 20

(731) Private joint-stock company "KREMENCHUK PLANT OF ROAD MACHINES"

4, Svobody avenue, Kremenchug, Poltava region 39600, Ukraine

(540)

(591) Black, white

(531) 28.05

(511)

21 – Dish covers; manual glass jar sealers for household purposes; household utensils, non-electric, used during sterilization of jars; funnels; buckets; bowls (basins); fruit presses, non-electric, for household purposes.

(260) AM 2019 99233 A

(800) 1365858

(151) 2017 03 07

(891) 2018 06 20

(731) Private joint-stock company "KREMENCHUK PLANT OF ROAD MACHINES"

4, Svobody avenue Kremenchug, Poltava region 39600, Ukraine

(540)

(591) Black, white

(531) 27.05.21; 28.05

(511)

21 – Dish covers; manual glass jar sealers, non-electric, for household purposes; household utensils, non-electric, used during sterilization of jars; funnels; buckets.

(260) AM 2019 99234 A

(800) 1393073

(151) 2017 09 26

(891) 2018 07 16

(731) A.V.K. CONFECTIONERY HOLDINGS LIMITED

1, Lampousas Street, CY-1095 Nicosia, Cyprus

(540)



(591) Yellow, mustard, red, white and brown

(531) 05.07.02; 05.07.06; 26.04.07; 26.04.18;
29.01.13

(511)

30 – Peanut confectionery; cereal bars; high-protein cereal bars; pastries; bread rolls; buns; vanillin [vanilla substitute]; waffles; oatmeal; cookies; cake frosting [icing]; glucose for culinary purposes; chocolate-coated nuts; gluten additives for culinary purposes; cereal-based snack food; artificial coffee; frozen yoghurt [confectionery ices]; wheat germ for human consumption; cereal preparations; ginger [spice]; coffee; unroasted coffee; coffee beverages with milk; cocoa; cocoa beverages with milk; caramels [candy]; potato flour; confectionery; confectionery for decorating Christmas trees; hominy grits; groats for human food; corn, milled; corn, roasted; corn flour; corn flakes; couscous [semolina]; liquorice [confectionery]; macaroni; pasta; hominy; semolina; marzipan; honey; molasses for food; almond paste; almond confectionery; ice cream; dessert mousses [confectionery]; chocolate mousses; nutmegs; muesli; mint for confectionery; peppermint sweets; tea-based beverages; star aniseed; infusions, not medicinal; crushed oats; husked oats; husked barley; stick liquorice [confectionery]; palm sugar; pastilles [confectionery]; fondants [confectionery]; pralines; candy decorations for cakes; seasonings; unleavened bread; gingerbread; puddings; cake powder; wheat flour; preparations for stiffening whipped cream; rice; rice pudding; rice cakes; vegetal preparations

for use as coffee substitutes; sago; golden syrup; malt extract for food; sweetmeats [candy]; sauces [condiments]; rusks; breadcrumbs; petit-beurre biscuits; sushi; tabbouleh; tapioca; cakes; dough; cake batter; pastry dough; fruit jellies [confectionery]; halvah; candy; cheeseburgers [sandwiches]; chocolate; chocolate beverages with milk.

(260) AM 2019 99245 A

(800) 1420969

(151) 2018 06 06

(891) 2018 06 06

(731) TEATRO FRAGRANZE UNICHE S.R.L.
Via Palmiro Togliatti, 6, I-50023 Impruneta
(FI), Italy

(540)

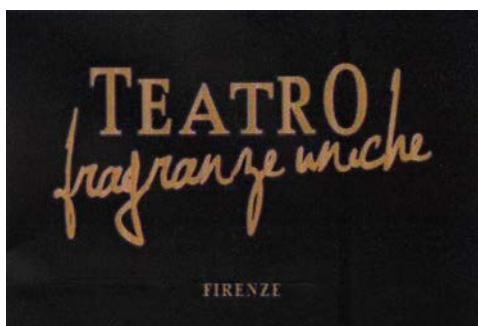

(591) Gold and black

(531) 27.05.09; 27.05.24; 29.01.12

(511)

3 – Soaps, perfumery, essential oils, cosmetics, hair lotions.

(260) AM 2019 99247 A

(800) 1421056

(151) 2018 06 21

(891) 2018 06 21

(731) AGRO SELECTIONS FRUITS
La Prade de Mousseillous, F-66200 ELNE,
France

(540)

CANDINE

(591) Black, white

(511)

31 – Fresh fruit; non-prepared fruit; apples; raw apples; fresh apples; non-prepared apples.

(260) AM 2019 99248 A

(800) 1421057

(151) 2018 02 09

(891) 2018 02 09

(731) L.B. PLAST S.r.l.
Viale Francia, 19, I-35020 Tribano (PD),
Italy

(540)



(591) Black, white, blue, light blue and grey

(531) 01.15.15; 14.01.01; 26.04.18; 29.01.13

(511)

6 – Pipes, tubes and hoses, and fittings therefor, including valves, of metal; drain pipes of metal; drain traps (valves) of metal; metal hose fittings; metal hoses for plumbing use; junctions of metal for pipes; floor drains of metal; drains made of metal; drain traps of metal; plugs of metal for wash basins.

11 – Water supply installations; sanitary apparatus and installations; flexible pipes being parts of sink plumbing installations; flexible pipes being parts of basin plumbing installations; valves [plumbing fittings]; faucet filters [plumbing fittings]; waste pipes for sanitary installations; water filtering apparatus; fittings for the draining of water; waste fittings for basins; waste fittings for sinks; bath sanitary installations; flexible strip wound pipes of metal [parts of sanitary installations]; waste fittings for sanitary ware; bath fittings; sanitary water conduit fittings; strainers for water lines; sink strainer (plumbing fittings); bath plumbing fixture; plumbing fixture namely, drain traps, sink and basin wastes; plumbing fittings for the draining of water for sinks and basins; water distribution installations; water pipes for sanitary installations; elbow bends (plastic -) for pipes (parts of sanitary installations); strainer wastes in metal.

(260) AM 2019 99285 A

(800) 1421922

(151) 2018 07 12

(891) 2018 07 12

(731) RIEDEL COMMUNICATIONS
INTERNATIONAL GMBH
Uellendahler Str. 353, 42109 Wuppertal,
Germany

(540)

PUNQTUM

(591) Black, white

(511)

9 – Studio technology apparatus, namely apparatus for recording, playing and storing audio data; software, in particular application software for mobile terminals; telecommunications equipment, signalling and checking (supervision) apparatus and instruments, apparatus for recording, transmission or reproduction of sound or images; data processing apparatus and computers, network data processing apparatus and network computers, all for use on audio,

video and telecommunications networks; audio, video and/or telecommunications networks and components therefor.

(260) AM 2019 99288 A

(800) 1421966

(151) 2018 07 26

(891) 2018 07 26

(731) DR. THEISS NATURWAREN GMBH

Michelinstr. 10, 66424 Homburg, Germany

(540)

HAIR MASCARAméd

(591) Black, white

(511)

3 – Bleaching preparations and other substances for laundry use; cleaning, polishing, scouring and abrasive preparations; perfumery, essential oils, non-medicated cosmetics, including non-medicated skin cleaning and skin care preparations, and hair care preparations; non-medicated dentifrices.

5 – Pharmaceutical and veterinary preparations; medicines for human purposes; medicines for veterinary purposes; sanitary preparations for medical purposes; dietetic foodstuffs and substances adapted for medical use; nutritional supplements for humans and animals; vitamin preparations.

(260) AM 2019 99289 A

(800) 1421981

(151) 2017 12 19

(891) 2017 12 19

(731) MOTOROLA TRADEMARK HOLDINGS, LLC

222 W. Merchandise Mart Plaza, Suite 1800,
Chicago IL 60654, USA

(540)

MOTOROLA

(591) Black, white

(511)

9 – Scientific, nautical, surveying, photographic, cinematographic, optical, weighing, measuring, signalling, checking (supervision), life-saving and teaching apparatus and instruments; apparatus and instruments for conducting, switching, transforming, accumulating, regulating or controlling electricity; apparatus for recording, transmission or reproduction of sound or images; magnetic data carriers, recording discs; compact discs, DVDs and other digital recording media; calculating machines, data processing equipment; mobile phones; cell phones; smart phones; cordless telephones; smart watches; wireless communication devices; computers; tablet computers; laptop computers; work stations [computers]; mobile workstations; computer modems; USB modems; cable modems; computer servers; network

routers; computer network hubs; external computer hard drives; electrical adapters; devices providing Internet gateways; data storage devices, namely, flash drives, Secure Digital (SD) Memory Cards; keyboards [computers]; mouse [computers]; computer docking stations; scanners [data processing equipment]; 3D scanners; headphones; devices for streaming media content over local wireless networks, namely, media streaming boxes and media streaming sticks; speakerphones; headsets for telephones; wireless headsets; mobile phone base stations; docking stations [mobile phones]; earbuds; virtual reality hardware; virtual reality headsets; virtual reality software; 3D glasses; wearable fitness tracker; cases for smart phones; cases for computers; covers for smart phones; covers for tablet computers; mobile phone display screen protectors in the nature of films; batteries, electric; battery chargers; accumulators, power packs [batteries]; computer operating software; computer software, recorded; computer software applications, downloadable; computer programs [downloadable software]; software and applications for mobile devices; remote control apparatus for opening and closing vehicle doors; computerized vehicle engine analyzers; digital video players for car; dashboard cameras; rearview cameras for vehicles; navigation apparatus for vehicles [on-board computers]; tire pressure gauges; automatic indicators of low pressure in vehicle tires; vehicle radios; hands-free kits for telephones; cameras [photography]; audio speakers; portable electronic wireless speakers; wireless charging units for mobile phones for use with wireless charging pads; wireless charging pads; dashboard mounts for mobile phones; MP3 players, MP4 players; digital video disc players, digital video players; digital video recorders; television apparatus; set-top boxes; video projectors; power adapters; charging appliances for rechargeable equipment; solar panels for the production of electricity; voltage surge protectors; power strips with movable sockets; electrical power extension cords; audio-video (AV) cords; cables, electric; connectors [electricity]; USB cables, HDMI cables, Ethernet and audio cables and connectors; electronic adapters; wireless controllers to remotely monitor and control the function and status of other electrical, electronic, and mechanical devices or systems; control panels [electricity]; joysticks for use with computers, other than for video games; baby monitors; scales; pet monitors; electronic collars to train animals; wireless pet fencing system consisting of a wireless transmitter and an electronic collar to train animals; monitoring apparatus, electric; slatted blind controls [electric]; remote controllers for controlling electronic products; remote controls for window shades; measuring apparatus, namely, particle counters, CO2 detectors and smoke detectors; fire alarms; thermostats; barometers; hygrometers; temperature monitors and sensors; water leakage detection

alarms; digital weather stations; digital thermometers, not for medical purposes; locks, electric; lighting control apparatus; light dimmers [regulators], electric; doorbell cameras; door and window sensors; motion sensors; acoustic [sound] alarms; security alarms; satellite navigational apparatus; navigational instruments; directional compasses; GPS navigation devices; GPS tracking and location devices; beacons, luminous; digital binoculars; digital photo frames; body worn cameras; body worn camera accessories namely connecting cables, vest mounts, shoulder straps, windshield mounts, micro-USB chargers, carry holsters, multi-unit chargers, batteries, battery charging trays, wireless speakers that have Bluetooth capability, receive-only earpieces; microphones; two-way radio base stations; two-way radio repeater; two-way radio accessories namely wireless push-to-talk (PTT) button, headsets, rechargeable batteries, ear receivers, faceplates, wall stands, desk stands, belt clips, carrying cases, microphones, wall chargers; interconnect gateway to allow a radio system to connect to Public Switched Telephone Network (PSTN) or Private Branch Exchange (PBX) telephone system; data encryption apparatus and equipment; radio pagers; two-way radio trunking devices and systems; radio dispatch consoles for commercial or public safety use; wireless dispatch two-way radio system consoles; Voice-over-IP (VOIP) telecommunication devices and systems; deskset radio system hardware devices for use in public safety and corresponding systems consisting of these goods; portable LTE (Long Term Evolution) infrastructure devices and corresponding systems consisting of these goods to provide incident scene video streaming; supervisory control and data acquisition (SCADA) remote terminal equipment for use in industrial settings; instruction manuals in electronic format; watches with wireless communication functions; bracelets [jewellery] incorporating functions of watches, including speed sensors, pace counters, apparatus for measuring calorie consumption, distances, momentums, heartbeat measuring monitors and built-in pedometers.

(260) AM 2019 99292 A
 (800) 1362645
 (151) 2017 06 01
 (891) 2018 07 27
 (731) ABBOTT PRODUCTS OPERATIONS AG
 Hegenheimermattweg 127, CH-4123
 Allschwil, Switzerland
 (540)



The logo for 'a:care' features the word 'a:care' in a bold, blue, sans-serif font. The colon is replaced by a vertical line with a dot above and below it, resembling a stylized 'a' or a vertical separator.

(591) Light blue and dark blue
 (531) 24.17.02; 29.01.04

(511)
 9 – Computer software; electronic publications, being downloadable; applications for electronic apparatus, particularly for smartphones and computers.

16 – Instructional or teaching material (except apparatus); printing products; printed publications, books, teaching documents, pamphlets, manuals, calendars, posters, placards of paper or cardboard, paintings, stickers, stamps.

41 – Education; provision of training by electronic means and also via the Internet; preparation and hosting of colloquiums, conferences, congresses, symposiums, seminars and training workshops.

42 – Scientific and technological services as well as research and design services relating thereto; industrial analysis and research services; design and development of computers and software.

44 – Medical services.

(260) AM 2019 99293 A
 (800) 1370554
 (151) 2017 07 10
 (891) 2018 07 24
 (731) OERLEMANS FOODS SIEMIATYCZE SP.
 Z O.O.
 ul. Armii Krajowej 31, PL-17-300
 Siemiatycze, Poland

(540)



(591) Gold, white and blue
 (531) 01.15.11; 26.01.20; 26.04.10; 26.11.01;
 26.11.09; 27.05.01; 27.05.11; 29.01.13

(511)

29 – Processed fruits, vegetables and mushrooms; ready meals having a fruit, vegetable and mushroom base; soups and broths; snacks and desserts having a fruit, vegetable, milk and milk-products base.

(260) AM 2019 99369 A
 (800) 1422011
 (151) 2018 06 26
 (891) 2018 06 26
 (731) FOOD FOR LIFE BAKING CO., INC.
 2991 East Doherty, Corona CA 92879, USA
 (540)

SPROUTSMART

(591) Black, white

(511)
30 – Pasta; baked goods, namely, bread, pita bread, bagels, rolls, cookies, biscuits, crackers, croutons, bagel chips, buns, chips and muffins; grain based food bars; tortillas; grain based snack foods; mixes for bakery goods; cake mixes; flour; biscuit mixes; muffin mixes; scone mixes; cookie mixes; brownie mixes; bread mixes; baked goods, namely, bread, buns and muffins; tortillas.

(260) AM 2019 99371 A
(800) 1422085
(151) 2018 04 20
(891) 2018 04 20
(731) UNICAL AG S.P.A.
Via Roma, 123, I-46033 CASTEL D'ARIO
(MANTOVA), Italy

(540)

WIESBERG

(591) Black, white
(531) 27.05.01
(511)

11 – Boilers; domestic boilers; heating boilers; central heating boilers; gas boilers for central heating; gas boilers [other than parts of machines]; biomass, diesel, diathermic oil and superheated water boilers; heat exchangers; heat pumps in individual form or in integrated systems; apparatus for accounting for and distributing energy in buildings, namely heat cost allocators [parts for heating and air conditioning installations]; space heaters; air heating installations; gas fired space heating apparatus; boilers for central heating installations and components thereof; air-conditioning installations; solar collectors for heating; solar thermal collectors [heating]; radiant linear heating systems; equipment for heating, ventilating, air conditioning and air purification [for indoor use]; HVAC [heating, ventilating and air conditioning] systems; de-aerators [parts for heating and air conditioning installations]; economisers [parts for heating and air conditioning installations]; collection and cooling condenser tanks [parts for heating and air conditioning installations]; apparatus for lighting, heating, steam generating, cooking, refrigerating, drying, ventilating, water supply and sanitary purposes.

(260) AM 2019 99373 A
(800) 1422205
(151) 2018 05 14
(891) 2018 05 14
(731) EGIS GYÓGYSZERGYÁR ZRT.
Keresztúri út 30-38., H-1106 Budapest,
Hungary

(540)

ТОРВАЗИН

(591) Black, white
(531) 28.05
(511)
5 – Pharmaceutical preparations for human use.

(260) AM 2019 99374 A
(800) 1422220
(151) 2018 05 17
(891) 2018 05 17
(731) Limited Liability Company "RPE BIOTUM"
Noyabrskaya str., 144, mkr. Yuryevets,
RU-600901 g. Vladimir, Russian Federation

(540)

BIOTUM

(591) Black, white
(511)

17 – Acrylic resins [semi-finished products]; adhesive bands, other than stationery and not for medical or household purposes; anti-dazzle films for windows [tinted films]; asbestos; asbestos cloth; asbestos coverings; asbestos fabrics; asbestos felt; asbestos fibers [fibres]; asbestos millboards; asbestos packing; asbestos paper; asbestos safety curtains; asbestos sheets; asbestos slate; bags [envelopes, pouches] of rubber, for packaging; balata; bark coverings for sound insulation; boiler composition to prevent the radiation of heat; brake lining materials, partly processed; canvas hose pipes; carbon fibers [fibres], other than for textile use; caulking materials; cellulose acetate, semi-processed; chemical compositions for repairing leaks; clack valves of rubber; clutch linings; compositions to prevent the radiation of heat; connecting hose for vehicle radiators; cords of rubber; cotton wool for packing [caulking]; cylinder jointings; dielectrics [insulators]; door stops of rubber; duct tapes; ebonite [vulcanite]; ebonite [vulcanite] molds [moulds]; elastic threads, not for use in textiles; expansion joint fillers; fiberglass [fibreglass] fabrics, for insulation; fiberglass for insulation; filtering materials [semi-processed foams or films of plastic]; fittings, not of metal, for compressed air lines; fittings, not of metal, for flexible pipes; fittings, not of metal, for rigid pipes; flexible hoses, not of metal; floating anti-pollution barriers; foam supports for flower arrangements [semi-finished products]; foils of metal for insulating; gaskets; glass wool for insulation; gum, raw or semi-worked; gutta-percha; hoses of textile material; insulating fabrics; insulating felt; insulating gloves; insulating materials; insulating oil for transformers; insulating oils; insulating paints; insulating paper; insulating plaster; insulating refractory materials; insulating tapes; insulating varnish; insulators; insulators for cables; insulators for electric mains; insulators for railway tracks; junctions, not of metal, for flexible pipes; latex [rubber]; liquid rubber; lute; mica, raw or partly processed; mineral wool [insulator]; non-conducting

materials for retaining heat; packing [cushioning, stuffing] materials of rubber or plastics; padding materials of rubber or plastics; paper for electrical capacitors; pipe gaskets; pipe muffers, not of metal; plastic fibers [fibres], not for textile use; plastic film, other than for wrapping; plastic sheeting for agricultural purposes; plastic substances, semi-processed; reinforcing materials, not of metal, for pipes; rings of rubber; rubber material for recapping tires [tyres]; rubber, raw or semi-worked; rubber seals for jars; rubber solutions; rubber stoppers; sealant compounds for joints; self-adhesive tapes, other than stationery and not for medical or household purposes; sheets of regenerated cellulose, other than for wrapping; shock-absorbing buffers of rubber; slag wool [insulator]; sleeves of rubber for protecting parts of machines; soundproofing materials; stops of rubber; substances for insulating buildings against moisture; synthetic resins [semi-finished products]; synthetic rubber; threads of plastic for soldering; threads of plastic materials, not for textile use; threads of rubber, not for use in textiles; valves of india-rubber or vulcanized fiber [fibre]; viscose sheets, other than for wrapping; vulcanized fiber [fibre]; washers of rubber or vulcanized fiber [fibre]; watering hose; waterproof packings; water-tight rings; weathers-tripping; weatherstripping compositions; window stops of rubber.

19 – Advertisement columns, not of metal; agglomerated bagasses of cane [building material]; agglomerated cork for building; alabaster; alabaster glass; angle irons, not of metal; aquaria [structures]; aquarium gravel; aquarium sand; arbours [structures], not of metal; armored doors, not of metal; armour-plating, not of metal; artificial stone; asbestos cement; asbestos mortar; asphalt; asphalt paving; aviaries [structures], not of metal; balustrades, not of metal; beacons, not of metal, non-luminous; beams, not of metal; bicycle parking installations, not of metal; binding agents for making briquettes; bitumen; bitumen paper for building; bituminous coatings for roofing; bituminous products for building; brackets, not of metal, for building; branching pipes, not of metal; bricks; building glass; building materials, not of metal; building panels, not of metal; building paper; buildings, not of metal; building stone; buildings, transportable, not of metal; building timber; burial vaults, not of metal; busts of stone, concrete or marble; cabanas, not of metal; caissons for construction work under water; calcareous marl; casement windows, not of metal; cask wood; ceilings, not of metal; cement; cement for blast furnaces; cement for furnaces; cement posts; cement slabs; chicken-houses, not of metal; chimney cowl, not of metal; chimney pots, not of metal; chimney shafts, not of metal; chimneys, not of metal; cladding, not of metal, for building; clay; clinker ballast; clinker stone; coal tar; coatings [building materials]; concrete; concrete building elements; cornices, not

of metal; crash barriers, not of metal, for roads; diving boards, not of metal; door frames, not of metal; door panels, not of metal; doors, not of metal; drain pipes, not of metal; drain traps [valves], not of metal or plastic; duckboards, not of metal; ducts, not of metal, for ventilating and air-conditioning installations; earth for bricks; enamelled glass, for building; fair huts; felt for building; fences, not of metal; figurines [statuettes] of stone, concrete or marble; fire burrs; fireplace mantles, not of metal; fireproof cement coatings; flagpoles, not of metal; flashing, not of metal, for building; floating docks, not of metal, for mooring boats; floors, not of metal; floor tiles, not of metal; folding doors, not of metal; foundry molds [moulds], not of metal; framework, not of metal, for building; furrings of wood; gates, not of metal; geotextiles; glass granules for road marking; granite; gravel; grave slabs, not of metal; gravestones; greenhouse frames, not of metal; greenhouses, transportable, not of metal; grog [fired refractory material]; gutter pipes, not of metal; gypsum; hips for roofing; huts; insect screens, not of metal; insulating glass for building; jalousies, not of metal; joists, not of metal; laths, not of metal; lengthening pieces, not of metal, for chimneys; letter boxes of masonry; lime; limestone; linings, not of metal, for building; lintels, not of metal; luminous paving blocks; macadam; magnesia cement; manhole covers, not of metal; manufactured timber; marble; masts [poles], not of metal; materials for making and coating roads; memorial plaques, not of metal; moldable wood; moldings, not of metal, for building; moldings, not of metal, for cornices; monuments, not of metal; mooring bollards, not of metal; mortar for building; mosaics for building; non-luminous and non-mechanical signs, not of metal; olivine for building; outdoor blinds, not of metal and not of textile; paint spraying booths, not of metal; palisading, not of metal; pantiles, not of metal; paperboard for building; parquet floor boards; parquet flooring; partitions, not of metal; paving blocks, not of metal; paving slabs, not of metal; penstock pipes, not of metal; perches; pigsties, not of metal; pillars, not of metal, for building; pitch; planks of wood for building; plaster; plastic landscape edgings; plate glass [windows] for building; platforms, prefabricated, not of metal; plywood; poles, not of metal, for power lines; porches [structures], not of metal; porphyry [stone]; posts, not of metal; potters' clay; potters' clay [raw material]; prefabricated houses [kits], not of metal; props, not of metal; quartz; railway sleepers, not of metal; raw chalk; reeds for building; refractory construction materials, not of metal; reinforcing materials, not of metal, for building; rigid pipes, not of metal, for building; road coating materials; road marking sheets and strips of synthetic material; road signs, non-luminous and non-mechanical, not of metal; rock crystal; rocket launching platforms, not of metal; roof coverings, not of metal; roof flashing, not of

metal; roof gutters, not of metal; roofing, not of metal, incorporating solar cells; roofing shingles; roofing tiles, not of metal; rubber bearings for seismic isolation of buildings; rubble; safety glass; sand, except foundry sand; sandstone for building; sandstone pipes; sawn timber; scaffolding, not of metal; scantlings [carpentry]; schists; sheet piles, not of metal; shuttering, not of metal, for concrete; shutters, not of metal; signalling panels, non-luminous and non-mechanical, not of metal; silica [quartz]; sills, not of metal; silos, not of metal; silver sand; skating rinks [structures], not of metal; slabs, not of metal, for building; slag [building material]; slate; slate powder; stables, not of metal; stained-glass windows; staircases, not of metal; stair-treads [steps], not of metal; statues of stone, concrete or marble; stone; street gutters, not of metal; stringers [parts of staircases], not of metal; swimming pools [structures], not of metal; tanks of masonry; tar; tarred strips for building; telegraph posts, not of metal; telephone booths, not of metal; terra cotta; tile floorings, not of metal; tiles, not of metal, for building; tomb or grave enclosures, not of metal; tombs [monuments], not of metal; tombs, not of metal; tombstone plaques, not of metal; tombstone stelae, not of metal; trellises, not of metal; tufa; turnstiles, not of metal; veneer wood; vinyl siding; wainscoting, not of metal; wall claddings, not of metal, for building; wall linings, not of metal, for building; wall tiles, not of metal; water-pipes, not of metal; water-pipe valves, not of metal or plastic; window frames, not of metal; window glass for building; window glass, other than vehicle window glass; windows, not of metal; wooden floor boards; wood for making household utensils; wood panelling; wood paving; wood pulp board for building; wood, semi-worked; wood veneers; works of art of stone, concrete or marble; works of stonemasonry; xylolith.

37 – Airplane maintenance and repair; anti-rust treatment for vehicles; artificial snow-making services; asphaltting; boiler cleaning and repair; bricklaying; building construction supervision; building insulating; building of fair stalls and shops; building sealing; burglar alarm installation and repair; burner maintenance and repair; carpentry services; chimney sweeping; cleaning of buildings [exterior surface]; cleaning of buildings [interior]; cleaning of clothing; clock and watch repair; clothing repair; construction; construction consultancy; construction information; demolition of buildings; diaper cleaning; disinfecting; drilling of deep oil or gas wells; drilling of wells; dry cleaning; electric appliance installation and repair; elevator installation and repair; factory construction; film projector repair and maintenance; fire alarm installation and repair; freezing equipment installation and repair; fur care, cleaning and repair; furnace installation and repair; furniture maintenance; furniture restoration; harbour construction; heating equipment installation and repair; hydraulic

fracturing services; installation and repair of air-conditioning apparatus; installation, maintenance and repair of computer hardware; installation of doors and windows; interference suppression in electrical apparatus; irrigation devices installation and repair; kitchen equipment installation; knife sharpening; laundering; laying of cable; leather care, cleaning and repair; linen ironing; machinery installation, maintenance and repair; masonry; mining extraction; motor vehicle maintenance and repair; office machines and equipment installation, maintenance and repair; painting, interior and exterior; painting or repair of signs; paper hanging; parasol repair; pest control services, other than for agriculture, aquaculture, horticulture and forestry; photographic apparatus repair; pier breakwater building; pipeline construction and maintenance; plastering; plumbing; pressing of clothing; pumicing; pump repair; quarrying services; rat exterminating; rebuilding engines that have been worn or partially destroyed; rebuilding machines that have been worn or partially destroyed; refilling of toner cartridges; renovation of clothing; rental of bulldozers; rental of cleaning machines; rental of construction equipment; rental of cranes [construction equipment]; rental of dish drying machines; rental of dish washing machines; rental of drainage pumps; rental of excavators; rental of laundry washing machines; rental of road sweeping machines; repair information; repair of power lines; repair of security locks; restoration of musical instruments; restoration of works of art; re-tinning; re-reading of tires [tyres]; riveting; road paving; roofing services; rustproofing; safe maintenance and repair; sanding; scaffolding; shipbuilding; shoe repair; sterilization of medical instruments; street cleaning; strong-room maintenance and repair; swimming-pool maintenance; telephone installation and repair; tire balancing; tuning of musical instruments; umbrella repair; underwater construction; underwater repair; upholstering; upholstery repair; varnishing; vehicle battery charging; vehicle breakdown repair services; vehicle cleaning; vehicle lubrication [greasing]; vehicle maintenance; vehicle polishing; vehicle service stations [refuelling and maintenance]; vehicle washing; vermin exterminating, other than for agriculture, aquaculture, horticulture and forestry; vulcanization of tires [tyres] [repair]; warehouse construction and repair; washing; washing of linen; window cleaning.

(260) AM 2019 99378 A

(800) 1422292

(151) 2018 05 14

(891) 2018 05 14

(731) EGIS GYÓGYSZERGYÁR ZRT.

Keresztúri út 30-38., H-1106 Budapest,
Hungary

(540)

ЭГИТИМ

(591) Black, white

(531) 28.05

(511)

5 – Pharmaceutical preparations for human use.

(260) AM 2019 99379 A

(800) 1422301

(151) 2018 05 11

(891) 2018 05 11

(731) GOPPION CAFFE' S.P.A.

Via Terraglio, 48, Preganziol, LOC. SAN
TROVASO (TREVISO), Italy

(540)



(591) Black, white

(531) 26.01.18; 26.04.22; 26.04.24; 27.05.24

(511)

30 – Coffee; artificial coffee; instant coffee; coffee pods; coffee capsules, filled; mixtures of coffee; ground coffee; disposable ground coffee drippers, filled; instant barley; barley coffee in single-dose pods; barley-based beverages; espresso; caffeine-free coffee; coffee in whole-bean form; coffee in brewed form; freeze-dried coffee; coffee beans; unroasted coffee; roasted coffee beans; coffee concentrates; coffee extracts; chicory [coffee substitute]; chicory-based coffee substitutes; mixtures of coffee and chicory; vegetal preparations for use as coffee substitutes; coffee essences; coffee flavorings [flavourings], cocoa; chocolate; chocolate coffee; instant chocolate sachets; coffee-based beverages; cocoa-based beverages; chocolate-based beverages; coffee beverages with milk; coffee-based beverages containing milk; cocoa beverages with milk; chocolate beverages with milk; chamomile-based beverages; cappuccino; hot chocolate; tea, tea in filter bags and instant tea sachets; tea bags; iced tea; tea-based beverages; flowers or leaves for use as tea substitutes; aromatic teas [other than for medicinal use]; instant tea; theine-free tea; herbal teas, other than for medicinal use; tea capsules, filled; capsules containing herbal infusions; tea substitutes; tea beverages; mixes for making tea; tea pods, filled; infusions, not medicinal; processed ginseng for use as a herb, spice or flavouring for food or beverages; cocoa powder; chocolate powder; coffee-based sweets; sugar-coated coffee beans; chocolate products; confectionery; almond confectionery; chocolate-coated almonds;

cookies; candy; waffles; aromatic preparations for food; cones for ice cream; essences for foodstuffs, except etheric essences and essential oils; flavored ices; edible ices; ice cream; herbal infusions; binding agents for ice cream; cocoa mixes; sorbet mixes [ices]; powders for making ice cream; sherbets [ices]; frozen yogurt [confectionery ices]; sugar; sugar sachets; natural sweeteners; sugar substitutes; honey; ice; sauces; seasonings; cereal-based snack food.

35 – Retail and wholesale services, also on-line, of beverages, coffee, tea, cocoa, artificial coffee, rice, tapioca, sago, flour and preparations made from cereals, bread, pastries, confectionery, edible ices, sugar, honey, treacle, yeast, baking-powder, salt, mustard, vinegar, sauces, spices, ice; retail and wholesale services, also on-line, of household or kitchen utensils and containers, combs and sponges, brushes, brush-making materials, articles for cleaning purposes, steelwool, glass, glassware, porcelain and earthenware; retail and wholesale services, also on-line, of paper and cardboard, and goods made from these materials, printed matter, bookbinding material, photographs, stationery, adhesives, materials for artists, paintbrushes, typewriters and office requisites, instructional and teaching materials, plastic materials for packaging; assistance in the development and management of a commercial enterprise; dissemination of advertising matter; distribution of samples for advertising purposes; distribution of products for advertising purposes; advertising of goods and services on the Internet and by means of mobile telephony services and by electronic mail; presentation of goods on communication media, for retail purposes; sales promotion for others; commercial information and advice for consumers [consumer advice shop]; provision of commercial and business contact information; procurement services for others [purchasing goods and services for other businesses]; demonstration of goods; organization of events, exhibitions, fairs and shows for commercial, promotional and advertising purposes; shop window dressing; personnel recruitment; publication of publicity texts; outsourcing services [business assistance]; advertising; publicity; import-export agencies; providing business information.

(260) AM 2019 99396 A

(800) 1422848

(151) 2018 01 29

(891) 2018 01 29

(731) BELASSI GMBH

Im Südpark 183, A-4030 Linz, Austria

(540)

(591) Black, white

(531) 26.11.03; 26.11.21; 27.05.08

(511)
7 – Engines for water vehicles.
12 – Vehicles for travel by land and by water; engines for land vehicles.

(260) AM 2019 99397 A
(800) 1422922
(151) 2018 08 21
(891) 2018 08 21
(731) SEATTLE GENETICS, INC.
21823 30th Drive S.E., Bothell WA 98021,
USA;
AGENSYS, INC.
1800 Stewart Street, Santa Monica CA 90404,
USA

(540)

DOVIQEV

(591) Black, white
(511)
5 – Pharmaceutical preparations and substances for the treatment of cancer; pharmaceutical preparations and substances for use in oncology.

(260) AM 2019 99405 A
(800) 1423077
(151) 2018 07 05
(891) 2018 07 05
(731) APPLE INC.
One Apple Park Way, Cupertino CA 95014,
USA

(540)

APPLE BOOKS

(591) Black, white
(511)
9 – Computer software for searching, browsing, sampling, purchasing, downloading, reading, displaying, storing, transmitting, sharing, organizing, highlighting, annotating, customizing, reviewing, rating, authoring, designing, and publishing electronic books, magazines, newspapers, periodicals, journals, newsletters, brochures, audiobooks, multimedia works, and other publications and documents.

(260) AM 2019 99406 A
(800) 1423078
(151) 2018 05 03
(891) 2018 05 03
(731) APPLE INC.
One Apple Park Way, Cupertino CA 95014,
USA

(540)



(591) Blue, white, black
(531) 26.01.03; 26.01.18; 26.01.24; 27.05.09;
27.05.24; 29.01.13

(511)
9 – Software for video, image, audio, and music recognition and identification; databases containing downloadable recorded music files; downloadable audio, video and multimedia content; application development software; computer game software featuring music quizzes; user interfaces for on-board motor vehicle computers and electronic devices, namely electronic control panels, monitors, touchscreens, remote controls, docking stations, connectors, switches, and voice activated controls; computer software enabling viewer of radio, television or streaming programs, films, or audiovisual entertainment or information content to access, online or via mobile phone or computer, interactive audio and visual entertainment or information content, offers or competitions or retail service providers; software for accessing information relating to music and audio and visual content; software enabling discovery, interaction with, and sharing of audio, video, printed, multimedia or augmented reality content.

38 – Messaging services; broadcasting and transmission of voice data, images, music audio, video, multimedia, television and radio by means of telecommunications networks, computer networks, the internet, satellite, radio, wireless communications networks, television and cable; matching users for the transfer of music, audio, video, and multimedia by means of telecommunications networks, computer networks, the internet, satellite, radio, wireless communications networks, television and cable; providing access to websites, databases, electronic bulletin boards, on-line forums, directories, music and video and audio programs.

41 – Arranging, organizing, conducting and presenting concerts, live performances, entertainment special events, arts and cultural events, festivals, and sporting events; production, distribution, and presentation of radio programs, music, television programs, motion pictures and sound recordings; providing information, schedules, reviews and personalized recommendations of entertainment, motion pictures, concerts, live performances, competitions, fairs, festivals, exhibitions, expositions and sporting events; publication and presentation of reviews, surveys, and ratings, and providing online interactive information in the field of music, entertainment and films.

42 – Hosting websites featuring entertainment and music; hosting interactive websites and computer software applications for the posting and sharing of reviews, survey and ratings relating to entertainment, concerts, live performances, competitions, fairs, festivals, and exhibitions.

(260) AM 2019 99407 A
 (800) 1423151
 (151) 2018 06 15
 (891) 2018 06 15
 (731) APPLE INC.

One Apple Park Way, Cupertino CA 95014,
 USA

(540)



(591) Black, white
 (531) 05.07.13; 05.07.23; 26.04.04; 26.04.15
 (511)

9 – Computers; computer hardware; handheld computers; tablet computers; telecommunications apparatus and instruments; telephones; mobile telephones; smartphones; network communication apparatus; smartwatches; smartglasses; smart rings; wearable activity trackers; connected bracelets; electronic book readers; computer software; computer software for setting up, configuring, operating and controlling computers, computer peripherals, mobile devices, mobile telephones, smartwatches, smartglasses, wearable devices, earphones, headphones, televisions, set top boxes, audio and video players and recorders, home theatre systems, and entertainment systems; computer game software; downloadable pre-recorded audio, video and multimedia content; computer peripheral devices; peripheral devices for computers, mobile telephones, mobile electronic devices, wearable electronic devices, smartwatches, smartglasses, earphones, headphones, televisions, set top boxes, and audio and video players and recorders; wearable peripherals for use with computers, mobile telephones, mobile electronic devices, smartwatches, smartglasses, smart rings, earphones, headphones, televisions, set top boxes, and audio and video players and recorders; biometric identification and authentication apparatus; accelerometers; altimeters; distance measuring apparatus; distance recording apparatus; pedometers; pressure measuring apparatus; pressure indicators; monitors, display screens, head mounted displays, and headsets for use with computers, smartphones, mobile electronic devices, wearable electronic devices, smart watches, smartglasses, televisions, set top boxes, and audio and video players and recorders; virtual and augmented reality displays, goggles, controllers, and headsets; 3D spectacles; eyeglasses; sunglasses; spectacle lenses; optical glass; optical goods; optical apparatus and instruments; cameras; keyboards, mice, mouse pads, printers, disk drives, and hard drives; sound recording

and reproducing apparatus; digital audio and video players and recorders; audio speakers; audio amplifiers and receivers; voice recording and voice recognition apparatus; earphones; headphones; microphones; televisions; television receivers and monitors; set top boxes; radios; radio transmitters and receivers; global positioning systems (GPS devices); navigational instruments; remote controls for controlling computers, mobile telephones, mobile electronic devices, wearable electronic devices, smartwatches, smartglasses, earphones, headphones, audio and video players and recorders, televisions, set top boxes, speakers, amplifiers, home theatre systems, and entertainment systems; wearable devices for controlling computers, mobile telephones, mobile electronic devices, smart watches, smartglasses, earphones, headphones, audio and video players and recorders, televisions, set top boxes, speakers, amplifiers, home theatre systems, and entertainment systems; data storage apparatus; electrical and electronic connectors, couplers, wires, cables, chargers, docks, docking stations, and adapters for use with computers, mobile telephones, handheld computers, computer peripherals, mobile telephones, mobile electronic devices, wearable electronic devices, smartwatches, smartglasses, earphones, headphones, audio and video players and recorders, televisions, and set top boxes; interactive touchscreens; interfaces for computers, computer screens, mobile telephones, mobile electronic devices, wearable electronic devices, smartwatches, smartglasses, televisions, set top boxes, and audio and video players and recorders; parts and accessories for computers, computer peripherals, mobile telephones, mobile electronic devices, wearable electronic devices, smartwatches, smartglasses, earphones, headphones, audio and video players and recorders, televisions, and set top boxes.

(260) AM 2019 99408 A
 (800) 1423172
 (151) 2018 06 15
 (891) 2018 06 15
 (731) APPLE INC.

One Apple Park Way, Cupertino CA 95014,
 USA

(540)



(591) Black, white
 (531) 05.07.13; 05.07.23; 26.04.04; 26.04.15

(511)

9 – Computers; computer hardware; handheld computers; tablet computers; telecommunications apparatus and instruments; telephones; mobile telephones; smartphones; network communication apparatus; smartwatches; smartglasses; smart rings; wearable activity trackers; connected bracelets; electronic book readers; computer software; computer software for setting up, configuring, operating and controlling computers, computer peripherals, mobile devices, mobile telephones, smartwatches, smartglasses, wearable devices, earphones, headphones, televisions, set top boxes, audio and video players and recorders, home theatre systems, and entertainment systems; computer game software; downloadable pre-recorded audio, video and multimedia content; computer peripheral devices; peripheral devices for computers, mobile telephones, mobile electronic devices, wearable electronic devices, smartwatches, smartglasses, earphones, headphones, televisions, set top boxes, and audio and video players and recorders; wearable peripherals for use with computers, mobile telephones, mobile electronic devices, smartwatches, smartglasses, smart rings, earphones, headphones, televisions, set top boxes, and audio and video players and recorders; biometric identification and authentication apparatus; accelerometers; altimeters; distance measuring apparatus; distance recording apparatus; pedometers; pressure measuring apparatus; pressure indicators; monitors, display screens, head mounted displays, and headsets for use with computers, smartphones, mobile electronic devices, wearable electronic devices, smart watches, smartglasses, televisions, set top boxes, and audio and video players and recorders; virtual and augmented reality displays, goggles, controllers, and headsets; 3D spectacles; eyeglasses; sunglasses; spectacle lenses; optical glass; optical goods; optical apparatus and instruments; cameras; keyboards, mice, mouse pads, printers, disk drives, and hard drives; sound recording and reproducing apparatus; digital audio and video players and recorders; audio speakers; audio amplifiers and receivers; voice recording and voice recognition apparatus; earphones; headphones; microphones; televisions; television receivers and monitors; set top boxes; radios; radio transmitters and receivers; global positioning systems (GPS devices); navigational instruments; remote controls for controlling computers, mobile telephones, mobile electronic devices, wearable electronic devices, smartwatches, smartglasses, earphones, headphones, audio and video players and recorders, televisions, set top boxes, speakers, amplifiers, home theatre systems, and entertainment systems; wearable devices for controlling computers, mobile telephones, mobile electronic devices, smart watches, smartglasses, earphones, headphones, audio and video players and recorders, televisions, set top boxes, speakers, amplifiers, home theatre systems,

and entertainment systems; data storage apparatus; electrical and electronic connectors, couplers, wires, cables, chargers, docks, docking stations, and adapters for use with computers, mobile telephones, handheld computers, computer peripherals, mobile telephones, mobile electronic devices, wearable electronic devices, smartwatches, smartglasses, earphones, headphones, audio and video players and recorders, televisions, and set top boxes; interactive touchscreens; interfaces for computers, computer screens, mobile telephones, mobile electronic devices, wearable electronic devices, smartwatches, smartglasses, televisions, set top boxes, and audio and video players and recorders; parts and accessories for computers, computer peripherals, mobile telephones, mobile electronic devices, wearable electronic devices, smartwatches, smartglasses, earphones, headphones, audio and video players and recorders, televisions, and set top boxes.

28 – Toys; games and playthings; electronic handheld game units; musical toys, games and playthings; toy audio apparatus; toy musical instruments; battery operated toys; electronic toys; electric computer games, other than those adapted for use with television receivers; electrical and electronic amusement apparatus (automatic, coin/counter freed); toy handheld electronic devices.

(260) AM 2019 99409 A

(800) 1423178

(151) 2018 06 15

(891) 2018 06 15

(731) APPLE INC.

One Apple Park Way, Cupertino CA 95014,
USA

(540)



(591) Black, white

(531) 05.07.13; 05.07.23; 26.04.04; 26.04.15

(511)

9 – Computers; computer hardware; handheld computers; tablet computers; telecommunications apparatus and instruments; telephones; mobile telephones; smartphones; network communication apparatus; smartwatches; smartglasses; smart rings; wearable activity trackers; connected bracelets; electronic book readers; computer software; computer software for setting up, configuring, operating and controlling computers, computer peripherals, mobile devices, mobile telephones, smartwatches, smartglasses, wearable devices, earphones, headphones, televisions, set top boxes, audio and video players and

recorders, home theatre systems, and entertainment systems; computer game software; downloadable pre-recorded audio, video and multimedia content; computer peripheral devices; peripheral devices for computers, mobile telephones, mobile electronic devices, wearable electronic devices, smartwatches, smartglasses, earphones, headphones, televisions, set top boxes, and audio and video players and recorders; wearable peripherals for use with computers, mobile telephones, mobile electronic devices, smartwatches, smartglasses, smart rings, earphones, headphones, televisions, set top boxes, and audio and video players and recorders; biometric identification and authentication apparatus; accelerometers; altimeters; distance measuring apparatus; distance recording apparatus; pedometers; pressure measuring apparatus; pressure indicators; monitors, display screens, head mounted displays, and headsets for use with computers, smartphones, mobile electronic devices, wearable electronic devices, smart watches, smartglasses, televisions, set top boxes, and audio and video players and recorders; virtual and augmented reality displays, goggles, controllers, and headsets; 3D spectacles; eyeglasses; sunglasses; spectacle lenses; optical glass; optical goods; optical apparatus and instruments; cameras; keyboards, mice, mouse pads, printers, disk drives, and hard drives; sound recording and reproducing apparatus; digital audio and video players and recorders; audio speakers; audio amplifiers and receivers; voice recording and voice recognition apparatus; earphones; headphones; microphones; televisions; television receivers and monitors; set top boxes; radios; radio transmitters and receivers; global positioning systems (GPS devices); navigational instruments; remote controls for controlling computers, mobile telephones, mobile electronic devices, wearable electronic devices, smartwatches, smartglasses, earphones, headphones, audio and video players and recorders, televisions, set top boxes, speakers, amplifiers, home theatre systems, and entertainment systems; wearable devices for controlling computers, mobile telephones, mobile electronic devices, smart watches, smartglasses, earphones, headphones, audio and video players and recorders, televisions, set top boxes, speakers, amplifiers, home theatre systems, and entertainment systems; data storage apparatus; electrical and electronic connectors, couplers, wires, cables, chargers, docks, docking stations, and adapters for use with computers, mobile telephones, handheld computers, computer peripherals, mobile telephones, mobile electronic devices, wearable electronic devices, smartwatches, smartglasses, earphones, headphones, audio and video players and recorders, televisions, and set top boxes; interactive touchscreens; interfaces for computers, computer screens, mobile telephones, mobile electronic devices, wearable electronic devices, smartwatches, smartglasses, televisions, set top boxes, and audio

and video players and recorders; parts and accessories for computers, computer peripherals, mobile telephones, mobile electronic devices, wearable electronic devices, smartwatches, smartglasses, earphones, headphones, audio and video players and recorders, televisions, and set top boxes.

14 – Horological and chronometric instruments; watches; clocks; timepieces; chronographs for use as timepieces; chronometers; watchstraps; watch bands; cases for watches, clocks, and horological and chronometric instruments; parts for watches, clocks, and horological and chronometric instruments; jewelry.

(260) AM 2019 99410 A

(800) 1423219

(151) 2018 04 25

(891) 2018 04 25

(731) HUAWEI TECHNOLOGIES CO., LTD
Administration Building, Huawei Technologies Co., LTD Bantian, Longgang District, Shenzhen, China

(540)



(591) Black, white

(531) 27.05.01; 27.05.21; 27.07.01; 27.07.11;
27.07.25

(511)

9 – Smartphones; smartwatches; smartglasses; wearable activity trackers; protective films adapted for smartphones; cases for smartphones; covers for smartphones; cabinets for loudspeakers; digital photo frames; network communication apparatus; selfie sticks (hand-held monopods); modems; microphones; sleeves for laptops; electric batteries; tablet computers; battery chargers; mobile power source (rechargeable batteries); laptop computers; headphones; virtual reality headsets; loudspeakers; set-top boxes; notebook computers; digital video recorders for cars; earphones; portable media players; humanoid robots with artificial intelligence; computer software applications, downloadable; sound transmitting apparatus; computer programs, recorded; camcorders; cameras (photography); smart rings; downloadable graphics for mobile phones; wearable computers; personal digital assistants (PDAs); audio interfaces; security surveillance robots; selfie sticks adapted for mobile phones; wearable video display monitors; selfie lenses; telecommunication apparatus in the form of jewelry; USB cables.

(260) AM 2019 99413 A

(800) 1423319

(151) 2018 04 25

(891) 2018 04 25

(731) HUAWEI TECHNOLOGIES CO., LTD

Administration Building, Huawei Technologies Co., LTD Bantian, Longgang District, Shenzhen, China

(540)



(591) Black, white

(531) 27.05.01; 27.05.21; 27.07.01; 27.07.11

(511)

9 – Smartphones; smartwatches; smartglasses; wearable activity trackers; protective films adapted for smartphones; cases for smartphones; covers for smartphones; cabinets for loudspeakers; digital photo frames; network communication apparatus; selfie sticks (hand-held monopods); modems; microphones; sleeves for laptops; electric batteries; tablet computers; battery chargers; mobile power source (rechargeable batteries); laptop computers; headphones; virtual reality headsets; loudspeakers; set-top boxes; notebook computers; digital video recorders for cars; earphones; portable media players; humanoid robots with artificial intelligence; computer software applications, downloadable; sound transmitting apparatus; computer programs, recorded; camcorders; cameras (photography); smart rings; downloadable graphics for mobile phones; wearable computers; personal digital assistants (PDAs); audio interfaces; security surveillance robots; selfie sticks adapted for mobile phones; wearable video display monitors; selfie lenses; telecommunication apparatus in the form of jewelry; USB cables.

(260) AM 2019 99414 A

(800) 1423323

(151) 2018 07 20

(891) 2018 07 20

(731) SOPRO BAUCHEMIE GMBH

Biebricher Strasse 74, 65203 Wiesbaden, Germany

(540)

X8-TEX

(591) Black, white

(511)

1 – Chemicals used in industry; impregnating preparations; adhesives used in industry, in particular made of synthetic resins; chemicals used in industry,

being additives for building materials; chemicals used in industry, being additives for screed, concrete and mortar; liquid plastics, unprocessed, included in this class; preservatives for building materials (except for organic substances); refining agents for concrete, mortar and screed, included in this class, in particular for preventing the drying out of concrete and mortar, for screeds and finished concrete parts, for enhancing the resistance of cement screeds to impact, wear, frost and chemical stress, for increasing imperviousness against liquids and gases as well as for controlling the working consistency; unprocessed artificial resins; surface-active agents (tensides); damp proofing preparations for brickwork, except paints; horticulture chemicals; antifreeze; chemicals as aid for washing out (removing and cleaning) joint compounds; solvents for paints, varnishes and lacquers; silicones.

17 – Rubber; gutta-percha; gum; asbestos; mica; goods made of plastics as semi-finished products; artificial and synthetic resins (semi-finished products); resins (semi-finished products) for fabricating adhesives; cast resins (semi-finished products) including silica sand; sealing, packing and insulating materials; sealing tapes; sealing collars; rubber gloves for insulating purposes, not for household purposes; joint fillers (sealant compounds for joints); insulating coatings (paints); insulating lacquers; insulating paints; self-adhesive tapes, other than stationery and not for medical or household purposes; insulating coatings; insulating materials; filling material as insulating, damping and sealing materials; bituminous coatings for roofing, for sealing and insulating purposes; fiberglass insulation materials for building purposes; fiberglass fabrics for building insulation.

19 – Building materials (non-metallic), in particular with damping and insulating properties; building materials (non-metallic), namely hydraulic binding agents such as cement, lime, gypsum and as additives for binding and hardening concrete, mortar and stony-type building materials; building materials (non-metallic), namely hydraulic binding agents and mixtures composed thereof containing aggregates, pozzolanic materials (concrete admixtures) and/or chemical substances (concrete admixtures); mortar (building material); plaster (building material); screeds (building material); reinforcing fabrics (non-metallic) for building purposes; contact sludges (non-metallic) for building purposes; building materials, non-metallic, in the form of filling materials for building purposes for preparing surfaces made of concrete, mortar and other stony-type building materials; silica sand for building purposes; bitumen; bituminous products for building; pipes, not of metal, for building purposes; concrete; concrete building elements; roof coverings, not of metal; bituminous coatings for roofing (except for sealing and insulating purposes); windows, not of metal; felts for building;

gravel; sand for building purposes; prefabricated swimming pools (not of metal); prefabricated chimneys, not of metal; floor tiles, not of metal; tile floorings, not of metal; binding material for road repair; road coating materials.

(260) AM 2019 99564 A
 (800) 451893
 (151) 1980 04 16
 (891) 2018 07 02
 (731) KARL STORZ GMBH & CO. KG
 Mittelstrasse 8, 78532 Tuttlingen, Germany
 (540)

Karl Storz

(591) Black, white
 (531) 27.05.17
 (511)
 10 – Surgical, medical and veterinary apparatus and instruments, including artificial limbs and eyes.

(260) AM 2019 99573 A
 (800) 1424239
 (151) 2018 07 09
 (891) 2018 07 09
 (731) BURGERMEISTER FRANCHISE GMBH
 Bevernstraße 4, 10997 Berlin, Germany
 (540)

BURGERMEISTER

(591) Black, white
 (511)
 29 – Vegetarian hamburger fillings based on tofu and/or vegetables; fried mushrooms; french fries, fried potato sticks; fried potato wedges; spiced cheese; baked cheese; bacon, fried bacon rashers; pickled vegetables; pickled jalapeños, pickled peppers.
 30 – Hamburgers in buns; cheeseburgers [sandwiches]; cheeseburgers with chilli peppers; hamburgers with grilled meat; sour cream-based sauces; peanut butter-based sauces; mango and curry based sauces; cheese preparations, namely cheese sauces; edible ices; pizza; rolls; tacos.
 43 – Accommodation and catering for guests; canteens; restaurants; snack-bars; catering for the provision of food and beverages; catering.

(260) AM 2019 99589 A
 (800) 1424747
 (151) 2018 03 21
 (891) 2018 03 21
 (731) JOINT STOCK COMPANY "RUSSIAN RAILWAYS"
 NOVAYA BASMANNAYA STR., 2,
 RU-107174 MOSCOW, Russian Federation

(540)



(591) RED
 (531) 28.05; 29.01.01
 (511)
 37 – Construction; rental of construction equipment; vehicle maintenance; repair information; electric appliance installation and repair.
 39 – Railway transport; transportation information.
 42 – Construction drafting; conducting technical project studies; engineering; computer programming; computer software design; updating of computer software; surveying; consultancy in the field of energy-saving.

(260) AM 2019 99590 A
 (800) 1424758
 (151) 2018 03 21
 (891) 2018 03 21
 (731) JOINT STOCK COMPANY "RUSSIAN RAILWAYS"
 NOVAYA BASMANNAYA STR., 2,
 RU-107174 MOSCOW, Russian Federation
 (540)



(591) Black, white
 (531) 28.05
 (511)
 37 – Construction; rental of construction equipment; vehicle maintenance; repair information; electric appliance installation and repair.
 39 – Railway transport; transportation information.
 42 – Construction drafting; conducting technical project studies; engineering; computer programming; computer software design; updating of computer software; surveying; consultancy in the field of energy-saving.

(260) AM 2019 99591 A
 (800) 1424776
 (151) 2018 01 23
 (891) 2018 01 23
 (731) Euro Games Technology LTD
 "Maritsa" Str. 4, "Vranya-Lozen-Triugulnika",
 BG-1151 Sofia, Bulgaria

(540)

40BURNING HOT

(591) Green and brown

(531) 27.05.03; 27.07.03; 29.01.12

(511)

9 – Apparatus for recording, transmission or reproduction of sound or image; computer software, recorded; monitors, computer hardware.

28 – Games that are not included in other classes; gaming machines operating with coins, banknotes and cards; gaming machines for gambling.

(260) AM 2019 99592 A

(800) 1424790

(151) 2018 06 07

(891) 2018 06 07

(731) HEBEI SHENZHOU THERMAL BUILDING MATERIAL GROUP CO., LTD
Liugezhuang Town, Dacheng County,
Hebei Province, China

(540)



(591) Black, white

(531) 26.13.25; 28.03

(511)

17 – Non-conducting materials for retaining heat; soundproofing materials; boards and tubes for thermal insulation; asbestos rope, thread, tape, rubber-asbestos.

(260) AM 2019 99610 A

(800) 1425310

(151) 2018 07 26

(891) 2018 07 26

(731) JANSSEN PHARMACEUTICA NV
Turnhoutseweg 30, B-2340 BEERSE,
Belgium

(540)

APELFRO

(591) Black, white

(511)

5 – Pharmaceutical preparations for human purposes.

(260) AM 2019 99611 A

(800) 1425365

(151) 2018 02 22

(891) 2018 02 22

(731) ARCOS HERMANOS, S.A.

Poligono Industrial Campollano, C/B Num. 7,
E-02006 ALBACETE, Spain

(540)



(591) Black, white

(531) 11.01.03; 27.05.15

(511)

7 – Electric knives; machines for cleaning knives; machines for polishing knives; machines for sharpening knives.

8 – Knife sharpeners [manual tools]; bags for knives; knives; penknives; covers for knives; blades for knives; knife handles; wheels for sharpening knives and penknives.

21 – Knife-rests.

35 – Wholesale services, retail sale services in stores and by means of global computer networks for electric knives, machines for cleaning knives, machines for polishing knives, machines for sharpening knives, manual knife sharpeners, bags for knives, knives, penknives, covers for knives, blades for knives, knife handles, wheels for sharpening knives and penknives, knife holders; sales promotion for others; procurement services for others [purchasing goods and services for other businesses]; import and export agency services; presentation of products via any type of communication for retail sale; commercial management of the licensing of goods and services for third parties; marketing; administrative processing of purchase orders; sponsorship search.

(260) AM 2019 99613 A

(800) 1425391

(151) 2018 05 30

(891) 2018 05 30

(731) LEVEL (FZE)

Saif Desk Q1-07-120/A, P.O.Box 513873,
Sharjah, United Arab Emirates

(540)

Faraon

(591) Black, white

(531) 27.05.17

(511)

34 – Absorbent paper for tobacco pipes; flavourings, other than essential oils, for use in electronic cigarettes/flavourings, other than essential oils, for use in electronic cigarettes; flavourings, other than essential oils, for tobacco/flavourings, other than essential oils, for tobacco; tips of yellow amber for cigar and cigarette holders; oral vaporizers for smokers; tobacco jars; gas containers for cigar lighters; chewing tobacco; lighters for smokers; pipe cleaners for tobacco pipes; tobacco pouches; pocket machines for rolling cigarettes; books of cigarette papers; firestones; tobacco pipes; cigar holders; cigarette holders; cigarette tips; mouthpieces for cigarette holders; pipe racks for tobacco pipes; spittoons for tobacco users; ashtrays for smokers; cigarette cases; liquid solutions for use in electronic cigarettes; cigarettes; electronic cigarettes; cigarettes containing tobacco substitutes, not for medical purposes; cigarette paper; cigarette filters; cigars; cigarillos; cigar cases; cigar cutters; matches; matchboxes; match holders; snuffboxes; herbs for smoking; tobacco; snuff; humidors.

(260) AM 2019 99625 A

(800) 1071158

(151) 2010 12 03

(891) 2018 07 17

(731) Товариство з обмеженою відповідальністю "TALAMUS LTD"
vul. Malynovskogo, 16 A, m. Odesa 65017,
Ukraine

(540)

TALAMUS
TALAMUS

(591) Black, white

(531) 28.05

(511)

6 – Aluminium foil; aluminium wire; aluminium; anchors; anchor plates; fittings of metal for buildings; valves of metal, other than parts of machines; reinforcing materials of metal for building; reinforcing materials, of metal, for concrete; reinforcing materials of metal for pipes; reinforcing materials of metal for machine belts; advertisement columns of metal; white metal; beacons of metal, non-luminous; vats of metal; girders of metal; bottles (metal containers) for compressed gas or liquid air; preserve tins; barrel hoops of metal; barrels of metal; swimming pools (metal structures); safety cash boxes; beryllium (glucinium); sash pulleys; pulleys of metal, other than for machines; blooms (metallurgy); eye bolts; bolts of metal; taps for casks, of metal; cask stands of metal; casks of metal; mooring buoys of metal; identification bracelets of metal for hospitals; bronze; bronzes for tombstones; bronzes (works

of art); armour plating; armour plate; building or furniture fittings of nickel- silver; framework of metal for building; building materials of metal; building boards of metal; letters and numerals of common metal, except type; silos of metal; hoppers of metal, non-mechanical; limonite; vanadium; bird baths (structures of metal); loading gauge rods, of metal, for railway waggons; loading pallets, of metal; troughs of metal for mixing mortar; diving boards of metal; bicycle parking installations of metal; water-pipe valves of metal; ducts of metal for ventilating and air conditioning installations; vice benches of metal: door scrapers; signboards of metal; hardware of metal, small; fittings of metal for windows; windows of metal; window casement bolts; shutters of metal; window fasteners of metal; sash fasteners of metal for windows; window frames of metal; containers of metal (storage, transport); containers of metal for liquid fuel; containers of metal for compressed gas or liquid air; tanks of metal; refractory construction materials of metal; water-pipes of metal; tungsten; door stops of metal; gates of metal; sleeves (metal hardware); horseshoe nails; bindings of metal; nuts of metal; hooks for slate (metal hardware); pitons of metal (mountaineering equipment); galena (ore); wheel clamps (boots); celtium (hafnium); hooks (metal hardware); hooks of metal for clothes rails; screws of metal; germanium; lattice-work of metal; money boxes of metal; cashboxes of metal; vice claws of metal; grease nipples; roof coverings of metal; door openers, non-electric; door closers, non-electric; doors of metal; turnstiles, non-automatic; door bells, non-electric; door bolts; door knockers; door cases of metal; door handles of metal; door panels of metal; door fittings, of metal; tree protectors of metal; ferrules of metal for handles; chimney cowls of metal; bells; bells for animals; chimney pots of metal; chimneys of metal; chimney shafts of metal; paving blocks of metal; ladders of metal; steps (ladders) of metal; drain traps (valves) of metal; drain pipes of metal; wire stretchers (tension links); wire for aerials; wire of common metal; wire of common metal alloys, except fuse wire; wire rope; wire cloth; badges of metal for vehicles; outdoor blinds of metal; jalousies of metal; poles of metal; tinplate; tin-plate packings; jets of metal; strap-hinges of metal; cotter pins; rivets of metal; tubing of metal; casings of metal for oilwells; sealing caps of metal; iron wire; railway points; railroad ties of metal; iron ores; hoop iron; ironwork for windows; ironwork for doors; iron, unwrought or semi-wrought; locks of metal for bags; locks of metal for vehicles; locks of metal, other than electric; padlocks; spring locks; latch bars of metal; safety chains of metal; lock bolts; closures of metal for containers; bolts, flat; bolts; crampons of metal (cramps); clips of metal for cables and pipes; bungs of metal; wall plugs of metal; furnace fire screens; crash barriers of metal for roads; flashing of metal, for building; lat-

ches of metal; rods of metal for welding; common metals, unwrought or semi-wrought; traps for wild animals; junctions of metal for pipes; couplings of metal for chains; cable joints of metal, non-electric; ingots of common metal; signs, non-luminous and non-mechanical, of metal, for roads; signs, non-luminous and non-mechanical, of metal; gold solder; indium; tool handles of metal; tool boxes of metal, empty; tool chests of metal, empty; telephone booths of metal; cabanas of metal; cadmium; pot hooks of metal; rope thimbles of metal; ropes of metal; cables of metal, non-electric; telpher cables; greenhouse frames of metal; cornices of metal; bins of metal; tiles of metal for building; tile floorings of metal; cermets; pegs of metal; rings of common metal for keys; rings of metal; ferrules of metal; scythe handles of metal; metal cages for wild animals; aviaries of metal (structures); keys; cobalt, raw; anvils; anvils (portable); beak-irons (bick-irons); skating rinks (structures of metal); bottle caps of metal; chill-molds (foundry); manifolds of metal for pipelines; elbows of metal for pipes; furniture casters of metal; runners of metal for sliding doors; pillars of metal for buildings; barbed wire; insect screens of metal; brackets of metal for building; buildings of metal; guard rails of metal; baskets of metal; box fasteners of metal; boxes of common metal; reels of metal, non-mechanical, for flexible hoses; silicon iron; binding screws of metal for cables; collars of metal for fastening pipes; balls of steel; chicken-houses, of metal; angle irons; chains for dogs; chains of metal; brass, unwrought or semi-wrought; foundry molds (moulds) of metal; sheets and plates of metal; cast steel; ice moulds of metal; bed casters of metal; fittings of metal for beds; manhole covers of metal; magnesium; manganese; materials of metal for funicular railway permanent ways; fittings of metal for furniture; memorial plaques, of metal; ferrules of metal for walking sticks; metals in powder form; washers of metal; copper wire, not insulated; copper rings; copper, unwrought or semi-wrought; broom handles of metal; enclosures of metal for tombs; molybdenum; crampons (climbing irons); chests of metal for food; tombs of metal; tombstone plaques of metal; monuments of metal for tombs; gravestone slabs of metal; tombstone stelae of metal; fish plates (rails); tent pegs of metal; winding spools of metal, non-mechanical, for flexible hoses; penstock pipes of metal; handcuffs; nozzles of metal; duckboards of metal; tension links; stretchers for metal bands (tension links); belt stretchers of metal; German silver; thread of metal for tying-up purposes; nickel; nickel-silver; niobium; knife handles of metal; house numbers of metal, non-luminous; number plates, of metal; foils of metal for wrapping and packaging; cladding of metal for construction and building; fences of metal; clothes hooks of metal; moldings of metal for cornices; tin; shuttering of metal for concrete; poles of metal, for electric lines; greenhouses of me-

tal, transportable; spurs; filings of metal; packaging containers of metal; pins (hardware); monuments of metal; wainscotting of metal; belts of metal for handling loads; soldering wire of metal; rods of metal for brazing; transport pallets of metal; binding thread of metal for agricultural purposes; bands of metal for tying-up purposes; partitions of metal; lintels of metal; handling pallets of metal; braces of metal for handling loads; slings of metal for handling loads; furnace fireguards; porches of metal (building); floors of metal; floor tiles, of metal; props of metal; firedogs (andirons); floating containers of metal; floating docks of metal for mooring boats; laths of metal; platforms, prefabricated, of metal; lead seals; bottle closures of metal; turntables (railways); busts of common metal; stringers (parts of staircases) of metal; roof flashing of metal; roofing of metal; joists of metal; sills of metal; silver plated tin alloy; containers of metal for storing acids; letter boxes of metal; silver solder; wind-driven bird-repelling devices made of metal; shims; anti-friction metal; springs (metal hardware); rods of metal for brazing and welding; rocket launching platforms of metal; frames of metal for building; rails of metal; railway material of metal; gratings of metal; gutter pipes of metal; gutters of metal; scaffolding of metal; branching pipes of metal; identity plates of metal; roller blinds of steel; ores of metal; knobs of metal; pyrophoric metals; lead, unwrought or semi-wrought; safes (strong boxes); towel dispensers, fixed, of metal; signaling panels, non-luminous and non-mechanical, of metal; vaults of metal (burial); buckles of common metal (hardware); sheaf binders of metal; alloys of common metal; buildings, transportable, of metal; hoop steel; steel wire; steel buildings; steel masts; iron slabs; stretchers for iron bands (tension links); steel pipes; steel alloys; steel sheets; tin foil; molybdenum iron; chrome iron; steel, unwrought or semi-wrought; figurines (statuettes) of common metal; statues of common metal; ceilings of metal; wall linings of metal (building); wall claddings of metal (building); posts of metal; stops of metal; bars for metal railings; casement windows of metal; boarding stairs of metal, mobile, for passengers; stair treads (steps) of metal; staircases of metal; tantalum (metal); brazing alloys; telegraph posts of metal; titanium; tombac; pipe muffs of metal; pipes of metal; ducts and pipes of metal for central heating installations; pipework of metal; fittings of metal for coffins; machine belt fasteners of metal; booths of metal for spraying paint; tungsten iron; ferrotitanium; fittings of metal for compressed air ducts; flanges of metal (collars); weather- or wind-vanes of metal; chromium; chrome ores; cattle chains; works of art of common metal; nails; brads; zinc; zirconium; cast iron, unwrought or semi-wrought; palings of metal; tiles of metal; hinges of metal; mooring bollards of metal; pilings of metal; masts of metal.

35 – Marketing studies; organization of exhibitions for commercial or advertising purposes; business research; business information; business investigations; marketing research; advertising; sales promotion for others.

(260) AM 2019 99626 A

(800) 1084552

(151) 2010 12 03

(891) 2018 07 17

(731) Tovarystvo z obmezhenoyu vidpovidalnistyu "TALAMUS LTD"

vul. Malynovskogo, 16 A, m. Odesa 65017, Ukraine

(540)



(591) Black, white

(531) 26.01.18; 27.05.21

(511)

6 – Aluminium foil; aluminium wire; aluminium; anchors; anchor plates; fittings of metal for buildings; valves of metal, other than parts of machines; reinforcing materials of metal for building; reinforcing materials, of metal, for concrete; reinforcing materials of metal for pipes; reinforcing materials of metal for machine belts; advertisement columns of metal; white metal; beacons of metal, non-luminous; vats of metal; girders of metal; bottles (metal containers) for compressed gas or liquid air; preserve tins; barrel hoops of metal; barrels of metal; swimming pools (metal structures); safety cash boxes; beryllium (glucinium); sash pulleys; pulleys of metal, other than for machines; blooms (metallurgy); eye bolts; bolts of metal; taps for casks, of metal; cask stands of metal; casks of metal; mooring buoys of metal; identification bracelets of metal for hospitals; bronze; bronzes for tombstones; bronzes (works of art); armour plating; armour plate; building or furniture fittings of nickel-silver; framework of metal for building; building materials of metal; building boards of metal; letters and numerals of common metal, except type; silos of metal; hoppers of metal, non-mechanical; limonite; vanadium; bird baths (structures of metal); loading gauge rods, of metal, for railway waggons; loading pallets, of metal; troughs of metal for mixing mortar; diving boards of metal; bicycle parking installations of metal; water-pipe valves of metal; ducts of metal for ventilating and air conditioning installations; vice benches of metal; door scrapers; signboards of metal; hardware of metal, small; fittings of metal for windows; windows of

metal; window casement bolts; shutters of metal; window fasteners of metal; sash fasteners of metal for windows; window frames of metal; containers of metal (storage, transport); containers of metal for liquid fuel; containers of metal for compressed gas or liquid air; tanks of metal; refractory construction materials of metal; water-pipes of metal; tungsten; door stops of metal; gates of metal; sleeves (metal hardware); horseshoe nails; bindings of metal; nuts of metal; hooks for slate (metal hardware); pitons of metal (mountaineering equipment); galena (ore); wheel clamps (boots); cerium (hafnium); hooks (metal hardware); hooks of metal for clothes rails; screws of metal; germanium; latticework of metal; money boxes of metal; cashboxes of metal; vice claws of metal; grease nipples; roof coverings of metal; door openers, non-electric; door closers, non-electric; doors of metal; turnstiles, non-automatic; door bells, non-electric; door bolts; door knockers; door cases of metal; door handles of metal; door panels of metal; door fittings, of metal; tree protectors of metal; ferrules of metal for handles; chimney cowls of metal; bells; bells for animals; chimney pots of metal; chimneys of metal; chimney shafts of metal; paving blocks of metal; ladders of metal; steps (ladders) of metal; drain traps (valves) of metal; drain pipes of metal; wire stretchers (tension links); wire for aerials; wire of common metal; wire of common metal alloys, except fuse wire; wire rope; wire cloth; badges of metal for vehicles; outdoor blinds of metal; jalousies of metal; poles of metal; tinplate; tin-plate packings; jets of metal; strap-hinges of metal; cotter pins; rivets of metal; tubing of metal; casings of metal for oilwells; sealing caps of metal; iron wire; railway points; railroad ties of metal; iron ores; hoop iron; ironwork for windows; ironwork for doors; iron, unwrought or semi-wrought; locks of metal for bags; locks of metal for vehicles; locks of metal, other than electric; padlocks; spring locks; latch bars of metal; safety chains of metal; lock bolts; closures of metal for containers; bolts, flat; bolts; crampons of metal (cramps); clips of metal for cables and pipes; bungs of metal; wall plugs of metal; furnace fire screens; crash barriers of metal for roads; flashing of metal, for building; latches of metal; rods of metal for welding; common metals, unwrought or semi-wrought; traps for wild animals; junctions of metal for pipes; couplings of metal for chains; cable joints of metal, non-electric; ingots of common metal; signs, non-luminous and non-mechanical, of metal, for roads; signs, non-luminous and non-mechanical, of metal; gold solder; indium; tool handles of metal; tool boxes of metal, empty; tool chests of metal, empty; telephone booths of metal; cabanas of metal; cadmium; pot hooks of metal; rope thimbles of metal; ropes of metal; cables of metal, non-electric; telfer cables; greenhouse frames of metal; cornices of metal; bins of metal; tiles of metal for building; tile floorings of metal; cer-

mets; pegs of metal; rings of common metal for keys; rings of metal; ferrules of metal; scythe handles of metal; metal cages for wild animals; aviaries of metal (structures); keys; cobalt, raw; anvils; anvils (portable); beak-irons (bick-irons); skating rinks (structures of metal); bottle caps of metal; chill-molds (foundry); manifolds of metal for pipelines; elbows of metal for pipes; furniture casters of metal; runners of metal for sliding doors; pillars of metal for buildings; barbed wire; insect screens of metal; brackets of metal for building; buildings of metal; guard rails of metal; baskets of metal; box fasteners of metal; boxes of common metal; reels of metal, non-mechanical, for flexible hoses; silicon iron; binding screws of metal for cables; collars of metal for fastening pipes; balls of steel; chicken-houses, of metal; angle irons; chains for dogs; chains of metal; brass, unwrought or semi-wrought; foundry molds (moulds) of metal; sheets and plates of metal; cast steel; ice moulds of metal; bed casters of metal; fittings of metal for beds; manhole covers of metal; magnesium; manganese; materials of metal for funicular railway permanent ways; fittings of metal for furniture; memorial plaques, of metal; ferrules of metal for walking sticks; metals in powder form; washers of metal; copper wire, not insulated; copper rings; copper, unwrought or semi-wrought; broom handles of metal; enclosures of metal for tombs; molybdenum; crampons (climbing irons); chests of metal for food; tombs of metal; tombstone plaques of metal; monuments of metal for tombs; gravestone slabs of metal; tombstone stelae of metal; fish plates (rails); tent pegs of metal; winding spools of metal, non-mechanical, for flexible hoses; penstock pipes of metal; handcuffs; nozzles of metal; duckboards of metal; tension links; stretchers for metal bands (tension links); belt stretchers of metal; German silver; thread of metal for tying-up purposes; nickel; nickel-silver; niobium; knife handles of metal; house numbers of metal, non-luminous; number plates, of metal; foils of metal for wrapping and packaging; cladding of metal for construction and building; fences of metal; clothes hooks of metal; moldings of metal for cornices; tin; shuttering of metal for concrete; poles of metal, for electric lines; greenhouses of metal, transportable; spurs; filings of metal; packaging containers of metal; pins (hardware); monuments of metal; wainscotting of metal; belts of metal for handling loads; soldering wire of metal; rods of metal for brazing; transport pallets of metal; binding thread of metal for agricultural purposes; bands of metal for tying-up purposes; partitions of metal; lintels of metal; handling pallets of metal; braces of metal for handling loads; slings of metal for handling loads; furnace fireguards; porches of metal (building); floors of metal; floor tiles, of metal; props of metal; firedogs (andirons); floating containers of metal; floating docks of metal for mooring boats; laths of metal; platforms, prefabricated, of metal; lead

seals; bottle closures of metal; turntables (railways); busts of common metal; stringers (parts of staircases) of metal; roof flashing of metal; roofing of metal; joists of metal; sills of metal; silver plated tin alloy; containers of metal for storing acids; letter boxes of metal; silver solder; wind-driven bird-repelling devices made of metal; shims; anti-friction metal; springs (metal hardware); rods of metal for brazing and welding; rocket launching platforms of metal; frames of metal for building; rails of metal; railway material of metal; gratings of metal; gutter pipes of metal; gutters of metal; scaffolding of metal; branching pipes of metal; identity plates of metal; roller blinds of steel; ores of metal; knobs of metal; pyrophoric metals; lead, unwrought or semi-wrought; safes (strong boxes); towel dispensers, fixed, of metal; signaling panels, non-luminous and non-mechanical, of metal; vaults of metal (burial); buckles of common metal (hardware); sheaf binders of metal; alloys of common metal; buildings, transportable, of metal; hoop steel; steel wire; steel buildings; steel masts; iron slabs; stretchers for iron bands (tension links); steel pipes; steel alloys; steel sheets; tinfoil; molybdenum iron; chrome iron; steel, unwrought or semi-wrought; figurines (statuettes) of common metal; statues of common metal; ceilings of metal; wall linings of metal (building); wall claddings of metal (building); posts of metal; stops of metal; bars for metal railings; casement windows of metal; boarding stairs of metal, mobile, for passengers; stair treads (steps) of metal; staircases of metal; tantalum (metal); brazing alloys; telegraph posts of metal; titanium; tombac; pipe muffs of metal; pipes of metal; ducts and pipes of metal for central heating installations; pipework of metal; fittings of metal for coffins; machine belt fasteners of metal; booths of metal for spraying paint; tungsten iron; ferrotitanium; fittings of metal for compressed air ducts; flanges of metal (collars); weather- or wind-vanes of metal; chromium; chrome ores; cattle chains; works of art of common metal; nails; brads; zinc; zirconium; cast iron, unwrought or semi-wrought; palings of metal; tiles of metal; hinges of metal; mooring bollards of metal; pilings of metal; masts of metal.

35 – Marketing studies; organization of exhibitions for commercial or advertising purposes; business research; business information; business investigations; marketing research; advertising; sales promotion for others.

(260) AM 2019 99627 A

(800) 1211419

(151) 2014 04 04

(891) 2018 09 11

(731) ROLEX SA

3-5-7 rue François-Dussaud, CH-1211
Genève 26, Switzerland

(540)

OYSTERFLEX

(591) Black, white

(511)

14 – Jewelry, jewelry products, timepieces, namely watches, wristwatches, component parts of timepieces and accessories for timepieces not included in other classes, clocks and other chronometric instruments, chronometers, chronographs (timepieces), sports timing apparatus, apparatus and instruments for measuring and marking time not included in other classes; watch bands, dials (clock and watch-making), cases and presentation cases for timepieces and jewelry, watch movements and their parts.

(260) AM 2019 99628 A

(800) 1223853

(151) 2014 07 08

(891) 2018 06 01

(731) TOVARYSTVO Z OBMEZHENOIU VIDPOVIDALNISTIU "POSHTOVO-LOHISTYCHNA HRUPA "MIST HRUP" vul. Zelena, 147, m. Lviv 79035, Ukraine

(540)

MYMEEST

(591) Black, white

(511)

39 – Transport; packaging and storage of goods; arranging of travel tours; bus transport; car transport; barge transport; towing; vehicle breakdown assistance (towing); arranging of cruises; piloting; boat transport; water supplying; water distribution; delivery of newspapers; flower delivery; message delivery; parcel delivery; delivery of goods; delivery of goods by mail order; sightseeing (tourism); electricity distribution; distribution of energy; stevedoring; railway transport; launching of satellites for others; guarded transport of valuables; warehousing; boat storage; refloating of ships; traffic information; storage information; transportation information; operating canal locks; ice-breaking; lighterage services; transportation logistics; marine transport; providing driving directions for travel purposes; garage rental; parking place rental; rental of warehouses; rental of vehicle roof racks; rental of aircraft engines; motor coach rental; car rental; rental of diving bells; rental of diving suits; railway truck rental; rental of storage containers; rental of wheelchairs; horse rental; aircraft rental; rental of freezers; rental of navigational systems; railway coach rental; rental of motor racing cars; frozen-food locker rental; vehicle rental; boat rental; wrapping of goods; car parking; passenger transport; armored-car transport; hauling; carting; transport and storage of trash; transporting furniture; transport of travellers; freight (shipping of goods); portage; air transport; booking of seats for travel;

travel reservation; transport reservation; ferry-boat transport; shipbrokerage; transport brokerage; freight brokerage; chauffeur services; pleasure boat transport; bottling services; courier services (messages or merchandise); taxi transport; freight forwarding; removal services; salvaging; river transport; unloading cargo; rescue operations (transport); underwater salvage; salvage of ships; ambulance transport; escorting of travellers; streetcar transport; transport by pipeline; physical storage of electronically-stored data or documents; franking of mail; freighting.

(260) AM 2019 99630 A

(800) 1314319

(151) 2016 07 12

(891) 2018 07 23

(731) D.O.N CO., LTD

5-10, Ogondori, Nakamura-ku, Nagoya-shi, Aichi 453-0804, Japan

(540)

TAION

(591) Black, white

(531) 27.05.17

(511)

25 – Clothing; footwear; clothes for sports; special footwear for sports.

(260) AM 2019 99631 A

(800) 1351426

(151) 2017 04 04

(891) 2018 08 10

(731) Guangzhou Tigernu Leather Co., LTD Shanqian Sec, Aiqun Community, Xinyang Village, Shiling Town, Huadu District, Guangzhou City, Guangdong Province, China

(540)



(591) Black, white

(531) 24.03.09; 27.05.19; 27.05.24

(511)

18 – Leather, unworked or semi-worked; school bags; backpacks; pocket wallets; handbags; travelling sets [leatherware]; leather shoulder belts; bags; umbrellas; clothing for pets.

(260) AM 2019 99633 A
 (800) 1368334
 (151) 2017 08 11
 (891) 2018 09 07
 (731) WENGER S.A.
 Route de Bâle 63, CH-2800 Delémont,
 Switzerland
 (540)



(591) Red and black
 (531) 24.13.01; 24.13.23; 26.04.04; 26.04.06;
 26.04.16; 26.04.24; 29.01.12
 (511)
 18 – Trunks and suitcases; bags, briefcases (leather goods), wallets, beach bags, bags for campers, shopping bags, handbags, travel bags, school bags, backpacks; umbrellas, parasols and walking sticks.

(260) AM 2019 99634 A
 (800) 1373684
 (151) 2017 09 04
 (891) 2018 06 07
 (731) NEXUS AUTOMOTIVE INTERNATIONAL
 SA
 Chemin de Château-Bloch 11, CH-1219 Le
 Lignon – Genève, Switzerland
 (540)



(591) Anthracite (Pantone PMS 425), orange
 (Pantone PMS 148)
 (531) 24.17.04; 27.05.21; 29.01.12
 (511)
 35 – Organization, operation and supervision of promotional incentive and sales schemes; negotiation of business contracts for third parties; commercial intermediary services for spare parts for automobiles; commercial intermediary services in the framework of bringing prospective private investors in contact with entrepreneurs looking for financing; wholesale of spare parts for automobiles; online wholesale of spare parts for automobiles; promotional services; organization of exhibitions and trade fairs for commercial or advertising purposes; services provided by consultants and commercial business management; advice in connection with communication (ad-

vertising); organization of opinion polling; organization of market surveys; commercial information services; organization, operation and supervision of customer loyalty schemes.

37 – Garage services for automobile maintenance and repair; repair information; rebuilding of worn or partially destroyed engines; service stations (filling with fuel and maintenance); wheel balancing services; washing and cleaning of vehicles; retreading of tires.

(260) AM 2019 99636 A
 (800) 1399499
 (151) 2018 03 16
 (891) 2018 09 11
 (731) FALL CREEK FARM AND NURSERY,
 INC.
 39318 Jasper-Lowell Road, Lowell OR 97452,
 USA
 (540)

SEKOYA POP

(591) Black, white
 (511)
 31 – Living plants; fresh fruit.

(260) AM 2019 99637 A
 (800) 1399503
 (151) 2018 03 16
 (891) 2018 09 11
 (731) FALL CREEK FARM AND NURSERY,
 INC.
 39318 Jasper-Lowell Road, Lowell OR 97452,
 USA
 (540)

SEKOYA BEAUTY

(591) Black, white
 (511)
 31 – Living plants; fresh fruit.

(260) AM 2019 99638 A
 (800) 1400596
 (151) 2018 03 16
 (891) 2018 09 11
 (731) FALL CREEK FARM AND NURSERY,
 INC.
 39318 Jasper-Lowell Road, Lowell OR 97452,
 USA
 (540)

SEKOYA CRUNCH

(591) Black, white
 (511)
 31 – Living plants; fresh fruit.

(260) AM 2019 99639 A
 (800) 1406067
 (151) 2018 03 16
 (891) 2018 09 11
 (731) FALL CREEK FARM AND NURSERY, INC.
 39318 Jasper-Lowell Road, Lowell OR 97452,
 USA

(540)
SEKOYA GRANDE

(591) Black, white
 (511)
 31 – Living blueberry plants; fresh fruit.

(260) AM 2019 99640 A
 (800) 1406516
 (151) 2018 03 16
 (891) 2018 09 11
 (731) FALL CREEK FARM AND NURSERY,
 INC.
 39318 Jasper-Lowell Road; Lowell OR 97452,
 USA

(540)
SEKOYA PEACH

(591) Black, white
 (511)
 31 – Living blueberry plants; fresh fruit.

(260) AM 2019 99641 A
 (800) 1412099
 (151) 2018 04 23
 (891) 2018 09 06
 (731) GLOVOAPP23, S.L.
 Carrer Pujades, 94, E-08005 Barcelona, Spain

(540)

(591) Green "Pantone 7473C" and yellow "Pantone
 1225C"
 (531) 18.05.06; 24.17.04; 29.01.12
 (511)
 9 – Software; computer programs [downloadable
 software]; downloadable computer applications.
 39 – Courier services (goods).

(260) AM 2019 99642 A
 (800) 1416989
 (151) 2018 06 08
 (891) 2018 07 30
 (731) OSRAM GmbH
 Marcel-Breuer-Straße 6, 80807 München,
 Germany

(540)

SharXS

(591) Black, white
 (511)
 11 – Lighting apparatus, especially electric lamps
 and luminaires parts of all the aforesaid goods in-
 cluded in class 11.

(260) AM 2019 99643 A
 (800) 1422534
 (151) 2017 10 02
 (891) 2018 09 05
 (731) SANY BAGS, S.L.
 Polig. Les Pedreres C/ Aparadoras, 7 A,
 E-03610 PETRER, Spain

(540)



(591) Black, white
 (531) 02.05.03
 (511)
 3 – Bleaching preparations and other substances for
 laundry use; cleaning, polishing, degreasing and ab-
 rasive preparations; soaps; perfumery products, per-
 fumes, essential oils, cosmetics, hair lotions; denti-
 frices; preparations for perfuming rooms; toiletries;
 preparations for manicure; products and preparations
 for the care and cleaning of hair and skin; adhesives
 for cosmetic use; after-shave lotions; antiperspirants
 [toiletries]; antistatic preparations for household use;
 aromatic agents for fragrances; quillaia bark for was-
 hing; bath salts; cosmetic preparations for baths;
 beauty masks; bleaching salts; bleaching soda; blu-
 ing for laundry; breath freshening sprays; breath-
 freshening strips; chemical products for domestic
 use for color-brightening [laundry]; color-removing
 products; cosmetic kits; cosmetic preparations for
 slimming; cosmetics for animals; cotton sticks for
 cosmetic use; cotton wool for cosmetic use; cosme-
 tic creams; skin whitening creams; creams for leat-
 her; degreasing (products for); denture polishes;
 preparations for cleaning dentures; deodorants for
 the human body; deodorants for animals and pets;
 detergents; cosmetic dyes; cologne; toilet water; hair
 dyes; hair dyes; hair cream, hair gel, shampoos, hair
 conditioner and hair-moistening preparations; perfu-
 mes; lipsticks; creams and lotions for the skin and
 face; false nails; nail enamels and varnishes and thi-
 nners for them; solar filter; bleaches for cosmetic
 use; sanitary products [toiletries]; pastry flavorings

[essential oils]; cleansing milk for toilet purposes; eyebrow cosmetics; eyebrow pencils; softeners; false eyelashes; floor wax; hair sprays; hair waving preparations; bleaching products for laundry use; laundry soaking products; laundry starch; lotions for cosmetic use; make-up; make-up powder; make-up products; make-up removing preparations; mascara; mouthwashes not for medical use; decorative nail transfers; nail care products; cosmetic pencils; products for polishing furniture and flooring; pomades for cosmetic use; potpourri; pumice stone; emery cloth; sandpaper; scented wood; shampoos for pets; boot polish; shoe black (shoe polish); shoe wax; smoothing products [starching]; soap for brightening textile; laundry starch; skin tanning preparations; tissues impregnated with cosmetic lotions; nail polish removing products; depilatory wax; laundry wax; polishing wax; creams for leather; depilatories; jelly (petroleum) for cosmetic uses; decorative patterns for cosmetic use; incense sticks [perfumed sticks]; fragrances; skin oil blotting paper; facial blotting paper; non-medicinal bath preparations.

9 – Scientific, nautical, surveying, photographic, cinematographic, optical, weighing, measuring, signaling, checking (supervision), life-saving and teaching apparatus and instruments; electric apparatus and instruments for controlling, distributing, transforming, adjusting, conducting, accumulating and storage of electricity, apparatus for the recording, transmission, reproduction of sound or images; magnetic recording media, sound recording disks; compact disks, DVDs and other digital recording media; mechanisms for coin-operated apparatus; cash registers, calculating machines, data processing equipment and computers; software; fire extinguishers; abacuses; audiovisual teaching apparatus; wet cells; accumulator boxes; battery chargers; binoculars; calculators; cameras, cinematographic cameras, and parts and fittings thereof; camera lenses; capacity measures; animated cartoons; cassette players; chains for spectacles; exposed cinematographic films; time clocks [time recording devices]; compact disc players; compact disks [audio-video]; compact disks [read-only memory]; recorded computer operating programs; software; computer programs (recorded); computers; computer printers; contact lenses; containers for contact lenses; data processing apparatus; dressmakers' measures; electric door bells; electronic pocket translators; fire extinguishers; exposed films; fire alarms; flashlights [photography]; frames for photographic transparencies; heat-regulating apparatus; coin-operated musical automata [juke boxes]; optical lenses; letter scales; life belts; life buoys; life jackets; lifeboats; electric locks; electronic locks and keys; magnetic data media; encoded magnetic cards; magnetic encoders; magnets; magnifying glasses; apparatus, devices and instruments for measuring; microphones; microscopes; neon signs; portable computers; electronic pens [visual display units];

phonograph records; photocopiers; pocket calculators; projection apparatus; projection screens; radios; record players; remote control apparatus; rules [measuring instruments]; balancing devices; smart cards [integrated circuit cards]; smoke detectors; sockets, plugs and other contacts [electric connections]; sound recording apparatus; phonograph records; apparatus for reproducing sound; sound transmitting apparatus; pince-nez cases; eyeglass frames; glasses and lenses; sunglasses; electric switches; sockets, plugs and other contacts [electric connections]; magnetic tape recorders; telephone apparatus, receivers, transmitters, wires; telescopes; television apparatus; television apparatus; temperature indicator apparatus; electric theft prevention installations; thermometers; thermostats; video cassettes, video game cartridges; video recordings; videotapes; video screens; video recorders; word processing equipment; video compact discs; digital versatile video disks; video compact disc players and digital versatile video disks; audiovisual apparatus with devices for singing; mounts, supports, cases for audio and video cassettes, compact discs, laser disks, video discs and digital versatile video disks; mouse pads; telephones, cordless telephones, cellular telephones, mobile telephones, and parts, fittings and accessories thereof; mobile telephone cases or casings; pagers, and parts and fittings thereof; cases or casings for paging apparatus; bags, coverings, containers, holders and stands for mobile telephones and pagers; helmets as headphones; earphones; headphones and microphones for use with mobile telephones; call indicators for telephones, mobile telephones and pagers; electronic agendas; alarms; bar code readers; barometers; buzzers; electronic buzzers; central processing units; integrated circuit chips; chronographs [time recording apparatus]; laptop carrier; computer keyboards; computer memory devices; peripheral devices for computers; acoustic couplers; couplers [data processing equipment]; optical data media; optical disks; magnetic disks; apparatus for electricity conduits; divers' masks; diving suits; electronic notice boards; electronic pens [visual display units]; eyeglass cords; eyepieces; facsimile equipment; filters for cameras; floppy disks; head cleaning tapes; hygrometers; integrated circuits; intercommunication apparatus; couplers (data processing equipment); invoicing machines; lens covers; magnetic tape units for computers; magnetic tapes; measuring spoons; metronomes; microprocessors; modems; money counting and sorting machines; monitors [computer hardware]; monitors [computer programs]; mice [computer peripherals]; light conducting filaments; optical glass; optical products; parking meters; protractors [measuring instruments]; radiotelegraphy sets; radiotelephony sets; scanners [data processing equipment]; semi-conductors; transparencies; sound recording strips; demagnetizing apparatus for magnetic tapes; telegraph cables; telegraphs

[apparatus]; teleprinters; teleprompters; teleprinters; ticket dispensers; transmitters [telecommunication]; transmitting sets [telecommunication]; vacuum gauges; video telephones; whistle alarms; earplugs for divers; egg timers; goggles for sports; protective helmets for sports; navigation apparatus for vehicles [on-board computers]; game software; electronic publications (downloadable); computer programs [downloadable software]; downloadable computer applications; personal stereos; satellites for scientific use; wrist rests for use with computers; straps for mobile telephones; stands for mobile telephones; caps for antennas for mobile telephones; electronic circuits and CD-ROMs which enable the recording of automatic interpreting programs for the use of electronic musical instruments; portable media players; downloadable image files; downloadable music files; downloadable ringtones for mobile telephones; DVD players; GPS (global positioning system) apparatus; USB flash drives; floppy disk drive units for computers; laptop computers; light-emitting diodes [LED]; protection devices for personal use against accidents; protective masks; straps for mobile telephones; compasses [measuring instruments]; electric couplings; covers for electric outlets; distribution consoles [electricity]; hands free kits for telephones; fire hoses; fire hose nozzles; game programs for video game machines; game programs for home video game machines; digital personal assistants; ear plugs for swimming; solar batteries; digital tablets; digital cameras, digital book readers, smartphones.

14 – Precious metals and their alloys and ingots of precious metal, boxes of precious metal, cuff links of precious metal, tie clips of precious metal, tie pins of precious metal, works of art of precious metal, ornamental pins made of precious metal, shoe ornaments of precious metal, statues of precious metal, statuettes of precious metal; jewelry articles; jewelry and ornaments; precious stones; timepieces and chronometric instruments; brooch; chains [jewelry]; charms; coins; tokens, in particular medals and/or coins; cuff links; earrings; gold thread; jewelry cases [caskets]; jewelry cases [caskets]; necklaces [jewelry]; pins [jewelry]; lapel pins; finger rings; statues and statuettes of precious metals; tie clips; clocks, watches and parts and fittings thereof; watch straps, watch bracelets, watch chains; watch cases; electric alarm clocks; stopwatches; ornaments [jewelry]; ornamental pins, tie pins; medals; keyrings, trinkets for keys (trinkets or fobs); key chains and key cases/carriers of precious metal and/or precious stones; pendants; bracelets [jewelry]; watch cases [presentation]; clock cases; electric clocks and watches; sundials; diamonds; jewelry [costume jewelry]; semi-precious stones; works of art of precious metal; alarm clocks; cuff links made of chenille; measured pins (tie pins); statuettes of precious metal; badges of precious metal; footwear ornaments of precious

metal; trophies of precious metal [prize cups]; commemorative shields; good luck charms.

16 – Paper; cardboard; printing products (printed matter); bookbinding material; photographs; stationery; adhesives (glues) for stationery or household use; artists' materials; paintbrushes; typewriters and office requisites (except furniture); instructional material or teaching material (excluding apparatus); plastic materials for packaging (not included in other classes); printing type; printing blocks; adhesive labels, stickers, decorative ribbons, paper envelopes, calendars, postcards, erasers, pencil sharpeners, pencil boxes, paints, pens, note books, agendas, diaries, note books, books, pencil holders.

18 – Leather and imitation leather; animal skins; bag, thermal bag, wash bag, sports bag, sack bag, wallet, document bag, banderole, hand bag, shopper bag, bowling bag, clutch bag, backpack bag, bag, holder, wallet, purse, wallet, suitcase, trolley suitcase, travel bag, backpack, backpack trolley, school backpack, trunks and suitcases; umbrellas and parasols; reins for guiding children; walking sticks; whips, harness and saddlery.

21 – Household and kitchen utensils and containers; combs and sponges; brushes; brush-making materials; cleaning material; steel wool; unworked or semi-worked glass (except building glass); glassware, porcelain and earthenware articles not included in other classes; baby baths (portable); baskets for household use; bowls; bird cages; non-electric blenders for household use; ironing boards; boot jacks; bottle openers, electric and non-electric; corks for bottles made of ceramic, china, crystal, glass, earthenware, terracotta and porcelain; bottles; basins (bowls); soap holders [cases]; bread cutting boards; buckets; cabarets [trays]; cages for pets; cake molds; waffle irons; candle extinguishers; candle rings; candelabra [candlesticks]; candy boxes; comb cases; china, porcelain ornaments; chopsticks [table utensils]; clothing stretchers; cleaning cloths; coasters; cocktail stirrers; coffee filters; coffee grinders; coffee percolators; coffee services; coffee pots; electric combs; combs for animals; confectioners' decorating bags (pastry bags); cookery molds; cooking pots; skewers; ice buckets; non-electric portable coolers; food cooling devices containing heat exchange fluids, for household use; corkscrews, electric and non-electric; cosmetic utensils; dish covers; flower pots; chinaware; cups; cutting boards for the kitchen; decanters; non-electric deep fryers; soap dishes [soap holders]; soap dispensers; flasks, glasses, cups, pots; drying racks for laundry; trash cans; egg cups; feeders; flowerpots [containers]; fly swatters; gloves for household use; mugs; graters; non-electric toasters; thermally insulated containers; non-electric heaters for feeding bottles; flower holders; pots that retain heat; ice buckets; ice cube molds; shaped ironing board covers; pitchers; non-electric kettles; knife blocks;

lazy Susans [table utensils]; liquor sets; lunch boxes; menu card holders; lunch boxes; mixing spoons [kitchen utensils]; mops; napkin holders; napkin holders; sprayers for watering cans; pads for cleaning; pans for fondue; paper plates; pastry cutters; hand-operated pepper mills; fragrance burners; perfume atomizers; perfume atomizers; picnic baskets; money boxes; pot lids; pots; pressure cookers; trash cans; salt cellars; pepper pots; ladles; saucers; ladles; pads for cleaning; shaving brushes; shirt stretchers; brushes for boots; shoe horns; shoe trees; sieves; smoke absorber products for household use; soap dishes [soap holders]; soup bowls; spice racks; sponge holders [sponge bags]; sponges for household use; shaving brush stands; statues of porcelain, terracotta or glass; figurines (statuettes) of porcelain, terracotta or glass; strainers; syringes for watering flowers and plants; tableware; tankards; tea diffusers; tea caddies; tea diffusers; tea services; teapots; toilet brushes; toilet cases; toilet paper holders; toilet sponges; toilet paper dispensers; toilet utensils; toothbrushes; electric toothbrushes; toothpick holders; toothpicks; towel rails and rings; trash cans; litter boxes (trays) for pets; trays for domestic purposes; place-mats [table utensils]; trouser presses; pants stretchers; vacuum bottles; toilet cases; vases; waffle and pancake irons [non-electric]; non-electric grills for cooking; washing boards; washtubs; watering cans; watering implements; works of art of porcelain, ceramic, earthenware or glass; decorations for windows or doors made of ceramic, china, crystal, glass, earthenware, terracotta or porcelain; boxes and containers for food; mouse traps; dental floss; straps for lunch boxes and containers for household and kitchen; containers for aromatics and fragrances; cooling bottles; boxes of glass; brooms; brush goods; butter dishes [crocery]; butter-dish covers; cauldrons [saucepans]; hand-operated cleaning instruments; clothes pegs; portable cold boxes (non-electric); cookie jars; non-electric cooking utensils; eyebrow brushes; brushes for boots; frying pans; funnels; gardening gloves; glass jars [receptacles]; vacuum bottles; powder puffs; cocktail shakers; tea strainers, not of precious metal; multi-purpose linings and sheets for household and kitchen; mixers, blenders, non-electric; apparatus for making ices and sorbets; biscuit cutters and biscuits; cruets, holders for vinegar; dusters; cocktail shakers; cosmetic powders; pill boxes; wood or plastic covers for tissue boxes; toothbrush holders; handles for dental floss; containers for household items; household and domestic utensils; coffee sets [tableware]; non-electric coffee makers; kitchen receptacles; tableware; cases and boxes for the household or for domestic use; pill boxes [of wood, plastic materials]; make-up removing appliances; drinking straws; deodorizing apparatus for personal use; wastepaper baskets; basins; beer mugs; insulated containers; heat insulated containers for beverages; indoor aquariums; tea cosies;

electric devices for attracting and killing insects; spatulas for cosmetic use, bottle openers, electric or non-electric.

25 – Clothing, t-shirts, dresses, pajamas, camisoles, ponchos, waterproof clothing, underwear, skirts, shorts, dressing gowns, bathing suits, bikinis, slippers, housecoats, wellington boots, slippers, footwear, headgear; sun visors.

26 – Lace and embroidery, ribbons and braid; buttons, eyelets and hooks; pins and needles; artificial flowers; artificial fruit; artificial garlands; ornamental badges; badges for wear not of precious metal; zip fasteners for bags; expanding bands for holding sleeves; hair bands; hair slides; belt clasps; blouse fasteners; bows for the hair; sewing boxes; needle boxes and holders; fastenings for suspenders; cords; curtain holders; buckles; shoe buckles; pin cushions [cushions for needles]; pin cushions; thermoadhesive parts for the repair and decoration of textile articles; fasteners for footwear; racks; fastenings for clothing; fastenings for suspenders; wreaths of artificial flowers; gold embroidery; haberdashery; slides [hair grips]; hair coloring caps; hair curlers, other than hand implements; pins for curlers; slides [hair grips]; hair nets; hair ornaments; hair pins; hat ornaments, not of precious metal; hooks for corsets; knitting needles; shoe ornaments, not of precious metal; prize ribbons; bands with badges; sewing needles; sewing thimbles; shoe hooks; shoe laces; tassels [haberdashery]; top-knots (pompoms); woollen laces; racks; racks; rubber bands for styling ponytails; pins; clips and fasteners for bibs and aprons; frills [lacework]; appliqués (textile decorations); buttons; collar supports; hair curling paper; hair coloring caps; wigs; hairpieces.

28 – Toys, games and playthings; dolls; plush toys; teddy bears; toy figures and play sets; gymnastic and sporting articles; balls and balloons; decorations and ornaments for Christmas trees; novelties for parties, dances [party favors]; toy vehicles; electric vehicles (games); surf boards; snowboards; inline skates; ice skates; skateboards [toys]; protective paddings or guards for sports and games; air pistols [toys]; backgammon games; balls for games; bells for Christmas trees; billiard balls; billiard tables; building blocks [toys]; board games; explosive bonbons [Christmas crackers]; skate boots; bowling apparatus and machinery; building games; candle holders for Christmas trees; checkerboards; checkers [games]; chess games; chessboards; Christmas trees made of synthetic materials; Christmas tree stands; conjuring apparatus; explosive bonbons [Christmas crackers]; cups for dice; darts; dice; dolls' beds; dolls' clothes; dolls' houses; dolls' rooms; dominoes; checkerboards; checkers [games]; bars with weights [dumbbells]; elbow guards [sports articles]; chest expanders [exercisers]; carousels [merry-go-rounds]; dolls' feeding bottles; fish hooks; fishing tackle; flippers for swimming;

floats for fishing; flying discs [toys]; automatic games; rackets; apparatus for games; video game apparatus; portable games with liquid crystal displays; arcade video game machines; bags for golf clubs; golf clubs; golf gloves; gloves for games and sports; practical jokes [novelties]; kite reels; kites; knee guards [sports articles]; mah-jong games; marbles for games; puppets; theatrical masks; masks [toys]; mobiles [toys]; scale model vehicles; paper party supplies; padded protectors [parts of sports suits]; parlor games; detonating capsules [toys]; toy pistols; playing balls; puppets; rackets; rattles; ring games; rocking horses; roller skates; sailboards; skis; sleighs [sports articles]; slides [game articles]; soap bubbles [toys]; spinning tops [toys]; trampolines [sports articles]; stationary exercise bicycles; swimming pools [game or sports articles]; flippers for swimming; swings; Tables for table tennis; toys for domestic pets; waterskis; play articles for swimming, games, sports and water activities; beach balls; amusement machines, automatic and coin-operated; bags especially designed for skis and surfboards; bingo cards; butterfly nets; playing cards; confetti; in-line roller skates; jigsaw puzzles [puzzles]; kaleidoscopes; masts for sailboards; landing nets for anglers; remote-controlled vehicles; roulette wheels; snow balls (playthings); snowshoes; Japanese playing cards; swimming jackets; swimming belts; water wings; swimming devices; water wings; paper party hats [party favors]; body-building apparatus; chips for gambling; scratch cards; scale model kits [toys]; pachinkos; slot machines [gaming machines].

35 – Advertising, business management, business administration, office functions; franchising services for assistance with the operation or management of a commercial company; sales services via telephone and catalogs; retail sale and wholesale in stores and sale via global computer networks of: bleaching preparations and other substances for laundering garments, cleaning, polishing, scouring and abrasive preparations, soaps, perfumery products, perfumes, essential oils, cosmetics, hair lotions, dentifrices, preparations for perfuming rooms, toiletries, preparations for manicure, products and preparations for the care and cleaning of hair and skin, adhesives [glues] for cosmetic use, after-shave lotions, antiperspirant products [toiletries], antistatic preparations for household use, aromatics for fragrances, quillaia bark for washing, bath salts, cosmetic preparations for baths, cosmetic masks, bleaching salts, bleaching soda, bluing, breath freshening sprays, breath freshening strips, chemicals for household use to brighten colors [laundry], color-removing preparations, cosmetic kits, cosmetic preparations for slimming purposes, cosmetics for animals, cotton sticks for cosmetic use, cotton wool for cosmetic use, cosmetic creams, skin whitening creams, creams for leather, degreasing [products], preparations for polishing dental prostheses, preparations for cleaning dentures,

deodorants for the human body, deodorants for animals and pets, detergents, cosmetic dyes, cologne, eau de toilette, hair dyes, hair cream, hair gel, shampoos, hair conditioner and hair moistening preparations, perfumes, lipsticks, creams and lotions for the skin and face, false nails, nail enamels and varnishes and thinners for them, solar filter, bleaching preparations for cosmetic use, hygiene products [toiletries], pastry flavorings [essential oils], toiletry cleansing milks, eyebrow cosmetics, eyebrow pencils, softeners, false eyelashes, floor wax, hair spray, hair waving preparations, bleaching products for laundering garments, laundry soaking preparations, starch for laundry purposes, lotions for cosmetic use, make-up, make-up powder, make-up preparations, make-up removing preparations, mascara, mouth washes not for medical use, decorative transfers for nails, nail-care products, cosmetic pencils, products for polishing furniture and flooring, pomades for cosmetic purposes, potpourri, pumice stone, emery cloth, sandpaper, scented woods, shampoos for pets, shoe cream, shoe polish, shoe wax, smoothing products [laundry], soaps for brightening textile colors, starch for laundry purposes, sun-tanning preparations, wipes impregnated with cosmetic lotions, lacquers [removal products], depilatory wax, laundry wax, polishing wax, creams for leather, depilatories, jelly [petroleum] for cosmetic use, decorative transfers for cosmetic use, incense sticks [perfumed sticks], fragrances, skin oil blotting paper, facial blotting paper, non-medicated bath preparations, scientific, nautical, surveying, photographic, cinematographic, optical, weighing, measuring, signaling, checking [supervision], life-saving and teaching apparatus, electrical instruments and apparatus for controlling, switching, transforming, adjusting, conducting, accumulation and storage of electricity, apparatus for the recording, transmission, reproduction of sound or images, magnetic recording media, sound recording discs, compact discs, DVDs and other digital recording media, mechanisms for coin-operated apparatus, cash registers, calculating machines, data processing equipment and computers, software, extinguishers, abacuses, audiovisual teaching apparatus, wet cells, battery boxes, battery chargers, binoculars, calculators, cameras, cinematographic cameras, and parts and fittings thereof, camera lenses, capacity measures, animated cartoons, cassette players, chains for spectacles, exposed cinematographic films, time clocks, compact disc players, compact discs [audio and video], compact discs [read-only memory], recorded computer operating systems programs, software, computer programs [registered], computers, laptop carrier, computer printers, contact lenses, cases for contact lenses, data processing apparatus, tape measures for dressmaking, electric door bells, electronic pocket translators, extinguishers, exposed films, fire alarms, flashlights, frames for photographic transparencies, heat regulating apparatus, musi-

cal juke boxes, optical lenses, letter scales, life belts, life jackets, life boats, electric locks, electronic locks and keys, magnetic data carriers, magnetic encoded cards, magnetic encoders, magnets, magnifying glasses, apparatus, devices and instruments for measuring, microphones, microscopes, neon signs, portable computers, electronic pens for visual display units, phonograph records, photocopiers, pocket calculators, projection apparatus, projection screens, radio apparatus, record players, remote control apparatus, rules [measuring instruments], balancing apparatus, smart cards, smoke detectors, sockets, sound recording apparatus, phonograph records, apparatus for reproduction of sound, sound transmitting apparatus, eyeglass cases, eyeglass frames, spectacles and lenses, sunglasses, electric switches, sockets, tape recorders, telephone apparatus, receivers, transmitters, cables, telescopes, televisions, television sets, apparatus for indicating temperature, electric theft-prevention installations, thermometers, thermostats, video cassettes, video game cartridges, video recordings, video tapes, video screens, video recorders, equipment for word processing, video compact discs, digital versatile video disks, video compact disc players and digital versatile video disks, audiovisual apparatus with devices for singing, bases, stands, cases for audio and video cassettes, compact discs, laser disks, video discs and digital versatile video disks, mouse pads, telephones, cordless telephones, cellular telephones, mobile telephones, and their parts, parts and accessories, mobile telephone cases or casings, pagers, and parts and fittings thereof, cases or casings for paging apparatus, bags, coverings, containers, holders and stands for mobile telephones and pagers, helmets as headphones, headphones, earphones and microphones for use with mobile telephones, call indicators for telephones, mobile telephones and pagers, electric alarm clocks, electronic agendas, alarms, bar code readers, barometers, buzzers, electronic buzzers, central processing units, integrated circuit chips, chronographs [time recording apparatus], computer keyboards, computer memories, peripheral devices for computers, acoustic couplers, couplers [data processing equipment], optical data media, optical discs, magnetic discs, apparatus for electricity conduits, divers' masks, diving suits, electronic bulletin boards, electronic pens for visual display units, pince-nez cords, eyepieces, visors, facsimile equipment, camera filters, diskettes, head cleaning tapes, hygrometers, integrated circuits, intercommunication apparatus, couplers [data processing equipment], billing machines, covers for lenses, magnetic tape units [computing], magnetic tapes, spoons, metronomes, microprocessors, modems, money counting and sorting machines, monitors [computer hardware], monitors [computer programs], mouse [data processing equipment], light conducting filaments, optical glass, optical goods, parking meters, conveyors [measuring

instruments], radiotelegraphy sets, radiotelephony sets, scanners [data processing equipment], semiconductors, slides, sound recording strips, demagnetizing apparatus for magnetic tapes, telegraph wires, telegraphs [apparatus], teletypewriter, teleprompters, teletypewriters, ticket dispensers, transmitters [telecommunication], transmitters [telecommunication], vacuum gages, videophones, whistle alarms, earplugs for divers, egg timers, goggles for sports, protective helmets for sports, navigation apparatus for vehicles [on-board computers], game software, downloadable electronic publications, computer programs [downloadable software], downloadable computer applications, personal stereos, satellites for scientific purposes, wrist rests for use with computers, straps for mobile telephones, holders for mobile telephones, caps for antennas for mobile phones, electronic circuits and CD-ROMs which enable the recording of automatic performance programs for the use of electronic musical instruments, portable media players, downloadable image files, downloadable music files, downloadable ring tones for mobile telephones, DVD players, GPS, USB memory apparatus, floppy disk drive units for computers, laptop computers, light-emitting diodes [LED], personal protection devices against accidents, protective masks, mobile telephone straps, compasses [measuring instruments], electric connections, covers for electric outlets, distribution consoles [electricity], hands-free kits for telephones, fire hoses, fire hose nozzles, game programs for video game machine entertainment, game programs for home video game machines, personal digital assistants, ear plugs for swimming, solar batteries, digital tablets, digital cameras, digital book readers, smartphones, precious metals and their alloys and ingots of precious metals, boxes of precious metal, cuff links of precious metal, tie clips of precious metal, tie pins of precious metal, works of art of precious metal, ornamental pins made of precious metal, shoe ornaments of precious metal, statues of precious metal, statuettes of precious metal, jewelry and ornaments, precious stones, horological and chronometric instruments, brooch, chains [jewelry], charms, coins, tokens, namely medals and/or coins, cuff-links, earrings, gold thread, jewelry cases, jewelry boxes, necklaces [jewelry], pins [jewelry], pins, finger rings, statues and statuettes of precious metal, tie clips, clocks, watches, and parts and fittings thereof, watch straps, watch bracelets, watch chains, watch cases, stop-watches, ornaments [jewelry], ornamental pins, tie pins, medals, key rings, trinkets for keys [trinkets or fobs], key chains and key cases/carriers of precious metal and/or precious stones, pendants, bracelets [jewelry], cases for watches [presentation], watch cases, electric clocks, sundials, diamonds, jewelry [costume jewelry], semi-precious stones, works of art of precious metal, alarm clocks, cuff links made of chenille [pattern pins, tie pins], statuettes of pre-

precious metal, badges of precious metal, shoe ornaments of precious metal, trophies of precious materials [prize cups], commemorative shields, good luck charms, paper, cardboard, printed matter, bookbinding material, photographs, stationery, adhesives [glues] for stationery or household purposes, artists' materials, paintbrushes, typewriters and office requisites [except furniture], instructional or teaching material [except apparatus], plastic materials for packaging [not included in other classes], printing type, printing blocks, adhesive labels, stickers, decorative ribbons, paper envelopes, calendars, postcards, erasers, pencil sharpeners, pencil box, paints, pens, note books, diaries, note books, diaries, books, pencil holder, leather and imitation leather, animal skins, bag, thermal bag, wash bag, sports bag, sack bag, wallet, document bag, banderole, hand bag, shopper bag, bowling bag, clutch bag, backpack bag, bag, holder, wallet, purse, wallet, suitcase, trolley suitcase, travel bag, backpack, backpack trolley, school backpack, trunks and suitcases, umbrellas and parasol, harnesses to guide children, canes, whips and harness items, utensils and containers for domestic and culinary use, combs and sponges, brushes, brush-making materials, articles for cleaning purposes, steel wool, unworked or semi-worked glass [except building glass], glassware, porcelain and earthenware not included in other classes, baby baths [portable], baskets for household use, bowls, bird cages, non-electric blenders for household purposes, ironing boards, boot jacks, bottle openers, electric and non-electric, bottle stoppers made of ceramics, china, crystal, glass, earthenware, terracotta, porcelain, bottles, bowls [basins], soap holders [cases], bread boards, bread bins, cabarets [trays], cages for pets, cake molds, waffle irons, candle extinguishers, candle rings, candlesticks, candy boxes, comb cases, porcelain ornaments, porcelain, chopsticks [table utensils], clothing stretchers, cleaning cloths, coasters, cocktail stirrers, coffee filters, coffee grinders, coffee percolators, coffee services, coffee machines, electric combs, combs for animals, confectioners' decorating bags, cookery molds, cooking pots, skewers, ice buckets, portable non-electric cool boxes, food cooling devices containing heat exchange fluids, for household use, electric and non-electric corkscrews, cosmetic utensils, dish covers, flower pots, crockery, cups, cutting boards for the kitchen, decanters, non-electric deep fryers, soap holders [dishes], soap dispensers, flasks, glasses, cups, pots, drying racks for washing, garbage cans, egg cups, feeding vessels, pots, fly swatters, gloves for household use, mugs, graters, non-electric grill plates, thermally insulated containers, non-electric heaters for feeding bottles, flower stands, pots that maintain heat, ice buckets, ice cube molds, ironing board covers, jugs, non-electric kettles, knife blocks, lazy susans [table utensils], lunch boxes, menu card holders, lunch boxes, mixing spoons [kitchen utensils], mops, nap-

kin holders, napkin rings, sprayers for watering cans, pads for cleaning, stew-pans for fondue, paper plates, pastry cutters, hand-operated pepper mills, fragrance burners, perfume sprayers, perfume vaporizers, fitted picnic baskets, money boxes, pot lids, pots, pressure cookers, bins, salt, pepper pots, ladles, saucers [small meals], ladles, pads for cleaning, shaving brushes, shirt stretchers, brushes for boots, shoe horns, shoe trees, sieves, smoke absorbers for household use, soap holders [dishes], soup bowls, spice sets [holders], sponge holders, sponges for household use, shaving brush stands, statues of porcelain, terracotta or glass, figurines [statuettes] of porcelain, terracotta or glass, strainers, syringes for watering flowers and plants, tableware, tankards, tea diffusers, tea caddies, tea diffusers, tea services, tea pots, toilet brushes, vanity cases, toilet paper holders, toilet sponges, toilet paper dispensers, toilet utensils, toothbrushes, electric toothbrushes, toothpick holders, toothpicks, towel rails and rings, bins, litter boxes [trays] for pets, trays for domestic purposes, coasters [table utensils], pants presses, pants stretchers, insulating flasks, vanity cases, vases, waffle and pancake irons [non-electric], flat grills for cooking, washing boards, washtubs, watering cans, watering devices, works of art of porcelain, ceramic, earthenware or glass, decorations for windows or doors made of ceramic, china, crystal, glass, earthenware, terracotta or porcelain, boxes and containers for food, mouse traps, dental floss, straps for lunch boxes and containers for household and kitchen, containers for aromatics and fragrances, refrigerating bottles, glass boxes, brooms, brush products, butter dishes, butter-dish covers, boilers [pots], cleaning instruments [hand-operated], clothes pegs, portable cold boxes [non-electric], cookie jars, non-electric cooking utensils, eyebrow brushes, brushes for boots, pans, funnels, gardening gloves, glass flasks [containers], insulating flasks, powder puffs, shakers, tea strainers, not of precious metal, multi-purpose linings and sheets for household and kitchen, mixers, non-electric mixers, apparatus for making ices and iced drinks, biscuit cutters and biscuits, cruets, holders for vinegar, dusters, shakers, cosmetic powder, pill boxes, wood or plastic covers for tissue boxes, toothbrush holders, handles for dental floss, containers for household, household and domestic utensils, coffee services [tableware], non-electric coffeepots, kitchen containers, tableware, cases and boxes for the household or for household use, pill boxes [of wood, plastic], apparatus for removing make-up, drinking straws, deodorizing apparatus for personal use, baskets, basins, beer mugs, thermal insulated containers, beverages [heat insulated containers therefor], indoor aquaria, tea cosies, insects [electric devices for attracting and killing thereof], spatulas for cosmetic use, electric or non-electric bottle openers, clothing, t-shirts, dresses, pajamas, camisoles, ponchos, waterproof clothing, underwear, skirts,

shorts, dressing gowns, bathing suits, bikinis, home footwear, waterproof boots, flip flops, footwear, headgear, lace and embroidery, ribbons and braid, buttons, eyes and hooks and eyelets, pins and needles, artificial flowers, artificial fruit, artificial garlands, ornamental badges, insignia, not of precious metal, slide locks for bags, expanding bands for holding sleeves, hair bands, hair slides, belt clasps, hooks for blouses, bows for the hair, sewing boxes, boxes and cases for needles, brace fasteners, cords, curtain holders, buckles, shoe buckles, needle cushions, needle boxes [needle cushions], thermoadhesive parts for the repair and decoration of textile articles, shoe fasteners, zippers, fastenings for clothing, brace fasteners, wreaths of artificial flowers, gold embroidery, haberdashery, hair grips, hair coloring caps, hair curlers, pins for curlers, hair grips, hair nets, hair ornaments, hair pins, ornaments, not of precious metal for hats, hooks for corsets, knitting needles, ornaments, not of precious metal, bands [pins], bands with badges, sewing needles, sewing thimbles, shoe hooks, shoe laces, tassels [haberdashery], tassels, wool laces, zip fasteners, zippers, rubber bands for styling horse tails, safety pins, clamps and fastenings for bibs and aprons, frills [lace], appliqués [textile decorations], buttons, pins for detachable collars, hair curling paper, hair coloring caps, wigs, false hair, toys, games and toys, dolls, plush toys, teddy bears, toy figures and play sets, gymnastic and sporting articles, balls and balloons, decorations and ornaments for Christmas trees, party favors, toy vehicles, electric vehicles [toys], surfboards, snowboards, inline roller skates, ice skates, skateboards [toys], protective paddings or guards for sports and games, air pistols [toys], backgammon games, balls for games, bells for Christmas trees, billiard balls, billiard tables, building blocks [toys], board games, toy bangers, soap bubbles, boots for skates, bowling apparatus and machinery, building games, candle holders for Christmas trees, checkerboards, checkers, chess games, chessboards, Christmas trees of synthetic material, Christmas tree stands, conjuring apparatus, toy bangers, soap bubbles, cups for dice, darts, dice [games], dolls' beds, dolls' clothes, dolls' houses, dolls' rooms, dominoes, checkerboards, checkers, bar-bells [weights for gym], elbow guards [sports articles], chest expanders, rotating decks [fairground ride apparatus], feeding bottles for dolls, fish hooks, fishing tackle, flippers for swimming, floats for fishing, flying discs [toys], automatic games, rackets, apparatus for games, video game apparatus, portable games with liquid crystal displays, video game machines, arcade games, golf bags, golf clubs, golf gloves, gloves for games and sports, practical jokes, kites, kite reels, knee guards [sports articles], mah-jong, marbles for games, puppets, theatrical masks, masks [toys], mobiles, scale model vehicles, paper party supplies, protective paddings [parts of sports suits], parlor games, detonating

capsules [toys], toy pistols, balls for games, puppets, rackets, rattles, ring games, rocking horses [toys], roller skates, sailboards, skis, sleighs [sports articles], slides [playthings], soap bubbles, spinning tops [toys], spring boards [sports articles], stationary exercise bicycles, swimming pools [play articles], flippers for swimming, swings, tables for table tennis, toys for pets, water skis, play articles for swimming, games, sports and water activities, beach balls, automatic and coin-operated amusement machines, bags especially designed for skis and surfboards, bingo cards, butterfly nets, playing cards, confetti, inline roller skates, puzzles, kaleidoscopes, masts for sailboards, landing nets for fishing, remote-controlled vehicles, wheels, snow balls [toys], snowshoes, Japanese playing cards, swimming jackets, swimming belts, water wings, swimming devices, water wings, paper party hats [party favors], body-building apparatus, counters for gambling, printed lottery scratch cards, scale model kits [toys], coin-operated games, pachinko.

(260) AM 2019 99695 A

(800) 1425875

(151) 2018 06 12

(891) 2018 06 12

(731) Private Joint-Stock Company "KYIV CARDBOARD AND PAPER MILL"
vul. Kyivska, 130, m. Obukhiv, Kyivska obl.
08700, Ukraine

(540)

Soffione Grande

(591) Black, white

(511)

16 – Fountain pens; albums; almanacs; banknotes; drawing pads; pamphlets; booklets; signboards of paper or cardboard; toilet paper; printed matter; printed publications; labels, not of textile; magazines (periodicals); bookmarkers; note books; pads (stationery); calendars; tracing paper; office requisites, except furniture; stationery; wood pulp board (stationery); cardboard; cardboard tubes; adhesive tapes for stationery or household purposes; conical paper bags; carbon paper; copying paper (stationery); boxes of paper or cardboard; cases for stamps (seals); absorbent sheets of paper or plastic for foodstuff packaging; humidity control sheets of paper or plastic for foodstuff packaging; flyers; bags (envelopes, pouches) of paper or plastics, for packaging; garbage bags of paper or of plastics; stuffing of paper or cardboard; waxed paper; handkerchiefs of paper; covers (stationery); printers' blankets, not of textile; cream containers of paper; packing (cushioning, stuffing) materials of paper or cardboard; paper tapes; paper sheets (stationery); packing paper; paper for recording machines; wood pulp paper; paper; document files (stationery); folders for papers; writing materials (sets); writing paper; writing cases (stationery);

coasters of paper; tablemats of paper; bottle wrappers of cardboard or paper; bottle envelopes of cardboard or paper; flags of paper; blotters; towels of paper; luminous paper; face towels of paper; tissues of paper for removing make-up; tablecloths of paper; loose-leaf binders; table linen of paper; table napkins of paper; tablemats of paper; placards of paper or cardboard.

(260) AM 2019 99696 A

(800) 1425879

(151) 2018 05 09

(891) 2018 05 09

(731) APAYDIN ISITMA VE ENERJİ
SİSTEMLERİ SANAYİ VE TİCARET
LİMİTED ŞİRKETİ
İlkadım Sanayi Sitesi Uzunlar Cad. No:5,
Tekkeköy / Samsun, Turkey

(540)



(591) Orange, blue and green.

(531) 26.04.03; 26.07.25; 29.01.13

(511)

11 – Heating installations using solid, liquid or gas fuels or electricity, central heating boilers, boilers for heating installations, radiators [heating], heat exchangers, not parts of machines, stoves, kitchen stoves, installations for air-conditioning and ventilating; cooling installations and freezers, electric and gas-powered devices, installations and apparatus for cooking, drying and boiling; cookers, electric cooking pots, electric water heaters, barbecues, electric laundry driers; hair driers; hand drying apparatus; sanitary installations, taps [faucets], shower installations, toilets [water-closets], shower and bathing cubicles, bath tubs, toilet seats, sinks, wash-hand basins [parts of sanitary installations]; sanitary installations, taps [faucets], shower installations, toilets [water-closets], shower and bathing cubicles, bath tubs, toilet seats, sinks, wash-hand basins [parts of sanitary installations]; water softening apparatus; water purification apparatus; water purification installations; waste water purification installations; industrial type installations for cooking, drying and cooling purposes.

35 – The bringing together, for the benefit of others, of a variety of goods, namely; ores of non-precious metal common metals and their alloys and semi-finished products made of these materials; goods and materials of common metal used for storage, wrapping, packaging and sheltering purposes, containers of metal (storage, transport), buildings of metal frames of metal for building, poles of metal for building, metal boxes, packaging containers of metal aluminium foil, fences made of metal, guard barriers

of metal, metal tubes, storage containers of metal, metal containers for the transportation of goods, ladders of metal, goods of common metal for filtering and sifting purposes, included in this class, doors, windows, shutters, jalousies and their cases and fittings of metal, non-electric cables and wires of metal, ironmongery, small hardware of metal ventilation ducts, vents, vent covers, pipes, chimney caps, manhole covers, grilles of metal for ventilation, heating, sewage, telephone, underground electricity and air conditioning installations, metal panels or boards (non-luminous and non-mechanical) used for signalling, route showing, publicity purposes, signboards of metal, advertisement columns of metal, signaling panels of metal, non-luminous and non-mechanical traffic signs of metal pipes of metal for transportation of liquids and gas, drilling pipes of metal and their metal fittings, valves of metal, couplings of metal for pipes, elbows of metal for pipes, clips of metal for pipes, connectors of metal for pipes, sates (strong boxes) of metal, metal railway materials, metal rails, metal railway ties, railway switches, bollards of metal, floating docks of metal, mooring buoys of metal, anchors, metal moulds for casting, other than machine parts, works of art made of common metals or their alloys, metal closures, bottle caps of metal, metal poles, metal pallets and metal ropes for lifting, loading and transportation purposes; metal hangers, tics, straps, tapes and bands used for load-lifting and load-carrying, wheel chocks made primarily of metal, lighting installations; lights for vehicles and interior-exterior spaces heating installations using solid, liquid or gas fuels or electricity, central heating boilers, boilers for heating installations, radiators [heating], heat exchangers, not parts of machines, stoves, kitchen stoves, solar thermal collectors [heating]; steam, gas and fog generators, steam boilers, other than parts of machines, acetylene generators, oxygen generators, nitrogen generators, installations for air-conditioning and ventilating, cooling installations and freezers, electric and gas-powered devices, installations and apparatus for cooking, drying and boiling; cookers, electric cooking pots, electric water heaters, barbecues, electric laundry driers; hair driers; hand diving apparatus, sanitary installations, taps [faucets], shower installations, toilets [water-closets], shower and bathing cubicles, bath tubs, toilet seats, sinks, wash-hand basins [parts of sanitary installations]; water softening apparatus; water purification apparatus; water purification installations; waste water purification installations, electric bed warmers and electric blankets, not for medical use; electric pillow warmers; electric or non-electric footwarmers; hot water bottles, filters for aquariums and aquarium filtration apparatus, industrial type installations for cooking, drying and cooling purposes, pasteurizers and sterilizers, enabling customers to conveniently view and purchase those goods, such services may be pro-

vided by retail stores, wholesale outlets, by means of electronic media or through mail order catalogues.

(260) AM 2019 99697 A
 (800) 1425928
 (151) 2018 06 22
 (891) 2018 06 22
 (731) "ADRIATIC MARINAS" D.O.O.
 Obala bb, Tivat, 85320 Crna Gora,
 Montenegro
 (540)

Porto Montenegro

(591) Black, white
 (531) 27.05.01
 (511)
 36 – Insurance; financial affairs; monetary affairs; real estate affairs.
 39 – Transport; packaging and storage of goods; travel arrangement.
 41 – Education; providing of training; entertainment; sporting and cultural activities.
 43 – Services for providing food and drink; temporary accommodation.
 44 – Medical services; veterinary services; hygienic and beauty care for human beings or animals; agriculture, horticulture and forestry services.

(260) AM 2019 99698 A
 (800) 1425929
 (151) 2018 06 22
 (891) 2018 06 22
 (731) "ADRIATIC MARINAS" D.O.O.
 Obala bb, Tivat, 85320 Crna Gora,
 Montenegro
 (540)

Royal Montenegro Golf Club

(591) Black, white
 (531) 27.05.01
 (511)
 36 – Insurance; financial affairs; monetary affairs; real estate affairs.
 39 – Transport; packaging and storage of goods; travel arrangement.
 41 – Education; providing of training; entertainment; sporting and cultural activities.
 43 – Services for providing food and drink; temporary accommodation.
 44 – Medical services; veterinary services; hygienic and beauty care for human beings or animals; agriculture, horticulture and forestry services.

(260) AM 2019 99699 A
 (800) 1425935
 (151) 2018 06 20
 (891) 2018 06 20
 (731) BELLA ITALIA RESTAURANTS LIMITED
 163 Eversholt Street, London NW1 1BU,
 United Kingdom
 (540)

BELLA ITALIA

(591) Black, white
 (511)
 43 – Services for providing food and drink; restaurant services; bar services; cafes; snack bars; catering services; take away services.

(260) AM 2019 99700 A
 (800) 1425960
 (151) 2017 05 18
 (891) 2017 05 18
 (731) ALTON WINE ACADEMY
 17700 Castleton St, Suite 168, City of Industry
 CA 91748, USA
 (540)



(591) Black, white
 (531) 02.01.18; 02.03.18; 26.01.04; 26.01.14;
 26.01.21

(526) WINE RATINGS
 (511)

41 – Providing classes, workshops, seminars and camps in the field of wine tasting, wine critics and ratings, wine educations and trainings, and wine research and development in terroir, viticulture and vinifications; providing on-line training classes, workshops, seminars and camps in the field of wine tasting, wine critics and ratings, wine educations and trainings, and wine research and development in terroir, viticulture and vinifications.

(260) AM 2019 99701 A
 (800) 1425980
 (151) 2018 06 20
 (891) 2018 06 20
 (731) T.R.M. Tisch Limited
 1st Floor, 163 Eversholt Street, London NW1
 1BU, United Kingdom

(540)

BELGO

(591) Black, white

(511)

43 – Restaurant and bar services; catering services.

(260) AM 2019 99702 A

(800) 1426105

(151) 2018 05 21

(891) 2018 05 21

(731) LABORATORIOS NORMON, S.A.

Ronda de Valdecarrizo, 6, E-28760 Tres
Cantos Madrid, Spain

(540)

MEPACAIN

(591) Black, white

(511)

5 – Pharmaceutical products; preparations for medical use; anesthetics.

(260) AM 2019 99703 A

(800) 1426149

(151) 2018 05 17

(891) 2018 05 17

(731) GREEN CROSS HOLDINGS
CORPORATION107, Ihyeon-ro 30 beon-gil, Giheung-gu,
Yongin-si, Gyeonggi-do, Republic of Korea

(540)



(591) Red, yellow, green and deep blue.

(531) 02.09.01; 24.13.01; 29.01.14

(511)

3 – Flavorings for beverages [essential oils]; cosmetics; soaps for personal use; oils for perfumes and scents; pre-moistened cosmetic tissues; detergent soap; toothpaste; mouthwashes, not for medical purposes; shoe polish; polishing wax; deodorants for animals; pre-moistened cleansing tissues for babies; abrasives; laundry preparations; toiletry preparations; cleaning/polishing/scouring and abrasive preparations; essential oils for personal use; adhesive for false eyelashes, hair and nails.

5 – Medicines for human purposes; baby food made from agricultural products; milk sugar for pharmaceutical purposes; lacteal flour for babies; household deodorants; microorganisms for medical purposes; medical diagnostic test strips; gauze for medical purposes; material for repairing teeth; babies' diapers;

mothproofing paper; food for babies; medicated plasters; vaccines; veterinary preparations; chemical preparations for medicinal purposes; reagents for use in medical genetic testing; antibacterial hand washes; biological preparations for medical or veterinary purposes; dietary supplements; medicines for dental purposes; dietary supplement drinks; health food supplements mainly based on deer antlers.

9 – Calculating machines, data-processing equipment and computers; goggles; DVDs; protective shoes; video screens; cameras; detection apparatus; gas alarms; underwater breathing apparatus; electrified fences; USB chargers; dry cells and batteries; digital multi-meters; cables and fibres for the transmission of sounds and images; earphones for use with mobile telecommunication devices; wireless headsets; computer software; semi-conductors; safety headwear; protective suits [against accident or injury]; mobile telephone covers made of cloth or textile materials; air pollution measuring devices; pollutant sensors; smartphones; mobile communication terminals; dust masks; semiconductor component; semiconductor elements inspection equipment; inspecting apparatus for semiconductor; testing equipment for semiconductor; lasers for non-medical purposes; laser installations, other than for medical use; apparatus and instruments for physics; research laboratory analyzers for measuring, testing and analyzing blood and other bodily fluids; physical analyzers [other than for medical use]; electronic components for computers; downloadable electronic periodicals; gene analyzing and extracting devices; physical and chemical apparatus for analyzing genes; genetic probe assay apparatus.

10 – Medical apparatus and instruments; medical instruments; testing apparatus for medical purposes; orthopedic articles; dental equipment; contraceptive apparatus; nursing appliances; esthetic skin massage apparatus; medical clothing; gloves for use in hospitals; sanitary masks for medical purposes; massaging apparatus for personal use; medical diagnostic apparatus and instruments; electromedical diagnostic instruments; apparatus for use in medical analysis; medical health signal measuring instruments; wireless bio-signal measuring instruments for medical purposes; precision sensors for medical use; laser machining tools for medical use; gene (genetic) testing apparatus.

29 – Frozen beans; pollen prepared as foodstuff; frozen vegetables; dried fruit and vegetables; fruit juices for cooking; foods prepared from bean curds (tofu); pulses, processed; frozen fruits; croquettes; chicken; eggs; preserved meats and sausages; vegetable oils and fats (for food); processed seaweed products; preserved fish; preserved/frozen/dried and cooked fruits and vegetables; prepared side dishes consisting primarily of meat, fish, poultry or vegetables; meat, poultry and game; ginseng processed food products.

30 – Flour and preparations made from cereals; condiments; chocolate products; ice cream; spices and ice; baking powder; wheat germ for human consumption; honey and treacle; rice cakes; soy sauce and soy bean paste; dressings for salad; salt; fruit teas; prepared coffee beverages; beverages with a tea base; ginseng confectionery; ginseng confectionery preserved in honey; ginseng confectionery in jelly form; ginseng candy.

32 – Mineral and aerated waters; preparations for beverages; malt extracts for making liquors; non-alcoholic beverages; beer; ale; lager; stout; porter; ginseng powders for beverages; ginseng extracts for beverages; ginseng nectar; aerated water containing ginseng; ginseng juices (beverages); aloe juice drinks.

33 – Alcoholic beverages except beers; alcoholic beverages containing fruit; pre-mixed alcoholic beverages, other than beer-based; champagne; alcoholic malt beverages, except beers; alcoholic carbonated beverages, except beer; wines; whisky; ginseng liquor.

35 – Retail store services featuring electromedical diagnostic instruments; retail store services featuring computer hardware and computer peripheral devices; retail store services featuring health food supplements for persons with special dietary requirements; retail store services featuring cosmetics; retail store services featuring personal handheld communication terminals; retail store services featuring periodicals; retail store services featuring computer software; wholesale store services featuring laser processing (working) machines; wholesale store services featuring semi-conductors; wholesale store services featuring semiconductor processing machines; wholesale store services featuring pharmaceutical preparations for the treatment of cells; retail or wholesale store services featuring pharmaceutical and veterinary preparations; advertising and commercial information services; business information and accounting advisory services; secretarial and clerical services; business administration and office work; employment recruitment services; advertising relating to pharmaceutical products and in-vivo imaging products; health care cost management; human resources management; personnel recruitment; electronic data processing services relating to health care information; import-export agency services; medical billing services for hospitals; auctioneering; consultancy services relating to the management of telephone call centers; rental of sales stands; arranging subscriptions to information media; online comprehensive shopping mall services; business management services relating to franchising; intermediary services relating to the trading of goods and services; compilation and systemization of information into computer databases; customer relationship management; business management consultancy; retail store

services featuring laser processing (working) machines; retail store services featuring semi-conductors; retail store services featuring semiconductor processing machines; retail store services featuring pharmaceutical preparations for the treatment of cells; retail store services featuring medical instruments; retail store services featuring medical apparatus; retail store services featuring biological preparations for medical or veterinary purposes; retail store services featuring medical genetic analyzer; wholesale store services featuring medical instruments; wholesale store services featuring medical apparatus; wholesale store services featuring biological preparations for medical or veterinary purposes; wholesale store services featuring medical genetic analyzer; wholesale store services featuring electromedical diagnostic instruments; wholesale store services featuring computer hardware and computer peripheral devices; wholesale store services featuring health food supplements for persons with special dietary requirements; wholesale store services featuring cosmetics; business intermediary and advisory services in the field of medical instruments; business intermediary and advisory services in the field of medical apparatus; business intermediary and advisory services in the field of pharmaceutical and veterinary preparations; business intermediary and advisory services in the field of health food supplements for persons with special dietary requirements; business intermediary and advisory services in the field of cosmetics sales.

36 – Providing information relating to financial and monetary affairs; banking and insurance services; financial sponsorship of medical research; financing services in the field of medical engineering and technology; financing of medical research; medical savings account services; health insurance brokerage; medical insurance services; financial advisory, management and consultancy services; rental of real estate; financial credit scoring services; customs brokerage; providing information relating to art appraisal; appraisal of precious metals; philanthropic services concerning monetary donations; charitable fund raising services to support medical research; capital investment services.

38 – Data transmission and data broadcasting; providing access to Internet portal services via smart phone applications; telecommunications; cellular telephone communication of pharmaceutical or medical information; provision of access to medical information via the internet; radio and television broadcasting services; satellite and cable broadcasting; internet broadcasting services; internet provider services; providing telecommunication services for e-commerce platforms on the Internet and other electronic media; transmission of digital audio/video and multimedia content via communications; communications by computer terminals; wireless communication; communication by mobile telephone; providing ac-

cess to electronic communications networks and electronic databases.

39 – Transport, delivery, packaging, and storage of goods; logistics services consisting of the packaging and storage of goods; medical transport services; traffic information; storage of medical apparatus and instruments; storage of energy and fuels; depot services for the storage of vehicles; medical travel tour services; provision of medical sightseeing (tourism) information; physical storage of electronically stored information and data; heat supplying [distribution]; rental of diving suits and wheelchairs; travel arrangement for individuals and groups; travel guide services; transportation of merchandise and passengers; collection, transport and delivery of goods, documents, packages and letters; transport of passengers and goods; postal, freight and courier services; arranging of transport; pharmaceuticals transport; car transport; warehousing.

41 – Photographic reporting; translation and language interpreter services; health education services; telecommunications education; publication and editing of books, newspapers and periodicals; organization of competitions [education or entertainment]; providing facilities for movies/shows/plays/music or educational training; coaching [training]; educational services; ticket reservation and booking services for entertainment, sporting and cultural events; publication of the results of clinical trials for pharmaceutical preparations; publication of books; publication of electronic books and magazines on-line; rental of sound and video recording apparatus; rental of sound recordings and video recordings; night club entertainment services; electronic library services; organising of cultural events; organization of seminars, working groups, research groups and conventions, in the field of medicine; cosmetology education; operation of theme parks; digital filming services.

42 – Measuring and analysis of water pollution; research and development in the pharmaceutical and biotechnology fields; research in the field of gene analysis; hosting a website featuring medical information; medical studies; operation of medical laboratory; research and development of technology for medicinal chemical manufacturing; consulting on the test/inspection/research of medical products; research and development of electronic components; design of information systems; development of computer software application solutions; technological research relating to computers; soil pollution surveys; quality checking and testing; providing research and development services in the field of environment; research and development of technology for environmental protection; research and development of vaccines and medicines; clinical studies of medicines; biopsy for medical research; research for medical products; electronic storage of medical records; computer programming in the medical field;

marine/aerial and land surveying; conducting technical project studies; testing/inspection or research of pharmaceuticals/cosmetics or foodstuff; services for the planning (design) of hospitals; medical packaging design; clothing design; computer programming; technical project research in the field of environmental protection; laboratory analysis in the field of cosmetics; meteorological research; laboratory services for agricultural research; research relating to urban planning; engineering services relating to robotics; scientific research relating to biology; scientific research in the field of genetic engineering; provision of geographical information; research and development of medical equipment; design and development of networks; product research/custom design and testing for new product development regarding semiconductors; design of semiconductor manufacturing machines; molecular analysis; development of devices for molecular analysis; industrial technology research; research and development of technology for biotechnology; scientific research in the fields of biomedicine; laboratory research in the field of biology; development of cell therapy products; drug discovery services; software development, programming and implementation; water quality control services; medical research services relating to clinical data.

44 – Chiropractic; medical and pharmaceutical consultancy; hygienic and beauty care; services for the care of the skin; medical and health care services; information services relating to farming; fish farming for others; pharmacy services; consultancy and information services relating to pharmaceutical products; dispensing of pharmaceuticals; preparation and dispensing of medications; information services relating to medical products; provision of information relating to dentistry; medical and health services relating to DNA, genetics and genetic testing; managed health care services; genetic testing of animals for diagnostic or treatment purposes; services for the care of the hair; rental of sanitation facilities; massage; floral design; landscape design; hygienic and beauty care for animals; psychological testing services; medical services relating to the removal, treatment and processing of human blood, umbilical cord blood, human cells, stem cells and bone marrow; ambulant medical care; medical examinations; rental of medical machines and apparatus; services for the provision of medical facilities; health clinic services [medical]; analysis of human tissues for medical treatment; medical consultancy for selecting appropriate medicines; human tissue bank services; clinical pathology examination; cord blood bank services; health centers.

(260) AM 2019 99704 A

(800) 1426152

(151) 2018 03 22

(891) 2018 03 22

(731) PIRELLI TYRE S.p.A.

Viale Piero e Alberto Pirelli, 25, I-20126

MILAN, Italy

(540)



(591) Black, white

(531) 18.01.21; 27.03.15

(511)

9 – Data transfer units; electronic monitoring instruments, other than for medical use, including point-to-point communications equipment; network communication apparatus; wireless communication apparatus; computer software (recorded); downloadable applications for use with mobile devices; software and applications for mobile devices including software and applications; downloadable computer software for remote monitoring and analysis; software for data transmission; applications for smartphones for measuring data of vehicle running motion; computer programs for measuring data of vehicle running motion; navigation, guidance, tracking, targeting and map making devices; safety, security, protection and signaling devices; measuring, detecting and monitoring instruments, indicators and controllers; sensors; tire monitoring apparatus; tire pressure sensors; tire pressure gauge.

12 – Vehicles and parts and fittings for vehicles; apparatus for vehicles and tires; treads for vehicles; tires, solid, for vehicle wheels; pneumatic, semi pneumatic and/or solid tires; vehicle wheels; wheel rims; inner tubes and mousse for vehicle tires.

35 – Retail services or wholesale services for tires; business information services in the field of tires; commercial services, associated with the tires management, consisting in facilitating and organizing the maintenance, repair of tires, vehicle breakdown assistance, tracking and monitoring vehicles for commercial purposes; business consultation services relating to the management of a tires for commercial purposes; database management services; inventory management services; compilation of data in computer databases; customer loyalty services and customer club services, for commercial, promotional and/or advertising purposes; computerized file management, services for capturing, processing, collecting and organizing data in a central file; computerised business information services; providing information, consultancy and advice in the field of tyres and vehicle.

37 – Maintenance and repair services for vehicles and their component parts and accessories; maintenance, repair, retreading and replacement services for vehicle tires; installation, maintenance repair and replacement services for vehicle equipment, instruments and electric and electronic devices; information and advice services for drivers and vehicle fleet managers related to vehicle maintenance and repair; retreading of tires; vulcanizing of vehicle tires; tire rotating and balancing; installation, maintenance, replacement and repair services for vehicle equipment, instruments and electric and electronic devices; services relating to the inspection of cars, namely checking the technical state of tires.

39 – Delivery of equipment, instruments and electric and electronic devices for vehicles and their component parts, and of tires and/or vehicle wheels; storage of equipment, instruments and electric and electronic devices for vehicles and their component parts, and of tires and/or vehicle wheels; information and advice services for drivers and vehicle fleet managers related to vehicle geolocation and routes; transport services for passengers; vehicle transport; storage services; conveyance of persons, goods and motor vehicles; vehicle rental (including car sharing and courtesy car); chauffeur services; car parking services, parking place rental and procurement of parking places for motor vehicles; carpooling; delivery of pneumatic tyres and/or wheels for vehicles, storage of pneumatic tyres and/or wheels for vehicles; towing in the event of vehicle breakdown, repatriation, by all means, of people and/or vehicles in the event of breakdown; providing information relating to vehicle driving services.

(260) AM 2019 99821 A

(800) 1427629

(151) 2018 06 20

(891) 2018 06 20

(731) SOPRO BAUCHEMIE GMBH

Biebricher Str. 74, 65203 Wiesbaden,
Germany

(540)

FKM XL

(591) Black, white

(511)

1 – Chemicals used in industry; chemical agents for impregnating concrete, mortar, plaster, textiles, non-woven and woven fabrics as well as marble, natural and cast stone surfaces; adhesives used in industry, in particular made of synthetic resins; chemicals used in industry, being additives for building materials; chemicals used in industry, being additives for screed, concrete and mortar; liquid plastics, unprocessed, included in this class; preservatives for building materials (except for organic substances); refining agents for concrete, mortar and screed, included

in class 1, in particular for preventing the drying out of concrete and mortar, for screeds and finished concrete parts, for enhancing the resistance of cement screeds to impact, wear, frost and chemical stress, for increasing imperviousness against liquids and gases as well as for controlling the working consistency; unprocessed artificial resins; surface-active agents (tensides); damp proofing preparations for brickwork, except paints; horticulture chemicals; antifreeze; chemicals as aid for washing out (removing and cleaning) during manufacturing processes; solvents for paints, varnishes and lacquers; silicones.

17 – Rubber; gutta-percha; gum; asbestos; mica; goods made of plastics as semi-finished products; artificial and synthetic resins (semi-finished products); resins (semi-finished products) for fabricating adhesives; cast resins (semi-finished products) including silica sand; sealing, packing and insulating materials; sealing tapes; sealing collars; rubber gloves for insulating purposes, not for household purposes; joint fillers (sealant compounds for joints); insulating coatings (paints) and insulating lacquers; insulating paints; self-adhesive tapes, other than stationery and not for medical or household purposes; insulating coatings and insulating materials; filling material as insulating, damping and sealing materials.

19 – Building materials (non-metallic), in particular with damping and insulating properties; building materials (non-metallic), namely hydraulic binding agents such as cement, lime, gypsum and as additives for binding and hardening concrete, mortar and stony-type building materials; building materials (non-metallic), namely hydraulic binding agents and mixtures composed thereof containing aggregates, pozzolanic materials (concrete admixtures) and/or chemical substances (concrete admixtures); mortar (building material); plaster (building material); screeds (building material); reinforcing fabrics (non-metallic) for building purposes; contact sludges (non-metallic) for building purposes; building materials, non-metallic, in the form of filling materials for building purposes for preparing surfaces made of concrete, mortar and other stony-type building materials; silica sand for building purposes; bitumen; bituminous products for building; pipes, not of metal, for building purposes; concrete; concrete building elements; roof coverings, not of metal; bituminous coatings for roofing (except for sealing and insulating purposes); windows, not of metal; felts for building; gravel; sand for building purposes; prefabricated swimming pools (not of metal); prefabricated chimneys, not of metal; floor tiles, not of metal; tile floorings, not of metal; binding material for road repair, road coating materials; bituminous coatings for roofing, for sealing and insulating purposes.

(260) AM 2019 99826 A

(800) 1427756

(151) 2018 04 27

(891) 2018 04 27

(731) DAUDRUY VAN CAUWENBERGHE

Zone Industrielle de Petite Synthe, Rue Van
Cauwenberghe, F-59640 DUNKERQUE,
France

(540)

DAUDRUY

(591) Black, white

(511)

1 – Transmission oils.

4 – Industrial oils and greases; lubricants; dust absorbing, wetting and binding compositions; fuels (including motor spirit) and illuminants; candles and wicks for lighting; oils for the preservation of masonry; painting oils; motor oils; cutting fluids; moistening oils; oils for painting; industrial rape oil; cutting oil; oil for the preservation of leather; combustible oils (fuel oil); industrial bone oil; non-edible fish oil; white oils; industrial oils and greases; cutting fluids; industrial oils and greases, lubricants; oils for the preservation of masonry; oils for releasing form work; oils for fabrics; soybean oil preparations for non-stick treatment of cooking utensils; oils for fabrics; castor oil for technical use; textile oils; soybean oil preparations for non-stick treatment of cooking utensils; motor oils; oils for gearboxes; moistening oil; lubricating oils; insoluble cutting oils; light oils; lubricating oils; oil gas; industrial oils; lubricating oil for motor vehicle engines; oils for form stripping; castor oil for technical use; soluble cutting oils; oils for the preservation of masonry; leather (preparations for) (oils and greases); leather preservatives (oils and greases); coal naphtha; oil for lamps; lubricating oils; industrial sunflower oil; oil-gas; coal tar oil; mold releasing oils.

29 – Meat, fish, poultry and game; meat extracts; preserved, frozen, dried and cooked fruits and vegetables; jellies, jams, compotes; eggs; milk and dairy products; edible oils and fats; rapeseed oil for food; coconut oil; palm oil [food]; sesame oil; sunflower oil for food; peanut oil; edible oils; edible oils and fats; olive oil; corn oil; edible rape oil; linseed oil for cooking; sunflower oil for food; palm kernel oil [food]; bone oil for food; olive oil for food; cooking oils.

31 – Grains and agricultural, horticultural and forestry products, not included in other classes; live animals; fresh fruits and vegetables; seeds; natural plants and flowers; animal foodstuffs; malt.

(260) AM 2019 99827 A

(800) 1427896

(151) 2018 07 02

(891) 2018 07 02

(731) BEIJING MOBIKE TECHNOLOGY CO.,
LTD
Room 1231, Building B-2, #5 Xueyuan Road,
Haidian District, Beijing, China

(540)

mobike

(591) Black, white

(531) 27.05.01

(511)

39 – Freighting; rescue operations [transport]; transport reservation; vehicle breakdown towing services; wrapping of goods; car parking; vehicle rental; chauffeur services; rental of motor racing cars; rental of navigational systems.

INTERNATIONAL TRADEMARKS PROTECTED IN GEORGIA

(260) AM 2019 92412 A
(800) 1344755
(151) 2016 12 07
(181) 2026 12 07
(891) 2016 12 07

(260) AM 2019 93306 A
(800) 1353392
(151) 2017 05 01
(181) 2027 05 01
(891) 2017 05 01

(260) AM 2019 93970 A
(800) 1361552
(151) 2017 06 29
(181) 2027 06 29
(891) 2017 06 29
(511) 30

(260) AM 2019 94826 A
(800) 1372306
(151) 2017 08 29
(181) 2027 08 29
(891) 2017 08 29
(511) 18

(260) AM 2019 95617 A
(800) 1378790
(151) 2017 06 07
(181) 2027 06 07
(891) 2017 06 07
(511) 02, 06, 09, 14, 16, 18, 26, 28, 35, 36, 38, 40,
41, 42, 44, 45

(260) AM 2019 95628 A
(800) 1378787
(151) 2017 06 07
(181) 2027 12 07
(891) 2017 06 07
(511) 02, 06, 09, 14, 16, 18, 26, 28, 35, 36, 38, 40,
41, 42, 44, 45

(260) AM 2019 95748 A
(800) 1379908
(151) 2017 08 15
(181) 2027 08 15

(891) 2017 08 15
(511) 34

(260) AM 2019 97052 A
(800) 1394030
(151) 2018 01 05
(181) 2028 01 05
(891) 2018 01 05
(511) 41

(260) AM 2019 97116 A
(800) 1395381
(151) 2017 11 30
(181) 2027 11 30
(891) 2017 11 30
(511) 05

(260) AM 2019 97253 A
(800) 1396190
(151) 2017 07 06
(181) 2027 07 06
(891) 2017 07 06
(511) 05, 09, 10, 11, 38, 42

(260) AM 2019 97254 A
(800) 1396201
(151) 2017 11 07
(181) 2027 11 07
(891) 2017 11 07
(511) 09, 35, 36, 38, 41, 42, 45

(260) AM 2019 97255 A
(800) 1396212
(151) 2017 12 08
(181) 2027 12 08
(891) 2017 12 08
(511) 14, 35

(260) AM 2019 97256 A
(800) 1396302
(151) 2017 12 12
(181) 2027 12 12
(891) 2017 12 12
(511) 09, 22, 24, 25

(260) AM 2019 97257 A
(800) 1396304
(151) 2017 11 30
(181) 2027 11 30
(891) 2017 11 30
(511) 07, 09, 11, 37

(260) AM 2019 97258 A
(800) 1396326
(151) 2017 12 21
(181) 2027 12 21
(891) 2017 12 21
(511) 01

(260) AM 2019 97259 A
(800) 1396347
(151) 2018 02 09
(181) 2028 02 09
(891) 2018 02 09
(511) 05

(260) AM 2019 97260 A
(800) 1396367
(151) 2017 09 22
(181) 2027 09 22
(891) 2017 09 22
(511) 29, 30, 35

(260) AM 2019 97261 A
(800) 1396447
(151) 2017 08 22
(181) 2027 08 22
(891) 2017 08 22
(511) 01, 17, 19

(260) AM 2019 97262 A
(800) 1396482
(151) 2017 12 14
(181) 2027 12 14
(891) 2017 12 14
(511) 05, 10

(260) AM 2019 97341 A
(800) 1397371
(151) 2017 03 01
(181) 2027 03 01
(891) 2017 03 01
(511) 09, 35, 37

(260) AM 2019 97354 A
(800) 341863
(151) 1968 01 12

(181) 2028 01 12
(891) 2018 03 14
(511) 07, 09, 10, 11

(260) AM 2019 97356 A
(800) 1102515
(151) 2011 11 09
(181) 2021 11 09
(891) 2018 03 05
(511) 02, 42

(260) AM 2019 97357 A
(800) 1194241
(151) 2014 01 31
(181) 2024 01 31
(891) 2018 02 23
(511) 30

(260) AM 2019 97359 A
(800) 1234472
(151) 2014 12 18
(181) 2024 12 18
(891) 2018 02 22
(511) 05

(260) AM 2019 97360 A
(800) 1251547
(151) 2015 04 07
(181) 2025 04 07
(891) 2017 12 19
(511) 35, 42

(260) AM 2019 97361 A
(800) 1370999
(151) 2017 04 21
(181) 2027 04 21
(891) 2018 03 27
(511) 11, 19, 20, 21

(260) AM 2019 97362 A
(800) 1390083
(151) 2017 12 12
(181) 2027 12 12
(891) 2018 03 28
(511) 34

(260) AM 2019 97486 A
(800) 1397602
(151) 2018 01 09
(181) 2028 01 09
(891) 2018 01 09
(511) 01, 03, 04

(260) AM 2019 97500 A
(800) 1397996
(151) 2017 10 11
(181) 2027 10 11
(891) 2017 10 11
(511) 09, 10, 41, 42

(260) AM 2019 97509 A
(800) 1398138
(151) 2018 02 28
(181) 2028 02 28
(891) 2018 02 28
(511) 03

(260) AM 2019 97510 A
(800) 1108183
(151) 2012 01 13
(181) 2022 01 13
(891) 2018 02 27
(511) 25

(260) AM 2019 97512 A
(800) 1260120
(151) 2015 06 08
(181) 2025 06 08
(891) 2018 03 30
(511) 05, 10

(260) AM 2019 97520 A
(800) 1398264
(151) 2017 11 08
(181) 2027 11 08
(891) 2017 11 08
(511) 30

(260) AM 2019 97521 A
(800) 1398299
(151) 2017 11 15
(181) 2027 11 15
(891) 2017 11 15
(511) 30

(260) AM 2019 97523 A
(800) 1398376
(151) 2018 01 26
(181) 2028 01 26
(891) 2018 01 26
(511) 35, 38, 41, 42

(260) AM 2019 97524 A
(800) 1398399
(151) 2017 09 08
(181) 2027 09 08

(891) 2017 09 08
(511) 04, 25

(260) AM 2019 97530 A
(800) 1398657
(151) 2017 06 14
(181) 2027 06 14
(891) 2017 06 14
(511) 10

(260) AM 2019 97531 A
(800) 1398729
(151) 2017 12 07
(181) 2027 12 07
(891) 2017 12 07
(511) 03, 05

(260) AM 2019 97533 A
(800) 1398736
(151) 2017 12 26
(181) 2027 12 26
(891) 2017 12 26
(511) 41

(260) AM 2019 97534 A
(800) 1398749
(151) 2016 11 14
(181) 2026 11 14
(891) 2016 11 14
(511) 25

(260) AM 2019 97535 A
(800) 1398788
(151) 2017 11 22
(181) 2027 11 22
(891) 2017 11 22
(511) 03, 05, 10, 16, 21, 24, 35, 40

(260) AM 2019 97536 A
(800) 1398794
(151) 2017 11 30
(181) 2027 11 30
(891) 2017 11 30
(511) 07, 12, 35

(260) AM 2019 97537 A
(800) 1398797
(151) 2017 12 22
(181) 2027 12 22
(891) 2017 12 22
(511) 05, 10

(260) AM 2019 97538 A
(800) 1398835
(151) 2018 01 15
(181) 2028 01 15
(891) 2018 01 15
(511) 29, 35

(260) AM 2019 97540 A
(800) 1398875
(151) 2017 12 11
(181) 2027 12 11
(891) 2017 12 11
(511) 19

(260) AM 2019 97541 A
(800) 1398915
(151) 2018 01 31
(181) 2028 01 31
(891) 2018 01 31
(511) 05

(260) AM 2019 97542 A
(800) 1398991
(151) 2018 01 04
(181) 2028 01 04
(891) 2018 01 04
(511) 09

(260) AM 2019 97543 A
(800) 1398999
(151) 2017 10 30
(181) 2027 10 30
(891) 2017 10 30
(511) 09

(260) AM 2019 97544 A
(800) 1399000
(151) 2017 10 30
(181) 2027 10 30
(891) 2017 10 30
(511) 09

(260) AM 2019 97545 A
(800) 1399004
(151) 2018 02 28
(181) 2028 02 28
(891) 2018 02 28
(511) 05, 10, 44

(260) AM 2019 97546 A
(800) 1399005
(151) 2018 02 28
(181) 2028 02 28

(891) 2018 02 28
(511) 05, 10, 44

(260) AM 2019 97547 A
(800) 1399006
(151) 2018 02 28
(181) 2028 02 28
(891) 2018 02 28
(511) 05, 10, 44

(260) AM 2019 97553 A
(800) 1399168
(151) 2017 12 07
(181) 2027 12 07
(891) 2017 12 07
(511) 11

(260) AM 2019 97569 A
(800) 1323664
(151) 2016 07 28
(181) 2026 07 28
(891) 2018 03 19
(511) 03

(260) AM 2019 97571 A
(800) 1336207
(151) 2016 02 26
(181) 2026 02 26
(891) 2018 04 09
(511) 19, 35, 39

(260) AM 2019 97575 A
(800) 1368886
(151) 2017 06 20
(181) 2027 06 20
(891) 2018 03 12
(511) 18, 25

(260) AM 2019 97579 A
(800) 1399286
(151) 2018 01 12
(181) 2028 01 12
(891) 2018 01 12
(511) 38, 45

(260) AM 2019 97580 A
(800) 1399308
(151) 2017 12 22
(181) 2027 12 22
(891) 2017 12 22
(511) 32

(260) AM 2019 97581 A
(800) 1399314
(151) 2018 02 21
(181) 2028 02 21
(891) 2018 02 21
(511) 34

(260) AM 2019 97582 A
(800) 1399344
(151) 2017 12 07
(181) 2027 12 07
(891) 2017 12 07
(511) 32

(260) AM 2019 97583 A
(800) 1399347
(151) 2017 12 27
(181) 2027 12 27
(891) 2017 12 27
(511) 12

(260) AM 2019 97584 A
(800) 1399368
(151) 2017 09 14
(181) 2027 09 14
(891) 2017 09 14
(511) 35

(260) AM 2019 97585 A
(800) 1399374
(151) 2018 01 12
(181) 2028 01 12
(891) 2018 01 12
(511) 12

(260) AM 2019 97586 A
(800) 1399390
(151) 2018 02 28
(181) 2028 02 28
(891) 2018 02 28
(511) 05, 10, 44

(260) AM 2019 97587 A
(800) 1399391
(151) 2018 02 28
(181) 2028 02 28
(891) 2018 02 28
(511) 05, 10, 44

(260) AM 2019 97588 A
(800) 1399392
(151) 2018 02 28
(181) 2028 02 28

(891) 2018 02 28
(511) 05, 10, 44

(260) AM 2019 97597 A
(800) 1399761
(151) 2018 03 19
(181) 2028 03 19
(891) 2018 03 19
(511) 09

(260) AM 2019 97609 A
(800) 1400090
(151) 2017 12 27
(181) 2027 12 27
(891) 2017 12 27
(511) 01

(260) AM 2019 97610 A
(800) 1400151
(151) 2018 01 08
(181) 2028 01 08
(891) 2018 01 08
(511) 06, 09, 40

(260) AM 2019 97611 A
(800) 1400171
(151) 2018 03 07
(181) 2028 03 07
(891) 2018 03 07
(511) 35, 36

(260) AM 2019 97612 A
(800) 1400182
(151) 2018 01 12
(181) 2028 01 12
(891) 2018 01 12
(511) 06, 07, 08, 09, 10, 12, 13, 19

(260) AM 2019 97614 A
(800) 1400270
(151) 2017 10 23
(181) 2027 10 23
(891) 2017 10 23
(511) 32

(260) AM 2019 97615 A
(800) 1400279
(151) 2017 12 27
(181) 2027 12 27
(891) 2017 12 27
(511) 01

(260) AM 2019 97616 A
(800) 1400280
(151) 2017 12 27
(181) 2027 12 27
(891) 2017 12 27
(511) 01

(260) AM 2019 97622 A
(800) 1305576
(151) 2016 06 09
(181) 2026 06 09
(891) 2018 03 30
(511) 03

(260) AM 2019 97623 A
(800) 1338509
(151) 2016 11 10
(181) 2026 11 10
(891) 2018 03 21
(511) 07, 08, 09, 11, 21, 35, 37, 42

(260) AM 2019 97624 A
(800) 1400331
(151) 2018 01 12
(181) 2028 01 12
(891) 2018 01 12
(511) 14, 15, 16, 18, 21, 22, 23, 24, 25, 26, 27, 28

(260) AM 2019 97625 A
(800) 1400337
(151) 2017 12 01
(181) 2027 12 01
(891) 2017 12 01
(511) 05, 16, 29, 30, 43, 44

(260) AM 2019 97627 A
(800) 1400376
(151) 2017 12 27
(181) 2027 12 27
(891) 2017 12 27
(511) 43

(260) AM 2019 97636 A
(800) 1400562
(151) 2017 11 21
(181) 2027 11 21
(891) 2017 11 21
(511) 08, 20

(260) AM 2019 97637 A
(800) 1400563
(151) 2017 10 09

(181) 2027 10 09
(891) 2017 10 09
(511) 04

(260) AM 2019 97638 A
(800) 1400576
(151) 2017 12 14
(181) 2027 12 14
(891) 2017 12 14
(511) 03

(260) AM 2019 97639 A
(800) 1400585
(151) 2018 02 20
(181) 2028 02 20
(891) 2018 02 20
(511) 09, 28

(260) AM 2019 97640 A
(800) 1400614
(151) 2018 03 01
(181) 2028 03 01
(891) 2018 03 01
(511) 03, 05

(260) AM 2019 97661 A
(800) 1401409
(151) 2018 01 26
(181) 2028 01 26
(891) 2018 01 26
(511) 12

(260) AM 2019 97665 A
(800) 1401494
(151) 2017 10 19
(181) 2027 10 19
(891) 2017 10 19
(511) 01, 04, 06, 07, 09, 12, 13, 17, 19, 37, 39, 42

(260) AM 2019 97671 A
(800) 1340652
(151) 2017 02 13
(181) 2027 02 13
(891) 2018 03 23
(511) 05

(260) AM 2019 97672 A
(800) 1365529
(151) 2017 07 13
(181) 2027 07 13
(891) 2018 03 23
(511) 05

(260) AM 2019 97674 A
(800) 1375898
(151) 2017 05 04
(181) 2027 05 04
(891) 2018 04 25
(511) 35, 36, 44

(260) AM 2019 97675 A
(800) 1380854
(151) 2017 09 11
(181) 2027 09 11
(891) 2018 03 05
(511) 34

(260) AM 2019 97716 A
(800) 1401628
(151) 2017 12 29
(181) 2027 12 29
(891) 2017 12 29
(511) 04, 37, 40, 41, 42, 45

(260) AM 2019 97717 A
(800) 1401634
(151) 2018 02 05
(181) 2028 02 05
(891) 2018 02 05
(511) 29, 30, 31, 32

(260) AM 2019 97718 A
(800) 1401676
(151) 2018 03 23
(181) 2028 03 23
(891) 2018 03 23
(511) 32

(260) AM 2019 97731 A
(800) 1402152
(151) 2018 02 19
(181) 2028 02 19
(891) 2018 02 19
(511) 30

(260) AM 2019 97732 A
(800) 1402230
(151) 2018 01 12
(181) 2028 01 12
(891) 2018 01 12
(511) 01, 02, 03, 04, 11, 17, 20

(260) AM 2019 97736 A
(800) 1402334
(151) 2017 10 03

(181) 2027 10 03
(891) 2017 10 03
(511) 10, 16, 18, 20, 24, 25, 28, 35, 36, 39, 41, 43

(260) AM 2019 97737 A
(800) 1402339
(151) 2017 10 03
(181) 2027 10 03
(891) 2017 10 03
(511) 10, 16, 18, 20, 24, 25, 28, 35, 36, 39, 41, 43

(260) AM 2019 97816 A
(800) 1402690
(151) 2018 01 17
(181) 2028 01 17
(891) 2018 01 17
(511) 35, 40, 44

(260) AM 2019 97820 A
(800) 1402711
(151) 2018 01 12
(181) 2028 01 12
(891) 2018 01 12
(511) 05

(260) AM 2019 97834 A
(800) 1403051
(151) 2018 03 01
(181) 2028 03 01
(891) 2018 03 01
(511) 05

(260) AM 2019 97835 A
(800) 1403150
(151) 2017 11 30
(181) 2027 11 30
(891) 2017 11 30
(511) 33

(260) AM 2019 97843 A
(800) 1403357
(151) 2017 11 24
(181) 2027 11 24
(891) 2017 11 24
(511) 24, 35

(260) AM 2019 97844 A
(800) 1403360
(151) 2017 12 29
(181) 2027 12 29
(891) 2017 12 29
(511) 03, 05, 09, 10, 16, 17, 20, 21, 22, 23, 24, 25, 27

(260) AM 2019 97906 A
(800) 1403963
(151) 2018 01 12
(181) 2028 01 12
(891) 2018 01 12
(511) 35, 36, 37, 38, 39, 40, 41, 42, 43, 44, 45

(260) AM 2019 97908 A
(800) 1403989
(151) 2018 02 22
(181) 2028 02 22
(891) 2018 02 22
(511) 05

(260) AM 2019 97950 A
(800) 1166412
(151) 2013 05 30
(181) 2023 05 30
(891) 2018 04 18
(511) 34

(260) AM 2019 98027 A
(800) 1405455
(151) 2018 03 03
(181) 2028 03 03
(891) 2018 03 03
(511) 03

(260) AM 2019 98028 A
(800) 1405467
(151) 2017 12 21
(181) 2027 12 21
(891) 2017 12 21
(511) 09, 19

(260) AM 2019 98030 A
(800) 1405483
(151) 2018 03 07
(181) 2028 03 07
(891) 2018 03 07
(511) 34

(260) AM 2019 98032 A
(800) 1405529
(151) 2018 02 01
(181) 2028 02 01
(891) 2018 02 01
(511) 35

(260) AM 2019 98036 A
(800) 1405630
(151) 2018 03 23

(181) 2028 03 23
(891) 2018 03 23
(511) 14

(260) AM 2019 98146 A
(800) 1396587
(151) 2018 01 04
(181) 2028 01 04
(891) 2018 05 14
(511) 43

(260) AM 2019 98319 A
(800) 1409079
(151) 2018 03 22
(181) 2028 03 22
(891) 2018 03 22
(511) 30

(260) AM 2019 98369 A
(800) 1400643
(151) 2018 01 29
(181) 2028 01 29
(891) 2018 06 07
(511) 29, 30, 32, 43

(260) AM 2019 98370 A
(800) 1403126
(151) 2018 01 30
(181) 2028 01 30
(891) 2018 06 07
(511) 29, 30, 32, 43

OFFICIAL NOTIFICATION

INVENTIONS

RENEWALL OF PATENTS

(21) AP 2011 12941

(11) P 2015 6234 B

(73) LES LABORATOIRES SERVIER

(54) **AGOMELATINE INTERMEDIATES AND PREPARATION METHOD THEREOF**

DATE OF CANCELLATION OF PATENT: 2018 06 08

DATE OF RESTORATION OF PATENT: 2019 06 10

(21) AP 2013 13329

(11) P 2015 6334 B

(73) Nikoloz Iakobidze

(54) **DEVICE FOR PRODUCING MOLDED ARTICLES**

DATE OF CANCELLATION OF PATENT: 2018 12 18

DATE OF RESTORATION OF PATENT: 2019 06 10

(21) AP 2006 9798

(11) P 2008 4457 B

(73) Anzor Getsadze;

Leila Getsadze;

Davit Getsadze

(54) **VEGETATIVE GATHER FOR TREATMENT OF DISEASES OF THE LIVER AND THE GALL-BLADDER**

DATE OF CANCELLATION OF PATENT: 2018 12 28

DATE OF RESTORATION OF PATENT: 2019 06 10

ABOLITION OF PATENTS WITH THE RIGHT TO RESTORE

(21) AP 2009 11256

(11) P 2011 5286 B

(73) Devi Vasadze

(54) **NOTIFICATION SYSTEM OF AIR-RAID PRECAUTIONS**

DATE OF CANCELLATION OF PATENT: 2019 05 15

PATENT RESTORATION IS AVAILABLE: 2020 05 15

(21) AP 2013 13084

(11) P 2015 6314 B

(73) Merab Poladashvili;

Giorgi Tavadze;

Otar Goldsvaridze;

Zurab Aslamazashvili;

Garegin Zaharov;

Giorgi Oniashvili;

Giorgi Mikaberidze;

Avtandil Khvdagiani

(54) METHOD OF ARTICLE FROM POWDERED EXOTHERMIC CHARGE

DATE OF CANCELLATION OF PATENT: 2019 05 10

PATENT RESTORATION IS AVAILABLE: 2020 05 10

(21) AP 2014 13468

(11) P 2015 6416 B

(73) LES LABORATOIRES SERVIER

(54) PROCESS FOR SYNTHESIS OF 3,4-DIMETHOXY BICIKLO[4.2.0] OCTA-1,3,5-DIEN-7-CARBONITRILE, AND APPLICATION IN SYNTHESIS OF IVABRADINE AND ADDITION SALTS THEREOF

DATE OF CANCELLATION OF PATENT: 2019 05 14

PATENT RESTORATION IS AVAILABLE: 2020 05 14

(21) AP 2013 13668

(11) P 2016 6548 B

(73) SCIPHARM SÀRL

(54) PROCESS FOR THE PREPARATION OF TREPROSTINIL AND DERIVATIVES THEREOF

DATE OF CANCELLATION OF PATENT: 2019 05 22

PATENT RESTORATION IS AVAILABLE: 2020 05 22

(21) AP 2014 13745

(11) P 2017 6653 B

(73) HYUN ENGINEERING AND CONSTRUCTION CO., LTD

(54) METHOD FOR REINFORCING PILLAR PART OF ADJACENTLY CONSTRUCTED PARALLEL TUNNELS WITH REINFORCING RODS AND EXCAVATION METHOD

DATE OF CANCELLATION OF PATENT: 2019 05 08

PATENT RESTORATION IS AVAILABLE: 2020 05 08

(21) AP 2015 13827

(11) P 2016 6565 B

(73) LEPL Grigol Tsulukidze Mining Institute;

David Pataraiia;

Alexander Kartvelishvili;

Giorgi Nozadze;

Rusudan Maisuradze

(54) INCLINED ABUTMENT BASE

DATE OF CANCELLATION OF PATENT: 2019 05 15

PATENT RESTORATION IS AVAILABLE: 2020 05 15

(21) AP 2013 14111

(11) P 2018 6826 B

(73) SCIPHARM SÀRL

(54) INTERMEDIATE PRODUCT FOR TREPROSTINIL SYNTHESIS AND METHODS FOR PREPARATION THEREOF

DATE OF CANCELLATION OF PATENT: 2019 05 22

PATENT RESTORATION IS AVAILABLE: 2020 05 22

(21) AP 2015 14335

(11) P 2018 6888 B

(73) JSC "OLAINPHARM"

(54) **PHARMACEUTICAL COMPOSITION FOR THE PREVENTION AND TREATMENT OF DISEASES ASSOCIATED WITH ELEVATED INDUCIBLE NITRIC OXIDE SYNTHASE**

DATE OF CANCELLATION OF PATENT: 2019 05 14

PATENT RESTORATION IS AVAILABLE: 2020 05 14

(21) AP 2004 9073

(11) P 2008 4567 B

(73) OTSUKA PHARMACEUTICAL CO., LTD.

(54) **CARBOSTYRIL DERIVATIVES AND MOOD STABILIZERS FOR TREATING MOOD DISORDERS**

DATE OF CANCELLATION OF PATENT: 2019 05 19

PATENT RESTORATION IS AVAILABLE: 2020 05 19

EXPIRATION OF TERM OF RESTORATION OF PATENTS

(21) AP 2008 10696

(11) P 2009 4739 B

(73) Zaur Tsikhelashvili;

Darejan Garuchava;

Archil Prangishvili;

Tamaz Batsikadze;

Ioseb Batsikadze;

Paata Giorgadze;

Nodar Chkheidze;

Giorgi Katsitadze;

Merab Davitaia;

Giorgi Mikadze;

Ioseb Tsikhelashvili;

Shota Tsikhelashvili;

Davit Kakhadze;

Leri Rukhadze

(54) **FLOATING DESIGN WITH DEVICE OF WAVES DAMPING**

DATE OF CANCELLATION OF PATENT: 2018 05 16

THE TERM OF RESTORATION OF PATENT VALIDITY HAS EXPIRED: 2019 05 16

(21) AP 2009 12027

(11) P 2014 6061 B

(73) AYUMI Pharmaceutical Corporation

(54) **GLUCOCORTICOID RECEPTOR AGONIST COMPOSED OF 2,2,4-TRIMETHYL-6-PHENYL-1,2-DIHYDROQUINOLINE DERIVATIVE HAVING SUBSTITUTED OXY GROUP**

DATE OF CANCELLATION OF PATENT: 2018 05 12

THE TERM OF RESTORATION OF PATENT VALIDITY HAS EXPIRED: 2019 05 12

(21) AP 2009 12032

(11) P 2012 5621 B

(73) Aziende Chimiche Riunite Angelini Francesco A.C.R.A.F. S.p.A.

(54) **3-AMINOCARBAZOLE COMPOUND, PHARMACEUTICAL COMPOSITION CONTAINING IT AND PREPARATION METHOD THEREFOR**

DATE OF CANCELLATION OF PATENT: 2018 05 11

THE TERM OF RESTORATION OF PATENT VALIDITY HAS EXPIRED: 2019 05 11

(21) AP 2009 12038

(11) P 2012 5622 B

(73) David Murray MELROSE

(54) **METHOD OF HEADSPACE MODIFICATION FOR VACUUM PRESSURE REMOVAL AND APPARATUS FOR EMBODIMENT THEREOF**

DATE OF CANCELLATION OF PATENT: 2018 05 18

THE TERM OF RESTORATION OF PATENT VALIDITY HAS EXPIRED: 2019 05 18

(21) AP 2010 12454

(11) P 2014 6115 B

(73) KATHOLIEKE UNIVERSITEIT LEUVEN

(54) **THIENO [2,3-B] PYRIDINE DERIVATIVES AS VIRAL REPLICATION INHIBITORS**

DATE OF CANCELLATION OF PATENT: 2018 05 17

THE TERM OF RESTORATION OF PATENT VALIDITY HAS EXPIRED: 2019 05 17

(21) AP 2013 13093

(11) P 2015 6290 B

(73) Givi Arabidze

(54) **INTERNAL COMBUSTION ENGINE CONNECTING ROD**

DATE OF CANCELLATION OF PATENT: 2018 05 22

THE TERM OF RESTORATION OF PATENT VALIDITY HAS EXPIRED: 2019 05 22

(21) AP 2013 13621

(11) P 2016 6532 B

(73) Novartis AG

(54) **BENZAMIDE DERIVATIVES FOR INHIBITING THE ACTIVITY OF ABL1, ABL2 AND BCR-ABL1**

DATE OF CANCELLATION OF PATENT: 2018 05 09

THE TERM OF RESTORATION OF PATENT VALIDITY HAS EXPIRED: 2019 05 09

(21) AP 2013 13665

(11) P 2017 6800 B

(73) IDENIX PHARMACEUTICALS LLC

(54) **D-AMINO ACID COMPOUNDS FOR LIVER DISEASE**

DATE OF CANCELLATION OF PATENT: 2018 05 21

THE TERM OF RESTORATION OF PATENT VALIDITY HAS EXPIRED: 2019 05 21

(21) AP 1999 5632

(11) P 2002 2750 B

(73) ESIFARMS

(54) **MULTIPARTICULATE PHARMACEUTICAL COMPOSITION IN THE FORM OF SPHEROIDS AND METHOD FOR ITS PRODUCTION**

DATE OF CANCELLATION OF PATENT: 2018 05 20

THE TERM OF RESTORATION OF PATENT VALIDITY HAS EXPIRED: 2019 05 20

(21) AP 1999 5678

(11) P 2003 2987 B

(73) Warner-Lambert Company

(54) **STABILIZED SOLID COMPOSITIONS CONTAINING GAMMA-AMINOBUTYRIC ACID DERIVATIVES FOR TREATMENT OF NEUROPATHOLOGIC DISEASES AND PROCESS FOR PREPARING THE SAME**

DATE OF CANCELLATION OF PATENT: 2018 05 10

THE TERM OF RESTORATION OF PATENT VALIDITY HAS EXPIRED: 2019 05 10

ISSUING ADDITIONAL CERTIFICATE OF PROTECTION

(According to Article 5 of the "Patent Law of Georgia")

(21) AP 2003 5674

(11) P 2006 3909 B

(22) 10 01 2003

(54) **2-(PYRIDIN-2-YLAMINO)-PYRIDO[2,3d] PYRIMIDIN-7-ONES**

ESTIMATED TERM OF PATENT VALIDITY: 2028 01 10

UTILITY MODELS

RENEWAL OF PATENT

(21) AU 2016 14358

(11) U 2018 1966 Y

(73) Nugzar Meladze

(54) **BIOACTIVE FOOD ADDITIVE "REZIGRAV"**

DATE OF CANCELLATION OF PATENT: 2018 12 22

DATE OF RESTORATION OF PATENT: 2019 06 10

ABOLITION OF PATENT WITH THE RIGHT TO RESTORE

(21) AU 2014 13464

(11) U 2015 1862 Y

(73) Dodo Tavdidishvili;

Manana Pkhakadze;

Tsira Khutsidze

(54) **BIOLOGICALLY ACTIVE CONFECTIONERY PRODUCT**

DATE OF CANCELLATION OF PATENT: 2019 05 14

MODEL RESTORATION IS AVAILABLE: 2020 05 14

EXPIRATION OF TERM OF RESTORATION OF PATENTS

(21) AU 2010 11794

(11) U 2011 1674 Y

(73) Levan Longurashvili;
Maka Kharchilava

(54) **DEVICE FOR PREPARATION OF COFFEE**

DATE OF CANCELLATION OF PATENT: 2018 05 13

THE TERM OF RESTORATION OF PATENT VALIDITY HAS EXPIRED: 2019 05 13

(21) AU 2011 12317

(11) U 2013 1760 Y

(73) Ketevan Imedashvili

(54) **METHOD OF OBTAINING AVAILABLE SOLUTION FROM GRAPEVINE WASTE**

DATE OF CANCELLATION OF PATENT: 2017 07 25

THE TERM OF RESTORATION OF PATENT VALIDITY HAS EXPIRED: 2018 07 25

(21) AU 2015 13830

(11) U 2017 1922 Y

(73) Givi Papava;
Marine Gurgenishvili;
Eldar Gugava;
Ia Chitrekashvili;
Nazi Gelashvili;
Nora Docturidze;
Nunu Maisuradze;
Vitaly Sherozia;
Eter Gavashelidze;
Shalva Papava;
Nanuli Khotenashvili;
Riva Liparteliani

(54) **THE METHOD OF OBTAINING POLYMERIC NITROGEN FERTILIZATION OF PROLONGED ACTION**

DATE OF CANCELLATION OF PATENT: 2018 05 20

THE TERM OF RESTORATION OF PATENT VALIDITY HAS EXPIRED: 2019 05 20

DESIGNS

CONTINUE THE PERIOD OF DESIGN REGISTRATION

(11) D 2015 632 S

(73) JSC "SARAJISHVILI" (GE)

D. Sarajishvili Av. 4, 0153, Tbilisi, Georgia (GE)

(54) **BOTTLES FOR ALCOHOL BEVERAGES**

(28) 2

(24) 2014 07 17

(18) 2024 07 17

(58) 2019 05 23

CANCELLATION OF DESIGNS REGISTRATIONS

(11) D 2009 378 S

(73) SICHUAN WENJUN SPIRITS COMPANY LIMITED (CN)

N33, East Ring Road, Linqiong Town, Qionglai City, Chengdu City, Sichuan Province, P.R. (CN)

(54) **BOTTLE WITH STOPPER**

(18) 2018 11 14

(58) 2019 05 24

(11) D 2014 591 S

(73) Shalva Kurdadze (GE)

Leselidze St., I ent. 3, 5700, Khashuri, Georgia (GE)

(54) **BOTTLE**

(18) 2018 10 23

(58) 2019 05 24

(11) D 2014 578 S

(73) Beka Pkhakadze (GE)

Vazha-Pshavela Av., II Quarter, Bl. 22, ap. 5, 0186, Tbilisi, Georgia (GE)

(54) **BUILDING**

(18) 2018 11 11

(58) 2019 05 24

(11) D 2014 579 S

(73) Simon Begheladze (GE)

Village Gamoghma Argveti, 4000, Sachkhere, Georgia (GE)

(54) **CONTAINER-SOUVENIR**

(18) 2018 11 12

(58) 2019 05 24

TRADEMARKS**RENEWAL OF REGISTRATIONS**

(111) M 1999 12278 R2

(156) 1999 05 24

(186) 2029 05 24

(732) BEAUTYGE BRANDS USA, INC.

9560 Towne Centre Drive, San Diego,
California 92121, USA

(111) M 1999 12459 R2

(156) 1999 07 09

(186) 2029 07 09

(732) ELF AQUITAINE, Societe Anonyme

2, place Jean Millier, La Defense 6, F-92400
Courbevoie, France

(111) M 1999 12291 R2

(156) 1999 05 24

(186) 2029 05 24

(732) HILTON WORLDWIDE HOLDING LLP

Maple Court Central Park, Reeds Crescent,
Watford, WD24 4QQ, United Kingdom

(111) M 1999 11990 R2

(156) 1999 05 10

(186) 2029 05 10

(732) CISA S.P.A.

Via Oberdan 42, 48018 Faenza (Ravenna),
Italy

(111) M 1999 12301 R2

(156) 1999 05 24

(186) 2029 05 24

(732) EVYAP SABUN YAG GLISERIN SANAYI
VE TICARET ANONIM SIRKETI

Ayazaga, Cendere Yolu N10/A 80670 Levent,
Istanbul, Turkey

(111) M 1999 12302 R2

(156) 1999 05 24

(186) 2029 05 24

(732) EVYAP SABUN YAG GLISERIN SANAYI
VE TICARET ANONIM SIRKETI

Ayazaga, Cendere Yolu N10/A 80670 Levent,
Istanbul, Turkey

(111) M 1999 12370 R2

(156) 1999 06 15

(186) 2029 06 15

(732) EVYAP SABUN YAG GLISERIN SANAYI
VE TICARET ANONIM SIRKETI

Ayazaga, Cendere Yolu N10/A 80670 Levent,
Istanbul, Turkey

(111) M 1999 12305 R2

(156) 1999 05 24

(186) 2029 05 24

(732) EVYAP SABUN YAG GLISERIN SANAYI
VE TICARET ANONIM SIRKETI

Ayazaga, Cendere Yolu N10/A 80670 Levent,
Istanbul, Turkey

(111) M 1999 12311 R2

(156) 1999 05 24

(186) 2029 05 24

(732) THE GILLETTE COMPANY LLC

One Gillette Park, Boston, Massachusetts
02127, USA

(111) M 1999 12218 R2

(156) 1999 05 14

(186) 2029 05 14

(732) POTOMAC TOBACCO COMPANY LTD

Mil Meli, Suit 6, Uikems Kei 1, S/k 3085,
Roud-tauni, Tortola, Virgin Islands (British)

(111) M 1999 12257 R2

(156) 1999 05 14

(186) 2029 05 14

(732) PIONEER CORPORATION

28-8, Honkomagome 2-chome, Bunkyo-ku,
Tokyo, Japan

(111) M 1999 12389 R2

(156) 1999 06 15

(186) 2029 06 15

(732) ALBERTO-CULVER INTERNATIONAL,
INC.

a corporation of Daleware
700 Sylvan Avenue, Englewood Cliffs, NJ
07632, USA

(111) M 1999 12427 R2

(156) 1999 07 02

(186) 2029 07 02

(732) WYETH LLC
235 East 42 nd Street, New York,
NY 10017, USA

Eastern Point Road, Groton, Connecticut
06340, USA

(111) M 1999 12428 R2
(156) 1999 07 02
(186) 2029 07 02
(732) WYETH LLC
235 East 42 nd Street, New York,
NY 10017, USA

(111) M 1999 12656 R2
(156) 1999 08 24
(186) 2029 08 24
(732) SANOFI
54, rue La Boétie, 75008 Paris, France

(111) M 1999 12429 R2
(156) 1999 07 02
(186) 2029 07 02
(732) CHANEL SARL
Burgstrasse 26, CH-8750 GLARIS,
Switzerland

(111) M 1999 12484 R2
(156) 1999 07 12
(186) 2029 07 12
(732) THE POLO/LAUREN COMPANY L.P.
650 Medison Avenue, NEW YORK,
NEW YORK 10022, USA

(111) M 1999 12594 R2
(156) 1999 08 23
(186) 2029 08 23
(732) SANOFI
54, rue La Boétie, 75008 Paris, France

(111) M 1999 12670 R2
(156) 1999 08 24
(186) 2029 08 24
(732) Pasabahce Cam Sanaii Ve Ticaret A.S.
İçmeler Mah. D-100 Karayolu Cad. Çarşı
Ofis Binasi A Blok N44 A1 34947 Tuzla
Istanbul, Turkey

(111) M 1999 12700 R2
(156) 1999 08 24
(186) 2029 08 24
(732) UNITED PARCEL SERVICE OF
AMERICA, INC. (a Delaware corporation)
55 Glenlake Parkway, NE Atlanta, Georgia
30328, USA

(111) M 1999 12515 R2
(156) 1999 07 12
(186) 2029 07 12
(732) WYETH LLC
235 East 42 nd Street, New York, NY 10017,
USA

(111) M 1999 12337 R2
(156) 1999 06 15
(186) 2029 06 15
(732) A.T. CROSS COMPANY, LLC
10990 Wilshire Blvd., Suite 440, Los Angeles,
CA 90024, USA

(111) M 1999 12622 R2
(156) 1999 08 24
(186) 2029 08 24
(732) LESAFFRE & CIE
41, rue Etienne Marcel, 75001 Paris, France

(111) M 1999 12338 R2
(156) 1999 06 15
(186) 2029 06 15
(732) A.T. CROSS COMPANY, LLC
10990 Wilshire Blvd., Suite 440, Los Angeles,
CA 90024, USA

(111) M 1999 12704 R2
(156) 1999 08 24
(186) 2029 08 24
(732) C.P. Pharmaceuticals International C.V.
c/o General Partners, Pfizer Manufacturing
LLC and Pfizer Production LLC, 235 East
42nd Street, New York, NY 10017, USA

(111) M 1999 12640 R2
(156) 1999 08 24
(186) 2029 08 24
(732) PFIZER PRODUCTS INC.
a Connecticut Corporation

(111) M 2008 18555 R1
(156) 2008 06 16
(186) 2028 06 16
(732) LTD "V.D. SANAPIRO"
Kostavas q. 77, 0175, Tbilisi, Georgia

(111) M 2008 18671 R1
(156) 2008 08 29
(186) 2028 08 29
(732) LTD "EMBAWOOD GEORGIA"
Marneulis q. 37, 0165, Tbilisi, Georgia

(111) M 1999 12524 R2
(156) 1999 07 12
(186) 2029 07 12
(732) CRODA INTERNATIONAL PLC
Cowick Hall, Snaith, Goole, East Yorkshire,
DN14 9AA, United Kingdom

(111) M 2009 19292 R1
(156) 2009 05 15
(186) 2029 05 15
(732) GENTING INTERNATIONAL
MANAGEMENT LIMITED
First Names House, Victoria Road, Douglas,
Isle of Man, IM2 4DF, Isle of Man

(111) M 2009 19371 R1
(156) 2009 05 27
(186) 2029 05 27
(732) GM KOREA COMPANY
Cheongcheon-Dong, 233 Bupyeongdaero,
Bupyeong-Gu, Incheon, 403-714, Republic
of Korea

(111) M 1999 12213 R2
(156) 1999 05 14
(186) 2029 05 14
(732) NBCUniversal Media, LLC
30 Rockefeller Plaza, New York, New York,
USA

(111) M 2009 19277 R1
(156) 2009 04 29
(186) 2029 04 29
(732) IPC MEDIA LIMITED
The Blue Fin Building, 110 Southwark Street,
London, SE1 0SU, United Kingdom

(111) M 2009 19278 R1
(156) 2009 04 29
(186) 2029 04 29
(732) IPC MEDIA LIMITED
The Blue Fin Building, 110 Southwark Street,
London, SE1 0SU, United Kingdom

(111) M 2009 19661 R1
(156) 2009 09 08
(186) 2029 09 08

(732) LTD "INTELIGENS GROUP"
Tkhinvalis q. 9/7, 0108, Tbilisi, Georgia;
LTD "GLOBAL IDEA"
Tkhinvalis q. 9/7, 0108, Tbilisi, Georgia

(111) M 2009 19430 R1
(156) 2009 06 16
(186) 2029 06 16
(732) Mitsubishi Jidosha Kogyo Kabushiki Kaisha
33-8, Shiba 5-chome, Minato-ku, Tokyo,
Japan

(111) M 2009 19678 R1
(156) 2009 09 08
(186) 2029 09 08
(732) LTD "MEGHVINEOBA KHAREBA"
Davit Agmasheneblis khevani me-6 km.,
0131, Tbilisi, Georgia

(111) M 2009 19504 R1
(156) 2009 06 29
(186) 2029 06 29
(732) NINE WEST DEVELOPMENT LLC
1411 Broadway, New York, NY 10018, USA

(111) M 2009 19592 R1
(156) 2009 07 24
(186) 2029 07 24
(732) JSC "Nobel Ilac Sanayii Ve Ticaret Anonim
Sirketi"-Is Tsarm. Sakqartveloshi
Tavisulebis Moedani 4, 0105, Tbilisi,
Georgia

(111) M 2009 19593 R1
(156) 2009 07 24
(186) 2029 07 24
(732) JSC "Nobel Ilac Sanayii Ve Ticaret Anonim
Sirketi"-Is Tsarm. Sakartveloshi
Tavisuplebis Moedani 4, 0105, Tbilisi, Georgia

(111) M 2009 19594 R1
(156) 2009 07 24
(186) 2029 07 24
(732) JSC "Nobel Ilac Sanayii Ve Ticaret Anonim
Sirketi"-Is Tsarm. Sakartveloshi
Tavisuplebis Moedani 4, 0105, Tbilisi,
Georgia

(111) M 2009 19711 R1
(156) 2009 09 08
(186) 2029 09 08
(732) LTD "MEGHVINEOBA KHAREBA"

Davit Agmasheneblis kheivani me-6 km., 0131, Tbilisi, Georgia	(111) M 1999 12400 R2 (156) 1999 07 02 (186) 2029 07 02 (732) Taittinger Compagnie Commerciale Et Viticole Champenoise 9 Place Saint Nicaise, 51100 Reims, France
(111) M 2009 19714 R1 (156) 2009 09 08 (186) 2029 09 08 (732) GENZYME CORPORATION (a Massachusetts Corporation) 500 Kendall Street, Cambridge, Massachusetts 02142, USA	(111) M 1999 12044 R2 (156) 1999 05 10 (186) 2029 05 10 (732) THE GILLETTE COMPANY LLC One Gillette Park, Boston, Massachusetts 02127, USA
(111) M 2009 19924 R1 (156) 2009 11 02 (186) 2029 11 02 (732) Kaane American international Tobacco Company FZE Plot No. MO 07111, P.O. Box 61021, Jabel Ali, Free Zone Area, Dubai, United Arab Emirates	(111) M 1999 12046 R2 (156) 1999 05 10 (186) 2029 05 10 (732) THE GILLETTE COMPANY LLC One Gillette Park, Boston, Massachusetts 02127, USA
(111) M 2009 19882 R1 (156) 2009 10 16 (186) 2029 10 16 (732) KAANE AMERICAN INTERNATIONAL TOBACCO COMPANY FZE Plot No. MO 07111, P.O. Box 61021, Jabel Ali, Free Zone Area, Dubai, United Arab Emirates	(111) M 1999 12047 R2 (156) 1999 05 10 (186) 2029 05 10 (732) THE GILLETTE COMPANY LLC One Gillette Park, Boston, Massachusetts 02127, USA
(111) M 2009 19975 R1 (156) 2009 11 18 (186) 2029 11 18 (732) JSC "Nobel Ilac Sanayii Ve Ticaret Anonim Sirketi"-Is Tsarm. Sakartveloshi Tavisuplebis Moedani 4, 0105, Tbilisi, Georgia	(111) M 1999 11999 R2 (156) 1999 05 10 (186) 2029 05 10 (732) THE GILLETTE COMPANY LLC One Gillette Park, Boston, Massachusetts 02127, USA
(111) M 2009 19901 R1 (156) 2009 10 16 (186) 2029 10 16 (732) PHILIP MORRIS BRANDS SARL Quai Jeanrenaud 3, 2000 Neuchâtel, Switzerland	(111) M 1998 11105 R2 (156) 1998 11 25 (186) 2028 11 25 (732) ELEQTRA ENTERTEINMENT GRUP INK. 1633 Broadway, New York, New York 1001, USA
(111) M 2009 20018 R1 (156) 2009 11 18 (186) 2029 11 18 (732) COLGATE-PALMOLIVE COMPANY 300 Park Avenue, NEW YORK, N.Y. 10022, USA	(111) M 1999 11881 R2 (156) 1999 04 20 (186) 2029 04 20 (732) KABUSHIKI KAISHA HITACHI SEISAKUSHO (HITACHI LTD) 6-6, Marunouchi 1-chome, Chiyoda-ku, Tokyo, Japan

-
- (111) M 1999 11882 R2
(156) 1999 04 20
(186) 2029 04 20
(732) KABUSHIKI KAISHA HITACHI
SEISAKUSHO (HITACHI LTD)
6-6, Marunouchi 1-chome, Chiyoda-ku,
Tokyo, Japan
-
- (111) M 1999 12067 R2
(156) 1999 05 10
(186) 2029 05 10
(732) ALPS ALPINE CO., LTD
1-7, Yukigaya Otsukamachi, Ota-ku, Tokyo
145-8501, Japan
-
- (111) M 1999 12068 R2
(156) 1999 05 10
(186) 2029 05 10
(732) SHARP KABUSHIKI KAISHA
(SHARP CORPORATION)
22-22, Nagaïke-cho, Abeno-ku, Osaka, Japan
-
- (111) M 1999 12069 R2
(156) 1999 05 10
(186) 2029 05 10
(732) SHARP KABUSHIKI KAISHA
(SHARP CORPORATION)
22-22, Nagaïke-cho, Abeno-ku, Osaka, Japan
-
- (111) M 1999 12070 R2
(156) 1999 05 10
(186) 2029 05 10
(732) SHARP KABUSHIKI KAISHA
(SHARP CORPORATION)
22-22, Nagaïke-cho, Abeno-ku, Osaka, Japan
-
- (111) M 1999 11706 R2
(156) 1999 03 16
(186) 2029 03 16
(732) JANTZEN APPAREL, LLC
Concord Plaza, 3411 Silverside Road,
Wilmington, Delaware, USA
-
- (111) M 1999 11707 R2
(156) 1999 03 16
(186) 2029 03 16
(732) JANTZEN APPAREL, LLC
Concord Plaza, 3411 Silverside Road,
Wilmington, Delaware, USA
-
- (111) M 1999 12161 R2
(156) 1999 05 12
(186) 2029 05 12
- (732) TEFAL
15 Avenue des Alpes, Zae Rumilly Est, BR
89, 74150 Rumilly, France
-
- (111) M 1999 12101 R2
(156) 1999 05 10
(186) 2029 05 10
(732) MERCK SHARP & DOHME B.V
Waarderweg 39, 2013 BN Haarlem,
Netherlands
-
- (111) M 1999 11731 R2
(156) 1999 03 17
(186) 2029 03 17
(732) PREMIX, INC.
RT. 20 & HARMON RD., N. KINGSVILLE,
OHIO 44068, USA
-
- (111) M 1999 12548 R2
(156) 1999 07 12
(186) 2029 07 12
(732) COMPAGNE GENERALE DES
ESTABLISSEMENTS MICHELIN
23, Place des Carmes-dechaux, 63000
Klermont-Ferrand, France
-
- (111) M 1999 12549 R2
(156) 1999 07 12
(186) 2029 07 12
(732) COMPAGNE GENERALE DES
ESTABLISSEMENTS MICHELIN
23, Place des Carmes-dechaux, 63000
Klermont-Ferrand, France
-
- (111) M 1999 12551 R2
(156) 1999 07 12
(186) 2029 07 12
(732) COMPAGNE GENERALE DES
ESTABLISSEMENTS MICHELIN
23, Place des Carmes-dechaux, 63000
Klermont-Ferrand, France
-
- (111) M 1999 11745 R2
(156) 1999 03 17
(186) 2029 03 17
(732) FLUOR CORPORATION
6700 Las Colinas Boulevard, Irving, Texas
75039, USA
-
- (111) M 2008 18659P R1
(156) 2008 08 29
(186) 2028 08 29
-

(732) LTD "SAVE FROUZEN FOOD - GEORGIA"
Dzmebi Zubalashvilebis q. 41, 0108, Tbilisi,
Georgia

(111) M 1999 11979 R2
(156) 1999 05 10
(186) 2029 05 10
(732) PIRELLI & C. S.p.A.
Viale Piero e Alberto Pirelli No.25, 20126
Milano, Italy

(111) M 1999 12115 R2
(156) 1999 05 10
(186) 2029 05 10
(732) FRATELLI GUZZINI S.P.A.
60, C. da Mattonata, Localita S. Leopardo
I-62019 Recanati, Macerata, Italy

(111) M 1999 12178 R2
(156) 1999 05 12
(186) 2029 05 12
(732) W.L. GORE & Associates GmbH
22, Hermann-Oberth-Strasse, D-85640
Putzbrunn, Germany

(111) M 1998 11150 R2
(156) 1998 11 27
(186) 2028 11 27
(732) CANALI IREALAND LIMITED
7 D'Olier Street, D02HF60, Dublini 2, Ireland

COMPLETE TRANSFER OF RIGHTS

-
- (111) M 1998 8261 R
(732) PORTFOLIO CONCENTRATE
SOLUTIONS UNLIMITED COMPANY
5 Eastgate Road, Eastgate Business Park,
Little Island, Co.Cork, Ireland
(770) THE CONCENTRATE MANUFACTURING
COMPANY OF IRELAND
Swan Building, 3th Floor, 26 Victoria Street,
Hamilton HM 12, Bermuda
(580) 01 05 2019
-
- (111) M 1998 8262 R
(732) PORTFOLIO CONCENTRATE
SOLUTIONS UNLIMITED COMPANY
5 Eastgate Road, Eastgate Business Park,
Little Island, Co.Cork, Ireland
(770) THE CONCENTRATE MANUFACTURING
COMPANY OF IRELAND
Swan Building, 3th Floor, 26 Victoria Street,
Hamilton HM 12, Bermuda
(580) 01 05 2019
-
- (111) M 1997 5985 R
(732) PORTFOLIO CONCENTRATE
SOLUTIONS UNLIMITED COMPANY
5 Eastgate Road, Eastgate Business Park,
Little Island, Co.Cork, Ireland
(770) THE CONCENTRATE MANUFACTURING
COMPANY OF IRELAND
Swan Building, 3th Floor, 26 Victoria Street,
Hamilton HM 12, Bermuda
(580) 01 05 2019
-
- (111) M 1997 5691 R
(732) PORTFOLIO CONCENTRATE
SOLUTIONS UNLIMITED COMPANY
5 Eastgate Road, Eastgate Business Park,
Little Island, Co.Cork, Ireland
(770) THE CONCENTRATE MANUFACTURING
COMPANY OF IRELAND
Swan Building, 3th Floor, 26 Victoria Street,
Hamilton HM 12, Bermuda
(580) 01 05 2019
-
- (111) M 1999 12337 R
(732) A.T. CROSS COMPANY, LLC
10990 Wilshire Blvd., Suite 440, Los Angeles,
CA 90024, USA
(770) SHEAFFER PEN CORPORATION
One BIC Way, Suite 1, Shelton,
CT 06484-6299, USA
(580) 10 05 2019
-
- (111) M 1999 12338 R
(732) A.T. CROSS COMPANY, LLC
10990 Wilshire Blvd., Suite 440, Los Angeles,
CA 90024, USA
(770) SHEAFFER PEN CORPORATION
One BIC Way, Suite 1, Shelton, CT 06484-
6299, USA
(580) 10 05 2019
-
- (111) M 2001 14143 R
(732) Nanjing Chervon Industry CO., LTD
No.159 Czian-cziun Road, Cziannin
Ekonomik End Teqnikal Development Zoun,
Nanakin 211106, China
(770) ROBERT BOSCH TOOL CORPORATION
1800 West Central Road, Mount Prospect,
Illinois 60056, USA
(580) 13 05 2019
-
- (111) M 2004 15626 R
(732) PORTFOLIO CONCENTRATE
SOLUTIONS UNLIMITED COMPANY
5 Eastgate Road, Eastgate Business Park,
Little Island, Co.Cork, Ireland
(770) THE CONCENTRATE MANUFACTURING
COMPANY OF IRELAND
Swan Building, 3th Floor, 26 Victoria Street,
Hamilton HM 12, Bermuda
(580) 01 05 2019
-
- (111) M 2004 15628 R
(732) PORTFOLIO CONCENTRATE
SOLUTIONS UNLIMITED COMPANY
5 Eastgate Road, Eastgate Business Park,
Little Island, Co.Cork, Ireland
(770) THE CONCENTRATE MANUFACTURING
COMPANY OF IRELAND
Swan Building, 3th Floor, 26 Victoria Street,
Hamilton HM 12, Bermuda
(580) 01 05 2019
-
- (111) M 1997 7220 R
(732) ADAMED PHARMA S.A.
Pieńków, Ul. Mariana Adamkiewicza 6A
05-152 Czosnów, Poland
(770) ADMARKA SP. Z O.O.
Pieńków 149, 05-152 Czosnów, Poland
(580) 10 05 2019
-

(111) M 2008 18197 R
(732) Brown-Forman Distillery Inc.
2921 Dixie Highway, Shively, Kentucky
40216, USA
(770) BROWN-FORMAN CORPORATION
850 Dixie Highway, Louisville, Kentucky
40210, USA
(580) 13 05 2019

(111) M 2008 18476 R
(732) PORTFOLIO CONCENTRATE
SOLUTIONS UNLIMITED COMPANY
5 Eastgate Road, Eastgate Business Park,
Little Island, Co.Cork, Ireland
(770) THE CONCENTRATE MANUFACTURING
COMPANY OF IRELAND
Swan Building, 3th Floor, 26 Victoria Street,
Hamilton HM 12, Bermuda
(580) 01 05 2019

(111) M 2011 21456 R
(732) LIFESCAN IP HOLDINGS, LLC
360 North Crescent Drive, Beverly Hills, CA
90210, USA
(770) JOHNSON & JOHNSON (corporation
organized and existing under the laws of the
State of New Jersey)
One Johnson & Johnson Plaza, New
Brunswick, New Jersey 08933, USA
(580) 15 05 2019

(111) M 2009 19746 R
(732) ADAMED PHARMA S.A.
Pieńków, Ul. Mariana Adamkiewicza 6A
05-152 Czosnów, Poland
(770) ADMARKA SP. Z O.O.
Pieńków 149, 05-152 Czosnów, Poland
(580) 10 05 2019

(111) M 2010 20683 R
(732) TENGIZ AFKHAIDZE
Fanaskertelis 16, b. 32, 0194, Tbilisi, Georgia
(770) LTD "LOIDLI"
Tseretlis gamz. 87, 0119, Tbilisi Georgia
(580) 30 04 2019

(111) M 1996 3624 R
(732) NARDOBEL
Route de Castelnaudary, 31250 Revel, France
(770) NUTRINAT AG
c/o ENGEL COPERA AG, Waldeggstrasse
37, CH-3097 Bern-Liebefeld, Switzerland
(580) 06 05 2019

(111) M 2010 20484 R
(732) INTERNATIONAL BEER BREWERIES
LTD
5 Bar-lev Blvd., Ashkelon, Israel
(770) Gat Givat Chaim, Cooperative Society For
Preservation of Agricultural Products LTD
Givat Haim, 38100, Israel
(580) 01 05 2019

(111) M 1998 8733 R
(732) ADAMED PHARMA S.A.
Pieńków, Ul. Mariana Adamkiewicza 6A
05-152 Czosnów, Poland
(770) ADMARKA SP. Z O.O.
Pieńków 149, 05-152 Czosnów, Poland
(580) 10 05 2019

(111) M 2013 23237 R
(732) PORTFOLIO CONCENTRATE
SOLUTIONS UNLIMITED COMPANY
5 Eastgate Road, Eastgate Business Park,
Little Island, Co.Cork, Ireland
(770) THE CONCENTRATE MANUFACTURING
COMPANY OF IRELAND
Swan Building, 3th Floor, 26 Victoria Street,
Hamilton HM 12, Bermuda
(580) 01 05 2019

(111) M 2011 21809 R
(732) TENGIZ APKHAIDZE
Panaskertelis q. 16, b. 32, 0194, Tbilisi,
Georgia
(770) LTD "LOIDLI"
A. Tseretlis gamz. 87, 0119, Tbilisi Georgia
(580) 30 04 2019

(111) M 2011 21903 R
(732) TENGIZ APKHAIDZE
Panaskertelis q. 16, b. 32, 0194, Tbilisi,
Georgia
(770) LTD "LOIDLI"
A. Tseretlis gamz. 87, 0119, Tbilisi Georgia
(580) 30 04 2019

(111) M 1999 12000 R
(732) ADAMED PHARMA S.A.
Pieńków, Ul. Mariana Adamkiewicza 6A
05-152 Czosnów, Poland
(770) ADMARKA SP. Z O.O.
Pieńków 149, 05-152 Czosnów, Poland
(580) 10 05 2019

(111) M 2013 23945 R
(732) ADAMED PHARMA S.A.
Pieńków, Ul. Mariana Adamkiewicza 6A
05-152 Czosnów, Poland
(770) ADMARKA SP. Z O.O.
Pieńków 149, 05-152 Czosnów, Poland
(580) 10 05 2019

(111) M 2013 23946 R
(732) ADAMED PHARMA S.A.
Pieńków, Ul. Mariana Adamkiewicza 6A
05-152 Czosnów, Poland
(770) ADMARKA SP. Z O.O.
Pieńków 149, 05-152 Czosnów, Poland
(580) 10 05 2019

(111) M 2013 23947 R
(732) ADAMED PHARMA S.A.
Pieńków, Ul. Mariana Adamkiewicza 6A
05-152 Czosnów, Poland
(770) ADMARKA SP. Z O.O.
Pieńków 149, 05-152 Czosnów, Poland
(580) 10 05 2019

(111) M 2014 25245 R
(732) TENGIZ APKHAIDZE
Panaskertelis q. 16, b. 32, 0194, Tbilisi,
Georgia
(770) LTD "LOIDLI"
A. Tseretlis gamz. 87, 0119, Tbilisi Georgia
(580) 30 04 2019

(111) M 2014 24409 R
(732) TENGIZ APKHAIDZE
Panaskertelis q. 16, b. 32, 0194, Tbilisi,
Georgia
(770) LTD "LOIDLI"
A. Tseretlis gamz. 87, 0119, Tbilisi Georgia
(580) 30 04 2019

(111) M 2014 24410 R
(732) TENGIZ APKHAIDZE
Panaskertelis q. 16, b. 32, 0194, Tbilisi,
Georgia
(770) LTD "LOIDLI"
A. Tseretlis gamz. 87, 0119, Tbilisi Georgia
(580) 02 05 2019

(111) M 2014 24411 R
(732) TENGIZ APKHAIDZE
Panaskertelis q. 16, b. 32, 0194, Tbilisi,
Georgia

(770) LTD "LOIDLI"
A. Tseretlis gamz. 87, 0119, Tbilisi Georgia
(580) 30 04 2019

(111) M 2017 28556 R
(732) LIFESCAN IP HOLDINGS, LLC
360 North Crescent Drive, Beverly Hills,
CA 90210, USA
(770) JOHNSON & JOHNSON
ONE JOHNSON & JOHNSON PLAZA,
NEW BRUNSWICK, NEW JERSEY 08933,
USA
(580) 13 05 2019

(111) M 2016 27318 R
(732) ASCLEPION LASER TECHNOLOGIES
GMBH
Brüsseler Strasse 10, 07747 Jena, Germany
(770) LTD R-MEDICAL
V. Dolidzis q.105, 0171, Tbilisi Georgia
(580) 10 05 2019

CHANGES OF NAMES AND/OR ADDRESS OF OWNERS

(111) M 1999 12278 R	Five Giralda Farms, Madison, New Jersey, 07940, USA	
(732) Beautyge Brands USA Inc. 9560 Towne Centre Drive, San Diego, California 92121, USA	(580) 07 05 2019	
<hr/>		
(770) American Crew Inc. 1515 Wazee Street, Suite 200, Denver, Colorado 80202, USA	(111) M 2000 13474 R	
(580) 19 04 2019	(732) ROTO FRANK AG Wilhelm-Frank-Platz 1, 70771 Leinfelden- Echterdingen, Germany	
<hr/>		
(111) M 1999 11990 R	(770) ROTO FRANK AG Stuttgarter Strasse 145-149, D-70771 Leinfelden-Echterdingen, Germany	
(732) CISA S.P.A. Via Oberdan 42, 48018 Faenza (Ravenna), Italy	(580) 21 05 2019	
(770) CISA S.P.A. Via Guglielmo Oberdan 42, Faenza (Ravenna), Italy	<hr/>	
(580) 10 05 2019	(111) M 2001 14005 R	
<hr/>		
(111) M 1999 12257 R	(732) ROTO FRANK AG Wilhelm-Frank-Platz 1, 70771 Leinfelden- Echterdingen, Germany	
(732) PIONEER CORPORATION 28-8, Honkomagome 2-chome, Bunkyo-ku, Tokyo, Japan	(770) ROTO FRANK AG Stuttgarter Strasse 145-149, D-70771 Leinfelden-Echterdingen, Germany	
(770) PIONEER CORPORATION 1-1, Shin-ogura, Saiwai-ku, Kawasaki-shi, Kanagawa, Japan	(580) 21 05 2019	
(580) 13 05 2019	<hr/>	
(111) M 1999 12257 R	(111) M 1999 12670 R	
(732) PIONEER CORPORATION 1-1, Shin-ogura, Saiwai-ku, Kawasaki-shi, Kanagawa, Japan	(732) Pasabahce Cam Sanaii Ve Ticaret A.S. İçmeler Mah. D-100 Karayolu Cad. Çarşı Ofis Binasi A Blok N44 A1 34947 Tuzla Istanbul, Turkey	
(770) PIONEER CORPORATION 4 - 1, Meguro 1-chome, meguro-ku, Tokyo, Japan	(770) Pasabahce Cam Sanaii Ve Ticaret A.S. Is Kuleleri Kule-3, 4 levent/Istanbul, Turkey	
(580) 13 05 2019	(580) 14 05 2019	
<hr/>		
(111) M 1999 12427 R	(111) M 1999 12515 R	
(732) WYETH LLC 235 East 42 nd Street, New York, NY 10017, USA	(732) WYETH LLC 235 East 42 nd Street, New York, NY 10017, USA	
(770) WYETH LLC Five Giralda Farms, Madison, New Jersey, 07940, USA	(770) WYETH LLC Five Giralda Farms, Madison, New Jersey, 07940, USA	
(580) 07 05 2019	(580) 07 05 2019	
<hr/>		
(111) M 1999 12428 R	(111) M 2004 15571 R	
(732) WYETH LLC 235 East 42 nd Street, New York, NY 10017, USA	(732) GUARDIAN INDUSTRIES LLC 2300 Harmon Road, Auburn Hills, Michigan 48326, USA	
(770) WYETH LLC	(770) Guardian Industries Corp. a Delaware corporation 2300 Harmon Road, Auburn Hills, Michigan 48326, USA	
	(580) 10 05 2019	
<hr/>		

-
- (111) M 2004 15572 R
(732) GUARDIAN INDUSTRIES LLC
2300 Harmon Road, Auburn Hills, Michigan
48326, USA
(770) GUARDIAN INDUSTRIES CORP.
a Delaware corporation
2300 Harmon Road, Auburn Hills, Michigan
48326, USA
(580) 10 05 2019
-
- (111) M 2004 15605 R
(732) GUARDIAN EUROPE S.A.R.L.
19, Rue Du Puits-Romain, L-8070 Bertrange,
Luxembourg
(770) GUARDIAN EUROPE S.A.R.L.
Zone Industrielle Wolser, L-3452 Dudelange,
Grand Duce de, Luxembourg
(580) 10 05 2019
-
- (111) M 2004 15583 R
(732) GUARDIAN EUROPE S.A.R.L.
19, Rue Du Puits-Romain, L-8070 Bertrange,
Luxembourg
(770) GUARDIAN EUROPE S.A.R.L.
Zone Industrielle Wolser, L-3452 Dudelange,
Grand Duce de, Luxembourg
(580) 10 05 2019
-
- (111) M 2009 19292 R
(732) GENTING INTERNATIONAL
MANAGEMENT LIMITED
First Names House, Victoria Road, Douglas,
Isle of Man, IM2 4DF, Isle of Man
(770) GENTING INTERNATIONAL
MANAGEMENT LIMITED
International House, Kasl-hill, Victoria
Road, Douglas, Isle of Man, IM2 4DF,
Isle of Man
(580) 15 05 2019
-
- (111) M 1999 11881 R
(732) KABUSHIKI KAISHA HITACHI
SEISAKUSHO (HITACHI LTD)
6-6, Marunouchi 1-chome, Chiyoda-ku,
Tokio, Japan
(770) KABUSHIKI KAISHA HITACHI
SEISAKUSHO (HITACHI LTD)
6, Kanda-Surugaday 4 Chome, Chiyoda-ku,
Tokyo, Japan
(580) 18 04 2019
-
- (111) M 1999 11882 R
(732) KABUSHIKI KAISHA HITACHI
SEISAKUSHO (HITACHI LTD)
-
- 6-6, Marunouchi 1-chome, Chiyoda-ku,
Tokyo, Japan
(770) KABUSHIKI KAISHA HITACHI
SEISAKUSHO (HITACHI LTD)
6, Kanda-Surugaday 4 Chome, Chiyoda-ku,
Tokyo, Japan
(580) 18 04 2019
-
- (111) M 1999 12067 R
(732) ALPS ALPINE CO., LTD
1-7, Yukigaya Otsukamachi, Ota-ku, Tokyo
145-8501, Japan
(770) ALPS ALPINE CO., LTD
1-7, Yukigaia Otsukamachi, Ohta-ku, Tokyo,
Japan
(580) 10 05 2019
-
- (111) M 1999 12161 R
(732) TEFAL
15 Avenue des Alpes, Zae Rumilly Est,
BR 89, 74150 Rumilly, France
(770) TEFAL S.A.
Rumilie, France
(580) 13 05 2019
-
- (111) M 1999 12548 R
(732) COMPAGNE GENERALE DES
ESTABLISSEMENTS MICHELIN
23, Place des Carmes-dechaux, 63000
Klermont-Ferrand, France
(770) COMPAGNE GENERALE DES
ESTABLISSEMENTS MICHELIN
12, cours Sablon, 63000, Clermont-Ferrand ,
France
(580) 10 05 2019
-
- (111) M 1999 12549 R
(732) COMPAGNE GENERALE DES
ESTABLISSEMENTS MICHELIN
23, Place des Carmes-dechaux, 63000
Klermont-Ferrand, France
(770) COMPAGNE GENERALE DES
ESTABLISSEMENTS MICHELIN
12, cours Sablon, 63000, Clermont-Ferrand ,
France
(580) 10 05 2019
-
- (111) M 1999 12551 R
(732) COMPAGNE GENERALE DES
ESTABLISSEMENTS MICHELIN
23, Place des Carmes-dechaux, 63000
Klermont-Ferrand, France
(770) COMPAGNE GENERALE DES
ESTABLISSEMENTS MICHELIN
-

12, cours Sablon, 63000, Clermont-Ferrand ,
France
(580) 10 05 2019

(111) M 2017 28854 R
(732) LTD "GEORGIAN Hospitality Investments"
Besikis q. 4, b. 4, 0108, Tbilisi, Georgia
(770) LTD "Georgian Hospitality Investments"
Pekinis gamz., I kvart., korp. 6a, b. 25, 0171,
Tbilisi, Georgia
(580) 15 03 2019

TERMINATION OF TRADEMARKS REGISTRATION

(111) M 1998 11089 R

(151) 1998 11 11

(732) APTALIS PHARMA SAS

Poute de Bû, La Prévôté 78550 Houdan,
France

(111) M 2008 18876 R

(151) 2008 11 17

(732) SAROME CO., LTD

8-17-1 Miyama, Funabashi-City, Chiba Pref.,
274-0072, Japan

(111) M 2008 18863 R

(151) 2008 11 17

(732) WORLD MEDICINE LIMITED

48 Quenn Anne Street, London W1G9JJ,
United Kingdom

(111) M 2008 18877 R

(151) 2008 11 17

(732) LTD "TOP UPI"

Sop. Jikhashkari, Zugdidis raioni, 2142,
Georgia

(111) M 2008 18869 R

(151) 2008 11 17

(732) ROTAPHARM LIMITED

48 Queen Anne Street, London W1G9JJ,
United Kingdom

(111) M 2008 18880 R

(151) 2008 11 17

(732) LTD "ASPHARMA" - Georgian Pharmaceutical
Company

Shevchenkos q. 12, 0108, Tbilisi, Georgia

(111) M 2008 18870 R

(151) 2008 11 17

(732) WORLD MEDICINE LIMITED

48 Quenn Anne Street, London W1G9JJ,
United Kingdom

(111) M 2008 18881 R

(151) 2008 11 17

(732) LTD "ASPHARMA" - Georgian Pharmaceutical
Company

Shevchenkos q. 12, 0108, Tbilisi, Georgia

(111) M 2008 18871 R

(151) 2008 11 17

(732) WORLD MEDICINE LIMITED

48 Quenn Anne Street, London W1G9JJ,
United Kingdom

(111) M 2008 18883 R

(151) 2008 11 17

(732) BAYER CONSUMER CARE AG

Peter Merian-Str. 84, 4052 Basel, Switzerland

(111) M 2008 18918 R

(151) 2008 11 17

(732) ROTAPHARM LIMITED

48 Queen Anne Street, London W1G9JJ,
United Kingdom

(111) M 2008 18884 R

(151) 2008 11 17

(732) JSC BANK "REPUBLIC"

Grigol Abashidzis q. 2, 0179, Tbilisi, Georgia

(111) M 2008 18872 R

(151) 2008 11 17

(732) LTD "RAKEEN DEVELOPMENTI"

Baratashvilis q. 2, 0105, Tbilisi, Georgia

(111) M 2008 18887 R

(151) 2008 11 17

(732) WYETH LLC

Five Giralda Farms, Madison, New Jersey,
07940, USA

(111) M 2008 18873 R

(151) 2008 11 17

(732) GENERAL MOTORS LLC

300 Renaissance Center, City Detroit,
Michigan State 48265-3000, USA

(111) M 2008 18888 R

(151) 2008 11 17

(732) EKATERINE MGALOBlishvili

Tamar Mepis q. 50, 4610, Kutaisi, Georgia

(111) M 2008 18914 R
(151) 2008 11 17
(732) LTD "ASPHARMA" - Georgian Pharmaceutical
Company
Shevchenkos q. 12, 0108, Tbilisi, Georgia

(111) M 2008 18891 R
(151) 2008 11 17
(732) LTD "A-B-C Pharmaceuticals"
Lisis Tba 1, 0177, Tbilisi, Georgia

(111) M 2008 18894 R
(151) 2008 11 17
(732) LTD "BATPHARMA"
Noneshvilis q. 65, 6007, Batumi, Georgia

(111) M 2008 18895 R
(151) 2008 11 17
(732) BLACKBERRY LIMITED
2200 University Avenue East, Waterloo,
Ontario N2K 0A7, Canada

(111) M 2008 18896 R
(151) 2008 11 17
(732) BLACKBERRY LIMITED
2200 University Avenue East, Waterloo,
Ontario N2K 0A7, Canada

(111) M 2008 18897 R
(151) 2008 11 17
(732) LTD "KAFEINI"
I. Abashidzis q. 27, 0179, Tbilisi, Georgia

(111) M 2008 18898 R
(151) 2008 11 17
(732) EUROPEAN REFRESHMENTS
Southgate, Dublin Road, Drogheda, County
Meath, Ireland

(111) M 2008 18899 R
(151) 2008 11 17
(732) WM. WRIGLEY JR. COMPANY
410 North Michigan Avenue, Chicago, Illinois
60611, USA

(111) M 2008 18903 R
(151) 2008 11 17
(732) JSC "MOBI PLUS"
Vazha-Pshavelas gamz. 45, 0177, Tbilisi,
Georgia

(111) M 2008 18904 R
(151) 2008 11 17
(732) KIMBERLY-CLARK WORLDWIDE, INC.
NEENAH, WI 54956, USA

(111) M 2008 18906 R
(151) 2008 11 17
(732) KIMBERLY-CLARK WORLDWIDE, INC.
NEENAH, WI 54956, USA

(111) M 2008 18909 R
(151) 2008 11 17
(732) LA SENZA CORPORATION
1608 St. Regis, Dorval, H9P 1H6, Quebec,
Canada

(111) M 2008 18915 R
(151) 2008 11 17
(732) LTD "VITEL GEORGIA"
Tavisuplebis Moedani 4, 0105, Tbilisi,
Georgia

(111) M 2008 18917 R
(151) 2008 11 17
(732) LTD "PRIMETIME"
M. Lagidzis q. 4, 0108, Tbilisi, Georgia

CLASSIFICATION INDEXES

INVENTIONS

CONCORDANCE TABLE OF INTERNATIONAL CLASSIFICATION INDEX AND PUBLICATION NUMBERS

INTERNATIONAL CLASSIFICATION INDEXES (51)	NUMBER OF PUBLISHED APPLICATION (10)
A 61 B 18/02; A 61 B 18/00; A 61 B 18/14	AP 2019 14560 A
A 61 K 31/44; A 61 K 3/506; C 07 D 239/24	AP 2019 14395 A
B 42 D 25/00	AP 2019 14628 A
H 01 S 3/10	AP 2019 14805 A

CONCORDANCE TABLE OF PUBLICATION NUMBERS AND INTERNATIONAL CLASSIFICATION INDEX

NUMBER OF PUBLISHED APPLICATION (10)	INTERNATIONAL CLASSIFICATION INDEXES (51)
AP 2019 14395 A	A 61 K 31/44; A 61 K 3/506; C 07 D 239/24
AP 2019 14560 A	A 61 B 18/02; A 61 B 18/00; A 61 B 18/14
AP 2019 14628 A	B 42 D 25/00
AP 2019 14805 A	H 01 S 3/10

CONCORDANCE TABLE OF INTERNATIONAL CLASSIFICATION INDEX, PATENT NUMBERS AND PUBLICATION NUMBERS

INTERNATIONAL CLASSIFICATION INDEX (51)	NUMBER OF PATENT (11)	NUMBER OF PUBLISHED APPLICATION (10)
A 47 J 31/00; B 65 D 85/804; C 12 G 3/06	P 2019 6980 B	AP 2019 14581 A
A 61 K 9/20; A 61 K 31/40	P 2019 6977 B	AP 2019 14292 A
A 61 K 39/17; A 61 P 35/00; C 12 N 15/09	P 2019 6976 B	AP 2019 13952 A
A 62 C 13/66; A 62 C 13/74	P 2019 6979 B	AP 2019 14393 A
B 64 C 5/06	P 2019 6973 B	AP 2019 14489 A
B 66 D 5/26	P 2019 6975 B	AP 2019 14509 A
C 07 B 57/00; C 07 D 487/06	P 2019 6978 B	AP 2019 14340 A
C 07 D 235/04; C 07 D 235/06; C 07 D 407/12	P 2019 6974 B	AP 2019 14554 A

**CONCORDANCE TABLE OF PATENT NUMBERS,
PUBLICATION NUMBERS AND INTERNATIONAL CLASSIFICATION INDEX**

NUMBER OF PATENT (11)	NUMBER OF PUBLISHED APPLICATION (10)	INTERNATIONAL CLASSIFICATION INDEX (51)
P 2019 6973 B	AP 2019 14489 A	B 64 C 5/06
P 2019 6974 B	AP 2019 14554 A	C 07 D 235/04; C 07 D 235/06; C 07 D 407/12
P 2019 6975 B	AP 2019 14509 A	B 66 D 5/26
P 2019 6976 B	AP 2019 13952 A	A 61 K 39/17; A 61 P 35/00; C 12 N 15/09
P 2019 6977 B	AP 2019 14292 A	A 61 K 9/20; A 61 K 31/40
P 2019 6978 B	AP 2019 14340 A	C 07 B 57/00; C 07 D 487/06
P 2019 6979 B	AP 2019 14393 A	A 62 C 13/66; A 62 C 13/74
P 2019 6980 B	AP 2019 14581 A	A 47 J 31/00; B 65 D 85/804; C 12 G 3/06

**CONCORDANCE TABLE OF APPLICATION NUMBERS, PUBLICATION NUMBERS
AND PATENTS**

NUMBER OF APPLICATION (21)	NUMBER OF PUBLISHED APPLICATION (10)	NUMBER OF PATENT (11)
AP 2014 13952	AP 2019 13952 A	P 2019 6976 B
AP 2015 14292	AP 2019 14292 A	P 2019 6977 B
AP 2014 14340	AP 2019 14340 A	P 2019 6978 B
AP 2015 14393	AP 2019 14393 A	P 2019 6979 B
AP 2015 14393	AP 2019 14393 A	P 2019 6979 B
AP 2017 14489	AP 2019 14489 A	P 2019 6973 B
AP 2017 14509	AP 2019 14509 A	P 2019 6975 B
AP 2015 14554	AP 2019 14554 A	P 2019 6974 B
AP 2016 14581	AP 2019 14581 A	P 2019 6980 B

UTILITY MODEL

**CONCORDANCE TABLE OF INTERNATIONAL CLASSIFICATION INDEX
AND PUBLICATION NUMBERS**

INTERNATIONAL CLASSIFICATION INDEXES (51)	NUMBER OF PUBLISHED APPLICATION (10)
B 60 T 17/22; B 60 T 17/08; G 01 L 5/28	AU 2019 14799 U

**CONCORDANCE TABLE OF PUBLICATION NUMBERS
AND INTERNATIONAL CLASSIFICATION INDEX**

NUMBER OF PUBLISHED APPLICATION (10)	INTERNATIONAL CLASSIFICATION INDEXES (51)
AU 2019 14799 U	B 60 T 17/22; B 60 T 17/08; G 01 L 5/28

TRADEMARKS

CONCORDANCE TABLE OF REGISTRATION NUMBERS, APPLICATION NUMBERS, PUBLICATION NUMBERS AND BULLETIN NUMBERS

NUMBER OF REGISTRATION (111)	NUMBER OF APPLICATIONS (210)	NUMBER OF PUBLISHED APPLICATIONS (260)	NUMBER OF BULLETIN
M 2019 31233 R	AM 103002	-	11(519)2019
M 2019 31234 R	AM 102728	-	11(519)2019
M 2019 31235 R	AM 103092	-	11(519)2019
M 2019 31236 R	AM 103026	-	11(519)2019
M 2019 31237 R	AM 103110	-	11(519)2019
M 2019 31238 R	AM 103212	-	11(519)2019
M 2019 31239 R	AM 103215	-	11(519)2019
M 2019 31240 R	AM 103201	-	11(519)2019
M 2019 31241 R	AM 103214	-	11(519)2019
M 2019 31242 R	AM 103220	-	11(519)2019
M 2019 31243 R	AM 103100	-	11(519)2019
M 2019 31244 R	AM 103305	-	11(519)2019
M 2019 31245 R	AM 103321	-	11(519)2019
M 2019 31246 R	AM 87132	AM 2016 87132 A	23(459)2016
M 2019 31247 R	AM 87237	AM 2017 87237 A	2(462)2017
M 2019 31248 R	AM 92047	AM 2018 92047 A	5(489)2018
M 2019 31249 R	AM 92065	AM 2018 92065 A	19(503)2018
M 2019 31250 R	AM 93532	AM 2018 93532 A	21(505)2018
M 2019 31251 R	AM 95172	AM 2018 95172 A	21(505)2018
M 2019 31252 R	AM 95173	AM 2018 95173 A	21(505)2018
M 2019 31253 R	AM 96764	AM 2018 96764 A	21(505)2018
M 2019 31254 R	AM 96916	AM 2018 96916 A	21(505)2018
M 2019 31255 R	AM 97024	AM 2018 97024 A	21(505)2018
M 2019 31256 R	AM 97183	AM 2019 97183 A	2(510)2019
M 2019 31257 R	AM 97193	AM 2018 97193 A	21(505)2018
M 2019 31258 R	AM 97372	AM 2018 97372 A	22(506)2018
M 2019 31259 R	AM 97374	AM 2019 97374 A	2(510)2019
M 2019 31260 R	AM 97375	AM 2019 97375 A	2(510)2019
M 2019 31261 R	AM 97412	AM 2019 97412 A	1(509)2019
M 2019 31262 R	AM 97413	AM 2019 97413 A	1(509)2019
M 2019 31263 R	AM 97414	AM 2019 97414 A	1(509)2019
M 2019 31264 R	AM 97415	AM 2019 97415 A	1(509)2019
M 2019 31265 R	AM 97460	AM 2018 97460 A	24(508)2018
M 2019 31266 R	AM 97463	AM 2018 97463 A	24(508)2018
M 2019 31267 R	AM 97678	AM 2018 97678 A	24(508)2018
M 2019 31268 R	AM 97683	AM 2018 97683 A	24(508)2018
M 2019 31269 R	AM 97877	AM 2019 97877 A	1(509)2019
M 2019 31270 R	AM 97878	AM 2019 97878 A	1(509)2019
M 2019 31271 R	AM 97879	AM 2019 97879 A	1(509)2019
M 2019 31272 R	AM 97888	AM 2018 97888 A	24(508)2018
M 2019 31273 R	AM 97963	AM 2019 97963 A	3(511)2019
M 2019 31274 R	AM 97964	AM 2019 97964 A	3(511)2019
M 2019 31275 R	AM 97993	AM 2019 97993 A	2(510)2019
M 2019 31276 R	AM 98151	AM 2019 98151 A	3(511)2019
M 2019 31277 R	AM 98152	AM 2019 98152 A	3(511)2019
M 2019 31278 R	AM 98153	AM 2019 98153 A	3(511)2019
M 2019 31279 R	AM 98154	AM 2019 98154 A	3(511)2019

1	2	3	4
M 2019 31280 R	AM 98155	AM 2019 98155 A	3(511)2019
M 2019 31281 R	AM 98156	AM 2019 98156 A	2(510)2019
M 2019 31282 R	AM 98157	AM 2019 98157 A	2(510)2019
M 2019 31283 R	AM 98162	AM 2019 98162 A	3(511)2019
M 2019 31284 R	AM 98169	AM 2019 98169 A	2(510)2019
M 2019 31285 R	AM 98199	AM 2019 98199 A	3(511)2019
M 2019 31286 R	AM 98222	AM 2019 98222 A	3(511)2019
M 2019 31287 R	AM 98236	AM 2019 98236 A	3(511)2019
M 2019 31288 R	AM 98241	AM 2019 98241 A	2(510)2019
M 2019 31289 R	AM 98242	AM 2019 98242 A	2(510)2019
M 2019 31290 R	AM 98243	AM 2019 98243 A	2(510)2019
M 2019 31291 R	AM 98376	AM 2019 98376 A	4(512)2019
M 2019 31292 R	AM 98437	AM 2019 98437 A	4(512)2019
M 2019 31293 R	AM 98565	AM 2019 98565 A	4(512)2019
M 2019 31294 R	AM 98566	AM 2019 98566 A	4(512)2019
M 2019 31295 R	AM 98683	AM 2019 98683 A	4(512)2019
M 2019 31296 R	AM 98684	AM 2019 98684 A	4(512)2019
M 2019 31297 R	AM 98685	AM 2019 98685 A	4(512)2019
M 2019 31298 R	AM 98691	AM 2019 98691 A	4(512)2019
M 2019 31299 R	AM 103311	-	11(519)2019
M 2019 31300 R	AM 103190	-	11(519)2019
M 2019 31301 R	AM 103445	-	11(519)2019
M 2019 31302 R	AM 103181	-	11(519)2019
M 2019 31303 R	AM 103195	-	11(519)2019
M 2019 31304 R	AM 103196	-	11(519)2019
M 2019 31305 R	AM 103197	-	11(519)2019
M 2019 31306 R	AM 103198	-	11(519)2019

CONCORDANCE TABLE OF PUBLICATION NUMBERS
AND APPLICATION NUMBERS

NUMBER OF PUBLISHED APPLICATION (260)	NUMBER OF APPLICATION (210)	1	2
		1	2
AM 2019 100000 A	AM 100000	AM 2019 100091 A	AM 100091
AM 2019 100001 A	AM 100001	AM 2019 100093 A	AM 100093
AM 2019 100002 A	AM 100002	AM 2019 100097 A	AM 100097
AM 2019 100003 A	AM 100003	AM 2019 100368 A	AM 100368
AM 2019 100004 A	AM 100004	AM 2019 100379 A	AM 100379
AM 2019 100006 A	AM 100006	AM 2019 100380 A	AM 100380
AM 2019 100008 A	AM 100008	AM 2019 100387 A	AM 100387
AM 2019 100019 A	AM 100019	AM 2019 100388 A	AM 100388
AM 2019 100020 A	AM 100020	AM 2019 100391 A	AM 100391
AM 2019 100042 A	AM 100042	AM 2019 100392 A	AM 100392
AM 2019 100051 A	AM 100051	AM 2019 100396 A	AM 100396
AM 2019 100074 A	AM 100074	AM 2019 100398 A	AM 100398
AM 2019 100075 A	AM 100075	AM 2019 100400 A	AM 100400
AM 2019 100080 A	AM 100080	AM 2019 100411 A	AM 100411
AM 2019 100081 A	AM 100081	AM 2019 100412 A	AM 100412
AM 2019 100086 A	AM 100086	AM 2019 100413 A	AM 100413
		AM 2019 100431 A	AM 100431
		AM 2019 100460 A	AM 100460
		AM 2019 100584 A	AM 100584
		AM 2019 100585 A	AM 100585
		AM 2019 100793 A	AM 100793

1	2
AM 2019 100800 A	AM 100800
AM 2019 100801 A	AM 100801
AM 2019 95941 A	AM 95941
AM 2019 98185 A	AM 98185
AM 2019 99427 A	AM 99427
AM 2019 99680 A	AM 99680
AM 2019 99760 A	AM 99760
AM 2019 99764 A	AM 99764
AM 2019 99765 A	AM 99765
AM 2019 99767 A	AM 99767
AM 2019 99768 A	AM 99768
AM 2019 99770 A	AM 99770
AM 2019 99772 A	AM 99772
AM 2019 99775 A	AM 99775
AM 2019 99778 A	AM 99778
AM 2019 99779 A	AM 99779
AM 2019 99862 A	AM 99862
AM 2019 99870 A	AM 99870
AM 2019 99871 A	AM 99871
AM 2019 99887 A	AM 99887

1	2
AM 2019 99890 A	AM 99890
AM 2019 99891 A	AM 99891
AM 2019 99894 A	AM 99894
AM 2019 99897 A	AM 99897
AM 2019 99907 A	AM 99907
AM 2019 99908 A	AM 99908
AM 2019 99909 A	AM 99909
AM 2019 99912 A	AM 99912
AM 2019 99914 A	AM 99914
AM 2019 99939 A	AM 99939
AM 2019 99955 A	AM 99955
AM 2019 99963 A	AM 99963
AM 2019 99965 A	AM 99965
AM 2019 99977 A	AM 99977
AM 2019 99978 A	AM 99978
AM 2019 99985 A	AM 99985
AM 2019 99986 A	AM 99986
AM 2019 99988 A	AM 99988
AM 2019 99989 A	AM 99989

**CONCORDANCE TABLE OF INDEX OF GOODS AND/OR SERVICES
AND APPLICATION NUMBERS**

INDEX OF GOODS AND/OR SERVICES (511)	NUMBER OF PUBLISHED APPLICATIONS (26)
1	2
2	AM 2019 100075 A
3	AM 2019 100086 A
3	AM 2019 100391 A
3	AM 2019 100392 A
3	AM 2019 100091 A
3	AM 2019 100093 A
3	AM 2019 99894 A
5	AM 2019 100000 A
5	AM 2019 100002 A
5	AM 2019 100003 A
5	AM 2019 100004 A
5	AM 2019 100006 A
5	AM 2019 100008 A
5	AM 2019 100019 A
5	AM 2019 100020 A
5	AM 2019 100042 A
5	AM 2019 100097 A
5	AM 2019 100411 A
5	AM 2019 100412 A
5	AM 2019 100413 A
5	AM 2019 100800 A
5	AM 2019 100091 A
5	AM 2019 99779 A
5	AM 2019 100800 A

1	2
5	AM 2019 100801 A
5	AM 2019 99887 A
5	AM 2019 99890 A
5	AM 2019 99891 A
5	AM 2019 99897 A
5	AM 2019 99907 A
5	AM 2019 99908 A
5	AM 2019 99909 A
5	AM 2019 99912 A
5	AM 2019 99977 A
5	AM 2019 99978 A
5	AM 2019 99985 A
5	AM 2019 99986 A
5	AM 2019 99988 A
5	AM 2019 99989 A
7	AM 2019 100431 A
7	AM 2019 100460 A
7	AM 2019 99939 A
9	AM 2019 100398 A
12	AM 2019 100460 A
20	AM 2019 100074 A
21	AM 2019 100074 A
24	AM 2019 100074 A
24	AM 2019 99914 A
30	AM 2019 99680 A
30	AM 2019 99767 A
30	AM 2019 99768 A
32	AM 2019 100396 A
32	AM 2019 99887 A

1	2
33	AM 2019 100001 A
33	AM 2019 100051 A
33	AM 2019 100380 A
33	AM 2019 100387 A
33	AM 2019 100388 A
33	AM 2019 100396 A
33	AM 2019 100793 A
33	AM 2019 95941 A
34	AM 2019 100400 A
34	AM 2019 99775 A
34	AM 2019 99955 A
34	AM 2019 99963 A
34	AM 2019 99965 A
35	AM 2019 100391 A
35	AM 2019 100392 A
35	AM 2019 100398 A
35	AM 2019 99427 A
35	AM 2019 99862 A
35	AM 2019 99887 A
35	AM 2019 99914 A
36	AM 2019 100398 A
37	AM 2019 100368 A
37	AM 2019 100584 A
37	AM 2019 100585 A
37	AM 2019 99862 A

1	2
38	AM 2019 100379 A
38	AM 2019 100398 A
41	AM 2019 100398 A
42	AM 2019 100398 A
42	AM 2019 100584 A
42	AM 2019 100585 A
42	AM 2019 99862 A
43	AM 2019 100368 A
43	AM 2019 100396 A
43	AM 2019 98185 A
43	AM 2019 99760 A
43	AM 2019 99764 A
43	AM 2019 99765 A
43	AM 2019 99767 A
43	AM 2019 99768 A
43	AM 2019 99770 A
43	AM 2019 99772 A
43	AM 2019 99870 A
43	AM 2019 99871 A
44	AM 2019 100391 A
44	AM 2019 100392 A
44	AM 2019 100081 A
44	AM 2019 99778 A
45	AM 2019 100398 A

CONCORDANCE TABLE OF INDEX OF GOODS AND/OR SERVICES
AND NUMBERS OF TRADEMARKS REGISTERED ACCORDING
TO THE ACCELERATED PROCEDURE

INDEX OF GOODS AND/OR SERVICES (511)	NUMBERS OF REGISTERED ACCORDING TO THE ACCELERATED PROCEDURE (111)
3	M 2019 31299 R
5	M 2019 31238 R
5	M 2019 31239 R
7	M 2019 31244 R
8	M 2019 31244 R
9	M 2019 31233 R
9	M 2019 31243 R
12	M 2019 31303 R
12	M 2019 31304 R
12	M 2019 31305 R
12	M 2019 31306 R
16	M 2019 31242 R
21	M 2019 31242 R
29	M 2019 31242 R
30	M 2019 31242 R
32	M 2019 31234 R
32	M 2019 31242 R
34	M 2019 31240 R
34	M 2019 31241 R
35	M 2019 31233 R
35	M 2019 31237 R
35	M 2019 31245 R

1	2
35	M 2019 31302 R
36	M 2019 31233 R
39	M 2019 31302 R
41	M 2019 31235 R
42	M 2019 31302 R
44	M 2019 31236 R
44	M 2019 31301 R
45	M 2019 31235 R
45	M 2019 31300 R

OFFICIAL BULLETIN OF THE INDUSTRIAL PROPERTY

INVENTIONS
UTILITY MODELS
DESIGNS
TRADEMARKS

11(519)

EDITOR-IN-CHIEF: N. Bebrishvili

EDITOR-TRANSLATOR: E. Gabunia

PROOFREADER: A. Shikhashvili

COMPUTER LAYOUT: M. Ordenidze
K. Svanidze

www.sakpatenti.gov.ge

E-mail: info@sakpatenti.org.ge