



**NATIONAL INTELLECTUAL PROPERTY CENTER OF GEORGIA  
SAKPATENTI**

**OFFICIAL BULLETIN  
OF THE INDUSTRIAL PROPERTY**

**1(413)**

**2015  
TBILISI**

# INID CODES FOR IDENTIFICATION OF BIBLIOGRAPHIC DATA

## INVENTIONS, UTILITY MODELS

- (10) Number of publication for application, which has been examined
- (11) Number of patent and kind of document
- (21) Serial number of application
- (22) Date of filing of the application
- (23) Date of exhibition or the date of the earlier filing and the number of application, if any
- (24) Date from which patent may have effect
- (31) Number of priority application
- (32) Date of filing of priority application
- (33) Code of the country or regional organization allotting priority application number
- (44) Date of publication of application not granted, but examined and number of bulletin
- (45) Date of publication of registered document
- (51) International Patent Classification Index
- (54) Title of the invention
- (57) Abstract
- (60) Number of examined patent document granted by foreign patent office, date from which patent has effect and country code
- (62) Number of the earlier application and in case of divided application, date of filing an application
- (71) Name, surname and address of applicant (country code)
- (72) Name, surname of inventor (country code)
- (73) Name, surname and address of patent owner (country code)
- (74) Name, surname of representative or patent attorney
- (85) Date of commencement of the national phase of International Application
- (86) Number and date of filing of international application
- (87) Number and date of publication of international application

## DESIGNS

- (10) Number of publication for application
- (11) Number of patent and kind of document or number of registration
- (15) Date of registration/Date of patent renewal
- (18) Expected expiration date of patent or registration
- (21) Serial number of application
- (22) Date of filing of the application
- (23) Date of exhibition or the date of the earlier filing and the number of application, if any
- (24) Date from which patent may have effect
- (28) Number of designs included in the application
- (30) Data relating to priority (number of application, date of filing of application, two-letter code identifying the authority with whom the priority application was made)
- (31) Number of priority application
- (32) Date of filing of priority application
- (33) Code of the country or regional organization allotting priority application number
- (34) Two-letter code according to WIPO St.3 identifying the authority with which the priority application was made
- (44) Date of publication of design and number of bulletin (the first publication)
- (45) Date of publication of design registered by WIPO and number of bulletin
- (51) International Classification for designs (class and subclass of the Locarno Classification)
- (54) Title of the invention
- (55) Reproduction of the design
- (57) Description of characteristic features of the design including indication of colors
- (58) Date of recording of any kind of amendment in the Register
- (62) Number of the earlier application, registration and document number and if available the date of filing an application in case of divided application
- (71) Name, surname and address of applicant (country code)
- (72) Name, surname of creator (country code)
- (73) Name, surname and address of patent owner (country code)
- (74) Name, surname of representative or patent attorney
- (81) Contracting states concerned
  - II designated contracting states according to the 1960 Act
  - III designated contracting states according to the 1999 Act
- (85) Owner's permanent address
- (86) Owner's nationality
- (87) Owner's residence
- (88) State in which the owner has a real and effective industrial or commercial establishment

## TRADEMARKS

- (111) – Number of registration
- (151) – Date of registration
- (156) – Date of the renewal
- (181) – Expected expiration date of registration
- (186) – Renewal expiration date of registration
- (141) – Date of cancel of duration of the mark
- (210) – Serial number of application
- (220) – Date of filing of the application
- (230) – Date concerning exhibition
- (260) – Number of application, for which favorable decision of examination about registration has been taken (publication number)
- (310) – Number of the first application
- (320) – Date of filing of the first application
- (330) – Code, identifying national or regional Office where the first application was made
- (511) – International Classification of Goods and Services for the purposes of registration of trade marks and/or list of goods and/or services classified according thereto
- (531) – Description of figurative elements of Trade Marks according to the International Classification of the Figurative Elements of Marks
- (540) – Reproduction of Trade Mark
- (550) – Nature and kind of Trade Mark
- (580) – Date of recording of any kind changes in respect of applications or registrations
- (591) – Information concerning colors claimed
- (731) – Name and address of the applicant
- (732) – Name and address of the holder of the registration
- (740) – Name and address of the representative
- (750) – Address for correspondence
- (770) – Name and address of the previous applicant or holder in case of change in ownership
- (771) – Previous name and address of the applicant or holder in case of change in ownership
- (791) – Name and address of the licensee
- (793) – Indication of conditions and/or restrictions under the license (Type of license, number of license agreement, data of license, data of validity of license)
- (800) – Certain data relating to the international registration of Trade Marks under the Protocol Relating to Madrid Agreement (International registration number)

## CODES FOR PUBLICATION IN BULLETIN

- (21) AP 0000 000000 – serial number of application for invention
- (10) AP 0000 0000 A – number of published application for invention (first publication)
- (11) P 0000 0000 B – number of patent for invention (second publication)
- (21) API 0000 000000 – number of application for imported patent
- (11) PI 0000 0000 A – number of imported patent (first publication)
- (21) AU 0000 000000 – serial number of application for utility model
- (10) AU 0000 000 U – number of published application for utility model (first publication)
- (11) U 0000 000 Y – number of patent for utility model (second publication)
- (21) AD 0000 000000 – serial number of application for design
- (10) AD 0000 000 S – number of published application for design (first publication)
- (11) D 0000 000 S – number of patent for design (second publication)

## INTERNATIONAL PATENT CLASSIFICATION FOR INVENTIONS AND UTILITY MODELS

- SECTION A – HUMAN NECESSITIES
- SECTION B – PERFORMING OPERATIONS; TRANSPORTING
- SECTION C – CHEMISTRY; METALLURGY
- SECTION D – TEXTILES; PAPER
- SECTION E – FIXED CONSTRUCTIONS
- SECTION F – MECHANICAL ENGINEERING; LIGHTING; HEATING; WEAPONS; BLASTING
- SECTION G – PHYSICS
- SECTION H – ELECTRICITY

- 
- M – Trade Mark
  - (210) AM 0000 000000 – Serial number of application;
  - (260) AAM 0000 00000 A – Publication number of application;
  - (111) M 0000 00000 R – Number of registration;
  - (111) MMM0000 00000 Rn – Number of renewals, in which n=1,2,3;
  - (111) M 0000 00000 R(P) – Number of registration under partial assignment of rights
-



**NATIONAL INTELLECTUAL PROPERTY CENTER OF GEORGIA  
SAKPATENTI**

**OFFICIAL BULLETIN  
OF THE INDUSTRIAL PROPERTY**

**ОФИЦИАЛЬНЫЙ БЮЛЛЕТЕНЬ  
ПРОМЫШЛЕННОЙ СОБСТВЕННОСТИ**

**1(413)**

**INVENTIONS  
UTILITY MODELS  
TRADEMARKS**

DATE OF PUBLICATION

2015 01 12

# CONTENTS

<b>PUBLISHED TITLES OF PROTECTION .....</b>	<b>2</b>
<b>INVENTIONS</b>	
▪ APPLICATIONS APPROVED FOR GRANTING PATENTS .....	4
▪ PATENTED INVENTIONS .....	6
<b>UTILITY MODELS</b>	
▪ APPLICATIONS APPROVED FOR GRANTING PATENT .....	9
▪ PATENTED UTILITY MODEL .....	10
<b>TRADEMARKS</b>	
▪ APPLICATIONS FILED UNDER THE NATIONAL PROCEDURE APPROVED FOR REGISTRATION .....	11
▪ REGISTERED TRADEMARKS .....	17
▪ TRADEMARKS REGISTERED ACCORDING TO THE ACCELERATED PROCEDURE .....	19
▪ INTERNATIONAL TRADEMARKS FOR WHICH A DECISION ON GANTING PROTECTION IS TAKEN .....	22
▪ INTERNATIONAL TRADEMARKS PROTECTED IN GEORGIA .....	126
<b>OFFICIAL NOTIFICATIONS</b>	
<b>TRADEMARKS</b>	
▪ RENEWAL OF REGISTRATIONS .....	133
▪ COMPLETE TRANSFER OF RIGHTS .....	134
▪ CHANGES IN NAMES AND/OR ADDRESSES OF OWNERS .....	135
▪ CORRECTION OF PUBLISED INFORMATIONS .....	136
<b>CLASSIFICATION INDEXES</b>	
INVENTIONS .....	137
UTILITY MODELS .....	139
TRADEMARKS .....	140

## **PUBLISHED TITLES OF PROTECTION**

### **INVENTIONS**

- **APPLICATIONS APPROVED FOR GRANTING PATENTS:**  
12434; 13190; 13268
- **PATENTED INVENTIONS:**  
6209-6219

### **UTILITY MODELS**

- **APPLICATIONS APPROVED FOR GRANTING PATENT:**  
13182
- **PATENTED UTILITY MODEL:**  
1841

### **TRADEMARKS**

- **APPLICATIONS FILED UNDER THE NATIONAL PROCEDURE APPROVED FOR REGISTRATION:**  
72315; 74373\*; 74374\*; 74400\*; 74899; 75243; 75768; 75785-75788; 75790-75792; 75835; 75895; 75919; 75925; 75991; 76071; 76182; 76428, 76429; 76730; 76765; 76796-76798; 76829; 76953; 77058; 77060
- **REGISTERED TRADEMARKS:**  
25511-25528
- **TRADEMARKS REGISTERED ACCORDING TO THE ACCELERATED PROCEDURE:**  
25533-25545
- **INTERNATIONAL TRADEMARKS FOR WHICH A DECISION ON GRANTING PROTECTIONS IS TAKEN:**  
71869\*; 71958\*; 73577\*; 74124\*; 74215\*; 74278\*; 75045-75050; 75052, 75053; 75055; 75057; 75061, 75062; 75064; 75180, 75181; 75186-75190; 75192-75195; 75267; 75337-75344; 75349-75354; 75360-75362; 75364-75371; 75378, 75379; 75381-75385; 75388, 75389; 75391-75395; 75397; 75400, 75401; 75403, 75404; 75406; 75410-75412; 75423-75425; 75430, 75431; 75437, 75438; 75440-75450; 75466, 75467; 75473-75475; 75490; 75502-75504; 75506; 75509, 75510; 75529-75534; 75537-75539; 75543-75547; 75557-75559; 75563; 75568, 75569; 75578; 75580-75585; 75613-75620; 75623-75634; 75637-75639; 75738; 75740; 75743, 75744; 75879; 75884; 75888; 75944; 76049; 76052, 76053; 76094; 76096-76100; 76112-76114; 76117-76121; 76123; 76125; 76132, 76133; 76137-76139; 76149, 76150; 76152, 76153; 76155-76159; 76164; 76169; 76172; 76176; 76178, 76179; 76205; 76218, 76219; 76221; 76224; 76226, 76227; 76229-76233; 76282-76285; 76287, 76288; 76290; 76294, 76295; 76298; 76303-76305; 76309; 76315-76317; 76319-76321; 76336; 76381-76384; 76386-76393; 76396-76398; 76400; 76407; 76410; 76434; 76436; 76439; 76441; 76444-76448; 76450, 76451; 76458; 76463-76466; 76478-76484; 76488, 76489; 77108; 77110; 77113-77115; 77117-77120; 77122-77124; 77126; 77130-77137; 77260; 77264, 77265
- **INTERNATIONAL TRADEMARKS PROTECTED IN GEORGIA:**  
70827; 71404; 72283; 72794; 73045; 73071; 73073-73076; 73079, 73080; 73191; 73194, 73195; 73199, 73200; 74202; 74223-74226; 74228-74231; 74235-74241; 74251-74255; 74258-74261; 74279; 74460; 74462-74480; 74581-74588; 74590; 74603; 74605-74612; 74662-74669; 74671; 74686, 74687; 74794-74798; 74803; 74812, 74813; 74817-74819

# INVENTIONS

## APPLICATIONS APPROVED FOR GRANTING PATENTS

The decision can be appealed at the Chamber of Appeal of Sakpatenti within 3 months from the publication or at the Mtskheta District Court Administrative Cases Board (Address: №17, Samkhedro str., Mtskheta), within 1 month following the publication.

### PART A

#### A 01

(10) AP 2015 12434 A (51) Int. Cl. (2006)  
A 61 M 15/00

(21) AP 2010 012434 (22) 2010 03 30

(31) TR2009/02446

(32) 2009 03 30

(33) TR

(71) ILAC SANAYI VE TICARET ANONIM  
SIRKETI (TR)

Istinye Mah. Balabandere Cad. No. 14 34460

Sariyer, Istanbul (TR)

(72) TOKSOZ, Ahmet (TR);

TOKSOZ, Zafer (TR);

CIFTER, Musa Umit (TR)

(74) Shalva Gvaramadze

(85) 2011 10 28

(86) PCT/TR2010/000068, 2010 03 30

(54) **DRY POWDER INHALER DEVICE**

(57) There is represented dry powder inhaler device comprising an outer housing (1), an inner housing (2) disposed therein, a lid (devil) executed rotatable relative to outer housing (1), blister band (4) locked by turning, lower first chamber (2.2) including said band coiled, and a mouthpiece (3); at that, additionally, it comprises an moving element (5) allocated movable in axle, clips (music) allocated rotatable around turning contact pin (8.2) and a cushion (8.4) having blocking lug (8.1) in one end thereof. Furthermore, the inhaler device comprises a holding lug (5.1) allocated capable to be engaged with blocking lug (8.1) on the actuating element (5), a spring (9) and a pusher (6.1) connected to lid disengaging the actuating element (5).

Claims: 1 independent

10 dependent

Fig.: 10

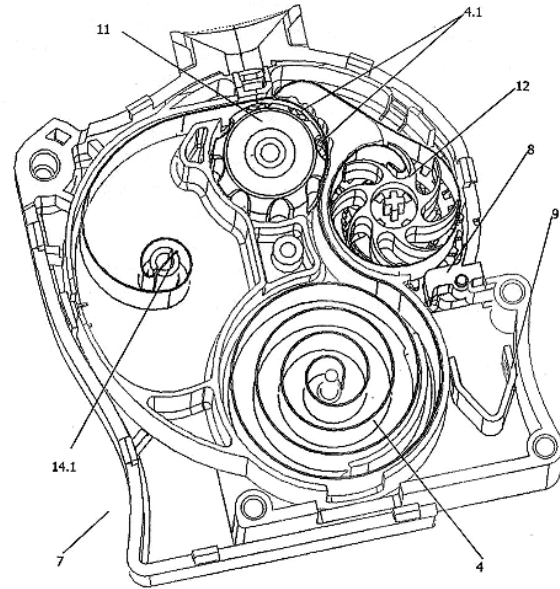

Fig. 10

### PART B

#### B 03

(10) AP 2015 13190 A (51) Int. Cl. (2006)

B 03 C 3/014

B 03 C 3/16

B 01 D 47/06

B 01 D 50/00

(21) AP 2011 013190 (22) 2011 07 14

(31) 20110007

(32) 2011 01 12

(33) FI

(71) AAVI TECHNOLOGIES LTD (FI)

Kirkonkyläntie 37A, FI-00700 Helsinki (FI)

(72) ILMASTI, Veikko Ilmari (FI)

(74) Shalva Gvaramadze

(85) 2013 08 07

(86) PCT/FI2011/000037, 2011 07 14

(54) **DEVICE AND METHOD FOR  
PURIFYING AIR FROM NON-DESIRED  
COMPONENTS AND FOR  
ELIMINATING SUCH COMPONENTS**

(57) Present invention relates to device for purifying air from non-desired gases, microorganisms and drops. The device comprises purifying chamber throughout which the purified air flow is passing. Ionized air 1 is directed to mist spray or vapor in purifying chamber. Ionizing voltage is increased to create ozone; then, the flow is passing to ionic flow sprayers 8 working under high voltage and creating continuous flow collecting surfaces 9 and gripping the drops, hard particles, as well as fluid componentry connected therewith. Purified air volume specifies purifying device shape and volume.

Claims: 2 independent  
9 dependent

Fig.: 1

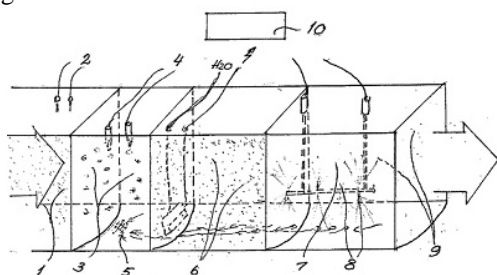

Fig. 1

along shaft axle and turn its plane substantially decreasing clearance between the discs, as well as toothed divisions, and increasing frequency.

Claims: 1 independent

Fig.: 9

## PART H

### H 02

(10) AP 2015 13268 A (51) Int. Cl. (2006)  
H 02 K 19/00  
G 01 M 1/38

(21) AP 2013 013268 (22) 2013 10 24

(71) Levan Nikoladze (GE)

Zh. Shartavas q. 35, b. 18, 0160, Tbilisi (GE);  
Vyacheslav Zagoruichenko (GE)

Zh. Shartavas q. 35, b. 18, 0160, Tbilisi (GE)

(72) Levan Nikoladze (GE);

Vyacheslav Zagoruichenko (GE)

(54) **MULTIPLATE PARTITIONED  
INDUCTOR GENERATOR WITH  
OFFSET COILS AND SELF-INSTAL-  
LING ROTOR DISCS**

(57) There is represented multiplate partitioned inductor generator construction with offset coils and self-installing rotor discs. The generator includes stator and rotor discs, in which radial cutouts the magnetic segments are inserted. Ring magnetic cores are installed from disc inductor face side; ring magnetic cores are switched to the cores with the coils offset outside the discs. Fluoroplastic bearings are installed between rotor and stator discs. Rotor disc is bounded with especial dowel with a shaft making rotor disc capable be shifted



## PATENTED INVENTIONS

### PART A

#### A 01

- (11) **P 2015 6219 B** (51) **Int. Cl. (2006)**  
**A 01 N 29/04**  
**A 61 K 31/025**
- (10) AP 2014 13166 A (44) 18(406)/2014  
 (21) AP 2011 013166  
 (22) 2011 12 22  
 (24) 2011 12 22  
 (31) 61/426,379  
 (32) 2010 12 22  
 (33) US  
 (86) PCT/US2011/066690, 2011 12 22  
 (73) H. LUNDBECK A/S (DK)  
 Ottiliavej 9, DK-2500 Valby (DK)  
 (72) LI, Guiying (US);  
 ZHOU, Hao (US);  
 WEISS, Jesse (US);  
 DOLLER, Dario (US);  
 FORD, James (US)  
 (74) Shalva Gvaramadze  
 (54) **BICYCLO [3.2.1] OCTYL AMIDE  
 DERIVATIVES AND USAGE THEREOF**

#### A 61

- (11) **P 2015 6209 B** (51) **Int. Cl. (2006)**  
**A 61 K 38/00**  
**A 61 K 9/50**  
**A 61 K 9/16**  
**A 61 K 9/20**  
**A 61 K 9/48**
- (10) AP 2014 12142 A (44) 18(406)/2014  
 (21) AP 2009 012142  
 (22) 2009 08 14  
 (24) 2009 08 14  
 (31) 61/089,422; 61/273,332; 61/231,725  
 (32) 2008 08 15; 2009 08 03; 2009 08 06  
 (33) US; US; US  
 (86) PCT/US2009/004675, 2009 08 14  
 (73) IRONWOOD PHARMACEUTICALS, INC. (US)  
 301 Binney Street Cambridge, MA 02142 (US)  
 (72) FRETZEN, Angelika (US);  
 WITOWSKI, Steven (US);  
 GROSSI, Alfredo (US);  
 ZHAO, Hong (US);  
 DEDHIYA, Mahendra (US);  
 MO, Yun (US)  
 (74) Shalva Gvaramadze  
 (54) **LINACLOTIDE-CONTAINING  
 FORMULATIONS FOR ORAL  
 ADMINISTRATION**

### PART B

#### B 01

- (11) **P 2015 6210 B** (51) **Int. Cl. (2006)**  
**B 01 D 53/14**  
**B 01 D 53/58**  
**C 01 C 1/10**  
**C 01 C 1/12**  
**B 01 D 61/36**
- (10) AP 2014 12328 A (44) 18(406)/2014  
 (21) AP 2010 012328  
 (22) 2010 01 11  
 (24) 2010 01 11  
 (31) MI2009A 000025  
 (32) 2009 01 13  
 (33) IT  
 (86) PCT/EP2010/000189, 2010 01 11  
 (73) SAIPEM S.P.A. (IT)  
 Via Martiri di Cefalonia 67, San Donato  
 Milanese, I-20097 (IT)  
 (72) CASARA, Paolo (IT);  
 GIANAZZA, Alessandro (IT);  
 MIRACCA, Ivano (IT)  
 (74) Shalva Gvaramadze  
 (54) **PROCESS FOR RECOVERY OF  
 AMMONIA FROM GASEOUS STREAM**

### PART C

#### C 07

- (11) **P 2015 6211 B** (51) **Int. Cl. (2006)**  
**C 07 D 231/12**  
**C 07 D 231/20**  
**C 07 D 231/38**  
**C 07 D 401/04**  
**C 07 D 401/12**  
**C 07 D 401/14**  
**C 07 D 403/12**  
**C 07 D 407/12**  
**C 07 D 409/04**  
**C 07 D 417/12**  
**A 61 K 31/4155**
- (10) AP 2014 12393 A (44) 18(406)/2014  
 (21) AP 2010 012393  
 (22) 2010 03 03  
 (24) 2010 03 03  
 (31) 61/157,046; 61/304,053  
 (32) 2009 03 03; 2010 02 12  
 (33) US; US  
 (86) PCT/US2010/026003, 2010 03 03

- (73) E. I. DU PONT DE NEMOURS AND COMPANY (US)  
1007 Market Street, Wilmington, DE-19898 (US)
- (72) LONG, Jeffrey, Keith (US);  
HONG, Wonpyo (KR);  
TAGGI, Andrew, Edmund (US)
- (74) Tamaz Shilakadze
- (54) **FUNGICIDAL PYRAZOLES**

(11) P 2015 6215 B (51) Int. Cl. (2006)  
C 07 D 307/20  
C 07 D 307/28  
C 07 D 307/30  
C 07 D 307/32  
C 07 D 307/58  
C 07 D 405/04  
C 07 D 405/10  
C 07 D 407/12  
C 07 D 409/12  
C 07 D 409/14  
C 07 D 413/12  
A 01 N 43/08

- (10) AP 2014 12861 A (44) 18(406)/2014  
(21) AP 2011 012861  
(22) 2011 01 31  
(24) 2011 01 31  
(31) 10154297.5; 10154301.5  
(32) 2010 02 22; 2010 02 22  
(33) EP; EP  
(86) PCT/EP2011/051284, 2011 01 31  
(73) SYNGENTA PARTICIPATIONS AG (CH)  
Schwarzwaldallee 215, CH-4058, Basel (CH)
- (72) EL QACEMI, Myriem (FR);  
CASSAYRE, Jérôme Yves (FR);  
TOUEG, Julie Clementine (FR);  
RENOLD, Peter (CH);  
PITTERNA, Thomas (AT)
- (74) Tamar Kochlamazashvili
- (54) **DIHYDROFURAN DERIVATIVES AS INSECTICIDAL COMPOUNDS**

(11) P 2015 6218 B (51) Int. Cl. (2006)  
C 07 D 471/04  
A 61 K 31/519  
A 61 P 3/10  
A 61 P 3/04

- (10) AP 2014 13077 A (44) 18(406)/2014  
(21) AP 2011 013077  
(22) 2011 10 31  
(24) 2011 10 31  
(31) 10-2010-0107868  
(32) 2010 11 01  
(33) KR  
(86) PCT/KR2011/008186, 2011 10 31  
(73) LG LIFE SCIENCES LTD. (KR)  
LG Gwanghwamun Bldg. 92, Sinmunno 2-ga,  
Jongno-gu Seoul 110-062 (KR)

- (72) PARK, Ki Sook (KR);  
YUN, Jung Min (KR);  
KIM, Bong Chan (KR);  
KIM, Kyu Young (KR);  
LEE, Ji Hye (KR)
- (74) Shalva Gvaramadze
- (54) **HYDRATE OF 1-((2S)-2-AMINO-4-[2,4-BIS(TRIFLUOROMETHYL)-5,8-DI-HYDROPYRIDO[3,4-D]PYRIMIDIN-7(6H)-YL]-4-OXOBUTYL)-5,5-DIFLUORO-PIPERIDIN-2-ONE TARTRATE**

(11) P 2015 6217 B (51) Int. Cl. (2006)  
C 07 D 487/04  
A 61 K 31/519  
A 61 P 25/28

- (10) AP 2014 13025 A (44) 18(406)/2014  
(21) AP 2011 013025  
(22) 2011 08 09  
(24) 2011 08 09  
(31) 10172597.6; 11154397.1  
(32) 2010 08 12; 2011 02 14  
(33) EP; EP  
(86) PCT/EP2011/063705, 2011 08 09  
(73) BOEHRINGER INGELHEIM INTERNATIONAL GMBH (DE)  
Binger Straße 173, 55216 Ingelheim Am Rhein (DE)
- (72) HEINE, Niklas (DE);  
EICKMEIER, Christian (DE);  
FERRARA, Marco (IT);  
GIOVANNINI, Riccardo (IT);  
ROSENBROCK, Holger (DE);  
SCHAENZLE, Gerhard (DE)
- (74) Tamar Kochlamazashvili
- (54) **6-CYCLOALKYL-1, 5-DIHYDRO-PYRAZOLO [3, 4-D] PYRIMIDIN-4-ONE DERIVATIVES AND THEIR USE AS PDE9A INHIBITORS**

(11) P 2015 6216 B (51) Int. Cl. (2006)  
C 07 D 513/04  
A 61 K 31/542  
A 61 P 25/00

- (10) AP 2014 13021 A (44) 18(406)/2014  
(21) AP 2011 013021  
(22) 2011 08 09  
(24) 2011 08 09  
(31) 2010-179577  
(32) 2010 08 10  
(33) JP  
(86) PCT/JP2011/068497, 2011 08 09  
(73) TAKEDA PHARMACEUTICAL COMPANY LIMITED (JP)  
1-1, Doshomachi 4-chome, Chuo-ku, Osaka-shi, Osaka 5410045 (JP)
- (72) KORI, Masakuni (JP);  
IMAEDA, Toshihiro (JP);

NAKAMURA, Shinji (JP);  
 TOYOFUKU, Masashi (JP);  
 HONDA, Eiji (JP);  
 ASANO, Yasutomi (JP);  
 UJIKAWA, Osamu (JP);  
 MOCHIZUKI, Michiyo (JP)

(74) Shalva Gvaramadze  
 (54) **HETEROCYCLIC COMPOUND AND  
 USAGE THEREOF**

---

## C 12

**(11) P 2015 6213 B**      **(51) Int. Cl. (2006)  
 C 12 G 3/00**

(10) AP 2014 12666 A      (44) 12(400)/2014  
 (21) AP 2012 012666  
 (22) 2012 04 11  
 (24) 2012 04 11  
 (73) Nugzar Baghaturia (GE)  
 Razmadzis q. 57, b. 7, 0179, Tbilisi (GE);  
 Archil Prangishvili (GE)  
 Pasteris q. 1a, b. 2, 0102, Tbilisi (GE);  
 Tamaz Batsikadze (GE)  
 Ir. Abashidzis q. 83, b. 8, 0179, Tbilisi (GE);  
 Koba Sokhadze  
 Kaspis q. 3a, b. 2, 0144, Tbilisi (GE);  
 Nana Begiashvili  
 Mosashvilis q. 2, b. 13, 0179, Tbilisi (GE)  
 (72) Nugzar Baghaturia (GE);  
 Archil Prangishvili (GE);  
 Tamaz Batsikadze (GE);  
 Koba Sokhadze (GE);  
 Nana Begiashvili (GE)

(54) **METHOD OF WHISKY PRODUCTION**

---

**(11) P 2015 6214 B**      **(51) Int. Cl. (2006)  
 C 12 P 21/08  
 A 61 K 35/14  
 G 01 N 33/35**

(10) AP 2014 12676 A      (44) 18(406)/2014  
 (21) AP 2010 012676  
 (22) 2010 09 30  
 (24) 2010 09 30  
 (31) 61/248,014  
 (32) 2009 10 02  
 (33) US  
 (86) PCT/US2010/050873, 2010 09 30  
 (73) THE REGENTS OF THE UNIVERSITY OF  
 CALIFORNIA (US)  
 1111 Franklin Street 8th Floor Oakland, CA  
 94607-5200 (US)  
 (72) AKASSOGLOU, Katerina (US)  
 (74) Alexander Gegechkori  
 (54) **MONOCLONAL ANTIBODIES**

## PART E

### E 02

**(11) P 2015 6212 B**      **(51) Int. Cl. (2006)  
 E 02 F 7/06  
 B 03 B 9/00**

(10) AP 2014 12415 A      (44) 18(406)/2014  
 (21) AP 2010 012415  
 (22) 2010 03 15  
 (24) 2010 03 15  
 (31) 2009/0158  
 (32) 2009 03 16  
 (33) BE  
 (86) PCT/US2010/053288, 2010 03 15  
 (73) DREDGING INTERNATIONAL N.V. (BE)  
 Scheldedijk 30, B-2070 Zwijndrecht (BE)  
 (72) VANDYCKE, Stefaan (BE)  
 (74) Tamaz Shilakadze  
 (54) **METHOD AND DEVICE FOR  
 TREATING DREDGED MATERIAL  
 EXTRACTED BY MEANS OF  
 DREDGING VESSEL**

---

# UTILITY MODELS

## APPLICATION APPROVED FOR GRANTING PATENT

The decision can be appealed at the Chamber of Appeal of Sakpatenti within 3 months from the publication or at the Mtskheta District Court Administrative Cases Board (Address: №17, Samkhedro str., Mtskheta), within 1 month following the publication.

### PART A

#### A 47

(10) AU 2015 13182 U (51) Int. Cl. (2006)  
A 47 C 23/04

(21) AU 2013 013182 (22) 2013 07 30

(71) JSC "ASKONA-VEK" (RU)

Russia 601900, Vladimirskaya Obl.,  
Kovrov, Ul. Komsomolskaya, d. 116-G,  
Str. 25 (RU)

(72) Tom Wells (US)

(74) Zurab Lomsadze

(54) **SPRING CARTRIDGE**

(57) There is represented spring cartridge comprising independent springs 1 placed in independent bags 5 made with nonwoven fabric; at that, the bags are executed in concordance with tangent surface shape of external zones of independent springs, and between coils of independent springs the bag zones are concave-shaped relative to spring vertical axle.

Claims: 1 independent

Fig.: 1

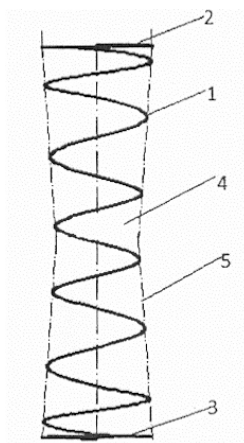

Fig. 1

## PATENTED UTILITY MODEL

### PART B

#### B 65

(11) U 2015 1841 Y (51) Int. Cl. (2006)  
B 65 D 5/30

(10) AU 2014 13430 U (44) 18(406)/2014

(21) AU 2014 013430

(22) 2014 03 27

(24) 2014 03 27

(73) TASTE BRAKE, JSC (GE)

Varketili 3, I mkr., korp. 32, b. 10,  
0163, Tbilisi (GE)

(72) Devid Endeladze (GE)

(54) **CARTON CUTOUT**

---

---

# TRADEMARKS

## APPLICATIONS FILED UNDER THE NATIONAL PROCEDURE APPROVED FOR REGISTRATION

The decision can be appealed at the Chamber of Appeal of Sakpatenti within 3 months from the publication or at the Mtskheta District Court Administrative Cases Board (Address: №17, Samkhedro str., Mtskheta), within 1 month following the publication.

(260) AM 2015 72315 A  
(210) AM 72315  
(220) 2013 05 22  
(731) LTD "GEORGIAN BEIKERS"  
Gorgaslis q. №115, 0114, Tbilisi, Georgia  
(540)



(591) Yellow, red, blue, white, black, violet,  
carrot-red, sky-blue  
(531) 01.03.01-25.01.05-27.05.02-29.01.14-  
(511) 30

---

(260) AM 2015 74373 A\*  
(210) AM 074373  
(220) 2013 10 18  
(731) OAO "TMK"  
40 bldg. 2a, Pokrovka striti, Moscow 105062,  
Russian Federation  
(740) Giorgi Taktakishvili  
(540)



(591) Black, white  
(531) 01.07.06-26.04.22-26.04.24-26.11.12-  
27.05.24-  
(511) 6, 7, 11, 19

---

(260) AM 2015 74374 A\*  
(210) AM 074374  
(220) 2013 10 18  
(731) OAO "TMK"  
40 bldg. 2a, Pokrovka striti, Moscow 105062,  
Russian Federation  
(740) Giorgi Taktakishvili  
(540)



(591) Orange, black  
(531) 01.07.06-26.04.22-26.04.24-26.11.12-  
27.05.24-  
(511) 6, 7, 11, 19

---

(260) AM 2015 74400 A\*  
(210) AM 74400  
(220) 2013 10 21  
(731) LTD "OMEGA-2"  
Sarajishvilis q. №13-15-17, 0159, Tbilisi,  
Georgia  
(740) Givi Akopashvili  
(540)

**სიბი შოპი**  
**CITY SHOP**

(591) Black, white  
(526) The trademark is protected as a whole. The  
word "SHOP" included therein shall not be subject  
to independent legal protection.  
(511) 35

---

(260) AM 2015 74899 A  
(210) AM 74899  
(220) 2014 07 04  
(731) LTD "KARTULI LIMONATI"  
Zhiuli Shartavas q. 16, b. 22, 0160, Tbilisi,  
Georgia  
(540)

**ხილიანი**  
**KHILIANI**  
**ХИЛИАНИ**

(591) Black, white  
(511) 29, 32, 33

---

(260) AM 2015 75243 A  
(210) AM 75243  
(220) 2013 12 24  
(731) LTD "GOA DA KOMPANIA"  
Marjanishvilis q. №18, 0102, Tbilisi, Georgia  
(540)



(591) Black and red  
 (531) 24.09.10, 24.09.04, 27.05.01, 29.01.12  
 (511) 14, 35, 41

(260) AM 2015 75768 A  
 (210) AM 75768  
 (220) 2014 02 04  
 (731) "NEW YORK FILM ACADEMY" INC  
 100 East 17th Street, New York City, 10003,  
 USA  
 (740) Giorgi Taktakishvili  
 (540)

**NYFA**

(511) 41

(260) AM 2015 75785 A  
 (210) AM 75785  
 (220) 2014 02 05  
 (731) LTD "TIFLISKI VINI POGREB"  
 Iumashevis q. 27, 0198, Tbilisi, Georgia  
 (740) Shalva Gvaramadze  
 (540)



(591) Black, white  
 (531) 05.07.10, 19.09.02, 24.03.14, 26.01.21,  
 27.05.17, 28.19  
 (526) The trademark is protected as a whole. The  
 words „ტიფლისის ვინი პოგრეპ“, "TIFLISKI  
 VINI POGREB" included therein shall not be sub-  
 ject to independent legal protection.  
 (511) 33

(260) AM 2015 75786 A  
 (210) AM 75786  
 (220) 2014 02 05  
 (731) LTD "TIFLISKI VINI POGREB"  
 Iumashevis q. 27, 0198, Tbilisi, Georgia  
 (740) Shalva Gvaramadze  
 (540)



(591) Black, white

(531) 01.03.20, 05.07.10, 26.01.21, 27.05.01, 28.19  
 (526) The trademark is protected as a whole. The  
 words „ქართული“, "KARTULI" included therein  
 shall not be subject to independent legal protection.  
 (511) 32, 33

(260) AM 2015 75787 A  
 (210) AM 75787  
 (220) 2014 02 05  
 (731) Giorgi Iukuridze  
 Zhukovskis q. 19, b. 9, Odesa, Ukraine  
 (740) Giorgi Taktakishvili  
 (540)

**ერისიონი**  
**ЕРИСИОНИ**  
**ERISIONI**

(511) 35, 41, 43

(260) AM 2015 75788 A  
 (210) AM 75788  
 (220) 2014 02 06  
 (731) Eldar Iukuridze  
 Zhukovskis q. 19, b. 9, Odesa, Ukraine  
 (740) Giorgi Taktakishvili  
 (540)

**SHABO**

(591) Black, white  
 (531) 28.03, 26.13.25, 27.05.17  
 (511) 35, 41, 43

(260) AM 2015 75790 A  
 (210) AM 75790  
 (220) 2014 02 06  
 (731) Gelodi Kobaladze  
 Ushangi Ghambashidzis q. №2, 0179, Tbilisi,  
 Georgia  
 (740) Tamaz Shilakadze  
 (540)



(591) Black, white  
 (531) 05.07.02, 08.01.03, 27.05.01  
 (511) 30, 35

(260) AM 2015 75791 A  
 (210) AM 75791  
 (220) 2014 02 06  
 (731) FREMANTLE MEDIA LIMITED  
 1 Stephen Street, London W1T 1AL, United  
 Kingdom

(740) Tamaz Shilakadze

(540)



(591) Black, white

(531) 27.05.21, 28.19

(511) 38, 41

(260) AM 2015 75792 A

(210) AM 75792

(220) 2014 02 06

(731) FREMANTLEMEDIA LIMITED

1 Stephen Street, London W1T 1AL, United Kingdom

(740) Tamaz Shilakadze

(540)



(591) Red, white, black, grey

(531) 25.01.01, 27.05.21, 27.05.24, 28.19, 29.01.14

(511) 38, 41

(260) AM 2015 75835 A

(210) AM 75835

(220) 2014 02 10

(731) BITBURGER BRAUGRUPPE GMBH

Romermauer 3, 54634 Bitburg, Germany

(740) Giorgi Meipariani

(540)

## KÖNIG Premium Beer

(526) The trademark is protected as a whole. The words "Premium Beer" included therein shall not be subject to independent legal protection.

(511) 32, 43

(260) AM 2015 75895 A

(210) AM 75895

(220) 2014 02 13

(731) NOXELL CORPORATION

11050 York Road, Hunt Valley, Maryland 21030-2098, USA

(740) Shalva Gvaramadze

(540)

## COLOUR ELIXIR

(511) 3

(260) AM 2015 75919 A

(210) AM 75919

(220) 2014 02 14

(731) Malkhaz Beridze

Sop. Kokotauri, Kedis raioni, Atcharis Avtonomiuri Respublika, Georgia

(740) Shalva Gvaramadze

(540)



(591) Black, white

(531) 03.01.08, 26.01.15, 26.01.21, 27.05.01

(511) 7, 8, 11, 12

(260) AM 2015 75925 A

(210) AM 75925

(220) 2014 02 14

(310) UK00003019811

(320) 2013 08 28

(330) GB

(731) BRITISH AMERICAN TOBACCO

(BRANDS) INC. (a Delaware corporation)  
2711 Centerville Road, Suite 300,  
Wilmington, Delaware 19808, USA

(740) Tamar Kochlamazashvili

(540)



(591) Dark blue, sky-blue, white, black and grey

(531) 25.05.02, 10.01.07, 25.07.15, 26.11.13,  
27.05.01, 27.05.22, 29.01.15

(511) 34

(260) AM 2015 75991 A

(210) AM 75991

(220) 2014 02 19

(310) UK00003019798

(320) 2013 08 28

(330) GB



(731) BRITISH AMERICAN TOBACCO  
(BRANDS) INC. (a Delaware corporation)  
2711 Centerville Road, Suite 300,  
Wilmington, Delaware 19808, USA

(740) Tamar Kochlamazashvili  
(540)



(591) Dark blue, white, black, grey  
(531) 10.01.15, 25.07.15, 25.07.22, 26.11.13,  
27.05.01, 27.05.22  
(511) 34

(260) AM 2015 76071 A  
(210) AM 76071  
(220) 2014 02 25  
(731) ARIAN KIMYA TICARET VE SANAYI  
ANONIM SIRKETI  
Tem Otoyolu Üzeri, Tekstilkent Koza Plaza,  
B Blok, Kat: 31 NO:118 Esenler Istanbul/  
Turkiye, Turkiye

(740) Vakhtang Torotadze  
(540)

**HOME PLUS**

(511) 5

(260) AM 2015 76182 A  
(210) AM 76182  
(220) 2014 03 07  
(731) LTD "CORPORATION GEORGIAN WINE"  
Simon Chikovanis q. №35, 0171, Tbilisi,  
Georgia

(540)



(591) Black, white, light yellow, golden,

bronze golden, green, wine-red, brick-red,  
clay color, cornelian cherry color  
(531) 05.13.06, 24.01.03, 24.01.15, 19.01.05,  
19.09.01, 25.01.15, 25.01.19, 26.01.02, 28.05,  
27.05.21, 29.01.15

(526) The trademark is protected as a whole. The  
words "ЗЕДАШЕ КОРПОРАЦИЯ ГРУЗИНСКОЕ  
ВИНО CGW" included therein shall not be subject  
to independent legal protection.

(511) 33

(260) AM 2015 76428 A  
(210) AM 76428  
(220) 2014 03 26  
(731) MARRIOTT WORLDWIDE CORPORATION  
(a Maryland corporation)  
10400 Fernwood Road, Bethesda, Maryland  
20817, USA  
(740) Tamar Kochlamazashvili  
(540)



(591) Black, white  
(531) 27.05.21, 27.05.05  
(511) 43

(260) AM 2015 76429 A  
(210) AM 76429  
(220) 2014 03 26  
(731) MARRIOTT WORLDWIDE CORPORATION  
(a Maryland corporation)  
10400 Fernwood Road, Bethesda, Maryland  
20817, USA

(740) Tamar Kochlamazashvili  
(540)



(591) Black, white  
(531) 27.05.21  
(511) 43

(260) AM 2015 76730 A  
(210) AM 76730  
(220) 2014 04 16  
(731) LTD "SHALVINO"  
Bakhtrionis q., korp. 1, b. 10, 0160,  
Tbilisi, Georgia  
(740) Ekaterine Nemsadze  
(540)

**შავი თოლვაბი  
ОЧИ ЧЁРНЫЕ**

(591) Black, white  
(511) 33

(260) AM 2015 76765 A  
(210) AM 76765  
(220) 2014 04 22  
(731) CHONGQING CHANGAN AUTOMOBILE CO., LTD  
260 Jianxin East Road, Jiangbei District, Chongqing, China  
(740) Shalva Gvaramadze  
(540)



(591) Black, white  
(531) 26.04.07, 26.04.18, 27.05.21, 24.11.25, 26.04.04  
(511) 12

(260) AM 2015 76796 A  
(210) AM 76796  
(220) 2014 04 24  
(731) LTD "MOTORSTARI"  
Leonidzis q., korp. 24, b. 100, Rustavi, Georgia  
(740) Tamar Pipia  
(540)

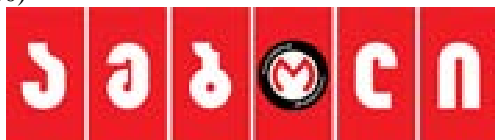

(591) Red, white, black  
(531) 26.04.18, 26.01.18, 26.04.24, 28.19, 29.01.13  
(511) 12, 35

(260) AM 2015 76797 A  
(210) AM 76797  
(220) 2014 04 24  
(731) LTD "MOTORSTARI"  
Leonidzis q., korp. 24, b. 100, Rustavi, Georgia  
(740) Tamar Pipia  
(540)

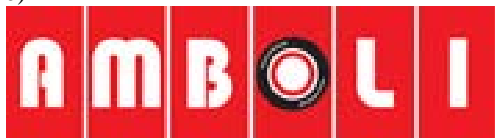

(591) Red, white, black  
(531) 26.04.18, 26.04.24, 26.01.18, 27.05.24, 29.01.13  
(511) 12, 35

(260) AM 2015 76798 A  
(210) AM 76798  
(220) 2014 04 24  
(731) LTD "MOTORSTARI"  
Leonidzis q., korp. 24, b. 100, Rustavi, Georgia  
(740) Tamar Pipia  
(540)



(591) Orange, dark blue  
(531) 27.05.10, 27.05.17, 27.05.11, 29.01.12  
(511) 12, 35

(260) AM 2015 76829 A  
(210) AM 76829  
(220) 2014 04 25  
(731) LTD "MONDIALI"  
O. Dgebuadzis q. 8, Tbilisi, Georgia  
(740) Tiniko Nadirashvili  
(540)



(591) Red, white, cornelian cherry color  
(531) 26.04.04, 26.04.07, 26.04.24, 27.05.24, 29.01.13  
(526) The trademark is protected as a whole. The words "Mondial" and "Products" included therein shall not be subject to independent legal protection.  
(511) 3, 5, 16, 17, 19, 29, 30, 31, 32, 33, 34, 35, 36, 39

(260) AM 2015 76953 A  
(210) AM 76953  
(220) 2014 05 01  
(731) THE PROCTER & GAMBLE COMPANY  
One Procter & Gamble Plaza, Cincinnati Ohio 45202, USA  
(740) Shalva Gvaramadze  
(540)



(591) Black, white  
(531) 05.05.20, 26.01.06  
(511) 3

(260) AM 2015 77058 A  
(210) AM 77058  
(220) 2014 05 08  
(731) ORION CORPORATION  
13, Baekbeom-ro 90da-gil, Yongsan-gu,

Seoul, Republic of Korea  
(740) Shalva Gvaramadze  
(540)



(591) Red, different tone yellow, white, brown,  
sky-blue, blue, black  
(531) 25.01.01, 27.05.24, 08.01.10  
(511) 30

---

(260) AM 2015 77060 A  
(210) AM 77060  
(220) 2014 05 08  
(731) ORION CORPORATION  
13, Baekbeom-ro 90da-gil, Yongsan-gu,  
Seoul, Republic of Korea  
(740) Shalva Gvaramadze  
(540)



(591) Dark red, different tone yellow, white, brown,  
sky-blue, blue, black  
(531) 27.05.24, 08.01.23, 29.01.15, 08.01.10  
(511) 30

---

## REGISTERED TRADEMARKS

<p>(111) M 2015 25511 R            (151) 2014 12 19            (181) 2024 12 19            (260) AM 2014 72750 A            (220) 2013 06 18            (732) LTD "UNIMED GRUP KORP"            Ad. Mitskevichis q. №29, b. 61, 0194, Tbilisi,            Georgia</p>	<p>One Amgen Center Drive, Thousand Oaks,            California 91320-1799, USA</p>
<p>(111) M 2015 25512 R            (151) 2014 12 19            (181) 2024 12 19            (260) AM 2014 71148 A            (220) 2013 02 28            (732) LTD "UNIMED GRUP KORP"            Ad. Mitskevichis q. №29, b. 61, 0194, Tbilisi,            Georgia</p>	<p>(111) M 2015 25517 R            (151) 2014 12 19            (181) 2024 12 19            (260) AM 2014 73122 A            (220) 2013 07 15            (732) Lavena PLC            P.O. Box 114, 9700 Shumen, Bulgaria</p>
<p>(111) M 2015 25513 R            (151) 2014 12 19            (181) 2024 12 19            (260) AM 2014 71149 A            (220) 2013 02 28            (732) LTD "UNIMED GRUP KORP"            Ad. Mitskevichis q. №29, b. 61, 0194, Tbilisi,            Georgia</p>	<p>(111) M 2015 25518 R            (151) 2014 12 19            (181) 2024 12 19            (260) AM 2014 73123 A            (220) 2013 07 16            (732) HENKEL AG &amp; Co. KgaA            Henkelstrasse 67, D-40589 Dusseldorf,            Germany</p>
<p>(111) M 2015 25514 R            (151) 2014 12 19            (181) 2024 12 19            (260) AM 2014 72077 A            (220) 2013 04 30            (732) LTD "MASTER PARKE"            Sop. Karajalari, 1329, Gardabnis raioni,            Georgia</p>	<p>(111) M 2015 25519 R            (151) 2014 12 19            (181) 2024 12 19            (260) AM 2014 73277 A            (220) 2013 07 30            (732) THE GILLETTE COMPANY            One Gillette Park, Boston, Massachusetts            02127, USA</p>
<p>(111) M 2015 25515 R            (151) 2014 12 19            (181) 2024 12 19            (260) AM 2014 73119 A            (220) 2013 07 15            (732) AMGEN INC            One Amgen Center Drive, Thousand Oaks,            California 91320-1799, USA</p>	<p>(111) M 2015 25520 R            (151) 2014 12 19            (181) 2024 12 19            (260) AM 2014 73377 A            (220) 2013 08 02            (732) NOXELL CORPORATION            11050 York Road, Hunt Valley, Maryland            21030-2098, USA</p>
<p>(111) M 2015 25516 R            (151) 2014 12 19            (181) 2024 12 19            (260) AM 2014 73121 A            (220) 2013 07 15            (732) AMGEN INC</p>	<p>(111) M 2015 25521 R            (151) 2014 12 19            (181) 2024 12 19            (260) AM 2014 73634 A            (220) 2013 08 22            (732) NIA NATBILADZE            Al. Kazbegis gamz. 1, b. 12, 0160, Tbilisi,            Georgia</p>
<p>(111) M 2015 25522 R            (151) 2014 12 19            (181) 2024 12 19</p>	<p>(111) M 2015 25522 R            (151) 2014 12 19            (181) 2024 12 19</p>

(260) AM 2014 73925 A  
(220) 2013 09 13  
(732) AMGEN INC  
One Amgen Center Drive, Thousand Oaks,  
California 91320-1799, USA

---

(111) M 2015 25523 R  
(151) 2014 12 19  
(181) 2024 12 19  
(260) AM 2014 73926 A  
(220) 2013 09 13  
(732) AMGEN INC  
One Amgen Center Drive, Thousand Oaks,  
California 91320-1799, USA

---

(111) M 2015 25524 R  
(151) 2014 12 19  
(181) 2024 12 19  
(260) AM 2014 73944 A  
(220) 2013 09 18  
(732) COLGATE-PALMOLIVE COMPANY,  
a Delaware corporation  
300 Park Avenue, New York, New York  
10022, USA

---

(111) M 2015 25525 R  
(151) 2014 12 19  
(181) 2024 12 19  
(260) AM 2014 74327 A  
(220) 2013 10 11  
(732) JOLIDON EXPORT IMPORT SRL  
Str. Tabacarilor nr.1, Judetul Cluj, CLUJ  
NAPOCA, 400139, Romania

---

(111) M 2015 25526 R  
(151) 2014 12 19  
(181) 2024 12 19  
(260) AM 2014 73120 A  
(220) 2013 07 15  
(732) AMGEN INC  
One Amgen Center Drive, Thousand Oaks,  
California 91320-1799, USA

---

(111) M 2015 25527 R  
(151) 2014 12 19  
(181) 2024 12 19  
(260) AM 2014 74570 A  
(220) 2013 11 01  
(732) PHILIP MORRIS PRODUCTS S.A.  
Quai Jeanrenaud 3, 2000 NEUCHATEL,  
Switzerland

---

(111) M 2015 25528 R  
(151) 2014 12 19  
(181) 2024 12 19  
(260) AM 2014 74571 A  
(220) 2013 11 01  
(732) PHILIP MORRIS PRODUCTS S.A.  
Quai Jeanrenaud 3, 2000 NEUCHATEL,  
Switzerland

---

## TRADEMARKS REGISTERED ACCORDING TO THE ACCELERATED PROCEDURE

The decision can be appealed at the Chamber of Appeal of Sakpatenti within 3 months from the publication.

(111) M 2015 25533 R

(151) 2014 12 26

(181) 2024 12 26

(210) AM 079791

(220) 2014 12 04

(732) LTD "UNIMED GRUP KORP"

Ad. Mitskevichis q. №29, b. 61, 0177, Tbilisi,  
Georgia

(740) Nadezhda Vazhinskaia

(540)

**UNITEX**

**УНИТЕКС**

**უნიტექსი**

(591) Black, white

(531) 27.05.05-28.05.00-28.19.00-

(511) 5

(111) M 2015 25534 R

(151) 2014 12 26

(181) 2024 12 26

(210) AM 079795

(220) 2014 12 04

(732) LTD "UNIMED GRUP KORP"

Ad. Mitskevichis q. №29, b. 61, 0177, Tbilisi,  
Georgia

(740) Nadezhda Vazhinskaia

(540)

**HONDRONYX**

**ХОНДРОНИКС**

**ხონდრონიქსი**

(591) Black, white

(531) 27.05.05-28.05.00-28.19.00-

(511) 5

(111) M 2015 25535 R

(151) 2014 12 26

(181) 2024 12 26

(210) AM 079941

(220) 2014 12 15

(732) LTD "BEIBI FUD"

Tevdore-Mgvdlis q. 51-53, 0154, Tbilisi,  
Georgia

(740) Nugzar Ksovreli

(540)



(591) Cornelian cherry color, red, white

(531) 26.04.03-26.04.19-27.05.02-29.01.13-

(511) 30

(111) M 2015 25536 R

(151) 2014 12 26

(181) 2024 12 26

(210) AM 079942

(220) 2014 12 15

(732) LTD "BEIBI FUD"

Tevdore-Mgvdlis q. 51-53, 0154, Tbilisi,  
Georgia

(740) Nugzar Ksovreli

(540)



(591) Grey

(531) 26.03.23-26.04.19-27.05.17-

(511) 30

(111) M 2015 25537 R

(151) 2014 12 26

(181) 2024 12 26

(210) AM 079792

(220) 2014 12 04

(732) LTD "UNIMED GRUP KORP"

Ad. Mitskevichis q. №29, b. 61, 0177, Tbilisi,  
Georgia

(740) Nadezhda Vazhinskaia

(540)

**VITA-CEF**

**ВИТА-ЦЕФ**

**ვიტა-ცეფი**

(591) Black, white

(531) 27.05.05-28.05.00-28.19.00-

(511) 5

(111) M 2015 25538 R  
 (151) 2014 12 26  
 (181) 2024 12 26  
 (210) AM 079794  
 (220) 2014 12 04  
 (732) LTD "UNIMED GRUP KORP"  
 Ad. mitskevichis q. №29, b. 61, 0177, Tbilisi,  
 Georgia  
 (740) Nadezhda Vazhinskaia  
 (540)

MONTEZIN  
 МОНТЕЗИН  
 მონტეზინი

(591) Black, white  
 (531) 27.05.05-28.05.00-28.19.00-  
 (511) 5

(111) M 2015 25539 R  
 (151) 2014 12 26  
 (181) 2024 12 26  
 (210) AM 079968  
 (220) 2014 12 19  
 (732) OOO FIRMA "DISNA"  
 Ul. Lavrskaia 16, 01015 q. Kievi, Ukraine  
 (740) Davit Zurabishvili  
 (540)



(591) White, brown, tobacco  
 (531) 07.01.01-25.01.19-27.05.11-29.01.13-  
 (526) – The trademark is protected as a whole. The  
 word "KARTUWINE" included therein shall not be  
 subject to independent legal protection.  
 (511) 33

(111) M 2015 25540 R  
 (151) 2014 12 26  
 (181) 2024 12 26  
 (210) AM 079969

(220) 2014 12 19  
 (732) OOO FIRMA "DISNA"  
 Ul. Lavrskaia 16, 01015 q. Kievi, Ukraine  
 (740) Davit Zurabishvili  
 (540)



(591) White, black, beige, wine-coloured  
 (531) 07.01.03-25.01.19-27.05.01-29.01.13-  
 (526) – The trademark is protected as a whole. The  
 word "KARTULI WINE" included therein shall not  
 be subject to independent legal protection.  
 (511) 33

(111) M 2015 25541 R  
 (151) 2014 12 31  
 (181) 2024 12 31  
 (210) AM 079840  
 (220) 2014 12 08  
 (732) LTD "FRESH GEORGIA"  
 Avtomsheneblis q. 88, 4600, Kutaisi, Georgia  
 (740) Evgeni Jikhvadze  
 (540)



(591) Grey, red  
 (531) 26.01.02-26.01.06-26.01.20-27.05.05-  
 29.01.12-  
 (526) – The trademark is protected as a whole. The  
 word "MILANO" included therein shall not be  
 subject to independent legal protection.  
 (511) 11

(111) M 2015 25542 R  
 (151) 2014 12 31  
 (181) 2024 12 31  
 (210) AM 079843  
 (220) 2014 12 08  
 (732) LTD "FRESH GEORGIA"  
 Avtomsheneblis q. 88, 4600, Kutaisi, Georgia

(740) Evgeni Jikhvadze  
(540)



(591) Blue, green  
(531) 24.15.07-24.15.13-26.01.12-26.01.18-  
27.05.17-29.01.13-  
(511) 11

(740) Nadezhda Vazhinskaia  
(540)

კონტრიმაქსი  
CONTRIMAX  
КОНТРИМАКС

(591) Black, white  
(531) 27.05.05-28.05.00-28.19.00-  
(511) 5

(111) M 2015 25543 R  
(151) 2014 12 31  
(181) 2024 12 31  
(210) AM 079793  
(220) 2014 12 04  
(732) LTD "UNIMED GRUP KORP"  
Ad. Mitskevichis q. №29, b. 61, 0177, Tbilisi,  
Georgia  
(740) Nadezhda Vazhinskaia  
(540)

CEREBRAZOL-UNI  
ЦЕРЕБРАЗОЛ-УНИ  
ცერებრაზოლ-უნი

(591) Black, white  
(531) 27.05.05-28.05.00-28.19.00-  
(511) 5

(111) M 2015 25544 R  
(151) 2014 12 31  
(181) 2024 12 31  
(210) AM 079807  
(220) 2014 12 05  
(732) LTD "KANDIER OTA"  
g. Samarkand, Ul. Ishtikhanskaya 14a,  
Uzbekistan  
(740) Nodar Obolashvili  
(540)

კონტრილენსი  
CONTRILENS  
КОНТРИЛЭНС

(591) Black, white  
(531) 27.05.05-28.05.00-28.19.00-  
(511) 5

(111) M 2015 25545 R  
(151) 2015 01 05  
(181) 2025 01 05  
(210) AM 079790  
(220) 2014 12 04  
(732) LTD "UNIMED GRUP KORP"  
Ad. Mitskevichis q. №29, b. 61, 0177, Tbilisi,  
Georgia



## INTERNATIONAL TRADEMARKS FOR WHICH A DECISION ON GRANTING PROTECTIONS IS TAKEN

The decision can be appealed at the Chamber of Appeal of Sakpatenti within 3 months from the publication or at the Mtskheta District Court Administrative Cases Board (Address: №17, Samkhedro str., Mtskheta), within 1 month following the publication.

(260) AM 2015 71869 A\*  
 (800) 1153302  
 (731) MAN Truck & Bus AG  
 Dachauer Str. 667, 80995 München, Germany  
 (540)



(591) Black, white  
 (511)  
 12 – Vehicles; apparatus for locomotion by land, air or water.  
 25 – Clothing, footwear, headgear.  
 36 – Insurance; financial affairs; monetary affairs.

(260) AM 2015 71958 A\*  
 (800) 1154544  
 (731) GRUNDIG MULTIMEDIA B.V.  
 Luna ArenA, Herikerbergweg 238, NL-1101  
 CM Amsterdam Zuidoost, Netherlands  
 (540)

### Quick&Healthy

(591) Black, white  
 (511)  
 11 – Air conditioning devices; cooling apparatus, namely refrigerators, milk coolers, water coolers, ice-boxes, ice machines and devices, freezers; electric and gas operated apparatus, machines and devices used in cooling; industrial type cooling installations.

(260) AM 2015 73577 A\*  
 (800) 1170389  
 (731) SKYY SPIRITS, LLC  
 1255 Battery St., Suite 500, San Francisco CA  
 94111, USA  
 (540)



(591) Black, white  
 (511)  
 33 – Distilled spirits.

(260) AM 74124 A\*  
 (800) 736707  
 (731) SCHÄRF COFFEESHOP GMBH  
 Dr. Alexander Schärf Platz 1, A-7100  
 Neusiedl am See, Austria  
 (540)



(591) White, red, black, ocher and green  
 (526) The trademark is protected as a whole. The words "COFFEESHOP" and "COMPANY" included therein shall not be subject to independent legal protection.  
 (511)  
 42 – Provision of food and drinks in coffee houses and cafeterias.

(260) AM 74215 A\*  
 (800) 987720  
 (731) SCHÄRF COFFEESHOP GMBH  
 Dr. Alexander Schärf Platz 1, A-7100  
 Neusiedl am See, Austria  
 (540)



(591) Light green, dark green, black, red and white  
 (526) The trademark is protected as a whole. The words "COFFEESHOP" and "COMPANY" included therein shall not be subject to independent legal protection.

(511)  
30 – Coffee; coffee-based beverages; tea; ice tea; non-medicated herbal teas; coffee substitutes; herbal coffee substitutes; cocoa; cocoa-based beverages; cocoa preparations; chocolate; chocolate-based beverages; coffee beverages with milk; cocoa beverages with milk; chocolate beverages with milk; coffee flavours; herbal flavours for beverages, except essential oils; essences for nutritional purposes, except essential essences and oils; syrups for flavouring coffee beverages.

(260) AM 2015 74278 A\*  
(800) 1176268  
(731) EGIS GYÓGYSZERGYÁR ZRT.  
Keresztúri út 30-38, H-1106 Budapest,  
Hungary

(540)

## FILGRAM

(591) Black, white  
(511) 5 – Human pharmaceutical preparations for use in the oncological and immunotherapeutic fields.

(260) AM 2015 75045 A  
(800) 1183352  
(151) 2013 09 24  
(731) KRAFT BEBEK URUNLERI TICARET VE  
SANAYI LIMITED SIRKETI  
Buyukdere Cad., Maya Binasi No:102 K.20,  
Esentepe Istanbul, Turkey

(540)

**KRAFT**® 

(591) Blue and red  
(511)  
12 – Covers for baby carriages, pushchair covers, stroller covers [pushchairs], fitted perambulator covers; pushchair hoods, hoods for baby carriages; pushchairs, baby carriages, prams [baby carriages], strollers.

20 – High chairs for babies; playpens for babies; baby changing mats; wall-mounted diaper [napkin] changing platforms, baby changing platforms.

(260) AM 2015 75046 A  
(800) 1183387  
(151) 2013 09 09  
(731) Obschestvo s Ogranichennoy Otvetstvennostyu  
"LABORATORIYA SOVREMENNOGO  
ZDOROVYA"  
ul. Khimzavodskaya, 11/20, Berdsk, RU-633004  
Novosibirskaya oblast', Russian Federation

(540)

## ENERGOVITALS

(591) Black, white  
(511)  
5 – Albumin dietary supplements; albuminous food-stuffs for medical purposes; alginate dietary supplements; albuminous preparations for medical purposes; aloe vera preparations for pharmaceutical purposes; antioxidant pills; appetite suppressant pills; bath preparations, medicated; balms for medical purposes; biocides; biological preparations for medical purposes; by-products of the processing of cereals for dietetic or medical purposes; casein dietary supplements; decoctions for pharmaceutical purposes; diabetic bread adapted for medical use; dietary fiber; dietetic beverages adapted for medical purposes; dietetic foods adapted for medical purposes; dietetic substances adapted for medical use; digestives for pharmaceutical purposes; enzyme dietary supplements; enzyme preparations for medical purposes; flaxseed dietary supplements; flaxseed oil dietary supplements; flour for pharmaceutical purposes; food for babies; glucose dietary supplements; hematogen; lacteal flour for babies; lecithin dietary supplements; liniments; lotions for pharmaceutical purposes; malted milk beverages for medical purposes; medicinal herbs; medicinal infusions; medicinal oils; medicinal roots; medicinal tea; milk ferments for pharmaceutical purposes; mineral food supplements; nervines; nutritional supplements; pharmaceutical preparations for skin care; pollen dietary supplements; preparations of trace elements for human and animal use; propolis dietary supplements; protein dietary supplements; royal jelly dietary supplements; royal jelly for pharmaceutical purposes; slimming pills; syrups for pharmaceutical purposes; vitamin preparations; wheat germ dietary supplements; yeast dietary supplements; yeast for pharmaceutical purposes.

(260) AM 2015 75047 A  
(800) 1183388  
(151) 2013 09 09  
(731) Obschestvo s ogranichennoy otvetstvennostyu  
"LABORATORIYA SOVREMENNOGO  
ZDOROVYA"  
ul. Khimzavodskaya, 11/20, Berdsk,  
RU-633004 Novosibirskaya oblast', Russian  
Federation

(540)

## MELLIFLORA

(591) Black, white  
(511)  
5 – Albumin dietary supplements; albuminous food-stuffs for medical purposes; alginate dietary supplements; albuminous preparations for medical purposes; aloe vera preparations for pharmaceutical purposes; antioxidant pills; appetite suppressant pills; bath preparations, medicated; balms for medical purposes; biocides; biological preparations for medical

purposes; by-products of the processing of cereals for dietetic or medical purposes; casein dietary supplements; decoctions for pharmaceutical purposes; diabetic bread adapted for medical use; dietary fiber; dietetic beverages adapted for medical purposes; dietetic foods adapted for medical purposes; dietetic substances adapted for medical use; digestives for pharmaceutical purposes; enzyme dietary supplements; enzyme preparations for medical purposes; flaxseed dietary supplements; flaxseed oil dietary supplements; flour for pharmaceutical purposes; food for babies; glucose dietary supplements; hema-togen; lacteal flour for babies; lecithin dietary supplements; liniments; lotions for pharmaceutical purposes; malted milk beverages for medical purposes; medicinal herbs; medicinal infusions; medicinal oils; medicinal roots; medicinal tea; milk ferments for pharmaceutical purposes; mineral food supplements; nervines; nutritional supplements; pharmaceutical preparations for skin care; pollen dietary supplements; preparations of trace elements for human and animal use; propolis dietary supplements; protein dietary supplements; royal jelly dietary supplements; royal jelly for pharmaceutical purposes; slimming pills; syrups for pharmaceutical purposes; vitamin preparations; wheat germ dietary supplements; yeast dietary supplements; yeast for pharmaceutical purposes.

(260) AM 2015 75048 A

(800) 1183393

(151) 2013 09 06

(731) NATIONAL GEOGRAPHIC SOCIETY  
1145 17th Street, N.W. Washington, D.C.  
20036-4688, USA

(540)



(591) Yellow and grey

(511)

38 – Broadcasting; communications and telecommunications; audio and video broadcasting via the Internet; television broadcasting services; cable television broadcasting services; television narrowcasting services; direct broadcast satellite television services; satellite transmission services; streaming of audio, visual and audio-visual material via a global computer network or other communication networks; transmission, broadcast, reception and conveyance by means of electronic communication systems of audio video, still and moving images, text, messages, information, and data; mobile media services in the nature of electronic transmission, broadcasting and delivery of audio, video and multimedia entertainment content including text, data, images, audio, video and audio visual files by means of the Internet, wireless communication, electronic

communications networks and computer networks; video-on-demand transmission services.

41 – Entertainment services; educational services; provision of training; sporting and cultural activities; production of television programs; production, presentation, distribution, syndication and rental of radio programs, television programs and of films, motion pictures, pre-recorded video tapes, audio and/or visual material, pre-recorded video cassettes, DVDs or pre-recorded video discs; provision of audio visual content relating to entertainment, education, training, sport and culture; provision of non-downloadable radio programs, television programs, films, videos, sound and images accessed from the Internet or other communication networks; provision of non-downloadable data relating to entertainment, education, training, sporting and cultural activities; provision of video-on-demand and near-video-on-demand entertainment, educational, sporting and cultural services; provision of non-downloadable films and television programs via a video-on-demand service; providing on-going television programs, movies, videos, webcasts, and images via a global computer network or other communication networks; providing online maps and schedules for live events and exhibitions.

(260) AM 2015 75049 A

(800) 1183405

(151) 2013 09 19

(731) AVON PRODUCTS, INC.  
World Headquarters, 777 Third Avenue,  
New York, NY 10017, USA

(540)

## AVON SPORT BOLD FOCUS

(591) Black, white

(511)

3 – Non-medicated toilet preparations; toiletries; skin care preparations; skin moisturizers; body and beauty care preparations; powders, creams and lotions, all for the face, hands and body; cosmetic suntan preparations; soaps; shower and bath preparations; beauty masks; talcum powder; nail polish; nail polish remover; enamel for nails; false nails; adhesives for cosmetic purposes; cosmetics; eye makeup remover, eye shadow, eye liner, mascara, lipstick, lip liner, lip gloss; make-up foundation; blusher; tissues impregnated with cosmetic lotions; cotton sticks for cosmetic purposes; cotton wool for cosmetic purposes; preparations for cleaning, moisturising, colouring and styling the hair; preparations for cleaning the teeth; shaving and aftershave preparations; perfumes, fragrances, toilet waters, cologne; deodorants for human beings; anti-perspirants for personal use (toiletries); essential oils (cosmetic).

(260) AM 2015 75050 A

(800) 1183406

(151) 2013 09 19

(731) AVON PRODUCTS, INC.

World Headquarters, 777 Third Avenue,  
New York, NY 10017, USA

(540)

## AVON SPORT DYNAMIC FRESH

(591) Black, white

(511)

3 – Non-medicated toilet preparations; toiletries; skin care preparations; skin moisturizers; body and beauty care preparations; powders, creams and lotions, all for the face, hands and body; cosmetic sun-tan preparations; soaps; shower and bath preparations; beauty masks; talcum powder; nail polish; nail polish remover; enamel for nails; false nails; adhesives for cosmetic purposes; cosmetics; eye makeup remover, eye shadow, eye liner, mascara, lipstick, lip liner, lip gloss; make-up foundation; blusher; tissues impregnated with cosmetic lotions; cotton sticks for cosmetic purposes; cotton wool for cosmetic purposes; preparations for cleaning, moisturising, colouring and styling the hair; preparations for cleaning the teeth; shaving and aftershave preparations; perfumes, fragrances, toilet waters, cologne; deodorants for human beings; anti-perspirants for personal use (toiletries); essential oils (cosmetic).

(260) AM 2015 75052 A

(800) 1183440

(151) 2013 05 01

(731) THE TORO COMPANY

8111 Lyndale Avenue South, Bloomington,  
MN 55420, USA

(540)

## TORO

(591) Black, white

(511)

7 – Outdoor landscape maintenance equipment and light earth working machinery, namely, mowers and riding lawn mowers and machines for grading, leveling, scarifying, slicing, aerating, boring, seeding, fertilizing, rolling, trenching and raking; suction type pick-up machines for leaves, grass cuttings and debris; power-operated turf and yard care machines, namely, aerators, stump grinders, log splitters, sweepers, mulchers, edgers, trimmers, sand trap and sports field groomers, blowers and combination blowers and vacuums for leaves and debris; greens roller machines for use on golf greens, tennis courts and bowling greens; snow throwers, snow removal machines, namely, snow blowers, snow plows, plow blades for snow plows and electric rotary snow brooms; turf and yard care machines, namely, vehicle-mounted, power-operated sprayers for applying

fertilizers or pesticides to turf; top dressing machines, namely, vehicle-mounted mechanical spreaders for distributing dressing material upon turf; and structural parts of the foregoing; valve actuators; pressure regulators.

11 – Irrigation equipment and components, namely, sprinklers, valves, spray nozzles, water emitters for drip lines, spray heads, sprinkler nozzles, sprinkler supports and bases, drippers, emitters, soakers, sprinkler system filters, and replacement parts of the foregoing.

17 – Plastic irrigation hoses; drip tape.

(260) AM 2015 75053 A

(800) 1183443

(151) 2013 05 07

(731) THE AMERICAN SOCIETY OF  
MECHANICAL ENGINEERS

Two Park Avenue, New York NY  
10016-5990, USA

(540)



(591) Black, white

(511)

9 – Downloadable electronic publications in the nature of e-books, magazines, journals, printed codes, manuals, books, academic papers, newspapers, pamphlets and newsletters in the field of engineering, technology and science; multimedia software recorded on digital media featuring educational courses, workshops, seminars, conferences, symposia, and training in the field of engineering, technology and science; downloadable computer software featuring educational courses, workshops, seminars, conferences, symposia and training in the field of engineering, technology and science.

16 – Publications of all kinds namely magazines, printed codes, manuals, books, newspapers, and pamphlets of an engineering and science nature.

35 – Association services, namely, promoting the interest of those involved with mechanical engineering profession and promoting the use and services of engineers (Terms too vague in the opinion of the International Bureau – Rule 13(2)(b) of the Common Regulations).

41 – Educational services, namely, conducting seminars, conferences and courses in the fields of engineering, science and public speaking; providing on-line publications in the nature of e-books, magazines, journals, printed codes, manuals, books, academic papers, newspapers, pamphlets and newsletters in the field of engineering, technology and science; on-line academic library services; education

services, namely, providing live and on-line classes, seminars and workshops in the field of engineering, technology and science.

42 – Indicating membership in an association of mechanical engineers (Terms too vague in the opinion of the International Bureau – Rule 13(2)(b) of the Common Regulations); assessment and evaluation of the services of manufacturers, fabricators, designers, inspection companies, and personnel in meeting codes and standards in the field of engineering, technology and science, and issuance of certifications and accreditation in accordance with the results of such assessment and evaluation.

(260) AM 2015 75055 A

(800) 1183508

(151) 2013 09 02

(731) MAGLITAL S.R.L.

S.S. Flaminia Km. 145 Parrano, I-06032  
TREVI (PG), Italy

(540)



(591) Black, white

(511)

14 – Bracelets made of macramé and/or embroidery, chains made of macramé and/or embroidery, necklaces made of macramé and/or embroidery, rings made of macramé and/or embroidery, earrings made of macramé and/or embroidery, pendants made of macramé and/or embroidery, brooches made of macramé and/or embroidery, anklets made of macramé and/or embroidery; jewelry accessories, namely, bracelets, chains, necklaces, rings, earrings, pendants, brooches, anklets, medals, cuff links, tie clips, watches, watch straps, watch bands, chains for watches, cases for watches, all the aforesaid goods in gold, silver or other precious metals.

18 – Leather and imitations of leather; trunks and travel bags; umbrellas, parasols and walking sticks; travelling bags for clothing; key cases; bags, namely, duffel bags, handbags; rucksacks, rucksacks for mountaineers; school backpacks; shoulder bags; suitcases, briefcases; purses; pocket wallets; drawstring pouches; boxes and cases of leather, beauty cases sold empty.

25 – Articles of clothing, clothing for sports; bathing suits; pareos; ponchos; underwear, namely, leotards, boxers, T-shirts, shorts, panties; leather wear; loungewear; bath robes; nightgowns, pajamas; trousers, jeans, shorts, jackets, coats, waistcoats, overcoats, raincoats, hosiery, knitwear, sweaters, cardigans, fleece pants and tops, jumpers, pullovers, twinsets,

vests; tracksuits, bodysuits, shirts, plush shirts, polo shirts, T-shirts, gowns, skirts, dresses; socks; dressing gowns; bands; scarves, silk scarves; gloves; headgear, namely, headdress, hats and bandanas; belts and ties; footwear, shoes, dress shoes, gymnastic shoes, boots, sandals, slippers.

26 – Lace; embroidery and embroidery for garments; ribbons; hair strings, bindings for hemming garments; buttons, brooches (clothing accessories); artificial flowers.

(260) AM 2015 75057 A

(800) 1183514

(151) 2013 08 15

(731) OBSHCHESTVO S OGRANICHENNOY  
OTVETSTVENNOSTYU "LIVIZ"

ul. Nagornaya, Krasnoe selo, d.5, RU-198320  
SANKT-PETERBURG, Russian Federation

(540)

## WHITE EAGLE

(591) Black, white

(511)

32 – Aperitifs, non-alcoholic; waters [beverages]; kvass [non-alcoholic beverage]; cocktails, non-alcoholic; lemonades; peanut milk [soft drink]; non-alcoholic beverages; isotonic beverages; non-alcoholic honey-based beverages; whey beverages; non-alcoholic fruit juice beverages; milk of almonds [beverage]; fruit nectars, non-alcoholic; orgeat; beer; powders for effervescing beverages; sarsaparilla [non-alcoholic beverage]; syrups for lemonade; syrups for beverages; tomato juice [beverage]; cider, non-alcoholic; vegetable juices [beverages]; fruit juices; preparations for making aerated water; preparations for making liqueurs; preparations for making mineral water; preparations for making beverages; grape must, unfermented; beer wort; malt wort; pastilles for effervescing beverages; sherbets [beverages]; non-alcoholic fruit extracts; extracts of hops for making beer; essences for making beverages.

33 – Aperitifs; arak [arrack]; brandy; wine; piquette; whisky; vodka; gin; digesters [liqueurs and spirits]; cocktails; liqueurs; alcoholic beverages, except beer; alcoholic beverages containing fruit; spirits [beverages]; distilled beverages; hydromel [mead]; peppermint liqueurs; bitters; rum; sake; cider; rice alcohol; alcoholic extracts; fruit extracts, alcoholic; alcoholic essences.

(260) AM 2015 75061 A

(800) 1183544

(151) 2013 09 25

(731) VÖLKER & KRUSE GMBH

Gertigstrasse 19, 22303 Hamburg, Germany

(540)

## MAMACHECK

(591) Black, white  
 (511)  
 5 – Pharmaceutical preparations, including tests and test articles for diagnostic purposes; diagnostic articles, including express tests, tests for different diseases; pregnancy tests; ovulation tests.

(260) AM 2015 75062 A  
 (800) 1183545  
 (151) 2013 10 30  
 (731) AVON PRODUCTS, INC.  
 World Headquarters, 777 Third Avenue,  
 New York, NY 10017, USA

(540)  
**AVON UNIQUE ROSE**

(591) Black, white  
 (511)  
 3 – Non-medicated toilet preparations; toiletries; skin care preparations; skin moisturizers; body and beauty care preparations; powders, creams and lotions, all for the face, hands and body; cosmetic suntan preparations; soaps; shower and bath preparations; beauty masks; talcum powder; nail polish; nail polish remover; enamel for nails; false nails; adhesives for cosmetic purposes; cosmetics; eye makeup remover, eye shadow, eye liner, mascara, lipstick, lip liner, lipgloss; make-up foundation; blusher; tissues impregnated with cosmetic lotions; cotton sticks for cosmetic purposes; cotton wool for cosmetic purposes; preparations for cleaning, moisturising, colouring and styling the hair; preparations for cleaning the teeth; shaving and aftershave preparations; perfumes, fragrances, toilet waters, cologne; deodorants for human beings; anti-perspirants for personal use (toiletries); essential oils (cosmetic).

(260) AM 2015 75064 A  
 (800) 1047896  
 (151) 2010 03 24  
 (891) 2013 10 11  
 (731) C. JOSEF LAMY GMBH  
 Grenzhöfer Weg 32, 69123 Heidelberg, Germany

(540)  
**Lamy**

(591) Black, white  
 (511)  
 9 – Apparatus for recording, transmission or reproduction of sound or images; magnet data carriers, recording discs; data processing equipment and computers; teaching apparatus and instruments; protective helmets, especially bicycle helmets.

16 – Writing instruments, especially fountain pens, ballpoint pens, pencils, coloured pencils, mechanical pencils, ink pens, felt-tip pens, inks, ink cartridges and refills for writing instruments; leads for writing instruments, rubber erasers, pencil sharpeners, paint

brushes; pen cases; office requisites (other than furniture), especially stands and holders for writing instruments; paper, cardboard and goods made of these materials, included in this class, especially notebooks, writing cases, sketch blocks and notepads, ring binders; protective covers for books and notebooks; ID holders, colouring and paint boxes (school and art supplies); instructional and teaching material (except apparatus), especially exercise books, textbooks; printed matter for advertising, also in combination with writing instruments and office requisites carrying advertisements to be given out as promotional gifts.

18 – Leather and imitations of leather, and goods made of these materials and not included in other classes, especially suitcases, handbags, shopping bags, wallets, purses, money purses, key cases (made of leather), writing instrument cases, neck purses, travelling bags, trolleys, garment bags, board cases (suitcases), reporter bags, toilet bags and cosmetic bags, college briefcases (included in this class), folders (included in this class), attaché cases, portfolios, briefcases, pilot cases, clutch bags, shoulder bags, backpacks, bathing bags, match bags, bread bags, sports bags, and book bags, school satchels and schoolbags, umbrellas and parasols.

20 – Furniture, especially school furniture, school desks and school desk chairs.

(260) AM 2015 75180 A  
 (800) 1184456  
 (891) 2013 10 01  
 (731) ZENTIVA GROUP, A.S.  
 U Kabelovny 130 CZ-102 37 Praha  
 10 – Dolní Měcholupy, Czech Republik

(540)  
**TRIAMLO**

(511)  
 5 – Medicines, pharmaceutical preparations for human use.

(260) AM 2015 75181 A  
 (800) 1184479  
 (891) 2013 10 30  
 (731) MELLO TRADING AG  
 Torgasse 4, CH-8001 Zürich, Switzerland

(540)  
**Louis D'OR**

(511)  
 33 – Alcoholic beverages (except beers).

(260) AM 2015 75186 A  
 (800) 1184495  
 (891) 2013 11 14  
 (731) CELGENE CORPORATION  
 86 Morris Avenue Summit, NJ 07901, USA

(540)

**ORCOMPAS**

(511)

5 – Pharmaceutical preparations, namely, cytokine inhibitory drugs; pharmaceutical preparations that modulate the immune system; pharmaceutical preparations for the treatment of blood disease and cancer.

(260) AM 2015 75187 A

(800) 1184520

(891) 2013 08 09

(731) POLECAST VENTURES LIMITED

5 Petrou Illadi Street, CHLOE RESIDENCE,  
1st Floor, Flat/Office 101, CY-2015 Nicosia,  
Cyprus

(540)

**RANDEMIC**

(591) Light red and dark red

(511)

35 – Marketing, advertising, business management assistance, compilation of information into computer databases, online advertising.

41 – Entertainment and recreational services.

(260) AM 2015 75188 A

(800) 1184521

(891) 2013 11 07

(731) PENETRON INTERNATIONAL LTD.

45 RESEARCH WAY, SUITE 203, EAST  
SETAUKET NY 11733, USA

(540)

**PENETRON ADMIX**

(511)

1 – Waterproofing additive for concrete.

(260) AM 2015 75189 A

(800) 1184522

(891) 2013 06 24

(731) SENUR ELEKTRİK MOTORLARI

SANAYİ VE TİCARET ANONİM ŞİRKETİ  
Cihangir Mah. Dolum Tesisleri Cad. Şehit  
Piyade Er Yavuz Bahar Sk. No:7, Ambarlı-  
İstanbul, Turkey

(540)

**arnica™**

(591) Red

(511)

7 – Painting machines, automatic guns for spraying paints, electric stamping machines and guns, electric glue guns; electric nail guns, spraying machines, electric hand drills, motor handsaws, machines for carving out, spiral machines, pressured air produ-

cers, compressors, vehicle washing machines and robots functioning in the same way with the above mentioned machines and tools; alternators, generators, electricity generators, generators working with solar energy; press machines; packaging machines, bottle filling, stoppering and closing machines, labeling machines, robots and robotic mechanisms functioning in the same way with the above mentioned machines (including electrical closing/sealing machines made of plastic); textile machines, sewing machines and industrial robots functioning in the same way with them; pumps not part of the engines or motors (including fuel filling and dispensing pumps and their guns); electric apparatus used in kitchen for chopping, grinding, crushing, beating and crumbling; washing machines (including dishwashers, washing machines, spin driers); electric machines for cleaning floor or carpet, vacuum cleaners and their parts; welding machines and robots functioning in the same way with them; metal surface galvanizing apparatus; electrical and electronic on-off mechanisms; machines and tool benches for processing and shaping wood, metal, glass and plastic materials, and industrial robots used for this purpose; machines for working metals and machine tools for metal working and robotic mechanisms functioning in the same way; lifting, carrying and transmitting machines and robotic mechanisms functioning in the same way (including elevators, escalators, cranes); machines and robotic mechanisms used in the fields of agriculture, animal breeding, farming and in processing grain, fruit, vegetable, food; motors except for land vehicles, electric motors, their parts and fittings; roller bearings; ball bearings; tire fixing and detaching machines; welding machines and robots functioning in the same way with them.

(260) AM 2015 75190 A

(800) 1184528

(891) 2013 06 19

(731) THE AMERICAN SOCIETY OF  
MECHANICAL ENGINEERS

Two Park Avenue, New York NY  
10016-5990, USA

(540)

**ASME**

(511)

9 – Downloadable electronic publications in the nature of e-books, magazines, journals, printed codes, manuals, books, academic papers, newspapers, pamphlets and newsletters in the field of engineering, technology and science; multimedia software recorded on digital media featuring educational courses, workshops, seminars, conferences, symposia, and training in the field of engineering, technology and science; downloadable computer software featuring educational courses, workshops, seminars, conferences, symposia and training in the field of engineering, technology and science.

16 – Publications of all kinds namely magazines, printed codes, manuals, books, newspapers, and pamphlets of an engineering and science nature.

35 – Association services, namely, promoting the interest of those involved with the mechanical engineering profession and promoting the use and services of engineers (terms too vague in the opinion of the International Bureau – Rule 13(2)(b) of the Common Regulations).

41 – Providing on-line publications in the nature of e-books, magazines, journals, printed codes, manuals, books, academic papers, newspapers, pamphlets and newsletters in the field of engineering, technology and science; on-line academic library services; education services, namely, providing live and on-line classes, seminars and workshops in the field of engineering, technology and science; educational services, namely, conducting seminars, conferences and courses in the fields of engineering, science and public speaking.

42 – Indicating membership in applicant organization (terms too vague in the opinion of the International Bureau – Rule 13(2)(b) of the Common Regulations); assessment and evaluation of the services of manufacturers, fabricators, designers, inspection companies, and personnel in meeting codes and standards in the field of engineering, technology and science, and issuance of certifications and accreditation in accordance with the results of such assessment and evaluation.

(260) AM 2015 75192 A  
(800) 1184531  
(891) 2013 11 14  
(731) CELGENE CORPORATOIN  
86 Morris Avenue, Summit NJ 07901, USA  
(540)

## OGARTEZ

(511)  
5 – Pharmaceutical preparations, namely, cytokine inhibitory drugs; pharmaceutical preparations that modulate the immune system; pharmaceutical preparations for the treatment of blood disease and cancer.

(260) AM 2015 75193 A  
(800) 1184532  
(891) 2013 11 14  
(731) CELGENE CORPORATOIN  
86 Morris Avenue, Summit NJ 07901, USA  
(540)

## OCRUZO

(511)  
5 – Pharmaceutical preparations, namely, cytokine inhibitory drugs; pharmaceutical preparations that modulate the immune system; pharmaceutical preparations for the treatment of blood disease and cancer.

(260) AM 2015 75194 A  
(800) 1184545  
(891) 2013 04 26  
(731) NINTENDO CO., LTD.  
11-1, Hokotate-cho, Kamitoba, Minami-ku,  
Kyotoshi, Kyoto 601-8501, Japan  
(540)

## SUPER MARIO

(591) Black, white  
(511)  
41 – Providing images via communication by hand-held game apparatus with liquid crystal displays; providing images via communication by arcade video game machines; providing images via communication by consumer video game apparatus; providing images via other communications; organization of video game events; providing games via communication by handheld game apparatus with liquid crystal displays; providing games via communication by arcade video game machines; providing games via communication by consumer video game apparatus; providing games via other communications; providing entertainment information by computer terminals; providing games for consumer video game apparatus; providing games for handheld game apparatus with liquid crystal displays; providing games for arcade video game machines; rental of consumer video game apparatus; providing games via telecommunication network; providing games via communication network; educational and instruction services relating to arts, crafts, sports or general knowledge; presentation of movies, shows, plays or musical performances; movie showing, movie film production, or movie film distribution; rental of toys; rental of amusement machines and apparatus; rental of game machines and apparatus.

(260) AM 2015 75195 A  
(800) 1184546  
(891) 2013 04 18  
(731) LAUFEN CZ s.r.o.  
V Tůňích 3/1637, CZ-120 00 Praha 2,  
Czech Republic  
(540)

## TIGO

(591) Black, white  
(511)  
11 – Apparatus for lighting, heating, steam generating, cooking, apparatus for cooling, drying, ventilating, water distribution; sanitary (toilet) apparatus and equipment; components and accessories of aforementioned goods, especially showers, shower cabins, taps and valves for pipes, bath tubs, bath tubs for sitz baths, bath tubs for spas, bath accessories (valves), equipment for hot water heating for bath, portable cabins for steam baths; bath fittings; bath linings; shaped linings for furnaces; moulded linings



for stoves; metal structures for furnaces and ovens; fireplaces; lamp shades; electric lamps; spa equipment (hot air baths); LED light emitting diodes (lights); sinks; disinfectant dispensers for toilets; disinfectant containers for toilets; electric lamps; means for odour removal, except means for personal use; urinals (sanitary fixtures); radiators (for heating); equipment for saunas; seats (for toilets); flushers; flushing equipment; WC (toilet) bowls; toilets (with flushing); portable toilets; wash-hand basins (parts of sanitary installations); hand dryers for washrooms; whirlpool-jet apparatus; water intake apparatus; washers for water taps; water supply facilities; all included in this class.

19 – Non-metallic building materials; building ceramics and glass; rigid non-metallic pipes for building; asphalt; pitch; transportable non-metallic structures; non metallic monuments, in particular non-metallic pavement; floor tiles (not of metal); wall tiles for construction (not of metal); linings for the construction industry (not of metal); floors (not of metal); all included in this class.

20 – Furniture, mirrors, picture frames; goods (not included in other classes) of wood, cork, reed, willow wicker, horn, bone, ivory, whalebone, tortoiseshell, amber, mother-of-pearl, meerschaum and substitutes for all these materials, or of plastics; bathroom furniture of wood and plastics; non-metallic hangers and holders for bathrooms (furniture) included in this class; parts and accessories of furniture included in this class, especially chests of wood or plastics, wood furniture parts, doors of furniture, casters for furniture (not of metal), laths for furniture of plastics, furniture linings (not of metal); fixed towel dispensers (not of metal); newspaper holders; office furniture; metallic furniture; school furniture; bolsters; footstools; racks; shelves; silvered glass for the production of mirrors; plates of glass for mirrors; small mirrors (hand-held) for toiletry; wardrobes; storage cabinets; towel cabinets (furniture); medicine cabinets; water valves of plastics; all included in this class; vats; hooks for hanging (not of metal).

21 – Utensils and containers for household and kitchen; combs and sponges; brushes (except paint brushes); brush-making materials; articles for cleaning purposes; steel wool for cleaning parquetry; unworked and semi-worked glass (except glass used in building); glassware, porcelain and earthenware and goods made from these materials, not included in other classes, in particular technical ceramics and glass included in this class; decorative ceramics and glassware; figurines (statuettes) and works of art made of porcelain, terracotta or glass; aerosol dispensers (except dispensers for medical purposes); soap dispensers; paper towel dispensers; toilet paper dispensers; deep bowls; brushes; ceramics for household use; sanitary litter bowls for pets; dishes for washing sponges; soap cases; night containers (cha-

mber pots); small bath tubs (for babies, portable); washing tubs; storage boxes (metallic) for paper towels; reservoirs (tanks) for soap; hangers and brackets for bathrooms included in this class; jugs and buckets; flasks; holders; spouts.

(260) AM 2015 75267 A

(800) 1185125

(891) 2013 10 08

(731) SICHUAN MIANZHU JIAN NAN CHUN DISTILLERY CO., LTD.

No:289 Chunyijie Street, Mianzhu Sichuan, China

(540)

绵竹大曲

(591) Black, white

(511)

33 – Alcoholic fruit extracts; arrack; distilled beverages; wine; spirits [beverages]; alcoholic extracts; alcoholic beverages except beers; alcoholic beverages containing fruit; rice alcohol; yellow wine.

(260) AM 2015 75337 A

(800) 1185792

(891) 2013 09 27

(731) COTTON CLUB INVESTMENT LTD.

1 st Lipovy, building number 4, Moscow area, Balashihinsky area, RU-143985 Sobolikh, Russian Federation

(540)

TRA LA LA

(511)

3 – Cotton wool for cosmetic purposes; make-up; perfumes; perfumery; ionone [perfumery]; cosmetic pencils; adhesives for affixing false hair; cosmetic dyes; cosmetic creams; skin whitening creams; nail polish; oils for cosmetic purposes; oils for toilet purposes; essential oils; soap; disinfectant soap; deodorant soap; soap for brightening textile; medicated soap; almond soap; cosmetic kits; lipsticks; cosmetic preparations for baths; toiletries; hair waving preparations; paint stripping preparations; lacquer-removing preparations; nail care preparations; false eyelashes; eyebrow cosmetics; cosmetic preparations for skin care; cosmetics; talcum powder, for toilet use; shampoos; lip glosses; petroleum jelly for cosmetic purposes; toilet water; dental bleaching gels; decorative transfers for cosmetic purposes; hair lotions; lotions for cosmetic purposes; cakes of toilet soap; pomades for cosmetic purposes; detergents other than for use in manufacturing operations and for medical purposes; degreasers other than for use in manufacturing processes; bleaching preparations [decolorants] for cosmetic purposes; antiperspirants [toiletries].

5 – Absorbent cotton; wadding for medical purposes; dressings, medical; surgical dressings; corn remedies; tissues impregnated with pharmaceutical lotions; remedies for perspiration; vulnerary sponges; sea water for medicinal bathing; mineral waters for medical purposes; thermal water; dietetic beverages adapted for medical purposes; breast-nursing pads; pomades for medical purposes; babies' napkin-pants [diaper-pants].

10 – Orthopedic articles; surgical, medical, dental and veterinary apparatus and instruments; feeding bottles; babies' pacifiers [teats]; spoons for administering medicine; incubators for babies; breast pumps; nursing appliances; incontinence sheets; elastic stockings for surgical purposes; stockings for varices.

16 – Paper; toilet paper; table linen of paper; towels of paper; face towels of paper; note books; pads [stationery]; drawing pads; loose-leaf binders; pamphlets; booklets; paper sheets [stationery]; calendars; tracing paper; pencils; pencil lead holders; charcoal pencils; pictures; transfers [decalcomanias]; paintings [pictures], framed or unframed; wood pulp board [stationery]; writing chalk; bibs of paper; stickers [stationery]; modelling paste; pen cases; book-bindings; handkerchiefs of paper; rubber erasers; elastic bands for offices; tablemats of paper; tablecloths of paper; stencil plates; manuals [handbooks]; stamps [seals]; writing ink; inkwells; cardboard articles; printed matter; stationery.

21 – Sponges for household purposes; toilet sponges; containers for household or kitchen use; kitchen containers; chamois leather for cleaning; toothpicks; brush goods; cleaning instruments, hand-operated; material for brush-making; saucepan scourers of metal; gloves for household purposes; polishing gloves; gardening gloves; abrasive pads for kitchen purposes; scouring pads; crumb trays; cups of paper or plastic; drinking glasses; disposable table plates; cloth for washing floors; cloths for cleaning; dusting cloths [rags]; furniture dusters; kitchen utensils; ice cube molds [moulds]; dishwashing brushes; brushes for cleaning tanks and containers; lamp-glass brushes; scrubbing brushes; brushes for footwear; heaters for feeding bottles, non-electric; drinking troughs; pots; cooking pots; painted glassware; tableware, other than knives, forks and spoons; porcelain ware; earthenware; crystal [glassware]; cosmetic utensils; toilet utensils; drinking straws; drinking vessels; glass [receptacles]; combs; steel wool; cooking utensils, non-electric.

22 – String; tarpaulins; wadding for filtering; clothes lines; textile fibers [fibres]; horsehair; hammocks; jute; wax ends; cord; cocoons; rope ladders; liber; twine for nets; thread, not of metal, for wrapping or binding; sawdust; straw wrappers for bottles; tow; cotton tow; silk flock; tents; sails; hemp; feathers for

bedding; animal hair; fibrous gaskets for ships; down [feathers]; eiderdown; raffia; fleece wool; nets; bags for washing hosiery; raw fibrous textile; network; raw cotton; raw silk; carded wool; camel hair; wood wool; combed wool; raw or treated wool; shorn wool; wadding not of rubber, paper or plastic for padding and stuffing; wrapping or binding bands, not of metal; cables, not of metal.

24 – Textile material; tulle; covers [loose] for furniture; washing mitts; glass cloths [towels]; napkins, of cloth, for removing make-up; face towels of textile; tablemats, not of paper; place mats, not of paper; table napkins of textile; mosquito nets; calico; oilcloth for use as tablecloths; tablecloths, not of paper; labels of cloth.

44 – Veterinary services; speech therapy services; massage; medical services.

(260) AM 2015 75338 A

(800) 1185794

(891) 2013 10 17

(731) Gesellschaft mit beschränkter Haftung  
"EHRMANN"

pos.RAOS, 15, Ramenskiy r-n, RU-140025  
Moscow Region, Russian Federation

(540)



(591) White, gray, light gray, blue, yellow, green, dark green, light green, light brown, beige, pink, crimson and dark crimson

(511)

29 – Yoghurt.

(260) AM 2015 75339 A

(800) 1185800

(891) 2013 10 16

(731) LABORATORIOS HIPRA, S.A.

Avda. de la Selva, 135, E-17170 AMER  
(Girona), Spain

(540)



(591) Blue and white

(511)  
5 – Pharmaceutical and veterinary products; sanitary products for medical use; dietetic food and substances for medical or veterinary use, food for babies; nutritional supplements for humans and animals; plasters, materials for dressings; teeth filling and dental impression materials; disinfectants; products for destroying vermin; fungicides, herbicides.

(260) AM 2015 75340 A  
(800) 1185816  
(891) 2013 11 20  
(731) APPLE INC.  
1 Infinite Loop, Cupertino CA 95014, USA  
(540)

## IPAD AIR

(511)  
9 – Handheld mobile digital electronic device comprising a tablet computer, electronic book and periodical reader, digital audio and video player, camera, electronic personal organizer, personal digital assistant, electronic calendar, and mapping and global positioning system (GPS) device, and capable of providing access to the Internet and sending, receiving, and storing messages and other data.

(260) AM 2015 75341 A  
(800) 1185829  
(891) 2013 11 21  
(731) DAVIDOFF & CIE SA  
2, rue de Rive, CH-1200 Genève, Switzerland  
(540)

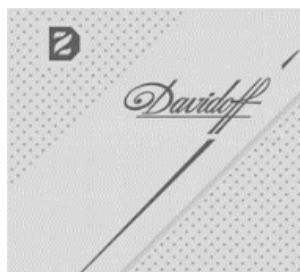

(591) Black, white  
(511)  
34 – Tobacco, raw or manufactured; tobacco products; tobacco substitutes, for non-medical and non-curative use; cigarettes; smokers' articles, cigarette lighters, ashtrays; matches.

(260) AM 2015 75342 A  
(800) 1185847  
(891) 2013 03 25  
(731) TRUPHONE LIMITED  
4 Royal Mint Court, London EC3N 4HJ,  
United Kingdom  
(540)

## truphone

(591) Black, white  
(511)  
9 – Telecommunications, telephonic and communications apparatus and instruments; mobile and fixed telephones; digital telecommunications apparatus; computer software; computer software downloadable from global computer information networks; communication software; telecommunication software; telephony software; apparatus for recording, transmission, processing and reproduction of sound, images or data, and software for use in relation thereto; software for communication apparatus and instruments; software that provides customers with access to and use of global wireless communication and computer networks via computers, portable computers, personal computers and other wireless devices, cellular phones or handheld and personal digital assistants; software and apparatus featuring voice over Internet protocol (VOIP) technology; software that enables the location of wireless communication networks and computer networks; software incorporating address book management systems and contact management systems; electrical and electronic accessories and peripheral equipment designed for use with telecommunications and communications apparatus, computers, portable computers, personal computers and other wireless devices, cellular phones or handheld and personal digital assistants, and with computer networks; dongles; software for secure data storage and retrieval and transmission of confidential customer information used by individuals, companies and financial institutions; hardware and software used to identify subscribers on telecommunications apparatus and SIM cards; caller display software; caller identification software; payment cards including cards containing an integrated circuit chip ("smartcards"); SIM cards; radio frequency identification devices (transponders); media for storage and/or reproduction of sound and/or visual images; interactive and multimedia software; electronic media apparatus; mousepads and other computer accessories; software featuring voice over Internet protocol (VOIP) technology.

38 – Telecommunications; telecommunications services; communications; communications services; providing access to telecommunications networks via wireless communications and computer networks; operation of telecommunications systems; operation of telecommunications systems featuring voice over Internet protocol (VOIP) technology; operation of telecommunications systems featuring Global System for Mobile Communications (GSM); operation of telecommunications systems featuring Code Division Multiple Access (CDMA); communications services, namely, telephone, mobile telephone, message collection and transmission, call diversion, and electronic mail services; transmission, delivery and reception of sound, data, images, music

and information; personal numbering services (telephony); call recording services; operation of telecommunication systems featuring multiple mobile subscriber identity module technology; providing telecommunications connections to computer databases, the Internet or other electronic networks; providing user access to the Internet; providing access to databases including through wireless networks; delivery of audio, video and data by telecommunications; leasing of access time to a computer database via a dedicated line; provision of advice and information in relation to communications and communication technologies.

(260) AM 2015 75343 A

(800) 1185848

(891) 2013 04 26

(731) SABIC International Holdings B.V.  
Europaboulevard 1, NL-6135 LD Sittard,  
Netherlands

(540)



(591) Yellow and blue

(511)

1 – Chemicals used in industry, science and photography, namely, photographic chemicals, as well as in agriculture, horticulture and forestry; unprocessed artificial resins, unprocessed plastics; manures; fire extinguishing compositions; tempering and soldering preparations; chemical substances for preserving foodstuffs; tanning substances; adhesives used in industry; plastics, namely, rough artificial resins; unprocessed plastics; engineered plastics, namely, plastic moulding compounds for use in the manufacture of moulded plastic articles; unprocessed synthetic resins; unprocessed plastics, namely, recombined plastics, mixtures, compositions and dispersions of plastics, all for use in the further manufacture of plastics.

6 – Common metals and their alloys; metal building materials, metal billets and slabs, hot rolled products, namely, pre-fabricated steel buildings, pre-fabricated parts for ship building, pipes and tubes, transportable buildings of metal; materials of metal for railway tracks; non-electric cables and wire of common metal; small items of metal hardware, namely, wire rods and metal bars; pipes and tubes of metal; metal safes; metal ores.

42 – Technical consulting services in the use of chemical products and synthetic materials; design for others of factories and installations; engineering and consulting services with regard to the design of factories and installations; simulation of chemical

and scientific processes; scientific research and technological consultation and research in the field of chemistry, biology, physics, microbiology, bacteriology and genetics; industrial analysis and research services.

(260) AM 2015 75344 A

(800) 1185865

(891) 2012 12 13

(731) KOC HOLDING ANONIM SIRKETI  
Nakkastepe Azizbey Sokak No:1,  
ISTANBUL, Turkey

(540)



(591) Red, white and black

(511)

7 – Belts for motors and engines, timing belts for engines and motors, dynamo belts, belts for conveyors; kitchen machines, electric namely mixers, blenders, electric, for household purposes, electric food processors, electric knives, electric meat grinders, garbage disposals; electric vacuum cleaners, electric machines and apparatus for carpet shampooing, brushes for vacuum cleaners, hoses for vacuum cleaners, dust bags for vacuum cleaners, dust filters for vacuum cleaners, suction nozzles for vacuum cleaners, vacuum cleaner attachments for disseminating perfumes and disinfectants, electric fan units for vacuum cleaners, vacuum cleaner bags, vacuum cleaner hoses; vehicle washing machines, kneading machines, dough maturing machines, dough cutting machines, grain humidifying machines, grain separators, sifters, winnowers, air suction machines, hoppers, milling machines, machines for processing grain, grinding machines, sieve machines, grain husking machines.

9 – Aerometers; alcoholmeters, altimeters, ammeters, anemometers, apertometers, acid hydrometers, apparatus, barometers, wavemeters, densimeters, apparatus for measuring the thickness of skins, appliances for measuring the thickness of leather, dynamometers, ergometers, photometers, frequency meters, gas testing instruments, gasometers, precision measuring apparatus, hydrometers, speed measuring apparatus, urinometers, capacity gauges, slide calipers, thread counters, lactometers, manometers, clinometers, micrometers, hygrometers, ohmmeters, thermometers, not for medical purposes, oil level sensors, pyrometers, planimeters, polarimeters, light meters, saccharometers, salinometers, azimuth instruments, sulphitometers, lactodensimeters, barometers, telemeters, theodolites, telemeters, variometers, verniers, voltmeters, densimeters, thermocouples, microscopes, magnifying spectacles, telescopes, periscopes; apparatus and instruments for conducting,

switching, transforming, accumulating, regulating or controlling electricity; apparatus for recording, transmission or reproduction of sound or images; magnetic data carriers, recording discs; compact discs, DVDs and other digital recording media; mechanisms for coin-operated apparatus; cash registers, calculating machines, data processing equipment, computers; computer software; fire-extinguishing apparatus.

11 – Apparatus for lighting, heating, steam generating, cooking, refrigerating, drying, ventilating, water supply and sanitary purposes.

35 – Advertising; business management; business administration; office functions; the bringing together, for the benefit of others, of a variety of goods (excluding the transport thereof), enabling customers to conveniently view and purchase those goods (such services may be provided by retail stores, wholesale outlets, means of electronic media, through mail order catalogues or other similar services).

36 – Insurance; banking services, financial management services, financial analysis services, financial sponsorship, financial trading, financial clearing-houses, banking financial evaluation, providing financial information, financial consultation services, factoring, debt collection agencies, check verification, issuing of travellers' checks, electronic funds transfer services, lease-purchase financing services, leasing of real estate, guarantees, bail-bonding, securities brokerage, credit and loan services, credit bureaux, credit card services, issuance of credit cards, hire-purchase financing, savings bank services, exchanging money, charitable fund raising services, mortgage banking, lending against security, trusteeship, trustee services, rent collection, retirement payment services; real estate affairs; customs brokerage.

37 – Building construction; vehicle maintenance and repair, repair or maintenance of vessels, maintenance and repair of air vehicles, maintenance and repair of furniture, repair of heating apparatus, repair of air conditioning system, repair of water system, maintenance and repair of clothing, laundry services, film projector repair and maintenance, repair of industrial machinery, repair of electrical equipment, repair or maintenance of office machines and apparatus, repair or maintenance of computers, maintenance and repair of computer hardware, maintenance and repair of security and safety equipment, telephone repair, repair or maintenance of elevators [lifts], clock and watch repair or maintenance, wallpapering, mining extraction services, sanding, re-tinning, knife sharpening, safe maintenance and repair, umbrella repair, parasol repair, shoe repair services, installation services.

39 – Transport; packaging and storage of goods; travel arrangement.

40 – Metal treatment services, namely, galvanizing, metal plating, metal casting, cadmium plating, chromium plating, gold-plating, tin-plating, silver-plating, nickel plating, coppersmithing, electroplating, soldering, magnetization, metal tempering, metal casting, boiler-making, providing material treatment information; photocomposing services, photographic printing, photogravure, processing of photographic and cinematographic films, photographic processing; processing of raw materials for the manufacture of food and beverages, food canning, food smoking, food and drink preservation, millworking, flour milling, fruit crushing; slaughtering of animals; working of leather and furs, namely, fur dyeing, fur glossing, fur mothproofing, fur staining, custom fashioning of fur, leather staining, leather tanning, leather dyeing; taxidermy; preparation and treatment of fabric, namely, warping (looms), textile mothproofing, cloth edging, cloth cutting, fabric bleaching, cloth dyeing, printing of patterns on textiles, fabric fireproofing, fabric waterproofing, pre-shrinking of fabric, crease-resistant treatment of fabric; wool treating; tailoring; dressmaking, cloth cutting, clothing alteration, embroidery services; woodworking, timber felling and processing, sawmill planning; engraving, framing of works of art; water treating, processing of chemicals, processing of gas, air purification, air freshening, air deodorizing, recycling of waste materials, sorting of waste and recyclable material (transformation), refining services, processing of oil, water purification, water treating; glass-blowing, glass tinting, glass polishing; custom assembling of materials; dental technician services; pottery firing; production of energy; rental of generators; paper treating; bookbinding; laser scribing; laminating; saddlery working; shoe staining and dyeing; quilting.

43 – Services for providing food and drink; temporary accommodation.

(260) AM 2015 75349 A

(800) 1185895

(891) 2013 06 12

(731) DR. SERTUS İLAÇ SANAYİ VE TİCARET LİMİTED ŞİRKETİ

Evren Mah. Camiyolu Cad. No:50 K.2,  
Güneşli, Bağcılar, İstanbul, Turkey

(540)

**L-VIAVA Л-ВИАВА**

(511)

5 – Medicines for human purposes; medicines for veterinary purposes; vitamin preparations; chemical preparations for medical purposes; dietetic substances adapted for medical use; dietetic foods adapted for medical purposes; baby foods; medicinal herbs; herbal beverages adapted for medical purposes; nutritional supplements; pollen dietary supplements; mineral food supplements; protein dietary supple-

ments; medicines for dental purposes; hygienic products for medical purposes including pads; wadding for medical purposes; plasters for medical purposes; dressings for medical purposes; babies' napkins; preparations for destroying noxious plants; preparations for destroying noxious animals; fungicides; deodorants other than for human beings or for animals; disinfectants for hygiene purposes; antiseptics; detergents for medical purposes.

(260) AM 2015 75350 A  
(800) 1185938  
(891) 2013 07 30  
(731) JUWEL AQUARIUM GMBH & CO. KG  
Karl-Göx Str. 1, 27356 Rotenburg, Germany  
(540)



(591) Black, white  
(511)  
7 – Ventilation pumps and water pumps.

11 – Lighting and heating apparatus and installations; lamps and ultra-violet lamps; lighting equipment and lighting devices for aquaria; filtration apparatus; filters (parts of domestic or industrial facilities); heating mats and radiators, water inlets and outlets, water aeration equipment, water distribution equipment, parts for all the aforesaid goods, and fittings therefor.

21 – Indoor aquaria; aquarium covers; indoor terrariums, covers for terrariums.

(260) AM 2015 75351 A  
(800) 1185954  
(891) 2013 09 18  
(731) ROLEX SA  
3-5-7 rue François-Dussaud, CH-1211  
Genève 26, Switzerland  
(540)

## SYLOXI

(511)  
14 – Jewelry, timepieces, namely watches, wristwatches, components of timepieces and accessories for timepieces not included in other classes, clocks and other chronometric instruments, chronometers, chronographs (timepieces), apparatus for timing sports events, time measuring and marking apparatus and instruments not included in other classes; dials (for timepieces), hands (for timepieces), hairsprings (for timepieces), oscillators (for timepieces), boxes, cases and presentation cases for timepieces and jewelry.

(260) AM 2015 75352 A  
(800) 1185987  
(891) 2013 10 24  
(731) CADBURY UK LIMITED  
Bournville, BIRMINGHAM B30 2LU,  
United Kingdom  
(540)



(591) Black, white  
(511)  
30 – Chocolate and chocolate confectionery.

(260) AM 2015 75353 A  
(800) 1186026  
(891) 2013 09 24  
(731) TSN Brands LTD  
Geneva Place, Waterfront Drive, P.O. Box  
3469, Road Town, Tortola British Virgin  
Islands  
(540)

## VAMPIRE

(511)  
32 – Aperitifs, non-alcoholic; lithia water; seltzer water; soda water; waters [beverages]; aerated water; mineral water [beverages]; table waters; kvass [non-alcoholic beverage]; cocktails, non-alcoholic; lemonades; peanut milk [non-alcoholic beverage]; milk of almonds [beverage]; non-alcoholic beverages; isotonic beverages; non-alcoholic honey-based beverages; aloe vera drinks, non-alcoholic; whey beverages; non-alcoholic fruit juice beverages; fruit nectars, non-alcoholic; orgeat; beer; ginger beer; malt beer; powders for effervescing beverages; sarsaparilla [non-alcoholic beverage]; syrups for lemonade; syrups for beverages; smoothies; tomato juice [beverage]; cider, non-alcoholic; vegetable juices [beverages]; fruit juices; preparations for making aerated water; preparations for making liqueurs; preparations for making mineral water; preparations for making beverages; must; grape must, unfermented; beer wort; malt wort; pastilles for effervescing beverages; sherbets [beverages]; non-alcoholic fruit extracts; extracts of hops for making beer; essences for making beverages.

(260) AM 2015 75354 A  
(800) 1186027  
(891) 2013 09 20  
(731) EGIS GYOGYSZERGYÁR Nyilvánosan  
Működő Részvénytársaság  
Kereszturi ut 30-38, H-1106 Budapest,  
Hungary  
(540)

## RAMLOLIPIN

(511)  
5 – Pharmaceutical preparations for human use.

(260) AM 2015 75360 A

(800) 1186061

(891) 2013 09 20

(731) EGIS GYÓGYSZERGYÁR  
NYILVÁNOSAN MŰKÖDŐ  
RÉSZVÉNYTÁRSASÁG  
Keresztúri út 30-38, H-1106 Budapest,  
Hungary

(540)

**TENSIFORT**

(511)  
5 – Pharmaceutical preparations for human use.

(260) AM 2015 75361 A

(800) 1186064

(891) 2013 10 31

(731) JANSSEN PHARMACEUTICA NV  
Turnhoutseweg 30, B-2340 BEERSE, Belgium

(540)

**ВОКАНАМЕТ**

(591) Black, white

(511)

5 – Human pharmaceutical preparations.

(260) AM 2015 75362 A

(800) 1186071

(891) 2013 11 01

(731) Obschestvo s ogranichennoi  
otvetstvennostyu "ALEKSANDROVY  
POGREBA"  
Altufyevskoye shosse, d.79, "A", str. 25,  
RU-127410 Moscow, Russian Federation

(540)

**БУЛАТИ/BULATI**

(511)  
33 – Alcoholic beverages, except beers.

32 – Beer; mineral and aerated waters; non-alcoholic  
beverages; fruit beverages; fruit juices; syrups for  
beverages; preparations for making beverages.

(260) AM 2015 75364 A

(800) 1186082

(891) 2013 09 20

(731) EGIS GYÓGYSZERGYÁR  
NYILVÁNOSAN MŰKÖDŐ  
RÉSZVÉNYTÁRSASÁG  
Keresztúri út 30-38, H-1106 Budapest,  
Hungary

(540)

**ТИРЕГИС**

(511)  
5 – Pharmaceutical, veterinary and sanitary prepara-  
tions; dietetic substances adapted for medical use;  
food for babies; disinfectants; preparations for des-  
troying vermin, fungicides, herbicides.

(260) AM 2015 75365 A

(800) 1186108

(891) 2013 10 17

(731) PHILIP MORRIS PRODUCTS S.A.  
Quai Jeanrenaud 3, CH-2000 Neuchâtel,  
Switzerland

(540)

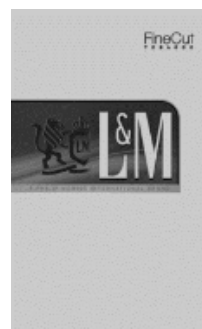

(591) White, black, gray and silver

(526) The trademark is protected as a whole. The  
words "FineCut", "TOBACCO", "INTERNATIO-  
NAL", "BRAND" included therein shall not be sub-  
ject to independent legal protection.

(511)

34 – Tobacco, raw or manufactured; tobacco pro-  
ducts, including cigars, cigarettes, cigarillos, tobacco  
for roll-your-own cigarettes, pipe tobacco, chewing  
tobacco, snuff tobacco, kretek; snus; tobacco sub-  
stitutes (not for medical purposes); smokers' articles,  
including cigarette paper and tubes, cigarette filters,  
tobacco tins, cigarette cases and ashtrays, pipes, poc-  
ket apparatus for rolling cigarettes, lighters; mat-  
ches.

(260) AM 2015 75366 A

(800) 1186113

(891) 2013 11 15

(731) LA QUINTA WORLDWIDE, LLC  
909 Hidden Ridge, Suite 600, Irving,  
TX 75038, USA

(540)

**LQ HOTEL**

(526) The trademark is protected as a whole. The  
word "HOTEL" included therein shall not be subject  
to independent legal protection.

(511)

43 – Hotel and motel services.

(260) AM 2015 75367 A

(800) 1186125

(891) 2013 10 15

(731) ABYSSAL JAPAN CO., LTD  
1304-4, Minami 4jo Nishi 12, Chuo-ku,  
Sapporo city, Hokkaido 064-0804, Japan

(540)  
**SUCREMOR**  
シュクレモア

(591) Black, white  
(511)  
3 – Cosmetics; cosmetic creams; lotions for cosmetic purposes; cleansing milk for toilet purposes; oils for cosmetic purposes; toilet water; toiletries; soap; shampoos; cosmetic preparations for skin care; dentifrices; mouth washes, not for medical purposes; detergents other than for use in manufacturing operations and for medical purposes; perfumery; perfumes.

(260) AM 2015 75368 A  
(800) 1186133  
(891) 2013 07 29  
(731) LUIGI LAVAZZA S.P.A.  
Corso Novara, 59, I-10154 TORINO, Italy

(540)  
**LAVAZZA**

(511)  
7 – Electric machines for preparing beverages and infusions.

11 – Electric coffee machines; electric coffee percolators.

(260) AM 2015 75369 A  
(800) 1186136  
(891) 2013 10 08  
(731) RĪGAS DZIRNAVNIĒKS, AS  
Lizuma iela 5, LV-1006 RĪGA, Latvia

(540)  

(591) Red and white  
(511)  
30 – Flour and preparations made from cereals; rice; cereal products, including instant porridge, muesli, muesli bars, cereal flakes; bread, pastry and confectionery.

(260) AM 2015 75370 A  
(800) 1186158  
(891) 2013 07 25  
(731) Obshchestvo s ogranichennoy  
otvetstvennostyu "UPECO"  
Chaplygina ul. 13/2, office 104, RU-103062  
Moscow, Russian Federation

(540)



(591) Black, grey, white, red  
(511)

3 – Amber [perfume]; antistatic preparations for household purposes; aromatics [essential oils]; air fragrancing preparations; canned pressurized air for cleaning and dusting purposes; balms other than for medical purposes; petroleum jelly for cosmetic purposes; cotton wool for cosmetic purposes; sachets for perfuming linen; scented water; dental bleaching gels; deodorants for human beings or for animals; scented wood; perfumes; greases for cosmetic purposes; perfumery; decorative transfers for cosmetic purposes; cosmetic pencils; laundry blueing; colorants for toilet purposes; cosmetic dyes; creams for leather; waxes for leather; polishing creams; cosmetic creams; incense; hair lotions; after-shave lotions; beauty masks; oils for perfumes and scents; oils for cosmetic purposes; oils for toilet purposes; essential oils; essential oils of lemon; oils for cleaning purposes; bergamot oil; gaultheria oil; jasmine oil; lavender oil; almond oil; rose oil; cleansing milk for toilet purposes; musk [perfumery]; soap; disinfectant soap; deodorant soap; medicated soap; mint for perfumery; cosmetic kits; eau de cologne; bases for flower perfumes; cotton sticks for cosmetic purposes; joss sticks; dentifrices; pumice stone; hydrogen peroxide for cosmetic purposes; lipsticks; pomades for cosmetic purposes; shaving preparations; toiletries; douching preparations for personal sanitary or deodorant purposes [toiletries]; mouth washes, not for medical purposes; laundry bleach; cleaning preparations; aloe vera preparations for cosmetic purposes; sunscreen preparations; stain removers; scouring solutions; tissues impregnated with cosmetic lotions; turpentine, for degreasing; potpourris [fragrances]; bath salts, not for medical purposes; fumigation preparations [perfumes]; ammonia [volatile alkali] [detergent]; sun-tanning preparations [cosmetics]; depilatories; cosmetic preparations for skin care; cosmetics; cosmetics for animals; detergents other than for use in manufacturing operations and for medical purposes; degreasers other than for use in manufacturing processes; talcum powder, for toilet use; terpenes [essential oils]; cloths impregnated with a detergent for cleaning; shampoos; shampoos for pets; dry shampoos; extracts of flowers [perfumes]; ethereal essences; mint essence [essential oil]; air freshening preparations.

4 – Anthracite; benzine; benzene; wood briquettes; combustible briquettes; illuminating wax; paper spills for lighting; cutting fluids; lanolin; illumine-



ting grease; grease for leather; tallow; wood spills for lighting; combustible oil; lubricating oil; moistening oil; lubricants; nightlights [candles]; paraffin; dust removing preparations; firelighters; perfumed candles; candles; alcohol [fuel]; preservatives for leather [oils and greases]; stearine; lighting fuel; lamp wicks; wicks for candles.

5 – Germicides; balms for medical purposes; fly catching paper; mothproofing paper; air deodorising preparations; deodorants, other than for human beings or for animals; deodorants for clothing and textiles; insecticides; liniments; anti-horsefly oils; medicinal oils; menthol; fly catching adhesives; mint for pharmaceutical purposes; eucalyptol for pharmaceutical purposes; tinctures for medical purposes; tincture of iodine; medicinal infusions; antiparasitic collars for animals; medical plasters; air purifying preparations; preparations for destroying noxious animals; preparations for destroying noxious plants; larvae exterminating preparations; fly destroying preparations; preparations for destroying mice; vermin destroying preparations; pharmaceutical preparations for skin care; mothproofing preparations; parasiticides; tissues impregnated with pharmaceutical lotions; insect repellents; insect repellent incense; fungicides; tobacco extracts [insecticides]; elixirs [pharmaceutical preparations]; ethers for pharmaceutical purposes; esters for pharmaceutical purposes.

11 – Lamp shades; disinfectant apparatus; air deodorising apparatus; burners; burners for lamps; lampshade holders; lighters; searchlights; light bulbs; acetylene flares; oil lamps; electric lamps; deodorising apparatus, not for personal use; fumigation apparatus, not for medical purposes; air purifying apparatus and machines; lamps; lanterns for lighting; heating elements.

21 – Rat traps; insect traps; mouse traps; sprinklers; dusting apparatus, non-electric; aerosol dispensers, not for medical purposes; electric devices for attracting and killing insects; fly swatters.

---

(260) AM 2015 75371 A  
 (800) 1186176  
 (891) 2013 09 18  
 (731) SWATCH AG (SWATCH SA)  
 (SWATCH LTD.)  
 Jakob-Stämpfli-Strasse 94, CH-2502  
 Biel/Bienne, Switzerland  
 (540)

## ISKIN

(511)  
 9 – Apparatus for recording, transmission and reproduction of sound or images; magnetic recording media, sound recording disks; compact disks, DVDs and other digital recording media; apparatus enabling the playing of compressed sound files (mp3);

calculating machines and data processing equipment, software; games for mobile telephones, for computers and for digital personal stereos; electronic game software for mobile telephones, for computers and for digital personal stereos; computers, portable computers, handheld computers, mobile computers, personal computers, wrist computers, electronic tablets and mobile and computer devices, digital personal stereos, mobile telephones and new-generation mobile telephones incorporating greater functionality (smartphones); telecommunications apparatus and instruments; apparatus for recording, transmission, reproduction of sound or images, particularly mobile telephones and new-generation mobile telephones incorporating greater functionality (smartphones); handheld electronic apparatus for accessing the Internet and sending, receiving, recording and storing of short messages, electronic messages, telephone calls, faxes, video-conferences, images, sound, music, text and other digital data; handheld electronic apparatus for wireless receiving, storing and transmitting of data or messages; handheld electronic apparatus for monitoring and organizing personal information; handheld electronic apparatus for global positioning [GPS] and displaying maps and transport information; handheld electronic devices for detecting, monitoring, storing, surveillance and transmitting data relating to the user activity, namely position, itinerary, distance traveled, heart rate; covers for computers, portable and mobile telephones; optical apparatus and instruments, particularly spectacles, sunglasses, magnifying glasses; cases for spectacles, magnifying glasses and sunglasses; batteries for electronic apparatus and computers, batteries for timepieces and chronometric instruments.

14 – Precious metals and their alloys and goods made of these materials or coated therewith included in this class, namely figurines, trophies; jewelry, namely rings, earrings, cuff links, bracelets, charms, brooches, chains, necklaces, tie pins, tie clips, jewelry caskets (cases), cases; precious stones, semi-precious stones; timepieces and chronometric instruments, namely chronometers, chronographs, clocks, watches, wristwatches, wall clocks, alarm clocks as well as parts and accessories for the aforesaid goods, namely hands, anchors, pendulums, barrels, watch cases, watch straps, watch dials, clockworks, watch chains, movements for timepieces, watch springs, watch glasses, presentation cases for timepieces, cases for timepieces.

---

(260) AM 2015 75378 A  
 (800) 1186203  
 (891) 2013 09 24  
 (731) TSN Brands LTD  
 Geneva Place, Waterfront Drive, P.O. Box  
 3469, Road Town, Tortola, British Virgin  
 Islands

(540)

**MIO MIO**

(511)

32 – Beer; ginger beer; malt beer; preparations for making liqueurs; beer wort; extracts of hops for making beer.

33 – Aperitifs; arrack [arak]; brandy; wine; piquette; whisky; vodka; kirsch; gin; digesters [liqueurs and spirits]; cocktails; curacao; anise [liqueur]; liqueurs; pre-mixed alcoholic beverages, other than beer-based; alcoholic beverages, except beer; alcoholic beverages containing fruit; spirits [beverages]; distilled beverages; mead [hydromel]; peppermint liqueurs; bitters; rum; sake; perry; cider; rice alcohol; alcoholic extracts; fruit extracts, alcoholic; alcoholic essences.

(260) AM 2015 75379 A

(800) 1186204

(891) 2013 09 24

(731) TSN Brands LTD

Geneva Place, Waterfront Drive, P.O. Box  
3469, Road Town, Tortola British Virgin  
Islands

(540)

**VAMPIRE**

(511)

33 – Aperitifs; arrack [arak]; brandy; wine; piquette; whisky; vodka; anisette [liqueur]; kirsch; gin; digesters [liqueurs and spirits]; cocktails; curacao; anise [liqueur]; liqueurs; pre-mixed alcoholic beverages, other than beer-based; alcoholic beverages, except beer; alcoholic beverages containing fruit; spirits [beverages]; distilled beverages; mead [hydromel]; peppermint liqueurs; bitters; rum; sake; cider; perry; rice alcohol; alcoholic extracts; fruit extracts, alcoholic; alcoholic essences.

(260) AM 2015 75381 A

(800) 1186205

(891) 2013 09 24

(731) TSN Brands LTD

Geneva Place, Waterfront Drive, P.O. Box  
3469, Road Town, Tortola, British Virgin  
Islands

(540)

**IMPRESSO**

(511)

32 – Beer.

33 – Aperitifs; arrack [arak]; brandy; wine; piquette; whisky; vodka; gin; digesters [liqueurs and spirits]; cocktails; liqueurs; alcoholic beverages, except beer; alcoholic beverages containing fruit; spirits [beverages]; distilled beverages; mead [hydromel]; peppermint liqueurs; bitters; rum; sake; cider; rice alcohol;

alcoholic extracts; fruit extracts, alcoholic; alcoholic essences.

(260) AM 2015 75382 A

(800) 1186220

(891) 2013 09 20

(731) EGIS GYÓGYSZERGYÁR  
NYILVÁNOSAN MŰKÖDŐ  
RÉSZVÉNYTÁRSASÁG

Keresztúri út 30-38, H-1106 Budapest,  
Hungary

(540)

**GIFENASIN**

(511)

5 – Pharmaceutical preparations for human use.

(260) AM 2015 75383 A

(800) 1186223

(891) 2013 10 28

(731) ALLNEX IP SARL

76, Grand-Rue, L-1660 LUXEMBOURG,  
Luxembourg

(540)



(591) Black, white

(511)

1 – Chemicals used in industry, science, photography, as well as in agriculture, horticulture and forestry; unprocessed artificial resins; unprocessed plastics; manure for agriculture; fire extinguishing compositions; tempering and soldering preparations; chemical products used for preserving foodstuffs; tanning materials; adhesives for use in industry; synthetic hardeners and synthetic resins; chemical additives for use in the manufacture of lacquers; unsaturated polyester resins for use in the production of lacquers and shaped objects.

2 – Dyes, varnishes, lacquers; preservatives against rust and against deterioration of wood; dyestuffs; mordants; raw natural resins; metals in foil and powder form for painters, decorators, printers and artists; water lacquers; enameled lacquers; mastic; binders for lacquers.

(260) AM 2015 75384 A

(800) 1186236

(891) 2013 11 05

(731) N.V. NUTRICIA

Eerste Stationsstraat 186, NL-2712 HM  
ZOETERMEER, Netherlands

(540)

**PROFUTURA**

(511)

5 – Food for special medical purposes; dietetic substances adapted for medical use; food for babies, including milk for babies and infants; food for babies with special nutritional needs; nutritional dietary supplements for medical use; nutritional products for medical use; foodstuffs and drinks for pregnant and breast-feeding women, for medical use; nutritional supplements and vitamin and mineral preparations for women, preconceptual, during and after pregnancy, all for medical use; vitamin waters; vitamin drinks; dietary supplemental drinks.

29 – Milk and milk products.

30 – Cereals and preparations made from cereals; breakfast cereals.

32 – Non-alcoholic beverages enriched with additional minerals, not being for medical use; non-alcoholic beverages enriched with added vitamins, not for medical purposes; mineral waters (beverages); mineral-enriched non-alcoholic beverages; flavoured waters (beverages); fruit beverages and fruit juices.

(260) AM 2015 75385 A

(800) 1186238

(891) 2013 11 01

(731) OBSHCHESTVO S OGRANICHENNOI OTVETSTVENNOSTYU "INTEL"

Varshavskove shosse, d. 75, korp. 1,

RU-117556 Moscow, Russian Federation

(540)

## Comte de la Fère, Athos

(511)

32 – Beer; mineral and aerated waters and other non-alcoholic beverages; fruit beverages and fruit juices; syrups and other preparations for making beverages.

33 – Alcoholic beverages (except beers).

(260) AM 2015 75388 A

(800) 591517

(891) 2013 01 07

(731) Door International B.V.

Staalweg 19, NL-4104 AS CULEMBORG,

Netherlands

(540)



(591) Black, white

(511)

41 – Education, teaching and instruction; correspondence courses; editing of educational radio and television programs; language lessons; production of films; rental of films; book and magazine loans and dissemination; publication and editing of books, newspapers and magazines.

(260) AM 2015 75389 A

(800) 599418

(891) 2013 08 19

(731) Ludwig Schokolade GmbH &amp; Co. KG

Senefelderstrasse 44, 51469 Bergisch

Gladbach, Germany

(540)

## Schogetten

(511)

30 – Cocoa, oats cocoa, cocoa products, namely chocolate compounds and toppings; chocolate, sugar confectionery, marzipan, marzipan substitutes, cooking compounds and filling compounds; chocolate and sugar confectionery for use as Christmas tree trimmings; pralines filled with liquids, particularly with wines and spirits, candy, bakery, pastry and confectionery articles, cakes, biscuits, cookies, rusks, yeast, baking powder, pudding mix, ice cream, fruit ice, yeast extracts for food, powder for edible ices.

(260) AM 2015 75391 A

(800) 610399

(891) 2013 11 11

(731) COVEX, S.A.

5, calle Acero, Polígono Industrial, E-28770

COLMENAR VIEJO, Spain

(540)

## INTELECTOL

(511)

5 – Pharmaceutical, veterinary and sanitary-pharmaceutical products; dietetic substances for medical use, food for babies; plasters, materials for dressings; materials for filling teeth and making dental impressions; disinfectants; preparations for destroying vermin; fungicides, herbicides.

(260) AM 2015 75392 A

(800) 1028190

(891) 2013 10 16

(731) SMART PROJECTS S.R.L.

Via Romano, 12, I-10010 Scarmagno (TO),

Italy

(540)

## ARDUINO

(511)

9 – Peripheral devices (computer); stand alone general purpose micro controller boards used for calculation and interface to low voltage electronic components, electromechanical components and electronic systems like personal computers, modems and wireless devices.

(260) AM 2015 75393 A

(800) 1116769

(891) 2013 09 11

(731) SOLBRTT AS  
Viljandi str.91e, EE-79514 Rapla, Estonia  
(540)

## NUPPI

(511)  
5 – Food for babies.  
30 – Gruel with a milk base for food.

(260) AM 2015 75394 A  
(800) 1186250  
(891) 2013 10 22  
(731) JAPAN TOBACCO INC.  
2-2-1 Toranomom, Minato-ku, Tokyo, Japan  
(540)

## IMAGINEERING THE FUTURE

(511)  
34 – Tobacco, raw or manufactured; smoking tobacco, pipe tobacco, rolling tobacco, chewing tobacco, moist tobacco powder called "snus"; cigarettes, cigars, cigarillos; substances for smoking sold separately or mixed with tobacco for non-medical and non-therapeutic purposes; snuff; smokers' articles included in this class; cigarette paper, cigarette tubes and matches.

(260) AM 2015 75395 A  
(800) 1186258  
(891) 2013 10 16  
(731) SASSA MODE GMBH  
Mauchentalstr. 71, 72574 Bad Urach, Germany  
(540)

## sassa mode

(511)  
25 – Clothing, footwear, headgear.

(260) AM 2015 75397 A  
(800) 1186282  
(891) 2013 09 13  
(731) CHERY HEAVY INDUSTRY CO., LTD  
The Eighth, Ninth, Tenth Floor, Lianhe  
Building, Sanshan District, 241080 Wuhu  
City, China  
(540)

## DETANK

(591) Black, white  
(511)  
7 – Agricultural machines; harvesting machines; succulence cut-off machines; woodworking machines; drying machines (tea manufacturing); rice hullers [machines]; mineral water making machines; mineworking machines; agitators; excavators; ho-

ists; metalworking machines; diesel engines (not including for land vehicles); turbines other than for land vehicles; motors other than for land vehicles; centrifugal machines; road sweeping machines (self propelled).

11 – Light bulbs; oil lamps; electric water heaters; cooling installations for liquids; drying apparatus for fodder and forage; drying apparatus and installations; heat accumulators; flushing installations; disinfectant apparatus; lighters.

12 – Vehicles for locomotion by land, air, water or rail; fork lift trucks; tractors; mine cart wheels; carriages; wheel tires for vehicles; aeroplanes; boats; electric vehicles.

(260) AM 2015 75400 A  
(800) 1186381  
(891) 2013 11 14  
(731) CELGENE CORPORATOIN  
86 Morris Avenue, Summit NJ 07901, USA  
(540)

## ONCRUZO

(511)  
5 – Pharmaceutical preparations, namely, cytokine inhibitory drugs; pharmaceutical preparations that modulate the immune system; pharmaceutical preparations for the treatment of blood disease and cancer.

(260) AM 2015 75401 A  
(800) 1186382  
(891) 2013 11 14  
(731) CELGENE CORPORATOIN  
86 Morris Avenue, Summit NJ 07901, USA  
(540)

## EMCRUZO

(511)  
5 – Pharmaceutical preparations, namely, cytokine inhibitory drugs; pharmaceutical preparations that modulate the immune system; pharmaceutical preparations for the treatment of blood disease and cancer.

(260) AM 2015 75403 A  
(800) 1186383  
(891) 2013 11 14  
(731) CELGENE CORPORATOIN  
86 Morris Avenue, Summit NJ 07901, USA  
(540)

## OKEZLI

(511)  
5 – Pharmaceutical preparations, namely, cytokine inhibitory drugs; pharmaceutical preparations that modulate the immune system; pharmaceutical preparations for the treatment of blood disease and cancer.

(260) AM 2015 75404 A  
 (800) 1186384  
 (891) 2013 11 14  
 (731) CELGENE CORPORATOIN  
 86 Morris Avenue, Summit NJ 07901, USA  
 (540)

## ONUREG

(511)  
 5 – Pharmaceutical preparations, namely, cytokine inhibitory drugs; pharmaceutical preparations that modulate the immune system; pharmaceutical preparations for the treatment of blood disease and cancer.

(260) AM 2015 75406 A  
 (800) 1186387  
 (891) 2013 11 14  
 (731) CELGENE CORPORATION  
 86 Morris Avenue, Summit, NJ 07901, USA  
 (540)

## RYORLO

(511)  
 5 – Pharmaceutical preparations, namely, cytokine inhibitory drugs; pharmaceutical preparations that modulate the immune system; pharmaceutical preparations for the treatment of blood disease and cancer.

(260) AM 2015 75410 A  
 (800) 1186399  
 (891) 2013 09 20  
 (731) EGIS GYÓGYSZERGYÁR  
 NYILVÁNOSAN MŰKÖDŐ  
 RÉSZVÉNYTÁRSASÁG  
 Keresztúri út 30-38, H-1106 Budapest,  
 Hungary  
 (540)

## TRINDOLIS

(511)  
 5 – Pharmaceutical preparations for human use.

(260) AM 2015 75411 A  
 (800) 1186400  
 (891) 2013 09 20  
 (731) EGIS GYÓGYSZERGYÁR  
 NYILVÁNOSAN MŰKÖDŐ  
 RÉSZVÉNYTÁRSASÁG  
 Keresztúri út 30-38, H-1106 Budapest,  
 Hungary  
 (540)

## TRIOTENS

(511)  
 5 – Pharmaceutical preparations for human use.

(260) AM 2015 75412 A  
 (800) 1186433  
 (891) 2013 10 29

(731) ACINO PHARMA AG  
 Birsweg 2, CH-4253 Liesberg Switzerland  
 (540)

## OPTIPATCH

(511)  
 5 – Pharmaceutical and veterinary products; plasters, materials for dressings; medical plasters.

(260) AM 2015 75423 A  
 (800) 1186484  
 (891) 2013 10 21  
 (731) DALIA MOCKAITIENĖ  
 Apuolės g. 88, LT-48305 Kaunas,  
 Lithuania  
 (540)

## SWEET LESSON

(511)  
 30 – Chocolate and chocolate candies (educational puzzles).

(260) AM 2015 75424 A  
 (800) 1186494  
 (891) 2013 10 29  
 (731) 2Wheel-Distribution GmbH & Co. KG  
 Erich-Blum-Str. 33, 71665 Vaihingen/Enz,  
 Germany  
 (540)

## O'NEAL

(511)  
 28 – Kidney belts and elbow protectors for motorcyclists and cyclists.

(260) AM 2015 75425 A  
 (800) 1186509  
 (891) 2013 05 24  
 (731) KAZIM ÖZEREN  
 İkitelli Org., Çorapçılar San. Sit., E Blok  
 No:1, Basakşehir-Istanbul, Turkey  
 (540)

**O N U R C A N**

**Ç O R A P**

(591) Black, white  
 (511)  
 25 – Socks for women, men, kids.

(260) AM 2015 75430 A  
 (800) 1186526  
 (891) 2013 07 01  
 (731) AYONA IP LIMITED  
 Thasou, 3, Dadlaw House, CY-1520 Nicosia,  
 Cyprus

(540)

**AYONA**

(591) Black, white

(511)

5 – Acaricides; aconitine; alkaloids for medical purposes; alginates for pharmaceutical purposes; algicides; aldehydes for pharmaceutical purposes; dental amalgams of gold; dental amalgams; amino acids for veterinary purposes; amino acids for medical purposes; analgesics; anaesthetics; antibiotics; antiseptics; medicine cases, portable, filled; first-aid boxes, filled; aluminium acetate for pharmaceutical purposes; acetates for pharmaceutical purposes; germicides; balms for medical purposes; bandages for dressings; biocides; bracelets for medical purposes; anti-rheumatism bracelets; bromine for pharmaceutical purposes; paper for mustard plasters; fly catching paper; mothproofing paper; petroleum jelly for medical purposes; vaccines; oxygen baths; antiseptic cotton; aseptic cotton; absorbent cotton; wadding for medical purposes; cotton for medical purposes; dietetic substances adapted for medical use; radiological contrast substances for medical purposes; nutritive substances for microorganisms; radioactive substances for medical purposes; melissa water for pharmaceutical purposes; sea water for medicinal bathing; mineral waters for medical purposes; thermal water; dietary fiber; molding wax for dentists; gases for medical purposes; guaiacol for pharmaceutical purposes; haematogen; haemoglobin; hydrastine; hydrastinine; glycerine for medical purposes; glycerophosphates; glucose for medical purposes; gentian for pharmaceutical purposes; hormones for medical purposes; mustard for pharmaceutical purposes; mustard plasters; mud for baths; medicinal mud; gamboge for medical purposes; gurjun [gurjon, gurjan] balsam for medical purposes; air deodorising preparations; deodorants, other than for human beings or for animals; deodorants for clothing and textiles; diastase for medical purposes; digitalin; mineral food supplements; nutritional supplements; albumin dietary supplements; dietary supplements for animals; alginate dietary supplements; glucose dietary supplements; casein dietary supplements; lecithin dietary supplements; flaxseed oil dietary supplements; propolis dietary supplements; protein dietary supplements; protein supplements for animals; royal jelly dietary supplements; pollen dietary supplements; wheat germ dietary supplements; flaxseed dietary supplements; enzyme dietary supplements; yeast for pharmaceutical purposes; gelatine for medical purposes; cod liver oil; isotopes for medical purposes; insecticides; iodine for pharmaceutical purposes; iodides for pharmaceutical purposes; alkaline iodides for pharmaceutical purposes; iodoform; calomel; cream of tartar for pharmaceutical purposes; tartar for pharmaceutical purposes; camphor for medical purposes; capsules for medicines; cachets

for pharmaceutical purposes; haemostatic pencils; wart pencils; caustic pencils; headache pencils; carbolineum [parasiticide]; caustics for pharmaceutical purposes; cachou for pharmaceutical purposes; quassia for medical purposes; quebracho for medical purposes; oxygen for medical purposes; gallic acid for pharmaceutical purposes; acids for pharmaceutical purposes; adhesives for dentures; stem cells for veterinary purposes; stem cells for medical purposes; cocaine; collodion for pharmaceutical purposes; corn rings for the feet; anti-rheumatism rings; candy, medicated; angostura bark for medical purposes; barks for pharmaceutical purposes; cedar wood for use as an insect repellent; condurango bark for medical purposes; croton bark; mangrove bark for pharmaceutical purposes; myrobalan bark for pharmaceutical purposes; cinchona for medical purposes; medicinal roots; rhubarb roots for pharmaceutical purposes; lint for medical purposes; starch for dietetic or pharmaceutical purposes; creosote for pharmaceutical purposes; blood for medical purposes; cultures of microorganisms for medical and veterinary use; curare; dental lacquer; liquorice for pharmaceutical purposes; lactose for pharmaceutical purposes; candy for medical purposes; adhesive plasters; medicines for alleviating constipation; adhesive bands for medical purposes; lecithin for medical purposes; lotions for veterinary purposes; dog lotions; lotions for pharmaceutical purposes; personal sexual lubricants; lupulin for pharmaceutical purposes; magnesia for pharmaceutical purposes; liniments; ointments for pharmaceutical purposes; sunburn ointments; mercurial ointments; frostbite salve for pharmaceutical purposes; gauze for dressings; medicinal oils; mustard oil for medical purposes; camphor oil for medical purposes; castor oil for medical purposes; oil of turpentine for pharmaceutical purposes; dill oil for medical purposes; dental mastics; dental abrasives; dental impression materials; teeth filling material; dressings, medical; surgical dressings; drugs for medical purposes; medicines for veterinary purposes; serotherapeutic medicines; medicines for human purposes; medicines for dental purposes; menthol; medicinal drinks; moleskin for medical purposes; milk of almonds for pharmaceutical purposes; royal jelly for pharmaceutical purposes; milk ferments for pharmaceutical purposes; irish moss for medical purposes; flour for pharmaceutical purposes; flaxseed meal for pharmaceutical purposes; fish meal for pharmaceutical purposes; fly catching adhesives; mint for pharmaceutical purposes; dietetic beverages adapted for medical purposes; malted milk beverages for medical purposes; narcotics; medicinal infusions; tincture of iodine; eucalyptol for pharmaceutical purposes; tinctures for medical purposes; opium; opodeldoc; decoctions for pharmaceutical purposes; antiparasitic collars for animals; stick liquorice for pharmaceutical purposes; sulphur sticks [disinfectants]; lozenges for pharmaceutical

purposes; pectin for pharmaceutical purposes; pepsins for pharmaceutical purposes; peptones for pharmaceutical purposes; hydrogen peroxide for medical purposes; food for babies; leeches for medical purposes; blood plasma; eyepatches for medical purposes; poultices; compresses; scapulars for surgical purposes; diapers [babies' napkins]; bunion pads; breast-nursing pads; pomades for medical purposes; powder of cantharides; pyrethrum powder; belts for sanitary napkins [towels]; anti-uric preparations; bacterial preparations for medical and veterinary use; bacteriological preparations for medical and veterinary use; balsamic preparations for medical purposes; albuminous preparations for medical purposes; biological preparations for veterinary purposes; biological preparations for medical purposes; veterinary preparations; bismuth preparations for pharmaceutical purposes; vitamin preparations; diagnostic preparations for medical purposes; therapeutic preparations for the bath; haemorrhoid preparations; preparations for callouses; preparations to facilitate teething; preparations for the treatment of burns; fumigation preparations for medical purposes; opotherapy preparations; air purifying preparations; eyewashes; bronchodilating preparations; preparations for reducing sexual activity; sterilising preparations; soil-sterilising preparations; corn remedies; pharmaceutical preparations for treating dandruff; preparations for destroying noxious animals; herbicides; preparations for destroying dry rot fungus; larvae exterminating preparations; fly destroying preparations; preparations for destroying mice; slug exterminating preparations; vermin destroying preparations; pharmaceutical preparations for skin care; contact lens cleaning preparations; preparations of lime for pharmaceutical purposes; bath preparations, medicated; medicinal hair growth preparations; opiates; anticryptogamic preparations; aloe vera preparations for pharmaceutical purposes; preparations of trace elements for human and animal use; sulfonamides [medicines]; pharmaceutical preparations; sunburn preparations for pharmaceutical purposes; enzyme preparations for veterinary purposes; enzyme preparations for medical purposes; chemico-pharmaceutical preparations; chemical preparations for veterinary purposes; chemical preparations for the diagnosis of pregnancy; chemical preparations to treat wheat blight [smut]; vine disease treating chemicals; chemical preparations to treat mildew; chemical preparations for treating phylloxera; chemical preparations for pharmaceutical purposes; chilblain preparations; mothproofing preparations; collyrium; goulard water; chemical conductors for electrocardiograph electrodes; albuminous foodstuffs for medical purposes; dietetic foods adapted for medical purposes; by-products of the processing of cereals for dietetic or medical purposes; sanitary napkins; napkins for incontinents; menstruation bandages; panty liners [sanitary]; propolis for pharmaceutical

purposes; pearl powder for medical purposes; radium for medical purposes; hydrated chloral for pharmaceutical purposes; solvents for removing adhesive plasters; vaginal washes; solutions for contact lenses; chemical reagents for medical or veterinary purposes; gum for medical purposes; rubber for dental purposes; chewing gum for medical purposes; insect repellents; insect repellent incense; repellents for dogs; tissues impregnated with pharmaceutical lotions; sarsaparilla for medical purposes; sugar for medical purposes; asthmatic tea; fumigating pastilles; flaxseed for pharmaceutical purposes; tobacco-free cigarettes for medical purposes; siccatives [drying agents] for medical purposes; syrups for pharmaceutical purposes; turpentine for pharmaceutical purposes; milking grease; greases for veterinary purposes; greases for medical purposes; lacteal flour for babies; soporifics; bicarbonate of soda for pharmaceutical purposes; bath salts for medical purposes; salts for mineral water baths; salts for medical purposes; potassium salts for medical purposes; sodium salts for medical purposes; smelling salts; mineral water salts; malt for pharmaceutical purposes; semen for artificial insemination; alcohol for pharmaceutical purposes; alloys of precious metals for dental purposes; ergot for pharmaceutical purposes; cooling sprays for medical purposes; adjuvants for medical purposes; styptic preparations; anthelmintics; vermifuges; disinfectants for hygiene purposes; disinfectants for chemical toilets; douching preparations for medical purposes; appetite suppressants for medical purposes; medical preparations for slimming purposes; parasiticides; mouthwashes for medical purposes; febrifuges; depuratives; animal washes; detergents for medical purposes; cattle washes; dog washes; vesicants; articles for headache; evacuants; remedies for perspiration; remedies for foot perspiration; chemical contraceptives; antiparasitic preparations; sedatives; laxatives; tonics [medicines]; nervines; digestives for pharmaceutical purposes; bouillons for bacteriological cultures; steroids; strychnine; suppositories; serums; tanning pills; appetite suppressant pills; slimming pills; yeast dietary supplements; antioxidant pills; menstruation tampons; vulnerary sponges; thymol for pharmaceutical purposes; biological tissue cultures for veterinary purposes; biological tissue cultures for medical purposes; surgical cloth [tissues]; smoking herbs for medical purposes; medicinal herbs; surgical implants [living tissues]; pants, absorbent, for incontinents; menstruation knickers; babies' napkin-pants [diaper-pants]; charcoal for pharmaceutical purposes; fennel for medical purposes; porcelain for dental prostheses; phenol for pharmaceutical purposes; enzymes for veterinary purposes; enzymes for medical purposes; ferments for pharmaceutical purposes; formic aldehyde for pharmaceutical purposes; phosphates for pharmaceutical purposes; fungicides; quinine for medical purposes; chinoline for

medical purposes; diabetic bread adapted for medical use; chloroform; flowers of sulphur for pharmaceutical purposes; cement for animal hooves; bone cement for surgical and orthopaedic purposes; dental cements; medicinal tea; herbal teas for medicinal purposes; eucalyptus for pharmaceutical purposes; tobacco extracts [insecticides]; extracts of hops for pharmaceutical purposes; elixirs [pharmaceutical preparations]; ethers for pharmaceutical purposes; esters for pharmaceutical purposes; cellulose esters for pharmaceutical purposes; cellulose ethers for pharmaceutical purposes; jujube, medicated; rat poison; poisons; bacterial poisons; jalap.

9 – Dvd players; ticket dispensers; juke boxes, musical; answering machines; motor fire engines; accumulators, electric; accumulators, electric, for vehicles; actinometers; alidades; altimeters; ammeters; anemometers; anodes; aerials; anticathodes; apertometers [optics]; high-frequency apparatus; testing apparatus not for medical purposes; remote control apparatus; electro-dynamic apparatus for the remote control of railway points; electro-dynamic apparatus for the remote control of signals; monitoring apparatus, electric; sound recording apparatus; global positioning system [gps] apparatus; distillation apparatus for scientific purposes; diffraction apparatus [microscopy]; air analysis apparatus; apparatus to check franking; sound transmitting apparatus; apparatus for fermentation [laboratory apparatus]; breathing apparatus for underwater swimming; breathing apparatus, except for artificial respiration; apparatus and installations for the production of X-rays, not for medical purposes; cash registers; electric apparatus for commutation; intercommunication apparatus; stills for laboratory experiments; projection apparatus; radiological apparatus for industrial purposes; x-ray apparatus not for medical purposes; blueprint apparatus; blinkers [signalling lights]; stereoscopic apparatus; telephone apparatus; facsimile machines; phototelegraphy apparatus; igniting apparatus, electric, for igniting at a distance; acid hydrometers; salinometers; acidimeters for batteries; aerometers; beacons, luminous; accumulator jars; barometers; anode batteries; galvanic batteries; batteries for lighting; solar batteries; batteries, electric; balances [steelyards]; betatrons; binoculars; electronic tags for goods; lens hoods; magnetic tape units for computers; computer memory devices; fire hose nozzles; encoded identification bracelets, magnetic; safety tarpaulins; signalling buoys; life buoys; marking buoys; directional compasses; vacuum gauges; electrolyzers; variometers; verniers; scales; letter scales; weighbridges; precision balances; levelling staffs [surveying instruments]; camcorders; video cassettes; video telephones; video screens; viewfinders, photographic; plugs, sockets and other contacts [electric connections]; micrometer screws for optical instruments; viscosimeters; circuit closers; wavemeters; voltmeters; switchboxes [electricity]; current

rectifiers; gas testing instruments; gasometers [measuring instruments]; galvanometers; hands free kits for phones; heliographic apparatus; hygrometers; hydrometers; weights; peepholes [magnifying lenses] for doors; holograms; plotters; loudspeakers; sounding leads; plumb bobs; range finders; densimeters; densitometers; optical goods; detectors; smoke detectors; counterfeit [false] coin detectors; slides [photography]; slide projectors; diaphragms [photography]; dictating machines; dynamometers; light-emitting diodes [led]; floppy disks; phonograph records; disks, magnetic; optical discs; calculating disks; disk drives for computers; juke boxes for computers; dna chips; electronic notice boards; bullet-proof waistcoats [vests (am.)]; life jackets; identification threads for electric wires; nose clips for divers and swimmers; locks, electric; bells [warning devices]; alarm bells, electric; electric door bells; signal bells; acoustic conduits; mirrors for inspecting work; road signs, luminous or mechanical; mechanical signs; signs, luminous; marine depth finders; probes for scientific purposes; buzzers; needles for record players; measures; pressure measuring apparatus; simulators for the steering and control of vehicles; inverters [electricity]; pressure indicators; temperature indicators; incubators for bacteria culture; measuring instruments; cosmographic instruments; mathematical instruments; levelling instruments; instruments containing eyepieces; surveying instruments; azimuth instruments; interfaces for computers; ionization apparatus not for the treatment of air or water; spark-guards; coaxial cables; fibre [fiber (am.)] optic cables; cables, electric; calipers; slide calipers; screw-tapping gauges; calculating machines; pocket calculators; decompression chambers; cinematographic cameras; electronic pens [visual display units]; holders for electric coils; identity cards, magnetic; video game cartridges; encoded magnetic cards; riding helmets; protective helmets; carriers for dark plates [photography]; automated teller machines [atm]; cathodes; spools [photography]; choking coils [impedance]; coils, electric; electromagnetic coils; cinematographic film, exposed; computer keyboards; solenoid valves [electromagnetic switches]; wire connectors [electricity]; electronic agendas; push buttons for bells; mouse pads; magnetic encoders; anti-dazzle shades; collectors, electric; calibrating rings; protective suits for aviators; commutators; compact discs [audio-video]; compact discs [read-only memory]; comparators; marine compasses; computers; laptop computers; notebook computers; capacitors; contacts, electric; wind socks for indicating wind direction; branch boxes [electricity]; distribution boxes [electricity]; junction boxes [electricity]; accumulator boxes; cabinets for loudspeakers; diving suits; garments for protection against fire; galena crystals [detectors]; reflecting discs for wear, for the prevention of traffic accidents; covers for electric outlets; logs [meas-



ring instruments]; lasers, not for medical purposes; lactodensimeters; lactometers; vacuum tubes [radio]; darkroom lamps [photography]; thermionic tubes; amplifying tubes; flashlights [photography]; head cleaning tapes [recording]; magnetic tapes; videotapes; surveying chains; fire escapes; rulers [measuring instruments]; slide-rules; contact lenses; correcting lenses [optics]; optical lenses; optical condensers; sounding lines; electricity conduits; measuring spoons; magnifying glasses [optics]; thread counters; magnets; decorative magnets; crash test dummies; resuscitation mannequins [teaching apparatus]; mouse [data processing equipment]; manometers; divers' masks; solderers' helmets; protective masks; materials for electricity mains [wires, cables]; voting machines; money counting and sorting machines; material testing instruments and machines; furniture especially made for laboratories; megaphones; portable media players; diaphragms [acoustics]; diaphragms for scientific apparatus; metal detectors for industrial or military purposes; metronomes; rules [measuring instruments]; carpenters' rules; dress-makers' measures; mechanisms for coin-operated apparatus; mechanisms for counter-operated apparatus; coin-operated mechanisms for television sets; shutter releases [photography]; micrometer gauges; micrometers; microprocessors; microscopes; microtomes; microphones; modems; lightning arresters; monitors [computer hardware]; monitors [computer programs]; terminals [electricity]; junction sleeves for electric cables; cases fitted with dissecting instruments [microscopy]; teeth protectors; knee-pads for workers; headphones; surveyors' levels; sound recording carriers; magnetic data media; optical data media; socks, electrically heated; computer software, recorded; sheaths for electric cables; identification sheaths for electric wires; weighing machines; punched card machines for offices; life saving apparatus and equipment; shoes for protection against accidents, irradiation and fire; objectives [lenses] [optics]; lenses for astrophotography; egg-candlers; fire extinguishers; electrified fences; limiters [electricity]; clothing for protection against accidents, irradiation and fire; clothing for protection against fire; asbestos clothing for protection against fire; clothing especially made for laboratories; ozonisers [ozonators]; octants; eyepieces; ohmmeters; wrist rests for use with computers; spectacle frames; eyeglass frames; oscillographs; plumb lines; mirrors [optics]; spectacles [optics]; sunglasses; goggles for sports; signalling panels, luminous or mechanical; radio pagers; eyeglasses; pince-nez; electronic pocket translators; transmitters [telecommunication]; telephone transmitters; transmitters of electronic signals; switches, electric; periscopes; gloves for divers; gloves for protection against accidents; gloves for protection against x-rays for industrial purposes; asbestos gloves for protection against accidents; furnaces for laboratory use; pipettes; pyrometers;

planimeters; plane tables [surveying instruments]; plates for batteries; wafers for integrated circuits; printed circuit boards; compact disc players; cassette players; sound recording strips; x-ray films, exposed; films, exposed; life-saving rafts; laboratory trays; semi-conductors; polarimeters; fire engines; measuring glassware; life belts; fuses; circuit breakers; converters, electric; telerupters; food analysis apparatus; diagnostic apparatus, not for medical purposes; distance recording apparatus; distance measuring apparatus; speed measuring apparatus [photography]; appliances for measuring the thickness of leather; apparatus for measuring the thickness of skins; speed checking apparatus for vehicles; teaching apparatus; time recording apparatus; hemline markers; apparatus and instruments for astronomy; surveying apparatus and instruments; weighing apparatus and instruments; nautical apparatus and instruments; navigational instruments; optical apparatus and instruments; apparatus and instruments for physics; chemistry apparatus and instruments; measuring apparatus; measuring devices, electric; boiler control instruments; meteorological instruments; naval signalling apparatus; observation instruments; navigation apparatus for vehicles [on-board computers]; satellite navigational apparatus; regulating apparatus, electric; precision measuring apparatus; audio- and video-receivers; prisms [optics]; printers for use with computers; hemline markers; retorts' stands; apparatus for changing record player needles; drainers for use in photography; cleaning apparatus for phonograph records; fire beaters; sighting telescopes for firearms; test tubes; pressure indicator plugs for valves; magnetic wires; telegraph wires; telephone wires; wires, electric; conductors, electric; copper wire, insulated; fuse wire; computer programmes [programs], recorded; computer game programmes; computer programs [downloadable software]; computer operating programs, recorded; record players; central processing units [processors]; rods for water diviners; electronic publications, downloadable; distribution consoles [electricity]; control panels [electricity]; radar apparatus; masts for wireless aerials; transmitting sets [telecommunication]; radios; vehicle radios; sprinkler systems for fire protection; frames for photographic transparencies; screens for photoengraving; walkie-talkies; voltage surge protectors; voltage regulators for vehicles; stage lighting regulators; light dimmers [regulators], electric; speed regulators for record players; cell switches [electricity]; washing trays [photography]; marking gauges [joinery]; time switches, automatic; relays, electric; safety restraints, other than for vehicle seats and sports equipment; x-ray photographs, other than for medical purposes; rheostats; respirators for filtering air; respirators, other than for artificial respiration; retorts; refractometers; refractors; grids for batteries; speaking tubes; horns for loudspeakers; saccharometers; light conducting fila-

ments [optical fibers [fibres]]; traffic-light apparatus [signalling devices]; dog whistles; signalling whistles; sextants; inductors [electricity]; life nets; nets for protection against accidents; fire alarms; signals, luminous or mechanical; sirens; scanners [data processing equipment]; integrated circuit cards [smart cards]; connections for electric lines; connections, electric; connectors [electricity]; sonars; sound locating instruments; lighting ballasts; resistances, electric; spectrograph apparatus; spectrosopes; speed indicators; alcoholmeters; satellites for scientific purposes; protection devices for personal use against accidents; audiovisual teaching apparatus; radiotelegraphy sets; radiotelephony sets; spectacle lenses; glass covered with an electrical conductor; anti-glare glasses; optical glass; personal stereos; stereoscopes; stands for photographic apparatus; fire boats; sulphitometers; drying racks [photography]; spherometers; integrated circuits; printed circuits; counters; parking meters; kilometer recorders for vehicles; revolution counters; abacuses; egg timers [sandglasses]; taximeters; ear plugs for divers; tachometers; television apparatus; telegraphs [apparatus]; telescopes; teleprompters; teleprinters; portable telephones; theodolites; thermometers, not for medical purposes; thermostats; thermostats for vehicles; crucibles [laboratory]; tone arms for record players; totalizers; transistors [electronic]; transponders; protactors [measuring instruments]; transformers [electricity]; step-up transformers; vehicle breakdown warning triangles; triodes; starter cables for motors; discharge tubes, electric, other than for lighting; capillary tubes; neon signs; x-ray tubes not for medical purposes; telephone receivers; gauges; quantity indicators; automatic indicators of low pressure in vehicle tires [tyres]; gasoline gauges; water level indicators; electric loss indicators; light-emitting electronic pointers; clinometers; levels [instruments for determining the horizontal]; mercury levels; spirit levels; urinometers; amplifiers; particle accelerators; electric installations for the remote control of industrial operations; steering apparatus, automatic, for vehicles; balancing apparatus; video recorders; sound reproduction apparatus; invoicing machines; tape recorders; protection devices against x-rays, not for medical purposes; railway traffic safety appliances; data processing apparatus; oxygen transvasing apparatus; theft prevention installations, electric; film cutting apparatus; drying apparatus for photographic prints; optical character readers; centering apparatus for photographic transparencies; dosage dispensers; battery chargers; chargers for electric batteries; acoustic [sound] alarms; sounding apparatus and machines; editing appliances for cinematographic films; cathodic anti-corrosion apparatus; couplers [data processing equipment]; anti-theft warning apparatus; computer peripheral devices; anti-interference devices [electricity]; demagnetizing apparatus for magnetic tapes; acoustic couplers;

alarms; fog signals, non-explosive; whistle alarms; adding machines; readers [data processing equipment]; heat regulating apparatus; photocopiers [photographic, electrostatic, thermic]; bar code readers; downloadable ring tones for mobile phones; downloadable image files; downloadable music files; animated cartoons; filters [photography]; filters for respiratory masks; filters for ultraviolet rays, for photography; usb flash drives; magic lanterns; optical lamps; signal lanterns; cameras [photography]; glazing apparatus for photographic prints; shutters [photography]; darkrooms [photography]; photometers; flash-bulbs [photography]; enlarging apparatus [photography]; photovoltaic cells; containers for contact lenses; spectacle cases; eyeglass cases; containers for microscope slides; cases especially made for photographic apparatus and instruments; chromatography apparatus for laboratory use; chronographs [time recording apparatus]; laboratory centrifuges; eyeglass chains; cyclotrons; compasses [measuring instruments]; frequency meters; time clocks [time recording devices]; fire blankets; chips [integrated circuits]; jigs [measuring instruments]; pedometers; meteorological balloons; electrified rails for mounting spot lights; asbestos screens for firemen; fire hose; protective helmets for sports; cell phone straps; eyeglass cords; tripods for cameras; switchboards; distribution boards [electricity]; screens [photography]; workmen's protective face-shields; projection screens; radiology screens for industrial purposes; fluorescent screens; exposure meters [light meters]; ducts [electricity]; galvanic cells; epidiascopes; ergometers; armatures [electricity].

14 – Agates; diamonds; amulets [jewellery, jewelry (am.)]; anchors [clock and watch making]; barrels [clock and watch making]; bracelets [jewellery, jewelry (am.)]; straps for wristwatches; charms [jewellery, jewelry (am.)]; key rings [trinkets or fobs]; brooches [jewellery, jewelry (am.)]; alarm clocks; pins [jewellery, jewelry (am.)]; ornamental pins; tie pins; beads for making jewelry; pearls made of ambroid [pressed amber]; busts of precious metal; jet, unwrought or semi-wrought; pearls [jewellery, jewelry (am.)]; copper tokens; tie clips; cuff links; badges of precious metal; gold, unwrought or beaten; cloisonné jewellery [jewelry (am.)]; ivory [jewellery, jewelry (am.)]; works of art of precious metal; jewellery; jewellery of yellow amber; iridium; precious stones; semi-precious stones; spun silver [silver wire]; necklaces [jewellery, jewelry (am.)]; rings [jewellery, jewelry (am.)]; boxes of precious metal; watch cases; clock cases; pendulums [clock and watch making]; medals; locketts [jewellery, jewelry (am.)]; precious metals, unwrought or semi-wrought; movements for clocks and watches; clockworks; coins; gold thread [jewellery, jewelry (am.)]; threads of precious metal [jewellery, jewelry (am.)]; silver thread; olivine [gems]; osmium; palladium; platinum [metal]; chronometrical instruments; watch

springs; rhodium; ruthenium; stopwatches; silver, unwrought or beaten; earrings; ingots of precious metals; alloys of precious metal; statues of precious metal; statuettes of precious metal; watch crystals; paste jewellery [costume jewelry (am.)]; clock hands [clock and watch making]; ornaments [jewellery, jewelry (am.)]; shoe ornaments of precious metal; hat ornaments of precious metal; ornaments of jet; cases for watches [presentation]; cases for clock- and watchmaking; chronographs [watches]; chronometers; chronoscopes; chains [jewellery, jewelry (am.)]; watch chains; dials [clock and watch making]; atomic clocks; watches; sundials; clocks and watches, electric; cont.

16 – Fountain pens; aquarelles; albums; almanacs; document laminators for office use; mimeograph apparatus and machines; atlases; posters; paper bows; table linen of paper; tickets; forms, printed; announcement cards [stationery]; note books; pads [stationery]; drawing pads; loose-leaf binders; wristbands for the retention of writing instruments; pamphlets; booklets; paper sheets [stationery]; waxed paper; paper for recording machines; electrocardiograph paper; electrocardiograph paper; drawer liners of paper, perfumed or not; wood pulp paper; carbon paper; copying paper [stationery]; parchment paper; writing paper; luminous paper; modelling wax, not for dental purposes; signboards of paper or cardboard; patterns for making clothes; patterns for dressmaking; newspapers; electrotypes; hectographs; modelling clay; terrestrial globes; drawing sets; engravings; slate pencils; pencil leads; document holders [stationery]; pencil holders; chalk holders; holders for checkbooks [cheque books]; holders for stamps [seals]; diagrams; engraving plates; writing slates; blackboards; galley racks [printing]; drawing boards; advertisement boards of paper or cardboard; duplicators; punches [office requisites]; cream containers of paper; magazines [periodicals]; money clips; tags for index cards; pen clips; bookmarks; etching needles; tracing needles for drawing purposes; periodicals; printed publications; cardboard articles; paper shredders for office use; graphic representations; credit card imprinters, non-electric; graining combs; drawing instruments; calendars; tracing paper; tracing cloth; tracing patterns; gums [adhesives] for stationery or household purposes; lithographic stones; ink stones [ink reservoirs]; pencils; pencil lead holders; charcoal pencils; pictures; decalcomanias; paintings [pictures], framed or unframed; wood pulp board [stationery]; cardboard; hat boxes of cardboard; files [office requisites]; cards; index cards [stationery]; geographical maps; paper tapes and cards for the recordal of computer programmes; trading cards other than for games; perforated cards for jacquard looms; catalogues; spools for inking ribbons; covers of paper for flower pots; paintbrushes; painters' brushes; writing brushes; typewriter keys; glue for stationery or household purposes;

isinglass for stationery or household purposes; gluten [glue] for stationery or household purposes; starch paste [adhesive] for stationery or household purposes; printing blocks; books; manifolds [stationery]; comic books; drawing pins; cigar bands; envelopes [stationery]; cases for stamps [seals]; boxes of cardboard or paper; paint boxes [articles for use in school]; correcting fluids [office requisites]; stencils [stationery]; french curves; paper ribbons; typewriter ribbons; gummed tape [stationery]; adhesive bands for stationery or household purposes; correcting tapes [office requisites]; inking ribbons; inking ribbons for computer printers; adhesive tapes for stationery or household purposes; self-adhesive tapes for stationery or household purposes; drawing rulers; square rulers; absorbent sheets of paper or plastic for foodstuff packaging; humidity control sheets of paper or plastic for foodstuff packaging; viscose sheets for wrapping; sheets of reclaimed cellulose for wrapping; plastic bubble packs for wrapping or packaging; steel letters; letters [type]; lithographs; paint trays; architects' models; postage stamps; plastics for modelling; graphic prints; modelling materials; teaching materials [except apparatus]; sealing compounds for stationery purposes; adhesives [glues] for stationery or household purposes; bookbinding material; packaging material made of starches; filtering materials [paper]; addressing machines; electric or non-electric pencil sharpening machines; bookbinding apparatus and machines [office equipment]; typewriters, electric or non-electric; folders [stationery]; franking machines for office use; chalk for lithography; writing chalk; tailors' chalk; marking chalk; bags [envelopes, pouches] of paper or plastics, for packaging; garbage bags of paper or of plastics; painters' easels; hand-rests for painters; writing cases [stationery]; printing sets, portable [office requisites]; bibs of paper; stickers [stationery]; finger-stalls [office requisites]; bookbinding cords; paper knives [cutters] [office requisites]; numbering apparatus; bottle envelopes of cardboard or paper; sealing wafers; covers [stationery]; passport holders; plastic cling film, extensible, for palletization; embroidery designs [patterns]; handwriting specimens for copying; oleographs; musical greeting cards; greeting cards; postcards; etchings; conical paper bags; bags for microwave cooking; palettes for painters; ink sticks; pantographs [drawing instruments]; folders for papers; papier mâché; pastels [crayons]; modelling paste; boxes for pens; bookbindings; pen wipers; office perforators; pens [office requisites]; nibs of gold; nibs; steel pens; drawing pens; song books; seals [stamps]; sealing stamps; clipboards; address plates for addressing machines; handkerchiefs of paper; plastic film for wrapping; writing pads; letter trays; trays for sorting and counting money; coasters of paper; bookends; stamp stands; mats for beer glasses; stands for pens and pencils; photograph stands; inking pads; stamp pads; binding

strips [bookbinding]; towels of paper; inking sheets for document reproducing machines; inking sheets for duplicators; bookbinding cloth; gummed cloth for stationery purposes; printers' blankets, not of textile; paperweights; writing cases [sets]; inkstands; office requisites, except furniture; writing materials; writing instruments; drawing materials; school supplies [stationery]; adhesive tape dispensers [office requisites]; hand labelling appliances; printed matter; lithographic works of art; prospectuses; printed timetables; ledgers [books]; printers' galleys; indexes; rubber erasers; elastic bands for offices; drawing t-squares; graphic reproductions; penholders; marking pens [stationery]; napkins of paper for removing make-up; face towels of paper; table napkins of paper; place mats of paper; tablemats of paper; tablecloths of paper; paper clasps; document files [stationery]; scrapers [erasers] for offices; paper-clips; clips for offices; erasing products; biological samples for use in microscopy [teaching materials]; histological sections for teaching purposes; steatite [tailor's chalk]; writing board erasers; composing frames [printing]; sealing wax; arithmetical tables; placards of paper or cardboard; writing or drawing books; fabrics for bookbinding; stationery; pencil sharpeners, electric or non-electric; transparencies [stationery]; stencil plates; cardboard tubes; indian inks; moisteners [office requisites]; moisteners for gummed surfaces [office requisites]; drawing squares; chart pointers, non-electronic; bottle wrappers of cardboard or paper; envelope sealing machines, for offices; sealing machines for offices; vignetting apparatus; apparatus for mounting photographs; stapling presses [office requisites]; handbooks [manuals]; figurines [statuettes] of papier mâché; paper coffee filters; flags of paper; flyers; silver paper; molds for modelling clays [artists' materials]; photo-engravings; photographs [printed]; stencil cases; canvas for painting; chromolithographs [chromos]; compasses for drawing; numbers [type]; artists' watercolor [watercolour] saucers; correcting ink [heliography]; ink; inkwells; blueprints; chaplets; stencils; erasing shields; balls for ball-point pens; cabinets for stationery [office requisites]; printing type; address stamps; stamps [seals]; shields [paper seals]; prints [engravings]; labels, not of textile.

18 – Alpenstocks; pocket wallets; card cases [note-cases]; reins; harness fittings; parts of rubber for stirrups; chamois leather, other than for cleaning purposes; umbrellas; parasols; saddlery; frames for umbrellas or parasols; handbag frames; cases, of leather or leatherboard; valves of leather; whips; imitation leather; leather, unworked or semi-worked; leatherboard; casings, of leather, for springs; umbrella rings; hat boxes of leather; boxes of leather or leather board; boxes of vulcanised fibre; chain mesh purses; purses; fastenings for saddles; butts [parts of hides]; saddle trees; bags [envelopes, pouches] of

leather, for packaging; moleskin [imitation of leather]; travelling sets [leatherware]; knee-pads for horses; muzzles; halters; vanity cases, not fitted; leather thread; furniture coverings of leather; gut for making sausages; clothing for pets; trimmings of leather for furniture; collars for animals; music cases; slings for carrying infants; gold beaters' skin; cat o' nine tails; leather leads; pads for horse saddles; horseshoes; girths of leather; coverings of skins [furs]; horse blankets; bandoliers; briefcases; traces [harness]; fur; haversacks; leather straps; straps for soldiers' equipment; harness straps; straps for skates; straps of leather [saddlery]; chin straps, of leather; stirrup leathers; umbrella handles; walking cane handles; suitcase handles; backpacks; travelling bags; riding saddles; net bags for shopping; umbrella or parasol ribs; stirrups; bags for climbers; sling bags for carrying infants; garment bags for travel; valises; handbags; tool bags of leather, empty; beach bags; bags for sports; bags for campers; shopping bags; wheeled shopping bags; school bags; pouch baby carriers; travelling trunks; nose bags [feed bags]; bridoons; canes; umbrella sticks; walking stick seats; bits for animals [harness]; bridles [harness]; harness for animals; key cases; horse collars; trunks [luggage]; suitcases; attaché cases; covers for horse-saddles; umbrella covers; kid; curried skins; animal skins; cattle skins; leather laces; blinders [harness]; game bags [hunting accessories].

20 – Picture frame brackets; reels, not of metal, non-mechanical, for flexible hoses; pulleys of plastics for blinds; bolts, not of metal; casks of wood for decanting wine; mooring buoys, not of metal; casks, not of metal; barrels, not of metal; identification bracelets, not of metal, for hospitals; sideboards; busts of wood, wax, plaster or plastic; costume stands; bolsters; fans for personal use, non-electric; work benches; vice benches, not of metal; coat hangers; coatstands; shoulder poles [yokes]; screws, not of metal; display stands; showcases [furniture]; newspaper display stands; artificial honeycombs; signboards of wood or plastics; loading gauge rods, not of metal, for railway waggons [wagons]; nuts, not of metal; covers for clothing [wardrobe]; nesting boxes; coffins; doors for furniture; curtain holders, not of textile material; dowels, not of metal; divans; kennels for household pets; keyboards for hanging keys; display boards; flagpoles; plugs [dowels], not of metal; containers, not of metal, for liquid fuel; troughs, not of metal, for mixing mortar; packaging containers of plastic; flower-stands [furniture]; curtain tie-backs; cable or pipe clips of plastics; binding screws, not of metal, for cables; rivets, not of metal; tortoiseshell imitation; locks, not of metal, for vehicles; locks, other than electric, not of metal; bead curtains for decoration; door bolts not of metal; bottle closures, not of metal; closures, not of metal, for containers; latches, not of metal; mirrors [looking glasses]; hand-held mirrors [toilet mirrors]; bamboo;

scratching posts for cats; animal claws; animal hooves; coral; meerschaum; whalebone, unworked or semi-worked; stag antlers; tortoiseshell; shells; horn, unworked or semi-worked; animal horns; rattan; ivory, unworked or semi-worked; corozo; plaited straw, except matting; wickerwork; hampers [baskets]; works of art, of wood, wax, plaster or plastic; cabinet work; reeds [plaiting materials]; settees; curtain rods; index cabinets [furniture]; reels of wood for yarn, silk, cord; drain traps [valves] of plastic; water-pipe valves of plastic; valves, not of metal, other than parts of machines; staves of wood; plastic key cards, not encoded; mats for infant playpens; saw horses; bed casters, not of metal; furniture casters, not of metal; brush mountings; chopping blocks [tables]; wind chimes [decoration]; bottle caps, not of metal; bassinets; tent pegs, not of metal; curtain rings; chests of drawers; floating containers, not of metal; containers, not of metal [storage, transport]; lecterns; dog kennels; bakers' bread baskets; baskets, not of metal; trays, not of metal; bottle casings of wood; taps for casks, not of metal; armchairs; hairdressers' chairs; deck chairs; hospital beds; bedsteads of wood; beds; edgings of plastic for furniture; table tops; coathooks, not of metal; curtain hooks; clothes hooks, not of metal; beds for household pets; nesting boxes for household pets; ladders of wood or plastics; playpens for babies; dressmakers' dummies; air mattresses, not for medical purposes; spring mattresses; mattresses; hydrostatic beds, not for medical purposes; furniture of metal; office furniture; school furniture; sleeping bags for camping; mobiles [decoration]; curtain rails; house numbers, not of metal, non-luminous; barrel hoops, not of metal; furniture; moldings for picture frames; furniture partitions of wood; mother-of-pearl, unworked or semi-worked; mirror tiles; ambroid plates; numberplates, not of metal; identity plates, not of metal; loading pallets, not of metal; handling pallets, not of metal; transport pallets, not of metal; head-rests [furniture]; stakes for plants or trees; trestles [furniture]; magazine racks; book rests [furniture]; stands for calculating machines; flower-pot pedestals; baby changing mats; pet cushions; pillows; cushions; air cushions, not for medical purposes; air pillows, not for medical purposes; mats, removable, for sinks; racks [furniture]; library shelves; shelves for filing-cabinets [furniture]; furniture shelves; comb foundations for beehives; shelves for storage; wood ribbon; straw edgings; towel closets [furniture]; hat stands; cask stands, not of metal; inflatable publicity objects; counters [tables]; bedding, except linen; corks for bottles; corks; sealing caps, not of metal; stair rods; standing desks; embroidery frames; towel dispensers, fixed, not of metal; picture frames; sections of wood for beehives; reservoirs, not of metal nor of masonry; fodder racks; curtain rollers; tool handles, not of metal; knife handles, not of metal; door handles, not of metal; scythe handles, not of metal; bro-

om handles, not of metal; knobs, not of metal; fishing baskets; writing desks; seats of metal; benches [furniture]; vats, not of metal; honeycombs; sofas; bungs, not of metal; statues of wood, wax, plaster or plastic; figurines [statuettes] of wood, wax, plaster or plastic; oyster shells; silvered glass [mirrors]; ambroid bars; umbrella stands; gun racks; carts for computers [furniture]; dressing tables; washstands [furniture]; shelves for typewriters; draughtman's tables; massage tables; tables of metal; baby changing platforms; desks; tea carts; dinner wagons [furniture]; tables; steps [ladders], not of metal; chairs [seats]; high chairs for babies; bins, not of metal; placards of wood or plastics; footstools; crates; trolleys [furniture]; straw plaits; boarding stairs, not of metal, mobile, for passengers; straw mattresses; decorations of plastic for foodstuffs; beehives; funerary urns; winding spools, not of metal, non-mechanical, for flexible hoses; wax figures; door fittings, not of metal; coffin fittings, not of metal; bed fittings, not of metal; furniture fittings, not of metal; window fittings, not of metal; infant walkers; garment covers [storage]; stuffed animals; stuffed birds; hinges, not of metal; easy chairs; poles, not of metal; screens [furniture]; cupboards; filing cabinets; medicine cabinets; meat chests, not of metal; plate racks; bamboo curtains; paper blinds; slatted indoor blinds; woven timber blinds [furniture]; indoor window blinds [shades] [furniture]; interior textile window blinds; fire screens, domestic; yellow amber; lockers; bins of wood or plastic; chests for toys; letter boxes, not of metal or masonry; bottle racks.

21 – Autoclaves [pressure cookers], non-electric; indoor aquaria; buckets; china ornaments; dishes; paper plates; vegetable dishes; saucers; boxes for sweetmeats; bottles; carboys; busts of china, terra-cotta or glass; vases; epergnes; fruit cups; bird baths; baby baths, portable; plungers for clearing blocked drains; waffle irons, non-electric; coolers [ice pails]; buckets made of woven fabrics; whisks, non-electric, for household purposes; cooking skewers, of metal; rails and rings for towels; clothing stretchers; hair for brushes; birdcages; funnels; carpet beaters [hand instruments]; signboards of porcelain or glass; candle extinguishers; flower pots; chamber pots; glue-pots; cruets; decanters; large-toothed combs for the hair; combs for animals; tea cosies; abrasive sponges for scrubbing the skin; sponges for household purposes; toilet sponges; deodorising apparatus for personal use; sponge holders; toothpick holders; dishes for soap; napkin holders; holders for flowers and plants [flower arranging]; shaving brush stands; toilet paper holders; soap dispensers; ironing boards; cutting boards for the kitchen; bread boards; washing boards; strainers; smoke absorbers for household purposes; containers for household or kitchen use; kitchen containers; glass jars [carboys]; heat-insulated containers; heat insulated containers for beverages; thermally insulated containers for food; glass

flasks [containers]; frying pans; closures for pot lids; buckskin for cleaning; toothpicks; ceramics for household purposes; majolica; works of art, of porcelain, terra-cotta or glass; brush goods; domestic grinders, non-electric; cleaning instruments, hand-operated; cabarets [trays]; stew-pans; covers, not of paper, for flower pots; shaving brushes; cages for household pets; polishing leather; hot pots, not electrically heated; glass bulbs [receptacles]; boot trees [stretchers]; napkin rings; poultry rings; rings for birds; piggy banks; bread baskets, domestic; baskets for domestic use; waste paper baskets; feeding troughs; mangers for animals; lunch boxes; cookie jars; tea caddies; washtubs; earthenware saucepans; mess-tins; cauldrons; coffee percolators, non-electric; coffee-pots, non-electric; coffee grinders, hand-operated; fused silica [semi-worked product], other than for building; beer mugs; tankards; rat traps; pot lids; aquarium hoods; butter-dish covers; covers for dishes; cheese-dish covers; buttonhooks; jugs; perfume burners; non-electric portable coolers (am.); watering cans; insect traps; mixing spoons [kitchen utensils]; basting spoons, for kitchen use; scoops [tableware]; pie servers; spatulas [kitchen utensils]; butter dishes; material for brush-making; polishing materials for making shiny, except preparations, paper and stone; noodle machines, hand-operated; polishing apparatus and machines, for household purposes, non-electric; pepper mills, hand-operated; mills for domestic purposes, hand-operated; feather-dusters; brooms; isothermic bags; confectioners' decorating bags [pastry bags]; mixers, manual [cocktail shakers]; basins [bowls]; mosaics of glass, not for building; saucepan scourers of metal; soap boxes; mouse traps; cooking pot sets; nozzles for watering cans; spouts; nozzles for sprinkler hose; fitted picnic baskets, including dishes; toilet cases; floss for dental purposes; fiberglass thread, not for textile use; cookie [biscuit] cutters; pastry cutters; sprinklers; sprinklers for watering flowers and plants; cotton waste for cleaning; wool waste for cleaning; cleaning tow; chopsticks; cocktail stirrers; pepper pots; gloves for household purposes; polishing gloves; gardening gloves; plates to prevent milk boiling over; trays for domestic purposes; trays for domestic purposes, of paper; lazy susans; heaters for feeding bottles, non-electric; candlesticks; trivets [table utensils]; coasters, not of paper and other than table linen; menu card holders; knife rests for the table; flat-iron stands; egg cups; grill supports; abrasive pads for kitchen purposes; pads for cleaning; drinking troughs; powdered glass for decoration; pottery; pots; cooking pots; painted glassware; tableware, other than knives, forks and spoons; porcelain ware; crockery; crystal [glassware]; cosmetic utensils; toilet utensils; trouser presses; cruet sets for oil and vinegar; make-up removing appliances; spice sets; food cooling devices, containing heat exchange fluids, for household purposes; apparatus for wax-

polishing, non-electric; bottle openers; glove stretchers; bootjacks; crumb trays; tie presses; clothespins; glass caps; powder compacts; perfume sprayers; powder puffs; dusting apparatus, non-electric; toilet paper dispensers; combs; electric combs; griddles [cooking utensils]; sifters [household utensils]; drinking horns; shoe horns; candle rings; salad bowls; sugar bowls; beaters, non-electric; services [dishes]; coffee services [tableware]; liqueur sets; tea services [tableware]; sieves [household utensils]; cinder sifters [household utensils]; tea strainers; pipettes [wine-tasters]; siphons for carbonated water; rolling pins, domestic; steel wool for cleaning; currycombs; blenders, non-electric, for household purposes; fruit presses, non-electric, for household purposes; drinking straws; salt cellars; drinking vessels; vessels of metal for making ices and iced drinks; refrigerating bottles; cups of paper or plastic; glass [receptacles]; drinking glasses; statues of porcelain, earthenware, ceramic or glass; figurines [statuettes] of porcelain, ceramic, earthenware or glass; glass for vehicle windows [semi-finished product]; plate glass [raw material]; opal glass; opaline glass; glass incorporating fine electrical conductors; enamelled glass; glass, unworked or semi-worked, except building glass; glass wool other than for insulation; vitreous silica fibers [fibres], not for textile use; fiberglass other than for insulation or textile use; clothes racks, for drying; soup bowls; drying racks for washing; basins [receptacles]; table plates; disposable table plates; graters [household utensils]; insulating flasks; indoor terrariums [plant cultivation]; indoor terrariums [vivariums]; cloth for washing floors; cloths for cleaning; dusting cloths [rags]; furniture dusters; litter boxes [trays] for pets; urns; aerosol dispensers, not for medical purposes; wax-polishing appliances, non-electric, for shoes; water apparatus for cleaning teeth and gums; electric devices for attracting and killing insects; sprinkling devices; utensils for household purposes; kitchen utensils; cooking utensils, non-electric; strainers for household purposes; coffee filters, non-electric; flasks; bottle gourds; molds [kitchen utensils]; cake molds [moulds]; ice cube molds [moulds]; cookery molds [moulds]; deep fryers, non-electric; comb cases; bread bins; fly catchers [traps or whisks]; teapots; kettles, non-electric; cups; garlic presses [kitchen utensils]; ironing board covers, shaped; tea balls; glass bowls; mops; mop wringers; corkscrews; animal bristles [brushware]; pig bristles; dishwashing brushes; brushes for cleaning tanks and containers; lamp-glass brushes; horse brushes; scrubbing brushes; toothbrushes; toothbrushes, electric; carpet sweepers; brushes for footwear; tar-brushes, long handled; toilet brushes; electric brushes, except parts of machines; brushes; eyebrow brushes; nail brushes; nest eggs, artificial; boxes of metal, for dispensing paper towels; garbage cans; window-boxes; boxes of glass.

24 – Frieze [cloth]; velvet; household linen; diapered linen; bath linen, except clothing; bed linen; table linen, not of paper; buckram; dimity; felt; gauze [cloth]; damask; jersey [fabric]; table runners; drugget; shower curtains of textile or plastic; curtains of textile or plastic; net curtains; zephyr [cloth]; banners; canvas for tapestry or embroidery; bolting cloth; crepe [fabric]; crepon; marabouts [cloth]; furniture coverings of textile; fabrics for textile use; filtering materials of textile; wall hangings of textile; non-woven textile fabrics; plastic material [substitute for fabrics]; textile material; sleeping bags [sheeting]; moleskin [fabric]; pillowcases; mattress covers; bed blankets; brocades; handkerchiefs of textile; travelling rugs [lap robes]; coasters [table linen]; linings [textile]; hat linings, of textile, in the piece; curtain holders of textile material; bed covers; bed covers of paper; coverings of plastic for furniture; towels of textile; hemp cloth; gummed cloth, other than for stationery; printers' blankets of textile; cloth; door curtains; bed clothes; sheets [textile]; eiderdowns [down coverlets]; washing mitts; shrouds; glass cloths [towels]; napkins, of cloth, for removing make-up; face towels of textile; tablemats, not of paper; place mats, not of paper; serviettes of textile; mosquito nets; calico; oilcloth for use as tablecloths; tablecloths, not of paper; billiard cloth; taffeta [cloth]; ticks [mattress covers]; tick [linen]; lingerie fabric; fabric, impervious to gases, for aeronautical balloons; jute fabric; fabric for footwear; ramie fabric; esparto fabric; rayon fabric; fiberglass fabrics, for textile use; adhesive fabric for application by heat; linen cloth; upholstery fabrics; hemp fabric; lining fabric for shoes; traced cloths for embroidery; chenille fabric; printed calico cloth; bunting; knitted fabric; cotton fabrics; silk fabrics for printing patterns; woollen cloth; elastic woven material; fabric; fabric of imitation animal skins; haircloth [sackcloth]; cheese cloth; tulle; flags, not of paper; flannel [fabric]; sanitary flannel; trellis [cloth]; covers for cushions; fitted toilet lid covers of fabric; covers [loose] for furniture; pillow shams; cheviots [cloth]; silk [cloth]; labels of cloth.

25 – Wimples; bandanas [neckerchiefs]; underclothing; sweat-absorbent underclothing [underwear]; berets; overalls; boas [necklets]; teddies [undergarments]; half-boots; ski boots; boots for sports; breeches for wear; trousers; football boots; brassieres; detachable collars; collars [clothing]; shirt yokes; veils [clothing]; gabardines [clothing]; galoshes; neckties; ascots; leg warmers; gaiters; boot uppers; corselets; jerseys [clothing]; vests; singlets; hosiery; heels; pants; hoods [clothing]; hat frames [skeletons]; pockets for clothing; collar protectors; cap peaks; tights; slips [undergarments]; combinations [clothing]; wet suits for water-skiing; bodices [lingerie]; corsets [underclothing]; suits; bathing suits; masquerade costumes; beach clothes; jackets [clothing]; stuff jackets [clothing]; fishing vests; leggings

[trousers]; liveries; camisoles; cuffs; short-sleeve shirts; mantillas; coats; sleep masks; furs [clothing]; mittens; miters [hats]; muffs [clothing]; footmuffs, not electrically heated; heelpieces for footwear; bibs, not of paper; fur stoles; ear muffs [clothing]; socks; beach shoes; sports shoes; footwear; paper clothing; outerclothing; ready-made clothing; motorists' clothing; cyclists' clothing; clothing for gymnastics; clothing of imitations of leather; clothing of leather; uniforms; clothing; fittings of metal for footwear; maniples; overcoats; parkas; pelerines; gloves [clothing]; ski gloves; pyjamas; bathing trunks; shirt fronts; scarfs; pocket squares; dresses; waterproof clothing; headbands [clothing]; garters; sock suspenders; stocking suspenders; ready-made linings [parts of clothing]; dress shields; soles for footwear; suspenders; lace boots; ponchos; girdles; belts [clothing]; money belts [clothing]; layettes [clothing]; non-slipping devices for footwear; pullovers; heelpieces for stockings; welts for footwear; chasubles; shirts; wooden shoes; sandals; bath sandals; boots; sarongs; jumper dresses; saris; sweaters; footwear uppers; inner soles; bath slippers; togas; knitwear [clothing]; underpants; gymnastic shoes; slippers; shoes; skull caps; turbans; headgear for wear; aprons [clothing]; tee-shirts; dressing gowns; bath robes; top hats; tips for footwear; stockings; sweat-absorbent stockings; shawls; caps [headwear]; paper hats [clothing]; shower caps; bathing caps; sashes for wear; studs for football boots; hats; babies' pants [clothing]; gaiter straps; pelisses; esparto shoes or sandals; skirts; petticoats; skorts.

28 – Arcade video game machines; video game machines; gaming machines for gambling; amusement machines, automatic and coin-operated; toy vehicles; swimming pools [play articles]; trampolines; novelties for parties, dances [party favors, favours]; scratch cards for playing lottery games; starting blocks for sports; body boards; skating boots with skates attached; dolls' feeding bottles; stationary exercise bicycles; creels [fishing traps]; shuttlecocks; spinning tops [toys]; jigsaw puzzles; clay pigeons [targets]; punching bags; bite sensors [fishing tackle]; hang gliders; flying discs [toys]; discuses for sports; dolls' houses; dominoes; swimming kick boards; surfboards; spring boards [sports articles]; skateboards; sailboards; chessboards; checkerboards; darts; Christmas trees of synthetic material; cups for dice; swimming jackets; ascenders [mountaineering equipment]; kites; toys; toys for domestic pets; stuffed toys; plush toys; mobiles [toys]; practical jokes [novelties]; parlor games; board games; ring games; games; building games; kaleidoscopes; bladders of balls for games; rosin used by athletes; edges of skis; bingo cards; playing cards; fairground ride apparatus; reels for fishing; rocking horses; swings; skittles; ninepins; billiard cues; golf clubs; hockey sticks; seal skins [coverings for skis]; bells for Christmas trees; dolls' rooms; confetti; explosive

bonbons [christmas crackers]; ice skates; roller skates; in-line roller skates; dice; paintballs [sports apparatus]; ski bindings; dolls' beds; roulette wheels; fish hooks; building blocks [toys]; dolls; flippers for swimming; lines for fishing; gut for fishing; bows for archery; skis; waterskis; surf skis; mah-jong; wax for skis; hunting game calls; marionettes; toy masks; theatrical masks; fencing masks; masts for sailboards; teddy bears; chalk for billiard cues; targets; electronic targets; scale model kits [toys]; scale model vehicles; balls for games; artificial fishing bait; billiard table cushions; knee guards [sports articles]; billiard cue tips; elbow guards [sports articles]; dolls' clothes; fencing weapons; twirling batons; paragliders; pachinkos; baseball gloves; boxing gloves; golf gloves; gloves for games; batting gloves [accessories for games]; fencing gauntlets; piñatas; toy pistols; air pistols [toys]; detonating caps [toys]; caps for pistols [toys]; rattles [playthings]; horseshoe games; candle holders for christmas trees; christmas tree stands; sole coverings for skis; floats for bathing and swimming; floats for fishing; portable games with liquid crystal displays; swimming belts; decoys for hunting or fishing; scent lures for hunting or fishing; archery implements; kite reels; soap bubbles [toys]; divot repair tools [golf accessories]; billiard markers; protective paddings [parts of sports suits]; bats for games; surfboard leashes; harness for sailboards; weight lifting belts [sports articles]; sling shots [sports articles]; rollers for stationary exercise bicycles; harpoon guns [sports articles]; scooters [toys]; sleighs [sports articles]; bob-sleighs; butterfly nets; landing nets for anglers; nets for sports; tennis nets; bite indicators [fishing tackle]; scrapers for skis; slot machines [gaming machines]; appliances for gymnastics; quoits; bar-bells; climbers' harness; fishing tackle; artificial snow for christmas trees; snowshoes; snowboards; clay pigeon traps; billiard tables; coin-operated billiard tables; tables for table tennis; tables for indoor football; strings for rackets; gut for rackets; cricket bags; golf bags, with or without wheels; slides [playthings]; radio-controlled toy vehicles; body-building apparatus; machines for physical exercises; backgammon games; men's athletic supporters [sports articles]; rods for fishing; ornaments for christmas trees, except illumination articles and confectionery; tennis ball throwing apparatus; conjuring apparatus; apparatus for games; bowling apparatus and machinery; counters [discs] for games; chips for gambling; bags especially designed for skis and surfboards; marbles for games; billiard balls; playing balls; play balloons; paintballs [ammunition for paintball guns] [sports apparatus]; snow globes; chess games; checkers [games]; poles for pole vaulting; paper party hats; shin guards [sports articles]; camouflaged screens [sports articles]; chest expanders [exercisers].

35 – Arranging subscriptions to telecommunication services for others; import-export agencies; commer-

cial information agencies; advertising agencies; cost price analysis; rental of advertising space; business auditing; employment agencies; computerized file management; accounting; invoicing; business efficiency expert services; demonstration of goods; transcription; opinion polling; marketing studies; business information; commercial information and advice for consumers [consumer advice shop]; business investigations; business research; marketing research; personnel recruitment; business management and organization consultancy; business organization consultancy; business management consultancy; personnel management consultancy; professional business consultancy; layout services for advertising purposes; marketing; business management of performing artists; business management of sports people; news clipping services; updating of advertising material; word processing; organization of exhibitions for commercial or advertising purposes; arranging newspaper subscriptions for others; organization of fashion shows for promotional purposes; organization of trade fairs for commercial or advertising purposes; shop window dressing; business appraisals; payroll preparation; data search in computer files for others; sponsorship search; business management assistance; commercial or industrial management assistance; presentation of goods on communication media, for retail purposes; economic forecasting; auctioneering; sales promotion for others; production of advertising films; office machines and equipment rental; rental of advertising time on communication media; publicity material rental; rental of vending machines; rental of photocopying machines; publication of publicity texts; radio advertising; outdoor advertising; distribution of samples; dissemination of advertising matter; direct mail advertising; writing of publicity texts; advertising; on-line advertising on a computer network; advertising by mail order; television advertising; document reproduction; compilation of statistics; compilation of information into computer databases; business inquiries; systemization of information into computer databases; advisory services for business management; tax preparation; drawing up of statements of accounts; publicity columns preparation; telemarketing services; psychological testing for the selection of personnel; business management of hotels; commercial administration of the licensing of the goods and services of others; administrative processing of purchase orders; public relations; modelling for advertising or sales promotion; typing; relocation services for businesses; price comparison services; secretarial services; procurement services for others [purchasing goods and services for other businesses]; short-hand; outsourcing services [business assistance]; telephone answering for unavailable subscribers; photocopying services.

36 – Credit bureaux; debt collection agencies; real estate agencies; financial analysis; renting of apar-



tments; leasing of real estate; rental of offices [real estate]; leasing of farms; hire-purchase financing; savings bank services; accommodation bureaux [apartments]; rent collection; issuing of travellers' checks [cheques]; issuance of credit cards; issue of tokens of value; capital investments; insurance information; financial information; clearing, financial; insurance consultancy; financial consultancy; stock exchange quotations; lending against security; business liquidation services, financial; brokerage; financial management; exchanging money; home banking; debit card services; credit card services; factoring; organization of collections; antique appraisal; jewellery appraisal; financial evaluation of standing timber; stamp appraisal; real estate appraisal; numismatic appraisal; art appraisal; financial evaluation of wool; financial evaluation [insurance, banking, real estate]; repair costs evaluation [financial appraisal]; electronic funds transfer; bail-bonding; securities brokerage; housing agents; brokerage of carbon credits; insurance brokerage; loans [financing]; pawn-brokerage; check [cheque] verification; charitable fund raising; financial sponsorship; mortgage banking; instalment loans; insurance underwriting; life insurance underwriting; health insurance underwriting; accident insurance underwriting; marine insurance underwriting; fire insurance underwriting; apartment house management; real estate management; actuarial services; banking; retirement payment services; fiduciary; provident fund services; customs brokerage; mutual funds; financing services; safe deposit services; deposits of valuables; fiscal assessments.

37 – Asphaltting; drilling of deep oil or gas-wells; drilling of wells; rebuilding engines that have been worn or partially destroyed; rebuilding machines that have been worn or partially destroyed; re-treading of tires [tyres]; vulcanization of tires [tyres] [repair]; building sealing; linen ironing; pressing of clothing; disinfecting; rat exterminating; mining extraction; refilling of toner cartridges; knife sharpening; building insulating; repair information; construction information; bricklaying; riveting; construction consultation; varnishing; re-tinning; scaffolding; road paving; car wash; window cleaning; vehicle wash; building construction supervision; upholstery; renovation of clothing; rustproofing; anti-rust treatment for vehicles; sanding; pumicing; strong-room maintenance and repair; vehicle maintenance; paper hanging; painting or repair of signs; cleaning of buildings [exterior surface]; vehicle polishing; vehicle breakdown assistance [repair]; mending clothing; rental of bulldozers; rental of road sweeping machines; rental of cleaning machines; rental of cranes [construction equipment]; rental of construction equipment; rental of excavators; plumbing; masonry; cabinet making [repair]; roofing services; painting, interior and exterior; carpentry services; underwater repair; plastering; quarrying services; repair of secu-

urity locks; umbrella repair; parasol repair; motor vehicle maintenance and repair; burner maintenance and repair; film projector repair and maintenance; airplane maintenance and repair; safe maintenance and repair; clock and watch repair; pump repair; upholstery repair; shoe repair; clothing repair; photographic apparatus repair; furniture restoration; restoration of musical instruments; restoration of works of art; vehicle lubrication [greasing]; demolition of buildings; warehouse construction and repair; vehicle service stations [refuelling and maintenance]; washing; washing of linen; pipeline construction and maintenance; pier breakwater building; underwater construction; harbour construction; factory construction; building of fair stalls and shops; construction; shipbuilding; cleaning of buildings [interior]; street cleaning; vermin exterminating, other than for agriculture; artificial snow-making services; laundering; installation of doors and windows; irrigation devices installation and repair; elevator installation and repair; heating equipment installation and repair; burglar alarm installation and repair; furnace installation and repair; telephone installation and repair; air conditioning apparatus installation and repair; fire alarm installation and repair; freezing equipment installation and repair; electric appliance installation and repair; kitchen equipment installation; installation, maintenance and repair of computer hardware; machinery installation, maintenance and repair; office machines and equipment installation, maintenance and repair; interference suppression in electrical apparatus; swimming-pool maintenance; furniture maintenance; chimney sweeping; boiler cleaning and repair; cleaning of clothing; dry cleaning; vehicle cleaning; diaper cleaning; leather care, cleaning and repair; fur care, cleaning and repair.

38 – News agencies; wireless broadcasting; television broadcasting; cable television broadcasting; electronic bulletin board services [telecommunications services]; information about telecommunication; providing user access to global computer networks; providing access to databases; providing internet chatrooms; providing telecommunications connections to a global computer network; providing telecommunication channels for teleshopping services; transmission of greeting cards online; message sending; computer aided transmission of messages and images; transmission of telegrams; transmission of digital files; electronic mail; rental of message sending apparatus; rental of access time to global computer networks; rental of modems; rental of telecommunication equipment; rental of telephones; rental of facsimile apparatus; radio broadcasting; communications by fiber [fibre] optic networks; cellular telephone communication; communications by computer terminals; satellite transmission; communications by telegrams; communications by telephone; facsimile transmission; paging services [radio, telephone or other means of electronic communica-

tion]; teleconferencing services; telex services; voice mail services; telecommunications routing and junction services; telegraph services; telephone services.

39 – Air transport; motor coach rental; boat rental; garage rental; rental of vehicle roof racks; aircraft rental; parking place rental; rental of warehouses; booking of seats for travel; travel reservation; transport reservation; towing; bottling services; water distribution; delivery of newspapers; message delivery; parcel delivery; delivery of goods; delivery of goods by mail order; flower delivery; launching of satellites for others; traffic information; transportation information; storage information; transportation logistics; rescue operations [transport]; arranging of cruises; arranging of travel tours; hauling; carting; transport and storage of trash; transporting furniture; lighterage services; ferry-boat transport; removal services; transport of travellers; armored-car transport; bus transport; car transport; barge transport; boat transport; railway transport; marine transport; passenger transport; river transport; portage; refloating of ships; vehicle breakdown assistance [towing]; shipbrokerage; transport brokerage; freight brokerage [forwarding (Am.)]; car rental; railway truck rental; rental of diving bells; rental of diving suits; rental of motor racing cars; railway coach rental; rental of wheelchairs; rental of storage containers; horse rental; rental of freezers; frozen-food locker rental; vehicle rental; stevedoring; unloading cargo; electricity distribution; distribution of energy; packaging of goods; ice-breaking; piloting; water supplying; escorting of travellers; ambulance transport; streetcar transport; transport by pipeline; wrapping of goods; operating canal locks; car parking; chauffeur services; pleasure boat transport; courier services [messages or merchandise]; transport; salvaging; salvage of ships; underwater salvage; taxi transport; franking of mail; freight [shipping of goods]; freighting; physical storage of electronically-stored data or documents; boat storage; storage of goods; storage; sightseeing [tourism]; freight forwarding.

41 – Modelling for artists; academies [education]; rental of sports grounds; rental of tennis courts; lending libraries; booking of seats for shows; videotaping; physical education; discotheque services; animal training; dubbing; gambling; publication of books; education information; recreation information; entertainment information; movie studios; health club services [health and fitness training]; night clubs; layout services, other than for advertising purposes; microfilming; videotape editing; production of radio and television programmes; music-halls; production of music; game services provided on-line from a computer network; providing on-line electronic publications, not downloadable; religious education; gymnastic instruction; correspondence courses; practical training [demonstration]; organization of

balls; organization of exhibitions for cultural or educational purposes; providing recreation facilities; arranging and conducting of colloquiums; arranging and conducting of congresses; arranging and conducting of conferences; arranging and conducting of concerts; arranging and conducting of workshops [training]; arranging and conducting of seminars; arranging and conducting of symposiums; organization of competitions [education or entertainment]; arranging of beauty contests; operating lotteries; organization of fashion shows for entertainment purposes; organization of shows [impresario services]; organization of sports competitions; vocational guidance [education or training advice]; amusement parks; sign language interpretation; television entertainment; bookmobile services; vocational retraining; providing karaoke services; providing golf facilities; providing sports facilities; providing amusement arcade services; cinema presentations; presentation of live performances; theatre productions; conducting fitness classes; educational examination; timing of sports events; videotape film production; film production, other than advertising films; rental of audio equipment; rental of camcorders; rental of video cassette recorders; rental of videotapes; rental of show scenery; rental of sound recordings; toy rental; rental of movie projectors and accessories; rental of cine-films; games equipment rental; rental of stadium facilities; rental of lighting apparatus for theatrical sets or television studios; rental of radio and television sets; rental of skin diving equipment; rental of sports equipment, except vehicles; rental of stage scenery; electronic desktop publishing; publication of electronic books and journals online; publication of texts, other than publicity texts; radio entertainment; entertainer services; amusements; writing of texts, other than publicity texts; zoological garden services; news reporters services; party planning [entertainment]; music composition services; subtitling; holiday camp services [entertainment]; disc jockey services; personal trainer services [fitness training]; providing casino facilities [gambling]; calligraphy services; club services [entertainment or education]; providing museum facilities [presentation, exhibitions]; educational services; orchestra services; translation; scriptwriting services; ticket agency services [entertainment]; coaching [training]; sport camp services; recording studio services; language interpreter services; nursery schools; photography; photographic reporting; circuses; boarding schools; production of shows.

42 – Water analysis; computer system analysis; handwriting analysis [graphology]; chemical analysis; architecture; recovery of computer data; industrial design; graphic arts design; computer virus protection services; technical project studies; oil-field surveys; geological surveys; engineering; installation of computer software; meteorological information; material testing; textile testing; bacteriological

research; biological research; geological research; research in the field of environmental protection; cosmetic research; mechanical research; chemical research; research and development of new products for others; analysis for oil-field exploitation; underwater exploration; technical research; calibration [measuring]; consultancy in the design and development of computer hardware; architectural consultancy; computer software consultancy; oil-well testing; quality control; vehicle roadworthiness testing; land surveying; dress designing; updating of computer software; monitoring of computer systems by remote access; maintenance of computer software; authenticating works of art; design of interior decor; quality valuation of standing timber; quality evaluation of wool; digitization of documents [scanning]; conversion of data or documents from physical to electronic media; urban planning; provision of scientific information, advice and consultancy in relation to carbon offsetting; providing search engines for the internet; data conversion of computer programs and data [not physical conversion]; computer system design; rental of web servers; computer rental; rental of computer software; geological prospecting; oil prospecting; hosting computer sites [web sites]; duplication of computer programs; construction drafting; computer software design; cloud seeding; consultancy in the field of energy-saving; creating and maintaining web sites for others; computer programming; chemistry services; packaging design; scientific laboratory services; styling [industrial design]; physics [research]; surveying.

43 – Accommodation bureaux [hotels, boarding; houses]; rental of temporary accommodation; rental of meeting rooms; tourist homes; hotel reservations; boarding house bookings; temporary accommodation reservations; hotels; retirement homes; snack-bars; cafés; cafeterias; motels; boarding houses; boarding for animals; rental of cooking apparatus; rental of chairs, tables, table linen, glassware; rental of tents; rental of transportable buildings; rental of drinking water dispensers; restaurants; self-service restaurants; canteens; holiday camp services [lodging]; bar services; providing campground facilities; food and drink catering; day-nurseries [crèches].

44 – Public baths for hygiene purposes; turkish baths; hospitals; rehabilitation for substance abuse patients; landscape design; convalescent homes; nursing homes; wreath making; hair implantation; pharmacy advice; aromatherapy services; manicuring; chiropractics; massage; horticulture; artificial insemination services; hairdressing salons; midwife services; veterinary assistance; dentistry; medical assistance; tree planting for carbon offsetting purposes; medical equipment rental; rental of sanitation facilities; farming equipment rental; aerial and surface spreading of fertilizers and other agricultural chemicals; animal breeding; gardening; landscape gar-

dening; beauty salons; sanatoriums; blood bank services; health care; flower arranging; tattooing; vermin exterminating for agriculture, horticulture and forestry; weed killing; health spa services; aquaculture services; visagists' services; medical clinic services; opticians' services; plant nurseries; in vitro fertilization services; services of a psychologist; sauna services; solarium services; telemedicine services; therapy services; pharmacists' services to make up prescriptions; nursing, medical; lawn care; animal grooming; pet grooming; physical therapy; plastic surgery; tree surgery; hospices; health centers.

45 – Marriage agencies; detective agencies; night guards; adoption agency services; arbitration services; rental of safes; undertaking; lost property return; genealogical research; legal research; security consultancy; intellectual property consultancy; intellectual property watching services; monitoring of burglar and security alarms; crematorium services; licensing of intellectual property; licensing of computer software [legal services]; organization of religious meetings; opening of security locks; guards; planning and arranging of wedding ceremonies; missing person investigations; litigation services; baby sitting; pet sitting; baggage inspection for security purposes; inspection of factories for safety purposes; evening dress rental; rental of fire extinguishers; clothing rental; rental of fire alarms; registration of domain names [legal services]; personal background investigations; fire-fighting; escorting in society [chaperoning]; horoscope casting; copyright management; dating services; alternative dispute resolution services; house sitting; mediation; funerals; personal body guarding.

(260) AM 2015 75431 A

(800) 1186530

(891) 2013 06 22

(731) JOMOO GROUP CO., LTD.

No:28 Dengfeng Industry zone, Luncang Town, 362304 Nan'an City, Fujian, China

(540)

**JOMOO**

(591) Black, white

(511)

6 – Valves of metal, other than parts of machines; pipe work of metal; cabanas of metal; drain traps (valves) of metal; nozzles of metal; pegs of metal; water-pipe valves of metal; knobs of metal; iron-mongery.

7 – Valves (parts of machines); pressure valves (parts of machines); hydraulic pressure valves; regulating valves; steam traps; pneumatic controls for machines, motors and engines; pumps (machines); water separators; pressure regulators (parts of machines); wrapping machines.

9 – Plugs, sockets and other contacts (electric connections); transducer; switches, electric; materials for electricity mains (wires, cables); transmitters of electronic signals; cell switches (electricity); integrated circuit cards (smart cards); variometers; electrodynamic apparatus for the remote control of signals; switchboxes (electricity).

17 – Waterproof packings; water-tight rings; flexible tubes, not of metal; pipe gaskets; filtering materials (semi-processed foams or films of plastic); insulating materials; stuffing rings; seals; joint packings; rings of rubber.

19 – Ceramic tiles; marble; waterproof roll material for building; gutter pipes, not of metal; water-pipe valves, not of metal or plastic; granite; fired refractory materials not of metal; cement; coatings (building materials).

20 – Office furniture; tea tables; coat hangers; dressing tables; furniture; furniture fittings, not of metal; furniture of metal; drain traps (valves) of plastic; water-pipe valves of plastic; washstands (furniture); clothes hooks, not of metal.

21 – Clothing stretchers; napkin holders, not of precious metal; kitchen utensils, not of precious metal; epergnes, not of precious metal; soap boxes; cosmetic utensils; cleaning utensils; toilet paper holders; toothbrushes; toilet utensils.

35 – Advertising; organisation of technology exhibitions for commercial or advertising purposes; business management of performing artists; photocopying; compilation of information into computer databases; rental of vending machines; sponsorship search; sales promotion for others; commercial administration of the licensing of the goods and services of others; accounting.

(260) AM 2015 75437 A  
(800) 1186672  
(891) 2013 10 17  
(731) SONGWON INDUSTRIAL CO., LTD.  
83, Jangsaengpo-ro, Nam-gu, Ulsan,  
Republic of Korea

(540)

## SONGXTEND

(511)

1 – Chemical blends for use as plastic additives to stabilize plastic materials and for protecting polymers from degradation during processing or due to ultraviolet radiation and long term heat aging.

(260) AM 2015 75438 A  
(800) 1186715  
(891) 2013 11 20  
(731) BRAY INTERNATIONAL, INC.  
13333 WESTLAND EAST BLVD, Houston  
TX 77041, USA

(540)

## POLAR

(511)

6 – Metal valves not being parts of machines and parts therefor.

(260) AM 2015 75440 A

(800) 1186725

(891) 2013 09 24

(731) PRIVATE JOINT STOCK COMPANY  
"INDUSTRIAL ASSOCIATION "KONTI"  
Bul. Shevchenko, 6-b, Donetsk 83015,  
Ukraine

(540)

## Apte

(511)

30 – Coffee, tea, cocoa and artificial coffee; rice; tapioca and sago; flour and preparations made from cereals; bread, pastry and confectionery; ices; sugar, honey, treacle; yeast, baking-powder; salt; mustard; vinegar, sauces (condiments); spices; ice; aniseed; peanut confectionery; high-protein cereal bars; baking soda (bicarbonate of soda for cooking purposes); soya bean paste (condiment); bean meal; star aniseed; tapioca flour for food; flour; flour-milling products; bread rolls; buns; sandwiches; vanillin (vanilla substitute); vanilla (flavoring); waffles; vermicelli (noodles); cream of tartar for culinary purposes; farinaceous foods; oatmeal; oat flakes; oat-based food; sea water for cooking; seaweed (condiment); binding agents for ice cream (edible ices); biscuits; cloves (spice); mustard meal; cake frosting (icing); glucose for culinary purposes; relish (condiment); gluten additives for culinary purposes; essences for foodstuffs, except etheric essences and essential oils; fruit jellies (confectionery); chewing gum; custard; leaven; rice-based snack food; cereal-based snack food; frozen yogurt (confectionery ices); frozen kefir (confectionery ices); flavorings, other than essential oils, for beverages; flavorings, other than essential oils, for cakes; flavorings, other than essential oils; wheat germ for human consumption; preparations for stiffening whipped cream; thickening agents for cooking foodstuffs; chips (cereal products); ginger (spice); unroasted coffee; coffee flavorings; coffee-based beverages; coffee beverages with milk; vegetal preparations for use as coffee substitutes; cocoa beverages with milk; cocoa-based beverages; cocoa products; capers; caramels (candy); lozenges (confectionery); curry (spice); potato flour for food; ketchup (sauce); gluten prepared as foodstuff; confectionery with sugar; tortillas; cinnamon (spice); starch for food; hominy grits; groats for human food; corn, milled; corn, roasted; corn flour; pop corn; corn flakes; turmeric for food; couscous (semolina); salt for preserving foodstuffs; confectionery for decorating Christmas

trees; edible ices; ice for refreshment; ice, natural or artificial; liquorice (confectionery); noodles; candy; flaxseed for human consumption; mayonnaise; macaroni; maltose; hominy; chow-chow (condiment); marinades; marzipan; royal jelly; honey; molasses for food; macaroons (pastry); almond paste; almond confectionery; pancakes; spring rolls; gruel, with a milk base, for food; ice-cream; dessert mousses (confectionery); chocolate mousses; nutmegs; muesli; meat gravies; meat tenderizers, for household purposes; mint for confectionery; peppermint sweets; infusions, not medicinal; husked oats; ravioli; pepper; pesto (sauce); beer vinegar; quiches; sweetmeats (candy); pizzas; pies; fondants (confectionery); powder for edible ices; pralines; condiments; dressings for salad; seasonings; unleavened bread; bee glue; gingerbread; puddings; cake powder; fruit coulis (sauces); rice cakes; baking powder; ferments for pastes; sago; garden herbs, preserved (seasonings); celery salt; golden syrup; salt for preserving foodstuffs; soya flour; soya sauce; malt for human consumption; malt biscuits; malt extract for food; tomato sauce; spaghetti; noodle-based prepared meals; ham glaze; rusks; breadcrumbs; petit-beurre biscuits; sushi; tabbouleh; tacos; tapioca; petits fours (cakes); crackers; cake paste; tarts; sorbets (ices); halvah; bread; chicory (coffee substitute); iced tea; tea-based beverages; chutneys (condiments); saffron (seasoning); chocolate; chocolate based beverages; chocolate beverages with milk; barley meal; barley (crushed).

(260) AM 2015 75441 A

(800) 1186726

(891) 2013 09 24

(731) PRIVATE JOINT STOCK COMPANY  
"INDUSTRIAL ASSOCIATION "KONTI"  
Bul. Shevchenko, 6-b, Donetsk 83015,  
Ukraine

(540)

## Конкур

(511)

30 – Coffee, tea, cocoa and artificial coffee; rice; tapioca and sago; flour and preparations made from cereals; bread, pastry and confectionery; ices; sugar, honey, treacle; yeast, baking-powder; salt; mustard; vinegar, sauces (condiments); spices; ice; aniseed; peanut confectionery; high-protein cereal bars; baking soda (bicarbonate of soda for cooking purposes); soya bean paste (condiment); bean meal; star aniseed; tapioca flour for food; flour; flour-milling products; bread rolls; buns; sandwiches; vanillin (vanilla substitute); vanilla (flavoring); waffles; vermicelli (noodles); cream of tartar for culinary purposes; farinaceous foods; oatmeal; oat flakes; oat-based food; sea water for cooking; seaweed (condiment); binding agents for ice cream (edible ices); biscuits; cloves (spice); mustard meal; cake frosting (icing);

glucose for culinary purposes; relish (condiment); gluten additives for culinary purposes; essences for foodstuffs, except etheric essences and essential oils; fruit jellies (confectionery); chewing gum; custard; leaven; rice-based snack food; cereal-based snack food; frozen yogurt (confectionery ices); frozen kefir (confectionery ices); flavorings, other than essential oils, for beverages; flavorings, other than essential oils, for cakes; flavorings, other than essential oils; wheat germ for human consumption; preparations for stiffening whipped cream; thickening agents for cooking foodstuffs; chips (cereal products); ginger (spice); unroasted coffee; coffee flavorings; coffee-based beverages; coffee beverages with milk; vegetal preparations for use as coffee substitutes; cocoa beverages with milk; cocoa-based beverages; cocoa products; capers; caramels (candy); lozenges (confectionery); curry (spice); potato flour for food; ketchup (sauce); gluten prepared as foodstuff; confectionery with sugar; tortillas; cinnamon (spice); starch for food; hominy grits; groats for human food; corn, milled; corn, roasted; corn flour; pop corn; corn flakes; turmeric for food; couscous (semolina); salt for preserving foodstuffs; confectionery for decorating Christmas trees; edible ices; ice for refreshment; ice, natural or artificial; liquorice (confectionery); noodles; candy; flaxseed for human consumption; mayonnaise; macaroni; maltose; hominy; chow-chow (condiment); marinades; marzipan; royal jelly; honey; molasses for food; macaroons (pastry); almond paste; almond confectionery; pancakes; spring rolls; gruel, with a milk base, for food; ice-cream; dessert mousses (confectionery); chocolate mousses; nutmegs; muesli; meat gravies; meat tenderizers, for household purposes; mint for confectionery; peppermint sweets; infusions, not medicinal; husked oats; ravioli; pepper; pesto (sauce); beer vinegar; quiches; sweetmeats (candy); pizzas; pies; fondants (confectionery); powder for edible ices; pralines; condiments; dressings for salad; seasonings; unleavened bread; bee glue; gingerbread; puddings; cake powder; fruit coulis (sauces); rice cakes; baking powder; ferments for pastes; sago; garden herbs, preserved (seasonings); celery salt; golden syrup; salt for preserving foodstuffs; soya flour; soya sauce; malt for human consumption; malt biscuits; malt extract for food; tomato sauce; spaghetti; noodle-based prepared meals; ham glaze; rusks; breadcrumbs; petit-beurre biscuits; sushi; tabbouleh; tacos; tapioca; petits fours (cakes); crackers; cake paste; tarts; sorbets (ices); halvah; bread; chicory (coffee substitute); iced tea; tea-based beverages; chutneys (condiments); saffron (seasoning); chocolate; chocolate-based beverages; chocolate beverages with milk; barley meal; barley (crushed).

(260) AM 2015 75442 A

(800) 1186734

(891) 2013 10 02

(731) Otkrytoe aktsionerное obschestvo "MAKFA"  
pos. Roshchino, Sosnovsky raion, RU-456513  
Chelyabinskaya obl., Russian Federation

(540)



(591) Dark blue, blue, red, white, brown, light  
brown, light yellow and gray

(511)

30 – Farinaceous food pastes, including noodles;  
spaghetti; vermicelli [noodles].

(260) AM 2015 75443 A

(800) 1186747

(891) 2013 11 22

(731) WIZZ Air Hungary Légiközlekedési Korlátolt  
Felelősségű Társaság BUD Nemzetközi  
Repülőtér, (BUD International Airport) 221.  
ép., H-1185, Budapest, Hungary

(540)

## Wizz Tours

(511)

36 – Insurance; financial affairs; monetary affairs;  
real estate affairs; debt advisory services; fiscal valuations;  
brokerage; accident insurance underwriting; banking;  
stamp appraisal; apartment house management; health insurance underwriting; actuarial services;  
insurance consultancy; insurance brokerage; insurance underwriting; check [cheque] verification;  
jewelry appraisal; life insurance underwriting; issue of tokens of value; deposits of valuables; factoring;  
business liquidation services, financial; financing services; provident fund services; financial evaluation of wool;  
organization of collections; marine insurance underwriting; credit bureaux; credit card services; issuance of credit cards; insurance information;  
real estate management; leasing of real estate; real estate appraisal; real estate agencies; rental of offices [real estate];  
repair costs evaluation [financial appraisal]; mortgage banking; charitable fund raising; clearing, financial; loans [financing];  
lending against security; mutual funds; brokerage of carbon credits; debt collection agencies; financial valuation of standing timber;  
renting of flats; housing agents; rent collection; leasing of farms; art appraisal; numismatic appraisal; retirement payment

services; guarantees; electronic funds transfer; financial analysis; financial evaluation [insurance, banking, real estate]; financial information; financial management; financial sponsorship; financial consultancy; exchanging money; antique appraisal; installment loans; accommodation bureaux [apartments]; safe deposit services; savings bank services; home banking; debit card services; fund investments; stock exchange quotations; stock brokerage services; securities brokerage; hire-purchase financing; fire insurance underwriting; issuing of travellers' checks [cheques]; fiduciary; customs brokerage; pawnbrokerage.

39 – Transport; packaging and storage of goods; travel arrangement; electricity distribution; wrapping of goods; storage of goods; delivery of goods; car rental; bus transport; motor coach rental; ambulance transport; transporting furniture; rental of diving bells; rental of diving suits; operating canal locks; parcel delivery; physical storage of electronically-stored data or documents; distribution of energy; rental of freezers; river transport; courier services [messages or merchandise]; transport; carting; lighterage services; garage rental; rental of vehicle roof racks; car transport; salvage of ships; stevedoring; transport reservation; booking of seats for travel; travel reservation; refrigerator rental; transportation information; storage information; vehicle rental; chauffeur services; ice-breaking; piloting; hauling; removal services; ferry-boat transport; traffic information; sightseeing [tourism]; air transport; aircraft rental; delivery of goods by mail order; horse rental; refloating of ships; salvaging; launching of satellites for others; newspaper delivery; guarded transport of valuables; bottling services; car parking; parking place rental; franking of mail; message delivery; rental of warehouses; storage; rental of aircraft engines; rescue operations [transport]; vehicle breakdown assistance [towing]; pleasure boat transport; transport by pipeline; armored-car transport; barge transport; transportation logistics; freight forwarding; transport brokerage; freighting; transport of travellers; taxi transport; transport and storage of trash; rental of storage containers; freight [shipping of goods]; unloading cargo; portorage; underwater salvage; marine transport; shipbrokerage; packaging of goods; rental of wheelchairs; freight brokerage; escorting of travellers; passenger transport; travel arrangement; railway coach rental; railway transport; railway truck rental; rental of motor racing cars; tram transport; flower delivery; water distribution; boat rental; boat storage; boat transport; arranging of cruises; water supplying; towing.

43 – Services for providing food and drink; temporary accommodation; boarding for animals; rental of temporary accommodation; bar services; cafeterias; restaurants; rental of cooking apparatus; snack-bars; boarding house bookings; hotel reservations; rental

of transportable buildings; rental of drinking water dispensers; canteens; cafés; motels; retirement homes; self-service restaurants; day-nurseries [crèches]; boarding houses; rental of meeting rooms; rental of tents; temporary accommodation reservations; accommodation bureaux [hotels, boarding houses]; hotels; rental of chairs, tables, table linen, glassware; providing campground facilities; tourist homes; holiday camp services [lodging]; food and drink catering; rental of lighting apparatus other than for theatrical sets or television studios.

(260) AM 2015 75444 A

(800) 1186748

(891) 2013 11 26

(731) JOHN PLAYER & SONS LIMITED

21 Beckett Way, Park West, Nangor Road,  
Dublin 12, Ireland

(540)

## X-LINE

(511)

34 – Tobacco, whether manufactured or unmanufactured; tobacco products; tobacco substitutes, none being for medicinal or curative purposes; cigarettes; hand-rolling tobacco; matches and smokers' articles; cigarette tubes; cigarette filters; cigarette papers.

(260) AM 2015 75445 A

(800) 1186758

(891) 2013 11 20

(731) DR. THEISS NATURWAREN GMBH

Michelinstr. 10, 66424 Homburg, Germany

(540)

**DR.THEISS**  
**BI**  **Active-Complex**

(591) Black, white

(511)

3 – Soaps; perfumery, essential oils, cosmetics, hair lotions; dentifrices.

5 – Pharmaceutical and veterinary preparations; medicines for human or veterinary purposes; nutritional supplements; sanitary preparations for medical purposes; dietetic substances adapted for medical use, food for babies; plasters, materials for dressings.

44 – Hygienic and beauty care for human beings or animals.

(260) AM 2015 75446 A

(800) 1186760

(891) 2013 11 27

(731) MARIA FRANCESCA ANGELINI MARIA

FRANCESCA ANGELINI

Via Vecchia del Pinocchio, 22, I-60131  
Ancona, Italy

(540)

## ANJELIF di Francesca Angelini

(511)

3 – Bleaching preparations and other substances for laundry use; cleaning, polishing, scouring and abrasive preparations; soaps; perfumery, essential oils, cosmetics, hair lotions; dentifrices.

5 – Pharmaceutical and veterinary preparations; sanitary preparations for medical purposes; dietetic substances for medical use, foodstuffs for babies; plasters, materials for dressings; material for stopping teeth, dental wax; disinfectants; preparations for destroying vermin; fungicides, herbicides.

(260) AM 2015 75447 A

(800) 1186765

(891) 2013 10 03

(731) JT International S.A.

1, Rue de la Gabelle, CH-1211 Genève 26,  
Switzerland

(540)

## U PICK

(511)

34 – Tobacco, raw or manufactured; smoking tobacco, pipe tobacco, rolling tobacco, chewing tobacco, moist tobacco powder called "snus"; cigarettes, cigars, cigarillos; substances for smoking sold separately or mixed with tobacco for non-medical and non-therapeutic purposes; snuff; smokers' articles included in this class; cigarette paper, cigarette tubes and matches.

(260) AM 2015 75448 A

(800) 1186766

(891) 2013 10 03

(731) JT International S.A.

1, Rue de la Gabelle, CH-1211 Genève 26,  
Switzerland

(540)

## MY5

(511)

34 – Tobacco, raw or manufactured; smoking tobacco, pipe tobacco, rolling tobacco, chewing tobacco, moist tobacco powder called "snus"; cigarettes, cigars, cigarillos; substances for smoking sold separately or mixed with tobacco for non-medical and non-therapeutic purposes; snuff; smokers' articles included in this class; cigarette paper, cigarette tubes and matches.

(260) AM 2015 75449 A

(800) 1186775

(891) 2013 10 21

(731) TORUŃSKIE ZAKŁADY MATERIAŁÓW  
OPATRUNKOWYCH, SPÓŁKA AKCYJNA  
Żółkiewskiego 20/26, PL-87-100 Toruń, Poland

(540)



(591) Blue, dark navy blue and white

(511)

3 – Hygienic hankies impregnated with cosmetic liquids.

16 – Paper towels, paper tissues, paper napkins, toilet paper.

(260) AM 2015 75450 A

(800) 1186774

(891) 2013 10 10

(731) MARELLA S.R.L.

Via Giulia Maramotti, 4, I-42124 REGGIO  
EMILIA (RE), Italy

(540)

**EMMÉ**

MARELLA

(591) Black, white

(511)

18 – Bags; leather bags; bags of synthetic material; shoulder bags; handbags; leather handbags; shoulder belts; haversacks; clutch bags; pocket wallets; purses; suit cases; backpacks; key wallets; document cases; travel garment covers; shoe carriers for travel; beach bags; bags of textile material; vanity cases (not fitted); harness made from leather; umbrellas.

25 – Clothing, footwear, headgear; coats; jackets [clothing]; trousers; skirts; tops; waterproof clothing; topcoats; belts; women's dresses; long jackets; sweaters; denims; dresses; cloaks; pullovers; shirts; body shirts; cardigans; body linen; dressing gowns; swimwear and swimming costumes; cover-ups; evening dresses; shawls; sashes for wear; fleece pullovers; knitwear; polo shirts; bodies; blazers; shorts; slippers; boots; sandals; clothing gloves; ponchos; sashes; fur clothing; clothing with fur inserts.

(260) AM 2015 75466 A

(800) 1186857

(891) 2013 08 29

(731) JANSSEN R&D IRELAND

Eastgate Village, Eastgate, Little Island, Co  
Cork, Ireland

(540)

**PREZIDUO**

(511)

5 – Human pharmaceutical preparations.

(260) AM 2015 75467 A

(800) 1186858

(891) 2013 08 29

(731) JANSSEN R&D IRELAND

Eastgate Village, Eastgate, Little Island, Co  
Cork, Ireland

(540)

**COZISTA**

(511)

5 – Human pharmaceutical preparations.

(260) AM 2015 75473 A

(800) 1186859

(891) 2013 08 29

(731) JANSSEN R&D IRELAND

Eastgate Village, Eastgate, Little Island, Co  
Cork, Ireland

(540)

**PREZINGA**

(511)

5 – Human pharmaceutical preparations.

(260) AM 2015 75474 A

(800) 1186860

(891) 2013 08 30

(731) JANSSEN R&D IRELAND

Eastgate Village, Eastgate, Little Island, Co  
Cork, Switzerland

(540)

**PREZCOBIX**

(511)

5 – Human pharmaceutical preparations.

(260) AM 2015 75475 A

(800) 1186861

(891) 2013 08 30

(731) JANSSEN R&D IRELAND

Eastgate Village, Eastgate, Little Island, Co  
Cork, Ireland

(540)

**PREZYNCRO**

(511)

5 – Human pharmaceutical preparations.

(260) AM 2015 75490 A

(800) 1186980

(891) 2013 09 30

(731) PRIVATE JOINT STOCK COMPANY

"INDUSTRIAL ASSOCIATION "KONTI"  
Bul. Shevchenko, 6-b Donetsk 83015,  
Ukraine

(540)

**Шоколадные истории**



(511)  
30 – Coffee, tea, cocoa, sugar, rice, tapioca, sago, artificial coffee; flour and preparations made from cereals, bread, pastry and confectionery, ices; honey, treacle; yeast, baking-powder; salt, mustard; vinegar, sauces (condiments); spices; edible ice; pastries; waffles; waffles with various fillings; cocoa products; caramels; candies; confectionery for decorating Christmas trees; candy for food; cookies; cookies glazed with chocolate; chips (cereal products); fondants (confectionery); gingerbread; petits fours (cakes); crackers; halvah; sweetmeats (candy); sugar confectionery; chocolate.

(260) AM 2015 75502 A  
(800) 1187041  
(891) 2013 11 29  
(731) CARTIER INTERNATIONAL AG  
Hinterbergstrasse 22, Postfach 61, CH-6312  
Steinhausen, Switzerland

(540)  
**BALLON DE CARTIER**

(511)  
14 – Jewelry; jewelry products; precious stones; precious metals and their alloys; pearls; cuff links; tie clips; rings; bracelets; earrings; necklaces; brooches; charms; key rings of precious metal; jewelry cases [caskets]; boxes of precious metal; timepieces and chronometric instruments; watches; chronometers; wall clocks; small clocks; watch straps; cases or presentation cases for timepieces.

(260) AM 2015 75503 A  
(800) 1187073  
(891) 2013 11 06  
(731) ASTELLAS PHARMA INC.  
5-1, Nihonbashi-Honcho 2-chome, Chuo-ku,  
Tokyo 103-8411, Japan

(540)  
**DEFINDRA**

(511)  
5 – Vaccines for human use.

(260) AM 2015 75504 A  
(800) 1187074  
(891) 2013 11 06  
(731) ASTELLAS PHARMA INC.  
5-1, Nihonbashi-Honcho 2-chome, Chuo-ku,  
Tokyo 103-8411, Japan

(540)  
**GANECT**

(511)  
5 – Vaccines for human use.

(260) AM 2015 75506 A  
(800) 1187179  
(891) 2013 11 12  
(731) ZHONGSHAN ENAITER ELECTRICAL  
APPLIANCES CO., LTD.  
Yongyi Industrial Zone, No:5 Donghai Road,  
Dongfeng Town, Zhongshan City,  
Guangdong, China

(540)  
**Enaiter**

(591) Black, white  
(511)  
11 – Electric cooking utensils; cooking apparatus; electric water heaters; cooling appliances and installations; air conditioning installations; heating apparatus; heating installations; bath installations; disinfectant apparatus; radiators.

(260) AM 2015 75509 A  
(800) 1187245  
(891) 2013 11 12  
(731) LIMITED LIABILITY COMPANY  
"PREMIUM STYLE"  
Magistralny tupik 1-st, d.5a, RU-123290  
Moscow, Russian Federation

(540)  
**Вегетэль**

(511)  
32 – Waters [beverages]; kvass [non-alcoholic beverage]; cocktails, non-alcoholic; lemonades; non-alcoholic beverages; non-alcoholic fruit juice beverages; fruit nectars, non-alcoholic; smoothies; tomato juice [beverage]; vegetable juices [beverages]; fruit juices.

(260) AM 2015 75510 A  
(800) 1187246  
(891) 2013 11 12  
(731) LIMITED LIABILITY COMPANY  
"PREMIUM STYLE"  
Magistralny tupik 1-st, d.5a, RU-123290  
Moscow, Russian Federation

(540)  
**Светлик**

(511)  
32 – Waters [beverages] for children; kvass [non-alcoholic beverage] for children; cocktails, non-alcoholic for children; lemonades for children; non-alcoholic beverages for children; non-alcoholic fruit juice beverages for children; fruit nectars, non-alcoholic for children; smoothies for children; tomato juice [beverage] for children; vegetable juices [beverages] for children; fruit juices for children.

(260) AM 2015 75529 A

(800) 1187534

(891) 2012 07 13

(731) DAIKIN INDUSTRIES, LTD.

Umeda Center Building, 4-12, Nakazaki-nishi  
2-chome, Kita-Ku, Osaka-shi, Osaka 530-8323,  
Japan

(540)



(591) Black, white

(511)

1 – Chemicals; adhesives (not for stationery or household purposes); plant growth regulating preparations; fertilizers; ceramic glazings; higher fatty acids; nonferrous metals; non-metallic minerals; photographic chemicals; photographic paper; sensitized photographic plates; reagent paper; artificial sweeteners; flour and starch for industrial purposes; unprocessed plastics (plastics in primary form); pulp; wallpaper removing preparations.

2 – Canada balsam; copal; sandarac; shellac; pine oil; dammar; mordants; mastic; pine gum; wood preservatives; dyestuffs; pigments; coatings (paints); printing ink; colors (for drawing pictures); anti-rust greases; nonferrous metals in foil or powder form for painters, decorators, printers and artists; precious metals in foil or powder form for painters, decorators, printers and artists.

7 – Metalworking machines and tools; mining machines and apparatus; construction machines and apparatus; loading-unloading machines and apparatus; net hauling machines [fishing]; chemical processing machines and apparatus; textile machines and apparatus; food or beverage processing machines and apparatus; lumbering, woodworking, or veneer or plywood making machines and apparatus; pulp making, papermaking or paper-working machines and apparatus; printing or bookbinding machines and apparatus; sewing machines; agricultural machines, agricultural implements other than hand-operated; shoe making machines; leather tanning machines; tobacco processing machines; glassware manufacturing machines and apparatus; painting machines and apparatus; packaging or wrapping machines and apparatus; potters' wheels; plastic processing machines and apparatus; semiconductor manufacturing machines and systems; machines and apparatus for manufacturing rubber goods; stone working machines and apparatus; non-electric prime movers (not for land vehicles) and parts thereof; pneumatic or hydraulic machines and instruments; adhesive tape dispensing machines; automatic stamping machines; dishwashers; machines and apparatus for wax-polishing, electric; washing machines; vacuum cleaners; electric food blenders (for household purposes); mechanical parking systems; vehicle washing installations; power sprayers for disinfecting, insecticides and de-

odorants (not for agricultural purposes); machine elements (not for land vehicles); lawnmowers; curtain drawing devices electrically operated; waste compacting machines and apparatus; waste crushing machines; starters for motors and engines; AC motors and DC motors (not including those for land vehicles but including "parts" for any AC motors and DC motors); alternators; DC generators; dynamo brushes; arc welding machines; electric metal cutting machines (by arc, gas or plasma); electric welding apparatus (for metal working); vending machines; fuel dispensing pumps for service stations; electric door openers.

9 – Ear plugs for divers; optical glass; glass covered with an electrical conductor; ozonisers (ozonators); electrolyzers; egg-candlers; cash registers; coin counting or sorting machines; electric sign boards for displaying target figures, current outputs or the like; photo-copying machines; calculating machines; drawing apparatus and instruments adapted for use with computers; time and date stamping machines; time clocks (time recording devices); punched card office machines; voting machines; billing machine; postage stamp checking apparatus; mechanisms for coin-operated apparatus; life saving apparatus and equipment; fire extinguishers; fire hose nozzles; sprinkler systems for fire protection; fire alarms; gas alarms; anti-theft warning apparatus; protective helmets; railway signal apparatus, luminous or mechanical; vehicle breakdown warning triangles; luminous or mechanical road signs; divers' apparatus (not for sports); game programs for arcade video game machines; simulators for the steering and control of vehicles; laboratory apparatus and instruments; photographic machines and apparatus; cinematographic machines and apparatus; optical machines and apparatus; measuring or testing machines and instruments; power distribution or control machines and apparatus; rotary converters; phase modifiers; batteries and cells; electric or magnetic meters and testers; electric wires and cables; telecommunication machines and apparatus; electronic machines, apparatus and their parts; magnetic cores; resistance wires; fuel cell electrodes; gloves for protection against accidents; dust masks; gas masks; welding masks; fireproof garments; glasses; game programs for consumer games adopted for use with an external display screen or monitor; electronic circuits and CD-ROMs recorded with programs for hand-held games with liquid crystal displays; weight belts (for scuba diving); diving wet suits; protective helmets for sports; air tanks (for scuba diving); regulators for scuba diving; phonograph records; metronomes; electronic circuits and CD-ROMs recorded with automatic performance programs for electronic musical instruments; slide-rules; exposed cinematographic films; exposed slide films; slide film mounts; recorded video discs and video tapes; electronic publications.

11 – Water closets; set units of bathroom; drying apparatus; recuperators; steamers; evaporators; distillers; heat exchangers; milk sterilizers; industrial furnaces; nuclear reactors (atomic piles); forage drying apparatus; boilers (other than parts of prime movers, engines); air-conditioning apparatus; freezing machines and apparatus; laundry dryers [electric, for industrial purposes]; apparatus and instruments for use in beauty salons or barbers' shops (not including "hairdressing chairs"); cooking equipment for industrial purposes; industrial dish drying machines for industrial purposes; dish disinfectant apparatus for industrial purposes; tap water faucets; level controlling valves in tanks; pipe line cocks; waste water treatment tanks (for industrial purposes; septic tanks (for industrial purposes); garbage incinerators; solar water heaters; industrial water purifying apparatus; electric lamps and other lighting apparatus; household electrothermic appliances; washers for water taps; gas water heaters (for household purposes); non-electric cooking heaters (for household purposes); kitchen worktops; kitchen sinks; ice boxes; ice-cooling refrigerators (for household purposes); household tap-water filters; bath fittings; standing paper lanterns (andon); Chinese lanterns; gas lamps; oil lamps; lamp chimneys; warming pans (non-electric); pocket warmers; stick fuel for Japanese pocket warmers (kairo-bai); hot water bottles; toilet stool units with a washing water squirter; disinfectant dispensers for toilets; toilet bowls; seatings for use with Japanese style toilet bowls; waste water treatment tanks for household purposes; septic tanks for household purposes; heating or cooling packs filled with chemical substances ready to react when required; Japanese charcoal heaters for household purposes (hibachi); fire hydrants.

37 – Construction; construction consultancy; operation, check or maintenance of building equipment; shipbuilding; repair or maintenance of vessels; aircraft repair or maintenance; repair of bicycles; repair or maintenance of automobiles; repair or maintenance of railway rolling stocks; repair or maintenance of two-wheeled motor vehicles; repair or maintenance of cinematographic machines and apparatus; repair or maintenance of optical machines and apparatus; repair or maintenance of photographic machines and apparatus; repair or maintenance of loading-unloading machines and apparatus; repair or maintenance of fire alarms; repair or maintenance of office machines and equipment; repair or maintenance of air-conditioning apparatus (for industrial purposes); repair or maintenance of burners; repair or maintenance of boilers; repair or maintenance of pumps; repair or maintenance of freezing machines and apparatus; repair or maintenance of electronic machines and apparatus; repair or maintenance of telecommunication machines and apparatus; repair or maintenance of construction machines and apparatus; repair or maintenance of consumer electric

appliances; repair or maintenance of electric lighting apparatus; repair or maintenance of power distribution or control machines and apparatus; repair or maintenance of power generators; repair or maintenance of electric motors; repair or maintenance of laboratory apparatus and instruments; repair or maintenance of measuring and testing machines and instruments; repair or maintenance of medical apparatus and instruments; repair or maintenance of firearms; repair or maintenance of printing or book-binding machines and apparatus; repair or maintenance of chemical processing machines and apparatus; repair or maintenance of glassware manufacturing machines and apparatus; repair or maintenance of fishing machines and instruments; repair or maintenance of metal working machines and tools; repair or maintenance of shoe making machines; repair or maintenance of industrial furnaces; repair or maintenance of mining machines and apparatus; repair or maintenance of rubber-goods manufacturing machines and apparatus; repair or maintenance of integrated circuits manufacturing machines and systems; repair or maintenance of semiconductor manufacturing machines and systems; repair or maintenance of machines and apparatus for processing foods or beverages; repair or maintenance of machines and apparatus for lumbering, woodworking, or veneer or plywood making; repair or maintenance of textile machines and apparatus; repair or maintenance of tobacco processing machines; repair or maintenance of painting machines and apparatus; repair or maintenance of agricultural machines and implements; repair or maintenance of machines and apparatus for pulp-making, papermaking or paper-working; repair or maintenance of plastic processing machines and apparatus; repair or maintenance of packaging or wrapping machines and apparatus; repair or maintenance of sewing machines; repair or maintenance of reservoirs; repair or maintenance of gasoline station equipment; repair or maintenance of mechanical parking systems; repair or maintenance of bicycle parking apparatus; repair or maintenance of industrial dishwashers; repair or maintenance of cooking equipment for industrial purposes; repair or maintenance of electric washing machines for industrial purposes; repair or maintenance of vehicle washing installations; repair or maintenance of vending machines; repair or maintenance of power-driven floor cleaning machines; repair or maintenance of amusement machines and apparatus; repair or maintenance of apparatus and instruments for use in beauty salons or barbers' shops; repair or maintenance of water pollution control equipment; repair or maintenance of water purifying apparatus; repair or maintenance of waste compacting machines and apparatus; repair or maintenance of waste crushing machines; repair or maintenance of divers' apparatus; repair or maintenance of nuclear power plants; repair or maintenance of chemical plants; furniture restoration; umb-

rella repair; repair or maintenance of musical instruments; safe maintenance or repair; shoe repair; clock and watch repair or maintenance; sharpening of scissors and kitchen knives; setup or repair of locks; repair or maintenance of gas water heaters; repair or maintenance of non-electric cooking heaters; repair or maintenance of cooking pots and pans; repair or maintenance of signboards; repair of bags or pouches; repair of personal ornaments; repair of toys or dolls; repair of sports equipment; repair of billiard equipment; repair of game machines and apparatus; repair or maintenance of bath fittings; repair of toilet stool units with a washing water squirts; repair of fishing tackle; repair of spectacles; fur care and repair; laundering; pressing of clothing; clothing repair (mending clothing); fluffing of cotton batting for futon; repair of tatami mats; chimney sweeping; cleaning of building exterior surfaces; window cleaning; carpet and rug cleaning; floor polishing; septic tank cleaning; bathtub and bath boiler cleaning; street cleaning; reservoirs cleaning; disinfecting of telephone hand-sets; vermin exterminating (other than for agriculture, horticulture or forestry); sterilization of medical apparatus and instruments; rental of construction machines and apparatus; rental of floor cleaning machines; rental of mops; rental of car-washing apparatus; rental of electric washing machines; rental of laundry dryers; rental of spin dryers for clothes; rental of mining machines and apparatus.

42 – Meteorological information; architectural design; surveying; geological surveys; designing of machines, apparatus, instruments (including their parts) or systems composed of such machines, apparatus and instruments; designing; computer programming; technical advice relating to performance, operation, etc. of computers, automobiles and other machines that require high levels of personal knowledge, skill or experience of the operators to meet the required accuracy in operating them; testing, inspection or research of pharmaceuticals, cosmetics or foodstuff; research on building construction or city planning; testing or research on prevention of pollution; testing or research on electricity; testing or research on civil engineering; testing, inspection or research on agriculture, livestock breeding or fisheries; testing or research on machines, apparatus and instruments; rental of measuring apparatus; rental of computers; providing computer programs; rental of laboratory apparatus and instruments; rental of drawing instruments.

(260) AM 2015 75530 A

(800) 1187540

(891) 2012 10 12

(731) RAUSHAN TAHIYEU

Avrupa Konutlari 6-A Blok D:10, Halkalı-İstanbul, Turkey

(540)



(591) Green, dark blue

(526) The trademark is protected as a whole. The word "PHARM" included therein shall not be subject to independent legal protection.

(511)

3 – Preparations for bleaching and cleaning purposes; perfumery; cosmetic products, scent products for personal use including the deodorants for personal use and for animals; soaps; tooth care products; abrasive products namely, emery cloths, emery papers, pumice stones, including pastes; polish and maintenance products for leather, vinyl, metal, wood.

5 – Medicines for human purposes, medicines for veterinary purposes, chemical preparations for medical purposes, dietetic substances adapted for medical use; dietetic foods adapted for medical purposes; aminoacids for medical purposes, nutritional substances, pollen dietary substances, mineral food substances, protein dietary supplements, baby foods, medicinal herbs, herbal beverages adapted for medical purposes; medicines for dental purposes, hygienic products for medical purposes including pads, waddings for medical purposes, plasters for medical purposes, dressings for medical purposes, preparations for destroying noxious plants, preparations for destroying noxious animals, fungicides, disinfectants for hygiene purposes, antiseptics, detergents for medical purposes.

10 – Surgical, medical, dental and veterinary apparatus and instruments; artificial limbs, eyes and teeth and prosthesis including ear plugs for protection purposes; orthopedic articles; suture materials and surgical sterile sheets; adult sexual aids; preservatives (condoms); feeding bottles, feeding bottle teats, babies' pacifiers, teething rings for babies.

16 – Paper, cardboard and goods made from these materials (except goods used for stationery); packaging and wrapping materials made of plastic materials; printed matter and bookbinding materials; printed documents; printed publications, calendars, posters, photographs, notices, charts, stickers, stamps; stationery, office requisites, educational and teaching materials (except furniture and devices); office machines, included in this class; whitewashing and painting brushes and rollers.

29 – Meat, fish, meat of poultry and game and all kinds of processed meat products; dried beans; dried peas; ready-made soups, bouillons; processed olives, olive paste; milk and milk products (including butter); edible vegetable oils; dried, preserved, frozen, cooked, smoked, pickled fruits and vegetables inclu-

ding pollen prepared as foodstuff; dried fruits and seeds, hazelnut and peanut pastes, tahini (sesame seed paste); eggs, powdered eggs; potato chips.

35 – Services related to advertising, marketing and public relations including organization of exhibitions and fairs for commercial or advertising purposes, office services, business management and administration, consultancy for business management and administration including accountancy services, import export agency services, commercial and industrial management expertise services, organization of auctioneering services and auctioneering, the bringing together of a variety of goods enabling customers to conveniently view and purchase those goods "preparations for bleaching and cleaning purposes; perfumery; cosmetic products, scent products for personal use including the deodorants for personal use and for animals; soaps; tooth care products; abrasive products namely, emery clothes, emery papers, pumice stones, including pastes; polish and maintenance products for leather, vinyl, metal, wood; medicines for human purposes, medicines for veterinary purposes, chemical preparations for medical purposes, dietetic substances adapted for medical use; dietetic foods adapted for medical purposes; aminoacids for medical purposes, nutritional substances, pollen dietary substances, mineral food substances, protein dietary supplements, baby foods, medicinal herbs, herbal beverages adapted for medical purposes; medicines for dental purposes, hygienic products for medical purposes including pads, waddings for medical purposes, plasters for medical purposes, dressings for medical purposes, preparations for destroying noxious plants, preparations for destroying noxious animals, fungicides, disinfectants for hygiene purposes, antiseptics, detergents for medical purposes; surgical, medical, dental and veterinary apparatus and instruments; artificial limbs, eyes and teeth and prosthesis including ear plugs for protection purposes; orthopedic articles; suture materials and sterilized covers; devices and equipments for sexual purposes; preservatives (condoms); feeding bottles, feeding bottle teats, babies' pacifiers, teethers for babies paper, cardboard and goods made from these materials (except goods used for stationery); packaging and wrapping materials made of plastic materials; printed matter and bookbinding materials; printed documents; printed publications, calendars, posters, photographs, notices, charts, stickers, stamps; stationery, office requisites, educational and teaching materials (except furniture and devices); office machines, included in this class; whitewashing and painting brushes and rolls; meat, fish, meat of poultry and game and all kinds of processed meat products; dried beans; dried peas; ready-made soups, bouillons; olives, olive paste; milk and milk products (including butter); edible vegetable oils; dried, preserved, frozen, cooked, smoked, pickled fruits and vegetables including pollen

prepared as foodstuff; dried fruits and seeds, hazelnut and peanut pastes, tahini (sesame seed paste); eggs, powdered eggs; potato chips" (the mentioned services can be provided by wholesale outlets, retail stores, by means of electronic media or through mail order catalogues and other similar methods).

36 – Insurance services, financial and money services, brokerage and consultancy of real estate, real estate management, customs brokerage.

39 – Land, air and sea transport services and rental of land, air and sea vehicles (including tour organization services, booking for travel services, courier services); rental of parking lot services; garage rental services; boat sheltering services; pipeline transport services; electricity distribution services; water supply services; rescue operation for vehicles and merchandise; storage, packaging and crating of goods; garbage storage and transport services, waste collection and transport services.

41 – Educational services, arranging and conducting of conferences, congresses, seminars, symposiums; sports events, entertainment services; publication of books, magazines, newspapers, etc; film, television and radio program production; news reporters services, photographic reporting services, photography services, translation services.

42 – Scientific and industrial examination, research services; engineering services; computer services namely managing web sites for others; all types of design services not included in other classes within the scope of engineering, architecture, computer services included in this class; graphic art design services; services of determining authenticity of works of art.

44 – Medical services; hygienic and beauty care for human beings; veterinary and animal breeding services, agriculture, horticulture and forestry services.

---

(260) AM 2015 75531 A

(800) 1187555

(891) 2013 03 22

(731) AVON PRODUCTS, INC.

World Headquarters, 777 Third Avenue,  
New York, NY 10017, USA

(540)

## **E-DEFENSE**

(511)

3 – Non-medicated toilet preparations; toiletries; skin care preparations; skin moisturizers; body and beauty care preparations; powders, creams and lotions, all for the face, hands and body; cosmetic sun-tan preparations; soaps; shower and bath preparations; beauty masks; talcum powder; nail polish; nail polish remover; enamel for nails; false nails; adhesives for cosmetic purposes; cosmetics; eye makeup remover, eye shadow, eye liner, mascara, lipstick,

lip liner, lip gloss; make-up foundation; blusher; tissues impregnated with cosmetic lotions; cotton sticks for cosmetic purposes; cotton wool for cosmetic purposes; preparations for cleaning, moisturising, colouring and styling the hair; preparations for cleaning the teeth; shaving and aftershave preparations; perfumes, fragrance, toilet waters, colognes; deodorants and anti-perspirants for personal use; essential oils (cosmetic).

(260) AM 2015 75532 A

(800) 1187558

(891) 2013 03 29

(731) JOINT STOCK COMPANY GAZPROM  
NEFT

Galernaya street, 5, lit A, RU-190000  
St. Petersburg, Russian Federation

(540)



(591) White, grey, orange, black

(511)

1 – Acetate of cellulose, unprocessed; acetates [chemicals]; acetic anhydride; acetone; acetylene tetrachloride; acetylene; acid proof chemical compositions; acids; acidulated water for recharging accumulators; acidulated water for recharging batteries; anti-frothing solutions for batteries; acrylic resins, unprocessed; actinium; activated carbons; additives, chemical, to drilling muds; additives, chemical, to fungicides; additives, chemical, to insecticides; additives, chemical, to motor fuel; adhesive preparations for surgical bandages; adhesives for billposting; adhesives for industrial purposes; adhesives for paper-hanging; adhesives for wall tiles; adhesives for wallpaper; agar-agar; agglutinants for concrete; agricultural chemicals, except fungicides, weedkillers, herbicides, insecticides and parasiticides; albumin [animal or vegetable, raw material]; albuminized paper; alcohol; aldehydes; alginates for industrial purposes; alginates for the food industry; alkalies; alkaline iodides for industrial purposes; alkaline metals; alkaline-earth metals; alkaloids; alum; alumina; aluminium acetate; aluminium alum; aluminium chloride; aluminium hydrate; aluminium iodide; aluminium silicate; americium; ammonia [volatile alkali] for industrial purposes; ammonia; ammonia alum; ammoniacal salts; ammonium aldehyde; ammonium salts; amyl acetate; amyl alcohol; anhydrides; anhydrous ammonia; animal albumen [raw material]; animal carbon preparations; animal carbon; animal charcoal; blood charcoal; bone charcoal; anti-boil preparations for engine coolants; anti-frothing solutions for accumulators; anti-incrustants; anti-knock substances for internal combustion engines; anti-sprouting preparations for vegetables; anti-tarnishing chemicals for windows; antifreeze; antimony oxide;

antimony sulphide; antimony; antistatic preparations, other than for household purposes; antranilic acid; argon; arsenic; arsenious acid; artificial resins, unprocessed; artificial sweeteners [chemical preparations]; astatine; automobile body fillers; auxiliary fluids for use with abrasives; bacterial preparations other than for medical and veterinary use; bacteriological preparations for acetification; bacteriological preparations other than for medical and veterinary use; balm of gurjun [gurjon, gurjan] for making varnish; barium compounds; barium sulphate; barium; baryta paper; baryta; barytes; bases [chemical preparations]; basic gallate of bismuth; bate for dressing skins; baths for galvanizing; bauxite; beer preserving agents; beer-clarifying and preserving agents; bentonite; benzene derivatives; benzene-based acids; benzoic acid; benzoic sulphide; berkelium; bicarbonate of soda for chemical purposes; bichloride of tin; bichromate of potassium; bichromate of soda; biochemical catalysts; biological preparations, other than for medical or veterinary purposes; biological tissue cultures other than for medical or veterinary purposes; birdlime; bismuth nitrite for chemical purposes; bismuth; bleaching preparations [decolorants] for industrial purposes; blueprint cloth; blueprint paper; borax; boric acid for industrial purposes; brake fluid; brake fluids; brazing fluxes; brazing preparations; brickwork preservatives, except paints and oils; bromine for chemical purposes; by-products of the processing of cereals for industrial purposes; caesium; calcined soda; calcium carbide; calcium cyanamide [fertilizer]; calcium salts; californium; camphor, for industrial purposes; car body fillers; carbide; carbolineum for the protection of plants; carbon black for industrial purposes; carbon for filters; carbon sulphide; carbon tetrachloride; carbon; carbonates; carbonic acid; carbonic hydrates; casein for industrial purposes; casein for the food industry; cassiopium [lutetium]; catalysts; catechu; caustic alkali; caustic soda for industrial purposes; caustics for industrial purposes; cellulose; cement [metallurgy]; cement for pneumatic tires [tyres]; cement preservatives, except paints and oils; cement-waterproofing preparations, except paints; ceramic compositions for sintering [granules and powders]; ceramic glazings; ceramic materials in particulate form, for use as filtering media; cerium; chemical additives for oils; chemical additives to drilling muds; chemical additives to fungicides; chemical additives to motor fuel; chemical condensation preparations; chemical intensifiers for paper; chemical intensifiers for rubber; chemical preparations for analyses in laboratories, other than for medical or veterinary purposes; chemical preparations for de-carbonising engines; chemical preparations for facilitating the alloying of metals; chemical preparations for protection against wheat blight [smut]; chemical preparations for scientific purposes, other than for medical or veterinary use; chemical prepa-

rations for smoking meat; chemical preparations for the manufacture of paints; chemical preparations for the manufacture of pigments; chemical preparations for use in photography; chemical preparations to prevent mildew; chemical preparations to prevent wheat smut; chemical preparations, except pigments, for the manufacture of enamel; chemical reagents, other than for medical or veterinary purposes; chemical substances for analyses in laboratories, other than for medical or veterinary purposes; chemical substances for preserving foodstuffs; cement for footwear; chemicals for forestry, except fungicides, herbicides, insecticides and parasiticides; chemicals used in fermenting wine; chimney cleaners, chemical; china clay; china slip; chlorates; chlorides; chlorine; cholic acid; chromates; chrome alum; chrome salts; chromic acid; chromic salts; chromium oxide; cinematographic film, sensitized but not exposed; cinematographic films, sensitized but not exposed; citric acid for industrial purposes; clarification preparations; coal saving preparations; cobalt oxide for industrial purposes; collodion; color-brightening chemicals for industrial purposes; colour-brightening chemicals for industrial purposes; combusting preparations [chemical additives to motor fuel]; compositions for repairing inner tubes of tires [tyres]; chemical additives to insecticides; compositions for repairing tires [tyres]; compositions for the manufacture of phonograph records; compositions for the manufacture of technical ceramics; compositions for threading; compost; concrete preservatives, except paints and oils; concrete-aeration chemicals; condensation-preventing chemicals; coolants for vehicle engines; copper sulphate [vitriol]; corrosive preparations; creosote for chemical purposes; crotonic aldehyde; cryogenic preparations; cultures of microorganisms other than for medical and veterinary use; curium; currying preparations for leather; currying preparations for skins; cyanides [prussiates]; cymene; damp proofing preparations, except paints, for masonry; decolorants for industrial purposes; defoliant; degreasing preparations for use in manufacturing processes; degumming preparations; dehydrating preparations for industrial purposes; detergent additives to gasoline [petrol]; detergent additives to gasoline; detergent additives to petrol [gasoline]; detergents for use in manufacturing processes; dextrine size; diagnostic preparations, other than for medical or veterinary purposes; diastase for industrial purposes; diatomaceous earth; diazo paper; diazo papers; dioxide of hydrogen; disincrustants; dispersions of plastics; distilled water; dolomite for industrial purposes; dressing and finishing preparations for textiles; dressing, except oils, for skins; drilling muds; dry ice [carbon dioxide]; dysprosium; earth for growing; electrophoresis gels, other than for medical or veterinary purposes; emollients for industrial purposes; emulsifiers; enamel and glass-staining-chemicals; enamel-staining

chemicals; engine-decarbonising chemicals; enzyme preparations for industrial purposes; enzyme preparations for the food industry; enzymes for industrial purposes; enzymes for the food industry; epoxy resins, unprocessed; erbium; esters; ethane; ethers; ethyl alcohol; ethyl ether; europium; expanded-clay for hydroponic plant growing [substrate]; fat-bleaching chemicals; fatty acids; ferments for chemical purposes; fermium; ferrocyanides; ferrotype plates [photography]; fertilizers; fertilizing preparations; fillers for automobile bodies; fillers for car bodies; filtering materials [chemical preparations]; filtering materials [mineral substances]; filtering materials [unprocessed plastics]; filtering materials [vegetable substances]; filtering preparations for the beverages industry; finishing preparations for use in the manufacture of steel; fire extinguishing compositions; fireproofing preparations; fish meal fertilizers; fissionable chemical elements; fissionable material for nuclear energy; fixing baths [photography]; fixing solutions [photography]; flashlight preparations; flocculants; flour for industrial purposes; flower preservatives; flowers of sulphur for chemical purposes; fluids for hydraulic circuits; fluorine; fluorspar compounds; formic acid; formic aldehyde for chemical purposes; foundry binding substances; foundry molding [moulding] preparations; foundry molding preparations; foundry moulding preparations; foundry sand; francium; fuel for atomic piles; fuel-saving preparations; fuller's earth for use in textile industry; fulling preparations for use in textile industry; fulling preparations; gadolinium; gall nuts; gallic acid for the manufacture of ink; gallium; gallnuts; gallotannic acid; galvanizing baths; galvanizing preparations; gambier; gas propellents for aerosols; gas purifying preparations; gelatine for industrial purposes; gelatine for photographic purposes; genes of seeds for agricultural production; getters [chemically active substances]; glass-frosting chemicals; glass-staining chemicals; glaziers' putty; glucose for industrial purposes; glucose for the food industry; glucosides; glue for industrial purposes; gluten [glue], other than for stationery or household purposes; gluten for industrial purposes; gluten for the food industry; glutinous preparations for tree-banding; glutinous preparations for tree-grafting; glutinous tree-banding preparations; glutinous tree-grafting preparations; glycerides; glycerine for industrial purposes; glycol ether; glycol; gold salts; grafting mastic for trees; grafting wax for trees; graphite for industrial purposes; grease-removing preparations for use in manufacturing processes; guano; gum arabic for industrial purposes; gum solvents; gums [adhesives], other than for stationery or household purposes; heavy water; helium; holmium; hormones for hastening the ripening of fruit; horticulture chemicals, except fungicides, herbicides, insecticides and parasiticides; humus top dressing; humus; hydrates; hydrazine; hydrochlorates;

hydrochloric acid; hydrofluoric acid; hydrogen peroxide; hydrogen; hypochlorite of soda; hyposulphites; industrial chemicals; iodic acid; iodine for chemical purposes; iodine for industrial purposes; iodised albumen; malt albumen; iodised salts; ion exchangers [chemicals]; ion exchangers [chemical preparations]; iron salts; isinglass other than for stationery, household or alimentary purposes; isotopes for industrial purposes; kainite; kaolin; ketones; kieselgur; krypton; lactic acid; lactose [raw material]; lactose for industrial purposes; lactose for the food industry; lamp black for industrial purposes; lanthanum; lead acetate; lead arsenate; lead oxide; leather glues; leather-dressing chemicals; leather-impregnating chemicals; leather-renovating chemicals; leather-waterproofing chemicals; lecithin [raw material]; lecithin for industrial purposes; lecithin for the food industry; lime acetate; lime carbonate; lime chloride; limestone hardening substances; liquids for hydraulic circuits; liquids for removing sulphates from accumulators; liquids for removing sulphates from batteries; lithia [lithium oxide]; lithium; litmus paper; loam; lutetium [cassiopeium]; magnesite; magnesium carbonate; magnesium chloride; magnetic fluid for industrial purposes; manganate; manganese dioxide; mangrove bark for industrial purposes; manure for agriculture; masonry preservatives, except paints and oils; mastic for leather; mastic for tires [tyres]; mastic for tires; mastic for tyres; meat tenderizers for industrial purposes; mercuric oxide; mercury salts; mercury; metal annealing preparations; metal earths; rare earths; metal hardening preparations; metal tempering preparations; metalloids; methane; methyl benzene; methyl benzol; methyl ether; milk ferments for chemical purposes; milk ferments for industrial purposes; milk ferments for the food industry; mineral acids; moderating materials for nuclear reactors; moistening [wetting] preparations for use in bleaching; moistening [wetting] preparations for use in dyeing; moistening [wetting] preparations for use in the textile industry; mold-release preparations; mordants for metals; mould-release preparations; must-finishing preparations; naphthalene; neodymium; neon; neptunium; nitrate of uranium; nitrate paper; nitrates; nitric acid; nitric monoxide; nitrogen; nitrogenous fertilisers; nitrogenous lime [manure]; nitrous oxide; oenological bactericides [chemical preparations used in wine making]; oil cement [putty]; oil dispersants; oil-bleaching chemicals; oil-purifying chemicals; oil-separating chemicals; oils for currying leather; oils for preparing leather in the course of manufacture; oils for tanning leather; oils for the preservation of food; oleic acid; olivine [chemical preparations]; opacifiers for enamel; opacifiers for enamel or glass; opacifiers for glass; organic-bleaching chemicals; oxalates; oxalic acid; oxygen; palladium chlorides; paper pulp; wood pulp; peat [fertiliser]; peat pots for horticulture; pectin [photography]; pectin for indus-

trial purposes; pectin for the food industry; perborate of soda; percarbonates; perchlorates; persulphates; persulphuric acid; petroleum dispersants; phenol for industrial purposes; phosphates [fertilisers]; phosphatides; phosphoric acid; phosphorus; photographic developers; photographic emulsions; photographic paper; photographic sensitizers; photometric paper; photosensitive plates; sensitized photographic plates; picric acid; plant growth regulating preparations; plasticizers; plastics, unprocessed; plastisols; Plutonium; polish removing substances; polonium; potash water; potash; potassium dioxalate; potassium; potato flour for industrial purposes; potting soil; power steering fluid; praseodymium; preparations for preventing the tarnishing of glass; preparations for preventing the tarnishing of lenses; preparations for stimulating cooking for industrial purposes; preparations for the purification of gas; preparations for the separation of greases; preparations of microorganisms other than for medical and veterinary use; preparations of the distillation of wood alcohol; preservatives for pharmaceutical preparations; preservatives for tiles, except paints and oils; promethium; protactinium; protective gases for welding; protein [raw material]; prussiates; purification preparations; pyrogallic acid; pyroligneous acid [wood vinegar]; quebracho for industrial purposes; radiator flushing chemicals; radioactive elements for scientific purposes; radium for scientific purposes; radon; reducing agents for use in photography; refrigerants; refrigerating preparations; renovating preparations for phonograph records; rhenium; rock salt; rubber preservatives; rubidium; saccharin; sal ammoniac spirits; sal ammoniac; salicylic acid; salpetre; salt for preserving, other than for foodstuffs; salt, raw; salt-peter; salts [chemical preparations]; salts [fertilisers]; salts for coloring [colouring] metal; salts for coloring metal; salts for colouring metal; salts for galvanic batteries; salts for galvanic cells; salts for industrial purposes; salts from rare earth metals; salts of alkaline metals; salts of precious metals for industrial purposes; sauce for preparing tobacco; scale removing preparations, other than for household purposes; scandium; sea water for industrial purposes; seaweeds [fertilizers]; sebacic acid; seed preserving substances; selenium; self-toning paper [photography]; sensitized cloth for photography; sensitized films, unexposed; sensitized paper; sensitized plates for offset printing; separating and unsticking [ungluing] preparations; silicates; silicon; silicones; silver nitrate; silver salt solutions for silvering; size for finishing and priming; sizing preparations; slag [fertilisers]; soap [metallic] for industrial purposes; soda ash; sodium salts [chemical preparations]; sodium; soil conditioning preparations; soldering chemicals; soldering fluxes; solidified gases for industrial purposes; solutions for cyanotyping; solvents for varnishes; soot for industrial or agricultural purposes; sorrel salt; spinel [chemical



preparations]; spirits of salt; spirits of vinegar [dilute acetic acid]; stain-preventing chemicals for use on fabrics; starch for industrial purposes; starch paste [adhesive], other than for stationery or household purposes; starch size [chemical preparations]; starch-liquifying chemicals [ungluing agents]; stearic acid; stem cells other than for medical or veterinary purposes; strontium; substances for preventing runs in stockings; substances for removing polish; substrates for soil-free growing [agriculture]; sulphates; sulphides; sulphonic acids; sulphur; sulphuric acid; sulphuric ether; sulphurous acid; sumac for use in tanning; superphosphates [fertilisers]; surface-active chemical agents; synthetic materials for absorbing oil; synthetic resins, unprocessed; talc [magnesium silicate]; tan-wood; tan; tannic acid; tannin; tanning substances; tapioca flour for industrial purposes; tartar other than for pharmaceutical purposes; tartaric acid; technetium; tellurium; tensio-active agents; terbium; test paper, chemical; tetrachlorides; textile-brightening chemicals; textile-impregnating chemicals; textile-waterproofing chemicals; thallium; thiocarbonyl; thorium; thulium; tire repairing compositions; titanite; titanium dioxide for industrial purposes; toluene; toluol; toning baths [photography]; toning salts [photography]; toxic gas neutralizers; tragacanth gum for use in manufactures; transmission fluid; tree cavity fillers [forestry]; tungstic acid; tyre repairing compositions; ungluing agents [chemical preparations for liquifying starch]; ungluing preparations; unsticking and separating preparations; uranium oxide; uranium; vine disease preventing chemicals; vinic alcohol; viscose; vitriol; volatile alkali [ammonia] for industrial purposes; vulcanisation accelerators; vulcanising preparations; wallpaper removing preparations; water glass [soluble glass]; water purifying chemicals; water-softening preparations; wax-bleaching chemicals; welding chemicals; wetting preparations for use in bleaching; wetting preparations for use in dyeing; wetting preparations for use in the textile industry; wine finings; witherite; wood alcohol; wood vinegar [pyroligneous acid]; x-ray films, sensitized but not exposed; xenon; ytterbium; yttrium; zirconia.

4 – Additives, non-chemical, to motor fuel; alcohol [fuel]; anthracite; beeswax; belting wax; benzene; benzine; benzol; blocks of peat [fuel]; bone oil for industrial purposes; candles; carburants; carnauba wax; castor oil for technical purposes; ceresine; charcoal [fuel]; Christmas tree candles; perfumed candles; coal briquettes; coal dust [fuel]; coal naphtha; coal tar oil; coal; coke; combustible oil; cutting fluids; diesel oil; dust binding compositions for sweeping; dust laying compositions; dust removing preparations; electrical energy; ethanol [fuel]; fire-lighters; firewood; fish oil, not edible; fuel gas; fuel oil; fuel with an alcoholic base; fuel; gas for lighting; gasoline; grease for arms [weapons]; grease for belts; non-slipping preparations for belts; grease for

boots; combustible briquettes; grease for leather; grease for shoes; illuminating grease; illuminating wax; industrial grease; industrial oil; industrial wax; kerosene; lamp wicks; lanolin; lighting fuel; lignite; ligroin; lubricants; lubricating graphite; lubricating grease; lubricating oil; mazut; methylated spirit; mineral fuel; moistening oil; motor fuel; motor oil; naphtha; nightlights [candles]; oil for the preservation of leather; oil for the preservation of masonry; oil-gas; oils for paints; oils for releasing form work [building]; oleine; ozocerite [ozokerite]; paper spills for lighting; wood spills for lighting; paraffin; peat [fuel]; peat briquettes [fuel]; petrol; petroleum ether; petroleum jelly for industrial purposes; petroleum, raw or refined; preservatives for leather [oils and greases]; producer gas; rape oil for industrial purposes; solidified gas [fuel]; solidified gases [fuel]; soya bean oil preparations for non-stick treatment of cooking utensils; stearine; sunflower oil for industrial purposes; tallow; tapers; textile oil; tinder; vaporized fuel mixtures; wax [raw material]; wicks for candles; wood briquettes; wool grease; xylene; xylol.

19 – Advertisement columns, not of metal; agglomerated bagasses of cane [building material]; alabaster glass; alabaster; angle irons, not of metal; aquaria [structures]; aquarium gravel; aquarium sand; arbours [structures not of metal]; artificial stone; asbestos cement; asbestos mortar; asphalt paving; asphalt; aviaries, not of metal [structures]; balustrading; beacons, not of metal, non-luminous; beams, not of metal; bicycle parking installations, not of metal; binding agents for making briquettes; binding agents for making stones; binding material for road repair; bird baths [structures, not of metal]; bitumen; bituminous coatings for roofing; bituminous products for building; blinds [outdoor], not of metal and not of textile; branching pipes, not of metal; bricks; building cardboard [asphalted]; building cardboard; building glass; building materials, not of metal; building paper; building stone; building timber; buildings, not of metal; buildings, transportable, not of metal; busts of stone, concrete or marble; cabanas not of metal; caissons for construction work under water; calcareous marl; calcareous stone; casement windows, not of metal; cask wood; ceilings, not of metal; cement for blast furnaces; cement for furnaces; cement posts; cement slabs; cement; chicken-houses, not of metal; chimney cowls, not of metal; chimney pots, not of metal; chimney shafts, not of metal; chimneys, not of metal; cladding, not of metal, for building; clay; clinker ballast; clinker stone; coal tar; coatings [building materials]; concrete building elements; concrete; construction materials, not of metal; cork [compressed]; cornices, not of metal; coverings, not of metal, for building; crash barriers, not of metal, for roads; diving boards, not of metal; door casings, not of metal; door frames, not of metal; door panels, not of metal; doors, not of metal;

drain pipes, not of metal; drain traps [valves], not of metal or plastic; duckboards, not of metal; ducts, not of metal, for ventilating and air-conditioning installations; earth for bricks; facings, not of metal, for building; fair huts; felt for building; fences, not of metal; figurines [statuettes] of stone, concrete or marble; fire burrs; fireclay; fireproof cement coatings; flashing, not of metal, for building; floating docks, not of metal, for mooring boats; floor tiles, not of metal; floors, not of metal; folding doors, not of metal; foundry molds [moulds], not of metal; framework for building, not of metal; framework, not of metal, for building; furrings of wood; gates, not of metal; geotextiles; girders, not of metal; glass granules for marking out roads; glass granules for road marking; granite; grave or tomb enclosures, not of metal; gravel; gravestones; greenhouse frames, not of metal; greenhouses, transportable, not of metal; grog [fired refractory material]; grout; gutter pipes, not of metal; gypsum; hips for roofing; horticultural frames, not of metal; huts; insect screens not of metal; insulating glass [building]; jalousies, not of metal; joists, not of metal; laths, not of metal; latticework, not of metal; lengthening pieces, not of metal, for chimneys; letter boxes of masonry; lighting slabs; lime; limestone; linings, not of metal, for building; lintels, not of metal; lumber; luminous paving; macadam; magnesia cement; manhole covers, not of metal; mantlepieces; marble; masts [poles], not of metal; materials for making and coating roads; memorial plaques, not of metal; moldable wood; moldings, not of metal, for building; moldings, not of metal, for cornices; monuments, not of metal; mooring bollards, not of metal; mortar for building; mosaics for building; mouldable wood; mouldings, not of metal, for building; mouldings, not of metal, for cornices; olivine for building; paint spraying booths, not of metal; palings, not of metal; palisading, not of metal; pantiles; paperboard for building; parquet floor boards; parquet flooring; partitions, not of metal; paving blocks, not of metal; paving slabs, not of metal; penstock pipes, not of metal; perches; pilings, not of metal; pitch; planks [wood for building]; plaster; plate glass [windows], for building; platforms, prefabricated, not of metal; plywood; poles, not of metal, for electric power lines; porches, not of metal, for building; porphyry [stone]; posts, not of metal; props, not of metal; quartz; railroad ties, not of metal; railway sleepers, not of metal; raw chalk; reeds, for building; refractory construction materials, not of metal; reinforcing materials, not of metal, for building; rigid pipes, not of metal [building]; road coating materials; road marking sheets and strips of synthetic material; rock crystal; rocket launching platforms, not of metal; roof coverings, not of metal; roof flashing, not of metal; roof gutters, not of metal; roofing shingles; roofing slates; roofing, not of metal, incorporating solar cells; roofing, not of metal; rubble; safety

glass; sand, except foundry sand; sandstone for building; sandstone tubes; sawn timber; scaffolding, not of metal; scantlings [carpentry]; schists; sheet piles, not of metal; shutters, not of metal; signalling panels, non-luminous and non-mechanical, not of metal; silica [quartz]; sills, not of metal; silver sand; skating rinks [structures, not of metal]; slabs, not of metal; slag [building material]; slag stone; slate powder; slate; stained-glass windows; stair-treads [steps], not of metal; staircases, not of metal; statues of stone, concrete or marble; stave wood; stone; street gutters, not of metal; stringers [parts of staircases], not of metal; surfacings, not of metal, for building; swimming pools [structures, not of metal]; tanks of masonry; tar; tarred strips, for building; telegraph posts, not of metal; telephone booths, not of metal; telephone boxes, not of metal; terra cotta; tile floorings, not of metal; tiles, not of metal, for building; tiles, not of metal; tomb or grave enclosures, not of metal; tombs [monuments], not of metal; tombs, not of metal; tombstone plaques, not of metal; tombstone stelae, not of metal; tombstones; trellises, not of metal; tufa; vaults, not of metal [burial]; veneer wood; veneers; vinyl siding; wainscoting, not of metal; wall claddings, not of metal, for building; wall linings, not of metal, for building; wall tiles, not of metal, for building; water pipes, not of metal; water-pipes, not of metal; window frames, not of metal; window glass, except glass for vehicle windows; window glass, for building; windows, not of metal; wood for making household utensils; wood panelling; wood paving; wood pulp board, for building; wood veneers; wood, semi-worked; works of art of stone, concrete or marble; works of stonemasonry; xylolith.

(260) AM 2015 75533 A

(800) 1187573

(891) 2013 04 01

(731) STRAUSS COFFEE B.V.

Prof. J.H. Bavincklaan 2, NL-1183 AT  
Amstelveen, Netherlands

(540)



(591) Black, white

(511)

30 – Coffee; unroasted coffee; artificial coffee; vegetal preparations for use as coffee substitutes;

coffee-based beverages; coffee beverages with milk; coffee flavorings [flavourings]; cocoa; cocoa-based beverages; cocoa beverages with milk; chocolate-based beverages; chocolate beverages with milk; chocolate; tea; tea-based beverages; chicory [coffee substitute]; confectionery; ice cream; edible ices.

35 – Advertising; distribution of samples; dissemination of advertising matter.

(260) AM 2015 75534 A

(800) 1187578

(891) 2013 04 03

(731) ROTAPHARM İLAÇLARI LİMİTED  
ŞİRKETİ

Evren Mah. Camiyolu, Cad. No:50 K.2,

GÜNEŞLİ BAĞCILAR İSTANBUL, Turkey

(540)

## **Rotafer kids**

## **Ротафер кидс**

(526) The trademark is protected as a whole. The words "kids", "кидс" included therein shall not be subject to independent legal protection.

(511)

5 – Medicines for human purposes; medicines for veterinary purposes; chemical preparations for medical purposes; dietetic substances adapted for medical use; dietetic foods adapted for medical purposes; amino acids for medical purposes; nutritional supplements; pollen dietary substances; mineral food supplements; protein dietary supplements; baby foods; medicinal herbs; herbal beverages adapted for medical purposes; medicines for dental purposes; hygienic products for medical purposes including pads, waddings for medical purposes, plasters for medical purposes, dressings for medical purposes; preparations for destroying noxious plants, preparations for destroying noxious animals, fungicides; deodorants other than for human beings or for animals; disinfectants for hygiene purposes, antiseptics, detergents for medical purposes.

(260) AM 2015 75537 A

(800) 1187587

(891) 2013 05 27

(731) Foscarini S.R.L.

Via Delle Industrie, 27, I-30020 Marcon (VE),  
Italy

(540)

## **FOSCARINI**

(511)

11 – Table lamps, wall lamps, outdoor lamps, hanging lamps, ceiling lights, floor lights, fitted lights, modular lamps, of metal and glass, modular style chandeliers of glass, lamps, lamps in general, lamps of materials of all kinds.

(260) AM 2015 75538 A

(800) 1187590

(891) 2013 05 27

(731) KTM-Sportmotorcycle AG

Stallhofner Straße 3, A-5230 Mattighofen,  
Austria

(540)

## **KTM Adventure Tours**

(511)

12 – Bicycles, motorcycles, small motorcycles, motor scooters, mopeds, and all parts and accessories therefor, namely motors for land vehicles, saddles for bicycles and motorcycles, tyres, wheels, rims, brake linings, brake discs, door trims, luggage carriers, luggage boxes, panniers, tank rucksacks, stands, mudguards, spoilers, rear sections, mirrors, petrol caps, tanks, chains, bench seats; Motorised vehicles, namely dual-axle or multi-axle vehicles, including off-road vehicles (all-terrain vehicles, quad bikes); vehicles and parts therefor; Small motor bicycles, motorcycles, light motorcycles, pedelecs, electric two-wheeled vehicles and bicycles, training and children's bicycles, seat covers for motor vehicles; saddle covers for bicycles and motorcycles.

35 – Advertising; business management; business administration; Office functions.

41 – Education; providing of training; entertainment; sporting and cultural activities.

(260) AM 2015 75539 A

(800) 1187627

(891) 2013 08 02

(731) AVON PRODUCTS, INC.

World Headquarters, 777 Third Avenue,  
New York, NY 10017, USA

(540)

## **YOU MAKE IT BEAUTIFUL**

(511)

35 – Door-to-door retail merchandising of products, distributorship services, retail store services, retail services by direct solicitation by independent sales representatives, telephone shop at home services, mail order catalog services, interactive retail store services rendered by means of a global computer information network, all in the fields of beauty care and salon services, housewares, clothing, toiletries, cosmetics, jewelry, gift items not including products in the telecommunications field, toys, personal care products, pre-recorded videos, audio tapes and CD's.

(260) AM 2015 75543 A

(800) 1187694

(891) 2013 09 20

(731) EGIS Gyógyszergyár Zrt.

Keresztúri út 30-38, H-1106 Budapest,  
Hungary

(540)

**CROGON**

(511)

5 – Pharmaceutical preparations for human use.

(260) AM 2015 75544 A

(800) 1187695

(891) 2013 09 20

(731) EGIS Gyógyszergyár Zrt.

Keresztúri út 30-38, H-1106 Budapest,  
Hungary

(540)

**ULAIN**

(511)

5 – Pharmaceutical preparations for human use.

(260) AM 2015 75545 A

(800) 1187696

(891) 2013 09 20

(731) EGIS Gyógyszergyár Zrt.

Keresztúri út 30-38, H-1106 Budapest,  
Hungary

(540)

**BI-HART**

(511)

5 – Pharmaceutical preparations for human use except pharmaceutical preparations for extracorporeal blood treatment and renal insufficiency.

(260) AM 2015 75546 A

(800) 1187697

(891) 2013 09 20

(731) EGIS Gyógyszergyár Zrt.

Keresztúri út 30-38, H-1106 Budapest,  
Hungary

(540)

**LENTULIL**

(511)

5 – Pharmaceutical preparations for human use.

(260) AM 2015 75547 A

(800) 1187698

(891) 2013 09 20

(731) EGIS Gyógyszergyár Zrt.

Keresztúri út 30-38, H-1106 Budapest,  
Hungary

(540)

**NORETTA**

(511)

5 – Human pharmaceutical preparations for gynecologic use.

(260) AM 2015 75557 A

(800) 1187894

(891) 2013 11 06

(731) ASTELLAS PHARMA INC.

5-1, Nihonbashi-Honcho 2-chome, Chuo-ku,  
Tokyo 103-8411, Japan

(540)

**MYTREMIS**

(511)

5 – Vaccines for human use.

(260) AM 2015 75558 A

(800) 1187895

(891) 2013 11 06

(731) ASTELLAS PHARMA INC.

5-1, Nihonbashi-Honcho 2-chome, Chuo-ku,  
Tokyo 103-8411, Japan

(540)

**DYFANTRO**

(511)

5 – Vaccines for human use.

(260) AM 2015 75559 A

(800) 1187897

(891) 2013 04 30

(731) ROTAPHARM İLAÇLARI LİMİTED  
ŞİRKETİEvren Mah. Camiyolu, Cad. No:50 K.2,  
GÜNEŞLİ BAĞCILAR İSTANBUL,  
Turkey

(540)

**DYNAMIX SAPIENS**

(511)

5 – Medicines for human purposes, medicines for veterinary purposes, chemical preparations for medical purposes, dietetic substances adapted for medical use; dietetic foods adapted for medical purposes; aminoacids for medical purposes, nutritional supplements, pollen dietary substances, mineral food supplements, protein dietary supplements, baby foods, medicinal herbs, herbal beverages adapted for medical purposes; medicines for dental purposes, hygienic products for medical purposes including pads, waddings for medical purposes, plasters for medical purposes, dressings for medical purposes, preparations for destroying noxious plants, preparations for destroying noxious animals, fungicides, deodorants other than for human beings or for animals, disinfectants for hygiene purposes, antiseptics, detergents for medical purposes.

(260) AM 2015 75563 A

(800) 1187958

(891) 2013 08 21

(731) OTKRYTOE AKTSIONERNOE  
OBCHTCHESTVO "NEFTYANAYA  
KOMPANIYA "LUKOIL"  
Sretensky boulyar 11, RU-101000 MOSKVA,  
Russian Federation

(540)

## KARVINIL

(511)

1 – Chemical products for use in industry and science; unprocessed plastics.

(260) AM 2015 75568 A

(800) 1188054

(891) 2013 07 19

(731) WORLD MEDICINE İLAÇ SANAYİ VE  
TİCARET LİMİTED ŞİRKETİ  
Evren Mah. Camiyolu Cad. No:50 K.1B,  
Zemin – 4-5-6, GÜNESLİ/BAGCILAR/  
İSTANBUL, Turkey

(540)

## Bimagan Бимаган

(511)

5 – Medicines for human purposes, medicines for veterinary purposes, vitamin preparations, chemical preparations for medical purposes, dietetic substances adapted for medical use; dietetic foods adapted for medical purposes; baby foods, medicinal herbs, herbal beverages adapted for medical purposes, nutritional supplements, pollen dietary supplements, mineral food supplements, protein dietary supplements; medicines for dental purposes, hygienic products for medical purposes including pads, waddings for medical purposes, plasters for medical purposes, dressings for medical purposes, babies' napkins, preparations for destroying noxious plants, preparations for destroying noxious animals, fungicides, deodorants other than for human beings or for animals, disinfectants for hygiene purposes, antiseptics, detergents for medical purposes.

(260) AM 2015 75569 A

(800) 1188065

(891) 2013 12 04

(731) ACTELION PHARMACEUTICALS LTD  
Gewerbstrasse 16, CH-4123 Allschwil,  
Switzerland

(540)

## УПТРАВИ

(511)

5 – Pharmaceutical preparations.

(260) AM 2015 75578 A

(800) 1188169

(891) 2013 08 20

(731) ODY, LLC

343 Quail Run Road, Farmington UT 84025, USA

(540)

## Electric Run

(511)

41 – Entertainment in the nature of foot races; organizing and conducting athletic programs and activities; administering, regulating and governing athletic programs and activities (Terms too vague in the opinion of the International Bureau – Rule 13(2)(b) of the Common Regulations); entertainment services, namely, participation in a foot race event; organizing community sporting events; organizing sporting events, namely, foot races.

(260) AM 2015 75580 A

(800) 1188209

(891) 2013 10 09

(731) TAIZHOU GUANGFENG PLASTIC CO., LTD.  
Yousheng Village, Sanjia Street, Jiaojiang  
District, Taizhou City, ZHEJIANG  
PROVINCE China

(540)

## Farmguard

(511)

8 – Syringes for spraying insecticides; garden tools, hand-operated; insecticide atomizers [hand tools].

(260) AM 2015 75581 A

(800) 1188267

(891) 2013 11 11

(731) Obshestvo s Ogranichennoy Otvetstvennostyu  
"LEGION CO"  
16 A, Navoi Street, district Shayhontohur,  
Tashkent city 100011, Uzbekistan

(540)

## Белое Солнце

(511)

33 – Vodka.

(260) AM 2015 75582 A

(800) 1188271

(891) 2013 10 10

(731) F.LLI GANCIA & C. S.p.A.  
Corso Libertà, 66, I-14053 CANELLI (AT),  
Italy

(540)

## ROMANOFF

(511)

33 – Alcoholic beverages (except beers).

(260) AM 2015 75583 A

(800) 1188303

(891) 2013 10 02

(731) Tovarystvo Z Obmezhenoiu Vidpovidalnistiu  
"KRYMSKA VODOCHNA COMPANIIA"  
vul. Sadova, 19, s. Mazanka, Simferopolskyi  
r-n, AR Krym 97530, Ukraine

(540)

## РІДНА РОСА

(511)

33 – Alcoholic beverages, except beer; aperitifs; arak [arrack]; brandy; wine; sparkling wine; whisky; anisette [liqueur]; vodka; anise [liqueur]; hydromel [mead]; kirsch; perry; gin; cognac; cocktails; curacao; liqueurs; peppermint liqueurs; distilled beverages; alcoholic beverages containing fruit; bitters; piquette; rice alcohol; rum; sake; cider; spirits [beverages]; alcoholic extracts; alcoholic essences; fruit extracts, alcoholic; digesters (liqueurs and spirits).

(260) AM 2015 75584 A

(800) 1188310

(891) 2013 10 15

(731) PRIVATE JOINT STOCK COMPANY  
"INDUSTRIAL ASSOCIATION "KONTI"  
Bul. Shevchenko, 6-b, Donetsk 83015  
Ukraine

(540)

## «Натюрель» – вдохновение природы...

(511)

30 – Coffee, tea, cocoa, sugar, rice, tapioca, sago, artificial coffee; flour and preparations made from cereals, bread, pastry and confectionery, ices; honey, treacle; yeast, baking-powder; salt, mustard; vinegar, sauces (condiments); spices; edible ice; pastries; waffles; waffle with various fillings; waffle cakes; cereal product; dragee (confectionery); fruit jellies (confectionery); chewing gum; custard; frozen kefir; frozen yogurt; cocoa products; caramels (candy); cakes; crackers; confectionery for decorating Christmas trees; candy for food; marzipan; almond confectionery; flour-milling products; muesli; paskha (Easter cake); cookies; cookies glazed with chocolate; quiches (confectionery); chips (cereal products); fondants (confectionery); gingerbread; puddings; bread rolls (confectionery); sweetmeats (candy); cakes; halvah; sugar confectionery; waffle candies; chocolate; chocolate bars; chocolate figurines.

(260) AM 2015 75585 A

(800) 1188320

(891) 2013 11 26

(731) PENETRON INTERNATIONAL LTD.  
45 Research Way, Suite 203, East Setauket  
NY 11733, USA

(540)

## PENEBAR

(511)

19 – Non-metal building materials, namely, prefabricated waterstops for installation between adjacent sections of concrete structures to effect a watertight joint.

(260) AM 2015 75613 A

(800) 1133053

(891) 2012 08 22

(731) GILEAD SCIENCES LIMITED  
IDA Business and Technology Park,  
Carrigtohill, Co. Cork, Ireland

(540)

## SOVALDI

(511)

5 – Pharmaceuticals.

(260) AM 2015 75614 A

(800) 1188668

(891) 2013 11 05

(731) Novartis AG  
CH-4002 Basel, Switzerland

(540)

## QUINGARD

(511)

5 – Vaccines for human use.

(260) AM 2015 75615 A

(800) 1188782

(891) 2013 08 06

(731) WORLD MEDICINE İLAÇ SANAYİ VE  
TİCARET LİMİTED ŞİRKETİ  
Evren Mah. Camiyolu Cad. No:50 K.1B,  
Zemin -4-5-6, GÜNEŞLİ/BAĞCILAR/  
İSTANBUL, Turkey

(540)

## Tirfens Тирфенс

(511)

5 – Medicines for human purposes, medicines for veterinary purposes, vitamin preparations, chemical preparations for medical purposes, dietetic substances adapted for medical use; dietetic foods adapted for medical purposes; baby foods, medicinal herbs, herbal beverages adapted for medical purposes, nutritional supplements, pollen dietary supplements, mineral food supplements, protein dietary supplements; medicines for dental purposes, hygienic products for medical purposes including pads, waddings for medical purposes, plasters for medical purposes, dressings for medical purposes, babies' napkins, preparations for destroying noxious plants, preparations for destroying noxious animals, fungicides, deodorants other than for human beings or for animals, air deodorising preparations, disinfectants

for hygiene purposes, antiseptics, detergents for medical purposes.

(260) AM 2015 75616 A

(800) 1188816

(891) 2013 07 23

(731) BURLINGTON FASHION GmbH

Oststraße 5, 57392 Schmalleberg,

Germany

(540)

## Burlington

(511)

3 – Soaps for cosmetic purposes, perfumery goods, essential oils; products for personal hygiene and beauty care; cosmetic products to clean, care for and beautify the skin, the scalp and the hair; toilet articles, included in this class, deodorants for personal use, pre shave and after shave products.

14 – Jewellery, watches.

18 – Goods made of leather and imitations of leather (included in this class), bags, suitcases, backpacks; small leather articles (included in this class), especially purses, wallets, key cases; umbrellas and sunshades.

25 – All kind of shoes; clothing, especially all kind of hosiery, knitwear, outerwear, sportswear; underwear; headwear, belts.

(260) AM 2015 75617 A

(800) 1188817

(891) 2013 08 02

(731) FIDUCIAL

41 rue du Capitaine Guynemer F-92400

COURBEVOIE, France

(540)



FIDUCIAL

(591) Black, white

(511)

9 – Magnetic purchase vouchers, magnetic promotional vouchers, magnetic gift payment certificates, magnetic gift payment cards, magnetic discount vouchers; adding machines; electronic agendas; alarms (instruments); sound amplifiers; flashlights [photography]; thermionic bulbs; scales; punched card machines for offices; covers for electric outlets; cash registers; rulers and disks for calculating; calculating machines; integrated circuit cards [smart cards]; bar code readers; computer peripherals; headphones; detectors for false coins, smoke and metal objects for industrial or military purposes; video and projection screens; dictating machines; calculating disks; headphones; telephone receivers; cases especially made for photographic apparatus and instruments; lumi-

nous and mechanical signs; electronic tags for goods; invoicing machines; computer printers; intercommunication apparatus; furniture especially made for laboratories; electric batteries; bar code readers; software (recorded programs); word processors; DVD and compact disk players; computer memories; measures and rulers (measuring instruments); memories, printers and other computer peripheral; school apparatus; mouse pads; thermometers, (not for medical purposes); electronic notice boards; scientific (other than for medical use), nautical, surveying, photographic, cinematographic, optical, weighing, measuring, signaling, checking (supervision), life-saving and teaching apparatus and instruments; apparatus and instruments for conducting, switching, transforming, accumulating, regulating or controlling electricity; audiovisual, telecommunication, data communication apparatus and instruments, television sets, tape recorders, video recorders, radios, projectors, car radios, antennae, satellite dishes, cabinets for loudspeakers, amplifiers, high-fidelity sound systems, microphones, telephones, apparatus for recording, transmitting, reproducing and processing sound or images; magnetic recording media, sound recording or optical disks, floppy disks; equipment for data processing and computers; fire extinguishers; detectors; electric wires; electric relays; diving suits, gloves or masks; clothing for protection against accidents, irradiation and fire; protection devices for personal use against accidents; spectacles (optics); optical goods; spectacle cases; diagnostic apparatus, not for medical purposes; integrated circuit cards [smart cards]; safety tarpaulins; encoded identification documents readable by apparatus enabling access to premises and optionally time-stamping.

16 – Diaries; glues, adhesives, self-adhesive and adhesive tapes for stationery or household purposes, dispensers for adhesive tape (stationery articles); document holders; modeling paste; cases for patterns; sealing wax; sealing machines for offices; coffee filters of paper; wristbands for the retention of writing instruments; hand towels of paper; instructional and teaching equipment (except apparatus), blackboards, paper for boards, board erasers; posters; manuals, instructional manuals, including for computer software; albums; atlases; pads; notepad holders; writing or drawing books; calendars; maps, maps featuring time-management forecasting for individuals and/or legal entities and machines; notebooks; paper cards; catalogs; files for documents; labels for files; folders for papers; portfolios for documents for signature; cases for stationery; envelopes (stationery); bags and small bags for packaging, of paper or plastics; newspapers; blueprints; record books; books; indexes; seals; printed forms; school supplies; geographical maps; terrestrial globes; printed timetables; portable printing sets (office requisites); pencils; paper clasps; pencil sharpeners;

pencil leads; pencil holders; pencil lead holders; stencils; felt pens; marking pens; document markers [highlighting pens]; stands for pens and pencils; ink sticks; balls for ball-point pens; paintbrushes; writing chalk and chalk holders; supplies and instruments for drawing and writing; pens; ball-point pens; fountain pens; writing and drawing pens; pen holders; pen wipers; writing tablets; rubber erasers; erasing products and goods; elastic bands for offices; staples for offices; staplers; compasses for drawing; letter trays; conical paper bags; correction fluids (office supplies) and correcting ink (heliography); document laminators; non-encoded identification documents, readable by apparatus for the access to certain premises and optionally time-stamping and hooks for holding such documents; paper, cardboard and goods made from these materials, namely hand towels of paper, handkerchiefs of paper, toilet paper, towels of paper, coffee filters of paper, garbage bags of paper, cardboard articles, bags, sachets, envelopes, small bags of paper, cardboard tubes, paper for recording machines; low weight and recycled paper; silver paper; tracing paper; cardboard articles; document folders of paper and plastic; paper for recording machines; filter paper; parchment paper; Xuan paper (for Chinese painting and calligraphy); handkerchiefs of paper; tracing paper; copying paper (stationery); carbon paper; paper for recording machines; papier mâché; waxed paper; wrapping paper; sheets (stationery); divider sheets; index cards (stationery); bookmarks; paperweights; paper ribbons; inking ribbons; boxes of cardboard or paper; advertisement boards of paper or cardboard; stapling presses; transparencies (stationery); inking pads; drawing sets; cardboard tubes; office hole punches; thimbles (office equipment); rollers for typewriters; typewriters; thumbtacks (drawing pins); rulers; printers' galleys; apparatus, articles and machines for bookbinding (office equipment); any other printed matter and stationery; any other office requisite (except furniture); purchase vouchers, promotional vouchers, gift payment certificates, gift payment cards, discount vouchers.

20 – Works of art made of wood, wax, plaster, cork, reed, cane, wicker, horn, bone, ivory, whalebone, shell, amber, mother-of-pearl, meerschaum, substitutes for all these materials or of plastic; cushions; packaging containers of plastic; armchairs; bedding (except bed linen); mattresses; funerary urns; plate racks; wickerwork; boxes of wood or plastic; display boards, key boards; cushions; furniture items; curtain rings; head-rests (furniture); furniture; cupboards; office cupboards; medicine cabinets; bookcase shelves and shelving; mail boxes not of masonry or metal; dinner wagons (furniture); coat hangers; hat stands; holders for books and magazines; umbrella stands; clothes hangers; napkin holders; shelves for files; chests; showcases; furniture of metal; frames; settees; benches (furniture); seats; chairs (seats),

seats of metal; sofas; trolleys (furniture); indoor window blinds; school furniture; office tables, drawing tables; lockers; baskets, not of metal; coat hangers; armchairs; chests of drawers; display stands; newspaper display stands; standing desks; furniture shelves; mirrors (looking glasses); mobiles (decoration); clothes hooks not of metal; furniture items; tea carts; trolleys for computers.

35 – Advertising, including online advertising on a computer network, advertising by correspondence (including electronic), radio advertising, television advertising; arranging subscriptions to newspapers and to telecommunications services for others; commercial administration of the licensing of the goods and services of others; business management assistance; business management and organization consultancy; book-keeping; dissemination of advertisements and advertising material (tracts, prospectuses, printed matter, samples); procurement services (purchasing goods and services for other businesses); office machines and equipment rental; administrative processing of purchase orders; retail services via any means, particularly via the Internet, namely of office requisites, paper, furniture, office furniture, newspapers, periodicals and magazines, clothing, computer consumables, software, agricultural and animal products, wine, olive oils, beverages, mats, clothing, fabrics, building materials; auctioneering; presentation of goods on any communication means, particularly on the Internet, for retail sale purposes; sales promotion for others; price comparison services; accounting; accountancy, business organization auditing, personnel management auditing, personnel recruitment, recruitment advice, consultancy on matters relating to personnel, personnel selection; placement of personnel on behalf of others, placement of personnel employed to protect against theft, fire and other damage; telephone answering services; secretarial services, namely reception services; statutory auditor services; assistance in the management of commercial or industrial companies, business appraisals, compilation and systemization of information into computer databases, tax declaration preparation, drawing up of statistics, drawing up of statements of accounts, press review services, auditing; document reproduction; employment agencies; computer file management; organization of exhibitions for commercial or advertising purposes; commercial information and advice for consumers; advertising mail; document reproduction; invoicing; organization of trade fairs for commercial or advertising purposes; rental of advertising time on all communication media; rental of advertising space; creation and publication of advertising matter; sponsorship search; business advice relating to franchising.

36 – Insurance underwriting; insurance underwriting services; banking; exchanging money, lending aga-



inst security; debt collecting; financial affairs; real estate agencies; real estate appraisals; monetary affairs; real estate affairs; tax assessments, tax valuations; actuarial services; provident funds; issue of travelers' checks or credit cards; real estate appraisals; real estate management; financing services; financial analysis; raising or investing capital; financial consultancy services; financial evaluation (insurance, banking, real estate); fund investments; financial auditing; finance in connection with franchising; safe deposit services for securities and valuables.

37 – Construction of permanent buildings, roads and bridges; construction information; building construction supervision; masonry; plastering or plumbing; roofing services; building sealing; demolition of buildings; rental of construction equipment; cleaning of building interiors, building exteriors or windows; cleaning or servicing of vehicles; vehicle breakdown assistance (repair); paper hanging; disinfecting; rat exterminating; laundering; renovation of clothing; leather or fur care, cleaning and repair; linen ironing; shoe repair; retreading or vulcanization (repair) of tires; office machine and equipment installation, maintenance and repair; installation, maintenance and repair of machinery; installation, maintenance and repair of computer hardware; maintenance and repair of timepieces; construction, installation, maintenance and repair of electric and electronic apparatus and installations, security apparatus, alarm devices and installations, central alarm stations as well as systems, installations and apparatus for safety, identification equipment, assembly of alarm systems; assembly, maintenance and repair of equipment for protection, alarm and identification as well as equipment for prevention and protection necessary for security in any field; repair of locks; furniture restoration; painting and repair of signs; ship-building.

38 – Rental access time to global computer networks; news agencies; wire service (news agencies); transmission of information by telematic means; sending and transmitting dispatches, messages and images; communication by computer terminals; computer-aided transmission of messages and images; television program and radio program broadcasting; radio broadcasting; satellite transmission; communications by fiber-optic networks and by computer terminals; broadcasting of radio and television programs; transmission and dissemination of information online (texts, sounds, pictures, film, video, photographs, multimedia content) particularly by means of global communication networks such as the Internet) or private or reserved access (intranet or extranet); television broadcasting; provision of discussion forums on the Internet; providing access to databases, transmission of information held in data banks; providing access to a global computer network, providing access to information held in

data banks; information about telecommunications; rental of telecommunication apparatus; electronic messaging; teleconferencing services; electric radio paging services (radio, telephone or other means of electronic communication); telecommunications routing and junction services; electronic bulletin board services (telecommunication services); voice mail services; cable television broadcasting; consulting in electronic communications and telecommunications.

39 – Transport of passengers, goods, luggage, guarded transport of coins, currencies, securities works of art, jewelry, and other valuables and documents; packaging and storage of goods; arranging of tours; furniture removal services; transportation information; distribution of newspapers, mail and messages; water or energy distribution; delivery services; towing; rental of garages or parking places; rental of vehicles, boats or horses; taxi transport, travel reservation; physical storage of electronically-stored data or documents.

41 – Training and education services; lending libraries; production of films, films on video tapes, television films, television broadcasts, sound and video recordings, photography services; services of a training center; organization and conducting of training workshops; entertainment, radio entertainment, via television and the Internet, sporting and cultural activities; games and interactive entertainment via television and the Internet, publication and editing of books, magazines and newspapers on any medium; publishing of software (recorded programs); publication of electronic books and journals on-line; electronic desktop publishing; organization of competitions in connection with education or entertainment; rental of books, magazines and printed matter; rental of films; arranging and conducting colloquiums, conferences and conventions; organization of exhibitions for cultural or educational purposes; organization of shows (impresario services); booking of seats for shows.

42 – Evaluations, estimates and research in the fields of science and technology; creation and maintenance of web sites for others; development (design), installation, maintenance, updating or rental of software; programming for computers; conversion of computer programs and data (other than physical conversion); conversion of documents from a physical to an electronic medium; computer and software consultancy; research and development of new products for others; fashion and graphic designers' services; industrial design and interior design; styling (industrial design).

45 – Legal services, legal advice to companies in the field of business particularly in connection with company law and social law, legal and judicial research, legal expert appraisals; litigation services; security services for the protection of property and

individuals (excluding the transport thereof); bodyguards' services; civil protection (guards); night guards; monitoring of burglar and security alarms; security consultancy; detective agencies; computer security in the field of business; computerized security services for private organizations and household purposes; security services in the field of aeronautics; identification services, namely identifying individuals; consultancy in the fields of safety; advice related to fire safety; monitoring of industrial installations for security purposes; security services for the protection of property and persons; marriage agencies; horoscope casting; undertaking, crematorium services; clothing rental; legal research; intellectual property consultancy; legal advice for others in the field of franchising; providing legal advice for others in the field of franchising; legal advice for others in the field of security and guarding; providing legal advice for others in the field of security and guarding; providing information online to consumers in relation to alarm and guard services.

(260) AM 2015 75618 A  
(800) 1188821  
(891) 2013 08 26  
(731) ZENTIVA GROUP, A.S.  
U Kabelovny 130, CZ-102 37 Praha  
10 – Dolní Měcholupy, Czech Republic  
(540)

## GABAZEN

(511)  
5 – Medicines, pharmaceutical preparations for human use.

(260) AM 2015 75619 A  
(800) 1188825  
(891) 2013 08 06  
(731) WORLD MEDICINE İLAÇ SANAYİ VE  
TİCARET LİMİTED ŞİRKETİ  
Evren Mah. Camiyolu Cad. No:50 K.1B,  
Zemin -4-5-6, GÜNEŞLİ/BAĞCILAR/  
İSTANBUL, Turkey  
(540)

## TRAVOMED

(511)  
5 – Medicines for human purposes, medicines for veterinary purposes, vitamin preparations, chemical preparations for medical purposes, dietetic substances adapted for medical use; dietetic foods adapted for medical purposes; baby foods, medicinal herbs, herbal beverages adapted for medical purposes, nutritional supplements, pollen dietary supplements, mineral food supplements, protein dietary supplements; medicines for dental purposes, hygienic products for medical purposes including pads, waddings for medical purposes, plasters for medical purposes, dressings for medical purposes, babies' napkins, pre-

parations for destroying noxious plants, preparations for destroying noxious animals, fungicides, deodorants other than for human beings or for animals, air deodorising preparations, disinfectants for hygiene purposes, antiseptics, detergents for medical purposes.

(260) AM 2015 75620 A  
(800) 1188826  
(891) 2013 08 06  
(731) DR.SERTUS İLAÇ SANAYİ VE TİCARET  
LİMİTED ŞİRKETİ  
Evren Mah.Camiyolu Cad. No:50 K.2,  
Güneşli/Bağcılar/İstanbul, Turkey  
(540)

## SERTOFOΛ CEPTOΦOΛ

(511)  
5 – Medicines for human purposes, medicines for veterinary purposes, vitamin preparations, chemical preparations for medical purposes, dietetic substances adapted for medical use; dietetic foods adapted for medical purposes; baby foods, medicinal herbs, herbal beverages adapted for medical purposes, nutritional supplements, pollen dietary supplements, mineral food supplements, protein dietary supplements; medicines for dental purposes, hygienic products for medical purposes including pads, waddings for medical purposes, plasters for medical purposes, dressings for medical purposes, babies' napkins, preparations for destroying noxious plants, preparations for destroying noxious animals, fungicides, deodorants other than for human beings or for animals, air deodorising preparations, disinfectants for hygiene purposes, antiseptics, detergents for medical purposes.

(260) AM 2015 75623 A  
(800) 1188912  
(891) 2013 03 27  
(731) ZF Friedrichshafen AG  
Graf-von-Soden-Platz 1, 88046  
Friedrichshafen, Germany  
(540)

LEMFÖRDER 

(591) Black, white  
(511)  
12 – Axial joints, axle struts, suspension joints, A-arms, four-point control arms, pitman arms, thrust rods, intermediate knuckler arms, steering rods, hinged supports, tie rods, control arms, ball joints, steering shafts, wheel studs, stabilizer rods.  
16 – Printed materials, in particular magazines for driveline and chassis technology; instructional and teaching material (except apparatus); photographs.

17 – Rubber, gum and products made of these materials if they are not included in other classes; plastics in extruded form for use in manufacture; hoses (not made of metal); shock-absorbing buffers of rubber for vehicles, chassis systems, engines, drives, and their components.

(260) AM 2015 75624 A

(800) 1188950

(891) 2013 07 24

(731) RADİM RADYATÖR SANAYİ VE  
TİCARET LİMİTED ŞİRKETİ

Organize Sanayi Bölgesi 104, Cadde No:4 75.  
Yıl Mah. Odunpazarı, Eskisehir, Turkey

(540)



(591) Black, white

(526) The trademark is protected as a whole. The word "radiator" included therein shall not be subject to independent legal protection.

(511)

11 – Heating radiators.

(260) AM 2015 75625 A

(800) 1188952

(891) 2013 07 08

(731) İSKO PLASTİK VE KALIP SANAYİ  
TİCARET ANONİM ŞİRKETİ

Esenyurt Sanayi Mahallesi Isıso, San. Sit. 12,  
Yol Y Blok N. 5-6-7-11-12, Esenyurt İstanbul,  
Turkey

(540)



(591) Black, White and Blue

(511)

7 – Machines for processing, wood, metal, glass, plastic materials and ore, machine tools and industrial robots which are used for the same purpose for moulding wood, metal, glass, plastic materials and ore; construction equipment, robotic mechanisms which have the same functions.

17 – Rubber, gutta-percha, gum, asbestos, mica or semi-finished synthetic materials made from these materials in the form of powders, plates, rods and folio; insulation, filling and stopping materials including fillers for expansion joints, gaskets, non-metallic pipe joints and o-rings; flexible pipes made of elastic, plastic or rubber, hoses made of elastic, plastic or rubber including the ones used in vehicles; hoses whose pipes, cases and connecting parts are of

textile, fire hoses, non-metal pipe cases and connecting parts, hose unions, radiator hoses for vehicles.

(260) AM 2015 75626 A

(800) 1188953

(891) 2013 08 26

(731) ZENTIVA GROUP, A.S.

U Kabelovny 130, CZ-102 37 Praha

10 – Dolní Měcholupy, Czech Republic

(540)

**GABALIZEN**

(511)

5 – Medicines, pharmaceutical preparations for Human use.

(260) AM 2015 75627 A

(800) 1188959

(891) 2013 09 06

(731) LOU CHONGLI

Zele Street, Xinyuan Village, Xiaolin Town,

Cixi, 315300 Zhejiang,

(540)



(591) Black, white

(511)

8 – Wrenches [hand tools]; spanners [hand tools]; dies [hand tools]; hand tools, hand-operated; screwdrivers; pestles for pounding; pliers; hand pumps; lifting jacks, hand-operated; cutting tools; perforating tools [hand tools].

(260) AM 2015 75628 A

(800) 1188963

(891) 2013 08 09

(731) HYUNDAI MOTOR COMPANY

231, Yangjae-Dong, Seocho-Gu, Seoul

137-938, Republic of Korea

(540)



**EQUUS**

(591) Black, white

(511)

12 – Passenger cars [automobiles]; passenger cars for more than 7 passengers; lorries; dump cars; buses; trucks; ambulances; carrier tricycles; motor home buses; two-wheeled motor vehicles; parts and accessories for automobiles; air bags [safety devices for automobiles]; bumpers for automobiles; automobile bodies; automobile chassis; undercarriages for

automobiles; wheels for automobiles; balance weights for automobile wheels; electric cars; ski carriers for vehicles; covers for vehicle steering wheels; caps for wheel rims; camping cars; pickup trucks; braking systems for vehicles and parts thereof; non-skid devices for vehicle tires; braking devices for vehicles; automobile engines; motive power machines for land vehicles; engines for land vehicles; power transmissions and gearings for land vehicles; speed change gears for land vehicles; transmissions for land vehicles; transmission mechanisms for land vehicles; gears for vehicles; motors for land vehicles.

(260) AM 2015 75629 A  
(800) 1188997  
(891) 2013 11 07  
(731) AVEX SARL  
29 rue de MARGNAN, F-75008 PARIS,  
France  
(540)

## DERMACTIV

(511)  
3 – Creams, gels, milks, powders, lotions, ointments, foams, preparations and substances for skin, body, hand and foot care and cleansing (for cosmetic use), cosmetic preparations for baths, soaps, Perfumes, essential oils, cosmetics, hair lotions, make-up removing products.

5 – Pharmaceuticals, creams, powders, gels, milks, lotions and ointments (for medical use) for care and the cleansing of the skin, body, hands and feet, sanitary products, dermatological products for medical use, disinfectants, medical skin care preparations and substances.

(260) AM 2015 75630 A  
(800) 1189011  
(891) 2013 11 07  
(731) GROUPE AUCHAN  
40 avenue de Flandre, F-59170 CROIX,  
France  
(540)

## GARDEN STAR

(511)  
7 – Machine tools; hand-held tools, other than hand-operated; saws (machines); saw blades (parts of machines); electric shears; clippers (machines); lawnmowers (machines); cable guides and grass recovery trays; machine tools for agriculture and gardening; motorized cultivators; motor hoes; mechanical apparatus for the treatment of turf; harvesting machines; cutters (machines); root slicers; weeding machines; sowers; pumps; cutting machines; chainsaws; harvesting machines; apparatus for adding fertilizers and plant protection substances; mechanical reels for flexible hoses.

8 – Hand-operated hand tools and implements; instruments for grinding and sharpening; shears, shear blades; secateurs; scissors; scythes; shovels (tools); rakes (tools); bill-hooks; hand-operated hand tools and implements for gardening; hand-held lawn clippers; insecticide atomizers (tools); plant parasite killing apparatus.

12 – Tractors; trailers (vehicles); handling carts; two-wheeled trolleys; wheelbarrows.

(260) AM 2015 75631 A  
(800) 1189016  
(891) 2013 09 26  
(731) VANGUARD TRADEMARK HOLDINGS  
USA LLC  
600 Corporate Park Drive, St. Louis MO  
63105, USA  
(540)



(591) Black, white  
(511)  
39 – Automobile rental and leasing services; reservation services for the rental and leasing of vehicles.

(260) AM 2015 75632 A  
(800) 1189017  
(891) 2013 11 28  
(731) PAKSHOO MANUFACTURING &  
CHEMICAL CO  
No:29, The 2nd Alley, Pakistan St., Beheshti  
Ave, Tehran, Iran (Islamic Republic of)  
(540)



(591) Black, white  
(511)  
3 – Toothpaste for adults and children, mouth fresher pills, mouthwash.  
21 – Toothbrushes, toothpicks.  
35 – Advertising, marketing services.

(260) AM 2015 75633 A  
(800) 1189041  
(891) 2013 10 14  
(731) TOLIDI SHIRALAT MAHSAN POUYA  
No:1664, Shahin St., Golestan St., Dorna  
St., Ebne Sina Blv., Abbas Abbad Industrial  
Park, Tehran Iran (Islamic Republic of)

(540)

**RASSAN**

(591) Black, white

(511)

6 – Valves of metal (other than parts of machines).

11 – Sinks; taps [faucets]; faucets for pipes; sanitary apparatus and installations.

(260) AM 2015 75634 A

(800) 1189063

(891) 2013 12 06

(731) ASILOMAR ENTERPRISES LLC  
1209 Orange Street, Wilmington DE 19801, USA

(540)

**FARALLON**

(511)

9 – Computer hardware; digital video players; computer software.

(260) AM 2015 75637 A

(800) 1189065

(891) 2013 12 06

(731) ASILOMAR ENTERPRISES LLC  
1209 Orange Street, Wilmington DE 19801,  
USA

(540)

**TIBURON**

(511)

9 – Computer hardware; digital video players; computer software.

(260) AM 2015 75638 A

(800) 1189067

(891) 2013 12 06

(731) LANDMARK ASSOCIATES LLC  
1209 Orange Street, Wilmington DE 19801,  
USA

(540)

**RINCON**

(511)

9 – Computers; application development software; computer operating system software.

(260) AM 2015 75639 A

(800) 1189068

(891) 2013 12 06

(731) LANDMARK ASSOCIATES LLC  
1209 Orange Street, Wilmington DE 19801,  
USA

(540)

**EL CAP**

(511)

9 – Computers; application development software; computer operating system software.

(260) AM 2015 75738 A

(800) 768753

(891) 2013 11 27

(731) BAMBO A/S  
Egelund 37 DK-6200 Aabenraa, Denmark

(540)

**ABENA**

(511)

3 – Soaps, perfumery products, essential oils, cosmetics, hair lotions, dentifrices.

5 – Sanitary preparations, hygiene articles for medical use, including napkins and sanitary pads for incontinents, panty liners, menstruation tampons, menstruation bandages.

16 – Babies' napkins of paper, paper for household purposes including kitchen rolls, toilet paper, towels of paper in sheets and roll form, napkins, place mats and paper covers.

(260) AM 2015 75740 A

(800) 906353

(891) 2013 10 31

(731) TENACTA GROUP S.P.A.  
Via Piemonte, 5/11, I-24052 AZZANO S.  
PAOLO (BG) (IT), Italy

(540)

**CARAVAGGIO**

(511)

11 – Electric coffee makers; coffee roasters; electric coffee filters; coffee percolators.

30 – Coffee, coffee beverages; artificial coffee, coffee flavourings.

43 – Providing of food and drink for guests; canteens.

(260) AM 2015 75743 A

(800) 1145520

(891) 2013 12 11

(731) FRIESLAND BRANDS BV  
Stationsplein 4, NL-3818 LE Amersfoort,  
Netherlands

(540)



(591) White and various shades of green

(511)

29 – Dairy products; dairy-based beverages, the dairy component predominating; dairy produce for die-

tetic purposes (not for medical purposes) dairy-based spreads for bread; milk and milk products; fermented milk products; preserved milk products; milk powder; condensed milk; buttermilk; yoghurt and yoghurt products; cottage cheese, quark; cheese and cheese products; cream, whipped cream, sour cream, coffee creamer; vegetable-based substitutes for whipped cream and coffee creamer; edible oils and fats; butter, butter ghee; desserts included in this class; dairy-based meat substitutes; the aforesaid dairy products, both natural and flavoured; breakfast drinks and meal-replacement drinks consisting primarily of dairy products; dairy snacks included in this class.

30 – Coffee, tea or herbal tea-based drinks; cocoa based drinks; milk chocolate; chocolate beverages with milk; rice pudding; milk-based groats, porridge, semolina products; sauces, cream sauces and butter sauces; fruit sauces; pudding (dessert); Bavarian cream, chocolate and/or fruit mousse; ice-cream; desserts, included in this class; breakfast drinks, included in this class; custard.

(260) AM 2015 75744 A  
(800) 1182298  
(891) 2013 12 17  
(731) INCIPIO TECHNOLOGIES, INC.  
6001 Oak Canyon, Irvine CA 92618, USA  
(540)

## INCIPIO

(511)  
9 – Audio headphones; audio earphones; audio connection cables; video connection cables; battery chargers; computer carrying cases.

(260) AM 2015 75879 A  
(800) 1039984  
(891) 2013 11 25  
(731) OYSTER COSMETICS S.p.A.  
Via Barzizza, 37/A I-46043 Castiglione delle Stiviere (MN), Italy  
(540)

## REGÍA

(511)  
3 – Bleaching preparations and other substances for laundry use; cleaning, polishing, scouring and abrasive preparations; soaps; perfumery, essential oils, cosmetics, hair lotions; shampoos and hair dyes; dentifrices.

(260) AM 2015 75884 A  
(800) 1159949  
(891) 2013 06 20  
(731) LEO Pharma A/S  
Industriparken 55 DK-2750 Ballerup, Denmark

(540)

## BELSTYN

(511)  
3 – Non-medicated skin and hair care preparations; cosmetic preparations, including preparations for the reconditioning of hair and skin after medicinal treatments; medicated soaps; medicated shampoos; artificial fingernails; talcum powders and foundation for the treatment of dermatological disorders, cancer and skin infections; artificial fingernails, for medical use.

5 – Pharmaceutical preparations for the treatment of cancer and dermatological, hematological, renal and endocrine disorders; medicated powders, creams, lotions, gels and lip balm for the treatment of dermatological disorders, cancer and skin infections; glues for medical use; medical and wound dressings; dressings for the treatment of dermatological disorders, cancer and skin infections.

10 – Medical apparatus and instruments, including medical devices for applying pharmaceutical preparations and for introducing pharmaceutical preparations into the human body; medical and non-medical devices for the treatment of cancer and dermatological, hematological, renal and endocrine disorders; medical apparatus and units for dosage, measuring and monitoring, including drug introducing devices and systems; medical devices, including devices for measuring body surface area affected by disease; medical devices for the treatment of cancer, dermatological, hematological, renal and endocrine disorders, including biofeedback sensors; microneedles for medical use; containers specially for medical waste and for storage of drugs.

(260) AM 2015 75888 A  
(800) 1177809  
(891) 2013 10 30  
(731) HT HEALTH TRADE S.R.L.  
Via dei Faggi, 26, I-47894 CHIESANUOVA  
(San Marino), Italy  
(540)



(591) Black, light green "Pantone 375" and dark green "Pantone 349"

(511)  
6 – Cans of metal for beverages, cans of metal for non-alcoholic and alcoholic beverages, cans of metal, cans sold empty.

32 – Non alcoholic beverages including refreshing drinks, energy drinks, whey beverages, isotonic, hypertonic and hypotonic drinks (for use and/or as re-

quired by athletes); beer, malt beer, wheat beer, porter, ale, stout and lager; non alcoholic malt beverages; mineral water and aerated waters; drinks, juices and fruit juices; syrups, essences and other preparations for making beverages as well as effervescent (sherbet) tablets and effervescent powders for drinks and non-alcoholic cocktails.

33 – Alcoholic beverages (other than beers); hot and mixed alcoholic drinks, including alcoholic energy drinks, mulled wine and mixed drinks containing milk; alcoholic malt beverages, malt liquor; wines, spirits (beverages) and liqueurs; alcoholic preparations for making beverages; cocktails and aperitifs based on spirits or wines; beverages containing wine.

35 – Commercial consultancy, advertising, advertising services provided over the Internet; presentation of goods and services on the Internet; business management; marketing; wholesaling and retailing, including via the Internet, of cans of metal for beverages, cans of metal for non-alcoholic and alcoholic beverages, cans of metal, cans sold empty; wholesaling and retailing, including via the Internet, of non-alcoholic beverages, including refreshing drinks, energy drinks, whey beverages, isotonic beverages, hypertonic and hypotonic beverages (for and/as required by athletes), beer, malt beer, wheat beer, ale and porter, stout and lager, non-alcoholic malt beverages, mineral and aerated waters, fruit drinks and fruit juices, syrups, essences and other preparations for making beverages, and tablets and powders for effervescing beverages and non-alcoholic cocktails; wholesaling and retailing, including via the Internet, of alcoholic beverages (except beers), hot and mixed alcoholic beverages, including alcoholic energy drinks, alcoholic beverages based on mulled wine and mixed beverages containing milk, alcoholic malt beverages, liqueurs based on malt, wines, spirits and liqueurs, alcoholic preparations for making beverages, cocktails and aperitifs based on spirits or wine, beverages containing wine; wholesaling and retailing, including via the Internet, of cosmetics, creams, food supplements, pharmaceutical preparations and substances, pharmaceutical goods, herbal preparations, preparations and substances derived from herbs, plants and flowers, remedies made with flowers and essences made with flowers, dietetic products, dietetic preparations and substances, substances included in foodstuffs of vegetable origin; wholesaling and retailing, including via the Internet, of foodstuffs of vegetable origin; marketing on the Internet; auctioneering, in particular in the Internet; business administration; business advisory services relating to franchising; commercial management assistance in relation to franchises; office functions, office functions for others.

43 – Services for providing food and drink, including bar services, cafes, cafeterias, canteens, snack

bars, restaurants, self-service restaurants; food and drink catering; temporary accommodation including hotels, boarding houses, holiday camps, tourist homes, motels; temporary accommodation reservations; boarding for animals; rental of transportable buildings, bars and tents; rental of chairs, tables, table linen, glassware and bar equipment.

(260) AM 2015 75944 A

(800) 1191310

(891) 2013 08 06

(731) WORLD MEDICINE İLAÇ SANAYİ VE TİCARET LİMİTED ŞİRKETİ

Evren Mah. Camiyolu Cad. No:50 K:1 B,  
Zemin 4-5-6, Güneşli Bağcılar İstanbul,  
Turkey

(540)

**MOMEZON**  
**MOME3OH**

(591) Black, white

(511)

5 – Medicines for human purposes, medicines for veterinary purposes, vitamin preparations, chemical preparations for medical purposes, dietetic substances adapted for medical use; dietetic foods adapted for medical purposes; baby foods, medicinal herbs, herbal beverages adapted for medical purposes, nutritional supplements, pollen dietary supplements, mineral food supplements, protein dietary supplements; medicines for dental purposes, hygienic products for medical purposes including pads, waddings for medical purposes, plasters for medical purposes, dressings for medical purposes, babies' napkins, preparations for destroying noxious plants, preparations for destroying noxious animals, fungicides, deodorants other than for human beings or for animals, air deodorising preparations, disinfectants for hygiene purposes, antiseptics, detergents for medical purposes.

(260) AM 2015 76049 A

(800) 1098893

(891) 2013 11 20

(731) F. Hoffmann-La Roche AG

Grenzacherstrasse 124, CH-4070 Basel,  
Switzerland

(540)

**GATUZA**

(511)

5 – Pharmaceutical preparations.

(260) AM 2015 76052 A

(800) 1179863

(891) 2013 11 28

(731) WACOAL CORP.  
29, Nakajima-cho, Kisshoin, Minami-ku,  
Kyoto-shi, Kyoto 601-8530, Japan

(540)



(591) Black, white

(511)

25 – Outerwear; shirts, sweaters, coats, skirts, jackets, pants, shorts, dresses, one-piece dresses, blouses; leggings (trousers); nightwear; pyjamas; negligees; bathrobes; night gowns; night caps; house coats; lounge coats; underwear; brassieres; bralettes; corsets; body briefs; body suits; girdle; slips; braslips; half slips; panties; camisoles; swimwear; swimming caps; Japanese traditional clothing; sleep masks; aprons (clothing); collar protectors (for wear); socks and stockings; tights; puttees and gaiters; fur stoles; shawls; scarves (scarfs); Japanese style socks (Tabi); Japanese style socks covers (Tabi covers); gloves and mittens (clothing); neckties; neckerchieves; bandanas (neckerchiefs); thermal supporters [clothing]; mufflers; ear muffs (clothing); hoods; sedge hats (suge-gasa); headgear for wear; thermal headgear; garters; sock suspenders; suspenders (braces); waistbands; belts for clothing; footwear; shoes; boots; tongue or pullstrap for shoes and boots; protective metal members for shoes and boots; Japanese style wooden clogs (Geta); Japanese style sandals (Zori); slippers; masquerade costumes; special sporting and gymnastic wear; tights for sports; brassieres for sports; sports shorts; shoes and boots for sports; horse-riding boots.

26 – Pads for brassieres.

(260) AM 2015 76053 A

(800) 1182568

(891) 2014 01 07

(731) GOLDEN LADY COMPANY S.p.A.  
Via G. Leopardi, 3/5, I-46043  
CASTIGLIONE DELLE STIVIERE (MN),  
Italy

(540)

**NERINO G.**

(591) Black, white

(511)

22 – Ropes, string, nets, tents, awnings, tarpaulins, sails, sacks and bags (not included in other classes); padding and stuffing materials (except of rubber or plastics); raw fibrous textile materials.

23 – Threads for textile use, yarns.

24 – Textiles and textile goods, not included in other classes, non-woven textile fabrics, cloth, bed blan-

kets, traveling rugs, quilts, lingerie fabric, bath linen except clothing, household linen, bed linen, table linen not of paper; table covers, covers for cushions, pillow shams, mattress covers, curtains of textile or plastic, shower curtains of textile or plastic.

25 – Clothing; suits and dresses, shirts, hosiery, singlets, sweaters, T-shirts, trousers, leggings (trousers), skirts, jackets, overcoats, top coats, raincoats, dressing gowns, swimsuits, neckerchiefs, underwear, stockings, socks, tights, gloves, hats, berets; footwear, shoes, belts.

27 – Carpets, rugs, mats and matting, linoleum and other materials for covering existing floors; wall hangings (non-textile).

(260) AM 2015 76094 A

(800) 1192720

(891) 2013 12 26

(731) HASTINGS MANUFACTURING  
COMPANY  
325 NORTH HANOVER STREET,  
HASTINGS MI 49058, USA

(540)

**FLEX-VENT**

(511)

7 – Piston Rings.

(260) AM 2015 76096 A

(800) 1192730

(891) 2013 05 21

(731) "IT SOLOMIYA" LIMITED LIABILITY  
COMPANY  
Donetska Str., 16/2, Kyiv 03151, Ukraine

(540)



(591) Black, white

(511)

35 – Advertising; business management; business administration; office functions; commercial information agencies; administrative processing of purchase orders; cost price analysis; auctioneering; banner advertising; accounting; marketing studies; organization of exhibitions and trade fairs for commercial or advertising purposes, including organization thereof in the Internet; organization and conducting of various events, actions, campaigns, opinion polls, quizzes, shows, contests and presentations for commercial or advertising purposes; payroll preparation; demonstration of goods; business inquiries; business information; professional business consulting; assistance to customers in choosing and acquisition of goods, namely, computer and data processing equipment and parts thereof, portable devices, computer



software, telecommunication, peripheral and network equipment; compilation of statistics; compilation of information into computer databases; import-export agencies; import and export of various goods including computer and data processing equipment and parts thereof, portable devices, computer software, telecommunication, peripheral and network equipment; invoicing; on-line advertising on a computer network; computerized file management; commercial information and advice for consumers (consumer advice shop); commercial administration of the licensing of the goods and services of others; business consulting services; layout services for advertising purposes; marketing; publicity material rental; rental of advertising space; rental of advertising time on communication media; writing of publicity texts; word processing; updating of advertising material; shop window dressing; arranging subscriptions to telecommunication services for others; public relations services; price comparison services; outsourcing services (business assistance); procurement services for others (purchasing goods and services for other businesses); sponsorship search; presentation of goods on communication media, for retail purposes; professional consultancy in the field of retail management; publication of publicity texts; dissemination of advertising matter; distribution of samples; the bringing together for the benefit of others of a variety of goods, namely, computer and data processing equipment and parts thereof, portable devices, computer software, telecommunication, peripheral and network equipment that allows customers to conveniently view and purchase these goods at retail and wholesale stores, on-line shops, or by means of electronic devices; providing business information about various products, as well as the services rendered, on the Internet, on web-sites and on web pages that allow customers to conveniently view, order, and buy those goods and services from web-sites and web pages and to get necessary information about these goods and services; sales promotion for others; production of advertising films; telemarketing services; systemization of information into computer databases; data search in computer files for others.

41 – Education; providing of training; entertainment; sporting and cultural activities; educational examination; educational and instructional services; organization of exhibitions, including photo exhibitions, for cultural or educational purposes, including organization thereof via Internet; publishing services; publication of text books, manuals and guides, books, newspapers, magazines and journals; arranging and conducting of congresses, conferences, forums, disputes, debates, discussions, colloquiums, lectures, trainings, workshops, and symposiums, including organization thereof in the Internet; arranging and conducting of briefings, "round tables", press conferences, quizzes, tournament, fests, educational

contests; arranging and conducting of educational institutions presentations; organization of educational tests; organization of competitions (educational or leisure); organization of educational process; organization and conducting of training at practical workshops; organization of various events for the purpose of cooperation in the field of education, training, history, culture and science; production of radio and television programs; electronic desktop publishing; dubbing; recording studio services; distance learning; production of educational films; information on education, learning, educational programs, leisure, upbringing, history, culture, art, sport, music, social life, everyday life events; master classes; layout services, other than for advertising purposes; educational, instructional services; teaching; tuition; collective education; vocational training; practical training; educational centers and single-purpose institutions; providing on-line electronic publications, not downloadable; rental of sound and video recordings; rental of educational apparatus and equipment; rental of equipment for simultaneous translation; writing of texts, other than publicity texts; providing recreation facilities; vocational guidance (education or training advice); vocational retraining; party planning (entertainment); services of lecturers, teachers, tutors; services of interpreters and translators; services of educationalists, trainers, coaches, instructors; services of simultaneous translation; placing of information materials, except for advertising materials; club services; social club services; development and implementation of educational projects and programs; personnel training; publication of texts, other than publicity texts; publication of electronic books, journals, texts, magazines on-line; radio education and training; publication and editing services; news reporters services; development of educational video presentations; production of films, not for advertising purposes; film production, not for advertising purposes; TV, radio, and online event commenting; informational and educational television; reporting.

42 – Scientific and technological services and research and design relating thereto; industrial analysis and research services; design and development of computer hardware and software; analyzing quality, maintainability, usability of software application and use of Internet sites; technical project studies; recovery of data in computer databases; installation and maintenance of computer programs and software; design; software interface design; design of computer games and interactive presentations; maintenance of computer programs and software; recovery of computer data; duplication of computer programs; engineering; computer programming; data conversion of computer programs and data (not physical conversion); conversion of data or documents from physical to electronic media; consultancy in the design and development of computer hardware; com-

puter software consultancy; monitoring of computer systems by remote access; providing search engines for the Internet; rental of computers and computer hardware; rental of web servers; rental of computer software; updating and maintenance of computer software; quality control; new software development and implementation; computer virus protection services; improvement and maintenance of computer programs; computer system design; research and development of new goods for others; web hosting services; design and maintenance of web-sites and web-pages for others; development of individual server program products; development of corporate program software; development of program software for mobile phones and portable equipment; design and development of electronic database software; web design.

(260) AM 2015 76097 A

(800) 1192751

(891) 2013 08 23

(731) TOVARYSTVO Z OBMEZHENOIU  
VIDPOVIDALNISTIU "FABRYKA  
MEBLIV "BIS-M"

vul. Georgiivska, 10, Kharkiv 61010, Ukraine

(540)



(591) Black, white

(511)

20 – Furniture, mirrors (looking glasses), picture frames; goods (not included in other classes) of wood, cork, reed, cane, wicker, horn, bone, ivory, whalebone, shell, amber, mother-of-pearl, meerschaum and substitutes for all these materials, or of plastics; moldings for picture frames; vats, not of metal; bamboo curtains; bamboo; barrels, not of metal; library shelves; bead curtains for decoration; door bolts not of metal; bolts, not of metal; cask stands, not of metal; casks of wood for decanting wine; casks, not of metal; mooring buoys, not of metal; identification bracelets, not of metal, for hospitals; kennels for household pets; yellow amber; ambroid plates; ambroid bars; sideboards; dinner wagons (furniture); loading gauge rods, not of metal, for railway wagons (wagons); loading pallets, not of metal; water-pipe valves of plastic; work benches; vice benches, not of metal; signboards of wood or plastics; cabinet work; works of art, of wood, wax, plaster or plastic; high chairs for babies; embroidery frames; trolleys (furniture); window fittings, not of metal; display stands; showcases (furniture); coat hangers; shoulder poles (yokes); coatstands; coathooks, not of metal; fans for personal use, non-electric; towel dispensers, fixed, not of metal; reservoirs, not of metal nor of masonry; containers, not of metal (storage, transport); containers, not of metal, for liquid fuel; packaging containers of plastic; hydrostatic beds, not

for medical purposes; wax figures; comb foundations for beehives; beehives; newspaper display stands; nuts, not of metal; clothes hooks, not of metal; curtain hooks; screws, not of metal; nesting boxes for household pets; door handles, not of metal; door fittings, not of metal; doors for furniture; wood ribbon; tool handles, not of metal; broom handles, not of metal; flagpoles; mirror tiles; divans; cots; troughs, not of metal, for mixing mortar; keyboards for hanging keys; display boards; umbrella stands; ladders of wood or plastics; steps (ladders), not of metal; stair rods; drain traps (valves) of plastic; dowels, not of metal; fire screens, domestic; poles, not of metal; magazine racks; curtain tie-backs; rivets, not of metal; sealing caps, not of metal; locks, not of metal, for vehicles; locks, other than electric, not of metal; latches, not of metal; slatted indoor blinds; woven timber blinds (furniture); closures, not of metal, for containers; bottle closures, not of metal; binding screws, not of metal, for cables; cable or pipe clips of plastics; bungs, not of metal; plugs (dowels), not of metal; identity plates, not of metal; settees; hat stands; bedsteads of wood; curtain rods; plastic key cards, not encoded; index cabinets (furniture); lecterns; mats for infant playpens; tent pegs, not of metal; curtain rings; flower-stands (furniture); scythe handles, not of metal; staves of wood; book rests (furniture); bottle caps, not of metal; saw horses; furniture casters, not of metal; chopping blocks (tables); reeds (plaiting materials); chests of drawers; desks; office furniture; coral; corks; corks for bottles; boxes of wood or plastic; reels of wood for yarn, silk, cord; reels, not of metal, non-mechanical, for flexible hoses; curtain rollers; baskets, not of metal; hampers (baskets); fishing baskets; taps for casks, not of metal; draughtman's tables; armchairs; chairs (seats); benches (furniture); bed casters, not of metal; beds for household pets; hospital beds; beds; medicine cabinets; playpens for babies; mannequins; massage tables; spring mattresses; mattresses; baby changing mats; furniture partitions of wood; furniture shelves; furniture fittings, not of metal; furniture of metal; school furniture; honeycombs; plate racks; sleeping bags for camping; easy chairs; air mattresses, not for medical purposes; air pillows, not for medical purposes; air cushions, not for medical purposes; inflatable publicity objects; winding spools, not of metal, non-mechanical, for flexible hoses; knife handles, not of metal; house numbers, not of metal, non-luminous; numberplates, not of metal; barrel hoops, not of metal; garment covers (storage); edgings of plastic for furniture; decorations of plastic for foodstuffs; crates; stuffed birds; stuffed animals; footstools; animal claws; tortoiseshell imitation; bakers' bread baskets; handling pallets, not of metal; mother-of-pearl, unworked or semi-worked; hairdressers' chairs; writing desks; head-rests (furniture); transport pallets, not of metal; stakes for plants or trees; trestles (furniture); flower-pot pedestals;

stands for calculating machines; floating containers, not of metal; picture frame brackets; wickerwork; straw plaits; bottle racks; bottle casings of wood; busts of wood, wax, plaster or plastic; costume stands; pillows; cushions; pet cushions; bolsters; shelves for storage; shelves for filing-cabinets (furniture); silvered glass (mirrors); bedding, except linen; letter boxes, not of metal or masonry; counters (tables); standing desks; sections of wood for beehives; animal hooves; curtain rails; stag antlers; horn, unworked or semi-worked; rattan; bins, not of metal; meat chests, not of metal; mobiles (decoration); wind chimes (decoration); knobs, not of metal; hand-held mirrors (toilet mirrors); straw mattresses; chests for toys; corozo; cork bands; dog kennels; straw edgings; sofas; plaited straw, except matting; figurines (statuettes) of wood, wax, plaster or plastic; statues of wood, wax, plaster or plastic; racks (furniture); foundations for beehives; table tops; chairs (seats); seats of metal; footstools; shelves for typewriters; baby changing platforms; tables of metal; wall-mounted diaper (napkin) changing platforms; tables; carts for computers (furniture); tea carts; gun racks; mobile boarding stairs, not of metal, for passengers; placards of wood or plastics; trays, not of metal; curtain holders, not of textile material; valves, not of metal, other than parts of machines; coffins; dressing tables; washstands (furniture); funerary urns; mats, removable, for sinks; oyster shells; coffin fittings, not of metal; bed fittings, not of metal; infant walkers; hinges, not of metal; cupboards; towel closets (furniture); filing cabinets; covers for clothing (wardrobe); deck chairs; scratching posts for cats; screens (furniture); pulleys of plastics for blinds; nesting boxes; indoor window blinds (shades) (furniture); interior textile window blinds; paper blinds; lockers; brush mountings; fodder racks.

35 – Advertising; business management; business administration; office functions; commercial information agencies; administrative processing of purchase orders; cost price analysis; auctioneering; accounting; marketing studies; opinion polling; psychological testing for the selection of personnel; telephone answering for unavailable subscribers; organization of exhibitions for commercial or advertising purposes; organization of trade fairs for commercial or advertising purposes; demonstration of goods; business research; business information; business appraisals; business investigations; business inquiries; business management assistance; marketing research; economic forecasting; business efficiency expert services; transcription; compilation of information into computer databases; compilation of statistics; drawing up of statements of accounts; public relations; import-export agencies; invoicing; on-line advertising on a computer network; office machines and equipment rental; commercial or industrial management assistance; advisory services for

business management; computerized file management; business management consultancy; business management and organization consultancy; business management of performing artists; business management of hotels; business management of sports people; commercial information and advice for consumers (consumer advice shop); commercial administration of the licensing of the goods and services of others; personnel recruitment; systemization of information into computer databases; professional business consultancy; business organization consultancy; personnel management consultancy; layout services for advertising purposes; modelling for advertising or sales promotion; marketing; typing; document reproduction; writing of publicity texts; word processing; news clipping services; updating of advertising material; shop window dressing; auditing; arranging newspaper subscriptions for others; arranging subscriptions to telecommunication services for others; payroll preparation; tax preparation; organization of fashion shows for promotional purposes; price comparison services; procurement services for others (purchasing goods and services for other businesses); outsourcing services (business assistance); secretarial services; shorthand; relocation services for businesses; photocopying services; sponsorship search; employment agencies; presentation of goods on communication media, for retail purposes; publication of publicity texts; radio advertising; advertising by mail order; rental of advertising space; rental of advertising time on communication media; advertising agencies; publicity material rental; dissemination of advertising matter; publicity columns preparation; production of advertising films; outdoor advertising; distribution of samples; direct mail advertising; sales promotion for others; television advertising; telemarketing services; rental of vending machines; rental of photocopying machines; data search in computer files for others; the bringing together, for the benefit of others, of a variety of goods (excluding the transport thereof), enabling customers to conveniently view and purchase those goods through retail stores, wholesale outlets, through mail order catalogues or by means of electronic media through web sites or television shopping programmes.

---

(260) AM 2015 76098 A

(800) 1192752

(891) 2013 08 30

(731) JANSSEN R&D IRELAND

Eastgate Village, Eastgate Little Island, Co  
Cork, Ireland

(540)

**PREZICO**

(511)

5 – Human pharmaceutical preparations.

---

(260) AM 2015 76099 A

(800) 1192754

(891) 2013 07 17

(731) İPEK İDROFİL PAMUK SANAYİ VE  
TİCARET ANONİM ŞİRKETİBayar Cad., Gülbahar Sok., Perdemsac Plaza,  
17/7, Kozyatağı Kadıköy İSTANBUL,  
Turkey

(540)

**IPELINA**

(511)

3 – Preparations used for bleaching and cleaning purpose; perfumery; cosmetic products; deodorants for human beings or animals; cotton wool for cosmetic purposes, cotton for make-up removing, cotton impregnated with cosmetic solutions, tissues impregnated with cosmetic solutions, tissues impregnated with eau-de-Cologne or lotions, cotton sticks for cosmetic purposes; soaps; dentifrices; abrasive products: emery cloth, emery paper, emery powders and pastes, pumice stones, pastes; polishes and care products for leather, vinyl, metal and wood etc. (terms considered too vague by the International Bureau – rule 13.2.b) of the Common Regulations); tissues impregnated with detergent or cleaning preparations.

5 – Cotton for medical purposes; sanitary pads; sanitary tampons; cotton impregnated with medical preparations; antiseptic cotton; hygienic products including pads, tampons, diapers, blisters, plasters, bandages, bandaging materials for medical purposes; deodorants other than for human beings or animals, deodorants for textile and clothing; disinfectants; antiseptics; detergents for medical purposes; tissues impregnated with medical solutions; antiseptics; disinfectants.

(260) AM 2015 76100 A

(800) 1192759

(891) 2013 08 28

(731) KASTAMONU ENTEGRE AĞAÇ SANAYİ  
VE TİCARET ANONİM ŞİRKETİMahir iz Cad. No:25 TR-34662 Altunizade  
Üsküdar İstanbul, Turkey

(540)



(591) Black, white, red

(511)

19 – Sand, gravel, aggregate, asphalt, pitch, cement, gypsum for building, repairing and coating purposes, wood, plastic or synthetic materials for construction, concrete building elements, movable concrete structures, beams not of metal, crash barriers not of metal, including doors and windows made of wood and synthetic materials, natural or synthetic surface co-

verings in form of layers or bands, synthetic coatings made adhered through heat.

20 – Furniture made of any kinds of substances and materials, coat hanger with stand or fixable, mirrors, artificial honeycombs and wax bars, boards, pictures, frame for paintings made of wood and synthetic materials, wooden or synthetic cases, boxes, package sheets, chests, carrying palettes and their taps thereof, furniture fittings, nonmetal connections, opening-closing installations made of wood or synthetic, ornaments and decorative articles made of wood or plastic, pet cushions, ladders of wood or plastic, mobile ladders, bamboo curtains, window blinds, strip curtains made of synthetic.

35 – Services relating to the advertising, marketing and public relations including the organization of exhibitions and fairs for trade purposes, business administration, management and consultancy services related with these matters, the accounting services including import-export agency services, the bringing together, for the benefit of others, of a variety of goods, enabling customers to conveniently view and purchase those goods, sand, gravel, aggregate, asphalt, pitch, cement, gypsum for building, repairing and coating purposes, wood, plastic or synthetic materials for construction, concrete building elements, movable concrete structures, beams not of metal, crash barriers not of metal, including doors and windows made of wood and synthetic materials, natural or synthetic surface coverings in form of layers or bands, synthetic coatings made adhered through heat, furniture made of any kinds of substances and materials, coat hanger with stand or fixable, mirrors, artificial honeycombs and wax bars, boards, pictures, frame for paintings made of wood and synthetic materials, wooden or synthetic cases, boxes, package sheets, chests, carrying palettes and their taps thereof, furniture fittings, nonmetal connections, opening-closing installations made of wood or synthetic, ornaments and decorative articles made of wood or plastic, pet cushions, ladders of wood or plastic, mobile ladders, bamboo curtains, window blinds, strip curtains made of synthetic, all of the aforementioned services may be provided by retail stores, wholesale outlets, by means of electronic media, through catalogues.

(260) AM 2015 76112 A

(800) 1192840

(891) 2013 12 04

(731) ROBERT BOSCH GMBH

70469 Stuttgart, Germany

(540)

**Blue Performance**

(511)

7 – Electrically operated machine tools; drilling machines, hammer drills, bench drilling machines, drill

chucks, drill hammers and chisels for machines; cordless screwdrivers; groove milling machines; grinding, cutting and roughing equipment such as orbital sanders, angle grinders, triangular grinders, eccentric grinders, belt grinders, angle polishers, straight grinders; plate shears (electrically operated); glue guns; tackers (electrically operated); saws (electrically operated); circular saws (machines); jigsaws (machines); lopping saws and mitre-box saws (machines); sabre saws (machines); band saw machines; planing machines; milling machines; bench belt sanding machines; suction apparatus and dust removal apparatus for the aforesaid goods; universal suction equipment; the aforesaid goods also being battery-powered hand-held tools; parts, tools and adapters (non-electric), add-on parts and accessories for abovementioned goods, included in this class.

8 – Hand-operated tools and hand-operated implements for garden and forestry purposes, for machine and vehicle construction as well as building technique.

(260) AM 2015 76113 A

(800) 1192889

(891) 2013 12 24

(731) NOODLE HEAD, INC.

920 Garden Street, c/o Koenig & Associates,  
Santa Barbara CA 93101, USA

(540)

**MINNO**

(591) Black, white

(511)

9 – Computer hardware; computers; handheld computers; mobile computers; notebook computers; pc tablets; personal computers; tablet computer.

(260) AM 2015 76114 A

(800) 1192901

(891) 2013 09 16

(731) HISPALCO, S.A.

C/ Barranco Pascual 45, Esq. Calle  
Labradores, Pol. Ind. Campo Anibal,  
E-46530 Puzol, Spain

(540)

**unicorn** 

(591) Black, white

(511)

31 – Grains and agricultural, horticultural and forestry products not included in other classes; live animals; fresh fruit and vegetables; grains (seeds); natural plants and flowers; animal foodstuffs; malt.

(260) AM 2015 76117 A

(800) 1192947

(891) 2013 08 06

(731) WORLD MEDICINE İLAÇ SANAYİ VE  
TİCARET LİMİTED ŞİRKETİ  
Evren Mah. Camiyolu Cad. No:50 K.1B,  
Zemin -4-5-6, GÜNEŞLİ/BAĞCILAR/  
İSTANBUL, Turkey

(540)

**COLEDAN**  
**КОЛЕДАН**

(591) Black, white

(511)

5 – Medicines for human purposes, medicines for veterinary purposes, vitamin preparations, chemical preparations for medical purposes, dietetic substances adapted for medical use; dietetic foods adapted for medical purposes; baby foods, medicinal herbs, herbal beverages adapted for medical purposes, nutritional supplements, pollen dietary supplements, mineral food supplements, protein dietary supplements; medicines for dental purposes, hygienic products for medical purposes including pads, waddings for medical purposes, plasters for medical purposes, dressings for medical purposes, babies' napkins, preparations for destroying noxious plants, preparations for destroying noxious animals, fungicides, deodorants other than for human beings or for animals, air deodorising preparations, disinfectants for hygiene purposes, antiseptics, detergents for medical purposes.

(260) AM 2015 76118 A

(800) 1192958

(891) 2013 10 30

(731) AVON PRODUCTS, INC.

World Headquarters, 777 Third Avenue,  
New York NY 10017, USA

(540)

**AVON BIG & DARING**

(511)

3 – Non-medicated toilet preparations; toiletries; skin care preparations; skin moisturizers; body and beauty care preparations; powders, creams and lotions, all for the face, hands and body; cosmetic sun-tan preparations; soaps; shower and bath preparations; beauty masks; talcum powder; nail polish; nail polish remover; enamel for nails; false nails; adhesives for cosmetic purposes; cosmetics; eye makeup remover, eye shadow, eye liner, mascara, lipstick, lip liner, lip gloss; make-up foundation; blusher; tissues impregnated with cosmetic lotions; cotton sticks for cosmetic purposes; cotton wool for cosmetic purposes; preparations for cleaning, moisturising, colouring and styling the hair; preparations for cleaning the teeth; shaving and aftershave preparations; perfumes, fragrances, toilet waters, cologne; deodorants for human beings; anti-perspirants for personal use (toiletries); essential oils (cosmetic).

(260) AM 2015 76119 A

(800) 1192965

(891) 2013 11 02

(731) ZF FRIEDRICHSHAFEN AG

Graf-von-Soden-Platz 1, 88046

Friedrichshafen, Germany

(540)



**MOTION AND MOBILITY**

(591) Black, white

(511)

9 – Online publications (downloadable).

16 – Office requisites, printed matter, bookbinding material, forms, photographs, calendars, catalogue, paper, cardboard (carton) and goods made from these materials, as far as not included in other classes; brochures, posters, boxes of cardboard or paper, writing materials, instructional and teaching material (except apparatus), plastic materials for packaging, if not contained in other classes; printers' type, printing blocks, magazines, newspapers.

35 – Advertising, business management, business administration, office work, marketing, public relations, online advertising on a computer network, organization of exhibitions for commercial or advertising purposes, organization of trade fairs and exhibitions for commercial or advertising purposes, advertising, systemization and compilation of information into computer databases, particularly parts lists, material masters, documents, plates [book illustrations], order lists, spare parts catalogue and service information; retail and wholesale services in the field of vehicles and vehicle accessories.

38 – Telecommunications, providing access to computer programs on data networks, information on the Internet and on a global computer network, as well as platforms and portals on the Internet.

41 – Education, entertainment, sporting and cultural activities; desktop publishing [creating publications using computers]; online providing of electronic, non-downloadable publications, online publication of electronic books and magazines, arranging and conducting of seminars, workshops, exhibitions, press events.

(260) AM 2015 76120 A

(800) 1192968

(891) 2013 10 25

(731) ZAKRYTOYE AKTCIONERNOYE

OBSHCHESTVO "NITA-FARM"

ul. Osipova, 1, RU-410010 Saratov,

Russian Federation

(540)

**Нита**  
**Nita**

(591) Black, white

(511)

5 – Acaricides; algicides; amino acids for veterinary purposes; amino acids for medical purposes; analgesics; anaesthetics; antibiotics; antiseptics; medicine cases, portable, filled; first-aid boxes, filled; aluminium acetate for pharmaceutical purposes; acetates for pharmaceutical purposes; germicides; balms for medical purposes; bandages for dressings; biocides; bracelets for medical purposes; anti-rheumatism bracelets; bromine for pharmaceutical purposes; paper for mustard plasters; fly catching paper; reagent paper for medical or veterinary purposes; mothproofing paper; petroleum jelly for medical purposes; vaccines; oxygen baths; antiseptic cotton; aseptic cotton; absorbent cotton; wadding for medical purposes; cotton for medical purposes; dietetic substances adapted for medical use; radiological contrast substances for medical purposes; nutritive substances for microorganisms; radioactive substances for medical purposes; bismuth subnitrate for pharmaceutical purposes; melissa water for pharmaceutical purposes; sea water for medicinal bathing; mineral waters for medical purposes; thermal water; dietary fiber; molding wax for dentists; gases for medical purposes; guaiacol for pharmaceutical purposes; hemato-gen; hemoglobin; hydrastine; hydrastinine; glycerine for medical purposes; glycerophosphates; glucose for medical purposes; gentian for pharmaceutical purposes; hormones for medical purposes; mustard for pharmaceutical purposes; mustard plasters; mud for baths; medicinal mud; gamboge for medical purposes; gurjun [gurjon, gurjan] balsam for medical purposes; air deodorising preparations; deodorants, other than for human beings or for animals; deodorants for clothing and textiles; diastase for medical purposes; digitalin; mineral food supplements; nutritional supplements; albumin dietary supplements; dietary supplements for animals; alginate dietary supplements; glucose dietary supplements; casein dietary supplements; lecithin dietary supplements; linseed oil dietary supplements; propolis dietary supplements; protein dietary supplements; protein supplements for animals; royal jelly dietary supplements; pollen dietary supplements; wheat germ dietary supplements; linseed dietary supplements; enzyme dietary supplements; yeast for pharmaceutical purposes; gelatine for medical purposes; cod liver oil; isotopes for medical purposes; insecticides; iodine for pharmaceutical purposes; iodides for pharmaceutical purposes; alkaline iodides for pharmaceutical purposes; iodoform; calomel; cream of tartar for pharmaceutical purposes; tartar for pharmaceutical purposes; camphor for medical purposes; capsules for medicines; cachets for pharmaceutical purposes; hemostatic pencils; wart pencils; caustic pencils; headache pencils; carbolineum [parasiticide]; caustics for pharmaceutical purposes; cachou for pharmaceutical purposes; quassia for me-

dical purposes; quebracho for medical purposes; oxygen for medical purposes; gallic acid for pharmaceutical purposes; acids for pharmaceutical purposes; adhesives for dentures; adhesive tapes for medical purposes; stem cells for veterinary purposes; stem cells for medical purposes; collodion for pharmaceutical purposes; corn rings for the feet; anti-rheumatism rings; candy, medicated; angostura bark for medical purposes; barks for pharmaceutical purposes; cedar wood for use as an insect repellent; condurango bark for medical purposes; croton bark; mangrove bark for pharmaceutical purposes; myrobalan bark for pharmaceutical purposes; quinquina for medical purposes; medicinal roots; rhubarb roots for pharmaceutical purposes; lint for medical purposes; starch for dietetic or pharmaceutical purposes; creosote for pharmaceutical purposes; blood for medical purposes; cultures of microorganisms for medical and veterinary use; dental lacquer; liquorice for pharmaceutical purposes; lactose for pharmaceutical purposes; candy for medical purposes; adhesive plasters; medicines for alleviating constipation; lecithin for medical purposes; lotions for veterinary purposes; dog lotions; lotions for pharmaceutical purposes; personal sexual lubricants; lupulin for pharmaceutical purposes; magnesia for pharmaceutical purposes; liniments; ointments for pharmaceutical purposes; sunburn ointments; frostbite salve for pharmaceutical purposes; mercurial ointments; gauze for dressings; medicinal oils; mustard oil for medical purposes; camphor oil for medical purposes; castor oil for medical purposes; oil of turpentine for pharmaceutical purposes; dill oil for medical purposes; dental mastics; dental abrasives; dental impression materials; teeth filling material; dressings, medical; surgical dressings; drugs for medical purposes; medicines for veterinary purposes; serotherapeutic medicines; medicines for human purposes; medicines for dental purposes; menthol; medicinal drinks; moleskin for medical purposes; milk of almonds for pharmaceutical purposes; royal jelly for pharmaceutical purposes; milk ferments for pharmaceutical purposes; Irish moss for medical purposes; flour for pharmaceutical purposes; linseed meal for pharmaceutical purposes; fish meal for pharmaceutical purposes; fly glue; mint for pharmaceutical purposes; dietetic beverages adapted for medical purposes; malted milk beverages for medical purposes; medicinal infusions; tincture of iodine; eucalyptol for pharmaceutical purposes; tinctures for medical purposes; opodeldoc; decoctions for pharmaceutical purposes; antiparasitic collars for animals; stick liquorice for pharmaceutical purposes; sulphur sticks [disinfectants]; pastilles for pharmaceutical purposes; pectin for pharmaceutical purposes; pepsins for pharmaceutical purposes; peptones for pharmaceutical purposes; hydrogen peroxide for medical purposes; pesticides; food for babies; leeches for medical purposes; blood plasma; eyepatches for me-

dical purposes; poultices; compresses; scapulars for surgical purposes; diapers [babies' napkins]; diapers for pets; breast-nursing pads; bunion pads; pomades for medical purposes; powder of cantharides; pyrethrum powder; belts for sanitary napkins [towels]; anti-uric preparations; bacterial preparations for medical and veterinary use; bacteriological preparations for medical and veterinary use; balsamic preparations for medical purposes; albuminous preparations for medical purposes; biological preparations for veterinary purposes; biological preparations for medical purposes; veterinary preparations; bismuth preparations for pharmaceutical purposes; vitamin preparations; diagnostic preparations for medical purposes; therapeutic preparations for the bath; hemorrhoid preparations; preparations for callouses; preparations to facilitate teething; preparations for the treatment of burns; fumigation preparations for medical purposes; opotherapy preparations; air purifying preparations; eye-washes; bronchodilating preparations; preparations for reducing sexual activity; sterilising preparations; soil-sterilising preparations; corn remedies; pharmaceutical preparations for treating dandruff; preparations for destroying noxious animals; herbicides; preparations for destroying dry rot fungus; fly destroying preparations; preparations for destroying mice; slug exterminating preparations; vermin destroying preparations; pharmaceutical preparations for skin care; contact lens cleaning preparations; preparations of lime for pharmaceutical purposes; chilblain preparations; bath preparations, medicated; medicinal hair growth preparations; mothproofing preparations; anticryptogamic preparations; aloe vera preparations for pharmaceutical purposes; preparations of trace elements for human and animal use; sulphonamides [medicines]; pharmaceutical preparations; sunburn preparations for pharmaceutical purposes; enzyme preparations for veterinary purposes; enzyme preparations for medical purposes; chemico-pharmaceutical preparations; chemical preparations for veterinary purposes; chemical preparations for the diagnosis of pregnancy; chemical preparations for medical purposes; chemical preparations to treat wheat blight [smut]; vine disease treating chemicals; chemical preparations to treat mildew; chemical preparations for treating phylloxera; chemical preparations for pharmaceutical purposes; collyrium; lead water; chemical conductors for electrocardiograph electrodes; albuminous foodstuffs for medical purposes; dietetic foods adapted for medical purposes; by-products of the processing of cereals for dietetic or medical purposes; sanitary towels; napkins for incontinents; sanitary pads; panty liners [sanitary]; propolis for pharmaceutical purposes; pearl powder for medical purposes; radium for medical purposes; solvents for removing adhesive plasters; hydrated chloral for pharmaceutical purposes; vaginal washes; solutions for contact lenses; chemical reagents for medical or

veterinary purposes; gum for medical purposes; rubber for dental purposes; chewing gum for medical purposes; insect repellents; insect repellent incense; repellents for dogs; tissues impregnated with pharmaceutical lotions; sarsaparilla for medical purposes; sugar for medical purposes; asthmatic tea; fumigating sticks; suppositories; linseed for pharmaceutical purposes; tobacco-free cigarettes for medical purposes; siccatives [drying agents] for medical purposes; syrups for pharmaceutical purposes; turpentine for pharmaceutical purposes; milking grease; greases for veterinary purposes; greases for medical purposes; lacteal flour for babies; soporifics; bicarbonate of soda for pharmaceutical purposes; mineral water salts; bath salts for medical purposes; salts for mineral water baths; salts for medical purposes; potassium salts for medical purposes; sodium salts for medical purposes; smelling salts; malt for pharmaceutical purposes; semen for artificial insemination; alcohol for pharmaceutical purposes; medicinal alcohol; alloys of precious metals for dental purposes; ergot for pharmaceutical purposes; cooling sprays for medical purposes; adjuvants for medical purposes; styptic preparations; vermifuges; disinfectants for hygiene purposes; disinfectants for chemical toilets; douching preparations for medical purposes; appetite suppressants for medical purposes; medical preparations for slimming purposes; parasiticides; mouthwashes for medical purposes; febrifuges; depuratives; animal washes; detergents for medical purposes; cattle washes; dog washes; vesicants; articles for headache; purgatives; chemical contraceptives; antiparasitic preparations; remedies for perspiration; remedies for foot perspiration; sedatives; laxatives; digestives for pharmaceutical purposes; tonics [medicines]; nervines; media for bacteriological cultures; steroids; strychnine; serums; antioxidant pills; tanning pills; appetite suppressant pills; slimming pills; yeast dietary supplements; jujube, medicated; sanitary tampons; vulnerary sponges; thymol for pharmaceutical purposes; biological tissue cultures for veterinary purposes; surgical cloth [tissues]; smoking herbs for medical purposes; medicinal herbs; surgical implants [living tissues]; pants, absorbent, for incontinents; sanitary panties; babies' napkin-pants [diaper-pants]; charcoal for pharmaceutical purposes; fennel for medical purposes; porcelain for dental prostheses; phenol for pharmaceutical purposes; enzymes for veterinary purposes; enzymes for medical purposes; ferments for pharmaceutical purposes; formic aldehyde for pharmaceutical purposes; phosphates for pharmaceutical purposes; fungicides; quinine for medical purposes; chinoline for medical purposes; diabetic bread adapted for medical use; chloroform; flowers of sulphur for pharmaceutical purposes; cement for animal hooves; bone cement for surgical and orthopaedic purposes; dental cements; medicinal tea; herbal teas for medicinal purposes; eucalyptus for pharmaceutical pur-

poses; tobacco extracts [insecticides]; extracts of hops for pharmaceutical purposes; elixirs [pharmaceutical preparations]; ethers for pharmaceutical purposes; esters for pharmaceutical purposes; cellulose esters for pharmaceutical purposes; cellulose ethers for pharmaceutical purposes; rat poison; poisons; bacterial poisons; jalap.

16 – Pamphlets; booklets; wrapping paper; newspapers; magazines [periodicals]; periodicals; printed publications; catalogues; flyers; bags [envelopes, pouches] of paper or plastics, for packaging; plastic film for wrapping; printed matter; printing type.

31 – Algarovilla for animal consumption; algae for human or animal consumption; dog biscuits; yeast for animal consumption; edible chews for animals; peanut cake for animals; oil cake; maize cake for cattle; rape cake for cattle; grains for animal consumption; lime for animal forage; animal foodstuffs; pet food; stall food for animals; bird food; strengthening animal forage; groats for poultry; bran mash for animal consumption; peanut meal for animals; linseed meal for animal consumption; meal for animals; flax meal [fodder]; rice meal for forage; fish meal for animal consumption; beverages for pets; oats; distillery waste for animal consumption; cuttle bone for birds; aromatic sand for pets [litter]; mash for fattening livestock; animal fattening preparations; preparations for egg laying poultry; by-products of the processing of cereals, for animal consumption; sanded paper for pets [litter].

41 – Academies [education]; rental of sports grounds; discotheque services; animal training; publication of books; education information; recreation information; entertainment information; health club services [health and fitness training]; corresponddence courses; practical training [demonstration]; organization of balls; organization of exhibitions for cultural or educational purposes; providing recreation facilities; arranging and conducting of colloquiums; arranging and conducting of congresses; arranging and conducting of conferences; arranging and conducting of workshops [training]; arranging and conducting of seminars; arranging and conducting of symposiums; organization of competitions [education or entertainment]; organization of sports competitions; vocational guidance [education or training advice]; vocational retraining; educational examination; publication of electronic books and journals online; publication of texts, other than publicity texts; entertainer services; entertainment; holiday camp services [entertainment]; club services [entertainment or education]; educational services; production of shows.

42 – Clinical trials; bacteriological research; biological research; chemical research; research and development of new products for others; scientific research; chemistry services; scientific laboratory services.



44 – Pharmacy advice; artificial insemination services; veterinary assistance; animal breeding; vermin exterminating for agriculture, horticulture and forestry; weed killing; pharmacists' services to make up prescriptions; animal grooming; pet grooming.

(260) AM 2015 76121 A

(800) 1192994

(891) 2013 12 03

(731) Obshchestvo s ogranitchenoy otvetstvennost'yu "Koordiniroyushchy raspredelitel'ny tsentr "EFKO-Kaskad" ul. Frunze 4, RU-309850 Belgorodskaya obl., g. Alekseevka, Russian Federation

(540)



(591) Black, white

(511)

30 – Coffee, tea, cocoa and artificial coffee; rice; tapioca and sago; flour and preparations made from cereals; bread, pastry and confectionery; ices; sugar, honey, treacle; yeast, baking-powder; salt; mustard; vinegar, sauces (condiments), including mayonnaise and ketchup; spices; ice.

35 – Advertising; business management; business administration; office functions; sales promotion for others, including wholesaling and retailing of foodstuffs.

43 – Services for providing food and drink; temporary accommodation.

(260) AM 2015 76123 A

(800) 1193017

(891) 2013 10 23

(731) ANAND INTERNATIONAL Devendra Saligram Anand, Saligram Dayasingh Anand, Mrs. Jyoti 76 a & b, Government industrial estate, Charkop, Kandivali (West), Mumbai 400 067, India

(540)

**DIGNO**

(511)

16 – Pens, ball pens, refills and writing instruments of all kinds, and office stationery.

(260) AM 2015 76125 A

(800) 1193088

(891) 2013 10 24

(731) MABXIENCE, S.A. Yaguaron 1407, 11100 Montevideo, Uruguay

(540)

**ABXEDA**

(511)

5 – Pharmaceutical and veterinary preparations for use in the treatment of ophthalmological, dermatological, digestive, gynecological, hormonal, metabolic, blood diseases and disorders and cancer; pharmaceutical and veterinary preparations for use in the treatment of cardiovascular, vascular, gastrointestinal, genitourinary, immunological, infectious, inflammatory, neurological, psychiatric, central nervous system, musculo-skeletal system, respiratory system, circulatory system, viral, dental and oral diseases; pharmaceutical and veterinary preparations for use in the treatment of glaucoma, obesity, headaches, migraine, cholesterol, arterial blood pressure, rheumatism and for liver treatments; reagents used in pregnancy tests, ovulation tests and for diabetes; contraceptives; nutraceutical products; dietetic foods for medical use.

(260) AM 2015 76132 A

(800) 654362

(891) 2013 10 03

(731) Blancpain SA (Blancpain AG) (Blancpain Ltd) Le Rocher 12, CH-1348 Le Brassus, Switzerland

(540)

**BLANCPAIN**

(511)

14 – Timepieces, watches, watch parts, watch boxes, watch movements, watch dials and cases.

(260) AM 2015 76133 A

(800) 798776

(891) 2013 11 04

(731) DIVAPHARMA CHUR AG Wiesenalstrasse 126, CH-7006 Chur, Switzerland

(540)

**Bedan**

(511)

3 – Bleaching preparations and other substances for laundry use; cleaning, polishing, scouring and abrasive preparations; soaps; perfumery, essential oils, cosmetics, hair lotions; dentifrices.

5 – Medicines; pharmaceutical, veterinary and sanitary preparations; dietetic preparations; dietetic food for sanitary use and food supplements for medical use on the basis of vitamins, minerals and trace elements containing one or more of these ingredients separately or combined.

30 – Dietetic preparations and food supplements for non-medical use on the basis of carbohydrates, roughage and containing plant substances, with the addition of vitamins, trace elements, containing one or

more of these ingredients separately or combined (included in this class).

(260) AM 2015 76137 A

(800) 855176

(891) 2014 01 21

(731) ROBERT BOSCH TOOL CORPORATION

1800 Central Road, Mount Prospect,  
IL 60056, USA

(540)

**DREMEL**

(511)

7 – Electric tools, namely hand-manipulable, rotating chuck type for grinding, drilling, routing, polishing, engraving, sanding, sawing, marking, deburring, carving, sharpening, shaping and cutting; hand-manipulable, reciprocating sanders, polishers and engravers; both hand-manipulable and mounted jig saws, sanders, grinders and buffers, and hand-manipulable scroll saws; fixtures, flexible shafts and accessories for the above-mentioned tools; kits comprising various combinations of the above-mentioned tools, including drills, saw blades, brushes, carving cutters, routing cutters, collets, emery wheels, dressing stones, polishing wheels, cut-off wheels, buffing wheels, grinding wheels, wire wheels, engraving points and mandrels.

(260) AM 2015 76138 A

(800) 857135

(891) 2013 11 29

(731) WIZZ Air Hungary Kft.

BUD Nemzetközi Repulotér, (BUD  
International Airport) 221. ép., H-1185  
Budapest, Hungary

(540)

**WIZZ**

(511)

38 – Computer aided transmission of messages and images.

(260) AM 2015 76139 A

(800) 857136

(891) 2013 11 22

(731) WIZZ Air Hungary Kft.

BUD Nemzetközi Repulotér, (BUD  
International Airport) 221. ép., H-1185  
Budapest, Hungary

(540)



(591) Purple and Pink

(511)

38 – Computer aided transmission of messages and images.

(260) AM 2015 76149 A

(800) 1069951

(891) 2013 12 30

(731) 5.11, INC.

4300 Spyres Way, Modesto, CA 95356, USA

(540)

**5.11** 

(591) Black, white

(511)

9 – Carrying cases specially adapted for global positioning system (gps) apparatus, personal digital assistants (pda), radios, pagers, and mobile phones; specialty holster for carrying global positioning system (gps) apparatus, personal digital assistants (pda), radios, pagers, and mobile phones; protective clothing, namely, protective gloves; protective industrial shoes and boots, eyewear, sunglasses; trauma pads worn by a user to protect against blunt force trauma to the body; kneepads for public safety personnel and military use; dvds featuring instruction and information in self defense, the use of knives, and law enforcement tactics; personal safety and protective clothing, namely, duty belts, load bearing equipment belts, load bearing equipment vests and accessory carrying vests for public safety personnel and military use.

18 – Duffel bags; all-purpose gear bags; all-purpose utility bags; all purpose carrying bags; backpacks; carryalls; carry all bags; kit bags; tote bags.

25 – Clothing, namely, pants, shorts, vests, shirts, t-shirts, polo shirts, fleece pullovers, coats, jackets, blazers, parkas, wind resistant jackets, coveralls, dungarees, jump suits, uniforms, waterproof jackets, waterproof pants, underwear; head wear, hats, caps; gloves, belts, socks, footwear, boots.

(260) AM 2015 76150 A

(800) 1079055

(891) 2013 12 17

(731) SAIC MOTOR CO., LTD.

Room 509, block 1, No: 563 Songtao Road,  
Zhangjiang High Tech Park, Shanghai,  
China

(540)

**MAXUS**

(591) Black, white

(511)

12 – Electric vehicles; vans (vehicles); vehicles for locomotion by land, air, water or rail; cars; automobiles; vehicle bumpers; clutches for land vehicles;

bodies for vehicles; seats for vehicles; outfits for repairing vehicle tires and inner tubes.

37 – Repair information; rental of construction cranes; machinery installation, maintenance and repair; electric appliance installation and repair; air conditioning apparatus installation and repair; illuminating apparatus installation and repair; motor vehicle maintenance and repair; vehicle service stations (refueling and maintenance); rustproofing; mending rubber tires.

39 – Transport; packaging of goods; packaging of gifts; car transport; automotive leasing services; vehicle rental; storage of goods; courier services (letters or goods); arranging of sightseeing.

(260) AM 2015 76152 A  
(800) 1084036  
(891) 2014 01 13  
(731) ACTELION PHARMACEUTICALS LTD  
Gewerbstrasse 16, CH-4123 Allschwil,  
Switzerland  
(540)

## UPTRAVI

(511)  
5 – Pharmaceutical preparations.

(260) AM 2015 76153 A  
(800) 1085758  
(891) 2013 12 19  
(731) SHANGHAI HUIZHONG AUTOMOTIVE  
MANUFACTURING CO., LTD.  
1493 South Pu Dong Road, 200122 Shanghai,  
China  
(540)



(591) Blavck, white

(511)  
12 – Electric vehicles; vans (vehicles); vehicles for locomotion by land, air water or rail; cars; automobiles; vehicle bumpers; clutches for land vehicles; seats for vehicles; bodies for vehicles; outfits for repairing vehicle tires and inner tubes.

37 – Repair information; rental of construction cranes; machinery installation, maintenance and repair; electric appliance installation and repair; air conditioning apparatus installation and repair; installation and maintenance of illuminating apparatus; motor vehicle maintenance and repair; vehicle service station (refuelling and maintenance).

39 – Transport; packaging of goods; packaging of gifts; car transport; automotive leasing services; vehicle rental; storage of goods; courier services (letters or goods); delivery (letters and goods); arranging of sightseeing.

(260) AM 2015 76155 A  
(800) 1129800  
(891) 2013 12 20  
(731) NOVARTIS AG  
CH-4002 Basel, Switzerland  
(540)

## VEOBEX

(511)  
5 – Vaccines for human use.

(260) AM 2015 76156 A  
(800) 1141126  
(891) 2013 12 20  
(731) NOVARTIS AG  
CH-4002 Basel (CH), Switzerland  
(540)

## NESREXO

(511)  
5 – Vaccines for human use.

(260) AM 2015 76157 A  
(800) 1142645  
(891) 2013 10 21  
(731) ACM  
17 rue de Neuilly, Impasse Passoir, F-92110  
CLICHY, France  
(540)

## Cicastim

(511)  
3 – Soaps; perfumery, essential oils, cosmetics; gels, creams, milks, lotions, pomades and cosmetic preparations for skin care; hair lotions; dentifrices; astringents for cosmetic purposes; balms other than for medical purposes; cosmetic sun-tanning preparations; cosmetic preparation favoring wound healing; hair lotions; shampoos; shampoos in dry form; cosmetic creams; make-up removing products; oils for cosmetic use; oils for toilet purposes; almond milk for cosmetic purposes; cleansing milk for toilet purposes; lotions for cosmetic use.

(260) AM 2015 76158 A  
(800) 1159617  
(891) 2013 11 21  
(731) ARES TRADING S.A.  
Zone Industrielle de l'Ouriettaz, CH-1170  
Aubonne, Switzerland

(540)

**DAVICTREL**

(511)

5 – Pharmaceutical products for human use; dietetic substances for medical use.

(260) AM 2015 76159 A

(800) 1175514

(891) 2013 12 04

(731) COMLINE AUTO PARTS LIMITED

Unit B1, Luton Enterprise Park, Sundon Park Road, Luton, Bedfordshire LU3 3GU, United Kingdom

(540)



(591) Black, white, grey

(511)

4 – Industrial oils and greases; lubricants; fuels (including motor spirit); additives, non-chemical, to motor fuel; petrol.

7 – Filters (parts of machines or engines); exhausts for motors and engines; pumps (parts of machines, engines or motors); fans for motors and engines; fan belts for motors and engines; timing belts for vehicle engines.

12 – Clutches for land vehicles; clutch cables, clutch cylinders, clutch discs, clutch levers, clutch mechanisms, all for land vehicles; couplings for use with clutches for land vehicles; double clutch transmissions for land vehicles; brakes for vehicles; brake systems for vehicles and components therefor; brake disks for vehicles; brake cylinders for vehicles; brake pads for vehicles; brake facings for vehicles; brake linings for vehicles; brake hardware for vehicles; brake levers for vehicles; brake drums for vehicles; brake sets for vehicles; brake segments for vehicles; constant velocity joints (vehicle parts); suspension shock absorbers for vehicles; steering columns for vehicles; steering linkages for vehicles; steering racks for vehicles; steering wheel covers; steering wheel locks; steering apparatus for vehicles; shock absorbing springs being parts of vehicle suspension; axles for suspension systems in vehicles; suspensions for vehicles; suspension arms for vehicles; suspension struts for vehicles; transmission for land vehicles; transmission mechanisms for land vehicles; consoles being parts of vehicle interiors; containers adapted for use in vehicle interiors; interior panels for vehicles; interior pouches for vehicles; parts of interior trim of vehicles; seat covers for vehicle seats; children's seats for vehicles; child restraints for vehicle seats; child booster cushions

for vehicle seats; safety harnesses for vehicle seats; head-rests for vehicles; vehicle seats; windscreens; windscreen wipers; windscreen wiper blades; wheels; tyres; vehicle wheel rims, bodies for vehicles; body panels for vehicles; parts of vehicle interiors.

(260) AM 2015 76164 A

(800) 1179972

(891) 2013 11 07

(731) CAFÈS NOVELL, S.A.

Pol. Ind. Estació de Mercaderies, C. Font de l'Avellaner, s/n, E-08720 Vilafranca del Penedès, Spain

(540)



(591) Green and yellow

(511)

30 – Coffee, tea, cocoa, artificial coffee; non-medical infusions.

(260) AM 2015 76169 A

(800) 1193185

(891) 2014 01 27

(731) AMERICAN-CIGARETTE COMPANY (OVERSEAS) LIMITED

Zaehlerweg 4, CH-6300 Zug, Switzerland

(540)



(591) Grey, white

(511)

34 – Cigarettes; tobacco; tobacco products; lighters; matches; smokers' articles.

(260) AM 2015 76172 A

(800) 1193250

(891) 2013 09 30

(731) Subsidiary Enterprise "BOOK CLUB" "FAMILY LEISURE CLUB"

prospekt Haharina 20-A, Kharkiv 61140, Ukraine

(540)

**KSD**

(591) Black, white

(511)

16 – Albums; pamphlets; booklets; greeting cards; newspapers; printed matter; printed publications;

magazines (periodicals); note books; calendars; catalogues; books; comic books; handbooks (manuals); posters; prospectuses.

25 – Berets; outer clothing; footwear; ready-made clothing; pelisses; hats; combinations (clothing); suits; jackets (clothing); singlets; body linen (garments); headgear for wear; overcoats; pyjamas; coats; pullovers; overalls; sweaters; shirts; cyclists' clothing; sports jerseys; dresses; aprons (clothing); tee-shirts; dressing gowns; caps (headwear); trousers.

35 – Representation in one palace for other persons of the books, what allows comfortably choose, look and buy mentioned products using special catalogues (Terms too vague in the opinion of the International Bureau – Rule 13(2)(b) of the Common Regulations).

41 – Amusements; family leisure time with the help of the books (Terms too vague in the opinion of the International Bureau – Rule 13(2)(b) of the Common Regulations).

(260) AM 2015 76176 A

(800) 1193260

(891) 2013 09 03

(731) RAMA MEHR ARYA CO.

No:13 and 14 G, Sousan 5th Str., Chamran Blvd., Shahrak Sanati-ye Shokohieh, Qom Iran (Islamic Republic of)

(540)



(591) Yellow, black, white, orange and red

(511)

5 – Food supplements.

29 – Nuts, peanuts, meat products, sausages, ham, hamburger, soya bean burgers (meat substitute only, not sandwiches); fish, poultry and game, meat extracts, edible oils and fats; potato chips; dates.

30 – Pizzas, flours, breads, biscuits, chocolates, cakes, sweets and confectionary, cookies, corn flour, candies, chewing gums, taffy; cocoa, wafers; rice, ice products, sauces, sugar halvah, spices, saffron, cereal products, bread crumbs, frozen confectionary, cube sugar, sugars, honey, molasses, yeast, salt, mustards, vinegar, tapioca and sago, ice, ice creams.

35 – Export services and retail and wholesale services for all aforementioned goods.

39 – Distribution (delivery), packaging of all aforementioned goods.

(260) AM 2015 76178 A

(800) 1193281

(891) 2013 10 08

(731) STURM HANDELS GMBH

Graf-Bentzel-Str. 85, 72108 Rottenburg am Neckar, Germany

(540)

**TEESAR**

(511)

25 – Clothing including clothing of leather, headgear, belts, scarfs, gloves, neckties, suspenders (braces for clothing), shoes, all aforementioned goods also from army stock, especially American or military look-like clothing, headgear and footwear, included in this class.

(260) AM 2015 76179 A

(800) 1193287

(891) 2013 10 18

(731) PAKSHOO MANUFACTURING & CHEMICAL CO

No:29, The 2nd Alley, Pakistan St., Beheshti Ave, Tehran, Iran (Islamic Republic of)

(540)

**SPIF**

اسپیف

(591) Black, white

(511)

3 – Cosmetics, hygiene detergents for household use and laundry preparations, shampoos, baby shampoo, body shampoo, soap and soap powder, hair lotion, hand washing liquid and hand cleaning gels, toothpastes, dish washing liquids, hair conditioner, softeners for laundry use, bleaches, window and glass cleaners, oven cleaners, whiteners for laundry, bathroom detergents, kinds of car cleaners, Laundromat and manual laundry powders (terms incomprehensible in the opinion of the International Bureau – Rule 13(2)(b) of the Common Regulations), laundry and dish washer detergent tablets, dishwasher in powder, laundry liquids, surface cleaners in cream and liquid form, carpet shampoos in liquid and foam form, multi purpose liquid cleaner, faucet and pipe preparations for unblocking drain pipes, mouth wash not for medical purposes, mouth freshener pills, lime and stain removers.

5 – Disinfectants for hygiene purposes, insect repellents, fungicides; air fresheners, antiseptic gels.

35 – Advertising and business management, business administration affairs, administrative goods and office wares (term incomprehensible in the opinion of the International Bureau – Rule 13(2)(b) of the Common Regulations) and export services.

(260) AM 2015 76205 A  
 (800) 1193394  
 (891) 2013 09 30  
 (731) Subsidiary Enterprise "BOOK CLUB"  
 "FAMILY LEISURE CLUB"  
 prospekt Haharina 20-A, Kharkiv 61140,  
 Ukraine

(540)

**КСД**

(591) Black, white

(511)

16 – Albums; pamphlets; booklets; greeting cards; newspapers; printed matter; printed publications; magazines (periodicals); note books; calendars; catalogues; books; comic books; handbooks (manuals); posters; prospectuses.

25 – Berets; outer clothing; footwear; ready-made clothing; pelisses; hats; combinations (clothing); suits; jackets (clothing); singlets; body linen (garments); headgear for wear; overcoats; pyjamas; coats; pullovers; overalls; sweaters; shirts; cyclists' clothing; sports jerseys; dresses; aprons (clothing); tee-shirts; dressing gowns; caps (headwear); trousers.

35 – Representation in one palace for other persons of the books, what allows comfortably choose, look and buy mentioned products using special catalogues (Terms too vague in the opinion of the International Bureau – Rule 13(2)(b) of the Common Regulations).

41 – Amusements; family leisure time with the help of the books (Terms too vague in the opinion of the International Bureau – Rule 13(2)(b) of the Common Regulations).

(260) AM 2015 76218 A  
 (800) 1193440  
 (891) 2013 11 29  
 (731) COMPAGNIE GENERALE DES  
 ETABLISSEMENTS MICHELIN  
 12 Cours Sablon, F-63000 CLERMONT  
 FERRAND, France

(540)

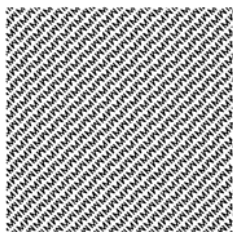

(591) Black, white

(511)

12 – Pneumatic tires and inner tubes for vehicle wheels; treads for retreading tires; tracks for track vehicles.

(260) AM 2015 76219 A  
 (800) 1193444  
 (891) 2013 12 18  
 (731) BAYER INTELLECTUAL PROPERTY  
 GMBH  
 Alfred-Nobel-Straße 10, 40789 Monheim am  
 Rhein, Germany

(540)

**BALVALOR**

(511)

5 – Pharmaceutical preparations.

(260) AM 2015 76221 A  
 (800) 1193451  
 (891) 2013 11 29  
 (731) OBSHCHESTVO S OGRANICHENNOI  
 OTVETSTVENNOSTYU "ROTOR HOUSE"  
 37/51, bld. 1, 9-th Parkovaya St. RU-105264  
 Moscow, Russian Federation

(540)

**АУР ДЕ БАЛАНЕШТЬ**

(591) Black, white

(511)

33 – Alcoholic beverages (except beers).

(260) AM 2015 76224 A  
 (800) 1193453  
 (891) 2014 02 03  
 (731) THE COLOMER GROUP SPAIN, S.L.  
 WTC Almeda Park, c/ Tirso de Molina, 40,  
 E-08940 Cornellá de Llobregat (Barcelona),  
 Spain

(540)

**COLORSMETIQUE**

(511)

3 – Hair lotions, hair dyes, hair dyes, hair treatments, conditioners for hair, hair masks, shampoo.

(260) AM 2015 76226 A  
 (800) 1193455  
 (891) 2013 08 23  
 (731) ZENTIVA GROUP, A.S.  
 U Kabelovny 130, CZ-102 37 Praha  
 10 – Dolní Měcholupy, Czech Republic

(540)

**ВОРАНО**

(511)

5 – Pharmaceuticals, pharmaceutical preparations for human use.

(260) AM 2015 76227 A  
 (800) 1193468  
 (891) 2013 07 26  
 (731) HUVEPHARMA AD

5th floor, Nikolay Haitov Str 3 A, BG-1113  
Sofia, Bulgaria

(540)

**COXAM**

(511)

5 – Veterinary preparations; medicines for veterinary purposes; supplements to fodder for veterinary purposes; animal feed supplements for veterinary purposes.

31 – Additives to animal feed not for medical purposes; additives to fodder not for medical purposes.

(260) AM 2015 76229 A

(800) 1193494

(891) 2013 07 26

(731) HUVEPHARMA AD

5th floor, Nikolay Haitov Str 3 A, BG-1113  
Sofia, Bulgaria

(540)

**COXAR**

(511)

5 – Veterinary preparations; medicines for veterinary purposes; supplements to fodder for veterinary purposes; animal feed supplements for veterinary purposes.

31 – Additives to animal feed not for medical purposes; additives to fodder not for medical purposes.

(260) AM 2015 76230 A

(800) 1193503

(891) 2013 12 26

(731) HASTINGS MANUFACTURING  
COMPANY

325 North Hanover Street, HASTINGS MI  
49058, USA

(540)

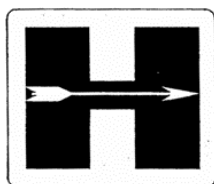

(591) Black, white

(511)

7 – Internal combustion engine parts, namely, piston rings.

(260) AM 2015 76231 A

(800) 1193528

(891) 2013 09 04

(731) WORLD MEDICINE İLAÇ SANAYİ VE  
TİCARET LİMİTED ŞİRKETİ

Evren Mah. Camiyolu Cad. No.50 K.1B,  
Zemin -4-5-6, GÜNEŞLİ/BAĞCILAR/  
İSTANBUL, Turkey

(540)

**CEFPRODO  
ЦЕФПОДО**

(591) Black, white

(511)

5 – Medicines for human purposes, medicines for veterinary purposes, vitamin preparations, chemical preparations for medical purposes, dietetic substances adapted for medical use; dietetic foods adapted for medical purposes; baby foods, medicinal herbs, herbal beverages adapted for medical purposes, nutritional supplements, pollen dietary supplements, mineral food supplements, protein dietary supplements; medicines for dental purposes, hygienic products for medical purposes including pads, waddings for medical purposes, plasters for medical purposes, dressings for medical purposes, babies' napkins, preparations for destroying noxious plants, preparations for destroying noxious animals, fungicides, deodorants other than for human beings or for animals, air deodorising preparations, disinfectants for hygiene purposes, antiseptics, detergents for medical purposes.

(260) AM 2015 76232 A

(800) 1193529

(891) 2013 09 04

(731) WORLD VET İLAÇ SANAYİ VE TİCARET  
LİMİTED ŞİRKETİ

Evren Mah. Camiyolu Cad. No:50 K.1,  
GÜNEŞLİ İSTANBUL, Turkey

(540)

**CYFLUTRAM  
ЦИФЛУТРАМ**

(591) Black, white

(511)

5 – Medicines for human purposes, medicines for veterinary purposes, vitamin preparations, chemical preparations for medical purposes, dietetic substances adapted for medical use; dietetic foods adapted for medical purposes; baby foods, medicinal herbs, herbal beverages adapted for medical purposes, nutritional supplements, pollen dietary supplements, mineral food supplements, protein dietary supplements; medicines for dental purposes, hygienic products for medical purposes including pads, waddings for medical purposes, plasters for medical purposes, dressings for medical purposes, babies' napkins, preparations for destroying noxious plants, preparations for destroying noxious animals, fungicides, deodorants other than for human beings or for animals, air deodorising preparations, disinfectants for hygiene purposes, antiseptics, detergents for medical purposes.

(260) AM 2015 76233 A  
 (800) 1193535  
 (891) 2013 08 30  
 (731) ZENTIVA GROUP, A.S.  
 U Kabelovny 130, CZ-102 37 Praha  
 10 – Dolní Měcholupy, Czech Republic  
 (540)

## INFLAXIB

(511)  
 5 – Pharmaceuticals, pharmaceutical preparations for human use.

(260) AM 2015 76282 A  
 (800) 857134  
 (891) 2013 11 22  
 (731) WIZZ Air Hungary Kft.  
 BUD Nemzetközi Repulotér (BUD  
 International Airport) 221. ép., H-1185  
 Budapest, Hungary  
 (540)



(591) Purple and Pink  
 (511)  
 38 – Computer aided transmission of messages and images.

(260) AM 2015 76283 A  
 (800) 892895  
 (891) 2013 12 23  
 (731) MAGNETI MARELLI AFTER MARKET  
 PARTS AND SERVICES S.p.A.  
 Viale Aldo Borletti, 61/63, Corbetta (Milano),  
 Italy  
 (540)



(591) Black, grey  
 (511)  
 7 – Shock absorbers, silencers, water pumps and oil pumps, brake components other than for land vehicles, starters for motors and engines, electrical motors, alternators, injectors, carburettors, spark plugs, glow plugs.  
 9 – Electronic systems for vehicles; electrical equipment for vehicles, odometers, GPS for vehicles, satellite anti-theft systems, diagnostic equipment for vehicles, CD, DVD, videos, GPS programs, protective helmets, protective gloves, protective clothing, protective masks, protective face masks, personal protection devices, batteries.

11 – Lights, lighting instruments and equipment for vehicles, air conditioning equipment for vehicles.

12 – Rear-view mirrors, engines for vehicles, starting motors for vehicles, windscreen-wiper brushes.

25 – Articles of clothing.

35 – Organisation of franchising networks, franchising services for third parties.

41 – Organisation of courses, car-repair training services, organisation of exhibitions, congresses, seminars, symposia, organisation of sporting and cultural activities.

42 – Technical planning services relating to vehicles and their parts; product quality certification services.

(260) AM 2015 76284 A  
 (800) 923290  
 (891) 2014 01 28  
 (731) ACM  
 17 rue de Neuilly, Impasse Passoir, F-92110  
 CLICHY, France  
 (540)

## SEBIONEX

(591) Black, white  
 (511)  
 3 – Cosmetic products for protection, hygiene, care, prevention and treatment of acne; cosmetic creams for the face.

(260) AM 2015 76285 A  
 (800) 947762  
 (891) 2013 12 18  
 (731) ERYtech Pharma  
 60 avenue Rockefeller, Bâtiment Adenine,  
 F-69008 LYON, France  
 (540)



(591) Red, blue  
 (511)  
 5 – Pharmaceutical preparations; chemical preparations for medical purposes.  
 42 – Scientific research for medical purposes.  
 44 – Medical and health services.

(260) AM 2015 76287 A  
 (800) 1087371  
 (891) 2013 12 10  
 (731) OTKRYTOE AKTSIONERNOE  
 OBSHCHESTVO "NIGEGORODSKIY  
 MASLO-GIROVOY KOMDINAT"  
 11, Girkombinata sh., RU-603950 Nizhny  
 Novgorod, Russian Federation



(540)



(591) white

(511)

29 – Meat, fish, poultry and game; meat extracts; preserved, frozen, dried and cooked fruits and vegetables; jellies, jams, compotes; eggs, milk and milk products; edible oils and fats; alginates for food; anchovy; peanuts, processed; albumen for food; white of eggs; beans, preserved; soya beans, preserved, for food; bouillon; ginger jam; fatty substances for the manufacture of edible fats; edible birds' nests; peas, preserved; mushrooms, preserved; game, not live; gelatine for food; meat jellies; jellies for food; fruit jellies; yolk of eggs; coconut fat; bone oil, edible; lard for food; suet for food; edible fats; fruit-based snack food; raisins; caviar; yogurt; sauerkraut; isinglass for food; black pudding [blood sausage]; meat, tinned [canned (Am.)]; vegetables, tinned [canned (Am.)]; fish, tinned [canned (Am.)]; fruits, tinned [canned (Am.)]; bouillon concentrates; gherkins; shrimps, not live; buttercream; croquettes; silkworm chrysalis, for human consumption; toasted laver; spiny lobsters, not live; salmon; onions, preserved; margarine; piccalilli; marmalade; peanut butter; cocoa butter; coconut butter; butter; shellfish, not live; almonds, ground; animal marrow for food; milk; soya milk [milk substitute]; clams [not live]; fishmeal for human consumption; fruit pulp; meat; meat, preserved; vegetables, preserved; vegetables, dried; vegetables, cooked; potato fritters; olives, preserved; lobsters, not live; coconut, desiccated; nuts, prepared; tomato purée; liver pâté; pectin for food; liver; pickles; jams; powdered eggs; ham; fermented vegetable foods [kimchi]; foods prepared from fish; curd; protein for human consumption; poultry, not live; pollen prepared as foodstuff; cranberry sauce [compote]; apple purée; crustaceans, not live; fish, not live; fish, preserved; vegetable salads; fruit salads; bacon; sardines; pork; herrings; whipped cream; fat-containing mixtures for bread slices; tomato juice for cooking; vegetable juices for cooking; salted meats; sausages in batter; preparations for making bouillon; preparations for making soup; tripe; soups; vegetable soup preparations; cheese; tahini [sesame seed paste]; tofu; sea-cucumbers, not live; truffles, preserved; tuna fish; oysters, not live; rennet; fish fillets; dates; crystallized fruits; frozen fruits; fruit, preserved; fruit preserved in alcohol; fruit, stewed; potato flakes; hummus [chickpea paste]; fruit peel; lentils, preserved; potato chips; fruit chips; weed extracts for food; meat extracts; snail eggs for consumption; eggs.

(260) AM 2015 76288 A

(800) 1144069

(891) 2013 12 06

(731) CATALYSIS, S.L.

Macarena, 14, E-28016 Madrid, Spain

(540)

## RENALOF

(511)

5 – Dietetic substances for medical use, including nutritional supplements for medical use.

(260) AM 2015 76290 A

(800) 1163281

(891) 2014 01 21

(731) ONE BEAUTY ITALIA S.r.l.

Via G. Meoni, 9, I-59100 PRATO, Italy

(540)

## KEZY

(511)

3 – Cosmetics preparations; perfumery; hair care and treatment preparations; hair colorants; hair color; bleaching preparations [decolorants] for hair; hair cream; conditioners for use on the hair; hair lacquer; hair lotions; waving preparations for the hair; preparations for setting hair; hair styling preparations; hair shampoos; soaps and cleansers for the scalp.

(260) AM 2015 76294 A

(800) 1175910

(891) 2013 11 25

(731) BRUNO JOSEPH BOUR

25 rue des Mesanges, F-67260 Herbitzheim;

FLORSCH JEAN LUC

10 rue Principale, F-57200 Blies, Guersviller

France

(540)

## BBruno Bour Bruno

(591) Black, white

(511)

34 – Cigarettes; raw and manufactured tobacco; tobacco products; smokers' articles; matches.

(260) AM 2015 76295 A

(800) 1193855

(891) 2013 09 04

(731) ABB Asea Brown Boveri Ltd

Affolternstrasse 44, CH-8050 Zürich,

Switzerland

(540)

## WINMATION

(511)

7 – Machines and machine tools as well as their parts including automated machines and machine tools as well as their parts; motors and engines (other than for land vehicles); couplings and devices for power transmission (except those for land crafts); agricultural implements other than hand-operated; electric generators and current generators; apparatus for handling and transporting included in this class; transport and handling belts; pneumatic transporters; transporters and conveyors; control devices for machines or motors; pneumatic controls for machines, motors and engines; drives for machines; driving motors other than for land vehicles, particularly drives for ships, hydraulic controls for machines and engines; hydraulic engines and motors; robots; turbocompressors; pumps; compressors; mills; generators for wind turbines; floating or non-floating drilling rigs; elevator control devices.

9 – Scientific, nautical, surveying, photographic, cinematographic, optical, weighing, measuring, analyzing, indicating, signaling, monitoring apparatus, instruments and devices, including: parts for all the aforesaid goods, emergency (rescue) and teaching apparatus and instruments; apparatus and instruments for conducting, switching, transforming, accumulating, regulating or controlling electricity, including parts for all the aforesaid goods; CDs; electronic publications, downloadable; apparatus for recording, transmitting and reproducing sound and images; data processing equipment and computers; microprocessors; software; lasers, not for medical purposes; chargers for electric storage batteries; timer switches (except for clockwork mechanisms); condensers [capacitors]; electric collectors; electric pliers; electric wires, lines and cables; accumulator boxes and connection boxes; cable identification sheaths for electrical transmission lines and cable identification yarns for electrical transmission lines; cable ducts; inductors; magnetic recording media; semi-conductors; electric and electronic apparatus, devices and instruments including parts thereof for the production, distribution and supply of energy, particularly alternative energy; fuel cells; sound recording disks; mechanisms for coin-operated apparatus; cash registers; calculating machines; extinguishers; electronic, magnetic and optical storage, floppy disks, magnetic disks, optical disks; data protection apparatus; computer peripherals; current inverters; current rectifiers; current converters; electrical connection parts; connection sleeves; transistors, thyristors, electric diodes; semiconductor power elements; transformers [electricity]; resistances, electric; distribution panels and cabinets; batteries; integrated switching circuits (chips); printed circuit boards; computer operating programs; diagnostic apparatus (not for medical purposes); remote control apparatus; anti-interference devices; memories for apparatus for data processing; switching panels and

consoles; commutators (switches); electric relays; modems; ducts [electricity]; connectors for electrical transmission lines; electric measuring and regulating apparatus in the form of voltage regulators; sensors; fuses and electrical safety devices included in this class; distribution connection panels; voltmeters; counters; electric current switches; dosing and measuring apparatus; electric power distribution installations; electric and electronic installations for (remote) control of automated industrial processes, including electronic display boards as well as acoustic and optical warning devices, control panels, distribution consoles, control cables and buttons; automatic steering apparatus for vehicles; installations and apparatus for transmitting, switching and controlling electric current included in this class, including their parts, particularly high, medium and low-voltage electrical distribution installations and installations for transmitting high-voltage direct current; heavy current circuits; aerial cables for heavy currents; electric power reactors, transformers and components therefor; distribution transformers; solar.

11 – Apparatus for lighting as well as heating, cooling and ventilation, including fans, sanitary installations; ventilation and air-conditioning installations; apparatus for steam generation, cooking, ventilation and water supply; solar collectors; heat pumps; ovens.

37 – Construction, including advice in this field; repair; installation work, including advice in this field; servicing, commissioning and maintenance as well as installation works particularly for industrial installations; installation, implementation, maintenance and repair of computer hardware and office machines; maintenance of computer hardware, particularly computers and computer network installations; installation, maintenance, repair and noise suppression of machines and apparatus and electrical installations; installation and maintenance of oil pipelines; underwater construction; consulting in connection with repairs and installation work; consulting in any of the aforesaid services.

42 – Research in the scientific and industrial field; programming for data processing; provision of computer programs on data networks, particularly on the Internet and the World Wide Web; providing technical information concerning the use of computers, computer hardware, software, computer databases and computer networks; materials testing; services provided by an industrial designer; services of a designer for packaging; quality control; underwater exploration; raw material testing; engineering services relating to environmental impact, advice in the field of energy saving, providing technical advice in connection with energy-saving measures, technical advisors' services in the field of energy saving and energy performance; computer software design, particularly in the field of computer security; network engineers' services including computer and network

security consulting; scientific and industrial research in the field of network technology; actualization (update) of software; executing of chemical analyses; analyses for the exploitation of oil reservoirs; oil prospecting; oil-well testing; preparation of analyses for oil reservoir exploitation; oil-field surveys; services provided by architects; physics research; chemical research; physicist services; computer consulting services, particularly in the field of technical security; reconstitution of computer data; software maintenance; computer system analyses; research and development; research in the field of machine construction and engineering; technical surveys; engineering work including advice provided by engineers, particularly consultation in the field of technical security; technical project studies as well as related consulting; rental of computer software and data processing apparatus; development of software; services provided by an engineer.

45 – Legal services; licensing of intellectual property rights; exploitation of patents.

(260) AM 2015 76298 A

(800) 1193864

(891) 2013 08 07

(731) ZAKRYTOE AKTSIONERNOE

OBSHCHESTVO "NATSIONAL'NAYA

KHIMICHESKAYA KOMPANIYA"

Ul. Chistova, 4A, str. 2, RU-109390 Moskva,

Russian Federation

(540)

**IKEEP!**

(591) Black, white

(511)

9 – Scientific, nautical, surveying, photographic, cinematographic, optical, weighing, measuring, signalling, checking (supervision), life-saving and teaching apparatus and instruments; apparatus and instruments for conducting, switching, transforming, accumulating, regulating or controlling electricity; apparatus for recording, transmission or reproduction of sound or images; magnetic data carriers, recording discs; compact discs, DVDs and other digital recording media; mechanisms for coin-operated apparatus; cash registers, calculating machines, data processing equipment, computers; computer software; fire-extinguishing apparatus; DVD players; ticket dispensers; coin-operated musical automata [juke boxes]; answering machines; motor fire engines; accumulators, electric; accumulators, electric, for vehicles; actinometers; alidades; altimeters; ammeters; anemometers; anodes; antennas; anticathodes; aperimeters [optics]; high-frequency apparatus; testing apparatus not for medical purposes; remote control apparatus; electro-dynamic apparatus for the remote control of railway points; electro-dynamic apparatus for the remote control of signals; monitoring appa-

ratus, electric; sound recording apparatus; Global Positioning System [GPS] apparatus; distillation apparatus for scientific purposes; diffraction apparatus [microscopy]; air analysis apparatus; apparatus to check franking; sound transmitting apparatus; apparatus for fermentation [laboratory apparatus]; breathing apparatus for underwater swimming; breathing apparatus, except for artificial respiration; apparatus and installations for the production of X-rays, not for medical purposes; cash registers; electric apparatus for commutation; intercommunication apparatus; stills for laboratory experiments; projection apparatus; radiological apparatus for industrial purposes; X-ray apparatus not for medical purposes; blueprint apparatus; flashing lights [luminous signals]; stereoscopic apparatus; telephone apparatus; facsimile machines; phototelegraphy apparatus; igniting apparatus, electric, for igniting at a distance; acid hydrometers; salinometers; acidimeters for batteries; aerometers; beacons, luminous; battery jars; barometers; anode batteries; galvanic batteries; batteries for lighting; solar batteries; batteries, electric; balances [steelyards]; betatrons; binoculars; electronic tags for goods; lens hoods; magnetic tape units for computers; computer memory devices; fire hose nozzles; encoded identification bracelets, magnetic; safety tarpaulins; signalling buoys; life buoys; marking buoys; directional compasses; vacuum gauges; electrolyzers; variometers; verniers; scales; letter scales; weighbridges; precision balances; levelling staffs [surveying instruments]; camcorders; video cassettes; video telephones; video screens; viewfinders, photographic; plugs, sockets and other contacts [electric connections]; micrometer screws for optical instruments; viscosimeters; circuit closers; wavemeters; voltmeters; switchboxes [electricity]; current rectifiers; gas testing instruments; gasometers [measuring instruments]; galvanometers; hands free kits for phones; heliographic apparatus; hygrometers; hydrometers; weights; peepholes [magnifying lenses] for doors; holograms; plotters; loudspeakers; sounding leads; plumb bobs; range finders; densimeters; densitometers; optical goods; detectors; smoke detectors; counterfeit [false] coin detectors; transparencies [photography]; slide projectors; diaphragms [photography]; dictating machines; dynamometers; light-emitting diodes [LED]; floppy disks; sound recording discs; disks, magnetic; optical discs; calculating disks; disk drives for computers; juke boxes for computers; DNA chips; electronic notice boards; bullet-proof waistcoats [vests (Am.)]; life jackets; identification threads for electric wires; screw-tapping gauges; calculating machines; pocket calculators; decompression chambers; cinematographic cameras; electronic pens [visual display units]; holders for electric coils; identity cards, magnetic; video game cartridges; encoded magnetic cards; riding helmets; protective helmets; carriers for dark plates [photography]; automated teller machines [ATM];

cathodes; spools [photography]; choking coils [impedance]; coils, electric; electromagnetic coils; cinematographic film, exposed; computer keyboards; solenoid valves [electromagnetic switches]; wire connectors [electricity]; electronic agendas; push buttons for bells; mouse pads; magnetic encoders; anti-glare visors; collectors, electric; calibrating rings; protective suits for aviators; commutators; compact discs [audio-video]; compact discs [read-only memory]; comparators; marine compasses; computers; laptop computers; notebook computers; condensers [capacitors]; contacts, electric; wind socks for indicating wind direction; branch boxes [electricity]; distribution boxes [electricity]; junction boxes [electricity]; battery boxes; cabinets for loudspeakers; diving suits; garments for protection against fire; galena crystals [detectors]; reflecting discs for wear, for the prevention of traffic accidents; covers for electric outlets; logs [measuring instruments]; lasers, not for medical purposes; lactodensimeters; lactometers; vacuum tubes [radio]; darkroom lamps [photography]; thermionic tubes; amplifying tubes; flashlights [photography]; head cleaning tapes [recording]; magnetic tapes; videotapes; surveying chains; fire escapes; rulers [measuring instruments]; slide-rules; contact lenses; correcting lenses [optics]; optical lenses; optical condensers; sounding lines; electricity conduits; measuring spoons; magnifying glasses [optics]; thread counters; magnets; decorative magnets; crash test dummies; resuscitation mannequins [teaching apparatus]; mouse [data processing equipment]; pressure gauges; divers' masks; solderers' helmets; protective masks; materials for electricity mains [wires, cables]; voting machines; money counting and sorting machines; material testing instruments and machines; furniture especially made for laboratories; megaphones; portable media players; diaphragms [acoustics]; diaphragms for scientific apparatus; metal detectors for industrial or military purposes; metronomes; rules [measuring instruments]; carpenters' rules; dressmakers' measures; mechanisms for counter-operated apparatus; coin-operated mechanisms for television sets; shutter releases [photography]; micrometers; microprocessors; microscopes; microtomes; microphones; modems; lightning conductors [rods]; monitors [computer hardware]; monitors [computer programs]; terminals [electricity]; junction sleeves for electric cables; cases fitted with dissecting instruments [microscopy]; teeth protectors; knee-pads for workers; headphones; surveyors' levels; sound recording carriers; magnetic data media; optical data media; socks, electrically heated; computer software, recorded; sheaths for electric cables; identification sheaths for electric wires; weighing machines; punched card machines for offices; life saving apparatus and equipment; shoes for protection against accidents, irradiation and fire; objectives [lenses] [optics]; lenses for astrophotography; egg-candlers; fire extinguish-

ers; electrified fences; limiters [electricity]; clothing for protection against accidents, irradiation and fire; clothing for protection against fire; asbestos clothing for protection against fire; clothing especially made for laboratories; ozonisers [ozonators]; octants; eyepieces; ohmmeters; wrist rests for use with computers; spectacle frames; eyeglass frames; oscillographs; plumb lines; mirrors [optics]; spectacles [optics]; sunglasses; goggles for sports; signalling panels, luminous or mechanical; radio pagers; pince-nez; electronic pocket translators; transmitters [telecommunication]; telephone transmitters; transmitters of electronic signals; switches, electric; periscopes; gloves for divers; gloves for protection against accidents; gloves for protection against X-rays for industrial purposes; asbestos gloves for protection against accidents; furnaces for laboratory use; pipettes; pyrometers; planimeters; plane tables [surveying instruments]; plates for batteries; wafers for integrated circuits; printed circuit boards; compact disc players; cassette players; sound recording strips; X-ray films, exposed; films, exposed; life-saving rafts; laboratory trays; semi-conductors; polarimeters; fire pumps; measuring glassware; life belts; fuses; circuit breakers; converters, electric; telerupters; food analysis apparatus; diagnostic apparatus, not for medical purposes; distance recording apparatus; distance measuring apparatus; speed measuring apparatus [photography]; appliances for measuring the thickness of leather; apparatus for measuring the thickness of skins; speed checking apparatus for vehicles; teaching apparatus; time recording apparatus; hemline markers; apparatus and instruments for astronomy; surveying apparatus and instruments; weighing apparatus and instruments; nautical apparatus and instruments; navigational instruments; optical apparatus and instruments; apparatus and instruments for physics; chemistry apparatus and instruments; measuring apparatus; measuring devices, electric; boiler control instruments; meteorological instruments; naval signalling apparatus; observation instruments; navigation apparatus for vehicles [on-board computers]; satellite navigational apparatus; regulating apparatus, electric; precision measuring apparatus; audio- and video-receivers; prisms [optics]; printers for use with computers; retorts' stands; apparatus for changing record player needles; drainers for use in photography; cleaning apparatus for sound recording discs; fire beaters; sighting telescopes for firearms; test tubes; pressure indicator plugs for valves; magnetic wires; telegraph wires; telephone wires; wires, electric; conductors, electric; copper wire, insulated; fuse wire; distribution consoles [electricity]; control panels [electricity]; radar apparatus; computer programmes [programs], recorded; computer game software; computer programs [downloadable software]; computer operating programs, recorded; record players; processors [central

processing units]; rods for water diviners; electronic publications, downloadable; masts for wireless aerials; transmitting sets [telecommunication]; radios; vehicle radios; sprinkler systems for fire protection; frames for photographic transparencies; screens for photoengraving; walkie-talkies; voltage surge protectors; voltage regulators for vehicles; stage lighting regulators; light dimmers [regulators], electric; speed regulators for record players; cell switches [electricity]; washing trays [photography]; marking gauges [joinery]; time switches, automatic; relays, electric; safety restraints, other than for vehicle seats and sports equipment; X-ray photographs, other than for medical purposes; rheostats; respirators for filtering air; respiratory masks, other than for artificial respiration; retorts; refractometers; refractors; grids for batteries; speaking tubes; horns for loudspeakers; saccharometers; optical fibers [fibres] [light conducting filaments]; traffic-light apparatus [signalling devices]; dog whistles; signalling whistles; sextants; inductors [electricity]; safety nets; nets for protection against accidents; fire alarms; signals, luminous or mechanical; sirens; scanners [data processing equipment]; integrated circuit cards [smart cards]; connections for electric lines; couplings, electric; connectors [electricity]; sonars; sound locating instruments; lighting ballasts; resistances, electric; spectrograph apparatus; spectrometers; speed indicators; alcoholmeters; satellites for scientific purposes; protection devices for personal use against accidents; audiovisual teaching apparatus; radiotelegraphy sets; radiotelephony sets; spectacle lenses; glass covered with an electrical conductor; anti-glare glasses; optical glass; personal stereos; stereoscopes; stands for photographic apparatus; fire boats; sulphitometers; drying racks [photography]; spherometers; integrated circuits; printed circuits; counters; parking meters; kilometer recorders for vehicles; revolution counters; abacuses; egg timers [sandglasses]; taximeters; ear plugs for divers; tachometers; television apparatus; telegraphs [apparatus]; telescopes; teleprompters; teleprinters; portable telephones; theodolites; thermometers, not for medical purposes; thermostats; thermostats for vehicles; crucibles [laboratory]; tone arms for record players; totalizers; transistors [electronic]; transponders; protractors [measuring instruments]; transformers [electricity]; step-up transformers; vehicle breakdown warning triangles; triodes; starter cables for motors; discharge tubes, electric, other than for lighting; capillary tubes; neon signs; X-ray tubes not for medical purposes; telephone receivers; gauges; quantity indicators; automatic indicators of low pressure in vehicle tires [tyres]; gasoline gauges; water level indicators; electric loss indicators; light-emitting electronic pointers; slope indicators; levels [instruments for determining the horizontal]; mercury levels; spirit levels; urinometers; amplifiers; particle accelerators; electric installations for the remote control of indus-

trial operations; steering apparatus, automatic, for vehicles; balancing apparatus; video recorders; sound reproduction apparatus; invoicing machines; tape recorders; protection devices against X-rays, not for medical purposes; railway traffic safety appliances; data processing apparatus; oxygen trans-vasing apparatus; theft prevention installations, electric; film cutting apparatus; drying apparatus for photographic prints; optical character readers; centering apparatus for photographic transparencies; dosage dispensers; battery chargers; chargers for electric batteries; acoustic [sound] alarms; sounding apparatus and machines; editing appliances for cinematographic films; cathodic anti-corrosion apparatus; couplers [data processing equipment]; anti-theft warning apparatus; computer peripheral devices; anti-interference devices [electricity]; demagnetizing apparatus for magnetic tapes; acoustic couplers; alarms; fog signals, non-explosive; whistle alarms; adding machines; readers [data processing equipment]; heat regulating apparatus; photocopiers [photographic, electrostatic, thermic]; bar code readers; downloadable ring tones for mobile phones; downloadable image files; downloadable music files; animated cartoons; filters [photography]; filters for respiratory masks; filters for ultraviolet rays, for photography; USB flash drives; magic lanterns; optical lamps; signal lanterns; cameras [photography]; glazing apparatus for photographic prints; shutters [photography]; darkrooms [photography]; photometers; flash-bulbs [photography]; enlarging apparatus [photography]; photovoltaic cells; containers for contact lenses; spectacle cases; pince-nez cases; containers for microscope slides; cases especially made for photographic apparatus and instruments; chromatography apparatus for laboratory use; chronographs [time recording apparatus]; laboratory centrifuges; eyeglass chains; cyclotrons; compasses [measuring instruments]; frequency meters; time clocks [time recording devices]; fire blankets; chips [integrated circuits]; jigs [measuring instruments]; pedometers; meteorological balloons; electrified rails for mounting spot lights; asbestos screens for firemen; fire hose; protective helmets for sports; cell phone straps; eyeglass cords; tripods for cameras; switchboards; distribution boards [electricity]; screens [photography]; workmen's protective face-shields; projection screens; radiology screens for industrial purposes; fluorescent screens; exposure meters [light meters]; ducts [electricity]; galvanic cells; epidiascopes; ergometers; armatures [electricity].

---

(260) AM 2015 76303 A

(800) 1193866

(891) 2013 08 09

(731) CAVAG-AVIA LIMITED

Griva Digeni 115, Trident Centre, CY-3101  
Limassol, Cyprus

(540)

**CAVAG**

(511)

7 – Air start units, namely aircraft-engine starting units; baggage lifts; cargo loading ramps; conveyor belts; conveyor belt loaders; conveyor rollers; de-icing equipment, namely aircraft deicers for the mobile deicing and anti-icing of all type of aircraft; engine and auxiliary power unit hoist (APU); ground power units (GPUs); hoses and couplings; hydraulic power units; lifts (cargo, etc); main deck loaders; maintenance stands and docking; pallet loaders; scissor lifts; Foreign Object Damage (FOD) removal equipment; aircraft exterior cleaning & polishing equipment; runway Foreign Object Damage (FOD) sweepers.

9 – Cables & connectors; fall protection; frequency converters (400 Hz); runway friction measurement equipment; tracking and monitoring systems; weighing systems.

11 – Portable heaters.

12 – Aircraft service trucks; aircraft tags and tractors; airfield service vehicles; baggage handling dollies and trailers; catering vehicles; container dollies; electric vehicles; fire-fighting vehicles; luggage carts; refuelling vehicles; toilet service vehicles; tugs and tractors; water carts.

19 – Aircraft docking systems.

37 – Airport tug manufacturing.

---

(260) AM 2015 76304 A

(800) 1193873

(891) 2013 12 18

(731) BAYER INTELLECTUAL PROPERTY  
GMBH

Alfred-Nobel-Straße 10, 40789 Monheim am  
Rhein, Germany

(540)

**BPREMIR**

(511)

5 – Pharmaceutical preparations; dietetic foods and substances adapted for medical use; dietary supplements for humans.

---

(260) AM 2015 76305 A

(800) 1193879

(891) 2013 09 25

(731) YOOX SpA

Via Nannetti, 1, I-40069 Zola Predosa (BO),  
Italy

(540)

**YOOX.COM**

(526) The trademark is protected as a whole. The word "COM" included therein shall not be subject to independent legal protection.

(511)

18 – Leather and imitations of leather, and goods made of these materials and not included in other classes; animal skins, hides; trunks and travelling bags; umbrellas and parasols; walking sticks; whips, harness and saddlery; clothing for pets; umbrella rings; saddle trees; saddlery; key cases; fastenings for saddles; bandoliers; harness for animals; alpenstocks; walking sticks; umbrella sticks; vanity cases, not fitted; trunks [luggage]; travelling trunks; bags; sling bags for carrying infants; bags for sports; chain mesh purses; tool bags of leather, empty; purses; handbags; travelling sets [leatherware]; bridles [harness]; bridoons; gut for making sausages; straps for soldiers' equipment; kid; game bags [hunting accessories]; briefcases; school bags; leatherboard; cases, of leather or leatherboard; halters; girths of leather; collars for animals; horse collars; coverings of skins [furs]; horse blankets; leather laces; leather straps; straps of leather [saddlery]; harness straps; straps for skates; leather, unworked or semi-worked; horsehoes; leather twist; moleskin [imitation of leather]; umbrella covers; whips; knee-pads for horses; casings, of leather, for springs; covers for horse-saddles; pads for horse saddles; leather trimmings for furniture; harness fittings; leather leads; imitation leather; walking cane handles; umbrella handles; suitcase handles; slings for carrying infants; pouch baby carriers; cat o' nine tails; chin straps, of leather; bits for animals [harness]; muzzles; parasols; blinders [harness]; umbrellas; pelts; cattle skins; curried skins; chamois leather, other than for cleaning purposes; fur; goldbeaters' skin; parts of rubber for stirrups; card cases [notecases]; music cases; pocket wallets; reins; net bags for shopping; furniture coverings of leather; haversacks; nose bags [feed bags]; pouches, of leather, for packaging; bags for campers; beach bags; travelling bags; bags for climbers; shopping bags; wheeled shopping bags; boxes of leather or leather board; boxes of vulcanised fibre; hat boxes of leather; butts [parts of hides]; walking stick seats; riding saddles; stirrups; stirrup leathers; umbrella or parasol ribs; frames for umbrellas or parasols; handbag frames; traces [harness]; valises; suitcases; attaché cases; garment bags for travel; valves of leather; backpacks.

25 – Clothing, footwear, headgear; clothing of imitations of leather; clothing of leather; motorists' clothing; cyclists' clothing; clothing for gymnastics; dresses; dressing gowns; bath robes; non-slipping devices for footwear; clothing; bandanas [neckerchiefs]; bibs, not of paper; caps [headwear]; berets; underwear; anti-sweat underwear; smocks; boas [necklets]; teddies [undergarments]; suspenders; studs for football boots; corsets [underclothing]; galoshes; skull caps; footwear; boots for sports; stockings;

sweat-absorbent stockings; slippers; socks; breeches for wear; short-sleeve shirts; shirts; stuff jackets [clothing]; bodices [lingerie]; hats; top hats; paper hats [clothing]; coats; hoods [clothing]; hat frames [skeletons]; footmuffs, not electrically heated; belts [clothing]; money belts [clothing]; tights; shoulder wraps; detachable collars; camisoles; headgear for wear; collar protectors; ear muffs [clothing]; layettes [clothing]; corselets; suits; beach clothes; masquerade costumes; neckties; ascots; bathing caps; shower caps; headbands [clothing]; pocket squares; scarfs; fittings of metal for footwear; ready-made linings [parts of clothing]; gabardines [clothing]; spats; jackets [clothing]; fishing vests; garters; skirts; jumper dresses; aprons [clothing]; girdles; gloves [clothing]; mittens; ski gloves; welts for footwear; waterproof clothing; ready-made clothing; paper clothing; knitwear [clothing]; jerseys [clothing]; leg warmers; leggings [trousers]; liveries; singlets; hosiery; swimsuits; sweaters; muffs [clothing]; maniples; pelerines; mantillas; sleep masks; skorts; miters [hats]; pants; bathing trunks; vests; babies' pants [clothing]; trousers; parkas; pelisses; furs [clothing]; shirt yokes; chasubles; pyjamas; cuffs; ponchos; pullovers; tips for footwear; stocking suspenders; sock suspenders; brassieres; heelpieces for footwear; heelpieces for stockings; sandals; bath sandals; saris; sarongs; shoes; esparto shoes or sandals; bath slippers; gymnastic shoes; beach shoes; football boots; sports shoes; ski boots; shawls; sashes for wear; underpants; lace boots; wimples; top-coats; outerclothing; dress shields; gaiter straps; petticoats; slips [undergarments]; shirt fronts; half-boots; boots; fur stoles; soles for footwear; inner soles; heels; pockets for clothing; tee-shirts; togas; footwear uppers; boot uppers; turbans; wet suits for water-skiing; combinations [clothing]; uniforms; veils [clothing]; cap peaks; cap peaks; wooden shoes.

(260) AM 2015 76309 A  
 (800) 1193880  
 (891) 2013 07 26  
 (731) HUVEPHARMA AD  
 5th floor, Nikolay Haitov Str 3 A, BG-1113  
 Sofia, Bulgaria  
 (540)

## FlavoCombi

(511)  
 5 – Veterinary preparations; medicines for veterinary purposes; supplements to fodder for veterinary purposes; animal feed supplements for veterinary purposes.

31 – Additives to animal feed not for medical purposes; additives to fodder not for medical purposes.

(260) AM 2015 76315 A  
 (800) 1193883  
 (891) 2013 12 20  
 (731) Nemiroff Intellectual Property Establishment  
 Staedtler 31, FL-9490 Vaduz, Liechtenstein  
 (540)



(591) White, black, red, pink, light yellow, yellow, light green, green, light brown, brown and baby blue

(511)  
 33 – Aperitifs; vodka; digestives (liqueurs and alcoholic beverages); cocktails; alcoholic beverages, except beers; alcoholic beverages containing fruit; spirits; distilled beverages; bitters; alcohol extracts; fruit alcohol extracts; spirit essences.

(260) AM 2015 76316 A  
 (800) 1193920  
 (891) 2013 09 04  
 (731) WORLD VET İLAÇ SANAYİ VE TİCARET  
 LİMİTED ŞİRKETİ  
 Evren Mah. Camiyolu Cad. No:50 K.1,  
 GÜNEŞLİ İSTANBUL, Turkey  
 (540)

## ELVETRAN ЭЛЬВЕТРАН

(591) Black, white

(511)  
 5 – Medicines for human purposes, medicines for veterinary purposes, vitamin preparations, chemical preparations for medical purposes, dietetic substances adapted for medical use; dietetic foods adapted for medical purposes; baby foods, medicinal herbs, herbal beverages adapted for medical purposes, nutritional supplements, pollen dietary supplements, mineral food supplements, protein dietary supplements; medicines for dental purposes, hygienic products for medical purposes including pads, waddings for medical purposes, plasters for medical purposes, dressings for medical purposes, babies' napkins, preparations for destroying noxious plants, preparations for destroying noxious animals, fungicides, deodorants other than for human beings or for animals, air deodorising preparations, disinfectants for hygiene

purposes, antiseptics, detergents for medical purposes.

(260) AM 2015 76317 A

(800) 1193921

(891) 2013 09 30

(731) Subsidiary Enterprise "BOOK CLUB"  
"FAMILY LEISURE CLUB"  
prospekt Naharina 20-A, Kharkiv 61140,  
Ukraine

(540)

## КЛУБ СЕМЕЙНОГО ДОСУГА

(511)

16 – Albums; pamphlets; booklets; photographs, greeting cards; newspapers; printed matter; printed publications; magazines (periodicals); note books; calendars; catalogues; books; comic books; handbooks (manuals); posters; prospectuses.

25 – Berets; outerclothing; footwear; ready-made clothing; pelisses; hats; combinations (clothing); suits; jackets (clothing); singlets; body linen (garments); headgear for wear; overcoats; pyjamas; coats; pullovers; overalls; sweaters; shirts; cyclists' clothing; sports jerseys; dresses; aprons (clothing); tee-shirts; dressing gowns; caps (headwear); trousers.

35 – Assistance (mediation) of selling goods by means of post for the people with special printed catalogues. (terms considered too vague by the International Bureau rule 13.2.b) of the Common Regulations).

41 – Entertainment; amusements.

(260) AM 2015 76319 A

(800) 1193933

(891) 2013 10 17

(731) GESELLSCHAFT MIT BESCHRÄNKTER  
HAFTUNG "EHRMANN"  
pos.RAOS, 15, Ramenskiy r-n, RU-140025  
Moscow Region, Russian Federation

(540)



(591) Blue, light blue, azure, light azure, dark azure, yellow, white, beige, crimson, light crimson, green, light green, back and dark gray

(511)

29 – Milk products, namely yoghurt, drinking yogurt, dessert quark, quark products with fruit, milk-based and cream-based desserts, milk-based and cream-based desserts with addition of fruit filling, milk-based and cream-based buttercream.

(260) AM 2015 76320 A

(800) 1193934

(891) 2013 10 17

(731) GESELLSCHAFT MIT BESCHRÄNKTER  
HAFTUNG "EHRMANN"  
pos.RAOS, 15, Ramenskiy r-n RU-140025  
Moscow Region, Russian Federation

(540)



(591) Blue, dark blue, white, light gray, dark gray and black, light yellow, yellow, beige, brown, light brown

(511)

29 – Milk products, namely yoghurt, drinking yogurt, dessert quark, quark products with fruit, milk-based and cream-based desserts, milk-based and cream-based desserts with addition of fruit filling, milk-based and cream-based buttercream.

(260) AM 2015 76321 A

(800) 1193935

(891) 2013 10 17

(731) GESELLSCHAFT MIT BESCHRÄNKTER  
HAFTUNG "EHRMANN"  
pos.RAOS, 15, Ramenskiy r-n, RU-140025  
Moscow Region, Russian Federation

(540)



(591) Green, light green, dark green, azure, dark azure, red, blue, yellow, white, brown, light brown, black, beige and light gray

(511)

29 – Milk products, namely yoghurt, drinking yogurt, dessert quark, quark products with fruit,



milk-based and cream-based desserts, milk-based and cream-based desserts with addition of fruit filling, milk-based and cream-based buttercream.

(260) AM 2015 76336 A  
 (800) 1194063  
 (891) 2013 12 12  
 (731) BRUPHARMEXPORT SPRL  
 Rue de la Grotte 14, B-1020 Bruxelles,  
 Belgium  
 (540)

## Протон

(511)  
 5 – Pharmaceutical and veterinary products; sanitary products for medicine; dietetic food and substances for medical or veterinary use; food for babies; food supplements for humans and animals; plasters; materials for dressings; material for dental fillings and dental impressions; disinfectants; products for destroying vermin; fungicides; herbicides.

(260) AM 2015 76381 A  
 (800) 1194474  
 (891) 2014 01 24  
 (731) OBSHCHESTVO S OGRANICHENNOI  
 OTVETSTVENNOSTYU  
 "ALEKSANDROVY POGREBA"  
 Itufyevskoye shosse, d.79, "A", str. 25,  
 RU-127410 Moscow, Russian Federation  
 (540)

## AMIRANI

(511)  
 33 – Alcoholic beverages (except beers) originating from Georgia.

(260) AM 2015 76382 A  
 (800) 1194479  
 (891) 2014 02 05  
 (731) Santen SAS  
 1 rue Pierre Fontaine, Bâtiment Genavenir IV,  
 F-91000 Evry, France  
 (540)

## IKERVIS

(511)  
 5 – Pharmaceutical products for ophthalmic use; for veterinary and sanitary use; oiled paper for medical use; pharmaceutical wafers; gauze for dressings; empty capsules for pharmaceutical products; eye covers; ear bandages; sanitary pads; sanitary tampons; sanitary towels; sanitary panties; absorbent cotton; adhesive plaster; bandages for dressings; colloidion for pharmaceutical use; breast-nursing pads; dietetic supplements for human consumption; dietetic beverages for medical use; dietetic foods for

medical use; beverages for babies; food for babies; food supplements for animals.

(260) AM 2015 76383 A  
 (800) 1194480  
 (891) 2013 12 30  
 (731) LIMITED LIABILITY COMPANY  
 "INTERNET COMPANY MAIL.RU"  
 Leningradsky pr-kt, d. 39, str. 79, RU-125167  
 Moscow, Russian Federation  
 (540)



(591) Black, white  
 (511)  
 9 – Video cassettes; video game cartridges; compact discs [audio-video]; compact discs [read-only memory]; magnetic data media; optical data media; computer software, recorded; computer programmes [programs], recorded; computer game software; computer programs [downloadable software]; computer operating programs, recorded; downloadable image files; downloadable music files; animated cartoons; USB flash drives.

16 – Almanacs; atlases; posters; pamphlets; booklets; newsletters; newspapers; engravings; magazines [periodicals]; periodicals; printed publications; graphic representations; calendars; geographical maps; catalogues; books; comic books; lithographs; graphic prints; greeting cards; postcards; printed matter; prospectuses; manuals [handbooks]; photographs [printed].

28 – Arcade video game machines; video game machines; gaming machines for gambling; amusement machines, automatic and coin-operated; jigsaw puzzles; toys; mobiles [toys]; parlor games; board games; games; building games; playing cards; scale model kits [toys]; portable games with liquid crystal displays; apparatus for games.

35 – Rental of advertising space; computerized file management; demonstration of goods; opinion polling; marketing studies; business investigations; marketing research; news clipping services; updating of advertising material; organization of exhibitions for commercial or advertising purposes; organization of trade fairs for commercial or advertising purposes; shop window dressing; data search in computer files for others; commercial or industrial management assistance; presentation of goods on communication media, for retail purposes; auctioneering; sales promotion for others; production of advertising films; rental of advertising time on communication media; publicity material rental; publication of publicity texts; radio advertising; bill-posting; dissemination of advertising matter; direct mail advertising;

advertising; on-line advertising on a computer network; advertising by mail order; television advertising; compilation of information into computer databases; systemization of information into computer databases; publicity columns preparation; administrative processing of purchase orders; public relations.

38 – News agencies; television broadcasting; cable television broadcasting; electronic bulletin board services [telecommunications services]; information about telecommunication; providing user access to global computer networks; providing access to databases; providing internet chatrooms; providing telecommunications connections to a global computer network; providing telecommunication channels for teleshopping services; transmission of greeting cards online; message sending; computer aided transmission of messages and images; transmission of digital files; electronic mail; providing online forums; rental of access time to global computer networks; radio broadcasting; communications by fiber [fibre] optic networks; cellular telephone communication; communications by computer terminals; communications by telephone; paging services [radio, telephone or other means of electronic communication]; teleconferencing services; voice mail services; telephone services.

41 – Booking of seats for shows; videotaping; gambling; publication of books; education information; recreation information; entertainment information; health club services [health and fitness training]; night clubs; layout services, other than for advertising purposes; videotape editing; game services provided on-line from a computer network; providing on-line electronic publications, not downloadable; practical training [demonstration]; organization of exhibitions for cultural or educational purposes; providing recreation facilities; arranging and conducting of colloquiums; arranging and conducting of conferences; arranging and conducting of workshops [training]; arranging and conducting of seminars; organization of competitions [education or entertainment]; operating lotteries; television entertainment; videotape film production; rental of videotapes; rental of sound recordings; publication of electronic books and journals online; publication of texts, other than publicity texts; radio entertainment; entertainer services; entertainment; writing of texts, other than publicity texts; news reporters services; party planning [entertainment]; providing casino facilities [gambling]; club services [entertainment or education]; teaching; recording studio services; photography; production of shows.

42 – Computer system analysis; recovery of computer data; computer virus protection services; installation of computer software; information technology [IT] consultancy; consultancy in the design and development of computer hardware; computer software

re consultancy; updating of computer software; maintenance of computer software; providing search engines for the internet; data conversion of computer programs and data [not physical conversion]; computer system design; computer rental; rental of computer software; hosting computer sites [web sites]; server hosting; duplication of computer programs; computer software design; creating and maintaining web sites for others; computer programming.

45 – Missing person investigations; personal background investigations; dating services.

---

(260) AM 2015 76384 A

(800) 169218

(891) 2014 01 17

(731) PHARMAZEUTISCHE FABRIK  
MONTAVIT GESELLSCHAFT M.B.H.  
A-6060 ABSAM, Austria

(540)

## MONTAVIT

(511)

5 – Medicines, chemical products for medical and sanitary use, pharmaceutical drugs, plasters and surgical dressings, protective agents for plants, disinfectants, dietetic foodstuffs.

---

(260) AM 2015 76386 A

(800) 400587

(891) 2013 12 10

(731) EGIS Gyógyszergyár Zrt.  
Keresztúri út 30-38, H-1106 Budapest,  
Hungary

(540)

## LUDIRADOL

(511)

5 – Pharmaceutical products for human and veterinary use, proprietary medicines.

---

(260) AM 2015 76387 A

(800) 713557

(891) 2013 12 23

(731) LACOTE S.r.l.  
Via San Geminiano, 2/A I-41030 San  
Prospero (MO), Italy

(540)

## GUAM

(511)

3 – Creams and cosmetics for body and beauty care.

---

(260) AM 2015 76388 A

(800) 737339

(891) 2014 01 17

(731) RADEBERGER GRUPPE HOLDING GMBH  
Darmstädter Landstrasse 185, 60598

Frankfurt/Main, Germany  
(540)

## Clausthaler

(511)  
32 – Alcohol-free beer.

(260) AM 2015 76389 A  
(800) 821167  
(891) 2013 12 09  
(731) SHIN HEUNG PRECISION CO., LTD.  
Je 3(sam)gongdan 3(sam)-gil 53, Seowoon-  
Myeon, Gyeonggi-Do, Republic of Korea  
(540)



(591) Orange, blue and green  
(511)  
9 – Electronic cash registers, point of sales systems, namely POS systems, electronic label printers, magnetic card readers, scales, fixed scanners, hand-held scanners, receipt printers.

(260) AM 2015 76390 A  
(800) 901778  
(891) 2014 01 01  
(731) YILMAZ MAKİNE SANAYİ VE TİCARET  
ANONİM ŞİRKETİ  
Çamlık Mahallesi Turgut Özal, Bulvarı  
No:229 Tasdelen, Ümraniye-Istanbul, Turkey  
(540)



(591) Black, white  
(511)  
7 – Machines and machine tools for the cutting and forming of materials; wood chipping machines; wood planing machines; wood sawing machines; milling machines; wood milling machines; electric welding machines; gas welding machines; air compressors; electric motors for machines.

(260) AM 2015 76391 A  
(800) 1073346  
(891) 2013 11 15  
(731) BREVA GENEVE SA  
c/o WEALTHINGS SA, Chemin Frank-  
Thomas 32, CH-1208 Genève, Switzerland  
(540)

## BREVA

(511)  
14 – Jewelry; jewelry, precious stones; horological and chronometric instruments; precious metals and

their alloys; coins; works of art of precious metal; jewelry cases; boxes of precious metal; watch cases, bands, chains, springs or glasses; key rings [trinkets or fobs]; statues or figurines (statuettes) of precious metal; cases or presentation cases for timepieces; medals.

(260) AM 2015 76392 A  
(800) 1119284  
(891) 2013 12 12  
(731) BZZB  
152, avenue Alfred Motte, F-59100  
ROUBAIX, France  
(540)

## BIZZBEE

(511)  
14 – Precious metals and their alloys; jewelry, precious stones, cufflinks, necktie pins, necktie clips, medals, medallions; key cases; timepieces and chronometric instruments, watches, watch cases, bracelets and chains.

18 – Leather and imitation leather; animal skins; trunks and travelling bags; umbrellas, parasols and walking sticks; rucksacks, school bags, beach bags, handbags, wheeled bags, traveling bags and sets, garment bags for travel, school satchels, card cases, wallets, key cases (leatherware), document cases, purses not of precious metal.

25 – Clothing, footwear, headgear, clothing items, bandanas (neckerchiefs), headbands [clothing], suspenders, belts and money belts [clothing], neckties, ready-made linings (parts of clothing), sashes for wear, stoles, scarves, shawls, furs [clothing], gloves [clothing], mittens, dressing gowns, beach and swimwear, body linen (garments), underwear.

(260) AM 2015 76393 A  
(800) 1159501  
(891) 2013 12 27  
(731) LIM, JOOMI  
555 West 23rd Street, Apt. S12C, New York  
NY 10011, USA  
(540)

## JOOMI LIM

(511)  
14 – Jewelry.  
35 – On-line retail store services featuring jewelry.

(260) AM 2015 76396 A  
(800) 1194483  
(891) 2013 11 18  
(731) JT International S.A.  
Rue de la Gabelle 1, CH-1211 Geneva 26,  
Switzerland

(540)

**VAPEBLEND**

(511)

34 – Tobacco, whether manufactured or unmanufactured; smoking tobacco, pipe tobacco, hand rolling tobacco, chewing tobacco, snus tobacco; cigarettes, cigars, cigarillos; tobacco sold in pods; substances for smoking sold separately or blended with tobacco, none being for medicinal or curative purposes; snuff; smokers' articles included in this class; cigarette papers, cigarette tubes and matches; electronic cigarettes; electronic cigarette liquids; electronic smoking apparatus; cases for electronic cigarettes.

(260) AM 2015 76397 A

(800) 1194487

(891) 2013 10 04

(731) WORLD MEDICINE İLAÇ SANAYİ VE TİCARET LİMİTED ŞİRKETİ

Evren Mahallesi Cami Yolu, Caddesi No:50  
Kat 1 B Zemin 4-5-6, Güneşli Bağcılar  
İSTANBUL, Turkey

(540)

**ZOLTONAR 30JTOHAP**

(511)

5 – Medicines for human purposes, medicines for veterinary purposes, chemical preparations for medical purposes, dietetic substances adapted for medical use; dietetic foods adapted for medical purposes; aminoacids for medical purposes, nutritional supplements, pollen dietary substances, mineral food supplements, protein dietary supplements, baby foods, medicinal herbs, herbal beverages adapted for medical purposes; medicines for dental purposes, hygienic products for medical purposes including pads, waddings for medical purposes, plasters for medical purposes, dressings for medical purposes; preparations for destroying noxious plants, preparations for destroying noxious animals, fungicides; deodorants other than for human beings or for animals; disinfectants for hygiene purposes, antiseptics, detergents for medical purposes.

(260) AM 2015 76398 A

(800) 1194504

(891) 2014 01 17

(731) NOVARTIS AG

CH-4002 Basel, Switzerland

(540)



(591) Black, white

(511)

5 – Pharmaceutical preparations.

(260) AM 2015 76400 A

(800) 1194598

(891) 2013 08 06

(731) WORLD MEDICINE İLAÇ SANAYİ VE TİCARET LİMİTED ŞİRKETİ

Evren Mah. Camiyolu Cad. No.50 K.1B,  
Zemin -4-5-6, GÜNEŞLİ/BAĞCILAR/  
İSTANBUL, Turkey

(540)

**ZOLIDAS**

(511)

5 – Medicines for human purposes, medicines for veterinary purposes, vitamin preparations, chemical preparations for medical purposes, dietetic substances adapted for medical use; dietetic foods adapted for medical purposes; baby foods, medicinal herbs, herbal beverages adapted for medical purposes, nutritional supplements, pollen dietary supplements, mineral food supplements, protein dietary supplements; medicines for dental purposes, hygienic products for medical purposes including pads (Term too vague in the opinion of the International Bureau – Rule 13(2)(b) of the Common Regulations), waddings for medical purposes, plasters for medical purposes, dressings for medical purposes, babies' napkins, preparations for destroying noxious plants, preparations for destroying noxious animals, fungicides, deodorants other than for human beings or for animals, air deodorising preparations, disinfectants for hygiene purposes, antiseptics, detergents for medical purposes.

(260) AM 2015 76407 A

(800) 1194605

(891) 2013 09 30

(731) PERNOD RICARD WINEMAKERS NEW ZEALAND LIMITED

4 Viaduct Harbour Avenue Auckland 1010,  
New Zealand

(540)

**BRANCOTT  
ESTATE**

(591) Black, white, gold

(511)

33 – Alcoholic beverages except beers; wines.

(260) AM 2015 76410 A

(800) 1194654

(891) 2013 11 21

(731) PUBLICHNE AKTSIONERNE  
TOVARYSTVO "LUTSK-FUDZ"  
vul. Levadna, 2 A, s. Zmiinets, Lutskiyi r-n,  
Volynska obl. 45632, Ukraine

(540)



(591) Black, white

(511)

29 – Beans, preserved; bouillon; peas, preserved; mushrooms, preserved; jellies for food; caviar; compotes; vegetables, tinned [canned (Am.)]; fruits, tinned [canned (Am.)]; bouillon concentrates; preserved, frozen, dried and cooked fruits and vegetables; tomato puree; vegetable salads; fruit salads; preparations for making soup; vegetable juices for cooking; soups; vegetable soup preparations.

30 – Flavorings [flavourings], other than essential oils, for beverages; vermicelli [noodles]; mustard; dressings for salad; pasta; ketchup [sauce]; noodles; mayonnaise; macaroni; mustard meal; condiments; spices; sauces [condiments]; tomato sauce; spaghetti; seasonings; garden herbs, preserved [seasonings]; vinegar; chips [cereal products]; oat flakes.

(260) AM 2015 76434 A

(800) 1195000

(891) 2014 01 13

(731) LIMITED LIABILITY COMPANY

"NESTLE ROSSIYA"

Paveletskaya square 2, build. 1, RU-115054  
Moscow, Russian Federation

(540)



(591) Gold, red, bordeaux and white

(511)

30 – Coffee; tea; cocoa; cocoa-based ingredients for confectionery products; chocolate; sugar; rice; tapioca and sago; artificial coffee; flour; bean meal; corn flour; mustard; barley meal; soya flour; wheat flour; potato flour for food; tapioca flour for food; crushed oats; chips [cereal products]; corn flakes; oat flakes; chicory [coffee substitute]; bread, pastry and confectionery; peanut confectionery; almond confectionery; ice cream; honey; golden syrup; yeast; baking powder; cooking salt; vinegar; sauces [condiments]; spices; edible ices.

(260) AM 2015 76436 A

(800) 1195003

(891) 2014 01 09

(731) BAYER INTELLECTUAL PROPERTY

GMBH

Alfred-Nobel-Straße 10, 40789 Monheim am  
Rhein, Germany

(540)

## KOVALTRY

(511)

5 – Pharmaceutical preparations.

(260) AM 2015 76439 A

(800) 1195021

(891) 2014 01 27

(731) ISKRA INDUSTRY CO., LTD.

1-14-2, Nihonbashi, Chuo-ku, Tokyo, Japan

(540)

## TOYTI

(511)

5 – Mineral food supplements; nutritional supplements for medical purposes; dietetic food preparations adapted for medical purposes.

(260) AM 2015 76441 A

(800) 1195026

(891) 2013 11 18

(731) JT International S.A.

1, Rue de la Gabelle, CH-1211 Genève 26,  
Switzerland

(540)

## VAPELEAF

(511)

34 – Tobacco, whether manufactured or unmanufactured; smoking tobacco, pipe tobacco, hand rolling tobacco, chewing tobacco, snus tobacco; cigarettes, cigars, cigarillos; tobacco sold in pods; substances for smoking sold separately or blended with tobacco, none being for medicinal or curative purposes; snuff; smokers' articles included in this class; cigarette papers, cigarette tubes and matches; electronic cigarettes; electronic cigarette liquids; electronic smoking apparatus; cases for electronic cigarettes.

(260) AM 2015 76444 A

(800) 1195061

(891) 2013 09 24

(731) PRIVATE JOINT STOCK COMPANY

"INDUSTRIAL ASSOCIATION "KONTI"

Bul. Shevchenko, 6-b, Donetsk 83015,  
Ukraine

(540)

## Калейдоскоп

(511)

30 – Coffee, tea, cocoa and artificial coffee; rice; tapioca and sago; flour and preparations made from cereals; bread, pastry and confectionery; ices; sugar, honey, treacle; yeast, baking-powder; salt; mustard; vinegar, sauces (condiments); spices; ice; aniseed; peanut confectionery; high-protein cereal bars; baking soda (bicarbonate of soda for cooking purposes); soya bean paste (condiment); bean meal; star aniseed; tapioca flour for food; flour; flour-milling products; bread rolls; buns; sandwiches; vanillin (vanilla substitute); vanilla (flavoring); waffles; vermicelli (noodles); cream of tartar for culinary purposes; farinaceous foods; oatmeal; oat flakes; oat-based food; sea water for cooking; seaweed (condiment); binding agents for ice cream (edible ices); biscuits; cloves (spice); mustard meal; cake frosting (icing); glucose for culinary purposes; relish (condiment); gluten additives for culinary purposes; essences for foodstuffs, except etheric essences and essential oils; fruit jellies (confectionery); chewing gum; custard; leaven; rice-based snack food; cereal-based snack food; frozen yogurt (confectionery ices); frozen kefir (confectionery ices); flavorings, other than essential oils, for beverages; flavorings, other than essential oils, for cakes; flavorings, other than essential oils; wheat germ for human consumption; preparations for stiffening whipped cream; thickening agents for cooking foodstuffs; chips (cereal products); ginger (spice); unroasted coffee; coffee flavorings; coffee-based beverages; coffee beverages with milk; vegetal preparations for use as coffee substitutes; cocoa beverages with milk; cocoa-based beverages; cocoa-based ingredients for confectionery products, cocoa, cocoa mixes, cocoa powder, cocoa spreads; capers; caramels (candy); lozenges (confectionery); curry (spice); potato flour for food; ketchup (sauce); gluten prepared as foodstuff; sugar confectionery; tortillas; cinnamon (spice); starch for food; hominy grits; groats for human food; corn, milled; corn, roasted; corn flour; pop corn; corn flakes; turmeric for food; couscous (semolina); salt for preserving foodstuffs; confectionery for decorating Christmas trees; edible ices; ice for refreshment; ice, natural or artificial; liquorice (confectionery); noodles; candy; flaxseed for human consumption; mayonnaise; macaroni; maltose; hominy; chow-chow (condiment); marinades; marzipan; royal jelly; honey; molasses for food; macarons (pastry); almond paste; almond confectionery; pancakes; spring rolls; gruel, with a milk base, for food; ice-cream; dessert mousses (confectionery); chocolate mousses; nutmegs; muesli; meat gravies; meat tenderizers, for household purposes; mint for confectionery; peppermint sweets; infusions, not medicinal; husked oats; ravioli; pepper; pesto (sauce); beer vinegar; quiches; sweetmeats (candy); pizzas; pies; fondants (confectionery); powder for edible ices; pralines; condiments; dressings for salad; seasonings; unleavened bread; bee glue;

gingerbread; puddings; cake powder; fruit coulis (sauces); rice cakes; baking powder; ferments for pastes; sago; garden herbs, preserved (seasonings); celery salt; golden syrup; salt for preserving foodstuffs; soya flour; soya sauce; malt for human consumption; malt biscuits; malt extract for food; tomato sauce; spaghetti; noodle based prepared meals; ham glaze; rusks; breadcrumbs; petit-beurre biscuits; sushi; tabbouleh; tacos; tapioca; petits fours (cakes); crackers; cake paste; tarts; sorbets (ices); halvah; bread; chicory (coffee substitute); iced tea; tea-based beverages; chutneys (condiments); saffron (seasoning); chocolate; chocolate-based beverages; chocolate beverages with milk; barley meal; crushed barley.

(260) AM 2015 76445 A

(800) 1195062

(891) 2013 09 30

(731) PRIVATE JOINT STOCK COMPANY  
"INDUSTRIAL ASSOCIATION "KONTI"  
Bul. Shevchenko, 6-b, Donetsk 83015,  
Ukraine

(540)

## Джек

(511)

30 – Coffee, tea, cocoa, sugar, rice, tapioca, sago, artificial coffee; flour and preparations made from cereals, bread, pastry and confectionery, ices; honey, treacle; yeast, baking-powder; salt, mustard; vinegar, sauces (condiments); spices; edible ices; pastries; waffles; waffles with various fillings; cocoa-based ingredients for confectionery products, cocoa, cocoa mixes, cocoa powder, cocoa spreads; caramels; candies; confectionery for decorating Christmas trees; candy for food; cookies; cookies glazed with chocolate; chips (cereal products); fondants (confectionery); gingerbread; petits fours (cakes); crackers; halvah; sweetmeats (candy); sugar confectionery; chocolate.

(260) AM 2015 76446 A

(800) 1195063

(891) 2013 09 30

(731) PRIVATE JOINT STOCK COMPANY  
"INDUSTRIAL ASSOCIATION "KONTI"  
Bul. Shevchenko, 6-b, Donetsk 83015,  
Ukraine

(540)

## HOLLY-DOLLY

(511)

30 – Confectionery; pastries; waffles; waffle cakes; dragee (confectionery); fruit and berry jellies (confectionery); jelly candies; marshmallow; marshmallow covered with chocolate; caramels; cakes; crackers; confectionery for decorating Christmas trees;

almond confectionery; paste (confectionery); cookies; cookies glazed with chocolate; fondants (confectionery); gingerbread; gingerbread with various fillings; puddings; turkish delight; sweetmeats (candy); petits fours (cakes); cakes; halvah; candy/chocolate decorations for cakes; sugar confectionery; waffle candies; chocolate; chocolate desserts; chocolate cream; chocolate paste; chocolate cakes; chocolate candies; chocolate bars; chocolate figurines.

(260) AM 2015 76447 A  
 (800) 1195065  
 (891) 2013 12 20  
 (731) VERB PRODUCTS, INC.  
 11835 W. Olympic Boulevard #1235 Los Angeles CA 90064, USA  
 (540)

## VERB

(511)  
 3 – Hair care products, namely, hair cleaning preparations, and hair styling preparations; body and beauty care cosmetics; cosmetic preparations for body care; cosmetics and cosmetic preparations; hair care lotions; hair care preparations; hair cleaning preparations; hair shampoos and conditioners; hair sprays and hair gels; hair styling preparations; perfumes; soaps for personal use.

18 – Beach bags; cosmetic bags sold empty; cosmetic cases sold empty; leather and imitation leather; purses; toiletry bags sold empty; toiletry cases sold empty; travel cases; traveling bags; travelling trunks; umbrellas and parasols; wallets.

21 – Combs; containers for household or kitchen use; cosmetic brushes; hair brushes; toiletry sponges.

(260) AM 2015 76448 A  
 (800) 1195067  
 (891) 2014 01 06  
 (731) SATURDAYS SURF LLC  
 401 Broadway, 26th Floor, New York NY 10013, USA

(540)



(591) Black, white  
 (511)  
 9 – Sunglasses.

18 – Handbags, purses and wallets.

25 – Clothing, namely, t-shirts, collared shirts, sweaters, sweatshirts, hooded sweatshirts, jackets, shorts, pants, slacks, trousers, swimwear, gloves, scarves, socks, and shoes.

35 – Retail and on-line retail store services featuring clothing, clothing accessories, personal grooming products, coffee, and artwork.

(260) AM 2015 76450 A  
 (800) 1195117  
 (891) 2013 10 24  
 (731) TROPIC 2000 LTD  
 Studentski grad, bl.7A, ap.98, BG-1700 Sofia, Bulgaria  
 (540)



(591) Yellow, orange, white, black, green, red, blue, light orange, grey and light yellow

(511)  
 13 – Bengal lights; detonating fuses, for explosives; tear-gas weapons; pyrotechnic products; pyrophoric substances; signal rockets; fog signals, explosive; fireworks; air pistols [weapons].

(260) AM 2015 76451 A  
 (800) 1195141  
 (891) 2014 01 23  
 (731) COLGATE-PALMOLIVE COMPANY  
 300 Park Avenue, New York NY 10022, USA  
 (540)

## TRI-TIP

(511)  
 21 – Toothbrushes.

(260) AM 2015 76458 A  
 (800) 1195158  
 (891) 2013 11 29  
 (731) VIENNA INSURANCE GROUP AG Wiener Versicherung Gruppe  
 Schottenring 30, A-1010 Vienna, Austria  
 (540)



(591) Yellow, blue, red and black  
(511)  
36 – Insurance; financial affairs; monetary affairs;  
real estate affairs.

(260) AM 2015 76463 A  
(800) 1195184  
(891) 2014 01 09  
(731) BAYER INTELLECTUAL PROPERTY  
GMBH  
Alfred-Nobel-Straße 10, 40789 Monheim am  
Rhein, Germany

(540)

## ZERVOKO

(511)  
5 – Pharmaceutical preparations.

(260) AM 2015 76464 A  
(800) 1195189  
(891) 2013 10 01  
(731) ZENTIVA GROUP, A.S.  
U Kabelovny 130, CZ-102 37 Praha  
10 – Dolní Měcholupy, Czech Republic

(540)

## MICALCET

(511)  
5 – Medicines, pharmaceutical preparations for hu-  
man use.

(260) AM 2015 76465 A  
(800) 1195190  
(891) 2013 10 01  
(731) ZENTIVA GROUP, A.S.  
U Kabelovny 130, CZ-102 37 Praha  
10 – Dolní Měcholupy, Czech Republic

(540)

## PRIAMLO

(511)  
5 – Medicines, pharmaceutical preparations for hu-  
man use.

(260) AM 2015 76466 A  
(800) 1195191  
(891) 2013 10 01  
(731) ZENTIVA GROUP, A.S.  
U Kabelovny 130, CZ-102 37 Praha  
10 – Dolní Měcholupy, Czech Republic

(540)

## TRITAMLO

(511)  
5 – Medicines, pharmaceutical preparations for hu-  
man use.

(260) AM 2015 76478 A  
(800) 1195317  
(891) 2013 12 20  
(731) KRKA, tovarna zdravil, d.d., Novo mesto  
Šmarješka cesta 6, SI-8501 Novo mesto,  
Slovenia

(540)

## MOLOXIN

(511)  
5 – Pharmaceutical preparations.

(260) AM 2015 76479 A  
(800) 203631  
(891) 2014 01 17  
(731) HENNINGER-BRÄU AG  
armstädter Landstraße 185, 60598 Frankfurt  
am Main, Germany

(540)

## Henninger

(511)  
32 – Beer, beer wort, natural and artificial mineral  
waters, non-alcoholic beverages, lemonades, malt  
wort, fruit juices.

(260) AM 2015 76480 A  
(800) 248122  
(891) 2013 12 19  
(731) ASTELLAS PHARMA EUROPE B.V.  
Sylviusweg 62, NL-2333 BE Leiden,  
Netherlands

(540)

## PIMAFUCORT

(511)  
5 – Pharmaceutical preparations, antibiotics and  
steroids for pharmaceutical purposes.

(260) AM 2015 76481 A  
(800) 411562  
(891) 2013 12 30  
(731) LOEWE S.A.  
Calle Goya, 4, E-28001 MADRID, Spain

(540)

## LOEWE

(511)  
3 – Perfumery and cosmetic products.

(260) AM 2015 76482 A  
(800) 631439  
(891) 2013 12 19  
(731) ASTELLAS PHARMA EUROPE B.V.  
Sylviusweg 62 NL-2333 BE Leiden,  
Netherlands



(540)

**ПИМАФУКОРТ**

(511)

5 – Pharmaceutical preparations and substances for human use.

(260) AM 2015 76483 A

(800) 772490

(891) 2013 12 19

(731) YAMASA SHOYU KABUSHIKI KAISHA  
(also trading as YAMASA CORPORATION)  
10-1, Araoi-cho 2-chome, Choshi-shi, Chiba-  
ken 288-0056, Japan

(540)



(591) Black, white

(511)

30 – Soy sauce, Japanese-style barbecue sauce (teriyaki sauce), barbecue sauce, Japanese-style vinegar sauce (ponzu), salad dressings and other seasonings (except miso); spices.

(260) AM 2015 76484 A

(800) 797171

(891) 2013 12 24

(731) BUCURIA S.A.  
Str. Columna nr. 162, MD-2004 Chişinău,  
Republic of Moldova

(540)



(591) Black, white

(511)

29 – Jellies, jams, compotes.

30 – Coffee, pastry and confectionery, edible ice.

35 – Intermediation services in connection with commercialization of goods.

(260) AM 2015 76488 A

(800) 1167728

(891) 2014 01 14

(731) NADİR AY KUYUMCULUK VE  
HEDİYELİK EŞYA SANAYİ VE TİCARET  
LİMİTED ŞİRKETİ  
Topçular Kışla Caddesi, Koçhay İş Merkezi  
No:25/29-34, Eyüp – İstanbul, Turkey

(540)



(591) Dark blue

(526) The trademark is protected as a whole. The word "Z." included therein shall not be subject to independent legal protection.

(511)

14 – Precious metals and their alloys, namely, gold, silver, platinum; precious stones, jewelry made of precious metal or coated therewith, namely bracelets, rings, charms, necklaces, ear clips, cuff-links, earrings, ornamental pins, tie pins, pendants, rings being jewelry, medallions, brooches; ornaments of precious metal, trinkets, statues of precious metal, busts of precious metal; horological and chronometric instruments and parts and accessories thereof, namely, chronometers, wrist watches, pocket watches, jewelry watches, wall clocks, table clocks, watch bands, watch straps, watch bracelets, watch chains, cases for watches and clocks, parts for watches and clocks.

25 – Clothing, namely, trousers, jackets, overcoats, coats, skirts, suits, jerseys, waistcoats, shirts, ready-made leather linings (parts of clothing), T-shirts, sweatshirts, dresses, Bermuda shorts, shorts, pajamas, pullovers, jeans, tracksuits, rainwear, beachwear, bathing suits, swimming suits; clothing for sports (for exclusive use for sports), clothing for babies, namely, shirts, pants, coats, dresses; underclothing, namely, boxer shorts, brassieres, briefs, pants, socks; footwear, namely shoes excluding orthopedic shoes, sandals, waterproof boots, walking boots, booties, sporting shoes, slippers; shoe parts namely heelpieces, insoles for footwear, footwear uppers; headgear, namely caps, skull caps, sports caps, hats, berets; gloves (clothing), stockings, belts (clothing), camisoles, sarongs, scarves, neck scarves, shawls, collars, neckties, ties, suspender belts.

26 – Laces and embroidery, eyelets for clothing, braids and decorative cords for clothing, ornamental ribbons made of textiles, reinforcing tapes for dressmaking, namely, hook and loop fastening tape; embroidered emblems, shoulder pads for clothing; buttons for clothing, hooks and eyes, loops for clothing, zippers, shoe buckles, belt buckles not of precious metal for clothing, snap fasteners, rivet buttons, elastic tape, sewing pins, safety pins, sewing machine needles, knitting needles, needle cases not of precious metal, pin and needle cushions; artificial flowers, artificial flower arrangements, artificial garlands and wreaths, artificial fruit; hair nets, hair bands, hair buckles, non-electric hair curlers, hair

curl clips, wigs, hair pieces, false mustaches, false beards.

(260) AM 2015 76489 A

(800) 1178512

(891) 2013 12 02

(731) CHEN Zhen Wen

69, Huicaocaoweixi, Changlong Village,  
Junbu Town, Puning, 510000 Guangdong,  
China

(540)



(591) Black, white

(511)

9 – Radiotelephony sets; headphones; galvanic batteries; clothing for protection against accidents, irradiation and fire; computer memories; data processing equipment, namely mouse, computer keyboards, material for electricity mains, namely data wire; computer peripheral devices; telephone set sheath.

(260) AM 2015 77108 A

(800) 1200973

(891) 2013 11 01

(731) WORLD MEDICINE İLAÇ SANAYİ VE  
TİCARET LİMİTED ŞİRKETİ

Evren Mah. Camiyolu Cad. No:50 K:1 B,  
Zemin 4-5-6, Güneşli Bağcılar İstanbul,  
Turkey

(540)

**DESOCORT**

(591) Black, white

(511)

5 – Medicines for human purposes, medicines for veterinary purposes, vitamin preparations, chemical preparations for medical purposes, dietetic substances adapted for medical use; dietetic foods adapted for medical purposes; baby foods, medicinal herbs, herbal beverages adapted for medical purposes, nutritional supplements, pollen dietary supplements, mineral food supplements, protein dietary supplements; medicines for dental purposes, hygienic products for medical purposes including sanitary pads, breast-nursing pads and bunion pads, waddings for medical purposes, plasters for medical purposes, dressings for medical purposes, babies' napkins, preparations for destroying noxious plants, preparations for destroying noxious animals, fungicides, deodorants other than for human beings or for animals, air deodorising preparations, disinfectants for hygiene purposes, antiseptics, detergents for medical purposes.

(260) AM 2015 77110 A

(800) 1200987

(891) 2013 12 20

(731) WISEN INTERNATIONAL INDUSTRIES  
LTD

Suite 1112, 11/F, Ocean Centre, 5 Canton  
Road, Harbour City, Tsimshatsui, Kowloon,  
Hong Kong, China

(540)

**FLAME CLUB**

(511)

4 – Fuel gas; fuel; mineral fuel; fuel with an alcoholic base.

11 – Burners; gas lighters.

34 – Gas containers for cigar lighters; lighters for smokers; firestones; lighters.

35 – Import-export agencies; computerized file management; demonstration of goods; marketing studies; organization of exhibitions for commercial or advertising purposes; sales promotion for others; distribution of samples; publicity; compilation of information into computer databases; procurement services for others [purchasing goods and services for other businesses]; systemization of information into computer databases.

(260) AM 2015 77113 A

(800) 1200998

(891) 2014 02 11

(731) SHANDONG HENGYU SCIENCE &  
TECHNOLOGY CO., LTD.

Guangrao Economic Development Zone,  
Dongying City, Shandong Province, China

(540)



(591) Black, white

(511)

12 – Vehicles for locomotion by land, air, water or rail; cycle cars; hubs for automobile wheels; bicycles; bicycle pumps; cable cars; baby carriages; tires for vehicle wheels; automobile tires; repair outfits for inner tubes.

(260) AM 2015 77114 A

(800) 1201010

(891) 2014 01 14

(731) CALZATURIFICIO ELISABET S.R.L.  
Viale I Maggio, 35, I-63813 MONTE  
URANO (FM), Italy

(540)



(591) Black, white

(511)

18 – Leather and imitations of leather; trunks and travelling bags; umbrellas and parasols; walking sticks; rucksacks; all purpose sports bags; duffle bags; garment bags; beach bags; carrying cases for documents; change purses; wallets; coin purses; bags; handbags; shopping bags with wheels attached; textile shopping bags; handbags; leads for animals; school satchels; suitcases; sports bags; tote bags; shoulder bags; bum bags; cosmetic bags (empty).

25 – Clothing; sweaters; cardigans; waistcoats; dresses; trousers; shorts; jerseys; raincoats; leather clothing; stockings; stocking suspenders; sock suspenders; wind resistant jackets; ski pants; fur coats; coats; skirts; suits; jackets; undershirts; T-shirts; clothing for gymnastics; ladies' shirts; collars; shirts; foulards; swimming costumes; tracksuits; wedding dresses; underwear; brassieres; corsets; slips; underpants; briefs; nightshirts; housecoats; pyjamas; gloves; shawls; scarves; neckties; bow ties; belts (clothing); braces; hats; caps; shoes; boots; ankle boots; leather shoes; galoshes; rain boots; sports footwear; sandals; slippers; soles for footwear; heels; footwear uppers.

(260) AM 2015 77115 A

(800) 1201044

(891) 2014 02 04

(731) BAYER INTELLECTUAL PROPERTY GMBH

Alfred-Nobel-Straße 10, 40789 Monheim am Rhein, Germany

(540)



(591) Blue, light blue, red, green, yellow and white

(511)

5 – Pharmaceutical preparations.

(260) AM 2015 77117 A

(800) 1201077

(891) 2014 02 03

(731) ÖZEL DENT GRUP SAĞLIK HİZMETLERİ VE TİCARET LİMİTED ŞİRKETİ

Bağdat Caddesi, Cemilpaşa Apartmanı,  
No: 310, K:2, D:4, KAdıköy – İstanbul,  
Turkey

(540)



(591) Black, white

(526) The trademark is protected as a whole. The words "DIS HEKİMLİĞİ SANATI" included therein shall not be subject to independent legal protection.

(511)

44 – Medical services, namely, dentist services, dental hospitals.

(260) AM 2015 77118 A

(800) 1201082

(891) 2014 03 25

(731) CHENGDU AIMINER LEATHER PRODUCTS CO., LTD.

No:16, Wenchangzhonglu, Cuqiao, Wuhou District, Chengdu City, 610043 Sichuan Province, China

(540)

## she me

(511)

25 – Clothing, (namely shirts and pants), footwear, headgear for wear, layettes [clothing], gloves [clothing], mantillas, bathing suits, track shoes (with metal nails), belts [clothing], hosiery.

(260) AM 2015 77119 A

(800) 1201084

(891) 2014 03 10

(731) FUJIFILM Corporation

26-30, Nishiazabu 2-chome, Minato-ku,  
Tokyo 106-8620, Japan

(540)

## FUJINON

(591) Black, white

(511)

9 – Digital cameras; cameras; videocameras [camcorders]; lenses for television cameras; camera lenses; lenses for facsimile machines; projectors; lenses for projectors.

10 – Endoscopes for medical purposes.

(260) AM 2015 77120 A

(800) 1201113

(891) 2014 02 13

(731) HAITEC Aircraft Maintenance GmbH  
Maintenance Hangar 900, 55483 Hahn-Flughafen, Germany

(540)

## HAITEC

(511)

37 – Servicing, maintenance and repair of planes, aircrafts and flying machines.

(260) AM 2015 77122 A

(800) 1201137

(891) 2013 12 05

(731) BUREAU INTERNATIONAL DE  
MÉDECINS SANS FRONTIÈRES  
Rue de Lausanne 78, CP 116, CH-1211  
GENÈVE 21, Switzerland

(540)

## MEDECINS SANS FRONTIERES

(511)

44 – Health care, medical and surgical services; hospital services, medical clinics; medical and hygiene advice and pharmacy advice, especially on behalf of populations in developing countries; humanitarian medical assistance to communities experiencing hardship, including emergency aid in case of war, epidemics or natural disaster; lending of sanitary installations; development and implementation of programs of humanitarian medical and paramedical assistance; drug delivery services; dispensing of sanitary products in the context of humanitarian assistance.

(260) AM 2015 77123 A

(800) 1201155

(891) 2013 11 18

(731) TOP HORECA SRL

Str. Nicolae Caramfil nr. 63A, etaj 2, sector 1,  
014142 Bucuresti, Romania

(540)



(591) Orange (Pantone 1665C), blue (Pantone 5395C), blue (Pantone 296C) and grey (Pantone 432C)

(511)

9 – Cash registers, calculating machines, data processing equipment, computers; fire-extinguishing apparatus.

41 – Education; providing of training; entertainment; sporting and cultural activities.

42 – Scientific and technological services and research and design relating thereto; industrial analysis and research services; design and development of computer hardware and software.

(260) AM 2015 77124 A

(800) 1201157

(891) 2013 11 26

(731) REGATTA LTD.

Risol House, Mercury Way, Dimplington,  
Urmston, Manchester M41 7RR, United  
Kingdom

(540)



(591) Black, white

(511)

25 – Clothing, footwear, headgear; articles of clothing, footwear and headgear for use in sporting and outdoor pursuits; gloves [clothing]; mittens; scarves; gaiters, namely, neck gaiters, leg gaiters and ankle gaiters; socks; leggings [leg warmers]; leggings [trousers]; tights; underclothing; sweat-absorbent underclothing [underwear]; underwear; thermal underwear; vests; sleepwear; jackets [clothing]; jacket hoods; jerseys [clothing]; sports jerseys; jumpers; pullovers; body warmers; gilets; fleece pullovers, shorts, tops and vests; knitwear; shirts; short-sleeve shirts; sweaters; t-shirts; polo-shirts; tank-tops; leisurewear; tracksuits; skirts; trousers; pants; shorts; skorts; dresses; swimwear; outerwear, namely, shells, rain jackets, rain pants; waterproof clothing; waterproof jackets; overtrousers; coats; overcoats; raincoats; anoraks; parkas; ponchos; windcheaters; ski wear namely, ski suits, ski vests, ski jackets, ski bibs, bib overalls, bib pants, ski pants, ski hats, ski gloves; snowboard wear namely, snowboard jackets, snowboard trousers, snow suits; clothing for cyclists namely, cycle jerseys, cycle t-shirts, cycle jackets, cycle shorts, cycle bibs, cycle trousers, cycle leggings [trousers], waterproof clothing for cyclists, windproof clothing for cyclists, cycle gloves, cycle mitts; belts [clothing]; money belts (not of precious metal); leisure footwear; shoes; sandals; flip flops; athletic shoes; sneakers; trail shoes; boots; snow shoes and boots; ski and snowboard boots and shoes and parts thereof; cycle shoes; lace boots; galoshes; hiking shoes and boots; climbing shoes and boots; wellington boots (rain boots); inner soles; hats; caps [headwear]; headbands [clothing]; earbands; bandanas; ear muffs [clothing]; balaclavas; mufflers; beanies; knitted caps.

(260) AM 2015 77126 A

(800) 1201162

(891) 2014 03 20

(731) YEKALON INDUSTRY, INC.

3rd Floor, Jinxiu Building, Wenjin Mid Road,  
Luohu District, Shenzhen, Guangdong,  
China

(540)



(591) Black, white

(511)

35 – Business information; organization of trade fairs for commercial or advertising purposes; organi-

zation of exhibitions for commercial or advertising purposes; import-export agencies; procurement services for others [purchasing goods and services for other businesses]; sales promotion for others; advertising; relocation services for businesses; office machines and equipment rental; rental of vending machines.

(260) AM 2015 77130 A

(800) 1201180

(891) 2013 10 04

(731) ACCOR

110 Avenue de France, F-75013 PARIS,  
France

(540)



(591) Eggplant: Pantone 7664 and grayish beige  
Pantone 7536

(526) The trademark is protected as a whole. The word "HOTELS" included therein shall not be subject to independent legal protection.

(511)

43 – Hotels; motels; hotel services, services for providing food and drink; cafeteria, tea room and bar services (with the exception of clubs); temporary accommodation; tourist homes; hotel room reservation services for travelers; booking services for temporary accommodation; consulting and advice (unrelated to business operation) in connection with hotels and restaurants; rental of exhibition centers, of conference and meeting rooms; hotel and restaurant reservation services; on-line information services relating to hotel reservations.

(260) AM 2015 77131 A

(800) 1201185

(891) 2013 10 04

(731) DR. SERTUS İLAÇ SANAYİ VE TİCARET  
LİMİTED ŞİRKETİ

Evren Mahallesi Cami Yolu, Caddesi No:50  
K:2, Güneşli/Bağcılar, İstanbul, Turkey

(540)

**FORCE-OUT**  
**ΦΟΡC-AYT**

(591) Black, white

(511)

5 – Medicines for human purposes, medicines for veterinary purposes, vitamins, chemical preparations for medical purposes, dietetic substances adapted for medical use; dietetic foods adapted for medical purposes; amino acids for medical purposes, nutritional supplements, pollen dietary substances, mineral food

supplements, protein dietary supplements, baby foods, medicinal herbs, herbal beverages adapted for medical purposes; medicines for dental purposes, hygienic products for medical purposes including pads, waddings for medical purposes, plasters for medical purposes, dressings for medical purposes; preparations for destroying noxious plants, preparations for destroying noxious animals, fungicides; deodorants other than for human beings or for animals; air deodorising preparations; disinfectants for hygiene purposes, antiseptics, detergents for medical purposes.

(260) AM 2015 77132 A

(800) 1201186

(891) 2013 12 09

(731) PD PRODUCTS, LLC

21350 LASSEN STREET, CHATSWORTH  
CA 91311, USA

(540)

## **FETISH FANTASY SERIES**

(526) The trademark is protected as a whole. The words "FETISH" and "SERIES" included therein shall not be subject to independent legal protection.

(511)

6 – Handcuffs; metal legcuffs in the nature of handcuffs for restraining legs; metal clamps.

10 – Electric and non-electric massage apparatus and instruments, namely, instruments for massaging or vibrating portions of the face and body and pacifiers for massaging the lips; adult sexual aids for aiding in copulation and masturbation, namely, artificial penises and vaginas, penis pumps for penis enlargement, rings, non-metal clamps for applying pressure to the body, vaginal stimulators, vibrators, plugs for insertion into body cavities, sleeves on vibrators sold together with the massaging devices, harnesses for holding people used as a swing to obtain multiple positions during sexual intercourse, nipple clips, body prostheses in the nature of artificial penises, electrical apparatus for massaging the body for personal use, ticklers in the nature of feather tickler and feather streamers and paddles; adult sexual aid kits comprised of two or more of artificial penises, artificial vaginas, penis pumps for penis enlargement, rings, non-metal clamps for applying pressure to the body, vaginal stimulators, vibrators, plugs for insertion into body cavities, sleeves on vibrators sold together with the massaging devices, harnesses for holding people used as a swing to obtain multiple positions during sexual intercourse, nipple clips, body prostheses in the nature of artificial penises, electrical apparatus for massaging the body for personal use, ticklers in the nature of in the nature of feather ticklers and feather streamers and paddles; love dolls, namely, sex dolls; condoms and miniature condoms, adult sexual aids, namely, pacifiers

and gags for use by adults; adult sexual aids, namely, a harness for holding people used as a swing to obtain multiple positions during sexual intercourse.

20 – Chairs, stools, furniture.

(260) AM 2015 77133 A

(800) 1201208

(891) 2014 02 12

(731) FASHION ONE TELEVISION LLC

246 West Broadway, New York, NY 10013,  
USA

(540)

## Fashion One

(591) Black, white

(526) The trademark is protected as a whole. The word "FASHION" included therein shall not be subject to independent legal protection.

(511)

35 – Production of film and television advertising; Production of television commercials.

(260) AM 2015 77134 A

(800) 1201214

(891) 2014 01 27

(731) G.I.MEL. S.r.l.

S.P. 237 Per Noci, N.24, Z.I., I-70017  
Putignano, (BA), Italy

(540)



(591) Grey and red

(511)

25 – Clothing, clothing for children, namely, T-shirts, shirts, jumpers, trousers, skirts, jeans, jackets, rompers, bathing suits, hats and caps, footwear, children's footwear.

(260) AM 2015 77135 A

(800) 1201234

(891) 2014 01 21

(731) SOCIÉTÉ À RESPONSABILITÉ LIMITÉE  
"ALEX FITNESS"

Kondratyevsky prosp., 64, korp. 6, liter A,  
RU-195271 Sankt-Peterbourg, Russian  
Federation

(540)



(591) Blue, light blue, green, light green, yellow, orange, red, white and purple

(526) The trademark is protected as a whole. The word "FITNESS" included therein shall not be subject to independent legal protection.

(511)

25 – Clothing, footwear, headgear; underwear.

35 – Advertising; business management; business administration; organization of trade fairs, exhibitions for commercial or advertising purposes; demonstration of products; market study; shop window dressing; presentation of products on all communication media, for retail purposes; on-line advertising on a computer network; administrative processing of purchase orders; procurement services for others [purchasing goods and services for other businesses]; outsourcing services [business assistance]; collection and systematization of data in a central file; sales promotion for others, including sporting goods and related products for sport, furniture, machines for physical exercises, clothing, dietetic food preparations and products adapted for medical purposes, including for sportsmen and women, textile goods; public relations.

41 – Education; training; entertainment; sporting and cultural activities; booking of seats for shows and sports events; trainer services; training for coaches, physical fitness training; health clubs [health and fitness training] for children; health clubs [health and fitness training] for adults; organization of sports training; organization of training of coaches for combat sports, boxing and tennis; provision of swimming pool services, skating rinks; provision of machines for physical exercises; rental of machines for physical exercises; gymnastic instruction; educational and instruction services relating to dance; organization and conducting of training workshops; rental of stadium facilities; provision of stadium services; provision of sports facilities [except vehicles]; rental of sports equipment except vehicles; timing of sports events; physical education; organization of sports competitions; sports club services [health and fitness training]; nightclubs; club services [entertainment or education]; provision of educational courses relating to diets; cinematographic film projection; amusement arcade services; operating lotteries; organization of entertainment; organization of concerts; organization of theatrical performances, shows; organization of competitions [education or entertainment]; provision of information relating to physical exercises via an on-line web site; provision of information relating to physical education via an on-line web site; publication of books, periodicals; publication of electronic books and journals on-line; publication of texts other than advertising texts; provision of non-downloadable online electronic publications; organization of exhibitions for cultural or educational purposes; organization and conduc-

ting of seminars, congresses; photography; videotape film production; production of films other than advertising films; videotaping; recording studio services; rental of sound recordings and video recordings; rental of audio and video equipment; organization of award ceremonies; information relating to entertainment, recreation, education, culture and sports.

(260) AM 2015 77136 A

(800) 1201262

(891) 2014 03 12

(731) KIRNS CHEMICAL LTD

1802, Hualingxincheng Dibiao Mansion,  
208 East Laodong Road, Yuhua District,  
Changsha, 410007 Hunan, China

(540)



(591) Black, white

(511)

1 – Vitriol/copper sulphate [virio]; sulphates; industrial chemicals; agricultural chemicals, except fungicides, weedkillers, herbicides, insecticides and parasiticides; chemical substances for preserving foodstuffs; chemical reagents, other than for medical or veterinary purposes; chemical preparations for use in photography; plasticizers; fertilizers, manure for agriculture; fire extinguishing compositions; quenchant.

(260) AM 2015 77137 A

(800) 1201283

(891) 2014 03 25

(731) WIKIMEDIA FOUNDATION, INC.

149 New Montgomery Street, 3rd Floor,  
San Francisco CA 94105, USA

(540)



(511)

41 – Educational and entertainment services, namely, conferences, workshops, and hackathons for the promotion of free access to knowledge and educational content.

(260) AM 2015 77260 A

(800) 1202427

(891) 2014 03 12

(731) JOSÉ JOAQUÍN VELÁZQUEZ PÉREZ

Calle Requena, 2, 2do, izq. E-41010 Sevilla,  
Spain

(540)



We, the **entreprs** of the world

(591) Black, white

(511)

38 – Telecommunication services.

(260) AM 2015 77264 A

(800) 1202429

(891) 2013 08 28

(731) EGIS GYOGYSZERGYÁR Zrt.

Keresztúri út 30-38, H-1106 Budapest,  
Hungary

(540)



(591) Black, white

(511)

5 – Pharmaceutical and sanitary preparations; dietetic preparations adapted for medical purposes; vitamin preparations, mineral food supplements, dietetic food supplements, plasters, surgical dressings; material for stopping teeth and dental wax; disinfectants.

35 – Marketing relating to pharmaceutical and diagnostic products; medical advertising via communication to different target groups, business consultancy, provision of commercial information or advertising consultation in the field of pharmaceuticals, medicine or diagnostics; processing of computerized data; organization of exhibitions for commercial or advertising purposes; all kinds of advertising provided on-line by computer network, including the Internet; administrative services relating to registration of medicines and medicinal substances, marketing; sale of laboratory diagnostic service.

41 – Education, professional training relating to medicine, pharmaceuticals and diagnostics, arranging and conducting of conferences, congresses, seminars in the field of medicine and diagnostics, publishing of publications, books, handbooks and databases in the field of medicine, pharmaceuticals and diagnostics, providing information in the field of health care; arranging, conducting, making of exhibitions in the field of medicine and diagnostics for education or training purposes.

42 – Pharmaceutical, chemical and diagnostic research, research and development and clinical testing of medicines, provision of information and data relating to the research and development for medicines and medicinal substances, consultancy in the field of medicine, diagnostics or biotechnology, development of diagnostic kits, development and operation of laboratory diagnostic service.

44 – Medical and diagnostic services, diagnosing of various diseases, genetic diagnosis, determination of medicine responsiveness with genetic methods, recognizing, measuring and classifying oncologic and

chronic inflammatory diseases by IT or laboratory methods.

cognizing, measuring and classifying oncologic and chronic inflammatory diseases by IT or laboratory methods.

(260) AM 2015 77265 A

(800) 1202432

(891) 2013 08 28

(731) EGIS GYOGYSZERGYÁR Zrt.

Keresztúri út 30-38, H-1106 Budapest,  
Hungary

(540)



(591) Blue and dark blue

(511)

5 – Pharmaceutical and sanitary preparations; dietetic preparations adapted for medical purposes; vitamin preparations, mineral food supplements, dietetic food supplements, plasters, surgical dressings; material for stopping teeth and dental wax; disinfectants.

35 – Marketing relating to pharmaceutical and diagnostic products; medical advertising via communication to different target groups, business consultancy, provision of commercial information or advertising consultation in the field of pharmaceuticals, medicine or diagnostics; processing of computerized data; organization of exhibitions for commercial or advertising purposes; all kinds of advertising provided on-line by computer network, including the Internet; administrative services relating to registration of medicines and medicinal substances, marketing; sale of laboratory diagnostic service.

41 – Education, professional training relating to medicine, pharmaceuticals and diagnostics, arranging and conducting of conferences, congresses, seminars in the field of medicine and diagnostics, publishing of publications, books, handbooks and databases in the field of medicine, pharmaceuticals and diagnostics, providing information in the field of health care; arranging, conducting, making of exhibitions in the field of medicine and diagnostics for the education or training purposes.

42 – Pharmaceutical, chemical and diagnostic research, research and development and clinical testing of medicines, provision of information and data relating to the research and development for medicines and medicinal substances, consultancy in the field of medicine, diagnostics or biotechnology, development of diagnostic kits, development and operation of laboratory diagnostic services.

44 – Medical and diagnostic services, diagnosing of various diseases, genetic diagnosis, determination of medicine responsiveness with genetic methods, re-



**INTERNATIONAL TRADEMARKS PROTECTED IN GEORGIA**

(260) AM 2015 70827 A  
(800) 1145951  
(151) 2012 11 08  
(181) 2022 11 08  
(511) 09

---

(260) AM 2015 71404 A  
(800) 1073665  
(151) 2011 03 15  
(891) 2013 01 09  
(181) 2021 03 15  
(511) 05

---

(260) AM 2015 72283 A  
(800) 1025706  
(151) 2009 11 17  
(891) 2013 03 14  
(181) 2019 11 17  
(511) 30, 43

---

(260) AM 2015 72794 A  
(800) 933615  
(151) 2007 05 07  
(891) 2013 04 02  
(181) 2017 05 07  
(511) 30

---

(260) AM 2015 73045 A  
(800) 1164666  
(151) 2013 03 27  
(181) 2023 03 27  
(511) 11

---

(260) AM 2015 73071 A  
(800) 790476  
(151) 2002 10 29  
(891) 2013 02 25  
(181) 2022 10 29  
(511) 03

---

(260) AM 2015 73073 A  
(800) 1030086  
(151) 2009 12 01  
(891) 2013 05 30  
(181) 2019 12 01  
(511) 35, 39, 42

---

(260) AM 2015 73074 A  
(800) 1091363  
(151) 2011 06 10  
(891) 2013 04 08  
(181) 2021 06 10  
(511) 03, 05

---

(260) AM 2015 73075 A  
(800) 1102595  
(151) 2011 11 11  
(891) 2013 04 08  
(181) 2021 11 11  
(511) 05

---

(260) AM 2015 73076 A  
(800) 1106840  
(151) 2011 12 20  
(891) 2013 04 17  
(181) 2021 12 20  
(511) 09, 14, 18

---

(260) AM 2015 73079 A  
(800) 1137668  
(151) 2012 09 06  
(891) 2013 05 24  
(181) 2022 09 06  
(511) 03

---

(260) AM 2015 73080 A  
(800) 1140449  
(151) 2012 10 11  
(891) 2013 05 24  
(181) 2022 10 11  
(511) 03

---

(260) AM 2015 73191 A  
(800) 1165862  
(151) 2013 05 16  
(181) 2023 05 16  
(511) 03, 18, 25, 35

---

(260) AM 2015 73194 A  
(800) 1165905  
(151) 2013 06 07  
(181) 2023 06 07  
(511) 05, 42

---

(260) AM 2015 73195 A  
(800) 1165920  
(151) 2011 11 24  
(181) 2021 11 24  
(511) 12

---

(260) AM 2015 73199 A  
(800) 1165958  
(151) 2012 11 22  
(181) 2022 11 22  
(511) 24, 25, 35

---

(260) AM 2015 73200 A  
(800) 1165969  
(151) 2013 01 10  
(181) 2023 01 10  
(511) 25

---

(260) AM 2015 74202 A  
(800) 1175707  
(151) 2013 08 02  
(181) 2023 08 02  
(511) 35

---

(260) AM 2015 74223 A  
(800) 1175875  
(151) 2013 04 17  
(181) 2023 04 17  
(511) 05

---

(260) AM 2015 74224 A  
(800) 1175876  
(151) 2013 04 17  
(181) 2023 04 17  
(511) 05

---

(260) AM 2015 74225 A  
(800) 1175927  
(151) 2013 08 20  
(181) 2023 08 20  
(511) 01

---

(260) AM 2015 74226 A  
(800) 1175929  
(151) 2013 08 20  
(181) 2023 08 20  
(511) 09

---

(260) AM 2015 74228 A  
(800) 1175937  
(151) 2013 06 10

(181) 2023 06 10  
(511) 09, 36, 42

---

(260) AM 2015 74229 A  
(800) 1175961  
(151) 2013 03 01  
(181) 2023 03 01  
(511) 06, 19

---

(260) AM 2015 74230 A  
(800) 1175973  
(151) 2013 04 05  
(181) 2023 04 05  
(511) 18, 25, 35

---

(260) AM 2015 74231 A  
(800) 1175975  
(151) 2013 05 02  
(181) 2023 05 02  
(511) 03, 09, 14, 18, 25, 35

---

(260) AM 2015 74235 A  
(800) 1176006  
(151) 2013 05 28  
(181) 2023 05 28  
(511) 39, 41, 43

---

(260) AM 2015 74236 A  
(800) 1176015  
(151) 2013 06 12  
(181) 2023 06 12  
(511) 05, 16, 42, 44

---

(260) AM 2015 74237 A  
(800) 1176016  
(151) 2013 06 04  
(181) 2023 06 04  
(511) 38, 42, 45

---

(260) AM 2015 74238 A  
(800) 1176027  
(151) 2013 08 08  
(181) 2023 08 08  
(511) 30

---

(260) AM 2015 74239 A  
(800) 1176031  
(151) 2013 08 01  
(181) 2023 08 01  
(511) 07

---

(260) AM 2015 74240 A  
(800) 1176064  
(151) 2013 07 02  
(181) 2023 07 02  
(511) 05, 30, 32

---

(260) AM 2015 74241 A  
(800) 1176098  
(151) 2013 07 25  
(181) 2023 07 25  
(511) 05

---

(260) AM 2015 74251 A  
(800) 1176103  
(151) 2013 07 29  
(181) 2023 07 29  
(511) 06, 16, 21, 22, 24

---

(260) AM 2015 74252 A  
(800) 1176108  
(151) 2013 07 09  
(181) 2023 07 09  
(511) 05

---

(260) AM 2015 74253 A  
(800) 1176118  
(151) 2013 07 31  
(181) 2023 07 31  
(511) 05

---

(260) AM 2015 74254 A  
(800) 1176119  
(151) 2013 07 31  
(181) 2023 07 31  
(511) 05

---

(260) AM 2015 74255 A  
(800) 1176123  
(151) 2013 08 07  
(181) 2023 08 07  
(511) 05

---

(260) AM 2015 74258 A  
(800) 1176139  
(151) 2013 07 23  
(181) 2023 07 23  
(511) 03

---

(260) AM 2015 74259 A  
(800) 1176207  
(151) 2013 07 22

(181) 2023 07 22  
(511) 16

---

(260) AM 2015 74260 A  
(800) 1176211  
(151) 2013 07 11  
(181) 2023 07 11  
(511) 19

---

(260) AM 2015 74261 A  
(800) 1176219  
(151) 2013 08 06  
(181) 2023 08 06  
(511) 18

---

(260) AM 2015 74279 A  
(800) 1176271  
(151) 2012 11 15  
(181) 2022 11 15  
(511) 41, 45

---

(260) AM 2015 74460 A  
(800) 1178053  
(151) 2013 06 18  
(181) 2023 06 18  
(511) 25, 35

---

(260) AM 2015 74462 A  
(800) 1178074  
(151) 2013 07 17  
(181) 2023 07 17  
(511) 07, 09, 12, 35, 44

---

(260) AM 2015 74463 A  
(800) 1178077  
(151) 2013 08 08  
(181) 2023 08 08  
(511) 14

---

(260) AM 2015 74464 A  
(800) 1178085  
(151) 2013 08 14  
(181) 2023 08 14  
(511) 10

---

(260) AM 2015 74465 A  
(800) 1178116  
(151) 2013 08 29  
(181) 2023 08 29  
(511) 18, 25

---

(260) AM 2015 74466 A  
(800) 1178127  
(151) 2013 08 26  
(181) 2023 08 26  
(511) 03

---

(260) AM 2015 74467 A  
(800) 1178152  
(151) 2013 08 23  
(181) 2023 08 23  
(511) 30

---

(260) AM 2015 74468 A  
(800) 1178174  
(151) 2013 07 26  
(181) 2023 07 26  
(511) 05

---

(260) AM 2015 74469 A  
(800) 1178190  
(151) 2013 07 02  
(181) 2023 07 02  
(511) 29, 35

---

(260) AM 2015 74470 A  
(800) 1178215  
(151) 2013 06 04  
(181) 2023 06 04  
(511) 12

---

(260) AM 2015 74471 A  
(800) 1178233  
(151) 2013 01 19  
(181) 2023 01 19  
(511) 09, 35, 41, 42

---

(260) AM 2015 74472 A  
(800) 1178240  
(151) 2013 04 10  
(181) 2023 04 10  
(511) 16, 34, 35

---

(260) AM 2015 74473 A  
(800) 1178255  
(151) 2013 06 04  
(181) 2023 06 04  
(511) 12

---

(260) AM 2015 74474 A  
(800) 1178256  
(151) 2013 06 04

(181) 2023 06 04  
(511) 12

---

(260) AM 2015 74475 A  
(800) 1178259  
(151) 2013 06 04  
(181) 2023 06 04  
(511) 12

---

(260) AM 2015 74476 A  
(800) 1178260  
(151) 2013 06 04  
(181) 2023 06 04  
(511) 12

---

(260) AM 2015 74477 A  
(800) 1178268  
(151) 2013 07 05  
(181) 2023 07 05  
(511) 05

---

(260) AM 2015 74478 A  
(800) 1178369  
(151) 2013 08 26  
(181) 2023 08 26  
(511) 05

---

(260) AM 2015 74479 A  
(800) 1178406  
(151) 2013 09 20  
(181) 2023 09 20  
(511) 34

---

(260) AM 2015 74480 A  
(800) 1178408  
(151) 2013 08 07  
(181) 2023 08 07  
(511) 03

---

(260) AM 2015 74581 A  
(800) 1179128  
(151) 2013 07 29  
(181) 2023 07 29  
(511) 05

---

(260) AM 2015 74582 A  
(800) 1179176  
(151) 2013 09 13  
(181) 2023 09 13  
(511) 18

---

(260) AM 2015 74583 A  
(800) 1179211  
(151) 2013 09 16  
(181) 2023 09 16  
(511) 03, 05

---

(260) AM 2015 74584 A  
(800) 1179224  
(151) 2013 08 08  
(181) 2023 08 08  
(511) 29, 30

---

(260) AM 2015 74585 A  
(800) 1179225  
(151) 2013 08 08  
(181) 2023 08 08  
(511) 29, 30

---

(260) AM 2015 74586 A  
(800) 1179238  
(151) 2013 08 16  
(181) 2023 08 16  
(511) 34

---

(260) AM 2015 74587 A  
(800) 1179250  
(151) 2013 03 01  
(181) 2023 03 01  
(511) 01, 02, 03, 05, 09, 12, 17, 19, 22, 23, 30, 31,  
37, 39, 40, 42

---

(260) AM 2015 74588 A  
(800) 1179256  
(151) 2013 09 13  
(181) 2023 09 13  
(511) 05

---

(260) AM 2015 74590 A  
(800) 1179506  
(151) 2013 04 30  
(181) 2023 04 30  
(511) 05

---

(260) AM 2015 74603 A  
(800) 1179544  
(151) 2013 07 29  
(181) 2023 07 29  
(511) 05

---

(260) AM 2015 74605 A  
(800) 1179560  
(151) 2013 08 08

(181) 2023 08 08  
(511) 03, 14, 18, 25

---

(260) AM 2015 74606 A  
(800) 1179564  
(151) 2013 08 21  
(181) 2023 08 21  
(511) 06, 09

---

(260) AM 2015 74607 A  
(800) 1179606  
(151) 2013 08 13  
(181) 2023 08 13  
(511) 05, 35, 44

---

(260) AM 2015 74608 A  
(800) 1179618  
(151) 2013 09 10  
(181) 2023 09 10  
(511) 05

---

(260) AM 2015 74609 A  
(800) 1179648  
(151) 2013 09 23  
(181) 2023 09 23  
(511) 04, 06, 09

---

(260) AM 2015 74610 A  
(800) 1179653  
(151) 2013 09 26  
(181) 2023 09 26  
(511) 10

---

(260) AM 2015 74611 A  
(800) 431445  
(151) 1977 06 29  
(891) 2013 07 30  
(181) 2017 06 29  
(511) 05

---

(260) AM 2015 74612 A  
(800) 452281  
(151) 1980 03 28  
(891) 2013 07 30  
(181) 2020 03 28  
(511) 05

---

(260) AM 2015 74662 A  
(800) 1180204  
(151) 2013 08 23  
(181) 2023 08 23  
(511) 05

---

(260) AM 2015 74663 A  
(800) 1180205  
(151) 2013 08 23  
(181) 2023 08 23  
(511) 05

---

(260) AM 2015 74664 A  
(800) 1180206  
(151) 2013 08 23  
(181) 2023 08 23  
(511) 05

---

(260) AM 2015 74665 A  
(800) 1180207  
(151) 2013 08 23  
(181) 2023 08 23  
(511) 05

---

(260) AM 2015 74666 A  
(800) 1180215  
(151) 2013 08 16  
(181) 2023 08 16  
(511) 14

---

(260) AM 2015 74667 A  
(800) 1180220  
(151) 2013 09 09  
(181) 2023 09 09  
(511) 13

---

(260) AM 2015 74668 A  
(800) 1180223  
(151) 2013 08 28  
(181) 2023 08 28  
(511) 05

---

(260) AM 2015 74669 A  
(800) 1180224  
(151) 2013 08 28  
(181) 2023 08 28  
(511) 05

---

(260) AM 2015 74671 A  
(800) 1180234  
(151) 2013 03 18  
(181) 2023 03 18  
(511) 09, 16, 25, 35, 36, 38, 41, 45

---

(260) AM 2015 74686 A  
(800) 1180273  
(151) 2013 04 09

---

(181) 2023 04 09  
(511) 06, 09, 19, 35, 37, 42

---

(260) AM 2015 74687 A  
(800) 1180302  
(151) 2013 05 27  
(181) 2023 05 27  
(511) 07, 09, 12, 16

---

(260) AM 2015 74794 A  
(800) 1180894  
(151) 2013 08 26  
(181) 2023 08 26  
(511) 28

---

(260) AM 2015 74795 A  
(800) 1180917  
(151) 2013 08 09  
(891)  
(181) 2023 08 09  
(511) 01

---

(260) AM 2015 74796 A  
(800) 1180922  
(151) 2013 09 18  
(181) 2023 09 18  
(511) 05

---

(260) AM 2015 74797 A  
(800) 1180923  
(151) 2013 09 18  
(181) 2023 09 18  
(511) 05

---

(260) AM 2015 74798 A  
(800) 1180934  
(151) 2013 08 21  
(181) 2023 08 21  
(511) 01

---

(260) AM 2015 74803 A  
(800) 1180975  
(151) 2013 02 12  
(181) 2023 02 12  
(511) 41, 42

---

(260) AM 2015 74812 A  
(800) 1181087  
(151) 2013 09 26  
(181) 2023 09 26  
(511) 39

---

(260) AM 2015 74813 A  
(800) 1181110  
(151) 2013 08 02  
(181) 2023 08 02  
(511) 33

---

(260) AM 2015 74817 A  
(800) 1181122  
(151) 2013 09 06  
(181) 2023 09 06  
(511) 33

---

(260) AM 2015 74818 A  
(800) 1181147  
(151) 2013 09 03  
(181) 2023 09 03  
(511) 05

---

(260) AM 2015 74819 A  
(800) 1181148  
(151) 2013 09 30  
(181) 2023 09 30  
(511) 05

---

---

# OFFICIAL NOTIFICATIONS

## TRADEMARKS

### RENEWAL OF REGISTRATIONS

(111) M 2003 15337 R1

(156) 2014 10 11

(186) 2023 12 01

(732) JSC "TBILISIS TAMBAKO"

G. Nadareishvilis q. 5, 0137, Tbilisi, Georgia

---

(111) M 2004 15538 R1

(156) 2014 11 21

(186) 2024 05 31

(732) TAMAZ SHILAKADZE

Bakhtrionis q. 6, b. 24, 0160, Tbilisi,  
Georgia

---



## COMPLETE TRANSFER OF RIGHTS

(111) M 2000 013075 R1  
(732) BRF BRASIL FOODS PTE LIMITED  
8, Marina Boulevard, N 05-02, Marina Bay  
Financial Centre, 018981, Singapore,  
Singapore  
(770) SADIA S/A  
Rua Senador Attilio Fontana 86, Concordia-  
Santa-Catarina, Brazil  
(580) 2014 12 23

---

(111) M 2004 015808 R1  
(732) BRF BRASIL FOODS PTE LIMITED  
8, Marina Boulevard, N 05-02, Marina Bay  
Financial Centre, 018981, Singapore,  
Singapore  
(770) SADIA S.A.  
Rua Senador Attilio Fontana 86, Concordia-  
Santa-Catarina, Brazil  
(580) 2014 12 23

---

(111) M 2000 013076 R1  
(732) BRF BRASIL FOODS PTE LIMITED  
8, Marina Boulevard, N 05-02, Marina Bay  
Financial Centre, 018981, Singapore,  
Singapore  
(770) SADIA S/A  
Rua Senador Attilio Fontana 86, Concordia-  
Santa-Catarina, Brazil  
(580) 2014 12 23

---

(111) M 2000 013077 R1  
(732) BRF BRASIL FOODS PTE LIMITED  
8, Marina Boulevard, N 05-02, Marina Bay  
Financial Centre, 018981, Singapore,  
Singapore  
(770) SADIA S/A  
Rua Senador Attilio Fontana 86, Concordia-  
Santa Catarina, Brazil  
(580) 2014 12 23

---

(111) M 2003 015074 R1  
(732) BRF BRASIL FOODS PTE LIMITED  
8, Marina Boulevard, N 05-02, Marina Bay  
Financial Centre, 018981, Singapore,  
Singapore  
(770) SADIA S.A.  
Rua Senador Attilio Fontana 86, Concordia-  
Santa-Catarina, Brazil  
(580) 2014 12 23

---

(111) M 2004 015558 R1  
(732) BRF BRASIL FOODS PTE LIMITED  
8, Marina Boulevard, N 05-02, Marina Bay  
Financial Centre, 018981, Singapore,  
Singapore  
(770) SADIA S.A.  
Rua Senador Attilio Fontana 86, Concordia-  
Santa-Catarina, Brazil  
(580) 2014 12 23

---

## CHANGES IN NAMES AND/OR ADDRESSES OF OWNERS

(111) M 2000 013075 R1  
(732) BRF SINGAPORE FOODS PTE. LTD.  
8, Marina Boulevard, N 05-02, Marina Bay  
Financial Centre, 018981, Singapore,  
Singapore  
(770) BRF BRASIL FOODS PTE LIMITED  
8, Marina Boulevard, N05-02, Marina Bay  
Financial Centre, 018981, Singapore,  
Singapore  
(580) 2014 12 23

---

(111) M 2000 013076 R1  
(732) BRF SINGAPORE FOODS PTE. LTD.  
8, Marina Boulevard, N 05-02, Marina Bay  
Financial Centre, 018981, Singapore,  
Singapore  
(770) BRF BRASIL FOODS PTE LIMITED  
8, Marina Boulevard, N05-02, Marina Bay  
Financial Centre, 018981, Singapore,  
Singapore  
(580) 2014 12 23

---

(111) M 2000 013077 R1  
(732) BRF SINGAPORE FOODS PTE. LTD.  
8, Marina Boulevard, N 05-02, Marina Bay  
Financial Centre, 018981, Singapore,  
Singapore  
(770) BRF BRASIL FOODS PTE LIMITED  
8, Marina Boulevard, N05-02, Marina Bay  
Financial Centre, 018981, Singapore,  
Singapore  
(580) 2014 12 23

---

(111) M 2003 015074 R1  
(732) BRF SINGAPORE FOODS PTE. LTD.  
8, Marina Boulevard, N 05-02, Marina Bay  
Financial Centre, 018981, Singapore,  
Singapore  
(770) BRF BRASIL FOODS PTE LIMITED  
8, Marina Boulevard, N05-02, Marina Bay  
Financial Centre, 018981, Singapore,  
Singapore  
(580) 2014 12 23

---

(111) M 2004 015558 R1  
(732) BRF SINGAPORE FOODS PTE. LTD.  
8, Marina Boulevard, N 05-02, Marina Bay  
Financial Centre, 018981, Singapore,  
Singapore

(770) BRF BRASIL FOODS PTE LIMITED  
8, Marina Boulevard, N05-02, Marina Bay  
Financial Centre, 018981, Singapore,  
Singapore  
(580) 2014 12 23

---

(111) M 2004 015808 R1  
(732) BRF SINGAPORE FOODS PTE. LTD.  
8, Marina Boulevard, N 05-02, Marina Bay  
Financial Centre, 018981, Singapore,  
Singapore  
(770) BRF BRASIL FOODS PTE LIMITED  
8, Marina Boulevard, N05-02, Marina Bay  
Financial Centre, 018981, Singapore,  
Singapore  
(580) 2014 12 23

---

(111) M 2012 022761 R  
(732) JSC "SMARTEKSI"  
I. Chavchavadzis gamz. 74, 0162, Tbilisi,  
Georgia  
(770) LTD "SMARTEKSI"  
Ilia Chavchavadzis gamz. 74, 0162, Tbilisi,  
Georgia  
(580) 2014 12 22

---

## CORRECTION OF PUBLISHED INFORMATIONS

BULLETIN №	NUMBER OF PUBLISHED APPLICATION (10) (260)	Pg.	column	PUBLISHED	MUST BE
N19(407) 2014	AP 2014 12913 A	5	I	(72) SORS, Aurore (FR); TROCME-THIBIERGE, Caryn (FR)	(72) SORS, Aurore (FR); TROCME-THIBIERGE, Caryn (FR) MERDES, Annette (DE)
N24(412) 2014	AM 2014 75218 A	66	I	(731) HARRINGTON DEVE- LOPMENT INC. Elivira Mendez Street, Valerino Bldg, 3rd Floor, Panama, Panama	(731) HARRINGTON DEVE- LOPMENT INC. Elivira Mendez Street, Valarino Bldg, 3rd Floor, Panama, Panama

---

# CLASSIFICATION INDEXES

## INVENTIONS

### CONCORDANCE TABLE OF INTERNATIONAL CLASSIFICATION INDEX AND PUBLICATION NUMBERS

INTERNATIONAL CLASSIFICATION INDEXES (51)	NUMBER OF PUBLISHED APPLICATION (10)
A 61 M 15/00	AP 2015 12434 A
B 03 C 3/014; B 03 C 3/16; B 01 D 47/06; B 01 D 50/00	AP 2015 13190 A
H 02 K 19/00; G 01 M 1/38	AP 2015 13268 A

### CONCORDANCE TABLE OF PUBLICATION NUMBERS AND INTERNATIONAL CLASSIFICATION INDEX

NUMBER OF PUBLISHED APPLICATION (10)	INTERNATIONAL CLASSIFICATION INDEXES (51)
AP 2015 12434 A	A 61 M 15/00
AP 2015 13190 A	B 03 C 3/014; B 03 C 3/16; B 01 D 47/06; B 01 D 50/00
AP 2015 13268 A	H 02 K 19/00; G 01 M 1/38

### CONCORDANCE TABLE OF INTERNATIONAL CLASSIFICATION INDEX, PATENT NUMBERS AND PUBLICATION NUMBERS

INTERNATIONAL CLASSIFICATION INDEX (51)	NUMBER OF PATENT (11)	NUMBER OF PUBLISHED APPLICATION (10)
A 01 N 29/04; A 61 K 31/025	P 2015 6219 B	AP 2014 13166 A
A 61 K 38/00; A 61 K 9/50; A 61 K 9/16; A 61 K 9/20; A 61 K 9/48	P 2015 6209 B	AP 2014 12142 A
B 01 D 53/14; B 01 D 53/58; C 01 C 1/10; C 01 C 1/12; B 01 D 61/36	P 2015 6210 B	AP 2014 12328 A
C 07 D 231/12; C 07 D 231/20; C 07 D 231/38; C 07 D 401/04; C 07 D 401/12; C 07 D 401/14; C 07 D 403/12; C 07 D 407/12; C 07 D 409/04; C 07 D 417/12; A 61 K 31/4155	P 2015 6211 B	AP 2014 12393 A
C 07 D 307/20; C 07 D 307/28; C 07 D 307/30; C 07 D 307/32; C 07 D 307/58; C 07 D 405/04; C 07 D 405/10; C 07 D 407/12; C 07 D 409/12; C 07 D 409/14; C 07 D 413/12; A 01 N 43/08	P 2015 6215 B	AP 2014 12861 A
C 07 D 471/04; A 61 K 31/519; A 61 P 3/10; A 61 P 3/04	P 2015 6218 B	AP 2014 13077 A
C 07 D 487/04; A 61 K 31/519; A 61 P 25/28	P 2015 6217 B	AP 2014 13025 A
C 07 D 513/04; A 61 K 31/542; A 61 P 25/00	P 2015 6216 B	AP 2014 13021 A
C 12 G 3/00	P 2015 6213 B	AP 2014 12666 A
C 12 P 21/08; A 61 K 35/14; G 01 N 33/35	P 2015 6214 B	AP 2014 12676 A
E 02 F 7/06; B 03 B 9/00	P 2015 6212 B	AP 2014 12415 A

**CONCORDANCE TABLE OF PATENT NUMBERS,  
PUBLICATION NUMBERS AND INTERNATIONAL CLASSIFICATION INDEX**

NUMBER OF PATENT (11)	NUMBER OF PUBLISHED APPLICATION (10)	INTERNATIONAL CLASSIFICATION INDEX (51)
P 2015 6209 B	AP 2014 12142 A	A 61 K 38/00; A 61 K 9/50; A 61 K 9/16; A 61 K 9/20; A 61 K 9/48
P 2015 6210 B	AP 2014 12328 A	B 01 D 53/14; B 01 D 53/58; C 01 C 1/10; C 01 C 1/12; B 01 D 61/36
P 2015 6211 B	AP 2014 12393 A	C 07 D 231/12; C 07 D 231/20; C 07 D 231/38; C 07 D 401/04; C 07 D 401/12; C 07 D 401/14; C 07 D 403/12; C 07 D 407/12; C 07 D 409/04; C 07 D 417/12; A 61 K 31/4155
P 2015 6212 B	AP 2014 12415 A	E 02 F 7/06; B 03 B 9/00
P 2015 6213 B	AP 2014 12666 A	C 12 G 3/00
P 2015 6214 B	AP 2014 12676 A	C 12 P 21/08; A 61 K 35/14; G 01 N 33/35
P 2015 6215 B	AP 2014 12861 A	C 07 D 307/20; C 07 D 307/28; C 07 D 307/30; C 07 D 307/32; C 07 D 307/58; C 07 D 405/04; C 07 D 405/10; C 07 D 407/12; C 07 D 409/12; C 07 D 409/14; C 07 D 413/12; A 01 N 43/08
P 2015 6216 B	AP 2014 13021 A	C 07 D 513/04; A 61 K 31/542; A 61 P 25/00
P 2015 6217 B	AP 2014 13025 A	C 07 D 487/04; A 61 K 31/519; A 61 P 25/28
P 2015 6218 B	AP 2014 13077 A	C 07 D 471/04; A 61 K 31/519; A 61 P 3/10; A 61 P 3/04
P 2015 6219 B	AP 2014 13166 A	A 01 N 29/04; A 61 K 31/025

**CONCORDANCE TABLE OF APPLICATION NUMBERS, PUBLICATION NUMBERS  
AND PATENTS**

NUMBER OF APPLICATION (21)	NUMBER OF PUBLISHED APPLICATION (10)	NUMBER OF PATENT (11)
AP 2009 012142	AP 2014 12142 A	P 2015 6209 B
AP 2010 012328	AP 2014 12328 A	P 2015 6210 B
AP 2010 012393	AP 2014 12393 A	P 2015 6211 B
AP 2010 012415	AP 2014 12415 A	P 2015 6212 B
AP 2012 012666	AP 2014 12666 A	P 2015 6213 B
AP 2010 012676	AP 2014 12676 A	P 2015 6214 B
AP 2011 012861	AP 2014 12861 A	P 2015 6215 B
AP 2011 013021	AP 2014 13021 A	P 2015 6216 B
AP 2011 013025	AP 2014 13025 A	P 2015 6217 B
AP 2011 013077	AP 2014 13077 A	P 2015 6218 B
AP 2011 013166	AP 2014 13166 A	P 2015 6219 B

## UTILITY MODELS

### CONCORDANCE TABLE OF INTERNATIONAL CLASSIFICATION INDEX AND PUBLICATION NUMBERS

INTERNATIONAL CLASSIFICATION INDEXES (51)	NUMBER OF PUBLISHED APPLICATION (10)
A 47 C 23/04	AU 2015 13182 U

### CONCORDANCE TABLE OF PUBLICATION NUMBERS AND INTERNATIONAL CLASSIFICATION INDEX

NUMBER OF PUBLISHED APPLICATION (10)	INTERNATIONAL CLASSIFICATION INDEXES (51)
AU 2015 13182 U	A 47 C 23/04

### CONCORDANCE TABLE OF INTERNATIONAL CLASSIFICATION INDEX, PATENT NUMBERS AND PUBLICATION NUMBERS

INTERNATIONAL CLASSIFICATION INDEX (51)	NUMBER OF PATENT (11)	NUMBER OF PUBLISHED APPLICATION (10)
B 65 D 5/30	U 2015 1841 Y	AU 2014 13430 U

### CONCORDANCE TABLE OF PATENT NUMBERS, PUBLICATION NUMBERS AND INTERNATIONAL CLASSIFICATION INDEX

NUMBER OF PATENT (11)	NUMBER OF PUBLISHED APPLICATION (10)	INTERNATIONAL CLASSIFICATION INDEX (51)
U 2015 1841 Y	AU 2014 13430 U	B 65 D 5/30

### CONCORDANCE TABLE OF APPLICATION NUMBERS, PUBLICATION NUMBERS AND PATENTS

NUMBER OF APPLICATION (21)	NUMBER OF PUBLISHED APPLICATION (10)	NUMBER OF PATENT (11)
AU 2014 013430	AU 2014 13430 U	U 2015 1841 Y

## TRADEMARKS

### CONCORDANCE TABLE OF REGISTRATION NUMBERS, APPLICATION NUMBERS, PUBLICATION NUMBERS AND BULLETIN NUMBERS

NUMBER OF REGISTRATION (111)	NUMBER OF APPLICATION (210)	NUMBER OF PUBLISHED APPLICATION (260)	NUMBER OF BULLETIN
1	2	3	4
M 2015 25511 R	AM 2013 72750	AM 2014 72750 A	9(397) 2014
M 2015 25512 R	AM 2013 71148	AM 2014 71148 A	13(401) 2014
M 2015 25513 R	AM 2013 71149	AM 2014 71149 A	13(401) 2014
M 2015 25514 R	AM 2013 72077	AM 2014 72077 A	14(402) 2014
M 2015 25515 R	AM 2013 73119	AM 2014 73119 A	14(402) 2014
M 2015 25516 R	AM 2013 73121	AM 2014 73121 A	14(402) 2014
M 2015 25517 R	AM 2013 73122	AM 2014 73122 A	10(398) 2014
M 2015 25518 R	AM 2013 73123	AM 2014 73123 A	12(400) 2014
M 2015 25519 R	AM 2013 73277	AM 2014 73277 A	16(404) 2014
M 2015 25520 R	AM 2013 73377	AM 2014 73377 A	15(403) 2014
M 2015 25521 R	AM 2013 73634	AM 2014 73634 A	12(400) 2014
M 2015 25522 R	AM 2013 73925	AM 2014 73925 A	15(403) 2014
M 2015 25523 R	AM 2013 73926	AM 2014 73926 A	15(403) 2014
M 2015 25524 R	AM 2013 73944	AM 2014 73944 A	15(403) 2014
M 2015 25525 R	AM 2013 74327	AM 2014 74327 A	15(403) 2014
M 2015 25526 R	AM 2013 73120	AM 2014 73120 A	14(402) 2014
M 2015 25527 R	AM 2013 74570	AM 2014 74570 A	15(403) 2014
M 2015 25528 R	AM 2013 74571	AM 2014 74571 A	15(403) 2014
M 2015 25533 R	AM 2014 79791	-	1(413) 2015
M 2015 25534 R	AM 2014 79795	-	1(413) 2015
M 2015 25535 R	AM 2014 79941	-	1(413) 2015
M 2015 25536 R	AM 2014 79942	-	1(413) 2015
M 2015 25537 R	AM 2014 79792	-	1(413) 2015
M 2015 25538 R	AM 2014 79794	-	1(413) 2015
M 2015 25539 R	AM 2014 79968	-	1(413) 2015
M 2015 25540 R	AM 2014 79969	-	1(413) 2015
M 2015 25541 R	AM 2014 79840	-	1(413) 2015
M 2015 25542 R	AM 2014 79843	-	1(413) 2015
M 2015 25543 R	AM 2014 79793	-	1(413) 2015
M 2015 25544 R	AM 2014 79807	-	1(413) 2015
M 2015 25545 R	AM 2014 79790	-	1(413) 2015

**CONCORDANCE TABLE OF PUBLICATION NUMBERS  
AND APPLICATION NUMBERS**

NUMBER OF PUBLISHED APPLICATION (260)	NUMBER OF APPLICATION (210)	1	2
1	2		
AM 2015 72315 A	AM 2013 72315	AM 2015 75835 A	AM 2014 75835
AM 2015 74373 A*	AM 2013 74373	AM 2015 75895 A	AM 2014 75895
AM 2015 74374 A*	AM 2013 74374	AM 2015 75919 A	AM 2014 75919
AM 2015 74400 A*	AM 2013 74400	AM 2015 75925 A	AM 2014 75925
AM 2015 74899 A	AM 2013 74899	AM 2015 75991 A	AM 2014 75991
AM 2015 75243 A	AM 2013 75243	AM 2015 76071 A	AM 2014 76071
AM 2015 75768 A	AM 2014 75768	AM 2015 76182 A	AM 2014 76182
AM 2015 75785 A	AM 2014 75785	AM 2015 76428 A	AM 2014 76428
AM 2015 75786 A	AM 2014 75786	AM 2015 76429 A	AM 2014 76429
AM 2015 75787 A	AM 2014 75787	AM 2015 76730 A	AM 2014 76730
AM 2015 75788 A	AM 2014 75788	AM 2015 76765 A	AM 2014 76765
AM 2015 75790 A	AM 2014 75790	AM 2015 76796 A	AM 2014 76796
AM 2015 75791 A	AM 2014 75791	AM 2015 76797 A	AM 2014 76797
AM 2015 75792 A	AM 2014 75792	AM 2015 76798 A	AM 2014 76798
		AM 2015 76829 A	AM 2014 76829
		AM 2015 76953 A	AM 2014 76953
		AM 2015 77058 A	AM 2014 77058
		AM 2015 77060 A	AM 2014 77060

**CONCORDANCE TABLE OF INDEX OF GOODS AND/OR SERVICES  
AND APPLICATION NUMBERS**

INDEX OF GOODS AND/OR SERVICES (511)	NUMBER OF PUBLISHED APPLICATION (260)	1	2
1	2		
3	AM 2015 75895 A	16	AM 2015 76829 A
3	AM 2015 76829 A	17	AM 2015 76829 A
3	AM 2015 76953 A	19	AM 2015 74373 A*
5	AM 2015 76071 A	19	AM 2015 74374 A*
5	AM 2015 76829 A	19	AM 2015 76829 A
6	AM 2015 74373 A*	29	AM 2015 74899 A
6	AM 2015 74374 A*	29	AM 2015 76829 A
7	AM 2015 74373 A*	30	AM 2015 72315 A
7	AM 2015 74374 A*	30	AM 2015 75790 A
7	AM 2015 75919 A	30	AM 2015 76829 A
7	AM 2015 75919 A	30	AM 2015 77058 A
8	AM 2015 75919 A	30	AM 2015 77060 A
11	AM 2015 74373 A*	31	AM 2015 76829 A
11	AM 2015 74374 A*	32	AM 2015 74899 A
11	AM 2015 75919 A	32	AM 2015 75786 A
12	AM 2015 75919 A	32	AM 2015 75835 A
12	AM 2015 76765 A	32	AM 2015 76829 A
12	AM 2015 76796 A	33	AM 2015 74899 A
12	AM 2015 76797 A	33	AM 2015 75785 A
12	AM 2015 76798 A	33	AM 2015 75786 A
14	AM 2015 75243 A	33	AM 2015 76182 A
		33	AM 2015 76730 A
		33	AM 2015 76829 A
		34	AM 2015 75925 A
		34	AM 2015 75991 A



1	2	1	2
34	AM 2015 76829 A	38	AM 2015 75792 A
35	AM 2015 74400 A*	39	AM 2015 76829 A
35	AM 2015 75243 A	41	AM 2015 75768 A
35	AM 2015 75787 A	41	AM 2015 75786 A
35	AM 2015 75788 A	41	AM 2015 75788 A
35	AM 2015 75790 A	41	AM 2015 75791 A
35	AM 2015 75796 A	41	AM 2015 75792 A
35	AM 2015 75797 A	43	AM 2015 75786 A
35	AM 2015 75798 A	43	AM 2015 75788 A
35	AM 2015 76829 A	43	AM 2015 75835 A
36	AM 2015 76829 A	43	AM 2015 76428 A
38	AM 2015 75791 A	43	AM 2015 76429 A

CONCORDANCE TABLE OF INDEX OF GOODS AND/OR SERVICES  
AND NUMBERS OF TRADEMARKS REGISTERED ACCORDING  
TO THE ACCELERATED PROCEDURE

INDEX OF GOODS AND/OR SERVICES (511)	NUMBER OF REGISTERED ACCORDING TO THE ACCELERATED PROCEDURE (111)
5	M 2015 25533 R
5	M 2015 25534 R
5	M 2015 25537 R
5	M 2015 25538 R
5	M 2015 25543 R
5	M 2015 25544 R
5	M 2015 25545 R
11	M 2015 25541 R
11	M 2015 25542 R
30	M 2015 25535 R
30	M 2015 25536 R
33	M 2015 25539 R
33	M 2015 25540 R

# OFFICIAL BULLETIN OF THE INDUSTRIAL PROPERTY

## 1(413)

EDITOR-IN-CHIEF: N. Bebrishvili

EDITORS-TRANSLATORS: E. Gabunia  
G. Nadareishvili

PROOFREADER: L. Chanturia

COMPUTER LAYOUT: M. Ordenidze  
K. Svanidze

[www.sakpatenti.org.ge](http://www.sakpatenti.org.ge)  
E-mail: [info@sakpatenti.org.ge](mailto:info@sakpatenti.org.ge)