

Official Bulletin of the Industrial Property

Inventions

Utility Models

Designs

Trademarks

Appellation of Origin



საქართველოს ინტელექტუალური
საკუთრების ეროვნული ცენტრი

საქპატენტი

SAKPATENTI

NATIONAL INTELLECTUAL PROPERTY
CENTER OF GEORGIA

www.sakpatenti.gov.ge

Date of Publication – 2020 07 10

13(545)

INID CODES FOR IDENTIFICATION OF BIBLIOGRAPHIC DATA

INVENTIONS, UTILITY MODELS

- (10) Number of publication for application, which has been examined
- (11) Number of patent and kind of document
- (21) Serial number of application
- (22) Date of filing of the application
- (23) Date of exhibition or the date of the earlier filing and the number of application, if any
- (24) Date from which patent may have effect
- (31) Number of priority application
- (32) Date of filing of priority application
- (33) Code of the country or regional organization allotting priority application number
- (44) Date of publication of application not granted, but examined and number of bulletin
- (45) Date of publication of registered document
- (51) International Patent Classification Index

- (54) Title of the invention
- (57) Abstract
- (60) Number of examined patent document granted by foreign patent office, date from which patent has effect and country code
- (62) Number of the earlier application and in case of divided application, date of filing an application
- (71) Name, surname and address of applicant (country code)
- (72) Name, surname of inventor (country code)
- (73) Name, surname and address of patent owner (country code)
- (74) Name, surname of representative or patent attorney
- (85) Date of commencement of the national phase of International Application
- (86) Number and date of filing of international application
- (87) Number and date of publication of international application
- (94) Calculated date of expiry of the SPC or the duration of the SPC

DESIGNS

- (10) Number of publication for application
- (11) Number of patent and kind of document or number of registration
- (15) Date of registration/Date of patent renewal
- (18) Expected expiration date of patent or registration
- (21) Serial number of application
- (22) Date of filing of the application
- (23) Date of exhibition or the date of the earlier filing and the number of application, if any
- (24) Date from which patent may have effect
- (28) Number of designs included in the application
- (30) Data relating to priority (number of application, date of filing of application, two-letter code identifying the authority with whom the priority application was made)
- (31) Number of priority application
- (32) Date of filing of priority application
- (33) Code of the country or regional organization allotting priority application number
- (34) Two-letter code according to WIPO St.3 identifying the authority with which the priority application was made
- (44) Date of publication of design and number of bulletin (the first publication)
- (45) Date of publication of design registered by WIPO and number of bulletin

- (51) International Classification for designs (class and subclass of the Locarno Classification)
- (54) Title of the invention
- (55) Reproduction of the design
- (57) Description of characteristic features of the design including indication of colors
- (58) Date of recording of any kind of amendment in the Register
- (62) Number of the earlier application, registration and document number and if available the date of filing an application in case of divided application
- (71) Name, surname and address of applicant (country code)
- (72) Name, surname of creator (country code)
- (73) Name, surname and address of patent owner (country code)
- (74) Name, surname of representative or patent attorney
- (81) Contracting states concerned
 - II designated contracting states according to the 1960 Act
 - III designated contracting states according to the 1999 Act
- (85) Owner's permanent address
- (86) Owner's nationality
- (87) Owner's residence
- (88) State in which the owner has a real and effective industrial or commercial establishment

TRADEMARKS

- (111) - Number of registration
- (151) - Date of registration
- (156) - Date of the renewal
- (181) - Expected expiration date of registration
- (186) - Renewal expiration date of registration
- (141) - Date of cancel of duration of the mark
- (210) - Serial number of application
- (220) - Date of filing of the application
- (230) - Data concerning exhibition
- (260) - Number of application, for which favorable decision of examination about registration has been taken (publication number)
- (310) - Number of the first application
- (320) - Date of filing of the first application
- (330) - Code, identifying national or regional Office where the first application was made
- (511) - International Classification of Goods and Services for the purposes of registration of trade marks and/or list of goods and/or services classified according thereto
- (526) - Disclaimer
- (531) - Description of figurative elements of Trade Marks according to the International Classification of the Figurative Elements of Marks

- (540) - Reproduction of Trade Mark
- (550) - Nature and kind of Trade Mark
- (551) - Indication to the effect that the mark is a collective mark, a certification mark or a guarantee mark
- (554) - Three-dimensional mark
- (580) - Date of recording of any kind changes in respect of applications or registrations
- (591) - Information concerning colors claimed
- (731) - Name and address of the applicant
- (732) - Name and address of the holder of the registration
- (740) - Name and address of the representative
- (750) - Addreses for correspondence
- (770) - Name and address of the previous applicant or holder in case of change in ownership
- (771) - Previous name and address of the applicant or holder in case of change in ownership
- (791) - Name and address of the licensee
- (793) - Indication of conditions and/or restrictions under the license (Type of license, number of license agreement, data of license, data of validity of license)
- (800) - Certain data relating to the international registration of Trade Marks under the Protocol Relating to Madrid Agreement (International registration number
- (852) - Partial cancellation of the list of goods and services
- (891) - Date of subsequent designation

CODES FOR PUBLICATION IN BULLETIN

- (21) AP 0000 000000 - serial number of application for invention
- (10) AP 0000 0000 A - number of published application for invention (first publication)
- (11) P 0000 0000 B - number of patent for invention (second publication)
- (21) API 0000 000000 - number of application for imported patent
- (11) PI 0000 0000 A - number of imported patent (first publication)
- (21) AU 0000 000000 - serial number of application for utility model
- (10) AU 0000 000 U - number of published application for utility model (first publication)
- (11) U 0000 000 Y - number of patent for utility model (second publication)
- (21) AD 0000 000000 - serial number of application for design
- (10) AD 0000 000 S - number of published application for design (first publication)
- (11) D 0000 000 S - registered design

INTERNATIONAL PATENT CLASSIFICATION FOR INVENTIONS AND UTILITY MODELS

- SECTION A - HUMAN NECESSITIES
- SECTION B - PERFORMING OPERATIONS; TRANSPORTING
- SECTION C - CHEMISTRY; METALLURGY
- SECTION D - TEXTILES; PAPER
- SECTION E - FIXED CONSTRUCTIONS
- SECTION F - MECHANICAL ENGINEERING; LIGHTING; HEATING; WEAPONS; BLASTING
- SECTION G - PHYSICS
- SECTION H - ELECTRICITY

-
- M - Trade Mark
 - (210) AM 0000 000000 - Serial number of application;
 - (260) AAM 0000 00000 A - Publication number of application;
 - (111) M 0000 00000 R - Number of registration;
 - (111) MMM0000 00000 Rn - Number of renewals, in which n=1,2,3;
 - (111) M 0000 00000 R(P) - Number of registration under partial assignment of rights
-

Official Bulletin of the Industrial Property

Inventions

Utility Models

Designs

Trademarks

Appellation Of Origin

CONTENTS

PUBLISHED TITLES OF PROTECTION	3
INVENTIONS	
▪ APPLICATIONS APPROVED FOR GRANTING PATENTS	4
▪ PATENTED INVENTIONS	10
UTILITY MODELS	
▪ APPLICATION APPROVED FOR GRANTING PATENT	12
▪ PATENTED UTILITY MODELS	14
DESIGNS	
▪ APPLICATION APPROVED FOR REGISTRATION	15
▪ REGISTERED DESIGNS	17
▪ DESIGNS, WHICH HAVE BEEN REGISTERED WITH THE INTERNATIONAL BUREAU CLAIMING PRIORITY ON THE TERRITORY OF GEORGIA	18
TRADEMARKS	
▪ APPLICATIONS FILED UNDER THE NATIONAL PROCEDURE APPROVED FOR REGISTRATION	52
▪ REGISTERED TRADEMARKS	56
▪ TRADEMARKS REGISTERED ACCORDING TO THE ACCELERATED PROCEDURE	59
▪ INTERNATIONAL TRADEMARKS FOR WHICH A DECISION ON GRANTING PROTECTION IS TAKEN	63
▪ INTERNATIONAL TRADEMARKS PROTECTED IN GEORGIA	203
OFFICIAL NOTIFICATIONS	
INVENTIONS	
▪ EXPIRATION OF PATENTS RESTORATION	211
▪ ABOLITION OF PATENTS WITH THE RIGHT TO RESTORE	213
▪ EXPIRATION OF TERM OF RESTORATION OF PATENTS	215
▪ CHANGES OF NAMES AND/OR ADDRESSES OF PATENTOWNER	216
UTILITY MODELS	
▪ EXPIRATION OF PATENTS RESTORATION	217
▪ ABOLITION OF PATENTS WITH THE RIGHT TO RESTORE	217
DESIGNS	
▪ CANCELLATION OF DESIGN REGISTRATION	218
▪ EXTENSION OF REGISTRATION OF INTERNATIONAL DESIGNS	218
▪ CANCELLATION OF INTERNATIONAL DESIGNS REGISTRATION	222
TRADEMARKS	
▪ RENEWAL OF REGISTRATIONS	224
▪ COMPLETE TRANSFER OF RIGHTS	226
▪ CHANGES OF NAMES AND/OR ADDRESSES OF OWNERS	228
▪ TERMINATION OF TRADEMARKS REGISTRATION	229
▪ CANCELLATION OF INTERNATIONAL TRADEMARKS REGISTRATION	232
CLASSIFICATION INDEXES	
INVENTIONS	233
UTILITY MODELS	235
DESIGNS	236
TRADEMARKS	238

PUBLISHED TITLES OF PROTECTION

INVENTIONS

- **APPLICATIONS APPROVED FOR GRANTING PATENT:**
14891; 14909; 14955; 14968; 14811; 14825; 14264; 15162; 15065; 15012; 15277; 15077
- **PATENTED INVENTIONS:**
7128-7131

UTILITY MODELS

- **APPLICATIONS APPROVED FOR GRANTING PATENT:**
15204; 15300; 15275; 15238
- **PATENTED UTILITY MODELS:**
2043-2045

DESIGNS

- **APPLICATIONS APPROVED FOR REGISTRATION:**
1146; 1145
- **REGISTERED DESIGNS:**
847-851
- **DESIGNS, WHICH HAVE BEEN REGISTERED WITH THE INTERNATIONAL BUREAU CLAIMING PRIORITY ON THE TERRITORY OF GEORGIA:**
207357; 207538; 207358; 207402; 207408; 204345; 204811; 202352; 205045; 205522

TRADEMARKS

- **APPLICATIONS FILED UNDER THE NATIONAL PROCEDURE APPROVED FOR REGISTRATION:**
103313; 105026; 105454, 105455; 105740; 105742; 105783; 105819; 105882; 105884, 105885; 105890; 105892; 105967; 105974; 105984; 105990, 105991; 106167; 106183, 106184; 106280; 106320
- **REGISTERED TRADEMARKS:**
32805-32838
- **TRADEMARKS REGISTERED ACCORDING TO THE ACCELERATED PROCEDURE:**
32791-32804; 32839-32841
- **INTERNATIONAL TRADEMARKS FOR WHICH A DECISION ON GRANTING PROTECTIONS IS TAKEN:**
102182*, 102678*, 102856; 103408; 103551; 103723; 104016; 104051; 104225; 104239; 104247; 104382; 104392; 104497; 104570; 104603; 104696; 104704; 104719; 104723; 104735; 104785-104787; 104790; 104796; 104797; 104836; 104843, 104844; 104852-104858; 104860-104862; 104868; 104870-104872; 104874, 104875; 104878; 104946, 104947; 104950-104952; 104954-104957; 104959-104962; 104967-104978; 104983, 104984; 104988, 104989; 104991-104994; 105047; 105049-105053; 105061-105064; 105070, 105071; 105073-105076; 105079, 105080; 105090-105092; 105094-105098; 105100, 105101; 105103-105108; 105113, 105114; 105160-105165; 105173; 105178, 105179; 105184, 105185; 105188; 105191; 105195; 105200; 105207; 105271; 105282; 105287; 105289-105291; 105295, 105296; 105300-105304; 105306; 105309; 105312; 105323-105326; 105386-105388; 105390-105392; 105487-105489; 105513-105516; 105567-105571; 105897, 105898; 105905; 105960; 106286; 106288; 106293; 106426
- **INTERNATIONAL TRADEMARKS PROTECTED IN GEORGIA:**
99422, 99423; 100470; 101337; 102290; 102739; 102873; 102978; 103057-103060; 103146, 103147; 103149; 103163; 103238, 103239; 103281-103283; 103300; 103349; 103366; 103368-103370; 103384-103386; 103388, 103389; 103397-103401; 103492, 103493; 103505-103508; 103529; 103532-103535; 103537; 103539; 103541, 103542; 103548; 103550; 103553; 103595; 103605; 103607; 103613; 103615, 103616; 103618- 103620; 103627, 103628; 103633; 103638; 103642; 103647; 103707; 103718, 103719; 103728; 103732- 103734; 103736, 103737; 103745, 103746; 103807; 103811-103813; 103816-103820; 103822; 103827; 103830; 103834; 103905; 103912; 103923; 103925; 104136; 104333; 104337; 104343; 104390; 104393; 104519; 104521; 104654; 104657, 104658; 104694; 104733

INVENTIONS

APPLICATIONS APPROVED FOR GRANTING PATENTS

The decision can be appealed at the Chamber of Appeal of Sakpatenti within 3 months from the publication or at the Mtskheta District Court Administrative Cases Board (Address: №17, Samkhedro str., Mtskheta), within 1 month following the publication.

PART A

A 01

(10) AP 2020 14891 A (51) Int. Cl. (2006)
A 01 N 43/42
C 07 D 215/54

(21) AP 2017 14891 (22) 2017 03 07
(31) 16159707.5; 17154212.9
(32) 2016 03 10; 2017 02 01
(33) EP; EP
(71) SYNGENTA PARTICIPATIONS AG (CH)
Schwarzwaldallee 215, Basel, 4058,
Switzerland (CH)
(72) QUARANTA, Laura (CH);
BOU HAMDAN, Farhan (CH);
WEISS, Matthias (CH)
(74) Tamar Kochlamazashvili
(85) 2018 10 03

(86) PCT/EP2017/055273, 2017 03 07
(54) **MICROBIOCIDAL QUINOLINE
(THIO) CARBOXAMIDE DERIVATIVES**
(57) An invention relates to fungicide quinoline-
(thio) carboxamide derivatives of formula (I),

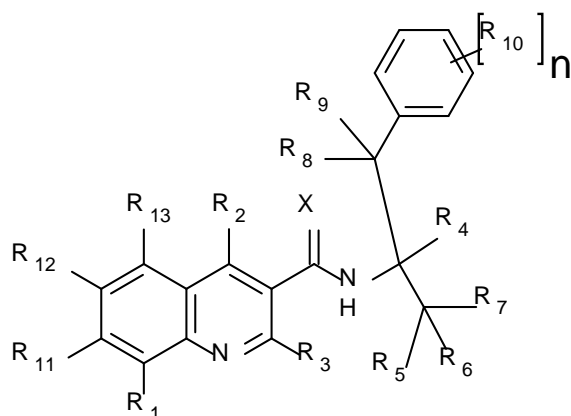

usage therein agriculture or horticulture for
controlling or preventing invasion caused by phy-
topathogenic microorganisms, particularly fungi in
the plants, harvest, feed crops, seeds or non-living
materials.

Claims: 3 independents
14 dependents

A 61

(10) AP 2020 14909 A (51) Int. Cl. (2006)
A 61 K 31/44
A 61 P 29/00
C 07 D 213/75
C 07 D 401/12

(21) AP 2014 14909 (22) 2014 01 29
(62) AP 2014 13922 2014 01 29
(31) 61/759,059
(32) 2013 01 31
(33) US
(71) VERTEX PHARMACEUTICALS
INCORPORATED (US)
50 Northern Avenue, Boston, MA, 02210,
USA (US)
(72) TERMIN, Andreas, P. (US);
BEAR, Brian, Richard (US);
JOHNSON, James, Philip (CA);
ARUMUGAM, Vijayalaksmi (US);
ANDERSON, Corey (US);
ASGIAN, Iuliana, Luci (US);
HADIDA-RUAH, Sara, Sabina (US)

(74) Shalva Gvaramadze
(85) 2018 10 19
(86) PCT/US2014/013652, 2014 01 29
(54) **PYRIDONE AMIDES AS MODULATORS
OF SODIUM CHANNELS**
(57) Compound of formula I,

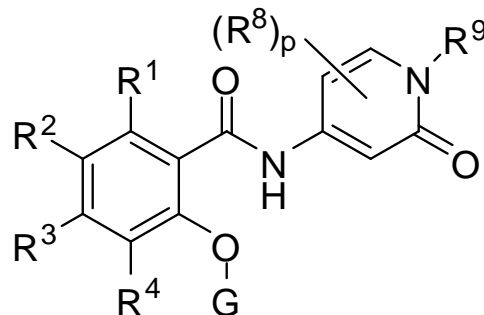

wherein values of R¹, R², R³, R⁴, R⁵, R⁶, R^{5'}, R^{6'}, R⁸^(I)
substitutes are provided in the claims, preparation
method and intermediate compounds thereof.

Claims: 6 independents
38 dependents

Table: 15

(10) AP 2020 14955 A (51) Int. Cl. (2006)
A 61 K 31/437
C 07 D 471/04

- (21) AP 2017 14955 (22) 2017 06 30
(31) PA 2017 00236; PA 2016 00612;
PA 2016 00397
(32) 2017 04 04; 2016 10 11; 2016 07 04
(33) DK; DK; DK
(71) H. LUNDBECK A/S (DK)
Ottliavej 9, Valby, DK-2500, Denmark (DK)
(72) VITAL, Paulo, Jorge, Vieira (DK);
MARIGO, Mauro (DK);
CLEMENTSON, Carl, Martin, Sebastian (DK);
JUHL, Karsten (DK);
KEHLER, Jan (DK);
RASMUSSEN, Lars, Kyhn (DK);
LANGGÅRD, Morten (DK);
JESSING, Mikkel (DK)
(74) Tamaz Shilakadze
(85) 2018 12 10
(86) PCT/EP2017/066255, 2017 06 30
(54) 1H-PYRAZOLO [4,3-B] PYRIDINES
AS PDE1 INHIBITORS
(57) Compound of formula (I),

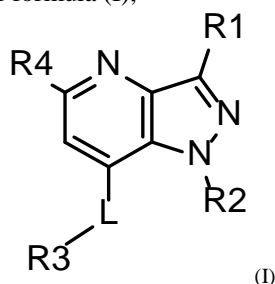

as PDE1 inhibitors, pharmaceutical compositions on the basis thereof, and their usage as remedies, particularly, for neurodegenerative and mental disorders treatment.

Claims: 5 independents
11 dependents

(10) AP 2020 14968 A (51) Int. Cl. (2006)
A 61 K 31/501
A 61 P 35/00
C 07 D 237/16
C 07 D 237/20
C 07 D 403/12
C 07 D 405/12

- (21) AP 2017 14968 (22) 2017 05 23
(31) PCT/CN2016/083308; PCT/CN2017/074408
(32) 2016 05 25; 2017 02 22
(33) CN; CN
(71) Deutsches Krebsforschungszentrum
(DKFZ) (DE)
Im Neuenheimer Feld 280, Heidelberg, 69120,
Germany (DE);
Bayer Pharma Aktiengesellschaft (DE)
Müllerstraße 178, Berlin, 13353,
Germany (DE)

- (72) ZORN, Ludwig (DE);
ZHAO, Na (CN);
IRLBACHER, Horst (DE);
SCHMEES, Norbert (DE);
BADER, Benjamin (DE);
STOECKIGT, Detlef (DE);
PLATTEN, Michael (DE);
GUTCHER, Ilona (DE);
ROESE, Lars (DE);
ROEHN, Ulrike (DE)
(74) Tamar Kochlamazashvili
(85) 2018 12 20
(86) PCT/EP2017/062355, 2017 05 23
(54) 3-OXO-2,6-DIPHENYL-2,3-DIHYDRO-
PYRIDAZINE-4-CARBOXAMIDES
(57) Compound of common formula (I),

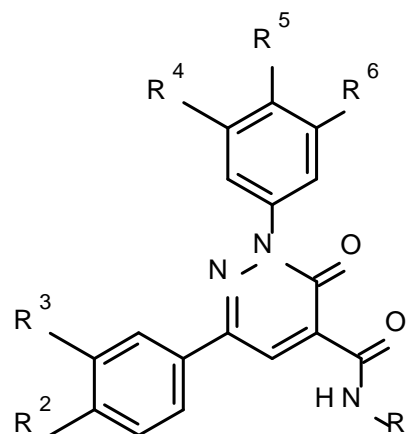

wherein values of R¹, R², R³, R⁴, R⁵, R⁶ substituents are provided in the claims, polymorphs, enantiomers, diastereomers, racemates, tautomers, N-oxygens, hydrates or solvates thereof, and their physiologically acceptable salts, solvates, and mixtures, as well, pharmaceutical composition on the basis thereof, and their usage for the treatment of cancer or conditions related to dysregulated immune responses caused by AHR, such as e.g. liquid and solid tumors.

Claims: 8 independents
5 dependents

Table: 9
Fig.: 1

(10) AP 2020 14811 A (51) Int. Cl. (2006)
A 61 K 39/395
C 07 K 16 18
C 07 K 16 28

- (21) AP 2016 14811 (22) 2016 11 17
(31) 62/257,001
(32) 2015 11 18
(33) US
(71) MERCK SHARP & DOHME CORP. (US)
126 East Lincoln Ave., Rahway, NJ 07065-
0907, USA (US)
(72) VICTOR, Bjorn (BE);

PUNNONEN, Juha (US);
 BEAUMONT, Maribel (US);
 BOUTTON, Carlo (BE);
 DOMBRECHT, Bruno (BE);
 KASTELEIN, Robert A. (US);
 BUYSE, Marie-Ange (BE)

(74) Shalva Gvaramadze

(85) 2018 06 15

(86) PCT/US2016/062393, 2016 11 17

(54) **CTLA4 BINDERS**

(57) There is represented molecules binding CTLA4 comprising immunoglobuline unit variable domains (ISVDs) produced with genetic engineering. Said molecules are used for increasing immune response, and cancer and/or infectious diseases treatment.

Claims: 14 independents

11 dependents

Fig.: 13

PART D

D 06

(10) AP 2020 14825 A (51) Int. Cl. (2006)

D 06 P 5/00

D 06 P 5/30

D 06 P 1/52

(21) AP 2016 14825

(22) 2016 12 22

(31) 102015000089200

(32) 2015 12 30

(33) IT

(71) MANIFATTURA DEL SEVESO S.P.A. (IT)

Via Monte Grappa, 7, Bergamo, 24121,
 Italy (IT)

(72) BOLOGNA, Franco (IT)

(74) Tamar Kochlamazashvili

(85) 2018 07 11

(86) PCT/EP2016/082328, 2016 12 22

(54) **PROCESS FOR OBTAINING A CLOTH WITH HIGH PERFORMANCES FOR DIGITAL PRINTING AND RELATIVE CLOTH**

(57) A process for preparing material, in particular, with cotton or viscose fabric for bookbinding with glaze/light or matted coating suitable for digital printing, wherein the process comprises the steps:

A) preparing unfinished material or fabric for bookbinding by desizing, washing, treating with optical white, sizing and drying;

B) pre-treating the cloth obtained from step A) by applying a paste on at least one of the two sides, at least one composition for the closure of the pores of said cloth so as to make the surface planar, wherein said paste contains acrylic resin, kaolin and vinyl resin of 23 mass% of the total amount of the substance, in dry form;

C) on the side of said fabric or said cloth intended to be printed, applying by coating a layer of a paste having a viscosity of at least 7500 cps, preferably comprised between 8000 and 12000 cps, and drying this layer; said paste being the mixture of at least one nonionic thickener, predominantly of polyurethane type and at least aqueous composition containing 35 mass% of acrylic resin and components in dry form that at temperatures of around 200°C for less than one minute initiate the state of polymerization/vulcanization, and non-essential additives, such as non-silicone and non-mineral foaming agents, which are suitable for coating with paste, however, the above-mentioned extract does not contain fiber dye and inorganic/organic pigment, such as calcium carbonate, clay, zeolite, and silicon dioxide; and

D) calendering at ambient temperature the cloth obtained from step C).

Claims: 3 independents

8 dependents

Fig.: 1

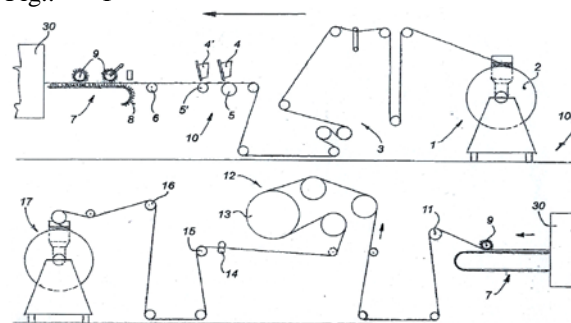

Fig. 1

PART E

E 02

(10) AP 2020 14264 A (51) Int. Cl. (2006)

E 02 D 31/00

E 01 C 3/00

E 01 C 3/04

E 01 B 2/00

(21) AP 2015 014264

(22) 2015 02 12

(31) 61/939,198

(32) 2014 02 12

(33) US

(71) GEOTECH TECHNOLOGIES LTD. (IL)

4 Kaufmann St. Sharbat House 12th floor,
 8213502 Tel Aviv, Israel (IL)

(72) HALAHMI, Izhar (IL);

EREZ, Oded (IL)

(74) Shalva Gvaramadze

(85) 2016 09 12

(86) PCT/IB2015/001410, 2015 02 12

(54) GEOCELL WITH IMPROVED COMPACTION AND DEFORMATION RESISTANCE

(57) Geocell material 10 has been made of set of perforated polymeric strips 14 having deformation no more than 3.5% during installation, and 3.0% – at loading therewith 6.1 kn/m engaged in perpendicular direction relative to cell strip stitches, at ambient temperature, during 90 minutes.

Claims: 2 independents

9 dependents

Fig.: 5

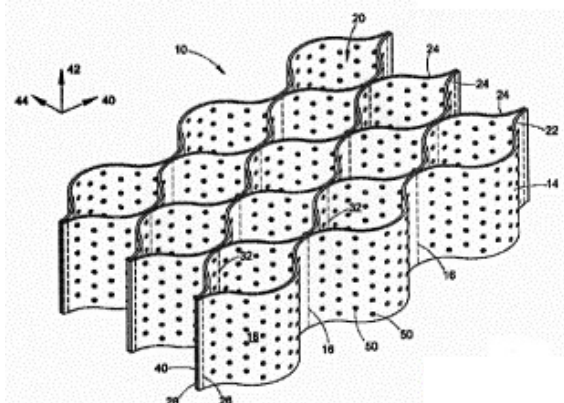

Fig. 1

E 03

(10) AP 2020 15162 A (51) Int. Cl. (2006) E 03 C 1/28

(21) AP 2019 15162 (22) 2019 08 05

(71) Gia Megrelishvili (GE)
26 May St. 101, Vill. Gldani, 0153,
Tbilisi, Georgia (GE)

(72) Gia Megrelishvili (GE)

(54) SEWERAGE DOUBLE PIPE

(57) Sewerage double pipe includes outer plastic pipe 1, wherein small diameter inner plastic pipe 2 is placed such that the radial gap 3 is created. Inner pipe is perforated in whole length, and adapter head thereof is attached to outer pipe adapter head inner wall.

Claims: 1 independents

Fig.: 2

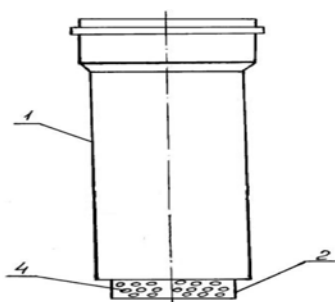

Fig. 1

E 04

(10) AP 2020 15065 A (51) Int. Cl. (2006) E 04 H 6/06

(21) AP 2019 15065 (22) 2019 05 02

(71) Sergo Jorbenadze (GE)
R. Tabukashvili St. 46, app. 8, 0108, Tbilisi,
Georgia (GE)

(72) Sergo Jorbenadze (GE)

(54) AUTO PARKING ELEVATOR "SERJO"

(57) An elevator includes metal carrier supporting poles 1, car platform 3 having lifting mechanism 7 and hydraulic actuator thereof, executed as hydrocylinder 13 with its actuator 14, mechanism keeping car platform in horizontal position, including two various rope-roller systems, wherein one system is executed as couple of rope-roller mechanism systems disposed opposite relative to each other, and the ropes 2 thereof are impaled crossed onto platform rollers 4 and fastened onto case pole 1 walls in upper part with one end thereof, and lower ends of couple mechanism ropes are fastened to case down part by means of spraining fixators 5, wherein, under platform, in ropes crossing places the brakes 6 are disposed, and second system is executed as synchronic motion protecting rope-roller mechanism, and engaged on the rollers 10, 11 thereof the rope 8 one end is fastened onto platform one side 9, and rope another end is fastened to platform another side 12, as well, which is connected to actuating mechanism by means of rope.

Claims: 1 independent

Fig.: 2

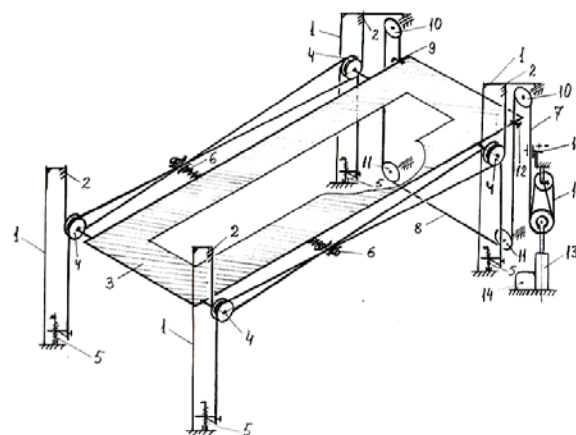

Fig. 1

PART G**G 06**

(10) AP 2020 15012 A (51) Int. Cl. (2006)
G 06 F 1/16

- (21) AP 2019 15012 (22) 2019 02 22
 (71) Irakli Petriashvili (GE)
 Nutsbidze Plateau, III mcr., quarter 3, corp. 8,
 app. 1, 0183, Tbilisi, Georgia (GE);
 Vasil Petriashvili (GE)
 Nutsbidze Plateau, III mcr., quarter 3, corp. 8,
 app. 1, 0183, Tbilisi, Georgia (GE)
 (72) Irakli Petriashvili (GE);
 Vasil Petriashvili (GE)
 (74) Aleksandre Gegechkori
 (54) **FOLDABLE PC (PERSONAL
 COMPUTER)**

(57) A case consists of three sections: the main – intended for computer componentry at least first group allocation; back – executed rotatable relative to the main and intended for computer componentry at least second group allocation; and display – executed rotatable relative to the main, in the position between folded, when display monitor covers main section and/or part of back section, and open, when display is lifted relative to main section, inherently, perpendicular thereto. At that, back section is executed rotatable relative to main section in the position between folded, when both, back and main sections are disposed in horizontal line, and open, when back section is lifted relative to main section, inherently, perpendicular thereto. Display and back sections are connected to the main, rotatable so that display together with back section would move into open position at the same time or sequentially.

Claims: 1 independent
6 dependents

Fig.: 7

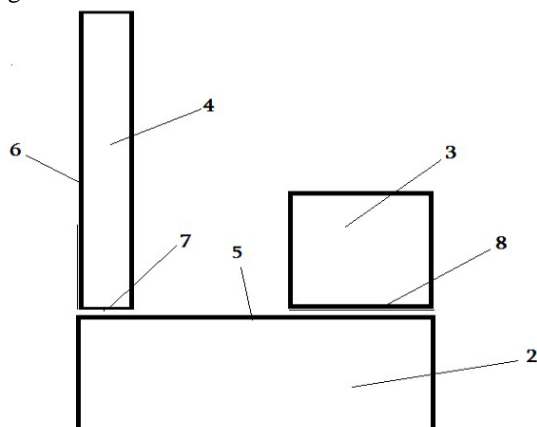

Fig. 2

(10) AP 2020 15277 A (51) Int. Cl. (2006)
G 06 K 7/00
G 06 K 17/00

- (21) AP 2020 15277 (22) 2020 02 14
 (71) Davit Topchishvili (GE)
 Kostava St. II Lane 2, 0179, Tbilisi,
 Georgia (GE)
 (72) Davit Topchishvili (GE)
 (74) Davit Dzamukashvili
 (54) **METHOD FOR TRADE AND
 SYSTEM FOR IMPLEMENTATION
 THEREOF**

(57) A method provides: taking trade basket by a customer, his passing through entrance and exit points, bought products getting from the shelves having electric scales, putting therein the basket by him, and accounting of product amount and bill. At that, human body communication system technology usage is provided. The customer would be identified by means of previously coded basket at the moment of his passing through entrance point by touching said point element and basket handle at the same time; after which, to enter him into trade space is permitted. The customer touches closet door- and basket handles at the same time at door opening; then, he would be informed about bill amount; after paying bill with card, he would be able to leave trade space. The invention provides the system for method implementation, as well.

Claims 2 independents
3 dependents

Fig.: 4

PART H**H 01**

(10) AP 2020 15077 A (51) Int. Cl. (2006)
H 01 L 31/00

- (21) AP 2019 15077 (22) 2019 05 13
 (71) LEPL "INSTITUTE OF MICRO-AND
 NANOELECTRONICS (IMNE)" (GE)
 I. Chavchavadze Av. 13, 0179, Tbilisi,
 Georgia (GE)
 (72) Amiran Bibilashvili (GE);
 Nina Khuchua (GE);
 Nugzar Dolidze (GE);
 Zurab Jibuti (GE);
 Nodar Gapishvili (GE);
 Revaz Melkadze (GE);
 Marina Tigishvili (GE)
 (74) Amiran Bibilashvili
 (54) **METHOD FOR INTEGRAL TWO
 RANGE ULTRAVIOLET AND INFRARED
 PHOTO DETECTOR CREATION**

(57) Suggested integral two range ultraviolet and infrared photo detector is a joint of matrix detectors made by means of planar technology obtained with boron ion implantation with appropriate large and small energies and different doses with optimal legitimacy regimes in separated areas of silicon plate.

Claims: 1 independent

5 dependents

Fig.: 6

PATENTED INVENTIONS

PART A

A 61

- (11) P 2020 7129 B** **(51) Int. Cl. (2006)**
A 61 K 31/56
A 61 P 31/16
 (10) AP 2020 13375 A (44) 3(535)/2020
 (21) AP 2010 13375
 (22) 2010 06 17
 (24) 2010 06 17
 (62) 61/187,713 2009 06 17 (US);
 61/287,781 2009 12 18 (US)
 (31) 61/187,713; 61/287,781
 (32) 2009 06 17; 2009 12 18
 (33) US; US
 (86) PCT/US2010/038988, 2010 06 17
 (73) Vertex Pharmaceuticals Incorporated (US)
 130 Waverly Street, Cambridge,
 MA 02139, USA (US)
 (72) CHARIFSON, Paul (US);
 CLARK, Michael, P. (US);
 BANDARAGE, Upul, K. (US);
 BETHIEL, Randy, S. (US);
 COURT, John, J. (US);
 DENG, Hongbo (CN);
 DRUTU, Ioana (RO);
 DUFFY, John, P. (US);
 FARMER, Luc (CA);
 GAO, Huai (CN);
 GU, Wenxin (CN);
 JACOBS, Dylan, H. (US);
 KENNEDY, Joseph, M. (US);
 LEDEBOER, Mark, W. (US);
 LEDFORD, Brian (US);
 MALTAIS, Francois (US);
 PEROLA, Emanuele (IT);
 WANG, Tiansheng (US);
 WANNAMAKER, M., Woods (US);
 BYRN, Randal (US);
 ZHOU, Yi (US);
 LIN, Chao (US);
 JIANG, Min (US);
 JONES, Steven (US);
 GERMANN, Ursula, A. (CH);
 SALITURO, G. Francesco (US);
 KWONG, Ann Dak-Yee (US)
 (74) Shalva Gvaramadze
 (54) **INHIBITORS OF INFLUENZA**
VIRUSES REPLICATION

- (11) P 2020 7130 B** **(51) Int. Cl. (2006)**
A 61 K 31/4178
A 61 P 11/00
C 07 D 403/04
C 07 D 413/14
C 07 D 403/14
C 07 D 417/14
 (10) AP 2020 14924 A (44) 6(538)/2020
 (21) AP 2017 14924
 (22) 2017 05 26
 (24) 2017 05 26
 (31) 16172196.4
 (32) 2016 05 31
 (33) EP
 (86) PCT/EP2017/062754, 2017 05 26
 (73) CHIESI FARMACEUTICI S.P.A. (IT)
 Via Palermo, 26/A, 43122 Parma, Italy (IT)
 (72) ARMANI, Elisabetta (IT);
 CAPALDI, Carmelida (IT);
 JENNINGS, Andrew Stephan Robert (IT);
 HEALD, Robert Andrew (IT);
 SUTTON, Jonathan Mark (IT)
 (74) Shalva Gvaramadze
 (85) 2018 11 14
 (86) PCT/EP2017/062754, 2017 05 26
 (54) **IMIDAZOLONE COMPOUNDS AS**
HUMAN NEUTROPHIL ELASTASE
INHIBITORS

- (11) P 2020 7131 B** **(51) Int. Cl. (2006)**
A 61 P 29/00
A 61 P 19/04
A 61 K 31/787
A 61 K 9/02
A 61 K 47/59
A 61 K 38/43
A 61 K 9/06
C 08 F 8/02
C 08 F 8/06
C 08 F 26/06
 (10) AP 2020 14813 A (44) 3(535)/2020
 (21) AP 2016 14813
 (22) 2016 11 09
 (24) 2016 11 09
 (31) 2015152036
 (32) 2015 12 04
 (33) RU
 (86) PCT/RU2016/000755, 2016 11 09
 (73) OBSHCHESTVO S OGRANICHENNOY
 OTVETSTVENNOSTYU "NPO PETRO-
 VAKS FARM" (RU)
 Ul. Sosnovaya 1, s. Pokrov, Podolsk,
 Moskovskaya obl., 142143, Russian
 Federation (RU)

(72) KARAPUTADZE, Nino Temurievna (RU);
KARAPUTADZE, Temuri Musaeovich (RU);
KOZUKOV, Alexander Vladimirovich (RU);
MEDVEDEV, Sergei Alekseevich (RU);
NEKRASOV, Arkadii Vasilevich (RU)

(74) Aleksandre Gegechkori

(54) **METHOD FOR PRODUCING
HYALURONIDASE CONJUGATE
WITH POLYETHYLENEPIPERAZINE
DERIVATIVES AND THE USE OF THE
CONJUGATE PRODUCED**

(11) P 2020 7128 B (51) Int. Cl. (2006)

A 61 P 31/22

A 61 K 31/426

A 61 K 31/662

C 07 D 277/54

C 07 F 9/44

C 07 F 9/40

C 07 F 9/38

(10) AP 2020 14916 A (44) 4(536)/2020

(21) AP 2017 14916

(22) 2017 04 05

(24) 2017 04 05

(31) 16000787.8

(32) 2016 04 06

(33) EP

(86) PCT/EP2017/058077, 2017 04 05

(73) INNOVATIVE MOLECULES GMBH (DE)

Leopoldshöherstrasse 7, 32107, Bad Salzuflen,
Germany (DE)

(72) KLEYMANN, Gerald (DE);

GEGE, Christian (DE)

(74) Liliana Darakhvelidze

(54) **AMINOTHIAZOLE DERIVATIVES
USEFUL AS ANTIVIRAL AGENTS**

UTILITY MODELS

APPLICATIONS APPROVED FOR GRANTING PATENTS

The decision can be appealed at the Chamber of Appeal of Sakpatenti within 3 months from the publication or at the Mtskheta District Court Administrative Cases Board (Address: №17, Samkhedro str., Mtskheta), within 1 month following the publication.

PART A

A 01

(10) AU 2020 15204 U (51) Int. Cl. (2006)
A 01 G 9/14

(21) AU 2019 15204 (22) 2019 10 25
(71) Avtandil Bitsadze (GE)
Gldani, Aleko Gobromidze Dead End 11,
0167, Tbilisi, Georgia (GE)

(72) Avtandil Bitsadze (GE)

(54) **GREENHOUSE FOR COLD REGIONS**

(57) A greenhouse includes thermoinsulated Eastern 3, Western 4, Southern 2 and Northern 1 walls; at that, the Northern is basic support and the highest; a tambourine 6; thermoinsulated Northern roof 8 mounted on Northern wall; connected to Northern roof and Southern wall the arched outer carcass 9 with transparent cover 10 fixed thereon. In the greenhouse, below outer carcass the inner carcass 11 having identical shape thereof is mounted, whereon intended for thermoinsulation the black blanket 12 capable to be open at night and folded per day by means of actuator 15, is disposed.

Claims: 1 independent

Fig.: 4

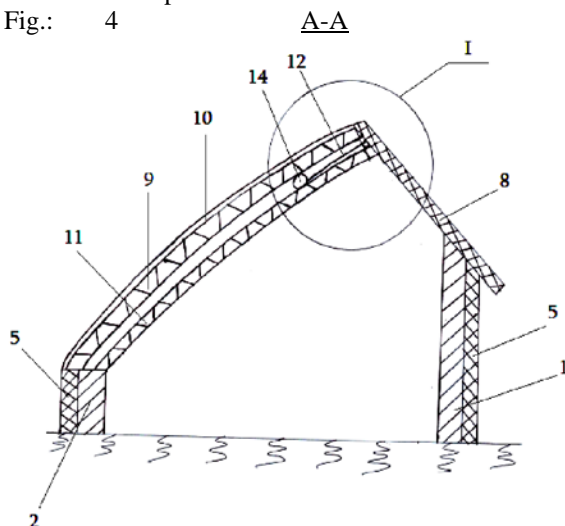

Fig. 2

(10) AU 2020 15300 U (51) Int. Cl. (2006)
A 01 K 47/00

(21) AU 2020 15300 (22) 2020 03 17

(71) Nikoloz Osikmishvili (GE)

A. Tsereteli St. 9, 3800, Sagarejo,
Georgia (GE)

(72) Nikoloz Osikmishvili (GE)

(74) Nugzar Ksovreli

(54) **TRANSPARENT BEEHIVE**

(57) A beehive includes removable cover 1 and a bottom 5, honeycomb holder executed as flat grate 4, a tank 2 for making honeycombs with feeding trough placed therein, and at least two cases 3, wherein the case is executed as two frontal and two side walls joint. An entrance 6 is executed on one of bottom side parts, and ventilation opening having a net 7 disposed therein is executed on lower part thereof. Beehive all case walls are executed with transparent material.

Claims: 1 independent

3 dependents

Fig.: 5

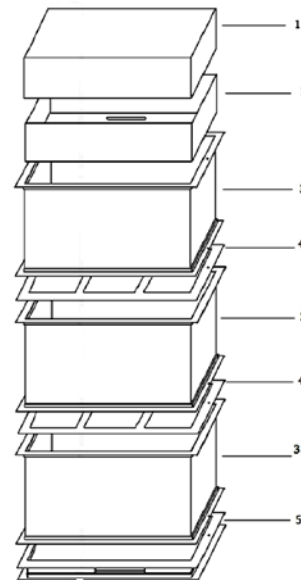

Fig. 1

A 47

(10) AU 2020 15275 U (51) Int. Cl. (2006)
 A 47 B 21/06
 A 47 B 13/00
 A 47 B 17/00
 A 47 B 19/00
 A 47 B 41/00

(21) AU 2020 15275 (22) 2020 02 13

(71) Davit Chichua (GE)

Kldiashvili St. 17/13, 3700, Rustavi,
 Georgia (GE)

(72) Davit Chichua (GE)

(54) **MOBILE SYSTEM FOR EDUCATIONAL,
 EXAMINATION OR CONFERENCE
 PURPOSES**

(57) Mobile system includes plurality of foldable chairs 1 and tables 2 for at least in one row disposition, at least, two fixing nodes 3 and 4 intended for placement on said row both sides. Furthermore, the system is equipped with at least one receive-transmit block and set of portable PCs (personal computers), with considering of one computer placement on the table. Each fixing node is executed as a joint of horizontal and vertical pipes, wherein fixing means are executed on vertical pipes to provide table leg fixation thereto. Common cable is located in one of fixing nodes and the plugs installed above each vertical pipe are switched thereto making possible portable PCs switching to the UPS, and another end thereof is executed switchable to receive-transmit block. Network cables of each PC are disposed in another fixing node, one ends therefrom are protruded from appropriate vertical pipes, and the others are switched to receive-transmit block executed switchable to the UPS and network central cable.

Claims: 1 independent

8 dependents

Fig.: 5

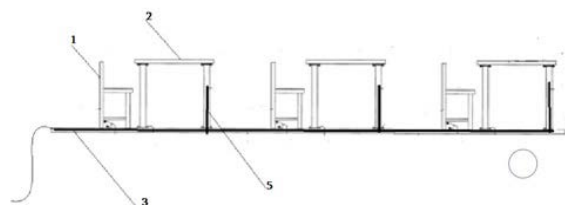

Fig. 1

PART B**B 65**

(10) AU 2020 15238 U (51) Int. Cl. (2006)
 B 65 D 81/03

(21) AU 2018 15238 (22) 2018 07 24

(31) 2017126900

(32) 2017 07 26

(33) RU

(71) Obshchestvo s Ogranichennoy

Otvetstvennostyu "DZHETLAB" (RU)

Nobel St. 7, place 142, Territory of Skolkovo
 Innovation Center, 121205, Moscow, Russian
 Federation (RU)

(72) YUSHINA, Valeriya Olegovna (RU)

(74) Shalva Gvaramadze

(85) 2019 12 18

(86) PCT/RU2018/000493, 2018 07 24

(54) **PACKAGE FOR THE TRANSPORTA-
 TION OF BOTTLE**

(57) A package for the transportation of bottles is first bag of water-impermeable design and it is open in upper part thereof and is characterized with this that contains smaller second bag therein made of bubble wrap and it is open in upper part thereof.

Claims: 1 independent

16 dependents

Fig.: 2

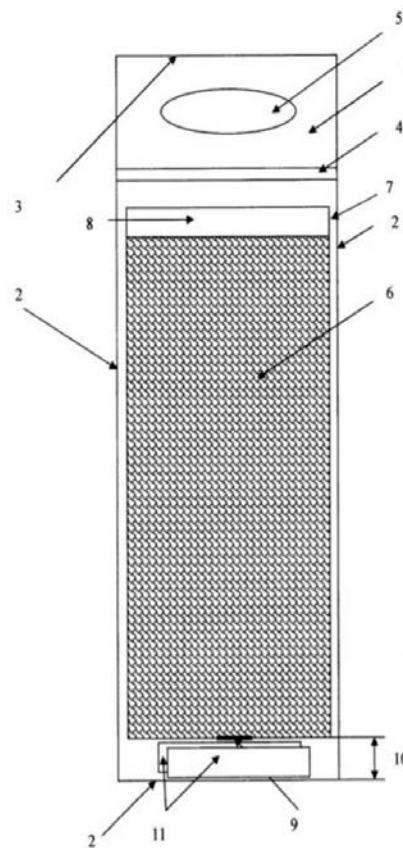

Fig. 1

DESIGNS

APPLICATIONS APPROVED FOR REGISTRATION

The decision can be appealed at the Chamber of Appeal of Sakpatenti within 3 months from the publication or at the Mtskheta District Court Administrative Cases Board (Address: №17, Samkhedro str., Mtskheta), within 1 month following the publication.

- (10) **AD 2020 1146 S** (51) **11-01**
(21) AD 2020 1146 (22) 2020 03 09
(28) 1
(71) Guliver Davituliani (GE)
 Tabidze St. 3, 1100, Bolnisi, Georgia (GE)
(72) Guliver Davituliani (GE)
(54) **GEORGIAN CROSS**
(55)



1.1



1.2

(10) AD 2020 1145 S

(51) 32-00

(21) AD 2020 1145

(22) 2020 03 04

(28) 1

(71) Nikoloz Nutsubidze (GE)

Z. Panaskerteli-Tsitsishvili St. 11, app. 68, 0194, Tbilisi, Georgia (GE)

(72) Nikoloz Nutsubidze (GE)

(54) ORNAMENT

(55)



1.1

REGISTERED DESIGNS

(11) D 2020 847 S **(51) 03-01**
 (10) AD 2020 1114 S (44) 2020 03 25 №6
 (21) AD 2019 1114
 (22) 2019 11 06
 (24) 2019 11 06
 (28) 1
 (18) 2024 11 06
 (73) Giorgi Kalandadze (GE)
 Sakhalkho St. 17, 0113, Tbilisi, Georgia (GE)
 (72) Giorgi Kalandadze (GE)
 (54) **HANDBAG**

(11) D 2020 851 S **(51) 03-01**
 (10) AD 2020 1117 S (44) 2020 03 25 №6
 (21) AD 2019 1117
 (22) 2019 11 08
 (24) 2019 11 08
 (28) 1
 (18) 2024 11 08
 (73) Viktoria Berishvili (GE)
 Budapesht St. 10, 0160, Tbilisi, Georgia (GE)
 (72) Viktoria Berishvili (GE)
 (54) **CASKET**

(11) D 2020 850 S **(51) 06-03; 06-04**
 (10) AD 2020 1116 S (44) 2020 03 25 №6
 (21) AD 2019 1116
 (22) 2019 11 08
 (24) 2019 11 08
 (28) 3
 (18) 2024 11 08
 (73) Viktoria Berishvili (GE)
 Budapesht St. 10, 0160, Tbilisi, Georgia (GE)
 (72) Viktoria Berishvili (GE)
 (54) **FURNITURE**

(11) D 2020 848 S **(51) 09-01**
 (10) AD 2020 1113 S (44) 2020 03 25 №6
 (21) AD 2019 1113
 (22) 2019 10 31
 (24) 2019 10 31
 (28) 1
 (18) 2024 10 31
 (73) Natalia Berezhnikh (RU)
 Ulitsa Sportivnaya, dom 15, Kanevskiy Raion,
 Kanevskaya Stanitsa, Krasnodarskiy Kray,
 Russian Federation (RU)
 (72) Natalia Berezhnikh (RU)
 (74) Naira Badaliani (GE)
 (54) **BOTTLE**

(11) D 2020 849 S **(51) 09-01**
 (10) AD 2020 1112 S (44) 2020 03 25 №6
 (21) AD 2019 1112
 (22) 2019 10 29
 (24) 2019 10 29
 (28) 2
 (18) 2024 10 29
 (73) LLC "ALAZANI WINERY" (GE)
 D. Tavdadebuli St. 3, 4800, Kvareli,
 Georgia (GE)
 (72) Giorgi Zautashvili (GE)
 (74) Giorgi Kartvelishvili (GE)
 (54) **BOTTLES**

DESIGNS, WHICH HAVE BEEN REGISTERED WITH THE INTERNATIONAL BUREAU CLAIMING PRIORITY ON THE TERRITORY OF GEORGIA

The decision can be appealed at the Chamber of Appeal of Sakpatenti within 3 months from the publication or at the Mtskheta District Court Administrative Cases Board (Address: №17, Samkhedro Str., Mtskheta), within 1 month following the publication.

- (11) **DM/207 357** **(51) 02-04**
(15) 2020 03 07 (44) 18/2020 (2020 05 01)
(22) 2020 03 07
(28) 2
(73) Valentino S.p.A
 Via Turati 16/18, 20121 Milano (IT)
(85) –
(86) IT, EM
(87) IT, EM
(88) IT, EM
(89) EM
(81) III. GE, TR, UA, KG, AZ, EM, KR, TJ, JP, RU
(72) Stefano Sassi
 C/o Valentino S.p.A., Via Turati 16/18, 20121, Milano (IT)
(74) Matteo Mozzi
 C/o Jacobacci & Partners Via Senato, 8, 20121 Milano (IT)
(54) 1.-2. Shoe
(55)

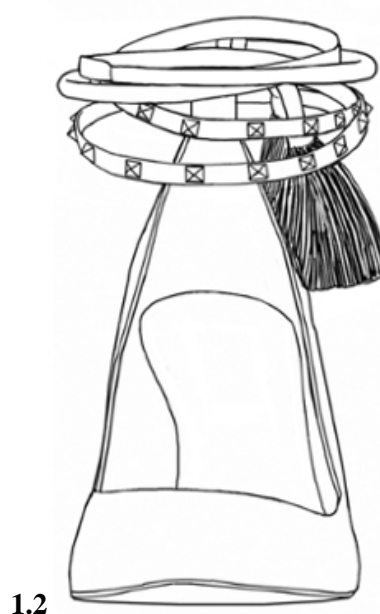
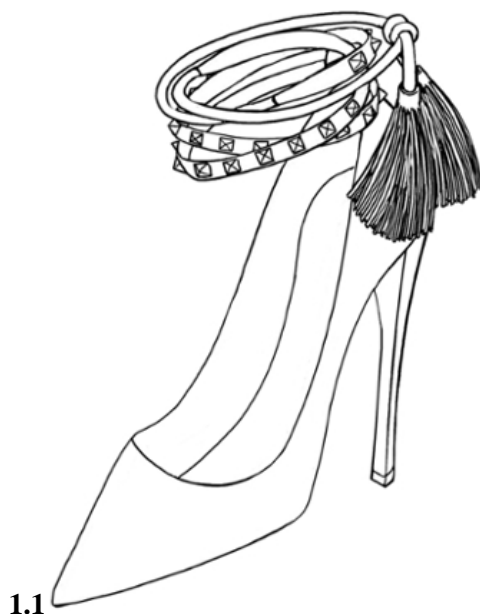

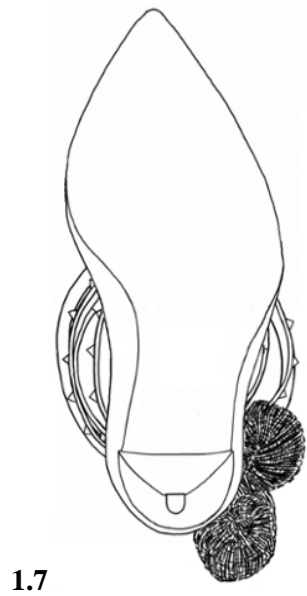
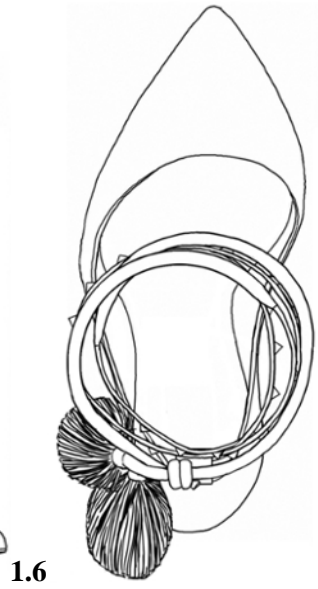

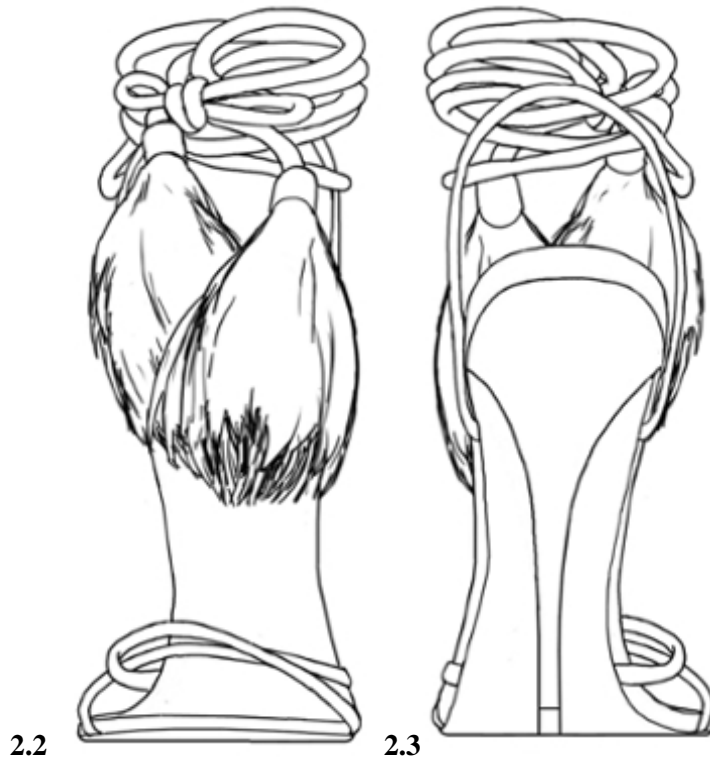



(11) DM/207 538

(51) 02-04

(15) 2019 09 04

(44) 18/2020 (2020 05 01)

(22) 2019 09 04

(28) 1

(30) No1: 05.03.2019; 006279600; EM

(73) Fento Knee Protection B.V.

Polderdyk 7, 8406 AR Tijnje (NL)

(85) EM

(86) BX

(87) BX

(88) BX

(89) EM

(81) II. MA, SR III. AM, IS, MD, TJ, BW, MN, GH, ST, TR, KH, GB, TN, KR, JP, CH, KP, UA, BN, AL, AZ, TM, ME, BZ, MC, SG, NA, OA, NO, RS, BA, US, OM, CA, MK, GE, LI, KG, SM, SY, RW, RU, EG

(72) Gerardus Bernardus Kaal

Polderdyk 7, 8406 AR, Tijnje (NL)

(74) Inaday

Hengelosestraat 141, 7521AA Enschede (NL)

(54) 1. Knee protector

(55)

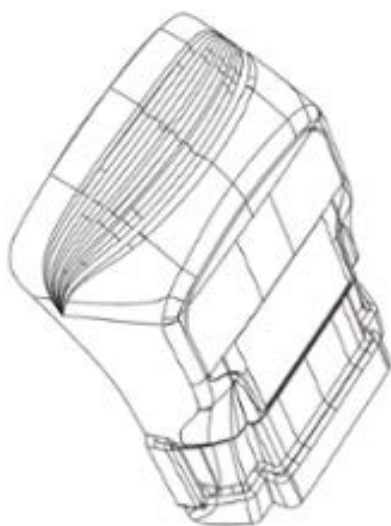

1.1

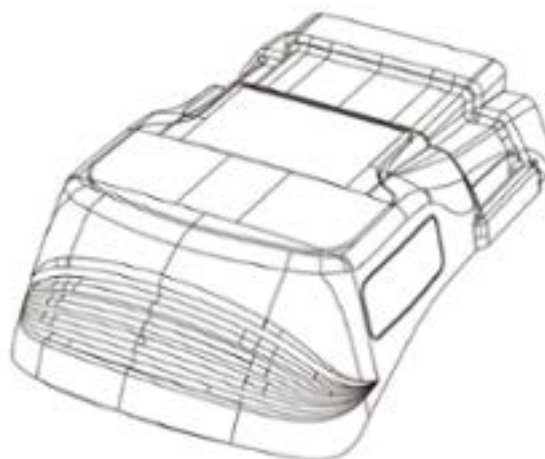

1.2

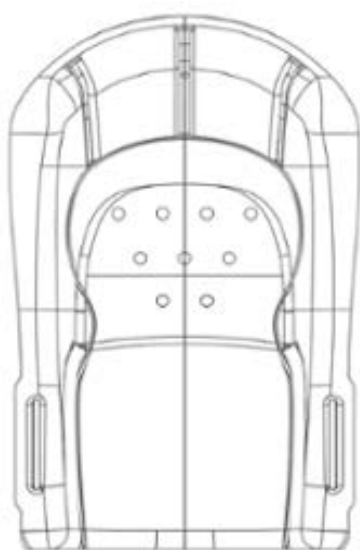

1.3

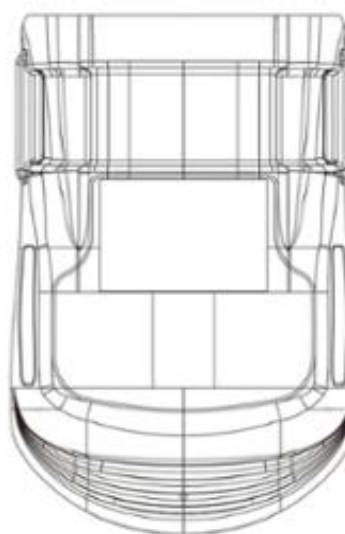

1.4

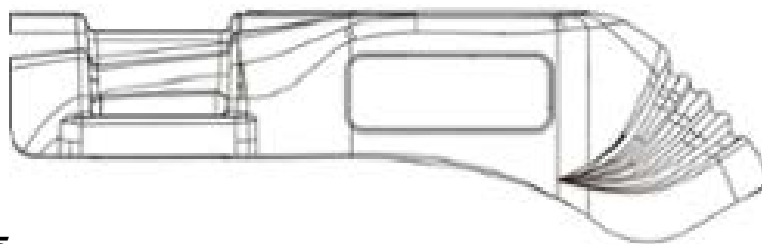

1.5

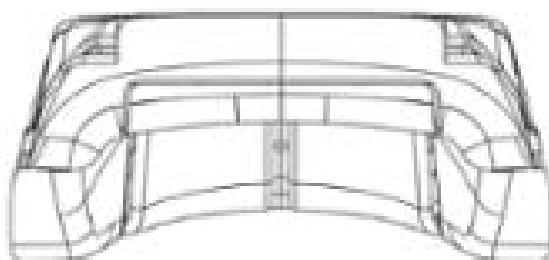

1.6

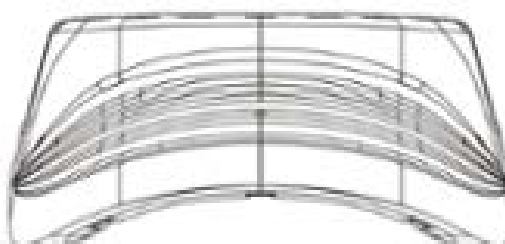

1.7

(11) DM/207 358

(15) 2020 03 07

(22) 2020 03 07

(28) 2

(73) Valentino S.p.A.

Via Turati, 16/18, 20121 Milan (IT)

(85) –

(86) IT, EM

(87) IT, EM

(88) IT, EM

(89) EM

(81) III. GE, TR, UA, KG, AZ, EM, KR, TJ, JP, RU

(72) Stefano Sassi

C/o Valentino S.p.A., Via Turati, 16/18, 20121, Milan (IT)

(74) Matteo Mozzi

C/o Jacobacci & Partners Spa, Via Senato, 8, 20121 Milan (IT)

(54) 1.-2. Bag

(55)

(51) 03-01

(44) 18/2020 (2020 05 01)

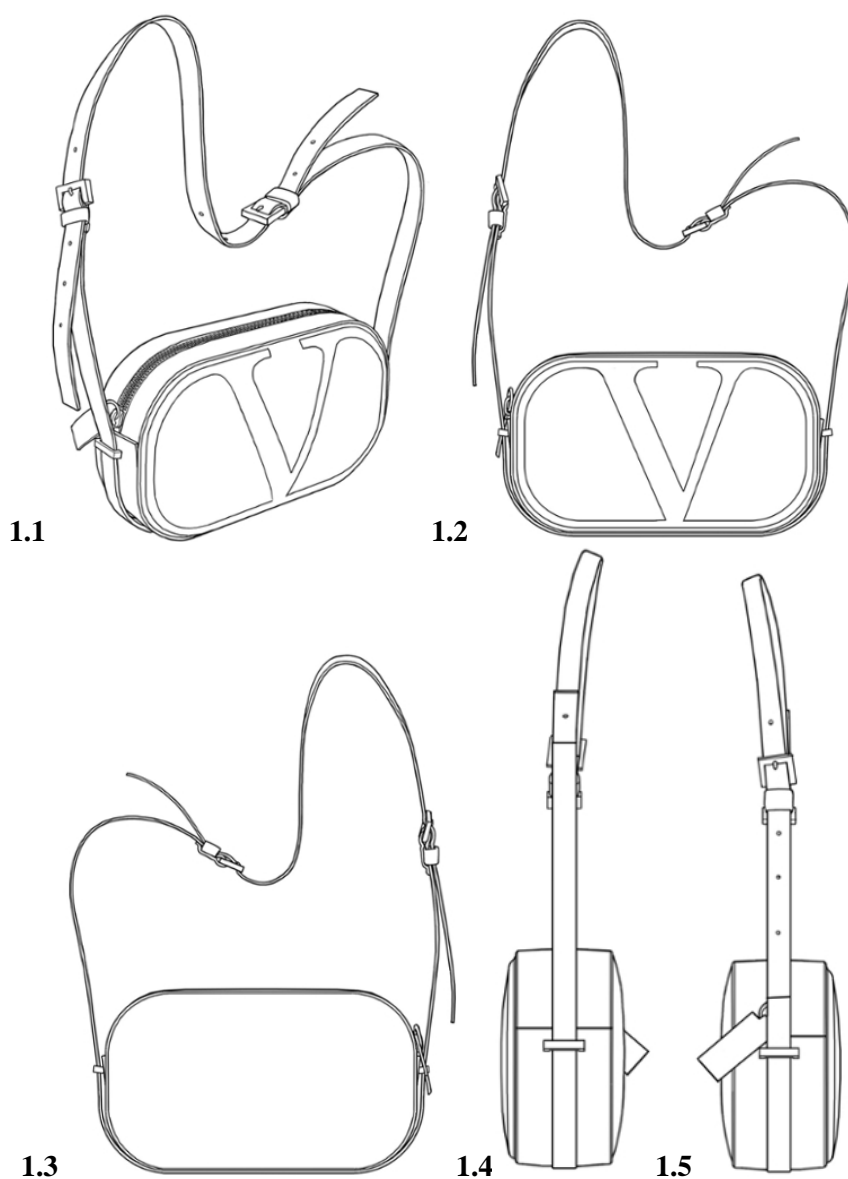

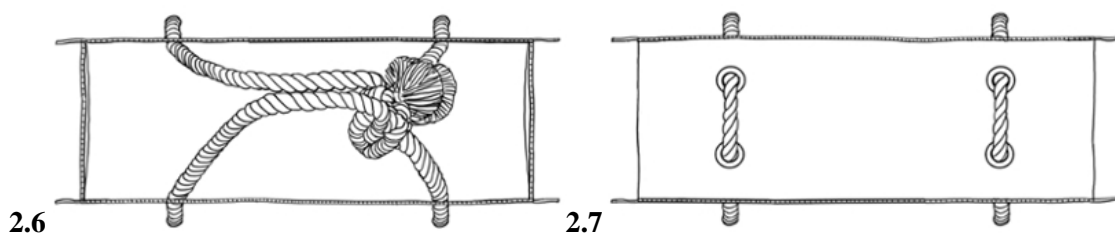
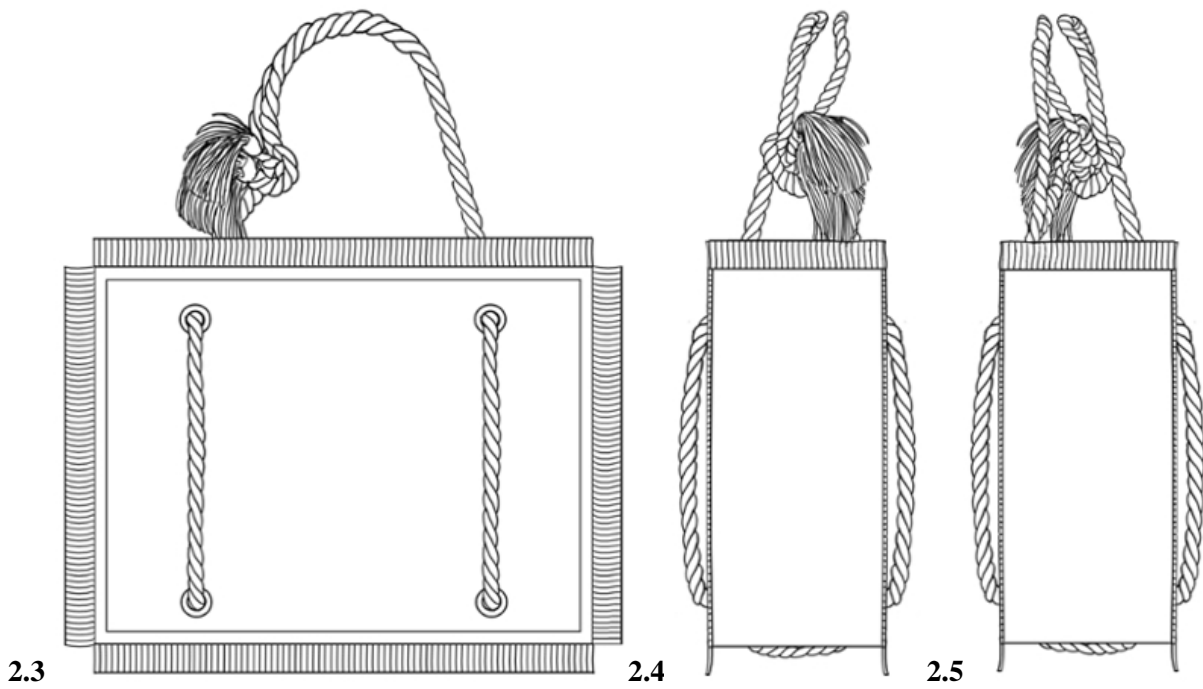
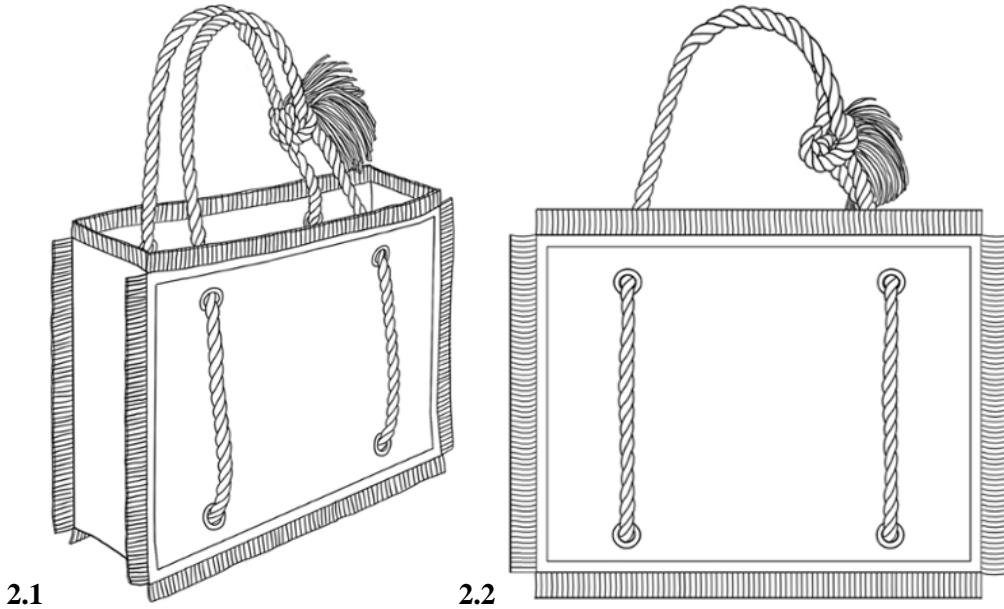
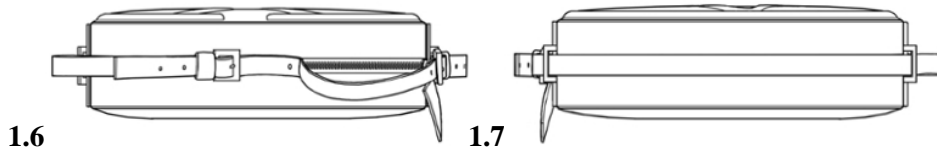

(11) DM/207 402

(15) 2020 03 26

(22) 2020 03 26

(28) 1

(30) No1: 07.09.2019; 2019504229; RU

(73) F&I Beverages AG

Baarerstrasse 52, CH-6300 Zug (CH)

(85) CH

(86) –

(87) CH

(88) CH

(89) CH

(81) IL, GR, GA, MA, SN, SR, IT, BJ, NE, CI, ML III, ES, HU, IS, MN, PL, GB, LT, KR, JP, BN, FR, AL, HR, LV, TM, BZ, MC, SG, NA, DE, BA, MK, US, LI, WS, KG, FI, EG, AM, VN, MD, TJ, BW, ST, GH, TR, KH, TN, CH, KP, IL, UA, AZ, ME, SI, BX, OA, RS, NO, EE, GE, CA, OM, RO, SM, EM, DK, SY, RW, BG

(72) Dmitriy Ignatenko

Frumoasa 43, Mun. Chisinau (MD)

(74) Patent Agency "Ermakova, Stolarova And Partners"

Bld. 2, 2, Shmitovsky Pr., 123100 Moscow (RU)

(54) 1. Beverage bottle

(55)

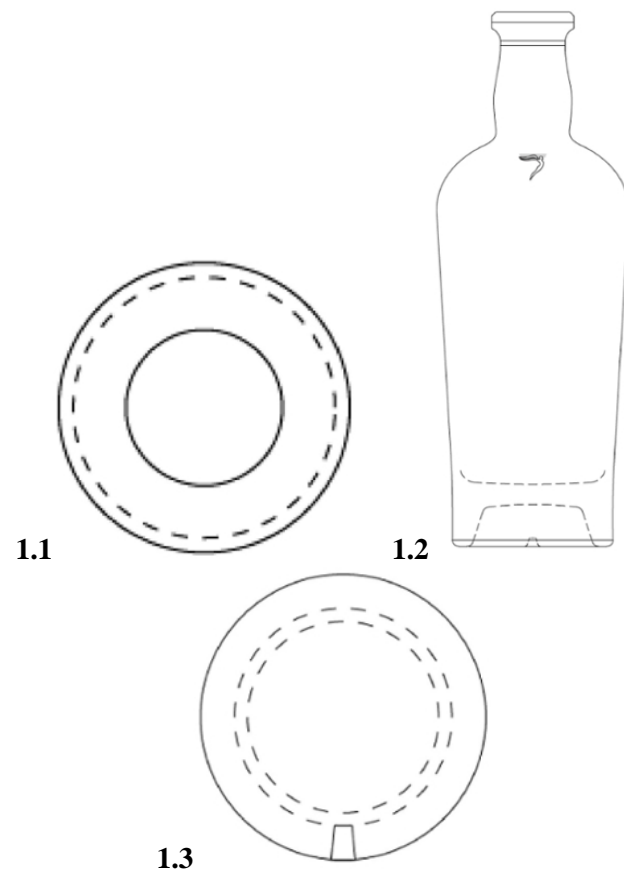

(11) DM/207 408

(51) 09-05

(15) 2020 03 18

(44) 18/2020 (2020 05 01)

(22) 2020 03 18

(28) 1

(73) Nastasya Olegovna Ivanova

Ul. Mashinostroeniya, 2-ya, 11-41, 115088 Moscow (RU)

(85) –

(86) RU

(87) RU

(88) –

(89) RU

(81) III. GE, US, AM, UA, EM, BG

(72) Nastasya Olegovna Ivanova

Ul. Mashinostroeniya, 2-ya, 11-41, 115088 Moscow (RU)

(74) Maxim Andreevich Chernyaev

Ul. Yasnogorskaya, 17-2-312, 117463 Moscow (RU)

(54) 1. Blister package

(55)

1.1

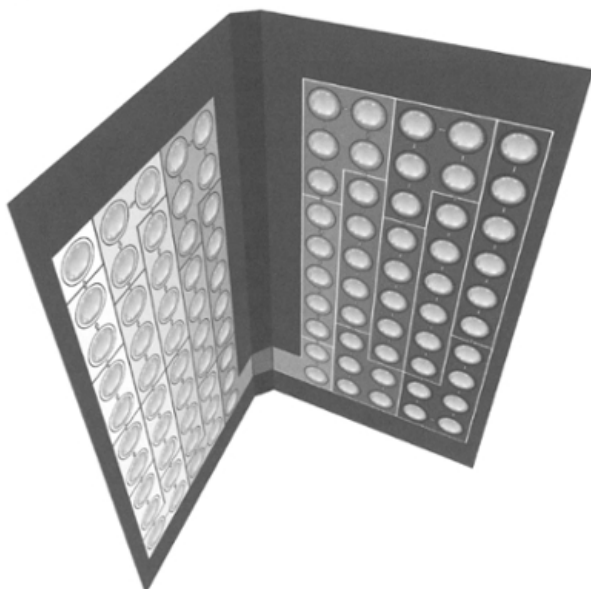

1.2

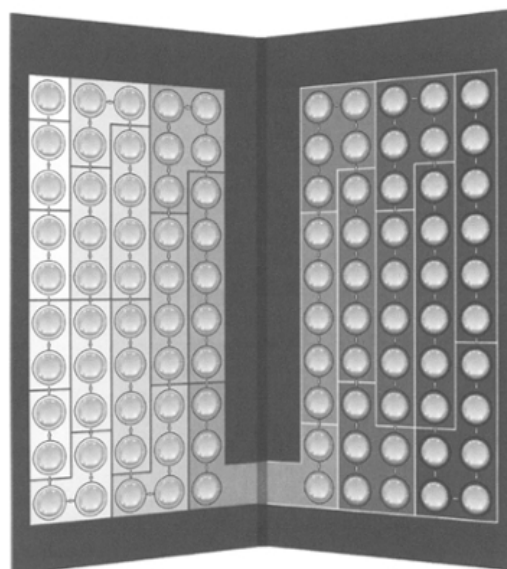

1.3

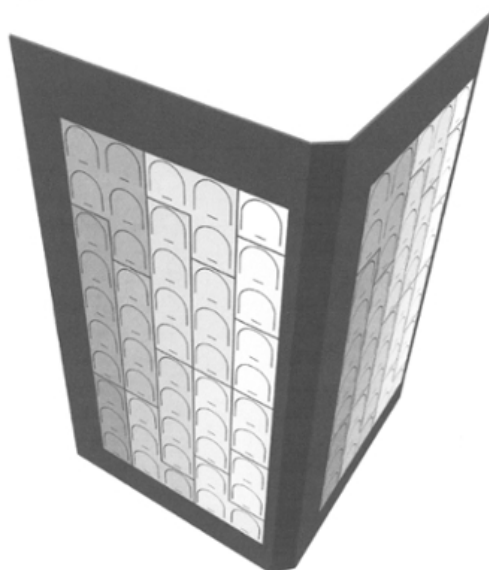

1.4

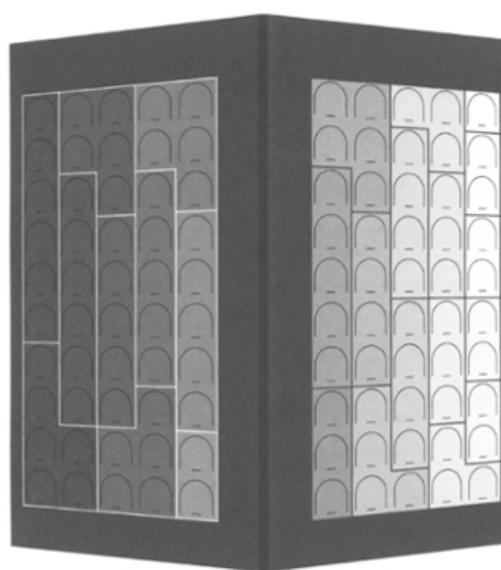

1.5

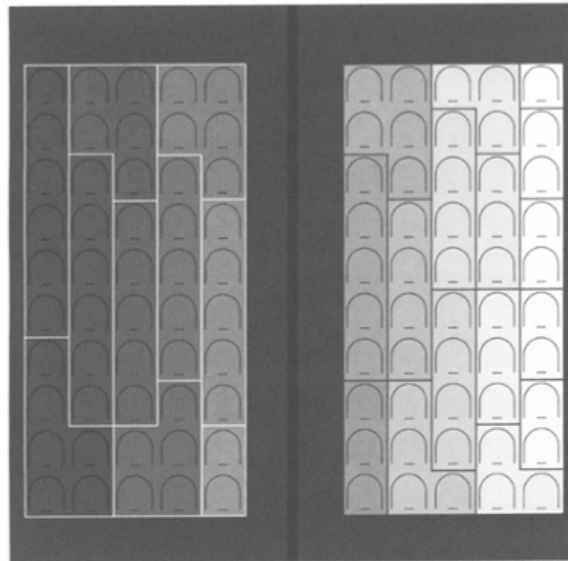

1.6

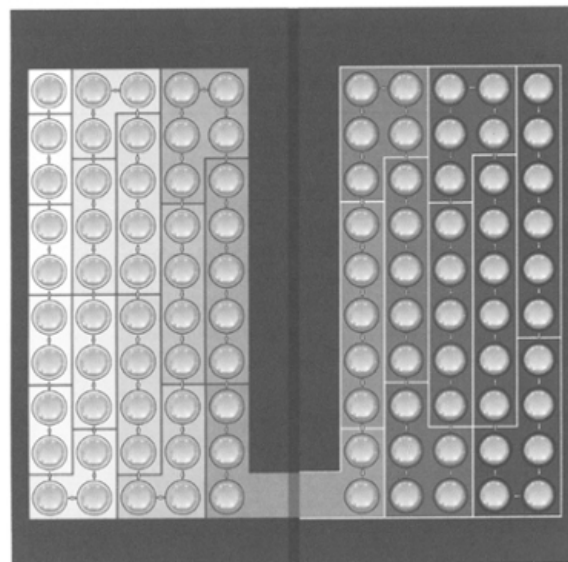

- (11) **DM/204 345** (51) **10-02**
(15) 2019 10 31 (44) 18/2020 (2020 05 01)
(22) 2019 10 31
(28) 2
(73) RADO UHREN AG (RADO WATCH CO. LTD.) (MONTRES RADO SA)
Bielstrasse 45, 2543 Lengnau (CH)
(85) –
(86) CH
(87) CH
(88) –
(89) CH
(81) II. MA III. NO, BA, OM, GE, TR, UA, GB, TN, EM, CH, SG
(72) Paulo Manuel BRAVO
Ch. Du Verger-en-Joran 4, 2074, Marin-Epagnier (CH)
(74) The Swatch Group SA (The Swatch Group AG) (The Swatch Group Ltd.)
Faubourg du Lac 6, 2501 Biel/Bienne (CH)
(54) 1.-2. Watch
(55)

1.1



1.2



1.3



1.4



1.5



1.6



1.7

1.8

2.1

2.2



2.3

2.4



2.5

2.6



2.7

2.8



(11) DM/204 811

(15) 2019 11 01

(22) 2019 11 01

(28) 1

(73) RADO UHREN AG (RADO WATCH CO. LTD.) (MONTRES RADO SA)
Bielstrasse 45, 2543 Lengnau (CH)

(85) –

(86) CH

(87) CH

(88) –

(89) CH

(81) II, MA III, NO, BA, GE, TR, OM, UA, GB, TN, EM, CH, SG

(72) Fabrice DUPORT

Avenue De La Gare 4, 2000, Neuchâtel (CH)

(74) The Swatch Group AG (The Swatch Group SA) (The Swatch Group Ltd.)

Faubourg Du Lac 6, 2501 Biel/Bienne (CH)

(54) 1. Wristwatch

(55)

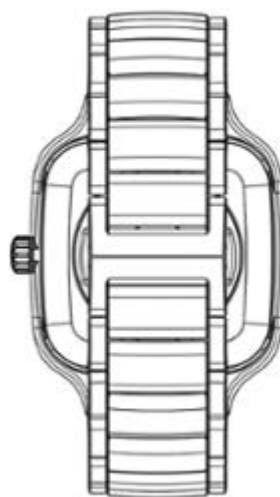
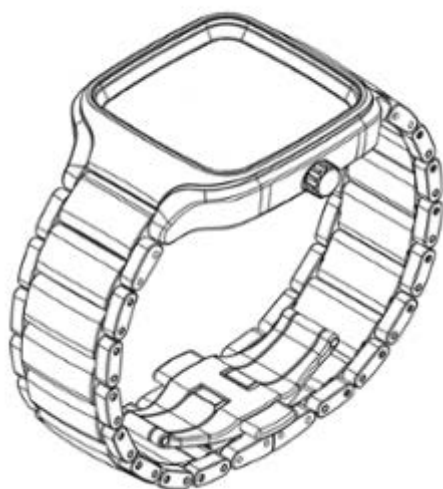
1.1**1.2****1.3****1.4**

1.5

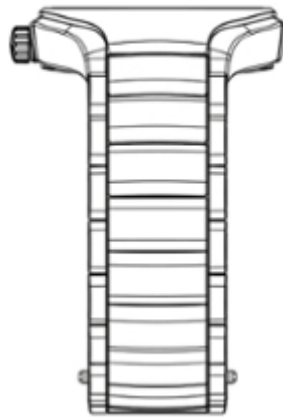

1.6

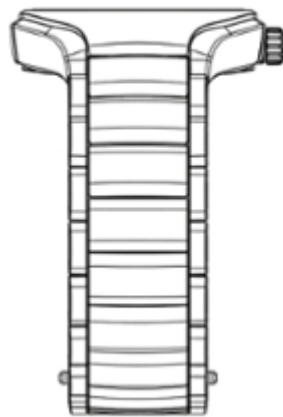

1.7

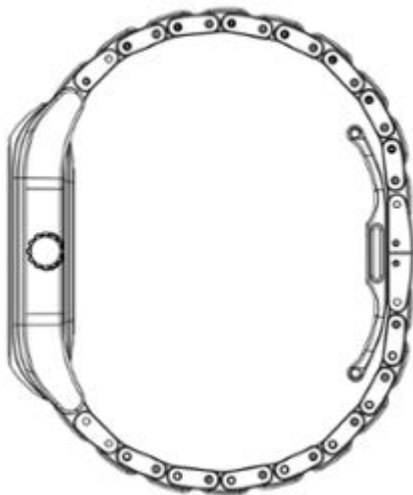

1.8

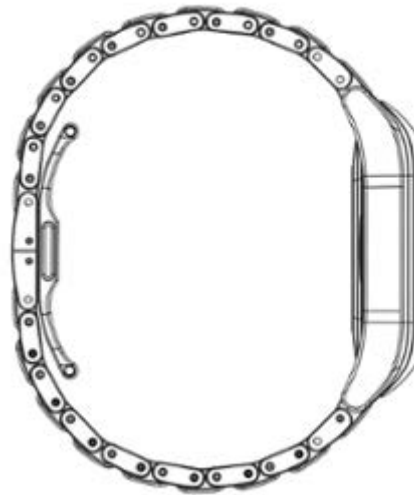

(11) DM/204 352

(15) 2019 10 28

(22) 2019 10 28

(28) 4

(73) HARRY WINSTON SA

Chemin du Tourbillon 8, 1228 Plan-les-Ouates (CH)

(85) CH

(86) CH

(87) CH

(88) CH

(89) CH

(81) II. MA III. AM, MD, MN, TR, GB, TN, CH, UA, AL, AZ, ME, BZ, MC, SG, NO, BA, OM, CA, MK, GE, LI, KG, EM, RU

(72) Rie YATSUGI-KANG

c/o Harry Winston Inc. 718 Fifth Avenue, 10019, New York (US)

(74) The Swatch Group AG (The Swatch Group SA) (The Swatch Group Ltd.)

Faubourg du Lac 6, 2501 Biel/Bienne (CH)

(54) 1. Pair of earrings, 2. Bracelet, 3.-4. Necklace

(55)

1.1**1.2**

1.3



1.4



1.5



1.6



1.7



1.8

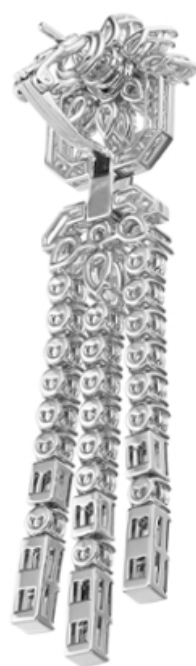

2.1



2.2



2.3



2.4



2.7



2.5



2.6



2.8



3.1



3.2



3.3



3.4



3.5



3.6



3.7



3.8



4.1



4.2



4.3



4.4



4.5



4.6



4.7



4.8



(11) DM/205 045

(15) 2019 11 01

(22) 2019 11 01

(28) 5

(73) HARRY WINSTON SA

Chemin Du Tourbillon 8, 1228 Plan-les-Ouates (CH)

(85) CH

(86) CH

(87) CH

(88) CH

(89) CH

(81) IL, MA III, AM, MD, MN, TR, GB, TN, CH, UA, AL, AZ, ME, BZ, MC, SG, NO, BA, GE, CA, MK, OM, LI, KG, EM, RU

(72) 1 Tobias WUEST

C/o Harry Winston Inc., 718 Fifth Avenue, 10019, New York (US);

1;5 Rie YATSUGI-KANG

C/o Harry Winston Inc., 718 Fifth Avenue, 10019, New York (US);

3 Dominique RIVIERE

C/o Harry Winston Inc., 718 Fifth Avenue, 10019, New York (US);

4 Delphine ABDOURAHIM

C/o Harry Winston Inc., 718 Fifth Avenue, 10019, New York (US)

(74) The Swatch Group AG (The Swatch Group SA) (The Swatch Group Ltd.)

Faubourg Du Lac 6, 2501 Biel/Bienne (CH)

(54) 1. Pair of earrings, 2. Necklace, 3. Pair of earrings, 4. Finger ring, 5. Necklace

(55)

1.1**1.2**

1.3



1.4



1.5



1.6



1.7



1.8



2.1



2.2



2.3



2.4



2.5



2.6



2.7



2.8



3.1

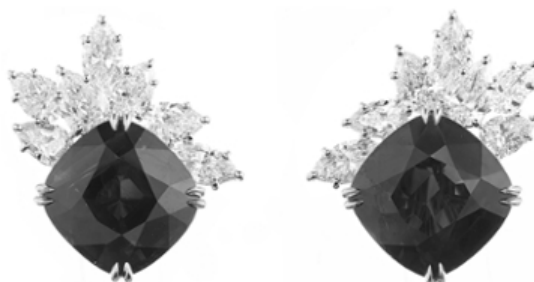

3.2



3.3



3.4



3.5



3.6



3.7



3.8



4.1



4.2



4.3



4.4



4.5



4.6



4.7



4.8



5.1



5.2



5.3



5.4



5.5



5.6



5.7



5.8



(11) DM/205 522

(51) 09-07

(15) 2019 11 07

(44) 19/2020 (2020 05 08)

(22) 2019 11 07

(28) 1

(73) COMPAÑÍA DE TAPONES IRRELLENABLES, S.A.

Polígono Industrial El Portal Marruecos, Parc 1B, 11406 Jerez De La Frontera, Cádiz (ES)

(85) ES

(86) ES

(87) ES

(88) ES

(89) EM

(81) III. GE, AM, GB, EM, RU

(72) Eduardo JIMÉNEZ GÁLVEZ

Polígono Industrial El Portal Marruecos, Parc 1B, 11406, Jerez De La Frontera, Cádiz (ES)

(74) ABG Intellectual Property Law, S.L.

Avenida De Burgos, 16D, 28036 Madrid (ES)

(54) 1. Bottle cap

(55)

1.1



1.2



1.3

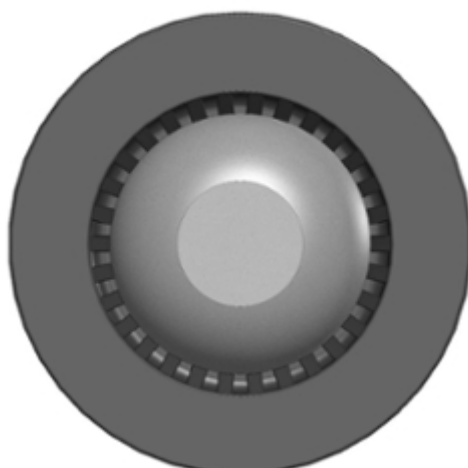

1.4



1.5

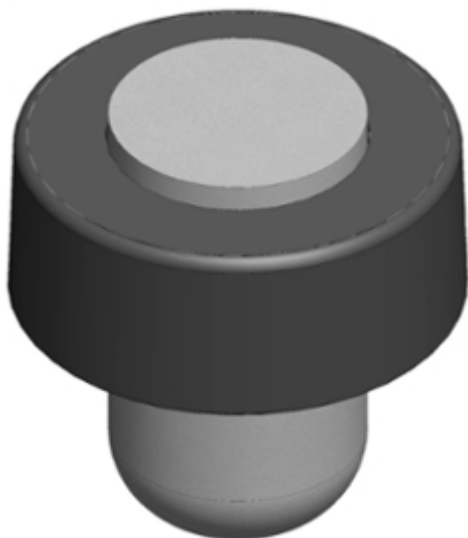

1.6

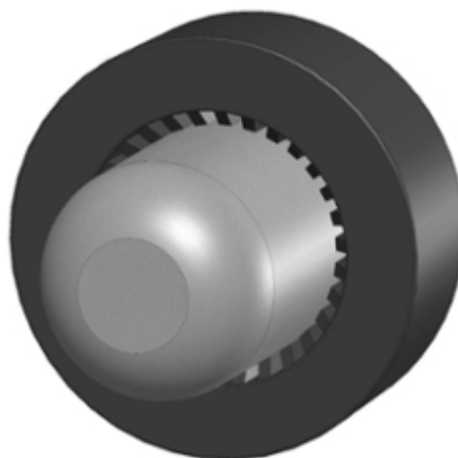

1.7



1.8



TRADEMARKS

APPLICATIONS FILED UNDER THE NATIONAL PROCEDURE APPROVED FOR REGISTRATION

The decision can be appealed at the Chamber of Appeal of Sakpatenti within 3 months from the publication or at the Mtskheta District Court Administrative Cases Board (Address: №17, Samkhedro St., Mtskheta), within 1 month following the publication.

(260) AM 2020 103313 A
(210) AM 103313
(220) 2019 11 21
(731) LTD "Georgian-German School Skhivi"
Dighomi Experimental Training Farm,
Plot 368, Vake-Saburtalo District, Tbilisi,
Georgia
(540)



(591) Black, red, lilac, white, cream-colored
(531) 04.05.04; 26.04.02; 26.04.22; 27.05.01;
27.05.09; 27.05.24; 29.01.14
(511) 41

(260) AM 2020 105026 A
(210) AM 105026
(220) 2019 09 24
(731) JSC "GEPHA"
Akaki Beliasvili St. 142, 0159, Tbilisi,
Georgia
(740) Salome Jeladze
(540)

GRANDOPTICA

(591) Black, white
(511) 9, 35, 44

(260) AM 2020 105454 A
(210) AM 105454
(220) 2019 10 24
(731) JSC "Georgian Capital"
Kazbegi St. 3-5, 0179, Mtatsminda District,
Tbilisi, Georgia
(740) Levan Dadiani
(540)



(591) Black, white
(531) 03.01.01; 03.01.16; 26.01.15; 28.19
(526) საქართველო
(511) 31, 32, 33, 35, 37, 38, 41, 43, 44

(260) AM 2020 105455 A
(210) AM 105455
(220) 2019 10 24
(731) JSC "Georgian Capital"
Kazbegi St. 3-5, 0179, Mtatsminda District,
Tbilisi, Georgia
(740) Levan Dadiani
(540)



(591) Black, white
(531) 03.01.01; 03.01.16; 26.01.15; 27.05.01
(526) Georgia
(511) 31, 32, 33, 35, 37, 38, 41, 43, 44

(260) AM 2020 105740 A
(210) AM 105740
(220) 2019 11 08
(731) MGA Entertainment Inc.
9220 Winnetka Avenue, Chatsworth,
California, 91311, USA
(740) Shalva Gvaramadze
(540)

L.O.L. SURPRISE!

(591) Black, white
(511) 3, 9, 14, 16, 18, 20, 21, 24, 25, 26, 28, 41

(260) AM 2020 105742 A
(210) AM 105742
(220) 2019 11 08
(731) MGA Entertainment Inc.

9220 Winnetka Avenue, Chatsworth,
California, 91311, USA

(740) Shalva Gvaramadze
(540)

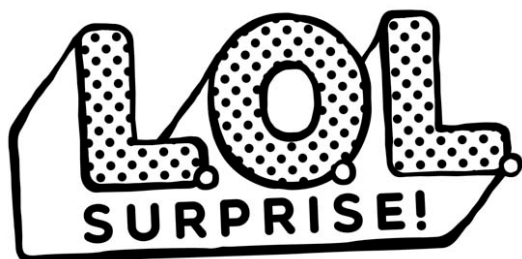

(591) Black, white
(531) 24.17.02; 24.17.04; 25.07.07; 27.05.01;
27.05.03; 27.05.04; 27.05.09; 27.05.25
(511) 3, 9, 14, 16, 18, 20, 21, 24, 25, 26, 28, 41

(260) AM 2020 105783 A
(210) AM 105783
(220) 2019 11 18
(731) GRUPO MASSIMO DUTTI, S.A.
Avenida de la Diputación, Edificio Inditex,
Arteixo (A Coruña), Spain
(740) Tamaz Shilakadze
(540)

მასიმო დუტი

(591) Black, white
(511) 35

(260) AM 2020 105819 A
(210) AM 105819
(220) 2019 11 21
(731) LTD "Kardenakhi Vineyards"
Kutaisi St. 27, app. 9, Batumi,
Georgia
(540)

ბანცალი
bantsali

(591) Black, white
(511) 33

(260) AM 2020 105882 A
(210) AM 105882
(220) 2019 11 26
(731) Guangzhou Xibin Trading Co., Ltd
1802-1803, Guanchjou Interneshnl
Fainans-senter, №5 Chjuczian Vest Roud,
Tianhe Distriqt, Guanchjou Siti, Guandun
Provins, China
(740) Liliana Darakhvelidze

(540)



(591) Light green, turquoise, white
(531) 26.04.01; 26.04.09; 26.04.18; 27.05.01
29.01.13
(511) 35

(260) AM 2020 105884 A
(210) AM 105884
(220) 2019 11 27
(310) № 40-2019-0103087
(320) 2019 07 03
(330) KR
(731) Kia Motors Corporation
12, Heolleung-ro, Seocho-gu, Seoul,
Republic of Korea
(740) Merab Kvimsadze
(540)

KIA K7

(591) Black, white
(531) 27.07.11
(511) 12

(260) AM 2020 105885 A
(210) AM 105885
(220) 2019 11 27
(731) Western Digital Technologies, Inc
5601 Great Oaks Parkway San Jose,
California, 95119, USA
(740) Tamar Kochlamazashvili
(540)



(591) Black, white
(531) 26.11.12; 27.01.01; 27.01.12; 27.05.21
(511) 9, 16, 35, 42

(260) AM 2020 105890 A
 (210) AM 105890
 (220) 2019 11 28
 (731) LTD "AVERSI-PHARMA"
 D. Aghmashenebeli Av. 148/2, 0112,
 Tbilisi, Georgia
 (540)

ამლოდოლი

Амлодол

Amlodol

(591) Black, white
 (511) 5

(260) AM 2020 105892 A
 (210) AM 105892
 (220) 2019 11 28
 (731) LTD "AVERSI-PHARMA"
 D. Aghmashenebeli Av. 148/2, 0112,
 Tbilisi, Georgia
 (540)

ამლოპერი

Амлопер

Amloper

(591) Black, white
 (511) 5

(260) AM 2020 105967 A
 (210) AM 105967
 (220) 2019 12 02
 (731) JSC "Georgian Beer Company"
 Vill. Saguramo, 3311, Mtskheta district,
 Georgia
 (540)

რამე

Rame

Pame

(591) Black, white
 (511) 32

(260) AM 2020 105974 A
 (210) AM 105974
 (220) 2019 12 03
 (731) LTD "KARIBCHE"
 P. Kavtaradze St. 14b, app. 29, Tbilisi,
 Georgia
 (740) Gela Peradze
 (540)

შატო კარიბჭე

SHATO KARIBTCHE

(591) Black, white
 (511) 33, 43

(260) AM 2020 105984 A
 (210) AM 105984
 (220) 2019 12 05
 (731) BASF Agro B.V. Arnhem (NL)
 Zweigniederlassung Freienbach
 Huobstrasse 3, Pfäffikon SZ, Switzerland
 (740) Giorgi Taktakishvili
 (540)

REVYSION

(591) Black, white
 (511) 1, 5

(260) AM 2020 105990 A
 (210) AM 105990
 (220) 2019 12 05
 (310) 34529
 (320) 2019 11 14
 (330) AD
 (731) PHILIP MORRIS BRANDS SÀRL
 Quai Jeanrenaud 3, 2000 Neuchâtel,
 Switzerland
 (740) Shalva Gvaramadze
 (540)

JUNGLE VIBES

(591) Black, white
 (511) 34

(260) AM 2020 105991 A
 (210) AM 105991
 (220) 2019 12 05
 (310) 34499
 (320) 2019 11 14
 (330) AD
 (731) PHILIP MORRIS BRANDS SÀRL
 Quai Jeanrenaud 3, 2000 Neuchâtel,
 Switzerland
 (740) Shalva Gvaramadze
 (540)

FOREST MIST

(591) Black, white
(511) 34

(260) AM 2020 106167 A
(210) AM 106167
(220) 2019 12 16
(310) 34551
(320) 2019 11 20
(330) AD
(731) PHILIP MORRIS BRANDS SÀRL
Quai Jeanrenaud 3, 2000 Neuchâtel,
Switzerland
(740) Shalva Gvaramadze
(540)

TEREA

(591) Black, white
(511) 34

(260) AM 2020 106183 A
(210) AM 106183
(220) 2019 12 18
(731) State Atomic Energy Corporation
"ROSATOM"
Bolshaya Ordynka St. 24, 119017, Moscow,
Russian Federation
(740) Natela Otariidze
(540)



ROSATOM

(591) White, light blue, blue, dark blue, dark gray,
gray
(531) 26.01.01; 26.01.10; 26.01.12; 26.03.06;
26.03.10; 29.01.12
(511) 1, 2, 4, 5, 6, 7, 9, 10, 11, 12, 13, 16, 17, 19, 22,
35, 36, 37, 38, 39, 40, 41, 42, 44, 45

(260) AM 2020 106184 A
(210) AM 106184
(220) 2019 12 18
(731) State Atomic Energy Corporation
"ROSATOM"
Bolshaya Ordynka St. 24, 119017, Moscow,
Russian Federation
(740) Natela Otariidze

(540)



POCATOM

(591) White, dark blue, light blue, blue, dark gray,
gray
(531) 26.01.01; 26.01.10; 26.01.12; 26.03.06;
26.03.10.27.05.10; 29.01.12
(511) 1, 2, 4, 5, 6, 7, 9, 10, 11, 12, 13, 16, 17, 19, 22,
35, 36, 37, 38, 39, 40, 41, 42, 44, 45

(260) AM 2020 106280 A
(210) AM 106280
(220) 2019 12 23
(310) 88/594,797; 88/594,948; 88/594,826;
88/594,850; 88/594,863; 88/594,884
(320) 2019 08 27
(330) US
(731) PW Branding, Inc.
c/o Aspire IP LLC, 444 E. Pikes Peak Ave.,
Suite 105, Colorado Springs, Colorado 80903,
USA
(740) Tamaz Shilakadze
(540)

HUMAN RACE

(591) Black, white
(511) 16, 18, 25, 27, 28

(260) AM 2020 106320 A
(210) AM 106320
(220) 2019 12 25
(731) LTD "SVI"
M. Kostava St. 75, app. 31, 0171, Tbilisi,
Georgia
(540)

ქუქუნა
Jujuna
жужуна

(591) Black, white
(511) 32, 33, 35, 43

REGISTERED TRADEMARKS

(111) M 2020 32805 R
(151) 2020 07 01
(181) 2030 07 01
(260) AM 2019 103028 A
(220) 2019 05 08
(732) LTD "Kvareli Wine Company"
Lermontov St. 3, Kvareli, Georgia

(111) M 2020 32806 R
(151) 2020 07 01
(181) 2030 07 01
(260) AM 2019 103107 A
(220) 2019 05 14
(732) LTD "Georgian Wine House"
Vill. Zegaani, 1500, Gurjaani district
Georgia

(111) M 2020 32807 R
(151) 2020 07 01
(181) 2030 07 01
(260) AM 2019 103114 A
(220) 2019 05 16
(732) Khayrat Al-Manafa for General
Trade end Public Transport Limited
Liability Company
27, Saborni St., Varna, Bulgaria

(111) M 2020 32808 R
(151) 2020 07 01
(181) 2030 07 01
(260) AM 2019 103115 A
(220) 2019 05 16
(732) Khayrat Al-Manafa for General
Trade end Public Transport Limited
Liability Company
27, Saborni St., Varna, Bulgaria

(111) M 2020 32809 R
(151) 2020 07 01
(181) 2030 07 01
(260) AM 2019 103119 A
(220) 2019 05 16
(732) Khayrat Al-Manafa for General
Trade end Public Transport Limited
Liability Company
27, Saborni St., Varna, Bulgaria

(111) M 2020 32810 R
(151) 2020 07 01
(181) 2030 07 01

(260) AM 2019 103120 A
(220) 2019 05 16
(732) Khayrat Al-Manafa for General
Trade end Public Transport Limited
Liability Company
27, Saborni St., Varna, Bulgaria

(111) M 2020 32811 R
(151) 2020 07 01
(181) 2030 07 01
(260) AM 2019 103203 A
(220) 2019 05 22
(732) Dali Gogitashvili
Racha St. 17, 4800, Kvareli, Georgia

(111) M 2020 32812 R
(151) 2020 07 01
(181) 2030 07 01
(260) AM 2019 103304 A
(220) 2019 05 24
(732) LTD "STARTLET GROUP"
R. Tabukashvili St. 119, app. 49, Kutaisi,
Georgia

(111) M 2020 32813 R
(151) 2020 07 01
(181) 2030 07 01
(260) AM 2019 103343 A
(220) 2019 05 30
(732) Shenzhen Bailuo Technology CO., LTD
Room C628, Mingyou Center, Baoyuan Road,
Xixiang, Bao'an District, Shenzhen, China

(111) M 2020 32814 R
(151) 2020 07 01
(181) 2030 07 01
(260) AM 2019 103559 A
(220) 2019 06 10
(732) LTD "MY OFFICE"
Ak. Beliashvili St. 9, 0159, Tbilisi, Georgia

(111) M 2020 32815 R
(151) 2020 07 01
(181) 2030 07 01
(260) AM 2019 103576 A
(220) 2019 06 12
(732) LTD "TMASI"
Zhoneti St. 13, Isani district, Tbilisi,
Georgia

(111) M 2020 32816 R
(151) 2020 07 01
(181) 2030 07 01
(260) AM 2019 103669 A
(220) 2019 06 19
(732) LTD "ALTA"
Ak. Beliashvili St. 104, 0159, Tbilisi, Georgia

(111) M 2020 32817 R
(151) 2020 07 01
(181) 2030 07 01
(260) AM 2019 103840 A
(220) 2019 06 28
(732) LTD "SHMPS"
Delisi St. 16, Saburtalo district, 0177,
Tbilisi, Georgia

(111) M 2020 32818 R
(151) 2020 07 01
(181) 2030 07 01
(260) AM 2019 103855 A
(220) 2019 07 01
(732) Temur Matiashvili
Vazha-Pshavela Lane II 6-36, Rustavi,
Georgia

(111) M 2020 32819 R
(151) 2020 07 01
(181) 2030 07 01
(260) AM 2019 103883 A
(220) 2019 07 05
(732) Millennium & Copthorne International
Limited
9 Raffles Place, N12-01 Republic Plaza,
Singapore 048619, Singapore

(111) M 2020 32820 R
(151) 2020 07 01
(181) 2030 07 01
(260) AM 2019 104060 A
(220) 2019 07 12
(732) Gigi Tevzadze
Japaridze St. 6, 0172, Tbilisi, Georgia;
Aliosha Bakuridze
Akhvlediani St. 22, 0131, Tbilisi, Georgia

(111) M 2020 32821 R
(151) 2020 07 01
(181) 2030 07 01
(260) AM 2019 104073 A
(220) 2019 07 12
(732) HANGZHOU EZVIZ NETWORK CO. LTD
No.555 Qianmo Road, Binjiang District,
Hangzhou, China

(111) M 2020 32822 R
(151) 2020 07 01
(181) 2030 07 01
(260) AM 2019 104084 A
(220) 2019 07 15
(732) LTD "Georgian Wine & Spirits Company"
Vill. Achinebuli, 2200, Telavi, Georgia

(111) M 2020 32823 R
(151) 2020 07 01
(181) 2030 07 01
(260) AM 2019 104088 A
(220) 2019 07 15
(732) TUANFANG LIU
Room 1603, Building 4, Shajingxi Garden,
No. 8230, Bao'an Avenue, Bao'an
District, Shenzhen, Guangdong, China

(111) M 2020 32824 R
(151) 2020 07 01
(181) 2030 07 01
(260) AM 2019 104217 A
(220) 2019 07 25
(732) LTD "COPPER CABLO"
D. Guramishvili St. 78, Batumi, Georgia

(111) M 2020 32825 R
(151) 2020 07 01
(181) 2030 07 01
(260) AM 2019 104307 A
(220) 2019 07 26
(732) NOVARTIS AG
4002 Basel, Switzerland

(111) M 2020 32826 R
(151) 2020 07 01
(181) 2030 07 01
(260) AM 2019 104402 A
(220) 2019 08 02
(732) Biologische Heilmittel Heel GmbH
Dr.-Reckeweg-Strasse 2-4, D-76532
BadenBaden, Germany

(111) M 2020 32827 R
(151) 2020 07 01
(181) 2030 07 01
(260) AM 2019 104403 A
(220) 2019 08 02
(732) Elvin Pashaev
Vill. Sartichala, 1324, Gardabani District,
Georgia

(111) M 2020 32828 R
(151) 2020 07 01
(181) 2030 07 01
(260) AM 2019 104535 A
(220) 2019 08 12
(732) LTD "Georgian Education Group"
P. Melikishvili Av. 8a/Erekle Tatishvili St. 1,
Mtatsminda district, 0179, Tbilisi, Georgia

(111) M 2020 32829 R
(151) 2020 07 01
(181) 2030 07 01
(260) AM 2019 104537 A
(220) 2019 08 12
(732) LTD "Georgian Education Group"
P. Melikishvili Av. 8a/Erekle Tatishvili St. 1,
Mtatsminda district, 0179, Tbilisi, Georgia

(111) M 2020 32830 R
(151) 2020 07 01
(181) 2030 07 01
(260) AM 2019 103004 A
(220) 2019 05 03
(732) JSC "Polimat Group"
D. Aghmashenebeli Av. 79, 0102,
Tbilisi Georgia

(111) M 2020 32831 R
(151) 2020 07 01
(181) 2030 07 01
(260) AM 2019 103019 A
(220) 2019 05 08
(732) LTD "Bolero & Company"
Kuchishvili St. 12-14-16, fl. 6, 0179,
Tbilisi, Georgia

(111) M 2020 32832 R
(151) 2020 07 01
(181) 2030 07 01
(260) AM 2019 103020 A
(220) 2019 05 08
(732) LTD "Bolero & Company"
Kuchishvili St. 12-14-16, fl. 6, 0179,
Tbilisi, Georgia

(111) M 2020 32833 R
(151) 2020 07 01
(181) 2030 07 01
(260) AM 2019 103209 A
(220) 2019 05 23
(732) Johnson & Johnson
One Johnson & Johnson Plaza,
New Brunswick, New Jersey
08933, USA

(111) M 2020 32834 R
(151) 2020 07 02
(181) 2030 07 02
(260) AM 2019 102832 A
(220) 2019 04 24
(732) LTD "KVARELI CELLAR"
Vill. Chikaani, 4814, Kvareli, Georgia

(111) M 2020 32835 R
(151) 2020 07 02
(181) 2030 07 02
(260) AM 2019 104555 A
(220) 2019 08 19
(732) LTD "BORAN LIGHT"
Marneuli St. 44, Ponichala, 0165, Tbilisi,
Georgia

(111) M 2020 32836 R
(151) 2020 07 02
(181) 2030 07 02
(260) AM 2019 104559 A
(220) 2019 08 21
(732) Import Foods Company LLC
47 Electrotecnicheskaya str., Kiev, 02660,
Ukraine

(111) M 2020 32837 R
(151) 2020 07 02
(181) 2030 07 02
(260) AM 2019 104759 A
(220) 2019 09 04
(732) KANEKA CORPORATION
2-3-18, Nakanoshima, Kita-ku, Osaka,
Japan

(111) M 2020 32838 R
(151) 2020 07 02
(181) 2030 07 02
(260) AM 2019 104812 A
(220) 2019 09 09
(732) F.S. "MALENZI"
Sh. Nutsubidze Plateau, II mcr., I qu.,
corp. 1a, app. 24, 0183, Tbilisi, Georgia

TRADEMARKS REGISTERED ACCORDING TO THE ACCELERATED PROCEDURE

The decision can be appealed at the Chamber of Appeal of Sakpatenti within 3 months from the publication.

(111) M 2020 32791 R
(151) 2020 06 24
(181) 2030 06 24
(210) AM 108521
(220) 2020 06 04
(732) LTD "GEORGIAN HOUSE"
Vill. Akaurta, Bolnisi, Georgia
(540)



(591) Yellow, red, light pink, black, white
(531) 08.05.01; 08.05.02; 08.05.03; 08.05.25;
14.07.02; 14.07.03; 25.01.09; 25.01.10;
25.01.18; 28.19; 29.01.13
(511) 29, 35

(111) M 2020 32792 R
(151) 2020 06 24
(181) 2030 06 24
(210) AM 108608
(220) 2020 06 11
(732) LTD "ECO BOHEMIA"
Vill. Tserovani, 3318, Mtskheta, Georgia
(540)

ღანამა

(591) Black, white
(511) 5

(111) M 2020 32793 R
(151) 2020 06 25
(181) 2030 06 25
(210) AM 108520
(220) 2020 06 04
(732) NOBEL ILAC SANAYII VE TICARET

ANONIM SIRKETI Representative in
Georgia
Liberty Sq. 4, 0105, Tbilisi, Georgia
(740) Tinatin Tskhvediani
(540)

NBL SOLEMAR
ნბლ სოლემარი

(591) Black, white
(511) 5, 35

(111) M 2020 32794 R
(151) 2020 06 25
(181) 2030 06 25
(210) AM 108529
(220) 2020 06 05
(732) NOBEL ILAC SANAYII VE TICARET
ANONIM SIRKETI Representative in
Georgia
Liberty Sq. 4, 0105, Tbilisi, Georgia
(740) Tinatin Tskhvediani
(540)

Parjil
პარჯილი

(591) Black, white
(511) 5, 35

(111) M 2020 32795 R
(151) 2020 06 25
(181) 2030 06 25
(210) AM 108573
(220) 2020 06 05
(732) NOBEL ILAC SANAYII VE TICARET
ANONIM SIRKETI Representative in
Georgia
Liberty Sq. 4, 0105, Tbilisi, Georgia
(740) Tinatin Tskhvediani
(540)

Bipro
ბიპრო

(591) Black, white
(511) 5, 35

(111) M 2020 32796 R
 (151) 2020 06 25
 (181) 2030 06 25
 (210) AM 108587
 (220) 2020 06 08
 (732)
 (732) N(N)LE Georgian Law Institute
 Titsian Tabidze St. 52, floor. 1, Tbilisi,
 Georgia
 (540)



(591) Orange, grey, black
 (531) 27.05.01; 27.05.11; 27.05.22; 28.19; 29.01.12
 (511) 41

(111) M 2020 32797 R
 (151) 2020 06 26
 (181) 2030 06 26
 (210) AM 108661
 (220) 2020 06 12
 (732) Tamar Janashvili
 I. Abashidze St. 20, app. 9, 0108, Tbilisi,
 Georgia

(540)

მამო

(591) Black, white
 (511) 32, 33, 35, 41, 43, 44

(111) M 2020 32798 R
 (151) 2020 06 30
 (181) 2030 06 30
 (210) AM 108691
 (220) 2020 06 18
 (732) Asfarma Medikal Dental Urunler ve İlach San.
 Tic. A.S.
 Bahcheliyler Mah. Resam Halim Sokak
 Kadir Has Ish Merkez N72 34189, Istanbul,
 Turkey
 (740) Maia Samadashvili
 (540)



(591) Yellow, black, white
 Yellow, black, white
 (531) 27.05.01; 27.05.04; 29.01.12
 (511) 5, 10, 35

(111) M 2020 32799 R
 (151) 2020 06 30
 (181) 2030 06 30
 (210) AM 108769
 (220) 2020 06 24
 (732) LTD "JAKARTA"
 D. Aghmashenebeli Av. 179, app. 39, Tbilisi,
 Georgia
 (540)



(591) Dark and light lilacs
 (531) 05.03.19; 05.07.10; 29.01.12
 (511) 33

(111) M 2020 32800 R
 (151) 2020 06 30
 (181) 2030 06 30
 (210) AM 108770
 (220) 2020 06 24
 (732) LTD "JAKARTA"
 D. Aghmashenebeli Av. 179, app. 39, Tbilisi,
 Georgia
 (540)



ROYAN VODKA®

(591) Black, white
 (531) 25.01.25; 27.05.01; 27.05.04; 27.05.21;
 27.05.25
 (511) 33

(111) M 2020 32801 R
 (151) 2020 06 30
 (181) 2030 06 30
 (210) AM 108771
 (220) 2020 06 24
 (732) LTD "JAKARTA"
 D. Aghmashenebeli Av. 179, app. 39, Tbilisi,
 Georgia

(540)



(591) Golden, black

(531) 02.09.01; 21.01.01; 21.01.02; 21.01.03;
25.01.25; 27.05.01; 27.05.04; 27.05.21;
27.05.25; 29.01.12

(511) 33

(111) M 2020 32802 R

(151) 2020 06 30

(181) 2030 06 30

(210) AM 108772

(220) 2020 06 24

(732) LTD "JAKARTA"

D. Aghmashenebeli Av. 179, app. 39, Tbilisi,
Georgia

(540)



(591) Golden, red

(531) 02.09.01; 21.01.01; 21.01.02; 21.01.03;
25.01.25; 27.05.01; 27.05.04; 27.05.25;
29.01.12

(511) 33

(111) M 2020 32803 R

(151) 2020 07 01

(181) 2030 07 01

(210) AM 108734

(220) 2020 06 19

(732) Kakha Zirakashvili

Kareli St. 16, Tbilisi, Georgia

(540)

NIGHT OFFICE CLUB**ნაით ოფის კლუბი**

(591) Black, white

(531) 27.05.01; 28.19

(511) 43

(111) M 2020 32804 R

(151) 2020 07 01

(181) 2030 07 01

(210) AM 108849

(220) 2020 06 26

(732) Giorgi Sarishvili

Nutsbidze Plateau, 2nd mcr., III qu.,
corp. 3, app. 1, Tbilisi Georgia

(540)

უხეში
ukheshi

(591) Black, white

(511) 32

(111) M 2020 32839 R

(151) 2020 07 03

(181) 2030 07 03

(210) AM 108676

(220) 2020 06 16

(732) LTD "New Pharm Group"

Irodion Evdoshvili St. 18, Office Space 2,
0154, Didube District, Tbilisi, Georgia

(540)

პიანტურო
Pianturo
Пиантуро

(591) Black, white

(511) 5

(111) M 2020 32840 R

(151) 2020 07 03

(181) 2030 07 03

(210) AM 108853

(220) 2020 06 29

(732) NOBEL ILAC SANAYII VE TICARET

ANONIM SIRKETI Representative in
Georgia

Liberty Sq. 4, 0105, Tbilisi, Georgia

(740) Tinatin Tskhvediani

(540)

Rivaban
Ривабан
რივაბანი

(591) Black, white

(511) 5, 35

(111) M 2020 32841 R

(151) 2020 07 03

(181) 2030 07 03

(210) AM 108744

(220) 2020 06 22

(732) LTD "MS GLDANI"

Rion Hes St. 59, Tbilisi, Georgia

(540)



(591) Black, white

(531) 02.09.14; 26.13.25; 28.19

(526) გლდანო

(511) 43

INTERNATIONAL TRADEMARKS FOR WHICH A DECISION ON GRANTING PROTECTIONS IS TAKEN

The decision can be appealed at the Chamber of Appeal of Sakpatenti within 3 months from the publication or at the Mtskheta District Court Administrative Cases Board (Address: №17, Samkhedro str., Mtskheta), within 1 month following the publication.

(260) AM 2020 102182 A*
 (800) 1454950
 (151) 2019 01 28
 (891) 2019 01 28
 (731) UAB ATLANTIC DUTY FREE
 Mokyklos g. 1, Mokolų km., LT-68461
 Marijampolės sav., Lithuania
 (540)

STOLYPIN

(591) Black, white
 (511)
 33 – Alcoholic beverages (except beer).

(260) AM 2020 102678 A*
 (800) 946227
 (151) 2007 11 21
 (891) 2019 03 06
 (731) WEETABIX LIMITED
 Weetabix Mills, Burton Latimer, Kettering,
 Northants NN15 5JR, United Kingdom
 (540)

WEETABIX MINIS

(591) Black, white
 (511)
 30 – Cereal preparations for food for human consumption.

(260) AM 2020 102856 A
 (800) 1462587
 (151) 2018 11 20
 (891) 2018 11 20
 (731) WILHELM LAYHER GMBH & CO KG
 Ochsenbacher Strasse 56, 74363 Gueglingen-
 Eibsensbach, Germany
 (540)

Layher 

(591) Black, white
 (531) 26.01.03; 26.01.24; 26.03.04; 27.05.01
 (511)
 6 – Ladders of metal; scaffolding of metal; parts of scaffolding of metal; mobile scaffolding of metal; staircases of metal; ramps of metal; metal scaffolding boards; metal scaffolding floors; trestle co-

lumns of metal; access platforms [scaffolding] of metal; balustrades of metal; prefabricated parts of metal for erecting scaffolding, work platforms, mobile working platforms, bleachers, stages, podiums, roofs and roof structures, dismantable halls and buildings; work platforms, bleachers, stages, podiums of metal; mobile working platforms of metal; roofs and roof structures of metal; dismantable halls and buildings of metal; racks [structures] of metal; traverse systems of metal, namely metal trusses used as show and event technology, exhibition stand equipment and event decoration; protective walls of metal; protective wall systems of metal; wall elements of metal; fences of metal; scaffolding spindles of metal; lattice girders of metal; scaffolding couplers of metal; metal pallets.

9 – Software.

19 – Scaffolding, not of metal; parts of scaffolding, not of metal; mobile scaffolding, not of metal; staircases, not of metal; ramps, not of metal; scaffolding boards, not of metal; scaffolding floors, not of metal; trestle columns, not of metal; access platforms [scaffolding], not of metal; balustrades, not of metal; prefabricated parts [not of metal] for erecting scaffolding, work platforms, mobile working platforms, bleachers, stages, podiums, roofs and roof structures, dismantable halls and buildings; work platforms, bleachers, stages, podiums, not of metal; mobile working platforms, not of metal; roofs and roof structures, not of metal; dismantable halls and buildings, not of metal; racks [structures] not of metal; traverse systems, not of metal, namely trusses used as show and event technology, exhibition stand equipment and event decoration; protective walls, not of metal; protective wall systems, not of metal; wall elements, not of metal; fences, not of metal; scaffolding spindles, not of metal; lattice girders, not of metal; scaffold couplers, not of metal.

20 – Ladders, not of metal; pallets, not of metal.

(260) AM 2020 103408 A
 (800) 1469417
 (151) 2018 11 14
 (891) 2018 11 14
 (731) TOTAL SA
 2 Place Jean Millier, La Défense 6, F-92400
 COURBEVOIE, France

(540)



(591) Pantone Red 185C, Pantone Blue 286C,
Pantone Blue 279C and Pantone Yellow 138C

(531) 26.11.03; 26.11.12; 26.15.01; 27.05.10;
29.01.15

(511)

1 – Chemicals used in industry, in agriculture, horticulture and forestry, aquaculture; manures and fertilizers; unprocessed plastics in all forms; adhesives for use in industry; petrochemical products and derivatives thereof; chemical and synthetic polymers; chemical additives for polymers; unprocessed artificial and synthetic resins; drilling muds and chemical additives for drilling muds; chemical solvents; lithium; sodium; hydrocarbons; hydrogen; detergents for industrial use; degreasing products for use in manufacturing processes; chemical absorbents enabling dispersing, absorbing, or removing all petroleum products; mold-release agents and fluids; chemicals for oil refining; chemical products for the treatment, purification and gas clean-up; urea, products derived from urea and ammonia; water treatment preparations; chemical additives for use in industry; chemical additives to motor fuel, lubricants, fuel, oil and other bitumen products; chemical additives for insecticides, herbicides and fungicides; antifreeze and de-icing products; coolants; transmission fluids, hydraulic fluids; brake fluids; petroleum-based solvents.

2 – Mastic (natural resin); anti-rust products; anti-corrosive preparations, paints for motor vehicles.

4 – Petroleum (crude or refined); electric energy in all its forms; products derived from petroleum and petroleum-based preparations; fuels; biofuels; fuels and biofuels; fuels; natural gas and petroleum gas of all kinds; lubricants, industrial oils and greases; base oils; non-chemical additives for use in industry; non-chemical additives to motor fuel, lubricants, fuel, oil and other bitumen products; non-chemical additives for insecticides, herbicides and fungicides; insulating fats.

5 – Products for destroying vermin; insecticides, herbicides, fungicides, pesticides; phytosanitary products; disinfectants; deodorants.

6 – Containers and metallic containers for storage and transport; caps of metal; metallic bottles, cisterns and vats for gas and oil products; metallic pipelines, conducts and tubes for the gas and petroleum products.

7 – wind turbines and parts thereof; oil refining machines; fuel dispensers for service stations.

9 – apparatus and installations for generating solar electricity; photovoltaic cells and modules; solar panels; loudspeaker cabinets; magnetic and electronic cards; transmitters, magnetic identification cards and badges for access to road or motorway networks.

11 – Apparatus for lighting, heating, cooking, steam production, refrigerating, drying and ventilating; installations and apparatus for waste disposal and destruction, namely incinerators; installations and apparatus for purification, decontamination, pollution control for the air, water and soil; solar energy collectors for heating; installations and apparatus for the treatment, distribution and supply of gas; installations and apparatus for the treatment and supply of water; control and safety systems for water and gas installations; boilers; lamps.

12 – Vehicles, and parts thereof; electric vehicles; drones; spare parts for land vehicle motors.

14 – Watches, clock and watchmaking and chronometric instruments; key rings.

16 – Printing products (printed matter); stationery and office requisites (excluding furniture); newspapers, magazines, brochures, catalogs, prospectuses, manuals, books; paper or cardboard bags for packaging; boxes of cardboard or paper; adhesives for stationery or household purposes; paper promotional media and advertising materials; self-adhesive labels; packaging with respect to plastic, namely bags, small bags, films and sheets.

17 – Artificial and synthetic semi-finished resins; elastomeric polymers; polymer films (other than for wrapping or packaging); synthetic rubber; unprocessed and semi-processed gum; semi-finished plastic materials; rubber stoppers; insulating products and materials; insulating oils; seals and sealant products; rubber in liquid form.

18 – Luggage, bags; umbrellas; parasols.

19 – Non-metallic building materials; asphalt, bitumen, tars and related derivative products; bituminous coatings and binding agents for use in construction; transportable buildings not of metal.

20 – Non-metallic containers for storage or transport; plastic packaging containers; stoppers not of metal.

25 – Clothing; footwear; headgear.

28 – Games; toys; scale models; gymnastic and sporting articles.

35 – Advertising and sales promotion; organization and management of commercial operations for customer loyalty; loyalty card services; organization of exhibitions or events for commercial or advertising purposes; advertising and commercial patronage and sponsoring; subscription and subscription manage-

ment services (for others) to publications; administration, billing and accounting for others; business management concerning the purchase, sale and supply of energy and petroleum and chemical products; arranging contracts for the purchase and sale of energy; reading of meters for billing purposes; promotion for others of goods operating on any kind of energy; business consultancy and business information collection with respect to energy consumption (improving and managing energy consumption); administrative management of vehicle fleets; electronic toll collection subscription services; administrative management of data files, databases and host platform; administrative management for purchase of products and/or services; retail or wholesale services for oil, gas and chemical products; retail services for the following products: automotive products (petroleum and maintenance), vehicle accessories, food and beverages, newspaper and stationery articles, books and publications, drugstore, hygiene and perfumery products, household cleaning products, audio and video products, toys, flowers, clothing and footwear, mobile phone products and accessories, lottery games.

36 – Financial business and information; banking services; credit and financing services; insurance services; pre-payment services and payment cards and other cards for financial purposes and related financial services; electronic transfer of funds; advice and financial information in the field of energy; collection of fees for others; management, valuation, trading, brokerage and carbon credit; financial sponsorship and patronage; fund investment; acquisition of financial participation in all companies or financial, commercial, industrial, securities or real estate companies; venture capital, private equity and development capital activities in the energy sector; advice relating to energy project financing; financial transactions on the wholesale markets for energy, gas, electricity and petroleum and chemical products; stock exchange brokerage in the field of energy; brokerage of raw materials; tax consultancy with respect to the conservation of energy.

37 – Extraction of natural resources; refueling services; vehicle service stations; servicing, washing and repair of vehicles and vehicle parts; vehicle emptying services; assistance in case of vehicle breakdown (repair); greasing, lubrication, tuning of engines; inflating, repairing and fitting tires; construction, maintenance and upkeep of roads; commissioning, maintenance, troubleshooting, repair and rental services of energy production and distribution apparatus and installations; construction, maintenance and upkeep of refineries and structures for the production, distribution and storage of petroleum and chemical products; rental of platforms and drilling apparatus; drilling of wells; construction, installation and maintenance of pipelines, oil pipelines and gas pipelines;

recharging of batteries; chargers for electric batteries for vehicles; installation, repair, maintenance of power supply and recharging facilities for batteries and vehicles.

38 – Telecommunications; telephone and mobile telephony services and installation of equipment relating thereto; providing services for connection and access to the Internet and other global computer networks; communication services via the Internet, intranet and extranet; broadcasting, transmission and exchange of data and information by all telecomputing means and more generally any medium, known or not; electronic messaging services; providing access to platforms, chat rooms and blogs on the Internet; provision of access to databases.

39 – Transport, packaging, distribution (delivery), storage, supply of merchandise, especially oil, gas and chemical products as well as all products sold at service stations; transport, distribution (delivery), storage and supply of energy in all its forms; advice and information relating to the aforesaid services; towing, providing temporary use and rental of vehicles; information relating to transport and traffic; ge positioning and transport of vehicles.

40 – Production of any kind of energy; processing and treatment of any material for the production of energy; transformation of natural elements (sun, water, wind) into energy; treatment of materials; treatment, recycling and elimination of waste and organic materials; refining services; purification, decontamination and pollution control of water, air and soil; pollution control, decontamination and purification of industrial plants and facilities, equipment and apparatus in the field of energy production; information and consultancy for others relating to the production of energy; rental of apparatus and installations for the production of energy in all its forms and provision of information relating thereto; rental of chemical process facilities and apparatus and provision of information relating thereto; services for mixing lubricants for others.

41 – Education; training; entertainment; sporting and cultural activities; editing of publications (other than advertising) in all forms; organizing and conducting lotteries, competitions and sports competitions; organizing and conducting forums, colloquiums, seminars, conferences and congresses; production of shows and films; organization of exhibitions for cultural and educational purposes; organizing information campaigns.

42 – Industrial analysis and research services; engineering services; research, prospecting and exploration for the oil, gas and mining industries; well testing; commissioning, studies and appraisals of oil, gas and mining deposits; scientific and technological research, technical assistance (engineering) in the

field of energy; design and development of energy distribution networks; architectural services and drafting of plans for the construction of installations in the field of energy and refining; technical consultancy and technical project studies in the field of energy production and distribution; analysis, research and development in the field of energy and chemical and petroleum products; studies and research in the field of environmental protection, processing of waste and sustainable development; analysis, diagnosis and testing in the field of energy; laboratory, analytical, diagnostic and testing services for petroleum and chemical products; audit and appraisal services with respect to energy and energy consumption; security and quality inspections and audits; technical assistance for certification and accreditation; technical inspections and appraisal (engineering work) of installations operating with all types of energy; vehicle roadworthiness testing; technical services for remote reading of energy consumption meters; transfer (provision) of technical know-how; design and analysis of computer systems; application service provider [ASP]; technical consultancy for others relating to energy production; studies and research into the production and processing of materials, especially in the field of energy; security monitoring of production, storage installations, processing and distribution of energy, water or oil and chemical products and consulting relating thereto; security consultancy with respect to the field of energy.

43 – Services for providing food and beverages; restaurants; cafeterias; hotel services, temporary accommodation and reservation services relating thereto.

45 – Licensing and especially licensing of intellectual property rights, technology and franchise concepts to others; legal advice with respect to the conservation of energy; online social networking services.

(260) AM 2020 103551 A

(800) 1177012

(151) 2013 01 04

(891) 2019 05 13

(731) YATAS YATAK VE YORGAN SANAYI VE TICARET ANONIM SIRKETI

Organize Sanayi Bölgesi 18., Cadde No:6
Melikgazi, Kayseri, Turkey

(540)



(591) Blue, white

(531) 24.17.25; 25.01.13; 27.05.17; 29.01.04

(511)

20 – Furniture without any classification of their raw-materials; bed mattresses, pillows, air mattresses and air pillows not for medical purposes, sleep-

ping bags for campers, inflatable beds for water; mirrors; beehives, artificial honeycombs, comb foundations for beehives; baby sits, inside playing parks with railing for children, cradles, infant walkers; frames for clipboards, pictures, paintings made of wood or synthetic materials, id cards, identification bracelets, identity plates, stickers; barrels, casks, jerrycans, tanks (stores), boxes, packaging containers, containers for transportation, chests, transportation pallets, valves, barrel faucets made of wood or synthetic materials; wooden or synthetic handles, grips, buttons for tools and kitchen utensils; bottle caps and stoppers, rivets, nails, screws, pegs, cable clips not of metal; fixed coat hangers that have stands and their covers; ornaments and decorative goods included in this class made of wood, wax, beeswax, plastic or plaster; baskets, fishing baskets; kennels, nests, beds for pets; portable ladders of wood or plastics, mobile ladders; hinges, mechanisms and parts for furniture made of plastic or synthetic materials, armatures for windows and doors, opening-closing devices, locks; bamboo curtains, store curtains, strip curtains, bead curtains for decoration; curtain hooks, curtain rings, curtain rollers.

24 – Woven and non-woven fabrics; household textile products (including flags, signal flags, handkerchiefs).

35 – Services related to advertising, marketing and public relations, including organization of exhibitions and fairs for commercial or advertising purposes; office services; business management and administration, consultancy for business management and administration including accountancy services; import-export agency services; commercial and industrial management expertise services; organization of auctioneering services and auctioneering; the bringing together of a variety of goods enabling customers to conveniently view and purchase those goods the mentioned services can be provided by wholesale, retail, electronic media, catalogues and alike other methods.

(260) AM 2020 103723 A

(800) 1473145

(151) 2019 05 14

(891) 2019 05 14

(731) BEIJING DEEPCOOL SCI-TECH CO., LTD.

No.101, Floor 1-4, Building 10, Dijin
Road 9, Haidian Dist., Beijing, China

(540)



GAMER STORM

(591) Black, white
(531) 04.05.21; 27.05.22
(511)

9 – Solar batteries; chronographs (time recording apparatus); electronic notice boards; photographic viewfinders; electrolysers; fire extinguishers; X-ray apparatus not for medical purposes; alarms; computer memory devices; computer peripheral devices; mouse pads; cases adapted for computers; navigation apparatus for vehicles in the nature of on-board computers; plastic-covered electrical wires; wire connectors (electricity); measures; portable media players; flowmeters; optical lanterns; downloadable applications for mobile phones; heat regulating apparatus; changeover switches for telecommunication apparatus; central processing unit [CPU] coolers; power switches; power adaptors; automatic gauges; electric installations for the remote control of industrial operations; animated cartoons; decorative magnets; interfaces for computers; couplers (data processing equipment); internal cooling fans for computers; stands for use with computers; materials for electricity mains (wires, cables); electrical extension cords; plugs, sockets and other contacts (electric connections); batteries; stable electrical source; low voltage power supply; photocopiers (photographic, electrostatic, thermic); wrist rests for use with computers; stands for tablet computers; rubber-covered electrical wires.

(260) AM 2020 104016 A
(800) 1476367
(151) 2018 11 30
(891) 2018 11 30
(731) ŠKODA AUTO a.s.

Tř. Václava Klementa 869, Mladá Boleslav II,
CZ-293 01 Mladá Boleslav, Czech Republic

(540)

ŠKODA

(591) Black, white
(531) 27.05.01
(511)

9 – Recorded content (computer programs, data and information); information and audio-visual equipment; navigation, control, tracking, aiming and cartography equipment; measuring, detection and monitoring instruments, indicators and controls; scientific research and laboratory apparatus; navigation apparatus for vehicles; computer software for the coordination of transport services; computer software for the acquisition, provision and booking of transport services; navigation software; computer software for the use of operators and passengers of motor vehicles and potential passengers for shared driving; computer software for the coordination and retrieval of delivery services; mobile application

software for the coordination of transport services; mobile application software for navigation; mobile application software for use by operators and passengers of motor vehicles and potential passengers for shared driving; all the aforesaid goods in connection with automobiles.

12 – Vehicles for max 9 persons and/or to max. 3,5 t and automobiles and their parts and accessories, all included in this class.

36 – Insurance; financing services; monetary affairs; lease-purchase financing; automobile lease financing; fundraising and sponsorship; valuation services; insurance brokerage; financial consultancy; banking; repair costs evaluation; all the aforesaid services in connection with automobiles.

37 – Automobile repair and maintenance services and activities; reconstruction, repair, dismantling, maintenance and servicing of vehicles; vehicle repair in the course of vehicle breakdown service; customized carrying out of alterations on body, chassis and motor of motor vehicles (tuning), included in this class; varnishing of vehicles; vehicle polishing; anti-rust treatments for vehicles; vehicle maintenance; vehicle cleaning; retreading of tires; repair information; leather care, cleaning and repair; disinfecting; burglar alarm installation and repair; advice, consultancy and information for all aforesaid services in connection with automobiles.

38 – Telecommunication services; telecommunication; electronic data transmission, communication provided electronically; telecommunication via platforms and portals and the internet; provision of access to the internet; all the aforesaid services in connection with automobiles.

39 – Transport; packaging and storage of goods; organizing trips; towing; taxi, car transport, transportation logistics; vehicle rental, in particular automobiles; transport of passengers; transport brokerage services; traffic information services; control of motor car park via navigation apparatus and locating apparatus (transport services); all the aforesaid services in connection with automobiles.

(260) AM 2020 104051 A
(800) 1130990
(151) 2012 06 05
(891) 2019 04 05

(731) Obshchestvo s ogranichennoy
otvetstvennostyu "ARENA"
ul. Sportivnaya, 5, Chernyahovsk, RU-238151
Kaliningradskaya obl., Russian Federation

(540)



The logo for POLAR features a stylized graphic of a snowflake or ice crystal to the left of the word "POLAR" in a bold, sans-serif font.

(591) Black, white
 (531) 26.03.04; 26.04.03
 (511)
 9 – Apparatus for transmission or reproduction of sound or images; cash registers; calculating machines, magnetic data media; phonograph records; extinguishers; weighing apparatus and instruments; optical apparatus and instruments; photographic apparatus and instruments; cinematographic apparatus and instruments; life-saving and teaching apparatus and instruments; mechanisms for coin-operated apparatus.

(260) AM 2020 104225 A
 (800) 1478305
 (151) 2019 05 16
 (891) 2019 05 16
 (731) Société à responsabilité limitée "MAGNAT"
 Volgogradsky prosp., 42, corp. 23, ét. 3,
 cab. 61, RU-109316 Moscou, Russian
 Federation

(540)

ЗЕМЛЯ КАМНЕЙ

(591) Black, white
 (531) 28.05
 (511)
 32 – mineral and aerated waters and other non-alcoholic beverages; syrups and other preparations for making beverages; non-alcoholic aperitifs; flavored mineral waters; carbonated water; distilled drinking water; spring water; glacier water; mineral-enriched waters [drinking products]; aerated mineral water; sparkling mineral waters; still water; drinking water; bottled water; seltzer water; soda water; sparkling waters; waters [beverages]; table waters; non-alcoholic cocktails; concentrates, syrups and powders for preparing non-alcoholic beverages; fruit juice concentrates; non-alcoholic beverages; non-alcoholic carbonated beverages; isotonic beverages; beverages based on fruit and fruit juices; non-alcoholic low-calorie beverages; protein-enriched sports beverages; non-alcoholic tea-flavored beverages; guarana beverages; non-alcoholic coffee-flavored beverages; non-alcoholic malt beverages; sports beverages; powders for effervescing beverages; powders for preparing non-alcoholic beverages; essences for making beverages; essences for preparing non-alcoholic beverages, except essential oils; mixed fruit or vegetable beverages [smoothies] [non-alcoholic beverages]; malt wort; non-alcoholic honey-based beverages; soy-based beverages, other than milk substitutes.

(260) AM 2020 104239 A
 (800) 1478534
 (151) 2019 05 08
 (891) 2019 05 08

(731) C.P.C. Creative Perfume Company Holding
 Holding SA
 Rue du Mont-de-Sion 8, c/o Lenhill Partners
 SA, CH-1206 Genève, Switzerland

(540)

DEAR POLLY

(591) Black, white
 (511)
 4 – Nightlights [candles]; perfumed candles; Christmas tree candles; candles.

(260) AM 2020 104247 A
 (800) 1478739
 (151) 2019 05 28
 (891) 2019 05 28
 (731) BITFURY GROUP LIMITED
 Harbour Pl., 103 South Church St, c/o Harneys
 Services (Cayman) Ltd., KY11002 George
 Town, Box 1024, Cayman Islands

(540)

CRYSTAL

(591) Black, white
 (511)
 42 – Providing on-line non-downloadable software for collecting, analyzing and displaying data in the fields of cryptocurrency transactions, cryptocurrency transaction participants, and cryptocurrency transaction trends.

(260) AM 2020 104382 A
 (800) 1480461
 (151) 2019 02 26
 (891) 2019 02 26
 (731) VEROO GmbH
 IZ NÖ-Süd, Straße 14, Objekt 15, A-2355
 Wiener Neudorf, Austria

(540)

VEROO

(591) Black, white
 (511)
 9 – Scientific research and laboratory apparatus, educational apparatus and simulators; apparatus, instruments and cables for electricity; recorded content; magnets, magnetizers and demagnetizers; measuring, detecting and monitoring instruments, indicators and controllers; navigation, guidance, tracking, targeting and map making devices; optical devices, enhancers and correctors; safety, security, protection and signalling devices; diving equipment; scientific and laboratory devices for treatment using electricity.

38 – Telecommunication services; provision and rental of telecommunications facilities and equipment.

39 – Vehicle parking and storage; transport; rental services related to transportation and storage; packaging and storage of goods; distribution by pipeline and cable; parking and vehicle storage, mooring.

42 – Design services; IT services (terms considered too vague by the International Bureau – rule 13.2.b) of the Common Regulations); testing, authentication and quality control; science and technology services (terms considered too vague by the International Bureau – rule 13.2.b) of the Common Regulations).

(260) AM 2020 104392 A

(800) 1480733

(151) 2018 10 15

(891) 2018 10 15

(731) TUNGSRAM OPERATIONS KFT.

Váci út 77, H-1044 Budapest, Hungary

(540)



(591) Black, white

(531) 27.05.14; 27.05.24

(511)

9 – Scientific, nautical, surveying, photographic, cinematographic, optical, weighing, measuring, signalling, checking (supervision), life-saving and teaching apparatus and instruments; apparatus and instruments for conducting, switching, transforming, accumulating, regulating, or controlling electricity; apparatus for recording, transmission or reproduction of sound or images; magnetic data carriers, recording discs; compact discs, DVDs and other digital recording media; mechanisms for coin-operated apparatus; cash registers, calculating machines, data processing equipment, computers; computer software; fire-extinguishing apparatus; 3D spectacles; abacuses; accelerometers; accumulator boxes; accumulator jars; accumulators, electric; accumulators, electric, for vehicles; acid hydrometers; acidimeters for batteries; acoustic alarms; acoustic conduits; acoustic couplers; actinometers; adding machines; aerometers; air analysis apparatus; alarm bells, electric; alarms; alcoholmeters; alidades; altimeters; ammeters; amplifiers; amplifying tubes; amplifying valves; anemometers; animated cartoons; anode batteries; anodes; answering machines; antennas; anticathodes; anti-glare glasses; anti-interference devices [electricity]; anti-theft warning apparatus; apertometers [optics]; apparatus and installations for the production of X-rays, not for medical purposes; apparatus and instruments for astronomy; apparatus and instruments for physics; apparatus for changing record player needles; apparatus for editing cinematographic film; apparatus for fermentation [laboratory apparatus]; apparatus for measuring the thick-

ness of skins; apparatus for recording distance; apparatus to check franking; apparatus to check stamping mail; appliances for measuring the thickness of leather; armatures [electricity]; asbestos clothing for protection against fire; asbestos gloves for protection against accidents; asbestos screens for firemen; audio- and video-receivers; audio interfaces; audio mixers, audiovisual teaching apparatus; automated teller machines [ATM]; automatic indicators of low pressure in vehicle tires; automatic indicators of low pressure in vehicle tyres; azimuth instruments; baby monitors; baby scales; bags adapted for laptops; balances [steelyards]; balancing apparatus; barcode readers; barometers; bathroom scales; batteries, electric; batteries, electric, for vehicles; batteries for electronic cigarettes; batteries for lighting; battery boxes; battery chargers; battery jars; beacons, luminous; bells [warning devices]; betatrons; binoculars; biochips; black boxes [data recorders]; blinkers [signalling lights]; blueprint apparatus; boiler control instruments; branch boxes [electricity], breathing apparatus, except for artificial respiration; breathing apparatus for underwater swimming; bullet-proof clothing; bullet-proof vests; bullet-proof waistcoats; buzzers; cabinets for loudspeakers; cables, electric; calculating machines; calibrating rings; calipers; calorimeters; camcorders; cameras [photography]; capacitors; capillary tubes; carpenters' rules; carriers for dark plates [photography]; cases especially made for photographic apparatus and instruments; cases for smartphones; cash registers; cassette players; cathodes; cathodic anti-corrosion apparatus; cell phones; cell phone straps; cell switches [electricity]; cellular phones; centering apparatus for photographic transparencies; central processing units [processors]; chargers for electric batteries; chargers for electronic cigarettes; charging stations for electric vehicles; chemistry apparatus and instruments; chips [integrated circuits]; choking coils [impedance]; chromatography apparatus for laboratory use; chronographs [time recording apparatus]; cinematographic cameras; cinematographic film, exposed; circuit breakers; circuit closers; circular slide rules; cleaning apparatus for phonograph records; cleaning apparatus for sound recording discs; clinometers; close-up lenses; clothing especially made for laboratories; clothing for protection against accidents, irradiation and fire; clothing for protection against fire; coaxial cables; coils, electric; coin-operated mechanisms for television sets; coin-operated musical automata [juke boxes]; collectors, electric; commutators; compact disc players; compact discs [audio-video]; compact discs [read-only memory]; comparators; compasses for measuring; computer game software; computer hardware; computer keyboards; computer memory devices; computer operating programs, recorded; computer peripheral devices; computer programs [downloadable software]; computer programs, recorded; computers; computer screen sa-

ver software, recorded or downloadable; computer software applications, downloadable; computer software platforms, recorded or downloadable; computer software, recorded; condensers [capacitors]; conductors, electric; connected bracelets [measuring instruments]; connections, electric; connections for electric lines; connectors [electricity]; contact lenses; contacts, electric; containers for contact lenses; containers for microscope slides; control panels [electricity]; converters, electric; copper wire, insulated; cordless telephones; correcting lenses [optics]; cosmographic instruments; counterfeit coin detectors; counters; couplers [data processing equipment]; couplings, electric; covers for electric outlets; covers for personal digital assistants [PDAs]; covers for smartphones; covers for tablet computers; crash test dummies; crucibles [laboratory]; cupels [laboratory]; current rectifiers; cyclotrons; darkroom lamps [photography]; darkrooms [photography]; data processing apparatus; decompression chambers; decorative magnets; demagnetizing apparatus for magnetic tapes; densimeters; densitometers; detectors; diagnostic apparatus, not for medical purposes; diaphragms [acoustics]; diaphragms for scientific apparatus; diaphragms [photography]; dictating machines; diffraction apparatus [microscopy]; digital photo frames; digital signs; digital weather stations; directional compasses; discharge tubes, electric, other than for lighting; disk drives for computers; disks, magnetic; distance measuring apparatus; distance recording apparatus; distillation apparatus for scientific purposes; distribution boards [electricity]; distribution boxes [electricity]; distribution consoles [electricity]; divers' masks; diving suits; DNA chips; dog whistles; dosage dispensers; dosimeters; downloadable graphics for mobile phones; downloadable image files; downloadable music files; downloadable ring tones for mobile phones; drainers for use in photography; dressmakers' measures; drying apparatus for photographic prints; drying racks [photography]; ducts [electricity]; DVD players; dynamometers; ear plugs for divers; egg-candlers; egg timers [sandglasses]; electrical adapters; electric and electronic effects units for musical instruments; electric apparatus for commutation; electric apparatus for remote ignition; electric discharge tubes, other than for lighting; electric door bells; electric installations for the remote control of industrial operations; electricity conduits; electric loss indicators; electric wire harnesses for automobiles; electrified fences; electrified rails for mounting spot lights; electro-dynamic apparatus for the remote control of railway points; electro-dynamic apparatus for the remote control of signals; electrolyzers; electromagnetic coils; electronic access control systems for interlocking doors; electronic agendas; electronic book readers; electronic collars to train animals; electronic interactive whiteboards; electronic key fobs being remote control apparatus; electronic notice boards; electronic nu-

meric displays; electronic pens [visual display units]; electronic pocket translators; electronic publications, downloadable; electronic sheet music, downloadable; electronic tags for goods; encoded identification bracelets, magnetic; encoded key cards; encoded magnetic cards; enlarging apparatus [photography]; epidiascopes; equalisers [audio apparatus]; equalizers [audio apparatus]; ergometers; exposure meters [light meters]; eyeglass cases; eyeglass chains; eyeglass cords; eyeglasses; eyeglass frames; eyeglass lenses; eyepieces; eyewear; facsimile machines; fiber optic cables; fibre optic cables; film cutting apparatus; films, exposed; filters for respiratory masks; filters for ultraviolet rays, for photography; filters [photography]; finger sizers; fire alarms; fire beaters; fire blankets; fire boats; fire engines; fire escapes; fire extinguishers; fire extinguishing apparatus; fire hose; fire hose nozzles; fire pumps; flash-bulbs [photography]; floppy disks; flowmeters; fluorescent screens; fog signals, non-explosive; food analysis apparatus; frames for photographic transparencies; frequency meters; furnaces for laboratory use; furniture especially made for laboratories; fuses; fuse wire; galena crystals [detectors]; galvanic batteries; galvanic cells; galvanometers; garments for protection against fire; gasoline gauges; gasometers [measuring instruments]; gas testing instruments; gauges; glazing apparatus for photographic prints; global positioning system [GPS] apparatus; gloves for divers; gloves for protection against accidents; gloves for protection against X-rays for industrial purposes; goggles for sports; gradient indicators; graduated glassware; grids for batteries; hand-held electronic dictionaries; hands-free kits for telephones; head cleaning tapes [recording]; head guards for sports; headphones; heat regulating apparatus; heliographic apparatus; hemline markers; high-frequency apparatus; high tension batteries; holders for electric coils; holograms; horns for loudspeakers; hourglasses; humanoid robots with artificial intelligence; hydrometers; hygrometers; identification sheaths for electric wires; identification threads for electric wires; identity cards, magnetic; igniting apparatus, electric, for igniting at a distance; inclinometers; incubators for bacteria culture; inductors [electricity]; infrared detectors; instruments containing eyepieces; integrated circuit cards [smart cards]; integrated circuits; interactive touch screen terminals; intercommunication apparatus; interfaces for computers; inverters [electricity]; invoicing machines; ionization apparatus not for the treatment of air or water; jigs [measuring instruments]; joysticks for use with computers, other than for video games; juke boxes for computers; juke boxes, musical; junction boxes [electricity]; junction sleeves for electric cables; kilometer recorders for vehicles; knee-pads for workers; laboratory centrifuges; laboratory robots; laboratory trays; lactodensimeters; lactometers; laptop computers; lasers, not for medical purposes; lenses for

astrophotography; lens hoods; letter scales; levelling instruments; levelling staffs [surveying instruments]; levels [instruments for determining the horizontal]; lever scales [steelyards]; life belts; life buoys; life jackets; life nets; life saving apparatus and equipment; life-saving capsules for natural disasters; life-saving rafts; limiters [electricity]; locks, electric; logs [measuring instruments]; loudspeakers; magic lanterns; magnetic data media; magnetic encoders; magnetic resonance imaging [MRI] apparatus, not for medical purposes; magnetic tapes; magnetic tape units for computers; magnetic wires; magnets; magnifying glasses [optics]; manometers; marine compasses; marine depth finders; marking buoys; marking gauges [joinery]; masts for wireless aerials; materials for electricity mains [wires, cables]; material testing instruments and machines; mathematical instruments; measures; measuring apparatus; measuring devices, electric; measuring glassware; measuring instruments; measuring spoons; mechanical signs; mechanisms for coin-operated apparatus; mechanisms for counter-operated apparatus; megaphones; memory cards for video game machines; mercury levels; metal detectors for industrial or military purposes; meteorological balloons; meteorological instruments; meters; metronomes; micrometer gauges; micrometers; micrometer screws for optical instruments; microphones; microprocessors; microscopes; microtomes; mileage recorders for vehicles; mirrors for inspecting work; mirrors [optics]; mobile telephones; modems; money counting and sorting machines; monitoring apparatus, other than for medical purposes; monitors [computer hardware]; monitors [computer programs]; mouse [computer peripheral]; mouse pads; mouth guards for sports; nautical apparatus and instruments; naval signalling apparatus; navigational instruments; navigation apparatus for vehicles [on-board computers]; needles for record players; needles for surveying compasses; neon signs; nets for protection against accidents; nose clips for divers and swimmers; notebook computers; objectives [lenses] [optics]; observation instruments; octants; ohmmeters; optical apparatus and instruments; optical character readers; optical condensers; optical data media; optical discs; optical glass; optical lenses; oscillographs; ovens for laboratory use; oxygen transvasing apparatus; ozonisers [ozonators]; parking meters; particle accelerators; pedometers; peepholes [magnifying lenses] for doors; periscopes; personal digital assistants [PDAs]; personal stereos; Petri dishes; petrol gauges; phonograph records; photocopiers [photographic, electrostatic, thermic]; photographic racks; photometers; phototelegraphy apparatus; photovoltaic cells; pince-nez; pipettes; Pitot tubes; plane tables [surveying instruments]; planimeters; plates for batteries; plotters; plugs, sockets and other contacts [electric connections]; plumb bobs; plumb lines; pocket calculators; polarimeters; portable media players; precision balances; precision

measuring apparatus; pressure gauges; pressure indicator plugs for valves; pressure indicators; pressure measuring apparatus; printed circuit boards; printed circuits; printers for use with computers, prisms [optics]; probes for scientific purposes; processors [central processing units]; projection apparatus; projection screens; protection devices against X-rays, not for medical purposes; protection devices for personal use against accidents; protective films adapted for computer screens; protective films adapted for smartphones; protective helmets; protective helmets for sports; protective masks; protective suits for aviators; protractors [measuring instruments]; punched card machines for offices; push buttons for bells; pyrometers; quantity indicators; radar apparatus; radiological apparatus for industrial purposes; radiology screens for industrial purposes; radio pagers; radios; radiotelegraphy sets; radiotelephony sets; railway traffic safety appliances; range finders; readers [data processing equipment]; rearview cameras for vehicles; record players; reducers [electricity]; reflective articles for wear, for the prevention of accidents; reflective safety vests; refractometers; refractors; regulating apparatus, electric; relays, electric; remote control apparatus; rescue laser signalling flares; resistances, electric; respirators for filtering air; respiratory masks, other than for artificial respiration; resuscitation mannequins [teaching apparatus]; resuscitation training simulators; retorts; retorts' stands; revolution counters; rheostats; riding helmets; ring sizers; rods for water diviners; rods [surveying instruments]; rulers [measuring instruments]; rules [measuring instruments]; saccharometers; safety nets; safety restraints, other than for vehicle seats and sports equipment; safety tarpaulins; salinometers; satellite finder meters; satellite navigational apparatus; satellites for scientific purposes; scales; scales with body mass analysers; scales with body mass analyzers; scanners [data processing equipment]; screens for photoengraving; screens [photography]; screw-tapping gauges; security surveillance robots; security tokens [encryption devices]; selfie lenses; selfie sticks [hand-held monopods]; semi-conductors; sextants; sheaths for electric cables; shoes for protection against accidents, irradiation and fire; shutter releases [photography]; shutters [photography]; sighting telescopes for firearms; signal bells; signalling buoys; signalling whistles; simulators for the steering and control of vehicles; sirens; sleeves for laptops; slide calipers; slide projectors; slide-rules; slides [photography]; slope indicators; smart cards [integrated circuit cards]; smartglasses; smartphones; smart rings; smartwatches; smoke detectors; snorkels; solar batteries; solar panels for the production of electricity; solderers' helmets; solenoid valves [electromagnetic switches]; sonars; sound alarms; sounding apparatus and machines; sounding leads; sounding lines; sound locating instruments; sound recording apparatus; sound recording

carriers; sound recording discs; sound recording strips; sound reproduction apparatus; sound transmitting apparatus; spark-guards; speaking tubes; spectacle cases; spectacle chains, spectacle cords; spectacle frames; spectacle lenses; spectacles; spectrograph apparatus; spectrometers; speed checking apparatus for vehicles; speed indicators; speed measuring apparatus [photography]; speed regulators for record players; spherometers; spirit levels; spools [photography]; sports whistles; sprinkler systems for fire protection; square rulers for measuring; squares for measuring; stage lighting regulators; stands for photographic apparatus; starter cables for motors; steelyards [lever scales]; steering apparatus, automatic, for vehicles; step-up transformers; stereoscopes; stereoscopic apparatus; stills for laboratory experiments; stroboscopes; styli for record players; subwoofers; sulfimeters; sunglasses; surveying apparatus and instruments; surveying chains; surveying instruments; surveyors' levels; switchboards; switchboxes [electricity]; switches, electric; tablet computers; tachometers; tape recorders; taximeters; teaching apparatus; teaching robots; teeth protectors; telecommunication apparatus in the form of jewellery; telecommunication apparatus in the form of jewelry; telegraphs [apparatus]; telegraph wires; telemeters; telephone apparatus; telephone receivers; telephone transmitters; telephone wires; teleprinters; teleprompters; telerupters; telescopes; telescopic sights for artillery; telescopic sights for firearms; teletypewriters; television apparatus; temperature indicator labels, not for medical purposes; temperature indicators; terminals [electricity]; testing apparatus not for medical purposes; test tubes; theft prevention installations, electric; theodolites; thermal imaging cameras; thermionic tubes; thermionic valves; thermo-hygrometers; thermometers, not for medical purposes; thermostats; thermostats for vehicles; thin client computers; thread counters; ticket dispensers; time clocks [time recording devices]; time recording apparatus; time switches, automatic; tone arms for record players; toner cartridges, unfilled, for printers and photocopiers; totalizers; traffic cones; traffic-light apparatus [signalling devices]; transformers [electricity]; transistors [electronic]; transmitters of electronic signals; transmitters [telecommunication]; transmitting sets [telecommunication]; transparencies [photography]; transparency projection apparatus; transponders; triodes; tripods for cameras; T-squares for measuring; urinometers; USB flash drives; vacuum gauges; vacuum tubes [radio]; variometers; vehicle breakdown warning triangles; vehicle radios; verniers; video baby monitors; video cassettes; video game cartridges; video recorders; video screens; videotapes; video telephones; viewfinders, photographic; virtual reality headsets; viscosimeters; visors for helmets; voltage regulators for vehicles; voltage surge protectors; voltmeters; voting machines; wafers for integrated cir-

cuits; walkie-talkies; washing trays [photography]; water level indicators; wavemeters; wearable activity trackers; wearable computers; wearable video display monitors; weighbridges; weighing apparatus and instruments; weighing machines; weights; whistle alarms; wind socks for indicating wind direction; wire connectors [electricity]; wires, electric; workmen's protective face-shields; wrist rests for use with computers; X-ray apparatus not for medical purposes; X-ray films, exposed; X-ray photographs, other than for medical purposes; X-ray tubes not for medical purposes; apparatus and instruments for storing or checking electricity; magnetic media for storing data and sound; electrical circuit boards; solar cells for electricity generation; electronic transformers; halogen transformers; halogen transformers and power sources; electrical control apparatus; electrical apparatus and instruments capable of destroying or repelling bacteria and other organisms; electrical apparatus and instruments for cleaning or disinfecting.

10 – Surgical, medical, dental and veterinary apparatus and instruments; therapeutic and assistive devices for the disabled; apparatus, devices and products for nursing infants; sexual activity apparatus, devices and products; apparatus and devices for destroying or repelling other organisms; mirrors for physicians, surgeons and dentists; thermo-electric compresses apparatus and installations for the production of X-rays, for medical purposes; X-ray tubes and radium tubes for medical purposes; radiological apparatus; lasers for medical purposes; magnetic resonance imaging apparatus for medical purposes and accessories thereof; incubators and accessories thereof; electric dental apparatus and other electric medical apparatus; electric heating cushions, electric heating pads, for medical purposes; electric acupuncture instruments; electrocardiographs; electrodes for medical use; analysers for bacterial identification.

11 – Apparatus for heating, steam generating, cooking, refrigerating, drying, ventilating, water supply and sanitary purposes; acetylene burners; acetylene flares; acetylene generators; air conditioners for vehicles; air-conditioning apparatus; air-conditioning installations; air cooling apparatus; air deodorising apparatus; air deodorizing apparatus; air driers; air dryers; air filtering installations; air fryers; air purifying apparatus and machines; air reheaters; air sterilisers; air sterilizers; air valves for steam heating installations; alcohol burners; anti-splash tap nozzles; apparatus for dehydrating food waste; aquarium filtration apparatus; aquarium heaters; ash conveyor installations, automatic; ash pits for furnaces; atomic piles; autoclaves, electric, for cooking; bakers' ovens; barbecues; bath fittings; bath installations; bath plumbing fixtures; bath tubs; bath tubs for site baths; bed warmers; beverage cooling apparatus; bidets; blankets, electric, not for medical purposes;

boiler pipes [tubes] for heating installations; boilers, other than parts of machines; book sterilisation apparatus; book sterilization apparatus; brackets for gas burners; bread baking machines; bread-making machines; bread toasters; burners; candle lanterns; central heating radiators; chandeliers; chimney blowers; chimney flues; chocolate fountains, electric; chromatography apparatus for industrial purposes; clean chambers [sanitary installations]; cocks for pipes and pipelines; coffee machines, electric; coffee percolators, electric; coffee roasters; coils [parts of distilling, heating or cooling installations]; cookers; cooking apparatus and installations; cooking rings; cooking stoves; cooking utensils, electric; cool boxes, electric; coolers, electric; coolers for furnaces; cooling appliances and installations; cooling installations and machines; cooling installations for liquids; cooling installations for tobacco; cooling installations for water; cooling vats for furnaces; dampers [heating]; deep fryers, electric; defrosters for vehicles; dental ovens; deodorising apparatus, not for personal use; desalination plants; desiccating apparatus; discharge tubes, electric, for lighting; disinfectant apparatus; disinfectant apparatus for medical purposes; disinfectant dispensers for toilets; disinfectant distributors for toilets; distillation apparatus; distillation columns; drip irrigation emitters [irrigation fittings]; drying apparatus; drying apparatus and installations; drying apparatus for fodder and forage; electrically heated carpets; electrically heated clothing; electric appliances for making yogurt; electric cooktops; electric fans for personal use; electric torches; evaporators; expansion tanks for central heating installations; extractor hoods for kitchens; fabric steamers; fans [air-conditioning]; fans [parts of air-conditioning installations]; faucets; faucets for pipes and pipelines; feeding apparatus for heating boilers; filaments for electric lamps; filters for air conditioning; filters for drinking water; fire bars; fireplaces, domestic; fittings, shaped, for furnaces; fittings, shaped, for ovens; flaming torches; flare stacks for use in the oil industry; flues for heating boilers; flushing apparatus; flushing tanks; food steamers, electric; footmuffs, electrically heated; footwarmers, electric or non-electric; forage drying apparatus; forges, portable; fountains; framework of metal for ovens; freezers; friction lighters for igniting gas; fruit roasters; fumigation apparatus, not for medical purposes; furnace ash boxes; furnace grates; furnaces, other than for laboratory use; gas boilers; gas burners; gas condensers, other than parts of machines; gas lamps; gas lighters; gas scrubbers [parts of gas installations]; gas scrubbing apparatus; germicidal burners; germicidal lamps for purifying air; glue-heating appliances; griddles [cooking appliances]; grills [cooking appliances]; hair driers; hair dryers; hand drying apparatus for washrooms; head torches; hearths; heat accumulators; heated display cabinets; heaters, el-

ectric, for feeding bottles; heaters for baths; heaters for heating irons; heaters for vehicles; heat exchangers, other than parts of machines; heat guns; heating and cooling apparatus for dispensing hot and cold beverages; heating apparatus; heating apparatus, electric; heating apparatus for defrosting vehicle windows; heating apparatus for solid, liquid or gaseous fuels; heating boilers; heating cushions, electric, not for medical purposes; heating elements; heating filaments, electric; heating installations; heating installations [water]; heating pads, electric, not for medical purposes; heating plates; heat pumps; heat regenerators; hot air apparatus; hot air bath fittings; hot air ovens; hot plates; hot water bottles; hot water heating installations; humidifiers for central heating radiators; hydrants; hydromassage bath apparatus; ice-cream making machines; ice machines and apparatus; immersion heaters; incandescent burners; incinerators; installations for processing nuclear fuel and nuclear moderating material; ionization apparatus for the treatment of air or water; kettles, electric; kiln furniture [supports]; kilns; kitchen ranges [ovens]; laboratory burners; laundry driers, electric; laundry dryers, electric; laundry room boilers; lava rocks for use in barbecue grills; level controlling valves in tanks; lighters; loading apparatus for furnaces; malt roasters; microbubble generators for baths; microwave ovens [cooking apparatus]; microwave ovens for industrial purposes; milk cooling installations; mixer faucets for water pipes; mixer taps for water pipes; multicookers; nuclear reactors; oil burners; oil-scrubbing apparatus; ornamental fountains; oven fittings made of fireclay; ovens, other than for laboratory use; oxyhydrogen burners; pasteurisers; petrol burners; pipes [parts of sanitary installations]; plate warmers; pocket warmers; polymerisation installations; portable headlamps; pounded rice cake making machines, electric, for household purposes; pressure cookers, electric; pressure water tanks; processing installations for fuel and nuclear moderating material; purification installations for sewage; radiator caps; radiators, electric; radiators [heating]; refining towers for distillation; refrigerating apparatus and machines; refrigerating appliances and installations; refrigerating cabinets; refrigerating chambers; refrigerating containers; refrigerating display cabinets; refrigerators; regulating accessories for water or gas apparatus and pipes; regulating and safety accessories for gas apparatus; regulating and safety accessories for gas pipes; regulating and safety accessories for water apparatus; roasters; roasting apparatus; roasting jacks; roasting spits; rotisseries; safety accessories for water or gas apparatus and pipes; sanitary apparatus and installations; sauna bath installations; scrubbers [parts of gas installations]; shaped fittings for furnaces; shaped fittings for ovens; shower cubicles; shower enclosures; showers; sinks; socks, electrically heated; solar furnaces; solar thermal collectors [heating]; sous-vide cookers, elec-

tric; spa baths [vessels]; spigots for pipes and pipelines; steam accumulators; steam boilers, other than parts of machines; steam facial apparatus [saunas]; steam generating installations; sterilisers; sterilizers; stills; stoves [heating apparatus]; structural plates for ovens; swimming pool chlorinating apparatus; tanning apparatus [sun beds]; taps; taps for pipes and pipelines; thermostatic valves [parts of heating installations]; toasters; tobacco roasters; toilet bowls; toilet seats; toilets, portable; toilets [water-closets]; tortilla presses, electric; Turkish bath cabinets, portable; urinals [sanitary fixtures]; vehicle reflectors; ventilation [air-conditioning] installations and apparatus; ventilation [air-conditioning] installations for vehicles; ventilation hoods; ventilation hoods for laboratories; waffle irons, electric; walk-in refrigerators; warming pans; washers for water faucets; washers for water taps; wash-hand basins [parts of sanitary installations]; wash-hand bowls [parts of sanitary installations]; washing coppers; water closets; water conduits installations; water distribution installations; water filtering apparatus; water flushing installations; water heaters; water heaters [apparatus]; watering installations, automatic; watering machines for agricultural purposes; water intake apparatus; water-pipes for sanitary installations; water purification installations; water purifying apparatus and machines; water softening apparatus and installations; water sterilisers; water sterilizers; water supply installations; whirlpool-jet apparatus; wicks adapted for oil stoves; wine cellars, electric; neon tubes; fluorescent tubes and starters; compact fluorescent tubes and compact fluorescent lamps; apparatus and devices for disinfecting and cleaning; disinfectant apparatus and devices and accessories thereof for medical, sanitary and biological purpose

(260) AM 2020 104497 A
 (800) 1481413
 (151) 2019 04 16
 (891) 2019 04 16
 (731) ALCHEM INTERNATIONAL PRIVATE LIMITED
 201, empire plaza, mehrauli gurgaon road,
 sultanpur, New delhi 110030, India

(540)
Phytocid-GT

(591) Black, white
 (531) 27.05.01
 (511)
 5 – Ayurvedic medicines.

(260) AM 2020 104570 A
 (800) 1482090
 (151) 2019 05 27
 (891) 2019 05 27

(731) Joint Venture Joint-Stock Company
 "KOMMUNARKA"
 ul. Aranskaya 18, 220033 Minsk, Belarus
 (540)

Весёлые трели

(591) Black, white
 (531) 28.05
 (511)
 30 – Cocoa; confectionery; waffles; confectionery for decorating Christmas trees; pastries; peanut confectionery; almond confectionery; caramels; sweetmeats; liquorice [confectionery]; peppermint sweets; crackers; candy; cocoa beverages with milk; chocolate beverages with milk; chocolate-based beverages; cocoa-based beverages; pastilles [confectionery]; cookies; fondants [confectionery]; pralines; gingerbread; powdered sugar; sugar confectionery; cakes; tarts; halvah; chocolate.

(260) AM 2020 104603 A
 (800) 1482982
 (151) 2019 03 25
 (891) 2019 03 25
 (731) Oriflame Cosmetics AG
 c/o Oriflame Global Management AG,
 Bleicheplatz 3, CH-8200 Schaffhausen,
 Switzerland

(540)
GIORDANI GOLD ESSENZA

(591) Black, white
 (511)
 3 – Non-medicated conditioning and care preparations for application to the hair, scalp, skin and nails; shampoos; hair conditioner; soaps; perfumes; perfumery; eau de cologne; toilet waters; essential and herbal oils; cosmetics; make-up; make-up preparations; lipsticks; nail varnishes; nail varnish removers; eyeliner; mascara; non-medicated toilet preparations; hair lotions; hair sprays and hair gels; preparations for use in the bath or shower; bath and shower oils, gels, creams and foams; face and body masks; face and body scrubs; facial washes; skin cleansers and hydrators; skin toners; skin moisturizers; blemish creams and blemish gels; deodorants; antiperspirants; preparations for use before shaving and after shaving; shaving soaps; shaving creams; shaving gels; after-shave preparations; pre-shave preparations; talcum powders; toiletries; dentifrices; toothpastes; foot care preparations (non-medicated).

(260) AM 2020 104696 A
 (800) 1484716
 (151) 2019 03 28
 (891) 2019 03 28
 (731) Agapova Julia Igorevna

St shosse Severnoe, bld 6, apt 64, Ramenskoye city, Ramensky district, RU-140105
Moscow region, Russian Federation

(540)



BARBARA

(591) Black, white

(531) 26.04.18; 27.05.22

(511)

35 – Commercial information and advice for consumers in the choice of products and services; procurement services for others [purchasing goods and services for other businesses].

44 – Beauty salon services; eyelash and eyebrow extensions services; eyelash and eyebrow coloring services; eyelash lamination services; eyelash curling services; eyebrow restoration; eyebrow tattooing services.

(260) AM 2020 104704 A

(800) 1484895

(151) 2019 07 04

(891) 2019 07 04

(731) JT International S.A.

Rue Kazem-Radjavi 8, CH-1202 Geneva,
Switzerland

(540)

LOGIC

(591) Black, white

(511)

9 – Electronic chargers, batteries.

34 – Electronic cigarettes; cases for electronic cigarettes; cases for electronic cigarette accessories; cigarettes; cigars; smokers' mouthpieces for electronic cigarettes; flavorings, other than essential oils, for use in electronic cigarettes; vaporizing devices for tobacco; vaporizers for smoking purposes; oral vaporizers for smokers; cartridges sold filled with chemical flavorings in liquid form for electronic cigarettes; electronic cigarette liquid comprised of flavorings in liquid form, other than essential oils, used to refill electronic cigarette cartridges; liquid nicotine solutions for electronic cigarettes; tobacco substitutes; tobacco; cigarettes containing tobacco substances, not for medicinal purposes; ashtrays; lighters for smokers; smokers' articles, tobacco products.

(260) AM 2020 104719 A

(800) 1485177

(151) 2019 02 27

(891) 2019 02 27

(731) ERSAŞ ALÜMİNYUM ANONİM ŞİRKETİ
Topçular Mah. İncirlik Cad., Ersas İş Merkezi
No:18, Eyüp, TR-34055 İSTANBUL, Turkey

(540)



(591) Red, gray, white

(531) 26.04.02; 26.04.09; 26.04.18; 27.05.01;
27.05.24; 29.01.13

(511)

6 – Ores of non-precious metal; common metals and their alloys and semi-finished products made of these materials, irons for construction, mats and stirrups of common metals for buildings, common metals in the form of plate, billet, stick, profile, sheet and sheeting; goods and materials of common metal used for storage, wrapping, packaging and sheltering purposes, containers of metal (storage, transport), buildings of metal, frames of metal for building, poles of metal for building, metal boxes, packaging containers of metal, aluminium foil, fences made of metal, guard barriers of metal, metal tubes, storage containers of metal, metal containers for the transportation of goods, ladders of metal; building materials of metal; furniture casters of metal; scaffolding of metal, metal scaffolding towers; doors, windows, shutters, jalousies and their cases and fittings of metal; non-electric cables and wires of metal; ironmongery, small hardware of metal, screws of metal, nails, bolts of metal, nuts of metal, pegs of metal, flakes of metal, pitons of metal, metal chains, furniture casters of metal, fittings of metal for furniture, door handles of metal, window handles of metal, hinges of metal, metal latches, metal locks, metal keys for locks, metal rings, metal pulleys; ventilation ducts, vents, vent covers, pipes, chimney caps, manhole covers, grilles of metal for ventilation, heating, sewage, telephone, underground electricity and air conditioning installations; metal panels or boards (non-luminous and non-mechanical) used for signalling, route showing, publicity purposes, signboards of metal, advertisement columns of metal, signaling panels of metal, non-luminous and non-mechanical traffic signs of metal; pipes of metal for transportation of liquids and gas, drilling pipes of metal and their metal fittings, valves of metal, couplings of metal for pipes, elbows of metal for pipes, clips of metal for pipes, connectors of metal for pipes; safes (strong boxes) of metal; metal railway materials, metal rails,

metal railway ties, railway switches; bollards of metal, floating docks of metal, mooring buoys of metal, anchors; metal moulds for casting, other than machine parts; works of art made of common metals or their alloys, trophies of common metal; metal closures, bottle caps of metal; metal poles, metal pillars, metal stakes; metal pallets and metal ropes for lifting, loading and transportation purposes, metal hangers, ties, straps, tapes and bands used for load-lifting and load-carrying; wheel chocks made primarily of metal; metal profile laths for vehicles for the purposes of decoration.

7 – Machines, machine tools and industrial robots for processing and shaping wood, metals, glass, plastics and minerals, 3D printers; construction machines and robotic mechanisms (machines) for use in construction; bulldozers, diggers (machines), excavators, road construction and road paving machines, drilling machines, rock drilling machines, road sweeping machines; lifting, loading and transmission machines and robotic mechanisms (machines) for lifting, loading and transmission purposes; elevators, escalators and cranes; machines and robotic mechanisms (machines) for use in agriculture and animal breeding, machines and robotic mechanisms (machines) for processing cereals, fruits, vegetables and food, machines for preparing and processing beverages; engines and motors, other than for land vehicles, parts and fittings therefor; hydraulic and pneumatic controls for engines and motors, brakes other than for vehicles, brake linings for engines, cranks-hafts, gearboxes, other than for land vehicles, cylinders for engines, pistons for engines, turbines, not for land vehicles, filters for engines and motors, oil, air and fuel filters for land vehicle engines, exhausts for land vehicle engines, exhaust manifolds for land vehicle engines, engine cylinders for land vehicles, engine cylinder heads for land vehicles, pistons for land vehicle engines, carburetors for land vehicles, fuel conversion apparatus for land vehicle engines, injectors for land vehicle engines, fuel economisers for land vehicle engines, pumps for land vehicle engines, valves for land vehicle engines, starter motors for land vehicles, dynamos for land vehicle engines, sparking plugs for land vehicle engines; bearings (parts of machines), roller or ball bearings; machines for mounting and detaching tires; alternators, current generators, electric generators, current generators operated with solar energy; painting machines, automatic spray guns for paint, electric, hydraulic and pneumatic punching machines and guns, electric adhesive tape dispensers (machines), electric guns for compressed gas or liquid spraying machines, electric hand drills, electric hand saws, electric jigsaw machines, spiral machines, compressed air machines, compressors (machines), vehicle washing installations, robotic mechanisms (machines) with the above-mentioned functions; printing machines; packaging

machines, filling, plugging and sealing machines, labellers (machines), sorting machines, industrial robots (machines) with the above-mentioned functions, electroplating machines; sealing machines for industrial purposes; machines for textile processing, sewing machines, industrial robots (machines) with the above-mentioned functions; hydrogen dispensing pumps for service stations; pumps for counter-current swimming; aerating pumps for aquaria; compressed air pumps; air pumps [garage installations], fuel dispensing pumps for service stations, self-regulating fuel pumps; electric kitchen machines for chopping, grinding, crushing, mixing and mincing foodstuff, washing machines, laundry washing machines, dishwashers, spin driers (not heated), electric cleaning machines for cleaning floors, carpets or floorings, vacuum cleaners and parts thereof; automatic vending machines; galvanizing and electroplating machines; electric door openers and closers; gaskets for engines and motors.

19 – Sand, gravel, crushed stone, asphalt, bitumen, cement, gypsum, plaster, concrete, marble blocks for construction, included in this class; building materials (as finished products) made of concrete, gypsum, clay, potters' clay, stone, marble, wood, plastics and synthetic materials for building, construction, road construction purposes, included in this class; non-metallic buildings, non-metallic building materials, poles not of metal for power lines, barriers not of metal, natural and synthetic coatings in the form of panels and sheets, being building materials, bitumen cardboard coatings for roofing, bitumen coating for roofing, doors and windows of wood and synthetic materials; traffic signs not of metal, non-luminous and non-mechanical, for roads; monuments and statuettes of stone, concrete and marble; building glass; prefabricated swimming pools not of metal (structures); aquarium sand.

35 – Advertising, marketing and public relations; organization of exhibitions and trade fairs for commercial or advertising purposes, design for advertising, provision of an online marketplace for buyers and sellers of goods and services; office functions, secretarial services, arranging newspaper subscriptions for others, compilation of statistics, rental of office machines, systemization of information into computer databases, telephone answering for unavailable subscribers; business management, business administration and business consultancy, accounting, commercial consultancy services, personnel recruitment, personnel placement, employment agencies, import-export agencies, temporary personnel placement services; auctioneering; the bringing together, for the benefit of others, of a variety of goods (excluding the transport thereof), enabling customers to conveniently view and purchase those goods, such services may be provided by retail stores, wholesale outlets, through vending machines, mail order cata-

logues or by means of electronic media, for example, through web sites or television shopping programmes; services consisting of the registration, transcription, composition, compilation or systematization of written communications and registrations, and also the compilation of mathematical or statistical data; services of advertising agencies and services such as the distribution of prospectuses, directly or through the post, or the distribution of samples.

37 – Construction services, rental of construction machines and equipment; cleaning services for buildings (interior and exterior), public areas, industrial premises, disinfecting, vermin exterminating services, other than for agriculture, rental of cleaning machines and equipment; vehicles service stations for land vehicles, maintenance, repair and refueling of land vehicles; vehicles service stations for marine vehicles, maintenance, repair and refueling of marine vehicles; repair and maintenance of air vehicles; upholstery, repair and restoration of furniture; installation, maintenance and repair of heating, cooling and sanitary installations; cleaning, care and repair of clothing; installation, maintenance and repair of industrial machines and equipment, office machines and equipment, communication apparatus, electric and electronic appliances; repair and maintenance of lifts; clock and watch repair; mining services and mining extraction; repair of shoes, bags and belts.

(260) AM 2020 104723 A
 (800) 1485251
 (151) 2019 05 15
 (891) 2019 05 15
 (731) DR. MED. GERHARD SIEBENHÜNER
 Burgstr. 8, 63477 Maintal, Germany
 (540)

EHP

(591) Black, white
 (511)

10 – Medical apparatus for treating tumors of the human or animal body; apparatus for purifying the blood during surgical or therapeutic procedures; medical apparatus and instruments; surgical apparatus and instruments; diagnostic and therapeutic equipment in the pharmaceutical, medical and veterinary fields; instruments for the extracorporeal destruction of cancer cells; instruments for the extracorporeal purification of blood and supply of natural or chemical substances to the body; patient cradle equipment suitable for use in hyperthermia, thermotherapy or thermometry treatments; equipment for high-frequency heat treatment; apparatus, equipment and instruments for chemotherapy and electrochemical tumor therapy; hyperthermia systems; electro-hyperthermia equipment; heat treatment equipment; ap-

paratus for dose planning and documentation of tumor radiotherapy; electrical equipment for medical and surgical purposes; medical and surgical instruments (including electrical).

42 – Advisory or additive services relating to therapy for the treatment of tumors of the human or animal body; advisory or additive services relating to therapy for the purification of blood in surgical or therapeutic procedures; services provided by a supplier of medical apparatus and instruments, namely technical advice relating to the purchase and operation of medical equipment and instruments adapted to the customer's specific applications; calibration of medical equipment and instruments; development and research services relating to new products [for third parties]; biological research; research in the field of chemistry; research in the field of technology.

44 – Medical services in the field of oncology; medical services for the treatment of diseases of the human or animal body; provision of heat therapy for treating tumors in human or animals; blood purification services for surgical or therapeutic procedures.

(260) AM 2020 104735 A
 (800) 1283380
 (151) 2015 07 07
 (891) 2019 08 13
 (731) SC IP Limited
 Charter Place, 23-27 Seaton Place,
 St Helier JE1 1JY, Jersey
 (540)

BETCONSTRUCT

(591) Black, white
 (511)

9 – Optical, weighing, measuring, signalling, checking (supervision), apparatus and instruments; apparatus and instruments for conducting, switching, transforming, accumulating, regulating or controlling electricity; apparatus for recording, transmission or reproduction of sound or images; magnetic data carriers; recording discs; application software; mechanisms for coin-operated apparatus; cash registers, calculating machines, data processing equipment and computers; apparatus and instruments for recording, transmission or reproduction of sound, data and/or images; application software relating to and for playing casino games, gambling and betting; audio and video tapes; calculators; cards bearing magnetic data; cash registers; CD-ROMs; checking (supervision) apparatus and instruments; compact discs; computer and electronic games software; computer game tapes; computer software for playing games; computer hardware for use in gaming equipment; computer hardware for use in amusement

machines; computer software for digital lotteries and casinos; computer hardware for use in digital lotteries; computer hardware for use in casinos; computer software for gaming, gambling and betting; computer hardware for use in gaming, gambling and betting apparatus and equipment; computer interfaces; computer lottery games; computer lottery games downloadable from the Internet; computer software; computer software applications, downloadable; computer software distributed via the Internet; computer software downloadable from the Internet; computer software and programs for use on computer networks including the Internet; computer software platforms for social networking; computer software to enable uploading, posting, showing, displaying, tagging, blogging, sharing or otherwise providing electronic media or information in the fields of virtual communities, electronic gaming, entertainment, and general interest via the Internet or other communications networks with third parties; computer software platforms for computer software programs running on, or in connection with, mobile devices; computer software for the provision and management of on-line games and competitions; computer software for use on computer networks, including the Internet for gaming, gambling and betting; computer software relating to and for playing casino games, gambling and betting; computer software for use on computer networks, including the Internet for gaming, gambling and betting; computer programs and application software for use on telephones and handheld mobile devices; computer programs relating to and for playing casino games, gambling and betting; data processing equipment and computers; electronic apparatus for checking tickets, passes and lottery tickets; mechanisms for coin, chip and card operated apparatus; digital video discs; display equipment and installations; downloadable electronic publications; downloadable electronic publications featuring gaming, gambling and betting; electronic cards for use in connection with promotion schemes; electronic loyalty scheme cards; electronic number generators; electronic number terminals; electronic publications; electronic publications and information provided on-line from databases or the Internet (downloadable); electronic publications provided by electronic mail; electronic publications featuring gaming, gambling and betting; electronic tags; electric apparatus for detecting winning symbols or winning numbers; entertainment software; equipment for apparatus for sorting and counting; games and competitions in electronic and computer software form; games, gaming, and gambling related software; holographic images; indication panels, data and information transmission installations, monitors, control consoles and printers all for bookmaking; disks containing information recorded on computer media; interactive computer systems; interactive computer and mobile device systems; interactive

software; interactive games, gaming and gambling software; Internet terminals and terminals for receiving and arranging sports betting; machines for issuing tickets, lottery tickets and forms; magnetic, optic and recording data and sound carriers; magnetic, optical, electronic and smart cards (cards with integrated circuits); magnetically encoded cards; on-line games, gaming and gambling related software; operating terminals for acceptance of betting games; publications in electronic form supplied online from a computer database or the Internet; interactive computer software; electronic number generators; software for use with games, entertainment, recreational, amusement, gaming and video game terminals, machines and apparatus; software for interactive scratch cards and scratch card games; software and software packages for the registration and operation of betting related to sports; software for automatic gaming machines; computer hardware for computer assisted gaming machines; software for processing bets including through the Internet; sound and video recordings; totalizators; video screens; virtual reality games software; voting machines; wagering systems [computer systems]; wagering terminals [computer systems]; parts and fittings for all the aforesaid goods.

16 – Paper, cardboard; printed matter; bookbinding material; photographs; stationery; adhesives for stationery or household purposes; artists' materials; paint brushes; typewriters and office requisites (except furniture); instructional and teaching material (except apparatus); plastic materials for packaging (not included in other classes); printers' type; printing blocks; instructional and informative printed matter relating to bets, betting, games, gaming and gambling betting forms; betting slips; coupons for betting purposes; calendars; printed cards; printed game instruction sheets; printed scoring sheets; tickets; paper tokens; vouchers; printed publications relating to bets, betting, games, gaming and gambling.

28 – Games, toys, playthings and novelties; apparatus for games; appliances, equipment and accessories for bingo [gaming machines]; arcade games; articles and apparatus for use in games, in lottery games and in playing games and lottery games; automatic gaming machines; automatic slot machines; bags specially adapted for handheld games; bags specially adapted for handheld video games; bingo game playing apparatus; bingo cards; bingo markers; board games; bill-operated gaming equipment; bowling apparatus and machines; card games; cards (games); casino games, equipment and accessories therefor; chips and dice [gaming equipment]; chips, counters, discs and tokens for gambling; action skill games; coin fed gaming machines; coin-operated amusement gaming machines; coin-operated gambling and betting machines; coin-operated

games; coin-operated gaming equipment; counters, discs and pawns for games; darts, quoits; dart games; dice and cases therefor; dice games; electronic board games; electronic games other than those adapted for use with television receivers only; free standing games apparatus; free standing video games apparatus; free standing gaming and gambling apparatus; game boards; game cards; gaming apparatus; gaming and amusement machines and parts and fittings therefor; gaming chips; apparatus for games; gaming machines; gaming machines, operated by inserting coins, counters, chips and cards; gaming tables; gaming tables for poker and blackjack; gambling machines; hand held electronic games; lottery balls; mahjong (Chinese gambling game); parlour games, devices, equipment and accessories therefor; pinball games; pinball games machines (coins or counter operated); pinball machines (pachinko machines, korinto games machines, smartball machines); playing cards; poker chips; portable games with liquid crystal displays; puzzle games; puzzles; question sets for games, gaming and gambling; quiz games; roulette sets, chips, wheels, tables, equipment and accessories therefor; scratch cards; scratch card games; slot machines (gaming devices); snooker tables and snooker accessories; sports games; amusement apparatus and accessories for games; amusement apparatus and accessories for games, adapted for use with televisions; betting terminals; betting terminals with internet connections; betting terminals with screens; coin, chip and card operated gaming equipment and amusement machines; electric and electronic gaming apparatus for betting offices; electric, electronic or mechanical gaming apparatus for betting; electrical and electronic gaming apparatus for use in on-line betting; electronic betting terminals; electronic game equipment; slot machines; gaming machines; parts and fittings for all the aforesaid goods; lottery tickets; scratch cards.

35 – Advertising; business management; business administration; office functions; auctioneering, including on the Internet; bookkeeping; business management; business administration; classified advertising services; collating of data in computer databases; compilation of statistics; computerised file managing; demonstration of goods; distribution of samples; business consultancy services related to establishing and providing sales, brokerage and collection points for betting; layout design for advertising purposes; loyalty card services; office functions; on-line advertising in computer networks; on-line advertising on a computer network; on-line data processing services; organisation of promotional incentive schemes; presentation of goods on communication media, for retail purposes; production of radio, television and cinema advertisements; retail services in relation to games, apparatus and devices for betting, games, gaming, gambling and wagering;

retail services in relation to software and software packages for the registration and operation of betting related to sports, magnetic, optic and recording data and sound carriers, data processing equipment and computers and CD-ROMs; sales promotion [for others]; sale of printed publications; promoting the goods and services of others by arranging for sponsors to affiliate their goods and services with awards programmes; systematic ordering of data in computer databases; business organization consultancy with regard to providing of betting; television advertising; vending machine rental services; wholesale services in relation to games, gaming and gambling equipment, games and books relating to gambling, and betting materials, devices and equipment; business services related to establishing of sports betting offices; information concerning the services mentioned before; services mentioned before through or not through the Internet; advisory and consultancy services in relation to the aforesaid.

41 – Education (training).

42 – Scientific and technological services and research and design relating thereto; industrial analysis and research services; design and development of computer hardware and software; application service provider (ASP); hosting websites that allow an on-line community for registered users to participate in competitions, showcase their skills, get feedback from their peers, form virtual communities, and engage in social networking; application service provider (ASP) featuring software to enable or facilitate the uploading, downloading, streaming, posting, displaying, blogging, linking, sharing or otherwise providing electronic media or information over communication networks; computer game design; creation, hosting, updating and maintaining Internet sites; design and development of software in the form of services relating to the development and creation of software for use in relation to electronic games downloadable from the Internet, electronic puzzles downloadable from the Internet, electronic board games downloadable from the Internet, electronic games of skill, electronic gambling games and electronic card games downloadable from the Internet, skill games, electronic games and software for fixed odds betting programs, spread betting programs, horse racing betting, instant lotteries, and pools; design and development services in relation to gaming and gambling machines, apparatus and accessories; design and development services in relation to interactive entertainment products; design of scratch cards and electronic scratch cards and scratch card games; design services relating to the production of computer games and interactive entertainment products; design services in relation to interactive games enabling users to buy, sell, and participate in auctions whilst participating in the game; design of graphics, visuals, virtual and inter-

active images, and of special effects for games, audiovisual, multimedia productions and for Internet gaming and gambling website pages; development of computer software applications solutions; providing temporary use of non-downloadable software for use in connection with interactive, multiplayer and single player games, gaming and gambling; providing temporary use of non-downloadable software applications in connection with interactive, multiplayer and single player games, gaming and gambling for third parties, all accessible via a web site; providing information on computer technology and programming via a web site; technical management with regard to providing of betting; consultancy, information and advisory services relating to all the aforesaid services.

(260) AM 2020 104785 A

(800) 1485790

(151) 2019 03 24

(891) 2019 03 24

(731) APPLE INC.

One Apple Park Way, Cupertino CA 95014,
USA

(540)

APPLE TV

(591) Black, white

(526) TV

(511)

38 – Telecommunications; broadcasting, transmission, and streaming of voice, data, images, audio, video, multimedia, television, by means of telecommunications networks, computer networks, the Internet, satellite, wireless communications networks, television, and cable; subscription and pay-per-view broadcasting, transmission, and streaming services by means of telecommunications networks, computer networks, the Internet, satellite, wireless communications networks, television, and cable; video-on-demand transmission services; providing access to telecommunications networks, computer networks, the Internet, satellite communications, wireless communications networks, and cable; providing access to websites, databases, electronic bulletin boards, on-line forums, directories, music, and video and audio programs; communication by computer; information, advisory and consultancy services relating to all the aforesaid; providing access to interactive websites and computer applications for the posting and sharing of reviews, survey, and ratings relating to educational programs, entertainment, motion pictures, theatre, arts and cultural events, concerts, live performances, competitions, fairs, festivals, exhibitions, expositions, and sporting events; providing access to a website for the uploading, storing, sharing, viewing and posting of images, audio,

videos, online journals, blogs, podcasts, and multimedia content.

41 – Development, production, distribution, rental, and presentation of television programs, motion pictures, and multimedia entertainment content; providing ongoing television, audio, video, and webcast non-downloadable programs; providing entertainment, sports, animation, music, informational, news, reality, documentary, current events, and arts and culture programming via websites by means of telecommunications networks, computer networks, the Internet, satellite, wireless communications networks, television, and cable television; providing non-downloadable entertainment, sports, animation, music, informational, news, reality, documentary, current events, and arts and culture programming; providing interactive guides for searching, selecting, recording, and archiving television programs, motion pictures, and multimedia entertainment content; providing entertainment, sports, animation, music, informational, news, reality, documentary, current events, and arts and culture programming via websites and computer applications; providing information in the field of entertainment, sports, music, news, documentaries, current events, and arts and culture via websites and computer applications; entertainment information; providing information, schedules, reviews and personalized recommendations of educational programs, entertainment, motion pictures, theatre, arts and cultural events, concerts, live performances, competitions, fairs, festivals, exhibitions, expositions, and sporting events; publication and presentation of reviews, surveys, and ratings; news reporting.

(260) AM 2020 104786 A

(800) 1485791

(151) 2019 03 24

(891) 2019 03 24

(731) APPLE INC.

One Apple Park Way, Cupertino CA 95014,
USA

(540)



(591) Black, white

(531) 05.07.13; 05.07.23

(526) tv

(511)

38 – Telecommunications; broadcasting, transmission, and streaming of voice, data, images, audio, video, multimedia, television, by means of telecommunications networks, computer networks, the Internet, satellite, wireless communications networks,

television, and cable; subscription and pay-per-view broadcasting, transmission, and streaming services by means of telecommunications networks, computer networks, the Internet, satellite, wireless communications networks, television, and cable; video-on-demand transmission services; providing access to telecommunications networks, computer networks, the Internet, satellite communications, wireless communications networks, and cable; providing access to websites, databases, electronic bulletin boards, on-line forums, directories, music, and video and audio programs; communication by computer; information, advisory and consultancy services relating to all the aforesaid; providing access to interactive websites and computer applications for the posting and sharing of reviews, survey, and ratings relating to educational programs, entertainment, motion pictures, theatre, arts and cultural events, concerts, live performances, competitions, fairs, festivals, exhibitions, expositions, and sporting events; providing access to websites for the uploading, storing, sharing, viewing and posting of images, audio, videos, online journals, blogs, podcasts, and multimedia content.

41 – Development, production, distribution, rental, and presentation of television programs, motion pictures, and multimedia entertainment content; providing ongoing television, audio, video, and webcast non-downloadable programs; providing entertainment, sports, animation, music, informational, news, reality, documentary, current events, and arts and culture programming by means of telecommunications networks, computer networks, the Internet, satellite, wireless communications networks, television, and cable television; providing non-downloadable entertainment, sports, animation, music, informational, news, reality, documentary, current events, and arts and culture programming; providing interactive guides for searching, selecting, recording, and archiving television programs, motion pictures, and multimedia entertainment content; providing entertainment, sports, animation, music, informational, news, reality, documentary, current events, and arts and culture programming via websites and computer applications; providing information in the field of entertainment, sports, music, news, documentaries, current events, and arts and culture via websites and computer applications; entertainment information; providing information, schedules, reviews and personalized recommendations of educational programs, entertainment, motion pictures, theatre, arts and cultural events, concerts, live performances, competitions, fairs, festivals, exhibitions, expositions, and sporting events; publication and presentation of reviews, surveys, and ratings; news reporting.

(260) AM 2020 104787 A

(800) 1485870

(151) 2019 05 31

(891) 2019 05 31

(731) HUAWEI TECHNOLOGIES CO., LTD.
ADMINISTRATION BUILDING, HUAWEI
TECHNOLOGIES CO., LTD., BANTIAN,
LONGGANG DISTRICT, 518129
SHENZHEN, China

(540)

HUAWEI Histen

(591) Black, white

(531) 27.05.01

(511)

9 – Downloadable mobile phone software applications; computer programs, recorded; smartglasses; smartwatches; smartphones; wearable activity trackers; tablet computers; notebook computers; downloadable music files; downloadable image files; electronic sheet music, downloadable; interactive touch screen terminals; smart rings; fingerprint identifier; human face recognition devices; electric and electronic effects units for musical instruments; audio interfaces; equalizers (audio apparatus); subwoofers; virtual reality headsets; audio mixers; earphones; computer programs for editing images, sound and videos; software for processing images, graphs and words; software for music composition; computer software for processing digital music files; central processing units (processors) for processing information, data, sound and images; software for controlling and improving sound quality of audio apparatus; computer software for operating and controlling audio and video apparatus; vibration absorber for electronic audio apparatus; digital sound processors.

(260) AM 2020 104790 A

(800) 1485962

(151) 2019 06 27

(891) 2019 06 27

(731) Zakrytoe Aktsionernoe Obshchestvo
"MINSKY ZAVOD VINOGRADNYKH
VIN"
ul. Kazintsa, k. 23, d.52A, 220099 Minsk,
Belarus

(540)



(591) Red, white, black, grey, light-blue, blue, green and brown

(531) 05.07.02; 06.03.05; 25.01.15; 25.01.15; 28.05; 29.01.15

(526) ВОДКА ФИЛЬТРАЦИЯ СЕРЕБРОМ
ИОНЫ СЕРЕБРА ОЧИЩЕНА СЕРЕБРОМ
СПЕЦИАЛЬНАЯ УМЯГЧЕННАЯ ВОДА
ТРАДИЦИОННАЯ РЕЦЕПТУРА
ПРОИЗВЕДЕНО В БЕЛАРУСИ 40% ОБ.,
0.5 Л.

(511)

33 – Vodka.

(260) AM 2020 104796 A

(800) 1486143

(151) 2019 05 10

(891) 2019 05 10

(731) Euro Games Technology Ltd.
"Maritsa" Str., 4, "Vranya-Lozen-
Triugulnika", BG-1151 Sofia, Bulgaria

(540)



(591) Yellow, orange and green.

(531) 27.05.02; 27.05.03; 27.05.10; 29.01.13

(511)

9 – Software; computer gaming software; computer software packages; computer operating system software; computer software, recorded; software drivers; virtual reality software; games software; entertainment software for computer games; computer programs for network management; operating computer software for main frame computers; monitors (computer hardware); computer hardware; apparatus for recording images; monitors (computer programs); computer game programs; computer programs for recorded games; apparatus for recording, transmission or reproduction of sound or images; communications servers [computer hardware]; electronic components for gambling machines; computer application software featuring games and gaming; computer software for the administration of on-line games and gaming; computer hardware for games and gaming; electronic components and computer software for gambling, gambling machines, gambling games on the internet and via telecommunication network.

28 – Gaming machines for gambling; chips for gambling; mah-jong; arcade games; gambling machines operating with coins, notes and cards; games; electronic games; parlor games; gaming chips; gaming tables; slot machines [gaming machines]; LCD game machines; slot machines and gaming devices; coin-

operated amusement machines; roulette chips; poker chips; chips and dice [gaming equipment]; equipment for casinos; roulette tables; gaming roulette wheels; casino games; gambling machines and amusement machines, automatic and coin-operated; coin-operated amusement machines and/or electronic coin-operated amusement machines with or without the possibility of gain; boxes for coin-operated machines, slot machines and gaming machines; electronic or electrotechnical amusement machines and apparatus, gaming machines, coin-operated entertainment machines; housings for coin-operated machines, gaming equipment, gaming machines, machines for gambling; electropneumatic and electrical gambling machines (slot machines).

41 – Gambling; services related to gambling; gaming services for entertainment purposes; casino, gaming and gambling services; training in the development of software systems; provision of equipment for gambling halls; providing casino equipment [gambling]; gaming machine entertainment services; providing casino facilities [gambling]; gaming hall services; amusement arcade services; games equipment rental; rental of gaming machines; providing amusement arcade services; rental of gaming machines with images of fruits; editing or recording of sounds and images; sound recording and video entertainment services; hire of sound reproducing apparatus; provision of gaming equipment for casinos; providing of casino facilities; online gambling services; casino, gaming and gambling services; provision of gaming establishments, gaming halls, internet casinos, online gaming services.

(260) AM 2020 104797 A

(800) 1012690

(151) 2009 08 05

(891) 2019 08 21

(731) BOGE KOMPRESSOREN Otto Boge GmbH
& Co. KG
Otto-Boge-Str. 1-7, 33739 Bielefeld, Germany

(540)



(591) Black, white

(531) 26.01.10; 26.03.01; 26.07.03; 27.05.17

(511)

9 – Electronic controls and control devices for installations with multiple compressors; electronic controls for compressors.

11 – Compressed-air filters as included in this class, compressed-air dryers, condensate drains as included in this class, converters for generating oil-free compressed-air as included in this class.

(260) AM 2020 104836 A

(800) 1486192

(151) 2019 04 25

(891) 2019 04 25

(731) Tovarichtchestvo s ogranitchennoi
otvetstvennost'iou "Arena S"
prospect Suyunbaya, dom 2, korpus 6, 050016
gorod Almaty, Kazakhstan

(540)



(591) White, black and red

(531) 25.03.03; 27.05.01; 29.01.13

(511)

9 – Scientific, nautical, surveying, photographic, cinematographic, optical, weighing, measuring, signalling, checking [supervision], life-saving and teaching apparatus and instruments; apparatus and instruments for conducting, switching, transforming, accumulating, regulating or controlling electricity; apparatus for recording, transmission or reproduction of sound or images; magnetic data carriers, recording discs; compact discs, DVDs and other digital recording media; mechanisms for coin-operated apparatus; cash registers, calculating machines, data processing equipment, computers; software; fire extinguishing apparatus; 3D spectacles; DVD players; ticket dispensers; coin-operated musical automata [juke boxes]; fire engines; answering machines; electrical adapters; batteries for electronic cigarettes; accumulators, electric; accumulators, electric, for vehicles; accelerometers; actinometers; alidades; altimeters; ammeters; anemometers; anodes; antennas; anticathodes; apertometers [optics]; high-frequency apparatus; testing apparatus not for medical purposes; electro-dynamic apparatus for the remote control of railway points; electro-dynamic apparatus for the remote control of signals; remote control apparatus; monitoring apparatus, other than for medical purposes; sound recording apparatus; global Positioning System [GPS] apparatus; distillation apparatus for scientific purposes; diffraction apparatus [microscopy]; air analysis apparatus; apparatus to check franking; sound transmitting apparatus; apparatus for fermentation [laboratory apparatus]; breathing apparatus for underwater swimming; breathing apparatus, except for artificial respiration; apparatus and installations for the production of X-rays, not for medical purposes; cash registers; electric apparatus for commutation; intercommunication apparatus; stills for laboratory experiments; projection apparatus; fire extinguishing apparatus; radiological apparatus for industrial purposes; X-ray apparatus not for medical purposes; blueprint apparatus; flashing lights [luminous signals]; stereoscopic apparatus; telephone apparatus; facsimile machines; phototelegraphy apparatus; igniting apparatus, electric, for igniting at a distance; acid hydrometers; sa-

linometers; acidimeters for batteries; aerometers; beacons, luminous; battery jars; barometers; anode batteries; galvanic batteries; batteries for lighting; solar batteries; solar panels for the production of electricity; batteries, electric; balances [steelyards]; betatrons; binoculars; biochips; electronic tags for goods; lens hoods; magnetic tape units for computers; computer memory devices; fire hose nozzles; encoded identification bracelets, magnetic; connected bracelets [measuring instruments]; safety tarpaulins; electronic key fobs being remote control apparatus; bullet-proof clothing; signalling buoys; life buoys; marking buoys; directional compasses; vacuum gauges; electrolyzers; variometers; verniers; scales; baby scales; bathroom scales; letter scales; weighbridges; precision balances; scales with body mass analysers; levelling staffs [surveying instruments]; camcorders; video baby monitors; video cassettes; video telephones; video screens; viewfinders, photographic; plugs, sockets and other contacts [electric connections]; micrometer screws for optical instruments; viscosimeters; circuit closers; wavemeters; voltmeters; mechanical signs; signs, luminous; switchboxes [electricity]; current rectifiers; gas testing instruments; gasometers [measuring instruments]; galvanometers; hands-free kits for telephones; heliographic apparatus; hygrometers; hydrometers; weights; peepholes [magnifying lenses] for doors; holograms; plotters; loudspeakers; sounding leads; plumb bobs; range finders; densimeters; densitometers; optical goods; detectors; smoke detectors; infrared detectors; counterfeit coin detectors; joysticks for use with computers, other than for video games; transparencies [photography]; slide projectors; diaphragms [photography]; dictating machines; dynamometers; light-emitting diodes [LED]; floppy disks; sound recording discs; disks, magnetic; optical discs; circular slide rules; disk drives for computers; juke boxes for computers; DNA chips; electronic interactive whiteboards; electronic notice boards; bullet-proof waistcoats; lifejackets; reflective safety vests; identification threads for electric wires; nose clips for divers and swimmers; locks, electric; bells [warning devices]; alarm bells, electric; electric door bells; signal bells; audio interfaces; acoustic conduits; mirrors for inspecting work; road signs, luminous or mechanical; marine depth finders; probes for scientific purposes; buzzers; needles for surveying compasses; needles for record players; measures; pressure measuring apparatus; simulators for the steering and control of vehicles; inverters [electricity]; pressure indicators; temperature indicators; incubators for bacteria culture; measuring instruments; cosmographic instruments; mathematical instruments; levelling instruments; instruments containing eyepieces; surveying instruments; azimuth instruments; interfaces for computers; ionization apparatus not for the treatment of air or water; sparkguards; coaxial cables; fiber optic cables; cables,

electric; calipers; slide calipers; screw-tapping gauges; calorimeters; calculating machines; pocket calculators; decompression chambers; cinematographic cameras; thermal imaging cameras; mouth guards for sports; life-saving capsules for natural disasters; electronic pens [visual display units]; holders for electric coils; identity cards, magnetic; video game cartridges; toner cartridges, unfilled, for printers and photocopiers; memory cards for video game machines; encoded magnetic cards; riding helmets; protective helmets; carriers for dark plates [photography]; automated teller machines [ATM]; cathodes; spools [photography]; choking coils [impedance]; coils, electric; electromagnetic coils; cinematographic film, exposed; computer keyboards; solenoid valves [electromagnetic switches]; wire connectors [electricity]; encoded key cards; electronic book readers; electronic agendas; push buttons for bells; mouse pads; magnetic encoders; anti-glare visors; collectors, electric; calibrating rings; smart rings; protective suits for aviators; commutators; compact discs [audio-video]; compact discs [read-only memory]; comparators; marine compasses; computers; laptop computers; tablet computers; notebook computers; condensers [capacitors]; contacts, electric; wind socks for indicating wind direction; traffic cones; branch boxes [electricity]; distribution boxes [electricity]; junction boxes [electricity]; connectors [electricity]; battery boxes; cabinets for loudspeakers; diving suits; galena crystals [detectors]; reflecting discs for wear, for the prevention of traffic accidents; covers for electric outlets; logs [measuring instruments]; lasers, not for medical purposes; lactodensimeters; lactometers; vacuum tubes [radio]; darkroom lamps [photography]; thermionic tubes; amplifying tubes; flashlights [photography]; head cleaning tapes [recording]; magnetic tapes; videotapes; surveying chains; fire escapes; rulers [measuring instruments]; square rulers for measuring; slide-rules; contact lenses; correcting lenses [optics]; close-up lenses; optical lenses; optical condensers; sounding lines; electricity conduits; measuring spoons; magnifying glasses [optics]; thread counters; magnets; decorative magnets; crash test dummies; resuscitation mannequins [teaching apparatus]; mouse [computer peripheral]; pressure gauges; security tokens [encryption devices]; divers' masks; solderers' helmets; protective masks; respiratory masks, other than for artificial respiration; materials for electricity mains [wires, cables]; voting machines; money counting and sorting machines; material testing instruments and machines; furniture especially made for laboratories; megaphones; portable media players; diaphragms [acoustics]; diaphragms for scientific apparatus; metal detectors for industrial or military purposes; digital weather stations; metronomes; rules [measuring instruments]; carpenters' rules; dressmakers' measures; mechanisms for coin-operated apparatus; mechanisms for counter-operated apparatus; coin-operated

mechanisms for television sets; shutter releases [photography]; micrometers; microprocessors; microscopes; microtomes; microphones; audio mixers; modems; lightning rods; monitors [computer hardware]; monitors [computer programs]; selfie sticks [hand-held monopods]; terminals [electricity]; junction sleeves for electric cables; teeth protectors; temperature indicator labels, not for medical purposes; knee-pads for workers; headphones; surveyors' levels; sound recording carriers; magnetic data media; optical data media; electronic sheet music, downloadable; computer software, recorded; sheaths for electric cables; identification sheaths for electric wires; weighing machines; computer hardware; punched card machines for offices; life saving apparatus and equipment; shoes for protection against accidents, irradiation and fire; objectives [lenses] [optics]; lenses for astrophotography; egg-candlers; fire extinguishers; electrified fences; limiters [electricity]; clothing for protection against accidents, irradiation and fire; clothing for protection against fire; asbestos clothing for protection against fire; clothing especially made for laboratories; ozonisers [ozonators]; octants; eyepieces; ohmmeters; wrist rests for use with computers; eyeglass frames; oscillographs; plumb lines; mirrors [optics]; eyeglasses; sunglasses; goggles for sports; electronic collars to train animals; signalling panels, luminous or mechanical; radio pagers; pince-nez; electronic pocket translators; transmitters [telecommunication]; telephone transmitters; transmitters of electronic signals; switches, electric; periscopes; gloves for divers; gloves for protection against accidents; gloves for protection against X-rays for industrial purposes; asbestos gloves for protection against accidents; furnaces for laboratory use; pipettes; pyrometers; planimeters; plane tables [surveying instruments]; plates for batteries; wafers for integrated circuits; printed circuit boards; compact disc players; cassette players; protective films adapted for computer screens; protective films adapted for smartphones; sound recording strips; X-ray films, exposed; films, exposed; life-saving rafts; laboratory trays; digital signs; semiconductor; polarimeters; fire pumps; measuring glassware; life belts; fuses; circuit breakers; converters, electric; telerupters; food analysis apparatus; diagnostic apparatus, not for medical purposes; distance recording apparatus; distance measuring apparatus; speed measuring apparatus [photography]; appliances for measuring the thickness of leather; apparatus for measuring the thickness of skins; speed checking apparatus for vehicles; teaching apparatus; time recording apparatus; apparatus and instruments for astronomy; surveying apparatus and instruments; weighing apparatus and instruments; nautical apparatus and instruments; navigational instruments; optical apparatus and instruments; apparatus and instruments for physics; chemistry apparatus and instruments; measuring apparatus; measuring devices,

electric; boiler control instruments; meteorological instruments; naval signalling apparatus; observation instruments; navigation apparatus for vehicles [on-board computers]; satellite navigational apparatus; regulating apparatus, electric; precision measuring apparatus; audio- and video-receivers; prisms [optics]; computer software applications, downloadable; printers for use with computers; hemline markers; retorts' stands; apparatus for changing record player needles; drainers for use in photography; cleaning apparatus for sound recording discs; fire beaters; telescopic sights for firearms; telescopic sights for artillery; test tubes; pressure indicator plugs for valves; magnetic wires; telegraph wires; telephone wires; wires, electric; conductors, electric; copper wire, insulated; fuse wire; computer programs, recorded; computer game software; computer programs [downloadable software]; computer operating programs, recorded; record players; processors [central processing units]; rods for water diviners; electronic publications, downloadable; distribution consoles [electricity]; control panels [electricity]; radar apparatus; baby monitors; masts for wireless aerials; transmitting sets [telecommunication]; radios; vehicle radios; sprinkler systems for fire protection; frames for photographic transparencies; screens for photoengraving; flowmeters; walkie-talkies; voltage surge protectors; voltage regulators for vehicles; stage lighting regulators; light dimmers [regulators], electric; speed regulators for record players; cell switches [electricity]; washing trays [photography]; marking gauges [joinery]; T-squares for measuring; time switches, automatic; relays, electric; safety restraints, other than for vehicle seats and sports equipment; X-ray photographs, other than for medical purposes; rheostats; respirators for filtering air; retorts; refractometers; refractors; grids for batteries; humanoid robots with artificial intelligence; speaking tubes; horns for loudspeakers; subwoofers; saccharometers; optical fibers [light conducting filaments]; traffic-light apparatus [signalling devices]; dog whistles; signalling whistles; sextants; inductors [electricity]; safety nets; nets for protection against accidents; fire alarms; signals, luminous or mechanical; sirens; electronic access control systems for interlocking doors; scanners [data processing equipment]; integrated circuit cards [smart cards]; smart-glasses; smartphones; smartwatches; connections for electric lines; couplings, electric; sonars; sound locating instruments; lighting ballasts; resistances, electric; spectrograph apparatus; spectroscopes; speed indicators; alcoholmeters; satellites for scientific purposes; protection devices for personal use against accidents; audiovisual teaching apparatus; charging stations for electric vehicles; radiotelegraphy sets; radiotelephony sets; spectacle lenses; anti-glare glasses; optical glass; personal stereos; stereoscopes; stands for photographic apparatus; stroboscopes; fire boats; sulfitemeters; bags adapted for laptops; drying

racks [photography]; spherometers; integrated circuits; printed circuits; counters; parking meters; kilometer recorders for vehicles; revolution counters; abacuses; egg timers [sandglasses]; taximeters; ear plugs for divers; tachometers; television apparatus; telegraphs [apparatus]; telescopes; teleprompters; teleprinters; cellular phones / mobile telephones / cell phones; cordless telephones; theodolites; interactive touch screen terminals; thermo-hygrometers; thermometers, not for medical purposes; thermostats; thermostats for vehicles; crucibles [laboratory]; tone arms for record players; totalizers; transistors [electronic]; transponders; protractors [measuring instruments]; transformers [electricity]; step-up transformers; vehicle breakdown warning triangles; triodes; starter cables for motors; discharge tubes, electric, other than for lighting; capillary tubes; neon signs; pitot tubes; X-ray tubes not for medical purposes; telephone receivers; squares for measuring; gauges; quantity indicators; gasoline gauges; water level indicators; electric loss indicators; light-emitting electronic pointers; slope indicators; levels [instruments for determining the horizontal]; mercury levels; spirit levels; urinometers; amplifiers; particle accelerators; electric installations for the remote control of industrial operations; steering apparatus, automatic, for vehicles; balancing apparatus; video recorders; sound reproduction apparatus; invoicing machines; tape recorders; protection devices against X-rays, not for medical purposes; railway traffic safety appliances; data processing apparatus; oxygen transvasing apparatus; theft prevention installations, electric; film cutting apparatus; drying apparatus for photographic prints; optical character readers; centering apparatus for photographic transparencies; dosage dispensers; battery chargers; chargers for electric batteries; chargers for electronic cigarettes; acoustic alarms; sounding apparatus and machines; apparatus for editing cinematographic film; cathodic anti-corrosion apparatus; couplers [data processing equipment]; wearable activity trackers; anti-theft warning apparatus; computer peripheral devices; anti-interference devices [electricity]; demagnetizing apparatus for magnetic tapes; acoustic couplers; alarms; fog signals, non-explosive; whistle alarms; adding machines; readers [data processing equipment]; heat regulating apparatus; photocopiers [photographic, electrostatic, thermic]; electric and electronic effects units for musical instruments; bar code readers; downloadable ring tones for mobile phones; downloadable image files; downloadable music files; animated cartoons; filters [photography]; filters for respiratory masks; filters for ultraviolet rays, for photography; USB flash drives; magic lanterns; optical lamps; signal lanterns; cameras [photography]; glazing apparatus for photographic prints; shutters [photography]; darkrooms [photography]; photometers; flash-bulbs [photography]; digital photo frames; enlarging apparatus [photography]; photovoltaic

cells; containers for contact lenses; eyeglass cases; containers for microscope slides; cases for smartphones; cases especially made for photographic apparatus and instruments; chromatography apparatus for laboratory use; chronographs [time recording apparatus]; laboratory centrifuges; eyeglass chains; cyclotrons; compasses for measuring; frequency meters; time clocks [time recording devices]; petri dishes; sleeves for laptops; covers for personal digital assistants [PDAs]; covers for tablet computers; covers for smartphones; fire blankets; chips [integrated circuits]; jigs [measuring instruments]; pedometers; meteorological balloons; electrified rails for mounting spot lights; asbestos screens for firemen; fire hose; virtual reality headsets; protective helmets for sports; head guards for sports; cell phone straps; eyeglass cords; tripods for cameras; switchboards; distribution boards [electricity]; equalizers [audio apparatus]; screens [photography]; workmen's protective face-shields; projection screens; radiology screens for industrial purposes; fluorescent screens; exposure meters [light meters]; ducts [electricity]; galvanic cells; epidiascopes; ergometers; armatures [electricity]; black boxes [data recorders].

12 – Vehicles; apparatus for locomotion by land, air or water; motor buses; motor coaches; motor homes; driverless cars [autonomous cars]; motor racing cars; cars; sports cars; concrete mixing vehicles; refrigerated vehicles; caravans; shock absorbers for automobiles; suspension shock absorbers for vehicles; space vehicles; aircraft; aeronautical apparatus, machines and appliances; air cushion vehicles; hot air balloons; ski carriers for cars; luggage carriers for vehicles; bumpers for automobiles; vehicle bumpers; tires for vehicle wheels; barges; brake shoes for vehicles; tailboard lifts [parts of land vehicles]; armored vehicles; buffers for railway rolling stock; dining cars [carriages]; mine cars; tilt trucks; carriages [railways]; sleeping cars; dining cars; refrigerated railway wagons; transmission shafts for land vehicles; bicycles; electric bicycles; valves for vehicle tires; automobile hoods; stroller hoods; hoods for vehicles; oars; paddles for canoes; sculls; screws [propellers] for ships; hydroplanes; seaplanes; flanges for railway wheel tires; trucks; horns for vehicles; treads for vehicles [tractor type]; doors for vehicles; bicycle motors; motorcycle engines; engines for land vehicles; jet engines for land vehicles; driving motors for land vehicles; screw-propellers; screw-propellers for boats; airships; brake discs for vehicles; telfer railways [cable cars]; dredgers [boats]; military drones; civilian drones; adhesive rubber patches for repairing inner tubes; bicycle bells; rearview mirrors; side view mirrors for vehicles; portholes; cars for cable transport installations; inner tubes for pneumatic tires; inner tubes for bicycle tires; canoes; hoods for vehicle engines; crankcases for land vehicle components, other than for engines; boats; caissons [vehic-

les]; bicycle wheels; vehicle wheels; mine cart wheels; steering wheels for vehicles; casters for trolleys [vehicles]; brake pads for automobiles; hub caps; strollers; side cars; prams; brake linings for vehicles; ships; baskets adapted for bicycles; gear boxes for land vehicles; ship hulls; panniers adapted for bicycles; panniers adapted for motorcycles; fenders for ships; bands for wheel hubs; ejector seats for aircraft; wheelchairs; caps for vehicle fuel tanks; boat hooks; automobile bodies; tipping bodies for trucks; bodies for vehicles; treads for retreading tires; locomotives; masts for boats; golf carts [vehicles]; sprinkling trucks; propulsion mechanisms for land vehicles; mopeds; motor scooters; motorcycles; tyre mousse inserts; fitted footmuffs for pushchairs; fitted footmuffs for prams; freewheels for land vehicles; clutches for land vehicles; repair outfits for inner tubes; air pumps [vehicle accessories]; pumps for bicycle tires; upholstery for vehicles; rims for bicycle wheels; rims for vehicle wheels; windows for vehicles; omnibuses; engine mounts for land vehicles; axles for vehicles; headlight wipers; parachutes; ferry boats; bicycle pedals; ashtrays for automobiles; gearing for land vehicles; carts; head-rests for vehicle seats; bicycle kickstands; vehicle running boards; air bags [safety devices for automobiles]; ski lifts; chairlifts; casings for pneumatic tires [tyres]; sleeping berths for vehicles; pontoons; torque converters for land vehicles; cigar lighters for automobiles; non-skid devices for vehicle tires; anti-glare devices for vehicles; anti-theft devices for vehicles; sun-blinds adapted for automobiles; balance weights for vehicle wheels; shock absorbing springs for vehicles; bicycle frames; motorcycle frames; spars for ships; reduction gears for land vehicles; safety belts for vehicle seats; security harness for vehicle seats; vehicle suspension springs; rudders; bicycle handlebars; motorcycle handlebars; vehicle joysticks; bicycle cranks; aeroplanes; amphibious airplanes; sleighs [vehicles]; kick sledges; brake segments for vehicles; bicycle saddles; luggage nets for vehicles; dress guards for bicycles; fitted stroller mosquito nets; anti-theft alarms for vehicles; reversing alarms for vehicles; safety seats for children, for vehicles; vehicle seats; bellows for articulated buses; hydraulic circuits for vehicles; mobility scooters; snowmobiles; rolling stock for railways; rolling stock for funicular railways; spokes for bicycle wheels; vehicle wheel spokes; spoilers for vehicles; air vehicles; vehicles for locomotion by land, air, water or rail; ambulances; autonomous underwater vehicles for seabed inspections; water vehicles; remotely operated vehicles for underwater inspections; remote control vehicles, other than toys; electric vehicles; tricycles; delivery tricycles; inclined ways for boats; windscreens; windshield wipers; motorcycle kickstands; hubs for bicycle wheels; hubs for vehicle wheels; bags adapted for pushchairs; saddlebags adapted for bicycles; railway couplings; trailer hitches

for vehicles; couplings for land vehicles; wheelbarrows; handling carts; two-wheeled trolleys; shopping trolleys; hose carts; bogies for railway cars; casting carriages; tilting-carts; forklift trucks; cleaning trolleys; bicycle brakes; brakes for vehicles; torsion bars for vehicles; tractors; tramcars; transmissions for land vehicles; military vehicles for transport; aerial conveyors; trailers [vehicles]; funnels for ships; funnels for locomotives; cleats [nautical]; turbines for land vehicles; direction indicators for bicycles; direction signals for vehicles; rowlocks; disengaging gear for boats; steering gears for ships; cable transport apparatus and installations; spoke clips for wheels; tipping apparatus [parts of railway wagons]; funiculars; vans [vehicles]; automobile chains; bicycle chains; motorcycle chains; driving chains for land vehicles; anti-skid chains; transmission chains for land vehicles; undercarriages for vehicles; stroller covers; spare wheel covers; covers for vehicle steering wheels; saddle covers for bicycles; saddle covers for motorcycles; seat covers for vehicles; vehicle covers [shaped]; automobile chassis; vehicle chassis; connecting rods for land vehicles, other than parts of motors and engines; axle journals; gears for bicycles; tubeless tires for bicycles; bicycle tyres; automobile tires; pneumatic tires; solid tires for vehicle wheels; spikes for tires; davits for boats; launches; timbers [frames] for ships; mudguards; bicycle mudguards; motors, electric, for land vehicles; yachts.

15 – Musical instruments; accordions; harps; balalaikas [stringed musical instruments]; banjos; bandonions; drums [musical instruments]; basses [musical instruments]; buccins [trumpets]; hats with bells [musical instruments]; Jews' harps [musical instruments]; violas; horsehair for bows for musical instruments; bagpipes; harmonicas; melodicas; guitars; oboes; gongs; clarions; musical instruments; stringed musical instruments; electronic musical instruments; reeds; tuning forks; colophony for stringed musical instruments; carillons [musical instruments]; castanets; catgut for musical instruments; keyboards for musical instruments; piano keyboards; keys for musical instruments; piano keys; valves for musical instruments; tuning hammers; drumheads; pegs for musical instruments; bow nuts for musical instruments; handbells [musical instruments]; double basses; concertinas; cornets [musical instruments]; xylophones; music rolls [piano]; perforated music rolls; lyres; kettledrums; mandolins; plectrums; bellows for musical instruments; mouthpieces for musical instruments; ocarinas; organs; drumsticks; conductors' batons; sticks for bows for musical instruments; pedals for musical instruments; bridges for musical instruments; pipa [Chinese guitars]; chin rests for violins; kettledrum frames; stands for musical instruments; turning apparatus for sheet music; music stands; intensity regulators for mechanical pianos;

horns [musical instruments]; saxophones; music synthesizers; violins; bows for musical instruments; harp strings; strings for musical instruments; piano strings; suona [Chinese trumpets]; mutes for musical instruments; tambourines; tom-toms; cymbals; triangles [musical instruments]; trombones; trumpets; wind pipes for organs; harmoniums; flutes; bamboo flutes; pianos; cases for musical instruments; huqin [Chinese violins]; zithers; barrel organs; musical boxes; sheng [Chinese musical wind instruments].

20 – Furniture, mirrors, picture frames; goods (not included in other classes) of horn, bone, ivory, mother-of-pearl, unworked or semi-worked; shells; meerschaum; yellow amber; picture frame brackets; bumper guards for cots, other than bed linen; reels, not of metal, non-mechanical, for flexible hoses; pulleys of plastics for blinds; bolts, not of metal; casks of wood for decanting wine; mooring buoys, not of metal; casks, not of metal; barrels, not of metal; identification bracelets, not of metal; sideboards; busts of wood, wax, plaster or plastic; costume stands; bolsters; fans for personal use, non-electric; work benches; vice benches [furniture]; valet stands; coatstands; coat hangers / clothes hangers; shoulder poles [yokes]; screws, not of metal; display stands; showcases [furniture]; newspaper display stands; jewelry organizer displays; collars, not of metal, for fastening pipes; comb foundations for beehives; signboards of wood or plastics; loading gauge rods, not of metal, for railway wagons; nuts, not of metal; covers for clothing [wardrobe]; shoe pegs, not of metal; nesting boxes; coffins; doors for furniture; curtain holders, not of textile material; pegs [pins], not of metal; divans; kennels for household pets; birdhouses; keyboards for hanging keys; display boards; plugs [dowels], not of metal; containers, not of metal, for liquid fuel; troughs, not of metal, for mixing mortar; packaging containers of plastic; flowerstands [furniture]; curtain tie-backs; clips, not of metal, for cables and pipes; binding screws, not of metal, for cables; clips of plastic for sealing bags; rivets, not of metal; imitation tortoiseshell; locks, not of metal, for vehicles; locks, other than electric, not of metal; bead curtains for decoration; door bolts, not of metal; bottle closures, not of metal; closures, not of metal, for containers; latches, not of metal; mirrors [looking glasses]; hand-held mirrors [toilet mirrors]; bamboo; scratching posts for cats; animal claws; animal hooves; coral; meerschaum; whalebone, unworked or semi-worked; stag antlers; tortoiseshell; shells; horn, unworked or semi-worked; animal horns; rattan; ivory, unworked or semi-worked; corozo; plaited straw, except matting; wickerwork; hampers [baskets] for the transport of items; works of art of wood, wax, plaster or plastic; cabinet work; reeds [plaiting materials]; settees; jerrycans, not of metal; curtain rods; index cabinets [furniture]; reels of wood for yarn, silk, cord; water-pipe valves of

plastic; valves, not of metal, other than parts of machines; staves of wood; plastic keys; plastic key cards, not encoded and not magnetic; mats for infant playpens; sleeping mats / sleeping pads; saw horses; bed casters, not of metal; furniture casters, not of metal; brush mountings; chopping blocks [tables]; wind chimes [decoration]; door bells, not of metal, non-electric; bottle caps, not of metal; cradles; tent pegs, not of metal; curtain rings; split rings, not of metal, for keys; chests of drawers; console tables; containers, not of metal [storage, transport]; floating containers, not of metal; lecterns; dog kennels; bakers' bread baskets; baskets, not of metal; Moses baskets; bottle casings of wood; tool boxes, not of metal, empty; faucets, not of metal, for casks; armchairs; hairdressers' chairs; deck chairs; hospital beds; bedsteads of wood; beds; cots for babies; edgings of plastic for furniture; brackets, not of metal, for furniture; screw tops, not of metal, for bottles; table tops; sash fasteners, not of metal, for windows; hooks, not of metal, for clothes rails; curtain hooks; clothes hooks, not of metal; bag hangers, not of metal; beds for household pets; nesting boxes for household pets; ladders of wood or plastics; playpens for babies; mannequins; air mattresses, not for medical purposes; mattresses; hydrostatic beds, not for medical purposes / water beds, not for medical purposes; furniture; furniture of metal; inflatable furniture; office furniture; school furniture; mobiles [decoration]; door knockers, not of metal; curtain rails; legs for furniture; feet for furniture; house numbers, not of metal, non-luminous; barrel hoops, not of metal; door stops, not of metal or rubber; window stops, not of metal or rubber; moldings for picture frames; bed bases; furniture partitions of wood; freestanding partitions [furniture]; mother-of-pearl, unworked or semi-worked; mirror tiles; ambroid plates; registration plates, not of metal; identity plates, not of metal; loading pallets, not of metal; handling pallets, not of metal; transport pallets, not of metal; head-rests [furniture]; trays, not of metal; stakes, not of metal, for plants or trees; trestles [furniture]; magazine racks; book rests [furniture]; flower-pot pedestals; baby changing mats; pet cushions; pillows; cushions; air cushions, not for medical purposes; air pillows, not for medical purposes; removable mats or covers for sinks; racks [furniture]; library shelves; shelves for file cabinets; furniture shelves; shelves for storage; wood ribbon; straw edgings; towel stands [furniture]; hat stands; bathtub grab bars, not of metal; cask stands, not of metal; inflatable publicity objects; counters [tables]; bedding, except linen; corks for bottles; sealing caps, not of metal; stair rods; standing desks; embroidery frames; dispensers for dog waste bags, fixed, not of metal; towel dispensers, fixed, not of metal; picture frames; sections of wood for beehives; tanks, not of metal nor of masonry; fodder racks; curtain rollers; door handles, not of metal; knobs, not of metal; fishing

baskets; writing desks; seats of metal; vats, not of metal; honeycombs; sofas; bungs, not of metal; statues of wood, wax, plaster or plastic; figurines of wood, wax, plaster or plastic; oyster shells; silvered glass [mirrors]; shelving units; ambroid bars; umbrella stands; gun racks; carts for computers [furniture]; dressing tables; washstands [furniture]; typing desks; drafting tables; massage tables; tables of metal; wall-mounted baby changing platforms; saw benches [furniture]; desks; tea carts; dinner wagons [furniture]; tables; steps [ladders], not of metal; step stools, not of metal; chairs [seats]; high chairs for babies; chests, not of metal; placards of wood or plastics; stools; footstools; crates; trolleys [furniture]; straw plaits; mobile boarding stairs, not of metal, for passengers; straw mattresses; decorations of plastic for foodstuffs; beehives; door fasteners, not of metal; window fasteners, not of metal; funerary urns; winding spools, not of metal, non-mechanical, for flexible hoses; door fittings, not of metal; coffin fittings, not of metal; bed fittings, not of metal; furniture fittings, not of metal; window fittings, not of metal; infant walkers; garment covers [storage]; stuffed animals; stuffed birds; hinges, not of metal; chaise longues; poles, not of metal; screens [furniture]; filing cabinets; medicine cabinets; plate racks; meat safes; bookcases; wardrobes; cupboards; shoe dowels, not of metal; bamboo curtains; paper blinds; slatted indoor blinds; woven timber blinds [furniture]; indoor window blinds [shades] [furniture] / indoor window shades [furniture]; interior textile window blinds; screens for fireplaces [furniture]; labels of plastic; yellow amber; lockers; chests for toys; tool chests, not of metal, empty; boxes of wood or plastic; letter boxes, not of metal or masonry; bottle racks.

21 – Household or kitchen utensils and containers; combs and sponges; brushes, except paintbrushes; material for brush-making; articles for cleaning purposes; glass, unworked or semi-worked, except building glass; glassware, porcelain and earthenware; autoclaves, non-electric, for cooking / pressure cookers, non-electric; indoor aquaria; wine aerators; buckets / pails; cookie jars; candle jars [holders]; china ornaments; dishes; paper plates; vegetable dishes; saucers; mugs; candy boxes; bottles; demijohns; busts of porcelain, ceramic, earthenware or glass; vases; epergnes; fruit cups; bird baths; baby baths, portable; plungers for clearing blocked drains; waffle irons, non-electric; coolers [ice pails]; mop wringer buckets; buckets made of woven fabrics; whisks, non-electric, for household purposes; cooking skewers of metal / cooking pins of metal; towel rails and rings; clothing stretchers / stretchers for clothing; hair for brushes; horsehair for brush-making; birdcages; funnels; carpet beaters [hand instruments]; signboards of porcelain or glass; candle extinguishers; heads for electric toothbrushes; flower

pots; chamber pots; glue-pots; cruets; decanters; large-toothed combs for the hair; combs for animals; tea cosies; abrasive sponges for scrubbing the skin; make-up sponges; sponges for household purposes; toilet sponges; sponge holders; toothpick holders; soap holders; table napkin holders; holders for flowers and plants [flower arranging]; shaving brush stands; toilet paper holders; soap dispensers; toilet paper dispensers; plug-in diffusers for mosquito repellents; ironing boards; cutting boards for the kitchen; bread boards; washing boards; crushers for kitchen use, non-electric; strainers for household purposes; smoke absorbers for household purposes; containers for household or kitchen use; kitchen containers; glass jars [carboys]; heat-insulated containers; heat-insulated containers for beverages; thermally insulated containers for food; glass flasks [containers]; closures for pot lids; chamois leather for cleaning; toothpicks; ceramics for household purposes; majolica; works of art of porcelain, ceramic, earthenware or glass; kitchen grinders, non-electric; cleaning instruments, hand-operated; cabarets [trays]; stew-pans; covers, not of paper, for flower pots; shaving brushes; make-up brushes; basting brushes; cages for household pets; baking mats; ladles for serving wine; polishing leather; hot pots, not electrically heated; glass bulbs [receptacles]; boot trees [stretchers]; shoe trees [stretchers]; napkin rings; poultry rings; rings for birds; coin banks; piggy banks; bread baskets for household purposes; baskets for household purposes; waste paper baskets; feeding troughs; mangers for animals; lunch boxes; tea caddies; washtubs; earthenware saucepans; mess-tins; cauldrons; coffee percolators, non-electric; coffee-pots, non-electric; coffee grinders, hand-operated; fused silica [semi-worked product], other than for building; beer mugs; tankards; rat traps; pot lids; aquarium hoods; butter-dish covers; dish covers; cheese-dish covers; buttonhooks; reusable ice cubes; pitchers; perfume burners; watering cans; fly traps; insect traps; ice cream scoops; mixing spoons [kitchen utensils]; basting spoons [cooking utensils]; pie servers; cosmetic spatulas; spatulas for kitchen use; litter boxes for pets; butter dishes; material for brush-making; polishing materials for making shiny, except preparations, paper and stone; tablemats, not of paper or textile; noodle machines, hand-operated; lint removers, electric or non-electric; polishing apparatus and machines, for household purposes, non-electric; pepper mills, hand-operated; mills for household purposes, hand-operated; feather-dusters; brooms; isothermic bags; confectioners' decorating bags [pastry bags]; bowls [basins]; mosaics of glass, not for building; saucepan scourers of metal; soap boxes; mouse traps; cooking pot sets; nozzles for watering cans; pouring spouts; nozzles for watering hose; fitted picnic baskets, including dishes; toilet cases; floss for dental purposes; fiberglass thread, other than for textile use; cookie [biscuit] cutters;

pastry cutters; sprinklers; syringes for watering flowers and plants; cotton waste for cleaning; wool waste for cleaning; cleaning tow; cold packs for chilling food and beverages; chopsticks; cocktail stirrers; food steamers, non-electric; pepper pots; oven mitts / kitchen mitts / barbecue mitts; gloves for household purposes; car washing mitts; polishing gloves; gardening gloves; pestles for kitchen use; plates to prevent milk boiling over; dripping pans; trays for household purposes; trays of paper, for household purposes; lazy susans; heaters for feeding bottles, non-electric; candelabra [candlesticks]; trivets [table utensils]; coasters, not of paper or textile; grill supports / gridiron supports; menu card holders; knife rests for the table; flat-iron stands; egg cups; abrasive pads for kitchen purposes; scouring pads; drinking troughs; serving ladles; powdered glass for decoration; pottery; pots; cooking pots; painted glassware; tableware, other than knives, forks and spoons; porcelain ware; earthenware; crystal [glassware]; cosmetic utensils; toilet utensils; trouser presses; tortilla presses, non-electric [kitchen utensils]; deodorizing apparatus for personal use; cruet sets for oil and vinegar; make-up removing appliances; spice sets; apparatus for wax-polishing, non-electric; bottle openers, electric and non-electric; glove stretchers; bootjacks; crumb trays; tie presses; clothes-pegs; glass stoppers; powder compacts; perfume vaporizers; powder puffs; dusting apparatus, non-electric; foam toe separators for use in pedicures; electric combs; combs; grills [cooking utensils]; sifters [household utensils]; drinking horns; shoe horns; candle drip rings; broom handles; salad bowls; place mats, not of paper or textile; sugar bowls; beaters, non-electric; egg separators, non-electric, for household purposes; coffee services [tableware]; liqueur sets; tea services [tableware]; sieves [household utensils]; tea strainers; wine-tasting pipettes; siphon bottles for carbonated water; rolling pins, domestic; frying pans; steel wool for cleaning; currycombs; blenders, non-electric, for household purposes; scoops for household purposes; fruit presses, non-electric, for household purposes; drinking straws / straws for drinking; salt cellars; drinking vessels; vessels of metal for making ices and iced drinks; refrigerating bottles; bulb basters; cups of paper or plastic; glasses [receptacles]; drinking glasses; statues of porcelain, ceramic, earthenware or glass; figurines [statuettes] of porcelain, ceramic, earthenware or glass; glass for vehicle windows [semi-finished product]; plate glass [raw material]; opal glass; glass, unworked or semi-worked, except building glass; opaline glass; glass incorporating fine electrical conductors; enamelled glass, not for building; glass wool, other than for insulation; vitreous silica fibers, other than for textile use; fiberglass, other than for insulation or textile use; mortars for kitchen use; portable cool boxes, non-electric; soup bowls; drying racks for laundry; basins [receptacles];

table plates; disposable table plates; graters for kitchen use; insulating flasks; indoor terrariums [plant cultivation]; indoor terrariums [vivariums]; cloth for washing floors; polishing cloths; cloths for cleaning; dusting cloths [rags]; furniture dusters; urns; aerosol dispensers, not for medical purposes; wax-polishing appliances, non-electric, for shoes; water apparatus for cleaning teeth and gums; electric devices for attracting and killing insects; watering devices; utensils for household purposes; kitchen utensils; cooking utensils, non-electric; coffee filters, non-electric; flasks; hip flasks; drinking bottles for sports; molds [kitchen utensils]; cake moulds; ice cube molds; cookery moulds; deep fryers, non-electric; comb cases; bread bins; fly swatters; teapots; kettles, non-electric; cups; garlic presses [kitchen utensils]; ironing board covers, shaped; tea infusers; glass bowls; mops; mop wringers; cocktail shakers; corkscrews, electric and non-electric; animal bristles [brushware]; pig bristles for brush-making; dishwashing brushes; ski wax brushes; brushes for cleaning tanks and containers; lamp-glass brushes; horse brushes; scrubbing brushes; toothbrushes; toothbrushes, electric; carpet sweepers; brushes for footwear; tar-brushes, long handled; toilet brushes; electric brushes, except parts of machines; eyebrow brushes; nail brushes; eyelash brushes; nutcrackers; ice tongs; salad tongs; sugar tongs; decanter tags; nest eggs, artificial; boxes for dispensing paper towels; dustbins; window-boxes; boxes of glass.

25 – Clothing, footwear, headgear; wimples; bandanas [neckerchiefs]; underwear; sweat-absorbent underwear; berets; overalls; boas [necklets]; teddies [underclothing]; boxer shorts; ankle boots; ski boots; boots for sports; breeches for wear; trousers; football boots; brassieres; valenki [felted boots]; collars [clothing]; detachable collars; shirt yokes; veils [clothing]; gabardines [clothing]; galoshes; neckties; ascots; leggings [leg warmers]; gaiters; boot uppers; corselets; jerseys [clothing]; vests; sports jerseys; hosiery; heels; hoods [clothing]; hat frames [skeletons]; pockets for clothing; neck scarfs [mufflers]; kimonos; visors [headwear]; cap peaks; tights; slippers [underclothing]; combinations [clothing]; wet suits for water-skiing; bodices [lingerie]; corsets [underclothing]; suits; bathing suits; masquerade costumes; beach clothes; leotards; jackets [clothing]; stuff jackets [clothing]; fishing vests; leggings [trousers]; liveries; camisoles; sports singlets; cuffs; short-sleeve shirts; mantillas; coats; sleep masks; furs [clothing]; hand warmers [fingerless gloves]; miters [hats]; muffs [clothing]; footmuffs, not electrically heated; heelpieces for footwear; bibs, not of paper; fur stoles; hairdressing capes; ear muffs [clothing]; socks; sweat-absorbent socks; beach shoes; sports shoes; paper clothing; outerclothing; ready-made clothing; motorists' clothing; cyclists' clothing; clothing for gymnastics; clothing of imitations of leat-

her; clothing of leather; waterproof clothing; uniforms; fittings of metal for footwear; maniples; overcoats; panties; parkas; pelerines; gloves [clothing]; ski gloves; pajamas; bathing trunks; shirt fronts; scarfs; pocket squares; headbands [clothing]; garters; sock suspenders; stocking suspenders; ready-made linings [parts of clothing]; dress shields; soles for footwear; braces for clothing [suspenders]; half-boots; lace boots; sweaters / pullovers / jumpers [pullovers]; ponchos; girdles; belts [clothing]; money belts [clothing]; layettes [clothing]; non-slipping devices for footwear; heelpieces for stockings; welts for footwear; chasubles; shirts; wooden shoes; sandals; bath sandals; boots; jumper dresses; saris; sarongs; footwear uppers; inner soles; albs; bath slippers; togas; knitwear [clothing]; underpants; shoes; skull caps; turbans; headwear; aprons [clothing]; judo uniforms; karate uniforms; tee-shirts; dressing gowns; bath robes; top hats; tips for footwear; stockings; sweat-absorbent stockings; shawls; caps [headwear]; paper hats [clothing]; shower caps; bathing caps; sashes for wear; studs for football boots; hats; babies' pants [underwear]; trouser straps; pelisses; esparto shoes or sandals; skirts; petticoats; skorts.

28 – Games and playthings; gymnastic and sporting articles; decorations for Christmas trees; arcade video game machines; video game machines; gaming machines for gambling; amusement machines, automatic and coin-operated; toy vehicles; swimming pools [play articles]; trampolines; novelty toys for parties; scratch cards for playing lottery games; starting blocks for sports; bodyboards; skating boots with skates attached; dolls' feeding bottles; tricycles for infants [toys]; stationary exercise bicycles; creels [fishing traps]; shuttlecocks; spinning tops [toys]; dumb-bells; gyroscopes and flight stabilizers for model aircraft; jigsaw puzzles; clay pigeons [targets]; punching bags; bite sensors [fishing tackle]; hang gliders; joysticks for video games; flying discs [toys]; discuses for sports; dolls' houses; dominoes; swimming kickboards; paddleboards; surfboards; spring boards [sports articles]; skateboards; sailboards; chessboards; checkerboards; drones [toys]; darts; Christmas trees of synthetic material; cups for dice; swimming jackets; ascenders [mountaineering equipment]; kites; needles for pumps for inflating balls for games; toys for pets; stuffed toys; plush toys; toy mobiles; novelty toys for playing jokes; parlor games; board games; ring games; building games; kaleidoscopes; bladders of balls for games; rosin used by athletes; edges of skis; bingo cards; playing cards; fairground ride apparatus; reels for fishing; rocking horses; swings; skittles; skittles [games]; billiard cues; golf clubs; hockey sticks; baby gyms; seal skins [coverings for skis]; bells for Christmas trees; dolls' rooms; controllers for game consoles; controllers for toys; confetti; explosive bonbons [Christmas crackers]; ice skates; roller skates;

in-line roller skates; dice; paintball guns [sports apparatus]; ski bindings; dolls' beds; roulette wheels; fish hooks; building blocks [toys]; dolls; flippers for swimming; fishing lines; gut for fishing; bows for archery; skis; waterskis; surf skis; mah-jong; toy models; hunting game calls; puppets; masks [playthings]; carnival masks; theatrical masks; fencing masks; matryoshka dolls; masts for sailboards; ball pitching machines; teddy bears; chalk for billiard cues; targets; electronic targets; scale model kits [toys]; scale model vehicles; kite reels; balls for games; artificial fishing bait; billiard table cushions; knee guards [sports articles]; billiard cue tips; elbow guards [sports articles]; backgammon games; pumps specially adapted for use with balls for games; dolls' clothes; fencing weapons; twirling batons; paragliders; pachinkos; baseball gloves; boxing gloves; golf gloves; gloves for games; batting gloves [accessories for games]; fencing gauntlets; piñatas; toy pistols; toy air pistols; percussion caps [toys]; caps for pistols [toys]; protective films adapted for screens for portable games; rattles [playthings]; horseshoe games; candle holders for Christmas trees; Christmas tree stands; sole coverings for skis; water wings; floats for fishing; portable games with liquid crystal displays; swimming belts; decoys for hunting or fishing; scent lures for hunting or fishing; archery implements; soap bubbles [toys]; divot repair tools [golf accessories]; billiard markers; protective padding [parts of sports suits]; rackets; surfboard leashes; harness for sailboards; weight lifting belts [sports articles]; toy robots; sling shots [sports articles]; rollers for stationary exercise bicycles; harpoon guns [sports articles]; plush toys with attached comfort blanket; scooters [toys]; sleds [sports articles]; bob-sleighs; butterfly nets; landing nets for anglers; nets for sports; tennis nets; bite indicators [fishing tackle]; slot machines [gaming machines]; appliances for gymnastics; quoits; bar-bells; climbers' harness; fishing tackle; artificial snow for Christmas trees; snowshoes; snowboards; remote-controlled toy vehicles; clay pigeon traps; billiard tables; coin-operated billiard tables; tables for table tennis; strings for rackets; gut for rackets; cricket bags; golf bags, with or without wheels; golf bag carts; slides [playthings]; body-building apparatus; machines for physical exercises; men's athletic supporters [sports articles]; rods for fishing; ornaments for Christmas trees, except illumination articles and confectionery; tennis ball throwing apparatus; conjuring apparatus; apparatus for games; bowling apparatus and machinery; toy figures; counters [discs] for games; chips for gambling; foosball tables; bags especially designed for skis and surfboards; marbles for games; billiard balls; playing balls; play balloons; paintballs [ammunition for paintball guns] [sports apparatus]; snow globes; chess games; checkers [games]; poles for pole vaulting; paper party hats; shin guards [sports articles]; camouflage screens [sports articles].

36 – Insurance underwriting; financial affairs; monetary affairs; real estate affairs; credit bureau services; debt collection agency services; real estate agency services; financial analysis; rental of apartments; rental of offices for co-working; rental of real estate; rental of offices [real estate]; rental of farms; lease-purchase financing; savings bank services; accommodation bureau services [apartments]; rent collection; issuance of travelers' checks; issuance of credit cards; issuance of tokens of value; capital investment; insurance information; financial information; insurance consultancy; financial consultancy; debt advisory services; stock exchange quotations; lending against security; business liquidation services, financial; brokerage; financial management; exchanging money; online banking; processing of debit card payments; processing of credit card payments; factoring; organization of collections; arranging finance for construction projects; antique appraisal; jewelry appraisal; financial evaluation of standing timber; stamp appraisal; real estate appraisal; numismatic appraisal; art appraisal; financial evaluation of wool; financial evaluation [insurance, banking, real estate]; repair costs evaluation [financial appraisal]; electronic funds transfer; surety services; securities brokerage; real estate brokerage; brokerage of carbon credits; insurance brokerage; providing rebates at participating establishments of others through use of a membership card; loans [financing]; pawnbrokerage; providing financial information via a web site; check verification; investment of funds; charitable fund raising; stocks and bonds brokerage; financial sponsorship; mortgage banking; instalment loans; insurance underwriting; life insurance underwriting; health insurance underwriting; accident insurance underwriting; marine insurance underwriting; fire insurance underwriting; apartment house management; real estate management; financial management of reimbursement payments for others; actuarial services; banking; stock brokerage services; retirement payment services; bail-bonding; trusteeship; provident fund services; financial customs brokerage services; mutual funds; financing services; safe deposit services; deposits of valuables; fiscal valuation.

37 – Construction; repair; installation services; asphaltting; drilling of deep oil or gas wells; drilling of wells; rebuilding engines that have been worn or partially destroyed; rebuilding machines that have been worn or partially destroyed; renovation of clothing; retreading of tires; vulcanization of tires [repair]; building sealing; linen ironing; pressing of clothing; disinfecting; rat exterminating; mining extraction; vehicle battery charging; knife sharpening; building insulating; repair information; construction information; bricklaying; riveting; construction consultancy; varnishing; re-tinning; scaffolding; road paving; window cleaning; vehicle washing; building

construction supervision; tuning of musical instruments; upholstery; rustproofing; anti-rust treatment for vehicles; sanding; pumicing; strong-room maintenance and repair; vehicle maintenance; paper hanging; painting or repair of signs; cleaning of buildings [exterior surface]; vehicle polishing; vehicle breakdown repair services; rental of bulldozers; rental of drainage pumps; rental of dish drying machines; rental of road sweeping machines; rental of cleaning machines; rental of cranes [construction equipment]; rental of dishwashing machines; rental of laundry washing machines; rental of construction equipment; rental of excavators; laying of cable; plumbing; masonry; roofing services; painting, interior and exterior; carpentry services; underwater repair; plastering; quarrying services; repair of security locks; umbrella repair; parasol repair; motor vehicle maintenance and repair; burner maintenance and repair; film projector repair and maintenance; airplane maintenance and repair; safe maintenance and repair; clock and watch repair; repair of power lines; pump repair; upholstery repair; shoe repair; clothing repair; photographic apparatus repair; furniture restoration; restoration of musical instruments; restoration of works of art; vehicle greasing; demolition of buildings; warehouse construction and repair; vehicle service stations [refuelling and maintenance]; sterilization of medical instruments; washing; washing of linen; pier breakwater building; pipeline construction and maintenance; underwater construction; harbour construction; factory construction; building of fair stalls and shops; shipbuilding; cleaning of buildings [interior]; street cleaning; vermin exterminating, other than for agriculture, aquaculture, horticulture and forestry; tire balancing; pest control services, other than for agriculture, aquaculture, horticulture and forestry; hydraulic fracturing services; artificial snow-making services; laundering; installation of doors and windows; irrigation devices installation and repair; elevator installation and repair; heating equipment installation and repair; burglar alarm installation and repair; furnace installation and repair; telephone installation and repair; installation and repair of air-conditioning apparatus; fire alarm installation and repair; freezing equipment installation and repair; electric appliance installation and repair; kitchen equipment installation; installation, maintenance and repair of computer hardware; machinery installation, maintenance and repair; office machines and equipment installation, maintenance and repair; interference suppression in electrical apparatus; swimming-pool maintenance; furniture maintenance; chimney sweeping; boiler cleaning and repair; cleaning of clothing; dry cleaning; vehicle cleaning; diaper cleaning; leather care, cleaning and repair; fur care, cleaning and repair.

39 – Transport; packaging and storage of goods; arranging of travel tours; air transport; motor coach

rental; boat rental; garage rental; rental of vehicle roof racks; aircraft rental; parking place rental; rental of warehouses; rental of tractors; booking of seats for travel; travel reservation; transport reservation; towing; vehicle breakdown towing services; bottling services; water distribution; delivery of newspapers; message delivery; parcel delivery; delivery of goods; delivery of goods by mail order; flower delivery; launching of satellites for others; traffic information; transportation information; storage information; transportation logistics; rescue operations [transport]; arranging of cruises; armored-car transport; hauling; carting; transport and storage of trash; transporting furniture; lighterage services; ferry-boat transport; removal services; transport of travellers; guarded transport of valuables; bus transport; car transport; barge transport; boat transport; railway transport; marine transport; passenger transport; river transport; ambulance transport; streetcar transport; portering; refloating of ships; cash replenishment of automated teller machines; shipbrokerage; transport brokerage; freight brokerage [forwarding (Am.)]; providing driving directions for travel purposes; car rental; railway truck rental; rental of diving bells; rental of diving suits; rental of motor racing cars; rental of aircraft engines; railway coach rental; rental of wheelchairs; rental of storage containers; horse rental; rental of freezers; rental of navigational systems; refrigerator rental; vehicle rental; rental of electric wine cellars; stevedoring; unloading cargo; electricity distribution; packaging of goods; collection of recyclable goods [transport]; ice-breaking; piloting; water supplying; escorting of travellers; transport by pipeline; wrapping of goods; operating canal locks; car parking; chauffeur services; pleasure boat transport; car sharing services; courier services [messages or merchandise]; salvaging; salvage of ships; underwater salvage; taxi transport; transport; transport services for sight-seeing tours; franking of mail; freight [shipping of goods]; freighting; physical storage of electronically stored data or documents; boat storage; storage of goods; storage; freight forwarding.

41 – Education; providing of training; entertainment services; sporting and cultural activities; modelling for artists; academies [education]; rental of indoor aquaria; rental of artwork; rental of sports grounds; rental of tennis courts; lending library services; booking of seats for shows; videotaping; physical education; production of music; discotheque services; animal training; dubbing; gambling services; publication of books; education information; recreation information; entertainment information; movie studio services; health club services [health and fitness training]; nightclub services [entertainment]; layout services, other than for advertising purposes; microfilming; videotape editing; production of radio and television programmes; screenplay writing; game

services provided on-line from a computer network; providing on-line electronic publications, not downloadable; religious education; aikido instruction; gymnastic instruction; correspondence courses; practical training [demonstration]; training services provided via simulators; organization of balls; organization of exhibitions for cultural or educational purposes; providing recreation facilities; arranging and conducting of colloquiums; arranging and conducting of congresses; arranging and conducting of conferences; arranging and conducting of concerts; arranging and conducting of workshops [training]; arranging and conducting of in-person educational forums; arranging and conducting of seminars; arranging and conducting of symposiums; organization of competitions [education or entertainment]; arranging of beauty contests; organization of lotteries; organization of fashion shows for entertainment purposes; organization of shows [impresario services]; organization of sports competitions; vocational guidance [education or training advice]; amusement park services; sign language interpretation; television entertainment; mobile library services; vocational retraining; providing online videos, not downloadable; providing online music, not downloadable; providing television programs, not downloadable, via video-on-demand services; providing films, not downloadable, via video-on-demand services; providing golf facilities; providing sports facilities; providing amusement arcade services; cinema presentations; presentation of circus performances; presentation of variety shows; presentation of live performances; theatre productions; conducting fitness classes; educational examination; film production, other than advertising films; rental of audio equipment; rental of video cameras; rental of video cassette recorders; rental of videotapes; rental of show scenery; rental of sound recordings; toy rental; rental of cinematographic apparatus; rental of motion pictures; games equipment rental; rental of stadium facilities; rental of lighting apparatus for theatrical sets or television studios; rental of radio and television sets; rental of skin diving equipment; rental of sports equipment, except vehicles; rental of stage scenery; electronic desktop publishing; online publication of electronic books and journals; publication of texts, other than publicity texts; radio entertainment; entertainer services; entertainment services; writing of texts; sado instruction [tea ceremony instruction]; zoological garden services; news reporters services; party planning [entertainment]; music composition services; subtitling; tutoring; holiday camp services [entertainment]; conducting guided tours; disc jockey services; personal trainer services [fitness training]; providing casino facilities [gambling]; calligraphy services; karaoke services; club services [entertainment or education]; songwriting; providing museum facilities [presentation, exhibitions]; teaching; educational services provided by schools;

orchestra services; translation; scriptwriting, other than for advertising purposes; ticket agency services [entertainment]; coaching [training]; sport camp services; recording studio services; language interpreter services; nursery schools; photography; photographic reporting; timing of sports events; boarding school education; production of shows.

42 – Scientific and technological services and research and design relating thereto; industrial analysis and industrial research services; design and development of computer hardware and software; water analysis; computer system analysis; handwriting analysis [graphology]; chemical analysis; energy auditing; recovery of computer data; interior design; industrial design; graphic arts design; computer virus protection services; oil-field surveys; geological surveys; engineering; installation of computer software; meteorological information; clinical trials; material testing; textile testing; bacteriological research; biological research; geological research; research in the field of environmental protection; cosmetic research; mechanical research; chemical research; research and development of new products for others; scientific research; analysis for oil-field exploitation; underwater exploration, technical research; calibration [measuring]; web site design consultancy; computer security consultancy; information technology [IT] consultancy; consultancy in the design and development of computer hardware; architectural consultancy; internet security consultancy; computer software consultancy; data security consultancy; technological consultancy; oil-well testing; quality control; vehicle roadworthiness testing; land surveying; dress designing; updating of computer software; monitoring of computer systems to detect breakdowns; monitoring of computer systems for detecting unauthorized access or data breach; monitoring of computer systems by remote access; software as a service [SaaS]; maintenance of computer software; authenticating works of art; design of interior decor; quality evaluation of standing timber; quality evaluation of wool; digitization of documents [scanning]; conversion of data or documents from physical to electronic media; urban planning; providing information on computer technology and programming via a web site; provision of scientific information, advice and consultancy in relation to carbon offsetting; providing search engines for the internet; conversion of computer programs and data, other than physical conversion; conducting technical project studies; design and development of computer systems; rental of web servers; computer rental; rental of computer software; unlocking of mobile phones; geological prospecting; oil prospecting; hosting computer sites [web sites]; server hosting; construction drafting; computer software design; cloud seeding; consultancy in the field of energy-saving; creating and designing website-based indexes of information for others

[information technology services]; creating and maintaining web sites for others; computer programming; technical writing; copying of computer programs; cloud computing; architectural services; chemistry services; outsource service providers in the field of information technology; packaging design; off-site data backup; computer technology consultancy; telecommunications technology consultancy; scientific laboratory services; weather forecasting; styling [industrial design]; cartography services; data encryption services; physics [research]; electronic data storage; surveying; electronic monitoring of credit card activity to detect fraud via the internet; electronic monitoring of personally identifying information to detect identity theft via the internet.

(260) AM 2020 104843 A

(800) 1486329

(151) 2018 12 22

(891) 2018 12 22

(731) FLEXPOR T, INC.

760 Market Street, 8th Floor, San Francisco
CA 94102, USA

(540)

FLEXPOR T

(591) Black, white

(511)

35 – Freight logistics business management; freight management services, namely, administrative processing of shipments, preparing shipping documents and invoices; administrative services, namely preparation and filing of documents relating to customs clearance; administrative services relating to customs clearance.

36 – Financial customs brokerage services; custom bonds payment services; insurance brokerage in the field of cargo insurance; bonding services in the nature of underwriting customs bonds, provision of temporary import bonds and provision of customs bonds; customs brokerage services in the field of customs classifications.

39 – Freight forwarding; freight transportation consultation in the field of freight transportation by truck, rail, air and ocean; freight ship transport; freight train transport; freight loading services; air freight shipping services; warehousing services, namely, storage, distribution, pick-up and packing for shipment of documents, packages, raw materials, and other freight for others; supply chain logistics and reverse logistics, namely, storage, transportation and delivery of documents, packages, raw materials, and other freight for others by air, rail, ship or truck; stevedoring; freight brokerage; freight management services, namely, tracking documents, packages and freight over computer networks, intranets, and the internet for business purposes; providing electronic

tracking of freight information to others; arranging for pickup, delivery, storage and transportation of documents, packages, freight and parcels via ground and air carriers.

42 – Software development in the field of end-to-end freight forwarding and shipment, ocean freight, air freight, trucking and delivery, government agency filings, customs clearances, customs bonds registration, product classification, cargo insurance, quality inspections and testing, warehousing and fulfillment, and setting up distribution of goods from ports; software as a service (SAAS) services featuring software for managing the forwarding and shipping of end-to-end freight, ocean freight, and air freight; software as a service (SAAS) services featuring software for managing trucking logistics and delivery of goods; software as a service (SAAS) services featuring software for preparation of forms and online filing of government agency documents, customs clearances, customs bonds registrations, product classifications, cargo insurance, quality inspections and testing; software as a service (SAAS) services featuring software for tracking and tracing shipments and freight, managing shipments and freight, searching for supply chain and shipping data, creating and distributing reports related to supply chain and shipments, generating quotes for freight and shipping, booking freight shipment, providing freight shipment billing, providing shipping and freight quotes, and searching denied parties lists; software as a service (SAAS) services featuring software for managing supply chain logistics and reverse logistics, namely, the storage, transportation and delivery of goods for others by air, rail, ship, or truck; software as a service (SAAS) services featuring software for managing distribution of goods from ports; software as a service (SAAS) services featuring software for managing warehouse inventories and order fulfillment; software as a service (SAAS) services featuring software for providing online non-downloadable software for creation of graphical representations of product data; providing online non-downloadable software for managing the forwarding and shipping of end-to-end freight, ocean freight, and air freight; providing online non-downloadable software for managing trucking logistics and delivery of goods; providing online non-downloadable software for preparation of forms and online filing of government agency documents, customs clearances, customs bonds registrations, product classifications, cargo insurance, quality inspections and testing; providing online non-downloadable software for tracking and tracing shipments and freight, managing shipments and freight, searching for supply chain and shipping data, creating and distributing reports related to supply chain and shipments, generating quotes for freight and shipping, booking freight shipment, providing freight shipment billing, provi-

ding shipping and freight quotes, and searching denied parties lists; providing online non-downloadable software for managing supply chain logistics and reverse logistics, namely, the storage, transportation and delivery of goods for others by air, rail, ship, or truck; providing online non-downloadable software for managing distribution of goods from ports; providing online non-downloadable software for managing warehouse inventories and order fulfillment; providing online non-downloadable software for creation of graphical representations of product data.

(260) AM 2020 104844 A

(800) 1486333

(151) 2019 04 15

(891) 2019 04 15

(731) JI NAN WASHING MACHINE FACTORY
NO.51 GONGYENAN ROAD, LIXIA
DISTRICT, JINAN, 250014 SHANDONG,
China

(540)

Little Duck

(591) Black, white

(531) 26.03.01; 26.03.24; 27.05.08

(526) LITTLE

(511)

7 – Washing machines [laundry]; vending machines; dishwashers; beaters, electric; welding machines, electric; turbines other than for land vehicles; lathes [machine tools]; engines, other than for land vehicles; vacuum cleaners; dry-cleaning machines; household machines for making soybean milk; meat mincers [machines]; punching machines; embossing machines; dry plastic mould pressing machines; die-stamping machines; cold-punching moulds; forging moulds; moulds [parts of machines]; molding machines; die-casting moulds; juice extractors, electric; spin dryers [not heated].

9 – Television apparatus; notebook computers; tablet computers; electric sockets; scales; weighing apparatus and instruments; solar batteries; batteries, electric; cameras [photography]; meters; transformers [electricity]; surveying instruments; navigational instruments; radio sets; camcorders; photovoltaic inverters; photovoltaic panels; photovoltaic apparatus and installations for generating solar electricity; equipment for the electrolysis of water into hydrogen, oxygen, namely power supplies, anodes and cathodes.

11 – Refrigerators; air conditioners for vehicles; refrigerating cabinets; refrigerating display cabinets; freezers; radiators, electric; laundry driers, electric; cooking utensils, electric; heating apparatus, electric; blankets, electric, not for medical purposes; electric fans for personal use; solar thermal collectors [hea-

ting]; bath installations; kettles, electric; microwave ovens [cooking apparatus]; heaters for baths; humidifiers for household purposes; electric hair driers; electric cookers; electric egg cookers; air condition fans; fuel stoves for household purposes; extractor hoods for kitchens; disinfectant apparatus; electric yoghurt makers; electric kettles for household purposes; water purifiers for household purposes; radiators [heating]; electric boilers.

12 – Motors, electric, for land vehicles; automobile tires; automobiles; brakes for vehicles; shock absorbers for automobiles; turbines for land vehicles; engines for land vehicles; bodies for vehicles; automobile chassis; hoods for vehicles; automobile wheel spokes; automobile wheels; automobile wheel axle holders; lug nuts for vehicle wheels; vehicle anti-theft equipment; automobile frames.

(260) AM 2020 104852 A

(800) 1486547

(151) 2019 07 23

(891) 2019 07 23

(731) APPLE INC.

One Apple Park Way, Cupertino CA 95014,
USA

(540)



(591) Black and grey

(531) 26.01.01; 26.01.06; 26.04.02; 26.04.04;
26.04.07; 26.04.10; 26.04.24

(511)

9 – Downloadable computer software for controlling the operations of televisions, video monitors, set-top boxes, audio, video, and media players and recorders, game players, entertainment systems, home theatre systems, home automation hubs, and consumer electronic devices and displays; downloadable computer software for voice command and recognition, for speech-to-text conversion, for personal information management, and for accessing, browsing, and searching online databases, audio, video, and multimedia content, games, software applications, software application marketplaces, program listings and guides, and video on demand.

(260) AM 2020 104853 A

(800) 1486612

(151) 2019 03 29

(891) 2019 03 29

(731) Al-Namura spol. s r.o.

Lysolajské údolí 107/25, CZ-165 00 Praha 6,
Czech Republic

(540)

SHOCKY

(591) Black, white

(531) 27.05.01

(511)

32 – Non-alcoholic isotonic and energy drinks, mineral water (natural or artificial), fizzy drinks, and other soft drinks, non-alcoholic fruit and vegetables drinks, non-alcoholic refreshing beverages, syrups and other preparations for making beverages, beer.

33 – Mixed drinks of all kinds with alcohol.

(260) AM 2020 104854 A

(800) 1486637

(151) 2019 06 27

(891) 2019 06 27

(731) ASKONA-VEK, LLC

116k 25 Komsomolskaya Str., Kovrov,
RU-601900 Vladimir region, Russian
Federation

(540)

ASKONA

(591) Black, white

(511)

6 – Common metals and their alloys, ores; metal materials for building and construction; transportable buildings of metal; non-electric cables and wires of common metal; small items of metal hardware; metal containers for storage or transport; safes; catches (furniture-) of metal; fittings of metal for furniture; furniture casters of metal; metal shelf brackets; fittings of metal for beds and cupboard.

9 – Scientific, research, navigation, surveying, photographic, cinematographic, audiovisual, optical, weighing, measuring, signaling, detecting, testing, inspecting, life-saving and teaching apparatus and instruments; apparatus and instruments for conducting, switching, transforming, accumulating, regulating or controlling the distribution or use of electricity; apparatus and instruments for recording, transmitting, reproducing or processing sound, images or data; recorded and downloadable media, computer software, blank digital or analogue recording and storage media; mechanisms for coin-operated apparatus; cash registers, calculating devices; computers and computer peripheral devices; diving suits, divers' masks, ear plugs for divers, nose clips for divers and swimmers, gloves for divers, breathing apparatus for underwater swimming; fire-extinguish-

ing apparatus; furniture especially made for laboratories.

20 – Furniture, mirrors, picture frames; containers, not of metal, for storage or transport; unworked or semi-worked bone, horn, whalebone or mother-of-pearl; shells; meerschaum; yellow amber; divans; mattresses; chairs; armchairs; pillows; cushions; anti-roll cushions for babies; U – shaped pillows; beds; bedding, except linen; hospital beds; beds for household pets; furniture fittings (non-metallic); fasteners, non-metallic.

22 – Ropes and string; nets; tents and tarpaulins; awnings of textile or synthetic materials; sails; sacks for the transport and storage of materials in bulk; padding, cushioning and stuffing materials, except of paper, cardboard, rubber or plastics; raw fibrous textile materials and substitutes therefor.

24 – Textiles and substitutes for textiles; household linen; curtains of textile or plastic; coverings for furniture; upholstery fabrics; towels of textile; bed throws; bed clothes, blankets; linens; kitchen and table linens; fabrics.

25 – Clothing; footwear, headwear.

35 – Advertising; business management; business administration; office functions; clerical services; retail and wholesale services for pillows, cushions, furniture, mirrors, frames, mattresses, sofas, chairs, armchairs, furniture fittings, household goods, clothing and footwear, fabrics and textiles, curtains, household linen, towels, padding, cushioning and stuffing materials.

37 – Building construction; repair; installation services; furniture maintenance; furniture restoration; furniture repair; cleaning soft furnishings; furniture installation.

(260) AM 2020 104855 A

(800) 1486736

(151) 2018 11 29

(891) 2018 11 29

(731) BURBERRY LIMITED

Horseferry House, Horseferry Road,
London SW1P 2AW, United Kingdom

(540)

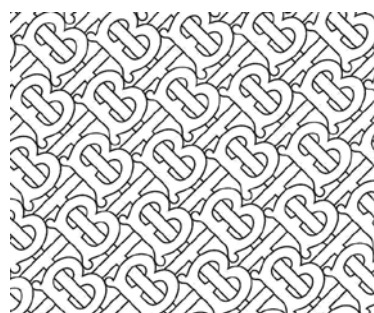

(591) Black, white
(531) 27.05.12; 27.05.22
(511)

3 – Non-medicated toilet preparations; cosmetics; glitter for cosmetic purposes; preparations for the bath and shower; body and skin care preparations; cosmetic preparations for teeth and for hair; nail care preparations and nail polish, false nails; soaps; anti-perspirants, deodorants; perfumes, eau de cologne, eau de toilette, toilet water and aftershave; essential oils, massage oil; pot pourri, room fragrance and incense; cleaning and care preparations for leather goods and non-leather goods.

9 – Sunglasses, spectacles, optical glasses, fitted frames and lenses for the aforesaid goods; cases and holders for the aforesaid goods; parts and fittings for all the aforesaid goods; cases and holders for portable electronic devices, mobile telephones, portable audio and video systems and computers; mouse mats; camera cases; mobile telephones, portable electronic devices; mobile phone accessories, including mobile phone covers and skins, lanyards for mobile phones, mobile phone fascias.

14 – Watches, clocks and parts, fittings and cases for all the aforesaid goods; watch straps and bracelets therefor; jewellery, imitation jewellery, tie-pins, tie clips and cuff links; articles made of precious metals or coated therewith, namely key rings, charms, badges, shoe ornaments; jewellery boxes and cases; models and figures of precious metal; jewellery rolls; key holders; cufflink cases.

18 – Leather and imitations of leather; bags; holdalls, handbags, shoulder bags; trunks, valises, suitcases, travelling bags, garment bags, bumbags, vanity cases (empty), baby bags, baby carriers, baby harnesses, rucksacks, satchels, shopping bags, wheeled shopping bags; purses, pouches; wallets, card holders, pochettes; labels and luggage labels, leather tags; cosmetic cases and bags (not fitted), cases for manicure sets (empty); tie cases; leather boxes; umbrellas, parasols; clothing for pets; horse blankets; collars and leashes for animals.

24 – Textiles and textile items; fabrics and linings; bed blankets; bed covers; bed linen; duvets; mattress covers; pillowcases; quilts and eiderdowns; bed sheets; curtains; towels; face cloths; table linen; table covers; placemats of textile; unfitted fabric furniture covers, curtains, wall hangings, cushion covers; handkerchiefs; travel rugs, picnic blankets; pet blankets; textile labels; throws.

25 – Clothing, footwear, headgear, belts.

(260) AM 2020 104856 A
(800) 1486739
(151) 2019 06 06

(891) 2019 06 06
(731) Ursapharm Arzneimittel GmbH
Industriestr. 35, 66129 Saarbrücken, Germany
(540)

Siccaprotect

(591) Black, white
(511)
3 – Non-medicated cosmetics and toiletry preparations; non-medicated dentifrices; perfumery, essential oils; bleaching preparations and other substances for laundry use; cleaning, polishing, scouring and abrasive preparations.

5 – Pharmaceuticals, medical and veterinary preparations; sanitary preparations for medical purposes; dietetic food and substances adapted for medical or veterinary use, food for babies; dietary supplements for human beings and animals; plasters, materials for dressings; material for stopping teeth, dental wax; disinfectants; preparations for destroying vermin; fungicides, herbicides; contact lens cleaning preparations; solutions for contact lenses; solutions for rinsing contact lenses; disinfectants for contact lenses; contact lens wetting solutions; solutions for neutralizing contact lenses; medicated creams; pharmaceutical creams; eye drops; ophthalmologic preparations; eye ointment.

(260) AM 2020 104857 A
(800) 1486743
(151) 2019 04 24
(891) 2019 04 24
(731) APPLE INC.
One Apple Park Way, Cupertino CA 95014, USA
(540)



(591) The color(s) black, blue and green is/are claimed as a feature of the mark
(531) 05.07.13; 05.07.23; 26.04.04; 26.04.15; 26.04.18; 26.04.24; 29.01.13
(526) TV
(511)
38 – Providing access to interactive websites and computer applications for the posting and sharing of reviews, survey, and ratings relating to educational programs, entertainment, motion pictures, theatre, arts and cultural events, concerts, live performances, competitions, fairs, festivals, exhibitions, expositions, and sporting events; providing access to inter-

active websites for the uploading, storing, sharing, viewing and posting of images, audio, videos, online journals, blogs, podcasts, and multimedia content.

41 – Development, production, distribution, rental, and presentation of television programs, motion pictures, and multimedia entertainment content; providing ongoing non-downloadable television, audio, video, and webcast programs; providing entertainment, sports, animation, music, informational, news, reality, documentary, current events, and arts and culture programming by means of telecommunications networks, computer networks, the Internet, satellite, wireless communications networks, television, and cable television; providing non-downloadable entertainment, sports, animation, music, informational, news, reality, documentary, current events, and arts and culture programming; providing interactive guides for searching, selecting, recording, and archiving television programs, motion pictures, and multimedia entertainment content; providing entertainment, sports, animation, music, informational, news, reality, documentary, current events, and arts and culture programming via websites and computer applications; providing information in the field of entertainment, sports, music, news, documentaries, current events, and arts and culture via websites and computer applications; providing information, schedules, reviews and personalized recommendations of educational programs, entertainment, motion pictures, theatre, arts and cultural events, concerts, live performances, competitions, fairs, festivals, exhibitions, expositions, and sporting events; publication and presentation of reviews, surveys, and ratings; news reporting.

(260) AM 2020 104858 A
 (800) 1486754
 (151) 2019 07 16
 (891) 2019 07 16
 (731) Bund der freien Waldorfschulen e.V.
 Wagenburgstraße 6, 70184 Stuttgart, Germany
 (540)

Rudolf Steiner

(591) Black, white
 (551) Collective
 (511)
 41 – School, boarding school and nursery school services, namely education, instruction and teaching of children and adolescents; training of kindergarten teachers and teachers; adult training, instruction and training for apprentices; leisure services for children.

(260) AM 2020 104860 A
 (800) 1486811
 (151) 2019 05 09

(891) 2019 05 09
 (731) Carlsberg Breweries A/S
 Ny Carlsberg Vej 100, DK-1799 Copenhagen V, Denmark

(540)



(591) White, blue and grey
 (531) 05.07.02; 05.07.03; 24.17.02; 27.05.03;
 27.05.11; 29.01.13
 (511)
 32 – Non-alcoholic beverages.

(260) AM 2020 104861 A
 (800) 1486833
 (151) 2019 05 17
 (891) 2019 05 17
 (731) FUJIAN WEIZHIXING SPORTS GOODS CO., LTD
 BINJIANG INDUSTRIAL PARK, XIAMEI TOWN, NAN'AN CITY, 362302 FUJIAN, China
 (540)



WESING

(591) Black, white
 (531) 27.05.01; 27.05.21
 (511)
 28 – Toys; exercise equipment; targets; machines for physical exercises; fitness gym jump platform; boxing gloves; fitness sandbag; plastic race track; waist protectors; chest protectors.

(260) AM 2020 104862 A
 (800) 1486867
 (151) 2019 06 26
 (891) 2019 06 26
 (731) Otkrytoe aktsionernoe obshchestvo
 "MINSKIY MOLOCHNY ZAVOD No.1"
 ul. Vokzalnaya 11, Zaslavl, 223034 Minskiy rayon, Belarus
 (540)



(591) White, blue, light-blue and red
 (531) 01.15.15; 08.03.01; 26.04.04; 26.04.05;
 26.04.16; 26.04.17; 26.04.24; 27.07.11;
 27.07.17; 28.05; 29.01.13

(511)
 29 – Milk and milk products; dairy-based oils and dairy-based fats for food; dairy-based beverages, non-alcoholic.

30 – Ice cream.

(260) AM 2020 104868 A

(800) 1486983

(151) 2019 05 10

(891) 2019 05 10

(731) Euro Games Technology Ltd.

"Maritsa" Str., 4, "Vranya-Lozen-Triugulnika", BG-1151 Sofia, Bulgaria

(540)



(591) White, black, red and yellow

(531) 27.05.02; 27.07.02; 29.01.14

(511)

9 – Software; computer gaming software; computer software packages; computer operating system software; computer software, recorded; software drivers; virtual reality software; games software; entertainment software for computer games; computer programs for network management; operating computer software for main frame computers; monitors (computer hardware); computer hardware; apparatus for recording images; monitors (computer programs); computer game programs; computer programs for recorded games; apparatus for recording, transmission or reproduction of sound or images; communications servers [computer hardware]; electronic components for gambling machines; computer application software featuring games and gaming; computer software for the administration of on-line games and gaming; computer hardware for games and gaming; electronic components and computer software for gambling, gambling machines, gambling games on the internet and via telecommunication network.

28 – Gaming machines for gambling; chips for gambling; mah-jong; arcade games; gambling machines operating with coins, notes and cards; games; electronic games; parlor games; gaming chips; gaming tables; slot machines [gaming machines]; LCD game machines; slot machines and gaming devices; coin-operated amusement machines; roulette chips; poker chips; chips and dice [gaming equipment]; equipment for casinos; roulette tables; gaming roulette wheels; casino games; gambling machines and amusement machines, automatic and coin-operated; coin-operated amusement machines and/or electronic

coin-operated amusement machines with or without the possibility of gain; boxes for coin-operated machines, slot machines and gaming machines; electronic or electrotechnical amusement machines and apparatus, gaming machines, coin-operated entertainment machines; housings for coin-operated machines, gaming equipment, gaming machines, machines for gambling; electropneumatic and electrical gambling machines (slot machines).

41 – Gambling; services related to gambling; gaming services for entertainment purposes; casino, gaming and gambling services; training in the development of software systems; provision of equipment for gambling halls; providing casino equipment [gambling]; gaming machine entertainment services; providing casino facilities [gambling]; gaming hall services; amusement arcade services; games equipment rental; rental of gaming machines; providing amusement arcade services; rental of gaming machines with images of fruits; editing or recording of sounds and images; sound recording and video entertainment services; hire of sound reproducing apparatus; provision of gaming equipment for casinos; providing of casino facilities; online gambling services; casino, gaming and gambling services; provision of gaming establishments, gaming halls, internet casinos, online gaming services.

(260) AM 2020 104870 A

(800) 1487005

(151) 2019 05 10

(891) 2019 05 10

(731) Euro Games Technology Ltd.

"Maritsa" Str., 4, "Vranya-Lozen-Triugulnika", BG-1151 Sofia, Bulgaria

(540)



(591) White, yellow, red and black

(531) 21.01.09; 27.05.02; 27.05.10; 27.07.02;
 29.01.14

(511)

9 – Software; computer gaming software; computer software packages; computer operating system software; computer software, recorded; software drivers; virtual reality software; games software; entertainment software for computer games; computer programs for network management; operating computer software for main frame computers; monitors (computer hardware); computer hardware; apparatus for recording images; monitors (computer programs); computer game programs; computer programs for recorded games; apparatus for recording, transmission or reproduction of sound or images; commu-

nications servers [computer hardware]; electronic components for gambling machines; computer application software featuring games and gaming; computer software for the administration of on-line games and gaming; computer hardware for games and gaming; electronic components and computer software for gambling, gambling machines, gambling games on the internet and via telecommunication network.

28 – Gaming machines for gambling; chips for gambling; mah-jong; arcade games; gambling machines operating with coins, notes and cards; games; electronic games; parlor games; gaming chips; gaming tables; slot machines [gaming machines]; LCD game machines; slot machines and gaming devices; coin-operated amusement machines; roulette chips; poker chips; chips and dice [gaming equipment]; equipment for casinos; roulette tables; gaming roulette wheels; casino games; gambling machines and amusement machines, automatic and coin-operated; coin-operated amusement machines and/or electronic coin-operated amusement machines with or without the possibility of gain; boxes for coin-operated machines, slot machines and gaming machines; electronic or electrotechnical amusement machines and apparatus, gaming machines, coin-operated entertainment machines; housings for coin-operated machines, gaming equipment, gaming machines, machines for gambling; electropneumatic and electrical gambling machines (slot machines).

41 – Gambling; services related to gambling; gaming services for entertainment purposes; casino, gaming and gambling services; training in the development of software systems; provision of equipment for gambling halls; providing casino equipment [gambling]; gaming machine entertainment services; providing casino facilities [gambling]; gaming hall services; amusement arcade services; games equipment rental; rental of gaming machines; providing amusement arcade services; rental of gaming machines with images of fruits; editing or recording of sounds and images; sound recording and video entertainment services; hire of sound reproducing apparatus; provision of gaming equipment for casinos; providing of casino facilities; online gambling services; casino, gaming and gambling services; provision of gaming establishments, gaming halls, internet casinos, online gaming services.

(260) AM 2020 104871 A

(800) 1487010

(151) 2019 04 05

(891) 2019 04 05

(731) TALAGAEVA ELENA VLADIMIROVNA
Kommunisticheskaya St., d. 3, kv. 145,
Ramenskoe, RU-140002 Moskovskaya oblast,
Russian Federation

(540)

ФИТОКОСМЕТИК

(591) Black, white

(531) 28.05

(511)

3 – Abrasives; descaling preparations for household purposes; antistatic preparations for household purposes; air fragrancing preparations; cake flavorings [essential oils]; flavorings for beverages [essential oils]; food flavorings [essential oils]; breath canned pressurized air for cleaning and dusting purposes; abrasive paper; emery paper; polishing paper; shoe polish; cobblers' wax; sachets for perfuming linen; drying agents for dishwashing machines; wax for parquet floors; floor wax; non-slipping wax for floors; tailors' wax; creams for leather; creams for leather; polish for furniture and flooring; shoemakers' wax; polishing wax; non-slipping liquids for floors; windshield cleaning liquids; volcanic ash for cleaning; silicon carbide [abrasive]; carbides of metal [abrasives]; quillaia bark for washing; polishing rouge; incense; pastes for razor strops; tripoli stone for polishing; corundum [abrasive]; laundry starch; laundry glaze; soap for brightening textile; abrasive cloth; glass cloth [abrasive cloth]; laundry soaking preparations; smoothing preparations [starching]; grinding preparations; color-removing preparations; leather bleaching preparations; polishing preparations; shoe cream; polishing creams; starch glaze for laundry purposes; refurbishing preparations; fabric softeners for laundry use; laundry bleach; dry-cleaning preparations; paint stripping preparations; floor wax removers [scouring preparations]; varnish-removing preparations; rust removing preparations; wallpaper cleaning preparations; preparations for unblocking drain pipes; laundry preparations; color-brightening chemicals for household purposes [laundry]; shining preparations [polish]; cleaning chalk; diamantine [abrasive]; stain removers; saffrol; laundry blueing; turpentine for degreasing; potpourris [fragrances]; bleaching soda; washing soda, for cleaning; bleaching salts; fumigation preparations [perfumes]; preservatives for leather [polishes]; ammonia [volatile alkali] [detergent]; preparations to make the leaves of plants shiny; shoe cream; detergents, other than for use in manufacturing operations and for medical purposes; degreasers, other than for use in manufacturing processes; emery cloth; cloths impregnated with a detergent for cleaning.

35 – Arranging subscriptions to telecommunication services for others; import-export agency services; commercial information agency services; advertising agency services; cost price analysis; rental of advertising space; business auditing; business intermediary services relating to the matching of potential private investors with entrepreneurs needing funding; employment agency services; computerized file ma-

nagement; book-keeping; invoicing; demonstration of goods; transcription of communications [office functions]; opinion polling; market studies; business information; commercial information and advice for consumers in the choice of products and services; business investigations; business research; marketing research; personnel recruitment; business management and organization consultancy; business organization consultancy; consultancy regarding public relations communication strategies; business management consultancy; personnel management consultancy; professional business consultancy; consultancy regarding advertising communication strategies; layout services for advertising purposes; marketing; business management of performing artists; business management of sports people; writing of résumés for others; scriptwriting for advertising purposes; news clipping services; updating and maintenance of information in registries; updating and maintenance of data in computer databases; updating of advertising material; word processing; organization of exhibitions for commercial or advertising purposes; arranging newspaper subscriptions for others; organization of fashion shows for promotional purposes; organization of exhibitions and trade fairs for commercial or advertising purposes; shop window dressing; design of advertising materials; business appraisals; payroll preparation; data search in computer files for others; sponsorship search; business management assistance; commercial or industrial management assistance; commercial intermediation services; providing business information via a web site; provision of commercial and business contact information; provision of an online marketplace for buyers and sellers of goods and services; web indexing for commercial or advertising purposes; presentation of goods on communication media, for retail purposes; economic forecasting; auctioneering; wholesale services for pharmaceutical, veterinary and sanitary preparations and medical supplies; retail services for pharmaceutical, veterinary and sanitary preparations and medical supplies; sales promotion for others; production of teleshopping programmes; production of advertising films; office machines and equipment rental; rental of advertising time on communication media; publicity material rental; rental of signs for advertising purposes; rental of vending machines; rental of sales stands; rental of photocopying machines; publication of publicity texts; radio advertising; bill-posting; distribution of samples; dissemination of advertising matter; direct mail advertising; registration of written communications and data; writing of publicity texts; online advertising on a computer network; advertising by mail order; television advertising; document reproduction; compilation of statistics; compilation of information into computer databases; business inquiries; systemization of information into computer databases; advisory services for business management;

negotiation of business contracts for others; negotiation and conclusion of commercial transactions for third parties; compiling indexes of information for commercial or advertising purposes; advice relating to tax preparation; drawing up of statements of accounts; telemarketing services; psychological testing for the selection of personnel; outsourced administrative management for companies; business management of hotels; business management for freelance service providers; business project management services for construction projects; commercial administration of the licensing of the goods and services of others; business management of reimbursement programs for others; administration of consumer loyalty programs; administration of frequent flyer programs; administrative processing of purchase orders; public relations; modelling for advertising or sales promotion; typing; appointment reminder services [office functions]; web site traffic optimization; relocation services for businesses; tax filing services; search engine optimization for sales promotion; appointment scheduling services [office functions]; price comparison services; advertising; pay per click advertising; secretarial services; procurement services for others [purchasing goods and services for other businesses]; shorthand; outsourcing services [business assistance]; telephone answering for unavailable subscribers; photocopying services; business efficiency expert services.

(260) AM 2020 104872 A

(800) 1487024

(151) 2019 07 15

(891) 2019 07 15

(731) McPhy Energy Italia Società a Responsabilità Limitata

Via Ayrton Senna 22, I-56028 San Miniato, Italy

(540)



(591) Azure.

(531) 27.05.17; 29.01.04

(511)

7 – Machines and plants for generation of gas; machines and plants for production of hydrogen and oxygen by electrolysis.

37 – Installation, maintenance, repair of machines and plants for generation of gas; installation, maintenance and repair of machines and plants for production of hydrogen and oxygen by electrolysis.

42 – Design of machines and plants for generation of gas; design of machines and plants for production of hydrogen and oxygen by electrolysis.

(260) AM 2020 104874 A

(800) 1487032

(151) 2019 05 27

(891) 2019 05 27

(731) TOYOTA JIDOSHA KABUSHIKI KAISHA,
(also trading as TOYOTA MOTOR
CORPORATION)
Toyota-cho, Toyota-shi 1, 471-8571 Aichi-ken
Japan

(540)

Lexus Link

(591) Black, white

(511)

9 – Telecommunication devices and apparatus; mobile phone accessories; loudspeakers; headphones; earphones; telephone apparatus; audio- and video-receivers; electric capacitors for telecommunication apparatus; electro-dynamic apparatus for the remote control of signals; global positioning system (GPS) apparatus; hands free kits for phones; high-frequency apparatus; intercommunication apparatus; microphones; electric monitoring apparatus; navigation apparatus for vehicles (on-board computers); radar apparatus; remote control apparatus; satellite navigational apparatus; sound and image recording apparatus; sound recording carriers; sound reproduction apparatus; sound transmitting apparatus; transmitters of electronic signals; vehicle radios; telecommunication machines and devices for use in assisting in improving safety of car driving; car stereos; car televisions; smartphones; cases for smartphones; radio communication machines and apparatus; communication apparatus for vehicles; communication devices for vehicles; electronic apparatus for wireless reception, storage and transmission of data and messages; computer software, recorded; computer programs [downloadable software]; computer application software for mobile phones; computer application software for mobile computer; navigation software for mobile phone; navigation software for mobile computers; route planning software for mobile phones, route planning software for mobile computers; protective cases for personal digital assistants; computer mouse; personal computers; personal computers for vehicles; tablet computers; covers and cases for tablet computers and notebook computers; computer programs for mobile phones; computer software applications, downloadable; data processing apparatus; disks, magnetic; electronic agendas; electronic book readers; electronic pocket translators; electronic tags for goods; integrated circuit cards; electronic control apparatus and instruments for vehicles; electronic display units for vehicles; mouse pads; computer e-commerce software to allow users to perform electronic business transactions via a global computer network; computer software platforms; electron tubes; semi-conductor devices; electronic circuits, not including those re-

corded with computer programs; computer programs and software; computer programs and software for wireless reception, storage and transmission of data and messages; computer programs and software for car navigation systems; electronic navigational and positioning apparatus and instruments; charging stations for electric vehicles; battery charging devices for electric vehicles; electricity meters having functions of controlling electricity utilization and of storing electricity, for use with battery charging devices for electric vehicles, lighting systems, and parking fee collection devices located at parking lots; power storage apparatus comprised of a power storage unit, a charging device, a converter that utilizes electricity stored in the power storage unit, and their control devices; automatic remote data collection devices for electricity consumption data using communication technology; electrical control apparatus; measuring apparatus and instrument; sensors [measurement apparatus], other than for medical use; detectors; computerized vehicle engine analyzers; power distribution or control machines and apparatus; rotary converters; phase modifiers; electrical cells and batteries; electric or magnetic meters and testers; electric wires and cables.

12 – Automobiles and structural parts thereof; electrically powered motor vehicles; electric tricycles; buses; trucks; ambulances; racing cars; amphibious vehicles; snowmobiles; armored vehicles; fork lift trucks; camping cars; tractors; trailers; trolley buses; hearses; structural parts for buses; structural parts for trucks; automobile bodies; automobile bonnets; automobile bumpers; automobile chassis; automobile dashboards; automobile doors; automobile door handles; automobile hoods; automobile horns; automobile seats; automobile seat covers; automobile sunroofs; automobile tires; automobile wheels; spokes for automobile wheels; inner tubes for automobile tires; automobile wheel rims; rearview mirrors for automobiles; automobile windows; automobile windscreens; automobile windshields; automobile convertible tops; safety belts for automobile seats; safety harnesses for automobile racing; safety harnesses for automobile seats; security harness for automobile seats; steering wheels for automobiles; steering wheel covers for automobiles; air bags for automobiles, buses and trucks; seat belt pre-tensioners for automobiles; brake pedals for land vehicles; direction signals for automobiles; leather upholstery for automobile seats; leather upholstery for automobiles; cigar lighters for automobiles; shaped automobile covers; mudguards for automobiles; luggage carriers for automobiles; spare wheel holders for automobiles; automobile roof racks; headlight wipers; windscreen wipers; windscreen wiper blades; motor vehicle brake control systems for applying emergency braking at low vehicle speeds; electronic brake control apparatus for automobiles; automobile

engines; engines for land vehicles; gasoline engines for land vehicles; diesel engines for land vehicles; internal combustion engines for land vehicles; motors for land vehicles; jet engines for land vehicles; turbines for land vehicles; anti-theft alarms for vehicles; two-wheeled motor vehicles, bicycles and parts and fittings for the aforesaid goods; boats and ships, other than air cushion vehicles; structural parts for boats; structural parts for ships other than air cushion vehicles; aircraft and their parts and fittings; railway rolling stock; structural parts for trains.

38 – Telecommunication services, other than broadcasting; transmission of messages via the Internet; web messaging services; transmission of emergency signals.

39 – Providing road and traffic information; vehicle location services in the nature of providing geographic information regarding the location of vehicles on the road; car transport; truck transport; taxi transport; bus transport; car sharing services; vehicle parking services; vehicle driving services; leasing of automobiles; providing information relating to vehicle location and operation; distribution of electricity for charging electric vehicles including electric cars and electric bicycles; providing information relating to the distribution of electricity; distribution of electricity; conducting of travel tours; travel tour guide services; providing information concerning travel; travel arrangement and reservation services, other than those for temporary accommodation.

(260) AM 2020 104875 A

(800) 1487035

(151) 2019 05 15

(891) 2019 05 15

(731) Vovk Volodymyr Lvovych
vul. Kamianetska, 17, m.Lviv 79034, Ukraine

(540)

WINSO

(591) Black, white

(531) 27.05.01; 27.05.07

(511)

3 – Cleaning, polishing, scouring and abrasive preparations for vehicles; soap for washing vehicles other than industrial; shining preparations for vehicles; bleaching soda; laundry preparations; laundry bleaching preparations; bleaching salts; bleaching preparations, decolorants for cosmetic purposes; cloths impregnated with a detergent for cleaning; varnish-removing preparations; lacquer-removing preparations; colour-removing preparations; degreasers, other than for use in manufacturing processes; descaling preparations for household purposes; polishing wax for vehicles; polishing pastes for vehicles; washing soda, for cleaning; emery; emery cloth; emery paper;

ammonia detergent for vehicles; oils for cleaning purposes for vehicles; furbishing preparations for vehicles; aromatic essential oils; ethereal oils; ethereal essences; essential oils of cedarwood; essential oils of lemon; essential oils of citron; oils for perfumes and scents; terpenes; essential oils; laundry glaze; air fragrancing preparations for vehicles; air fragrancing preparations in liquid form for vehicles; air fragrancing preparations in dry form for vehicles; air fragrancing preparations in gel form for vehicles; stain removers; rust removing preparations; paint stripping preparations; dry-cleaning preparations; windscreen cleaning liquids; scouring preparations namely floor wax removers; turpentine for degreasing; glass cloth being abrasive cloth; sandpaper; canned pressurized air for cleaning and dusting purposes; tripoli stone for polishing; cleaning chalk; scouring solutions for vehicles; shampoos for vehicles; cleaning preparations for external cleaning of engines, cabs, glass, disks and other parts of vehicles.

5 – Air deodorizing preparations; air purifying preparations; disinfectant soap for vehicles.

17 – Packing and stopping materials; rubber sleeves for protecting parts of machines; gutta-percha; dielectrics, insulators; lute; gaskets; sealant compounds for joints; expansion joint fillers; draught excluder strips; adhesive bands, other than stationery and not for medical or household purposes; weatherstripping compositions; brake lining materials, partly processed; compositions to prevent the radiation of heat; pipe gaskets; cylinder jointing; sealing and insulating materials for gaskets (red, black, gray, transparent); sealing gaskets for vehicle window glass; materials for sealing of threaded joints.

(260) AM 2020 104878 A

(800) 1487082

(151) 2019 06 12

(891) 2019 06 12

(731) ZELDIS VLADYSLAV YEVHENOVYCH
vul. Chervona, 49 A, m. Dnipro 49069,
Ukraine

(540)



(591) Black and yellow

(531) 26.04.02; 26.04.05; 26.04.12; 26.04.18;
26.11.01; 26.11.07; 27.05.09; 29.01.12

(511)

2 – Paints, varnishes, lacquers; protective preparations for metals; colorants; natural resins, raw; asbestos paints; alizarine dyes; aluminium paints; anti-corrosive preparations; auramine; bactericidal paints;

colorants for butter; dyes; bitumen varnish; bronze powder for painting; fireproof paints; litharge; primers; titanium dioxide (pigment); dyewood extracts; enamels for painting; enamels (varnishes); silver emulsions (pigments); thickeners for paints; undercoating for vehicle chassis; protective preparations for metals; gum resins; Canada balsam; colophony; copal; copal varnish; black japan; bronzing lacquers; anti-rust oils; mastic (natural resin); anti-rust greases; cobalt oxide (colorant); zinc oxide (pigment); pigments; coatings (paints); glazes (paints, lacquers); silvering powders; anti-rust preparations; anti-fouling paints; anti-corrosive bands; anti-tarnishing preparations for metals; mordants; thinners for paints; thinners for lacquers; soot (colorant); carbon black (pigment); lamp black (pigment); sandarac; white lead; minium; siccatives (drying agents) for paints; turpentine (thinner for paints); silver paste; sumac for varnishes; coatings for roofing felt (paints); repositionable paint patches; fixatives (varnishes).

(260) AM 2020 104946 A

(800) 1487196

(151) 2019 03 12

(891) 2019 03 12

(731) NANJING IVECO AUTOMOBILE CO., LTD.
No. 8, LILY ROAD, PUKOU DISTRICT,
NANJING, JIANGSU, China

(540)

NAVECO

(591) Black, white

(531) 27.05.17

(511)

12 – Cars; tram; vehicle parts (excluding tire); tire; repair outfits for inner tubes.

(260) AM 2020 104947 A

(800) 1487267

(151) 2019 05 10

(891) 2019 05 10

(731) Euro Games Technology Ltd.
"Maritsa" Str., 4, "Vranya-Lozen-
Triugulnika", BG-1151 Sofia, Bulgaria

(540)

40 SUPER DICE

(591) White, yellow and orange

(531) 27.05.02; 27.07.02; 29.01; 29.01.13

(511)

9 – Software; computer gaming software; computer software packages; computer operating system software; computer software, recorded; software drivers;

virtual reality software; games software; entertainment software for computer games; computer programs for network management; operating computer software for main frame computers; monitors (computer hardware); computer hardware; apparatus for recording images; monitors (computer programs); computer game programs; computer programs for recorded games; apparatus for recording, transmission or reproduction of sound or images; communications servers [computer hardware]; electronic components for gambling machines; computer application software featuring games and gaming; computer software for the administration of on-line games and gaming; computer hardware for games and gaming; electronic components and computer software for gambling, gambling machines, gambling games on the internet and via telecommunication network.

28 – Gaming machines for gambling; chips for gambling; mah-jong; arcade games; gambling machines operating with coins, notes and cards; games; electronic games; parlor games; gaming chips; gaming tables; slot machines [gaming machines]; LCD game machines; slot machines and gaming devices; coin-operated amusement machines; roulette chips; poker chips; chips and dice [gaming equipment]; equipment for casinos; roulette tables; gaming roulette wheels; casino games; gambling machines and amusement machines, automatic and coin-operated; coin-operated amusement machines and/or electronic coin-operated amusement machines with or without the possibility of gain; boxes for coin-operated machines, slot machines and gaming machines; electronic or electrotechnical amusement machines and apparatus, gaming machines, coin-operated entertainment machines; housings for coin-operated machines, gaming equipment, gaming machines, machines for gambling; electropneumatic and electrical gambling machines (slot machines).

41 – Gambling; services related to gambling; gaming services for entertainment purposes; casino, gaming and gambling services; training in the development of software systems; provision of equipment for gambling halls; providing casino equipment [gambling]; gaming machine entertainment services; providing casino facilities [gambling]; gaming hall services; amusement arcade services; games equipment rental; rental of gaming machines; providing amusement arcade services; rental of gaming machines with images of fruits; editing or recording of sounds and images; sound recording and video entertainment services; hire of sound reproducing apparatus; provision of gaming equipment for casinos; providing of casino facilities; online gambling services; casino, gaming and gambling services; provision of gaming establishments, gaming halls, internet casinos, online gaming services.

(260) AM 2020 104950 A

(800) 1487305

(151) 2019 03 04

(891) 2019 03 04

(731) ORALDENT LIMITED

6 Nene Road, Bicton Industrial Estate,
Kimbolton, Cambridgeshire PE28 0LF,
United Kingdom

(540)

PERIO PLUS+

(591) Black, white

(511)

3 – Mouth washes; mouth washes, not for medical purposes; non-medicated mouth washes; teeth cleaning (preparations for -); preparations for cleaning teeth; preparations for cleaning the teeth; non-medicated mouthwashes; oral hygiene preparations; toothpaste; toothpastes; tooth powder; tooth paste; tooth powders; tooth care preparations; tooth cleaning preparations; non-medicated toothpaste; dental rinses for non-medical purposes; dental rinses, non medicated; non-medicated dental rinse; non-medicated dentifrices; dentifrices and mouthwashes; mouthwash; mouthwashes; mouthwashes, not for medical purposes.

5 – Medicated mouth washes; mouth washes for medical purposes; mouth rinses for medical use; anti-cavity mouth rinses for medical purposes; medicated brush-on oral care gels; dental rinse; medicated dental rinses; medicated anti-cavity dental rinses; pharmaceutical preparations for dental use; dental preparations and articles, and medicated dentifrices; antibacterial mouthwashes; anticavity mouthwash; antimicrobial mouthwashes; antiseptic mouthwashes; antiseptic mouthwashes for rinsing; medical mouthwashes; medicated anti-cavity mouthwashes; medicated mouthwash; medicated mouthwashes; mouthwashes for medical purposes; mouthwashes [gargles] for medical purposes; medicated oral care gels.

21 – Electric and non-electric toothbrushes; electric toothbrushes; electric toothbrushes; electrical toothbrushes; manual toothbrushes; non-electric toothbrushes; toothbrushes; toothbrushes; toothbrushes, electric; toothbrushes [non-electric]; periodontal irrigators [electric] for personal use (term considered too vague by the International Bureau – Rule 13.2.b) of the Common Regulations); periodontal irrigators [non-electric] for personal use (term considered too vague by the International Bureau – Rule 13.2.b) of the Common Regulations).

(260) AM 2020 104951 A

(800) 1487309

(151) 2019 07 18

(891) 2019 07 18

(731) S-Oil Corporation

Baekbeom-ro 192 (Gongduk-dong), Mapo-gu,
Seoul, Republic of Korea

(540)



(591) GOLD, BLACK

(531) 01.03.02; 01.15.23; 26.11.12; 27.05.01;
27.07.01; 29.01; 29.01.12

(511)

4 – Industrial oil; industrial grease; lubricating oil; fuels; candles and wicks for lighting; industrial oils and fats; dust removing preparations; lubricants; grease for boots; oils for the preservation of leather; lamp wicks; electrical energy; solid fuels; gas fuels; liquid fuels; wax [raw material]; illuminating wax; fuel for lighters; tinder.

(260) AM 2020 104952 A

(800) 1487318

(151) 2019 07 26

(891) 2019 07 26

(731) Alpen Pharma AG

Casinoplatz 2, CH-3011 Bern,
Switzerland

(540)

ALPEXAVIT

(591) Black, white

(511)

5 – Pharmaceutical products, medical and veterinary preparations; sanitary products for medical purposes; dietetic substances and foodstuffs for medical or veterinary use, food for babies; food supplements for humans and animals; plasters, materials for dressings; material for dental fillings and dental impressions; disinfectants; products for destroying vermin; fungicides, herbicides.

10 – Surgical, medical, dental and veterinary apparatus and instruments; artificial limbs, eyes and teeth; orthopedic articles; suture material; therapeutic and assistance devices designed for people with disabilities; massage apparatus; apparatus, devices and articles for child care; apparatus, devices and articles for sexual activities.

(260) AM 2020 104954 A

(800) 1487395

(151) 2019 05 10

(891) 2019 05 10

- (731) Euro Games Technology Ltd.
"Maritsa" Str., 4, "Vranya-Lozen-
Triugulnika", BG-1151 Sofia, Bulgaria
(540)



- (591) White, orange, blue, brown, red, black
and green
(531) 27.05.02; 27.05.10; 29.01.15
(511)
9 – Software; computer gaming software; computer
software packages; computer operating system soft-
ware; computer software, recorded; software drivers;
virtual reality software; games software; entertain-
ment software for computer games; computer prog-
rams for network management; operating computer
software for main frame computers; monitors (com-
puter hardware); computer hardware; apparatus for
recording images; monitors (computer programs);
computer game programs; computer programs for
recorded games; apparatus for recording, transmis-
sion or reproduction of sound or images; communica-
tions servers [computer hardware]; electronic com-
ponents for gambling machines; computer appli-
cation software featuring games and gaming; com-
puter software for the administration of on-line gam-
es and gaming; computer hardware for games and
gaming; electronic components and computer soft-
ware for gambling, gambling machines, gambling
games on the internet and via telecommunication
network.

28 – Gaming machines for gambling; chips for gam-
bling; mah-jong; arcade games; gambling machines
operating with coins, notes and cards; games; elec-
tronic games; parlor games; gaming chips; gaming
tables; slot machines [gaming machines]; LCD game
machines; slot machines and gaming devices; coin-
operated amusement machines; roulette chips; poker
chips; chips and dice [gaming equipment]; equip-
ment for casinos; roulette tables; gaming roulette
wheels; casino games; gambling machines and amu-
sement machines, automatic and coin-operated; co-
in-operated amusement machines and/or electronic
coin-operated amusement machines with or without
the possibility of gain; boxes for coin-operated ma-
chines, slot machines and gaming machines; electro-
nic or electrotechnical amusement machines and ap-
paratus, gaming machines, coin-operated entertain-
ment machines; housings for coin-operated machi-
nes, gaming equipment, gaming machines, machines
for gambling; electropneumatic and electrical gam-
bling machines (slot machines).

41 – Gambling; services related to gambling; gam-
ing services for entertainment purposes; casino,
gaming and gambling services; training in the deve-

lopment of software systems; provision of equip-
ment for gambling halls; providing casino equipment
[gambling]; gaming machine entertainment services;
providing casino facilities [gambling]; gaming hall
services; amusement arcade services; games equip-
ment rental; rental of gaming machines; providing
amusement arcade services; rental of gaming machi-
nes with images of fruits; editing or recording of so-
unds and images; sound recording and video enter-
tainment services; hire of sound reproducing appa-
ratus; provision of gaming equipment for casinos;
providing of casino facilities; online gambling ser-
vices; casino, gaming and gambling services; provi-
sion of gaming establishments, gaming halls, inter-
net casinos, online gaming services.

- (260) AM 2020 104955 A
(800) 1487398
(151) 2019 05 07
(891) 2019 05 07
(731) SUZHOU DAKE MACHINERY CO., LTD.
No. 45 Songbei Road, Suzhou Industrial
Park, Suzhou City, 100031 Jiangsu Province,
China
(540)



- (591) Black, white
(531) 27.05.17
(511)
6 – Unwrought or semi-wrought common metals;
pipes of metal; sleeves [metal hardware]; fittings of
metal for building; railway material of metal; bands
of metal for tying-up purposes; clips of metal for
cables and pipes; small hardware of metal; buckles
of common metal [hardware]; nails; fittings of metal
for furniture; door bells of metal, non-electric; locks
of metal, other than electric; padlocks; fences of me-
tal; building materials of metal; scaffolding of metal;
steel wire; ropes of metal; wall plugs of metal;
screws of metal; hinges of metal; hooks [metal har-
dware]; pulleys of metal, other than for machines;
keys of metal; safes [strong boxes]; vice claws of
metal; tool chests of metal, empty; labels of metal;
bells for animals; rods of metal for welding; anchors;
identification bracelets of metal; weather- or wind-
vanes of metal; tree protectors of metal; traps for
wild animals; works of art of common metal; iron
ores; monuments of metal; angle irons of metal;
props of metal; elbows of metal for pipes; junctions
of metal for pipes; valves of metal, other than parts
of machines; reinforcing materials of metal for pi-
pes; collars of metal for fastening pipes; staircases of
metal; transportable buildings of metal.

11 – Electric lamps; lighting apparatus and installa-
tions; fluorescent lamp tubes; lights for vehicles;
germicidal lamps for purifying air; curling lamps; oil

lamps; cooking apparatus and installations; lava rocks for use in barbecue grills; cooling appliances and installations; air purifying apparatus and machines; fans [air-conditioning]; electric hair dryers; electric heating apparatus; fog machines; taps; pipes [parts of sanitary installations]; automatic watering installations; bath installations; sanitary apparatus and installations; water purification installations; electric radiators; lighters; polymerisation installations; electrically heated boots.

12 – Rolling stock for railways; vehicles for locomotion by land, air, water or rail; pumps for bicycle tires; bicycles; electric vehicles; trolleys; tires for vehicle wheels; repair outfits for inner tubes; air vehicles; boats; vehicle chassis; air pumps [vehicle accessories]; luggage carriers for vehicles; forklift trucks; vehicle wheels.

20 – Screws, not of metal; pegs [pins], not of metal; locks, other than electric, not of metal; stools; chairs [seats]; chaise longues; armchairs; trays, not of metal; vats, not of metal; transport pallets, not of metal; cushions; tool chests, not of metal, empty; tool boxes, not of metal, empty; boxes of wood or plastic; jerrycans, not of metal; ladders of wood or plastics; vice benches [furniture]; saw benches [furniture]; split rings, not of metal, for keys; furniture; containers, not of metal [storage, transport]; work benches; photograph frames; works of art made of bamboo and wood; cork craftwork; display boards; nesting boxes for household pets; furniture fittings, not of metal; door fittings, not of metal.

21 – Dustbins; steel wool for cleaning; containers for household or kitchen use; glass bowls; ceramics for household purposes; works of art of porcelain, ceramic, earthenware, terra-cotta or glass; toilet utensils; brushes; toothbrushes; drinking troughs; indoor aquaria; insect traps; drinking vessels; cosmetic utensils; thermally insulated containers for food; cleaning instruments, hand-operated; gardening gloves; glass, unworked or semi-worked, except building glass; mops; mop wringer buckets; watering cans.

35 – Advertising; online advertising on a computer network; business management assistance; organization of exhibitions for commercial or advertising purposes; commercial administration of the licensing of the goods and services of others; import-export agency services; sales promotion for others; procurement services for others [purchasing goods and services for other businesses]; personnel management consultancy; relocation services for businesses; systemization of information into computer databases; office machines and equipment rental; book-keeping; rental of vending machines; sponsorship search; rental of sales stands; retail services for pharmaceutical, veterinary and sanitary preparations and medical supplies; wholesale services for pharmaceutical, veterinary and sanitary preparations and

medical supplies; employment agency services; commercial information agency services; marketing; provision of an online marketplace for buyers and sellers of goods and services.

(260) AM 2020 104956 A

(800) 1487417

(151) 2019 05 10

(891) 2019 05 10

(731) Euro Games Technology Ltd.

"Maritsa" Str., 4, "Vranya-Lozen-

Triugulnika", BG-1151 Sofia, Bulgaria

(540)

20 BURNING DICE

(591) White, green and black

(531) 27.05.02; 27.07.02; 29.01.13

(511)

9 – Software; computer gaming software; computer software packages; computer operating system software; computer software, recorded; software drivers; virtual reality software; games software; entertainment software for computer games; computer programs for network management; operating computer software for main frame computers; monitors (computer hardware); computer hardware; apparatus for recording images; monitors (computer programs); computer game programs; computer programs for recorded games; apparatus for recording, transmission or reproduction of sound or images; communications servers [computer hardware]; electronic components for gambling machines; computer application software featuring games and gaming; computer software for the administration of on-line games and gaming; computer hardware for games and gaming; electronic components and computer software for gambling, gambling machines, gambling games on the internet and via telecommunication network.

28 – Gaming machines for gambling; chips for gambling; mah-jong; arcade games; gambling machines operating with coins, notes and cards; games; electronic games; parlor games; gaming chips; gaming tables; slot machines [gaming machines]; LCD game machines; slot machines and gaming devices; coin-operated amusement machines; roulette chips; poker chips; chips and dice [gaming equipment]; equipment for casinos; roulette tables; gaming roulette wheels; casino games; gambling machines and amusement machines, automatic and coin-operated; coin-operated amusement machines and/or electronic coin-operated amusement machines with or without the possibility of gain; boxes for coin-operated machines, slot machines and gaming machines; electronic or electrotechnical amusement machines and apparatus, gaming machines, coin-operated enter-

tainment machines; housings for coin-operated machines, gaming equipment, gaming machines, machines for gambling; electropneumatic and electrical gambling machines (slot machines).

41 – Gambling; services related to gambling; gaming services for entertainment purposes; casino, gaming and gambling services; training in the development of software systems; provision of equipment for gambling halls; providing casino equipment [gambling]; gaming machine entertainment services; providing casino facilities [gambling]; gaming hall services; amusement arcade services; games equipment rental; rental of gaming machines; providing amusement arcade services; rental of gaming machines with images of fruits; editing or recording of sounds and images; sound recording and video entertainment services; hire of sound reproducing apparatus; provision of gaming equipment for casinos; providing of casino facilities; online gambling services; casino, gaming and gambling services; provision of gaming establishments, gaming halls, internet casinos, online gaming services.

(260) AM 2020 104957 A

(800) 1487472

(151) 2019 05 27

(891) 2019 05 27

(731) TOYOTA JIDOSHA KABUSHIKI KAISHA,
(also trading as TOYOTA MOTOR
CORPORATION)

Toyota-cho, Toyota-shi 1, Aichi-ken
471-8571, Japan

(540)

MyT BY TOYOTA

(591) Black, white

(511)

9 – Telecommunication devices and apparatus; mobile phone accessories; loudspeakers; headphones; earphones; telephone apparatus; audio- and video-receivers; electric capacitors for telecommunication apparatus; electro-dynamic apparatus for the remote control of signals; global positioning system (gps) apparatus; hands free kits for phones; high-frequency apparatus; intercommunication apparatus; microphones; electric monitoring apparatus; navigation apparatus for vehicles (on-board computers); radar apparatus; remote control apparatus; satellite navigational apparatus; sound and image recording apparatus; sound recording carriers; sound reproduction apparatus; sound transmitting apparatus; transmitters of electronic signals; vehicle radios; telecommunication machines and devices for use in assisting in improving safety of car driving; car stereos; car televisions; smartphones; cases for smartphones; radio communication machines and apparatus; communication apparatus for vehicles; communication devices for vehicles; electronic apparatus

for wireless reception, storage and transmission of data and messages; computer software, recorded; computer programs [downloadable software]; computer application software for mobile phones; computer application software for mobile computer; navigation software for mobile phone; navigation software for mobile computers; route planning software for mobile phones, route planning software for mobile computers; protective cases for personal digital assistants; computer mouse; personal computers; personal computers for vehicles; tablet computers; covers and cases for tablet computers and notebook computers; computer programs for mobile phones; computer software applications, downloadable; data processing apparatus; disks, magnetic; electronic agendas; electronic book readers; electronic pocket translators; electronic tags for goods; integrated circuit cards; electronic control apparatus and instruments for vehicles; electronic display units for vehicles; mouse pads; computer e-commerce software to allow users to perform electronic business transactions via a global computer network; computer software platforms; electron tubes; semi-conductor devices; electronic circuits, not including those recorded with computer programs; computer programs and software; computer programs and software for wireless reception, storage and transmission of data and messages; computer programs and software for car navigation systems; electronic navigational and positioning apparatus and instruments; charging stations for electric vehicles; battery charging devices for electric vehicles; electricity meters having functions of controlling electricity utilization and of storing electricity, for use with battery charging devices for electric vehicles, lighting systems, and parking fee collection devices located at parking lots; power storage apparatus comprised of a power storage unit, a charging device, a converter that utilizes electricity stored in the power storage unit, and their control devices; automatic remote data collection devices for electricity consumption data using communication technology; electrical control apparatus; measuring apparatus and instrument; sensors [measurement apparatus], other than for medical use; detectors; computerized vehicle engine analyzers; power distribution or control machines and apparatus; rotary converters; phase modifiers; electrical cells and batteries; electric or magnetic meters and testers; electric wires and cables.

12 – Automobiles and structural parts thereof; electrically powered motor vehicles; electric tricycles; buses; trucks; ambulances; racing cars; amphibious vehicles; snowmobiles; armored vehicles; fork lift trucks; camping cars; tractors; trailers; trolley buses; hearses; structural parts for buses; structural parts for trucks; automobile bodies; automobile bonnets; automobile bumpers; automobile chassis; automobile dashboards; automobile doors; automobile door

handles; automobile hoods; automobile horns; automobile seats; automobile seat covers; automobile sunroofs; automobile tires; automobile wheels; spokes for automobile wheels; inner tubes for automobile tires; automobile wheel rims; rearview mirrors for automobiles; automobile windows; automobile windscreens; automobile windshields; automobile convertible tops; safety belts for automobile seats; safety harnesses for automobile racing; safety harnesses for automobile seats; security harness for automobile seats; steering wheels for automobiles; steering wheel covers for automobiles; air bags for automobiles, buses and trucks; seat belt pretensioners for automobiles; brake pedals for land vehicles; direction signals for automobiles; leather upholstery for automobile seats; leather upholstery for automobiles; cigar lighters for automobiles; shaped automobile covers; mudguards for automobiles; luggage carriers for automobiles; spare wheel holders for automobiles; automobile roof racks; headlight wipers; windshield wipers; windshield wiper blades; motor vehicle brake control systems for applying emergency braking at low vehicle speeds; electronic brake control apparatus for automobiles; automobile engines; engines for land vehicles; gasoline engines for land vehicles; diesel engines for land vehicles; internal combustion engines for land vehicles; motors for land vehicles; jet engines for land vehicles; turbines for land vehicles; anti-theft alarms for vehicles; two-wheeled motor vehicles, bicycles and parts and fittings for the aforesaid goods; boats and ships, other than air cushion vehicles; structural parts for boats; structural parts for ships other than air cushion vehicles; aircraft and their parts and fittings; railway rolling stock; structural parts for trains.

38 – Telecommunication services, other than broadcasting; transmission of messages via the Internet; web messaging services; transmission of emergency signals.

39 – Providing road and traffic information; vehicle location services in the nature of providing geographic information regarding the location of vehicles on the road; car transport; truck transport; taxi transport; bus transport; car sharing services; vehicle parking services; vehicle driving services; leasing of automobiles; providing information relating to vehicle location and operation; distribution of electricity for charging electric vehicles including electric cars and electric bicycles; providing information relating to the distribution of electricity; distribution of electricity; conducting of travel tours; travel tour guide services; providing information concerning travel; travel arrangement and reservation services, other than those for temporary accommodation.

(260) AM 2020 104959 A

(800) 1487507

(151) 2019 07 18

(891) 2019 07 18

(731) S-Oil Corporation

Baekbeom-ro 192 (Gongduk-dong), Mapo-gu, Seoul, Republic of Korea

(540)

S-OIL SEVEN 7

(591) Black, white

(531) 27.05.01

(511)

4 – Industrial oil; industrial grease; lubricating oil; fuels; candles and wicks for lighting; industrial oils and fats; dust removing preparations; lubricants; grease for boots; oils for the preservation of leather; lamp wicks; electrical energy; solid fuels; gas fuels; liquid fuels; wax [raw material]; illuminating wax; fuel for lighters; tinder.

(260) AM 2020 104960 A

(800) 1487518

(151) 2019 07 15

(891) 2019 07 15

(731) Obshchestvo s ogranichennoy

otvetstvennostyu "KUHMASTER"

p. Stroykeramika, str. 8, Volzhsky r-n,

RU-443528 Samarskaya oblast, Russian

Federation

(540)



(591) Red and white

(531) 25.03.01; 26.04.06; 28.05; 29.01.12

(511)

29 – Ajvar [preserved peppers]; aloe vera prepared for human consumption; alginates for culinary purposes; anchovy, not live; peanuts, prepared; albumen for culinary purposes; white of eggs; beans, preserved; soya beans, preserved, for food; bouillon; broth; ginger jam; ham; fatty substances for the manufacture of edible fats; edible birds' nests; peas, preserved; mushrooms, preserved; game, not live; gelatine; meat jellies; jellies for food; fruit jellies; yolk of eggs; coconut fat; bone oil for food; lard; suet for food; edible fats; curd; fruit-based snack food; charcuterie; raisins; caviar; fish roe, prepared; yogurt; yoghurt; sauerkraut; kephir [milk beverage]; kefir [milk beverage]; kimchi [fermented vegetable dish]; isinglass for food; clams, not live; milk shakes; black pudding, blood sausage; compotes; meat, tinned; meat, canned; vegetables, tinned; vegetables, canned; fish, tinned; fish, canned; fruits, tinned; fru-

its, canned; bouillon concentrates; broth concentrates; gherkins; shrimps, not live; prawns, not live; buttercream; croquettes; silkworm chrysalis for human consumption; kumys [milk beverage]; koumiss [milk beverage]; spiny lobsters, not live; lecithin for culinary purposes; salmon, not live; onions, preserved; margarine; marmalade; oils for food; peanut butter; cocoa butter for food; coconut oil for food; coconut butter; corn oil for food; maize oil for food; sesame oil for food; linseed oil for food; flaxseed oil for food; olive oil for food; palm oil for food; palm kernel oil for food; sunflower oil for food; colza oil for food; rape oil for food; butter; shellfish, not live; almonds, ground; animal marrow for food; mussels, not live; milk; condensed milk; albumin milk; protein milk; soya milk; fish meal for human consumption; vegetable mousses; fish mousses; fruit pulp; meat; meat, preserved; milk beverages, milk predominating; vegetables, preserved; vegetables, dried; vegetables, cooked; potato fritters; olives, preserved; lobsters, not live; coconut, desiccated; nuts, prepared; tomato paste; liver pâté; liver pastes; pectin for culinary purposes; liver; pickles; jams; powdered eggs; milk products; fish-based foodstuffs; prostokvasha [soured milk]; poultry, not live; pollen prepared as foodstuff; cranberry compote; tomato purée; apple purée; crayfish, not live; crustaceans, not live; fish, preserved; fish, not live; salted fish; ryazhenka [fermented baked milk]; vegetable salads; fruit salads; bacon; sardines, not live; pork; herrings, not live; seeds, prepared; sunflower seeds, prepared; cream [dairy products]; whipped cream; fat-containing mixtures for bread slices; smetana [sour cream]; tomato juice for cooking; vegetable juices for cooking; salted meats; sausages; sausages in batter; preparations for making bouillon; preparations for making soup; tripe; soups; vegetable soup preparations; whey; cheese; tahini [sesame seed paste]; tofu; sea-cucumbers, not live; truffles, preserved; tuna, not live; oysters, not live; milk ferments for culinary purposes; rennet; fish fillets; dates; crystallized fruits; frosted fruits; frozen fruits; fruit, preserved; fruit preserved in alcohol; fruit, stewed; potato flakes; hummus [chickpea paste]; fruit peel; preserved garlic; lentils, preserved; potato chips; potato crisps; low-fat potato chips; low-fat potato crisps; fruit chips; non-alcoholic eggnog; seaweed extracts for food; meat extracts; snail eggs for consumption; eggs.

30 – Flavorings [flavourings], other than essential oils, for cakes; flavorings, other than essential oils, for cakes; flavourings, other than essential oils, for cakes; flavourings, other than essential oils, for beverages; flavorings, other than essential oils, for beverages; coffee flavourings; coffee flavorings; food flavorings, other than essential oils; food flavourings, other than essential oils; star aniseed; cereal bars; high-protein cereal bars; pancakes; noodle-

based prepared meals; buns; bread rolls; vanillin [vanilla substitute]; waffles; vermicelli [noodles]; natural sweeteners; sausage binding materials; binding agents for ice cream; sea water for cooking; malt biscuits; cloves [spice]; cake frosting [icing]; glucose for culinary purposes; mustard; gluten additives for culinary purposes; yeast; thickening agents for cooking foodstuffs; leaven; rice-based snack food; cereal-based snack food; artificial coffee; vegetal preparations for use as coffee substitutes; dressings for salad; fruit jellies [confectionery]; confectionery for decorating Christmas trees; cakes; pastries; peanut confectionery; almond confectionery; pasta; ginger [spice]; frozen yogurt [confectionery ices]; frozen yoghurt [confectionery ices]; cocoa; cream of tartar for culinary purposes; capers; caramels [candy]; curry [spice]; ketchup [sauce]; quiches; gluten prepared as foodstuff; sweetmeats [candy]; liquorice [confectionery]; peppermint sweets; cinnamon [spice]; coffee; unroasted coffee; starch for food; crackers; custard; hominy grits; semolina; oatmeal; crushed barley; groats for human food; corn, milled; maize, milled; corn, roasted; maize, roasted; meat pies; turmeric; couscous [semolina]; noodles; ribbon vermicelli; ice for refreshment; ice, natural or artificial; edible ices; candy; rice cakes; mayonnaise; macarons [pastry]; macaroni; maltose; hominy; marinades; marzipan; honey; royal jelly; ice cream; bean meal; tapioca flour; potato flour; corn flour; corn meal; maize flour; maize meal; flour; meal; wheat flour; soya flour; barley meal; dessert mousses [confectionery]; chocolate mousses; muesli; mint for confectionery; cocoa beverages with milk; coffee beverages with milk; coffee-based beverages; cocoa-based beverages; tea-based beverages; chocolate beverages with milk; chocolate-based beverages; infusions, not medicinal; crushed oats; husked oats; nutmegs; stick liquorice [confectionery]; miso [condiment]; soya bean paste [condiment]; pastilles [confectionery]; lozenges [confectionery]; molasses for food; pâtés en croûte; pepper; allspice; peppers [seasonings]; pesto [sauce]; cookies; biscuits; petit-beurre biscuits; pies; pizzas; meat gravies; fondants [confectionery]; popcorn; powders for making ice cream; baking powder; mustard meal; pralines; condiments; meat tenderizers for household purposes; cereal preparations; oat-based food; propolis; bee glue; gingerbread; spices; petits fours [cakes]; puddings; cake powder; fruit coulis [sauces]; ravioli; chewing gum; relish [condiment]; rice; wheat germ for human consumption; spring rolls; sago; sugar; palm sugar; aniseed; golden syrup; confectionery; sugar confectionery; baking soda [bicarbonate of soda for cooking purposes]; bicarbonate of soda for cooking purposes [baking soda]; malt for human consumption; salt for preserving foodstuffs; cooking salt; celery salt; sherbets [ices]; sorbets [ices]; ham glaze; soya sauce; tomato sauce; pasta sauce; sauces [condiments]; spaghetti; seasonings;

preparations for stiffening whipped cream; rusks; breadcrumbs; sushi; sandwiches; tabbouleh; tacos; tapioca; tarts; dough; pastry dough; almond paste; cake dough; cake batter; tortillas; garden herbs, preserved [seasonings]; vinegar; beer vinegar; ferments for pastes; halvah; bread; unleavened bread; chips [cereal products]; corn flakes; maize flakes; oat flakes; flowers or leaves for use as tea substitutes; chicory [coffee substitute]; tea; iced tea; chutneys [condiments]; cheeseburgers [sandwiches]; chowchow [condiment]; saffron [seasoning]; chocolate; malt extract for food; essences for foodstuffs, except etheric essences and essential oils; husked barley.

32 – Aperitifs, non-alcoholic; lithia water; seltzer water; soda water; waters [beverages]; aerated water; carbonated water; mineral water [beverages]; table waters; kvass [non-alcoholic beverage]; cocktails, non-alcoholic; lemonades; non-alcoholic beverages; isotonic beverages; non-alcoholic honey-based beverages; aloe vera drinks, non-alcoholic; whey beverages; non-alcoholic fruit juice beverages; fruit nectars, non-alcoholic; orgeat; powders for effervescing beverages; sarsaparilla [non-alcoholic beverage]; syrups for lemonade; syrups for beverages; smoothies; tomato juice [beverage]; cider, non-alcoholic; vegetable juices [beverages]; fruit juices; fruit juice; preparations for making aerated water; preparations for making carbonated water; non-alcoholic preparations for making beverages; must; grape must, unfermented; malt wort; pastilles for effervescing beverages; sherbets [beverages]; sorbets [beverages]; non-alcoholic fruit extracts; essences for making beverages.

(260) AM 2020 104961 A

(800) 1487521

(151) 2019 07 30

(891) 2019 07 30

(731) Apple Inc.

One Apple Park Way, Cupertino CA 95014, USA

(540)



(591) White, light gray, blue, light green and medium green

(531) 15.09.25; 16.03.25; 21.03.21; 29.01.14

(511)

9 – Downloadable and recorded computer software for use in geographically locating and tracking electronic devices.

(260) AM 2020 104962 A

(800) 1487577

(151) 2019 07 29

(891) 2019 07 29

(731) SHENZHEN IVPS TECHNOLOGY CO., LTD.

4th Floor, Building 30, Changxing Science, and Technology Industrial Park, Changzhen Community, Gongming Street, Guangming New District, Shenzhen, Guangdong, China

(540)

SMOK

(591) Black, white

(531) 27.05.01

(511)

34 – Cigarettes containing tobacco substitutes, not for medical purposes; cigarillos; electronic cigarettes; tips of yellow amber for cigar and cigarette holders; liquid solutions for use in electronic cigarettes; flavorings, other than essential oils, for use in electronic cigarettes; cigarette cases; oral vaporizers for smokers; pipe racks for tobacco pipes; cigarette tips.

(260) AM 2020 104967 A

(800) 1487697

(151) 2019 05 10

(891) 2019 05 10

(731) Euro Games Technology Ltd.

"Maritsa" Str., 4, "Vranya-Lozen-Triugulnika", BG-1151 Sofia, Bulgaria

(540)

100 SUPER DICE

(591) White, yellow, orange and black

(531) 27.05.03; 27.07.03; 29.01.14

(511)

9 – Software; computer gaming software; computer software packages; computer operating system software; computer software, recorded; software drivers; virtual reality software; games software; entertainment software for computer games; computer programs for network management; operating computer software for main frame computers; monitors (computer hardware); computer hardware; apparatus for recording images; monitors (computer programs); computer game programs; computer programs for recorded games; apparatus for recording, transmission or reproduction of sound or images; communications servers [computer hardware]; electronic components for gambling machines; computer application software featuring games and gaming; computer

software for the administration of on-line games and gaming; computer hardware for games and gaming; electronic components and computer software for gambling, gambling machines, gambling games on the internet and via telecommunication network.

28 – Gaming machines for gambling; chips for gambling; mah-jong; arcade games; gambling machines operating with coins, notes and cards; games; electronic games; parlor games; gaming chips; gaming tables; slot machines [gaming machines]; LCD game machines; slot machines and gaming devices; coin-operated amusement machines; roulette chips; poker chips; chips and dice [gaming equipment]; equipment for casinos; roulette tables; gaming roulette wheels; casino games; gambling machines and amusement machines, automatic and coin-operated; coin-operated amusement machines and/or electronic coin-operated amusement machines with or without the possibility of gain; boxes for coin-operated machines, slot machines and gaming machines; electronic or electrotechnical amusement machines and apparatus, gaming machines, coin-operated entertainment machines; housings for coin-operated machines, gaming equipment, gaming machines, machines for gambling; electropneumatic and electrical gambling machines (slot machines).

41 – Gambling; services related to gambling; gaming services for entertainment purposes; casino, gaming and gambling services; training in the development of software systems; provision of equipment for gambling halls; providing casino equipment [gambling]; gaming machine entertainment services; providing casino facilities [gambling]; gaming hall services; amusement arcade services; games equipment rental; rental of gaming machines; providing amusement arcade services; rental of gaming machines with images of fruits; editing or recording of sounds and images; sound recording and video entertainment services; hire of sound reproducing apparatus; provision of gaming equipment for casinos; providing of casino facilities; online gambling services; casino, gaming and gambling services; provision of gaming establishments, gaming halls, internet casinos, online gaming services.

(260) AM 2020 104968 A

(800) 1487739

(151) 2019 05 31

(891) 2019 05 31

(731) Glasssix technology (Beijing) co., LTD
No. 101, 1st Floor, Building 21, No. 130,
Liangjiadian, Haidian District, 100095
Beijing, China

(540)

glasssix

(591) Black, white

(531) 27.05.01

(511)

9 – Chip (integrated circuit); electronic chip; remote control device; dimmer (electrical); sensor; control panel (electrical); stereoscopic instruments; integrated circuit; alarm.

(260) AM 2020 104969 A

(800) 1487792

(151) 2019 05 02

(891) 2019 05 02

(731) Rödl Equity Partner Beteiligung GmbH & Co.
KG
Äussere Sulzbacher Str. 100, 90491 Nürnberg,
Germany

(540)



(591) Black, yellow, red, grey

(531) 01.05.02; 01.05.15; 26.11.02; 26.11.09;

26.11.14; 27.05.01; 29.01.14

(511)

35 – Business management; business consultancy and advisory services, in particular taxation [accountancy] consultation and professional business consulting; presentation of and advertising for services for others via an Internet platform; arranging of contracts, for others, for the provision of services, in particular consultancy services in the field of business management, auditing, business process outsourcing and tax consultancy services, via an Internet platform; provision of commercial and business contacts via the Internet; collection, compilation and publication of directories of providers of services in electronic communications media, in particular via Internet platforms and e-mail newsletters; providing business information via a website.

36 – Insurance consultancy; financial analyses; financial consultancy; mutual funds; property management; real estate appraisal; real estate agency services; real estate management; health insurance; life insurance; pension fund services; fiscal assessments; accident insurance; insurance brokerage; financial management; trusteeship; insurance services.

38 – Internet and communications services, namely providing access to an online marketplace for service providers; providing access to and transmission of information on the Internet; providing access to a database in form of a computer-based market, in par-

ticular by providing access to and transmission of information on supply and demand for services; providing access to and online transmission of address and industry directories and information contained therein; transmission of information of editorial content, in particular via Internet platforms and e-mail newsletters; telecommunications services, in particular data transmission and transmission of messages via the Internet; providing access to an Internet platform for others; providing access to an online evaluation and feedback system via third parties, namely for contractors exchanging services via an Internet platform; leasing access time to databases.

41 – Arranging, conducting and organization of seminars, conferences, training sessions, exhibitions and congresses; organization of entertainment and social events.

42 – Providing internet search engines with specific search functions, in particular for searching for service providers.

45 – Legal services; providing information relating to legal services and legal affairs; advisory services relating to legal issues.

(260) AM 2020 104970 A

(800) 1487807

(151) 2019 06 05

(891) 2019 06 05

(731) Bayer Consumer Care AG

Peter Merian-Strasse 84, CH-4052 Basel,
Switzerland

(540)



(591) Red, white, blue, yellow and orange

(531) 01.15.09; 02.09.21; 02.09.25; 19.13.21;
25.05.03; 28.05; 29.01.15

(511)

5 – Pharmaceutical preparations and substances.

(260) AM 2020 104971 A

(800) 1487818

(151) 2019 05 10

(891) 2019 05 10

(731) UiPath SRL

Str. Vasile Alecsandri si Constantin Daniel,
Nr. 4 si 11, Corp A, Et. 5-6, Sector 1,
Bucharest, Romania

(540)



(591) Blue

(531) 26.04.01; 26.04.05; 26.04.18; 27.05.01;
29.01.04

(511)

9 – Computer programs [downloadable software]; downloadable computer utility programs; computer software applications, downloadable; application software for cloud computing services.

35 – Assistance in management of business activities; assistance and advice regarding business management; management assistance in business affairs; business assistance, management and administrative services; management and operation assistance to commercial businesses; assistance and advice regarding business organisation and management; advice relating to the organisation and management of business; business management assistance for industrial or commercial companies; assistance, advisory services and consultancy with regard to business management; assistance to commercial enterprises in the management of their business; commercial assistance in business management; efficiency experts; business efficiency expert services; business organisation consulting; business organization and operation consultancy; business management and organization consultancy; business management and enterprise organization consultancy; business organization and management consultancy including personnel management; assistance, advisory services and consultancy with regard to business organization; advisory services for business management; business management consultancy and advisory services; business consulting; professional consultancy relating to business management; business information; collecting information for business; dissemination of business information; computer assisted business information; business advisory and information services; information in business matters; business information for enterprises (provision of -); business information and research services; computerised business information services; provision of business information; analysis of business information; computerised business information retrieval; business statistical information services; business advice, inquiries or information; provision of business and commercial information; computerised business information processing services; business research and information services; provision of statistical information relating to business; provision of business management information; provision of computerised data relating to business; information services relating to businesses;

information services relating to business matters; providing business information via a web site; provision of computerised business management information; drawing up of business statistical information; economic information services for business purposes; business analysis, research and information services; compilation of business statistics and commercial information; advice and information concerning commercial business management; information or enquiries on business and marketing; computerised information services to business opportunities appraisals; provision of commercial and business contact information; provision of business information via global computer networks; provision of computerised information relating to business records; providing business information by way of computer terminals; provision of on-line business and commercial information; providing information about commercial business and commercial information via the global computer network; updating of business information on a computer data base; business consultancy relating to the administration of information technology; providing business information directory services, via a global computer network; information and data compiling and analyzing relating to business management; business management consulting services in the field of information technology; provision of commercial business information by means of a computer database; business information services provided on-line from a computer database or the internet; business information services provided online from a global computer network or the internet; providing business information, also via internet, the cable network or other forms of data transfer; compilation of information into computer databases; compilation and systemization of information into computer databases; compilation of statistics; compilation of business statistics; compilation of statistics [for business or commercial purposes]; computerized file management; data search in computer files for others; document reproduction; outsourcing services [business assistance]; systemization of information into computer databases; updating and maintenance of data in computer databases; advertising, marketing and promotional services; distribution of advertising, marketing and promotional material; dissemination of advertisements; dissemination of advertising matter; dissemination of advertising, marketing and publicity materials; dissemination of advertising matter online; dissemination of advertising for others; distribution of advertisements and commercial announcements; dissemination of advertising material [leaflets, brochure and printed matter]; distribution of advertising material; distribution of prospectuses and samples for advertising purposes; distribution of flyers, brochures, printed matter and samples for advertising purposes; distribution of products for advertising purposes; distribution and dissemination of advertising

materials [leaflets, prospectuses, printed material, samples]; dissemination services of advertisement matter; product demonstrations and product display services; arranging of displays for commercial purposes; arranging of displays for advertising purposes; organisation and conducting of product presentations; preparation and presentation of audio visual displays for advertising purposes; presentation of goods and services; demonstration of goods; advertising, marketing and promotional consultancy, advisory and assistance services; providing assistance in the field of business promotion; marketing assistance; consultancy regarding advertising communications strategy; consultations relating to business advertising; business advice relating to marketing management consultations; advice relating to marketing management; consultations relating to business promotion; advisory services relating to sales promotion; professional consultancy relating to marketing; consultancy relating to advertising and promotion services; business advice relating to strategic marketing; advertising and marketing consultancy; marketing advice; consultancy relating to advertising; business advice relating to marketing; business consultancy services relating to the marketing of fund raising campaigns; business consultancy services relating to the promotion of fund raising campaigns; organisation and management of business incentive and loyalty schemes; public relations consultancy; conducting studies in the field of public relations; commercial lobbying services; arranging of demonstrations for advertising purposes; organisation of events for commercial and advertising purposes; provision of computerised advertising services; provision of advertising space by electronic means and global information networks; provision of space on web-sites for advertising goods and services; provision of advertising space on electronic media; provision of advertising space on a global computer network; rental of advertising space online; leasing of advertising space on pamphlets; updating of advertising information on a computer data base; business assistance relating to business image; assistance to management in commercial enterprises in respect of advertising; management assistance for promoting business; market campaigns; collection of information relating to advertising; design of advertising logos; design of advertising materials; development of promotional campaigns; development of marketing strategies and concepts; estimations for marketing purposes; providing business marketing information; provision of information relating to advertising; affiliate marketing; trade marketing [other than selling]; database marketing; product marketing; arranging of presentations for advertising purposes; arranging and conducting of marketing events; arranging of competitions for advertising purposes; arrangement of advertising; planning of marketing strategies; preparation of adver-

tising campaigns; preparing audio-visual presentations for use in advertising; production of advertising matter and commercials; design of marketing surveys; computerised business promotion; promoting the goods and services of others via computer and communication networks; promoting the goods and services of others via a global computer network; promoting the goods and services of others; on-line promotion of computer networks and websites; promotion, advertising and marketing of on-line websites; promotion [advertising] of business; business promotion; sales promotion; publication of publicity materials; publication of publicity materials on-line; on-line advertising on a computer network; online advertising; advertising through all public communication means; radio and television advertising; advertising in the popular and professional press; magazine advertising; advertising and marketing; updating of advertising material; preparation of advertising material; production of video recordings for advertising purposes; electronic commerce services, namely, providing information about products via telecommunication networks for advertising and sales purposes; brand creation services (advertising and promotion); graphic advertising services; information services relating to advertising; merchandising; services with regard to product presentation to the public; promotion services; advertising services provided via the internet; advertising services provided via a data base; advertising and marketing services provided by means of blogging; advertising and marketing services provided by means of social media; advertising and promotion services and related consulting; brand strategy services; advertising services to create corporate and brand identity; advertising services relating to data bases; preparation of marketing plans; provision of marketing reports.

38 – Transmission of information for business purposes; providing access to databases; providing access to online computer databases; providing access to and leasing access time to computer databases; providing access to databases in computer networks; providing access to electronic communications networks and electronic databases; communications by computer terminals; computer-aided transmission of messages and images; computer aided transmission of messages, information and images; streaming of data; transmission of digital files.

41 – Teaching and training in business, industry and information technology; arranging and conducting of conferences; arranging, conducting and organisation of conferences; arranging and conducting of commercial, trade and business conferences; arranging and conducting of seminars; arranging and conducting of seminars and workshops; arranging, conducting and organisation of seminars; programming

[scheduling of programs] on a global computer network.

42 – Providing temporary use of non-downloadable computer programs; cloud computing; consulting in the field of cloud computing networks and applications; rental of operating software for accessing and using a cloud computing network; programming of operating software for accessing and using a cloud computing network; design and development of operating software for accessing and using a cloud computing network; providing temporary use of on-line non-downloadable operating software for accessing and using a cloud computing network; computer programming; scientific computer programming services; computer software programming services; computer programming and maintenance of computer programs; computer programming for data processing; computer design and programming services; computer programming and software design; computer programming for the internet; research relating to computer programming; computer programming services for data warehousing; design, development and programming of computer software; technical consultancy services relating to computer programming; computer programming for data processing and communication systems; computer programming services for commercial analysis and reporting; programming of computer software for reading, transmitting and organising data; programming of computer software for evaluation and calculation of data; advisory services relating to computer programming; computer software design; software design and development; computer software design and updating; design and writing of computer software; design and development of computer software architecture; design, maintenance and updating of computer software; design, drawing and commissioned writing of computer software; research, development, design and upgrading of computer software; design, maintenance, development and updating of computer software; design, maintenance, rental and updating of computer software; design and development of computer software for process control; consultancy relating to the design and development of computer software programs; design and development of computer software for reading, transmitting and organising data; design and development of computer software for evaluation and calculation of data; providing information about the design and development of computer software, systems and networks; rental of software; rental of computer database software; rental of computer software and programs; rental and maintenance of computer software; computer system analysis; advisory services relating to computer systems analysis; computer system design; advisory services relating to computer systems design; design services relating to the development of computerised information processing

systems; computer software consultancy; professional advisory services relating to computer software; technical consultancy relating to the installation and maintenance of computer software; technical consultancy relating to the application and use of computer software; providing information, advice and consultancy services in the field of computer software; consultancy and information services relating to the design, programming and maintenance of computer software; research and consultancy services relating to computer software; consultancy services relating to computer networks using mixed software environments; computer technology consultancy; computer and information technology consultancy services; consultancy in the field of computer security; professional consultancy relating to computer security; conversion of computer programs and data, other than physical conversion; electronic data storage; computer services concerning electronic data storage; compression of data for electronic storage; electronic data storage and data back-up services; electronic storage services for archiving databases; electronic storage services for archiving databases, images and other electronic data; temporary electronic storage of information and data; information technology [it] consultancy; providing information on computer technology and programming via a web site; installation of software; installation and maintenance of computer programs; installation and customisation of computer applications software; installation, maintenance and updating of computer software; installation, repair and maintenance of computer software; installation, maintenance, updating and upgrading of computer software; installation, setting up and maintenance of computer software; installation, maintenance, repair and servicing of computer software; installation, maintenance and repair of software for computer systems; maintenance of computer programs; development and maintenance of computer software; maintenance and updating of computer software; maintenance and upgrading of computer software; development and maintenance of computer database software; maintenance of computer software relating to computer security and prevention of computer risks; updating and maintenance of computer software and programs; monitoring of computer systems by remote access; off-site data backup; outsource service providers in the field of information technology; research and development for others; software as a service [saas]; technological consultation services; updating of computer software; updating and upgrading of computer software; updating of computer software for others; updating of software databases; updating of computer software relating to computer security and prevention of computer risks; updating of computer programs.

(260) AM 2020 104972 A

(800) 1487828

(151) 2019 05 10

(891) 2019 05 10

(731) UiPath SRL

Str. Vasile Alecsandri si Constantin Daniel,
Nr. 4 si 11, Corp A, Et. 5-6, Sector 1,
Bucharest, Romania

(540)



(591) Black, white

(531) 26.04.01; 26.04.05; 26.04.18; 27.05.01

(511)

9 – Computer programs [downloadable software]; downloadable computer utility programs; computer software applications, downloadable; application software for cloud computing services.

35 – Assistance in management of business activities; assistance and advice regarding business management; management assistance in business affairs; business assistance, management and administrative services; management and operation assistance to commercial businesses; assistance and advice regarding business organisation and management; advice relating to the organisation and management of business; business management assistance for industrial or commercial companies; assistance, advisory services and consultancy with regard to business management; assistance to commercial enterprises in the management of their business; commercial assistance in business management; efficiency experts; business efficiency expert services; business organisation consulting; business organization and operation consultancy; business management and organization consultancy; business management and enterprise organization consultancy; business organization and management consultancy including personnel management; assistance, advisory services and consultancy with regard to business organization; advisory services for business management; business management consultancy and advisory services; business consulting; professional consultancy relating to business management; business information; collecting information for business; dissemination of business information; computer assisted business information; business advisory and information services; information in business matters; business information for enterprises (provision of -); business information and research services; computerised business information services; provision of business information; analysis of business information; computerised business information retrieval; business statistical information services; business advice, inquiries or information;

provision of business and commercial information; computerised business information processing services; business research and information services; provision of statistical information relating to business; provision of business management information; provision of computerised data relating to business; information services relating to businesses; information services relating to business matters; providing business information via a web site; provision of computerised business management information; drawing up of business statistical information; economic information services for business purposes; business analysis, research and information services; compilation of business statistics and commercial information; advice and information concerning commercial business management; information or enquiries on business and marketing; computerised information services to business opportunities appraisals; provision of commercial and business contact information; provision of business information via global computer networks; provision of computerised information relating to business records; providing business information by way of computer terminals; provision of on-line business and commercial information; providing information about commercial business and commercial information via the global computer network; updating of business information on a computer data base; business consultancy relating to the administration of information technology; providing business information directory services, via a global computer network; information and data compiling and analyzing relating to business management; business management consulting services in the field of information technology; provision of commercial business information by means of a computer database; business information services provided on-line from a computer database or the internet; business information services provided online from a global computer network or the internet; providing business information, also via internet, the cable network or other forms of data transfer; compilation of information into computer databases; compilation and systemization of information into computer databases; compilation of statistics; compilation of business statistics; compilation of statistics [for business or commercial purposes]; computerized file management; data search in computer files for others; document reproduction; outsourcing services [business assistance]; systemization of information into computer databases; updating and maintenance of data in computer databases; advertising, marketing and promotional services; distribution of advertising, marketing and promotional material; dissemination of advertisements; dissemination of advertising matter; dissemination of advertising, marketing and publicity materials; dissemination of advertising matter online; dissemination of advertising for others; distribution of advertisements and commercial announcements; disse-

mination of advertising material [leaflets, brochure and printed matter]; distribution of advertising material; distribution of prospectuses and samples for advertising purposes; distribution of flyers, brochures, printed matter and samples for advertising purposes; distribution of products for advertising purposes; distribution and dissemination of advertising materials [leaflets, prospectuses, printed material, samples]; dissemination services of advertisement matter; product demonstrations and product display services; arranging of displays for commercial purposes; arranging of displays for advertising purposes; organisation and conducting of product presentations; preparation and presentation of audio visual displays for advertising purposes; presentation of goods and services; demonstration of goods; advertising, marketing and promotional consultancy, advisory and assistance services; providing assistance in the field of business promotion; marketing assistance; consultancy regarding advertising communications strategy; consultations relating to business advertising; business advice relating to marketing management consultations; advice relating to marketing management; consultations relating to business promotion; advisory services relating to sales promotion; professional consultancy relating to marketing; consultancy relating to advertising and promotion services; business advice relating to strategic marketing; advertising and marketing consultancy; marketing advice; consultancy relating to advertising; business advice relating to marketing; business consultancy services relating to the marketing of fund raising campaigns; business consultancy services relating to the promotion of fund raising campaigns; organisation and management of business incentive and loyalty schemes; public relations consultancy; conducting studies in the field of public relations; commercial lobbying services; arranging of demonstrations for advertising purposes; organisation of events for commercial and advertising purposes; provision of computerised advertising services; provision of advertising space by electronic means and global information networks; provision of space on web-sites for advertising goods and services; provision of advertising space on electronic media; provision of advertising space on a global computer network; rental of advertising space on-line; leasing of advertising space on pamphlets; updating of advertising information on a computer data base; business assistance relating to business image; assistance to management in commercial enterprises in respect of advertising; management assistance for promoting business; market campaigns; collection of information relating to advertising; design of advertising logos; design of advertising materials; development of promotional campaigns; development of marketing strategies and concepts; estimations for marketing purposes; providing business marketing information; provision of information relating to adver-

tising; affiliate marketing; trade marketing [other than selling]; database marketing; product marketing; arranging of presentations for advertising purposes; arranging and conducting of marketing events; arranging of competitions for advertising purposes; arrangement of advertising; planning of marketing strategies; preparation of advertising campaigns; preparing audio-visual presentations for use in advertising; production of advertising matter and commercials; design of marketing surveys; computerised business promotion; promoting the goods and services of others via computer and communication networks; promoting the goods and services of others via a global computer network; promoting the goods and services of others; on-line promotion of computer networks and websites; promotion, advertising and marketing of on-line websites; promotion [advertising] of business; business promotion; sales promotion; publication of publicity materials; publication of publicity materials on-line; on-line advertising on a computer network; online advertising; advertising through all public communication means; radio and television advertising; advertising in the popular and professional press; magazine advertising; advertising and marketing; updating of advertising material; preparation of advertising material; production of video recordings for advertising purposes; electronic commerce services, namely, providing information about products via telecommunication networks for advertising and sales purposes; brand creation services (advertising and promotion); graphic advertising services; information services relating to advertising; merchandising; services with regard to product presentation to the public; promotion services; advertising services provided via the internet; advertising services provided via a data base; advertising and marketing services provided by means of blogging; advertising and marketing services provided by means of social media; advertising and promotion services and related consulting; brand strategy services; advertising services to create corporate and brand identity; advertising services relating to data bases; preparation of marketing plans; provision of marketing reports.

38 – Transmission of information for business purposes; providing access to databases; providing access to online computer databases; providing access to and leasing access time to computer databases; providing access to databases in computer networks; providing access to electronic communications networks and electronic databases; communications by computer terminals; computer-aided transmission of messages and images; computer aided transmission of messages, information and images; streaming of data; transmission of digital files.

41 – Teaching and training in business, industry and information technology; arranging and conducting of conferences; arranging, conducting and organisation

of conferences; arranging and conducting of commercial, trade and business conferences; arranging and conducting of seminars; arranging and conducting of seminars and workshops; arranging, conducting and organisation of seminars; programming [scheduling of programs] on a global computer network.

42 – Providing temporary use of non-downloadable computer programs; cloud computing; consulting in the field of cloud computing networks and applications; rental of operating software for accessing and using a cloud computing network; programming of operating software for accessing and using a cloud computing network; design and development of operating software for accessing and using a cloud computing network; providing temporary use of on-line non-downloadable operating software for accessing and using a cloud computing network; computer programming; scientific computer programming services; computer software programming services; computer programming and maintenance of computer programs; computer programming for data processing; computer design and programming services; computer programming and software design; computer programming for the internet; research relating to computer programming; computer programming services for data warehousing; design, development and programming of computer software; technical consultancy services relating to computer programming; computer programming for data processing and communication systems; computer programming services for commercial analysis and reporting; programming of computer software for reading, transmitting and organising data; programming of computer software for evaluation and calculation of data; advisory services relating to computer programming; computer software design; software design and development; computer software design and updating; design and writing of computer software; design and development of computer software architecture; design, maintenance and updating of computer software; design, drawing and commissioned writing of computer software; research, development, design and upgrading of computer software; design, maintenance, development and updating of computer software; design, maintenance, rental and updating of computer software; design and development of computer software for process control; consultancy relating to the design and development of computer software programs; design and development of computer software for reading, transmitting and organising data; design and development of computer software for evaluation and calculation of data; providing information about the design and development of computer software, systems and networks; rental of software; rental of computer database software; rental of computer software and programs; rental and maintenance

of computer software; computer system analysis; advisory services relating to computer systems analysis; computer system design; advisory services relating to computer systems design; design services relating to the development of computerised information processing systems; computer software consultancy; professional advisory services relating to computer software; technical consultancy relating to the installation and maintenance of computer software; technical consultancy relating to the application and use of computer software; providing information, advice and consultancy services in the field of computer software; consultancy and information services relating to the design, programming and maintenance of computer software; research and consultancy services relating to computer software; consultancy services relating to computer networks using mixed software environments; computer technology consultancy; computer and information technology consultancy services; consultancy in the field of computer security; professional consultancy relating to computer security; conversion of computer programs and data, other than physical conversion; electronic data storage; computer services concerning electronic data storage; compression of data for electronic storage; electronic data storage and data back-up services; electronic storage services for archiving databases; electronic storage services for archiving databases, images and other electronic data; temporary electronic storage of information and data; information technology [it] consultancy; providing information on computer technology and programming via a web site; installation of software; installation and maintenance of computer programs; installation and customisation of computer applications software; installation, maintenance and updating of computer software; installation, repair and maintenance of computer software; installation, maintenance, updating and upgrading of computer software; installation, setting up and maintenance of computer software; installation, maintenance, repair and servicing of computer software; installation, maintenance and repair of software for computer systems; maintenance of computer programs; development and maintenance of computer software; maintenance and updating of computer software; maintenance and upgrading of computer software; development and maintenance of computer database software; maintenance of computer software relating to computer security and prevention of computer risks; updating and maintenance of computer software and programs; monitoring of computer systems by remote access; off-site data backup; outsource service providers in the field of information technology; research and development for others; software as a service [saas]; technological consultation services; updating of computer software; updating and upgrading of computer software; updating of computer software

for others; updating of software databases; updating of computer software relating to computer security and prevention of computer risks; updating of computer programs.

(260) AM 2020 104973 A

(800) 1487830

(151) 2019 05 10

(891) 2019 05 10

(731) UiPath SRL

Str. Vasile Alecsandri si Constantin Daniel,
Nr. 4 si 11, Corp A, Et. 5-6, Sector 1,
Bucharest, Romania

(540)



(591) Orange

(531) 26.04.01; 26.04.05; 26.04.18; 27.05.01;
29.01.01

(511)

9 – Computer programs [downloadable software]; downloadable computer utility programs; computer software applications, downloadable; application software for cloud computing services.

35 – Assistance in management of business activities; assistance and advice regarding business management; management assistance in business affairs; business assistance, management and administrative services; management and operation assistance to commercial businesses; assistance and advice regarding business organisation and management; advice relating to the organisation and management of business; business management assistance for industrial or commercial companies; assistance, advisory services and consultancy with regard to business management; assistance to commercial enterprises in the management of their business; commercial assistance in business management; efficiency experts; business efficiency expert services; business organization consulting; business organization and operation consultancy; business management and organization consultancy; business management and enterprise organization consultancy; business organization and management consultancy including personnel management; assistance, advisory services and consultancy with regard to business organization; advisory services for business management; business management consultancy and advisory services; business consulting; professional consultancy relating to business management; business information; collecting information for business; dissemination of business information; computer assisted business

information; business advisory and information services; information in business matters; business information for enterprises (provision of -); business information and research services; computerised business information services; provision of business information; analysis of business information; computerised business information retrieval; business statistical information services; business advice, inquiries or information; provision of business and commercial information; computerised business information processing services; business research and information services; provision of statistical information relating to business; provision of business management information; provision of computerised data relating to business; information services relating to businesses; information services relating to business matters; providing business information via a web site; provision of computerised business management information; drawing up of business statistical information; economic information services for business purposes; business analysis, research and information services; compilation of business statistics and commercial information; advice and information concerning commercial business management; information or enquiries on business and marketing; computerised information services to business opportunities appraisals; provision of commercial and business contact information; provision of business information via global computer networks; provision of computerised information relating to business records; providing business information by way of computer terminals; provision of on-line business and commercial information; providing information about commercial business and commercial information via the global computer network; updating of business information on a computer data base; business consultancy relating to the administration of information technology; providing business information directory services, via a global computer network; information and data compiling and analyzing relating to business management; business management consulting services in the field of information technology; provision of commercial business information by means of a computer database; business information services provided on-line from a computer database or the internet; business information services provided online from a global computer network or the internet; providing business information, also via internet, the cable network or other forms of data transfer; compilation of information into computer databases; compilation and systemization of information into computer databases; compilation of statistics; compilation of business statistics; compilation of statistics [for business or commercial purposes]; computerized file management; data search in computer files for others; document reproduction; outsourcing services [business assistance]; systemization of information into computer databases; updating and maintenance of data in

computer databases; advertising, marketing and promotional services; distribution of advertising, marketing and promotional material; dissemination of advertisements; dissemination of advertising matter; dissemination of advertising, marketing and publicity materials; dissemination of advertising matter online; dissemination of advertising for others; distribution of advertisements and commercial announcements; dissemination of advertising material [leaflets, brochure and printed matter]; distribution of advertising material; distribution of prospectuses and samples for advertising purposes; distribution of flyers, brochures, printed matter and samples for advertising purposes; distribution of products for advertising purposes; distribution and dissemination of advertising materials [leaflets, prospectuses, printed material, samples]; dissemination services of advertisement matter; product demonstrations and product display services; arranging of displays for commercial purposes; arranging of displays for advertising purposes; organisation and conducting of product presentations; preparation and presentation of audio visual displays for advertising purposes; presentation of goods and services; demonstration of goods; advertising, marketing and promotional consultancy, advisory and assistance services; providing assistance in the field of business promotion; marketing assistance; consultancy regarding advertising communications strategy; consultations relating to business advertising; business advice relating to marketing management consultations; advice relating to marketing management; consultations relating to business promotion; advisory services relating to sales promotion; professional consultancy relating to marketing; consultancy relating to advertising and promotion services; business advice relating to strategic marketing; advertising and marketing consultancy; marketing advice; consultancy relating to advertising; business advice relating to marketing; business consultancy services relating to the marketing of fund raising campaigns; business consultancy services relating to the promotion of fund raising campaigns; organisation and management of business incentive and loyalty schemes; public relations consultancy; conducting studies in the field of public relations; commercial lobbying services; arranging of demonstrations for advertising purposes; organisation of events for commercial and advertising purposes; provision of computerised advertising services; provision of advertising space by electronic means and global information networks; provision of space on web-sites for advertising goods and services; provision of advertising space on electronic media; provision of advertising space on a global computer network; rental of advertising space online; leasing of advertising space on pamphlets; updating of advertising information on a computer data base; business assistance relating to business image; assistance to management in commercial enterprises

in respect of advertising; management assistance for promoting business; market campaigns; collection of information relating to advertising; design of advertising logos; design of advertising materials; development of promotional campaigns; development of marketing strategies and concepts; estimations for marketing purposes; providing business marketing information; provision of information relating to advertising; affiliate marketing; trade marketing [other than selling]; database marketing; product marketing; arranging of presentations for advertising purposes; arranging and conducting of marketing events; arranging of competitions for advertising purposes; arrangement of advertising; planning of marketing strategies; preparation of advertising campaigns; preparing audio-visual presentations for use in advertising; production of advertising matter and commercials; design of marketing surveys; computerised business promotion; promoting the goods and services of others via computer and communication networks; promoting the goods and services of others via a global computer network; promoting the goods and services of others; on-line promotion of computer networks and websites; promotion, advertising and marketing of on-line websites; promotion [advertising] of business; business promotion; sales promotion; publication of publicity materials; publication of publicity materials on-line; on-line advertising on a computer network; online advertising; advertising through all public communication means; radio and television advertising; advertising in the popular and professional press; magazine advertising; advertising and marketing; updating of advertising material; preparation of advertising material; production of video recordings for advertising purposes; electronic commerce services, namely, providing information about products via telecommunication networks for advertising and sales purposes; brand creation services (advertising and promotion); graphic advertising services; information services relating to advertising; merchandising; services with regard to product presentation to the public; promotion services; advertising services provided via the internet; advertising services provided via a data base; advertising and marketing services provided by means of blogging; advertising and marketing services provided by means of social media; advertising and promotion services and related consulting; brand strategy services; advertising services to create corporate and brand identity; advertising services relating to data bases; preparation of marketing plans; provision of marketing reports.

38 – Transmission of information for business purposes; providing access to databases; providing access to online computer databases; providing access to and leasing access time to computer databases; providing access to databases in computer networks; providing access to electronic communications net-

works and electronic databases; communications by computer terminals; computer-aided transmission of messages and images; computer aided transmission of messages, information and images; streaming of data; transmission of digital files.

41 – Teaching and training in business, industry and information technology; arranging and conducting of conferences; arranging, conducting and organisation of conferences; arranging and conducting of commercial, trade and business conferences; arranging and conducting of seminars; arranging and conducting of seminars and workshops; arranging, conducting and organisation of seminars; programming [scheduling of programs] on a global computer network.

42 – Providing temporary use of non-downloadable computer programs; cloud computing; consulting in the field of cloud computing networks and applications; rental of operating software for accessing and using a cloud computing network; programming of operating software for accessing and using a cloud computing network; design and development of operating software for accessing and using a cloud computing network; providing temporary use of on-line non-downloadable operating software for accessing and using a cloud computing network; computer programming; scientific computer programming services; computer software programming services; computer programming and maintenance of computer programs; computer programming for data processing; computer design and programming services; computer programming and software design; computer programming for the internet; research relating to computer programming; computer programming services for data warehousing; design, development and programming of computer software; technical consultancy services relating to computer programming; computer programming for data processing and communication systems; computer programming services for commercial analysis and reporting; programming of computer software for reading, transmitting and organising data; programming of computer software for evaluation and calculation of data; advisory services relating to computer programming; computer software design; software design and development; computer software design and updating; design and writing of computer software; design and development of computer software architecture; design, maintenance and updating of computer software; design, drawing and commissioned writing of computer software; research, development, design and upgrading of computer software; design, maintenance, development and updating of computer software; design, maintenance, rental and updating of computer software; design and development of computer software for process control; consultancy relating to the design and development of computer software programs; design and development of computer software for reading, transmitting

and organising data; design and development of computer software for evaluation and calculation of data; providing information about the design and development of computer software, systems and networks; rental of software; rental of computer database software; rental of computer software and programs; rental and maintenance of computer software; computer system analysis; advisory services relating to computer systems analysis; computer system design; advisory services relating to computer systems design; design services relating to the development of computerised information processing systems; computer software consultancy; professional advisory services relating to computer software; technical consultancy relating to the installation and maintenance of computer software; technical consultancy relating to the application and use of computer software; providing information, advice and consultancy services in the field of computer software; consultancy and information services relating to the design, programming and maintenance of computer software; research and consultancy services relating to computer networks using mixed software environments; computer technology consultancy; computer and information technology consultancy services; consultancy in the field of computer security; professional consultancy relating to computer security; conversion of computer programs and data, other than physical conversion; electronic data storage; computer services concerning electronic data storage; compression of data for electronic storage; electronic data storage and data back-up services; electronic storage services for archiving databases; electronic storage services for archiving databases, images and other electronic data; temporary electronic storage of information and data; information technology [it] consultancy; providing information on computer technology and programming via a web site; installation of software; installation and maintenance of computer programs; installation and customisation of computer applications software; installation, maintenance and updating of computer software; installation, repair and maintenance of computer software; installation, maintenance, updating and upgrading of computer software; installation, setting up and maintenance of computer software; installation, maintenance, repair and servicing of computer software; installation, maintenance and repair of software for computer systems; maintenance of computer programs; development and maintenance of computer software; maintenance and updating of computer software; maintenance and upgrading of computer software; development and maintenance of computer database software; maintenance of computer software relating to computer security and prevention of computer risks; updating and maintenance of computer software and programs; monitoring of computer systems by remote access; off-site data backup;

outsource service providers in the field of information technology; research and development for others; software as a service [saas]; technological consultation services; updating of computer software; updating and upgrading of computer software; updating of computer software for others; updating of software databases; updating of computer software relating to computer security and prevention of computer risks; updating of computer programs.

- (260) AM 2020 104974 A
 (800) 1487859
 (151) 2019 05 10
 (891) 2019 05 10
 (731) EURO GAMES TECHNOLOGY LTD.
 4, "Maritsa" Str., "Vranya-Lozen-
 Triugulnika", BG-1151 Sofia, Bulgaria
 (540)



- (591) Yellow, gray, black, white, orange and red
 (531) 01.05.05; 27.05.01; 27.05.02; 27.05.03;
 27.05.10; 29.01.13
 (511)
 9 – Software; computer gaming software; computer software packages; computer operating system software; computer software, recorded; software drivers; virtual reality software; games software; entertainment software for computer games; computer programs for network management; operating computer software for main frame computers; monitors (computer hardware); computer hardware; apparatus for recording images; monitors (computer programs); computer game programs; computer programs for recorded games; apparatus for recording, transmission or reproduction of sound or images; communications servers [computer hardware]; electronic components for gambling machines; computer application software featuring games and gaming; computer software for the administration of on-line games and gaming; computer hardware for games and gaming; electronic components and computer software for gambling, gambling machines, gambling games on the internet and via telecommunication network.

28 – Gaming machines for gambling; chips for gambling; mah-jong; arcade games; gambling machines operating with coins, notes and cards; games; electronic games; parlor games; gaming chips; gaming tables; slot machines [gaming machines]; LCD game machines; slot machines and gaming devices; coin-operated amusement machines; roulette chips; poker chips; chips and dice [gaming equipment]; equipment for casinos; roulette tables; gaming roulette

wheels; casino games; gambling machines and amusement machines, automatic and coin-operated; coin-operated amusement machines and/or electronic coin-operated amusement machines with or without the possibility of gain; boxes for coin-operated machines, slot machines and gaming machines; electronic or electrotechnical amusement machines and apparatus, gaming machines, coin-operated entertainment machines; housings for coin-operated machines, gaming equipment, gaming machines, machines for gambling; electropneumatic and electrical slot machines (gaming machines for gambling).

41 – Gambling; services related to gambling; gaming services for entertainment purposes; casino, gaming and gambling services; training in the development of software systems; provision of equipment for gambling halls; providing casino equipment [gambling]; gaming machine entertainment services; providing casino facilities [gambling]; gaming hall services; amusement arcade services; games equipment rental; rental of gaming machines; providing amusement arcade services; rental of gaming machines with images of fruits; editing or recording of sounds and images; sound recording and video entertainment services; hire of sound reproducing apparatus; provision of gaming equipment for casinos; providing of casino facilities; online gambling services; casino, gaming and gambling services; provision of gaming establishments, gaming halls, Internet casinos, online gaming services.

(260) AM 2020 104975 A

(800) 1487866

(151) 2019 08 02

(891) 2019 08 02

(731) TEKA INDUSTRIAL, S.A.

Cajo, 17, E-39011 Santander (Cantabria),
Spain

(540)

STEAK MASTER TEKA

(591) Black, white

(511)

1 – Gas and electric ranges; induction cookers; combined stoves; cooking stoves; ovens; sinks; ventilation hoods; electric lamps; heating apparatus; steam generating apparatus; cooking apparatus and installations; refrigerating apparatus; personal heating and drying implements; drying installations; apparatus for ventilating; water supply installations; sanitary installations.

(260) AM 2020 104976 A

(800) 1487907

(151) 2018 11 29

(891) 2018 11 29

(731) BURBERRY LIMITED

Horseferry House, Horseferry Road, London
SW1P 2AW, United Kingdom

(540)



(591) Black, white

(531) 27.05.22

(511)

3 – Non-medicated toilet preparations; cosmetics; glitter for cosmetic purposes; preparations for the bath and shower; body and skin care preparations; cosmetic preparations for teeth and for hair; nail care preparations and nail polish, false nails; soaps; anti-perspirants, deodorants; perfumes, eau de cologne, eau de toilette, toilet water and aftershave; essential oils, massage oil; pot pourri, room fragrance and incense; cleaning and care preparations for leather goods and non-leather goods.

9 – Sunglasses, spectacles, optical glasses, fitted frames and lenses for the aforesaid goods; cases and holders for the aforesaid goods; parts and fittings for all the aforesaid goods; cases and holders for portable electronic devices, mobile telephones, portable audio and video systems and computers; mouse mats; camera cases; mobile telephones, portable electronic devices; mobile phone accessories, including mobile phone covers and skins, lanyards for mobile phones, mobile phone fascias.

14 – Watches, clocks and parts, fittings and cases for all the aforesaid goods; watch straps and bracelets therefor; jewellery, imitation jewellery, tie-pins, tie clips and cuff links; articles made of precious metals or coated therewith, namely key rings, charms, badges, shoe ornaments; jewellery boxes and cases; models and figures of precious metal; jewellery rolls; key holders; cufflink cases.

18 – Leather and imitations of leather; bags; handbags, shoulder bags; trunks, valises, suitcases, travelling bags, garment bags, bumbags, vanity cases (empty), baby bags, baby carriers, baby harnesses, rucksacks, satchels, shopping bags, wheeled shopping bags; purses, pouches; wallets, card holders, pochettes; labels and luggage labels, leather tags; cosmetic cases and bags (not fitted), cases for manicure sets (empty); tie cases, leather boxes; umbrellas, parasols; clothing for pets; horse blankets; collars and leashes for animals.

24 – Textiles and textile items; fabrics and linings; bed blankets; bed covers; bed linen; duvets; mattress

covers; pillowcases; quilts and eiderdowns; bed sheets; curtains; towels; face cloths; table linen; table covers; placemats of textile; unfitted fabric furniture covers, curtains, wall hangings, cushion covers; handkerchiefs; travel rugs, picnic blankets; pet blankets; textile labels; throws.

25 – Clothing, footwear, headgear, belts.

(260) AM 2020 104977 A

(800) 1487924

(151) 2019 04 02

(891) 2019 04 02

(731) FACEBOOK, INC.

1601 Willow Road, Menlo Park,
CA 94025, USA

(540)

WORKPLACE BY FACEBOOK

(591) Black, white

(511)

9 – Application programming interface (API) for computer software facilitating online services for social networking, development of social networking applications and enabling retrieval, uploading, downloading, accessing and managing data; software enabling electronic content or information to be uploaded, downloaded, accessed, published, displayed, tagged, blogged, disseminated, linked, shared or provided via other means via computer and communication networks; computer software for sending electronic message alerts and reminders via the Internet; software for transmitting and receiving electronic messages via the internet; downloadable software for modifying the appearance and enabling transmission of images, audiovisual and video content; software for the collection, publishing, organization, modification, transmission, storage and sharing of data and information; search engine software.

38 – Services for photograph sharing and video sharing, especially, electronic transmission of digital photo, video, audio-visual content files among Internet users; provision of access to electronic, computer and online databases; telecommunication services, especially electronic transmission of data, messages, graphics, images, video, audio content and information; providing online access to forums for communication on topics of general interest; Provision of on-line communication links which transfer the website user to other local and global web pages; providing access to websites or other electronic content of others via a universal login; providing access to on-line chatrooms, electronic mail and instant messaging and electronic display boards; dissemination of audio, text and video content over computer or other communication networks, especially uploading, pub-

lication, displaying, modifying, marking and electronic transmission of data, information, audio and video content; communication of voice over Internet protocol; communications by telephone; provision of access to computer databases in the fields of social networking, dating and social meetings.

42 – Computer services, namely, designing software for virtual communities enabling registered users to organize groups, take part in discussions, obtain feedback from their peers and engage in social networking, and to collaborate and communicate in the field of business; computing services, namely hosting electronic infrastructure for others for the arranging and conducting of interactive meetings, events and discussions via communication networks; application service provider (ASP) featuring computer software enabling or facilitating the uploading, downloading, dissemination, publication, displaying, blogging, linking, modification, sharing or otherwise providing electronic content or information over communication networks; providing an online network featuring technology enabling online users to create personal profiles presenting social and professional data and to transfer and share such information online over multiple infrastructures; providing access to online content from searchable databases and indexes, including electronic documents, texts, databases, graphics, photographic images and audiovisual information, over computer and communication networks; providing temporary use of non-downloadable software applications for social networking, creating a virtual community and transmitting, audio content, video content, photographic images, texts, graphics and data; computer services in the nature of customized online pages featuring information defined or specified by the user, personal profiles, audio content, video content, photographic images, texts, graphics and data; computer services, namely, providing search engines for recovery of data on global computer and communication networks; software as a service (SaaS) featuring software for sending electronic message alerts, for sending and receiving electronic messages, via a global computer network; platform as a service (PaaS) featuring technology enabling businesses, organizations and individuals to create and manage their online presence and communicate to online users information and messages about their activities, goods and services and participate in social networking and collaborate and communicate in the field of business; provision of search engines for obtaining data via communication networks; providing online facilities for others enabling users to upload, modify and share audio content, video content, photographic images, text, graphics and data; search engine management; computer services, namely, providing interactive online networks for others featuring technology enabling users to manage their audio and video con-

tent online and their social networking accounts and communication and collaboration in the field of business; on-line software for modifying the appearance and enabling transmission of audio, video content, photographic images, texts, graphics and data; file sharing services, namely, providing online interface for others featuring technology enabling users to upload and download electronic files.

45 – Social introduction and social networking services on the Internet; providing social services and information in the field of personal development, especially personal improvement, self-fulfillment, charitable, philanthropic, volunteer, public and community services, and humanitarian activities.

(260) AM 2020 104978 A

(800) 1487951

(151) 2019 08 20

(891) 2019 08 20

(731) AVON PRODUCTS, INC.

1 Avon Place, Suffern NY 10901, USA

(540)

AVON MAXIMA

(591) Black, white

(511)

3 – Toiletries; bath and shower gels; perfumery; deodorants for human beings; anti-perspirants for personal use (toiletries); essential oils (cosmetic).

(260) AM 2020 104983 A

(800) 1488091

(151) 2019 07 16

(891) 2019 07 16

(731) ADP GAUSELMANN GMBH

Merkur-Allee 1-15, 32339 Espelkamp,
Germany

(540)

Scatter Fortune

(591) Black, white

(511)

9 – Computer software; coin-operated mechanisms; computer and video games software; games software in particular for use on any computer platform, including electronic entertainment and games consoles; computer game programs; video games (software); computer games provided through a global computer network or supplied by means of multi-media electronic broadcast or through telecommunications or electronic transmission or via the internet; computer games, leisure and recreational software, video games and computer software, all being provided in the form of storage media; programs for operating electric and electronic apparatus for games, amusement and/or entertainment purposes; computer software for computer games on the internet; online ga-

mes (software) in particular for online betting games, online prize games, online gambling games, online games of skill and online casino games; computer software in the form of an app for mobile devices and computers; calculating apparatus in coin-operated machines and parts for the aforesaid goods; electric, electronic, optical or automatic apparatus, for identifying data carriers, identity cards and credit cards, bank notes and coins; software in particular for casino and/or amusement arcade games, for gaming machines and/or slot machines each one with or without prize payouts; gaming software that generates or displays wager outcomes of gaming machines; operational computer games software; computer software for managing of games (game collection); computer programs for video games; computer video game software.

28 – Games; toys; gaming apparatus (including coin-operated apparatus); coin-operated arcade games machines; games for amusement arcades (included in this class); coin-operated video gaming apparatus; video games apparatus adapted for use with external screens or monitors only; casino linings, namely roulette tables, roulette wheels; coin-operated automatic gaming machines and gaming machines, in particular for gaming arcades, with or without a prize payout; electronic or electrotechnical gaming apparatus, automatic gaming machines, gaming machines, slot machines operated by coins, tokens, banknotes, tickets or by means of electronic, magnetic or biometric storage media, in particular for commercial use in casinos and amusement arcades, with or without a prize payout; automatic gaming machines and gaming machines, in particular for commercial use in casinos and gaming arcades, with or without a prize payout; coin-operated gaming machines and for electronic money-based gaming apparatus (machines), with or without prizes; housings adapted for gaming machines, gaming apparatus and automatic gaming machines, operated by means of coins, tokens, tickets or by means of electronic, magnetic or biometric storage media, in particular for commercial use in casinos and gaming arcades, with or without a prize payout; electronic games; electronic game entertainment apparatus and parts thereof; video output game machines; drawing apparatus for prize games and lotteries, draws or raffles; housings of metal, plastic and/or wood adapted for coin-operated automatic amusement machines; apparatus for games (including video games), other than adapted for use with external screens or monitors only; electropneumatic and electric slot machines with pulling handles (gaming machines); gaming tables, in particular for table football, billiards, sliding games; flying discs (toys) and darts; gaming machines, namely electric, electronic or electromechanical apparatus for bingo games, lotteries or video lottery games and for betting offices, connected or unconnected to a computer

network; LCD games consoles; automatic gaming machines; all the aforesaid automatic machines operating in networks; apparatus and devices for accepting and storing money, being fittings for the aforesaid automatic machines, included in this class; automatic lottery machines.

(260) AM 2020 104984 A

(800) 1488093

(151) 2019 06 12

(891) 2019 06 12

(731) GSH TRADEMARKS LIMITED

Afroditis, 25, 2nd Floor, Office 204, Nicosia, Cyprus

(540)

CHOCOLATIER

(591) Black, white

(531) 27.05.11; 27.05.17

(511)

35 – Administrative processing of purchase orders; administration of consumer loyalty programs; cost price analysis; business auditing; auctioneering; outsourced administrative management for companies; market studies; opinion polling; demonstration of goods; business inquiries; business management assistance; commercial or industrial management assistance; advisory services for business management; business research; economic forecasting; providing business information via a web site; compilation of information into computer databases; compilation of statistics; business information; commercial information and advice for consumers in the choice of products and services; commercial administration of the licensing of the goods and services of others; computerized file management; business management consultancy; business organization consultancy; marketing; marketing research; provision of commercial and business contact information; provision of an online marketplace for buyers and sellers of goods and services; writing of publicity texts; scriptwriting for advertising purposes; updating of advertising material; updating and maintenance of data in computer databases; web site traffic optimization; organization of exhibitions for commercial or advertising purposes; organization of trade fairs for commercial or advertising purposes; rental of advertising space; shop window dressing; business appraisals; personnel recruitment; business management and organization consultancy; commercial information agency services; business efficiency expert services; commercial intermediation services; layout services for advertising purposes; price comparison services; import-export agency services; advertising agency services; public relations; sponsorship search; search engine optimization for sales promotion; presentation of goods on communication

media, for retail purposes; rental of billboards [advertising boards]; publicity material rental; rental of vending machines; rental of sales stands; advertising; distribution of samples; dissemination of advertising matter; design of advertising materials; business investigations; sales promotion for others; production of advertising films; telemarketing services; negotiation and conclusion of commercial transactions for third parties; professional business consultancy.

(260) AM 2020 104988 A

(800) 1488170

(151) 2019 05 10

(891) 2019 05 10

(731) EURO GAMES TECHNOLOGY LTD.

"Maritsa" Str., 4, "Vranya-Lozen-Triugulnika", BG-1151 Sofia, Bulgaria

(540)

30 Spicy DICE

(591) White, red, orange, black and green

(531) 05.09.15; 27.03.01; 27.03.11; 27.05.02; 27.05.03; 29.01.15

(511)

9 – Software; computer gaming software; computer software packages; computer operating system software; computer software, recorded; software drivers; virtual reality software; games software; entertainment software for computer games; computer programs for network management; operating computer software for main frame computers; monitors (computer hardware); computer hardware; apparatus for recording images; monitors (computer programs); computer game programs; computer programs for recorded games; apparatus for recording, transmission or reproduction of sound or images; communications servers [computer hardware]; electronic components for gambling machines; computer application software featuring games and gaming; computer software for the administration of on-line games and gaming; computer hardware for games and gaming; electronic components and computer software for gambling, gambling machines, gambling games on the internet and via telecommunication network.

28 – Gaming machines for gambling; chips for gambling; mah-jong; arcade games; gambling machines operating with coins, notes and cards; games; electronic games; parlor games; gaming chips; gaming tables; slot machines [gaming machines]; LCD game machines; slot machines and gaming devices; coin-operated amusement machines; roulette chips; poker chips; chips and dice [gaming equipment]; equipment for casinos; roulette tables; gaming roulette

wheels; casino games; gambling machines and amusement machines, automatic and coin-operated; coin-operated amusement machines and/or electronic coin-operated amusement machines with or without the possibility of gain; boxes for coin-operated machines, slot machines and gaming machines; electronic or electrotechnical amusement machines and apparatus, gaming machines, coin-operated entertainment machines; housings for coin-operated machines, gaming equipment, gaming machines, machines for gambling; electropneumatic and electrical gambling machines (slot machines).

41 – Gambling; services related to gambling; gaming services for entertainment purposes; casino, gaming and gambling services; training in the development of software systems; provision of equipment for gambling halls; providing casino equipment [gambling]; gaming machine entertainment services; providing casino facilities [gambling]; gaming hall services; amusement arcade services; games equipment rental; rental of gaming machines; providing amusement arcade services; rental of gaming machines with images of fruits; editing or recording of sounds and images; sound recording and video entertainment services; hire of sound reproducing apparatus; provision of gaming equipment for casinos; providing of casino facilities; online gambling services; casino, gaming and gambling services; provision of gaming establishments, gaming halls, internet casinos, online gaming services.

(260) AM 2020 104989 A
(800) 249539
(151) 1961 11 14
(891) 2019 06 14
(731) Novartis AG
CH-4002 Basel, Switzerland
(540)

LAMPREN

(591) Black, white
(531) 27.05.01; 27.05.17
(511)
5 – Medicines and pharmaceutical drugs.

(260) AM 2020 104991 A
(800) 1050778
(151) 2010 03 15
(891) 2019 08 30
(731) Obshchestvo s ogranichennoy
otvetstvennostyu "KONDITIONERSKAYA,
FABRIKA IM. N.K. KRUPSKOY"
Ropshinskoje shosse 9, derevnia Razbegaevo,
Lomonosovsky rayon, RU-188513
Leningradskaya oblast (Federation), Russian
Federation

(540)



(591) Red and yellow
(531) 04.03.01; 26.01.03; 28.05; 29.01.13
(511)

30 – Confectionery, confectionery for decorating Christmas trees, peanut confectionery, almond confectionery, waffles, cocoa, cocoa products, custard, cakes, sweetmeats, candy with caramel, liquorice, peppermint sweets, coffee, crackers, candy for food, fruit jellies, marzipan, lozenges, petits fours, biscuits, fondants, pralines, flour-milling products, gingerbread, tarts, halvah, tea, chocolate.

(260) AM 2020 104992 A
(800) 1127500
(151) 2012 04 05
(891) 2019 06 26
(731) Novartis AG
CH-4002 Basel, Switzerland
(540)

PAGENAX

(591) Black, white
(511)
5 – Pharmaceutical preparations.

(260) AM 2020 104993 A
(800) 1226773
(151) 2014 10 02
(891) 2019 06 20
(731) NOVARTIS AG
CH-4002 Basel, Switzerland
(540)

VSIQQ

(591) Black, white
(511)
5 – Pharmaceutical preparations.

(260) AM 2020 104994 A
(800) 1310972
(151) 2016 04 21
(891) 2019 06 17
(731) NOVARTIS AG
CH-4002 Basel, Switzerland
(540)

LAMPRENE

(591) Black, white
(511)
5 – Pharmaceutical preparations.

(260) AM 2020 105047 A
(800) 1488241
(151) 2019 06 07
(891) 2019 06 07
(731) MedXCell SA
World Trade Center, Avenue Gratta-Paille 2,
CH-1018 Lausanne, Switzerland
(540)

MedXcell

(591) Black, white
(511)
5 – Pharmaceutical preparations for cell therapy treatment of joint and vertebral trauma; pharmaceutical products for treatment of joint and vertebral trauma; cultures of micro-organisms for medical use; biological tissue cultures for medical use; surgical implants grown from stem cells; surgical implants composed of living tissue; stem cells for cell therapy; biological cell-derived products.

(260) AM 2020 105049 A
(800) 1488260
(151) 2019 04 24
(891) 2019 04 24
(731) TRELLEBORG BOHEMIA, A.S.
Akademika Bedrny 531/8a, CZ-500 03 Hradec
Králové, Věkoše, Czech Republic
(540)



(591) White and blue
(531) 26.01.18; 26.04.22; 26.04.24; 27.05.24;
29.01.12
(511)
7 – V-belts, cogged belts, flat belts, drive belts for engines and other driving machines; rubber shaft couplings for machines.
12 – Cycle tyres, bicycle tubes; V-belts, cogged belts, flat belts for land vehicles.
17 – Stuffing rings, not of metal; shaft gaskets; bearing seals; mechanical rubber goods; pneumatic-suspension bellows; rubber sleeves; gaskets; rubber plates; rubber foils; rubber grommets; liquid packings; rubber bellows; rubber inflatable dams; rubbery lifting pouches; rubber sealing pouches; rubber membranes; extruded hoses; extruded sections of rubber; rubber compensators.
20 – Rubber storage tanks; containers of rubber, for commercial use.

28 – Sports articles made of rubber; hockey pucks.

(260) AM 2020 105050 A
(800) 1488271
(151) 2019 04 24
(891) 2019 04 24
(731) TRELLEBORG BOHEMIA, A.S.
Akademika Bedrny 531/8a, CZ-500 03
Hradec Králové, Věkoše, Czech Republic
(540)



(591) Black, white
(531) 26.01.18; 26.04.22; 27.05.01; 27.05.04;
27.05.24
(511)
7 – V-belts, cogged belts, flat belts, drive belts for engines and other driving machines; rubber shaft couplings for machines.
12 – Cycle tyres, bicycle tubes; V-belts, cogged belts, flat belts for land vehicles.
17 – Stuffing rings, not of metal; shaft gaskets; bearing seals; mechanical rubber goods; pneumatic-suspension bellows; rubber sleeves; gaskets; rubber plates; rubber foils; rubber grommets; liquid packings; rubber bellows; rubber inflatable dams; rubber lifting pouches; rubber sealing pouches; rubber membranes; extruded hoses; extruded sections of rubber; rubber compensators.
20 – Rubber storage tanks; containers of rubber, for commercial use.
28 – Sports articles made of rubber; hockey pucks.

(260) AM 2020 105051 A
(800) 1488294
(151) 2019 04 18
(891) 2019 04 18
(731) Provincia S. Antonio dei Frati Minori
Via Guinizelli 3, I-40125 Bologna (BO),
Italy;
RAINBOW S.P.A.
Via Brece snc, I-60025 LORETO (AN),
Italy
(540)



(591) Black, white

(531) 03.01.06; 03.01.16; 27.07.24; 28.05
(511)

16 – Printed matter; stationery; stationery cases; diaries and agendas; pocket diaries; note pads; drawing pads; writing tablets; albums; notebook; printed tickets; gift cards; envelopes [stationery]; wrapping paper; folders for papers; folders of paper; ring binders; calendars; drawing paper; writing paper; adhesives [glues] for stationery or household purposes; stickers [decalcomanias]; collector trading cards; trivia cards; towels of paper; handkerchiefs of paper; party decorations of paper; paper party decorations; pads of party invitations; banners of paper; flags of paper; gift bags; babies' bibs of paper; table napkins of paper; tablecloths of paper; place mats of paper; paper bags and sacks; paper gift bags; stamps [seals]; inking pads; stamp mounts; stamp cases; artists' materials; paintbrushes; drawing instruments; pens [office requisites]; pencils; decorations for pencils; rubber erasers; crayons; felt-tip pens; children's paint-boxes; aquarelles; chalks for colouring; book-markers; paperweights; photographs [printed]; photograph stands; printed publications; educational publications; newspapers; periodicals; strategy guide magazines for card games; computer game instruction manuals; pamphlets; recipe books; books; children's books; sticker activity books; children's books incorporating an audio component; typewriters, electric or non-electric; office requisites, except furniture; instructional and teaching material (except apparatus); plastic materials for packaging; printing fonts; bookbinding material; printing blocks; modelling paste; paper decorations for cakes; removable tattoos [decalcomania]; glitter glue for stationery purposes.

18 – Leather, unworked or semi-worked; imitations of leather; artificial leather; bags; clutch purses; coin purses; wallets; belt bags; wallets for attachment to belts; credit card holders made of leather; keycases; key cases of imitation leather; rucksacks; all purpose sports bags; haversacks; beach bags; briefcases [leather goods]; carrying cases for documents; briefbags; business card cases; calling card cases; shopping bags with wheels attached; textile shopping bags; travel garment covers; school satchels; suitcases; sports bags; holdalls; wheeled suitcases; luggage covers; shoulder bags; bum bags; cosmetic bags (empty); cases of imitation leather (empty); trunks and travelling bags; luggage tags of leather; handbag frames; reins for guiding children; pouch baby carriers; sling bags for carrying infants; pouch baby carriers; boxes made of leather; boxes of leather or leatherboard; straps made of imitation leather; bags [envelopes, pouches] of leather, for packaging; umbrellas; parasols; walking sticks; leads for animals; leather leashes; leather laces; furniture coverings of leather; clothing for pets; transport bags for pets; blankets for animals.

21 – Hairbrushes; hair combs; toothbrushes; toothbrushes, electric; toothbrush cases; toothbrush holders; soap holders; dispensers for liquid soap; toilet brushes; toilet utensils; shaving bowls; shaving brushes; shaving brush stands; sponges; body sponges; towel rails and rings; household or kitchen utensils and containers; bottles; drinking glasses; coasters (tableware); sports bottles sold empty; table plates; plates and cups of paper or plastic; trivets [table utensils]; bowls [basins]; cups; porcelain mugs; tea cups; coffee cups; cabarets [trays]; tableware; picnic crockery; corkscrews; cake molds [moulds]; confectioners' decorating bags [pastry bags]; cookie jars; cookie [biscuit] cutters; storage tins for kitchen use; lunch boxes; thermally insulated containers for food and drink; thermal insulated bags for food or beverages; napkin holders; napkin rings; pie servers; waste baskets; waste paper baskets; baskets for domestic use; vases; household or kitchen utensils and containers; articles for cleaning purposes; brooms; brushes for footwear; clothes brushes; brushes for cleaning; cleaning sponges; perfume vaporizers; pomanders [containers]; glass holders for candles; candelabra [candlesticks]; drinking straws; oven mitts; figurines [statuettes] of porcelain, ceramic, earthenware or glass; decorative articles of porcelain; porcelain mugs; porcelain flower pots; china ornaments; signboards of porcelain or glass; ornamental models made of porcelain or glass; busts and figurines of porcelain, terra cotta or glass; works of art of terracotta, porcelain, glass, ceramic; ornaments and decorative goods of porcelain, terra-cotta, glass; decorative china; piggy banks of porcelain; boxes of porcelain; porcelain eggs; porcelain ware; crockery of porcelain; glass holders for candles; garden gnomes of glass, terra-cotta, porcelain; works of art made of glass; decorative objects made of glass; decorative boxes of glass; ornamental glass spheres; ornamental glass, not for building; ornaments made of terracotta; piggy banks of terra-cotta; boxes made of terracotta; earthenware basins; crockery of terracotta; plaques of pottery; ceramics for household purposes; ceramic ornaments; ceramic coin boxes; plaques of ceramic; ceramic hollowware; ceramic tableware.

25 – Clothing; hosiery; sweaters; cardigans; waistcoats; dresses; trousers; shorts; jerseys; leather clothing; waterproof clothing; stockings; stocking suspenders; sock suspenders; wind-resistant jackets; raincoats; ski pants; fur coats; evening coats; overcoats; skirts; suits; jackets; undershirts; T-shirts; clothing for gymnastics; collars; shirts; head scarves; neckerchiefs; swimming costumes; bikinis; sundresses; tracksuits; sweat suits; wedding dresses; bath robes; beach robes; underwear; brassieres; corsets; slippers; underpants; briefs; nightshirts; housecoats; pyjamas; gloves (clothing); mittens; shawls; scarves; ties; bow ties; cassocks; layettes [clothing]; cloth bibs; babies' bibs of plastic; sleepwear for babies;

aprons [clothing]; masquerade costumes; Halloween costumes; party hats [clothing]; belts made from imitation leather; textile belts [clothing]; belts made from leather or skin; braces; headgear for wear; caps; ear muffs [clothing]; wrist warmers; headbands; shoes; boots; ankle boots; leather shoes; galoshes; rain boots; sports footwear; sandals; slippers; soles for footwear; heels; footwear uppers.

28 – Games and playthings; dolls; dolls' clothing; dolls' clothing accessories; dolls' houses; furniture for dolls' houses; toy houses; bean bag dolls; carnival masks; toy figures; playsets for action figures; plush toys; marionettes; imitation cosmetic preparations being toys; parlour games; toys adapted for educational purposes; electronic educational teaching games; toy clocks and watches; electronic toys; hand-held electronic video games; free-standing video games apparatus; electronic amusement apparatus incorporating a liquid crystal display; free-standing video games machines; protective carrying cases specially adapted for handheld video games; mechanical toys; building games; toy building blocks; jigsaw puzzles; action skill games; chess games; board games; clockwork toys; magic tricks; playing cards; toy figures; musical toys; toy musical boxes; toy record cassette players; bathtub toys; infants' swings; multiple activity toys for babies; snow globes; marbles for games; spinning tops [toys]; novelties for parties, dances [party favors, favours]; party favor hats; toy horns; Halloween masks; costume masks; carnival caps; toy money boxes; inflatable toys; bouncy castles; inflatable bath toys; stuffed toys; bubble making wand and solution sets; kites; toy buckets and spades; swimming rings; toy furniture; play tents; play mats incorporating infant toys [playthings]; toy bicycles; ride-on toy vehicles; scale model vehicles; toy scooters; toy cars; toy trucks; toy model hobby craft kits; water squirting toys; gymnastic and sporting articles; rubber balls; balloons; soccer balls; basketballs; baseballs; beach balls; bowling balls; tennis balls; tables for table tennis; golf balls; golf gloves; gloves for games; gloves made specifically for use in playing sports; baseball bats; hockey pucks; roller skates; scooters [toys]; skateboards; snowboards; wakeboards; bags especially designed for skis and surfboards; protectors for elbows for use when riding bicycles [sports articles]; skipping rope; targets; punching bags; shuttlecocks; flying discs [toys]; paper party favours; paper party hats; streamers [party novelties]; decorations for Christmas trees, except illumination articles and confectionery; Christmas stockings, accessories for games; fishing tackle; toy putty; toy jewellery; toy cookware; toy sewing sets.

29 – Milk and milk products; powdered milk; skimmed milk; fermented milk; organic milk; rice milk [milk substitute]; soya milk; goat milk; sheep milk;

cows' milk; milk of almonds for culinary purposes; coconut milk for culinary purposes; milk beverages, milk based beverages; flavoured milk; milk-based beverages containing fruits; milkshakes; whey; cheese; cream cheese; soft white cheese; ripened cheeses; blended cheese; bean curd; cheese spreads; dairy spreads; low fat dairy spreads; cottage cheese preparations; curd cheese; ready grated cheese; mozzarella; cheese sticks; mozzarella sticks; cheese fondue; cheese dips; dairy-based dips; tofu; cheese substitutes; yogurt; drinks based on yogurt; preparations for making yogurt; soya yogurt; yogurt made from goats milk; yogurt desserts; flavoured yogurts; drinking yogurts; custard style yogurts; desserts made from milk products; chilled dairy desserts; milk based desserts; dairy puddings; cream [dairy products]; whipping cream; whipped cream; powdered cream [dairy products]; artificial cream [dairy product substitutes]; butter; buttercream; blended butter; butter preparations; eggs; prepared meals containing [principally] eggs; charcuterie; meat; fish, not live; cooked meals consisting principally of fish; chilled meals made from fish; fish, seafood and molluscs; fish and seafood spreads; poultry, not live; game, not live; meat extracts; ready cooked meals consisting wholly or substantially wholly of meat; croquettes; frankfurters [sausages]; preserved, frozen, dried and cooked fruits and vegetables; potato crisps in the form of snack foods; potato chips; frozen french fries; vegetable puree; vegetable extracts for cooking; vegetable juices for cooking; tomato puree; tomato preserves; vegetable-based entrees; frozen prepared meals consisting principally of vegetables; soup pastes; mixes for making soup; dips; pickles; marmalade; jellies; fruit jellies; compotes; fruit pulp; fruit preserves; fruit chips; fruit desserts; fruits, canned; fruit salads; prepared fruits; fruit paste; fruit-based snack food; compotes; fruit and vegetable spreads; milk shakes; olives, prepared; olives, preserved; olive paste; vegetables, dried; vegetables, cooked; vegetables, canned; soya [prepared]; soy-based snack foods; edible oils and fats.

30 – Cereal preparations; flour; bread; sandwich fillings; crackers; pizzas; pizza bases; pizza dough; prepared pizza meals; pies; croutons; cereal based snack foods; snacks made from cereals; cereals prepared for consumption by humans; bakery goods; pastries; confectionery; cakes; cookies; tarts; frozen yogurt pies; tiramisu; chocolate-based fillings for cakes and pies; cocoa; chocolate covered cakes; chocolates in the form of pralines; confectionery items coated with chocolate; caramels [candy]; flavorings, other than essential oils, for cakes; pastry dough; cake powder; natural sweeteners; cake mixes; cheesecakes; ice cream; frozen yogurt [edible ices]; ice milk [ice cream]; ice milk bars; ice cream drinks; ice lollies being milk flavoured; cocoa beverages with milk; coffee beverages with milk; chocolate spreads;

custards [baked desserts]; cream cakes; mixtures for making water ices; sauces for ice cream; ice cream substitute; soy-based ice cream substitute; mixes for making puddings; puddings; instant dessert puddings; preparations for stiffening whipped cream; cream pies; salad dressings containing cream; flavourings for butter; honey; golden syrup; yeast; baking-powder; salt; vinegar; mustard; spices; coffee; artificial coffee; tea; sugar; rice; tapioca; sago; ice; sauces (condiments); pasta sauce; cheese balls [snacks]; flavourings for cheeses; popcorn; pasta; dried pasta; fresh pasta; egg pasta; wholemeal pasta; pastry shells; pasta in the form of sheets; puff pastry; ready-made dishes containing pasta; pot pies; gravies (condiments); meat gravies.

32 – Non-alcoholic beverages; sherbets [beverages]; fruit-based beverages; vegetable-based beverages; energy drinks; part frozen slush drinks/granita (partially frozen beverage); concentrates for use in the preparation of soft drinks; fruit juices; grape juice; vegetable juice; fruit nectars, non-alcoholic; non-alcoholic fruit extracts; syrups for beverages; preparations for making beverages; smoothies [non-alcoholic fruit beverages]; flavoured waters; beer; mineral water [beverages].

41 – Entertainment services; entertainment in the form of films; producing, distribution and rental of motion pictures, television and radio programmes, sound recordings and videos; creating animated cartoons; production of cartoons; production of entertainment live performances; showing of cinematographic films; presentation of recital; television entertainment in the nature of live-action, comedy, drama, and/or animated television programmes; rental of videotapes; providing on-line electronic publications, not downloadable; television entertainment; education and entertainment services provided via a global computer network; providing of films available online on the internet, non-downloadable; provision of non-downloadable games on the Internet; publication of books, magazines and electronic publications on cinema, music and video games; information on services related to games, music and cinema services available on-line, not downloadable; booking of rooms for entertainment; provision of entertainment facilities; presentation of clown performances; holiday camp amusement centre services; amusement parks; amusement parks and arcades; theme park services; zoological garden services; amusement park services; providing waterpark services; entertainment services in the nature of an amusement park show; organisation of entertainment, sporting, recreational, cultural and artistic events; organisation of group recreational activities; ticket agency services; ticketing and event booking services; booking of seats for shows and booking of theatre tickets; booking agency services for cinema tickets; entertainment information; providing infor-

mation on entertainment through computer networks; providing entertainment events in the form of live music shows; rental of amusement machines and apparatus; conferences, exhibitions and seminars; arranging of contests; organization of competitions; theater productions; sporting and cultural activities; providing recreation facilities; teaching; providing of training; organization of training courses; workshops for training purposes; production of training videos; conducting of instructional seminars; provision of information relating to training; recreation and training services; provision of training facilities; instruction in group exercise; provision of instruction relating to nutrition; publishing printed matter and publications; publication of books, magazines, almanacs and journals; providing on-line publications.

(260) AM 2020 105052 A

(800) 1488334

(151) 2019 04 24

(891) 2019 04 24

(731) Tovarischestvo s ogranichennoy otvetstvennostyu "ALIYA TRADE" st. Communalnaya, 4, of. 11B, Zhetysu district, Almaty, Kazakhstan

(540)



(591) White, beige, pale red, yellow brown, yellow, green, golden yellow, gold, brown, red, dark beige, dark yellow, dark brown and black

(531) 11.03.14; 25.01.15; 28.05; 29.01.15

(511)

30 – Tea.

(260) AM 2020 105053 A

(800) 1488338

(151) 2019 07 22

(891) 2019 07 22

(731) MIRCO MARINI via Bosco Martese, n. 17, I-64021 Giulianova (Teramo), Italy

(540)



(591) Black, white

(531) 24.09.02; 24.09.03; 24.09.05; 24.09.25; 26.04.03; 26.04.09; 27.05.01

(511)

14 – Key rings and key chains, and charms therefor; jewels; decorative articles [trinkets or jewellery] for personal use; ornaments, made of or coated with precious or semiprecious metals or stones, or imitations thereof.

18 – Luggage, bags, wallets and other carriers; boxes made of leather; butts [parts of hides]; cases of leather or leatherboard; imitation leather; leather and imitations of leather; leather cloth; leather laces; leather straps.

25 – Clothing; footwear; headgear.

26 – Charms [not jewellery or for keys, rings or chains]; hair ornaments, hair rollers, hair fastening articles, and false hair.

(260) AM 2020 105061 A

(800) 1488549

(151) 2019 05 10

(891) 2019 05 10

(731) EURO GAMES TECHNOLOGY LTD.

"Maritsa" Str. 4, "Vranya-Lozen-Triugulnika",
BG-1151 Sofia, Bulgaria

(540)

ROLLING DICE

(591) Black, white

(511)

9 – Software; computer gaming software; computer software packages; computer operating system software; computer software, recorded; software drivers; virtual reality software; games software; entertainment software for computer games; computer programs for network management; operating computer software for main frame computers; monitors (computer hardware); computer hardware; apparatus for recording images; monitors (computer programs); computer game programs; computer programs for recorded games; apparatus for recording, transmission or reproduction of sound or images; communications servers [computer hardware]; electronic components for gambling machines; computer application software featuring games and gaming; computer software for the administration of on-line games and gaming; computer hardware for games and gaming; electronic components and computer software for gambling, gambling machines, gambling games on the internet and via telecommunication network.

28 – Gaming machines for gambling; chips for gambling; mah-jong; arcade games; gambling machines operating with coins, notes and cards; games; electronic games; parlor games; gaming chips; gaming tables; slot machines [gaming machines]; LCD game machines; slot machines and gaming devices; coin-operated amusement machines; roulette chips; poker

chips; chips and dice [gaming equipment]; equipment for casinos; roulette tables; gaming roulette wheels; casino games; gambling machines and amusement machines, automatic and coin-operated; coin-operated amusement machines and/or electronic coin-operated amusement machines with or without the possibility of gain; boxes for coin-operated machines, slot machines and gaming machines; electronic or electrotechnical amusement machines and apparatus, gaming machines, coin-operated entertainment machines; housings for coin-operated machines, gaming equipment, gaming machines, machines for gambling; electropneumatic and electrical slot machines (gaming machines for gambling).

41 – Gambling; services related to gambling; gaming services for entertainment purposes; casino, gaming and gambling services; training in the development of software systems; provision of equipment for gambling halls; providing casino equipment [gambling]; gaming machine entertainment services; providing casino facilities [gambling]; gaming hall services; amusement arcade services; games equipment rental; rental of gaming machines; providing amusement arcade services; rental of gaming machines with images of fruits; editing or recording of sounds and images; sound recording and video entertainment services; hire of sound reproducing apparatus; provision of gaming equipment for casinos; providing of casino facilities; online gambling services; casino, gaming and gambling services; provision of gaming establishments, gaming halls, Internet casinos, online gaming services.

(260) AM 2020 105062 A

(800) 1488562

(151) 2019 07 25

(891) 2019 07 25

(731) Zotos International, Inc.

100 Tokeneke Road, Darien CT 06820, USA

(540)

WELLPHORIA

(591) Black, white

(511) 03 – Hair care preparations; hair styling preparations; hand lotions; body lotion.

(260) AM 2020 105063 A

(800) 1488572

(151) 2019 06 14

(891) 2019 06 14

(731) Otkrytoe aktsionernoe obshchestvo

"BRETSKIY LIKERO – VODOCHNY
ZAVOD "BELALCO"

ul. Sovetskaya, 2/1, 224005 Brest, Belarus

(540)

GLUBINA

(591) Black, white

(511)

33 – Alcoholic beverages (except beers); aperitifs; arrack [arak]; brandy; wine; vodka; whisky; gin; digesters [liqueurs and spirits]; alcoholic cocktails; curacao; liqueurs; spirits [beverages]; distilled beverages; mead [hydromel]; peppermint liqueurs; biters; rum; cider; alcoholic extracts; alcoholic essences.

(260) AM 2020 105064 A

(800) 1488590

(151) 2019 05 24

(891) 2019 05 24

(731) Joint-stock company "LADA-IMAGE"
ulitsa Severnaya, dom 81, gorod Tol'yatti,
RU-445043 Samarskaya obl., Russian
Federation

(540)

LECAR

(591) Black, white

(531) 27.05.09; 27.05.10; 27.05.19

(511)

2 – Alizarine dyes; aluminium paints; aluminium powder for painting; aniline dyes; annatto [dyestuff]; anti-corrosive preparations; anti-corrosive bands; anti-fouling paints; anti-rust greases; anti-rust oils; anti-rust preparations; anti-tarnishing preparations for metals; asbestos paints; auramine; bactericidal paints; badigeon; binding preparations for paints; bitumen varnish; black japan; bronze powder for painting; bronzing lacquers; Canada balsam; caramel [food colorant]; carbon black [pigment]; carbonyl [wood preservative]; ceramic paints; coatings for roofing felt [paints]; coatings [paints]; cobalt oxide [colorant]; cochineal carmine; colophony; colorants for beverages; colorants for butter; colorants for beer; colorants; colorants for liqueurs; copal; copal varnish; creosote for wood preservation; distempers; dyes; dyewood; dyewood extracts; enamels [varnishes]; enamels for painting; engraving ink; fireproof paints; fixatives for watercolors [watercolours]; fixatives [varnishes]; metal foil for use in painting, decorating, printing and art; food dyes; gamboge for painting; glazes [paints, lacquers]; gum resins; gum-lac; indigo [colorant]; ink for leather; ink for skin-dressing; edible ink cartridges, filled, for printers; edible inks; lacquers; lamp black [pigment]; lime wash; malt caramel [food colorant]; malt colorants; marking ink for animals; mastic [natural resin]; metals in powder form for use in painting, decorating, printing and art; mordants; natural resins, raw; oil paints for use in art; oils for the preservation of wood; orange lead; repositionable paint patches; paints; paper for dyeing Easter eggs; pigments; primers; printers' pastes [ink]; printing ink; protective

preparations for metals; red lead; saffron [colorant]; sandarac; shoe dyes; siccatives [drying agents] for paints; sienna earth; silver paste; silver emulsions [pigments]; silvering powders; soot [colorant]; stains for leather; sumac for varnishes; thickeners for paints; thinners for paints; thinners for lacquers; titanium dioxide [pigment]; toner cartridges, filled, for printers and photocopiers; toners [ink] for photocopiers; turmeric [colorant]; turpentine [thinner for paints]; undercoating for vehicle chassis; varnishes; watercolour paints for use in art; white lead; white-wash; wood coatings [paints]; wood mordants; wood stains; wood preservatives; yellowwood [colorant]; zinc oxide [pigment].

4 – Additives, non-chemical, to motor fuel; alcohol [fuel]; anthracite; beeswax; belting wax; benzene fuel; benzine; biomass fuel; bone oil for industrial purposes; candles; motor fuel; carnauba wax; castor oil for industrial purposes; ceresine; charcoal [fuel]; Christmas tree candles; coal briquettes; coal; coal tar oil; coal naphtha; coal dust [fuel]; coke; combustible briquettes; cutting fluids; diesel oil; dust binding compositions for sweeping; dust removing preparations; dust laying compositions; dust absorbing compositions; electrical energy; ethanol [fuel]; firelighters; firewood; fish oil, not edible; fuel with an alcoholic base; fuel; fuel gas; fuel oil; gas for lighting; gasoline; grease for arms [weapons]; grease for footwear; grease for belts; grease for leather; greases for the preservation of leather; illuminating wax; illuminating grease; industrial wax; industrial grease; industrial oil; kerosene; lamp wicks; lighting fuel; lignite; ligroin; lubricants; lubricating oil; lubricating graphite; lubricating grease; mazut; methylated spirit; mineral fuel; moistening oil; motor oil; naphtha; nightlights [candles]; non-slipping preparations for belts; oil-gas; oils for releasing form work [building]; oils for the preservation of masonry; oils for the preservation of leather; oils for paints; oleine; ozocerite [ozokerite]; paper spills for lighting; paraffin; peat briquettes [fuel]; peat [fuel]; perfumed candles; petrol; petroleum ether; petroleum jelly for industrial purposes; petroleum, raw or refined; producer gas; rape oil for industrial purposes; solidified gases [fuel]; soya bean oil preparations for non-stick treatment of cooking utensils; stearine; sunflower oil for industrial purposes; tallow; textile oil; tinder; vaporized fuel mixtures; wax [raw material]; wax for skis; wicks for candles; wood spills for lighting; wood briquettes; wool grease; xylene fuel.

6 – Advertisement columns of metal; alloys of common metal; aluminium; aluminium wire; aluminium foil; anchor plates; anchors; angle irons of metal; anti-friction metal; anvils; anvils [portable]; arbours [structures] of metal; armour-plating of metal; armoured doors of metal; aviaries [structures] of metal; badges of metal for vehicles; bag hangers of metal; balls of steel; balustrades of metal; bands of

metal for tying-up purposes; barbed wire; barrel hoops of metal; barrels of metal; bars for metal railings; baskets of metal; bathtub grab bars of metal; beacons of metal, non-luminous; beak-irons [bick-irons]; beams of metal; bed casters of metal; bells for animals; bells; machine belt fasteners of metal; belt stretchers of metal; beryllium [glucinium]; bicycle parking installations of metal; binding screws of metal for cables; binding thread of metal for agricultural purposes; bindings of metal; bird baths [structures] of metal; blooms [metallurgy]; bolts of metal; bolts, flat; bottle caps of metal; bottle closures of metal; bottles [metal containers] for compressed gas or liquid air; box fasteners of metal; boxes of common metal; braces of metal for handling loads; brackets of metal for building; brackets of metal for furniture; branching pipes of metal; brass, unwrought or semi-wrought; brazing alloys; bright steel bars; bronze; bronzes for tombstones; bronzes [works of art]; buckles of common metal [hardware]; building materials of metal; building panels of metal; buildings, transportable, of metal; buildings of metal; burial vaults of metal; busts of common metal; cabanas of metal; cable joints of metal, non-electric; cables of metal, non-electric; cadmium; metal cages for wild animals; casement windows of metal; cashboxes [metal or non-metal]; casings of metal for oilwells; cask stands of metal; casks of metal; cast steel; cast iron, unwrought or semi-wrought; cattle chains; ceilings of metal; celtium [hafnium]; cermet; closures of metal for containers; clothes hooks of metal; cobalt, raw; collars of metal for fastening pipes; common metals, unwrought or semi-wrought; containers of metal for storing acids; containers of metal [storage, transport]; containers of metal for compressed gas or liquid air; containers of metal for liquid fuel; copper, unwrought or semi-wrought; copper rings; copper wire, not insulated; cornices of metal; cotter pins of metal; couplings of metal for chains; crampons [climbing irons]; cramps of metal [crampons]; crash barriers of metal for roads; dispensers for dog waste bags, fixed, of metal; diving boards of metal; door stops of metal; door scrapers; door bells of metal, non-electric; door closers, non-electric; door knockers of metal; door handles of metal; door panels of metal; door bolts of metal; door openers, non-electric; door frames of metal; door fittings of metal; door fasteners of metal; doors of metal; drain pipes of metal; drain traps [valves] of metal; drawn and polished metal bars; duckboards of metal; ducts of metal, for central heating installations; ducts of metal for ventilating and air-conditioning installations; elbows of metal for pipes; enclosures of metal for tombs; eye bolts; fences of metal; ferrules of metal for walking sticks; ferrules of metal for handles; ferrules of metal; figurines [statuettes] of common metal; filings of metal; firedogs [andirons]; fireplace mantles of metal; fish plates [rails]; fittings of metal for windows; fittings

of metal for building; fittings of metal for compressed air lines; fittings of metal for coffins; fittings of metal for furniture; fittings of metal for beds; flagpoles of metal; flanges of metal [collars]; flashing of metal for building; floating docks of metal, for mooring boats; floating containers of metal; floor tiles of metal; floors of metal; foils of metal for wrapping and packaging; folding doors of metal; foundry molds [moulds] of metal; frames of metal for building; framework of metal for building; materials of metal for funicular railway permanent ways; furnace fireguards of metal; furniture casters of metal; galena [ore]; gates of metal; German silver; germanium; gold solder; gratings of metal; grave slabs of metal; grease nipples; greenhouse frames of metal; greenhouses of metal, transportable; guard rails of metal; gutter pipes of metal; handcuffs; handling pallets of metal; hinges of metal; hooks [metal hardware]; hooks of metal for roofing slates; hooks of metal for clothes rails; hoppers of metal, non-mechanical; horseshoe nails; hot-rolled steel bars; house numbers of metal, non-luminous; ice moulds of metal; identification bracelets of metal; indium; ingots of common metal; insect screens of metal; iron slabs; iron, unwrought or semi-wrought; iron strip; iron wire; iron ores; ironmongery; ironwork for windows; ironwork for doors; jalousies of metal; jerrycans of metal; jets of metal; joists of metal; junctions of metal for pipes; keys of metal; knobs of metal; labels of metal; ladders of metal; latch bars of metal; latches of metal; laths of metal; latticework of metal; lead seals; lead, unwrought or semi-wrought; letter boxes of metal; letters and numerals of common metal, except type; limonite; linings of metal for building; lintels of metal; loading pallets of metal; loading gauge rods, of metal, for railway waggons; lock bolts; locks of metal, other than electric; locks of metal for vehicles; locks of metal for bags; magnesium; manganese; manhole covers of metal; manifolds of metal for pipelines; masts of metal; memorial plates of metal; metals in powder form; metals in foil or powder form for 3D printers; mobile boarding stairs of metal for passengers; molybdenum iron; molybdenum; monuments of metal for tombs; mooring bollards of metal; mooring buoys of metal; mouldings of metal for cornices; mouldings of metal for building; nails; nameplates of metal; nickel silver; nickel; niobium; nozzles of metal; nuts of metal; ores of metal; outdoor blinds of metal; packaging containers of metal; padlocks; paint spraying booths of metal; palings of metal; pantiles of metal; partitions of metal; paving blocks of metal; paving slabs of metal; peeled metal bars; pegs of metal; penstock pipes of metal; pigsties of metal; pillars of metal for building; pins [hardware]; pipe muffers of metal; pipework of metal; pitons of metal; platforms, prefabricated, of metal; plugs of metal; poles of metal; porches [structures] of metal; posts of metal; posts of

metal for power lines; pot hooks of metal; prefabricated houses [kits] of metal; preserving boxes of metal; props of metal; pulleys of metal, other than for machines; pyrophoric metals; rails of metal; railway switches; railway material of metal; railway sleepers of metal; reels of metal, non-mechanical, for flexible hoses; refractory construction materials of metal; registration plates of metal; reinforcing materials, of metal, for concrete; reinforcing materials of metal for pipes; reinforcing materials of metal for building; reinforcing materials of metal for machine belts; rings of metal; rivets of metal; road signs, non-luminous and non-mechanical, of metal; rocket launching platforms of metal; rods of metal for brazing; rods of metal for brazing and welding; rods of metal for welding; roller blinds of steel; roof flashing of metal; roof gutters of metal; roof coverings of metal; roofing tiles of metal; roofing of metal; roofing of metal, incorporating photovoltaic cells; rope thimbles of metal; ropes of metal; runners of metal for sliding doors; safes [metal or non-metal]; safes, electronic; safety cashboxes; safety chains of metal; sash fasteners of metal for windows; scaffolding of metal; screw tops of metal for bottles; screws of metal; sealing caps of metal; sheaf binders of metal; sheet piles of metal; sheets and plates of metal; shims; shoe pegs of metal; shoe dowels of metal; shuttering of metal for concrete; shutters of metal; signalling panels, non-luminous and non-mechanical, of metal; signboards of metal; signs, non-luminous and non-mechanical, of metal; silicon iron; sills of metal; silos of metal; silver solder; silver-plated tin alloys; skating rinks [structures] of metal; slabs of metal for building; sleeves [metal hardware]; slings of metal for handling loads; soldering wire of metal; split rings of common metal for keys; spring locks; springs [metal hardware]; spurs; stables of metal; stair treads [steps] of metal; staircases of metal; stakes of metal for plants or trees; statues of common metal; steel, unwrought or semi-wrought; steel alloys; steel strip; steel wire; steel masts; steel sheets; steel tubes; steel buildings; step stools of metal; steps [ladders] of metal; stops of metal; strap-hinges of metal; straps of metal for handling loads; street gutters of metal; stretchers for iron bands [tension links]; stretchers for metal bands [tension links]; stringers [parts of staircases] of metal; swimming pools [structures] of metal; tacks [nails]; tanks of metal; tantalum [metal]; taps of metal for casks; telegraph posts of metal; telephone booths of metal; telpher cables; tension links; tent pegs of metal; thread of metal for tying-up purposes; tile floorings of metal; tiles of metal for building; tin; tinfoil; tinsplate packings; tinsplate; titanium iron; titanium; tombac; tombs of metal; tombstone plaques of metal; tombstone stelae of metal; tool boxes of metal, empty; tool chests of metal, empty; towel dispensers, fixed, of metal; transport pallets of metal; traps for wild animals; trays of metal; tree protectors of metal;

troughs of metal for mixing mortar; tubing of metal; tubes of metal; tungsten iron; tungsten; turnstiles of metal; turntables [railways]; valves of metal, other than parts of machines; vanadium; vats of metal; vice claws of metal; wainscotting of metal; wall plugs of metal; wall claddings of metal for building; wall linings of metal for building; wall tiles of metal; washers of metal; water-pipe valves of metal; water-pipes of metal; weather- or wind-vanes of metal; wheel clamps [boots]; white metal; wind-driven bird-repelling devices made of metal; winding spools of metal, non-mechanical, for flexible hoses; window stops of metal; window pulleys; window casement bolts; window fasteners of metal; window frames of metal; window openers, non-electric; window closers, non-electric; windows of metal; wire of common metal; wire cloth; wire stretchers [tension links]; wire of common metal alloys, except fuse wire; wire rope; works of art of common metal; zinc; zirconium.

7 – 3D printers; acetylene cleaning apparatus; adhesive tape dispensers [machines]; adhesive bands for pulleys; aerating pumps for aquaria; apparatus for aerating beverages; apparatus for aerating water; aerocondensers; aeronautical engines; aeroplane engines; agitators; agricultural machines; agricultural elevators; agricultural implements, other than hand-operated; air condensers; air cushion devices for moving loads; air pumps [garage installations]; air suction machines; air brushes for applying colour; alternators; anti-friction bearings for machines; cream/milk separators; steam/oil separators; anti-pollution devices for motors and engines; aprons [parts of machines]; electric arc welding apparatus; electric arc cutting apparatus; axles for machines; ball rings for bearings; ball-bearings; basket presses; bearing brackets for machines; bearings [parts of machines]; bearings for transmission shafts; beaters, electric; beating machines; beer pumps; bellows [parts of machines]; belt conveyors; belts for conveyors; belts for machines; belts for motors and engines; bending machines; beverage preparation machines, electro-mechanical; bicycle dynamos; bicycle assembling machines; binding apparatus for hay; bitumen making machines; blade sharpening [stropping] machines; blade holders [parts of machines]; blades [parts of machines]; blenders, electric, for household purposes; blowing machines for the compression, exhaustion and transport of gases; blowing machines for the compression, sucking and carrying of grain; blowing machines; bobbins for weaving looms; boiler tubes [parts of machines]; bookbinding apparatus and machines for industrial purposes; bottle filling machines; bottle washing machines; bottle stoppering machines; bottle capping machines; bottle sealing machines; boxes for matrices [printing]; braiding machines; brake linings, other than for vehicles; brake shoes, other than for vehicles; brake segments,

other than for vehicles; brake pads, other than for vehicles; bread cutting machines; brewing machines; brushes [parts of machines]; brushes, electrically operated [parts of machines]; brushes for vacuum cleaners; bulldozers; butter machines; calendars; camshafts for vehicle engines; capstans; carbon brushes [electricity]; carburetter feeders; carburetters; card clothing [parts of carding machines]; carding machines; machines and apparatus for carpet shampooing, electric; cartridges for filtering machines; catalytic converters; central vacuum cleaning installations; centrifugal machines; centrifugal mills; centrifugal pumps; chaff cutter blades; chain saws; electromechanical machines for chemical industry; chisels for machines; chucks [parts of machines]; churns; cigarette machines for industrial purposes; cinder sifters [machines]; clack valves [parts of machines]; machines and apparatus for cleaning, electric; cleaning appliances utilizing steam; clippers [machines]; clutches, other than for land vehicles; coal-cutting machines; coffee grinders, other than hand-operated; coin-operated washing machines; compressed air engines; compressed air machines; compressed air pumps; compressed air guns for the extrusion of mastics; compressors [machines]; compressors for refrigerators; concrete mixers [machines]; condensing installations; connecting rods for machines, motors and engines; control cables for machines, engines or motors; control mechanisms for machines, engines or motors; hydraulic controls for machines, motors and engines; pneumatic controls for machines, motors and engines; converters for steelworks; conveyors [machines]; cord making machines; couplings, other than for land vehicles; cowlings [parts of machines]; cranes [lifting and hoisting apparatus]; crank shafts; crankcases for machines, motors and engines; cranks [parts of machines]; crushers for kitchen use, electric; crushing machines; cultivators [machines]; current generators; curtain drawing devices, electrically operated; cutters [machines]; cutting machines; cutting blow pipes, gas-operated; cylinder heads for engines; cylinders for machines; cylinders for motors and engines; dairy machines; darning machines; de-aerators for feedwater; degreasers [machines]; derricks; die-cutting and tapping machines; die-stamping machines; diggers [machines]; dishwashers; disintegrators; ditchers [ploughs]; dividing machines; door openers, hydraulic; door openers, pneumatic; door closers, electric; door openers, electric; door closers, hydraulic; door closers, pneumatic; drainage machines; apparatus for drawing up beer under pressure; metal drawing machines; drill chucks [parts of machines]; drilling heads [parts of machines]; drilling machines; drilling bits [parts of machines]; drilling rigs, floating or non-floating; driving motors, other than for land vehicles; driving chains, other than for land vehicles; drums [parts of machines]; dust exhausting installations for cleaning purposes; dust removing

installations for cleaning purposes; dyeing machines; dynamo brushes; dynamo belts; dynamos; earth moving machines; ejectors; electrodes for welding machines; electroplating machines; elevating apparatus; elevator belts; elevator chains [parts of machines]; elevator operating apparatus; elevators [lifts]; embossing machines; emergency power generators; engine mounts, other than for land vehicles; engines for air cushion vehicles; engines for boats; hydraulic engines and motors; engraving machines; excavators; exhaust manifold for engines; exhausts for motors and engines; expansion tanks [parts of machines]; fan belts for motors and engines; fans for motors and engines; feeders [parts of machines]; feeding apparatus for engine boilers; filling machines; filter presses; filtering machines; filters for cleaning cooling air, for engines; filters [parts of machines or engines]; finishing machines; fittings for engine boilers; fleshing machines; flour mill machines; flues for engine boilers; machine flywheels; fodder presses; food preparation machines, electromechanical; food processors, electric; forge bellows; foundry machines; freewheels, other than for land vehicles; friezing machines; fruit presses, electric, for household purposes; fuel economisers for motors and engines; fuel conversion apparatus for internal combustion engines; fuel dispensing pumps for service stations; galvanizing machines; garbage [waste] disposals; gas-operated blow torches; gear boxes, other than for land vehicles; gears for weaving looms; gears, other than for land vehicles; generators of electricity; glass-working machines; glaziers' diamonds [parts of machines]; glow plugs for Diesel engines; glue guns, electric; grain husking machines; grain separators; automatic grappels for marine purposes; grating machines for vegetables; grease rings [parts of machines]; grease boxes [parts of machines]; grinding machines; grindstones [parts of machines]; guides for machines; guns [tools using explosives]; hammers [parts of machines]; pneumatic hammers; electric hammers; electric hand drills; hand-held tools, other than hand-operated; handling apparatus for loading and unloading; handling machines, automatic [manipulators]; hangers [parts of machines]; harrows; harvesting machines; haulage apparatus [mining]; heat exchangers [parts of machines]; hemming machines; high pressure washers; hoists; holding devices for machine tools; hoppers [mechanical discharging]; hosiery looms; housings [parts of machines]; igniting devices for internal combustion engines; igniting magnetos; incubators for eggs; injectors for engines; inking apparatus for printing machines; ironing machines; jacks [machines]; pneumatic jacks; jet engines, other than for land vehicles; joints [parts of engines]; journal boxes [parts of machines]; journals [parts of machines]; joysticks being parts of machines, other than for game machines; juice extractors, electric; kick starters for motorcycles; kitchen machines, electric; kitchen grinders, el-

electric; kneading machines; knitting machines; knives [parts of machines]; knives, electric; knives for mowing machines; labellers [machines]; lace making machines; lasts for shoes [parts of machines]; lathes [machine tools]; lawnmowers [machines]; leather paring machines; leather-working machines; lifting apparatus; lifts, other than ski-lifts; mechanized livestock feeders; loading ramps; loom shafts; looms; lubricating pumps; lubricators [parts of machines]; machine tools; matrices for use in printing; meat choppers [machines]; metalworking machines; milking machines; milling machines; mills [machines]; mills for household purposes, other than hand-operated; millstones; mine borers; machines for the production of mineral water; mineworking machines; mixers [machines]; mixing machines; mortising machines; motorized cultivators; motors for boats; motors, other than for land vehicles; motors, electric, other than for land vehicles; moulding machines; moulds [parts of machines]; moving staircases [escalators]; moving pavements [sidewalks]; mud catchers and collectors [machines]; mufflers for motors and engines; nail extractors, electric; net hauling machines [fishing]; notchers [machine tools]; oil refining machines; ore treating machines; packaging machines; packing machines; painting machines; paper feeders [printing]; paper machines; papermaking machines; parquet wax-polishers, electric; machines for making pasta; pedal drives for sewing machines; peeling machines; pepper mills, other than hand-operated; pigs for cleaning pipes; piston segments; pistons for cylinders; pistons for engines; pistons [parts of machines or engines]; planing machines; ploughs; ploughshares; machines and apparatus for polishing [electric]; potters' wheels; power hammers; presses [machines for industrial purposes]; pressure reducers [parts of machines]; pressure regulators [parts of machines]; pressure valves [parts of machines]; printing cylinders; printing machines for use on sheet metal; printing plates; printing machines; printing presses; printing rollers for machines; machines for processing plastics; propulsion mechanisms, other than for land vehicles; puddling machines; pulleys; pulleys [parts of machines]; pulverisers [machines]; pump diaphragms; pumps [parts of machines, engines or motors]; pumps [machines]; pumps for heating installations; punches for punching machines; punching machines; rack and pinion jacks; racket stringing machines; radiators [cooling] for motors and engines; rail-laying machines; railroad constructing machines; rakes for raking machines; raking machines; rammers [machines]; rams [machines]; reapers; reapers and binders; reapers and threshers; reduction gears, other than for land vehicles; reeling apparatus, mechanical; reels, mechanical, for flexible hoses; reels [parts of machines]; regulators [parts of machines]; rinsing machines; riveting machines; road sweeping machines, self-propelled; road making machines; robots [machines]; roller

bridges; roller bearings; rolling mill cylinders; rolling mills; rotary printing presses; rotary steam presses, portable, for fabrics; rubber tracks being parts of crawlers on construction machines; rubber tracks being parts of crawlers on loading-unloading machines and apparatus; rubber tracks being parts of crawlers on agricultural machines; rubber tracks being parts of crawlers on mining machines; rubber tracks being parts of crawlers on snow ploughs; satinizing machines; sausage making machines; saw benches [parts of machines]; saw blades [parts of machines]; saws [machines]; scale collectors for machine boilers; scissors, electric; screwdrivers, electric; sealing machines for industrial purposes; electrical apparatus for sealing plastics [packaging]; self-oiling bearings; self-regulating fuel pumps; sewage pulverizers; sewing machines; shaft couplings [machines]; sharpening machines; sheaf-binding machines; shearing machines for animals; shears, electric; shock absorber plungers [parts of machines]; shoe polishers, electric; shovels, mechanical; shredders [machines] for industrial use; shuttles [parts of machines]; sieves [machines or parts of machines]; sifting installations; sifting machines; sizing machines; ski edge sharpening tools, electric; slide rests [parts of machines]; sliders for knitting machines; smoothing presses; snow ploughs; soldering apparatus, gas-operated; soldering blow pipes, gas-operated; soldering irons, gas-operated; soldering apparatus, electric; soldering irons, electric; soldering lamps; sorting machines for industry; sowers [machines]; sparking plugs for internal combustion engines; speed governors for machines, engines and motors; spin driers [not heated]; spinning machines; spinning wheels; spinning frames; spray guns for paint; springs [parts of machines]; stalk separators [machines]; stamping machines; stands for machines; starters for motors and engines; stators [parts of machines]; steam condensers [parts of machines]; steam engines; steam traps; steam engine boilers; steamrollers; stereotype machines; stitching machines; stone-working machines; straw [chaff] cutters; stuffing boxes [parts of machines]; suction machines for industrial purposes; suction nozzles for vacuum cleaners; machines for the production of sugar; superchargers; superheaters; swaging machines; tables for machines; tambours for embroidery machines; taps [parts of machines, engines or motors]; tarring machines; teat cups [suction cups] for milking machines; tedding machines; machines for the textile industry; thermic lances [machines]; threading machines; threshing machines; tilt hammers; tin openers, electric; tobacco processing machines; tools [parts of machines]; torque converters, other than for land vehicles; transmission shafts, other than for land vehicles; transmission chains, other than for land vehicles; transmissions, other than for land vehicles; transmissions for machines; pneumatic transporters; trimming machines; trueing machines; pneumatic tube

conveyors; hydraulic turbines; turbines, other than for land vehicles; turbocompressors; turf removing ploughs; tympan [parts of printing presses]; type-setting machines [printing]; type-setting machines [photocomposition]; typecasting machines; typographic presses; typographic machines; universal joints [Cardan joints]; vacuum pumps [machines]; vacuum cleaner attachments for disseminating perfumes and disinfectants; vacuum cleaner hoses; vacuum cleaners; vacuum cleaner bags; valves [parts of machines]; vending machines; vibrators [machines] for industrial use; vulcanisation apparatus; waggon lifts; washing apparatus; washing machines [laundry]; washing installations for vehicles; waste compacting machines; water heaters [parts of machines]; water separators; machines and apparatus for wax-polishing, electric; weeding machines; welding machines, electric; electric welding apparatus; machine wheels; machine wheelwork; whisks, electric, for household purposes; whitewashing machines; winches; wind turbines; window openers, electric; window closers, electric; window openers, hydraulic; window closers, hydraulic; window openers, pneumatic; window closers, pneumatic; wine presses; winnowers; woodworking machines; wrapping machines; wringing machines for laundry.

8 – Abrading instruments [hand instruments]; adzes [tools]; agricultural implements, hand-operated; agricultural forks [hand tools]; air pumps, hand-operated; annular screw plates; augers [hand tools]; awls; axes; baby spoons, table forks and table knives; metal band stretchers [hand tools]; bayonets; beard clippers; bench vices [hand implements]; billhooks; bits [parts of hand tools]; bits [hand tools]; blade sharpening instruments; blades for planes; blades [hand tools]; blades [weapons]; border shears; borers; bow saws; braiders [hand tools]; branding irons; breast drills; budding knives; carpenters' augers; cattle shearers; caulking irons; centre punches [hand tools]; ceramic knives; cheese slicers, non-electric; chisels; choppers [knives]; clamps for carpenters or coopers; cleavers; crimping irons; crow bars; curling tongs; cuticle tweezers; cutlery; cutter bars [hand tools]; cutters; cutting tools [hand tools]; daggers; implements for decanting liquids [hand tools]; depilation appliances, electric and non-electric; apparatus for destroying plant parasites, hand-operated; dies [hand tools]; diggers [hand tools]; ditchers [hand tools]; drawing knives; drill holders [hand tools]; ear-piercing apparatus; earth rammers [hand tools]; edge tools [hand tools]; egg slicers, non-electric; embossers [hand tools]; emery grinding wheels; emery files; emery boards; engraving needles; expanders [hand tools]; extension pieces for braces for screw taps; eyelash curlers; farriers' knives; files [tools]; fingernail polishers, electric or non-electric; fire irons; fireplate bellows [hand tools]; fish tapes [hand tools]; flat irons; foundry

ladles [hand tools]; frames for handsaws; fruit pickers [hand tools]; fullers [hand tools]; fulling tools [hand tools]; garden tools, hand-operated; gimlets [hand tools]; glaziers' diamonds [parts of hand tools]; goffering irons; gouges [hand tools]; grafting tools [hand tools]; graving tools [hand tools]; grinders [hand tools]; guns [hand tools]; guns, hand-operated, for the extrusion of mastics; hackles [hand tools]; hainault scythes; hair clippers for personal use, electric and non-electric; hair clippers for animals [hand instruments]; hair-removing tweezers; hammers [hand tools]; hand drills, hand-operated; hand tools, hand-operated; hand implements for hair curling; hand pumps; handles for hand-operated hand tools; harpoons; harpoons for fishing; hatchets; hobby knives [scalpels]; hoes [hand tools]; holing axes; hollowing bits [parts of hand tools]; hoop cutters [hand tools]; hunting knives; ice picks; insecticide vaporizers [hand tools]; irons [non-electric hand tools]; jigsaws; knife handles; knives; ladles [hand tools]; lasts [shoemakers' hand tools]; lawn clippers [hand instruments]; leather strops; levers; lifting jacks, hand-operated; livestock marking tools; machetes; mallets [hand instruments]; manicure sets; manicure sets, electric; marline spikes; masons' hammers; mattocks; milling cutters [hand tools]; mincing knives [hand tools]; mitre [miter (Am.)] boxes [hand tools]; money scoops; mortars for pounding [hand tools]; mortise chisels; moulding irons; nail extractors, hand-operated; nail drawers [hand tools]; nail punches; nail nippers; nail files; nail files, electric; nail clippers, electric or non-electric; needle files; non-electric caulking guns; numbering punches; oyster openers; palette knives; paring irons [hand tools]; paring knives; pedicure sets; penknives; perforating tools [hand tools]; pickaxes; pickhammers; picks [hand tools]; pin punches; pincers; pizza cutters, non-electric; plane irons; planes; plastic spoons, table forks and table knives; pliers; polishing irons [glazing tools]; priming irons [hand tools]; pruning scissors; pruning shears; pruning knives; punch rings [knuckle dusters]; punch pliers [hand tools]; punches [hand tools]; instruments for punching tickets; rab-beting planes; rakes [hand tools]; rammers [hand tools]; rams [hand tools]; rasps [hand tools]; ratchets [hand tools]; razor strops; razor cases; razor blades; razors, electric or non-electric; reamer sockets; reamers; riveters [hand tools]; riveting hammers [hand tools]; sabres; sand trap rakes; saw blades [parts of hand tools]; saw holders; saws [hand tools]; scaling knives; scissors; scrapers [hand tools]; scrapers for skis; scraping tools [hand tools]; screwdrivers, non-electric; sculptors' chisels; scythe rings; scythe stones; scythe handles; scythes; sharpening stones; sharpening steels; sharpening instruments; shaving cases; shear blades; shearers [hand instruments]; shears; shovels [hand tools]; sickles; side arms, other than firearms; silver plate [knives, forks and spoons]; ski edge sharpening tools, hand-operated; ins-

truments and tools for skinning animals; sledgehammers; spades [hand tools]; spanners [hand tools]; spatulas [hand tools]; spatulas for use by artists; spoons; squares [hand tools]; stamping-out tools [hand tools]; stone hammers; stropping instruments; sword scabbards; swords; syringes for spraying insecticides; table cutlery [knives, forks and spoons]; table forks; tap wrenches; taps [hand tools]; tattoo needles; apparatus for tattooing; thistle extirpators [hand tools]; tin openers, non-electric; tool belts [holders]; tree pruners; trowels [gardening]; trowels; trunchions; tube cutters [hand tools]; tube cutting instruments; tweezers; vegetable slicers; vegetable choppers; vices; weeding forks [hand tools]; whetstone holders; wick trimmers [scissors]; wire strippers [hand tools]; metal wire stretchers [hand tools].

9 – 3D spectacles; abacuses; accelerometers; accumulators, electric; acid hydrometers; acidimeters for batteries; acoustic alarms; acoustic conduits; acoustic couplers; actinometers; electrical adapters; adding machines; aerials; aerometers; air analysis apparatus; alarm bells, electric; alarms; alcoholmeters; alidades; altimeters; ammeters; amplifiers; amplifying tubes; anemometers; animated cartoons; anode batteries; anodes; answering machines; anti-dazzle shades; anti-glare glasses; anti-interference devices [electricity]; anti-theft warning apparatus; anticathodes; apertometers [optics]; armatures [electricity]; asbestos gloves for protection against accidents; asbestos clothing for protection against fire; asbestos screens for firemen; apparatus and instruments for astronomy; audio- and video-receivers; audio interfaces; audio mixers; audiovisual teaching apparatus; automated teller machines [ATM]; azimuth instruments; baby monitors; baby scales; bags adapted for laptops; balances [steelyards]; balancing apparatus; bar code readers; barometers; bathroom scales; batteries, electric, for vehicles; batteries for lighting; batteries, electric; batteries for electronic cigarettes; battery jars; battery boxes; battery chargers; beacons, luminous; bells [warning devices]; betatrons; binoculars; biochips; black boxes [data recorders]; blueprint apparatus; boiler control instruments; branch boxes [electricity]; breathing apparatus for underwater swimming; breathing apparatus, except for artificial respiration; bullet-proof waistcoats [vests (Am.)]; bullet-proof clothing; buzzers; cabinets for loudspeakers; cables, electric; calculating machines; calibrating rings; calipers; calorimeters; camcorders; cameras [photography]; capillary tubes; carpenters' rules; carriers for dark plates [photography]; cases especially made for photographic apparatus and instruments; cases for smartphones; cash registers; cassette players; cathodes; cathodic anti-corrosion apparatus; cell switches [electricity]; cell phone straps; centering apparatus for photographic transparencies; apparatus for changing record player needles; chargers for electric batteries; chargers for

electronic cigarettes; charging stations for electric vehicles; apparatus to check franking; chemistry apparatus and instruments; chips [integrated circuits]; choking coils [impedance]; chromatography apparatus for laboratory use; chronographs [time recording apparatus]; cinematographic cameras; cinematographic film, exposed; circuit closers; circuit breakers; circular slide rules; cleaning apparatus for phonograph records; close-up lenses; clothing for protection against accidents, irradiation and fire; clothing for protection against fire; clothing especially made for laboratories; coaxial cables; coils, electric; mechanisms for coin-operated apparatus; coin-operated mechanisms for television sets; collectors, electric; electric apparatus for commutation; commutators; compact discs [audio-video]; compact discs [read-only memory]; compact disc players; comparators; compasses for measuring; computer memory devices; computer programmes [programs], recorded; computer keyboards; computer operating programs, recorded; computer peripheral devices; computer software, recorded; computer programs [downloadable software]; computer game software; computer software applications, downloadable; computer hardware; computers; condensers [capacitors]; conductors, electric; connected bracelets [measuring instruments]; connections for electric lines; connectors [electricity]; contact lenses; contacts, electric; containers for microscope slides; containers for contact lenses; control panels [electricity]; converters, electric; copper wire, insulated; cordless telephones; correcting lenses [optics]; cosmographic instruments; mechanisms for counter-operated apparatus; counterfeit [false] coin detectors; counters; couplers [data processing equipment]; couplings, electric; covers for electric outlets; covers for smartphones; covers for personal digital assistants [PDAs]; covers for tablet computers; crash test dummies; crucibles [laboratory]; current rectifiers; cyclotrons; darkroom lamps [photography]; darkrooms [photography]; data processing apparatus; decompression chambers; decorative magnets; demagnetizing apparatus for magnetic tapes; densimeters; densitometers; metal detectors for industrial or military purposes; detectors; diagnostic apparatus, not for medical purposes; diaphragms [acoustics]; diaphragms for scientific apparatus; diaphragms [photography]; dictating machines; diffraction apparatus [microscopy]; digital photo frames; digital signs; digital weather stations; directional compasses; discharge tubes, electric, other than for lighting; disk drives for computers; disks, magnetic; distance measuring apparatus; distance recording apparatus; distillation apparatus for scientific purposes; distribution boxes [electricity]; distribution boards [electricity]; distribution consoles [electricity]; divers' masks; diving suits; DNA chips; dog whistles; electric door bells; dosage dispensers; downloadable ring tones for mobile phones; downloadable music files; downloadable image files;

drainers for use in photography; dressmakers' measures; drying racks [photography]; drying apparatus for photographic prints; ducts [electricity]; DVD players; dynamometers; ear plugs for divers; editing appliances for cinematographic films; egg timers [sandglasses]; egg-candlers; electricity conduits; materials for electricity mains [wires, cables]; electrified rails for mounting spot lights; electrified fences; electro-dynamic apparatus for the remote control of railway points; electro-dynamic apparatus for the remote control of signals; electrolyzers; electromagnetic coils; electronic pens [visual display units]; electronic agendas; electronic pocket translators; electronic tags for goods; electronic notice boards; electronic publications, downloadable; electronic book readers; electronic collars to train animals; electronic access control systems for interlocking doors; electric and electronic effects units for musical instruments; electronic interactive whiteboards; electronic key fobs being remote control apparatus; electronic sheet music, downloadable; encoded magnetic cards; encoded identification bracelets, magnetic; encoded key cards; enlarging apparatus [photography]; epidiascopes; equalizers [audio apparatus]; ergometers; exposure meters [light meters]; eyepieces; instruments containing eyepieces; facsimile machines; apparatus for fermentation [laboratory apparatus]; fibre [fiber (Am.)] optic cables; film cutting apparatus; films, exposed; filters for respiratory masks; filters [photography]; filters for ultraviolet rays, for photography; fire extinguishers; fire alarms; fire beaters; fire escapes; fire hose nozzles; fire engines; fire pumps; fire boats; fire blankets; fire hose; fire extinguishing apparatus; flash-bulbs [photography]; flashing lights [luminous signals]; flashlights [photography]; floppy disks; flowmeters; fluorescent screens; fog signals, non-explosive; food analysis apparatus; frames for photographic transparencies; frequency meters; furnaces for laboratory use; furniture especially made for laboratories; fuse wire; fuses; galena crystals [detectors]; galvanic cells; galvanic batteries; galvanometers; gas testing instruments; gasoline gauges; gasometers [measuring instruments]; gauges; glazing apparatus for photographic prints; Global Positioning System [GPS] apparatus; gloves for protection against accidents; gloves for divers; gloves for protection against X-rays for industrial purposes; goggles for sports; grids for batteries; hands-free kits for telephones; head cleaning tapes [recording]; head guards for sports; headphones; heat regulating apparatus; heliographic apparatus; hemline markers; high-frequency apparatus; holders for electric coils; holograms; horns for loudspeakers; humanoid robots with artificial intelligence; hydrometers; hygrometers; identification threads for electric wires; identification sheaths for electric wires; identity cards, magnetic; igniting apparatus, electric, for igniting at a distance; incubators for bacteria culture; automatic indicators of low pres-

sure in vehicle tires [tyres]; inductors [electricity]; infrared detectors; integrated circuits; integrated circuit cards [smart cards]; interactive touch screen terminals; intercommunication apparatus; interfaces for computers; inverters [electricity]; invoicing machines; ionization apparatus not for the treatment of air or water; jigs [measuring instruments]; joysticks for use with computers, other than for video games; juke boxes, musical; juke boxes for computers; junction boxes [electricity]; junction sleeves for electric cables; knee-pads for workers; laboratory trays; laboratory centrifuges; lactodensimeters; lactometers; laptop computers; lasers, not for medical purposes; lens hoods; lenses for astrophotography; letter scales; levelling staffs [surveying instruments]; levelling instruments; levels [instruments for determining the horizontal]; life saving apparatus and equipment; life buoys; life jackets; life belts; life-saving rafts; life-saving capsules for natural disasters; light dimmers [regulators], electric; light-emitting electronic pointers; light-emitting diodes [LED]; lighting ballasts; lightning conductors [rods]; limiters [electricity]; locks, electric; logs [measuring instruments]; electric loss indicators; loudspeakers; magic lanterns; magnetic tapes; magnetic wires; magnetic data media; magnetic encoders; magnetic tape units for computers; magnets; magnifying glasses [optics]; marine compasses; marine depth finders; marking gauges [joinery]; marking buoys; masts for wireless aerials; mathematical instruments; measures; appliances for measuring the thickness of leather; measuring apparatus; measuring devices, electric; measuring glassware; measuring instruments; apparatus for measuring the thickness of skins; measuring spoons; megaphones; memory cards for video game machines; mercury levels; meteorological balloons; meteorological instruments; metronomes; micrometer screws for optical instruments; micrometers; microphones; microprocessors; microscopes; microtomes; kilometer recorders for vehicles; mirrors for inspecting work; mirrors [optics]; mobile telephones; modems; money counting and sorting machines; monitoring apparatus, electric; monitors [computer hardware]; monitors [computer programs]; mouse [computer peripheral]; mouse pads; mouth guards for sports; nautical apparatus and instruments; naval signalling apparatus; navigation apparatus for vehicles [on-board computers]; navigational instruments; needles for record players; needles for surveying compasses; neon signs; nets for protection against accidents; nose clips for divers and swimmers; notebook computers; objectives [lenses] [optics]; observation instruments; octants; ohmmeters; optical lanterns; optical lenses; optical goods; optical apparatus and instruments; optical glass; optical fibers [fibres] [light conducting filaments]; optical condensers; optical character readers; optical data media; optical discs; oscillographs; oxygen transvasing apparatus; ozonisers [ozonators]; parking meters; par-

ticle accelerators; pedometers; peepholes [magnifying lenses] for doors; periscopes; Petri dishes; phonograph records; photocopiers [photographic, electrostatic, thermic]; photometers; phototelegraphy apparatus; photovoltaic cells; apparatus and instruments for physics; pince-nez; pipettes; Pitot tubes; plane tables [surveying instruments]; planimeters; plates for batteries; plotters; plumb bobs; plumb lines; pocket calculators; polarimeters; portable media players; precision measuring apparatus; precision balances; pressure indicator plugs for valves; pressure gauges; pressure measuring apparatus; pressure indicators; printed circuits; printed circuit boards; printers for use with computers; prisms [optics]; probes for scientific purposes; processors [central processing units]; projection screens; projection apparatus; protection devices for personal use against accidents; protection devices against X-rays, not for medical purposes; protective suits for aviators; protective helmets; protective masks; protective helmets for sports; protective films adapted for computer screens; protective films adapted for smartphones; protractors [measuring instruments]; punched card machines for offices; push buttons for bells; pyrometers; quantity indicators; radar apparatus; radio pagers; radiological apparatus for industrial purposes; radiology screens for industrial purposes; radios; radiotelegraphy sets; radiotelephony sets; railway traffic safety appliances; range finders; readers [data processing equipment]; record players; reflecting discs for wear, for the prevention of traffic accidents; reflective safety vests; refractometers; refractors; regulating apparatus, electric; relays, electric; electric installations for the remote control of industrial operations; remote control apparatus; resistances, electric; respirators for filtering air; respiratory masks, other than for artificial respiration; resuscitation mannequins [teaching apparatus]; retorts; retorts' stands; revolution counters; rheostats; riding helmets; road signs, luminous or mechanical; rods for water diviners; rulers [measuring instruments]; rules [measuring instruments]; saccharometers; safety nets; safety tarpaulins; safety restraints, other than for vehicle seats and sports equipment; salinometers; satellite navigational apparatus; satellites for scientific purposes; scales; scales with body mass analyzers; scanners [data processing equipment]; screens [photography]; screens for photoengraving; screw-tapping gauges; security tokens [encryption devices]; selfie sticks [hand-held monopods]; semi-conductors; sextants; sheaths for electric cables; shoes for protection against accidents, irradiation and fire; shutter releases [photography]; shutters [photography]; sighting telescopes for firearms; signal bells; signal lanterns; signalling panels, luminous or mechanical; signalling whistles; signalling buoys; signals, luminous or mechanical; mechanical signs; signs, luminous; simulators for the steering and control of vehicles; sirens; sleeves for laptops; slide calipers;

slide projectors; slide-rules; slope indicators; smart rings; smartglasses; smartphones; smartwatches; smoke detectors; sockets, plugs and other contacts [electric connections]; solar batteries; solar panels for the production of electricity; solderers' helmets; solenoid valves [electromagnetic switches]; sonars; sound recording carriers; sound recording strips; sound transmitting apparatus; sound recording apparatus; sound reproduction apparatus; sound locating instruments; sounding lines; sounding apparatus and machines; sounding leads; spark-guards; speaking tubes; spectacle chains; spectacle cords; spectacle lenses; spectacle frames; spectacle cases; spectacles; spectrograph apparatus; spectrosopes; speed checking apparatus for vehicles; speed indicators; speed measuring apparatus [photography]; speed regulators for record players; spherometers; spirit levels; spools [photography]; sprinkler systems for fire protection; square rulers for measuring; squares for measuring; stage lighting regulators; stands for photographic apparatus; starter cables for motors; steering apparatus, automatic, for vehicles; step-up transformers; personal stereos; stereoscopes; stereoscopic apparatus; stills for laboratory experiments; stroboscopes; subwoofers; sulfitometers; sunglasses; surveying instruments; surveying chains; surveying apparatus and instruments; surveyors' levels; switchboards; switchboxes [electricity]; switches, electric; T-squares for measuring; tablet computers; tachometers; tape recorders; taximeters; teaching apparatus; teeth protectors; telegraph wires; telegraphs [apparatus]; telephone receivers; telephone apparatus; telephone transmitters; telephone wires; teleprinters; teleprompters; telerupters; telescopes; telescopic sights for artillery; television apparatus; temperature indicators; temperature indicator labels, not for medical purposes; terminals [electricity]; test tubes; material testing instruments and machines; testing apparatus not for medical purposes; theft prevention installations, electric; theodolites; thermal imaging cameras; thermionic valves; thermo-hygrometers; thermometers, not for medical purposes; thermostats; thermostats for vehicles; thread counters; ticket dispensers; time switches, automatic; time recording apparatus; time clocks [time recording devices]; tone arms for record players; toner cartridges, unfilled, for printers and photocopiers; totalizers; traffic cones; traffic-light apparatus [signalling devices]; transformers [electricity]; transistors [electronic]; transmitters of electronic signals; transmitters [telecommunication]; transmitting sets [telecommunication]; transparencies [photography]; transponders; triodes; tripods for cameras; urinometers; USB flash drives; vacuum gauges; vacuum tubes [radio]; variometers; vehicle radios; vehicle breakdown warning triangles; verniers; video recorders; video cassettes; video game cartridges; video screens; video telephones; video baby monitors; videotapes; viewfinders, photographic; virtual reality headsets; viscosimeters; voltage

regulators for vehicles; voltage surge protectors; voltmeters; voting machines; wafers for integrated circuits; walkie-talkies; washing trays [photography]; water level indicators; wavemeters; wearable activity trackers; weighbridges; weighing machines; weighing apparatus and instruments; weights; whistle alarms; wind socks for indicating wind direction; wire connectors [electricity]; wires, electric; workmen's protective face-shields; wrist rests for use with computers; X-ray tubes not for medical purposes; X-ray apparatus not for medical purposes; X-ray films, exposed; X-ray photographs, other than for medical purposes; apparatus and installations for the production of X-rays, not for medical purposes.

11 – Acetylene burners; acetylene generators; acetylene flares; air deodorising apparatus; air cooling apparatus; air reheaters; air driers [dryers]; air filtering installations; air conditioners for vehicles; air valves for steam heating installations; air purifying apparatus and machines; air sterilisers; air-conditioning installations; air-conditioning apparatus; alcohol burners; anti-dazzle devices for automobiles [lamp fittings]; anti-glare devices for vehicles [lamp fittings]; anti-splash tap nozzles; aquarium filtration apparatus; aquarium heaters; aquarium lights; arc lamps; ash conveyor installations, automatic; autoclaves, electric, for cooking; bakers' ovens; barbecues; bath tubs; bath tubs for sitz baths; bath fittings; bath installations; bed warmers; beverage cooling apparatus; bicycle lights; bidets; blankets, electric, not for medical purposes; boiler pipes [tubes] for heating installations; boilers, other than parts of machines; book sterilization apparatus; brackets for gas burners; bread toasters; bread baking machines; bread-making machines; burners for lamps; burners; carbon for arc lamps; electrically heated carpets; ceiling lights; central heating radiators; chandeliers; chimney flues; chimney blowers; Chinese lanterns; chocolate fountains, electric; chromatography apparatus for industrial purposes; clean chambers [sanitary installations]; coffee roasters; coffee percolators, electric; coffee machines, electric; coils [parts of distilling, heating or cooling installations]; cooking utensils, electric; cooking stoves; cooking apparatus and installations; cooking rings; cool boxes, electric; coolers for furnaces; cooling installations for water; cooling installations for liquids; cooling installations and machines; cooling appliances and installations; cooling installations for tobacco; curling lamps; dampers [heating]; deep fryers, electric; defrosters for vehicles; apparatus for dehydrating food waste; dental ovens; deodorising apparatus, not for personal use; desalination plants; desiccating apparatus; discharge tubes, electric, for lighting; disinfectant dispensers for toilets; disinfectant apparatus; disinfectant apparatus for medical purposes; distillation columns; distillation apparatus; diving lights; drip irrigation emitters [irrigation fittings]; drying apparatus;

drying apparatus for fodder and forage; drying apparatus and installations; evaporators; expansion tanks for central heating installations; extractor hoods for kitchens; fabric steamers; fairy lights for festive decoration; fans [air-conditioning]; fans [parts of air-conditioning installations]; filaments for electric lamps; filters for air conditioning; filters for drinking water; fireplaces, domestic; fittings, shaped, for furnaces; flaming torches; flare stacks for use in the oil industry; flues for heating boilers; flushing tanks; food steamers, electric; footmuffs, electrically heated; footwarmers, electric or non-electric; forges, portable; fountains; freezers; friction lighters for igniting gas; fruit roasters; fumigation apparatus, not for medical purposes; furnace grates; furnace ash boxes; furnaces, other than for laboratory use; gas lighters; gas scrubbing apparatus; gas scrubbers [parts of gas installations]; gas burners; gas boilers; gas lamps; gas condensers, other than parts of machines; germicidal burners; germicidal lamps for purifying air; glue-heating appliances; hair driers [dryers]; hand drying apparatus for washrooms; headlights for automobiles; hearths; heat accumulators; heat regenerators; heat exchangers, other than parts of machines; heat pumps; heat guns; heated display cabinets; heaters for baths; heaters for vehicles; heaters for heating irons; heaters, electric, for feeding bottles; heating apparatus; heating installations; heating installations [water]; heating boilers; heating apparatus for solid, liquid or gaseous fuels; heating apparatus, electric; heating elements; heating plates; heating apparatus for defrosting vehicle windows; heating filaments, electric; heating cushions [pads], electric, not for medical purposes; hot air ovens; hot air apparatus; hot air bath fittings; hot plates; hot water bottles; luminous house numbers; humidifiers for central heating radiators; hydrants; hydromassage bath apparatus; ice machines and apparatus; immersion heaters; incandescent burners; incinerators; ionization apparatus for the treatment of air or water; kettles, electric; kiln furniture [supports]; kilns; kitchen ranges [ovens]; laboratory burners; laboratory lamps; lamp mantles; lamp glasses; lamp chimneys; lamp globes; lamp reflectors; lamp shades; electric lamps; lamps; lamps for directional signals of automobiles; lampshade holders; lanterns for lighting; laundry room boilers; laundry dryers, electric; lava rocks for use in barbecue grills; level controlling valves in tanks; light bulbs; light bulbs, electric; light bulbs for directional signals for vehicles; light diffusers; light-emitting diodes [LED] lighting apparatus; lighters; lighting installations for air vehicles; lighting apparatus and installations; lighting apparatus for vehicles; lights for vehicles; lights, electric, for Christmas trees; lights for automobiles; loading apparatus for furnaces; magnesium filaments for lighting; malt roasters; microwave ovens [cooking apparatus]; microwave ovens for industrial purposes; milk cooling installations; miners' lamps; mixer taps

for water pipes; motorcycle lights; multicookers; nuclear reactors; oil lamps; oil burners; oil-scrubbing apparatus; ornamental fountains; oven fittings made of fireclay; oxyhydrogen burners; pasteurisers; pipes [parts of sanitary installations]; plate warmers; pocket warmers; polymerisation installations; pressure cooking saucepans, electric; pressure water tanks; processing installations for fuel and nuclear moderating material; purification installations for sewage; radiator caps; radiators, electric; radiators [heating]; refining towers for distillation; refrigerating cabinets; refrigerating apparatus and machines; refrigerating chambers; refrigerating containers; refrigerating appliances and installations; refrigerating display cabinets; refrigerators; regulating accessories for water or gas apparatus and pipes; regulating and safety accessories for gas pipes; regulating and safety accessories for water apparatus; regulating and safety accessories for gas apparatus; roasters; roasting jacks; roasting spits; roasting apparatus; rotisseries; safety lamps; safety accessories for water or gas apparatus and pipes; sanitary apparatus and installations; sauna bath installations; searchlights; shower cubicles [enclosures (Am.)]; showers; sinks; sockets for electric lights; socks, electrically heated; solar thermal collectors [heating]; solar furnaces; spa baths [vessels]; steam boilers, other than parts of machines; steam generating installations; steam accumulators; steam facial apparatus [saunas]; sterilizers; stills; stoves [heating apparatus]; street lamps; structural plates for ovens; swimming pool chlorinating apparatus; tanning apparatus [sun beds]; taps [cocks, spigots] [faucets (Am.)] for pipes; taps [faucets]; thermostatic valves [parts of heating installations]; tobacco roasters; toilet bowls; toilet seats; toilets, portable; toilets [water-closets]; electric torches; tortilla presses, electric; luminous tubes for lighting; Turkish bath cabinets, portable; ultraviolet ray lamps, not for medical purposes; urinals [sanitary fixtures]; vehicle headlights; vehicle reflectors; ventilation hoods; ventilation [air-conditioning] installations and apparatus; ventilation [air-conditioning] installations for vehicles; ventilation hoods for laboratories; waffle irons, electric; warming pans; wash-hand basins [parts of sanitary installations]; washers for water taps; water heaters; water distribution installations; water conduits installations; water purification installations; water filtering apparatus; water sterilizers; water purifying apparatus and machines; water heaters [apparatus]; water softening apparatus and installations; water supply installations; water flushing installations; water intake apparatus; watering installations, automatic; watering machines for agricultural purposes; whirlpool-jet apparatus; wine cellars, electric; electric appliances for making yogurt.

12 – Adhesive rubber patches for repairing inner tubes; aerial conveyors; aeronautical apparatus, machi-

nes and appliances; aeroplanes; air vehicles; air pumps [vehicle accessories]; air cushion vehicles; air bags [safety devices for automobiles]; aircraft; ambulances; amphibious airplanes; anti-dazzle devices for vehicles; anti-skid chains; anti-theft devices for vehicles; anti-theft alarms for vehicles; armoured vehicles; ashtrays for automobiles; automobile hoods; automobile chains; automobile chassis; automobile tires [tyres]; automobile bodies; autonomous underwater vehicles for seabed inspections; axle journals; axles for vehicles; bags adapted for pushchairs; balance weights for vehicle wheels; bands for wheel hubs; barges; baskets adapted for bicycles; bellows for articulated buses; bicycle kickstands; bicycle chains; bicycle handlebars; bicycle tyres; bicycle brakes; bicycle mudguards; bicycle cranks; bicycle motors; bicycle pedals; bicycle wheels; bicycle saddles; bicycle frames; bicycle bells; bicycles; electric bicycles; boat hooks; boats; bodies for vehicles; bogies for railway cars; brake linings for vehicles; brake shoes for vehicles; brake segments for vehicles; brake pads for automobiles; brake discs for vehicles; brakes for vehicles; buffers for railway rolling stock; bumpers for automobiles; cable transport apparatus and installations; caissons [vehicles]; camping cars; canoes; caps for vehicle petrol [gas] tanks; caravans; carriages [railways]; cars for cable transport installations; cars; carts; casings for pneumatic tires [tyres]; casters for trolleys [vehicles] [carts (Am.)]; casting carriages; chairlifts; cigar lighters for automobiles; hydraulic circuits for vehicles; civilian drones; cleaning trolleys; cleats [nautical]; clutches for land vehicles; concrete mixing vehicles; connecting rods for land vehicles, other than parts of motors and engines; couplings for land vehicles; covers for vehicle steering wheels; crankcases for land vehicle components, other than for engines; davits for boats; delivery tricycles; dining cars; dining cars [carriages]; direction indicators for bicycles; direction signals for vehicles; dirigible balloons [airships]; disengaging gear for boats; doors for vehicles; dredgers [boats]; dress guards for bicycles; driverless cars [autonomous cars]; driving motors for land vehicles; driving chains for land vehicles; ejector seats for aircraft; engine mounts for land vehicles; engines for land vehicles; fenders for ships; ferry boats; flanges for railway wheel tires [tyres]; fitted footmuffs for prams; forklift trucks; freewheels for land vehicles; funiculars; funnels for ships; funnels for locomotives; gear boxes for land vehicles; gearing for land vehicles; gears for bicycles; golf carts [vehicles]; handling carts; head-rests for vehicle seats; headlight wipers; hoods for vehicle engines; hoods for vehicles; horns for vehicles; hose carts; hot air balloons; hub caps; hubs for vehicle wheels; hubs for bicycle wheels; hydroplanes; inclined ways for boats; jet engines for land vehicles; kick sledges; launches; locomotives; lorries; luggage carriers for vehicles; luggage nets for vehicles; masts for boats;

military vehicles for transport; military drones; mine cart wheels; mobility scooters; mopeds; motor buses; motor coaches; motor scooters; motor racing cars; motorcycle kickstands; motorcycle saddles; motorcycle chains; motorcycle frames; motorcycle handlebars; motorcycle engines; motorcycles; motors, electric, for land vehicles; mudguards; non-skid devices for vehicle tires [tyres]; oars; omnibuses; paddles for canoes; panniers adapted for bicycles; panniers adapted for motorcycles; parachutes; pontoons; portholes; prams; propulsion mechanisms for land vehicles; pumps for bicycle tyres; push scooters [vehicles]; pushchair covers; pushchair hoods; fitted pushchair mosquito nets; pushchairs; railway couplings; rear-view mirrors; reduction gears for land vehicles; refrigerated vehicles; refrigerated waggons [railroad vehicles]; remote control vehicles, other than toys; remotely operated vehicles for underwater inspections; repair outfits for inner tubes; reversing alarms for vehicles; rims for bicycle wheels; rims for vehicle wheels; rolling stock for funicular railways; rolling stock for railways; rowlocks; rudders; saddle covers for bicycles; saddle covers for motorcycles; saddlebags adapted for bicycles; safety belts for vehicle seats; safety seats for children, for vehicles; screw-propellers for boats; screw-propellers; screws [propellers] for ships; sculls; seaplanes; seat covers for vehicles; security harness for vehicle seats; ship hulls; ships; shock absorbing springs for vehicles; shock absorbers for automobiles; shopping trolleys [carts (Am.)]; side cars; side view mirrors for vehicles; ski carriers for cars; ski lifts; sleeping berths for vehicles; sleeping cars; sleighs [vehicles]; snowmobiles; solid tyres for vehicle wheels; space vehicles; spare wheel covers; spars for ships; spikes for tyres; spoilers for vehicles; spoke clips for wheels; spokes for bicycle wheels; sports cars; sprinkling trucks; steering gears for ships; steering wheels for vehicles; sun-blinds adapted for automobiles; suspension shock absorbers for vehicles; tailboard lifts [parts of land vehicles]; telfer railways [cable cars]; tilt trucks; tilting-carts; timbers [frames] for ships; tipping bodies for lorries [trucks]; tipping apparatus, parts of trucks and wagons; torque converters for land vehicles; torsion bars for vehicles; tractors; trailer hitches for vehicles; trailers [vehicles]; tramcars; transmission chains for land vehicles; transmission shafts for land vehicles; transmissions for land vehicles; treads for vehicles [tractor type]; treads for retreading tires [tyres]; tricycles; trolleys; tubeless tyres for bicycles; inner tubes for pneumatic tires [tyres]; inner tubes for bicycle tyres; turbines for land vehicles; two-wheeled trolleys; tyre mousse inserts; tyres for vehicle wheels; pneumatic tyres; undercarriages for vehicles; upholstery for vehicles; valves for vehicle tires [tyres]; vans [vehicles]; vehicle wheels; vehicle chassis; vehicle bumpers; vehicle running boards; vehicle wheel spokes; vehicle suspension springs; vehicle seats; vehicle covers

[shaped]; vehicle joysticks; electric vehicles; vehicles for locomotion by land, air, water or rail; wagons; water vehicles; wheelbarrows; wheelchairs; windows for vehicles; windscreens; windshield wipers; yachts.

20 – Air pillows, not for medical purposes; air cushions, not for medical purposes; air mattresses, not for medical purposes; ambroid bars; ambroid plates; animal claws; animal horns; animal hooves; armchairs; baby changing mats; bag hangers, not of metal; bakers' bread baskets; bamboo; bamboo curtains; barrels, not of metal; baskets, not of metal; bassinets; bathtub grab bars, not of metal; bead curtains for decoration; bed fittings, not of metal; bed casters, not of metal; bed bases; bedding, except linen; beds for household pets; beds; bedsteads of wood; beehives; benches [furniture]; work benches; binding screws, not of metal, for cables; bins, not of metal; birdhouses; bolsters; bolts, not of metal; book rests [furniture]; bookcases; bottle racks; bottle caps, not of metal; bottle closures, not of metal; bottle casings of wood; boxes of wood or plastic; brackets, not of metal, for furniture; brush mountings; bumper guards for cots, other than bed linen; busts of wood, wax, plaster or plastic; cabinet work; cask stands, not of metal; cask hoops, not of metal; casks of wood for decanting wine; casks, not of metal; chaise longues; chests of drawers; chests for toys; chopping blocks [tables]; clips, not of metal, for cables and pipes; clips of plastic for sealing bags; closures, not of metal, for containers; clothes hooks, not of metal; coat hangers; coathooks, not of metal; coatstands; coffin fittings, not of metal; coffins; collars, not of metal, for fastening pipes; comb foundations for beehives; console tables; containers, not of metal, for liquid fuel; containers, not of metal [storage, transport]; coral; corks for bottles; corks; corozo; costume stands; cots for babies; counters [tables]; covers for clothing [wardrobe]; crates; cupboards; curtain rings; curtain holders, not of textile material; curtain rollers; curtain rails; curtain rods; curtain hooks; curtain tie-backs; cushions; deck chairs; decorations of plastic for foodstuffs; desks; dinner wagons [furniture]; dispensers for dog waste bags, fixed, not of metal; display boards; display stands; divans; dog kennels; door fittings, not of metal; door handles, not of metal; door bolts, not of metal; door bells, not of metal, non-electric; door knockers, not of metal; door stops, not of metal or rubber; door fasteners, not of metal; doors for furniture; dowels, not of metal; drafting tables; drain traps [valves] of plastic; dressing tables; edgings of plastic for furniture; embroidery frames; fans for personal use, non-electric; feet for furniture; figurines [statuettes] of wood, wax, plaster or plastic; filing cabinets; fishing baskets; floating containers, not of metal; flower-pot pedestals; flower-stands [furniture]; fodder racks; footstools; freestanding partitions [furniture]; funera-

ry urns; furniture; furniture fittings, not of metal; furniture of metal; furniture partitions of wood; furniture casters, not of metal; furniture shelves; garment covers [storage]; gun racks; hairdressers' chairs; hampers [baskets] for the transport of items; hand-held mirrors [toilet mirrors]; handling pallets, not of metal; hat stands; head-rests [furniture]; high chairs for babies; hinges, not of metal; honeycombs; horn, unworked or semi-worked; hospital beds; house numbers, not of metal, non-luminous; hydrostatic [water] beds, not for medical purposes; identification bracelets, not of metal; imitation tortoiseshell; index cabinets [furniture]; indoor window blinds [shades] [furniture]; infant walkers; inflatable publicity objects; inflatable furniture; ivory, unworked or semi-worked; jerrycans, not of metal; jewellery organizer displays; kennels for household pets; keyboards for hanging keys; knobs, not of metal; labels of plastic; ladders of wood or plastics; latches, not of metal; lecterns; legs for furniture; letter boxes, not of metal or masonry; library shelves; loading pallets, not of metal; loading gauge rods, not of metal, for railway waggons [wagons]; lockers; locks, not of metal, for vehicles; locks, other than electric, not of metal; magazine racks; massage tables; mats, removable, for sinks; mats for infant playpens; mattresses; meat safes; medicine cabinets; meerscham; mirror tiles; mirrors [looking glasses]; mobile boarding stairs, not of metal, for passengers; mobiles [decoration]; moldings [mouldings] for picture frames; mooring buoys, not of metal; moses baskets; mother-of-pearl, unworked or semi-worked; nameplates, not of metal; nesting boxes for household pets; nesting boxes; newspaper display stands; numberplates, not of metal; nuts, not of metal; office furniture; oyster shells; packaging containers of plastic; paper blinds; pet cushions; picture frames; picture frame brackets; pillows; placards of wood or plastics; plaited straw, except matting; plastic key cards, not encoded and not magnetic; plastic keys; plate racks; playpens for babies; plugs, not of metal; plugs [dowels], not of metal; poles, not of metal; pulleys of plastics for blinds; racks [furniture]; rattan; reeds [plaiting materials]; reels of wood for yarn, silk, cord; reels, not of metal, non-mechanical, for flexible hoses; reservoirs, not of metal nor of masonry; rivets, not of metal; sash fasteners, not of metal, for windows; saw horses; saw benches [furniture]; school furniture; scratching posts for cats; screens for fireplaces [furniture]; screens [furniture]; screw tops, not of metal, for bottles; screws, not of metal; seats; seats of metal; sections of wood for beehives; settees; shells; shelves for file cabinets; shelves for storage; shelving units; shoe pegs, not of metal; shoe dowels, not of metal; shoulder poles [yokes]; showcases [furniture]; sideboards; signboards of wood or plastics; silvered glass [mirrors]; slatted indoor blinds; sleeping pads; sofas; split rings, not of metal, for keys; stag antlers; stair rods; stakes, not of metal, for

plants or trees; standing desks; stands for calculating machines; statues of wood, wax, plaster or plastic; staves of wood; step stools, not of metal; steps [ladders], not of metal; stools; stoppers, not of metal; straw mattresses; straw plaits; straw edgings; stuffed animals; stuffed birds; table tops; tables; tables of metal; tailors' dummies; taps, not of metal, for casks; tea trolleys; tent pegs, not of metal; interior textile window blinds; tool boxes, not of metal, empty; tool chests, not of metal, empty; tortoiseshell; towel dispensers, fixed, not of metal; towel stands [furniture]; transport pallets, not of metal; trays, not of metal; trestles [furniture]; trolleys [furniture]; trolleys for computers [furniture]; troughs, not of metal, for mixing mortar; typing desks; umbrella stands; valet stands; valves, not of metal, other than parts of machines; vats, not of metal; vice benches [furniture]; wall-mounted baby changing platforms; wardrobes; washstands [furniture]; water-pipe valves of plastic; whalebone, unworked or semi-worked; wickerwork; wind chimes [decoration]; winding spools, not of metal, non-mechanical, for flexible hoses; window fittings, not of metal; window stops, not of metal or rubber; window fasteners, not of metal; wood ribbon; works of art of wood, wax, plaster or plastic; woven timber blinds [furniture]; writing desks; yellow amber.

22 – Animal hair; animal feeding nets; awnings of textile; awnings of synthetic materials; bags [envelopes, pouches] of textile, for packaging; bags for washing hosiery; binding thread, not of metal, for agricultural purposes; bindings, not of metal; body bags; braces, not of metal, for handling loads; brattice cloth; cables, not of metal; camel hair; canvas for sails; car towing ropes; carbon fibers [fibres] for textile use; carded wool; coconut fiber [fibre]; cocoons; combed wool; cords for hanging pictures; raw cotton; cotton tow; cotton waste [flock] for padding and stuffing; covers for camouflage; down [feathers]; eiderdown; esparto grass; feathers for bedding; feathers for stuffing upholstery; raw fibrous textile; fibrous gaskets for ships; fishing nets; fleece wool; flock [stuffing]; glass fibers [fibres] for textile use; grasses for upholstering; hammocks; hemp; hemp bands; horsehair; jute; kapok; ladder tapes for Venetian blinds; liber; raw linen [flax]; linters; mail bags; net pens for fish farming; nets for camouflage; nets; network; outdoor blinds of textile; packing [cushioning, stuffing] materials, not of rubber, plastics, paper or cardboard; packing string; packing rope; padding materials, not of rubber, plastics, paper or cardboard; pig bristles; plastic fibers [fibres] for textile use; purse seines; raffia; ramie fibre; rope ladders; ropes, not of metal; ropes; sacks for the transport and storage of materials in bulk; sails; sails for ski sailing; sash cords; sawdust; schappe [raw silk waste]; seaweed for stuffing; sheaf-binding yarns; shorn wool; raw silk; silk flock; sisal; slings,

not of metal, for handling loads; snares [nets]; straps, not of metal, for handling loads; straw for stuffing upholstery; straw wrappers for bottles; string; strips for tying-up vines; tarpaulins; tents; textile fibers [fibres]; thread, not of metal, for wrapping or binding; tow; twine made of paper; twine for nets; upholstery wool [stuffing]; vehicle covers, not fitted; vitreous silica fibers [fibres] for textile use; wadding for filtering; wadding for padding and stuffing upholstery; wax ends; whipcord; wood shavings; wood wool; wool flock; raw or treated wool; wrapping or binding bands, not of metal.

(260) AM 2020 105070 A
 (800) 1488690
 (151) 2019 05 10
 (891) 2019 05 10
 (731) EURO GAMES TECHNOLOGY LTD.
 "Maritsa" Str., 4, "Vranya-Lozen-
 Triugulnika", BG-1151 Sofia, Bulgaria
 (540)

Casino Battle

(591) White, yellow, orange and black
 (531) 27.05.02; 27.05.04; 29.01.14
 (511)
 9 – Software; computer gaming software; computer software packages; computer operating system software; computer software, recorded; software drivers; virtual reality software; games software; entertainment software for computer games; computer programs for network management; operating computer software for main frame computers; monitors (computer hardware); computer hardware; apparatus for recording images; monitors (computer programs); computer game programs; computer programs for recorded games; apparatus for recording, transmission or reproduction of sound or images; communications servers [computer hardware]; electronic components for gambling machines; computer application software featuring games and gaming; computer software for the administration of on-line games and gaming; computer hardware for games and gaming; electronic components and computer software for gambling, gambling machines, gambling games on the internet and via telecommunication network.

28 – Gaming machines for gambling; chips for gambling; mah-jong; arcade games; gambling machines operating with coins, notes and cards; games; electronic games; parlor games; gaming chips; gaming tables; slot machines [gaming machines]; LCD game machines; slot machines and gaming devices; coin-operated amusement machines; roulette chips; poker chips; chips and dice [gaming equipment]; equipment for casinos; roulette tables; gaming roulette wheels; casino games; gambling machines and amu-

sement machines, automatic and coin-operated; coin-operated amusement machines and/or electronic coin-operated amusement machines with or without the possibility of gain; boxes for coin-operated machines, slot machines and gaming machines; electronic or electrotechnical amusement machines and apparatus, gaming machines, coin-operated entertainment machines; housings for coin-operated machines, gaming equipment, gaming machines, machines for gambling; electropneumatic and electrical gambling machines (slot machines).

41 – Gambling; services related to gambling; gaming services for entertainment purposes; casino, gaming and gambling services; training in the development of software systems; provision of equipment for gambling halls; providing casino equipment [gambling]; gaming machine entertainment services; providing casino facilities [gambling]; gaming hall services; amusement arcade services; games equipment rental; rental of gaming machines; providing amusement arcade services; rental of gaming machines with images of fruits; editing or recording of sounds and images; sound recording and video entertainment services; hire of sound reproducing apparatus; provision of gaming equipment for casinos; providing of casino facilities; online gambling services; casino, gaming and gambling services; provision of gaming establishments, gaming halls, internet casinos, online gaming services.

(260) AM 2020 105071 A
 (800) 1488708
 (151) 2019 05 10
 (891) 2019 05 10
 (731) EURO GAMES TECHNOLOGY LTD.
 "Maritsa" Str., 4, "Vranya-Lozen-
 Triugulnika", BG-1151 Sofia, Bulgaria
 (540)

♣ JACKPOT CARDS ♠

(591) Yellow, blue red and black
 (531) 21.01.01; 27.05.03; 29.01.14
 (511)
 9 – Software; computer gaming software; computer software packages; computer operating system software; computer software, recorded; software drivers; virtual reality software; games software; entertainment software for computer games; computer programs for network management; operating computer software for main frame computers; monitors (computer hardware); computer hardware; apparatus for recording images; monitors (computer programs); computer game programs; computer programs for recorded games; apparatus for recording, transmission or reproduction of sound or images; communications servers [computer hardware]; electronic components for gambling machines; computer appli-

cation software featuring games and gaming; computer software for the administration of on-line games and gaming; computer hardware for games and gaming; electronic components and computer software for gambling, gambling machines, gambling games on the internet and via telecommunication network.

28 – Gaming machines for gambling; chips for gambling; mah-jong; arcade games; gambling machines operating with coins, notes and cards; games; electronic games; parlor games; gaming chips; gaming tables; slot machines [gaming machines]; LCD game machines; slot machines and gaming devices; coin-operated amusement machines; roulette chips; poker chips; chips and dice [gaming equipment]; equipment for casinos; roulette tables; gaming roulette wheels; casino games; gambling machines and amusement machines, automatic and coin-operated; coin-operated amusement machines and/or electronic coin-operated amusement machines with or without the possibility of gain; boxes for coin-operated machines, slot machines and gaming machines; electronic or electrotechnical amusement machines and apparatus, gaming machines, coin-operated entertainment machines; housings for coin-operated machines, gaming equipment, gaming machines, machines for gambling; electropneumatic and electrical gambling machines (slot machines).

41 – Gambling; services related to gambling; gaming services for entertainment purposes; casino, gaming and gambling services; training in the development of software systems; provision of equipment for gambling halls; providing casino equipment [gambling]; gaming machine entertainment services; providing casino facilities [gambling]; gaming hall services; amusement arcade services; games equipment rental; rental of gaming machines; providing amusement arcade services; rental of gaming machines with images of fruits; editing or recording of sounds and images; sound recording and video entertainment services; hire of sound reproducing apparatus; provision of gaming equipment for casinos; providing of casino facilities; online gambling services; casino, gaming and gambling services; provision of gaming establishments, gaming halls, internet casinos, online gaming services.

(260) AM 2020 105073 A
 (800) 1488801
 (151) 2019 06 13
 (891) 2019 06 13
 (731) KRKA, tovarna zdravil, d.d., Novo mesto
 Šmarješka cesta 6, SI-8000 Novo mesto,
 Slovenia
 (540)

ROXATENZ

(591) Black, white
 (511)
 5 – Pharmaceutical preparations.

(260) AM 2020 105074 A
 (800) 1488839
 (151) 2019 07 05
 (891) 2019 07 05
 (731) EVOLUTION MALTA LIMITED
 Level 1, The Centre, Tigne Point, TPO 0001,
 Sliema, Malta
 (540)



(591) Brown, white, red, yellow
 (531) 21.01.09; 24.17.09; 26.04.17; 27.05.01;
 27.05.02; 27.05.03; 29.01.13

(511)
 9 – Computer software platforms; computer databases; computer programs for network management; interactive computer systems; application software for mobile phones; computer programs [downloadable software]; software; mobile apps; application software.

41 – Casino, gaming and gambling services; gambling; casino facilities [gambling] (providing -); leasing of casino games; online bingo parlor services; game services provided on-line from a computer network; providing of casino and gaming facilities; gaming services for entertainment purposes; entertainment provided via the internet; operating of lotteries; production of live television programmes for entertainment; entertainment services; entertainment services provided on-line from a computer database or the internet; education, entertainment and sport services; education, entertainment and sports; the provision of entertainment services.

(260) AM 2020 105075 A
 (800) 1488861
 (151) 2019 07 24
 (891) 2019 07 24
 (731) LABORATOIRES INNOTHERA
 22 avenue Aristide Briand, F-94110
 ARCUEIL, France
 (540)

VENASILK

(591) Black, white

(511)

3 – Soaps, perfumes, essential oils, cosmetic products, non-medicinal products for leg, foot, body and skin care; shower gels; creams, gels, lotions, oils, balms, powders, talcum powders for legs, feet, body and skin; non-medicinal products for treatment, care, cleansing, softening, revitalization and relaxation for legs, feet, body and skin; non-medicinal products for the bath in the form of salts, oils; non-medicinal toiletries; deodorant.

5 – Pharmaceutical, medicinal products; medicinal creams, gels, lotions, oils, balms, powders, talcum powders and sprays for legs, feet, body and skin.

(260) AM 2020 105076 A

(800) 1488924

(151) 2019 06 19

(891) 2019 06 19

(731) Chrome Hearts LLC

915 N. Mansfield, Hollywood CA 90038,
USA

(540)

CHROME HEARTS

(591) Black, white

(531) 27.05.01; 27.05.04

(511)

9 – Eyewear, namely, eyeglasses, sunglasses, their parts and cases; phone accessories, namely, phone straps, pouches specially adapted for holding phones, phone cases, tablet cases and laptop cases; pre-recorded CDs and DVDs in the field of music.

26 – Charms for phones.

(260) AM 2020 105079 A

(800) 1488963

(151) 2019 08 16

(891) 2019 08 16

(731) YONGKANG CHIEF TECHNOLOGY CO., LTD.

(3F, BUILDING 7, WITHIN ZHEJIANG,
LIKANG CIKED FOOD CO., LIMITED), LI
ER VILLAGE, WEST CITY STREET,
YONGKANG CITY, JINHUA CITY,
ZHEJIANG PROVINCE, China

(540)

SALIMA

(591) Black, white

(531) 27.05.01; 27.05.03

(511)

30 – Cakes; confectionery; bread; pastries; cereal preparations; cereal-based snack food; rice-based snack food; pies; starch for food; buns.

(260) AM 2020 105080 A

(800) 1488982

(151) 2019 08 07

(891) 2019 08 07

(731) CELLTRION, INC.

23, Academy-ro, Yeonsu-gu, Incheon 22014,
Republic of Korea

(540)

HUEXMA

(591) Black, white

(511)

5 – Pharmaceutical preparations for the treatment of autoimmune diseases.

(260) AM 2020 105090 A

(800) 1489267

(151) 2019 05 09

(891) 2019 05 09

(731) XIAOMI INC.

Floor 13, Rainbow City Shopping Mall II,
of China Resources, No. 68, Qinghe Middle
Street, Haidian District, Beijing, China

(540)

Redmi

(591) Black, white

(531) 27.05.01

(511)

7 – Electroplating machines; disintegrators; embossing machines; glass-working machines; equipment for manufacturing fertilizers; electromechanical machines for chemical industry; drilling machines; rolling mill cylinders; drilling rigs, floating or non-floating; hydraulic pressure coupler; water heaters [parts of machines]; anti-friction bearings for machines; adhesive bands for pulleys; welding machines, electric; rechargeable sweepers; sifting installations; curtain drawing devices, electrically operated; white-washing machines; elevators [lifts]; electric hammers; molding machines; scale collectors for machine boilers; igniting devices for internal combustion engines; hydraulic turbines; machines for manufacturing clips; machines for manufacturing zippers; industrial robots; machines for manufacturing electric wire and cable; scissors, electric; equipment for electronic industry; spectacle lens processing equipment; harvesting machines; aerating pumps for aquaria; mechanized livestock feeders; milking machines; hair clipping machines for animals; salt extracting machine; woodworking machines; papermaking machines; equipment for manufacturing paper diaper; printing cylinders; darning machines; dyeing machines; machines for pressing brick tea; bread cutting machines; beverage preparation machines, electromechanical; tobacco processing machines; leather paring machines; gas separation equipment; drums [parts of machines]; 3D printers; shoe polishers, el-

ectric; racket stringing machines; vending machines; joints for tanker aircraft; liquid reservoir [parts of machines]; ironing machines; bicycle assembling machines; engraving machines; potters' wheels; machines for pressing battery chip; cord making machines; machines for manufacturing enamel; machines for manufacturing lamp bulbs; bottle sealing machines; briquette making machine; juice extractors, electric; washing machines [laundry]; labellers [machines]; 3D printing pens; painting machines; bicycle dynamos; fans for motors and engines; pumps for heating installations; taps [parts of machines, engines or motors]; compressors for refrigerators.

11 – Lamps; lights for vehicles; germicidal lamps for purifying air; curling lamps; acetylene flares; cooking apparatus and installations; lava rocks for use in barbecue grills; refrigerators; air purifying apparatus and machines; hair dryers; water heaters; fog machines for stage use; heating installations; watering installations; automatic solar water heaters; filters for drinking water; radiators, electric; lighters; polymerisation installations.

12 – Locomotives; cars; bicycles; pumps for bicycle tires; strollers; carts; tires for vehicle wheels; repair outfits for inner tubes; civilian drones; launches; safety seats for children, for vehicles; electric vehicles; camera drones; funiculars; remote control vehicles, other than toys.

18 – Moleskin [imitation of leather]; travelling bags; bags for sports; wrist-mounted wallets; straps for skates; reins for guiding children; frames for umbrellas or parasols; mountaineering sticks; clothing for pets.

21 – Cooking pans, non-electric; food preserving jars of glass; earthenware saucepans; works of art of porcelain, ceramic, earthenware, terra-cotta or glass; drinking bottles for sports; perfume burners; electric combs; dishwashing brushes; hair for brushes; toothbrushes, electric; floss for dental purposes; cosmetic utensils; insulating flasks; mops; opaline glass; birdcages; indoor terrariums [vivariums]; plug-in diffusers for mosquito repellents; nozzles for watering hose.

28 – Protective films adapted for screens for portable games; slides [playthings]; smart toys; chess games; playing balls; body-building apparatus; electronic targets; skateboards; hunting game calls; swimming pools [play articles]; plastic running tracks; elbow guards [sports articles]; in-line roller skates; christmas tree stands; fishing tackle; twirling batons; camouflage screens [sports articles]; scratch cards for playing lottery games; games.

(260) AM 2020 105091 A
(800) 1489281
(151) 2019 05 29

(891) 2019 05 29

(731) Magdi Kamel Abdelmaksoud Megahed
Elkiran – Elmagd For Import & Export
Mahmoud Abdel Azim Street, Tmahy Square;
The first Mansoura-Dakahlia, Egypt

(540)



(591) Light brown, red, green, white and black

(531) 05.07.17; 26.04.03; 26.04.04; 26.04.18;
26.04.24; 28.01; 29.01.15

(511)

16 – Paper and cardboard, printed matter, bookbinding material, photographs, stationery and office requisites, except furniture, adhesives for stationery or household purposes, drawing materials and materials for artists, paintbrushes, instructional and teaching materials, plastic sheets, films and bags for wrapping and packaging, printers' type, printing blocks.

(260) AM 2020 105092 A

(800) 1489297

(151) 2019 03 15

(891) 2019 03 15

(731) FIDIA FARMACEUTICI S.p.A.

Via Ponte della Fabbrica, 3/A, I-35031
Abano Terme (PD), Italy

(540)

FIDIA

(591) Black, white

(511)

3 – Non-medicated cosmetics and toiletry preparations; non-medicated dentifrices; perfumery, essential oils; bleaching preparations and other substances for laundry use; cleaning, polishing, scouring and abrasive preparations; non-medicated soaps; shampoos; hair lotions.

5 – Pharmaceutical, medical and veterinary preparations; sanitary preparations for medical purposes; dietetic food and substances adapted for medical or veterinary use, food for babies; dietary supplements for human beings and animals; plasters, materials for dressings; material for stopping teeth, dental wax; disinfectants; preparations for destroying vermin; fungicides, herbicides; medicines; parapharmaceutical products; nutritional supplements; pre-filled syringes for medical purposes; surgical implants comprised of living tissues.

- (260) AM 2020 105094 A
 (800) 1489311
 (151) 2019 07 03
 (891) 2019 07 03
 (731) ASTRA ENERGY SA
 31, boulevard Helvetique, CH-1207 Geneva,
 Switzerland
 (540)

NATUROLEA

- (591) Black, white
 (511)
 29 – Oils for food; sunflower oil for food.

- (260) AM 2020 105095 A
 (800) 1489325
 (151) 2019 04 01
 (891) 2019 04 01
 (731) AZERBAIJAN STATE UNIVERSITY OF
 ECONOMICS (UNEC)
 Istiqlaliyyat Sk 6, AZ-1001 Bakü, Azerbaijan
 (540)



- (591) Blue, white
 (531) 01.05.01; 20.05.07; 20.07.01; 24.15.01;
 25.01.06; 26.01.03
 (511)
 9 – Measurement apparatus and equipment including those for scientific, nautical, topographic, meteorologic, industrial and laboratory purposes, thermometers, not for medical purposes, barometers, ammeters, voltmeters, hygrometers, testing apparatus not for medical purposes, telescopes, periscopes, directional compasses, speed indicators, laboratory apparatus, microscopes, magnifying glasses, stills, binoculars, ovens and furnaces for laboratory experiments; apparatus for recording, transmission or reproduction of sound or images, cameras, photographic cameras, television apparatus, video recorders; CD and DVD players and recorders; MP3 players, computers, desktop computers, tablet computers, wearable technological devices, namely smart watches, smart wristbands, head-mounted cameras; microphones, loudspeakers, earphones, telecommunications apparatus, apparatus for the reproduction of sound or images, computer peripheral devices, cell phones, covers for cell phones, telephone apparatus, computer printers, scanners [data processing equipment], photocopiers; magnetic and optic data carriers and computer software and programmes recorded there-

to, downloadable and recordable electronic publications, encoded magnetic and optic cards; movies, tv series and video music clips recorded on magnetic, optical and electronic media; antennas, satellite antennas, amplifiers for antennas, parts of the aforementioned goods; ticket dispensers, automatic teller machines (ATM); electronic components used in the electronic parts of machines and apparatus, semiconductors, electronic circuits, integrated circuits, chips [integrated circuits], diodes, transistors [electronic], magnetic heads for electronic apparatus, electronic locks, photocells, remote control apparatus for opening and closing doors, optical sensors; counters and quantity indicators for measuring the quantity of consumption, automatic time switches; clothing for protection against accidents, irradiation and fire, safety vests and life-saving apparatus and equipment; eyeglasses, sunglasses, optical lenses and cases, containers, parts and components thereof; apparatus and instruments for conducting, transforming, accumulating or controlling electricity, electric plugs, junction boxes [electricity], electric switches, circuit breakers, fuses, lighting ballasts, battery starter cables, electrical circuit boards, electric resistances, electric sockets, transformers [electricity], electrical adapters, battery chargers, electric door bells, electric and electronic cables, batteries, electric accumulators, solar panels for production of electricity; alarms and anti-theft alarms, other than for vehicles, electric bells; signalling apparatus and instruments, luminous or mechanical signs for traffic use; fire extinguishing apparatus, fire engines, fire hose and fire hose nozzles; radar apparatus, sonars, night vision apparatus and instruments; decorative magnets; metronomes.

16 – Paper and cardboard; paper and cardboard for packaging and wrapping purposes, cardboard boxes; paper towels; toilet paper; paper napkins; plastic materials for packaging and wrapping purposes; printing blocks and types; bookbinding material; printed publications; printed matter; books, magazines, newspapers, bill books, printed dispatch notes, printed vouchers, calendars; posters; photographs [printed]; paintings; stickers [stationery]; postage stamps; stationery, office stationery, instructional and teaching material [except furniture and apparatus]; writing and drawing implements; artists' materials; paper products for stationery purposes; adhesives for stationery purposes, pens, pencils, erasers, adhesive tapes for stationery purposes, cardboard cartons [artists' materials], writing paper, copying paper, paper rolls for cash registers, drawing materials, chalkboards, painting pencils, watercolors [paintings]; office requisites; paint rollers and paintbrushes for painting.

35 – Advertising, marketing and public relations; organization of exhibitions and trade fairs for commercial or advertising purposes; design for advertising;

provision of an online marketplace for buyers and sellers of goods and services; office functions; secretarial services; arranging newspaper subscriptions for others; compilation of statistics; rental of office machines; systemization of information into computer databases; telephone answering for unavailable subscribers; business management, business administration and business consultancy; accounting; commercial consultancy services; personnel recruitment, personnel placement, employment agencies, import-export agencies; temporary personnel placement services; auctioneering; the bringing together, for the benefit of others, of a variety of goods, namely, measurement apparatus and equipment including those for scientific, nautical, topographic, meteorologic, industrial and laboratory purposes, thermometers, not for medical purposes, barometers, ammeters, voltmeters, hygrometers, testing apparatus not for medical purposes, telescopes, periscopes, directional compasses, speed indicators, laboratory apparatus, microscopes, magnifying glasses, stills, binoculars, ovens and furnaces for laboratory experiments, apparatus for recording, transmission or reproduction of sound or images, cameras, photographic cameras, television apparatus, video recorders, CD and DVD players and recorders, MP3 players, computers, desktop computers, tablet computers, wearable technological devices (smart watches, wristbands, head-mounted devices), microphones, loudspeakers, earphones, telecommunications apparatus, apparatus for the reproduction of sound or images, computer peripheral devices, cell phones, covers for cell phones, telephone apparatus, computer printers, scanners [data processing equipment], photocopiers, magnetic and optic data carriers and computer software and programmes recorded thereto, downloadable and recordable electronic publications, encoded magnetic and optic cards, movies, tv series and video music clips recorded on magnetic, optical and electronic media, antennas, satellite antennas, amplifiers for antennas, parts of the aforementioned goods, ticket dispensers, automatic teller machines (ATM), electronic components used in the electronic parts of machines and apparatus, semi-conductors, electronic circuits, integrated circuits, chips [integrated circuits], diodes, transistors [electronic], magnetic heads for electronic apparatus, electronic locks, photocells, remote control apparatus for opening and closing doors, optical sensors, counters and quantity indicators for measuring the quantity of consumption, automatic time switches, clothing for protection against accidents, irradiation and fire, safety vests and life-saving apparatus and equipment, eyeglasses, sunglasses, optical lenses and cases, containers, parts and components thereof, apparatus and instruments for conducting, transforming, accumulating or controlling electricity, electric plugs, junction boxes [electricity], electric switches, circuit breakers, fuses, lighting ballasts, battery starter cables, electrical cir-

cuit boards, electric resistances, electric sockets, transformers [electricity], electrical adapters, battery chargers, electric door bells, electric and electronic cables, batteries, electric accumulators, solar panels for production of electricity, alarms and anti-theft alarms, other than for vehicles, electric bells, signalling apparatus and instruments, luminous or mechanical signs for traffic use, fire extinguishing apparatus, fire engines, fire hose and fire hose nozzles, radar apparatus, sonars, night vision apparatus and instruments, decorative magnets, metronomes, paper and cardboard, paper and cardboard for packaging and wrapping purposes, cardboard boxes, paper towel, toilet paper, paper napkins, plastic materials for packaging and wrapping purposes, printing blocks and types, bookbinding material, printed publications, printed matter, books, magazines, newspapers, bill books, printed dispatch notes, printed vouchers, calendars, posters, photographs [printed], paintings, stickers [stationery], postage stamps, stationery, office stationery, instructional and teaching material [except furniture and apparatus], writing and drawing implements, artists' materials, paper products for stationery purposes, adhesives for stationery purposes, pens, pencils, erasers, adhesive tapes for stationery purposes, cardboard cartons [artists' materials], writing paper, copying paper, paper rolls for cash registers, drawing materials, chalkboards, painting pencils, watercolors [paintings], office requisites, paint rollers and paintbrushes for painting, enabling customers to conveniently view and purchase those goods, such services may be provided by retail stores, wholesale outlets, by means of electronic media or through mail order catalogues.

41 – Education and training; arranging and conducting of conferences, congresses and seminars; sporting and cultural activities; entertainment; ticket reservation and booking services for entertainment, sporting and cultural events, including ticket reservation and booking services for theatres, cinemas, museums and concerts; publication and editing of printed matter, including magazines, books, newspapers, other than publicity texts; electronic publication services; production of movie films, radio and television programmes; news reporters services; photographic reporting services; photography; translation.

42 – Scientific and industrial analysis and research services; engineering; engineering and architectural design services; testing services for the certification of quality and standards; computer services, namely, computer programming, computer virus protection services, computer system design, creating, maintaining and updating websites for others, computer software design, updating and rental of computer software, providing search engines for the Internet, hosting websites, consultancy in the design and development of computer hardware, rental of computer

hardware; industrial design services, other than engineering, computer and architectural design; graphic arts designing; authenticating works of art.

(260) AM 2020 105096 A

(800) 1489375

(151) 2019 04 05

(891) 2019 04 05

(731) MAKITA CORPORATION

3-11-8, Sumiyoshi-cho, Anjo-shi, Aichi

446-8502, Japan

(540)

Makita

(591) Black, white

(531) 27.05.17; 27.05.19

(511)

4 – Fuels; mineral oils and greases for industrial purposes [not for fuel]; non-mineral oils and greases for industrial purposes [not for fuel]; engine oils; chain oils; lubricating oils [industrial lubricants]; lubricating grease; industrial greases; waxes [raw material]; liquid fuels; gaseous fuels; solid fuels; mixed gasoline; gasoline; solid lubricants.

6 – Loading and unloading pallets of metal; turntables for load handling; traversers for load handling; artificial fish reefs of metal; prefabricated sectional poultry houses of metal; paint spraying booths of metal; metal moulds for forming cement products; railway points; road signs of metal [not luminous nor mechanical]; beacons of metal [non-luminous]; liquid storage tanks or reservoirs of metal; industrial water storage tanks of metal; liquefied gas storage tanks of metal; gas storage tanks of metal; internal floating lids of aluminium for use with gas or liquefied gas storage tanks of metal; pulleys of metal, not machine elements; springs of metal, not machine elements; valves of metal, not machine elements; metal junctions for pipes; metal flanges; machine keys; cotter pins; nails; cut nails; wedges and pegs of metal; tacks of metal; screws; bolts of metal; nuts of metal; washers of metal; rivets; washers of metal; stud screws with external threading of metal; plugs of metal; anvils; swage blocks; water tanks of metal for household purposes; steps [ladders] of metal; portable buildings of metal.

7 – Metalworking machines and tools; power-driven hand-held tools; mining machines and apparatus; construction machines and apparatus; loading-unloading machines and apparatus; industrial fishing machines; chemical processing machines and apparatus; textile machines and apparatus; food or beverage NOTIFICATION (continued) processing machines and apparatus; lumbering, woodworking, or veneer or plywood making machines and appara-

tus; pulp making, papermaking or paper-working machines and apparatus; printing or bookbinding machines and apparatus; sewing machines; plowing machines and implements, other than hand-held tools; cultivating machines and implements; harvesting machines and implements; plant fiber processing machines and implements for agricultural purposes; fodder presses; fodder cutting machines [feed cutters]; fodder mixing machines [feed mixers]; cake-fodder crushing machines [feed mills]; milk filtering machines; milking machines; chick brooders; incubators for eggs; sericultural machines and implements; shoe making machines; leather tanning machines; tobacco processing machines; glassware manufacturing machines and apparatus; painting machines and apparatus; packaging or wrapping machines and apparatus; poweroperated potters' wheels; plastic processing machines and apparatus; semiconductor manufacturing machines and systems; machines and apparatus for manufacturing rubber goods; stone working machines and apparatus; non-electric prime movers, not for land vehicles, other than water mills and wind mills; parts for non-electric prime movers for land vehicles; water mills; wind mills; pneumatic or hydraulic machines and instruments; adhesive tape dispensing machines; automatic stamping machines; washing machines for industrial purposes [laundry]; repairing or fixing machines and apparatus; mechanical parking systems; vehicle washing installations; stirring and mixing machines for industrial purposes; food peeling machines for commercial use; dishwashers for industrial purposes; food cutting, chopping and slicing machines for commercial use; electric wax-polishing machines for industrial purposes; vacuum cleaners for industrial purposes; lawnmowers; curtain drawing devices electrically operated; waste compacting machines and apparatus; waste crushing machines; shafts, axles, spindles, bearings, couplings or connectors, machine elements other than land vehicles; power transmissions and gearing, machine elements not for land vehicles; shock absorbers, machine elements not for land vehicles; springs, machine elements not for land vehicles; brakes, machine elements not for land vehicles; valves, machine elements not for land vehicles; soil improving machines containing soil agitation function; transplanting machines and implements; cultivators [machines], other than hand-held tools; hedge trimmers, spraying machines, spreading machines, mowing machines, lawn mowers and other agricultural and forestry machines; agricultural machines and agricultural implements, other than hand-operated; rice polishing machines; chain saws; power sprayers for disinfecting, insecticides and deodorants [not for agricultural purposes]; generators not for land vehicles; pile drivers; lifting apparatus used upon being attached to vehicles; lifting apparatus used upon being attached to fire engines; vacuum cleaners; snow ploughs; electric arc welding

machines; electric metal cutting machines (by arc, gas or plasma); electric welding apparatus [for metalworking]; vending machines; electric door openers; fuel dispensing machines for service stations.

8 – Braiders [hand-held ones only]; hoes [hand-held]; digging forks [spading forks]; lawn rakes [hand-held ones only]; lasts for shoe-making [hand-held ones only]; electric razors and electric hair clippers; bladed or pointed hand tools and swords; hand tools, hand operated, other than bladed or pointed hand tools; scissors; planes; saws [hand-operated]; knives; hammers [hand tools]; spanners [hand tools]; screwdrivers, non-electric; wrenches [hand tools]; egg slicers, non-electric; non-electric planes for flaking dried bonito blocks [Katsuo-bushi planes]; can openers, non-electric; spoons; cheese slicers, non-electric; pizza cutters, non-electric; forks [cutlery]; flat irons [non-electric]; dressmakers' chalk sharpeners; fire pans for carrying live charcoal [Juno]; fire-plate bellows [hand-tools]; fire tongs; bludgeons; insecticide sprayers [hand-held ones only]; shaving cases; pedicure sets; eyelash curlers; manicure sets; palette knives; carpenters' inkpots and their accessories; razor strops [leather strops]; sharpening steels; whetstones [sharpening stones]; electric flat irons.

9 – Ozonisers [ozonators]; electrolyzers [electrolytic cells]; egg-candlers; cash registers; coin counting or sorting machines; job recording devices; photo-copying machines; calculating machines, hand-operated; mathematical instruments; time and date stamping machines; time clocks [time recording devices]; punched card office machines; voting machines; billing machines; postage stamp checking apparatus; mechanisms for coin-operated car parking gates; life saving apparatus and equipment; fire extinguishers; fireplugs; fire hose nozzles; sprinkler systems for fire protection; fire alarms; gas alarms; anti-theft warning apparatus; protective helmets; railway signal apparatus, luminous or mechanical; vehicle breakdown warning triangles; luminous or mechanical road signs; simulators for the steering and control of vehicles; sports training simulators; laboratory apparatus and instruments; photographic machines and apparatus; cinematographic machines and apparatus; optical machines and apparatus; measuring or testing machines and instruments; laser level measuring apparatus; power distribution or control machines and apparatus; rotary converters; phase modifiers; batteries and cells; electric or magnetic meters and testers; electric wires and cables; electric buzzers; telecommunication machines and apparatus; electronic machines, apparatus and their parts; magnetic cores; resistance wires; electrodes, other than welding electrodes or medical electrodes; fire boats; satellites for scientific purposes; fire engines; gloves for protection against accidents; dust masks; gas masks; welding masks; fireproof garments; spectacles [ey-

eglasses and goggles]; electronic circuits and CD-ROMs recorded with programs for hand-held games with liquid crystal displays; phonograph records; metronomes; electronic circuits and CD-ROMs recorded with automatic performance programs for electronic musical instruments; slide-rules; exposed cinematographic films; exposed slide films; slide film mounts; recorded video discs and video tapes; electronic publications; cell phone battery chargers; battery chargers for motor vehicles; electric batteries and battery chargers for lawn mowers and gardening tools; power adapters for battery chargers; battery chargers for power tools; automatic fire extinguishing apparatus; protective goggles; protective face shields other than goggles; accumulators [batteries]; battery chargers; power distribution or control machines and apparatus; fire pumps; loudspeakers; radios; television apparatus; wall scanners; laser distance meters.

11 – Drying apparatus [for chemical processing]; recuperators [for chemical processing]; steamers [for chemical processing]; evaporators [for chemical processing]; distillers [for chemical processing]; heat exchangers [for chemical processing]; milk sterilizers; industrial furnaces; nuclear reactors [atomic piles]; forage drying apparatus; boilers, other than parts of non-electric prime movers or engines; air-conditioning apparatus [for industrial purposes]; freezing machines and apparatus; laundry dryers, electric, for industrial purposes; cooking apparatus and installations for commercial use; dish drying machines for commercial use; waste water treatment tanks for industrial purposes; septic tanks for industrial purposes; garbage incinerators for industrial purposes; solar water heaters; water purifying apparatus; tap water faucets; level controlling valves for tanks; pipe line cocks; electric lamps and other lighting apparatus; light projectors; deodorizing apparatus, not for personal use; negative ion generation type air purifiers; cool boxes, electric; household electrothermic appliances; coffee machines, electric; blankets, electric, not for medical purposes; electric fans; refrigerators; microwave ovens [cooking apparatus]; thermo-pots, electric.

12 – Ropeways for cargo or freight handling; tipping apparatus, parts of railway freight cars; pusher cars for mining; puller cars for mining; traction engine; non-electric prime movers for land vehicles [not including "their parts"]; parachutes; antitheft alarms for vehicles; shafts, axles, spindles, bearings, couplings or connectors, machine elements for land vehicles; power transmissions and gearing, machine elements for land vehicles; shock absorbers and springs, machine elements for land vehicles; brakes, machine elements for land vehicles; cigar lighters for automobiles; transport vehicles for used in the field of agriculture and forestry; two-wheeled motor vehicles, bicycles and their parts and fittings; electric bi-

cycles and their parts and fittings; trolleys; bicycle trailers [Riyakah]; electric cargo carrier; rickshaws; sleighs and sleds [vehicles]; carts; horse drawn carriages; AC motors or DC motors for land vehicles, not including their parts; wheelchairs; baby carriage [prams]; traction engine; pumps for inflating bicycle tires.

18 – Suitcases; carry-on bags; trunks; boston bags; rucksacks; shopping bags; key cases; wallets; commutation-ticket holders; business card cases; bags; pouches; umbrellas and their parts; beach umbrellas [beach parasols]; vanity cases, not fitted; handbag frames; purse frames; attache cases.

20 – Loading pallets, not of metal; beehives [hive boxes or honeycombs]; hairdresser's chairs; barbers' chairs; liquid storage tanks or reservoirs, not of metal or masonry; industrial water storage tanks, not of metal or masonry; liquefied gas storage tanks, not of metal or masonry; gas storage tanks, not of metal or masonry; valves of plastics, not including machine elements; tool boxes, not of metal; industrial packaging containers of plastics; tool boxes of plastic, empty.

21 – Tub brushes; metal brushes; brushes for pipes; industrial brushes; ship-scrubbing brushes; sprinklers for gardening consisting of water spraying nozzles, watering hoses, hose winders and faucet connectors for hoses; portable cool boxes, non-electric; portable coldboxes [non-electric]; food preserving jars of glass; drinking flasks for travelers; vacuum bottles [insulated flasks]; heat-insulated containers for beverages; thermally insulated containers for food; coffee-makers, non-electric; food storage jars; plastic insulated cooling food containers; industrial packaging bottles of plastics; kitchen utensils and containers, not including gas water heaters for household use, non-electric cooking heaters for household purposes, kitchen worktops and kitchen sinks; cleaning tools and washing utensils; home gardening gloves; gloves for household purposes; gotoku [trivets for Japanese charcoal heaters for household purposes]; Japanese charcoal extinguishers [Hikeshitsubo]; sugar tongs; nutcrackers, not of precious metal; mags made of china, ceramic, glass and plastic; dustbins.

25 – Working clothing; jackets; jackets containing heating mechanism; jackets with cooling fan; polo shirts; trousers; coats; sport shirts; socks and stockings other than special sportswear; gloves and mittens [clothing]; neckties; bandanas [neckerchiefs]; mufflers; headgear for wear; clothing; belts for clothing; shoes and boots; boots, other than boots for sports; sneaker; footwear [other than special footwear for sports]; clothes for sports; special footwear for sports.

30 – Prepared coffee and coffee-based beverages; unroasted coffee beans; tea.

37 – Repair of power-driven hand-held tools; repair of blowers; repair of air plasma cutting machines; repair of air compressors; repair of agitators; repair of concrete vibrators; repair of high pressure washers; repair of electric welding machines; repair of rechargeable electric welding machines; repair of mowing machines; repair of scissors for tall branch; repair of desk drilling machines for metalworking; repair of vacuum cleaners; repair of dust catchers; repair of air plasma welding machines; repair of power generators; repair of winches; repair of pressure boosting machines; repair of chain hoist; repair of welding machines driven by engine powers; repair of power-driven mowing machines; repair of lawn mowers; repair of agrochemicals sprayers; repair of electric curtain rails; repair of pumps; repair of work benches for power-driven cutters; construction consultancy; repair or maintenance of building equipment; shipbuilding; repair or maintenance of vessels; repair or maintenance of aircrafts; repair of bicycles; repair or maintenance of automobiles; repair or maintenance of railway rolling stocks; repair or maintenance of two-wheeled motor vehicles; repair or maintenance of cinematographic machines and apparatus; repair or maintenance of optical machines and apparatus; repair or maintenance of photographic machines and apparatus; repair or maintenance of loading-unloading machines and apparatus; repair or maintenance of fire alarms; repair or maintenance of office machines and equipment; repair or maintenance of air-conditioning apparatus [for industrial purposes]; repair or maintenance of burners; repair or maintenance of boilers; repair or maintenance of freezing machines and apparatus; repair or maintenance of electronic machines and apparatus; repair or maintenance of telecommunication machines and apparatus; repair or maintenance of construction machines and apparatus; repair or maintenance of consumer electric appliances; repair or maintenance of electric lighting apparatus; repair or maintenance of power distribution or control machines and apparatus; repair or maintenance of electric motors; repair or maintenance of laboratory apparatus and instruments; repair or maintenance of measuring and testing machines and instruments; repair or maintenance of medical apparatus and instruments; repair or maintenance of firearms; repair or maintenance of printing or bookbinding machines and apparatus; repair or maintenance of chemical processing machines and apparatus; repair or maintenance of glassware manufacturing machines and apparatus; repair or maintenance of fishing machines and instruments; repair or maintenance of metalworking machines and tools; repair or maintenance of shoe making machines; repair or maintenance of industrial furnaces; repair or maintenance of mining machines and apparatus; repair or maintenance of rubber- NOTIFICATION (continued) goods manufacturing machines and apparatus; repair or maintenance of integ-

rated circuits manufacturing machines and systems; repair or maintenance of semiconductor manufacturing machines and systems; repair or maintenance of machines and apparatus for processing foods or beverages; repair or maintenance of machines and apparatus for lumbering, woodworking, or veneer or plywood making; repair or maintenance of textile machines and apparatus; repair or maintenance of tobacco processing machines; repair or maintenance of painting machines and apparatus; repair or maintenance of agricultural machines and implements; repair or maintenance of machines and apparatus for pulp-making, papermaking or paper-working; repair or maintenance of plastic processing machines and apparatus; repair or maintenance of packaging or wrapping machines and apparatus; repair or maintenance of sewing machines; repair or maintenance of reservoirs; repair or maintenance of gasoline station equipment; repair or maintenance of mechanical parking systems; repair or maintenance of bicycle parking apparatus; repair or maintenance of industrial dishwashers; repair or maintenance of cooking equipment for industrial purposes; repair or maintenance of electric washing machines for industrial purposes; repair or maintenance of vehicle washing installations; repair or maintenance of vending machines; repair or maintenance of power-driven floor cleaning machines; repair or maintenance of amusement machines and apparatus; repair or maintenance of apparatus and instruments for use in beauty salons or barbers' shops; repair or maintenance of water pollution control equipment; repair or maintenance of water purifying apparatus; repair or maintenance of waste compacting machines and apparatus; repair or maintenance of waste crushing machines; repair or maintenance of divers' apparatus; repair or maintenance of nuclear power plants; repair or maintenance of chemical plants; furniture restoration; umbrella repair; repair or maintenance of musical instruments; safe maintenance or repair; shoe repair; clock and watch repair or maintenance; sharpening of scissors and kitchen knives; setup or repair of locks; repair or maintenance of gas water heaters; repair or maintenance of non-electric cooking heaters; repair or maintenance of cooking pots and pans; repair or maintenance of signboards; repair of bags or pouches; repair of personal ornaments; repair of toys or dolls; repair of sports equipment; repair of billiard equipment; repair of game machines and apparatus; repair or maintenance of bath fittings; repair of toilet stool units with a washing water squirts; repair of fishing tackle; repair of spectacles; fur care and repair; laundering; pressing of clothing; clothing repair [mending clothing]; fluffing of cotton batting for futon; repair of tatami mats; chimney sweeping; cleaning of building exterior surfaces; window cleaning; carpet and rug cleaning; floor polishing; septic tank cleaning; bathtub and bath boiler cleaning; street cleaning; reservoirs cleaning; disinfecting of

telephone hand-sets; vermin exterminating [other than for agriculture, horticulture and forestry]; sterilization of medical apparatus and instruments; rental of construction machines and apparatus; rental of floor cleaning machines; rental of mops; rental of car-washing apparatus; rental of electric washing machines; rental of laundry dryers; rental of spin dryers for clothes; rental of mining machines and apparatus.

(260) AM 2020 105097 A

(800) 1489384

(151) 2019 07 01

(891) 2019 07 01

(731) INMAXO HOLDINGS LTD.

Amathountos 5, Pirilides Building, CY-3105
Limassol, Cyprus

(540)

KORVUS

(591) Black, white

(531) 27.05.01

(511)

2 – Paints, varnishes, lacquers; preservatives against rust and against deterioration of wood; colorants, dyes; mordants; natural resins, raw; metals in foil and powder form for use in painting, decorating, printing and art; annatto [dyestuff]; auramine; Canada balsam; white lead; paper for dyeing Easter eggs; binding preparations for paints; glazes [paints, lacquers]; litharge; primers; gamboge for painting; titanium dioxide [pigment]; repositionable paint patches; indigo [colorant]; gum resins; colophony; caramel [food colorant]; carbonyl [wood preservative]; cochineal carmine; copal; alizarine dyes; aniline dyes; ink for leather; colorants for liqueurs; colorants for beverages; shoe dyes; colorants for beer; colorants for butter; ink for skin-dressing; dyewood; malt colorants; food dyes; colorants; printing toner; aluminium paints; asbestos paints; bactericidal paints; wood stains; ceramic paints; marking ink for animals; distempers; fireproof paints; printing ink; engraving ink; enamels for painting; creosote for wood preservation; turmeric [colorant]; black japan; bitumen varnish; bronzing lacquers; copal varnish; anti-corrosive bands; anti-rust oils; oils for the preservation of wood; mastic [natural resin]; lime wash; cobalt oxide [colorant]; zinc oxide [pigment]; silver paste; printers' pastes [ink]; pigments; coatings [paints]; coatings for roofing felt [paints]; wood coatings [paints]; undercoating for vehicle chassis; anti-fouling paints; varnishes; aluminium powder for painting; bronze powder for painting; silvering powders; metals in powder form for use in painting, decorating, printing and art; anti-corrosive preparations; protective preparations for metals; wood mordants; mordants for leather; thinners for paints; thinners for

lacquers; whitewash; soot [colorant]; carbon black [pigment]; lamp black [pigment]; sandarac; thickeners for paints; sienna earth; siccatives [drying agents] for paints; anti-rust greases; malt caramel [food colorant]; badigeon; anti-tarnishing preparations for metals; anti-rust preparations; wood preservatives; sumac for varnishes; minium; turpentine [thinner for paints]; toner for printers and copiers; fixatives [varnishes]; fixatives for watercolors; metal foil for use in painting, decorating, printing and art; yellowwood [colorant]; saffron [colorant]; gum-lac; dyewood extracts; enamels [varnishes]; silver emulsions [pigments].

3 – Bleaching preparations and other substances for laundry use; cleaning, polishing, scouring and abrasive preparations; soap; perfumery, essential oils, cosmetics, hair lotions; non-medicated dentifrices; abrasives; amber [perfume]; descaling preparations for household purposes; antistatic preparations for household purposes; aromatics [essential oils]; air fragrancing preparations; cake flavorings [essential oils]; flavorings for beverages [essential oils]; breath freshening sprays; canned pressurized air for cleaning and dusting purposes; balms, other than for medical purposes; lip glosses; polishing stones; abrasive paper; emery paper; polishing paper; petroleum jelly for cosmetic purposes; shoe wax; cobblers' wax; cotton wool for cosmetic purposes; sachets for perfuming linen; drying agents for dishwashing machines; adhesives for cosmetic purposes; scented water; Javelle water; lavender water; toilet water; non-slipping wax for floors; depilatory wax; mustache wax; tailors' wax; polish for furniture and flooring; shoemakers' wax; polishing wax; massage gels, other than for medical purposes; heliotropine; dental bleaching gels; geraniol; make-up; deodorants for pets; deodorants for human beings or for animals; scented wood; perfumes; non-slipping liquids for floors; windshield cleaning liquids; greases for cosmetic purposes; volcanic ash for cleaning; perfumery; decorative transfers for cosmetic purposes; ionone [perfumery]; shaving stones [astringents]; smoothing stones; eyebrow pencils; cosmetic pencils; silicon carbide [abrasive]; carbides of metal [abrasives]; alum stones [astringents]; tripoli stone for polishing; adhesives for affixing false eyelashes; adhesives for affixing false hair; quillaia bark for washing; corundum [abrasive]; beard dyes; colorants for toilet purposes; cosmetic dyes; laundry starch; laundry glaze; creams for leather; polishing creams; cosmetic creams; skin whitening creams; polishing rouge; incense; hair spray; nail polish; lotions for cosmetic purposes; after-shave lotions; beauty masks; oils for perfumes and scents; oils for cosmetic purposes; oils for toilet purposes; essential oils; essential oils of cedarwood; essential oils of lemon; oils for cleaning purposes; bergamot oil; gaultheria oil; jasmine oil; lavender oil; almond oil; rose oil; oil

of turpentine for degreasing; whitening; cleaning chalk; almond milk for cosmetic purposes; cleansing milk for toilet purposes; musk [perfumery]; deodorant soap; shaving soap; soap for brightening textile; cakes of toilet soap; non-medicated soaps; antiperspirant soap; soap for foot perspiration; almond soap; mint for perfumery; cosmetic kits; emery; nail art stickers; false nails; eau de Cologne; bases for flower perfumes; cotton sticks for cosmetic purposes; joss sticks; pastes for razor strops; pumice stone; hydrogen peroxide for cosmetic purposes; breath freshening strips; abrasive cloth; glass cloth [abrasive cloth]; lipsticks; pomades for cosmetic purposes; shaving preparations; cosmetic preparations for baths; hair waving preparations; laundry soaking preparations; grinding preparations; douching preparations for personal sanitary or deodorant purposes [toiletries]; body deodorants [perfumery]; smoothing preparations [starching]; color-removing preparations; leather bleaching preparations; denture polishes; mouthwashes, not for medical purposes; cosmetic preparations for slimming purposes; starch glaze for laundry purposes; refurbishing preparations; fabric softeners for laundry use; laundry bleach; dry-cleaning preparations; paint stripping preparations; lacquer-removing preparations; make-up removing preparations; floor wax removers [scouring preparations]; varnish-removing preparations; rust removing preparations; nail care preparations; preparations for cleaning dentures; wallpaper cleaning preparations; preparations for unblocking drain pipes; laundry preparations; aloe vera preparations for cosmetic purposes; sunscreen preparations; color-brightening chemicals for household purposes [laundry]; shining preparations [polish]; make-up powder; diamantine [abrasive]; stain removers; scouring solutions; false eyelashes; tissues impregnated with cosmetic lotions; safrol; laundry blueing; turpentine for degreasing; potpourris [fragrances]; bleaching soda; washing soda, for cleaning; bath salts, not for medical purposes; bleaching salts; fumigation preparations [perfumes]; preservatives for leather [polishes]; ammonia [volatile alkali] [detergent]; astringents for cosmetic purposes; eyebrow cosmetics; make-up preparations; sun-tanning preparations [cosmetics]; hair dyes; neutralizers for permanent waving; preparations to make the leaves of plants shiny; cosmetic preparations for eyelashes; cosmetic preparations for skin care; cosmetics; cosmetics for animals; mascara; detergents, other than for use in manufacturing operations and for medical purposes; degreasers, other than for use in manufacturing processes; bleaching preparations [decolorants] for cosmetic purposes; antiperspirants [toiletries]; talcum powder, for toilet use; emery cloth; cloths impregnated with a detergent for cleaning; shampoos; shampoos for pets; dry shampoos; sandpaper; soda lye; extracts of flowers [perfumes]; ethereal essences; badian essence; mint essence [essential oil].

6 – Cables of metal, non-electric; aluminium; fittings of metal for compressed air lines; fittings of metal for building; white metal; beacons of metal, non-luminous; vats of metal; beams of metal; joists of metal; bottles [metal containers] for compressed gas or liquid air; tin cans; reels of metal, non-mechanical, for flexible hoses; swimming pools [structures] of metal; beryllium [glucinium]; arbours [structures] of metal; blooms [metallurgy]; ingots of common metal; anchors; bolts of metal; eye bolts; casks of metal; mooring buoys of metal; barrels of metal; identification bracelets of metal; bronze; bells for animals; bells; letters and numerals of common metal, except type; silos of metal; busts of common metal; vanadium; bird baths [structures] of metal; valves of metal, other than parts of machines; screws of metal; aviaries [structures] of metal; tungsten; hoppers of metal, non-mechanical; gates of metal; sleeves [metal hardware]; ferrules of metal for handles; signboards of metal; diving boards of metal; loading gauge rods of metal for railway wagons; nuts of metal; galena [ore]; hafnium [celtium]; nails; tacks [nails]; horseshoe nails; germanium; vice claws of metal; doors of metal; chimney pots of metal; memorial plates of metal; chimney shafts of metal; wall plugs of metal; troughs of metal for mixing mortar; packaging containers of metal; containers of metal for storing acids; jalousies of metal; iron strip; iron, unwrought or semi-wrought; roof gutters of metal; tinsplate; door bolts of metal; window fasteners of metal; bolts, flat; binding screws of metal for cables; crampons of metal [cramps]; wheel clamps [boots]; rivets of metal; padlocks; box fasteners of metal; locks of metal for bags; locks of metal for vehicles; locks of metal, other than electric; spring locks; closures of metal for containers; bungs of metal; latches of metal; tension links; couplings of metal for chains; door bells of metal, non-electric; road signs, non-luminous and non-mechanical, of metal; registration plates of metal; signs, non-luminous and non-mechanical, of metal; fences of metal; buckles of common metal [hardware]; bronzes [works of art]; works of art of common metal; hardware of metal, small; indium; cabanas of metal; telephone booths of metal; cadmium; paint spraying booths of metal; telpher cables; ropes of metal; greenhouse frames of metal; framework of metal for building; cornices of metal; skating rinks [structures] of metal; cermets; water-pipe valves of metal; drain traps [valves] of metal; metal cages for wild animals; keys; mooring bollards of metal; cobalt, raw; chill-molds [foundry]; elbows of metal for pipes; bed casters of metal; furniture casters of metal; manifolds of metal for pipelines; pillars of metal for building; casings of metal for oilwells; chimney cowls of metal; bottle caps of metal; sealing caps of metal; tent pegs of metal; pegs of metal; split rings of common metal for keys; copper rings; rings of metal; ferrules of metal; door fittings of metal; fit-

tings of metal for windows; buildings of metal; steel buildings; containers of metal [storage, transport]; guard rails of metal for railways; baskets of metal; door frames of metal; tool boxes of metal, empty; stringers [parts of staircases] of metal; faucets of metal for casks; tubing of metal; roofing of metal; brackets of metal for building; turntables [railways]; manhole covers of metal; pitons of metal; hooks [metal hardware]; pot hooks of metal; hooks of metal for roofing slates; hooks of metal for clothes rails; clothes hooks of metal; chicken-houses of metal; brass, unwrought or semi-wrought; wrapping or binding bands of metal; scaffolding of metal; staircases of metal; ladders of metal; limonite; steel sheets; cast steel; traps for wild animals; magnesium; manganese; reinforcing materials, of metal, for concrete; reinforcing materials of metal for machine belts; reinforcing materials of metal for pipes; reinforcing materials of metal for building; railway material of metal; materials of metal for funicular railway permanent ways; refractory construction materials of metal; masts of metal; steel masts; copper, unwrought or semi-wrought; sheets and plates of metal; common metals, unwrought or semi-wrought; pyrophoric metals; metals in powder form; moldings of metal for cornices; molybdenum; door knockers of metal; pipe muffs of metal; porches [structures] of metal; monuments of bronze for tombs; tombs of metal; flashing of metal for building; roof flashing of metal; fish plates [rails]; anvils; anvils [portable]; beak-irons; ferrules of metal for walking sticks; rope thimbles of metal; handcuffs; jets of metal; duckboards of metal; belt stretchers of metal; stretchers for metal bands [tension links]; wire stretchers [tension links]; stretchers for iron bands [tension links]; nickel silver; nickel; niobium; grease nipples; binding thread of metal for agricultural purposes; thread of metal for tying-up purposes; house numbers of metal, non-luminous; braces of metal for handling loads; wall claddings of metal for building; enclosures of metal for tombs; laths of metal; barrel hoops of metal; wall linings of metal for building; palings of metal; crash barriers of metal for roads; tree protectors of metal; trellis of metal; windows of metal; ironwork for doors; ironwork for windows; tin; shuttering of metal for concrete; filings of metal; poles of metal for power lines; props of metal; branching pipes of metal; monuments of metal; monuments of metal for tombs; wainscotting of metal; signalling panels, non-luminous and non-mechanical, of metal; building panels of metal; partitions of metal; lintels of metal; casement windows of metal; strap-hinges of metal; shims; rocket launching platforms of metal; transport pallets of metal; platforms, prefabricated, of metal; floor tiles of metal; slabs of metal for building; anchor plates; grave slabs of metal; tile floorings of metal; iron slabs; lead seals; loading pallets of metal; handling pallets of metal; fire dogs [andirons]; paving blocks of metal; roof coverings of

metal; linings of metal for building; steel strip; door panels of metal; floors of metal; sills of metal; ceilings of metal; gold solder; silver solder; door openers, non-electric; collars of metal for fastening pipes; winding spools of metal, non-mechanical, for flexible hoses; floating docks of metal, for mooring boats; aluminium wire; iron wire; wire of common metal; wire of common metal alloys, except fuse wire; barbed wire; copper wire, not insulated; soldering wire of metal; steel wire; springs [metal hardware]; rods of metal for welding; rods of metal for brazing and welding; rods of metal for brazing; window frames of metal; frames of metal for building; containers of metal for liquid fuel; containers of metal for compressed gas or liquid air; tanks of metal; floating containers of metal; rails of metal; straps of metal for handling loads; furnace fireguards of metal; grilles of metal; runners of metal for sliding doors; window pulleys; iron ores; ores of metal; chrome ores; door handles of metal; knobs of metal; sheet piles of metal; lead, unwrought or semi-wrought; insect screens of metal; burial vaults of metal; door scrapers; cable joints of metal, non-electric; junctions of metal for pipes; nozzles of metal; anti-friction metal; silver-plated tin alloys; alloys of common metal; sheaf binders of metal; bindings of metal; bottle closures of metal; shutters of metal; outdoor blinds of metal; steel alloys; steel, unwrought or semi-wrought; tinfoil; statues of common metal; figurines of common metal; cask stands of metal; tombstone stelae of metal; bars for metal railings; advertisement columns of metal; posts of metal; telegraph posts of metal; railway points; step stools of metal; slings of metal for handling loads; stair treads [steps] of metal; chests of metal; machine belt fasteners of metal; tombstone plaques of metal; identity plates of metal; tantalum [metal]; greenhouses of metal, transportable; titanium; wire cloth; tom-bac; mobile boarding stairs of metal for passengers; wire rope; pipework of metal; penstock pipes of metal; water-pipes of metal; gutter pipes of metal; ducts of metal for ventilating and air-conditioning installations; drain pipes of metal; chimneys of metal; ducts of metal, for central heating installations; steel pipes; turnstiles of metal; angle irons of metal; tinplate packings; door fasteners of metal; stops of metal; window stops of metal; bicycle parking installations of metal; wind-driven bird-repelling devices made of metal; towel dispensers, fixed, of metal; tungsten iron; molybdenum iron; silicon iron; titanium iron; chrome iron; flanges of metal [collars]; weather- or wind-vanes of metal; aluminium foil; foils of metal for wrapping and packaging; ice moulds of metal; foundry molds of metal; fittings of metal for coffins; fittings of metal for beds; fittings of metal for furniture; building or furniture fittings of nickel-silver; clips of metal for cables and pipes; chromium; cattle chains; chains of metal; safety chains of metal; zinc; zirconium; roofing tiles of metal;

cast iron, unwrought or semi-wrought; washers of metal; balls of steel; hinges of metal; poles of metal; crampons [climbing irons]; cashboxes of metal; safety cashboxes; chests of metal for food; pulleys of metal, other than for machines; railroad ties of metal; window casement bolts; cotter pins of metal; spurs; pins [hardware]; roller blinds of steel; latch bars of metal; badges of metal for vehicles; lock bolts; tool chests of metal, empty; boxes of common metal; letter boxes of metal; safes [metal or non-metal]; pipes of metal; armor-plating of metal.

7 – Machines and machine tools; motors, other than for land vehicles; machine coupling and transmission components, except for land vehicles; vending machines; welding machines, electric; welding apparatus, gas-operated; vulcanization apparatus; acetylene cleaning apparatus; high pressure washers; apparatus for drawing up beer under pressure; apparatus for aerating water; apparatus for aerating beverages; electrical apparatus for sealing plastics [packaging]; electric arc cutting apparatus; electric arc welding apparatus; electric welding apparatus; inking apparatus for printing machines; soldering apparatus, electric; fittings for engine boilers; expansion tanks [parts of machines]; drums [parts of machines]; reels, mechanical, for flexible hoses; brake shoes, other than for vehicles; concrete mixers [machines]; bobbins for weaving looms; harrows; journal boxes [parts of machines]; bulldozers; hoppers [mechanical discharging]; mine borers; railway wagon lifts; rolling mill cylinders; crank shafts; printing rollers for machines; transmission shafts, other than for land vehicles; valves [parts of machines]; fans for motors and engines; saw benches [parts of machines]; winnowers; vibrators [machines] for industrial use; bearings [parts of machines]; water heaters [parts of machines]; bellows [parts of machines]; agitators; exhausts for motors and engines; drilling rigs, floating or non-floating; lawnmowers [machines]; card clothing [parts of carding machines]; emergency power generators; alternators; dynamos; bicycle dynamos; current generators; generators of electricity; hydraulic controls for machines, motors and engines; mufflers for motors and engines; drilling heads [parts of machines]; drilling bits [parts of machines]; cylinder heads for engines; soldering blow pipes, gas-operated; gas-operated blow torches; raking machines; stalk separators [machines]; sieves [machines or parts of machines]; mud catchers and collectors [machines]; tarring machines; hydraulic engines and motors; aeronautical engines; aeroplane engines; engines for air cushion vehicles; compressed air engines; engines for boats; driving motors, other than for land vehicles; propulsion mechanisms, other than for land vehicles; de-aerators for feedwater; disintegrators; tympan [parts of printing presses]; holding devices for machine tools; turf removing ploughs; pump diaph-

ragms; chisels for machines; jacks [machines]; rack and pinion jacks; moving walkways; electric hand drills; crushers, electric, for household purposes; flues for engine boilers; reapers; reapers and binders; millstones; rakes for raking machines; shredders [machines] for industrial use; injectors for engines; incubators for eggs; tools [parts of machines]; hand-held tools, other than hand-operated; air condensers; control cables for machines, engines or motors; capstans; calenders; rotary steam presses, portable, for fabrics; ditchers [ploughs]; carburettors; carriages for knitting machines; crankcases for machines, motors and engines; steamrollers; reels [parts of machines]; pressure valves [parts of machines]; clack valves [parts of machines]; pressure reducers [parts of machines]; can openers, electric; cowlings [parts of machines]; machine wheels; freewheels, other than for land vehicles; scale collectors for machine boilers; lasts for shoes [parts of machines]; brake pads, other than for vehicles; piston segments; grease rings [parts of machines]; reapers and threshers; coal-cutting machines; compressors [machines]; air pumps [garage installations]; compressors for refrigerators; conveyors [machines]; belt conveyors; converters for steelworks; steam condensers [parts of machines]; aerocondensers; diggers [machines]; rams [machines]; thermic lances [machines]; mechanized livestock feeders; boxes for matrices [printing]; gear boxes, other than for land vehicles; grease boxes [parts of machines]; housings [parts of machines]; harvesting machines; steam engine boilers; coffee grinders, other than hand-operated; taps [parts of machines, engines or motors]; cranes [lifting and hoisting apparatus]; roller bridges; water separators; spray guns for paint; cranks [parts of machines]; potters' wheels; grindstones [parts of machines]; cultivators [machines]; soldering lamps; winches; ploughshares; belts for conveyors; igniting magnetos; handling machines, automatic [manipulators]; lubricators [parts of machines]; churns; matrices for use in printing; machine fly-wheels; hair clipping machines for animals; paper machines; blowing machines; knitting machines; galvanizing machines; bending machines; ironing machines; mineworking machines; net hauling machines [fishing]; electroplating machines; bottle sealing machines; sealing machines for industrial purposes; embossing machines; engraving machines; finishing machines; waste disposal units; blade sharpening [stropping] machines; earth moving machines; cord making machines; lace making machines; butter machines; cigarette machines for industrial purposes; sausage making machines; stereotype machines; hosiery looms; grinding machines; dyeing machines; bottle washing machines; dishwashers; bottle filling machines; racket stringing machines; leather-working machines; dairy machines; glass-working machines; tobacco processing machines; grain husking machines; painting machines; oil refining machines; peeling machines; ore treating

machines; printing machines for use on sheet metal; brewing machines; whitewashing machines; road sweeping machines, self-propelled; leather paring machines; bitumen making machines; papermaking machines; pasta making machines, electric; machines for the production of sugar; weeding machines; cinder sifters [machines]; puddling machines; notchers [machine tools]; bread cutting machines; blowing machines for the compression, exhaustion and transport of gases; road making machines; railroad constructing machines; machines for the textile industry; rail-laying machines; bottle capping machines; bottle stoppering machines; packaging machines; blowing machines or fans for the compression, sucking and carrying of grain; waste compacting machines; die-stamping machines; stamping machines; darning machines; milking machines; drainage machines; wrapping machines; grain separators; bookbinding apparatus and machines for industrial purposes; machines and apparatus for cleaning, electric; machines and apparatus for carpet shampooing, electric; machines and apparatus for polishing [electric]; sizing machines; punching machines; riveting machines; kitchen machines, electric; foundry machines; smoothing presses; fleshing machines; rinsing machines; flour mill machines; type-setting machines [printing]; hemming machines; grating machines for vegetables; braiding machines; wringing machines for laundry; cutting machines; steam engines; printing machines; rotary printing presses; compressed air machines; trimming machines; spinning machines; filling machines; friezing machines; cutters [machines]; satinizing machines; agricultural machines; mixing machines; sorting machines for industry; stitching machines; washing machines [laundry]; coin-operated washing machines; clippers [machines]; spinning frames; spin driers [not heated]; looms; kneading machines; typographic machines; type-setting machines [photocomposition]; beating machines; beaters, electric; packing machines; filtering machines; molding machines; carding machines; sewing machines; typecasting machines; electromechanical machines for chemical industry; labellers [machines]; mills [machines]; mills for household purposes, other than hand-operated; pepper mills, other than hand-operated; centrifugal mills; machine wheelwork; feeders [parts of machines]; forge blowers; mixers [machines]; blenders, electric, for household purposes; vacuum cleaner bags; threshing machines; pneumatic hammers; hammers [parts of machines]; tilt hammers; power hammers; reeling apparatus, mechanical; motorized cultivators; motors for boats; clutches, other than for land vehicles; meat choppers [machines]; superchargers; brake linings, other than for vehicles; guides for machines; vacuum cleaner attachments for disseminating perfumes and disinfectants; pumps [machines]; pumps [parts of machines, engines or motors]; aerating pumps for aquaria; vacuum pumps [machines]; compressed air

pumps; pumps for heating installations; beer pumps; lubricating pumps; self-regulating fuel pumps; fuel dispensing pumps for service stations; centrifugal pumps; blades [parts of machines]; knives for mowing machines; chaff cutter blades; knives, electric; shears, electric; scissors, electric; bearing brackets for machines; pulverisers [machines]; axles for machines; steam traps; chucks [parts of machines]; drill chucks [parts of machines]; exhaust manifold for engines; soldering irons, gas-operated; soldering irons, electric; superheaters; gears, other than for land vehicles; reduction gears, other than for land vehicles; drilling machines; saws [machines]; chain saws; guns [tools using explosives]; glue guns, electric; compressed air guns for the extrusion of mastics; carburetter feeders; feeding apparatus for engine boilers; loading ramps; ploughs; pneumatic transporters; hangers [parts of machines]; anti-friction bearings for machines; roller bearings; self-oiling bearings; bearings for transmission shafts; ball-bearings; elevators [lifts]; hoists; lifts, other than ski-lifts; pulleys; saw blades [parts of machines]; pistons [parts of machines or engines]; shock absorber plungers [parts of machines]; pistons for engines; pistons for cylinders; catalytic converters; torque converters, other than for land vehicles; fuel conversion apparatus for internal combustion engines; presses [machines for industrial purposes]; wine presses; basket presses; fodder presses; printing presses; typographic presses; swaging machines; pedal drives for sewing machines; cleaning appliances utilizing steam; food processors, electric; springs [parts of machines]; spinning wheels; punches for punching machines; vacuum cleaners; tambours for embroidery machines; radiators [cooling] for motors and engines; sewage pulverizers; air brushes for applying colour; knives [parts of machines]; cutting blow pipes, gas-operated; blade holders [parts of machines]; loom shafts; gears for weaving looms; belts for machines; elevator belts; fan belts for motors and engines; dynamo belts; belts for motors and engines; adhesive bands for pulleys; industrial robots; kick starters for motorcycles; stuffing boxes [parts of machines]; paper feeders [printing]; whisks, electric, for household purposes; sparking plugs for internal combustion engines; glow plugs for Diesel engines; tedding machines; separators; steam/oil separators; cream/milk separators; ball rings for bearings; sowers [machines]; snow ploughs; sheaf-binding machines; shaft couplings [machines]; fruit presses, electric, for household purposes; chaff cutters; suction cups for milking machines; stands for machines; die-cutting and tapping machines; woodworking machines; sharpening machines; bicycle assembling machines; mortising machines; stone-working machines; metalworking machines; threading machines; planing machines; lathes [machine tools]; milling machines; trueing machines; metal drawing; rolling mills; starters for motors and engines; stators [parts

of machines]; glaziers' diamonds [parts of machines]; tables for machines; derricks; slide rests [parts of machines]; heat exchangers [parts of machines]; transmissions for machines; boiler tubes [parts of machines]; wind turbines; hydraulic turbines; turbo-compressors; connecting rods for machines, motors and engines; joints [parts of engines]; central vacuum cleaning installations; suction machines for industrial purposes; washing installations for vehicles; degreasers [machines]; dust exhausting installations for cleaning purposes; sifting installations; pneumatic tube conveyors; dust removing installations for cleaning purposes; condensing installations; lifting apparatus; air suction machines; dividing machines; igniting devices for internal combustion engines; door closers, electric; washing apparatus; binding apparatus for hay; extractors for mines; door openers, electric; curtain drawing devices, electrically operated; adhesive tape dispensers [machines]; anti-pollution devices for motors and engines; beverage preparation machines, electromechanical; food preparation machines, electromechanical; elevator operating apparatus; control mechanisms for machines, engines or motors; shoe polishers, electric; machines and apparatus for wax-polishing, electric; air cushion devices for moving loads; handling apparatus for loading and unloading; elevating apparatus; aprons [parts of machines]; filter presses; filters for cleaning cooling air, for engines; molds [parts of machines]; printing plates; journals [parts of machines]; centrifugal machines; elevator chains [parts of machines]; cylinders for motors and engines; cylinders for machines; printing cylinders; shuttles [parts of machines]; universal joints [Cardan joints]; pulleys [parts of machines]; vacuum cleaner hoses; brushes [parts of machines]; dynamo brushes; brushes, electrically operated [parts of machines]; carbon brushes [electricity]; ejectors; fuel economisers for motors and engines; excavators; shovels, mechanical; agricultural elevators; electrodes for welding machines; electric hammers; parquet wax-polishers, electric; cartridges for filtering machines; moving staircases [escalators]; automatic grapnels for marine purposes; agricultural implements, other than hand-operated; jet engines, other than for land vehicles; motors, electric, other than for land vehicles; driving chains, other than for land vehicles; transmission chains, other than for land vehicles; filters being parts of machines or engines; door openers, hydraulic; door openers, pneumatic; machines for the mineralization of drinking water; couplings, other than for land vehicles; brake segments, other than for vehicles; pneumatic controls for machines, motors and engines.

8 – Scythe handles; knife handles; glaziers' diamonds [parts of hand tools]; apparatus for tattooing; razors, electric or non-electric; scythe stones; sharpening steels; borers; augers [hand tools]; carpenters'

augers; levers; table forks; weeding forks [hand tools]; lawn clippers [hand instruments]; harpoons; harpoons for fishing; rakes [hand tools]; sand trap rakes; whetstone holders; priming irons [hand tools]; pickhammers; lifting jacks, hand-operated; truncheons; clamps for carpenters or coopers; spades [hand tools]; rabbeting planes; chisels; engraving needles; edge tools [hand tools]; garden tools, hand-operated; abrading instruments [hand instruments]; numbering punches; goffering irons; implements for decanting liquids [hand tools]; depilation appliances, electric and non-electric; sharpening instruments; blade sharpening instruments; livestock marking tools; nail clippers, electric or non-electric; oyster openers; polishing irons [glazing tools]; ear-piercing apparatus; tube cutting instruments; wire strippers [hand tools]; riveters [hand tools]; expanders [hand tools]; cutting tools [hand tools]; hand tools, hand-operated; stamping-out tools [hand tools]; picks [hand tools]; sharpening stones; punch rings [knuckle dusters]; trowels; centre punches [hand tools]; daggers; pickaxes; mallets [hand instruments]; pliers; punch pliers [hand tools]; blades [weapons]; annular screw plates; wrenches [hand tools]; tap wrenches; ladles [hand tools]; foundry ladles [hand tools]; breast drills; lasts [shoemakers' hand tools]; scythe rings; instruments for punching tickets; diggers [hand tools]; rams [hand tools]; scythes; hainault scythes; fire irons; emery grinding wheels; grindstones [hand tools]; sledgehammers; thistle extractors [hand tools]; tree pruners; nail drawers [hand tools]; ice picks; blades [hand tools]; razor blades; blades for planes; plane irons; jig-saws; crow bars; shovels [hand tools]; machetes; beard clippers; hair clippers for personal use, electric and non-electric; hair clippers for animals [hand instruments]; taps [hand tools]; fireplace bellows [hand tools]; swords; hammers [hand tools]; stone hammers; masons' hammers; riveting hammers [hand tools]; mattocks; ditchers [hand tools]; mincing knives [hand tools]; manicure sets; manicure sets, electric; pedicure sets; needle files; bits [hand tools]; files [tools]; emery files; hand pumps; shaving cases; cheese slicers, non-electric; egg slicers, non-electric; pizza cutters, non-electric; scaling knives; molding irons; can openers, non-electric; farriers' knives; budding knives; hunting knives; penknives; grafting tools [hand tools]; braiders [hand tools]; bill-hooks; paring knives; knives; cleavers; wick trimmers [scissors]; cattle shearers; border shears; pruning shears; shears; shearers [hand instruments]; scissors; sword scabbards; vegetable slicers; agricultural implements, hand-operated; stroping instruments; sabres; reamer sockets; drill holders [hand tools]; perforating tools [hand tools]; nail files; nail files, electric; saws [hand tools]; bow saws; tweezers; hair-removing tweezers; guns [hand tools]; guns, hand-operated, for the extrusion of mastics; dies [hand tools]; fruit pickers [hand tools]; saw blades [parts of hand tools]; shear blades; tool

belts [holders]; table cutlery [knives, forks and spoons]; crimping irons; hand implements for hair curling; vegetable choppers; money scoops; instruments and tools for skinning animals; hackles [hand tools]; pin punches; nail punches; fish tapes [hand tools]; punches [hand tools]; insecticide sprayers [hand tools]; syringes for spraying insecticides; reamers; frames for handsaws; saw holders; rasps [hand tools]; cutters; paring irons [hand tools]; graving tools [hand tools]; milling cutters [hand tools]; razor strops; leather strops; planes; marline spikes; bits [parts of hand tools]; hollowing bits [parts of hand tools]; secateurs; silver plate [knives, forks and spoons]; pruning knives; sickles; drawing knives; scrapers [hand tools]; trowels [gardening]; mortise chisels; caulking irons; gouges [hand tools]; mortars for pounding; mitre boxes [hand tools]; branding irons; hatchets; adzes [tools]; vices; hoop cutters [hand tools]; axes; holing axes; fulling tools [hand tools]; earth rammers [hand tools]; tube cutters [hand tools]; squares [hand tools]; extension pieces for braces for screw taps; embossers [hand tools]; stretchers for wire and metal bands [hand tools]; flat irons; irons [non-electric hand tools]; razor cases; ratchets [hand tools]; scraping tools [hand tools]; awls; choppers [knives]; spatulas [hand tools]; palette knives; bayonets; curling tongs; nail nippers; cuticle tweezers; eyelash curlers; side arms, other than firearms; cutlery; table knives, forks and spoons for babies; nail pullers, hand-operated; cutter bars [hand tools]; fullers [hand tools]; screwdrivers, non-electric; apparatus for destroying plant parasites, hand-operated.

17 – Plastics in extruded form for use in manufacture; packing, stopping and insulating materials; flexible pipes, not of metal; shock-absorbing buffers of rubber; cellulose acetate, semi-processed; balata; asbestos paper; paper for electrical capacitors; insulating paper; cotton wool for packing [caulking]; mineral wool [insulator]; asbestos felt; insulating felt; plastic fibers, other than for textile use; asbestos fibers; vulcanized fiber; foam supports for flower arrangements [semi-finished products]; dielectrics [insulators]; lute; insulators; insulators for railway tracks; insulators for electric mains; insulators for cables; asbestos millboards; liquid rubber; synthetic rubber; rubber, raw or semi-worked; valves of india-rubber or vulcanized fiber; clack valves of rubber; rings of rubber; water-tight rings; insulating paints; insulating varnish; latex [rubber]; insulating tapes; adhesive bands, other than stationery and not for medical or household purposes; asbestos sheets; viscose sheets, other than for wrapping; insulating oils; insulating oil for transformers; reinforcing materials, not of metal, for pipes; weatherstripping compositions; brake lining materials, partly processed; soundproofing materials; insulating materials; insulating refractory materials; padding materials of rubber or

plastics; rubber material for recapping tires; non-conducting materials for retaining heat; boiler composition to prevent the radiation of heat; packing [cushioning, stuffing] materials of rubber or plastics; sealant compounds for joints; compositions to prevent the radiation of heat; bags [envelopes, pouches] of rubber, for packaging; pipe muffers, not of metal; sleeves of rubber for protecting parts of machines; asbestos packing; clutch linings; threads of plastic for soldering; threads of plastic materials, other than for textile use; threads of rubber, other than for textile use; elastic threads, other than for textile use; stops of rubber; insulating gloves; plastic substances, semi-processed; insulating plaster; plastic sheeting for agricultural purposes; anti-dazzle films for windows [tinted films]; asbestos coverings; bark coverings for sound insulation; asbestos cloth; rubber stoppers; expansion joint fillers; cylinder jointings; washers of rubber or vulcanized fiber; pipe gaskets; weatherstripping; gaskets; rubber solutions; mica, raw or partly processed; acrylic resins, semi-processed; synthetic resins, semi-processed; pipe couplings, not of metal; substances for insulating buildings against moisture; chemical compositions for repairing leaks; glass wool for insulation; fiberglass for insulation; asbestos fabrics; fiberglass fabrics for insulation; insulating fabrics; hoses of textile material; connecting hose for vehicle radiators; waterproof packings; rubber seals for jars; foils of metal for insulating; ebonite molds; asbestos slate; slag wool [insulator]; watering hose; canvas hose pipes; cords of rubber; asbestos safety curtains; ebonite; fittings, not of metal, for compressed air lines; plastic film, other than for wrapping; filtering materials of semi-processed foams of plastic; sheets of regenerated cellulose, other than for wrapping; self-adhesive tapes, other than stationery and not for medical or household purposes; carbon fibers, other than for textile use; floating anti-pollution barriers.

19 – Materials, not of metal, for building and construction; rigid pipes, not of metal, for building; asphalt, pitch and bitumen; buildings, transportable, not of metal; monuments, not of metal; aquaria [structures]; alabaster; door frames, not of metal; window frames, not of metal; asbestos cement; beams, not of metal; balustrades, not of metal; huts; swimming pools [structures], not of metal; silos, not of metal; arbours [structures], not of metal; concrete; joists, not of metal; telephone booths, not of metal; beacons, not of metal, non-luminous; building paper; busts of stone, concrete or marble; bird baths [structures], not of metal; binding agents for making briquettes; binding material for road repair; stained-glass windows; felt for building; aviaries [structures], not of metal; gates, not of metal; diving boards, not of metal; geotextiles; plaster; potters' clay; earth for bricks; clay; gravel; aquarium gravel; granite; doors, not of metal; folding doors, not of metal; coal

tar; chimney pots, not of metal; prefabricated houses [kits], not of metal; parquet floor boards; memorial plaques, not of metal; roofing shingles; wood for making household utensils; veneer wood; moldable wood; chimney shafts, not of metal; jalousies, not of metal; roof gutters, not of metal; street gutters, not of metal; agglomerated bagasses of cane [building material]; road signs, non-luminous and non-mechanical, not of metal; non-luminous and non-mechanical signs, not of metal; limestone; lime; fences, not of metal; works of stonemasonry; cabanas, not of metal; stone; rubble; artificial stone; building stone; paint spraying booths, not of metal; gravestones; reeds for building; greenhouse frames, not of metal; framework, not of metal, for building; cornices, not of metal; bitumen paper for building; wood pulp board for building; paperboard for building; skating rinks [structures], not of metal; quartz; caissons for construction work under water; bricks; fire burrs; water-pipe valves, not of metal or plastic; cask wood; mooring bollards, not of metal; cement posts; chimney cowls, not of metal; buildings, not of metal; stringers [parts of staircases], not of metal; silica [quartz]; roofing, not of metal; manhole covers, not of metal; xyloolith; chicken-houses, not of metal; building timber; manufactured timber; sawn timber; wood, semi-worked; staircases, not of metal; road marking sheets and strips of synthetic material; reinforcing materials, not of metal, for building; bituminous products for building; tar; road coating materials; materials for making and coating roads; grog [fired refractory material]; pitch; refractory construction materials, not of metal; masts [poles], not of metal; raw chalk; calcareous marl; mosaics for building; marble; slate powder; tombs, not of metal; flashing, not of metal, for building; roof flashing, not of metal; perches; duckboards, not of metal; moldings, not of metal, for cornices; moldings, not of metal, for building; coatings [building materials]; tomb or grave enclosures, not of metal; laths, not of metal; wood panelling; palisading, not of metal; crash barriers, not of metal, for roads; trellises, not of metal; windows, not of metal; olivine for building; shuttering, not of metal, for concrete; poles, not of metal, for power lines; props, not of metal; branching pipes, not of metal; fair huts; tombs [monuments], not of metal; wainscotting, not of metal; signalling panels, non-luminous and non-mechanical, not of metal; building panels, not of metal; parquet flooring; partitions, not of metal; lintels, not of metal; casement windows, not of metal; aquarium sand; silver sand; sandstone for building; rocket launching platforms, not of metal; platforms, prefabricated, not of metal; floor tiles, not of metal; paving slabs, not of metal; cement slabs; grave slabs, not of metal; scaffolding, not of metal; asphalt paving; wood paving; paving blocks, not of metal; luminous paving blocks; macadam; fireproof cement coatings; bituminous coatings for roofing; roof coverings, not

of metal; linings, not of metal, for building; fireplace mantles; door panels, not of metal; floors, not of metal; sills, not of metal; porphyry [stone]; ceilings, not of metal; floating docks, not of metal, for mooring boats; tanks of masonry; scantlings [carpentry]; furrings of wood; vinyl siding; sheet piles, not of metal; pigsties, not of metal; insect screens, not of metal; burial vaults, not of metal; schists; outdoor blinds, not of metal and not of textile; shutters, not of metal; figurines of stone; alabaster glass; safety glass; glass granules for road marking; window glass for building; window glass, other than vehicle window glass; building glass; plate glass [windows] for building; tombstone stelae, not of metal; advertisement columns, not of metal; posts, not of metal; telegraph posts, not of metal; hips for roofing; stair-treads [steps], not of metal; greenhouses, transportable, not of metal; penstock pipes, not of metal; water-pipes, not of metal; gutter pipes, not of metal; ducts, not of metal, for ventilating and air-conditioning installations; drain pipes, not of metal; chimneys, not of metal; sandstone pipes; tufa; angle irons, not of metal; lengthening pieces, not of metal, for chimneys; bicycle parking installations, not of metal; plywood; foundry molds, not of metal; cement for blast furnaces; cement for furnaces; magnesia cement; cement; slate; roofing slates; slag [building material]; clinker stone; railway sleepers, not of metal; wood veneers; clinker ballast; concrete building elements; gypsum [building material]; letter boxes of masonry; roofing tiles, not of metal; terra-cotta [building material]; insulating glass for building; statues of stone; asbestos mortar; agglomerated cork for building; roofing, not of metal, incorporating photovoltaic cells; tiles, not of metal, for building; tarred strips for building; planks of wood for building; sand, except foundry sand; wall linings, not of metal, for building; wall claddings, not of metal, for building; porches [structures], not of metal; drain traps [valves], not of metal or plastic; works of art of stone; Flagpoles [structures], not of metal.

20 – Picture frame brackets; reels, not of metal, non-mechanical, for flexible hoses; pulleys of plastics for blinds; bolts, not of metal; casks of wood for decanting wine; mooring buoys, not of metal; casks, not of metal; barrels, not of metal; identification bracelets, not of metal; sideboards; busts of wood, wax, plaster or plastic; costume stands; bolsters; fans for personal use, non-electric; work benches; vice benches, not of metal; coat hangers; coatstands; shoulder poles [yokes]; screws, not of metal; display stands; show-cases [furniture]; newspaper display stands; comb foundations for beehives; signboards of wood or plastics; loading gauge rods, not of metal, for railway wagons; nuts, not of metal; covers for clothing [wardrobe]; nesting boxes; coffins; doors for furniture; curtain holders, not of textile material; pegs [pins], not of metal; divans; kennels for household

pets; keyboards for hanging keys; display boards; plugs [dowels], not of metal; containers, not of metal, for liquid fuel; troughs, not of metal, for mixing mortar; packaging containers of plastic; flower-stands [furniture]; curtain tie-backs; clips, not of metal, for cables and pipes; binding screws, not of metal, for cables; rivets, not of metal; imitation tortoiseshell; hand-held mirrors [toilet mirrors]; bamboo; scratching posts for cats; animal claws; animal hooves; coral; whalebone, unworked or semi-worked; stag antlers; horn, unworked or semi-worked; animal horns; rattan; corozo; plaited straw, except matting; wickerwork; hampers [baskets]; works of art made of wood; cabinet work; reeds [plaiting materials]; settees; curtain rods; index cabinets [furniture]; drain traps [valves] of plastic; water-pipe valves of plastic; valves, not of metal, other than parts of machines; staves of wood; plastic key cards, not encoded and not magnetic; mats for infant playpens; saw horses; bed casters, not of metal; furniture casters, not of metal; brush mountings; chopping blocks [tables]; wind chimes [decoration]; bottle caps, not of metal; cradles; tent pegs, not of metal; curtain rings; chests of drawers; floating containers, not of metal; containers, not of metal [storage, transport]; lecterns; dog kennels; bakers' bread baskets; baskets, not of metal; bottle casings of wood; faucets, not of metal, for casks; armchairs; hairdressers' chairs; deck chairs; hospital beds; bedsteads of wood; beds; edgings of plastic for furniture; table tops; hooks, not of metal, for clothes rails; curtain hooks; clothes hooks, not of metal; beds for household pets; nesting boxes for household pets; ladders of wood or plastics; playpens for babies; mannequins; air mattresses, not for medical purposes; spring mattresses; furniture of metal; office furniture; school furniture; mobiles [decoration]; locks, not of metal, for vehicles; locks, other than electric, not of metal; bead curtains for decoration; door bolts, not of metal; bottle closures, not of metal; closures, not of metal, for containers; latches, not of metal; curtain rails; house numbers, not of metal, non-luminous; barrel hoops, not of metal; furniture; moldings for picture frames; furniture partitions of wood; mother-of-pearl, unworked or semi-worked; mirror tiles; ambroid plates; registration plates, not of metal; identity plates, not of metal; loading pallets, not of metal; handling pallets, not of metal; transport pallets, not of metal; head-rests [furniture]; stakes for plants or trees; trestles [furniture]; magazine racks; book rests [furniture]; stands for calculating machines; flower-pot pedestals; baby changing mats; pet cushions; pillows; cushions; air cushions, not for medical purposes; inflatable pillows; removable mats or covers for sinks; racks [furniture]; library shelves; shelves for file cabinets; furniture shelves; shelves for storage; wood ribbon; straw edgings; towel stands [furniture]; hat stands; cask stands, not of metal; inflatable publicity objects; counters [tables]; bedding,

except linen; corks for bottles; corks; sealing caps, not of metal; stair rods; standing desks; embroidery frames; towel dispensers, fixed, not of metal; picture frames; sections of wood for beehives; tanks, not of metal nor of masonry; fodder racks; curtain rollers; door handles, not of metal; knobs, not of metal; fishing baskets; writing desks; seats of metal; benches [furniture]; vats, not of metal; honeycombs; sofas; bungs, not of metal; statues of wood; figurines of wood; oyster shells; silvered glass [mirrors]; ambroid bars; umbrella stands; gun racks; carts for computers [furniture]; dressing tables; washstands [furniture]; typing desks; drafting tables; massage tables; tables of metal; wall-mounted baby changing platforms; desks; tea carts; dinner wagons [furniture]; tables; steps [ladders], not of metal; chairs [seats]; high chairs for babies; chests, not of metal; placards of wood or plastics; stools; crates; trolleys [furniture]; straw plaits; mobile boarding stairs, not of metal, for passengers; straw mattresses; decorations of plastic for foodstuffs; beehives; funerary urns; winding spools, not of metal, non-mechanical, for flexible hoses; wax figures; door fittings, not of metal; coffin fittings, not of metal; bed fittings, not of metal; furniture fittings, not of metal; window fittings, not of metal; infant walkers; garment covers [storage]; stuffed animals; stuffed birds; hinges, not of metal; chaise longues; poles, not of metal; screens [furniture]; filing cabinets; medicine cabinets; meat safes, not of metal; plate racks; bamboo curtains; slatted indoor blinds; screens for fireplaces [furniture]; yellow amber; lockers; cases of wood or plastic; chests for toys; bottle racks; letter boxes, not of metal or masonry.

21 – Broom handles; household or kitchen utensils and containers; combs and sponges; brushes, except paintbrushes; material for brush-making; articles for cleaning purposes; pressure cookers, non-electric; indoor aquaria; buckets; china ornaments; dishes; paper plates; vegetable dishes; saucers; mugs; candy boxes; bottles; demijohns; busts of porcelain, ceramic or glass; vases; epergnes; fruit cups; bird baths; baby baths, portable; plungers for clearing blocked drains; waffle irons, non-electric; coolers [ice pails]; buckets made of woven fabrics; whisks, non-electric, for household purposes; cooking skewers of metal; towel rails and rings; clothing stretchers; hair for brushes; birdcages; funnels; carpet beaters [hand instruments]; signboards of porcelain or glass; candle extinguishers; flower pots; chamber pots; glue-pots; cruets; decanters; large-toothed combs for the hair; combs for animals; tea cosies; abrasive sponges for scrubbing the skin; sponges for household purposes; toilet sponges; sponge holders; toothpick holders; soap holders; holders for flowers and plants [flower arranging]; shaving brush stands; toilet paper holders; soap dispensers; ironing boards; cutting boards for the kitchen; bread boards; washing boards;

strainers for household purposes; smoke absorbers for household purposes; containers for household or kitchen use; kitchen containers; glass jars [carboys]; heat-insulated containers; heat-insulated containers for beverages; thermally insulated containers for food; glass flasks [containers]; frying pans; closures for pot lids; chamois leather for cleaning; toothpicks; ceramics for household purposes; majolica; works of art of porcelain, ceramic or glass; kitchen grinders, non-electric; cleaning instruments, hand-operated; cabarets [trays]; stew-pans; covers, not of paper, for flower pots; shaving brushes; cages for household pets; polishing leather; hot pots, not electrically heated; glass bulbs [receptacles]; shoe trees; napkin rings; poultry rings; rings for birds; coin banks; bread baskets for household purposes; baskets for household purposes; waste paper baskets; feeding troughs; mangers for animals; lunch boxes; cookie jars; tea caddies; washtubs; earthenware saucepans; mess-tins; cauldrons; coffee percolators, non-electric; coffeepots, non-electric; coffee grinders, hand-operated; fused silica [semi-worked product], other than for building; beer mugs; tankards; rat traps; pot lids; aquarium hoods; butter-dish covers; dish covers; cheese-dish covers; buttonhooks; pitchers; perfume burners; portable cool boxes, non-electric; watering cans; insect traps; mixing spoons [kitchen utensils]; basting spoons [cooking utensils]; pie servers; spatulas for kitchen use; butter dishes; polishing materials for making shiny, except preparations, paper and stone; noodle machines, hand-operated; polishing apparatus and machines, for household purposes, non-electric; pepper mills, hand-operated; mills for household purposes, hand-operated; feather-dusters; brooms; isothermic bags; confectioners' decorating bags [pastry bags]; cocktail shakers; bowls [basins]; mosaics of glass, not for building; saucepan scourers of metal; soap boxes; mouse traps; cooking pot sets; nozzles for watering cans; pouring spouts; nozzles for watering hose; fitted picnic baskets, including dishes; toilet cases; floss for dental purposes; fiberglass thread, other than for textile use; cookie [biscuit] cutters; pastry cutters; sprinklers; syringes for watering flowers and plants; cotton waste for cleaning; wool waste for cleaning; cleaning tow; chopsticks; cocktail stirrers; pepper pots; gloves for household purposes; polishing gloves; gardening gloves; plates to prevent milk boiling over; trays for household purposes; trays of paper, for household purposes; lazy susans; heaters for feeding bottles, non-electric; candelabra [candlesticks]; trivets [table utensils]; coasters, not of paper or textile; menu card holders; knife rests for the table; flat-iron stands; egg cups; grill supports; abrasive pads for kitchen purposes; scouring pads; drinking troughs; powdered glass for decoration; pottery; pots; cooking pots; painted glassware; tableware, other than knives, forks and spoons; porcelain ware; earthenware; crystal [glassware]; cosmetic

utensils; toilet utensils; trouser presses; cruet sets for oil and vinegar; make-up removing appliances; spice sets; apparatus for wax-polishing, non-electric; bottle openers, electric and non-electric; glove stretchers; boot jacks; crumb trays; tie presses; clothespegs; glass stoppers; powder compacts; perfume vaporizers; powder puffs; dusting apparatus, non-electric; toilet paper dispensers; electric combs; grills [cooking utensils]; sifters [household utensils]; drinking horns; shoe horns; candle drip rings; salad bowls; sugar bowls; beaters, non-electric; services [dishes]; coffee services [tableware]; liqueur sets; tea services [tableware]; sieves [household utensils]; cinder sifters [household utensils]; tea strainers; wine-tasting pipettes; siphon bottles for carbonated water; rolling pins, domestic; steel wool for cleaning; currycombs; blenders, non-electric, for household purposes; fruit presses, non-electric, for household purposes; drinking straws; salt cellars; drinking vessels; vessels of metal for making ices and iced drinks; refrigerating bottles; cups of paper or plastic; glasses [receptacles]; drinking glasses; glass for vehicle windows [semi-finished product]; plate glass [raw material]; opal glass; opaline glass; glass incorporating fine electrical conductors; enamelled glass, not for building; glass wool, other than for insulation; vitreous silica fibers, other than for textile use; fiberglass, other than for insulation or textile use; soup bowls; drying racks for laundry; basins [receptacles]; table plates; disposable table plates; graters for kitchen use; insulating flasks; indoor terrariums [plant cultivation]; indoor terrariums [vivariums]; cloth for washing floors; cloths for cleaning; dusting cloths [rags]; furniture dusters; urns; aerosol dispensers, not for medical purposes; wax-polishing appliances, non-electric, for shoes; water apparatus for cleaning teeth and gums; electric devices for attracting and killing insects; watering devices; utensils for household purposes; cooking utensils, non-electric; coffee filters, non-electric; flasks; drinking flasks; molds [kitchen utensils]; cake moulds; ice cube molds; cookery moulds; deep fryers, non-electric; comb cases; bread bins; fly swatters; teapots; kettles, non-electric; cups; garlic presses [kitchen utensils]; ironing board covers, shaped; tea infusers; glass bowls; mops; mop wringers; corkscrews; animal bristles [brushware]; dishwashing brushes; brushes for cleaning tanks and containers; lamp-glass brushes; horse brushes; scrubbing brushes; toothbrushes; toothbrushes, electric; carpet sweepers; brushes for footwear; tar-brushes, long handled; toilet brushes; electric brushes, except parts of machines; eyebrow brushes; nail brushes; nest eggs, artificial; boxes for dispensing paper towels; dustbins; window-boxes; boxes of glass; deodorizing apparatus for personal use; figurines of porcelain, ceramic, earthenware, terra-cotta or glass.

(260) AM 2020 105098 A

(800) 1489391

(151) 2019 03 21

(891) 2019 03 21

(731) DALGAKIRAN MAKİNA SANAYİ VE
TİCARET ANONİM ŞİRKETİ

Eyüp Sultan Mahallesi Müminler Caddesi
No:70, Samandıra Sancaktepe, İstanbul,
Turkey

(540)

DALGAKIRAN

(591) Black and red

(531) 26.03.04; 27.01.05; 27.05.01; 27.05.04;
29.01.12

(511)

7 – Machines, machine tools and industrial robots for processing and shaping wood, metals, glass, plastics and minerals, 3d printers, construction machines and robotic mechanisms (machines) for use in construction; bulldozers, diggers (machines), excavators, road construction and road paving machines, drilling machines, rock drilling machines, road sweeping machines, lifting, loading and transmission machines and robotic mechanisms (machines) for lifting, loading and transmission purposes; elevators, escalators and cranes, machines and robotic mechanisms (machines) for use in agriculture and animal breeding, machines and robotic mechanisms (machines) for processing cereals, fruits, vegetables and food, machines for preparing and processing beverages, engines and motors, other than for land vehicles, parts and fittings therefor: hydraulic and pneumatic controls for engines and motors, brakes other than for vehicles, brake linings for engines, crankshafts, gearboxes, other than for land vehicles, gearboxes, cylinders for engines, pistons for engines, turbines, not for land vehicles, filters for engines and motors, oil, air and fuel filters for land vehicle engines, exhausts for land vehicle engines, exhaust manifolds for land vehicle engines, engine cylinders for land vehicles, engine cylinder heads for land vehicles, pistons for land vehicle engines, carburetors for land vehicles, fuel conversion apparatus for land vehicle engines, injectors for land vehicle engines, fuel economisers for land vehicle engines, pumps for land vehicle engines, valves for land vehicle engines, starter motors for land vehicles, dynamos for land vehicle engines, sparking plugs for land vehicle engines, bearings (parts of machines), roller or ball bearings, machines for mounting and detaching tires, alternators, current generators, electric generators, current generators operated with solar energy, painting machines, automatic spray guns for paint, electric, hydraulic and pneumatic punching machines and guns, electric adhesive tape dispensers (machines), electric guns for compressed gas or liquid spraying machines, electric hand drills, electric hand saws, electric

jigsaw machines, spiral machines, compressed air machines, compressors (machines), vehicle washing installations, robotic mechanisms (machines) with the abovementioned functions, electric and gas-operated welding apparatus, electric arc welding apparatus, electric soldering apparatus, electric arc cutting apparatus, electrodes for welding machines, industrial robots (machines) with the abovementioned functions, printing machines, packaging machines, filling, plugging and sealing machines, labellers (machines), sorting machines, industrial robots (machines) with the abovementioned functions, electric packing machines for plugging and sealing of plastics, machines for textile processing, sewing machines, industrial robots (machines) with the abovementioned functions, pumps other than parts of machines or engines (term considered too vague by the International Bureau – Rule 13 (2) (b) of the Common Regulations), fuel dispensing pumps for service stations, self-regulating fuel pumps, electric kitchen machines for chopping, grinding, crushing, mixing and mincing foodstuff, washing machines, laundry washing machines, dishwashers, spin driers (not heated), electric cleaning machines for cleaning floors, carpets or floorings, vacuum cleaners and parts thereof, automatic vending machines, galvanizing and electroplating machines, electric door openers and closers, gaskets for engines and motors.

(260) AM 2020 105100 A

(800) 1489423

(151) 2019 03 20

(891) 2019 03 20

(731) HUAWEI TECHNOLOGIES CO., LTD.

HUAWEI ADMINISTRATION BUILDING,
BANTIAN, LONGGANG DISTRICT,
SHENZHEN, 518129 GUANGDONG,
China

(540)

Hilink

(591) Black, white

(531) 27.05.01

(511)

7 – Electric steam mops; vacuum cleaners for household purposes; cordless vacuum cleaners; electric cordless sweepers; rechargeable sweepers; electric juicers; machines for making noodles; electric fruit presses for household purposes; dishwashers for household purposes; coffee grinders, other than hand-operated; mixing machines; kitchen machines, electric; whisks, electric, for household purposes; household soybean milk machine; electric coffee grinders; machines and apparatus for cleaning, electric; vacuum cleaner bags; steam mops; electric window cleaners; filters [parts of machines or engines]; curtain drawing devices, electrically operated.

8 – Razors, electric or non-electric; nail files, electric; eyelash curlers; electric irons for styling hair; laser hair removal apparatus, other than for medical purposes; electric fingernail polishers; cuticle pushers; electric ear hair trimmers; electric pedicure sets; electric nose hair trimmers.

9 – Humanoid robots with artificial intelligence; computer memory devices; memory expansion cards; memory cards; computer software, recorded; scales; scales with body mass analyzers; bathroom scales; talking scales; body fat scales for household use; digital bathroom scales; earphones; cabinets for loudspeakers; headphones; sound transmitting apparatus; sound recording apparatus; microphones; video recorders; camcorders; electric and electronic video surveillance installations; video monitors; security surveillance robots; selfie lenses; LCD projectors; video projectors; digital cameras; self-acting focusing projectors; mini beam projectors; monopods used to take photographs by positioning a smartphone or camera beyond the normal range of the arm; rapid imaging camera; connected bracelets [measuring instruments]; detectors; measuring apparatus; diagnostic apparatus, not for medical purposes; teaching robots; sensor; alarm sensors; electric plugs; electric sockets; plugboards; remote controls for household use; switches, electric; sound alarms; theft prevention installations, electric; smoke detectors; electronic access control systems for interlocking doors; alarms for the detection of inflammable gases; alarm central units; digital door locks; biometric fingerprint door locks; wireless chargers; USB chargers; battery chargers for laptop computers; power bank (rechargeable batteries).

11 – Light bulbs; electric lamps; book lights; LED luminaires; desk lamps; night lights; ceiling lights; air fryers; bakers' ovens; cooking utensils, electric; cookers; gas burners; hot plates; kitchen ranges [ovens]; pressure cookers, electric; coffee machines, electric; deep fryers, electric; kettles, electric; microwave ovens [cooking apparatus]; induction cookers; electric rice cookers; electric egg boilers; induction cookers, for household purposes; electric stew pot; deodorizing apparatus for refrigerators; refrigerators; cosmetic refrigerators; air purifiers; electric fans for personal use; fans [air-conditioning]; air conditioning apparatus; extractor hoods for kitchens; laundry driers, electric; air humidifying apparatus; electric hair driers; USB-powered humidifiers for household use; humidifiers for household use; air purifiers for household purposes; dehumidifiers for household purposes; water closets; toilet bowls; toilet seats; solar thermal collectors [heating]; steam facial apparatus [saunas]; solar water heaters; bath heater; water heater for washing (gas or electric heating); electric water purifiers for household purposes; disinfectant apparatus; water purification installations; water softening apparatus and installations; water distribution

installations; faucet filters for household purposes; electric bath-water purifying apparatus for household purposes; shoe sterilizers for household purposes; ultrasonic sterilizers for household purposes.

12 – Electric cars; self-balancing scooters; self-balancing one-wheeled electric scooters; self-balancing two-wheeled electric scooters; bicycles; push scooters [vehicles]; strollers; anti-theft alarms for vehicles; seat covers for vehicles; upholstery for vehicles; safety seats for children, for vehicles.

20 – Shoe cabinets; cupboards; desks; furniture; wardrobes; pillows; magnetic therapy pillow; curtain rails; curtain rods; curtain rollers.

21 – Containers for household or kitchen use; cups; vacuum flasks; cooking pot sets; mills for domestic purposes, hand-operated; daily use glassware (including cups, plates, pots, crocks); drinking vessels; drinking bottles for sports; tea services [tableware]; drinking glasses; toothbrushes, electric; replacement heads for electric toothbrushes; thermally insulated containers for food; heat-insulated containers for beverages; insulating flasks; vacuum bottles; refrigerating bottles; vessels of metal for making ices and iced drinks; portable cool boxes, non-electric; shaker bottles sold empty; dustbins for household purposes; electric combs; hair brushes; combs, electric; clothes drying hangers.

28 – Smart toys; toy robots; toy cars.

35 – Provision of an online marketplace for buyers and sellers of goods and services; search engine optimization for sales promotion; presentation of goods on communication media, for retail purposes; price comparison services; business information; advertising; sales promotion for others; on-line advertising on a computer network; commercial information and advice for consumers [consumer advice shop]; data search in computer files for others; business management assistance; marketing; providing information in the field of marketing; alcoholic beverage procurement services for others [purchasing goods for other businesses]; providing marketing consulting in the field of social media; outsourcing services in the nature of arranging procurement of goods for others; import-export agencies; accounting; business auditing; account auditing; accounting services for mergers and acquisitions; accounting for third parties; consulting and information concerning accounting.

36 – Currency trading; on-line real-time currency trading; bill payment services; trustee services; providing securities market information; insurance brokerage; insurance information; financing services; securities brokerage; financial information; electronic funds transfer; financial analysis; financial management; financial consultancy; online banking; providing financial information via a web site; providing rebates at participating establishments of others

through use of a membership card; processing of debit card payments; apartment house management; real estate management; credit and loan services; credit card transaction processing services; electronic transfer of funds by means of telecommunications networks; electronic transfer of funds; bill payment services provided through a web site; currency transfer; money order services; electronic check acceptance services; processing of credit card payments.

38 – Message sending; providing internet chatrooms; providing user access to global computer networks; providing access to databases; transmission of digital files; streaming of data; radio broadcasting; teleconferencing services; cellular telephone communication; videoconferencing services; video-on-demand transmission; computer aided transmission of messages and images.

41 – Training in the field of communication technologies; providing amusement arcade services; preparing subtitles for movies; education; training; training services provided via simulators; organization of competitions [education or entertainment]; arranging and conducting of colloquiums; arranging and conducting of symposiums; arranging and conducting of conferences; arranging and conducting of concerts; arranging and conducting of in-person educational forums; online publication of electronic books and journals; providing online electronic publications, not downloadable; production of radio and television programmes; providing online music, not downloadable; providing online videos, not downloadable; providing films, not downloadable, via video-on-demand services; providing television programs, not downloadable, via video-on-demand services; providing recreation facilities; entertainment information; game services provided online from a computer network; conducting fitness classes; production of sound recordings; providing entertainment information via a web site; providing information about online education; radio entertainment; entertainment services; conducting guided tours; ticket agency services [entertainment].

42 – Technical research; research and development of new products for others; scientific research; technical project studies; telecommunications technology consultancy; computer programming; computer software design; updating of computer software; consultancy in the design and development of computer hardware; maintenance of computer software; recovery of computer data; conversion of data or documents from physical to electronic media; computer system design; creating and maintaining web sites for others; data conversion of computer programs and data [not physical conversion]; computer software consultancy; rental of web servers; providing search engines for the internet; web site design con-

sultancy; information technology [IT] consultancy; electronic data storage; providing information on computer technology and programming via a web site; cloud computing; computer technology consultancy; computer security consultancy; developing of driver and operating system software.

(260) AM 2020 105101 A

(800) 1489432

(151) 2019 03 20

(891) 2019 03 20

(731) HUAWEI TECHNOLOGIES CO., LTD.
HUAWEI ADMINISTRATION BUILDING,
BANTIAN, LONGGANG DISTRICT,
SHENZHEN, 518129 GUANGDONG,
China

(540)

HUAWEI Hilink

(591) Black, white

(531) 27.05.01

(511)

7 – Electric steam mops; vacuum cleaners for household purposes; cordless vacuum cleaners; electric cordless sweepers; rechargeable sweepers; electric juicers; machines for making noodles; electric fruit presses for household purposes; dishwashers for household purposes; coffee grinders, other than hand-operated; mixing machines; kitchen machines, electric; whisks, electric, for household purposes; household soybean milk machine; electric coffee grinders; machines and apparatus for cleaning, electric; vacuum cleaner bags; steam mops; electric window cleaners; filters [parts of machines or engines]; curtain drawing devices, electrically operated.

8 – Razors, electric or non-electric; nail files, electric; eyelash curlers; electric irons for styling hair; laser hair removal apparatus, other than for medical purposes; electric fingernail polishers; cuticle pushers; electric ear hair trimmers; electric pedicure sets; electric nose hair trimmers.

9 – Humanoid robots with artificial intelligence; computer memory devices; memory expansion cards; memory cards; computer software, recorded; scales; scales with body mass analyzers; bathroom scales; talking scales; body fat scales for household use; digital bathroom scales; earphones; cabinets for loudspeakers; headphones; sound transmitting apparatus; sound recording apparatus; microphones; video recorders; camcorders; electric and electronic video surveillance installations; video monitors; security surveillance robots; selfie lenses; LCD projectors; video projectors; digital cameras; self-acting focusing projectors; mini beam projectors; monopods used to take photographs by positioning a smartphone or camera beyond the normal range of the arm; rapid imaging camera; connected bracelets [meas-

ring instruments]; detectors; measuring apparatus; diagnostic apparatus, not for medical purposes; teaching robots; sensor; alarm sensors; electric plugs; electric sockets; plugboards; remote controls for household use; switches, electric; sound alarms; theft prevention installations, electric; smoke detectors; electronic access control systems for interlocking doors; alarms for the detection of inflammable gases; alarm central units; digital door locks; biometric fingerprint door locks; wireless chargers; USB chargers; battery chargers for laptop computers; power bank (rechargeable batteries).

11 – Light bulbs; electric lamps; book lights; LED luminaires; desk lamps; night lights; ceiling lights; air fryers; bakers' ovens; cooking utensils, electric; cookers; gas burners; hot plates; kitchen ranges [ovens]; pressure cookers, electric; coffee machines, electric; deep fryers, electric; kettles, electric; microwave ovens [cooking apparatus]; induction cookers; electric rice cookers; electric egg boilers; induction cookers, for household purposes; electric stew pot; deodorizing apparatus for refrigerators; refrigerators; cosmetic refrigerators; air purifiers; electric fans for personal use; fans [air-conditioning]; air conditioning apparatus; extractor hoods for kitchens; laundry driers, electric; air humidifying apparatus; electric hair driers; USB-powered humidifiers for household use; humidifiers for household use; air purifiers for household purposes; dehumidifiers for household purposes; water closets; toilet bowls; toilet seats; solar thermal collectors [heating]; steam facial apparatus [saunas]; solar water heaters; bath heater; water heater for washing (gas or electric heating); electric water purifiers for household purposes; disinfectant apparatus; water purification installations; water softening apparatus and installations; water distribution installations; faucet filters for household purposes; electric bath-water purifying apparatus for household purposes; shoe sterilizers for household purposes; ultrasonic sterilizers for household purposes.

12 – Electric cars; self-balancing scooters; self-balancing one-wheeled electric scooters; self-balancing two-wheeled electric scooters; bicycles; push scooters [vehicles]; strollers; anti-theft alarms for vehicles; seat covers for vehicles; upholstery for vehicles; safety seats for children, for vehicles.

20 – Shoe cabinets; cupboards; desks; furniture; wardrobes; pillows; magnetic therapy pillow; curtain rails; curtain rods; curtain rollers.

21 – Containers for household or kitchen use; cups; vacuum flasks; cooking pot sets; mills for domestic purposes, hand-operated; daily use glassware (including cups, plates, pots, crocks); drinking vessels; drinking bottles for sports; tea services [tableware]; drinking glasses; toothbrushes, electric; replacement heads for electric toothbrushes; thermally insulated containers for food; heat-insulated containers for be-

verages; insulating flasks; vacuum bottles; refrigerating bottles; vessels of metal for making ices and iced drinks; portable cool boxes, non-electric; shaker bottles sold empty; dustbins for household purposes; electric combs; hair brushes; combs, electric; clothes drying hangers.

28 – Smart toys; toy robots; toy cars.

35 – Provision of an online marketplace for buyers and sellers of goods and services; search engine optimization for sales promotion; presentation of goods on communication media, for retail purposes; price comparison services; business information; advertising; sales promotion for others; on-line advertising on a computer network; commercial information and advice for consumers [consumer advice shop]; data search in computer files for others; business management assistance; marketing; providing information in the field of marketing; alcoholic beverage procurement services for others [purchasing goods for other businesses]; providing marketing consulting in the field of social media; outsourcing services in the nature of arranging procurement of goods for others; import-export agencies; accounting; business auditing; account auditing; accounting services for mergers and acquisitions; accounting for third parties; consulting and information concerning accounting.

36 – Currency trading; on-line real-time currency trading; bill payment services; trustee services; providing securities market information; insurance brokerage; insurance information; financing services; securities brokerage; financial information; electronic funds transfer; financial analysis; financial management; financial consultancy; online banking; providing financial information via a web site; providing rebates at participating establishments of others through use of a membership card; processing of debit card payments; apartment house management; real estate management; credit and loan services; credit card transaction processing services; electronic transfer of funds by means of telecommunications networks; electronic transfer of funds; bill payment services provided through a web site; currency transfer; money order services; electronic check acceptance services; processing of credit card payments.

38 – Message sending; providing internet chatrooms; providing user access to global computer networks; providing access to databases; transmission of digital files; streaming of data; radio broadcasting; teleconferencing services; cellular telephone communication; videoconferencing services; video-on-demand transmission; computer aided transmission of messages and images.

41 – Training in the field of communication technologies; providing amusement arcade services; preparing subtitles for movies; education; training; training services provided via simulators; organization

of competitions [education or entertainment]; arranging and conducting of colloquiums; arranging and conducting of symposiums; arranging and conducting of conferences; arranging and conducting of concerts; arranging and conducting of in-person educational forums; online publication of electronic books and journals; providing online electronic publications, not downloadable; production of radio and television programmes; providing online music, not downloadable; providing online videos, not downloadable; providing films, not downloadable, via video-on-demand services; providing television programs, not downloadable, via video-on-demand services; providing recreation facilities; entertainment information; game services provided online from a computer network; conducting fitness classes; production of sound recordings; providing entertainment information via a web site; providing information about online education; radio entertainment; entertainment services; conducting guided tours; ticket agency services [entertainment].

42 – Technical research; research and development of new products for others; scientific research; technical project studies; telecommunications technology consultancy; computer programming; computer software design; updating of computer software; consultancy in the design and development of computer hardware; maintenance of computer software; recovery of computer data; conversion of data or documents from physical to electronic media; computer system design; creating and maintaining web sites for others; data conversion of computer programs and data [not physical conversion]; computer software consultancy; rental of web servers; providing search engines for the internet; web site design consultancy; information technology [IT] consultancy; electronic data storage; providing information on computer technology and programming via a web site; cloud computing; computer technology consultancy; computer security consultancy; developing of driver and operating system software.

(260) AM 2020 105103 A

(800) 1489556

(151) 2019 08 12

(891) 2019 08 12

(731) SAILUN GROUP CO., LTD.

No. 588, Maoshan Road, Huangdao District,
Qingdao City, Shandong, China

(540)

T E R R A M A X

(591) Black, white

(531) 27.05.02

(511)

12 – Tyres for vehicle wheels; automobile tires; casings for pneumatic tyres; treads for retreading tires;

pneumatic tyres; inner tubes for automobile tires; bicycles.

(260) AM 2020 105104 A

(800) 1489560

(151) 2019 04 09

(891) 2019 04 09

(731) XIAMEN TUNGSTEN CO., LTD.

Kejingshe, Haicang District, Xiamen, Fujian, China

(540)



(591) Black, white

(531) 03.07.07; 03.07.16

(511)

6 – Tungsten; tungsten iron; molybdenum; molybdenum iron; alloys of common metal; sheets and plates of metal; poles of metal; laths of metal; cobalt, raw; rods of metal for welding; soldering wire of metal; titanium; foundry moulds of metal; anti-friction metal; cermets; tungsten powder.

7 – Tools [parts of machines]; blades [parts of machines]; drilling heads [parts of machines]; drill chucks [parts of machines]; knives [parts of machines]; clippers [machines]; hammers [parts of machines]; power hammers; electric hammers; tilt hammers; pneumatic hammers; broaching machines; milling cutters being parts of machine tools; precision turning tools [parts of machines]; blade holders [parts of machines]; molds [parts of machines]; metalworking machines; circular saw blades being parts of machines.

9 – Fuse wire; electromagnetic coils; holders for electric coils; magnets; anodes; cathodes; plates for batteries; batteries, electric.

11 – Filaments for electric lamps; heating filaments, electric; luminous tubes for lighting.

(260) AM 2020 105105 A

(800) 1489562

(151) 2019 07 01

(891) 2019 07 01

(731) YIWU DINGQI HARDWARE FIRM

Number F4-19265, International Trade City, China Commodity City, Yiwu, Jinhua, Zhejiang, China

(540)



(591) Black, white

(531) 24.09.02; 24.09.05; 26.13.25; 27.05.01; 28.03 (511)

6 – Fittings of metal for building; locks of metal, other than electric; common metals, unwrought or semi-wrought; aluminium alloy pulley, other than for machines; ironmongery; strap-hinges of metal; packaging containers of metal; cattle chains; rods of metal for welding; ropes of metal.

7 – Mixing machines; beaters, electric; machines and apparatus for polishing [electric]; welding machines, electric; washing apparatus; saws [machines]; machines, machine tools, power-operated tools for bicycle industry; transmissions for machines; bearings [parts of machines]; jacks [machines]; electric hammers; spray guns for paint.

(260) AM 2020 105106 A

(800) 1489565

(151) 2019 04 16

(891) 2019 04 16

(731) HUAWEI TECHNOLOGIES CO., LTD.

ADMINISTRATION BUILDING, HUAWEI TECHNOLOGIES CO., LTD., BANTIAN, LONGGANG DISTRICT, 518129 SHENZHEN, China

(540)

HONOR

(591) Black, white

(511)

7 – Vegetable spiralizers, electric; soybean milk making machines for household purposes; butter machines; centrifugal mills; kitchen machines, electric; robotic vacuum cleaners; juice extractors, electric; coffee grinders, other than hand-operated; electric juicers; sewing machines for household purposes; washing machines for laundry for household purposes; curtain drawing devices, electrically operated; portable rotary steam presses for fabrics; electric cordless sweepers; electric coffee grinders; dishwashers for household purposes; ironing machines; 3D printing pens; mixers (machines); machines and apparatus for cleaning, electric; crushers for kitchen use, electric; electric blenders for household purposes; hand-held electric grinders; grating machines for vegetables for household purposes; dry-cleaning machine; meat mincers for household purposes; wrin-

ging machines for laundry; shoe polishers, electric; 3D printers; industrial robots; mixing machines; rechargeable sweepers.

8 – Nail files, electric; manicure sets, electric; electric hair scissors; nail clippers (electric or non-electric); electric hair straighteners; electric steam irons; curling tongs; razors, electric or non-electric; peelers (hand tools); electric beard clippers; electric hair clippers for personal use; electric razors.

9 – USB data cables for mobile phones; laptop computers; computer software platforms, recorded or downloadable; thin client computers; tablet computers; notebook computers; computer operating programs, recorded; smartwatches; teaching robots; USB data cables; smartglasses; personal digital assistants (PDAs); hand-held electronic dictionaries; computer screen saver software, recorded or downloadable; downloadable graphics for mobile phones; wearable computers; laboratory robots; electronic numeric displays; infrared sensors; touchscreen sensors; electric locks; electronic key fobs being remote control apparatus; electronic audio apparatus for use with books; optical lenses; alarm sensors; gas testing instruments; lie detectors; digital weather stations; teaching machines; digital door locks; air analysis apparatus; electric theft prevention alarms; remote controlling and measuring apparatus; remote control apparatus; remote controls for household purposes; holders for mobile phones for use in vehicles; head-mounted video display monitors; televisions for vehicles; electrified fences; ultrasonic sensors; electronic locks; 3D spectacles; smartphones; speed checking apparatus for vehicles; sound alarms; smoke detectors; electronic scales for kitchen use; scales with body fat analyzers for household purposes; selfie sticks for mobile phones; electronic book readers; batteries for mobile phones; battery charging devices for motor vehicles; animated cartoons; security sensors; temperature sensors; portable projectors; multi-point patch panels; natural gas alarms; sunglasses; sleep sensors; humanoid robots with artificial intelligence; wearable video display monitors; video projectors; rearview cameras for vehicles; transfer switches for telecommunication apparatus; distance recording apparatus; temperature indicators; hygrometers; intercoms; closed circuit television cameras; photo printers; digital video recorder for vehicles; telecommunication apparatus in the form of jewellery; projectors with liquid crystal displays (LCD); measuring cups; gas analyzing apparatus; electric door bells; theft prevention installations, electric; sensors; automatic focus projectors; smart sockets; video monitors; electric and electronic video monitors; selfie monopods for smartphones and cameras; audiovisual teaching apparatus; smart camcorders; battery chargers for vehicles; smoke alarms.

10 – Mirrors for surgeons; galvanic belts for medical purposes; lasers for medical purposes; apparatus and installations for the production of X-rays for medical purposes; heart rate monitoring apparatus; cardiac defibrillation electrodes; electrically operated hearing aids; esthetic massage apparatus; vibromassage apparatus; galvanic therapeutic appliances; electric acupuncture instruments; apparatus for use in medical analysis; defibrillators; medical apparatus for ophthalmic purposes; electric massage apparatus for household use; surgical robots; radiology screens for medical purposes; electrocardiographs; physiotherapy apparatus; tomographs for medical purposes; electroencephalographs; foot massage apparatus; massage apparatus for eyes; vibrating massage apparatus; testing apparatus for medical purposes; massage apparatus for personal use; digital hearing aids; abdominal belts; heart rate monitors; electric knives for surgical purposes; medical apparatus for moxibustion treatment; blood pressure monitors; soporific pillows for insomnia; electric sphygmomanometers; electric thermometers for medical purposes; body composition monitors; body fat monitors; blood oxygen monitors.

11 – Oil burners for household purposes; air dryers; electric fans; ceiling fans; air conditioning fans; toilet seats; heaters for baths; drinking fountain; electric water purifiers for household purposes; thermostatic electric kettles; street lamps; coffee machines, electric; deep fryers, electric; microwave ovens (cooking apparatus); air fryers; electromagnetic ovens; electric machines for making coffee; electric kitchen ranges for household purposes; fabric steamers; air purifiers; toilet bowls; bath lamps for heating; shoe sterilizers for household purposes; electric flashlights; electric kettles for household purposes; ceiling lights; induction night lights; electric coffee pots; refrigerators for household purposes; electric fans for household purposes; air purifiers for automobiles; extractor hoods for kitchens; bread baking machines; food steamers, electric; kettles, electric; thermo-pots, electric; electrothermal cups; electric cookers for household purposes; laundry dryers, electric; portable electric fans; anion generating humidifiers; air conditioning apparatus; electric hot air hand dryers; electric baking ovens for household purposes.

12 – Side view mirrors for vehicles; civilian drones; electric folding bicycles; ultralight airplanes; electric scooters; camera drones; electric push scooters (vehicles); cars; self balancing unicycles; remote control vehicles, other than toys; balance weights for vehicle wheels; plug-in hybrid electric vehicles; self-balancing scooters; pilotless aircrafts; plug-in electric cars.

18 – Animal skins; pocket wallets; school bags; travelling trunks; backpacks; shopping bags; bags for

campers; handbags; travelling bags; trunks (luggage); bags for sports; bags; business card cases; reins for guiding children; umbrellas; walking sticks; clothing for pets; umbrellas for children.

20 – Shoe cabinets; curtain rings; beauty cabinets (furniture); bookcases; beds; bathroom mirrors; pivot mirrors; tea tables; massage tables; decoration mobiles; throw pillows; mirrors (looking glasses); neck pillows.

21 – Mugs, not of precious metal; table plates; services (dishes); beer mugs; teapots; electric hair combs; insulating flasks; magnetic therapeutic cups; brushes for footwear; electric brushes, except parts of machines; electric devices for attracting and killing insects; electric combs; electric make-up removing appliances; plug-in diffusers for mosquito repellents.

25 – Gloves (clothing); pullovers; hosiery; Tee-shirts; footwear; scarfs; swimsuits; waterproof clothing; sports shoes; hats; clothing.

28 – Smart toys; building blocks (toys); scale model airplanes; electronic action toys; toy musical boxes (play articles); running machines; toy robots; scale model vehicles; hand-operated toys; action figure toys; jigsaws and manipulative puzzles; automatic mahjong tables; video game machines for household purposes; electronic games for the teaching of children; battery-powered computer game machines with liquid crystal displays (LCD); magic cube puzzles; manipulative logic games; amusement apparatus adapted for use with television receivers only; scooters (toys); children's toy bicycles other than for transport.

37 – Repair information; upholstery repair; electric appliance installation and repair; installation, maintenance and repair of computer hardware; installation and maintenance of lighting apparatus; vehicle breakdown assistance (repair); photographic apparatus repair; clock and watch repair; furniture maintenance; burglar alarm installation and repair; telephone installation and repair; repair of hand tools; repair or maintenance of watches; installation, changing, replacement and repair of locks; repair or maintenance of telephone apparatus; repair of toys or dolls; telephone repair; repair and maintenance of smartphones; repair of game machines and apparatus; advisory services relating to the installation of telephone equipment.

(260) AM 2020 105107 A

(800) 1489569

(151) 2019 06 14

(891) 2019 06 14

(731) JOS. A. MAGNUS & CO., LLC

300 NEW JERSEY AVENUE NW, 9TH
FLOOR, WASHINGTON DC 20001, USA

(540)



(591) Black, white

(531) 03.01.02; 05.05.20; 05.05.21; 24.09.21;
24.15.03; 26.11.08

(511)

33 – Whiskey, gin and distilled spirits.

(260) AM 2020 105108 A

(800) 1489577

(151) 2019 06 28

(891) 2019 06 28

(731) FURLA S.P.A.

Via Bellaria 3-5, I-40068 SAN LAZZARO
DI SAVENA, BOLOGNA, Italy

(540)

FURLA

(591) Black, white

(511)

3 – Perfumes and eau de Cologne; lotions; essential oils; skin cleansers; body toner lotions; face creams for cosmetic purposes; skin creams [for cosmetic use]; body creams; soaps for personal use; shaving soaps and foams; after-shave lotions; toilet water; air fragrancing preparations; perfumery; fragrances; hair conditioners; make-up powder; cosmetics; cosmetic creams; skin whitening creams; dentifrices; deodorants for human beings or for animals; vaginal washes for personal sanitary or deodorant purposes; cleansers for intimate personal hygiene purposes, non medicated; ethereal essences; massage gels, other than for medical purposes; hair spray; cleansing milk for toilet purposes; hair lotions; lotions for cosmetic purposes; lip glosses; mascara; beauty masks; eyebrow pencils; cosmetic pencils; cosmetic kits; oils for toilet purposes; oils for perfumes and scents; oils for cosmetic purposes; potpourris [fragrances]; suntanning preparations [cosmetics]; cosmetic preparations for baths; phytocosmetic preparations; toiletry preparations; hair straightening preparations; hair waving preparations; cosmetic preparations for slimming purposes; breath freshening preparations for personal hygiene; cosmetic preparations for skin care; antiperspirants [toiletries]; make-up preparations; nail care preparations; shaving preparations; sachets for perfuming linen; make-up removing preparations; lipsticks; bath salts, not for medical purposes; tissues impregnated with make-up removing preparations; cakes of toilet soap; soap; deodorant soap; shampoos; shampoos for animals [non-medi-

cated grooming preparations]; nail polish; breath freshening sprays; talcum powder, for toilet use; tissues impregnated with cosmetic lotions; make-up; beauty creams; scented body lotions and creams; make-up removing gels; make-up removing lotions; bath and shower gels, not for medical purposes; sunscreen preparations; joss sticks; massage candles for cosmetic purposes.

(260) AM 2020 105113 A

(800) 1229206

(151) 2014 05 19

(891) 2019 09 10

(731) Bellman & Symfon Europe AB

S. Långebergsgatan 30, SE-421 32 Västra

Frölunda, Sweden

(540)

BELLMAN

(591) Black, white

(511)

9 – Apparatus and instruments for signalling, perception, conversion, recording, transmission or reproduction, detecting and analysis of signals, sound and images, all of the foregoing excluding telephones and telecommunications equipment; sensors and detectors; security, safety, protection and signalling apparatus; alarms and warning equipment; measuring, detecting and monitoring instruments, indicators and control units, including sensors for detecting fluids and diseases and similar incidents, pressure sensors; apparatus and instruments, sensors and detectors, for signalling, perception, conversion, recording, transmission or reproduction, detecting and analysis of signals and sound, all for protecting the hearing and improving the perception of sound, all for the purpose of protecting the hearing and improving the perception of sound; apparatus and instruments for transmitting and receiving vibration signals; alarms for deaf people, people with impaired hearing and/or people with impaired vision; luminous and/or mechanical signals; warning signals; bells [warning devices]; flashing lights (signalling lights); buzzers; amplifiers; listening apparatus for television, radio, computers and the internet; radio, infrared and wired communication apparatus, not including telephones, aerials or inverters; in-ear monitoring systems; transmitters; hearing aid batteries; receiving apparatus; transceivers; video players; parts and fittings for the aforesaid goods; downloadable software and software in the form of mobile applications for signalling, perception, conversion, recording, transmission or reproduction, detecting and analysis of signals, sound and images, sensors and detectors, security, safety, protection and signalling apparatus, alarms and warning equipment, all of the foregoing excluding telephones and telecommunications equipment; measuring, detecting and

monitoring instruments, indicators and control units, including sensors for detecting fluids and diseases and similar incidents, pressure sensors; apparatus and instruments for signalling, perception, conversion, recording, transmission or reproduction, detecting and analysis of signals, sound and images, for helping and aiding people with normal hearing in difficult listening conditions; apparatus and instruments for signalling, perception, conversion, recording, transmission or reproduction, detecting and analysis of signals, sound and images, for helping and aiding people with impaired vision.

10 – Medical and veterinary apparatus and instruments; medical apparatus and instruments for signalling, perception, conversion, recording, transmission or reproduction, detecting and analysis of signals, sound and images, for helping and aiding deaf people and/or people with impaired hearing; health monitoring systems for medical purpose including health monitoring sensors; medical measuring, detecting and monitoring instruments, indicators and control units, including sensors for detecting fluids and diseases and similar incidents, blood pressure measuring apparatus, medical and surgical apparatus and instrument for helping, aiding and making it possible to hear and/or perceive in some other way signals, sound and images, surgical and medical apparatus and instruments for protecting, investigating and treating hearing impairments, deafness and the ears and function of the ears; hearing aids; hearing protection devices; cleaning kits for hearing aids, namely brushes, picks, tube and vent cleaners, drying capsules, blowers; ear plugs; parts and accessories for the foregoing; medical apparatus and instruments for helping and aiding people.

37 – Installation, cleaning, repairing and maintenance of apparatus and instruments, sensors and detectors for signalling, perception, conversion, recording, transmission or reproduction, detecting and analysis of signals, sound and images; installation, cleaning, repairing and maintenance of security, safety, protective and signalling apparatus, alarms and warning equipment, measuring, detecting and monitoring instruments, indicators and control units, including sensors for detecting fluids and diseases and similar incidents; installation, cleaning, repairing and maintenance of pressure sensors; installation, cleaning, repair and maintenance of apparatus and instruments, sensors and detectors, for signalling, perception, conversion, recording, transmission or reproduction of sound, all for protecting the hearing and improving the perception of sound, all for the purpose of protect the hearing and improve the perception of sound; installation, cleaning, repairing and maintenance of apparatus and instruments for transmitting and receiving vibration signals, amplifiers, alarms, luminous and/or mechanical signals, listening apparatus for televisions, radio, computers

and the internet, radio infrared and wired communication apparatus, in-ear monitoring systems, microphones, warning signals, warning bells, flashing lights (signalling lights), receivers, transceivers, batteries for hearing aids, buzzers, parts and accessories for the aforesaid goods, and information and consultancy relating thereto; installation, cleaning, repairing and maintenance of apparatus and instruments for helping and aiding people.

(260) AM 2020 105114 A
 (800) 1346666
 (151) 2017 02 25
 (891) 2019 09 04
 (731) ROMAN PETER
 Hauptstrasse 32, CH-6034 Inwil, Switzerland
 (540)

Trash Hero

(591) Black, white
 (511)
 36 – Providing information relating to charitable fundraising; providing financial assistance to social, charitable and religious organizations; financial sponsorship of social, charitable and religious organizations.
 40 – Destruction of waste and trash; destruction of waste; rental of machines and apparatus for compacting waste; incineration of waste; incineration of waste; conversion of energy from waste into electricity (energy recycling services); conversion of energy from waste into electricity; conversion of energy from waste into water vapor (energy recycling services); conversion of energy from waste into water vapor; recycling of trash and waste; recycling of waste and providing information relating thereto; incineration and destruction of waste; information, delivery of advice and services provided by consultants relating to the recycling of waste and trash; industrial toxic waste disposal services; decontamination of nuclear waste; treatment services for soil, waste or water (environmental rehabilitation services); providing information relating to the rental of waste crushing machines and apparatus; provision of information relating to the rental of apparatus and machines for waste compacting; provision of information relating to the recycling of waste; services provided by consultants relating to the destruction of waste and trash; services provided by consultants relating to the incineration of waste and trash; treatment of industrial waste for carbon sequestration purposes; treatment of waste in the field of environmental pollution control; treatment of waste materials; recycling of waste; treatment and recycling of waste and trash; treatment of waste; recycling of waste; waste treatment (transformation); treatment

of waste and harmful substances; services provided by consultants relating to the recycling of waste and trash; treatment services for soil, waste or water (environmental rehabilitation services); recycling of waste and providing information relating thereto.

(260) AM 2020 105160 A
 (800) 1489598
 (151) 2019 05 23
 (891) 2019 05 23
 (731) UNIPHARM, INC.
 350 Fifth Avenue, Suite 6701, New York
 NY 10118, USA
 (540)

LACTOFORCE

(591) Black, white
 (531) 27.05.01; 27.05.17
 (511)
 3 – Non-medicated cosmetics and toiletry preparations; non-medicated dentifrices; perfumery, essential oils; bleaching preparations and other substances for laundry use; cleaning, polishing, scouring and abrasive preparations.
 5 – Pharmaceuticals, medical and veterinary preparations; sanitary preparations for medical purposes; dietetic food and substances adapted for medical or veterinary use, food for babies; dietary supplements for human beings and animals; plasters, materials for dressings; material for stopping teeth, dental wax; disinfectants; preparations for destroying vermin; fungicides, herbicides.
 10 – Surgical, medical, dental and veterinary apparatus and instruments; artificial limbs, eyes and teeth; orthopaedic articles; suture materials; therapeutic and assistive devices adapted for the disabled; massage apparatus; apparatus, devices and articles for nursing infants; sexual activity apparatus, devices and articles.
 32 – Beers; non-alcoholic beverages; mineral and aerated waters; fruit beverages and fruit juices; syrups and other non-alcoholic preparations for making beverages.

(260) AM 2020 105161 A
 (800) 1489613
 (151) 2019 05 15
 (891) 2019 05 15
 (731) "Dan King" Limited Liability Partnership
 Samal-1 microdistrict, house 21, office 12,
 Almaty city, Kazakhstan
 (540)

TUMIA

(591) Black, white

(511)

21 – Crystal [glassware]; cooking pots; earthenware; pots; porcelain ware; pottery; services [dishes]; tea services [tableware]; tableware, other than knives, forks and spoons; painted glassware; coffee services [tableware]; glass bulbs [receptacles]; glass flasks [containers]; drinking vessels; refrigerating bottles; vessels of metal for making ices and iced drinks; glasses [receptacles]; cups of paper or plastic; drinking glasses; heat-insulated containers for beverages; heat-insulated containers; containers for household or kitchen use; kitchen containers; mugs; coffee grinders, hand-operated; coffee filters, non-electric; coffee percolators, non-electric; coffeepots, non-electric; table plates; disposable table plates.

29 – Albumen for culinary purposes; seaweed extracts for food; gelatine; edible fats; anchovy, not live; peanut butter; butter; cocoa butter for food; coconut butter; buttercream; white of eggs; black pudding [blood sausage]/black pudding /blood sausage; bouillon/broth; preparations for making bouillon; caviar; fruit, preserved; charcuterie; potato chips/potato crisps; sauerkraut; coconut, desiccated; colza oil for food/rape oil for food; bouillon concentrates/broth concentrates; jams; frozen fruits; soups; raisins; gherkins; vegetables, preserved; vegetables, cooked; vegetables, dried; oils for food; cream [dairy products]; cheese; crystallized fruits/frosted fruits; croquettes; crustaceans, not live; dates; milk; crayfish, not live; fish fillets; rennet; fruit, stewed; fruit jellies; fruit pulp; meat; fish, not live; jellies for food; meat jellies; game, not live; ginger jam; soya beans, preserved, for food; fatty substances for the manufacture of edible fats; fat-containing mixtures for bread slices; herrings, not live; lobsters, not live; corn oil for food/maize oil for food; palm kernel oil for food; sesame oil for food; oysters, not live; isinglass for food; ham; yolk of eggs; yogurt/yoghurt; vegetable soup preparations; vegetable juices for cooking; meat extracts; kephir [milk beverage]/kefir [milk beverage]; kumys [kumyss] [milk beverage]/koumiss [kumiss] [milk beverage]; milk beverages, milk predominating; whey; milk products; spiny lobsters, not live; bacon; lentils, preserved; margarine; marmalade; animal marrow for food; shellfish, not live; mussels, not live; palm oil for food; nuts, prepared; eggs; powdered eggs; liver pâté/liver pastes; onions, preserved; olives, preserved; olive oil for food; bone oil for food; pectin for culinary purposes; pickles; peas, preserved; sausages; salted meats; preparations for making soup; tomato purée; vegetable salads; lard; fruit salads; sardines, not live; salmon, not live; suet for food; tuna, not live; tomato juice for cooking; sunflower oil for food; tripe; truffles, preserved; poultry, not live; fruit peel; alginates for culinary purposes; almonds, ground; peanuts, prepared; mushrooms, preserved; coconut

fat; coconut oil for food; beans, preserved; liver; fish-based foodstuffs; fruit chips; clams, not live; fruit preserved in alcohol; pollen prepared as foodstuff; prawns, not live; fish, preserved; meat, preserved; shrimps, not live; snail eggs for consumption; tofu; whipped cream; pork; edible birds' nests; fish, tinned [canned (Am.)]; fish meal for human consumption; fruits, tinned [canned (Am.)]; meat, tinned [canned (Am.)]; potato fritters; salted fish; sea-cucumbers, not live; silkworm chrysalis for human consumption; vegetables, tinned [canned (Am.)]; sausages in batter; potato flakes; apple purée; cranberry compote; tahini [sesame seed paste]; hummus [chickpea paste]; laver, preserved; fruit-based snack food; curd; kimchi [fermented vegetable dish]; soya milk; milk shakes; ajvar [preserved peppers]; sunflower seeds, prepared; fish mousses; non-alcoholic eggnog; vegetable mousses; fish roe, prepared; seeds, prepared; aloe vera prepared for human consumption; preserved garlic; albumin milk/protein milk; linseed oil for food; low-fat potato chips/low-fat potato crisps; lecithin for culinary purposes; milk ferments for culinary purposes; compotes; condensed milk; smetana [sour cream]; ryazhenka [fermented baked milk]; prostokvasha [soured milk]; tomato purée; vegetable marrow paste; eggplant paste/aubergine paste; peanut milk for culinary purposes; almond milk for culinary purposes; rice milk; artichokes, preserved; arrangements of processed fruit; powdered milk; yakitori; bulgogi [Korean beef dish]; candied nuts; flavoured nuts/flavored nuts; hazelnuts, prepared; berries, preserved; guacamole [mashed avocado]; onion rings; falafel; lemon juice for culinary purposes; freeze-dried meat/lyophilized meat/lyophilised meat; oat milk; vegetable-based cream; freeze-dried vegetables/lyophilized vegetables/lyophilised vegetables; extra virgin olive oil for food; galbi [grilled meat dish]; escamoles [edible ant larvae, prepared]; edible insects, not live; sweet corn, processed; nut-based spreads; potato-based dumplings; hot dog sausages; corn dogs; soya bean oil for food; milk substitutes; almond milk; peanut milk; coconut milk; coconut milk for culinary purposes; coconut milk-based beverages; rice milk for culinary purposes; almond milk-based beverages; peanut milk-based beverages; sausage casings, natural or artificial; klipfish [salted and dried cod]; cottage cheese fritters; pressed fruit paste; yuba [tofu skin]; soya patties; tofu patties.

30 – Seaweed [condiment]; pasta; almond paste; aniseed; star aniseed; confectionery for decorating Christmas trees; infusions, not medicinal; coffee flavourings/coffee flavorings; aromatic preparations for food; seasonings; unleavened bread; salt for preserving foodstuffs; rusks; cookies/biscuits; malt biscuits; peppermint sweets; sweetmeats [candy]; waffles; buns; cocoa; coffee; unroasted coffee; vegetal preparations for use as coffee substitutes; cakes;

cinnamon [spice]; capers; caramels [candy]; curry [spice]; cereal preparations; chewing gum; chicory [coffee substitute]; tea; chocolate; marzipan; cloves [spice]; condiments; confectionery/sugar confectionery; corn flakes/maize flakes; popcorn; preparations for stiffening whipped cream; ice cream; pancakes; essences for foodstuffs, except etheric essences and essential oils; cooking salt; thickening agents for cooking foodstuffs; turmeric; natural sweeteners; spices; gingerbread; pastries; petit-beurre biscuits; bread rolls; peppers [seasonings]; pizzas; pepper; potato flour; puddings; pralines; ravioli; liquorice [confectionery]; rice; saffron [seasoning]; sago; sauces [condiments]; celery salt; semolina; sherbets [ices]/sorbets [ices]; spaghetti; tapioca; tapioca flour; tarts; vanilla flavourings for culinary purposes/vanilla flavorings for culinary purposes; vanillin [vanilla substitute]; vermicelli [noodles]; meat pies; pâtés en croûte; meat tenderizers for household purposes; edible ices; powders for making ice cream; almond confectionery; peanut confectionery; food flavorings, other than essential oils/food flavourings, other than essential oils; flavourings, other than essential oils, for beverages/flavorings, other than essential oils, for beverages; crushed oats; husked oats; oat-based food; oat flakes; oatmeal; stick liquorice [confectionery]; beer vinegar; coffee-based beverages; cocoa-based beverages; chocolate-based beverages; artificial coffee; candy; chips [cereal products]; chow-chow [condiment]; couscous [semolina]; malt extract for food; malt for human consumption; propolis/bee glue; relish [condiment]; royal jelly; sea water for cooking; sushi; tomato sauce; mayonnaise; crackers; custard; fruit jellies [confectionery]; muesli; rice cakes; soya sauce; frozen yogurt [confectionery ices]/frozen yoghurt [confectionery ices]; chutneys [condiments]; spring rolls; tacos; tortillas; iced tea; tea-based beverages; dressings for salad; bread-crumbs; tabbouleh; halvah; quiches; meat gravies; miso [condiment]/soya bean paste [condiment]; cereal-based snack food; rice-based snack food; hominy; hominy grits; baking powder; baking soda [bicarbonate of soda for cooking purposes]/bicarbonate of soda for cooking purposes [baking soda]; garden herbs, preserved [seasonings]; noodle-based prepared meals; cake frosting [icing]; chocolate mousses; dessert mousses [confectionery]; fruit coulis [sauces]; marinades; cheeseburgers [sandwiches]; pesto [sauce]; ham glaze; linseed for culinary purposes [seasoning]/flaxseed for culinary purposes [seasoning]; wheat germ for human consumption; high-protein cereal bars; cream of tartar for culinary purposes; gluten additives for culinary purposes; pasta sauce; cereal bars; palm sugar; dough; flowers or leaves for use as tea substitutes; pastry dough; vareniki [stuffed dumplings]; pelmeni [dumplings stuffed with meat]; chocolate decorations for cakes; candy decorations for cakes; chocolate-coated nuts; rice pudding; nut flours; minced garlic [condiment]; ba-

ozi [stuffed buns]; rice pulp for culinary purposes; jiaozi [stuffed dumplings]; ramen [Japanese noodle-based dish]; okonomiyaki [Japanese savoury pancakes]/okonomiyaki [Japanese savory pancakes]; batter mixes for okonomiyaki [Japanese savoury pancakes]/batter mixes for okonomiyaki [Japanese savory pancakes]; burritos; gimbap [Korean rice dish]; edible paper; edible rice paper; chocolate-based spreads; chocolate spreads containing nuts; flour-based dumplings; agave syrup [natural sweetener]; mirror icing [mirror glaze]; freeze-dried dishes with main ingredient being rice/lyophilized dishes with main ingredient being rice/lyophilised dishes with main ingredient being rice; freeze-dried dishes with main ingredient being pasta/lyophilized dishes with main ingredient being pasta/lyophilised dishes with main ingredient being pasta; chamomile-based beverages; dulce de leche; bibimbap [rice mixed with vegetables and beef]; onigiri [rice balls]; instant rice; hot dog sandwiches; ice cubes; processed seeds for use as a seasoning; sesame seeds [seasonings]; piccalilli; quinoa, processed; bulgur; buckwheat, processed; buckwheat flour; cranberry sauce [condiment]; apple sauce [condiment]; croutons; lomper [potato-based flatbread]; zephyr [confectionery]; pastila [confectionery]; senbei [rice crackers]; kimchi-jeon [fermented vegetable pancakes]; shaved ice with sweetened red beans; mints for breath freshening; chewing gum for breath freshening; udon noodles; soba noodles.

32 – Non-alcoholic fruit extracts; beer; ginger beer/ginger ale; malt beer; beer wort; non-alcoholic fruit juice beverages; whey beverages; preparations for making beverages; essences for making beverages; fruit juices/fruit juice; syrups for beverages; waters [beverages]; preparations for making aerated water; lithia water; mineral water [beverages]; seltzer water; table waters; must; lemonades; extracts of hops for making beer; vegetable juices [beverages]; syrups for lemonade; essences for making non-alcoholic beverages, not in the nature of essential oils; malt wort; grape must, unfermented; orgeat; soda water; sherbets [beverages]/sorbets [beverages]; tomato juice [beverage]; non-alcoholic beverages; pastilles for effervescing beverages; powders for effervescing beverages; aerated water; sarsaparilla [non-alcoholic beverage]; aperitifs, non-alcoholic; cocktails, non-alcoholic; fruit nectars, non-alcoholic; isotonic beverages; cider, non-alcoholic; kvass [non-alcoholic beverage]; non-alcoholic honey-based beverages; smoothies; aloe vera drinks, non-alcoholic; beer-based cocktails; soya-based beverages, other than milk substitutes; protein-enriched sports beverages; rice-based beverages, other than milk substitutes; non-alcoholic beverages flavoured with coffee/non-alcoholic beverages flavored with coffee; non-alcoholic beverages flavoured with tea/non-al-

coholic beverages flavored with tea; soft drinks; barley wine [beer]; energy drinks.

35 – Marketing research; marketing; telemarketing services; targeted marketing; bill-posting/outdoor advertising; dissemination of advertising matter; direct mail advertising; updating of advertising material; publicity material rental; publication of publicity texts; advertising/publicity; radio advertising; television advertising; advertising agencies/publicity agencies; modelling for advertising or sales promotion; organization of exhibitions for commercial or advertising purposes; rental of advertising space; advertising by mail order; organization of trade fairs for commercial or advertising purposes; online advertising on a computer network; rental of advertising time on communication media; writing of publicity texts; layout services for advertising purposes; organization of fashion shows for promotional purposes; production of advertising films; pay per click advertising; design of advertising materials; rental of billboards [advertising boards]; web indexing for commercial or advertising purposes; scriptwriting for advertising purposes; compiling indexes of information for commercial or advertising purposes; consultancy regarding advertising communication strategies; bill-posting; sales promotion for others; search engine optimization for sales promotion/search engine optimisation for sales promotion; promotion of goods and services through sponsorship of sports events; demonstration of goods; distribution of samples; presentation of goods on communication media, for retail purposes; import-export agency services; shop window dressing; provision of an online marketplace for buyers and sellers of goods and services.

43 – Café services; cafeteria services; restaurant services; self-service restaurant services; bar services; snack-bar services; food and drink catering; canteen services; tourist home services; washoku restaurant services; udon and soba restaurant services.

(260) AM 2020 105162 A
(800) 1489651
(151) 2019 08 01
(891) 2019 08 01
(731) AN SHAN INTERNATIONAL CO. LTD.
51 ngo 444 Doi Can str, P. Cong Vi,
Q. Ba Dinh, Hanoi, Viet Nam

(540)

SEN SOY

(591) Black, white
(511)

32 – Beer; fruit beverages and fruit juices; aperitifs, non-alcoholic; barley wine [beer]; aerated water; lithia water; seltzer water; soda water; waters [beverages]; table waters; kvass [non-alcoholic beverage];

cocktails, non-alcoholic; beer-based cocktails; lemonades; non-alcoholic beverages; isotonic beverages; non-alcoholic honey-based beverages; rice-based beverages, other than milk substitutes; soya-based beverages, other than milk substitutes; aloe vera drinks, non-alcoholic; whey beverages; protein-enriched sports beverages; soft drinks; non-alcoholic beverages flavored with coffee; non-alcoholic beverages flavored with tea; non-alcoholic fruit juice beverages; energy drinks; fruit nectars, non-alcoholic; orgeat; ginger beer; malt beer; powders for effervescent beverages; sarsaparilla [non-alcoholic beverage]; syrups for lemonade; syrups for beverages; smoothies; tomato juice [beverage]; cider, non-alcoholic; vegetable juices [beverages]; preparations for making aerated water; must; grape must, unfermented; beer wort; malt wort; pastilles for effervescent beverages; non-alcoholic fruit extracts; extracts of hops for making beer; essences for making beverages; mineral and aerated waters; sherbets [beverages]; non-alcoholic preparations for making beverages; syrups and other non-alcoholic preparations for making beverages.

(260) AM 2020 105163 A
(800) 1489681
(151) 2019 07 30
(891) 2019 07 30
(731) Zabbix, SIA
Dzelzavas Street 117, LV-1021 Riga, Latvia
(540)

ZABBIX

(591) Black, white
(511)
9 – Computer software.

(260) AM 2020 105164 A
(800) 1489745
(151) 2019 07 10
(891) 2019 07 10
(731) LAMYRA LLP
14 Bowling Green Lane, LONDON
EC1R 0BD, United Kingdom
(540)

PROBACTO

(591) Black, white
(511)
3 – Perfumery, essential oils; cosmetics, lotions for hairs, toothpastes and tooth powders.

5 – Pharmaceuticals, medical preparations; dietetic food and substances adapted for medical use, food for babies; dietary supplements for humans and animals.

- (260) AM 2020 105165 A
 (800) 1489785
 (151) 2019 03 26
 (891) 2019 03 26
 (731) Maersk Line A/S
 Esplanaden 50, DK-1263 Copenhagen K,
 Denmark
 (540)

SEALAND

(591) Black, white
 (511)
 35 – Advertising; business management; business administration; office functions; issuing of transportation and customs papers, certificates and documents; administrative services in relation to customs clearance.

36 – Insurance; financial affairs; monetary affairs; real estate affairs; arrangement of cargo insurance; electronic funds transfer; electronic funds transfer for others; financial information; online banking services and financial services; credit card services; processing and transmission of bills and payments thereof, and providing insurance for financial transactions; funds transfer services; transmission of funds by electronic means for others; transfer of payments for others via the internet; financial services in the nature of billing and payment processing services; financial services provided by telecommunication means; payment administration services; card payment processing services; payment transaction card services; discount card services (financial services); financial transaction management; credit card transaction processing services, namely facilitating credit card, debit card and electronic check transactions of others via the internet and terminals and servers in a local area network; customs brokerage; issuing letters of credit and certificates of deposit; securities brokerage; financial customs clearance services, including financial customs clearance services in relation to import and export; administrative services relating to arrangement and issuance, completion, management or submission of papers, certificates and/or documents relating to security for goods, customs, logistics and/or transportation activities; issuing of securities for goods; customs brokerage.

38 – Telecommunications; data and telecommunication services; transmission and transfer of images, information and e-mails via the data, cellular and telecommunications network.

39 – Transport; packaging and storage of goods; travel arrangement; container transport; shipping agency services; shipping agency services in the nature of providing assistance in the preparation of documents and customs clearance; delivery and transport of packets, packages, parcels; freight of

goods by road, railway, air and sea; arranging for the transportation of goods by road, railway, air and sea; stevedoring (cargo loading and unloading), freight forwarding; container rental; information regarding shipment and transportation and storage; transportation logistics services; logistics services relating to shipment and transportation and storage; providing tracking and tracing of shipments; management and operation of container terminals and of air cargo terminals; port authorities services; transport, including marine transport, railway and truck transport, air transport, transport of oils and gases by pipeline; delivery of goods; towing; salvaging; ship brokerage; aircraft brokerage; leasing of aircrafts; computerized transportation logistics service; harbouring services for ships and boats; warehouse and store room rental; localization of goods by computer; transport and freight brokerage services; cargo tracking services; localization of freight and goods via computer; transportation and storage of goods, including computerized logistics services; advisory and consultancy services relating to all the aforesaid services.

-
- (260) AM 2020 105173 A
 (800) 1489961
 (151) 2019 08 01
 (891) 2019 08 01
 (731) Pryvatne pidpriemstvo "BEL"
 vul. Universytetska, 96, Donetsk 83114,
 Ukraine
 (540)



(591) Black, white
 (531) 02.09.14; 05.13.25; 11.03.01
 (511)
 33 – Alcoholic beverages, except beer; alcoholic beverages containing fruit; low-alcohol beverages, except beer; aperitifs; brandy; wine.

-
- (260) AM 2020 105178 A
 (800) 1490089
 (151) 2019 07 30
 (891) 2019 07 30
 (731) Limited Liability Company "WIMM-BILL-DANN FOODS"
 Dmitrovskoe avenue, 108, RU-127591
 Moscow, Russian Federation

(540)



(591) White, green, dark green

(531) 01.15.15; 27.05.24; 29.01.12

(511)

5 – Almond milk for pharmaceutical purposes; dietic beverages adapted for medical purposes; food for babies; serums.

29 – Yogurt; kephir [milk beverage]; milk shakes; buttercream; kumys [milk beverage]; butter; milk; albumin milk; powdered milk; milk beverages, milk predominating; milk products; prostokvasha [soured milk]; ryazhenka [fermented baked milk]; cream [dairy products]; whipped cream; fat-containing mixtures for bread slices; smetana [sour cream]; whey; cheese; tofu; milk ferments for culinary purposes.

30 – Leaven; frozen yogurt [confectionery ices]; ice cream; dessert mousses [confectionery]; chocolate mousses; cocoa beverages with milk; coffee beverages with milk; chocolate beverages with milk.

32 – Whey beverages.

(260) AM 2020 105179 A

(800) 1490095

(151) 2019 05 10

(891) 2019 05 10

(731) EURO GAMES TECHNOLOGY LTD.

"Maritsa" Str., 4, "Vranya-Lozen-Triugulnika", BG-1151 Sofia, Bulgaria

(540)



(591) White, yellow, red and black

(531) 27.05.03; 29.01.14

(511)

9 – Software; computer gaming software; computer software packages; computer operating system software; computer software, recorded; software drivers; virtual reality software; games software; entertainment software for computer games; computer programs for network management; operating computer software for main frame computers; monitors (computer hardware); computer hardware; apparatus for

recording images; monitors (computer programs); computer game programs; computer programs for recorded games; apparatus for recording, transmission or reproduction of sound or images; communications servers [computer hardware]; electronic components for gambling machines; computer application software featuring games and gaming; computer software for the administration of on-line games and gaming; computer hardware for games and gaming; electronic components and computer software for gambling, gambling machines, gambling games on the internet and via telecommunication network.

28 – Gaming machines for gambling; chips for gambling; mah-jong; arcade games; gambling machines operating with coins, notes and cards; games; electronic games; parlor games; gaming chips; gaming tables; slot machines [gaming machines]; LCD game machines; slot machines and gaming devices; coin-operated amusement machines; roulette chips; poker chips; chips and dice [gaming equipment]; equipment for casinos; roulette tables; gaming roulette wheels; casino games; gambling machines and amusement machines, automatic and coin-operated; coin-operated amusement machines and/or electronic coin-operated amusement machines with or without the possibility of gain; boxes for coin-operated machines, slot machines and gaming machines; electronic or electrotechnical amusement machines and apparatus, gaming machines, coin-operated entertainment machines; housings for coin-operated machines, gaming equipment, gaming machines, machines for gambling; electropneumatic and electrical gambling machines (slot machines).

41 – Gambling; services related to gambling; gaming services for entertainment purposes; casino, gaming and gambling services; training in the development of software systems; provision of equipment for gambling halls; providing casino equipment [gambling]; gaming machine entertainment services; providing casino facilities [gambling]; gaming hall services; amusement arcade services; games equipment rental; rental of gaming machines; providing amusement arcade services; rental of gaming machines with images of fruits; editing or recording of sounds and images; sound recording and video entertainment services; hire of sound reproducing apparatus; provision of gaming equipment for casinos; providing of casino facilities; online gambling services; casino, gaming and gambling services; provision of gaming establishments, gaming halls, internet casinos, online gaming services.

(260) AM 2020 105184 A

(800) 1490240

(151) 2019 08 15

(891) 2019 08 15

(731) DVA Agro GmbH
Valentinskamp 70, 20355 Hamburg, Germany
(540)

Incentia

(591) Black, white
(511)
1 – Agricultural chemicals; horticultural chemicals; industrial chemicals; chemical fertilizers; chemicals for use in agriculture, horticulture and forestry.
5 – Herbicides.

(260) AM 2020 105185 A
(800) 1490256
(151) 2019 07 09
(891) 2019 07 09
(731) GRINDEKS, AS
Krustpils iela 53, LV-1057 Rīga, Latvia
(540)



(591) Black, pink, dark pink, silver and white.
(531) 02.09.01; 09.03.17; 29.01.14
(511)
5 – Pharmaceutical preparations; veterinary preparations.

(260) AM 2020 105188 A
(800) 1490289
(151) 2019 07 09
(891) 2019 07 09
(731) GRINDEKS, AS
Krustpils iela 53, LV-1057 Rīga, Latvia
(540)



(591) Pink, dark pink, gray, silver, white and black
(531) 17.05.17; 22.01.21; 29.01.15
(511)
5 – Pharmaceutical preparations; veterinary preparations.

(260) AM 2020 105191 A
(800) 1490345
(151) 2019 04 01
(891) 2019 04 01
(731) UPL Ltd.
UPL House, 610 B/2, Bandra Village,
Off Western Express Highway, Bandra
(East), Mumbai 400 051, India
(540)

OpenAg

(591) Black, white
(531) 27.05.01
(511)
1 – Fertilizer and chemical products for use in agriculture, plant nutrient, additive chemical to fungicides, additive chemical to insecticides, flower preservatives, chemicals for forestry, except fungicides, herbicides, insecticides and parasiticides, phosphorus, plant growth regulating preparations, carbolineum for the protection of plant.

5 – Pesticides, insecticides, fungicides, herbicides, vermicides, rodenticides, weedicides, preparations for killing weeds and destroying vermin.

31 – Seeds, seedlings, agricultural, horticultural and forestry products and grains not included in other classes, fresh fruits and vegetable seeds, natural plants and flowers.

44 – Veterinary services; hygienic and beauty care for human beings or animals; agriculture, horticulture and forestry services.

(260) AM 2020 105195 A
(800) 1490620
(151) 2019 07 22
(891) 2019 07 22
(731) Chemische Fabrik Dr. Weigert GmbH & Co.
KG
Mühlenhagen 85, 20539 Hamburg, Germany
(540)

Dr. Weigert

(591) Black, white
(511)
3 – Cleaning preparations for machines, apparatus and equipment, in particular for use in the cosmetics industry, in the pharmaceutical industry, in the food industry, in the beverages industry or in the animal foodstuffs industry, for hotels and restaurants as well as for agriculture, in hospitals and in the healthcare sector; cleaning preparations for machine dishwashers; cleaning preparations for pharmaceutical, medical and surgical instruments and apparatus as well as for laboratory equipment.

5 – Disinfectants for machines, apparatus and equipment, in particular for use in the cosmetics industry, in the pharmaceutical industry, in the food industry, in the beverages industry or in the animal foodstuffs industry, for hotels and restaurants as well as for agriculture, in hospitals and in the healthcare sector; disinfectants for machine dishwashers; disinfectants for pharmaceutical, medical and surgical instruments and apparatus as well as for laboratory equipment.

(260) AM 2020 105200 A
 (800) 1199222
 (151) 2013 10 21
 (891) 2019 09 09
 (731) DEERE & COMPANY
 One John Deere Place, Moline, Illinois
 61265-8098, USA

(540)



(591) Green (Munsell 9.47 GY3.57/7.45); yellow
 (Munsell 5.06 Y7.63/10.66)
 (531) 25.05.02; 26.04.09; 29.01.12
 (511)

7 – Self-propelled, pushed, drawn, towed, mounted, built-on or semi-mounted agricultural and forestry machines and implements; self-propelled, pushed, drawn, towed, mounted, built-on, hand-held or semi-mounted machines and implements for the maintenance, cleaning and conditioning of soils, gardens, property, lawns, golf courses and sports grounds, parks and public areas, and for treating and handling plants; pushed or hand-held lawn mowers; machines and implements driven by running wheels and/or motorised, for the maintenance and cleaning of lawns, golf courses and sports grounds, parks and/or public areas, and for treating and handling plants and/or for use in horticulture.

12 – Self-propelled agricultural and forestry machines, in particular farm tractors, small tractors, lawn tractors, and trailers.

(260) AM 2020 105207 A
 (800) 1454952
 (151) 2019 02 01
 (891) 2019 08 20
 (731) F. Hoffmann-La Roche AG
 Grenzacherstrasse 124, CH-4070 Basel,
 Switzerland

(540)

ROPOLIVY

(591) Black, white
 (511)
 5 – Pharmaceutical preparations for use in oncology.

(260) AM 2020 105271 A
 (800) 1490884
 (151) 2019 07 01
 (891) 2019 07 01
 (731) HAILEYBURY AND IMPERIAL SERVICE
 COLLEGE
 Haileybury, Hertford SG13 7NU, United
 Kingdom

(540)

HAILEYBURY

(591) Black, white
 (511)
 41 – Arranging and conducting examinations; boarding school services; education services; instruction services; physical education; advice on the provision and operation of sporting and recreation facilities; publication of texts; school services; secondary education services; teaching; tuition; arranging and conducting educational exchange programmes for staff and pupils.

(260) AM 2020 105282 A
 (800) 1491293
 (151) 2019 08 27
 (891) 2019 08 27
 (731) INDIVIDUAL ENTREPRENEUR
 TIUTKOVA ALINA ANDREEVNA
 ulitsa imeni Marshala Chuykova, d. 39, kv. 84,
 RU-400005 Volgograd, Russian Federation

(540)



(591) Black, white
 (531) 27.05.24
 (511)
 43 – Accommodation bureau services [hotels, boarding houses]; rental of temporary accommodation; rental of meeting rooms; tourist home services; hotel reservations; temporary accommodation reservations; hotel services; snack-bar services; café services; cafeteria services; motel services; rental of cooking apparatus; rental of chairs, tables, table linen, glassware; rental of drinking water dispensers; restaurant

services; self-service restaurant services; reception services for temporary accommodation [management of arrivals and departures]; food sculpting; canteen services; holiday camp services [lodging]; bar services; providing campground facilities; food and drink catering; washoku restaurant services; udon and soba restaurant services.

(260) AM 2020 105287 A
 (800) 1491484
 (151) 2019 06 24
 (891) 2019 06 24
 (731) Aktsionernoe obschestvo "MAKFA"
 per. Vspol'nyj, d. 5, str. 1, of. 1, RU-123001
 Moskva, Russian Federation

(540)



(591) Red and white
 (531) 26.04.04; 26.04.07; 26.04.18; 26.04.24;
 27.05.24; 29.01.12
 (526) ®
 (511)
 30 – Noodle-based prepared meals; vermicelli [noodles]; pasta; groats for human food; ribbon vermicelli; macaroni; wheat flour; cereal preparations; ravioli; spaghetti; chips [cereal products].

(260) AM 2020 105289 A
 (800) 1491562
 (151) 2019 04 01
 (891) 2019 04 01
 (731) VIENNA INSURANCE GROUP AG Wiener
 Versicherung Gruppe
 Schottenring 30, A-1010 Wien, Austria

(540)



(591) Blue, white and orange
 (531) 03.13.01; 03.13.02; 03.13.24; 27.05.24;
 29.01.13
 (511)
 36 – Issuance of prepaid cards and tokens of value; fundraising and financial sponsorship; insurance services; real estate services; financial and monetary services, and banking; fundraising and financial sponsorship.

(260) AM 2020 105290 A
 (800) 1491588
 (151) 2019 09 02
 (891) 2019 09 02
 (731) SHENZHEN WOODY VAPES
 TECHNOLOGY CO., LTD.
 Block 1, Shapuyangyong Industry Park,
 Songgang, Bao'an District, 518000 Shenzhen,
 China

(540)



(591) Black, white
 (531) 27.05.01
 (511)
 34 – Smokeless cigarette vaporizer pipes; cigarette filters; oral vaporizers for smokers; lighters for smokers; electronic cigarettes; cigarettes; liquid solutions for use in electronic cigarettes; electronic hookahs; flavourings, other than essential oils, for tobacco.

(260) AM 2020 105291 A
 (800) 1491592
 (151) 2019 08 09
 (891) 2019 08 09
 (731) CHANGHUA CHEMICAL TECHNOLOGY,
 CO., LTD
 No.20 Beijing Road, Yangtze River International,
 Chemical Industry Park, Zhangjiagang,
 Suzhou, 215600 Jiangsu, China

(540)



(591) Black, white
 (531) 26.01.16; 26.01.24; 26.13.25
 (511)
 1 – Textile-waterproofing chemicals; adhesives for industrial purposes; polyurethane, unprocessed; polyvinyl chloride resins, unprocessed; synthetic resins, unprocessed; plastics, unprocessed; ethyl ether; flame retardants; esters; tan.

(260) AM 2020 105295 A
 (800) 1491642
 (151) 2019 07 16
 (891) 2019 07 16
 (731) Guangzhou Mei Ku Trading Co., Ltd.
 Room 2205, No.36, Yangong Street, Yuexiu
 District, Guangzhou, Guangdong, China

(540)

M A C Q N F

(591) Black, white

(531) 27.05.01

(511)

25 – Clothing; ready-made clothing; underwear; children's clothing; shoes; hats; hosiery; gloves [clothing]; scarves; belts [clothing].

(260) AM 2020 105296 A

(800) 1491646

(151) 2019 07 03

(891) 2019 07 03

(731) Shenzhen 4PX Express Co., Ltd.
309-31013-315, Air Cargo Terminals,
(Domestic Cargo Terminals), Airport
Route 4, Shenzhen International Airport,
Bao'an Dist., Shenzhen, 518128 Guangdong,
China

(540)

4PX

(591) Black, white

(531) 27.05.11; 27.05.17; 27.07.11

(511)

35 – Advertising by mail order; online advertising on a computer network; publicity; business management and organization consultancy; import-export agency services; procurement services for others [purchasing goods and services for other businesses]; marketing; relocation services for businesses; search engine optimisation for sales promotion; sponsorship search.

39 – Freight forwarding; transportation logistics; packaging of goods; freight [shipping of goods]; car transport; railway transport; air transport; storage of goods; rental of storage containers; courier services [messages or merchandise].

42 – Packaging design; providing search engines for the internet; rental of computer software; conversion of data or documents from physical to electronic media; creating and maintaining web sites for others; computer technology consultancy; computer security consultancy; cloud computing; outsource service providers in the field of information technology.

(260) AM 2020 105300 A

(800) 1491702

(151) 2019 05 29

(891) 2019 05 29

(731) Oriflame Cosmetics AG
c/o Oriflame Global Management AG,
Bleicheplatz 3, CH-8200 Schaffhausen,
Switzerland

(540)

ORIFLAME SUN360°

(591) Black, white

(511)

3 – Non-medicated conditioning and care preparations for application to the hair, scalp, skin and nails; shampoos; hair conditioner; soaps; perfumes; perfumery; eau de cologne; toilet waters; essential and herbal oils; cosmetics; make-up; make-up preparations; lipsticks; nail varnishes; nail varnish removers; eyeliner; mascara; non-medicated toilet preparations; hair lotions; hair sprays and hair gels; preparations for use in the bath or shower; bath and shower oils, gels, creams and foams; face and body masks; face and body scrubs; facial washes; skin cleansers and hydrators; skin toners; skin moisturizers; blemish creams and blemish gels; deodorants; antiperspirants; preparations for use before shaving and after shaving; shaving soaps; shaving creams; shaving gels; after-shave preparations; pre-shave preparations; talcum powders; toiletries; dentifrices; toothpastes; foot care preparations (non-medicated).

(260) AM 2020 105301 A

(800) 1491705

(151) 2019 06 28

(891) 2019 06 28

(731) SEPEHR PLASTIC PADIDEH CO.
Gandi St., No. 11, 15th Alley, Tehran,
Islamic Republic of Iran

(540)

PICO PLAST

پیکو پلاست

(591) Black, white

(531) 28.01

(526) PLAST

(511)

16 – Garbage bags of paper or plastics; bags for microwave cooking; bags (envelopes, pouches) of paper or plastics for packaging; plastic bubble packs for wrapping or packaging; plastic cling film, extensible, for palletization; plastic film for packaging; plastic sheets for lining cabinets; freezer bag; paper tablecloth; bags of plastic for packaging.

(260) AM 2020 105302 A

(800) 1491738

(151) 2019 05 10

(891) 2019 05 10

(731) BLUE PRISM LIMITED
2 Cinnamon Park Crab Lane, Fearnhead,
Warrington WA12 0XP, United Kingdom

(540)

BLUE PRISM

(591) Black, white

(511)

9 – Computer software; computer hardware; parts and fittings for the aforesaid goods; downloadable computer software updates; electronic documentation relating to computer software and computer hardware; computer hardware and computer software in relating to artificial intelligence apparatus; artificial intelligence software.

16 – Printed matter; brochures; computer software operating manuals; computer software reference and instruction manuals; computer hardware reference and instruction manuals.

35 – Business management consultancy; provision of an online marketplace for trading, exchanging, and sale of goods and services, namely, computer software, computer software support services, training materials in connection with the use of computer software and computer systems, with other users; online retail services in respect of computer software, computer software support services, training materials in connection with the use of computer software and computer systems.

38 – Providing an online forum for users to discuss and exchange computer software.

41 – Education and training services in connection with the use of computer software and computer systems; arranging and conducting examinations, conferences, courses, seminars, workshops, and webinars; educational assessment services.

42 – Computer software consultancy; design and development of computer software and hardware; installation, maintenance and updating of computer software; computer system design and consultancy related thereto; computer software technical support services; technical consultancy services relating to information technology; hosting on-line web facilities for others for managing and sharing on-line content in relation to computer software and discussions related thereto; hosting an online forum for users to discuss and exchange computer software; software as a service; software as a service in the field of artificial intelligence; design and development of artificial intelligence computer software and hardware.

(260) AM 2020 105303 A

(800) 1491750

(151) 2019 05 10

(891) 2019 05 10

(731) EURO GAMES TECHNOLOGY LTD.

"Maritsa" Str., 4, "Vranya-Lozen-Triugulnika", BG-1151 Sofia, Bulgaria

(540)



(591) White, orange, yellow, red, black, green, light blue and purple

(531) 21.01.09; 27.05.02; 29.01.15

(511)

9 – Software; computer gaming software; computer software packages; computer operating system software; computer software, recorded; software drivers; virtual reality software; games software; entertainment software for computer games; computer programs for network management; operating computer software for main frame computers; monitors (computer hardware); computer hardware; apparatus for recording images; monitors (computer programs); computer game programs; computer programs for recorded games; apparatus for recording, transmission or reproduction of sound or images; communications servers [computer hardware]; electronic components for gambling machines; computer application software featuring games and gaming; computer software for the administration of on-line games and gaming; computer hardware for games and gaming; electronic components and computer software for gambling, gambling machines, gambling games on the internet and via telecommunication network.

28 – Gaming machines for gambling; chips for gambling; mah-jong; arcade games; gambling machines operating with coins, notes and cards; games; electronic games; parlor games; gaming chips; gaming tables; slot machines [gaming machines]; LCD game machines; slot machines and gaming devices; coin-operated amusement machines; roulette chips; poker chips; chips and dice [gaming equipment]; equipment for casinos; roulette tables; gaming roulette wheels; casino games; gambling machines and amusement machines, automatic and coin-operated; coin-operated amusement machines and/or electronic coin-operated amusement machines with or without the possibility of gain; boxes for coin-operated, slot machines and gaming machines; electronic or electrotechnical amusement machines and apparatus, gaming machines, coin-operated entertainment machines; housings for coin-operated machines, gaming equipment, gaming machines, machines for gambling; electropneumatic and electrical gambling machines (slot machines).

41 – Gambling; services related to gambling; gaming services for entertainment purposes; casino, gaming and gambling services; training in the development of software systems; provision of equipment for gambling halls; providing casino equipment [gambling]; gaming machine entertainment services; providing casino facilities [gambling]; gaming hall services; amusement arcade services; games equip-

ment rental; rental of gaming machines; providing amusement arcade services; rental of gaming machines with images of fruits; editing or recording of sounds and images; sound recording and video entertainment services; hire of sound reproducing apparatus; provision of gaming equipment for casinos; providing of casino facilities; online gambling services; casino, gaming and gambling services; provision of gaming establishments, gaming halls, internet casinos, online gaming services.

(260) AM 2020 105304 A

(800) 1491769

(151) 2019 06 24

(891) 2019 06 24

(731) SHISHANG JIAHE (BEIJING)
INTERNATIONAL TRADING CO., LTD.
No. 20179, Floor 2, Building 2, National
Advertising Industrial Park, No. Jia 12,
West Dawang Road, Chaoyang District,
Beijing, China

(540)



(591) Black, white

(531) 27.07.01

(511)

25 – Clothing; neckties; hats; gloves [clothing]; hosiery; shoes; girdles; layettes [clothing]; bathing suits; football shoes.

35 – Distribution of samples; outsourcing services [business assistance]; commercial administration of the licensing of the goods and services of others; business management assistance; publicity; advertising; procurement services for others [purchasing goods and services for other businesses]; auctioneering; sales promotion for others; import-export agency services.

(260) AM 2020 105306 A

(800) 1491814

(151) 2019 08 12

(891) 2019 08 12

(731) ADP GAUSELMANN GMBH
Merkur-Allee 1-15, 32339 Espelkamp,
Germany

(540)

Gong Ting

(591) Black, white

(511)

9 – Computer software; coin-operated mechanisms; computer and video game software; games software in particular for use on any computer platform, including electronic entertainment and games consoles; computer game programs; video games (software); computer games provided through a global computer network or supplied by means of multi-media electronic broadcast or through telecommunications or electronic transmission or via the internet; computer games, leisure and recreational software, video games and computer software, all being provided in the form of storage media; programs for operating electric and electronic apparatus for games, entertainment and/or amusement purposes; computer software for computer games on the internet; online games (software), in particular for online betting games, online prize games, online gambling games, online games of skill and online casino games; computer software in the form of an app for mobile devices and computers; calculating apparatus in coin-operated machines and parts for the aforesaid goods; electric, electronic, optical or automatic apparatus, for identifying data carriers, identity cards and credit cards, bank notes and coins; software in particular for casino and/or amusement arcade games, for gaming machines and/or slot machines each one with or without prize payouts; gaming software that generates or displays wager outcomes of gaming machines; operational computer games software; computer software for managing of games (games collection); computer programs for video games; computer video game software.

28 – Games; toys; gaming apparatus (including coin-operated apparatus); coin-operated arcade games (machines); games for amusement arcades (included in this class); coin-operated video gaming apparatus; video games apparatus adapted for use with external screens or monitors only; casino fittings, namely roulette tables, roulette wheels; coin-operated automatic gaming machines and gaming machines, in particular for gaming arcades, with or without a prize payout; electronic or electrotechnical gaming apparatus, automatic gaming machines, gaming machines, slot machines operated by coins, tokens, banknotes, tickets or by means of electronic, magnetic or biometric storage media, in particular for commercial use in casinos and amusement arcades, with or without a prize payout; automatic gaming machines and gaming machines, in particular for commercial use in casinos and gaming arcades, with or without a prize payout; coin-operated gaming machines and/or electronic money-based gaming apparatus (machines), with or without prizes; housings adapted for gaming machines, gaming apparatus and automatic gaming machines, operated by means of coins, tokens, tickets or by means of electronic, magnetic or biometric storage media, in particular for commer-

cial use in casinos and gaming arcades, with or without a prize payout; electronic games; electronic game entertainment apparatus and parts thereof; video output game machines; drawing apparatus for prize games and lotteries, draws or raffles; housings of metal, plastic and/or wood adapted for coin-operated automatic amusement machines; apparatus for games (including video games), other than adapted for use with external screens or monitors only; electro-pneumatic and electric slot machines with pulling handles (gaming machines); gaming tables, in particular for table football, billiards, sliding games; flying discs (toys) and darts; gaming machines, namely electric, electronic or electromechanical apparatus for bingo games, lotteries or video lottery games and for betting offices, connected or unconnected to a computer network; LCD games consoles; automatic gaming machines; all the aforesaid automatic machines operating in networks; apparatus and devices for accepting and storing money, being fittings for the aforesaid automatic machines, included in this class; automatic lottery machines.

(260) AM 2020 105309 A
 (800) 1491850
 (151) 2019 05 10
 (891) 2019 05 10
 (731) EURO GAMES TECHNOLOGY LTD.
 "Maritsa" Str., 4, "Vranya-Lozen-
 Triugulnika", BG-1151 Sofia, Bulgaria
 (540)

20 SUPER DICE

(591) White, yellow, orange and black
 (531) 27.05.03; 27.07.03; 29.01; 29.01.14
 (511)

9 – Software; computer gaming software; computer software packages; computer operating system software; computer software, recorded; software drivers; virtual reality software; games software; entertainment software for computer games; computer programs for network management; operating computer software for main frame computers; monitors (computer hardware); computer hardware; apparatus for recording images; monitors (computer programs); computer game programs; computer programs for recorded games; apparatus for recording, transmission or reproduction of sound or images; communications servers [computer hardware]; electronic components for gambling machines; computer application software featuring games and gaming; computer software for the administration of on-line games and gaming; computer hardware for games and gaming; electronic components and computer software for gambling, gambling machines, gambling games on the internet and via telecommunication network.

28 – Gaming machines for gambling; chips for gambling; mah-jong; arcade games; gambling machines operating with coins, notes and cards; games; electronic games; parlor games; gaming chips; gaming tables; slot machines [gaming machines]; LCD game machines; slot machines and gaming devices; coin-operated amusement machines; roulette chips; poker chips; chips and dice [gaming equipment]; equipment for casinos; roulette tables; gaming roulette wheels; casino games; gambling machines and amusement machines, automatic and coin-operated; coin-operated amusement machines and/or electronic coin-operated amusement machines with or without the possibility of gain; boxes for coin-operated machines, slot machines and gaming machines; electronic or electrotechnical amusement machines and apparatus, gaming machines, coin-operated entertainment machines; housings for coin-operated machines, gaming equipment, gaming machines, machines for gambling; electropneumatic and electrical gambling machines (slot machines).

41 – Gambling; services related to gambling; gaming services for entertainment purposes; casino, gaming and gambling services; training in the development of software systems; provision of equipment for gambling halls; providing casino equipment [gambling]; gaming machine entertainment services; providing casino facilities [gambling]; gaming hall services; amusement arcade services; games equipment rental; rental of gaming machines; providing amusement arcade services; rental of gaming machines with images of fruits; editing or recording of sounds and images; sound recording and video entertainment services; hire of sound reproducing apparatus; provision of gaming equipment for casinos; providing of casino facilities; online gambling services; casino, gaming and gambling services; provision of gaming establishments, gaming halls, internet casinos, online gaming services.

(260) AM 2020 105312 A
 (800) 1491935
 (151) 2019 08 05
 (891) 2019 08 05
 (731) GUANGZHOU XIANGYU WATCHES CO.,
 LTD.
 SHOP A036, NO.1 BAIXING STREET,
 ZHANXI ROAD, YUEXIU DISTRICT,
 GUANGZHOU GUANGDONG, China
 (540)



NAVIFORCE

(591) Black, white
 (531) 26.04.04; 26.04.05; 26.04.18; 27.05.09
 (511)
 14 – Watch straps; presentation boxes for watches; watch chains; wristwatches; jewellery boxes; precious metals, unwrought or semi-wrought; clocks; movements for clocks and watches; watch hands; clock hands.

(260) AM 2020 105323 A
 (800) 1000010
 (151) 2008 09 19
 (891) 2019 08 16
 (731) Madara Cosmetics AS
 Zeltiņu iela 131, LV-2167 Mārupe, Mārupes nov. (LV), Latvia
 (540)

MÁDARA

(591) Black, white
 (511)
 3 – Cosmetic preparations including creams, lotions, tonics, balsams, ointments, beauty masks, oils for cosmetic purposes, bath salts; sunscreen preparations; tissues impregnated with cosmetic lotions; depilatory preparations; nail varnish; hair waving preparations; make-up preparations; massage preparations; deodorants for personal use; substances for nice smell included in this class; laundry fresheners; incense; soaps; perfumery; essential oils, cosmetic and hair preparations; tooth powders and pastes.

35 – Sales (retail and wholesale) services in respect of creams, lotions, tonics, balsams, ointments, beauty masks, oils for cosmetic purposes, bath salts, sunscreen preparations, tissues impregnated with cosmetic lotions, depilatory preparations, nail varnish, hair waving preparations, make-up preparations, massage preparations, combs and sponges, deodorants for personal use, substances for nice smell included in this class, laundry fresheners, incense, soap, perfumery, essential oils, cosmetic and hair preparations, tooth powders and pastes.

(260) AM 2020 105324 A
 (800) 1143502
 (151) 2012 10 05
 (891) 2019 08 21
 (731) Otkrytoe aktsionernoe obshchestvo
 "TUROVSKIY MOLOCHNY KOMBINAT"
 ul. Leninskaya 154, Zhitkovichskiy rayon,
 Gomelskaya oblast, 247980 Turov, Belarus
 (540)



The logo for Bonfesto features the word "Bonfesto" in a white, rounded, sans-serif font, centered within a dark grey rounded rectangular background.

(591) Black, white
 (531) 26.04.18; 26.04.24; 27.05.24
 (511)
 29 – Rental of warehouses; parcel delivery; delivery of goods; storage information; transportation logistics; hauling; car transport; wrapping of goods; storage of goods; storage; freight forwarding.

(260) AM 2020 105325 A
 (800) 1350762
 (151) 2016 07 25
 (891) 2019 09 24
 (731) SMM MACHINE LTD
 Agias Zonis, 1 Nicolaou Pentadromos,
 floor, flat/office 406, CY-3026 Limassol,
 Cyprus
 (540)



(591) Black, white
 (531) 26.04.11; 26.04.22
 (511)
 35 – Search engine optimization for social web platforms for sales promotion; advertising services, public relations, brand creation and management services, publicity, development of loyalty programs, direct marketing, sponsorship search, sales promotion, sales promotion for others, marketing and design of advertising materials namely: creation of creative ideas for advertising materials (terms too vague in the opinion of the International Bureau – Rule 13(2)(b) of the Common Regulations), copywriting; production of advertising films by integrated marketing communications to promote goods, services, brands and blogs in social networks and the internet.

41 – Arranging of educational courses to promote goods and services in social media.

42 – Software as a service [SaaS]; computer software consultancy and consultancy regarding the development of application software for mobile phones; development, maintenance, updating, design, installation, rental of computer software and mobile applications; graphic design of advertising materials.

(260) AM 2020 105326 A
 (800) 1376752
 (151) 2017 06 28
 (891) 2019 09 18
 (731) ANHUI KANGTAI BOYE TECHNOLOGY CO., LTD.
 Xujishen Road, Liuan Economic & Technical, Development Zone, Anhui Province, China

(540)



(591) Red and white

(531) 03.07.04; 03.07.17; 04.03.20; 26.04.05; 26.04.15; 26.04.18; 26.04.24; 27.05.10; 27.05.24; 27.07.24; 29.01.12

(511)

21 – Glass caps; glass stoppers; glass bowls; glass [receptacles]; painted glassware; boxes of glass; signboards of porcelain or glass; works of art of porcelain, ceramic, earthenware or glass; tea caddies; cabarets [trays]; decanters; drinking horns; liqueur sets; tea services [tableware]; saucers; teapots; mugs; tea infusers; coffee grinders, hand-operated; coffee filters, non-electric; coffee percolators, non-electric; coffeepots, non-electric; tea strainers; tankards; drinking straws; crystal [glassware]; enamelled glass, not for building; opaline glass.

(260) AM 2020 105386 A

(800) 1492731

(151) 2019 08 26

(891) 2019 08 26

(731) INTERNATIONAL ALLIED MANAGEMENT GROUP CO., LTD.
125 Old Broad Street, London EC2N 1AR,
United Kingdom

(540)

The letters "IAM" in a large, bold, black, serif font.

(591) Black, white

(531) 27.05.17; 27.05.23

(511)

7 – Road sweeping machines, self-propelled; dust removing installations for cleaning purposes; oxygen cutting devices; fruit presses, electric, for household purposes; blenders, electric, for household purposes; mills for household purposes, other than hand-operated; crushers for kitchen use, electric; dishwashers; washing machines [laundry]; wringing machines for laundry.

11 – Air purifying apparatus and machines; electric hair driers; refrigerators; electric fans; water purification installations; humidifiers for household use; air conditioning installations; cooking apparatus and installations; kettles, electric; electric hot water dispensers for household purposes.

21 – Toothbrushes, electric; containers for household or kitchen use; aromatic oil diffusers, other than

reed diffusers; cooking pot sets; strainers for household purposes; coffee grinders, hand-operated; cups; stew-pans; electric devices for attracting and killing insects; china ornaments.

(260) AM 2020 105387 A

(800) 1492789

(151) 2019 05 14

(891) 2019 05 14

(731) BANK OF AMERICA CORPORATION
100 North Tryon Street, Charlotte NC 28255,
USA

(540)



(591) Black, white

(531) 26.04.03; 26.11.03; 26.11.06; 26.11.09

(511)

9 – Automatic teller machines; magnetically encoded plastic access cards for use in banking, financial, investment and insurance industries; computer software for use in banking, financial, investment and insurance industries, namely, software for accessing and conducting electronic banking services via global computer networks and telecommunication networks; software for automated clearance house processing; software enabling banking customers to transmit payment and collection orders directly and automatically accept account reconciliation information from the bank; software for use in connection with electronic funds transfers; software for accessing data from one or more mainframes and other computer systems in presenting the data in a uniform format to other types of computer applications; software for educating mortgage lending personnel about fair lending practices; software for use in communication of data between computers and other computers or computer peripherals; software for use in connection with foreign exchange financial services.

36 – Banking and financing services; financial services, namely, providing financial analysis, consultation, planning and management, commercial and consumer lending and leasing services, mortgage lending, and loan financing; credit card authorization, payment processing, and transaction processing services; debit authorization, payment processing, and transaction processing card services; electronic payment, namely, electronic processing and transmission of bill payment data; financial information in the nature of rates of exchange; security services, namely, guaranteeing loans; cash management; mortgage banking; safety deposit box services; savings

account services; providing educational and college scholarships; automated teller machine services; investment services, namely, providing investment analysis, consultation, planning, management, advisory, brokerage, banking, and research services with respect to stocks, mutual funds, securities, bonds, commodities, real estate brokerage and other instruments of investment; insurance services, namely, providing insurance and annuity brokerage services, insurance agencies and insurance consultation services in the fields of life, property and casualty, accident, health and credit insurance services; providing banking, financial, investment and insurance consultation and information via global computer networks, internal computer information networks and telecommunication networks for the electronic, telephonic and telefacsimile transmission of voice, data, multi-media, graphics, video, photo and audio information; providing interactive banking, financial, investment and insurance consultation and information via global computer networks, internal computer information networks and telecommunication networks for the electronic, telephonic and telefacsimile transmission of voice, data, multi-media, graphics, video, photo and audio information; providing information on international finance and foreign exchange rates via global computer networks, internal computer information networks and telecommunication networks for electronic, telephonic and telefacsimile transmission of such information.

42 – Providing temporary use of on-line non-downloadable computer software for accessing financial information and services through an online global computer network; providing online non-downloadable computer software for financial research, financial information, financial analysis, financial planning, financial management, investment management, banking services, trading of foreign exchange, providing electronic processing of electronic funds transfer, ACH, electronic check and electronic payments, financial transactions, electronic funds transfers; design, maintenance, development and updating of computer software for financial research, financial information, financial analysis, financial planning, financial management, investment management, banking services, trading of foreign exchange, providing electronic processing of electronic funds transfer, ACH, electronic check and electronic payments, financial transactions, electronic funds transfers; providing temporary use of online non-downloadable computer software for bank, bank mortgage, home equity loan, and home equity line of credit customer use for storing, processing, transmitting, receiving, printing and managing real estate information, and information related to real estate transactions, namely, mortgage, home equity loan, and home equity line of credit application status information; providing temporary use of online non-

downloadable computer software for uploading and submission of mortgage, home equity loan, and home equity line of credit documentation.

(260) AM 2020 105388 A
 (800) 1492802
 (151) 2019 08 01
 (891) 2019 08 01
 (731) UNIQUE TECHNOLOGIES LIMITED
 LIABILITY COMPANY
 Malomoskovskaya St., 22, building 4, room 4,
 RU-129626 Moscow, Russian Federation

(540)

KHANN III

(591) Black, red, scarlet and claret
 (531) 26.11.07; 27.05.01; 29.01.12
 (511)

7 – Machine wheels.

11 – Headlights for automobiles; light bulbs for directional signals for vehicles; lights for automobiles; anti-glare devices for vehicles [lamp fittings].

12 – Vehicle wheels; hub caps; anti-glare devices for vehicles; automobile chassis; caravans; vehicle bumpers; hoods for vehicle engines; spoilers for vehicles; brakes for vehicles; brake linings for vehicles; brake pads for automobiles; brake discs for vehicles; automobile bodies; bodies for vehicles; tipping bodies for lorries; luggage carriers for vehicles; ski carriers for cars.

(260) AM 2020 105390 A
 (800) 1492830
 (151) 2019 08 15
 (891) 2019 08 15
 (731) HUAWEI TECHNOLOGIES CO., LTD.
 Administration Building, Huawei
 Technologies Co., Ltd., Bantian, Longgang
 District, Shenzhen, China

(540)

HONOR MagicLink

(591) Black, white
 (531) 27.05.01
 (511)

9 – Computer memory devices; computer programs, recorded; computer keyboards; mouse [computer peripheral]; integrated circuit cards [smart cards]; notebook computers; laptop computers; bags adapted for laptops; sleeves for laptops; computer software applications, downloadable; tablet computers; pedometers; fingerprint scanners; scales; switchboards; transmitters of electronic signals; transmitting sets [telecommunication]; radios; modems; transponders; smartphones; program-controlled telephone switching equipment; cabinets for loudspeakers;

loudspeakers; microphones; sound transmitting apparatus; television apparatus; camcorders; headphones; portable media players; digital photo frames; earphones; cameras [photography]; air analysis apparatus; gas testing instruments; optical lenses; materials for electricity mains [wires, cables]; integrated circuits; video screens; sensors; electronic chips; chargers for electric batteries; batteries, electric; computer hardware; rechargeable batteries; smartglasses; smart watches; wearable activity trackers; covers for smartphones; cases for smartphones; selfie sticks [hand-held monopods]; connected bracelets [measuring instruments]; large-screen LCDs; electronic diaries; flat panel displays; liquid crystal displays; intercoms; car televisions; video monitors; touch screens; touch screen pens; electronic pens; flexible flat panel displays for computers; stands adapted for tablet computers; video printers; stands adapted for mobile phones; USB cables; USB cables for cellphones; digital door locks; central alarms; security tokens [encryption devices]; covers for tablet computers; black boxes [data recorders]; interactive touch screen terminals; humanoid robots with artificial intelligence; electronic sheet music, downloadable; smart rings; downloadable software applications for mobile phones; face recognition devices; scales with body mass analyzers; bathroom scales; protective films adapted for smartphones; electric and electronic effects units for musical instruments; audio interfaces; equalisers [audio apparatus]; virtual reality headsets; car video recorders; set-top boxes; thermal imaging cameras; infrared detectors; digital weather stations; biochips; electronic key fobs being remote control apparatus; personal digital assistants [PDAs]; computer software platforms, recorded or downloadable; thin client computers; hand-held electronic dictionaries; computer screen saver software, recorded or downloadable; downloadable graphics for mobile phones; wearable computers; portable digital electronic scales; selfie sticks adapted for cellular phones; smartphones in the shape of a wristband; monitoring apparatus, other than for medical purposes; security surveillance robots; wearable video display monitors; selfie lenses; laboratory robots; teaching robots; stylus for computer; computer programs, downloadable; downloadable emoticons for mobile phones; electric plugs; electric sockets; telecommunication apparatus in the form of jewelry; network communication equipment; computer software, recorded; computer programs [downloadable software]; computer operating programs, recorded.

(260) AM 2020 105391 A
 (800) 1492851
 (151) 2019 07 08
 (891) 2019 07 08
 (731) BLAUMANN TRADING LTD.
 Trust Company Complex, Ajeltake Road,

Ajeltaka Island, Majuro MH 96960, Marshall Islands

(540)



(591) Black, white
 (531) 24.01.15; 27.05.10; 27.05.11; 27.05.24
 (526) Professional; Precision
 (511)

7 – Electric kitchen tools; electric kitchen machines for food preparation [other than cooking]; food processors for kitchen use; liquidizers [kitchen mixer machines]; electric knives; electric kitchen mixers; electric hand blenders; table blenders; electric crushers for kitchen use; electric can openers; electric food slicers; electric graters; electric salt and pepper mills; dishwashers; household washing machines; household steam cleaning equipment; electric vacuum cleaners; household vacuum cleaners; hand stick vacuum cleaner; centrifugal water pumps for household purposes; electric dough makers for household purposes; electric whisks for household purposes; electric fruit presses; juice extractors; electric vacuuming machines for food; steam cleaner; steam cleaner with iron.

11 – Induction cookers; electric ovens; induction ovens; microwave ovens; gas stoves; household gas lighters; electric kitchen machines for cooking; electronic cooking machines; electric water kettles; induction cookers; electric food warmers; electric barbecue grills; electric grills; electric panini makers; electric pressure cookers; electric waffle makers; electric coffee makers; induction coffee makers; electric cooler bags; electric steamers for cooking; toasters; water filters; water-filter towers; air purifiers; ventilation fans; household boilers; air conditioning equipments; hoods for household use; steam generators for household use; household water filter units; household radiators; gas fireplaces; gas stoves; hairdryers; air fryers; tumble dryers [household].

(260) AM 2020 105392 A
 (800) 1492862
 (151) 2019 04 30
 (891) 2019 04 30
 (731) Obshchestvo s ogranichennoy
 otvetstvennostyu "NALCHIKSKY
 MOLOCHNY KOMBINAT"
 ul. Kirova, d. 294 A, g. Nalchik, RU-360000
 Kabardino-Balkarskaya Respublika, Russian
 Federation

(540)

Горянка

(591) Black, white

(531) 28.05

(511)

29 – Milk and milk products; oils and fats for food, including fatty substances for the manufacture of edible fats; edible fats; suet for food; yogurt; kephir [milk beverage]; buttercream; margarine; butter; soya milk being milk substitute; curd; ryazhenka [fermented baked milk]; whipped cream; fat-containing mixtures for bread slices; cheese; strained cheese; tofu.

(260) AM 2020 105487 A

(800) 1494011

(151) 2019 08 22

(891) 2019 08 22

(731) UAB "ME investicija"

Račių g. 1, LT-03154 Vilnius, Lithuania

(540)



(591) Red, black and white

(531) 25.05.03; 26.11.03; 26.11.12; 27.05.10; 29.01.13

(511)

39 – Transport.

(260) AM 2020 105488 A

(800) 1494017

(151) 2019 09 17

(891) 2019 09 17

(731) J. CHOO LIMITED

10 Howick Place, London SW1P 1GW,
United Kingdom

(540)



(591) Black, white

(531) 27.05.01; 27.05.17; 27.05.19

(511)

9 – Eyewear, sunglasses, spectacles, sunglasses and spectacles cases and frames, optical frames; pouches and bags adapted to carry sunglasses and spectacles; laptop cases, laptop bags; mobile phone cases, smartphone cases, mobile phone straps; encoded bank cards, encoded loyalty cards; bags adapted for electrical apparatus and instruments, mobile phones, smartphones, laptops, PDAs; apparatus for recording, transmission or reproduction of sound or images, magnetic data carriers, recording discs; pre-recorded CDs, CD-ROMs, tapes and discs; protective footwear; electronic publications (downloadable);

software applications (Apps); mouse mats, electronic tags for goods.

(260) AM 2020 105489 A

(800) 1494033

(151) 2019 03 26

(891) 2019 03 26

(731) KMG International N.V.

Strawinskylaan 807, Tower A-8, NL-1077
XX Amsterdam, Netherlands

(540)

ROMPETROL GO

(591) Black, white

(511)

4 – Industrial oils and greases; lubricants; dust absorbing, wetting and binding compositions; fuels (including motor spirit) and illuminants; non-chemical motor fuel pastes; electrical energy; electrical energy; non-chemical additives to motor fuel.

35 – Advertising; business management; business administration; office functions; retail services in relation to fuels; business management; business services; office function; rental of advertising space; consumers (commercial information and advice for-) [consumer advice shop]; commercial information and commercial advice for consumers [consumer advice shop]; presentation of goods on communication media, for retail purposes; price comparison services; consumers (commercial information and advice for-) [consumer advice shop]; exhibitions (organization of-) for commercial or advertising purposes; presentation of goods on communication media, for retail purposes; public relations; rental of advertising space.

43 – Services for providing food and drink; temporary accommodation.

(260) AM 2020 105513 A

(800) 1494680

(151) 2019 08 02

(891) 2019 08 02

(731) DAW SE

Rossdörfer Str. 50, 64372 Ober-Ramstadt,
Germany

(540)



(591) Black, white

(531) 03.02.01; 03.02.24; 20.01.05; 27.05.11
(511)

1 – Industrial chemicals; preservative and damp-proofing preparations for masonry, roofing tiles, cement and concrete, except paints and oils; artificial resins, synthetic resins and unprocessed plastics; solvents (chemicals); solvents for varnishes and lacquers; adhesives used in industry; adhesives for wallpaper; adhesives used in building; filler for the treatment of subsurfaces for paints (not included in other classes).

2 – Paints; varnishes; lacquers; glazes; coatings; preservatives against rust; primers; colorants; dyestuffs; dye pastes; mordants; paint thickeners; fixatives for paints; siccatives for paints; raw natural resins; thinning and binding preparations for paints, lacquers and coatings; solvents for thinning paints; preparations for preserving wood; wood mordants and wood preserving oils; paints, including structuring paints; bactericidal and/or fungicidal paints; anti-corrosion preparations; protective preparations for metals; metals in foil and powder form for painters, decorators, printers and artists.

6 – Building materials of metal or mainly of metal; expanded pierced metal; wire cloths of metal or mainly of metal; adjusting and levelling parts of metal or mainly of metal for building purposes; screws, pins, and bolts (of metal or mainly of metal); spacers of metal or mainly of metal for building purposes; fixing anchors of metal or mainly of metal for building; sills of metal or mainly of metal; window sills of metal and components of metal for window sills.

7 – Machine tools, all for paint works and builder; hand-held tools, other than hand-operated, all for paint works and builder; mixing machines for paints, lacquers and coatings; compressed air guns for the extrusion of mastics; spray guns for paints, lacquers and plaster; painting machines, coating machines for lacquers and plaster.

8 – Hand tools and implements (hand-operated), all for painting; hand tools and implements (hand-operated), namely special-purpose tools and implements for facade claddings and coatings; hand-operated glueing apparatus, hand-operated stirring apparatus (tools), hand operated guns for the extrusion of mastics; hand-operated spray guns for applying sealing compounds; hand-operated spray guns for spraying paints, lacquers and plaster.

9 – Scientific, research, navigation, surveying, photographic, cinematographic, audiovisual, optical, weighing, measuring, signalling, detecting, testing, inspecting, life-saving and teaching apparatus and instruments; apparatus and instruments for conducting, switching, transforming, accumulating, regulating or controlling the distribution or use of electricity; apparatus and instruments for recording, transmitting, reproducing or processing sound, images or data; recorded and downloadable media, software; blank

digital or analogue recording and storage media; computers and computer peripheral devices; mobile Apps.

16 – Paper, cardboard; printed matter; catalogues; brochures; prospectuses; stickers (stationery); photographs; stationery; adhesives for stationery or household purposes; artists' materials; materials for painters and upholsterers, namely, paintbrushes, brushes, paint rollers, painters' rollers, paint trays, spin grid, paint and dirt protection paper; marking chalk; chalk holders; rulers; teaching materials (except apparatus); packaging materials; color and/or sample cards, color and/or sample fans, color and/or sample card collections, color and/or sample boards, color and/or sample board collections; colored paper.

17 – Sealing, thermal protection and insulating materials; insulating paints, insulating varnishes, insulating fabrics, insulating plaster; substances for insulating buildings against moisture; artificial and synthetic resins (semi-finished products); fabrics for building insulation; insulating tapes; heat insulators; insulating panels; grid mats of glass fiber fabric and/or plastics, in the form of parts for composite heat insulation systems; plastic films, other than for wrapping purposes; adhesive tapes and strips for building.

19 – Building materials, not of metal or mainly not of metal, in particular profile rails and corner irons, finishing profiles; adjusting and levelling parts, spacers for building, sills, all not of metal or mainly not of metal; natural and artificial stone; mortar (building materials); quartz; plaster [building materials]; coatings (building materials); wall and ceiling panels (not of metal or mainly not of metal, for building); fabric embedding compounds for building; fillers (building materials); fabrics for building, not of metal or mainly not of metal, in particular stabilising fabrics.

20 – Fixing materials (not of metal or mainly not of metal), in particular fixing anchors for building; bolts, plugs, pins, screws, nuts, not of metal or mainly not of metal.

24 – Textile wall hangings; non-woven fabrics; fabrics for textile use.

27 – Wall hangings (non-textile), even structuring in connection with paints; wallpaper; floor coverings.

35 – Advertising, marketing and sales promotion; business management; administrative services; commercial information and advice for consumers in the choice of products and services; import and export services, as well as wholesaling and retailing services, including via the Internet, in the fields of: chemicals, paints, machines, tools and metal hardware, construction articles, building materials, DIY articles

and gardening articles, craft supplies, electric goods and electronic goods, sound recording carriers and data carriers; import and export services, as well as wholesaling and retailing services, including via the Internet, in the fields of: apparatus for sanitary purposes, printed matter, stationery, office requisites, furnishings and decorative articles, tents, awnings, wall hangings, agricultural products, horticultural products and forestry products.

37 – Painting, in particular tinting of paints; constructions; construction consultancy; building insulating; scaffolding; wallpapering; consultancy with regard to the use of paints, plasters and other coating materials in the construction industry.

39 – Transport; packaging and storage of goods; rental of units, silos and containers for storage and transport.

42 – Architectural services; consultancy in the field of energy-saving; architectural consultancy with regard to the interior and exterior color designing for buildings (buildings and constructions); IT services, namely development, programming, updating and implementation of software; hosting services, software as a service [SaaS] and rental of software; IT consultancy, advisory and information services; design services; software design and software development; consultancy relating to the aforesaid services.

(260) AM 2020 105514 A

(800) 1494683

(151) 2019 04 30

(891) 2019 04 30

(731) MAGNETI MARELLI S.P.A.

Viale Aldo Borletti 61/63, I-20011

CORBETTA (MI), Italy

(540)



(591) Black, white

(531) 27.05.01; 27.05.10

(511)

7 – Igniting devices for internal combustion engines; electronic ignitions for vehicles; couplings for machines; shaft couplings for machines; camshafts for vehicle engines; axles for machines; carburetter feeders; bearing housings for machines; alternators; alternators for land vehicles; shock absorbers for machines; grease rings [parts of machines]; piston segments; ball rings for bearings; high-frequency motor spindles with high frequency electric conver-

ters and power supply units; push rods for motors and engines; connecting rods for land vehicle engines; automotive engine blocks; calenders; sparking plugs for internal combustion engines; glow plugs for diesel engines; carburetters; crankcases for machines, motors and engines; engine cylinders for vehicles; engine cylinders for land vehicles; cylinders for machines; cylinders for motors and engines; fan belts for land vehicle engines; timing belts for motors and engines; timing belts for land vehicle engines; fan belts for motors and engines; transmission belts, other than for land vehicles; belts for motors and engines; cowlings [parts of machines]; headers being parts of vehicle exhaust systems; automotive intake manifolds; intake manifolds for motors and engines; exhaust manifold for engines; scale collectors for machine boilers; hydraulic controls for machines, motors and engines; pneumatic controls for machines, motors and engines; air compressors for vehicles; compressors [machines]; compressors for air conditioners; air condensers; steam condensers [parts of machines]; catalytic converters; fuel conversion apparatus for internal combustion engines; automobile oil pans; rack and pinion jacks; brake pads, other than for vehicles; roller bearings; ball-bearings; self-oiling bearings; bearings [parts of machines]; bearings for transmission shafts; engine bearings; dynamos; ignition devices for land vehicle engines; fuel injection devices for internal combustion engines; fuel economisers for motors and engines; mechanical lifts for moving, parking and storing land vehicles; air cleaners [parts of engines]; air filters for automobile engines; oil filters; oil filters for motors and engines; filters being parts of machines or engines; fuel filters; filters for cleaning cooling air, for engines; generators for land vehicles; joints [parts of engines]; gaskets of metal for vehicle engines; gaskets, not of metal, for vehicle engines; injectors for engines; washing installations for vehicles; lubricators [parts of machines]; igniting magnetos; igniting magnetos for engines; exhausts for motors and engines; pump diaphragms; engines and motors for model vehicles; mechanical engine parts for land vehicles; shock absorber plungers [parts of machines]; pistons for cylinders; pistons for engines; pistons [parts of machines or engines]; pistons for vehicle engines; pistons for land vehicle engines; self-regulating fuel pumps; water pumps for land vehicle engines; oil pumps for land vehicle engines; fuel pumps for land vehicle engines; lubricating pumps; pumps for cooling engines; pumps for land vehicle engines; radiators [cooling] for motors and engines; speed governors for machines, engines and motors; pressure reducers [parts of machines]; water heaters [parts of machines]; industrial robots; mufflers for motors and engines; exhaust systems for diesel engines; automotive exhaust pipes; exhaust pipes for land vehicle engines; control valves for regulating the flow of gases and liquids [parts of machines];

fans for motors and engines; heat exchangers [parts of machines].

9 – Accumulators [batteries]; accumulators, electric; accumulators, electric, for vehicles; electronic power supplies; residual gas analyzers; car antennas; electrical and electronic control apparatus and instruments; electrical and electronic control apparatus for use with apparatus or installations for air-conditioning; electrical and electronic control apparatus for use with apparatus or installations for heating; electrical and electronic control apparatus for use with apparatus of installations for ventilation; measuring and control apparatus and instruments; electronic navigational, tracking and positioning apparatus and instruments; data communication apparatus and instruments; apparatus and instruments for recording, transmission or reproduction of sound or images; satellite broadcast receiving and decoding apparatus and instruments; apparatus and instruments for transferring, receiving and storing sound, images and data, both in digital and analog form; speed checking apparatus for vehicles; navigation apparatus for vehicles [on-board computers]; satellite navigational apparatus; signal transmission apparatus; regulating apparatus, electric; measuring devices, electric; signalling apparatus and instruments; apparatus and instalments for conducting, switching, transforming, accumulating, regulating or controlling the distribution or use of electricity; Global Positioning System [GPS] apparatus; distance recording apparatus; data processing apparatus; distance measuring apparatus; apparatus for testing vehicle brakes; apparatus for testing vehicle transmissions; vehicle radios; computer software applications, downloadable; audio books; emergency light bars for vehicles [luminous signals]; batteries; batteries for lighting; batteries, electric; batteries for vehicles; electric wire harnesses for automobiles; battery chargers; cables, electric; starter cables for motors; photovoltaic cells; electronic circuits; integrated circuits; power connectors; electric cable connectors; connectors [electricity]; counters; contacts, electric; light-emitting diodes [LED]; quantum dot light-emitting diodes [QLED]; organic light-emitting diodes [OLED]; vehicle tracking devices; igniting apparatus, electric, for igniting at a distance; electronic personal alarm devices; wires, electric; sheaths for electric cables; automatic indicators of low pressure in vehicle tires; quantity indicators; temperature indicators; water level indicators; fuel gauges; gasoline gauges; electric loss indicators; pressure indicators; speed indicators; interfaces for computers; circuit closers; power switches; circuit breakers; inverters [electricity]; measuring and testing machines and instruments; vehicle wheel alignment machines; tire balancing machines for land vehicles; magnets; junction sleeves for electric cables; pressure gauges; measuring apparatus; pressure measuring apparatus;

electrical cells and batteries; plates for batteries; electric sockets; data processors; digital signal processors; computer software products; computer programs, downloadable; electronic publications, downloadable; control panels [electricity]; switchboards; distribution boards [electricity]; radios for vehicles; voltage regulators for vehicles; resistances, electric; audio- and video-receivers; cell switches [electricity]; combination carbon monoxide and smoke detectors; heat detectors; smoke alarms; fire detectors; black boxes [data recorders]; semi-conductors; infrared sensors; acceleration sensors; distance sensors; level sensors; gas sensors; motion sensors; motion sensors for security lights; position sensors; pressure sensors; proximity sensors; timing sensors; temperature sensors; coolant-temperature sensors; vibration sensors; velocity sensors; optical sensors; locks, electric; power locks for motor vehicles; locks for vehicles, electric; vehicle driving simulators for training purposes; sirens for vehicles; fire extinguishing systems; satellite navigation systems; Global Positioning Systems; computer software for data processing; graphical user interface software; software for diagnostics and troubleshooting; software for satellite navigation systems; computer software for Global Positioning Systems [GPS]; downloadable computer software for remote monitoring and analysis; charging stations for electric vehicles; alarms; measuring instruments; navigational instruments; speedometers for vehicles; tachometers; pressure indicator plugs for valves; thermostats for vehicle engines; thermostats for vehicles; battery testers; transformers [electricity]; step-down transformers; backup drives for computers; voltage monitoring units; battery jars.

11 – Lighting apparatus for vehicles; lights for vehicles; vehicle headlights; taillights for vehicles; vehicle reflectors; map-reading lights for vehicles; running lights for land vehicles; backup lights for land vehicles; taillights for land vehicles; anti-glare devices for vehicles [lamp fittings]; light bulbs for directional signals for vehicles; lights for automobiles; headlights for automobiles; heaters for vehicles; defrosters for vehicles; ventilating fans for use in vehicles; air conditioners for vehicles; ventilation [air-conditioning] installations for vehicles; heating apparatus for defrosting vehicle windows; heat exchangers, other than parts of machines.

12 – Electric cigarette lighters for land vehicles; cigar lighters for automobiles; couplings for land vehicles; air bags [safety devices for automobiles]; air bags for vehicles; cardan shafts for vehicles; transmission shafts for land vehicles; sun-blinds adapted for automobiles; anti-theft alarms for vehicles; suspension shock absorbers for vehicles; shock absorbers for automobiles; shock absorbers for vehicles; brake segments for vehicles; anti-theft devices for vehicles; apparatus for locomotion by land; head-

rests for vehicle seats; vehicle roll bars; axles for land vehicles; trailer hitches for vehicles; electric cars; robotic cars; cars; sway bars for land vehicle suspensions; vehicle joysticks; tow bars for vehicles; torsion bars for automobiles; torsion bars for land vehicle suspensions; torsion bars for vehicles; connecting rods for land vehicles, other than parts of motors and engines; signal arms for vehicles; gear boxes for land vehicles; inner tubes for pneumatic tires; inner tubes for vehicle tires; trucks; hoods for vehicles; bodies for vehicles; automobile bodies; coachwork for motor vehicles; driving chains for land vehicles; transmission chains for land vehicles; automobile chains; tire chains for land vehicles; brake shoes for automobiles; brake shoes for vehicles; rims for vehicle wheels; tires for vehicle wheels; spikes for tires; brake cylinders for vehicles; brake cylinders for land vehicles; security harness for vehicle seats; transmission belts for land vehicles; safety belts for vehicle seats; hydraulic circuits for automobiles; hydraulic circuits for vehicles; clips adapted for fastening automobile parts to automobile bodies; torque converters for automobiles; torque converters for land vehicles; transmission top covers for land vehicles; casings for pneumatic tyres; fitted dashboard covers for vehicles; hoods for vehicle engines; wheel bearings for land vehicles; axle bearings for land vehicles; lug nuts for vehicle wheels; reduction gears for land vehicles; hub caps; brake discs for vehicles; anti-glare devices for vehicles; anti-theft devices for automobiles; non-skid devices for vehicle tires; vehicle bonnet pins; license plate fasteners; fender flares for land vehicles; windows for automobiles; interior trim for automobiles; block brakes for land vehicles; brakes for automobiles; brakes for vehicles; brakes for land vehicles; universal joints for land vehicles; solid tires for vehicle wheels; brake linings for automobiles; brake linings for vehicles; clutch linings for land vehicles; upholstery for vehicles; differential gears for land vehicles; reversing gears for land vehicles; drive gears for land vehicles; gearing for land vehicles; gear shifts for automobiles; gear shifts for land vehicles; driving motors for land vehicles; handles for automobile doors; clutch mechanisms for automobiles; clutch mechanisms for land vehicles; propulsion mechanisms for land vehicles; transmissions for land vehicles; leaf springs for land vehicle suspensions; shock absorbing springs for automobiles; shock absorbing springs for vehicles; suspension springs for automobiles; vehicle suspension springs; jet engines for land vehicles; automobile engines; diesel engines for land vehicles; electric motors for automobiles; motors, electric, for land vehicles; engines for land vehicles; hubs for vehicle wheels; roof panels for land vehicles; door panels for vehicles; door panels for land vehicles; windcreens; windshields for automobiles; windshields for vehicles; mudguards for automobiles; mudguards for land vehicles;

sun visors for automobiles; mud flaps for vehicles; vehicle bumpers; bumpers for automobiles; structural parts for automobiles; structural parts for vans; structural parts for trucks; brake pads for automobiles; brake pads for vehicles; brake pedals for vehicles; brake calipers for vehicles; balance weights for vehicle wheels; pneumatic tires; automobile tires; air pumps [vehicle accessories]; roof racks for automobiles; luggage carriers for vehicles; license plate holders; doors for vehicles; doors for automobiles; ashtrays for automobiles; vehicle running boards; vehicle wheel spokes; rearview mirrors; tire liners; fitted liners for the cargo area of vehicles; gear wheels for land vehicles; wheels for automobiles; vehicle wheels; transmission cases for land vehicles; vehicle seats; car seats for children; brake segments for automobiles; brake segments for land vehicles; horns for vehicles; reversing alarms for vehicles; fuel tanks for land vehicles; gas tanks for vehicles; brake systems for vehicles; suspension systems for automobiles; suspension systems for land vehicles; wheel suspensions; windshield wiper blades for vehicles; side view mirrors for vehicles; rearview mirrors for automobiles; spoilers for vehicles; engine mounts for land vehicles; mud flap hangers; spare tire carriers for vehicles; brake drums for vehicles; brake drums for land vehicles; caps for vehicle fuel tanks; caps for automobile gas tanks; valve stem caps for vehicle tires; vehicle chassis; automobile chassis; windshield wipers; headlight wipers; sunroofs for automobiles; convertible tops for automobiles; convertible tops for vehicles; gear boxes for automobiles; steering units for land vehicles; valves for vehicle tires; electric vehicles; driverless cars [autonomous cars].

37 – Fuelling of vehicles; vehicle washing; vehicle greasing; vehicle polishing; vehicle maintenance; repair of water vehicles; consultancy relating to vehicle repair; tuning of engines for motor vehicles; maintenance of motor vehicles; maintenance of vehicles and machines; maintenance, servicing and repair of vehicles; vehicle battery charging; repair of land vehicles; repair and maintenance of vehicles; emergency vehicle repair services; repair of brake systems for vehicles; repair and maintenance of engines for motor vehicles; repair and maintenance of motor vehicles and their engines; recharging services for electric vehicles; fuelling, washing, cleaning, maintenance and repair of vehicles; repair and maintenance of motor vehicles and parts thereof; information and consultancy services relating to vehicle repair; garage services for the maintenance and repair of motor vehicles; repair, maintenance, servicing, dismantling, rebuilding and cleaning of vehicle engines and parts thereof; repair of automobiles; tuning of motors and engines for automobiles; motor vehicle maintenance and repair; providing information relating to the repair or maintenance of automobiles; ins-

pection of automobiles and parts thereof prior to maintenance and repair.

(260) AM 2020 105515 A

(800) 1494687

(151) 2019 04 15

(891) 2019 04 15

(731) BITFURY GROUP LIMITED

c/o Harneys Services (Cayman) Limited,
Harbour Pl, 103 South Church St, 4th Fl,
KY1-1002 George Town, Box 10240, Cayman
Islands

(540)

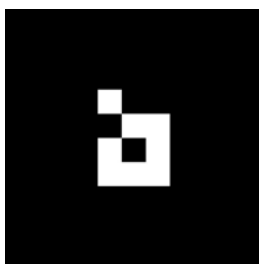

(591) Black, white

(531) 26.04.01; 26.04.09; 26.04.18; 26.04.24;
27.05.21; 27.05.24

(511)

9 – Downloadable software for use in the design, development and implementation of blockchains and blockchain-based computer applications; downloadable electronic databases for use in the design, development and implementation of blockchains and blockchain-based computer applications; downloadable software for managing, validating, authenticating, securing and transmitting encrypted data; computer chips for processing data; microchips; microprocessors; microchip sets; computer chip boards; printed circuit boards; semiconductors for use in computers; downloadable computer software frameworks for creating, designing, developing and implementing private and public blockchains; downloadable computer software for enabling encrypted, verifiable, and immutable records of transactions and documents; downloadable computer software for enabling encrypted, verifiable, and immutable records of transactions and documents in the fields of logistics, finance, virtual currency, legal agreements, and digital rights management; downloadable computer software for collecting, analyzing and displaying data in the fields of cryptocurrency transactions, cryptocurrency transaction participants, and cryptocurrency transaction trends; downloadable software, namely, software applications for accessing news, research, articles, educational materials, and other information in the fields of business, finance, distributed computing, blockchain technology, and cryptocurrencies; mobile datacenters; downloadable computer software for monitoring and analyzing the performance of mobile computing

datacenters; downloadable software for enabling and facilitating cryptocurrency micropayments; software in the fields of investigation and risk-assessment, namely, software for collecting, analyzing and displaying data using blockchain technology; apparatus for cooling electronic components and computer hardware.

35 – Management of databases; business advice and consultancy in the fields of digital rights management, namely, consulting relating to smart contract design, implementation and monitoring; business advice and consultancy in the field of voting process integrity; business advice and consultancy in the field of digital rights management; business services for the management and operation of data centers; data processing for others; automated data processing; collection of data for others (terms considered too vague by the International Bureau – Rule 13 (2) (b) of the Common Regulations); organizing and conducting business meetings, conventions, conferences, symposia, and courses, all in the fields of distributed computing, cryptocurrencies, and blockchain technology (terms considered too vague by the International Bureau – Rule 13 (2) (b) of the Common Regulations).

36 – Financial advice and consultancy relating to financial transaction security, transparency and optimization through the use of blockchain technology; credit scoring services; facilitation of financial transactions using currencies based on blockchain technology; facilitation of cryptocurrency transactions.

41 – Providing a website featuring articles, images, and photos in the fields of distributed computing, cryptocurrencies, and blockchain technology (terms considered too vague by the International Bureau – Rule 13 (2) (b) of the Common Regulations); organizing and conducting educational and entertainment meetings, conventions, conferences, symposia, and courses, all in the fields of distributed computing, cryptocurrencies and blockchain technology; organizing and conducting training in the fields of distributed computing, cryptocurrencies, and blockchain technology.

42 – Data encryption and decryption; coding and decoding of data; database design; providing online, non-downloadable computer software for use in the design, development and implementation of blockchains and blockchain-based computer applications; non-downloadable electronic databases for use in the design and implementation of blockchains and blockchain-based computer applications (terms considered too vague by the International Bureau – Rule 13 (2) (b) of the Common Regulations); providing online, non-downloadable computer software for managing, validating, authenticating, securing and transmitting encrypted data; computer programming, namely, developing blockchains for use by others;

non-downloadable computer software frameworks for creating, designing, developing and implementing private and public blockchains (terms considered too vague by the International Bureau – Rule 13 (2) (b) of the Common Regulations); providing on-line, non-downloadable computer software to facilitate virtual currency transactions by creating encrypted, verifiable, and immutable records of transactions; providing online, non-downloadable computer software to manage virtual currency transactions, by creating and maintaining encrypted records of transactions; providing online, non-downloadable computer software for use in the field of crowdfunding, namely, software to enable encrypted, verifiable, and immutable records of financial contributions to others; providing online, non-downloadable computer software to enable encrypted, verifiable, and immutable records of workflow status and asset location; providing online, non-downloadable computer software to enable the conduct and management of votes and referenda, namely, enabling encrypted, verifiable, and immutable records of voter selections; providing online, non-downloadable computer software to enable encrypted, verifiable, and immutable records of the rights, duties and obligations of parties to agreements and transactions, and to monitor and execute compliance therewith; non-downloadable computer software for managing, validating, authenticating, securing and transmitting encrypted data (terms considered too vague by the International Bureau – Rule 13 (2) (b) of the Common Regulations); non-downloadable computer software for enabling encrypted, verifiable, and immutable records of transactions and documents (terms considered too vague by the International Bureau – Rule 13 (2) (b) of the Common Regulations); on-line non-downloadable software for collecting, analyzing and displaying data in the fields of cryptocurrency transactions, cryptocurrency transaction participants, and cryptocurrency transaction trends (terms considered too vague by the International Bureau – Rule 13 (2) (b) of the Common Regulations); non-downloadable computer software for enabling encrypted, verifiable, and immutable records of transactions and documents in the fields of logistics, finance, virtual currency, legal agreements, and digital rights management (terms considered too vague by the International Bureau – Rule 13 (2) (b) of the Common Regulations); providing temporary use of on-line non-downloadable software in the fields of investigation and risk-assessment, namely, software for collecting, analyzing and displaying data using blockchain technology; providing online, non-downloadable computer software for accessing news, research, articles, educational materials, and other information in the fields of business, finance, distributed computing, blockchain technology, and cryptocurrencies; computer design and research; microchip design and research; microprocessor

design and research; leasing and rental of computers, computer servers, mobile computing datacenters, and computer processing time; virtual computer data storage, software and firmware (terms considered too vague by the International Bureau – Rule 13 (2) (b) of the Common Regulations); computer research and development in the field of blockchain technology and blockchain-related protocols; research and development in the field of cryptocurrency micropayment protocols; non-downloadable software for enabling and facilitating cryptocurrency micropayments (terms considered too vague by the International Bureau – Rule 13 (2) (b) of the Common Regulations); rental of apparatus for cooling electronic components and computer hardware (terms considered too vague by the International Bureau – Rule 13 (2) (b) of the Common Regulations); investigative and risk-assessment services, namely, providing temporary use of on-line non-downloadable software tools for collecting, analyzing and displaying data using blockchain technology; technical advice and consultancy relating to all of the foregoing.

(260) AM 2020 105516 A

(800) 1494702

(151) 2019 03 26

(891) 2019 03 26

(731) NORDISCHER MASCHINENBAU RUD.

BAADER GMBH + CO. KG

Geniner Str. 249, 23560 Lübeck, Germany

(540)

BAADER 

(591) Blue

(531) 26.11.03; 26.11.09; 27.05.01; 27.05.17;
29.01.04

(511)

7 – Filling machines; separators; fleshing machines; belt conveyors; handling apparatus for loading and unloading; packing machines; meat choppers [machines]; belts for conveyors; conveyers; moulding machines; bottle filling machines; blades and knives (parts of machines); bearings [parts of machines]; press separation machines; separating machines; sorting machines for industry; transferring machines; drums [parts of machines]; machines for the food industry; fish and meat processing machines and parts therefor, included in this class; machines for treating and processing fish, meat and poultry, and fruits and vegetables and goods made therefrom; mechanical conveyor belts for feeding machines with processing goods or with objects for further treatment; machines for production or treatment of packaging and packaging containers, including those made with film; machines for closing containers, including those made with film, and packaging bags;

machines for labelling goods; machines for packing of goods; parts for the aforesaid machines and equipment included in this class; suction machines for industrial purposes; grain separators; incubators for eggs; brushes [parts of machines]; brushes, electrically operated [parts of machines]; compressed air engines; pressure regulators [parts of machines]; pressure valves [parts of machines]; ejectors; labelers [machines]; springs [parts of machines]; filtering machines; crankcases for machines, motors and engines; hangers [parts of machines]; taps [parts of machines, engines or motors]; hoods [parts of machines]; elevating apparatus; lifting apparatus; joints (universal -) [cardan joints]; blades [parts of machines]; ball-bearings; automatic manipulators (parts of machines); housings [parts of machines]; knives [parts of machines]; electric knives; blade holders [parts of machines]; stropping machines; feeders [parts of machines]; mixers [machines]; tube conveyors, pneumatic; fruit presses; presses [machines for industrial purposes]; cleaning (machines and apparatus for -), electric; belts for machines; robots [machines]; bearings; sharpening wheels [parts of machines]; grease boxes [parts of machines]; lubricating pumps; lubricators [parts of machines]; self-foiling bearings; strainers (machines); control mechanisms for machines, engines or motors; stuffing boxes [parts of machines]; plunger pistons; dividing machines; transmissions for machines; vacuum pumps [machines]; heat exchangers [parts of machines]; washing apparatus; shaft couplings [machines]; tools [parts of machines]; holding devices for machine tools; sausage machines; centrifugal machines; slaughtering machines; machines for automated transport of objects, machine for automated transport of animals; machines for cleaning fish, meat, poultry, fruits and vegetables; machines for fumigating animals; machines for loading and unloading for and with animals and cages for animals; machine for dispensing solid and processable foodstuffs; homogenisers for foodstuffs; machines for killing fish; pumps for pumping whole fish.

9 – Data processing apparatus; computers; dosimeters; peripherals adapted for use with computers; computer software; electric sensors; optical sensors; infrared sensors; microwave sensing apparatus; optical apparatus and instruments and testing devices composed thereof; detectors; lasers, not for medical purposes; quantity indicators; measuring apparatus; weighing apparatus and instruments; weighing machines; commutation (electric apparatus for-); electric distribution consoles and control panels; x-ray apparatus not for medical purposes; temperature indicating apparatus; thermometers, not for medical purposes; cameras; camcorders; digital cameras; counters; meters; apparatus for metering (measuring) solid or malleable foodstuffs; photographic, cinematographic, optical, weighing, measuring and chec-

king (supervision) apparatus and instruments; sound recording apparatus; apparatus for recording images; sound transmitting apparatus; apparatus for the transmission of images; sound reproduction apparatus; apparatus for the reproduction of images; electrical and electronic controllers, control installations, control units, control systems and apparatus for controlling; programmable controllers; programmable control apparatus; controllers and control apparatus for the fish, meat and poultry processing industry; recorded content; recorded data [magnetic]; data recorded electronically; data recorded electronically from the internet; computer programmes for data processing; testing apparatus not for medical purposes.

11 – Apparatus for steaming, cooking, drying, refrigerating, freezing, defrosting, smoking, preserving and sterilising foodstuffs; heating apparatus for the scalding of poultry.

(260) AM 2020 105567 A

(800) 1494909

(151) 2019 05 21

(891) 2019 05 21

(731) WORLD VET İLAÇ SANAYİ VE TİCARET LİMİTED ŞİRKETİ

15 TEMMUZ MAH.CAMI, YOLU CAD.

NO.50 KAT.1, BAĞCILAR İstanbul, Turkey

(540)

Нафцивет-DC/ Nafcivet-DC

(591) Black, white

(531) 24.17.01; 27.05.01; 28.05

(511)

5 – Pharmaceutical and veterinary preparations for medical purposes, chemical preparations for medical purposes, dietary supplements, including those adapted for medical purposes, dietary supplements for slimming purposes, food for babies, herbs and herbal beverages adapted for medicinal purposes, dental preparations and articles, sanitary preparations for medical use, hygienic pads, hygienic tampons, plasters, materials for dressings, diapers, including those made of paper and textiles, preparations for destroying vermin, fungicides, herbicides, deodorants, other than for human beings or for animals, air deodorising preparations, disinfectants, antiseptics, detergents for medical purposes.

(260) AM 2020 105568 A

(800) 1494917

(151) 2019 09 03

(891) 2019 09 03

(731) Krevskiy Vladimir Nikolayevich

ul. Gaydara, d. 105, kv. 52; RU-236029

g. Kaliningrad, Russian Federation

(540)



(591) White, blue and yellow

(531) 26.01.03; 26.01.12; 27.05.01; 27.05.11; 28.05; 29.01.13

(511)

12 – Boats; ferry boats; ship hulls; boat hooks; steering gears for ships; disengaging gear for boats; inclined ways for boats; screw-propellers for boats; oars; davits for boats; launches; funnels for ships; timbers [frames] for ships; dredgers [boats]; spars for ships; sculls; stern oars; water vehicles; ships; screws [propellers] for ships; paddles for canoes; screw-propellers; cleats [nautical]; rowlocks; oarlocks; yachts; fenders for ships; remote control vehicles, other than toys; masts for boats; upholstery for vehicles.

37 – Vehicle breakdown repair services; repair information; plumbing; shipbuilding; machinery installation, maintenance and repair; underwater repair.

(260) AM 2020 105569 A

(800) 1494988

(151) 2019 09 12

(891) 2019 09 12

(731) SEA LION SRL

via Giovanni Ansaldo 7, I-47122 Forli, Italy

(540)

WALLYTENDER

(591) Black, white

(511)

12 – Seacraft; yachts; powerboats; sailboats; motor-sailers; rowing boats; jet boats; inflatable boats; personal water craft.

(260) AM 2020 105570 A

(800) 1495081

(151) 2019 07 23

(891) 2019 07 23

(731) IP Holdings (Antigua) Limited

The Ursula Jones Building, Coolidge,
P.O. Box 3511, St. John's, Antigua and
Barbuda

(540)



(591) Black, white

(531) 27.05.09; 27.05.22

(511)

36 – Financial services; monetary transfer; payment services; savings services; payment and credit services; charge card, cash card and bank card services; cash management; safe deposit services; bankers' clearing services; account debiting services; escrow services; cheque encashment services; credit brokerage; financing of loans; providing loans (financial) against security; financial investment services; capital investment services; trustee services; financial management services; services of brokers and agents (for bonds and other securities); financial consultation services; investment advice; financial guarantees (surety services); financial analysis and providing reports; financial information services; financial research services; financing services (securing funds for others); financial advisory services; services for the provision and purchase of financial and/or credit information; administration of financial affairs; computerized financial services; advice and enquiries regarding credit; services for the provision of credit; acceptance of deposits; discount of bills (notes); domestic remittance, liability guarantee, acceptance of bills, lending securities, acquisition and transfer of monetary claims; trusteeship of money; trading of futures contracts; brokerage of securities, transfer of monetary claims, trustee of personal property, land, land fixture surface rights and land leasing rights; money exchange and foreign exchange transactions, currency exchange services, issuing of travellers' cheques; issuing of letter of credit, securities trading, trading of securities index futures, brokerage of securities options, trading of, underwriting securities, selling securities, handling subscriptions and offerings of securities, providing stock market information, life insurance brokerage; mortgage services; information relating to economic (finance related) services provided on-line (not downloadable); information relating to financial, banking, insurance and investment services provided on-line (not downloadable); financial analysis and financial market reporting services; computerized financial services, namely online brokerage for transacting and trading of currency and other financial products; computerized financial services, namely providing for the exchange of currencies, futures, commodities, securities, financial instruments and options.

(260) AM 2020 105571 A

(800) 1495083

(151) 2019 07 16

(891) 2019 07 16

(731) UNILIN B.V.

Ooigemstraat 3, B-8710 Wielsbeke,
Belgium

(540)



(591) Blue, pink and white

(531) 24.17.02; 26.04.02; 26.04.07; 26.04.16;
26.04.18; 26.11.03; 26.11.09; 27.05.10;
27.05.24; 29.01.13

(511)

19 – Building materials (non-metallic); non-metallic transportable buildings; floors, not of metal; tile floorings, not of metal; paving slabs, not of metal; parquet flooring; laminated parquet flooring; laminated parquet floorboards; parquet floor boards; wood veneer parquet flooring; flooring underlays; building panels, not of metal; panels, not of metal, for floor; planks of non-metallic materials for use in construction; partitions, not of metal; building panels, not of metal; wall linings, not of metal, for building; wall panelling made of non-metallic materials; roof coverings, not of metal; non-metallic revetment for building; staircases, stair treads and stringers (parts of staircases), not of metal; timber mouldings; skirting boards (non-metallic -); expansion joint covers (non-metallic -); mouldings, not of metal, for cornices and staircases.

27 – Floor coverings; carpets, rugs and mats; linoleum; vinyl floor coverings; carpet underlay; carpet runners; wall coverings; wall hangings (non-textile); tapestry (wall hangings), not of textile; vinyl wall coverings; wall and ceiling coverings.

(260) AM 2020 105897 A

(800) 1499861

(151) 2019 10 11

(891) 2019 10 11

(731) JT International SA

8 rue Kazem-Radjavi, CH-1202 Genève,
Switzerland

(540)



(591) Green

(531) 10.01.01; 10.01.05; 10.01.25; 19.03.01;
25.07.07; 26.01.01; 26.01.18; 26.01.24;
26.02.03; 26.02.12; 26.04.05; 26.04.18;
26.04.24; 27.05.09; 29.01.03

(511)

9 – Electronic chargers, batteries.

34 – Electronic cigarettes; cases for electronic cigarettes; cases for electronic cigarette accessories; cigarettes; cigars; electronic cigarette tips for smokers; flavorings, other than essential oils, for use in electronic cigarettes; tobacco spraying apparatus; tobacco-related atomizers; oral atomizers for smokers; liquid aromatic cartridges for electronic cigarettes; liquids for electronic cigarettes containing flavorings, other than essential oils, for refilling electronic cigarette cartridges; liquid nicotine solutions for electronic cigarettes; tobacco substitutes; tobacco; cigarettes containing tobacco substances, not for medical purposes; ashtrays; lighters for smokers; smokers' articles, tobacco products.

(260) AM 2020 105898 A

(800) 1499867

(151) 2019 10 10

(891) 2019 10 10

(731) JT International SA

8 rue Kazem-Radjavi, CH-1202 Genève,
Switzerland

(540)



(591) Black, white

(531) 10.01.01; 10.01.05; 10.01.18; 10.01.25;
25.07.07; 26.01.01; 26.01.18; 26.01.24;
26.02.03; 27.05.09

(511)

9 – Electronic chargers, batteries.

34 – Electronic cigarettes; cases for electronic cigarettes; cases for electronic cigarette accessories; cigarettes; cigars; electronic cigarette tips for smokers; flavorings, other than essential oils, for use in electronic cigarettes; tobacco spraying apparatus; tobacco-related atomizers; oral atomizers for smokers; liquid aromatic cartridges for electronic cigarettes; liquids for electronic cigarettes containing flavorings, other than essential oils, for refilling electronic cigarette cartridges; liquid nicotine solutions for

electronic cigarettes; tobacco substitutes; tobacco; cigarettes containing tobacco substances, not for medical purposes; ashtrays; lighters for smokers; smokers' articles, tobacco products.

(260) AM 2020 105905 A
 (800) 1499889
 (151) 2019 09 24
 (891) 2019 09 24
 (731) LIMITED LIABILITY MANUFACTURING AND TRADING COMPANY "ACME"
 5 Promyslova Str., Ukrainka, Obukhivsky r-n, Kyivska obl. 08720, Ukraine
 (540)

DE MEN

(591) Black, white
 (531) 27.05.01
 (511)
 3 – Moustache wax; deodorants for human beings; beard and moustache dyes; cosmetic dyes; hair spray; after-shave lotions; shaving soap; cosmetic kits; shaving preparations; hair dyes; hair colorants; cosmetic products for skin care; cosmetics; shampoos.

(260) AM 2020 105960 A
 (800) 1361021
 (151) 2017 05 23
 (891) 2019 10 15
 (731) VALARTIN HOLDING LIMITED
 Stavrou, 56, flat/office 104, Strovolos, CY-2035 Nicosia, Cyprus
 (540)

SORBEX

(591) Black, white
 (511)
 5 – Charcoal for pharmaceutical purposes; dietetic foods, adapted for medical purposes.

(260) AM 2020 106286 A
 (800) 1497260
 (151) 2019 08 28
 (891) 2019 08 28
 (731) GRINDEKS, AS
 Krustpils iela 53, LV-1057 Rīga, Latvia
 (540)

KAPSIKAM

(591) Black, white
 (511)
 3 – Cosmetics and cosmetic preparations; cosmetic patches; cosmetic preparations for body care.
 5 – Pharmaceutical preparations; veterinary preparations; medical preparations; therapeutic creams [me-

dical]; therapeutic gels [medical]; therapeutic ointments [medical]; dietary supplements for therapeutic and medical use; sanitary preparations for medical purposes; plasters; medicated plasters; natural remedies; dietary supplements for human beings and animals.

10 – Medical apparatus for introducing pharmaceutical preparations into the human body; medical apparatus for the relief of pain; medical and veterinary apparatus and instruments.

(260) AM 2020 106288 A
 (800) 1497326
 (151) 2019 09 05
 (891) 2019 09 05
 (731) RAUCH Fruchtsäfte GmbH
 Langgasse 1, A-6830 Rankweil, Austria
 (540)

YIPPY

(591) Black, white
 (511)
 30 – Coffee, tea, cocoa and artificial coffee; coffee-based beverages; tea drinks; iced tea; green tea; drinking chocolate; cocoa-based beverages; beverages made on the basis of tea, chocolate, cocoa or coffee; rice; tapioca and sago; flour and preparations made from cereals; farinaceous foods; bread, pastry and confectionery; confections; confectionery; pralines and confectionery; chocolate and chocolate products; edible ices; ice cream; sugar, honey, treacle; yeast, baking-powder; salt; mustard; vinegar, sauces (condiments); marinades; fruit sauces; tomato sauces; spices; ice.

32 – Beers; shandy; waters; mineral and aerated waters; non-alcoholic beverages; juices; fruit beverages and fruit juices; cider (non-alcoholic); orange juice; fruit nectars, non-alcoholic; fruit nectars; fruit nectar beverages; vegetable juice, vegetable beverages and vegetable juices [beverages]; vegetable juice beverages; syrups and other preparations for making beverages; energy drinks; energy drinks; lemonades; non-alcoholic beverages; non-alcoholic beverages, in particular fruit-flavoured beverages; smoothies; waters, in particular with fruit flavouring; syrups for beverages; fruit syrups and other non-alcoholic fruit preparations for making non-alcoholic beverages; non-alcoholic sparkling wine.

33 – Alcoholic beverages (except beers); fruit (alcoholic beverages containing -).

(260) AM 2020 106293 A
 (800) 1497350
 (151) 2019 07 23
 (891) 2019 07 23

(731) Sovmestnoe obshchestvo s ogranichennoy otvetstvennostyu "MOROZPRODOUKT" ul. Oktiabrskaya, d. 133, k. 5, Marina Gorka, Pukhovitchski r-n, 222810 Minskaia obl., Belarus

(540)



(591) Dark blue, light blue, green, red, yellow, black, white, brown and beige

(531) 02.03.01; 07.01.01; 07.03.04; 07.03.25; 08.03.25; 28.05; 29.01.15

(511)

29 – Glazed curd snacks.

30 – Confectionery; ice cream, including in the form of cakes, cakes with biscuit, with flavors, fillers, filling, additives, in the glaze, multi-layered; cereal bars; cakes; pastries; peanut confectionery; almond confectionery; frozen yogurt [confectionery ices]; peppermint sweets.

(260) AM 2020 106426 A

(800) 1498599

(151) 2019 06 26

(891) 2019 06 26

(731) ETS ERSOY TURISTIK SERVISLERI ANONIM SIRKETI

Merdivenköy Mah, Nur Sokak, C Blok, 1/11 Kadıkoy, ISTANBUL, Turkey

(540)

etstur

(591) Burgundy

(531) 27.05.10; 29.01.01

(511)

41 – Sporting services: sports camp services, health club services, physical education services, provision of golf facilities, organization of golf tournaments, provision of tennis facilities, provision of gymnastics facilities, organization of sports competitions, provision of stadium facilities, provision of sporting facilities, arranging the time of sporting events, diving equipment rental (except protective clothing and cells) services, sports equipment (except vehicles) rental services; entertainment services: entertaining services, amusement park services, circus services, party organization (entertainment) services, prom arrangement services, discotheque services, holiday camp services (entertainment), zoo services, entertainment information, recreational activities

services, information on leisure time; translation services: sign language translation services, translation services.

43 – Services for providing food and drink; cafeteria services, canteen services, catering services, cocktail lounge services, restaurant services, self-service restaurant services, snack-bar services, rental of food service equipment; temporary accommodation services: accommodation services; temporary accommodation reservations, rental services for temporary accommodation, accommodation (hotels, motels) services, hotel reservations services, provision of campsite areas, holiday camp and holiday services (temporary accommodation), guest house services, hotel services (temporary accommodation), motel services (temporary accommodation), hostel services (temporary accommodation), renting of portable buildings, tourist houses (accommodation and reservation) services, tent rental services, youth camping services.

**INTERNATIONAL TRADEMARKS PROTECTED
IN GEORGIA**

(260) AM 2020 99422 A
(800) 1269336
(151) 2015 06 23
(181) 2025 06 23
(891) 2018 06 25
(511) 29, 30

(260) AM 2020 102978 A
(800) 1464615
(151) 2019 03 08
(181) 2029 03 08
(891) 2019 03 08
(511) 31, 44

(260) AM 2020 99423 A
(800) 1270613
(151) 2015 06 23
(181) 2025 06 23
(891) 2018 06 25
(511) 29, 30

(260) AM 2020 103057 A
(800) 1465649
(151) 2019 03 07
(181) 2029 03 07
(891) 2019 03 07
(511) 03, 05

(260) AM 2020 100470 A
(800) 1433787
(151) 2018 07 12
(181) 2028 07 12
(891) 2018 07 12
(511) 09, 35, 38, 42

(260) AM 2020 103058 A
(800) 1465654
(151) 2019 01 08
(181) 2029 01 08
(891) 2019 01 08
(511) 03

(260) AM 2020 101337 A
(800) 1445677
(151) 2018 07 02
(181) 2028 07 02
(891) 2018 07 02
(511) 09

(260) AM 2020 103059 A
(800) 1465700
(151) 2019 02 26
(181) 2029 02 26
(891) 2019 02 26
(511) 09

(260) AM 2020 102290 A
(800) 1456552
(151) 2019 01 17
(181) 2029 01 17
(891) 2019 01 17
(511) 02

(260) AM 2020 103060 A
(800) 1465703
(151) 2018 11 19
(181) 2028 11 19
(891) 2018 11 19
(511) 29, 30, 35, 43

(260) AM 2020 102739 A
(800) 1461033
(151) 2019 02 25
(181) 2029 02 25
(891) 2019 02 25
(511) 09, 36, 38, 41

(260) AM 2020 103146 A
(800) 1466686
(151) 2019 02 27
(181) 2029 02 27
(891) 2019 02 27
(511) 02, 19

(260) AM 2020 102873 A
(800) 1462889
(151) 2018 12 21
(181) 2028 12 21
(891) 2018 12 21
(511) 35

(260) AM 2020 103147 A
(800) 1466690
(151) 2019 02 08
(181) 2029 02 08
(891) 2019 02 08
(511) 05, 35

(260) AM 2020 103149 A
(800) 1466768
(151) 2018 11 27
(181) 2028 11 27
(891) 2018 11 27
(511) 02, 03, 05

(260) AM 2020 103163 A
(800) 1467086
(151) 2018 08 03
(181) 2028 08 03
(891) 2018 08 03
(511) 09, 10, 11, 12, 15, 17, 22, 23, 24, 25

(260) AM 2020 103238 A
(800) 1467527
(151) 2019 04 17
(181) 2029 04 17
(891) 2019 04 17
(511) 05

(260) AM 2020 103239 A
(800) 1467586
(151) 2019 04 03
(181) 2029 04 03
(891) 2019 04 03
(511) 41

(260) AM 2020 103281 A
(800) 1468422
(151) 2019 04 01
(181) 2029 04 01
(891) 2019 04 01
(511) 28

(260) AM 2020 103282 A
(800) 1468451
(151) 2019 03 15
(181) 2029 03 15
(891) 2019 03 15
(511) 05, 10, 35, 39, 40, 42

(260) AM 2020 103283 A
(800) 1468468
(151) 2019 03 26
(181) 2029 03 26
(891) 2019 03 26
(511) 29, 30, 31

(260) AM 2020 103300 A
(800) 1443772
(151) 2018 08 29
(181) 2028 08 29

(891) 2019 05 03
(511) 29, 31

(260) AM 2020 103349 A
(800) 1468603
(151) 2019 02 26
(181) 2029 02 26
(891) 2019 02 26
(511) 09

(260) AM 2020 103366 A
(800) 1468735
(151) 2019 03 26
(181) 2029 03 26
(891) 2019 03 26
(511) 03

(260) AM 2020 103368 A
(800) 1468753
(151) 2018 12 10
(181) 2028 12 10
(891) 2018 12 10
(511) 01, 02, 03, 07, 09, 11, 12, 17, 19, 20, 21, 37, 42

(260) AM 2020 103369 A
(800) 1468778
(151) 2019 03 26
(181) 2029 03 26
(891) 2019 03 26
(511) 10

(260) AM 2020 103370 A
(800) 1468802
(151) 2019 04 09
(181) 2029 04 09
(891) 2019 04 09
(511) 35

(260) AM 2020 103384 A
(800) 1468978
(151) 2019 02 28
(181) 2029 02 28
(891) 2019 02 28
(511) 05

(260) AM 2020 103385 A
(800) 1468979
(151) 2019 04 12
(181) 2029 04 12
(891) 2019 04 12
(511) 03

(260) AM 2020 103386 A
(800) 1469036
(151) 2019 04 15
(181) 2029 04 15
(891) 2019 04 15
(511) 05

(260) AM 2020 103388 A
(800) 1469088
(151) 2019 03 26
(181) 2029 03 26
(891) 2019 03 26
(511) 03

(260) AM 2020 103389 A
(800) 1469090
(151) 2019 03 26
(181) 2029 03 26
(891) 2019 03 26
(511) 03

(260) AM 2020 103397 A
(800) 1469122
(151) 2019 03 29
(181) 2029 03 29
(891) 2019 03 29
(511) 30

(260) AM 2020 103398 A
(800) 1469123
(151) 2019 03 28
(181) 2029 03 28
(891) 2019 03 28
(511) 30

(260) AM 2020 103399 A
(800) 1469129
(151) 2019 02 26
(181) 2029 02 26
(891) 2019 02 26
(511) 09, 35, 37

(260) AM 2020 103400 A
(800) 1469134
(151) 2019 02 28
(181) 2029 02 28
(891) 2019 02 28
(511) 09

(260) AM 2020 103401 A
(800) 1469248
(151) 2018 12 12
(181) 2028 12 12

(891) 2018 12 12
(511) 23

(260) AM 2020 103492 A
(800) 1469818
(151) 2019 04 10
(181) 2029 04 10
(891) 2019 04 10
(511) 05

(260) AM 2020 103493 A
(800) 1469828
(151) 2019 01 14
(181) 2029 01 14
(891) 2019 01 14
(511) 05

(260) AM 2020 103505 A
(800) 1470214
(151) 2019 03 07
(181) 2029 03 07
(891) 2019 03 07
(511) 08, 21

(260) AM 2020 103506 A
(800) 1470221
(151) 2019 04 12
(181) 2029 04 12
(891) 2019 04 12
(511) 11

(260) AM 2020 103507 A
(800) 1470280
(151) 2019 03 28
(181) 2029 03 28
(891) 2019 03 28
(511) 30

(260) AM 2020 103508 A
(800) 1470283
(151) 2019 03 05
(181) 2029 03 05
(891) 2019 03 05
(511) 03, 44

(260) AM 2020 103529 A
(800) 1470868
(151) 2019 01 21
(181) 2029 01 21
(891) 2019 01 21
(511) 09, 35, 36

(260) AM 2020 103532 A
(800) 1470919
(151) 2019 04 26
(181) 2029 04 26
(891) 2019 04 26
(511) 05

(260) AM 2020 103533 A
(800) 1470937
(151) 2018 06 18
(181) 2028 06 18
(891) 2018 06 18
(511) 35

(260) AM 2020 103534 A
(800) 1470938
(151) 2019 04 15
(181) 2029 04 15
(891) 2019 04 15
(511) 34

(260) AM 2020 103535 A
(800) 1470944
(151) 2019 04 16
(181) 2029 04 16
(891) 2019 04 16
(511) 30

(260) AM 2020 103537 A
(800) 1470968
(151) 2019 04 09
(181) 2029 04 09
(891) 2019 04 09
(511) 41

(260) AM 2020 103539 A
(800) 1471002
(151) 2018 07 10
(181) 2028 07 10
(891) 2018 07 10
(511) 01, 03, 05, 07, 09, 11, 21, 31

(260) AM 2020 103541 A
(800) 1471064
(151) 2019 03 08
(181) 2029 03 08
(891) 2019 03 08
(511) 09, 35, 36, 38, 39, 42

(260) AM 2020 103542 A
(800) 1471079
(151) 2019 04 26
(181) 2029 04 26

(891) 2019 04 26
(511) 05

(260) AM 2020 103548 A
(800) 1011340
(151) 2009 04 21
(181) 2029 04 21
(891) 2019 05 22
(511) 09

(260) AM 2020 103550 A
(800) 1105210
(151) 2011 10 19
(181) 2021 10 19
(891) 2019 05 21
(511) 01, 02, 03, 04, 05

(260) AM 2020 103553 A
(800) 1316265
(151) 2016 06 13
(181) 2026 06 13
(891) 2019 05 06
(511) 41

(260) AM 2020 103595 A
(800) 1471317
(151) 2019 03 11
(181) 2029 03 11
(891) 2019 03 11
(511) 33

(260) AM 2020 103605 A
(800) 1471618
(151) 2019 01 08
(181) 2029 01 08
(891) 2019 01 08
(511) 03, 09, 14, 18, 20, 24, 25, 26, 35

(260) AM 2020 103607 A
(800) 1471661
(151) 2019 05 08
(181) 2029 05 08
(891) 2019 05 08
(511) 10

(260) AM 2020 103613 A
(800) 1471757
(151) 2019 03 18
(181) 2029 03 18
(891) 2019 03 18
(511) 05

(260) AM 2020 103615 A
(800) 1471833
(151) 2018 10 29
(181) 2028 10 29
(891) 2018 10 29
(511) 07, 08

(260) AM 2020 103616 A
(800) 1471886
(151) 2019 04 05
(181) 2029 04 05
(891) 2019 04 05
(511) 12

(260) AM 2020 103618 A
(800) 1471918
(151) 2019 03 10
(181) 2029 03 10
(891) 2019 03 10
(511) 02, 35

(260) AM 2020 103619 A
(800) 1471989
(151) 2019 05 10
(181) 2029 05 10
(891) 2019 05 10
(511) 09

(260) AM 2020 103620 A
(800) 1472012
(151) 2019 02 21
(181) 2029 02 21
(891) 2019 02 21
(511) 33

(260) AM 2020 103627 A
(800) 1472078
(151) 2019 04 11
(181) 2029 04 11
(891) 2019 04 11
(511) 05, 10

(260) AM 2020 103628 A
(800) 1472144
(151) 2019 05 16
(181) 2029 05 16
(891) 2019 05 16
(511) 03

(260) AM 2020 103633 A
(800) 1472224
(151) 2019 04 30
(181) 2029 04 30

(891) 2019 04 30
(511) 41

(260) AM 2020 103638 A
(800) 1472319
(151) 2018 12 11
(181) 2028 12 11
(891) 2018 12 11
(511) 01, 02, 03, 04, 17

(260) AM 2020 103642 A
(800) 693322
(151) 1998 04 17
(181) 2028 04 17
(891) 2019 05 24
(511) 28

(260) AM 2020 103647 A
(800) 1224965
(151) 2014 07 16
(181) 2024 07 16
(891) 2019 05 21
(511) 30

(260) AM 2020 103707 A
(800) 1472601
(151) 2019 04 26
(181) 2029 04 26
(891) 2019 04 26
(511) 09, 42

(260) AM 2020 103718 A
(800) 1473014
(151) 2019 04 05
(181) 2029 04 05
(891) 2019 04 05
(511) 09

(260) AM 2020 103719 A
(800) 1473015
(151) 2019 04 05
(181) 2029 04 05
(891) 2019 04 05
(511) 09

(260) AM 2020 103728 A
(800) 1473217
(151) 2019 04 08
(181) 2029 04 08
(891) 2019 04 08
(511) 03

(260) AM 2020 103732 A
(800) 1473287
(151) 2019 04 18
(181) 2029 04 18
(891) 2019 04 18
(511) 05, 30, 35

(260) AM 2020 103733 A
(800) 1473291
(151) 2019 01 21
(181) 2029 01 21
(891) 2019 01 21
(511) 05

(260) AM 2020 103734 A
(800) 1473310
(151) 2019 04 17
(181) 2029 04 17
(891) 2019 04 17
(511) 03, 05, 10

(260) AM 2020 103736 A
(800) 1473362
(151) 2019 02 26
(181) 2029 02 26
(891) 2019 02 26
(511) 03, 06, 08, 09, 14, 16, 18, 20, 21, 24, 25, 26,
28, 41, 42

(260) AM 2020 103737 A
(800) 1473433
(151) 2019 02 05
(181) 2029 02 05
(891) 2019 02 05
(511) 33

(260) AM 2020 103745 A
(800) 1125404
(151) 2012 03 15
(181) 2022 03 15
(891) 2019 05 14
(511) 10

(260) AM 2020 103746 A
(800) 1153968
(151) 2013 01 16
(181) 2023 01 16
(891) 2019 05 29
(511) 01, 05, 09, 10

(260) AM 2020 103807 A
(800) 1473847
(151) 2019 05 17
(181) 2029 05 17

(891) 2019 05 17
(511) 03, 05, 10, 32, 33, 42, 44

(260) AM 2020 103811 A
(800) 1473960
(151) 2019 01 25
(181) 2029 01 25
(891) 2019 01 25
(511) 06, 07, 09, 11, 17, 20

(260) AM 2020 103812 A
(800) 1473975
(151) 2018 11 12
(181) 2028 11 12
(891) 2018 11 12
(511) 10, 25, 44

(260) AM 2020 103813 A
(800) 1473977
(151) 2019 05 06
(181) 2029 05 06
(891) 2019 05 06
(511) 09, 36, 42

(260) AM 2020 103816 A
(800) 1474017
(151) 2018 12 10
(181) 2028 12 10
(891) 2018 12 10
(511) 09, 28

(260) AM 2020 103817 A
(800) 1474049
(151) 2018 11 27
(181) 2028 11 27
(891) 2018 11 27
(511) 34

(260) AM 2020 103818 A
(800) 1474053
(151) 2019 05 14
(181) 2029 05 14
(891) 2019 05 14
(511) 05

(260) AM 2020 103819 A
(800) 1474087
(151) 2019 05 23
(181) 2029 05 23
(891) 2019 05 23
(511) 09

(260) AM 2020 103820 A
(800) 1474126
(151) 2019 05 17
(181) 2029 05 17
(891) 2019 05 17
(511) 01

(260) AM 2020 103822 A
(800) 1474150
(151) 2018 11 28
(181) 2028 11 28
(891) 2018 11 28
(511) 02, 19, 37

(260) AM 2020 103827 A
(800) 1474231
(151) 2019 02 07
(181) 2029 02 07
(891) 2019 02 07
(511) 01, 42, 44

(260) AM 2020 103830 A
(800) 1474377
(151) 2019 03 19
(181) 2029 03 19
(891) 2019 03 19
(511) 05

(260) AM 2020 103834 A
(800) 1344789
(151) 2016 08 23
(181) 2026 08 23
(891) 2018 06 25
(511) 31, 44

(260) AM 2020 103905 A
(800) 1474984
(151) 2019 04 04
(181) 2029 04 04
(891) 2019 04 04
(511) 09, 28

(260) AM 2020 103912 A
(800) 1475227
(151) 2019 02 01
(181) 2029 02 01
(891) 2019 02 01
(511) 12

(260) AM 2020 103923 A
(800) 1475592
(151) 2019 01 10
(181) 2029 01 10

(891) 2019 01 10
(511) 03

(260) AM 2020 103925 A
(800) 1475649
(151) 2019 03 11
(181) 2029 03 11
(891) 2019 03 11
(511) 35, 36, 38, 42, 45

(260) AM 2020 104136 A
(800) 1477357
(151) 2019 05 27
(181) 2029 05 27
(891) 2019 05 27
(511) 25, 26, 35

(260) AM 2020 104333 A
(800) 1479609
(151) 2019 05 08
(181) 2029 05 08
(891) 2019 05 08
(511) 03, 04

(260) AM 2020 104337 A
(800) 1479714
(151) 2019 05 08
(181) 2029 05 08
(891) 2019 05 08
(511) 03, 04

(260) AM 2020 104343 A
(800) 1479777
(151) 2019 06 19
(181) 2029 06 19
(891) 2019 06 19
(511) 09

(260) AM 2020 104390 A
(800) 1480643
(151) 2019 06 17
(181) 2029 06 17
(891) 2019 06 17
(511) 07, 09, 11

(260) AM 2020 104393 A
(800) 1480749
(151) 2019 02 15
(181) 2029 02 15
(891) 2019 02 15
(511) 30, 35

(260) AM 2020 104519 A
(800) 1482034
(151) 2019 03 25
(181) 2029 03 25
(891) 2019 03 25
(511) 03

(260) AM 2020 104521 A
(800) 737102
(151) 2000 07 03
(181) 2020 07 03
(891) 2019 07 25
(511) 25

(260) AM 2020 104654 A
(800) 1484068
(151) 2019 04 25
(181) 2029 04 25
(891) 2019 04 25
(511) 12

(260) AM 2020 104657 A
(800) 1484163
(151) 2019 06 28
(181) 2029 06 28
(891) 2019 06 28
(511) 12

(260) AM 2020 104658 A
(800) 1484166
(151) 2019 07 12
(181) 2029 07 12
(891) 2019 07 12
(511) 03

(260) AM 2020 104694 A
(800) 1484597
(151) 2019 04 24
(181) 2029 04 24
(891) 2019 04 24
(511) 05, 29, 30, 32

(260) AM 2020 104733 A
(800) 1165543
(151) 2013 04 12
(181) 2023 04 12
(891) 2019 07 22
(511) 03, 44

OFFICIAL NOTIFICATIONS

INVENTIONS

EXPIRATION OF PATENTS RESTORATION

(21) AP 2008 11637

(11) P 2012 5533 B

(73) Incyte Holdings Corporation

(54) **SALTS OF THE JANUS KINASE INHIBITOR (R)-3-(4-(7H-PYRROLO[2,3-D]PYRIMIDIN-4-YL)-1H-PYRAZOL-1-YL)-3-CYCLOPENTYL PROPANENITRILE**

DATE OF CANCELLATION OF PATENT: 2020 06 12

PATENT RESTRICTION DATE: 2020 07 10

(21) AP 2005 11830

(11) P 2013 5824 B

(73) GEOX S.P.A.

(54) **SHOE WITH BREATHABLE AND WATERPROOF SOLE AND UPPER**

DATE OF CANCELLATION OF PATENT: 2020 01 20

PATENT RESTRICTION DATE: 2020 07 10

(21) AP 2011 12850

(11) P 2017 6635 B

(73) GEOX S.P.A.

(54) **SHOE WITH WATERPROOF AND VAPOR-PERMEABLE UPPER AND SOLE**

DATE OF CANCELLATION OF PATENT: 2020 01 24

PATENT RESTRICTION DATE: 2020 07 10

(21) AP 2016 14189

(11) P 2019 6958 B

(73) Archil Geguchadze;

Jondo Noselidze;

Shorena Momtsemlidze;

Darejan Kaladze;

Giorgi Noselidze;

Sergi Kurashvili;

Tamar Kamkamidze

(54) **SELF-CLEANING SIPHON DEVICE FOR DAM STORAGE FROM SEDIMENTS**

DATE OF CANCELLATION OF PATENT: 2019 06 24

PATENT RESTRICTION DATE: 2020 07 10

(21) AP 2015 14386

(11) P 2019 7000 B

(73) ANDRITZ HYDRO LTD

(54) **FRANCIS TURBINE WITH SHORT BLADE AND SHORT BAND**

DATE OF CANCELLATION OF PATENT: 2020 04 30

PATENT RESTRICTION DATE: 2020 07 10

(21) AP 2015 14430

(11) P 2019 7003 B

(73) PFIZER INC.

(54) **AMINOPYRIMIDINYL COMPOUNDS AS JAK INHIBITORS**

DATE OF CANCELLATION OF PATENT: 2019 08 07

PATENT RESTRICTION DATE: 2020 07 10

(21) AP 2016 14678

(11) P 2020 7074 B

(73) VERNALIS (R&D) Ltd;

LES LABORATOIRES SERVIER

(54) **NEW HYDROXYESTER DERIVATIVES, A PROCESS FOR THEIR PREPARATION AND PHARMACEUTICAL COMPOSITIONS CONTAINING THEM**

DATE OF CANCELLATION OF PATENT: 2020 06 22

PATENT RESTRICTION DATE: 2020 07 10

(21) AP 2016 14679

(11) P 2020 7075 B

(73) VERNALIS (R&D) Ltd;

LES LABORATOIRES SERVIER

(54) **NEW AMINOACID DERIVATIVES, A PROCESS FOR THEIR PREPARATION AND PHARMACEUTICAL COMPOSITIONS CONTAINING THEM**

DATE OF CANCELLATION OF PATENT: 2020 06 22

PATENT RESTRICTION DATE: 2020 07 10

(21) AP 2016 14680

(11) P 2020 7076 B

(73) VERNALIS (R&D) Ltd;

LES LABORATOIRES SERVIER

(54) **NEW HYDROXYACID DERIVATIVES, A PROCESS FOR THEIR PREPARATION AND PHARMACEUTICAL COMPOSITIONS CONTAINING THEM**

DATE OF CANCELLATION OF PATENT: 2020 06 22

PATENT RESTRICTION DATE: 2020 07 10

(21) AP 2018 14808

(11) P 2020 7055 B

(73) Teimurax Ortoidze;

Elene Salia

(54) **GEORGIAN WINE YEAST**

DATE OF CANCELLATION OF PATENT: 2020 06 13

PATENT RESTRICTION DATE: 2020 07 10

(21) AP 2005 9505

(11) P 2011 5256 B

(73) GEOX S.P.A.

(54) **SHOE WITH BREATHABLE AND WATERPROOF SOLE AND UPPER**

DATE OF CANCELLATION OF PATENT: 2020 01 20

PATENT RESTRICTION DATE: 2020 07 10

ABOLITION OF PATENTS WITH THE RIGHT TO RESTORE

(21) AP 2008 11637

(11) P 2012 5533 B

(73) ISIDE HOLDING CORPORATION

(54) **SALTS OF THE JANUS KINASE INHIBITOR (R)-3-(4-(7H-PYRROLO[2,3-D]PYRIMIDIN-4-YL)-1H-PYRAZOL-1-YL)-3-CYCLOPENTYL PROPANENITRILE**

DATE OF CANCELLATION OF PATENT: 2020 06 12

THE TERM OF RESTORATION OF PATENT: 2022 06 12

(21) AP 2010 11845

(11) P 2013 5743 B

(73) Nora Mamulashvili

(54) **METHOD OF WATER SURFACE PURIFICATION FROM OIL AND OIL PRODUCTS**

DATE OF CANCELLATION OF PATENT: 2020 06 14

THE TERM OF RESTORATION OF PATENT: 2021 06 14

(21) AP 2009 12060

(11) P 2013 5847 B

(73) MILLENNIUM PHARMACEUTICALS INC.

(54) **BORONATE ESTER COMPOUNDS AND PHARMACEUTICAL COMPOSITIONS CONTAINING THEREOF**

DATE OF CANCELLATION OF PATENT: 2020 06 16

THE TERM OF RESTORATION OF PATENT: 2021 06 16

(21) AP 2009 12730

(11) P 2017 6703 B

(73) MILLENNIUM PHARMACEUTICALS INC.

(54) **BORONATE ESTER COMPOUNDS AND PHARMACEUTICAL COMPOSITIONS THEREOF**

DATE OF CANCELLATION OF PATENT: 2020 06 16

THE TERM OF RESTORATION OF PATENT: 2021 06 16

(21) AP 2011 12970

(11) P 2016 6507 B

(73) TAKEDA PHARMACEUTICAL COMPANY LIMITED

(54) **FUSED HETEROCYCLIC COMPOUNDS AS PHOSPHODIESTERASES (PDES) INHIBITORS**

DATE OF CANCELLATION OF PATENT: 2020 06 22

THE TERM OF RESTORATION OF PATENT: 2021 06 22

(21) AP 2015 13855

(11) P 2017 6724 B

(73) Marlen Abramishvili

(54) **INTERNAL-COMBUSTION ENGINE PISTON**

DATE OF CANCELLATION OF PATENT: 2020 06 12

THE TERM OF RESTORATION OF PATENT: 2021 06 12

(21) AP 2014 14043

(11) P 2017 6793 B

(73) ALIOS BIOPHARMA INC.

(54) **SUBSTITUTED NUCLEOSIDES, NUCLEOTIDES AND ANALOGS THEREOF**

DATE OF CANCELLATION OF PATENT: 2020 06 24

THE TERM OF RESTORATION OF PATENT: 2021 06 24

(21) AP 2016 14189

(11) P 2019 6958 B

(73) Archil Geguchadze;

Jondo Noselidze;

Shorena Momtsemlidze;

Darejan Kaladze;

Giorgi Noselidze;

Sergi Kurashvili;

Tamar Kamkamidze

(54) **SELF-CLEANING SIPHON DEVICE FOR DAM STORAGE FROM SEDIMENTS**

DATE OF CANCELLATION OF PATENT: 2020 06 24

THE TERM OF RESTORATION OF PATENT: 2021 06 24

(21) AP 2015 14392

(11) P 2019 7034 B

(73) MACROGENICS INC.

(54) **COVALENTLY BONDED DIABODIES HAVING IMMUNOREACTIVITY WITH PD-1 AND LAG-3, AND METHODS OF USE THEREOF**

DATE OF CANCELLATION OF PATENT: 2020 06 19

THE TERM OF RESTORATION OF PATENT: 2021 06 19

(21) AP 2017 14522

(11) P 2019 6993 B

(73) Marinam Tsiskarishvili;

Nino Jorbenadze

(54) **DEVICE FOR SPLITTING NUTS AND HAZELS**

DATE OF CANCELLATION OF PATENT: 2020 06 19

THE TERM OF RESTORATION OF PATENT: 2021 06 19

(21) AP 2014 14559

(11) P 2019 6990 B

(73) BAXALTA GMBH;

BAXALTA INCORPORATED

(54) **METHOD AND SYSTEM FOR PROVIDING A PHARMACOKINETIC DRUG DOSING REGIME**

DATE OF CANCELLATION OF PATENT: 2020 06 20

THE TERM OF RESTORATION OF PATENT: 2021 06 20

(21) AP 2016 14649

(11) P 2019 7039 B

(73) GEOX S.P.A.

(54) **WATERPROOF AND VAPOR-PERMEABLE SOLE FOR SHOES**

DATE OF CANCELLATION OF PATENT: 2020 06 08

THE TERM OF RESTORATION OF PATENT: 2021 06 08

(21) AP 2016 14678

(11) P 2020 7074 B

(73) VERNALIS (R&D) Ltd;

LES LABORATOIRES SERVIER

(54) **NEW HYDROXYESTER DERIVATIVES, A PROCESS FOR THEIR PREPARATION AND PHARMACEUTICAL COMPOSITIONS CONTAINING THEM**

DATE OF CANCELLATION OF PATENT: 2020 06 22

THE TERM OF RESTORATION OF PATENT: 2022 06 22

(21) AP 2016 14679

(11) P 2020 7075 B

(73) VERNALIS (R&D) Ltd;

LES LABORATOIRES SERVIER

(54) **NEW AMINOACID DERIVATIVES, A PROCESS FOR THEIR PREPARATION AND PHARMACEUTICAL COMPOSITIONS CONTAINING THEM**

DATE OF CANCELLATION OF PATENT: 2020 06 22

THE TERM OF RESTORATION OF PATENT: 2022 06 22

(21) AP 2016 14680

(11) P 2020 7076 B

(73) VERNALIS (R&D) Ltd;

LES LABORATOIRES SERVIER

(54) **NEW HYDROXYACID DERIVATIVES, A PROCESS FOR THEIR PREPARATION AND PHARMACEUTICAL COMPOSITIONS CONTAINING THEM**

DATE OF CANCELLATION OF PATENT: 2020 06 22

THE TERM OF RESTORATION OF PATENT: 2022 06 22

(21) AP 2018 14805

(11) P 2019 7035 B

(73) LEPL "Sokhumi Ilia Vekua Institute of Physics and Technology"

(54) **METHOD AND DEVICE FOR RECEIVING POWERFUL LASER PULSE**

DATE OF CANCELLATION OF PATENT: 2020 06 11

THE TERM OF RESTORATION OF PATENT: 2021 06 11

(21) AP 2018 14808

(11) P 2020 7055 B

(73) Teimuraz Ortoidze;

Elene Salia

(54) **GEORGIAN WINE YEAST**

DATE OF CANCELLATION OF PATENT: 2020 06 13

THE TERM OF RESTORATION OF PATENT: 2022 06 13

EXPIRATION OF TERM OF RESTORATION OF PATENTS

(21) AP 2007 11058

(11) P 2011 5201 B

(73) PIERRE FABRE MEDICAMENT

(54) **CINNAMOYL-PIPERAZINE DERIVATIVES AND THEIR USE AS PAR- I ANTAGONISTS**

DATE OF CANCELLATION OF PATENT: 2019 06 19

THE TERM OF RESTORATION OF PATENT VALIDITY HAS EXPIRED: 2020 06 19

(21) AP 2007 11069

(11) P 2012 5392 B

(73) TAKEDA PHARMACEUTICAL COMPANY LIMITED

(54) **TRICYCLIC COMPOUNDS AND PHARMACEUTICAL USE THEREOF**

DATE OF CANCELLATION OF PATENT: 2019 06 18

THE TERM OF RESTORATION OF PATENT VALIDITY HAS EXPIRED: 2020 06 18

(21) AP 2010 12529

(11) P 2014 6168 B

(73) TAKEDA PHARMACEUTICAL COMPANY LIMITED

(54) **PYRAZINOOXAZEPINE DERIVATIVES**

DATE OF CANCELLATION OF PATENT: 2019 06 14

THE TERM OF RESTORATION OF PATENT VALIDITY HAS EXPIRED: 2020 06 14

(21) AP 2013 13124

(11) P 2014 6204 B

(73) Dodo Tavdidishvili;

Manana Pkhakadze;

Tsira Khutsidze;

Nino Minadze

(54) **DESSERT WITH BEE-FARMING PRODUCTS**

DATE OF CANCELLATION OF PATENT: 2019 06 20

THE TERM OF RESTORATION OF PATENT VALIDITY HAS EXPIRED: 2020 06 20

(21) AP 2015 14349

(11) P 2018 6938 B

(73) CHIESI FARMACEUTICI S.P.A.

(54) **INDOLIZINE DERIVATIVES AS PHOSHOINOSITIDE 3-KINASES INHIBITORS**

DATE OF CANCELLATION OF PATENT: 2019 06 16

THE TERM OF RESTORATION OF PATENT VALIDITY HAS EXPIRED: 2020 06 16

CHANGES OF NAMES AND/OR ADDRESS OF PATENT OWNER

(21) AP 2014 14063

(11) P 2020 7070 B

(54) **NEW ISOINDOLINE OR ISOQUINOLINE COMPOUNDS, A PROCESS FOR THEIR PREPARATION AND PHARMACEUTICAL COMPOSITIONS CONTAINING THEM**

New name and/or address: LES LABORATOIRES SERVIER (FR)
35, rue de Verdun, 92284 Suresnes Cedex (FR);
VERNALIS (R&D) LTD (GB)

100 Berkshire Place Wharfedale Road, Winnersh Berkshire RG41 5RD (GB)

Former name and / or address: VERNALIS (R&D) LTD (GB)
100 Berkshire Place Wharfedale Road, Winnersh Berkshire RG41 5RD United Kingdom (GB);

LES LABORATOIRES SERVIER (FR)
35, rue de Verdun, 92284 Suresnes Cedex, France (FR)

DATE OF REGISTRATION: 29 06 2020

UTILITY MODELS

EXPIRATION OF PATENTS RESTORATION

(21) AU 2013 13112
(11) U 2014 1825 Y
(73) Elguja Shapakidze;
Vladimer Miruashvili
(54) **DEVICE REELING THREAD FROM COCOON**
DATE OF CANCELLATION OF PATENT: 2020 06 06
PATENT RESTRICTION DATE: 2020 07 10

(21) AU 2016 14175
(11) U 2018 1979 Y
(73) LTD "COMPANY TM RG"
(54) **METHOD FOR TIN HYDRO ARSENATE PREPARATION**
DATE OF CANCELLATION OF PATENT: 2020 06 13
PATENT RESTRICTION DATE: 2020 07 10

(21) AU 2018 14765
(11) U 2019 2013 Y
(73) Lali Ghurchumelia
(54) **FIRE EXTINGUISHING POWDER**
DATE OF CANCELLATION OF PATENT: 2020 04 24
PATENT RESTRICTION DATE: 2020 07 10

ABOLITION OF PATENTS WITH THE RIGHT TO RESTORE

(21) AU 2016 14175
(11) U 2018 1979 Y
(73) LTD "COMPANY TM RG"
(54) **METHOD FOR TIN HYDRO ARSENATE PREPARATION**
DATE OF CANCELLATION OF PATENT: 2020 06 13
THE TERM OF RESTORATION OF PATENT: 2022 06 13

(21) AU 2016 14183
(11) U 2017 1943 Y
(73) Geronti Meskhi
(54) **STEEL PROTECTIVE CASING FOR PLASTIC DOOR FRAME BASE**
DATE OF CANCELLATION OF PATENT: 2020 06 17
THE TERM OF RESTORATION OF PATENT: 2021 06 17

(21) AU 2016 14187
(11) U 2017 1936 Y
(73) Vakhtang Ghlonti;
Nino Ghlonti
(54) **BEEHIVE**
DATE OF CANCELLATION OF PATENT: 2020 06 23
THE TERM OF RESTORATION OF PATENT: 2021 06 23

DESIGNS

CANCELLATION OF DESIGNS REGISTRATION

(11) D 2014 605 S

(73) JSC "LOMISI" (GE)

Vill. Natakhtari, 3308, Mtskheta district, Georgia (GE)

(54) **BOTTLE**

(18) 2019 12 11

(58) 2020 06 19

(11) D 2015 612 S

(73) Gocha Pipia (GE)

Budapest St. 11, app. 55, 0160, Tbilisi, Georgia (GE)

(54) **BOX FOR BOTTLE TRANSPORTATION AND STORAGE**

(18) 2019 12 18

(58) 2020 06 26

(11) D 2015 613 S

(73) Kliment Kavtaradze (GE)

Kavtaradze St. 25, corp. 1, app. 3, 0186, Tbilisi, Georgia (GE)

(54) **COFFIN**

(18) 2019 12 19

(58) 2020 06 29

EXTENSION OF REGISTRATION OF INTERNATIONAL DESIGNS

(11) DM/66648

(73) SWATCH AG (SWATCH SA) (SWATCH LTD.)

94, Rue Jakob Stämpfli, CH-2502 BIENNE (CH)

(15) 2005 05 09

(24) 2005 05 09

(18) 2025 05 09

(28) 2

(28') 2

(54) 1.-2. Wristwatches

(11) DM/66715

(73) SWATCH AG (SWATCH SA) (SWATCH LTD.)

94, Rue Jakob Stämpfli, CH-2502 BIENNE (CH)

(15) 2005 05 31

(24) 2005 05 31

(18) 2025 05 31

(28) 2

(28') 2

(54) Wristwatches

(11) DM/66746
(73) SARA LEE HOUSEHOLD AND BODY CARE NEDERLAND B.V.
Traverse 2, NL-3905 NL Veenendaal (NL)
(15) 2005 06 13
(24) 2005 06 13
(18) 2025 06 13
(28) 2
(28') 2
(54) Air freshening apparatus, Refill for air freshening apparatus

(11) DM/66764
(73) EL-BI ELEKTRIK ITHALAT IHRACAT SANAYI TICARET LIMITED SIRKETI
Mehmet Akif Ersoy Mah. Kuskaya Mevkii 2007 Sok. Bila No Tasoluk-Arnavutkoy-Gaziosmanpasa,
Istanbul (TR)
(15) 2005 05 24
(24) 2005 05 24
(18) 2025 05 24
(28) 1
(28') 1
(54) Junction box

(11) DM/66821
(73) BRAUN GMBH
145, Frankfurter Str., 61476 Kronberg (DE)
(15) 2005 06 27
(24) 2005 06 27
(18) 2025 06 27
(28) 1

(28') 1
(54) Epilator

(11) DM/73555
(73) SWATCH AG (SWATCH SA)(SWATCH LTD)
Jakob-Stämpfli-Strasse 94, CH-2502 BIEL/BIENNE (CH)
(15) 2010 05 03
(24) 2010 05 03
(18) 2025 05 03
(28) 39
(28') 39
(54) Jewelry, in particular bracelets (1, 5, 9, 13, 18, 21, 25, 29, 33, 36), pendants (2, 31), rings (3, 6, 10, 14, 15, 19, 22, 26, 30, 37), earrings (4, 7, 11, 16, 23, 27, 32, 34, 38), necklaces (8, 12, 17, 20, 24, 28, 35, 39)

(11) DM/73661
(73) SWATCH AG (SWATCH SA)(SWATCH LTD)
Jakob-Stämpfli-Strasse 94, CH-2502 BIEL/BIENNE (CH)
(15) 2010 05 25
(24) 2010 05 25
(18) 2025 05 25
(28) 10
(28') 10
(54) Wristwatches

(11) DM/73665
(73) SUNAR MISIR ENTEGRE TESİSLERİ SANAYİ VE TİCARET ANONİM ŞİRKETİ
Mersin Yolu Üzeri 12. Km., ADANA (TR)
(15) 2010 05 20
(24) 2010 05 20
(18) 2025 05 20
(28) 1
(28') 1
(54) Bottle

(11) DM/73767
(73) SAVERGLASS
3 rue de la Gare, F-60960 FEUQUIERES (FR)
(15) 2010 05 10
(24) 2010 05 10
(18) 2025 05 10
(28) 2
(28') 2
(54) Bottles

(11) DM/86309
(73) SWATCH AG (SWATCH SA) (SWATCH LTD)
Jakob-Stämpfli-Strasse 94, CH-2502 Biel/Bienne (CH)
(15) 2015 05 04
(24) 2015 05 04
(18) 2025 05 04
(28) 2

(28') 2
(54) Wristwatches

(11) DM/86361
(73) TISSOT SA (TISSOT AG) (TISSOT LTD)
Chemin des Tourelles 17, CH-2400 Le Locle (CH)
(15) 2015 05 08
(24) 2015 05 08
(18) 2025 05 08
(28) 2
(28') 2
(54) Bracelets

(11) DM/86363
(73) SWATCH AG (SWATCH SA) (SWATCH LTD)
Jakob-Stämpfli-Strasse 94, CH-2502 Biel/Bienne (CH)
(15) 2015 05 11
(24) 2015 05 11
(18) 2025 05 11
(28) 2
(28') 2
(54) Wristwatches

(11) DM/86391
(73) SWATCH AG (SWATCH SA) (SWATCH LTD)
Jakob-Stämpfli-Strasse 94, CH-2502 Biel/Bienne (CH)
(15) 2015 05 05
(24) 2015 05 05
(18) 2025 05 05
(28) 1
(28') 1
(54) Watch strap

(11) DM/86407
(73) SWATCH AG (SWATCH SA) (SWATCH LTD)
Jakob-Stämpfli-Strasse 94, CH-2502 Biel/Bienne (CH)
(15) 2015 05 11
(24) 2015 05 11
(18) 2025 05 11
(28) 2
(28') 2
(54) Wristwatches

(11) DM/86408
(73) SWATCH AG (SWATCH SA) (SWATCH LTD)
Jakob-Stämpfli-Strasse 94, CH-2502 Biel/Bienne (CH)
(15) 2015 05 05
(24) 2015 05 05
(18) 2025 05 05
(28) 3
(28') 3
(54) 1.-2. Wristwatches, 3. Date disk [timepieces]

(11) DM/86412
(73) ETA SA MANUFACTURE HORLOGÈRE SUISSE
Schild-Rust-Strasse 17, CH-2540 Grenchen (CH)
(15) 2015 05 12
(24) 2015 05 12
(18) 2025 05 12
(28) 20
(28') 20
(54) Wristwatches

(11) DM/86444
(73) HARRY WINSTON SA
Chemin du Tourbillon 8, CH-1228 Plan-les-Ouates (CH)
(15) 2015 05 19
(24) 2015 05 19
(18) 2025 05 19
(28) 3
(28') 3
(54) Earring, Ring with gemstones

(11) DM/86781
(73) SCA HYGIENE PRODUCTS AB
SE-405 03 Göteborg (SE)
(15) 2015 06 11
(24) 2015 06 11

(18) 2025 06 11
(28) 5
(28') 5
(54) Paper dispensers

(11) DM/87857
(73) AME HOLDING AG
c/o Dr. Rudolf Mosimann Baarerstrasse 78, CH-6300 Zug (CH)
(15) 2015 08 19
(24) 2015 08 19
(18) 2025 08 19
(28) 2
(28') 2
(54) Bottles

CANCELLATION OF REGISTRATION OF INTERNATIONAL DESIGNS

(11) DM/66102
(73) DAIMLERCHRYSLER AG,
Epplestrasse 225, 70567 Stuttgart (DE)
Date of cancellation of registration: 2019 12 03
(58) 2020 07 01

(11) DM/66131
(73) SARA LEE HOUSEHOLD AND BODY CARE NEDERLAND B.V.,
Traverse 2, NL-3905 NL Veenendaal (NL)
Date of cancellation of registration: 2019 12 10
(58) 2020 07 01

(11) DM/72636
(73) SWATCH AG (SWATCH SA) (SWATCH LTD)
Jakob-Stämpfli-Strasse 94, CH-2502 Biel/Bienne (CH)
Date of cancellation of registration: 2019 11 09
(58) 2020 06 19

(11) DM/84711
(73) SWATCH AG (SWATCH SA) (SWATCH LTD)
Jakob-Stämpfli-Strasse 94, CH-2502 Biel/Bienne (CH)
Date of cancellation of registration: 2019 10 22
(58) 2020 06 18

(11) DM/84762
(73) SWATCH AG (SWATCH SA) (SWATCH LTD)
Jakob-Stämpfli-Strasse 94, CH-2502 Biel/Bienne (CH)
Date of cancellation of registration: 2019 10 22
(58) 2020 06 18

(11) DM/84763
(73) SWATCH AG (SWATCH SA) (SWATCH LTD)
Jakob-Stämpfli-Strasse 94, CH-2502 Biel/Bienne (CH)
Date of cancellation of registration: 2019 10 22
(58) 2020 06 18

(11) DM/84768
(73) SWATCH AG (SWATCH SA) (SWATCH LTD)
Jakob-Stämpfli-Strasse 94, CH-2502 Biel/Bienne (CH)
Date of cancellation of registration: 2019 10 22
(58) 2020 06 18

(11) DM/84847
(73) IBLUE AG
Metallstraße 8, CH-6300 Zug (CH)
Date of cancellation of registration: 2019 11 05
(58) 2020 06 18

(11) DM/85372
(73) 3SUN S.R.L.
Contrada Blocco Terrazze, snc, Z.I., I-95121 CATANIA (CT) (IT)
Date of cancellation of registration: 2019 10 22
(58) 2020 06 18

(11) DM/86312
(73) BORYSENKO VITALII MYKOLAIOVYCH
vul. Horianska, bud. 25, Kharkiv 61107 (UA)
Date of cancellation of registration: 2019 10 27
(58) 2020 06 18

TRADEMARKS**RENEWAL OF REGISTRATIONS**

(111) M 2000 13445 R2

(156) 2000 07 26

(186) 2030 07 26

(732) A. Menarini Industrie Farmaceutiche Riunite
S.R.L.
Via Sette Santi 3, 50131 Firanzo, Italy

(111) M 2000 13593 R2

(156) 2000 11 15

(186) 2030 11 15

(732) A. Menarini Industrie Farmaceutiche Riunite
S.R.L.
Via Sette Santi 3, 50131 Firanzo, Italy

(111) M 2000 13592 R2

(156) 2000 11 15

(186) 2030 11 15

(732) A. Menarini Industrie Farmaceutiche Riunite
S.R.L.
Via Sette Santi 3, 50131 Firanzo, Italy

(111) M 2000 13576 R2

(156) 2000 10 30

(186) 2030 10 30

(732) Hyundai Motor Company
(a Korean limited liability company
incorporated under the laws of Republic of
Korea)
231, Yangjae-Dong, Seocho-Gu, Seoul,
137-938, Republic of Korea

(111) M 2000 13633 R2

(156) 2000 12 21

(186) 2030 12 21

(732) PT Sumatra Tobacco Trading Company
Jln. Pattimura №3, Pematang Siantar,
Sumatera Utara, Indonesia

(111) M 2010 20717 R1

(156) 2010 09 10

(186) 2030 09 10

(732) MEIJI SEIKA PHARMA CO., LTD
4-16, Kyobashi 2-Chome, Chuo-ku, Tokyo,
Japan

(111) M 2010 20570 R1

(156) 2010 06 28

(186) 2030 06 28

(732) JSC "TBILCHEMPHARMA"

Tsuladze St. 34, 0113, Tbilisi, Georgia

(111) M 2010 20592 R1

(156) 2010 07 16

(186) 2030 07 16

(732) The Procter & Gamble Company
One Procter & Gamble Plaza, Cincinnati,
Ohio 45202, USA

(111) M 2010 20534 R1

(156) 2010 06 10

(186) 2030 06 10

(732) Swiss Pharma International AG
Waldmannstrasse 8, 8001 Zurich, Switzerland

(111) M 2010 20535 R1

(156) 2010 06 10

(186) 2030 06 10

(732) Swiss Pharma International AG
Waldmannstrasse 8, 8001 Zurich, Switzerland

(111) M 2010 20609 R1

(156) 2010 07 26

(186) 2030 07 26

(732) LTD "G-M-P"
Vill. Ponichala 65, 0165, Tbilisi, Georgia

(111) M 2010 20610 R1

(156) 2010 07 26

(186) 2030 07 26

(732) LTD "G-M-P"
Vill. Ponichala 65, 0165, Tbilisi, Georgia

(111) M 2010 20611 R1

(156) 2010 07 26

(186) 2030 07 26

(732) LTD "G-M-P"
Vill. Ponichala 65, 0165, Tbilisi, Georgia

(111) M 2010 20612 R1

(156) 2010 07 26

(186) 2030 07 26

(732) LTD "G-M-P"
Vill. Ponichala 65, 0165, Tbilisi, Georgia

(111) M 2010 20619 R1
(156) 2010 07 26
(186) 2030 07 26
(732) THE PROCTER & GAMBLE COMPANY
One Procter & Gamble Plaza, Cincinnati,
Ohio 45202, USA

(111) M 2010 20624 R1
(156) 2010 07 27
(186) 2030 07 27
(732) Maia Zhghenti
Iosebidge St. 61b, app. 40, 0160, Tbilisi,
Georgia

(111) M 2010 20773 R1
(156) 2010 09 24
(186) 2030 09 24
(732) MEIJI HOLDINGS Co., LTD
4-16, Kyobashi 2-chome, Chuo-ku, Tokyo,
Japan

(111) M 2010 20755 R1
(156) 2010 09 15
(186) 2030 09 15
(732) LTD "G-M-P"
Vill. Ponichala 65, 0165, Tbilisi, Georgia

(111) M 2011 21537 R1
(156) 2011 06 14
(186) 2031 06 14
(732) LTD "WEST INVEST"
Tevdore Mghvdeli St. 27, 0154, Tbilisi,
Georgia

(111) M 2000 13129 R2
(156) 2000 01 31
(186) 2030 01 31
(732) XYLEM EUROPE GMBH
Bleicheplatz 6, CH-8200 Schaffhausen,
Switzerland

COMPLETE TRANSFER OF RIGHTS

- | | |
|--|--|
| <p>(111) M 2019 31765 R
 (732) Advanced New Technologies Co., Ltd
 Cayman Corporate Centre, 27 Hospital
 Road, George Town, Grand Cayman
 KY1-9008, Cayman Islands
 (770) Alibaba Group Holding Limited
 Fourth Floor, One Capital Place, P. O.
 Box 847, George Town, Grand Cayman,
 Cayman Islands
 (580) 2020 06 19</p> <hr/> <p>(111) M 2019 31766 R
 (732) Advanced New Technologies Co., Ltd
 Cayman Corporate Centre, 27 Hospital
 Road, George Town, Grand Cayman
 KY1-9008, Cayman Islands
 (770) Alibaba Group Holding Limited
 Fourth Floor, One Capital Place, P. O.
 Box 847, George Town, Grand Cayman,
 Cayman Islands
 (580) 2020 06 19</p> <hr/> <p>(111) M 2019 32141 R
 (732) Advanced New Technologies Co., Ltd
 Cayman Corporate Centre, 27 Hospital
 Road, George Town, Grand Cayman
 KY1-9008, Cayman Islands
 (770) Alibaba Group Holding Limited
 Fourth Floor, One Capital Place, P. O.
 Box 847, George Town, Grand Cayman,
 Cayman Islands
 (580) 2020 06 19</p> <hr/> <p>(111) M 2019 31887 R
 (732) Advanced New Technologies Co., Ltd
 Cayman Corporate Centre, 27 Hospital
 Road, George Town, Grand Cayman
 KY1-9008, Cayman Islands
 (770) Alibaba Group Holding Limited
 Fourth Floor, One Capital Place, P. O.
 Box 847, George Town, Grand Cayman,
 Cayman Islands
 (580) 2020 06 19</p> <hr/> <p>(111) M 2010 20275 R
 (732) Eliava Found – Georgian Bacteriophage
 Development Association
 Gotua St. 3, 0160, Tbilisi, Georgia
 (770) "Bacteriophage Biopreparations"
 Gotua St. 3, 0160, Tbilisi, Georgia
 (580) 2020 06 10</p> <hr/> | <p>(111) M 2010 20276 R
 (732) Eliava Found – Georgian Bacteriophage
 Development Association
 Gotua St. 3, 0160, Tbilisi, Georgia
 (770) "Bacteriophage Biopreparations"
 Gotua St. 3, 0160, Tbilisi, Georgia
 (580) 2020 06 10</p> <hr/> <p>(111) M 2015 25569 R
 (732) AMGEN (EUROPE) GMBH
 Saurstoffi 22, 6343 Risch-Rotkreuz,
 Switzerland
 (770) CELGENE CORPORATION
 86 Morris Avenue, Summit, New Jersey
 07901, USA
 (580) 2020 06 29</p> <hr/> <p>(111) M 2000 13129 R
 (732) XYLEM INDUSTRIES S.À R.L.
 11, Breedewues, L-1259 Senningerberg,
 Luxembourg
 (770) XYLEM IP MANAGEMENT S.À.R.L.
 11, Breedewues, L-1259 Senningerberg,
 Luxembourg
 (580) 2020 07 01</p> <hr/> <p>(111) M 2000 13129 R
 (732) XYLEM EUROPE GMBH
 Bleicheplatz 6, CH-8200 Schaffhausen,
 Switzerland
 (770) XYLEM INDUSTRIES S.À R.L.
 11, Breedewues, L-1259 Senningerberg,
 Luxembourg
 (580) 2020 07 01</p> <hr/> <p>(111) M 2018 30179 R
 (732) LTD "ASBC"
 Akaki Beliashvili St. 104, 0159, Tbilisi,
 Georgia
 (770) LLC "ALTA"
 Akaki Beliashvili St. 104, 0159, Tbilisi,
 Georgia
 (580) 2020 06 22</p> <hr/> <p>(111) M 2019 31781 R
 (732) LTD "ASBC"
 Akaki Beliashvili St. 104, 0159, Tbilisi,
 Georgia
 (770) LLC "ALTA"
 Akaki Beliashvili St. 104, 0159, Tbilisi,
 Georgia
 (580) 2020 06 22</p> <hr/> |
|--|--|

(111) M 2019 31786 R
(732) LTD "ASBC"
Akaki Belashvili St. 104, 0159, Tbilisi,
Georgia
(770) LLC "ALTA"
Akaki Belashvili St. 104, 0159, Tbilisi,
Georgia
(580) 2020 06 22

(111) M 2019 31792 R
(732) LTD "ASBC"
Akaki Belashvili St. 104, 0159, Tbilisi,
Georgia
(770) LLC "ALTA"
Akaki Belashvili St. 104, 0159, Tbilisi,
Georgia
(580) 2020 06 22

CHANGES OF NAMES AND/OR ADDRESS OF OWNERS

(111) M 2000 13633 R
(732) PT Sumatra Tobacco Trading Company
Jln. Pattimura No3, Pematang Siantar,
Sumatera Utara, Indonesia
(770) N.V. SUMATRA TOBACCO TRADING
COMPANY
Jln. Pattimura No3, Pematang Siantar,
Sumatera Utara, Indonesia
(580) 2020 06 16

(111) M 2001 14003 R
(732) "HELLENIC FUELS AND LUBRICANTS
SINGLE MEMBER INDUSTRIAL AND
COMMERCIAL SOCIETE ANONYME"
also trading as "EKO ABEE"
8A Cheimarras street, 151 25 Marousi, Greece
(770) HELLENIC FUELS AND LUBRICANTS
INDUSTRIAL AND COMMERCIAL S.A."
also trading as "EKO ABEE"
8A Cheimarras street, 151 25 Marousi, Greece
(580) 2020 06 22

(111) M 2010 20609 R
(732) LTD "G-M-P"
Vill. Ponichala 65, 0165, Tbilisi, Georgia
(770) LTD "G-M-P"
Zemo Vedzisi St. 103, 0160, Tbilisi Georgia
(580) 2020 06 25

(111) M 2010 20610 R
(732) LTD "G-M-P"
Vill. Ponichala 65, 0165, Tbilisi, Georgia
(770) LTD "G-M-P"
Zemo Vedzisi St. 103, 0160, Tbilisi Georgia
(580) 2020 06 25

(111) M 2010 20611 R
(732) LTD "G-M-P"
Vill. Ponichala 65, 0165, Tbilisi, Georgia
(770) LTD "G-M-P"
Zemo Vedzisi St. 103, 0160, Tbilisi Georgia
(580) 2020 06 25

(111) M 2010 20612 R
(732) LTD "G-M-P"
Vill. Ponichala 65, 0165, Tbilisi, Georgia
(770) LTD "G-M-P"
Zemo Vedzisi St. 103, 0160, Tbilisi Georgia
(580) 2020 06 25

(111) M 2010 20755 R
(732) LTD "G-M-P"
Vill. Ponichala 65, 0165, Tbilisi, Georgia
(770) LTD "G-M-P"
Zemo Vedzisi St. 103, 0160, Tbilisi Georgia
(580) 2020 06 25

(111) M 2017 28777 R
(732) "HELLENIC FUELS AND LUBRICANTS
SINGLE MEMBER INDUSTRIAL AND
COMMERCIAL SOCIETE ANONYME"
also trading as "EKO ABEE"
8A Cheimarras street, 151 25 Marousi, Greece
(770) "HELLENIC FUELS AND LUBRICANTS
INDUSTRIAL AND COMMERCIAL S.A."
also trading as "EKO ABEE" Greece
8A Cheimarras street, 151 25 Marousi, Greece
(580) 2020 06 22

TERMINATION OF TRADEMARKS REGISTRATION

(111) M 1999 12999 R (151) 1999 12 10 (732) BATMARK LIMITED Globe House, 4 Temple Place, London WC2R 2PG, United Kingdom (141) 2020 06 26	(111) M 1999 13043 R (151) 1999 12 15 (732) MARS INC. 6885, Elm Street, McLean, Virginia, USA (141) 2020 06 30
(111) M 1999 13007 R (151) 1999 12 10 (732) FERAH TRIKO TEKSTIL INSAAT MAKINA SANAYI IC VE DIS TICARET LIMITED SIRKETI Cimhuriyet Mahallesi, Disbudak Sokak No.21, Kucukcekmece, Istanbul, Turkey (141) 2020 06 26	(111) M 1999 13023 R (151) 1999 12 14 (732) WM.WRIGLEY JR.COMPANY 410 North Michigan Avenue, Chicago, Illinois 60611, USA (141) 2020 06 30
(111) M 1999 13031 R (151) 1999 12 14 (732) MARS, INCORPORATED 6885 Elm Street Mclean, Virginia 22101-3883, USA (141) 2020 06 30	(111) M 1999 13050 R (151) 1999 12 15 (732) WM.WRIGLEY JR.COMPANY 410 North Michigan Avenue, Chicago, Illinois 60611, USA (141) 2020 06 30
(111) M 1999 13017 R (151) 1999 12 10 (732) BASF SE Carl-Bosch-Strasse 38, Ludwigshafen am Rhein, Germany (141) 2020 06 26	(111) M 1999 13054 R (151) 1999 12 15 (732) WM.WRIGLEY JR.COMPANY 410 North Michigan Avenue, Chicago, Illinois 60611, USA (141) 2020 06 30
(111) M 1999 13034 R (151) 1999 12 14 (732) Merck Sharp & Dohme Corp. One Merck Drive, Whitehouse Station, New Jersey 08889, USA (141) 2020 06 30	(111) M 1999 13055 R (151) 1999 12 15 (732) ROTHMANS OF PALL MALL LIMITED Zählerweg 4, Zug CH 6300, Switzerland (141) 2020 06 30
(111) M 1999 13038 R (151) 1999 12 14 (732) PFIZER PRODUCTS INC., a Connecticut Corporation Eastern Point Road, Groton, Connecticut 06340, USA (141) 2020 06 30	(111) M 1999 13019 R (151) 1999 12 14 (732) JSC "TBILGHVINO" Sarajishvilis Av. 2, 0153, Tbilisi, Georgia (141) 2020 06 30
(111) M 1999 13022 R (151) 1999 12 14 (732) MARS, INCORPORATED 6885, Elm Street, McLean, Virginia, USA (141) 2020 06 30	(111) M 1999 13020 R (151) 1999 12 14 (732) JSC "TBILGHVINO" Sarajishvilis Av. 2, 0153, Tbilisi, Georgia (141) 2020 06 30
	(111) M 2009 20063 R (151) 2009 12 09 (732) LTS "GEOLAND"

Telegraph St., Lane 3, 0105, Tbilisi,
Georgia
(141) 2020 06 26

(111) M 2009 20064 R
(151) 2009 12 15
(732) LTD "GREEN CENTER"
Pasanauri St. 9, 0112, Tbilisi, Georgia
(141) 2020 06 30

(111) M 2009 20065 R
(151) 2009 12 15
(732) LTD "GEOSTAR"
Ak. Tseretlis Av. 117, 0119, Tbilisi,
Georgia
(141) 2020 06 30

(111) M 2009 20066 R
(151) 2009 12 15
(732) BASF SE
Carl-Bosch-Strasse 38, Ludwigshafen
am Rhein, Germany
(141) 2020 06 30

(111) M 2009 20077 R
(151) 2009 12 15
(732) LTD "DEVELOPMENT SOLUSHENS"
Rose Revolution Square 1, 0108, Tbilisi,
Georgia
(141) 2020 06 30

(111) M 2009 20067 R
(151) 2009 12 15
(732) LTD "MIRROR STUDIO"
Vazha-Pshavela Av. 45, 0177, Tbilisi,
Georgia
(141) 2020 06 30

(111) M 2009 20062 R
(151) 2009 12 07
(732) LTD "MIRROR STUDIO"
Vazha-Pshavela Av. 45, 0177, Tbilisi,
Georgia
(141) 2020 06 30

(111) M 2009 20069 R
(151) 2009 12 15
(732) WM. WRIGLEY JR. COMPANY
410 North Michigan Avenue, Chicago,
Illinois 60611, USA
(141) 2020 06 30

(111) M 2009 20078 R
(151) 2009 12 15
(732) Publicis Groupe S.A.
133 Avenue des Champs-Elysees, 75008
Paris, France
(141) 2020 06 30

(111) M 2009 20079 R
(151) 2009 12 15
(732) JSC "GEORGIAN BANK"
Gagarini St. 29a, 0160, Tbilisi, Georgia
(141) 2020 06 30

(111) M 2009 20080 R
(151) 2009 12 15
(732) LTD "FREEDOM SQUARE 7"
Il. Chavchavadze Av. 11, 0179, Tbilisi,
Georgia
(141) 2020 06 30

(111) M 2009 20084 R
(151) 2009 12 15
(732) HENKEL AG & Co. KgaA
Henkelstrasse 67, 40589 Dusseldorf, Germany
(141) 2020 06 30

(111) M 2009 20085 R
(151) 2009 12 15
(732) Publicis Groupe S.A.
133 Avenue des Champs-Elysees, 75008
Paris, France
(141) 2020 06 30

(111) M 2009 20086 R
(151) 2009 12 15
(732) Giorgi Arjevanidze
Atskuri St. 3b, app. 34, 0144, Tbilisi, Georgia
(141) 2020 06 30

(111) M 2009 20090 R
(151) 2009 12 15
(732) Beyond Productions LLC
a Delaware Limited Liability Company
31 West 34th Street, New-York, New-York
10001, USA
(141) 2020 06 30

(111) M 2009 20091 R
(151) 2009 12 15
(732) Beyond Productions LLC
a Delaware Limited Liability Company

31 West 34th Street, New-York, New-York
10001, USA
(141) 2020 06 30

(111) M 2009 20092 R
(151) 2009 12 15
(732) Perio Inc.

6156 Wilcox Road, Dublin, Ohio
43016, USA
(141) 2020 06 30

(111) M 2009 20093 R
(151) 2009 12 15
(732) Perio Inc.

6156 Wilcox Road, Dublin, Ohio 43016, USA
(141) 2020 06 30

(111) M 2009 20094 R
(151) 2009 12 15

(732) LTD "Aspharma" – Georgian Pharmaceutical
Company
Shevchenko St. 12, 0108, Tbilisi, Georgia
(141) 2020 06 30

(111) M 2009 20097 R
(151) 2009 12 15

(732) British American Tobacco (Brands) Inc.
2711 Centerville Road, Suite 300,
Wilmington, Delaware 19808, USA
(141) 2020 06 30

(111) M 2009 20099 R
(151) 2009 12 15

(732) LTD "LUX 2004"
Tevdore Mghvdeli St. 53, 0154, Tbilisi,
Georgia
(141) 2020 06 30

(111) M 2009 20100 R
(151) 2009 12 15

(732) LTD "Aspharma" – Georgian Pharmaceutical
Company
Shevchenko St. 12, 0108, Tbilisi, Georgia
(141) 2020 06 30

(111) M 2009 20101 R
(151) 2009 12 15

(732) JSC "NOVA TECHNOLOGY"
Vazha-Pshavela Av. 19, 0160, Tbilisi,
Georgia
(141) 2020 06 30

(111) M 2009 20102 R
(151) 2009 12 15

(732) Fox International Channels (U.S.), Inc.
1211 Avenue of the Americas, New-York,
New-York 10036, USA
(141) 2020 06 30

(111) M 2009 20105 R
(151) 2009 12 15

(732) The Coca-Cola Company
One Coca-Cola Plaza, Atlanta, Georgia,
30313, USA
(141) 2020 06 30

(111) M 2009 20106 R
(151) 2009 12 15

(732) The Coca-Cola Company
One Coca-Cola Plaza, Atlanta, Georgia,
30313, USA
(141) 2020 06 30

(111) M 2009 20107 R
(151) 2009 12 15

(732) DELL INC.
One Dell Way, Round Rock, Texas
78682, USA
(141) 2020 06 30

(111) M 2009 20108 R
(151) 2009 12 15

(732) Zaza Dolidze
Nutsbidze plateau IV mkr., corp. 2, app. 23,
0183, Tbilisi, Georgia
(141) 2020 06 30

(111) M 2009 20109 R
(151) 2009 12 15

(732) BASF SE
Carl-Bosch-Strasse 38, Ludwigshafen am
Rhein, Germany
(141) 2020 06 30

(111) M 2009 20110 R
(151) 2009 12 15

(732) British American Tobacco (Brands) Inc.
2711 Centerville Road, Suite 300,
Wilmington, Delaware 19808, USA
(141) 2020 06 30

(111) M 1999 12994 R
(151) 1999 12 10
(732) PUIG FRANCE

Societe par Actions Simplifiee
6, Boulevard du Parc, 92200 Neuilly-Sur-
Seine, France
(141) 2020 06 26

CANCELLATION OF INTERNATIONAL TRADEMARK REGISTRATION

(800) 1107783
(141) 2020 06 30

Ground: Mtskheta District Court N2/214-19 (1.10.19) decision in accordance to the Article 27.2(a)
of "Trademark Law" of Georgia.

CLASSIFICATION INDEXES

INVENTIONS

CONCORDANCE TABLE OF INTERNATIONAL CLASSIFICATION INDEX AND PUBLICATION NUMBERS

INTERNATIONAL CLASSIFICATION INDEXES (51)	NUMBER OF PUBLISHED APPLICATION (10)
A 01 N 43/42; C 07 D 215/54	AP 2020 14891 A
A 61 K 31/44; A 61 P 29/00; C 07 D 213/75; C 07 D 401/12	AP 2020 14909 A
A 61 K 31/437; C 07 D 471/04	AP 2020 14955 A
A 61 K 31/501; A 61 P 35/00; C 07 D 237/16; C 07 D 237/20; C 07 D 403/12; C 07 D 405/12	AP 2020 14968 A
A 61 K 39/395; C 07 K 16 18; C 07 K 16 28	AP 2020 14811 A
D 06 P 5/00; D 06 P 5/30; D 06 P 1/52	AP 2020 14825 A
E 02 D 31/00; E 01 C 3/00; E 01 C 3/04; E 01 B 2/00	AP 2020 14264 A
E 03 C 1/28	AP 2020 15162 A
E 04 H 6/06	AP 2020 15065 A
G 06 F 1/16	AP 2020 15012 A
G 06 K 7/00; G 06 K 17/00	AP 2020 15277 A
H 01 L 31/00	AP 2020 15077 A

CONCORDANCE TABLE OF PUBLICATION NUMBERS AND INTERNATIONAL CLASSIFICATION INDEX

NUMBER OF PUBLISHED APPLICATION (10)	INTERNATIONAL CLASSIFICATION INDEXES (51)
AP 2020 14264 A	E 02 D 31/00; E 01 C 3/00; E 01 C 3/04; E 01 B 2/00
AP 2020 14811 A	A 61 K 39/395; C 07 K 16 18; C 07 K 16 28
AP 2020 14825 A	D 06 P 5/00; D 06 P 5/30; D 06 P 1/52
AP 2020 14891 A	A 01 N 43/42; C 07 D 215/54
AP 2020 14909 A	A 61 K 31/44; A 61 P 29/00; C 07 D 213/75; C 07 D 401/12
AP 2020 14955 A	A 61 K 31/437; C 07 D 471/04
AP 2020 14968 A	A 61 K 31/501; A 61 P 35/00; C 07 D 237/16; C 07 D 237/20; C 07 D 403/12; C 07 D 405/12
AP 2020 15012 A	G 06 F 1/16
AP 2020 15065 A	E 04 H 6/06
AP 2020 15077 A	H 01 L 31/00
AP 2020 15162 A	E 03 C 1/28
AP 2020 15277 A	G 06 K 7/00; G 06 K 17/00

**CONCORDANCE TABLE OF INTERNATIONAL CLASSIFICATION INDEX,
PATENT NUMBERS AND PUBLICATION NUMBERS**

INTERNATIONAL CLASSIFICATION INDEX (51)	NUMBER OF PATENT (11)	NUMBER OF PUBLISHED APPLICATION (10)
A 61 K 31/56; A 61 P 31/16	P 2020 7129 B	AP 2020 13375 A
A 61 K 31/4178; A 61 P 11/00; C 07 D 403/04; C 07 D 413/14; C 07 D 403/14; C 07 D 417/14	P 2020 7130 B	AP 2020 14924 A
A 61 P 29/00; A 61 P 19/04; A 61 K 31/787; A 61 K 9/02; A 61 K 47/59; A 61 K 38/43; A 61 K 9/06; C 08 F 8/02; C 08 F 8/06; C 08 F 26/06	P 2020 7131 B	AP 2020 14813 A
A 61 P 31/22; A 61 K 31/426; A 61 K 31/662; C 07 D 277/54; C 07 F 9/44; C 07 F 9/40; C 07 F 9/38	P 2020 7128 B	AP 2020 14916 A

**CONCORDANCE TABLE OF PATENT NUMBERS,
PUBLICATION NUMBERS AND INTERNATIONAL CLASSIFICATION INDEX**

NUMBER OF PATENT (11)	NUMBER OF PUBLISHED APPLICATION (10)	INTERNATIONAL CLASSIFICATION INDEX (51)
P 2020 7128 B	AP 2020 14916 A	A 61 P 31/22; A 61 K 31/426; A 61 K 31/662; C 07 D 277/54; C 07 F 9/44; C 07 F 9/40; C 07 F 9/38
P 2020 7129 B	AP 2020 13375 A	A 61 K 31/56; A 61 P 31/16
P 2020 7130 B	AP 2020 14924 A	A 61 K 31/4178; A 61 P 11/00; C 07 D 403/04; C 07 D 413/14; C 07 D 403/14; C 07 D 417/14
P 2020 7131 B	AP 2020 14813 A	A 61 P 29/00; A 61 P 19/04; A 61 K 31/787; A 61 K 9/02; A 61 K 47/59; A 61 K 38/43; A 61 K 9/06; C 08 F 8/02; C 08 F 8/06; C 08 F 26/06

**CONCORDANCE TABLE OF APPLICATION NUMBERS, PUBLICATION NUMBERS
AND PATENTS**

NUMBER OF APPLICATION (21)	NUMBER OF PUBLISHED APPLICATION (10)	NUMBER OF PATENT (11)
AP 2010 13375	AP 2020 13375 A	P 2020 7129 B
AP 2016 14813	AP 2020 14813 A	P 2020 7131 B
AP 2017 14916	AP 2020 14916 A	P 2020 7128 B
AP 2017 14924	AP 2020 14924 A	P 2020 7130 B

UTILITY MODELS

CONCORDANCE TABLE OF INTERNATIONAL CLASSIFICATION INDEX AND PUBLICATION NUMBERS

INTERNATIONAL CLASSIFICATION INDEXES (51)	NUMBER OF PUBLISHED APPLICATION (10)
A 01 G 9/14	AU 2020 15204 U
A 01 K 47/00	AU 2020 15300 U
A 47 B 21/06; A 47 B 13/00; A 47 B 17/00; A 47 B 19/00; A 47 B 41/00	AU 2020 15275 U
B 65 D 81/03	AU 2020 15238 U

CONCORDANCE TABLE OF PUBLICATION NUMBERS AND INTERNATIONAL CLASSIFICATION INDEX

NUMBER OF PUBLISHED APPLICATION (10)	INTERNATIONAL CLASSIFICATION INDEXES (51)
AU 2020 15204 U	A 01 G 9/14
AU 2020 15238 U	B 65 D 81/03
AU 2020 15275 U	A 47 B 21/06; A 47 B 13/00; A 47 B 17/00; A 47 B 19/00; A 47 B 41/00
AU 2020 15300 U	A 01 K 47/00

CONCORDANCE TABLE OF INTERNATIONAL CLASSIFICATION INDEX, PATENT NUMBERS AND PUBLICATION NUMBERS

INTERNATIONAL CLASSIFICATION INDEX (51)	NUMBER OF PATENT (11)	NUMBER OF PUBLISHED APPLICATION (10)
B 41 F 13/12	U 2020 2044 Y	AU 2019 14986 U
E 01 C 3/04	U 2020 2045 Y	AU 2020 14990 U
F 03 D 3/00; F 03 D 3/02	U 2020 2043 Y	AU 2020 15122 U

CONCORDANCE TABLE OF PATENT NUMBERS, PUBLICATION NUMBERS AND INTERNATIONAL CLASSIFICATION INDEX

NUMBER OF PATENT (11)	NUMBER OF PUBLISHED APPLICATION (10)	INTERNATIONAL CLASSIFICATION INDEX (51)
U 2020 2043 Y	AU 2020 15122 U	F 03 D 3/00; F 03 D 3/02
U 2020 2044 Y	AU 2019 14986 U	B 41 F 13/12
U 2020 2045 Y	AU 2020 14990 U	E 01 C 3/04

**CONCORDANCE TABLE OF APPLICATION NUMBERS, PUBLICATION NUMBERS
AND PATENTS**

NUMBER OF APPLICATION (21)	NUMBER OF PUBLISHED APPLICATION (10)	NUMBER OF PATENT (11)
AU 2019 14986	AU 2019 14986 U	U 2020 2044 Y
AU 2019 14990	AU 2020 14990 U	U 2020 2045 Y
AU 2019 15122	AU 2020 15122 U	U 2020 2043 Y

DESIGNS

**CONCORDANCE TABLE OF INTERNATIONAL CLASSIFICATION INDEX
AND PUBLICATION NUMBERS**

INTERNATIONAL CLASSIFICATION INDEXES (51)	NUMBER OF PUBLISHED APPLICATION (10)
11-01	AD 2020 1146 S
32-00	AD 2020 1145 S

**CONCORDANCE TABLE OF PUBLICATION NUMBERS
AND INTERNATIONAL CLASSIFICATION INDEX**

NUMBER OF PUBLISHED APPLICATION (10)	INTERNATIONAL CLASSIFICATION INDEXES (51)
AD 2020 1145 S	32-00
AD 2020 1146 S	11-01

**CONCORDANCE TABLE OF INTERNATIONAL CLASSIFICATION INDEX,
PATENT NUMBERS AND PUBLICATION NUMBERS**

INTERNATIONAL CLASSIFICATION INDEX (51)	NUMBER OF PATENT (11)	NUMBER OF PUBLISHED APPLICATION (10)
03-01	D 2020 847 S	AD 2020 1114 S
03-01	D 2020 851 S	AD 2020 1117 S
06-03; 06-04	D 2020 850 S	AD 2020 1116 S
09-01	D 2020 848 S	AD 2020 1113 S
09-01	D 2020 849 S	AD 2020 1112 S

**CONCORDANCE TABLE OF PATENT NUMBERS,
PUBLICATION NUMBERS AND INTERNATIONAL CLASSIFICATION INDEX**

NUMBER OF PATENT (11)	NUMBER OF PUBLISHED APPLICATION (10)	INTERNATIONAL CLASSIFICATION INDEX (51)
D 2020 847 S	AD 2020 1114 S	03-01
D 2020 848 S	AD 2020 1113 S	09-01
D 2020 849 S	AD 2020 1112 S	09-01
D 2020 850 S	AD 2020 1116 S	06-03; 06-04
D 2020 851 S	AD 2020 1117 S	03-01

**CONCORDANCE TABLE OF APPLICATION NUMBERS, PUBLICATION NUMBERS
AND PATENTS**

NUMBER OF APPLICATION (21)	NUMBER OF PUBLISHED APPLICATION (10)	NUMBER OF PATENT (11)
AD 2019 1112	AD 2020 1112 S	D 2020 849 S
AD 2019 1113	AD 2020 1113 S	D 2020 848 S
AD 2019 1114	AD 2020 1114 S	D 2020 847 S
AD 2019 1116	AD 2020 1116 S	D 2020 850 S
AD 2019 1117	AD 2020 1117 S	D 2020 851 S

TRADEMARKS

CONCORDANCE TABLE OF REGISTRATION NUMBERS, APPLICATION NUMBERS, PUBLICATION NUMBERS AND BULLETIN NUMBERS

NUMBER OF REGISTRATION (111)	NUMBER OF APPLICATIONS (210)	NUMBER OF PUBLISHED APPLICATIONS (260)	NUMBER OF BULLETIN
1	2	3	4
M 2020 32791 R	AM 108521	–	13(545)2020
M 2020 32792 R	AM 108608	–	13(545)2020
M 2020 32793 R	AM 108520	–	13(545)2020
M 2020 32794 R	AM 108529	–	13(545)2020
M 2020 32795 R	AM 108573	–	13(545)2020
M 2020 32796R	AM 108587	–	13(545)2020
M 2020 32797 R	AM 108661	–	13(545)2020
M 2020 32798 R	AM 108691	–	13(545)2020
M 2020 32799 R	AM 108769	–	13(545)2020
M 2020 32800 R	AM 108770	–	13(545)2020
M 2020 32801 R	AM 108771	–	13(545)2020
M 2020 32802 R	AM 108772	–	13(545)2020
M 2020 32803 R	AM 108734	–	13(545)2020
M 2020 32804 R	AM 108849	–	13(545)2020
M 2020 32805 R	AM 103028	AM 2019 103028 A	24(532)2019
M 2020 32806 R	AM 103107	AM 2019 103107 A	23(531)2019
M 2020 32807 R	AM 103114	AM 2019 103114 A	24(532)2019
M 2020 32808 R	AM 103115	AM 2019 103115 A	24(532)2019
M 2020 32809 R	AM 103119	AM 2019 103119 A	24(532)2019
M 2020 32810 R	AM 103120	AM 2019 103120 A	24(532)2019
M 2020 32811 R	AM 103203	AM 2019 103203 A	24(532)2019
M 2020 32812 R	AM 103304	AM 2019 103304 A	24(532)2019
M 2020 32813 R	AM 103343	AM 2019 103343 A	24(532)2019
M 2020 32814 R	AM 103559	AM 2020 103559 A	5(537)2020
M 2020 32815 R	AM 103576	AM 2020 103576 A	2(534)2020
M 2020 32816 R	AM 103669	AM 2020 103669 A	3(535)2020
M 2020 32817 R	AM 103840	AM 2020 103840 A	4(536)2020
M 2020 32818 R	AM 103855	AM 2020 103855 A	3(535)2020
M 2020 32819 R	AM 103883	AM 2020 103883 A	4(536)2020
M 2020 32820 R	AM 104060	AM 2020 104060 A	5(537)2020
M 2020 32821 R	AM 104073	AM 2020 104073 A	5(537)2020
M 2020 32822 R	AM 104084	AM 2020 104084 A	5(537)2020
M 2020 32823 R	AM 104088	AM 2020 104088 A	5(537)2020
M 2020 32824 R	AM 104217	AM 2020 104217 A	5(537)2020
M 2020 32825 R	AM 104307	AM 2020 104307 A	5(537)2020
M 2020 32826 R	AM 104402	AM 2020 104402 A	5(537)2020
M 2020 32827 R	AM 104403	AM 2020 104403 A	5(537)2020
M 2020 32828 R	AM 104535	AM 2020 104535 A	5(537)2020
M 2020 32829 R	AM 104537	AM 2020 104537 A	5(537)2020
M 2020 32830 R	AM 103004	AM 2019 103004 A	24(532)2019
M 2020 32831 R	AM 103019	AM 2019 103019 A	24(532)2019
M 2020 32832 R	AM 103020	AM 2019 103020 A	24(532)2019
M 2020 32833 R	AM 103209	AM 2020 103209 A	1(533)2020
M 2020 32834 R	AM 102832	AM 2020 102832 A	6(538)2020
M 2020 32835 R	AM 104555	AM 2020 104555 A	6(538)2020
M 2020 32836 R	AM 104559	AM 2020 104559 A	6(538)2020

1	2	3	4
M 2020 32837 R	AM 104759	AM 2020 104759 A	6(538)2020
M 2020 32838 R	AM 104812	AM 2020 104812 A	6(538)2020
M 2020 32839 R	AM 108676	–	13(545)2020
M 2020 32840 R	AM 108853	–	13(545)2020
M 2020 32841 R	AM 108744	–	13(545)2020

**CONCORDANCE TABLE OF PUBLICATION NUMBERS
AND APPLICATION NUMBERS**

NUMBER OF PUBLISHED APPLICATION (260)	NUMBER OF APPLICATION (210)	1	2
		1	2
AM 2020 103313 A	AM 103313	AM 2020 105884 A	AM 105884
AM 2020 105026 A	AM 105026	AM 2020 105885 A	AM 105885
AM 2020 105454 A	AM 105454	AM 2020 105890 A	AM 105890
AM 2020 105455 A	AM 105455	AM 2020 105892 A	AM 105892
AM 2020 105740 A	AM 105740	AM 2020 105967 A	AM 105967
AM 2020 105742 A	AM 105742	AM 2020 105974 A	AM 105974
AM 2020 105783 A	AM 105783	AM 2020 105984 A	AM 105984
AM 2020 105819 A	AM 105819	AM 2020 105990 A	AM 105990
AM 2020 105882 A	AM 105882	AM 2020 105991 A	AM 105991
		AM 2020 106167 A	AM 106167
		AM 2020 106183 A	AM 106183
		AM 2020 106184 A	AM 106184
		AM 2020 106280 A	AM 106280
		AM 2020 106320 A	AM 106320

CONCORDANCE TABLE OF INDEX OF GOODS AND/OR SERVICES
AND APPLICATION NUMBERS

INDEX OF GOODS AND/OR SERVICES (511)	NUMBER OF PUBLISHED APPLICATIONS (26)	1	2
1	2	20	AM 2020 105740 A
1	AM 2020 105984 A	20	AM 2020 105742 A
1	AM 2020 106183 A	21	AM 2020 105740 A
1	AM 2020 106184 A	21	AM 2020 105742 A
2	AM 2020 106183 A	22	AM 2020 106183 A
2	AM 2020 106184 A	22	AM 2020 106184 A
3	AM 2020 105740 A	24	AM 2020 105740 A
3	AM 2020 105742 A	24	AM 2020 105742 A
4	AM 2020 106183 A	25	AM 2020 105740 A
4	AM 2020 106184 A	25	AM 2020 105742 A
5	AM 2020 105890 A	25	AM 2020 106280 A
5	AM 2020 105892 A	26	AM 2020 105740 A
5	AM 2020 105984 A	26	AM 2020 105742 A
5	AM 2020 106183 A	27	AM 2020 106280 A
5	AM 2020 106184 A	28	AM 2020 105740 A
6	AM 2020 106183 A	28	AM 2020 105742 A
6	AM 2020 106184 A	28	AM 2020 106280 A
7	AM 2020 106183 A	31	AM 2020 105454 A
7	AM 2020 106184 A	31	AM 2020 105455 A
9	AM 2020 105026 A	32	AM 2020 105454 A
9	AM 2020 105740 A	32	AM 2020 105455 A
9	AM 2020 105742 A	32	AM 2020 105967 A
9	AM 2020 105885 A	32	AM 2020 106320 A
9	AM 2020 106183 A	33	AM 2020 105454 A
9	AM 2020 106184 A	33	AM 2020 105455 A
10	AM 2020 106183 A	33	AM 2020 105819 A
10	AM 2020 106184 A	33	AM 2020 105974 A
11	AM 2020 106183 A	33	AM 2020 106320 A
11	AM 2020 106184 A	34	AM 2020 105990 A
12	AM 2020 105884 A	34	AM 2020 105991 A
12	AM 2020 106183 A	34	AM 2020 106167 A
12	AM 2020 106184 A	35	AM 2020 105026 A
13	AM 2020 106183 A	35	AM 2020 105454 A
13	AM 2020 106184 A	35	AM 2020 105455 A
14	AM 2020 105740 A	35	AM 2020 105783 A
14	AM 2020 105742 A	35	AM 2020 105882 A
16	AM 2020 105740 A	35	AM 2020 105885 A
16	AM 2020 105742 A	35	AM 2020 106183 A
16	AM 2020 105885 A	35	AM 2020 106184 A
16	AM 2020 106183 A	35	AM 2020 106320 A
16	AM 2020 106184 A	36	AM 2020 106183 A
16	AM 2020 106280 A	36	AM 2020 106184 A
17	AM 2020 106183 A	37	AM 2020 105454 A
17	AM 2020 106184 A	37	AM 2020 105455 A
18	AM 2020 105740 A	37	AM 2020 106183 A
18	AM 2020 105742 A	37	AM 2020 106184 A
18	AM 2020 106280 A	37	AM 2020 106184 A
19	AM 2020 106183 A	38	AM 2020 105454 A
19	AM 2020 106184 A	38	AM 2020 105455 A
		38	AM 2020 106183 A
		38	AM 2020 106184 A
		39	AM 2020 106183 A
		39	AM 2020 106184 A
		40	AM 2020 106183 A

1	2
40	AM 2020 106184 A
41	AM 2020 103313 A
41	AM 2020 105454 A
41	AM 2020 105455 A
41	AM 2020 105740 A
41	AM 2020 105742 A
41	AM 2020 106183 A
41	AM 2020 106184 A
42	AM 2020 105885 A
42	AM 2020 106183 A
42	AM 2020 106184 A

1	2
43	AM 2020 105454 A
43	AM 2020 105455 A
43	AM 2020 105974 A
43	AM 2020 106320 A
44	AM 2020 105026 A
44	AM 2020 105454 A
44	AM 2020 105455 A
44	AM 2020 106183 A
44	AM 2020 106184 A
45	AM 2020 106183 A
45	AM 2020 106184 A

**CONCORDANCE TABLE OF INDEX OF GOODS AND/OR SERVICES
AND NUMBERS OF TRADEMARKS REGISTERED ACCORDING
TO THE ACCELERATED PROCEDURE**

INDEX OF GOODS AND/OR SERVICES (511)	NUMBERS OF REGISTERED ACCORDING TO THE ACCELERATED PROCEDURE (111)
5	M 2020 32792 R
5	M 2020 32793 R
5	M 2020 32794 R
5	M 2020 32795 R
5	M 2020 32798 R
5	M 2020 32839 R
5	M 2020 32840 R
10	M 2020 32798 R
29	M 2020 32791 R
32	M 2020 32797 R
32	M 2020 32804 R
33	M 2020 32797 R
33	M 2020 32799 R
33	M 2020 32800 R
33	M 2020 32801 R
33	M 2020 32802 R
35	M 2020 32791 R
35	M 2020 32793 R
35	M 2020 32794 R
35	M 2020 32795 R
35	M 2020 32797 R
35	M 2020 32798 R
35	M 2020 32840 R
41	M 2020 32796 R
41	M 2020 32797 R
43	M 2020 32797 R
43	M 2020 32803 R
43	M 2020 32841 R
44	M 2020 32797 R

OFFICIAL BULLETIN OF THE INDUSTRIAL PROPERTY

INVENTIONS
UTILITY MODELS
DESIGNS
TRADEMARKS

13(545)

EDITOR-IN-CHIEF: N. Bebrishvili

EDITOR-TRANSLATOR: E. Gabunia

PROOFREADER: A. Shikhashvili

COMPUTER LAYOUT: M. Ordenidze
K. Svanidze

www.sakpatenti.gov.ge

E-mail: info@sakpatenti.org.ge

**LIST OF CODES, IN ALPHABETIC SEQUENCE, AND THE CORRESPONDING (SHORT) NAMES OF STATES, OTHER ENTITIES AND INTERGOVERNMENTAL ORGANIZATIONS
(WIPO STANDARD ST.3)**

AD	Andorra				
AE	United Arab Emirates	GD	Grenada	NE	Niger
AF	Afghanistan	GG	Guernsey	NG	Nigeria
AG	Antigua and Barbuda	GH	Ghana	NI	Nicaragua
AI	Anguilla	GI	Gibraltar	NL	Netherlands
AL	Albania	GT	Guatemala	NO	Norway
AM	Armenia	GW	Guinea- Bissau	NP	Nepal
AN	Netherlands Antilles	GY	Guyana	NR	Nauru
AO	Angola	HK	The Hong Kong Special Administrative Region of the People's Republic of China	NZ	New Zealand
AP	African Regional Intellectual Property Organization (ARIPO)	HN	Honduras	OA	African Intellectual Property Organization (OAPI)
AR	Argentina	HR	Croatia	OM	Oman
AT	Austria	HT	Haiti	PA	Panama
AU	Australia	HU	Hungary	PE	Peru
AW	Aruba	IB	International Bureau of the World Intellectual Property Organization (WIPO)	PG	Papua New Guinea
AZ	Azerbaijan	ID	Indonesia	PH	Philippines
BA	Bosnia and Herzegovina	IE	Ireland	PK	Pakistan
BB	Barbados	IL	Israel	PL	Poland
BD	Bangladesh	IM	Isle of Man	PT	Portugal
BE	Belgium	IN	India	PW	Palau
BF	Burkina Faso	IQ	Iraq	PY	Paraguay
BG	Bulgaria	IR	Iran (Islamic Republic of)	QA	Qatar
BH	Bahrain	IS	Iceland	QZ	Community Plant Variety Office (European Community) (CPVO)
BI	Burundi	IT	Italy	RO	Romania
BJ	Benin	JE	Jersey	RS	Serbia
BM	Bermuda	JM	Jamaica	RU	Russian Federation
BN	Brunei Darussalam	JO	Jordan	RW	Rwanda
BO	Bolivia	JP	Japan	SA	Saudi Arabia
BR	Brazil	KE	Kenya	SB	Solomon Islands
BS	Bahamas	KG	Kyrgyzstan	SC	Seychelles
BT	Bhutan	KH	Cambodia	SD	Sudan
BV	Bouvet Island	KI	Kiribati	SG	Singapore
BW	Botswana	KM	Saint Kitts and Nevis	SH	Saint Helena
BX	Benelux Office for Intellectual Property (BOIP)	KP	Democratic People's Republic of Korea	SI	Slovenia
BY	Belarus	KR	Republic of Korea	SK	Slovakia
BZ	Belize	KW	Kuwait	SL	Sierra Leone
CA	Canada	KY	Cayman Islands	SM	San Marino
CD	Democratic Republic of the Congo	KZ	Kazakhstan	SN	Senegal
CF	Central African Republic	LA	Lao People's Democratic Republic	SO	Somalia
CG	Congo	LB	Lebanon	SR	Suriname
CH	Switzerland	LC	Saint Lucia	ST	Sao Tome and Principe
CI	Cote d'Ivoire	LI	Liechtenstein	SV	El Salvador
CK	Cook Islands	LK	Sri Lanka	SY	Syrian Arab Republic
CL	Chile	LR	Liberia	SZ	Swaziland
CM	Cameroon	LS	Lesotho	TC	Turks and Caicos Islands
CN	China	LT	Lithuania	TD	Chad
CO	Colombia	LU	Luxembourg	TG	Togo
CR	Costa Rica	LV	Latvia	TH	Thailand
CU	Cuba	LY	Libyan Arab Jamahiriya	TJ	Tajikistan
CV	Cape Verde	MA	Morocco	TL	Timor-Leste
CY	Cyprus	MC	Monaco	TM	Turkmenistan
CZ	Czech Republic	MD	Republic of Moldova	TN	Tunisia
DE	Germany	ME	Montenegro	TO	Tonga
DJ	Djibouti	MG	Madagascar	TR	Turkey
DM	Dominica	MK	The former Yugoslav Republic of Macedonia	SE	Sweden
DO	Dominican Republic	ML	Mali	TT	Trinidad and Tobago
DZ	Algeria	MM	Myanmar	TV	Tuvalu
EA	Eurasian Patent Organization (EAPO)	MN	Mongolia	TW	Taiwan, Province of China
EC	Ecuador	MO	Macao	TZ	United Republic of Tanzania
EE	Estonia	MP	Northern Mariana Islands	UA	Ukraine
EG	Egypt	MR	Mauritania	UG	Uganda
EH	Western Sahara	MS	Montserrat	US	United States of America
EM	Office for Harmonization in the Internal Market (Trademarks and Designs)(OHIM)	MT	Malta	UY	Uruguay
EP	European Patent Office (EPO)	MU	Mauritius	UZ	Uzbekistan
ER	Eritrea	MV	Maldives	VA	Holy See
ES	Spain	MW	Malawi	VC	Saint Vincent and the Grenadines
ET	Ethiopia	MX	Mexico	VE	Venezuela
FI	Finland	MY	Malaysia	VG	Virgin Islands (British)
FJ	Fiji	MZ	Mozambique	VN	Viet Nam
FK	Falkland Islands (Malvinas)	NA	Namibia	VU	Vanuatu
FO	Faroe Islands			WO	World Intellectual Property Organization (WIPO)
FR	France			WS	Samoa
GA	Gabon			XN	Nordic Patent Institute (NPI)
GB	United Kingdom			YE	Yemen
GC	Patent Office of the Cooperation Council for the Arab States of the Gulf (GCC)			ZA	South Africa
				ZM	Zambia
				ZW	Zimbabwe