

Official Bulletin of the Industrial Property

Inventions

Utility Models

Designs

Trademarks

Appellation of Origin of Goods



საქართველოს ინტელექტუალური
საკუთრების ეროვნული ცენტრი

საკპატი

SAKPATENTI

NATIONAL INTELLECTUAL PROPERTY
CENTER OF GEORGIA

www.sakpatenti.gov.ge

Date of Publication – 2020 07 27

14(546)

INID CODES FOR IDENTIFICATION OF BIBLIOGRAPHIC DATA

INVENTIONS, UTILITY MODELS

- (10) Number of publication for application, which has been examined
- (11) Number of patent and kind of document
- (21) Serial number of application
- (22) Date of filing of the application
- (23) Date of exhibition or the date of the earlier filing and the number of application, if any
- (24) Date from which patent may have effect
- (31) Number of priority application
- (32) Date of filing of priority application
- (33) Code of the country or regional organization allotting priority application number
- (44) Date of publication of application not granted, but examined and number of bulletin
- (45) Date of publication of registered document
- (51) International Patent Classification Index

- (54) Title of the invention
- (57) Abstract
- (60) Number of examined patent document granted by foreign patent office, date from which patent has effect and country code
- (62) Number of the earlier application and in case of divided application, date of filing an application
- (71) Name, surname and address of applicant (country code)
- (72) Name, surname of inventor (country code)
- (73) Name, surname and address of patent owner (country code)
- (74) Name, surname of representative or patent attorney
- (85) Date of commencement of the national phase of International Application
- (86) Number and date of filing of international application
- (87) Number and date of publication of international application
- (94) Calculated date of expiry of the SPC or the duration of the SPC

DESIGNS

- (10) Number of publication for application
- (11) Number of patent and kind of document or number of registration
- (15) Date of registration/Date of patent renewal
- (18) Expected expiration date of patent or registration
- (21) Serial number of application
- (22) Date of filing of the application
- (23) Date of exhibition or the date of the earlier filing and the number of application, if any
- (24) Date from which patent may have effect
- (28) Number of designs included in the application
- (30) Data relating to priority (number of application, date of filing of application, two-letter code identifying the authority with whom the priority application was made)
- (31) Number of priority application
- (32) Date of filing of priority application
- (33) Code of the country or regional organization allotting priority application number
- (34) Two-letter code according to WIPO St.3 identifying the authority with which the priority application was made
- (44) Date of publication of design and number of bulletin (the first publication)
- (45) Date of publication of design registered by WIPO and number of bulletin

- (51) International Classification for designs (class and subclass of the Locarno Classification)
- (54) Title of the invention
- (55) Reproduction of the design
- (57) Description of characteristic features of the design including indication of colors
- (58) Date of recording of any kind of amendment in the Register
- (62) Number of the earlier application, registration and document number and if available the date of filing an application in case of divided application
- (71) Name, surname and address of applicant (country code)
- (72) Name, surname of creator (country code)
- (73) Name, surname and address of patent owner (country code)
- (74) Name, surname of representative or patent attorney
- (81) Contracting states concerned
 - II designated contracting states according to the 1960 Act
 - III designated contracting states according to the 1999 Act
- (85) Owner's permanent address
- (86) Owner's nationality
- (87) Owner's residence
- (88) State in which the owner has a real and effective industrial or commercial establishment

TRADEMARKS

- (111) - Number of registration
- (151) - Date of registration
- (156) - Date of the renewal
- (181) - Expected expiration date of registration
- (186) - Renewal expiration date of registration
- (141) - Date of cancel of duration of the mark
- (210) - Serial number of application
- (220) - Date of filing of the application
- (230) - Data concerning exhibition
- (260) - Number of application, for which favorable decision of examination about registration has been taken (publication number)
- (310) - Number of the first application
- (320) - Date of filing of the first application
- (330) - Code, identifying national or regional Office where the first application was made
- (511) - International Classification of Goods and Services for the purposes of registration of trade marks and/or list of goods and/or services classified according thereto
- (526) - Disclaimer
- (531) - Description of figurative elements of Trade Marks according to the International Classification of the Figurative Elements of Marks

- (540) - Reproduction of Trade Mark
- (550) - Nature and kind of Trade Mark
- (551) - Indication to the effect that the mark is a collective mark, a certification mark or a guarantee mark
- (554) - Three-dimensional mark
- (580) - Date of recording of any kind changes in respect of applications or registrations
- (591) - Information concerning colors claimed
- (731) - Name and address of the applicant
- (732) - Name and address of the holder of the registration
- (740) - Name and address of the representative
- (750) - Addreses for correspondence
- (770) - Name and address of the previous applicant or holder in case of change in ownership
- (771) - Previous name and address of the applicant or holder in case of change in ownership
- (791) - Name and address of the licensee
- (793) - Indication of conditions and/or restrictions under the license (Type of license, number of license agreement, data of license, data of validity of license)
- (800) - Certain data relating to the international registration of Trade Marks under the Protocol Relating to Madrid Agreement (International registration number
- (852) - Partial cancellation of the list of goods and services
- (891) - Date of subsequent designation

CODES FOR PUBLICATION IN BULLETIN

- (21) AP 0000 000000 - serial number of application for invention
- (10) AP 0000 0000 A - number of published application for invention (first publication)
- (11) P 0000 0000 B - number of patent for invention (second publication)
- (21) API 0000 000000 - number of application for imported patent
- (11) PI 0000 0000 A - number of imported patent (first publication)
- (21) AU 0000 000000 - serial number of application for utility model
- (10) AU 0000 000 U - number of published application for utility model (first publication)
- (11) U 0000 000 Y - number of patent for utility model (second publication)
- (21) AD 0000 000000 - serial number of application for design
- (10) AD 0000 000 S - number of published application for design (first publication)
- (11) D 0000 000 S - registered design

INTERNATIONAL PATENT CLASSIFICATION FOR INVENTIONS AND UTILITY MODELS

- SECTION A - HUMAN NECESSITIES
- SECTION B - PERFORMING OPERATIONS; TRANSPORTING
- SECTION C - CHEMISTRY; METALLURGY
- SECTION D - TEXTILES; PAPER
- SECTION E - FIXED CONSTRUCTIONS
- SECTION F - MECHANICAL ENGINEERING; LIGHTING; HEATING; WEAPONS; BLASTING
- SECTION G - PHYSICS
- SECTION H - ELECTRICITY

-
- M - Trade Mark
 - (210) AM 0000 000000 - Serial number of application;
 - (260) AAM 0000 00000 A - Publication number of application;
 - (111) M 0000 00000 R - Number of registration;
 - (111) MMM0000 00000 Rn - Number of renewals, in which n=1,2,3;
 - (111) M 0000 00000 R(P) - Number of registration under partial assignment of rights
-

Official Bulletin of the Industrial Property

Inventions

Utility Models

Designs

Trademarks

Appellation Of Origin of Goods

CONTENTS

PUBLISHED TITLES OF PROTECTION	3
INVENTIONS	
▪ APPLICATIONS APPROVED FOR GRANTING PATENTS	4
▪ PATENTED INVENTIONS	10
UTILITY MODELS	
▪ APPLICATIONS APPROVED FOR GRANTING PATENTS	13
▪ PATENTED UTILITY MODEL	14
DESIGNS	
▪ DESIGNS, WICH HAVE BEEN REGISTERED WITH THE INTERNATIONAL BUREAU CLAIMING PRIORITY ON THE TERRITORY OF GEORGIA	15
TRADEMARKS	
▪ APPLICATIONS FILED UNDER THE NATIONAL PROCEDURE APPROVED FOR REGISTRATION	32
▪ REGISTERED TRADEMARKS	40
▪ TRADEMARKS REGISTERED ACCORDING TO THE ACCELERATED PROCEDURE	45
▪ INTERNATIONAL TRADEMARKS FOR WHICH A DECISION ON GRANTING PROTECTION IS TAKEN	49
▪ INTERNATIONAL TRADEMARKS PROTECTED IN GEORGIA	113
APPELLATION OF ORIGIN OF GOODS	
▪ PROTECTED INTERNATIONAL APPELLATION OF ORIGIN OF GOODS	126
OFFICIAL NOTIFICATIONS	
INVENTIONS	
▪ EXPIRATION OF PATENTS RESTORATION	127
▪ ABOLITION OF PATENTS WITH THE RIGHT TO RESTORE	127
▪ EXPIRATION OF TERM OF RESTORATION OF PATENTS	130
▪ CHANGES OF NAMES AND/OR ADDRESSES OF PATENTOWNER	131
UTILITY MODELS	
▪ EXPIRATION OF PATENTS RESTORATION	131
▪ ABOLITION OF PATENTS WITH THE RIGHT TO RESTORE	131
▪ EXPIRATION OF TERM OF RESTORATION OF PATENT	132
DESIGNS	
▪ CANCELLATION OF DESIGN REGISTRATION	132
▪ EXTENSION OF REGISTRATION OF INTERNATIONAL DESIGNS	132
▪ CANCELLATION OF INTERNATIONAL DESIGNS REGISTRATION	133
TRADEMARKS	
▪ COMPLET TRANSFER OF RIGHTS	134
▪ CHANGES OF NAMES AND/OR ADDRESSES OF OWNERS	136
▪ TERMINATION OF TRADEMARKS REGISTRATION	137
CLASSIFICATION INDEXES	
INVENTIONS	138
UTILITY MODELS	140
TRADEMARKS	142

PUBLISHED TITLES OF PROTECTION

INVENTIONS

- **APPLICATIONS APPROVED FOR GRANTING PATENT:**
15137; 14997; 14974; 15201; 14989; 14873; 14726; 15081; 14587; 15022; 14926; 14645; 15059; 15152
- **PATENTED INVENTIONS:**
7132-7139

UTILITY MODELS

- **APPLICATIONS APPROVED FOR GRANTING PATENT:**
15312; 15167
- **PATENTED UTILITY MODEL:**
2046

DESIGNS

- **DESIGNS, WHICH HAVE BEEN REGISTERED WITH THE INTERNATIONAL BUREAU CLAIMING PRIORITY ON THE TERRITORY OF GEORGIA:**
207859; 204712; 207831; 204991

TRADEMARKS

- **APPLICATIONS FILED UNDER THE NATIONAL PROCEDURE APPROVED FOR REGISTRATION:**
103464; 105249; 105982; 105986; 105988, 105989; 105994; 106046, 106047; 106049, 106050; 106062; 106064-106067; 106073, 106074; 106076; 106078; 106085; 106087-106090; 106158-106161; 106163; 106166; 106168; 106172; 106182; 106188, 106189; 106279; 106283; 106285; 106300; 106328; 106412; 106418-106420; 106436, 106437; 106523
- **REGISTERED TRADEMARKS:**
32851-32866; 32868-32884; 32894-32915
- **TRADEMARKS REGISTERED ACCORDING TO THE ACCELERATED PROCEDURE:**
32842-32850; 32867; 32885-32893
- **INTERNATIONAL TRADEMARKS FOR WHICH A DECISION ON GRANTING PROTECTIONS IS TAKEN:**
101355*; 102091; 103937; 104167, 104168; 104494; 104840; 104945; 104987; 105045, 105046; 105066; 105069; 105077, 105078; 105084; 105093; 105099; 105167-105172; 105174, 105175; 105177; 105180, 105181; 105186; 105189, 105190; 105194; 105203, 105204; 105206; 105261-105263; 105265; 105273; 105275; 105277-105280; 105292-105294; 105305; 105307, 105308; 105310, 105311; 105313-105321; 105332; 105486; 105490-105499; 105681; 105688, 105689; 105848; 105959; 105995-105997; 106000; 106016; 106020, 106021; 106287; 106359; 106425; 106429
- **INTERNATIONAL TRADEMARKS PROTECTED IN GEORGIA:**
100341; 100708; 101432; 102617; 102802; 102863; 102884; 103148; 103236, 103237; 103240; 103367; 103395; 103521-103523; 103525; 103530; 103540; 103547; 103556; 103593, 103594; 103596, 103597; 103602, 103603; 103614; 103621, 103622; 103637; 103641; 103643, 103644; 103646; 103704; 103709-103711; 103721, 103722; 103725-103727; 103729; 103735; 103738-103741; 103747-103749; 103790-103792; 103801-103805; 103808, 103809; 103824; 103826; 103831; 103836; 103885; 103888-103892; 103896; 103906; 103908-103911; 103913, 103914; 103917; 103926; 103929; 103936; 103993-104001; 104003; 104005, 104006; 104008-104010; 104013; 104018; 104021; 104037-104039; 104041; 104049, 104050; 104053, 104054; 104129; 104141-104143; 104145; 104147; 104149, 104150; 104162-104165; 104252-104254; 104256; 104272; 104274-104276; 104292; 104334; 104350-104354; 104394; 104470; 104479-104483; 104520; 104522, 104523; 104569; 104589-104596; 104653; 104655, 104656; 104660; 104683; 104685; 104691; 104693; 104701-104703; 104777; 104781, 104782; 104841, 104842; 104849-104851; 104859; 104963; 104965, 104966

APPELLATION OF ORIGIN OF GOOS

- **PROTECTED INTERNATIONAL APPELLATION OF ORIGIN OF GOODS:**
1134

INVENTIONS

APPLICATIONS APPROVED FOR GRANTING PATENTS

The decision can be appealed at the Chamber of Appeal of Sakpatenti within 3 months from the publication or at the Mtskheta District Court Administrative Cases Board (Address: №17, Samkhedro str., Mtskheta), within 1 month following the publication.

PART A

A 01

(10) AP 2020 15137 A (51) Int. Cl. (2006)
A 01 N 35/04
A 01 N 53/00
A 01 P 7/04
A 01 P 7/02

(21) AP 2019 15137 (22) 2019 07 15
(71) Ramaz Gakhokidze (GE)
Barnov St. 82, app. 7, 0179, Tbilisi,
Georgia (GE);
Lia Kvaratskhelia (GE)
Tbilisi Sea St., IV Lane, House 9, Tbilisi,
Georgia (GE)

(72) Ramaz Gakhokidze (GE);
Lia Kvaratskhelia (GE)

(54) **BIOINSECTICIDE REPELLENT
(SYNONYMS: BIOPHAR, ANTIPHAR,
BIORAL)**

(57) Pest control preparation disclosed in the invention relates to agriculture field; it is characterized with high insecticide activity and low toxicity for human and warm-blooded animals; it is less toxic for bees and other useful insects, fishes, and other aquatic organisms.

Claims: 1 independent

(10) AP 2020 14997 A (51) Int. Cl. (2006)
A 01 N 59/02
C 05 D 9/00
C 05 D 9/02

(21) AP 2019 14997 (22) 2019 02 11
(71) Giorgi Tsintskaladze (GE)
Bakhtrioni St. 11, app. 5, 0194, Tbilisi,
Georgia (GE);
Omar Lomtadze (GE)
Ak. Tsereteli Ave. 64, app. 57, 0154, Tbilisi,
Georgia (GE)

(72) Giorgi Tsintskaladze (GE);
Omar Lomtadze (GE)

(54) **CLAY-SULFUR COMPOSITION FOR
PLANT PESTS AND DISEASES
CONTROL**

(57) Clay-sulfur composition for plant pests and diseases control contains Askana bentonite clay and elemental sulfur; at that, sulfur molecules are in the content of Askana clay nano-size structural layers with the following ratio of componentry, in mass%:
Sulfur – 25-50;
Askana clay – 50-75.
Claims: 1 independent

A 61

(10) AP 2020 14974 A (51) Int. Cl. (2006)
A 61 K 9/08
A 61 K 9/19
A 61 K 47/26
A 61 K 31/675

(21) AP 2017 14974 (22) 2017 06 01

(31) 62/345,942

(32) 2016 06 06

(33) US

(71) HELSINN HEALTHCARE SA (CH)
Via Pian Scairolo 9, 6912, Lugano/ Pazzallo,
Switzerland (CH)

(72) VENTURINI, Alessio (IT);
CANNELLA, Roberta (IT)

(74) Shalva Gvaramadze

(85) 2018 12 25

(86) PCT/EP2017/063268, 2017 06 01

(54) **PHYSIOLOGICALLY BALANCED
INJECTABLE FORMULATIONS OF
FOSNETUPITANT**

(57) Formulation comprises fosnetupitant, palonosetron, sodium hydroxide, disodium edetate, hydrochloric acid and mannitol. At that, pH content is 7.0-10.

Claims: 3 independent

16 dependents

Fig.: 2

(10) AP 2020 15201 A (51) Int. Cl. (2006)
A 61 K 31/355
A 61 K 47/14
A 61 K 47/24
A 61 P 31/04
A 61 P 31/10

- (21) AP 2018 15201 (22) 2018 05 28
 (31) 102017000058311
 (32) 2017 05 29
 (33) IT
 (71) BIO.LO.GA. S.R.L. (IT)
 VIA GIUSEPPE LAZZARIN 66.
 CONEGLIANO, TREVISO, 31015 Italy (IT)
 (72) PANIN, Giorgio (IT)
 (74) Nugzar Ksovreli
 (85) 2019 10 21
 (86) PCT/EP2018/063926, 2018 05 28
 (54) **FORMULATION BASED ON
 VITAMIN E OR ESTER THEREOF
 FOR TREATING BACTERIAL
 AND FUNGAL BIOFILMS**
 (57) Vitamin E or local activity formulation
 comprising ester thereof is used for bacterial and/or
 fungal biofilm removal.
 Claims: 2 independents
 9 dependents
 Fig.: 2

- (10) **AP 2020 14989 A** (51) **Int. Cl. (2006)
 A 61 K 31/436
 A 61 P 27/02**
 (21) AP 2017 14989 (22) 2017 06 29
 (31) 62/440,658; 62/356,613
 (32) 2016 12 30; 2016 06 30
 (33) US; US
 (71) Santen Pharmaceutical CO., LTD. (JP)
 9-19 Shimoshinjo 3-tome, Higashi
 Yodogawa-ku. Osaka-si, Osaka 533-8651,
 Japan (JP);
 Durect Corporation (US)
 10260 Bubb Road, Cupertino, CA 95014-4166,
 USA (US)
 (72) MATSUMOTO, Naoki (JP);
 LIN, Weiqi (US);
 SU, Huey-Ching Lin (US);
 OKABE, Komei (JP);
 MUDUMBA, Sreenivasu (US);
 YAMADA, Kazuhito (JP);
 TAMRAZ, Wilma (US)
 (74) Shalva Gvaramadze
 (85) 2019 01 25
 (86) PCT/US2017/039968, 2017 06 29
 (54) **DEPOT FORMULATIONS**
 (57) Formulation comprises syrolimus, high visco-
 sity liquid carrier material (HVLCM) comprising
 sucrose acetate isobutyrate (SAIB), and hydropho-
 bic- and hydrophilic solvents.
 Claims: 3 independents
 14 dependents
 Fig.: 25

- (10) **AP 2020 14873 A** (51) **Int. Cl. (2006)
 A 61 K 31/7076
 A 61 P 31/18**
 (21) AP 2017 14873 (22) 2017 02 10
 (31) 62/294,576; 62/297,657
 (32) 2016 02 12; 2016 02 19
 (33) US; US
 (71) MERCK SHARP & DOHME CORP. (US)
 126 East Lincoln Avenue, Rahway, NJ 07065-
 0907, USA (US)
 (72) HAZUDA, Daria (US);
 MILLER, Michael D. (US);
 GROBLER, Jay A. (US);
 NICOLL-GRIFFITH, Deborah Anne (CA)
 (74) Shalva Gvaramadze
 (85) 2018 09 07
 (86) PCT/US2017/017283, 2017 02 10
 (54) **METHODS FOR TREATMENT AND
 PROPHYLAXIS OF HIV AND AIDS**
 (57) Compound of formula (I),

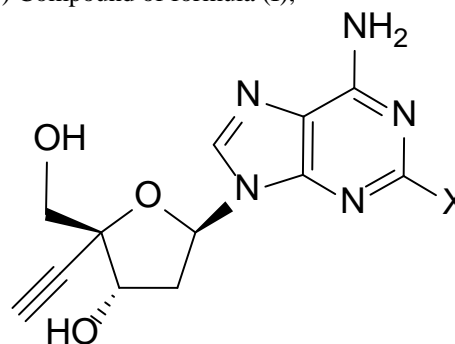

- (I)
 usage therefor HIV reverse transcriptase inhibition
 and the treatment of infection by HIV, and AIDS or
 ARC, as well.
 Claims: 2 independents
 20 dependents
 Fig.: 3

- (10) **AP 2020 14726 A** (51) **Int. Cl. (2006)
 A 61 K 31/7084
 A 61 P 35/00
 C 07 H 21/00**
 (21) AP 2016 14726 (22) 2016 08 11
 (31) 62/204,677; 62/ 268,723; 62/356,125
 (32) 2015 08 13; 2015 12 17; 2016 06 29
 (33) US; US; US
 (71) MERCK SHARP & DOHME CORP. (US)
 126 East Lincoln Avenue, Rahway,
 NJ 07065-0907, USA (US)
 (72) ALTMAN, Michael, D. (US);
 ANDRESEN, Brian (US);
 CHANG, Wonsuk (US);
 CHILDERS, Matthew Lloyd (US);
 CUMMING, Jared, N. (US);
 HAILDLE, Andrew Marc (US);
 HENDERSON, Timothy, J. (US);
 JEWELL, James, P. (US);
 LIANG, Rui (US);

LIM, Jongwon (US);
 LIU, Hong (US);
 LU, Min (US);
 NORTHRUP, Alan, B. (US);
 OTTE, Ryan, D. (US);
 SIU, Tony (US);
 TROTTER, Benjamin Wesley (US);
 TRUONG, Quang, T. (US);
 WALSH, Shawn, P. (US);
 ZHAO, Kake (US)

(74) Shalva Gvaramadze
 (85) 2018 03 09
 (86) PCT/US2016/046444, 2016 08 11
 (54) **CYCLIC DI-NUCLEOTIDE**

COMPOUNDS AS STING AGONISTS

(57) Compound of formula (I):

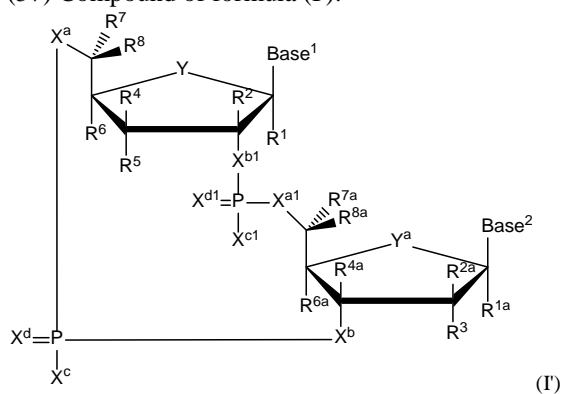

wherein values of Y, Y^a, X^a, X^{a1}, X^b, X^{b1}, X^{ac}, X^{cl}, R¹, R^{1a}, R², R^{2a}, R³, R⁴, R^{4a}, R⁵, R⁶, R^{6a}, R⁷, R^{7a}, R⁸, R^{8a}, R⁹, Base¹, Base² substituents are provided in the claims or pharmaceutically acceptable salts thereof, and pharmaceutical composition intended for immune response induction in the subject on the basis thereof.

Claims: 4 independents

10 dependents

Table: 14

PART B

B 65

(10) **AP 2020 15081 A** (51) **Int. Cl. (2006)**
B 65 D 81/20

(21) AP 2017 15081 (22) 2017 10 13
 (31) 16 60134
 (32) 2016 10 19
 (33) FR
 (71) JANNY SARL (FR)
 La Condemine Cidex 1556, 71260 Peronne,
 France (FR)
 (72) JANNY, Pierre (FR)
 (74) Larisa Amirkhanyan
 (85) 2019 05 17
 (86) PCT/FR2017/052823, 2017 10 13

(54) **DEVICE FOR SELECTING GASES**
FOR CONTAINER FOR STORING
PERISHABLE PRODUCTS

(57) A device 1 for selecting gases for sealed container 100 for modified or controlled atmosphere storage characterised in that it comprises hollow body 2 and at least first 3 and second 4 openings and first membrane 5, first and second openings connecting inside of body with outside, first membrane being arranged inside body between first and second openings such that the gases flowing from first opening to second, or vice versa, necessarily and only pass through said first membrane; at that, the body includes at least one first box-like part 6 having at least one first opening and second box-like part 7 having at least second opening, said second box-like part includes disposed on second opening level the hollow cylindric pipe 14 overhunged out from the body and executed capable to be inserted into an opening 102 executed on one 101 of container walls connecting inside of container space with outside, and in that the device is arranged to be secured in sealed manner, to one of container walls in such a way as to allow gas to flow from second opening of same through the wall or vice versa.

Claims: 1 independent

8 dependents

Fig.: 8

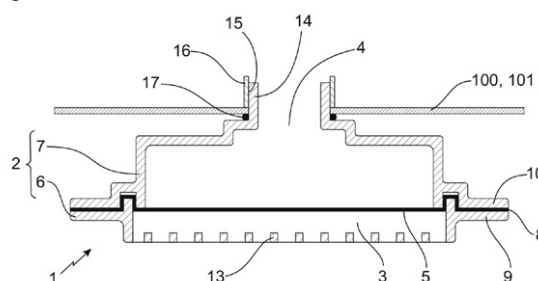

Fig. 1

PART C**C 08**

(10) AP 2020 14587 A (51) Int. Cl. (2006)
C 08 K 5/098
C 09 D 167/08

- (21) AP 2017 14587 (22) 2017 09 18
(31) 16189511.5
(32) 2016 09 19
(33) EP
(71) DAW SE (DE)
Roßdörfer Straße 50,64372 Ober-Ramstadt,
Germany (DE)
(72) BEATRIX, Herrmann (DE);
MENZEL, Stefan (DE);
DANIEL, Andre (DE)

(74) Liliana Darakhvelidze
(54) **SOLVENT-COATING COMPOSITION
FOR PAINT COATINGS**

(57) Solvent-based coating composition for paint coatings, particularly for building stains or their componentry consists of at least one oxidatively drying long-oil alkyd resin, at least one primary siccative based on iron, and at least one first secondary siccative; at that, oxidatively drying long-oil alkyd resin iodine number defined in accordance to the DIN 53241-1 standard is no more than 120.

Claims: 10 independents
11 dependents

PART E**E 01**

(10) AP 2020 15022 A (51) Int. Cl. (2006)
E 01 B 9/02
E 01 B 9/10
E 01 B 9/30
F 16 B 5/02
F 16 B 35/04

- (21) AP 2017 15022 (22) 2017 07 25
(31) 1613802.6
(32) 2016 08 11
(33) GB
(71) PANDROL LIMITED (GB)
63 Station Road Addlestone Surrey KT15
2AR, United Kingdom (GB)
(72) COX, Stephen John (GB);
JOHN DAVID, Spencer (GB)
(74) Liliana Darakhvelidze
(85) 2019 03 07
(86) PCT/GB2017/052164, 2017 07 25
(54) **SCREWED FASTENING SYSTEM
FOR RAILWAY RAILS**

(57) Improved screwed fastening system for railway rails is proposed to allow rail fastening clips 2, 2000 to be moved onto and off the rail 4 more easily, facilitating track installation and maintenance. One improvement comprises providing in screwed fastening system clip guiding device 1000, for guiding the rail fastening clip 2 whilst it is being driven having asymmetrically-located hole 1016 for receiving screw-threaded shank of screwbolt 3. Another improvement comprises providing in the screwed fastening system the rail fastening clip 2000 and screwbolt assembly 3000 having inter-engaging driving portions 2201, 3305. In each case, rotation of screwbolt 3, 3050 in one direction brings about translational movement of rail bearing portion 23, 2300 of clip 2, 2000 away from the screwbolt 3, 3050, and rotation of screwbolt 3, 3050 in opposite direction brings about translational movement of rail bearing portion 23, 2300 of clip 2, 2000 towards the screwbolt 3, 3050.

Claims: 4 independents
8 dependents

Fig.: 11

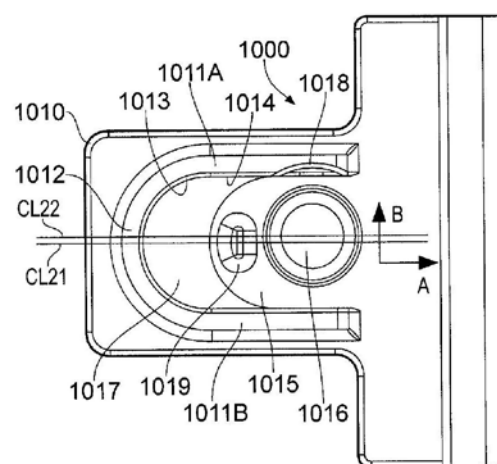

Fig. 3A

(10) AP 2020 14926 A (51) Int. Cl. (2006)
E 01 F 7/04

- (21) AP 2018 14926 (22) 2018 11 16
(71) Goga Chakhaia (GE)
Nutsubidze Plateau, I mcr., corp. 1, app. 4,
0183, Tbilisi, Georgia (GE);
Levan Tsulukidze (GE)
Nutsubidze Plateau, I mcr., corp. 1, app. 40,
0183, Tbilisi, Georgia (GE);
Zurab Lobzhanidze (GE)
Nutsubidze Plateau, I mcr., corp. 1, app. 4,
0183, Tbilisi, Georgia (GE);
Sopio Gogilava (GE)
Nutsubidze Plateau, I mcr., corp. 1, app. 4,
0183, Tbilisi, Georgia (GE);
LTD "High School Education Academy" (GE)
Ksani St. 35, 0141, Tbilisi, Georgia (GE)

- (72) Goga Chakhaia (GE);
Levan Tsulukidze (GE);
Zurab Lobzhanidze (GE);
Sopio Gogilava (GE)

(54) CONSTRUCTION FOR SNOWSLIDE CONTROL

(57) A construction is allocated towards snowslide motion at least three sections including metal flexible grid 5 hunged with one side thereon metal stem 4 hinged 3 onto avalanche slopes 2 rectangular relative to snowslide motion, and the loads 6 are hunged on grid another side. Metal stem is fastened to pinned onto the slopes the anchors with metal ropes 8 for construction sections strengthen.

Claims: 1 independent

Fig.: 4

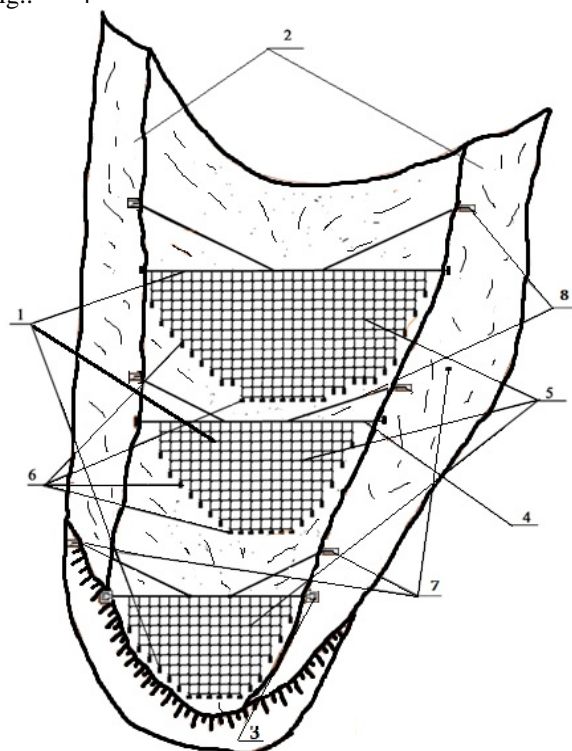

Fig. 1

E 02

(10) AP 2020 14645 A (51) Int. Cl. (2006) E 02 D 5/02

- (21) AP 2016 14645 (22) 2016 04 22
- (31) P.412127
- (32) 2015 04 27
- (33) PL
- (71) PPH S. I A. Pietrucha Andrzej Pietrucha (PL)
Ul. Przemysłowa 10, 98-235 Błaszki,
Polska (PL)
- (72) PIETRUCHA, Jerzy (PL);
KOLASIŃSKI, Daniel (PL);
EJCHMAN, Dariusz (PL);
PIETRUCHA, Andrzej (PL)
- (74) Khatuna Imnadze

- (85) 2017 12 06
- (86) PCT/PL2016/050015, 2016 04 22
- (54) **METHOD OF REINFORCED GEOTECHNICAL PROFILES MANUFACTURE AND PROFILES MANUFACTURED WITH SAID METHOD**

(57) A method of reinforced geotechnical profiles manufacture provides thermoplastic material, preferably hard and high-impact, PVC and/or PET and/or PE and/or ABS and/or PP plasticization in an extruder, after which it is pressed through cross die unit and internal reinforcing profiles (2, 4, 6, 8, 10, 12, 14, 16) in the form of flat bars, arched elements, angled elements, ribbed profiles or inner reinforcement profiles of any geometry (2, 4, 6, 8, 10, 12, 14, 16) are entered to it in the entire volume or at least in selected cross-section areas of geotechnical profiles (1, 3, 5, 7, 9, 11, 13, 15), whereas these profiles are created from continuous and/or chopped fiber produced simultaneously or as part of separate production process. The invention also relates to reinforced geotechnical profiles and sheet piling profiles and mobile flood prevention devices manufactured with thermoplastic material, wherein reinforcement profiles in the form of continuous fibers are entered locally or at least in selected cross-section areas, and then stabilized and maintained in position by layer/coat made of PVC and/or PET and/or PE and/or ABS and/or PP, which is permanently and inseparably connected to the glass fibers.

Claims: 2 independents

27 dependents

Fig.: 64

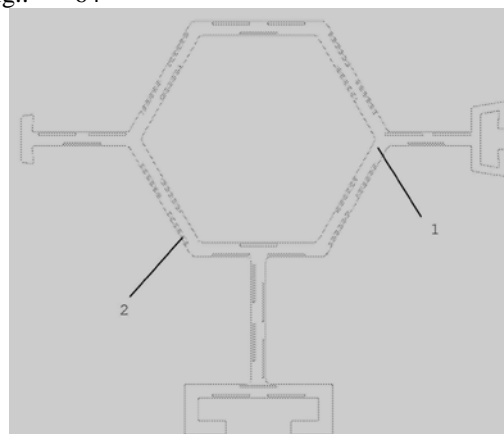

Fig. 1

(10) AP 2020 15059 A (51) Int. Cl. (2006) E 02 B 3/06 E 02 D 29/02

- (21) AP 2019 15059 (22) 2019 04 24
- (71) Shakhi Bakanidze (GE)
T. Zhordania St. 12, 0108, Tbilisi,
Georgia (GE);
Beka Surguladze (GE)

Gldani Mass., I mcr., corp. 19, app. 34, 0167,
Tbilisi, Georgia (GE);
Tamar Arunashvili (GE)
Gldani, VII mcr., corp. 6a, app. 33, 0167,
Tbilisi, Georgia (GE)

- (72) Shakhi Bakanidze (GE);
Beka Surguladze (GE);
Tamar Arunashvili (GE)

(54) **EARTHQUAKE LANDSLIDE
RESTRAINING CONSTRUCTION**

(57) Connecting construction anchor tighters to supporting wall the node is equipped with damping equipment including steel stem (3) placed in supporting wall and passed throughout pipe guide (10); steel stem has the holes (4) from both sides and a screw too – on wall muzzle side; and it is equipped with a nut (12). Curve and plate springs (6, 7) are impaled onto stem screwed end. Curve spring (6) has central hole and elypse loops – disposed radially on edges. Plate spring (7) has central hole and elypse loops – disposed radially on edges. Plate spring is fastened to the stem with the nut, and to the walls – with the bolts (11); ground anchor tighter (1) is fastened on stem another end. Antiseismic insulators are disposed between supporting wall and a basement.

Claims: 1 independent

Fig.: 5

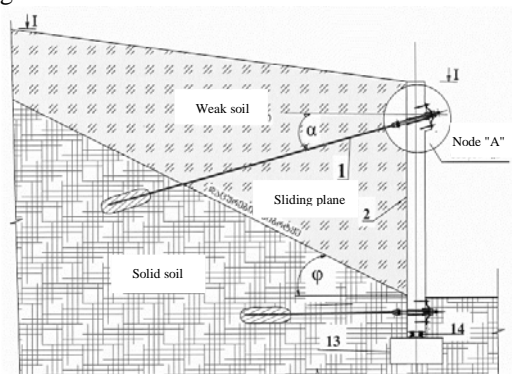

Fig. 1

cribed. Protons acceleration is provided in electrostatic type accelerator. Lithium is a material for synthesis, and cooling system heat transferring substance at the same time, at synthesis process. Usage of muon current, wherewith consist cosmic beams, is provided as nuclear synthesis catalyzer.

Claims: 1 independent

Fig.: 4

PART G

G 21

(10) AP 2020 15152 A (51) Int. Cl. (2006)
G 21 B 3/00

(21) AP 2019 15152 (22) 2019 07 24

(71) Davit Purtsvanidze (GE)
Ikalto St. 35a, 0171, Tbilisi, Georgia (GE)

(72) Davit Purtsvanidze (GE)

(54) **EQUIPMENT FOR PROTON-LITHIUM
SYNTHESIS**

(57) There is represented proton-lithium synthesis equipment, wherein proton-lithium interaction is carried out. Device unique constructions accomplishing proton source and their synthesis are des-

PATENTED INVENTIONS

PART A

A 21

- (11) **P 2020 7133 B** (51) **Int. Cl. (2006)**
A 21 D 13/066
A 21 D 13/06
A 23 L 7/10
A 23 L 5/20
A 23 L 7/196
A 23 L 5/30
C 12 C 1/02
- (10) AP 2020 14809 A (44) 7(539)/2020
 (21) AP 2016 14809
 (22) 2016 12 16
 (24) 2016 12 16
 (31) UB2015 A009442
 (32) 2015 12 17
 (33) IT
 (86) PCT/EP2016/081589, 2016 12 16
 (73) NEW GLUTEN WORLD S.R.L. (IT)
 Viale Michelangelo 177 71121 – Foggia (IT)
 (72) LAMACCHIA, Carmela (IT)
 (74) Larisa Amirkhanyan
 (54) **METHOD FOR THE DETOXIFICATION
 OF GLUTEN PROTEINS FROM CEREAL
 GRAINS AND USES THEREOF IN
 MEDICAL FIELD**

A 23

- (11) **P 2020 7135 B** (51) **Int. Cl. (2006)**
A 23 L 2/8
- (10) AP 2020 14846 A (44) 7(539)/2020
 (21) AP 2018 14846
 (22) 2018 08 01
 (24) 2018 08 01
 (73) Akaki Tsereteli State University (GE)
 Tamar Mepe St. 59, 4600, Kutaisi,
 Georgia (GE);
 Temur Ghvinianidze (GE)
 Mgaloblishvili St. 14, 4600, Kutaisi,
 Georgia (GE);
 Papuna Chikovani (GE)
 V. Barnov St. 64, 4600, Kutaisi,
 Georgia (GE);
 Teona Ghvinianidze (GE)
 Mgaloblishvili St. 14, 4600, Kutaisi,
 Georgia (GE);
 (72) Temur Ghvinianidze (GE)
 Papuna Chikovani (GE);
 Teona Ghvinianidze (GE);

- (74) Archil Geguchadze
 (54) **ANTIOXIDANT FOOD CONCENTRATE**

A 61

- (11) **P 2020 7132 B** (51) **Int. Cl. (2006)**
A 61 B 17/00
A 61 M 25/10
A 61 M 25/00
- (10) AP 2020 15041 A (44) 3(535)/2020
 (21) AP 2019 15041
 (22) 2019 04 03
 (24) 03 04 2019
 (73) Zviad Bakhutashvili (GE)
 Lvov St. 73, 0160, Tbilisi (GE)
 (72) Zviad Bakhutashvili (GE)
 (74) Shalva Gvaramadze
 (54) **SYSTEM FOR CARDIOPLEGIA**

- (11) **P 2020 7136 B** (51) **Int. Cl. (2006)**
A 61 K 31/79
A 61 K 31/10
A 61 K 31/517
A 61 K 31/14
A 61 K 45/06
A 61 K 31/235
A 61 K 9/70
A 61 K 47/42
A 61 K 9/06
A 61 K 9/00
A 61 K 31/167
A 61 K 31/185
A 61 K 31/047
A 61 P 17/02
- (10) AP 2020 15119 A (44) 7(539)/2020
 (21) AP 2017 15119
 (22) 2017 12 14
 (24) 2017 12 14
 (31) 2017106061
 (32) 2017 02 22
 (33) RU
 (86) PCT/RU2017/000905, 2017 12 14
 (73) Medid Innovation Development LTD (CY)
 Arch. Makariou III, 228, Agios Pavlos Court,
 Block B, 4th floor, Flat/Office 411-412, 3030,
 Limassol, Cyprus (CY)
 (72) AFINOGENOVA, Anna Gennadievna (RU);
 MATELO, Svetlana Konstantinovna (RU);
 AFINOGENOV, Gennady Evgenievich (RU);
 MANASHEROV, Tamaz Omarovich (RU)
 (74) Aleksandre Gegechkori

(54) **ANTISEPTIC COMPOSITION
COMPRISING OLYVINYLPYRROLIDONE
AND UNITHIOL AND USAGE OF
COMPOSITION**

(11) **P 2020 7137 B** (51) **Int. Cl. (2006)**
A 61 K 31/047
A 61 K 31/10
A 61 K 31/167
A 61 K 31/185
A 61 K 31/235
A 61 K 31/498
A 61 K 31/734
A 61 K 33/20
A 61 K 33/38
A 61 K 38/014
A 61 K 47/42
A 61 K 9/0014
A 61 K 9/06
A 61 K 9/7007
A 61 P 17/02

(10) AP 2020 15120 A (44) 7(539)/2020
 (21) AP 2017 15120
 (22) 2017 12 05
 (24) 2017 12 05
 (31) 2017106062
 (32) 2017 02 22
 (33) RU
 (86) PCT/RU2017/000906, 2017 12 05
 (73) Medid Innovation Development LTD (CY)
 Arch. Makariou III, 228, Agios Pavlos Court,
 Block B, 4th floor, Flat/Office 411-412, 3030,
 Limassol, Cyprus (CY)
 (72) MATELO, Svetlana Konstantinovna (RU);
 AFINOGENOVA, Anna Gennadievna (RU);
 MANASHEROV, Tamaz Omarovich (RU);
 AFINOGENOV, Gennady Evgenievich (RU)
 (74) Aleksandre Gegechkori
 (54) **ANTISEPTIC COMPOSITION
COMPRISING OLYVINYLPYRROLIDONE
AND UNITHIOL AND USE OF
COMPOSITION**

(11) **P 2020 7139 B** (51) **Int. Cl. (2006)**
A 61 K 47/26
A 61 K 47/02
A 61 K 38/48
A 61 K 47/18
A 61 K 31/506
A 61 K 31/405

(10) AP 2020 14939 A (44) 7(539)/2020
 (21) AP 2017 14939
 (22) 2017 05 26
 (24) 2017 05 26
 (31) PCT/EP2016/062085
 (32) 2016 05 27
 (33) EP
 (86) PCT/EP2017/062785, 2017 05 26

(73) IPSEN BIOPHARM LIMITED (GB)
 Unit 9, Ash Road Wrexham Industrial Estate
 WREXHAM LL13 9UF (GB)

(72) EDSTROM, Emilia (SE);
 GURELL, Ann (SE);
 PICKETT, Andrew (SE);
 STAHL, Ulf (SE);
 AGREN, Barbro (SE);
 JARSTAD, Anders (SE);
 FRIIS, Anna (SE)

(74) Shalva Gvaramadze

(85) 2018 11 27

(86) PCT/EP2017/062785, 2017 05 26

(54) **LIQUID NEUROTOXIN FORMULATION
STABILIZED WITH TRYPTOPHAN OR
TYROSINE**

PART B

B 01

(11) **P 2020 7138 B** (51) **Int. Cl. (2006)**
B 01 D 53/58
C 05 C 13/00

(10) AP 2020 14836 A (44) 6(538)/2020
 (21) AP 2016 14836
 (22) 2016 12 21
 (24) 2016 12 21
 (31) 15201598.8
 (32) 2015 12 21
 (33) EP
 (86) PCT/NL2016/050902, 2016 12 21
 (73) STAMICARBON B.V. (NL)
 Mercator, 3 NL-6135 KW Sittard (NL)
 (72) PUCI, Giusy Elisa (NL);
 DOBREE, Joey (NL)
 (74) Liliana Darakhvelidze
 (85) 2018 07 19
 (86) PCT/NL2016/050902, 2016 12 21
 (54) **CARBAMIDE AMMONIUM
NITRATE PRODUCTION**

PART H

H 01

- (11) P 2020 7134 B (51) Int. Cl. (2006)
H 01 L 31/0224
- (10) AP 2020 14975 A (44) 7(539)/2020
- (21) AP 2018 14975
- (22) 2018 12 27
- (24) 2018 12 27
- (73) Tamar Berberashvili (GE)
Kazbegi Ave. 47, 0177, Tbilisi, Georgia (GE);
Habib Ollah Bakhtiari (GE)
Ana Politkovskaya St. 47, 0186,
Tbilisi, Georgia (GE);
Paata Kervalishvili (GE)
Kazbegi Av. 9a, 0160, Tbilisi, Georgia (GE)
- (72) Tamar Berberashvili (GE);
Habib Ollah Bakhtiari (GE);
Paata Kervalishvili (GE);
- (54) **IMAGE CONVERTER**
-

UTILITY MODELS

APPLICATIONS APPROVED FOR GRANTING PATENTS

The decision can be appealed at the Chamber of Appeal of Sakpatenti within 3 months from the publication or at the Mtskheta District Court Administrative Cases Board (Address: №17, Samkhedro str., Mtskheta), within 1 month following the publication.

PART A

A 41

(10) AU 2020 15312 U (51) Int. Cl. (2006)
A 41 D 13/11

(21) AU 2020 15312 (22) 2020 04 14

(71) Davit Mizandari (GE)

Barakoni St. 4, 0101, Tbilisi, Georgia (GE)

(72) Davit Mizandari (GE)

(74) Nugzar Ksovreli

(54) **PROTECTING BREATHING DEVICE**

(57) A device includes a mask 1 equipped with fixing belts 2 and the clapans 14 for exhaled air outflow, filtrating cartridge 3 executed with two parts 4 and 6, wherefrom first one is connected to the mask, and another is executed connectable to first one as a connector. A hole 5 is executed in filtrating cartridge first part center on the mask for purified air supplement in mask inner space; and filter unit and the LEDs are placed in filtrating cartridge itself providing ultraviolet radiation. The device is equipped with accumulator batarea attached onto fixing belts, located in said filtrating cartridge the system increasing volume of air supplement, air conducting pipe and air ionizer.

Claims: 1 independent

5 dependents

Fig.: 1

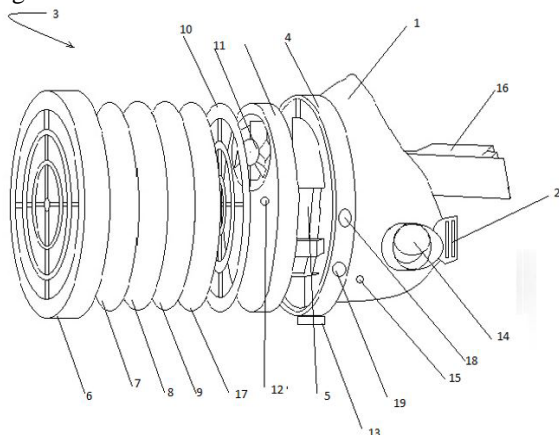

Fig. 1

PART E

E 04

(10) AU 2020 15167 U (51) Int. Cl. (2006)
E 04 C 2/16

(21) AU 2019 15167 (22) 2019 08 08

(71) Tamaz Nadirashvili (GE)

Nutsubidze Plateau, II mcr., IV qu., corp. 1,
app. 71, 0183, Tbilisi, Georgia (GE);

Mariam Lomtadze (GE)

Mtatsminda Lane 7b, app. 16, 0108, Tbilisi,
Georgia (GE)

(72) Tamaz Nadirashvili (GE)

Mariam Lomtadze (GE)

(54) **METHOD FOR WALL BUILDING
MATERIAL PRODUCTON WITH
STUBBLE**

(57) A method for wall building material producton with stubble provides stubble collection, thermal processing therewith a vapor of 90-110°C temperature, drying thereof till no more than 12-14% humidity, treating therewith slaked lime of no less than 25-27% pressing mass, stubble forming, pressing thereof under the pressure of 2-4,5 kg/cm², and binding therewith natural material e.g. silk or basalt rope or net.

Claims: 1 independent

PATENTED UTILITY MODEL

PART C

C 12

(11) U 2020 2046 Y (51) Int. Cl. (2006)

C 12 G 1/02

(10) AU 2020 15197 U (44) 7 (539) 2020

(21) AU 2019 15197

(22) 2019 10 16

(24) 2019 10 16

(73) Akaki Tsereteli State University (GE)

Tamar Mepe St. 59, 4600, Kutaisi,

Georgia (GE);

Temur Ghvinianidze (GE)

Mgaloblishvili St. 14, 4600, Kutaisi,

Georgia (GE)

(72) Temur Ghvinianidze (GE)

(74) Archil Geguchadze

(54) **ANTIOXIDANT SPECIAL DESSERT**

WINE

DESIGNS, WHICH HAVE BEEN REGISTERED WITH THE INTERNATIONAL BUREAU CLAIMING PRIORITY ON THE TERRITORY OF GEORGIA

The decision can be appealed at the Chamber of Appeal of Sakpatenti within 3 months from the publication or at the Mtskheta District Court Administrative Cases Board (Address: №17, Samkhedro Str., Mtskheta), within 1 month following the publication.

(11) DM/207 859

(51) 09-01

(15) 2020 04 20

(44) 20/2020 (2020 05 15)

(22) 2020 04 20

(28) 1

(30) No1: 21.10.2019; 2019/06605; TR

(73) TP ISTASYON ISLETMELERI ANONIM SIRKETI

Bulgurlu Mah. Gurpinar Cad. No:15 Uskudar Istanbul (TR)

(85) TR

(86) TR

(87) TR

(88) TR

(89) TR

(81) III. AM, MD, TJ, BW, ST, MN, KH, TN, UA, AL, AZ, TM, ME, MC, SG, NA, RS, BA, GE, MK, OM, LI, SM, EM, SY, RW, EG

(72) Sener KARAGULLE

Semizkumlar Kinali Mevkii Silivri, Istanbul (TR)

(74) ANKARA PATENT BUREAU

Kavaklidere Mahallesi Bestekar Caddesi No: 10, 06680 ANKARA (TR)

(54) 1. Bottle

(55)



1.1



1.2

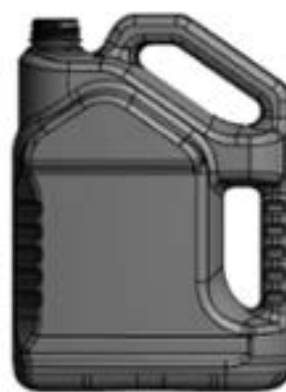

1.3

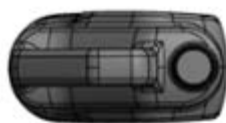

1.4



1.5

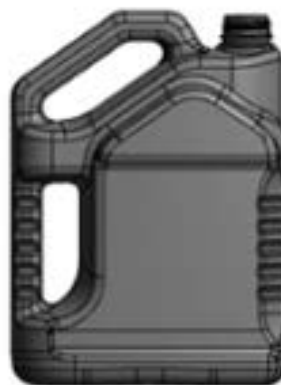

1.6

(11) DM/204 712

(15) 2019 11 13

(22) 2019 11 13

(28) 2

(73) HARRY WINSTON SA

Chemin Du Tourbillon 8, 1228 Plan-les-Ouates (CH)

(85) CH

(86) CH

(87) CH

(88) CH

(89) CH

(81) II. MA III. AM, MD, MN, TR, GB, TN, CH, UA, AL, AZ, BZ, ME, MC, SG, NO, BA, MK, GE, CA, OM, LI, KG, EM, RU

(72) Chaeree KWON

C/o Harry Winston Inc. 718 Fifth Avenue, 10019, New York (US)

(74) The Swatch Group AG (The Swatch Group SA) (The Swatch Group Ltd.)

Faubourg Du Lac 6, 2501 Biel/Bienne (CH)

(54) 1. Necklace, 2. Finger ring

(55)

(51) 11-01

(44) 20/2020 (2020 05 15)

1.1



1.2



1.3



1.4



1.5



1.6



1.7



1.8



2.1



2.2



2.3



2.4



2.5



2.6



2.7



2.8



(11) DM/207 831

(15) 2019 05 29

(22) 2019 05 29

(28) 4

(30) No1: 29.11.2018; 40 2018 101 214.9; DE; No2: 29.11.2018; 40 2018 101 214.9; DE;
No3: 29.11.2018; 40 2018 101 214.9; DE; No4: 29.11.2018; 40 2018 101 214.9; DE

(73) Purevento GmbH

Großenseer Straße 7, 22946 Trittau (DE)

(85) DE

(86) DE

(87) DE

(88) DE

(89) DE

(81) III. GE, CA, US, GB, EM, KR, JP, SG, RU

(72) Andreas Hildebrandt

Schwalbenplatz 15, 22307, Hamburg (DE)

(74) VKK Patentanwälte PartG MbB

An Der Alster 84, 20099 Hamburg (DE)

(54) 1.-4. Air cleaner

(55)

(51) 23-04

(44) 20/2020 (2020 05 15)

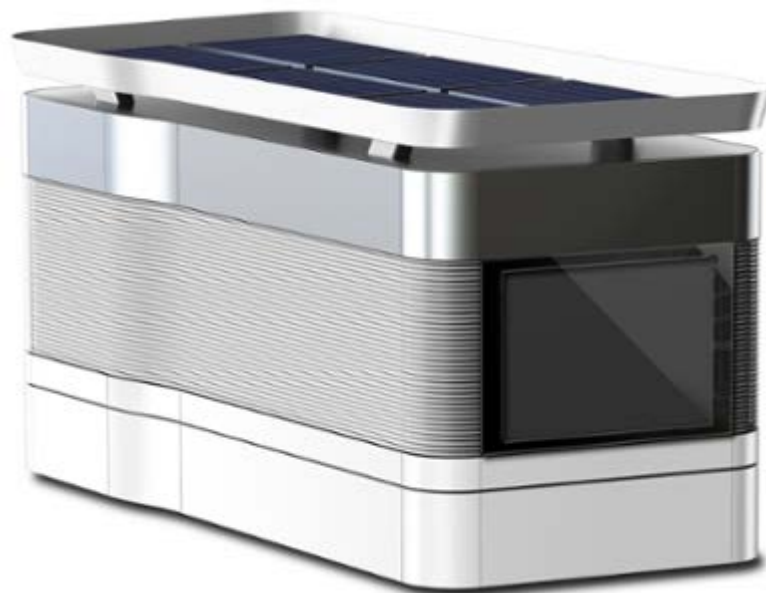

1.1



1.2



1.3



1.4

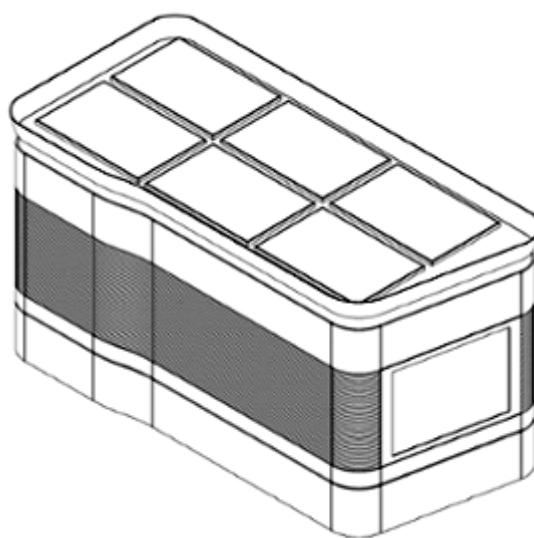

2.1

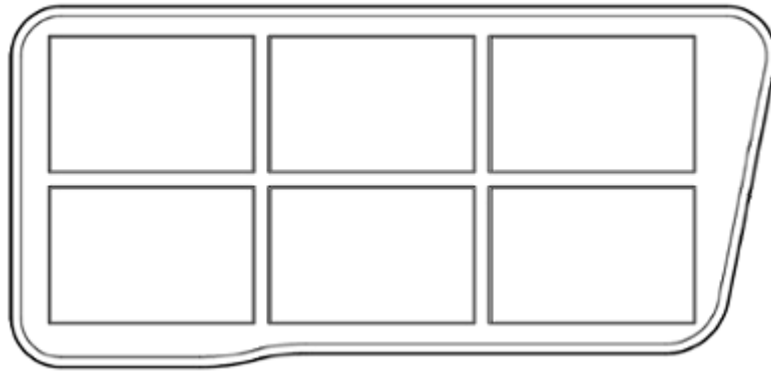

2.2

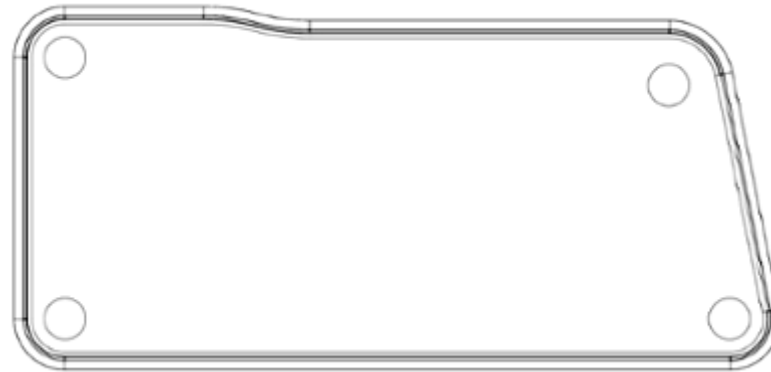

2.3

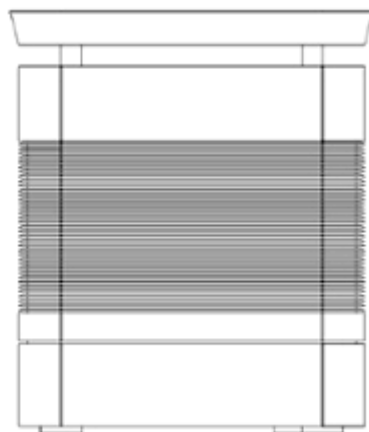

2.4

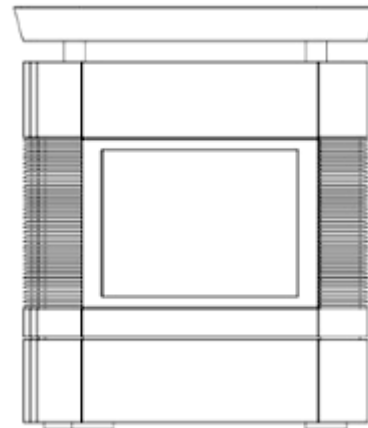

2.5

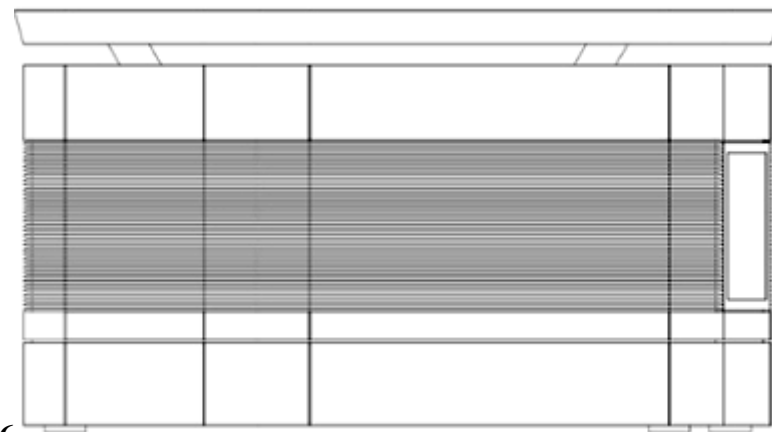

2.6

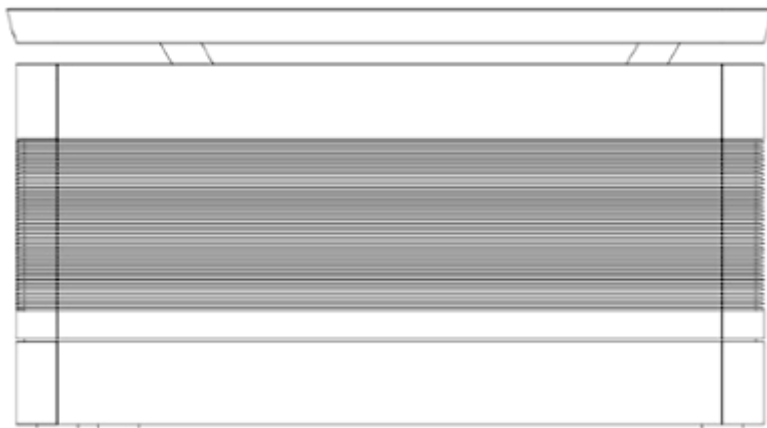

2.7



3.1



3.2



3.3



3.4

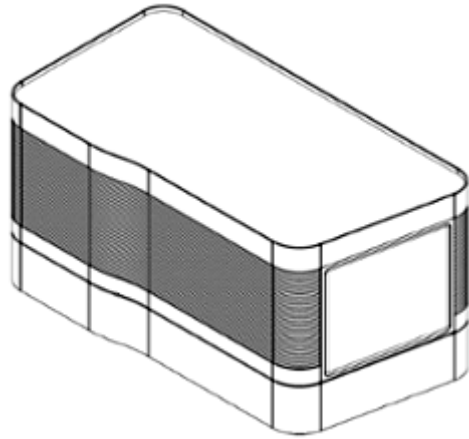

4.1



4.2

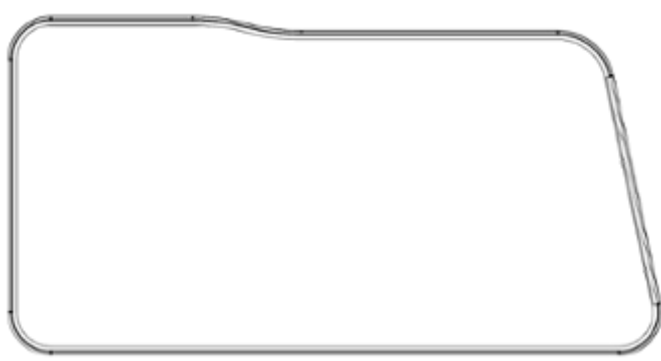

4.3

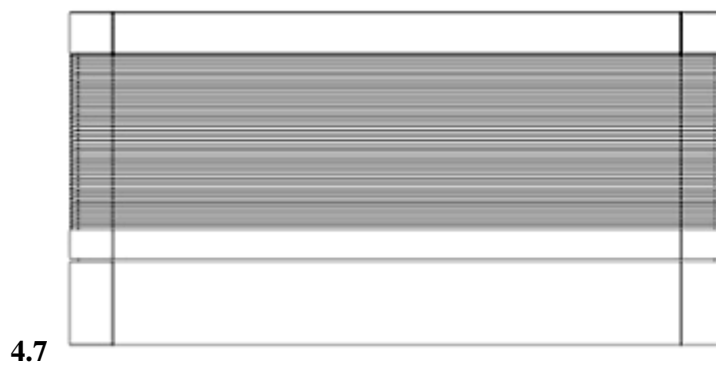
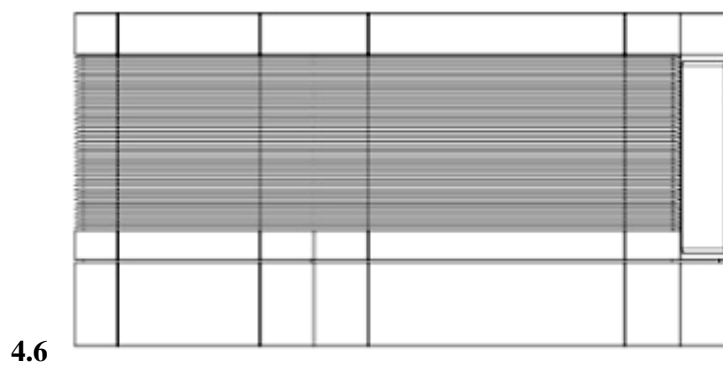
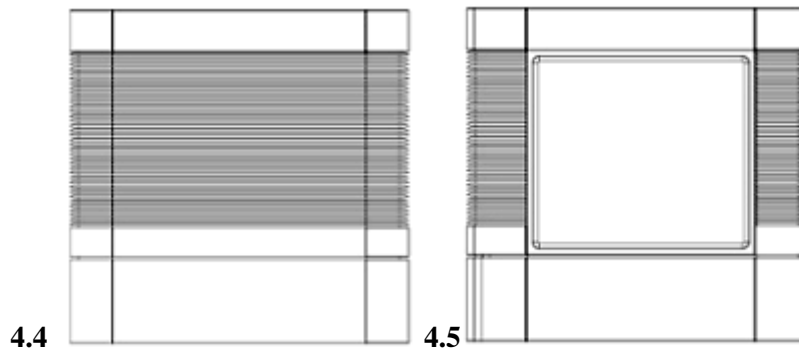

(11) DM/204 991

(51) 11-01

(15) 2019 11 27

(44) 22/2020 (2020 05 29)

(22) 2019 11 27

(28) 3

(73) HARRY WINSTON SA

Chemin Du Tourbillon 8, 1228 Plan-les-Ouates (CH)

(85) CH

(86) CH

(87) CH

(88) CH

(89) CH

(81) IL, MA, III, AM, MD, MN, TR, GB, TN, CH, UA, AL, AZ, ME, BZ, MC, SG, NO, BA, OM, MK, CA, GE, LI, KG, EM, RU

(72) 1. Rie YATSUGI-KANG

C/o Harry Winston Inc. 718 Fifth Avenue, 10019, New York (US);

2. Dominique RIVIERE

C/o Harry Winston Inc. 718 Fifth Avenue, 10019, New York (US);

3. Delphine ABDOURAHIM

C/o Harry Winston Inc. 718 Fifth Avenue, 10019, New York (US)

(74) The Swatch Group AG (The Swatch Group SA) (The Swatch Group Ltd.)

Faubourg Du Lac 6, 2501 Biel/Bienne (CH)

(54) 1. Necklace, 2. Pair of earrings, 3. Finger ring

(55)

1.1



1.2



1.3



1.4



1.5



1.6



1.7



1.8



2.1



2.2



2.3



2.4



2.5



2.6



2.7



2.8



3.1



3.2



3.3



3.4



3.5



3.6



3.7



3.8



TRADEMARKS

APPLICATIONS FILED UNDER THE NATIONAL PROCEDURE APPROVED FOR REGISTRATION

The decision can be appealed at the Chamber of Appeal of Sakpatenti within 3 months from the publication or at the Mtskheta District Court Administrative Cases Board (Address: №17, Samkhedro St., Mtskheta), within 1 month following the publication.

(260) AM 2020 103464 A
(210) AM 103464
(220) 2019 06 04
(731) Sport & Fashion Management Pte. Ltd.
6 Shenton Vei, 18-11, Oue Dauntaun 2,
068809, Singapore
(740) Vakhtang Torotadze
(540)



(591) Dark grey, red, white
(531) 01.01.01; 01.01.02; 01.01.10; 24.15.01;
27.05.01; 29.01.13
(511) 9, 12

(260) AM 2020 105249 A
(210) AM 105249
(220) 2019 10 10
(731) JSC "Georgian Beer Company"
Vill. Saguramo, 3311, Mtskheta, Georgia
(540)

ზედაზენი რადლერი
Zedazeni Radler

(591) Black, white
(526) "ზედაზენი", "Zedazeni"
(511) 32

(260) AM 2020 105982 A
(210) AM 105982
(220) 2019 12 04
(731) BASF Agro B.V. Arnhem (NL),
Zweigniederlassung Freienbach
Huobstrasse 3, Pfäffikon SZ, Switzerland
(740) Giorgi Taktakishvili
(540)

REVYSTAR

(591) Black, white
(511) 1, 5

(260) AM 2020 105986 A
(210) AM 105986
(220) 2019 12 05
(731) Aleksandre Bolkvadze
Z. Paliashvili St. 66, app. 51, 0179,
Tbilisi, Georgia

(540)



CHÂTEAUX de GÉORGIE

(591) Black, grey, brown, light pink, white
(531) 07.01.01; 27.05.01; 29.01.13
(526) Georgie
(511) 33, 35

(260) AM 2020 105988 A
(210) AM 105988
(220) 2019 12 05
(310) 35548
(320) 2019 11 18
(330) AD
(731) PHILIP MORRIS BRANDS SÀRL
Quai Jeanrenaud 3, 2000 Neuchâtel,
Switzerland
(740) Shalva Gvaramadze
(540)

VISTA

(591) Black, white
(531) 27.05.01
(511) 34

(260) AM 2020 105989 A
 (210) AM 105989
 (220) 2019 12 05
 (310) 34493
 (320) 2019 11 14
 (330) AD
 (731) PHILIP MORRIS BRANDS SÀRL
 Quai Jeanrenaud 3, 2000 Neuchâtel,
 Switzerland
 (740) Shalva Gvaramadze
 (540)

TROPICAL BREEZE

(591) Black, white
 (511) 34

(260) AM 2020 105994 A
 (210) AM 105994
 (220) 2019 12 05
 (731) Dentafill Plyus LLC
 Sergeli District, St. Margib, 1, Tashkent,
 100102, Uzbekistan
 (740) Nino Bakhtadze
 (540)

GALAXY

(591) Black, white
 (511) 3, 21

(260) AM 2020 106046 A
 (210) AM 106046
 (220) 2019 12 06
 (310) 4560731
 (320) 2019 06 18
 (330) FR
 (731) PROTEIN SCIENCES CORPORATION
 1000 Research Parkway, MERIDEN,
 CONNECTICUT 06450, USA
 (740) Shalva Gvaramadze
 (540)

ZACGENVA

(591) Black, white
 (511) 5

(260) AM 2020 106047 A
 (210) AM 106047
 (220) 2019 12 06
 (310) 4560494
 (320) 2019 06 18
 (330) FR
 (731) PROTEIN SCIENCES CORPORATION
 1000 Research Parkway, MERIDEN,
 CONNECTICUT 06450, USA
 (740) Shalva Gvaramadze

(540)

SUPEMTEK

(591) Black, white
 (511) 5

(260) AM 2020 106049 A
 (210) AM 106049
 (220) 2019 12 06
 (731) LTD "GEORGIAN WINE HOUSE"
 Vill. Zegaani, 1500, Gurjaani District,
 Georgia
 (740) Sopio Vacheishvili
 (540)

— GRAPE — WINE BAR

(591) Black, white
 (531) 27.05.09; 27.05.10; 28.11
 (511) 43

(260) AM 2020 106050 A
 (210) AM 106050
 (220) 2019 12 06
 (731) LTD "GEORGIAN WINE HOUSE"
 Vill. Zegaani, Gurjaani District, 1500,
 Georgia
 (740) Sopio Vacheishvili
 (540)



WINE BAR

(591) Black, white
 (531) 26.04.11; 26.04.18; 26.04.24; 27.05.09;
 27.05.10; 27.05.21; 27.05.24; 28.11
 (511) 33, 43

(260) AM 2020 106062 A
 (210) AM 106062
 (220) 2019 12 09
 (731) LLC "ICR TRADE"
 Dighomi Experimental Training Farm,
 5th Floor, Vake-Saburtalo District, Tbilisi,
 Georgia
 (540)

კომსო
აქსონი

(591) Red, white
 (531) 26.11.03; 26.11.07; 26.11.08; 27.05.01;
 27.05.11; 27.05.19; 28.19; 29.01.01
 (511) 14, 18, 25, 35

(260) AM 2020 106064 A
 (210) AM 106064
 (220) 2019 12 10
 (731) LTD "SALO"
 Ivane Javakhishvili St. 59, Tetrtskaro,
 Georgia
 (540)

სალო
SALO
CAJO

(591) Black, white
 (511) 3

(260) AM 2020 106065 A
 (210) AM 106065
 (220) 2019 12 10
 (731) Kraft Foods Danmark Intellectual
 Property ApS
 Ringager 2 A, 2.tv, DK-2605 Brøndby,
 Denmark
 (740) Giorgi Taktakishvili
 (540)



(591) Green, red, pink, black
 (531) 26.03.19; 27.05.01; 27.05.17; 29.01.14
 (511) 30

(260) AM 2020 106066 A
 (210) AM 106066
 (220) 2019 12 10
 (310) 4560470
 (320) 2019 06 18
 (330) FR
 (731) SANOFI PASTEUR INC.
 One Discovery Drive, SWIFTWATER,
 PA 18370, USA
 (740) Shalva Gvaramadze
 (540)

EFLUELDA

(591) Black, white
 (511) 5

(260) AM 2020 106067 A
 (210) AM 106067
 (220) 2019 12 10
 (310) 4560471
 (320) 2019 06 18
 (330) FR
 (731) SANOFI PASTEUR INC.
 One Discovery Drive, SWIFTWATER,
 PA 18370, USA
 (740) Shalva Gvaramadze
 (540)

PREVQUOIA

(591) Black, white
 (511) 5

(260) AM 2020 106073 A
 (210) AM 106073
 (220) 2019 12 11
 (731) LTD Boran Light
 Ponichala, Marneuli St. 44, 0165, Tbilisi,
 Georgia
 (540)

KEENGROSS

(591) Black, white
 (511) 7, 8

(260) AM 2020 106074 A
 (210) AM 106074
 (220) 2019 12 11
 (731) LTD "AGRONOM"
 B. Kvernadze St. 35, II Lane. 3rd floor, 0171,
 Tbilisi, Georgia
 (540)



(591) Green, black
 (531) 27.05.01; 27.05.22; 29.01.12
 (511) 1

(260) AM 2020 106076 A
 (210) AM 106076
 (220) 2019 12 11
 (310) 4566443
 (320) 2019 07 10
 (330) FR

(731) SANOFI PASTEUR INC.
One Discovery Drive, Swiftwater,
PA 18370, USA
(740) Shalva Gvaramadze
(540)

FLUPREVLİ

(591) Black, white
(511) 5

(260) AM 2020 106078 A
(210) AM 106078
(220) 2019 12 11
(731) LTD "AGRONOM"
B. Kvernadze St. 35, II Lane. 3rd floor, 0171,
Tbilisi, Georgia
(540)



(591) Green, blue, white
(531) 24.17.20; 26.01.01; 26.03.23; 27.05.10;
29.01.12
(511) 5

(260) AM 2020 106085 A
(210) AM 106085
(220) 2019 12 11
(731) Société des Produits Nestlé S.A.
1800 Vevey, Switzerland, Switzerland
(740) Tamaz Shilakadze
(540)

CHOCO CRUSH

(591) Black, white
(511) 30

(260) AM 2020 106087 A
(210) AM 106087
(220) 2019 12 11
(731) LLC "Georgian-American Family Medicine
Clinic"
Berkuti St. 7, Tbilisi, Georgia
(740) Lika Kartoza
(540)



(591) Blue, white, red
(531) 02.07.23; 27.01.01; 27.01.25; 29.01.12
(511) 35, 44

(260) AM 2020 106088 A
(210) AM 106088
(220) 2019 12 11
(731) "BRAINLY TRADE" Limited Liability
Company (LLC)
334, Karasaray St., Almazar District,
Tashkent, 100102, Uzbekistan
(740) Tamaz Shilakadze
(540)



(591) White, red
(531) 25.03.07; 26.01.01; 26.01.03; 26.01.18;
26.01.19; 27.05.09; 27.05.10; 27.05.22;
27.05.24; 29.01.12
(511) 30

(260) AM 2020 106089 A
(210) AM 106089
(220) 2019 12 12
(310) 078168
(320) 2019 07 11
(330) JM
(731) BRITISH AMERICAN TOBACCO
(BRANDS) INC. (a Delaware corporation)
251 Little Falls Drive, Suite 100, Delaware,
Wilmington, 19808-1674, USA
(740) Tamar Kochlamazashvili
(540)



(591) Red, dark red, golden, white
(531) 26.01.01; 26.01.04; 26.01.24; 26.02.01;
29.01.13
(511) 34

(260) AM 2020 106090 A
(210) AM 106090
(220) 2019 12 12

(310) DZ/T/2019/003065
 (320) 2019 06 18
 (330) DZ
 (731) BRITISH AMERICAN TOBACCO
 (BRANDS) INC. (a Delaware corporation)
 251 Little Falls Drive, Suite 100, Delaware,
 Wilmington, 19808-1674, USA
 (740) Tamar Kochlamazashvili
 (540)



(591) Golden, grey
 (531) 26.01.01; 26.01.04; 26.01.20; 26.02.01;
 26.02.09; 27.05.24; 29.01.13
 (511) 34

(260) AM 2020 106158 A
 (210) AM 106158
 (220) 2019 12 13
 (310) 34285
 (320) 2019-09-16
 (330) AD
 (731) Philip Morris Products S.A.
 Quai Jeanrenaud 3, 2000 Neuchâtel,
 Switzerland
 (740) Shalva Gvaramadze
 (540)

IQOS ILUMA

(591) Black, white
 (511) 9, 34

(260) AM 2020 106159 A
 (210) AM 106159
 (220) 2019 12 13
 (731) LLC "Green Wash"
 University St. 6, 0177, Tbilisi, Georgia
 (540)



(591) Sky-blue, green, white
 (531) 01.15.15; 24.17.20; 27.05.01; 27.05.21;
 27.05.21; 28.19; 29.01.03
 (511) 37

(260) AM 2020 106160 A
 (210) AM 106160
 (220) 2019 12 13
 (731) LLC "Green Wash"
 University St. 6, 0177, Tbilisi, Georgia
 (540)



(591) Green, sky-blue, white
 (531) 01.15.15; 24.17.20; 27.05.01; 27.05.01;
 27.05.21; 27.05.21; 29.01.03
 (511) 37

(260) AM 2020 106161 A
 (210) AM 106161
 (220) 2019 12 13
 (310) 34284
 (320) 2019 09 16
 (330) AD
 (731) Philip Morris Products S.A.
 Quai Jeanrenaud 3, 2000 Neuchâtel,
 Switzerland
 (740) Shalva Gvaramadze
 (540)

ILUMA

(591) Black, white
 (511) 9, 34

(260) AM 2020 106163 A
 (210) AM 106163
 (220) 2019 12 13
 (731) Omar Khubulov
 S. Todria St. 15, Tbilisi, Georgia
 (540)



(591) Yellow, red
 (531) 27.05.01; 28.19; 29.01.12
 (511) 43

(260) AM 2020 106166 A
 (210) AM 106166
 (220) 2019 12 16
 (310) 4562808
 (320) 2019 06 26
 (330) FR

(731) PROTEIN SCIENCES CORPORATION
1000 Research Parkway, MERIDEN,
CONNECTICUT 06450, USA

(740) Shalva Gvaramadze
(540)

FLUSPECZA

(591) Black, white
(511) 5

(260) AM 2020 106168 A
(210) AM 106168
(220) 2019 12 17
(731) LTD "Martali Wine"
Orpiri St. 41, Tbilisi, Georgia
(540)



(591) White, black, terracotta, amber-coloured,
cherryred
(531) 05.07.10; 19.09.02; 26.01.01; 26.01.04;
26.01.21; 29.01.13
(511) 29, 31, 33, 35, 43

(260) AM 2020 106172 A
(210) AM 106172
(220) 2019 12 17
(731) Giorgi Gakharia
Vill. Mukhuri, Chkhorotsku Municipality,
Georgia;
Mikheil Tsirdava
Vill. Mukhuri, Chkhorotsku Municipality,
Georgia;
David Jobava
Moscow Av., corp. 38, app. 113, Tbilisi
Georgia
(540)



(591) Red, black, maroon, white

(531) 02.01.20; 02.01.21; 19.09.02; 27.05.09;
27.05.10; 28.19; 29.01.13
(511) 33, 35

(260) AM 2020 106182 A
(210) AM 106182
(220) 2019 12 18
(731) Geox S.p.a.
Feltrina Centro 16, Frazione Biadene, 31044
Montebelluna (Treviso), Italy
(740) Merab Kvimsadze
(540)

GEOX

(591) Black, white
(531) 27.05.01
(511) 3, 25

(260) AM 2020 106188 A
(210) AM 106188
(220) 2019 12 19
(731) Giorgi Dakishvili
Vill. Shalauri, Telavi, Georgia
(540)

Dakishvili Family Selection

დაქიშვილი ფემილი
სელექშენ

(591) Black, white
(511) 33, 35

(260) AM 2020 106189 A
(210) AM 106189
(220) 2019 12 19
(731) LLC "KRINTI"
Madneuli St. 10, Vill. Kazreti, Bolnisi,
Georgia
(540)



(591) Green, red, white
(531) 27.05.01; 27.05.09; 27.05.10; 27.05.12;
27.05.17; 27.05.21; 27.05.25; 29.01.12
(511) 7, 8

(260) AM 2020 106279 A
(210) AM 106279
(220) 2019 12 21

(731) Association "GENESIS"
Zugdidi St. 3, app. 84, 0154, Tbilisi, Georgia

(540)



(591) White, indigo, green
(531) 05.03.20; 27.05.02; 28.19; 29.01.03
(511) 44

(260) AM 2020 106283 A
(210) AM 106283
(220) 2019 12 23
(731) Abbott Rapid Diagnostics International
Subsidiary Unlimited Company
70 Sir John Rogerson's Quay, Dublin, 2,
Ireland

(740) Tamar Kochlamazashvili
(540)

DETERMINE

(591) Black, white
(511) 1, 5

(260) AM 2020 106285 A
(210) AM 106285
(220) 2019 12 23
(731) Saharchin Salamat Company
Suite 218, 2nd Fl (administraciuli), N450,
Bazar Bozorg Mirdamad Buiding, on the
corner of Dafineh St., Mirdamad Blvd.,
Tehran, Islamic Republic of Iran

(740) Natela Otardize
(540)

TNT
B L A S T

(591) Black, white
(511) 32, 35

(260) AM 2020 106300 A
(210) AM 106300
(220) 2019 12 24
(731) LTD "NOBLEX"
Kakheti Highway 155, 0151, Tbilisi, Georgia
(740) Davit Dzamukashvili
(540)

რატციდი, ფ
RATICIDE, P

(591) Red
(511) 5

(260) AM 2020 106328 A
(210) AM 106328
(220) 2019 12 25
(731) LLC "ALAZANI WINERY"
D. Tavdadebuli St. 3, 4800, Kvareli, Georgia
(740) Giorgi Kartvelishvili
(540)

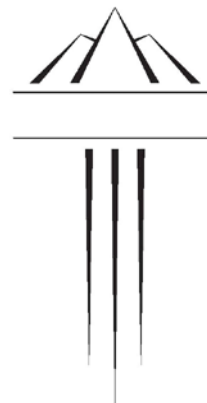

(591) Black, white
(531) 06.01.01; 06.01.04; 26.11.07; 26.11.08
(511) 33

(260) AM 2020 106412 A
(210) AM 106412
(220) 2019 12 27
(731) Abbott Rapid Diagnostics International
Unlimited Company
Office 32, Verdala Business Center Level 2,
LM Komplex, Brewery Street, Zone 3, Central
Busines District, Birkirkara, CBD 3040, Malta
(740) Tamar Kochlamazashvili
(540)

BIOLINE

(591) Black, white
(511) 1, 5

(260) AM 2020 106418 A
(210) AM 106418
(220) 2019 12 30
(731) Viorica -Cosmetic, Joint-Stock Company
1 str. Mesager, Chisinau, MD-2069, Republic
of Moldova
(740) Davit Dzamukashvili
(540)

VIORICA

(591) Grey, white
(531) 27.05.01
(511) 3

(260) AM 2020 106419 A
 (210) AM 106419
 (220) 2019 12 30
 (731) Shenzhen MicroBT Electronics Technology Co., Ltd.
 Iunit 801, Hanshen Saens & Teqnoloji Tauer,
 Gaosin Saus 6 Road, Nanshan Distriqt,
 Shenchjen, China
 (740) Liliana Darakhvelidze
 (540)



(591) Black, white
 (531) 03.03.01; 03.03.15; 03.03.24
 (511) 9

(260) AM 2020 106420 A
 (210) AM 106420
 (220) 2019 12 30
 (731) Viorica -Cosmetic, Joint-Stock Company
 1, St. Mesager, Chisinau, Moldova, MD-2069,
 Republic of Moldova
 (740) Davit Dzamukashvili
 (540)

COSMEPLANT

(591) Black, white
 (511) 3

(260) AM 2020 106436 A
 (210) AM 106436
 (220) 2019 12 31
 (731) Shenzhen MicroBT Electronics Technology Co., Ltd.
 Unit 801, Hangsheng Science & Technology Tower,
 Gaoxin South 6th Road, Nanshan District, Shenzhen, China
 (740) Giorgi Kartvelishvili
 (540)

whatsminer

(591) Black, white
 (511) 9

(260) AM 2020 106437 A
 (210) AM 106437
 (220) 2019 12 31
 (731) SHENZHEN YINCHEN TECHNOLOGY CO., LTD.
 4D83, Longsheng Mobile Phone Accessories

City, Huafa North Road, Futian District,
 Shenzhen, China
 (740) Giorgi Kartvelishvili
 (540)



(591) Black, white
 (531) 25.03.01; 25.03.03; 27.05.01; 27.05.19
 (511) 9

(260) AM 2020 106523 A
 (210) AM 106523
 (220) 2020 01 09
 (731) CEDC International sp. z o.o.
 Ul. Kowanowska 48, Oborniki, 64-600,
 Poland
 (740) Nugzar Ksovreli
 (540)



(591) Black, white, golden
 (531) 03.04.04; 03.04.05; 03.04.26; 19.07.01;
 19.07.09; 19.07.20; 27.01.12; 27.05.09;
 27.05.24; 29.01.13
 (511) 33

REGISTERED TRADEMARKS

(111) M 2020 32851 R

(151) 2020 07 10

(181) 2030 07 10

(260) AM 2019 100771 A

(220) 2019 09 04

(732) Alexandre Bolkvadze

Z. Paliashvili St. 66, app. 51, 0179, Tbilisi,
Georgia

(111) M 2020 32857 R

(151) 2020 07 10

(181) 2030 07 10

(260) AM 2019 103325 A

(220) 2019 05 30

(732) LTD "MEAMA"

Givi Amilakhvari St. 2, Samgori District,
0190, Tbilisi, Georgia

(111) M 2020 32852 R

(151) 2020 07 10

(181) 2030 07 10

(260) AM 2018 100874 A

(220) 2018 12 25

(732) LTD "SHALVINO"

Z. Panaskertel-Tsitsishvili St., corp. 1, app. 10,
0160, Tbilisi, Georgia

(111) M 2020 32858 R

(151) 2020 07 10

(181) 2030 07 10

(260) AM 2019 103429 A

(220) 2019 05 31

(732) LTD "MEAMA"

Givi Amilakhvari St. 2, Samgori District,
Tbilisi, Georgia

(111) M 2020 32853 R

(151) 2020 07 10

(181) 2030 07 10

(260) AM 2019 102718 A

(220) 2019 04 15

(732) Vladimir Tavadze

Nino Ramishvili St. 35b, app. 36, Tbilisi,
Georgia

(111) M 2020 32859 R

(151) 2020 07 10

(181) 2030 07 10

(260) AM 2019 103485 A

(220) 2019 06 07

(732) SHANDONG WEIFANG RAINBOW
CHEMICAL CO. LTDBinhais Ekonomikuri Ganvitarebis Zona, Vei-
fangi, Shandongi, 262737, Shandong, China

(111) M 2020 32854 R

(151) 2020 07 10

(181) 2030 07 10

(260) AM 2019 103099 A

(220) 2019 05 14

(732) Natia Baiashvili

Gldani, II mkr., corp. 46, app. 29, Tbilisi,
Georgia

(111) M 2020 32860 R

(151) 2020 07 10

(181) 2030 07 10

(260) AM 2019 103560 A

(220) 2019 06 10

(732) JSC "INSURANCE COMPANY ALDAGI"

B. Kvernadze St. 10, Tbilisi, Georgia

(111) M 2020 32855 R

(151) 2020 07 10

(181) 2030 07 10

(260) AM 2019 103306 A

(220) 2019 05 27

(732) LTD "NEW FORS CONSTRUCTION"

Archil Mepe St. 9, Tbilisi, Georgia

(111) M 2020 32861 R

(151) 2020 07 10

(181) 2030 07 10

(260) AM 2019 103562 A

(220) 2019 06 10

(732) JSC "INSURANCE COMPANY ALDAGI"

B. Kvernadze St. 10, Tbilisi, Georgia

(111) M 2020 32856 R

(151) 2020 07 10

(181) 2030 07 10

(260) AM 2019 103307 A

(220) 2019 05 27

(732) LTD "NEW FORS CONSTRUCTION"

Archil Mepe St. 9, Tbilisi, Georgia

(111) M 2020 32862 R

(151) 2020 07 10

(181) 2030 07 10

(260) AM 2019 103563 A

(220) 2019 06 10

(732) JSC "INSURANCE COMPANY ALDAGI"

B. Kvernadze St. 10, Tbilisi, Georgia

(111) M 2020 32863 R
(151) 2020 07 10
(181) 2030 07 10
(260) AM 2019 103589 A
(220) 2019 06 13
(732) LLC "Natur Import+"
Volokolamskoe shosse1, bld.1, fl. 8 place
IX, room 35, 36, office 5, Moscow, 125080,
Russian Federation

(111) M 2020 32864 R
(151) 2020 07 10
(181) 2030 07 10
(260) AM 2019 103942 A
(220) 2019 07 05
(732) LTD "KRINTI"
Madneuli St. 10,Vill. Kazreti, Bolnisi,
Georgia

(111) M 2020 32865 R
(151) 2020 07 10
(181) 2030 07 10
(260) AM 2019 103954 A
(220) 2019 07 08
(732) JSC "GEFA"
Ak. Beliashvili St. 142, 0159, Tbilisi,
Georgia

(111) M 2020 32866 R
(151) 2020 07 10
(181) 2030 07 10
(260) AM 2019 103955 A
(220) 2019 07 08
(732) JSC "GEFA"
Ak. Beliashvili St. 142, 0159, Tbilisi, Georgia

(111) M 2020 32868 R
(151) 2020 07 10
(181) 2030 07 10
(260) AM 2019 103985 A
(220) 2019 07 11
(732) CJSC "PHARMFIRMA" "SOTEX"
Selskoe Poselenie Berezhnyakovskoe,
Pos. Belikovo, dom 11, Sergievo-Posadskiy
Municipalni Raion, 141345, Moskovskya
Oblast, Russian Federation

(111) M 2020 32869 R
(151) 2020 07 10
(181) 2030 07 10
(260) AM 2019 104085 A
(220) 2019 07 15
(732) LTD "Georgian Wine and Spirits Company"
Vill. Achinebuli, 2200,Telavi, Georgia

(111) M 2020 32870 R
(151) 2020 07 10
(181) 2030 07 10
(260) AM 2019 104176 A
(220) 2019 07 19
(732) NUFARM EUROPE GMBH
11 Parsevalshtr. 40468 Diuseldorfi,
Germany

(111) M 2020 32871 R
(151) 2020 07 10
(181) 2030 07 10
(260) AM 2019 104207 A
(220) 2019 07 24
(732) Education, Science, Culture and Sport
Ministry of Georgia
D. Uznadze St. 52, Sanapiro St. 4, Tbilisi,
Georgia

(111) M 2020 32872 R
(151) 2020 07 10
(181) 2030 07 10
(260) AM 2019 104321 A
(220) 2019 07 31
(732) LTD "MULT"
Al. Kazbegi Av. 24g, app. 242, 0177, Tbilisi,
Georgia

(111) M 2020 32873 R
(151) 2020 07 10
(181) 2030 07 10
(260) AM 2019 104406 A
(220) 2019 08 02
(732) LTD "HERITAGE MANAGMENT"
St. Petersburg St. 6, app. 2, Tbilisi,
Georgia

(111) M 2020 32874 R
(151) 2020 07 10
(181) 2030 07 10
(260) AM 2019 104444 A
(220) 2019 08 07
(732) UNILEVER N.V.
Weena 455, 3013 AL Rotterdam,
Netherlands

(111) M 2020 32875 R
(151) 2020 07 10
(181) 2030 07 10
(260) AM 2019 104447 A
(220) 2019 08 07
(732) NOVARTIS AG
4002 Basel, Switzerland

(111) M 2020 32876 R
(151) 2020 07 10
(181) 2030 07 10
(260) AM 2019 104530 A
(220) 2019 08 09
(732) LTD "VAZIANI COMPANY"
Mshvidoba St. 42, 2200, Telavi, Georgia

(111) M 2020 32877 R
(151) 2020 07 10
(181) 2030 07 10
(260) AM 2019 104557 A
(220) 2019 08 20
(732) JSC "Georgian Beer Company"
Vill. Saguramo, 3311, Mtskheta, Georgia

(111) M 2020 32878 R
(151) 2020 07 10
(181) 2030 07 10
(260) AM 2019 104752 A
(220) 2019 09 03
(732) LTD "Pontos Maritime Consulting"
Zh. Shartava St. 32, app. 22, 0160,
Saburtalo District, Tbilisi, Georgia

(111) M 2020 32879 R
(151) 2020 07 10
(181) 2030 07 10
(260) AM 2019 104753 A
(220) 2019 09 03
(732) LTD "Pontos Maritime Consulting"
Zh. Shartava St. 32, app. 22, 0160,
Saburtalo District, Tbilisi, Georgia

(111) M 2020 32880 R
(151) 2020 07 10
(181) 2030 07 10
(260) AM 2019 104756 A
(220) 2019 09 04
(732) EURODRUG LABORATORIES B.V.
Regulusweg 11, 2516 AC The Hague,
Netherlands

(111) M 2020 32881 R
(151) 2020 07 10
(181) 2030 07 10
(260) AM 2019 104758 A
(220) 2019 09 04
(732) EURODRUG LABORATORIES B.V.
Regulusweg 11, 2516 AC The Hague,
Netherlands

(111) M 2020 32882 R
(151) 2020 07 10
(181) 2030 07 10
(260) AM 2019 98992 A
(220) 2019 05 31
(732) JSC "Elite Electronics"
Al. Kazbegi Av. 24, 0160, Tbilisi, Georgia

(111) M 2020 32883 R
(151) 2020 07 10
(181) 2030 07 10
(260) AM 2018 99947 A
(220) 2018 10 22
(732) Emerson Electric Co., Missouri Corporation
8000 West Florissant Avenue,
St. Louis, Missouri 63136, USA

(111) M 2020 32884 R
(151) 2020 07 10
(181) 2030 07 10
(260) AM 2018 99950 A
(220) 2018 10 22
(732) Emerson Electric Co., Missouri Corporation
8000 West Florissant Avenue,
St. Louis, Missouri 63136, USA

(111) M 2020 32894 R
(151) 2020 07 17
(181) 2030 07 17
(260) AM 2019 103013 A
(220) 2019 05 07
(732) Asharudhin Cholakkaparambil
Ortachala St. 7, Krtsanisi District,
Tbilisi Georgia

(111) M 2020 32895 R
(151) 2020 07 17
(181) 2030 07 17
(260) AM 2019 103193 A
(220) 2019 05 21
(732) Niko Beridze
T. Tabidze St., I Lane 10, 0179, Tbilisi,
Georgia

(111) M 2020 32896 R
(151) 2020 07 17
(181) 2030 07 17
(260) AM 2019 103316 A
(220) 2019 05 28
(732) Bait Al Mandi Restaurant
P.O. Box N. 80998, Dubai, United Arab
Emirates

(111) M 2020 32897 R
 (151) 2020 07 17
 (181) 2030 07 17
 (260) AM 2019 103657 A
 (220) 2019 06 14
 (732) LTD "ALANDON CAPITAL"
 Zhiuli Shartava St. 35-37, app. 67, Tbilisi,
 Georgia

(111) M 2020 32898 R
 (151) 2020 07 17
 (181) 2030 07 17
 (260) AM 2019 103767 A
 (220) 2019 06 24
 (732) Teimuraz Zazashvili
 Abastumani, Adigeni District, Georgia

(111) M 2020 32899 R
 (151) 2020 07 17
 (181) 2030 07 17
 (260) AM 2019 103970 A
 (220) 2019 07 10
 (732) LTD "INTER PHARM"
 D. Bakradze St. 6, 0119, Tbilisi, Georgia

(111) M 2020 32900 R
 (151) 2020 07 17
 (181) 2030 07 17
 (260) AM 2019 104063 A
 (220) 2019 07 12
 (732) AGRO LIFE SCIENCE CORPORATION
 1115, 11th FLOOR, HEMKUNT TOWER
 (MODI TOWER) 98, NEHRU PLACE,
 New Delhi, 110019, India

(111) M 2020 32901 R
 (151) 2020 07 17
 (181) 2030 07 17
 (260) AM 2019 104064 A
 (220) 2019 07 12
 (732) AGRO LIFE SCIENCE CORPORATION
 1115, 11th FLOOR, HEMKUNT TOWER
 (MODI TOWER) 98, NEHRU PLACE,
 New Delhi, 110019, India

(111) M 2020 32902 R
 (151) 2020 07 17
 (181) 2030 07 17
 (260) AM 2019 104065 A
 (220) 2019 07 12
 (732) AGRO LIFE SCIENCE CORPORATION
 1115, 11th FLOOR, HEMKUNT TOWER
 (MODI TOWER) 98, NEHRU PLACE,
 New Delhi, 110019, India

(111) M 2020 32903 R
 (151) 2020 07 17
 (181) 2030 07 17
 (260) AM 2019 104206 A
 (220) 2019 07 24
 (732) EXPRESS LUCK INDUSTRIAL
 (SHENZHEN) LIMITE
 1 St Flor, N1 Feqtori, N88, Baotong
 Saut Roud, Sikeng Komiuniti, Iuanshan
 Strit, Longgang Distriqt, Shenjen Siti,
 Guandunis Provincia, Shenzhen City, 518000,
 China

(111) M 2020 32904 R
 (151) 2020 07 17
 (181) 2030 07 17
 (260) AM 2019 104554 A
 (220) 2019 08 19
 (732) LTD "KANTI"
 Shandor Petefi St. 4, Tbilisi, Georgia

(111) M 2020 32905 R
 (151) 2020 07 17
 (181) 2030 07 17
 (260) AM 2019 104672 A
 (220) 2019 08 26
 (732) INTER IKEA SYSTEMS B.V.
 Olof Palmestraat 1, NL-2616 LN, Delft,
 2616 LN, Netherlands

(111) M 2020 32906 R
 (151) 2020 07 17
 (181) 2030 07 17
 (260) AM 2019 104675 A
 (220) 2019 08 26
 (732) INTER IKEA SYSTEMS B.V.
 Olof Palmestraat 1, NL-2616 LN, Delft,
 2616 LN, Netherlands

(111) M 2020 32907 R
 (151) 2020 07 17
 (181) 2030 07 17
 (260) AM 2019 104743 A
 (220) 2019 08 30
 (732) Shenzhen Ouni Technology CO., LTD.
 502, Jisheng Bldg. A1, No. 1049, Minzhi
 Avenue, Xinniu Community, Minzhi St.,
 Longhua Dist., Shenzhen, Guangdong,
 China

(111) M 2020 32908 R
 (151) 2020 07 17
 (181) 2030 07 17
 (260) AM 2019 104744 A

(220) 2019 08 30
(732) Shenzhen Ouni Technology CO., LTD.
502, Jisheng Bldg. A1, No. 1049, Minzhi
Avenue, Xinniu Community, Minzhi St.,
Longhua Dist., Shenzhen, Guangdong, China

(111) M 2020 32909 R
(151) 2020 07 17
(181) 2030 07 17
(260) AM 2019 104751 A
(220) 2019 09 03
(732) PALL CORPORATION
25 Harbor Park Drive Port Washington,
New York, 11050, USA

(111) M 2020 32910 R
(151) 2020 07 17
(181) 2030 07 17
(260) AM 2019 104769 A
(220) 2019 09 05
(732) YIWU YIBIN TRADING COMPANY
1st Floor, 40 Jiangdong Qiaodong Villa,
Zhejiang Province, Yiwu City, China

(111) M 2020 21911 R
(151) 2020 07 17
(181) 2030 07 17
(260) AM 2019 104815 A
(220) 2019 09 10
(732) LTD "BAUMA"
Vazha-Pshavela Av. 76, app. 46, 0186, Tbilisi,
Georgia

(111) M 2020 32912 R
(151) 2020 07 17
(181) 2030 07 17
(260) AM 2019 104904 A
(220) 2019 09 16
(732) LTD "SKA GROUP"
S. Chikovani St. 9-11, corp. 2, app. 42, 0171,
Tbilisi, Georgia

(111) M 2020 32913 R
(151) 2020 07 17
(181) 2030 07 17
(260) AM 2019 104926 A
(220) 2019 09 19
(732) ORION KORPORATION
Orionintie 1, 02200 Espoo, Finland

(111) M 2020 32914 R
(151) 2020 07 17
(181) 2030 07 17

(260) AM 2019 104927 A
(220) 2019 09 19
(732) ORION KORPORATION
Orionintie 1, 02200 Espoo, Finland

(111) M 2020 32915 R
(151) 2020 07 17
(181) 2030 07 17
(260) AM 2019 104928 A
(220) 2019 09 19
(732) ORION KORPORATION
Orionintie 1, 02200 Espoo, Finland

TRADEMARKS REGISTERED ACCORDING TO THE ACCELERATED PROCEDURE

The decision can be appealed at the Chamber of Appeal of Sakpatenti within 3 months from the publication.

(111) M 2020 32842 R
(151) 2020 07 07
(181) 2030 07 07
(210) AM 108789
(220) 2020 06 26
(732) LEPL "Public Broadcaster"
M. Kostava St. 68, 0171, Tbilisi, Georgia
(540)
პირველი არხი - ტელესკოლა

First Channel – TVschool

Pirveli Arkhi - Teleskola

(591) Black-white
(511) 9, 16, 35, 38, 41

(111) M 2020 32843 R
(151) 2020 07 07
(181) 2030 07 07
(210) AM 108867
(220) 2020 06 30
(732) LTD "ESS"
I. Gagarin St., II Lane 2/5-4, app. 1, Tbilisi,
Georgia
(540)



(591) White, green, brown
(531) 05.01.07; 05.01.16; 27.05.01; 28.19; 29.01.12
(511) 35

(111) M 2020 32844 R
(151) 2020 07 07
(181) 2030 07 07
(210) AM 108874

(220) 2020 06 30
(732) Cyber Secure Central LLC
Vazha-Pshavela Av.e 71, Block II, Office
Space 5, 0186, Tbilisi, Georgia
(740) Giorgi Sarajishvili
(540)



(591) Blue, orange, white
(531) 02.09.01; 29.01.12
(511) 9, 38, 45

(111) M 2020 32845 R
(151) 2020 07 07
(181) 2030 07 07
(210) AM 108877
(220) 2020 07 01
(732) JSC "Friend's Cellar"
Vill. Shilda, Kvareli District,
Georgia
(540)

ჩვენებური მამული
Chveneburi Estate
Чвенебури Эстейт

(591) Black-white
(511) 33, 43

(111) M 2020 32846 R
(151) 2020 07 07
(181) 2030 07 07
(210) AM 108513
(220) 2020 06 03
(732) LTD "Vaziani Company"
Mshvidoba St., 2200, Telavi,
Georgia

(540)

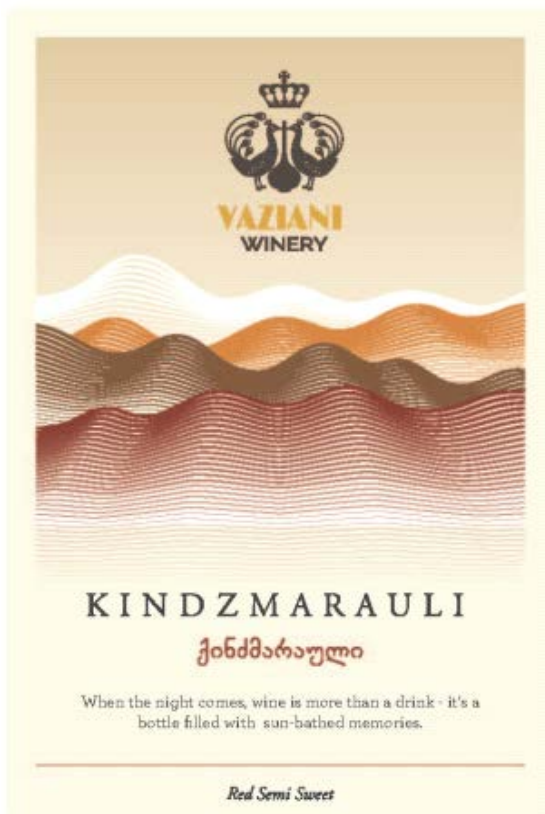

- (591) White, background – caramel-coloured, brown, bordeaux
 (531) 03.07.04; 24.09.01; 24.09.13; 26.11.13; 29.01.15
 (526) "KINDZMARAU LI", "ქინძმარაული"
 (511) 33

- 111) M 2020 32847 R
 (151) 2020 07 08
 (181) 2030 07 08
 (210) AM 108776
 (220) 2020 06 24
 (732) LLC "POLIVIM"
 Sul Khan Tsintsadze St. 12, Non-residential
 Space 3-16, 0160, Tbilisi, Georgia
 (740) Giorgi Taktakishvili
 (540)



POLYVIM

- (591) Green, dark green, white
 (531) 05.03.13; 05.03.14; 26.13.25; 27.05.01; 27.05.21; 29.01.03
 (511) 22, 40

- (111) M 2020 32848 R
 (151) 2020 07 08
 (181) 2030 07 08
 (210) AM 108873
 (220) 2020 06 30
 (732) "Cyber Secure Central" LLC
 Vazha-Pshavela Av. 71, Block II, Office
 Space 5, 0186, Tbilisi, Georgia
 (740) Giorgi Sarajishvili
 (540)

JIGSAW

- (591) Black-white
 (511) 9, 38, 45

- (111) M 2020 32849 R
 (151) 2020 07 08
 (181) 2030 07 08
 (210) AM 108864
 (220) 2020 06 30
 (732) TMH Worldwide LLC
 22 Sylvan Way, Parsippany, New Jersey
 07054, USA;
 Wyndham Hotels and Resorts, LLC
 22 Sylvan Way, Parsippany, New Jersey
 07054, USA
 (740) Tamaz Shilakadze
 (540)

TM
TRADEMARK
 COLLECTION BY WYNDHAM

- (591) Black-white
 (531) 27.05.01; 27.05.09; 27.05.10; 27.05.22
 (511) 43

- (111) M 2020 32850 R
 (151) 2020 07 10
 (181) 2030 07 10
 (210) AM 108847
 (220) 2020 06 26
 (732) LTD "GEOLN"
 Pirosmeni St. 18, Block A, app. 196, 6100,
 Batumi, Georgia
 (540)

GEOLN

- (591) Black-white
 (511) 35, 36

- (111) M 2020 32867 R
 (151) 2020 07 10
 (181) 2030 07 10

- (210) AM 108779
 (220) 2020 06 25
 (732) LTD "I.N.S."
 Melikishvili St. 10, app. 52, Kutaisi,
 Georgia
 (740) Tamaz Shilakadze
 (540)



- (591) White, black, red, grey
 (531) 26.04.02; 26.04.22; 26.04.24; 27.05.01;
 27.05.09; 27.05.10; 27.05.24; 29.01.14
 (511) 9

- (111) M 2020 32885 R
 (151) 2020 07 10
 (181) 2030 07 10
 (210) AM 108888
 (220) 2020 07 02
 (732) LTD "SG"
 Gakhokidze St. 49, Isani-Samgori District,
 Tbilisi, Georgia
 (540)



- (591) Black-white
 (531) 27.05.01; 27.05.10; 27.05.21
 (511) 25

- (111) M 2020 32886 R
 (151) 2020 07 10
 (181) 2030 07 10
 (210) AM 108941
 (220) 2020 07 03
 (732) JSC "ASYA SOFTWARE"
 Mtsvane St. 1, 6000, Batumi, Georgia
 (540)

JOYCARD

- (591) Black-white
 (511) 9, 36

- (111) M 2020 32887 R
 (151) 2020 07 13
 (181) 2030 07 13

- (210) AM 108754
 (220) 2020 06 23
 (732) LTD "AJARA TEXTILE"
 Tbeti St. 3, 6000, Batumi, Georgia
 (540)



- (591) White, green
 (531) 03.09.04; 26.04.15; 27.05.01; 27.05.10;
 29.01.12
 (526) "AJARA"
 (511) 16, 23, 24, 25, 35

- (111) M 2020 32888 R
 (151) 2020 07 13
 (181) 2030 07 13
 (210) AM 108952
 (220) 2020 07 07
 (732) Levan Losaberidze
 Eristavi St. 15, app. 22, Kutaisi, Georgia
 (540)



- (591) White, blue
 (531) 26.01.01; 26.01.03; 26.01.12; 27.05.01;
 29.01.04
 (511) 9

- (111) M 2020 32889 R
 (151) 2020 07 14
 (181) 2030 07 14
 (210) AM 108751
 (220) 2020 06 23
 (732) LTD "KARTLI TEXTILE"
 Tbeti St. 3, 6000, Batumi, Georgia
 (540)



- (591) White, golden, green, black
 (531) 26.04.22; 26.04.24; 27.05.21; 27.05.24; 28.19;
 29.01.13

(526) "ქართლი", "KARTLI"
(511) 16, 23, 24, 25, 35

(111) M 2020 32890 R
(151) 2020 07 14
(181) 2030 07 14
(210) AM 108854
(220) 2020 06 29

(732) HYGIENE INDUSTRY OF GEORGIA
Ak. Tsereteli Av. 116, 0119, Didube District,
Tbilisi, Georgia

(540)



(591) Red, grey, black, white
(531) 02.09.01; 26.03.06; 26.03.22; 27.05.07;
29.01.12
(511) 5

(111) M 2020 32891 R
(151) 2020 07 17
(181) 2030 07 17
(210) AM 108498
(220) 2020 06 01

(732) LTD "Kindzmarauli Cellar"
In the Eastern side from Tsalgverda, Kvareli,
Georgia

(540)



KINDZMARAU LI MARANI

(591) Brown (light), black
(531) 05.07.10; 27.05.01; 27.05.02; 27.05.08;
27.05.22; 28.19; 29.01.12
(526) KINDZMARAU LI
(511) 33

(111) M 2020 32892 R
(151) 2020 07 17
(181) 2030 07 17
(210) AM 108523
(220) 2020 06 04

(732) LLC "ALAZANI WINERY"
D. Tavdadebuli St. 3, 4800, Kvareli, Georgia

(740) Giorgi Kartvelishvili

(540)



(591) Black-white
(531) 06.01.01; 06.01.04; 26.11.07; 26.11.08;
27.05.01; 27.05.11
(526) "DARIAL"
(511) 33

(111) M 2020 32893 R
(151) 2020 07 17
(181) 2030 07 17
(210) AM 108963
(220) 2020 07 09

(732) LTD "SHIMON & COMPANY"
Karsani, 3301, Mtskheta, Georgia

(540)



(591) Black, white, silver, golden
(531) 24.01.10; 24.01.13; 24.01.17; 24.01.20;
25.01.10; 25.01.19; 26.01.18; 27.05.01;
27.05.10; 29.01.12
(511) 33

INTERNATIONAL TRADEMARKS FOR WHICH A DECISION ON GRANTING PROTECTIONS IS TAKEN

The decision can be appealed at the Chamber of Appeal of Sakpatenti within 3 months from the publication or at the Mtskheta District Court Administrative Cases Board (Address: №17, Samkhedro str., Mtskheta), within 1 month following the publication.

(260) AM 2020 101355 A*
 (800) 1446054
 (151) 2018 10 26
 (891) 2018 10 26
 (731) KERTEN UNLIMITED COMPANY
 13-18 City Quay Dublin 2, Ireland
 (540)



(591) Colours Pantone red 032U and Pantone process black U
 (531) 14.05.02; 26.01.18; 27.05.01; 27.05.09; 27.05.22; 29.01.12
 (511)
 43 – Providing of food and drink; temporary accommodation.

(260) AM 2020 102091 A
 (800) 1454014
 (151) 2018 10 03
 (891) 2018 10 03
 (731) INTERMAS NETS S.A.
 Ronda de Collsabadell, 11 -, Polígon Industrial, E-08450 Llinars del Vallès (Barcelona), Spain
 (540)



(591) Black, white
 (531) 24.15.01; 24.15.15; 27.05.01
 (511)
 1 – Chemical products for use in agriculture, horticulture and forestry; compost, manures, fertilizers; preparations of trace elements for plants; fertilizing preparations; soil conditioning preparations; plant growth regulating preparations; chemical preparations for protection against wheat blight [smut]; chemical preparations to prevent mildew; vine disease preventing chemicals; chemicals for forestry except fungicides, herbicides, insecticides and parasiticides;

chemical products for horticulture, excluding fungicides, herbicides, insecticides and parasiticides; anti-sprouting products for vegetables; glutinous tree-grafting products; flower preservatives; seed preserving products.

7 – Machine tools; machine tools, particularly packaging or wrapping machines; packaging machines; electrical apparatus for sealing plastics [packaging].

16 – Sheets, films, bags and small bags of plastic materials for packaging and wrapping; plastic foils for packaging; plastic bubble packs for wrapping or packaging; absorbent sheets of paper or plastic for foodstuff packaging; humidity control sheets of paper or plastic for foodstuff packaging.

17 – Semi-processed plastic materials; rods and profiles of plastic; tubes and flexible sheaths of plastic; filtering materials (semi-processed foams or plastic materials); insulating materials; films, sheets, plates and sheaths of plastic, perforated or not, and with mesh structure for gardening, agriculture, horticulture, forestry; biodegradable plastic sheets, films, plates and sheaths (semi-finished products); non-metallic reinforcements for ducting; insulating tapes; pipe seals; waterproof packings; watering hoses; pipes, of textile material; flexible pipes not of metal; pipe jackets, not of metal; junctions, not of metal, for pipes; rigid plastic materials (semi-finished products); sound insulating structures, not of metal; heatproof membranes (non-metallic); insulating membranes (non-metallic materials); water-repellent membranes (non-metallic); acoustic screens.

19 – Non-metallic building materials; transportable buildings not of metal; geotextiles; greenhouse frames (not of metal); grilles and railings not of metal; huts and summerhouses of non-metallic materials; drain gutters not of metal; water pipes not of metal; shutters, fences, trellises and palings not of metal; tanks (structures) of non-metallic materials; statues and figurines of stone, concrete or marble; earth retaining structures, not of metal; tree protection structures not of metal; chicken coops; transportable greenhouses not of metal; insect screens (not of metal); outdoor sun-blinds neither of metal, nor of textile; non-metallic gratings for trees; non-metallic coverings; non-luminous and non-mechanical signs; partitions and panels not of metal; non-woven fabrics for drainage of soil and land, for preserving and stabilizing soil and land; drain pipes, not of metal;

garden softwood chips; ready-shaped garden ponds (non-metallic constructions); paving slabs not of metal; mooring bollards, not of metal; grilles and gratings of plastic materials; fences, screens and edges not made of metal for marking off and shading of balconies, terraces, gardens and cultivated areas; reed lattices; non-metallic reinforcements for building and floor coverings; non-metallic materials for soil drainage; cabanas not of metal; balustrading; tiles not of metal for building; tile floorings, not of metal; non-metallic sieve screens; water-pipe valves, neither of metal, nor of plastic (not made of metal or plastics); roof coverings (not of metal); staircases not of metal; roof gutters not of metal; furrings of wood; marble; rubble; mosaics for building; insect screens not of metal; lighting slabs; swimming pools (non-metal structures); floors not of metal; diving boards, not of metal; posts not of metal (support stakes); reeds, for building; outdoor blinds not of metal and not of textile; arbors (building); glazing (glass for building); aviaries (non-metallic) constructions.

22 – Padding and stuffing materials (except rubber or plastics); nets, particularly nets made of plastic, nets for gardening and protection of crops from birds and other animals, support netting; packaging nets of plastic, tubular nets for mechanical protection; nets for camouflage; network; twine for nets; bags (not included in other classes); packing materials (except of rubber, paper or plastic); canopies, awnings, sails; tarpaulins; tarpaulin structures; hammocks; string, ropes, threads, straps and braces not of metal for handling loads; packing rope; plastic fibers for textile use; textile fibers; awnings; raw fibrous textile materials; bark (strings) for plants; raffia; bags (sacks) for the transport and storage of materials in bulk; refuse sacks of textile materials for the collection of vegetable waste; wrapping or binding bands not of metal; non-metallic binding strips and thread; tents; non-metallic tree nets.

24 – Fabrics, cloth, felts and textiles, non-woven, for gardening, agriculture, horticulture and forestry; haircloth; hemp fabrics; esparto fabric; curtains; covers and linings (cloths); oilcloth; plastic materials (fabric substitutes); woven plastic intended for use in agriculture; filtering materials of textile; mosquito nets; curtains of textile materials, roller curtains; fabrics for the manufacture of garden furniture or floor protection; waterproof fabrics; net curtains (curtains).

27 – Carpets, rugs, mats and matting, linoleum and other materials for covering existing floors; artificial turf; artificial turf.

(260) AM 2020 103937 A
(800) 1148450
(151) 2012 12 21

(891) 2019 05 29
(731) ROBERT BOSCH GMBH
Robert-Bosch-Platz 1, 70839 Gerlingen,
Germany
(540)



(591) Black, white
(531) 14.03.01; 14.03.03; 14.03.07; 26.01.16;
26.03.23; 26.11.08; 26.13.25; 27.05.10
(511)
28 – Games, playthings; gymnastic and sporting articles (as far as included in this class).

(260) AM 2020 104167 A
(800) 936294
(151) 2007 07 26
(891) 2019 05 27
(731) M SAN grupa d.d.
Buzinski prilaz 10, HR-10000 Zagreb, Croatia
(540)

VIVAX

(591) Black, white
(511)
9 – Photographic apparatus; apparatus for recording, transmitting and reproducing sound or images; cash registers; calculating machines; data processing equipment; computers.
11 – Apparatus for lighting, heating, steam generating, cooking, refrigerating, drying, ventilating, water supply and sanitary purposes.
35 – Advertising and business management; office functions.

(260) AM 2020 104168 A
(800) 1218187
(151) 2014 01 31
(891) 2019 05 27
(731) M SAN Grupa d.d.
Buzinski prilaz 10, HR-10010 Zagreb, Croatia
(540)

The logo for VIVAX consists of the word "VIVAX" in a bold, red, sans-serif font. The letters are closely spaced and have a slightly irregular, hand-drawn appearance.

(591) Red and white
(531) 27.05.17; 29.01.01

(511)

7 – Dishwashers; washing machines for clothes; meat choppers (machines); vacuum cleaners; electric blenders for household purposes; fruit presses, electric, for household purposes; electric pasta makers for domestic use; electric lawnmowers; smoothing presses; basket presses; cleaning appliances utilizing steam; multi-purpose steam cleaners; electrical apparatus for sealing plastics (packaging); electric vegetable peelers; vegetable grating machines; electric meat grinders; machine tools; motors and engines (except for land vehicles); machine coupling and transmission components (except for land vehicles); agricultural implements other than hand-operated; incubators for eggs; automatic vending machines.

8 – Hand tools and implements (hand-operated); cutlery; side arms; razors.

9 – Scientific, nautical, surveying, photographic, cinematographic, optical, weighing, measuring, signalling, checking (supervision), life-saving and teaching apparatus and instruments; apparatus and instruments for conducting, switching, transforming, accumulating, regulating or controlling electricity; apparatus for recording, transmission or reproduction of sound or images; magnetic data carriers, recording discs; compact discs; DVDs and other digital recording media; mechanisms for coin-operated apparatus; cash registers, calculating machines, data processing equipment, computers; computer software; fire-extinguishing apparatus.

11 – Apparatus for lighting, heating, steam generating, cooking, refrigerating, drying, ventilating, water supply and sanitary purposes.

16 – Paper, cardboard; printed matter; bookbinding material; photographs; stationery; adhesives for stationery or household purposes; artists' materials; paint brushes; typewriters and office requisites (except furniture); instructional and teaching material (except apparatus); plastic materials for packaging (not included in other classes); printers' type; printing blocks.

21 – Household or kitchen utensils and containers; combs and sponges; brushes (except paint brushes); brush-making materials; articles for cleaning purposes; steelwool; unworked or semi-worked glass (except glass used in building); glassware, porcelain and earthenware not included in other classes.

28 – Games and playthings; gymnastic and sporting articles not included in other classes; decorations for Christmas trees.

35 – Advertising; business management; business administration; office functions.

(260) AM 2020 104494 A

(800) 1481342

(151) 2019 05 03

(891) 2019 05 03

(731) OSTAPENKO LARYSA

Vul. Akademika Viliamsa, 52, korp. 2, kv. 40, m. Odesa 65015, Ukraine;

VASYLYEV OLEG

Vul. Itskhaka Rabina, 6, kv. 23, m. Odesa 65072, Ukraine

(540)



(591) Black, white

(531) 06.19.01; 06.19.09; 06.19.16; 24.03.15; 24.03.18; 25.01.06; 25.07.04; 28.05

(511)

32 – Aperitifs, non-alcoholic; non-alcoholic beverages; non-alcoholic honey-based beverages; non-alcoholic preparations for making beverages; non-alcoholic fruit extracts; non-alcoholic fruit juice beverages; grape must, unfermented; waters (beverages); aerated water, carbonated water; extracts of hops for making beer; essences for making beverages; seltzer water; isotonic beverages; ginger beer, ginger ale; kvass (non-alcoholic beverage); cocktails, non-alcoholic; beer-based cocktails; lemonades; lithia water; mineral water (beverages); energy drinks; aloe vera drinks, non-alcoholic; rice-based beverages, other than milk substitutes; soya-based beverages, other than milk substitutes; whey beverages; vegetable juices (beverages); orgeat; beer wort; beer; powders for effervescing beverages; sarsaparilla (non-alcoholic beverage); cider, non-alcoholic; syrups for lemonade; syrups for beverages; preparations for making aerated water, preparations for making carbonated water; smoothies; soda water; fruit juices, fruit juice; malt beer; malt wort; protein-enriched sports beverages; table waters; must; pastilles for effervescing beverages; tomato juice (beverage); soft drinks; fruit nectars, non-alcoholic; sherbets (beverages), sorbets (beverages); barley wine (beer)

(260) AM 2020 104840 A

(800) 1486254

(151) 2019 01 28

(891) 2019 01 28

(731) ROSEFIELD LUXEMBOURG, S.A.
Avenue de la Porte-Neuve 11 A, L-2227
Luxembourg, Luxembourg

(540)

PARFOIS

(591) Black, white

(511)

3 – Non-medicinal toiletry preparations and cosmetic products; non-medicinal dentifrices; perfumery products; essential oils; bleaching preparations and other substances for laundry use; cleaning, polishing, degreasing and abrasive preparations; perfumes; fragrances; eaux de Cologne; cosmetic products for skin care; make-up products; cosmetics for nails.

9 – Spectacles; sunglasses; eyeglass cords; chains for spectacles; spectacle cases; spectacle cases; containers for contact lenses; frames for spectacles and sunglasses; covers for mobile telephones; covers for electronics; covers adapted for computers; covers for laptops; downloadable electronic publications; downloadable computer applications; software and applications for mobile devices.

14 – Precious metals and their alloys; jewelry articles; precious and semi-precious stones; timepieces and chronometric instruments; jewelry; watches; wristwatches; cases for watches (presentation); bands and straps for watches; jewelry cases (boxes and cases); tiaras; brooches (jewelry); pins (jewelry); key rings [trinkets or fobs]; key holders of skin.

16 – Paper and cardboard; printing products (printed matter); bookbinding material; photographs; stationery and office supplies, except furniture; adhesives (glues) for stationery or household use; drawing materials and artists' materials; paintbrushes; instructional or teaching material; sheets, films and bags of plastic materials for wrapping and packaging; printing type; printing blocks; stationery; desk diaries; desk organizers; desk pads; diaries; writing or drawing books; notebooks; notepads; writing material; writing material cases; promotional publications; periodicals.

24 – Fabrics and their substitutes; household linen; curtains of textile or plastic materials; bed and table linen; bath linen (except for clothing); bath towels; traveling rugs (lap robes); bed blankets; bed covers; covers for cushions; mattress covers; pillowcases; sheets; duvets; duvet covers; table linen; woven-fabric handkerchiefs; handkerchiefs of textile.

26 – Lace and embroidery; ribbons and cords; buttons, hooks and eyes; pins and needles; artificial flowers; hair ornaments; hairpieces; bands for hair (accessories for hair); slides [hair grips]; hair pins; hair fasteners; hair bands; hair curling pins; hair bands; hair ornaments.

35 – Advertising; commercial business management; commercial administration; office functions; advertising by mail order; radio and television advertising; production of video recordings and audio-visual recordings for advertising and marketing; graphic advertising services; advertising in periodicals, newspapers and magazines; on-line advertising via a computer network; advertising via banner advertising; Provision of space on web sites for advertising of products and/or services; rental of advertising space; organization of events, exhibitions, fairs and shows for commercial, promotional and advertising purposes; mediation for advertising; provision of advertising space; publication of advertising texts; organization of presentations for advertising purposes; advertising via mobile phone networks; business advice relating to franchising; commercial advisory services relating to the establishment and operation of franchises; services provided by a franchiser, namely assistance in the operation or management of industrial or commercial businesses; presentation of goods on communication media for retail purposes; promotion of third-party goods and services through loyalty card programs; promoting goods and services of others via discount card schemes; retail sale and wholesale of cosmetic and perfumery products; retail sale and wholesale of publications, books, newspapers and magazines; retail sale and wholesale of stationary and desk supplies; retail sale and wholesale of spectacles, sunglasses, eyeglass cords and spectacle cases; retail and wholesale of covers and cases for mobile phones and tablet electronics; retail sale and wholesale of jewelry, costume jewelry and watches; retail sale and wholesale of bags, suitcases and luggage; retail sale and wholesale of bags, handbags, satchels (handbags), beach bags, traveling bags, bags with wheels, sports bags, all-purpose carrying bags, shoulder bags, rucksacks, purses, wallets with card compartments, card cases (wallets), briefcases (leatherware), shopping bags, key wallets and briefcases; retail and wholesale suitcases, travel suitcases, roller suitcases, labels used as identifiers for suitcases, traveling covers for clothing, traveling sets (leatherware), frames and straps for bags, bags for transporting articles for personal hygiene, cosmetic bags, umbrellas and umbrella covers; retail sale and wholesale of clothing, footwear, headgear, belts, gloves, scarves, foulards, shawls, neckerchiefs, bandanas, bath robes, bathing suits, pyjamas and lingerie; retail sale and wholesale of games and toys; retail sale and wholesale of porcelain and earthenware; retail sale and wholesale of glassware; retail sale and wholesale of bed and table covers, bath linen (except clothing), bath towels, traveling rugs, bed blankets, quilts, covers for cushions, mattress covers, pillowcases, sheets, quilts, quilt covers, table linen, handkerchiefs of textile and pocket handkerchiefs of textile; retail sale and wholesale of bands for hair (accessories for hair), hair grips, hair pins, hair fasteners, hair bands,

hair curling pins, hair bands and hair ornaments; retail sale and wholesale of furniture and fans; retail sale and wholesale of decorative products, namely: carpets, mirrors, cushions, frames, curtains, table runners, decorative baskets, statues, statuettes and works of art made of materials such as wood, wax, plaster or plastic, frames, coat stands, magazine racks, umbrella stands, curtain rods, candlesticks, decorative boxes, vases, candles, chandeliers, lamps and artificial flowers.

(260) AM 2020 104945 A

(800) 1487163

(151) 2019 04 17

(891) 2019 04 17

(731) XIAMEN TUNGSTEN CO., LTD.

Kejingshe, Haicang District, Xiamen, Fujian, China

(540)

XTC

(591) Black, white

(511)

6 – Tungsten; tungsten iron; molybdenum; molybdenum iron; alloys of common metal; sheets and plates of metal; poles of metal; laths of metal; cobalt, raw; rods of metal for welding; soldering wire of metal; titanium; foundry moulds of metal; anti-friction metal; cermets; tungsten powder.

9 – Electromagnetic coils; magnetic data media; fuse wire; holders for electric coils; magnets; anodes; materials for electricity mains [wires, cables]; magnetic wires; cathodes; plates for batteries; batteries, electric.

11 – Filaments for electric lamps; heating filaments, electric; luminous tubes for lighting.

(260) AM 2020 104987 A

(800) 1488158

(151) 2019 07 10

(891) 2019 07 10

(731) TEMSA ULAŞIM ARAÇLARI SANAYİ VE TİCARET ANONİM ŞİRKETİ

Sarıhamzalı Mahallesi, Turhan Cemal Beriker Bulvarı, No:563/A, Seyhan Adana, Turkey

(540)

TEMSA

SAFİR

(591) Black, white

(531) 27.05.09

(511)

12 – Motor land vehicles, motorcycles, mopeds; engines and motors for land vehicles; clutches for land

vehicles, transmissions, transmission belts and transmission chains for land vehicles, gearing for land vehicles, brakes, brake discs and brake linings for land vehicles, vehicle chassis, automobile bonnets, vehicle suspension springs, shock absorbers for automobiles, gearboxes for land vehicles, steering wheels for vehicles, rims for vehicle wheels, bicycles and their bodies, handlebars and mudguards for bicycles, vehicle bodies, tipping bodies for trucks, trailers for tractors, frigorific bodies for land vehicles; trailer hitches for vehicles, vehicle seats, head-rests for vehicle seats, safety seats for children, for vehicles, seat covers for vehicles, vehicle covers (shaped), sunblinds adapted for vehicles, direction signals and arms for direction signals for vehicles, windscreen wipers and wiper arms for vehicles, inner and outer tires for vehicle wheels, tubeless tires, tire-fixing sets comprised of tire patches and tire valves for vehicles, windows for vehicles, safety windows for vehicles, rearview mirrors and wing mirrors for vehicles, anti-skid chains for vehicles, luggage carriers for vehicles, bicycle and ski carriers for cars; saddles for bicycles or motorcycles, air pumps for vehicles, for inflating tires, anti-theft alarms for vehicles, horns for vehicles, safety belts for vehicle seats, air bags (safety devices for automobiles), baby carriages, wheelchairs, pushchairs, wheelbarrows, shopping carts, single or multi-wheeled wheelbarrows, shopping trolleys, grocery carts, handling carts, rail vehicles, locomotives, trains, trams, waggons, cable cars, chairlifts, vehicles for locomotion by water and their parts, other than their motors and engines, vehicles for locomotion by air and their parts, other than their motors and engines.

(260) AM 2020 105045 A

(800) 1488236

(151) 2019 04 24

(891) 2019 04 24

(731) DANVISTANO TRADING LTD.

Corner Hutson & Eyre Street, Blake Building, Suite 302, Belize City, Belize

(540)

NATIONAL

(591) Black, white

(511)

8 – Cutlery; razors; glaziers' diamonds [parts of hand tools]; apparatus for tattooing; pestles for pounding; razors, electric or non-electric; sharpening steels; scythe stones; augers [hand tools]; carpenters' augers; levers; table forks; pitchforks; lawn clippers [hand instruments]; harpoons; harpoons for fishing; rakes [hand tools]; sand trap rakes; whetstone holders; priming irons [hand tools]; lifting jacks, hand-operated; truncheons; clamps for carpenters or cooper; spades [hand tools]; rabbeting planes; chisels; engraving needles; edge tools [hand tools]; garden

tools, hand-operated; abrading instruments [hand instruments]; numbering punches; goffering irons; implements for decanting liquids [hand tools]; depilation appliances, electric and non-electric; sharpening instruments; blade sharpening instruments; livestock marking tools; oyster openers; polishing irons [glazing tools]; ear-piercing apparatus; tube cutting instruments; wire strippers [hand tools]; riveters [hand tools]; expanders [hand tools]; cutting tools [hand tools]; hand tools, hand-operated; stamping-out tools [hand tools]; picks [hand tools]; sharpening stones; punch rings [knuckle dusters]; trowels; centre punches [hand tools]; daggers; pickaxes; mallets [hand instruments]; punch pliers [hand tools]; blades [weapons]; annular screw plates; tap wrenches; ladles [hand tools]; foundry ladles [hand tools]; breast drills; lasts [shoemakers' hand tools]; scythe rings; instruments for punching tickets; diggers [hand tools]; rams [hand tools]; scythes; hainault scythes; fire irons; emery grinding wheels; grindstones [hand tools]; sledgehammers; tree pruners; nail drawers [hand tools]; ice picks; blades [hand tools]; razor blades; blades for planes; plane irons; jig-saws; crow bars; shovels [hand tools]; machetes; beard clippers; hair clippers for personal use, electric and non-electric; hair clippers for animals [hand instruments]; taps [hand tools]; fireplace bellows [hand tools]; hammers [hand tools]; stone hammers; masons' hammers; riveting hammers [hand tools]; mattocks; weeding forks [hand tools]; ditchers [hand tools]; mincing knives [hand tools]; manicure sets; manicure sets, electric; pedicure sets; needle files; bits [hand tools]; files [tools]; emery files; air pumps, hand-operated; hand pumps; shaving cases; scaling knives; hobby knives [scalpels]; molding irons; can openers, non-electric; farriers' knives; budding knives; hunting knives; penknives; grafting tools [hand tools]; braiders [hand tools]; billhooks; paring knives; knives; cleavers; wick trimmers [scissors]; cattle shearers; border shears; pruning shears; shearers [hand instruments]; scissors; sword scabbards; vegetable shears; side arms, other than firearms; stropping instruments; screwdrivers; reamer sockets; drill holders [hand tools]; perforating tools [hand tools]; nail files; nail files, electric; saws [hand tools]; bow saws; tweezers; guns [hand tools]; guns, hand-operated, for the extrusion of mastics; dies [hand tools]; fruit pickers [hand tools]; saw blades [parts of hand tools]; shear blades; tool belts [holders]; table cutlery [knives, forks and spoons]; crimping irons; hand implements for hair curling; vegetable choppers; money scoops; instruments and tools for skinning animals; hackles [hand tools]; pin punches; nail punches; fish tapes [hand tools]; punches [hand tools]; insecticide sprayers [hand tools]; syringes for spraying insecticides; reamers; frames for handsaws; saw holders; rasps [hand tools]; cutters; paring irons [hand tools]; graving tools [hand tools]; milling cutters [hand tools]; razor strops; leather strops; planes;

marine spikes; bits [parts of hand tools]; hollowing bits [parts of hand tools]; secateurs; silver plate [knives, forks and spoons]; pruning knives; sickles; drawing knives; scrapers [hand tools]; mortise chisels; caulking irons; gouges [hand tools]; mortars for pounding; mitre boxes [hand tools]; branding irons; hatchets; adzes [tools]; vices; hoop cutters [hand tools]; axes; holing axes; fulling tools [hand tools]; earth rammers [hand tools]; tube cutters [hand tools]; squares [hand tools]; extension pieces for braces for screw taps; embossers [hand tools]; metal band stretchers [hand tools]; metal wire stretchers [hand tools]; flat irons; irons [nonelectric hand tools]; razor cases; ratchets [hand tools]; scraping tools [hand tools]; awls; choppers [knives]; spatulas [hand tools]; bayonets; pliers; curling tongs; cuticle tweezers; eyelash curlers; nail clippers, electric or non-electric; hand-operated tools for shaving ice.

(260) AM 2020 105046 A

(800) 1488239

(151) 2019 05 14

(891) 2019 05 14

(731) PING AN INSURANCE (GROUP)

COMPANY OF CHINA, LTD.

47F-48F, 109F-112F, PING AN

INTERNATIONAL FINANCE CENTER,

5033 YITIAN ROAD, FUTIAN DISTRICT,

SHENZHEN, GUANGDONG, China

(540)

PING AN PUHUI

(591) Black, white

(531) 27.05.01

(511)

35 – Advertising; business information; provision of an on-line marketplace for buyers and sellers of goods and services; marketing; personnel management consultancy; systemization of information into computer databases; data search in computer files for others; accounting; sponsorship search; retail services for pharmaceutical, veterinary and sanitary preparations and medical supplies; brand evaluation services.

36 – Brokerage; surety services; charitable fund raising; insurance underwriting; financial consultancy; online banking; art appraisal; real estate management; trusteeship; lending against security; financial evaluation of intangible assets.

38 – Television broadcasting; internet broadcasting services; message sending; electronic bulletin board services [telecommunications services]; transmission of electronic mail; communications by computer terminals; providing user access to global computer networks; transmission of digital files; videoconferencing services; providing access to databases.

(260) AM 2020 105066 A
 (800) 1488604
 (151) 2019 05 10
 (891) 2019 05 10
 (731) EURO GAMES TECHNOLOGY LTD.
 "Maritsa" Str., 4, "Vranya-Lozen-
 Triugulnika", BG-1151 Sofia, Bulgaria
 (540)

40BURNING DICE

(591) White, green and black
 (531) 27.05.03; 27.07.03; 29.01.13
 (511)
 9 – Software; computer gaming software; computer software packages; computer operating system software; computer software, recorded; software drivers; virtual reality software; games software; entertainment software for computer games; computer programs for network management; operating computer software for main frame computers; monitors (computer hardware); computer hardware; apparatus for recording images; monitors (computer programs); computer game programs; computer programs for recorded games; apparatus for recording, transmission or reproduction of sound or images; communications servers [computer hardware]; electronic components for gambling machines; computer application software featuring games and gaming; computer software for the administration of on-line games and gaming; computer hardware for games and gaming; electronic components and computer software for gambling, gambling machines, gambling games on the internet and via telecommunication network.

28 – Gaming machines for gambling; chips for gambling; mah-jong; arcade games; gambling machines operating with coins, notes and cards; games; electronic games; parlor games; gaming chips; gaming tables; slot machines [gaming machines]; LCD game machines; slot machines and gaming devices; coin-operated amusement machines; roulette chips; poker chips; chips and dice [gaming equipment]; equipment for casinos; roulette tables; gaming roulette wheels; casino games; gambling machines and amusement machines, automatic and coin-operated; coin-operated amusement machines and/or electronic coin-operated amusement machines with or without the possibility of gain; boxes for coin-operated machines, slot machines and gaming machines; electronic or electrotechnical amusement machines and apparatus, gaming machines, coin-operated entertainment machines; housings for coin-operated machines, gaming equipment, gaming machines, machines for gambling; electropneumatic and electrical gambling machines (slot machines).

41 – Gambling; services related to gambling; gaming services for entertainment purposes; casino, gaming and gambling services; training in the de-

velopment of software systems; provision of equipment for gambling halls; providing casino equipment [gambling]; gaming machine entertainment services; providing casino facilities [gambling]; gaming hall services; amusement arcade services; games equipment rental; rental of gaming machines; providing amusement arcade services; rental of gaming machines with images of fruits; editing or recording of sounds and images; sound recording and video entertainment services; hire of sound reproducing apparatus; provision of gaming equipment for casinos; providing of casino facilities; online gambling services; casino, gaming and gambling services; provision of gaming establishments, gaming halls, internet casinos, online gaming services.

(260) AM 2020 105069 A
 (800) 1488684
 (151) 2019 06 04
 (891) 2019 06 04
 (731) AMOS Group Limited
 156 Gul Circle, Singapore 629613, Singapore
 (540)

ALCONA

(591) Black, white
 (531) 27.05.01
 (511)
 1 – Acetate of cellulose, unprocessed; acetates [chemicals]; acetic anhydride; acetone; acetylene; acetylene tetrachloride; acid proof chemical compositions; acids; acidulated water for recharging batteries; acidulated water for recharging accumulators; acrylic resins, unprocessed; actinium; activated carbon; activated charcoal; additives, chemical, to drilling muds; chemical additives to drilling muds; additives, chemical, to motor fuel; chemical additives to motor fuel; additives, chemical, to insecticides; chemical additives to insecticides; additives, chemical, to fungicides; chemical additives to fungicides; adhesive preparations for surgical bandages; adhesives for industrial purposes; adhesives for billposting; adhesives for paperhanging; adhesives for wallpaper; adhesives for wall tiles; adjuvants, other than for medical or veterinary purposes; agar-agar; agglutinants for concrete; agricultural chemicals, except fungicides, herbicides, insecticides and parasiticides; albumenized paper; albumin [animal or vegetable, raw material]; alcohol; aldehydes; alginates for industrial purposes; alginates for the food industry; alkalies; alkaline iodides for industrial purposes; alkaline metals; alkaline-earth metals; alkaloids; alum; alumina; aluminium alum; aluminium hydrate; aluminium silicate; aluminium chloride; aluminium iodide; aluminium acetate; americium; ammonia; ammonia alum; ammonia [volatile alkali] for industrial purposes; volatile alkali [ammonia] for industrial purposes; ammoniacal salts; ammonium aldehyde; ammonium

salts; ammonium nitrate; amyl acetate; amyl alcohol; anhydrides; anhydrous ammonia; animal charcoal; animal albumen [raw material]; animal carbon preparations; animal carbon; animal manure; metal annealing preparations; anthranilic acid; anti-boil preparations for engine coolants; anti-frothing solutions for batteries; anti-frothing solutions for accumulators; anti-incrustants; anti-knock substances for internal combustion engines; anti-sprouting preparations for vegetables; anti-tarnishing chemicals for windows; antifreeze; antimony; antimony oxide; antimony sulphide; antioxidants for use in manufacture; antioxidants for use in the manufacture of cosmetics; antioxidants for use in the manufacture of pharmaceuticals; antioxidants for use in the manufacture of food supplements; antistatic preparations, other than for household purposes; argon; arsenic; arsenious acid; artificial sweeteners [chemical preparations]; astatine; auxiliary fluids for use with abrasives; bacterial preparations, other than for medical and veterinary use; bacteriological preparations for acetification; bacteriological preparations, other than for medical and veterinary use; barium; barium compounds; barium sulfate; baryta; baryta paper; barytes; bases [chemical preparations]; basic gallate of bismuth; bate for dressing skins; dressing, except oils, for skins; bauxite; beer preserving agents; beer-clarifying and preserving agents; bentonite; benzene derivatives; benzene; benzene-based acids; benzoic acid; benzoic sulfimide; benzol; berkelium; bicarbonate of soda for chemical purposes; bichloride of tin; bichromate of potassium; bichromate of soda; biochemical catalysts; biological preparations, other than for medical or veterinary purposes; biological tissue cultures, other than for medical or veterinary purposes; birdlime; bismuth; bismuth subnitrate for chemical purposes; blood charcoal; blue vitriol; copper sulfate [blue vitriol]; blueprint paper; blueprint cloth; bone charcoal; borax; boric acid for industrial purposes; brake fluid; brazing preparations; brazing fluxes; brickwork preservatives, except paints and oils; bromine for chemical purposes; by-products of the processing of cereals for industrial purposes; caesium; calcined soda; calcium cyanamide [fertilizer]; calcium cyanamide [fertiliser]; calcium carbide; calcium salts; californium; calomel [mercurous chloride]; camphor, for industrial purposes; carbide; carbolineum for the protection of plants; carbon; carbon disulphide; carbon for filters; carbon tetrachloride; carbon black for industrial purposes; carbonates; carbonic acid; carbonic hydrates; casein for industrial purposes; casein for the food industry; cassiopium [lutetium]; lutetium [cassiopium]; catalysts; catechu; caustic alkali; caustic soda for industrial purposes; caustics for industrial purposes; cellulose; cellulose esters for industrial purposes; cellulose derivatives [chemicals]; cellulose ethers for industrial purposes; cement [metallurgy]; cement for footwear; cement for mending broken articles; cement preser-

vatives, except paints and oils; cement-waterproofing chemicals, except paints; ceramic glazings; ceramic materials in particulate form, for use as filtering media; ceramic compositions for sintering [granules and powders]; cerium; chemical condensation preparations; chemical substances for preserving foodstuffs; chemical preparations for facilitating the alloying of metals; chemical preparations for scientific purposes, other than for medical or veterinary use; chemical reagents, other than for medical or veterinary purposes; chemical substances for analyses in laboratories, other than for medical or veterinary purposes; chemical preparations for analyses in laboratories, other than for medical or veterinary purposes; chemical preparations for use in photography; chemical preparations for smoking meat; chemical preparations to prevent mildew; chemical preparations to prevent wheat blight; chemical preparations to prevent wheat smut; chemical intensifiers for paper; chemical intensifiers for rubber; chemical additives for oils; chemical coatings for ophthalmic lenses; chemicals, except pigments, for the manufacture of enamel; chemicals for use in forestry, except fungicides, herbicides, insecticides and parasiticides; chemicals for the manufacture of paints; chemicals for the manufacture of pigments; chimney cleaners, chemical; chlorates; chlorides; chlorine; cholic acid; chromates; chrome alum; chrome salts; chromic acid; chromic salts; chromium oxide; cinematographic film, sensitized but not exposed; cinematographic films, sensitized but not exposed; citric acid for industrial purposes; clarification preparations; purification preparations; coal saving preparations; cobalt oxide for industrial purposes; collagen for industrial purposes; collodion; colour-brightening chemicals for industrial purposes; color-brightening chemicals for industrial purposes; combusting preparations [chemical additives to motor fuel]; compost; concrete preservatives, except paints and oils; concrete-aeration chemicals; condensation-preventing chemicals; coolants for vehicle engines; corrosive preparations; cream of tartar for chemical purposes; cream of tartar for the food industry; cream of tartar for industrial purposes; creosote for chemical purposes; crotonic aldehyde; cryogenic preparations; cultures of microorganisms, other than for medical and veterinary use; curium; currying preparations for leather; currying preparations for skins; cyanides [prussiates]; prussiates; solutions for cyanotyping; cymene; damp-proofing chemicals, except paints, for masonry; decolorants for industrial purposes; bleaching preparations [decolorants] for industrial purposes; defoliants; degreasing preparations for use in manufacturing processes; grease-removing preparations for use in manufacturing processes; dehydrating preparations for industrial purposes; descaling preparations, other than for household purposes; detergent additives to petrol; detergent additives to gasoline; detergents for use in manufacturing processes; dext-

rin [size]; diagnostic preparations, other than for medical or veterinary purposes; diastase for industrial purposes; diatomaceous earth; diazo paper; disincrustants; dispersions of plastics; preparations of the distillation of wood alcohol; distilled water; dolomite for industrial purposes; drilling muds; dry ice [carbon dioxide]; dysprosium; electrophoresis gels; emollients for industrial purposes; emulsifiers; enamel-staining chemicals; engine-decarbonising chemicals; chemical preparations for decarbonising engines; enzyme preparations for industrial purposes; enzyme preparations for the food industry; enzymes for industrial purposes; enzymes for the food industry; epoxy resins, unprocessed; erbium; esters; ethane; ethers; ethyl alcohol; ethyl ether; europium; expanded clay for hydroponic plant growing [substrate]; fat-bleaching chemicals; fatty acids; ferments for chemical purposes; fermium; ferrocyanides; ferrotype plates [photography]; fertilizers; fertilisers; fertilizing preparations; fertilising preparations; filtering preparations for the beverages industry; filtering materials [unprocessed plastics]; filtering materials [chemical preparations]; filtering materials [mineral substances]; filtering materials [vegetable substances]; finishing preparations for use in the manufacture of steel; fire extinguishing compositions; fireproofing preparations; fish meal fertilizers; fish meal fertilisers; fissionable chemical elements; fissionable material for nuclear energy; fixing baths [photography]; fixing solutions [photography]; flashlight preparations; flavonoids [phenolic compounds] for industrial purposes; flocculants; flour for industrial purposes; flower preservatives; flowers of sulfur for chemical purposes; fluids for hydraulic circuits; liquids for hydraulic circuits; fluorine; fluorspar compounds; formic acid; formic aldehyde for chemical purposes; foundry binding substances; foundry moulding preparations; foundry molding preparations; foundry sand; francium; fuel for atomic piles; fuel-saving preparations; fuller's earth for use in the textile industry; fulling preparations for use in the textile industry; fulling preparations; gadolinium; gallic acid for the manufacture of ink; gallium; gallnuts; gallotannic acid; galvanizing baths; baths for galvanizing; galvanizing preparations; gambier; gas purifying preparations; preparations for the purification of gas; gelatine for photographic purposes; gelatine for industrial purposes; genes of seeds for agricultural production; getters [chemically active substances]; glass-frosting chemicals; glass-staining chemicals; glaziers' putty; glucose for industrial purposes; glucose for the food industry; glucosides; glue for industrial purposes; glutamic acid for industrial purposes; gluten [glue], other than for stationery or household purposes; gluten for the food industry; gluten for industrial purposes; glutinous tree-grafting preparations; glutinous tree-banding preparations; glutinous preparations for tree-banding; glutinous preparations for tree-grafting; glycerides; glycerine for in-

dustrial purposes; glycol ether; glycol; gold salts; grafting wax for trees; grafting mastic for trees; graphene; graphite for industrial purposes; guano; gum tragacanth for industrial purposes; gum arabic for industrial purposes; gum solvents; degumming preparations; gums [adhesives] for industrial purposes; gurjun balsam for making varnish; gypsum for use as a fertilizer; metal hardening preparations; heavy water; helium; holmium; hormones for hastening the ripening of fruit; horticultural chemicals, except fungicides, herbicides, insecticides and parasiticides; humus; humus top dressing; hydrates; hydrazine; hydrochlorates; hydrochloric acid; hydrofluoric acid; hydrogen; hydrogen peroxide for industrial purposes; hypochlorite of soda; hyposulfites; industrial chemicals; iodic acid; iodine for chemical purposes; iodine for industrial purposes; iodised albumen; iodised salts; ion exchangers [chemicals]; iron salts; isinglass, other than for stationery, household or alimentary purposes; isotopes for industrial purposes; kainite; kaolin; china slip; china clay; ketones; kieselgur; krypton; lactic acid; lactose for the food industry; lactose for industrial purposes; lactose [raw material]; lamp black for industrial purposes; lanthanum; lead arsenate; lead acetate; lead oxide; leather glues; leather-dressing chemicals; leather-impregnating chemicals; leather-renovating chemicals; leather-waterproofing chemicals; lecithin [raw material]; lecithin for the food industry; lecithin for industrial purposes; lime acetate; lime carbonate; lime chloride; limestone hardening substances; liquids for removing sulfates from batteries; liquids for removing sulfates from accumulators; lithia [lithium oxide]; lithium; litmus paper; loam; magnesite; magnesium carbonate; magnesium chloride; magnetic fluid for industrial purposes; malt albumen; manganate; manganese dioxide; mangrove bark for industrial purposes; masonry preservatives, except paints and oils; mastic for leather; mastic for tyres; mastic for tires; meat tenderizers for industrial purposes; mercuric oxide; mercury; mercury salts; metalloids; methane; methyl ether; methyl benzol; methyl benzene; preparations of microorganisms, other than for medical and veterinary use; milk ferments for chemical purposes; milk ferments for the food industry; milk ferments for industrial purposes; mineral acids; moderating materials for nuclear reactors; moistening [wetting] preparations for use in bleaching; wetting preparations for use in bleaching; moistening [wetting] preparations for use in dyeing; wetting preparations for use in dyeing; moistening [wetting] preparations for use in the textile industry; wetting preparations for use in the textile industry; mordants for metals; mould-release preparations; mold-release preparations; must-finishing preparations; naphthalene; neodymium; neon; neptunium; nitrate paper; nitrates; nitric acid; nitrogen; nitrogenous fertilizers; nitrogenous fertilisers; nitrous oxide; oenological bactericides [chemical preparations for use in wine ma-

king]; oil dispersants; oil cement [putty]; oil-bleaching chemicals; oil-purifying chemicals; oil-separating chemicals; oils for the preservation of food; oils for preparing leather in the course of manufacture; oils for tanning leather; oils for currying leather; oleic acid; olivine [silicate mineral]; opacifiers for enamel; opacifiers for glass; organic digestate [fertilizer]; organic digestate [fertiliser]; oxalates; oxalic acid; oxygen for industrial purposes; palladium chloride; paper pulp; paste fillers for automobile body repair; paste fillers for car body repair; peat pots for horticulture; peat [fertilizer]; peat [fertiliser]; pectin [photography]; pectin for the food industry; pectin for industrial purposes; perborate of soda; percarbonates; perchlorates; persulfates; persulfuric acid; petroleum dispersants; phenol for industrial purposes; compositions for the manufacture of phonograph records; phosphates [fertilizers]; phosphates [fertilisers]; phosphatides; phosphoric acid; phosphorus; photographic emulsions; photographic paper; photographic developers; photographic sensitizers; photometric paper; photosensitive plates; picric acid; plant growth regulating preparations; plasticizers; plastics, unprocessed; plastisols; plutonium; polish removing substances; substances for removing polish; polonium; polymer resins, unprocessed; potash; potash water; potassium dioxalate; potassium; potato flour for industrial purposes; potting soil; power steering fluid; praseodymium; preparations for stimulating cooking for industrial purposes; preservatives for use in the pharmaceutical industry; preservatives for tiles, except paints and oils; substances for preventing runs in stockings; preparations for preventing the tarnishing of lenses; preparations for preventing the tarnishing of glass; promethium; propellant gases for aerosols; protactinium; protective gases for welding; protein [raw material]; proteins for use in manufacture; proteins for use in the manufacture of food supplements; proteins for the food industry; pyrogalllic acid; quebracho for industrial purposes; radiator flushing chemicals; radioactive elements for scientific purposes; radium for scientific purposes; radon; rare earths; reagent paper, other than for medical or veterinary purposes; reducing agents for use in photography; refrigerants; renovating preparations for phonograph records; compositions for repairing inner tubes of tyres; compositions for repairing inner tubes of tires; compositions for repairing tyres; compositions for repairing tires; rhenium; rock salt; rubber preservatives; rubidium; saccharin; sal ammoniac; sal ammoniac spirits; salicylic acid; salt for preserving, other than for foodstuffs; salt, raw; saltpeter; salpetre; salts from rare earth metals; salts for colouring metal; salts for coloring metal; salts for galvanic cells; salts for galvanic batteries; salts of precious metals for industrial purposes; salts for industrial purposes; salts [chemical preparations]; salts [fertilizers]; salts [fertilisers]; salts of alkaline metals; samarium; sauce for

preparing tobacco; scandium; seawater for industrial purposes; seaweeds [fertilizers]; seaweeds [fertilisers]; sebacic acid; seed preserving substances; selenium; self-toning paper [photography]; sensitized cloth for photography; sensitized photographic plates; sensitized plates for offset printing; sensitized paper; sensitized films, unexposed; separating and unsticking [ungluing] preparations; ungluing preparations; unsticking and separating preparations; preparations for the separation of greases; silicates; silicon; silicon carbide [raw material]; silicones; silver salt solutions for silvering; silver nitrate; size for use in the textile industry; size for finishing and priming; sizing preparations; slag [fertilizers]; slag [fertilisers]; soap [metallic] for industrial purposes; soda ash; sodium; sodium salts [chemical compounds]; soil conditioning preparations; soil for growing; soldering chemicals; welding chemicals; soldering fluxes; solidified gases for industrial purposes; solvents for varnishes; soot for industrial or agricultural purposes; sorrel salt; spinel [oxide mineral]; spirits of salt; spirits of vinegar [dilute acetic acid]; stain-preventing chemicals for use on fabrics; starch for industrial purposes; starch paste [adhesive], other than for stationery or household purposes; starch-liquifying chemicals [ungluing agents]; ungluing agents [chemical preparations for liquifying starch]; stearic acid; stem cells, other than for medical or veterinary purposes; strontium; substrates for soil-free growing [agriculture]; sulfates; sulfides; sulfonic acids; sulfur; sulfuric ether; sulfuric acid; sulfurous acid; sumac for use in tanning; superphosphates [fertilizers]; superphosphates [fertilisers]; synthetic resins, unprocessed; artificial resins, unprocessed; synthetic materials for absorbing oil; talc [magnesium silicate]; tan; tan-wood; tannic acid; tannin; tanning substances; tapioca flour for industrial purposes; tartar, other than for pharmaceutical purposes; tartaric acid; tea extracts for use in the manufacture of pharmaceuticals; tea extracts for the food industry; tea extracts for use in the manufacture of cosmetics; technetium; compositions for the manufacture of technical ceramics; tellurium; metal tempering preparations; tensio-active agents; surface-active chemical agents; terbium; test paper, chemical; tetrachlorides; textile-brightening chemicals; textile-impregnating chemicals; textile-waterproofing chemicals; thallium; thiocarbanilide; thorium; compositions for threading; thulium; thymol for industrial purposes; titanite; titanium dioxide for industrial purposes; toluol; toluene; toning baths [photography]; toning salts [photography]; topsoil; toxic gas neutralizers; preparations of trace elements for plants; transmission fluid; transmission oil; tree cavity fillers [forestry]; tungstic acid; uranium nitrate; uranium; uranium oxide; vine disease preventing chemicals; vinic alcohol; viscose; vitamins for use in the manufacture of food supplements; vitamins for the food industry; vitamins for use in the manufacture of pharmaceu-

tics; vitamins for use in the manufacture of cosmetics; vulcanization accelerators; vulcanizing preparations; wallpaper removing preparations; water glass [soluble glass]; water-purifying chemicals; water-softening preparations; wax-bleaching chemicals; wine finings; witherite; wood alcohol; wood pulp; wood vinegar [pyroligneous acid]; pyroligneous acid [wood vinegar]; X-ray films, sensitized but not exposed; xenon; xylene; xylol; ytterbium; yttrium; zirconia.

3 – Abrasive paper; abrasives; adhesives for affixing false hair; adhesives for affixing false eyelashes; adhesives for cosmetic purposes; after-shave lotions; air fragrancing preparations; air fragrance reed diffusers; almond oil; almond soap; almond milk for cosmetic purposes; aloe vera preparations for cosmetic purposes; alum stones [astringents]; amber [perfume]; ammonia [volatile alkali] [detergent]; volatile alkali [ammonia] [detergent]; antiperspirant soap; antiperspirants [toiletries]; antistatic preparations for household purposes; aromatics [essential oils]; astringents for cosmetic purposes; badian essence; balms, other than for medical purposes; bases for flower perfumes; bath salts, not for medical purposes; bath preparations, not for medical purposes; beard dyes; beauty masks; bergamot oil; bleaching salts; bleaching soda; bleaching preparations [decolorants] for cosmetic purposes; bleaching preparations [decolorants] for household purposes; breath freshening sprays; breath freshening strips; breath freshening preparations for personal hygiene; cake flavourings [essential oils]; cake flavorings [essential oils]; cakes of toilet soap; cakes of soap; canned pressurized air for cleaning and dusting purposes; carbides of metal [abrasives]; chemical cleaning preparations for household purposes; cleaning chalk; cleaning preparations; preparations for cleaning dentures; cleansers for intimate personal hygiene purposes, non medicated; cleansing milk for toilet purposes; cloths impregnated with a detergent for cleaning; cobblers' wax; collagen preparations for cosmetic purposes; colorants for toilet purposes; colour-brightening chemicals for household purposes [laundry]; color-brightening chemicals for household purposes [laundry]; colour-removing preparations; color-removing preparations; corundum [abrasive]; cosmetic preparations for baths; cosmetic preparations for eyelashes; cosmetic kits; cosmetic pencils; cosmetic creams; cosmetic preparations for skin care; cosmetic dyes; cosmetic preparations for slimming purposes; cosmetics for animals; cosmetics; cosmetics for children; cotton swabs for cosmetic purposes; cotton sticks for cosmetic purposes; cotton wool for cosmetic purposes; creams for leather; waxes for leather; decorative transfers for cosmetic purposes; degreasers, other than for use in manufacturing processes; dental bleaching gels; dentifrices; denture polishes; deodorant soap; deodorants for hu-

man beings or for animals; deodorants for pets; depilatory preparations; depilatories; depilatory wax; descaling preparations for household purposes; detergents, other than for use in manufacturing operations and for medical purposes; diamantine [abrasive]; douching preparations for personal sanitary or deodorant purposes [toiletries]; dry shampoos; dry-cleaning preparations; drying agents for dishwashing machines; eau de Cologne; emery paper; emery cloth; emery; essential oils of cedarwood; essential oils of lemon; essential oils of citron; ethereal essences; ethereal oils; essential oils; extracts of flowers [perfumes]; eye-washes, not for medical purposes; eyebrow cosmetics; eyebrow pencils; fabric softeners for laundry use; false eyelashes; false nails; flavourings for beverages [essential oils]; flavorings for beverages [essential oils]; floor wax removers [scouring preparations]; floor wax; food flavourings [essential oils]; food flavorings [essential oils]; fumigation preparations [perfumes]; furbishing preparations; gaultheria oil; geraniol; glass cloth [abrasive cloth]; greases for cosmetic purposes; grinding preparations; sharpening preparations; hair lotions; hair dyes; hair colorants; hair waving preparations; waving preparations for the hair; hair spray; hair conditioners; hair straightening preparations; heliotropine; henna [cosmetic dye]; herbal extracts for cosmetic purposes; hydrogen peroxide for cosmetic purposes; incense; ionone [perfumery]; jasmine oil; Javelle water; potassium hypochloride; joss sticks; lacquer-removing preparations; laundry blueing; laundry bleach; laundry bleaching preparations; laundry glaze; laundry soaking preparations; preparations for soaking laundry; laundry preparations; lavender water; lavender oil; leather bleaching preparations; leather preservatives [polishes]; preservatives for leather [polishes]; preparations to make the leaves of plants shiny; lip glosses; lipstick cases; lipsticks; lotions for cosmetic purposes; make-up preparations; make-up removing preparations; make-up; make-up powder; mascara; massage gels, other than for medical purposes; massage candles for cosmetic purposes; mint essence [essential oil]; mint for perfumery; moustache wax; mustache wax; mouthwashes, not for medical purposes; musk [perfumery]; nail varnish; nail polish; nail care preparations; nail art stickers; nail varnish removers; nail polish removers; neutralizers for permanent waving; non-slipping wax for floors; non-slipping liquids for floors; oil of turpentine for degreasing; oils for cosmetic purposes; oils for cleaning purposes; oils for perfumes and scents; oils for toilet purposes; paint stripping preparations; pastes for razor strops; perfumery; perfumes; petroleum jelly for cosmetic purposes; phytocosmetic preparations; polish for furniture and flooring; polishing rouge; jewellers' rouge; polishing preparations; polishing wax; polishing creams; polishing paper; polishing stones; pomades for cosmetic purposes; potpourris [fragrances]; pumice stone; quillaia bark for

washing; rose oil; rust removing preparations; sachets for perfuming linen; safrol; sandcloth; abrasive cloth; sandpaper; glass paper; scented wood; scented water; scouring solutions; shampoos; shampoos for pets [non-medicated grooming preparations]; shampoos for animals [non-medicated grooming preparations]; shaving stones [astringents]; shaving soap; shaving preparations; shining preparations [polish]; shoe cream; shoe wax; shoe polish; shoemakers' wax; silicon carbide [abrasive]; skin whitening creams; cream for whitening the skin; smoothing stones; smoothing preparations [starching]; soap; soap for brightening textile; soap for foot perspiration; soda lye; stain removers; starch glaze for laundry purposes; starch for laundry purposes; laundry starch; sun-tanning preparations [cosmetics]; sunscreen preparations; tailors' wax; talcum powder, for toilet use; teeth whitening strips; terpenes [essential oils]; tissues impregnated with cosmetic lotions; tissues impregnated with make-up removing preparations; toilet water; toiletry preparations; tripoli stone for polishing; turpentine for degreasing; preparations for unblocking drain pipes; vaginal washes for personal sanitary or deodorant purposes; varnish-removing preparations; volcanic ash for cleaning; wallpaper cleaning preparations; washing soda, for cleaning; wax for parquet floors; whiting; windscreen cleaning liquids; windshield cleaning liquids.

7 – 3D printers; 3D printing pens; acetylene cleaning apparatus; adhesive tape dispensers [machines]; adhesive bands for pulleys; aerating pumps for aquaria; apparatus for aerating beverages; apparatus for aerating water; aerocondensers; aeronautical engines; aeroplane engines; agitators; agricultural machines; agricultural elevators; agricultural implements, other than hand-operated; air condensers; air cushion devices for moving loads; air pumps [garage installations]; air suction machines; air brushes for applying colour; alternators; anti-friction bearings for machines; anti-friction pads for machines; anti-pollution devices for motors and engines; aprons [parts of machines]; carriage aprons; electric arc welding apparatus; electric arc cutting apparatus; axles for machines; ball rings for bearings; ball-bearings; basket presses; bearing brackets for machines; bearings [parts of machines]; bearings for transmission shafts; beaters, electric; beating machines; beer pumps; bellows [parts of machines]; belt conveyors; belts for conveyors; belts for machines; belts for motors and engines; bending machines; beverage preparation machines, electromechanical; bicycle dynamos; bicycle assembling machines; binding apparatus for hay; trussing apparatus for hay; bitumen making machines; blade sharpening [stropping] machines; stropping machines; blade holders [parts of machines]; blades [parts of machines]; blenders, electric, for household purposes; blowing machines for the com-

pression, exhaustion and transport of gases; blowing machines for the compression, sucking and carrying of grain; fans for the compression, sucking and carrying of grain; blowing machines or fans for the compression, sucking and carrying of grain; blowing machines; bobbins for weaving looms; reels for weaving looms; boiler tubes [parts of machines]; book-binding apparatus and machines for industrial purposes; bottle filling machines; bottle washing machines; bottle stoppering machines; bottle capping machines; bottle sealing machines; boxes for matrices [printing]; braiding machines; brake linings, other than for vehicles; brake shoes, other than for vehicles; brake segments, other than for vehicles; brake pads, other than for vehicles; bread cutting machines; brewing machines; brushes [parts of machines]; brushes, electrically operated [parts of machines]; brushes for vacuum cleaners; bulldozers; butter machines; calenders; mangles; camshafts for vehicle engines; capstans; carbon brushes [electricity]; carburetter feeders; carburetters; card clothing [parts of carding machines]; carding machines; machines and apparatus for carpet shampooing, electric; cartridges for filtering machines; catalytic converters; central vacuum cleaning installations; centrifugal machines; centrifuges [machines]; centrifugal mills; centrifugal pumps; chaff cutter blades; chain saws; electromechanical machines for chemical industry; chisels for machines; chucks [parts of machines]; churns; cigarette machines for industrial purposes; cinder sifters [machines]; clack valves [parts of machines]; machines and apparatus for cleaning, electric; cleaning appliances utilizing steam; clippers [machines]; clutches, other than for land vehicles; coal-cutting machines; coffee grinders, other than hand-operated; coin-operated washing machines; compressed air engines; compressed air machines; compressed air pumps; compressed air guns for the extrusion of mastics; compressors [machines]; compressors for refrigerators; concrete mixers [machines]; condensing installations; connecting rods for machines, motors and engines; control cables for machines, engines or motors; control mechanisms for machines, engines or motors; hydraulic controls for machines, motors and engines; pneumatic controls for machines, motors and engines; converters for steelworks; conveyors [machines]; cord making machines; couplings, other than for land vehicles; cowlings [parts of machines]; guards [parts of machines]; hoods [parts of machines]; cranes [lifting and hoisting apparatus]; crank shafts; crankcases for machines, motors and engines; cranks [parts of machines]; crushers for kitchen use, electric; crushing machines; cultivators [machines]; current generators; curtain drawing devices, electrically operated; cutters [machines]; cutting machines; cutting blow pipes, gas-operated; cylinder heads for engines; cylinders for machines; cylinders for motors and engines; dairy machines; darning machines; de-aerators for

feedwater; degreasers [machines]; derricks; die-cutting and tapping machines; nut-tapping machines; die-stamping machines; diggers [machines]; dishwashers; disintegrators; ditchers [ploughs]; dividing machines; door openers, hydraulic; door openers, pneumatic; door closers, electric; door openers, electric; door closers, hydraulic; door closers, pneumatic; drainage machines; apparatus for drawing up beer under pressure; metal drawing machines; drill chucks [parts of machines]; drilling heads [parts of machines]; drilling machines; drilling bits [parts of machines]; drilling rigs, floating or non-floating; driving motors, other than for land vehicles; driving chains, other than for land vehicles; drums [parts of machines]; dust exhausting installations for cleaning purposes; dust removing installations for cleaning purposes; dyeing machines; dynamo brushes; dynamo belts; dynamos; earth moving machines; ejectors; electrodes for welding machines; electroplating machines; elevating apparatus; elevator belts; lift belts; elevator chains [parts of machines]; elevator operating apparatus; lift operating apparatus; elevators [lifts]; embossing machines; emergency power generators; engine mounts, other than for land vehicles; engines for air cushion vehicles; engines for boats; hydraulic engines and motors; engraving machines; excavators; exhaust manifold for engines; exhausts for motors and engines; expansion tanks [parts of machines]; fan belts for motors and engines; fans for motors and engines; feeders [parts of machines]; feeding apparatus for engine boilers; filling machines; filter presses; filtering machines; filters for cleaning cooling air, for engines; filters [parts of machines or engines]; finishing machines; fittings for engine boilers; fleshing machines; flour mill machines; flues for engine boilers; machine flywheels; fodder presses; food preparation machines, electromechanical; food processors, electric; forge bellows; foundry machines; freewheels, other than for land vehicles; friezing machines; fruit presses, electric, for household purposes; fuel economisers for motors and engines; fuel conversion apparatus for internal combustion engines; fuel dispensing pumps for service stations; galvanizing machines; gas-operated blow torches; gear boxes, other than for land vehicles; gears for weaving looms; gears, other than for land vehicles; generators of electricity; glass-working machines; glaziers' diamonds [parts of machines]; glow plugs for diesel engines; glue guns, electric; grain husking machines; corn husking machines; corn and grain husking machines; grain separators; automatic grappels for marine purposes; grating machines for vegetables; grease rings [parts of machines]; grease boxes [parts of machines]; grinding machines; grindstones [parts of machines]; sharpening wheels [parts of machines]; guides for machines; guns [tools using explosives]; hammers [parts of machines]; pneumatic hammers; electric hammers; electric hand drills; hand-held tools, other

than hand-operated; handling apparatus for loading and unloading; handling machines, automatic [manipulators]; hangers [parts of machines]; harrows; harvesting machines; mowing and reaping machines; haulage apparatus [mining]; extractors for mines; heat exchangers [parts of machines]; hemming machines; high pressure washers; hoists; holding devices for machine tools; hoppers [mechanical discharging]; hosiery looms; housings [parts of machines]; igniting devices for internal combustion engines; igniting magnetos; incubators for eggs; industrial robots; injectors for engines; inking apparatus for printing machines; ironing machines; jacks [machines]; pneumatic jacks; jet engines, other than for land vehicles; joints [parts of engines]; sealing joints [parts of engines]; journal boxes [parts of machines]; journals [parts of machines]; joysticks being parts of machines, other than for game machines; juice extractors, electric; kick starters for motorcycles; kitchen machines, electric; kitchen grinders, electric; kneading machines; knitting machines; knives [parts of machines]; knives, electric; knives for mowing machines; labellers [machines]; lace making machines; lasts for shoes [parts of machines]; shoe lasts [parts of machines]; lathes [machine tools]; lawnmowers [machines]; leather paring machines; leather-working machines; lifting apparatus; lifts, other than ski-lifts; mechanized livestock feeders; loading ramps; loom shafts; looms; lubricating pumps; lubricators [parts of machines]; machine tools; matrices for use in printing; meat choppers [machines]; meat mincers [machines]; metalworking machines; milking machines; milling machines; mills [machines]; mills for household purposes, other than hand-operated; millstones; mine borers; machines for the production of mineral water; mineworking machines; mixers [machines]; mixing machines; mortising machines; paring machines; motorized cultivators; motors for boats; motors, other than for land vehicles; engines, other than for land vehicles; motors, electric, other than for land vehicles; moulding machines; molding machines; moulds [parts of machines]; molds [parts of machines]; moving staircases [escalators]; escalators; moving walkways; moving sidewalks; mud catchers and collectors [machines]; mufflers for motors and engines; silencers for motors and engines; nail extractors, electric; nail pullers, electric; net hauling machines [fishing]; notchers [machine tools]; oil refining machines; ore treating machines; packaging machines; packing machines; painting machines; paper feeders [printing]; paper machines; papermaking machines; parquet wax-polishers, electric; machines for making pasta; pedal drives for sewing machines; peeling machines; pepper mills, other than hand-operated; pigs for cleaning pipes; piston segments; piston rings; pistons for cylinders; pistons for engines; pistons [parts of machines or engines]; planing machines; ploughs; ploughshares; machines and apparatus for polishing [electric]; potters' whe-

els; power hammers; presses [machines for industrial purposes]; pressure reducers [parts of machines]; pressure regulators [parts of machines]; pressure valves [parts of machines]; printing cylinders; printing machines for use on sheet metal; printing plates; printing machines; printing presses; printing rollers for machines; machines for processing plastics; propulsion mechanisms, other than for land vehicles; puddling machines; pulleys; pulleys [parts of machines]; pulverisers [machines]; atomisers [machines]; spraying machines; pump diaphragms; pumps [parts of machines, engines or motors]; pumps [machines]; pumps for heating installations; pumps for counter-current swimming; punches for punching machines; punching machines; rack and pinion jacks; racket stringing machines; radiators [cooling] for motors and engines; rail-laying machines; railroad constructing machines; railway wagon lifts; rakes for raking machines; raking machines; rammers [machines]; rams [machines]; reapers; reapers and binders; reapers and threshers; reduction gears, other than for land vehicles; reeling apparatus, mechanical; reels, mechanical, for flexible hoses; reels [parts of machines]; regulators [parts of machines]; rinsing machines; riveting machines; road sweeping machines, self-propelled; road making machines; road building machines; roller bridges; roller bearings; rolling mill cylinders; rolling mills; rotary printing presses; rotary steam presses, portable, for fabrics; rubber tracks being parts of crawlers on construction machines; rubber tracks being parts of crawlers on loading-unloading machines and apparatus; rubber tracks being parts of crawlers on agricultural machines; rubber tracks being parts of crawlers on mining machines; rubber tracks being parts of crawlers on snow ploughs; satinizing machines; sausage making machines; saw benches [parts of machines]; saw blades [parts of machines]; saws [machines]; scale collectors for machine boilers; scissors, electric; screwdrivers, electric; sealing machines for industrial purposes; electrical apparatus for sealing plastics [packaging]; self-oiling bearings; self-regulating fuel pumps; sewage pulverizers; sewage pulverisers; sewing machines; shaft couplings [machines]; sharpening machines; sheaf-binding machines; shearing machines for animals; hair clipping machines for animals; hair cutting machines for animals; shears, electric; shock absorber plungers [parts of machines]; dashpot plungers [parts of machines]; plunger pistons; shoe polishers, electric; shovels, mechanical; shredders [machines] for industrial use; shuttles [parts of machines]; sieves [machines or parts of machines]; sifting installations; sifting machines; sizing machines; ski edge sharpening tools, electric; slide rests [parts of machines]; sliders for knitting machines; carriages for knitting machines; slides for knitting machines; smoothing presses; snow ploughs; soldering apparatus, gas-operated; welding apparatus, gas-operated; soldering blow pipes, gas-operated;

ted; soldering irons, gas-operated; soldering apparatus, electric; soldering irons, electric; soldering lamps; sorting machines for industry; sowers [machines]; sparking plugs for internal combustion engines; speed governors for machines, engines and motors; spin dryers [not heated]; spin driers [not heated]; spinning machines; spinning wheels; spinning frames; spray guns for paint; springs [parts of machines]; stalk separators [machines]; stamping machines; stands for machines; starters for motors and engines; stators [parts of machines]; steam condensers [parts of machines]; steam oil separators; steam engines; steam traps; steam engine boilers; steamrollers; road rollers; stereotype machines; stitching machines; stone-working machines; straw [chaff] cutters; chaff cutters; stuffing boxes [parts of machines]; suction machines for industrial purposes; suction cups for milking machines; teat cups for milking machines; suction nozzles for vacuum cleaners; machines for the production of sugar; superchargers; superheaters; swaging machines; tables for machines; tambours for embroidery machines; taps [parts of machines, engines or motors]; faucets [parts of machines, engines or motors]; tarring machines; tedding machines; machines for the textile industry; thermic lances [machines]; threading machines; threshing machines; tilling machines for agricultural purposes; tilt hammers; tin openers, electric; can openers, electric; tobacco processing machines; tools [parts of machines]; torque converters, other than for land vehicles; transmission shafts, other than for land vehicles; transmission chains, other than for land vehicles; transmissions, other than for land vehicles; transmissions for machines; pneumatic transporters; trimming machines; apparatus for dressing; apparatus for machining; trueing machines; pneumatic tube conveyors; tube conveyors, pneumatic; hydraulic turbines; turbines, other than for land vehicles; turbocompressors; turf removing ploughs; tympan [parts of printing presses]; type-setting machines [printing]; type-setting machines [photocomposition]; typecasting machines; typographic presses; typographic machines; universal joints [Cardan joints]; vacuum pumps [machines]; vacuum cleaner attachments for disseminating perfumes and disinfectants; vacuum cleaner hoses; vacuum cleaners; vacuum cleaner bags; valves [parts of machines]; vegetable spiralizers, electric; vending machines; distribution machines, automatic; vibrators [machines] for industrial use; vulcanization apparatus; washing apparatus; washing machines [laundry]; washing installations for vehicles; vehicle washing installations; waste disposal units; garbage disposal units; waste compacting machines; trash compacting machines; pneumatic waste oil drainers; water heaters [parts of machines]; water separators; drain cocks; machines and apparatus for wax-polishing, electric; weeding machines; welding machines, electric; electric welding apparatus; machine wheels;

machine wheelwork; whisks, electric, for household purposes; whitewashing machines; colour-washing machines; winches; wind turbines; window openers, electric; window closers, electric; window openers, hydraulic; window closers, hydraulic; window openers, pneumatic; window closers, pneumatic; wine presses; winnowers; woodworking machines; wrapping machines; wringing machines for laundry; cream/milk separators.

8 – Abrading instruments [hand instruments]; adzes [tools]; agricultural implements, hand-operated; agricultural forks [hand tools]; air pumps, hand-operated; annular screw plates; augers [hand tools]; awls; axes; metal band stretchers [hand tools]; bayonets; beard clippers; bench vices [hand implements]; billhooks; bits [parts of hand tools]; bits [hand tools]; blade sharpening instruments; blades for planes; blades [hand tools]; blades [weapons]; border shears; borers; bow saws; box cutters; braiders [hand tools]; branding irons; breast drills; budding knives; carpenters' augers; cattle shearers; caulking irons; centre punches [hand tools]; ceramic knives; cheese slicers, non-electric; chisels; choppers [knives]; clamps for carpenters or coopers; cleavers; crimping irons; crow bars; curling tongs; cuticle tweezers; cuticle nippers; cutlery; cutter bars [hand tools]; cutters; cutting tools [hand tools]; daggers; implements for decanting liquids [hand tools]; depilation appliances, electric and non-electric; apparatus for destroying plant parasites, hand-operated; dies [hand tools]; screw stocks [hand tools]; screw-thread cutters [hand tools]; diggers [hand tools]; ditchers [hand tools]; drawing knives; drill holders [hand tools]; ear-piercing apparatus; earth rammers [hand tools]; edge tools [hand tools]; egg slicers, non-electric; embosers [hand tools]; emery grinding wheels; emery files; emery boards; engraving needles; expanders [hand tools]; extension pieces for braces for screw taps; eyelash curlers; farriers' knives; files [tools]; fingernail polishers, electric or non-electric; nail buffers, electric or non-electric; fire irons; fireplace bellows [hand tools]; fish tapes [hand tools]; draw wires [hand tools]; flat irons; foundry ladles [hand tools]; frames for handsaws; fruit pickers [hand tools]; fruit segmenters; fruit corers; fullers [hand tools]; fulling tools [hand tools]; garden tools, hand-operated; gimlets [hand tools]; glaziers' diamonds [parts of hand tools]; goffering irons; gouges [hand tools]; grafting tools [hand tools]; graving tools [hand tools]; grindstones [hand tools]; sharpening wheels [hand tools]; guns [hand tools]; guns, hand-operated, for the extrusion of mastics; hackles [hand tools]; hainault scythes; hair clippers for personal use, electric and non-electric; hair clippers for animals [hand instruments]; hair braiders, electric; hair-removing tweezers; hammers [hand tools]; hand drills, hand-operated; hand tools, hand-operated; hand implements for hair curling; hand pumps; han-

dles for hand-operated hand tools; harpoons; harpoons for fishing; hatchets; hobby knives [scalpels]; hoes [hand tools]; holing axes; mortise axes; hollowing bits [parts of hand tools]; hoop cutters [hand tools]; hunting knives; ice picks; insecticide vaporizers [hand tools]; insecticide atomizers [hand tools]; insecticide sprayers [hand tools]; irons [non-electric hand tools]; jig-saws; kitchen mandolines; knife handles; knives; ladles [hand tools]; lasts [shoemakers' hand tools]; lawn clippers [hand instruments]; leather strops; levers; lifting jacks, hand-operated; livestock marking tools; cattle marking tools; machetes; mallets [hand instruments]; manicure sets; manicure sets, electric; marline spikes; masons' hammers; mattocks; milling cutters [hand tools]; mincing knives [hand tools]; fleshing knives [hand tools]; meat choppers [hand tools]; mitre boxes [hand tools]; miter boxes [hand tools]; money scoops; mortars for pounding [hand tools]; mortise chisels; moulding irons; molding irons; nail extractors, hand-operated; nail pullers, hand-operated; nail drawers [hand tools]; nail punches; nail nippers; nail files; nail files, electric; nail clippers, electric or non-electric; needle files; non-electric caulking guns; numbering punches; oyster openers; palette knives; paring irons [hand tools]; paring knives; pedicure sets; penknives; perforating tools [hand tools]; pickaxes; pickhammers; bushhammers; picks [hand tools]; pin punches; pincers; nippers; tongs; pizza cutters, non-electric; plane irons; planes; pliers; polishing irons [glazing tools]; glazing irons; priming irons [hand tools]; pruning scissors; secateurs; pruning shears; pruning knives; punch rings [knuckle dusters]; knuckle dusters; punch pliers [hand tools]; punches [hand tools]; instruments for punching tickets; rabbeting planes; rakes [hand tools]; rammers [hand tools]; pestles for pounding [hand tools]; rams [hand tools]; rasps [hand tools]; ratchets [hand tools]; razor strops; razor cases; razor blades; razors, electric or non-electric; reamer sockets; reamers; riveters [hand tools]; riveting hammers [hand tools]; sabres; sand trap rakes; saw blades [parts of hand tools]; saw holders; saws [hand tools]; scaling knives; scissors; scrapers [hand tools]; scrapers for skis; scraping tools [hand tools]; screwdrivers, non-electric; sculptors' chisels; scythe rings; scythe stones; whetstones; scythe handles; scythes; sharpening stones; sharpening steels; knife steels; sharpening instruments; shaving cases; shear blades; shearers [hand instruments]; shears; shovels [hand tools]; sickles; side arms, other than firearms; silver plate [knives, forks and spoons]; ski edge sharpening tools, hand-operated; instruments and tools for skinning animals; sledgehammers; spades [hand tools]; spanners [hand tools]; wrenches [hand tools]; spatulas [hand tools]; spatulas for use by artists; spoons; squares [hand tools]; stamping-out tools [hand tools]; stamps [hand tools]; stirring sticks for mixing paint; stone hammers; stropping instruments; sword scabbards; swords; syringes for

spraying insecticides; table cutlery [knives, forks and spoons]; tableware [knives, forks and spoons]; table forks; table knives, forks and spoons of plastic; table knives, forks and spoons for babies; tap wrenches; taps [hand tools]; tattoo needles; apparatus for tattooing; thistle extractors [hand tools]; tin openers, non-electric; can openers, non-electric; tool belts [holders]; tree pruners; trowels [gardening]; trowels; truncheons; bludgeons; police batons; tube cutters [hand tools]; tube cutting instruments; tweezers; vegetable slicers; vegetable knives; vegetable shredders; vegetable choppers; vegetable spiralizers, hand-operated; vegetable peelers [hand tools]; vices; vises; weeding forks [hand tools]; whetstone holders; wick trimmers [scissors]; wine bottle foil cutters, hand-operated; wire strippers [hand tools]; metal wire stretchers [hand tools].

11 – Acetylene burners; acetylene generators; acetylene flares; air deodorizing apparatus; air deodorising apparatus; air cooling apparatus; air reheaters; air dryers; air driers; air filtering installations; air conditioners for vehicles; air valves for steam heating installations; air purifying apparatus and machines; air sterilizers; air sterilisers; air fryers; air-conditioning installations; air-conditioning apparatus; alcohol burners; anti-glare devices for vehicles [lamp fittings]; anti-dazzle devices for vehicles [lamp fittings]; anti-splash tap nozzles; aquarium filtration apparatus; aquarium heaters; aquarium lights; arc lamps; ash conveyor installations, automatic; autoclaves, electric, for cooking; pressure cookers, electric; bakers' ovens; barbecues; bath tubs; bath tubs for sitz baths; bath fittings; bath installations; bath plumbing fixtures; bed warmers; beverage cooling apparatus; bicycle lights; bidets; blankets, electric, not for medical purposes; boiler pipes [tubes] for heating installations; boilers, other than parts of machines; book sterilization apparatus; book sterilisation apparatus; brackets for gas burners; bread toasters; toasters; bread baking machines; bread-making machines; burners for lamps; burners; candle lanterns; carbon for arc lamps; electrically heated carpets; ceiling lights; central heating radiators; chandeliers; chimney flues; chimney blowers; Chinese lanterns; chocolate fountains, electric; chromatography apparatus for industrial purposes; clean chambers [sanitary installations]; electrically heated clothing; coffee roasters; coffee percolators, electric; coffee machines, electric; coils [parts of distilling, heating or cooling installations]; cooking utensils, electric; cooking stoves; cookers; cooking apparatus and installations; cooking rings; electric cooktops; cool boxes, electric; coolers, electric; coolers for furnaces; cooling vats for furnaces; cooling installations for water; cooling installations for liquids; cooling installations and machines; cooling appliances and installations; cooling installations for tobacco; curling lamps; dampers [heating]; deep fryers, electric;

defrosters for vehicles; apparatus for dehydrating food waste; dental ovens; deodorizing apparatus, not for personal use; deodorising apparatus, not for personal use; desalination plants; desiccating apparatus; directional lights for bicycles; discharge tubes, electric, for lighting; disinfectant dispensers for toilets; disinfectant distributors for toilets; disinfectant apparatus; disinfectant apparatus for medical purposes; distillation columns; distillation apparatus; diving lights; drip irrigation emitters [irrigation fittings]; drying apparatus; drying apparatus for fodder and forage; forage drying apparatus; drying apparatus and installations; evaporators; expansion tanks for central heating installations; extractor hoods for kitchens; fabric steamers; fairy lights for festive decoration; string lights for festive decoration; fans [air-conditioning]; fans [parts of air-conditioning installations]; electric fans for personal use; feeding apparatus for heating boilers; filaments for electric lamps; filters for air conditioning; filters for drinking water; fireplaces, domestic; fittings, shaped, for furnaces; fittings, shaped, for ovens; shaped fittings for furnaces; shaped fittings for ovens; flaming torches; flare stacks for use in the oil industry; flues for heating boilers; flushing tanks; food steamers, electric; footmuffs, electrically heated; footwarmers, electric or non-electric; forges, portable; fountains; freezers; friction lighters for igniting gas; fruit roasters; fumigation apparatus, not for medical purposes; furnace grates; fire bars; furnace ash boxes; ash pits for furnaces; furnaces, other than for laboratory use; ovens, other than for laboratory use; gas lighters; gas scrubbing apparatus; gas scrubbers [parts of gas installations]; scrubbers [parts of gas installations]; gas burners; gas boilers; gas lamps; gas condensers, other than parts of machines; germicidal burners; germicidal lamps for purifying air; glue-heating appliances; hair dryers; hair driers; hand drying apparatus for washrooms; head torches; portable headlamps; headlights for automobiles; hearths; heat accumulators; heat regenerators; heat exchangers, other than parts of machines; heat pumps; heat guns; heated display cabinets; heaters for baths; heaters for vehicles; heaters for heating irons; heaters, electric, for feeding bottles; heating apparatus; heating installations; heating installations [water]; hot water heating installations; heating boilers; heating apparatus for solid, liquid or gaseous fuels; heating apparatus, electric; heating elements; heating plates; heating apparatus for defrosting vehicle windows; heating filaments, electric; heating cushions, electric, not for medical purposes; heating pads, electric, not for medical purposes; heating and cooling apparatus for dispensing hot and cold beverages; hot air ovens; hot air apparatus; hot air bath fittings; hot plates; hot water bottles; luminous house numbers; humidifiers for central heating radiators; hydrants; hydromassage bath apparatus; ice machines and apparatus; ice-cream making machines; immersion heaters; incan-

descent burners; incinerators; ionization apparatus for the treatment of air or water; kettles, electric; kiln furniture [supports]; kilns; kitchen ranges [ovens]; laboratory burners; laboratory lamps; lamp mantles; lamp casings; lamp glasses; lamp chimneys; lamp globes; globes for lamps; lamp reflectors; lamp shades; electric lamps; lamps; lampshade holders; lanterns for lighting; laundry room boilers; washing coppers; laundry dryers, electric; laundry driers, electric; lava rocks for use in barbecue grills; level controlling valves in tanks; light bulbs; light bulbs, electric; light bulbs for directional signals for vehicles; light diffusers; light-emitting diodes [LED] lighting apparatus; lighters; lighting installations for air vehicles; lighting apparatus and installations; lighting apparatus for vehicles; lights for vehicles; lights, electric, for Christmas trees; electric lights for Christmas trees; lights for automobiles; automobile lights; loading apparatus for furnaces; magnesium filaments for lighting; malt roasters; microbubble generators for baths; microwave ovens [cooking apparatus]; microwave ovens for industrial purposes; milk cooling installations; miners' lamps; mixer taps for water pipes; mixer faucets for water pipes; motorcycle lights; multicookers; nail lamps; nuclear reactors; atomic piles; oil lamps; oil burners; oil-scrubbing apparatus; ornamental fountains; oven fittings made of fireclay; oxyhydrogen burners; pasteurisers; pipes [parts of sanitary installations]; water-pipes for sanitary installations; plate warmers; pocket warmers; polymerisation installations; pounded rice cake making machines, electric, for household purposes; pressure water tanks; processing installations for fuel and nuclear moderating material; installations for processing nuclear fuel and nuclear moderating material; purification installations for sewage; radiator caps; radiators, electric; radiators [heating]; refining towers for distillation; refrigerating cabinets; refrigerating apparatus and machines; refrigerating chambers; walk-in refrigerators; refrigerating containers; refrigerating appliances and installations; refrigerating display cabinets; refrigerators; regulating accessories for water or gas apparatus and pipes; regulating and safety accessories for gas pipes; regulating and safety accessories for water apparatus; regulating and safety accessories for gas apparatus; roasters; roasting jacks; roasting spits; roasting apparatus; griddles [cooking appliances]; grills [cooking appliances]; rotisseries; safety lamps; safety accessories for water or gas apparatus and pipes; sanitary apparatus and installations; sauna bath installations; searchlights; shower cubicles; shower enclosures; showers; sinks; sockets for electric lights; socks, electrically heated; solar thermal collectors [heating]; solar furnaces; sous-vide cookers, electric; spa baths [vessels]; steam boilers, other than parts of machines; steam generating installations; steam accumulators; steam facial apparatus [saunas]; sterilizers; sterilisers; stills; stoves [heating apparatus]; street

lamps; standard lamps; structural plates for ovens; framework of metal for ovens; swimming pool chlorinating apparatus; tanning apparatus [sun beds]; taps for pipes and pipelines; faucets for pipes and pipelines; spigots for pipes and pipelines; cocks for pipes and pipelines; taps; faucets; thermostatic valves [parts of heating installations]; tobacco roasters; toilet bowls; toilet seats; toilets, portable; toilets [water-closets]; water closets; electric torches; electric flashlights; tortilla presses, electric; luminous tubes for lighting; Turkish bath cabinets, portable; ultraviolet ray lamps, not for medical purposes; urinals [sanitary fixtures]; vehicle headlights; vehicle reflectors; ventilation hoods; ventilation [air-conditioning] installations and apparatus; ventilation [air-conditioning] installations for vehicles; ventilation hoods for laboratories; waffle irons, electric; warming pans; wash-hand basins [parts of sanitary installations]; wash-hand bowls [parts of sanitary installations]; washers for water taps; washers for water faucets; water heaters; water distribution installations; water conduits installations; water purification installations; water filtering apparatus; water sterilizers; water sterilisers; water purifying apparatus and machines; water heaters [apparatus]; water softening apparatus and installations; water supply installations; water flushing installations; flushing apparatus; water intake apparatus; watering installations, automatic; watering machines for agricultural purposes; whirlpool-jet apparatus; wicks adapted for oil stoves; wine cellars, electric; electric appliances for making yogurt.

17 – Acrylic resins, semi-processed; adhesive bands, other than stationery and not for medical or household purposes; adhesive tapes, other than stationery and not for medical or household purposes; anti-glare films for windows [tinted films]; anti-dazzle films for windows [tinted films]; asbestos safety curtains; safety curtains of asbestos; asbestos slate; slate asbestos; asbestos sheets; asbestos felt; asbestos paper; asbestos coverings; asbestos fabrics; asbestos cloth; asbestos packing; asbestos millboards; asbestos fibres; asbestos fibers; asbestos; bags [envelopes, pouches] of rubber, for packaging; balata; bark coverings for sound insulation; boiler composition to prevent the radiation of heat; brake lining materials, partly processed; canvas hose pipes; carbon fibres, other than for textile use; carbon fibers, other than for textile use; caulking materials; cellulose acetate, semi-processed; chemical compositions for repairing leaks; clack valves of rubber; clutch linings; connecting hose for vehicle radiators; cords of rubber; cotton wool for packing [caulking]; cylinder jointings; dielectrics [insulators]; door stops of rubber; draught excluder strips; weatherstripping; duct tapes; ebonite; ebonite moulds; ebonite molds; elastic yarns, other than for textile use; elastic threads, other than for textile use; expansion joint fillers; fillers for expansi-

on joints; fibreglass for insulation; fibreglass for insulation; glass fibers for insulation; fibreglass fabrics for insulation; fibreglass fabrics for insulation; filtering materials [semi-processed foams or films of plastic]; fittings, not of metal, for compressed air lines; fittings, not of metal, for flexible pipes; fittings, not of metal, for rigid pipes; flexible hoses, not of metal; floating anti-pollution barriers; foam supports for flower arrangements [semi-finished products]; foil of regenerated cellulose, other than for wrapping; sheets of regenerated cellulose, other than for wrapping; foils of metal for insulating; metal foil for insulation; gaskets; joint packings; seals; glass wool for insulation; gum, raw or semi-worked; gutta-percha; hoses of textile material; insulating materials; insulating felt; insulating gloves; insulating oil for transformers; insulating oils; insulating paper; insulating fabrics; insulating varnish; substances for insulating buildings against moisture; insulating paints; insulating bands; insulating tapes; insulating plaster; insulating refractory materials; insulators for railway tracks; insulators for cables; insulators for electric mains; insulators; junctions, not of metal, for pipes; latex [rubber]; liquid rubber; lute; mica, raw or partly processed; mineral wool [insulator]; non-conducting materials for retaining heat; packing [cushioning, stuffing] materials of rubber or plastics; padding materials of rubber or plastics; stuffing of rubber or plastics; paper for electrical capacitors; pipe gaskets; joint packings for pipes; pipe mufflers, not of metal; pipe jackets, not of metal; plastic film, other than for wrapping; plastic substances, semi-processed; plastic fibres, other than for textile use; plastic fibers, other than for textile use; plastic sheeting for agricultural purposes; compositions to prevent the radiation of heat; quay wall-mounted rubber cushioning materials for the prevention of damage to docks, ships and vessels; reinforcing materials, not of metal, for pipes; rings of rubber; rubber seals for jars; rubber, raw or semi-worked; rubber stoppers; rubber sleeves for protecting parts of machines; sleeves of rubber for protecting parts of machines; rubber material for recapping tyres; rubber material for recapping tires; rubber solutions; sealant compounds for joints; self-adhesive tapes, other than stationery and not for medical or household purposes; shock-absorbing buffers of rubber; slag wool [insulator]; soundproofing materials; stops of rubber; synthetic rubber; synthetic resins, semi-processed; artificial resins, semi-processed; threads of plastic for soldering; soldering threads of plastic; threads of rubber, other than for textile use; threads of plastic materials, other than for textile use; valves of India-rubber or vulcanized fibre; valves of India-rubber or vulcanized fiber; viscose sheets, other than for wrapping; vulcanized fibre; vulcanized fiber; washers of rubber or vulcanized fibre; washers of rubber or vulcanized fiber; water-tight rings; stuffing rings; watering hose; waterproof packings; weathers-

tripping compositions; window stops of rubber; glass fibres for insulation.

18 – Animal skins; pelts; attaché cases; bags for climbers; bags for campers; bags [envelopes, pouches] of leather, for packaging; bags for sports; bags; beach bags; bits for animals [harness]; blinkers [harness]; blinders [harness]; boxes of leather or leatherboard; boxes of vulcanized fibre; boxes of vulcanized fiber; bridles [harness]; bridoons; briefcases; business card cases; butts [parts of hides]; card cases [notecases]; cases of leather or leatherboard; casings, of leather, for springs; casings, of leather, for plate springs; cat o' nine tails; cattle skins; chain mesh purses; chamois leather, other than for cleaning purposes; skins of chamois, other than for cleaning purposes; chin straps, of leather; clothing for pets; collars for animals; compression cubes adapted for luggage; conference folders; conference portfolios; covers for animals; covers for horse saddles; credit card cases [wallets]; curried skins; fastenings for saddles; frames for umbrellas or parasols; fur; fur-skins; furniture coverings of leather; game bags [hunting accessories]; garment bags for travel; girths of leather; goldbeaters' skin; grips for holding shopping bags; halters; head-stalls; handbag frames; handbags; harness straps; harness traces; harness for animals; harness fittings; hat boxes of leather; haversacks; hiking sticks; trekking sticks; horse collars; horse blankets; horseshoes; imitation leather; key cases; kid; kneepads for horses; labels of leather; leather leashes; leather leads; leather laces; leather straps; leather thongs; leather, unworked or semi-worked; leather cords; leatherboard; luggage tags; moleskin [imitation of leather]; motorized suitcases; mountaineering sticks; alpenstocks; music cases; muzzles; net bags for shopping; nose bags [feed bags]; pads for horse saddles; parasols; pocket wallets; pouch baby carriers; purses; randsels [Japanese school satchels]; reins; reins for guiding children; riding saddles; rucksacks; backpacks; saddle trees; saddlebags; saddlecloths for horses; saddlery; school bags; school satchels; shopping bags; shoulder belts [straps] of leather; leather shoulder belts; leather shoulder straps; sling bags for carrying infants; slings for carrying infants; stirrup leathers; parts of rubber for stirrups; stirrups; straps for soldiers' equipment; straps of leather [saddlery]; straps for skates; suitcase handles; suitcases; suitcases with wheels; tefillin [phylacteries]; tool bags, empty; traces [harness]; travelling trunks; travelling bags; travelling sets [leatherware]; trimmings of leather for furniture; leather trimmings for furniture; trunks [luggage]; umbrella rings; umbrella or parasol ribs; umbrella sticks; umbrella covers; umbrella handles; umbrellas; valises; valves of leather; vanity cases, not fitted; walking sticks; canes; walking stick seats; walking stick handles; walking cane handles; wheeled shopping bags; whips.

21 – Abrasive pads for kitchen purposes; abrasive sponges for scrubbing the skin; aerosol dispensers, not for medical purposes; animal bristles [brushware]; aquarium hoods; electric devices for attracting and killing insects; autoclaves, non-electric, for cooking; pressure cookers, non-electric; baby baths, portable; baking mats; basins [receptacles]; baskets for household purposes; basting spoons [cooking utensils]; basting brushes; beaters, non-electric; beer mugs; bird baths; birdcages; blenders, non-electric, for household purposes; boot jacks; boot trees [stretchers]; bottle openers, electric and non-electric; bottles; bowls [basins]; basins [bowls]; boxes for dispensing paper towels; boxes of glass; bread baskets for household purposes; bread boards; bread bins; broom handles; brooms; brushes, except paint brushes; material for brush-making; brushes; brushes for footwear; electric brushes, except parts of machines; brushes for cleaning tanks and containers; buckets; pails; buckets made of woven fabrics; bulb basters; busts of porcelain, ceramic, earthenware, terra-cotta or glass; butter dishes; butter-dish covers; button-hooks; cabarets [trays]; cages for household pets; cake moulds; cake molds; cake decorating tips and tubes; candelabra [candlesticks]; candlesticks; candle rings; candle extinguishers; candle jars [holders]; candy boxes; boxes for sweetmeats; car washing mitts; carpet beaters [hand instruments]; carpet sweepers; cauldrons; ceramics for household purposes; chamber pots; chamois leather for cleaning; buckskin for cleaning; skins of chamois for cleaning; cheese-dish covers; china ornaments; chopsticks; cinder sifters [household utensils]; cleaning instruments, hand-operated; cleaning tow; closures for pot lids; cloth for washing floors; clothes-pegs; clothespins; clothing stretchers; stretchers for clothing; cloths for cleaning; rags for cleaning; coasters, not of paper or textile; cocktail shakers; cocktail stirrers; coffee grinders, hand-operated; coffee services [tableware]; coffee filters, non-electric; coffee percolators, non-electric; coffeepots, non-electric; coin banks; cold packs for chilling food and beverages; comb cases; combs for animals; combs; electric combs; confectioners' decorating bags [pastry bags]; containers for household or kitchen use; cookery moulds; cookery molds; cookie [biscuit] cutters; cookie jars; cooking pot sets; cooking skewers of metal; cooking pins of metal; cooking pots; cooking utensils, non-electric; cooking mesh bags, other than for microwaves; corkscrews, electric and non-electric; cosmetic utensils; cosmetic spatulas; cotton waste for cleaning; cruet sets for oil and vinegar; cruets; crumb trays; crushers for kitchen use, non-electric; crystal [glassware]; cups; cups of paper or plastic; currycombs; cutting boards for the kitchen; decanter tags; decanters; deep fryers, non-electric; demijohns; carboys; deodorizing apparatus for personal use; deodorising apparatus for personal use; dish covers; covers for dishes; dishes; dishwashing brus-

hes; disposable table plates; drinking troughs; drinking vessels; drinking horns; drinking bottles for sports; drinking glasses; dripping pans; drying racks for laundry; dustbins; garbage cans; refuse bins; trash cans; dusting apparatus, non-electric; dusting cloths [rags]; earthenware; crockery; earthenware saucepans; egg cups; egg separators, non-electric, for household purposes; enamelled glass, not for building; epergnes; eyebrow brushes; eyelash brushes; feather-dusters; feeding troughs; fibreglass, other than for insulation or textile use; fiberglass, other than for insulation or textile use; fiberglass thread, other than for textile use; fiberglass thread, other than for textile use; figurines of porcelain, ceramic, earthenware, terra-cotta or glass; statuettes of porcelain, ceramic, earthenware, terra-cotta or glass; flasks; flat-iron stands; floss for dental purposes; flower pots; flower-pot covers, not of paper; covers, not of paper, for flower pots; fly swatters; fly traps; foam toe separators for use in pedicures; food steamers, non-electric; fruit cups; fruit presses, non-electric, for household purposes; frying pans; funnels; furniture dusters; fused silica [semi-worked product], other than for building; gardening gloves; garlic presses [kitchen utensils]; glass bulbs [receptacles]; glass vials [receptacles]; glass flasks [containers]; glass jars [carboys]; glass stoppers; glass bowls; glass, unworked or semi-worked, except building glass; glass wool, other than for insulation; glass incorporating fine electrical conductors; glass for vehicle windows [semi-finished product]; glasses [receptacles]; glove stretchers; gloves for household purposes; glue-pots; graters for kitchen use; grill supports; gridiron supports; grills [cooking utensils]; griddles [cooking utensils]; hair for brushes; heads for electric toothbrushes; heat-insulated containers for beverages; heat-insulated containers; heaters for feeding bottles, non-electric; hip flasks; holders for flowers and plants [flower arranging]; horse brushes; horsehair for brush-making; hot pots, not electrically heated; ice cube moulds; ice cube molds; ice buckets; coolers [ice pails]; ice pails; ice tongs; ice cream scoops; indoor terrariums [plant cultivation]; indoor aquaria; tanks [indoor aquaria]; indoor terrariums [vivariums]; inflatable bath tubs for babies; insect traps; insulating flasks; vacuum bottles; ironing board covers, shaped; ironing boards; isothermic bags; jugs; pitchers; kettles, non-electric; kitchen grinders, non-electric; kitchen containers; kitchen utensils; knife rests for the table; ladles for serving wine; lamp-glass brushes; large-toothed combs for the hair; lazy susans; lint removers, electric or non-electric; liqueur sets; litter boxes for pets; litter trays for pets; lunch boxes; majolica; make-up removing appliances; make-up sponges; make-up brushes; mangers for animals; menu card holders; mess-tins; mills for household purposes, hand-operated; mixing spoons [kitchen utensils]; mop wringers; mop wringer buckets; mops; mortars for kitchen use;

mosaics of glass, not for building; moulds [kitchen utensils]; molds [kitchen utensils]; mouse traps; mugs; nail brushes; napkin rings; nest eggs, artificial; noodle machines, hand-operated; nozzles for watering hose; nozzles for watering cans; roses for watering cans; nutcrackers; opal glass; opaline glass; oven mitts; kitchen mitts; barbecue mitts; painted glassware; paper plates; pastry cutters; pepper mills, hand-operated; pepper pots; perfume burners; perfume vaporizers; perfume sprayers; pestles for kitchen use; fitted picnic baskets, including dishes; pie servers; tart scoops; pig bristles for brush-making; piggy banks; pipettes [wine-tasters]; wine tasters [siphons]; place mats, not of paper or textile; plate glass [raw material]; plates to prevent milk boiling over; plug-in diffusers for mosquito repellents; plungers for clearing blocked drains; polishing leather; polishing apparatus and machines, for household purposes, non-electric; polishing materials for making shiny, except preparations, paper and stone; polishing gloves; polishing cloths; porcelain ware; portable cool boxes, non-electric; portable coolers, non-electric; pot lids; potholders; pots; pottery; poultry rings; pouring spouts; powder puffs; powder compacts; powdered glass for decoration; rat traps; refrigerating bottles; reusable ice cubes; rings for birds; rolling pins, domestic; rotary washing lines; salad bowls; salad tongs; salt cellars; salt shakers; saucepan scourers of metal; saucers; scoops for household purposes; scouring pads; pads for cleaning; scrubbing brushes; services [dishes]; serving ladles; shaving brushes; shaving brush stands; stands for shaving brushes; shoe trees [stretchers]; shoe horns; sieves [household utensils]; sifters [household utensils]; signboards of porcelain or glass; siphon bottles for carbonated water; ski wax brushes; smoke absorbers for household purposes; soap boxes; soap dispensers; soap holders; dishes for soap; soup bowls; spatulas for kitchen use; spice sets; sponge holders; sponges for household purposes; sprinklers; stands for portable baby baths; statues of porcelain, ceramic, earthenware, terra-cotta or glass; steel wool for cleaning; stew-pans; strainers for household purposes; straws for drinking; drinking straws; sugar bowls; sugar tongs; syringes for watering flowers and plants; sprinklers for watering flowers and plants; table napkin holders; table plates; tablemats, not of paper or textile; tableware, other than knives, forks and spoons; tankards; tar-brushes, long handled; tea caddies; tea services [tableware]; tea infusers; tea balls; tea strainers; tea cosies; tea bag rests; teapots; thermally insulated containers for food; tie presses; toilet brushes; toilet cases; fitted vanity cases; toilet paper dispensers; toilet sponges; toilet utensils; toilet paper holders; toothbrushes; toothbrushes, electric; toothpick holders; toothpicks; tortilla presses, non-electric [kitchen utensils]; towel rails and rings; rails and rings for towels; trays of paper, for household purposes; trays for household purpo-

ses; trivets [table utensils]; trouser presses; urns; utensils for household purposes; vases; vegetable dishes; vessels of metal for making ices and iced drinks; vitreous silica fibres, other than for textile use; vitreous silica fibers, other than for textile use; waffle irons, non-electric; washing boards; wash-tubs; waste paper baskets; water apparatus for cleaning teeth and gums; watering devices; sprinkling devices; watering cans; apparatus for wax-polishing, non-electric; wax-polishing appliances, non-electric, for shoes; whisks, non-electric, for household purposes; window-boxes; wine aerators; wool waste for cleaning; works of art of porcelain, ceramic, earthenware, terra-cotta or glass.

22 – Animal hair; animal feeding nets; awnings of textile; awnings of synthetic materials; bags [envelopes, pouches] of textile, for packaging; binding thread, not of metal, for agricultural purposes; bindings, not of metal; body bags; braces, not of metal, for handling loads; harness, not of metal, for handling loads; brattice cloth; cables, not of metal; camel hair; canvas for sails; car towing ropes; carbon fibres for textile use; carbon fibers for textile use; carded wool; coconut fibre; coconut fiber; cocoons; combed wool; cords for hanging pictures; raw cotton; cotton tow; cotton waste [flock] for padding and stuffing; covers for camouflage; down [feathers]; dust sheets; drop cloths; eiderdown; esparto grass; feathers for bedding; feathers for stuffing upholstery; raw fibrous textile; fibrous gaskets for ships; fishing nets; fleece wool; flock [stuffing]; glass fibres for textile use; glass fibers for textile use; grasses for upholstery; hammocks; hemp; hemp bands; horsehair; jute; kapok; ladder tapes for venetian blinds; ladder tapes or webbing for venetian blinds; liber; raw linen [flax]; linters; mail bags; mesh bags for washing laundry; net pens for fish farming; nets for camouflage; nets; network; outdoor blinds of textile; packing [cushioning, stuffing] materials, not of rubber, plastics, paper or cardboard; packing string; packing rope; padding materials, not of rubber, plastics, paper or cardboard; stuffing, not of rubber, plastics, paper or cardboard; pig bristles; plastic fibres for textile use; plastic fibers for textile use; purse seines; raffia; ramie fibre; ramie fiber; rope ladders; ropes, not of metal; ropes; sacks for the transport and storage of materials in bulk; sails; sails for ski sailing; sash cords; sawdust; schappe [raw silk waste]; silk waste; seaweed for stuffing; sheaf-binding yarns; shorn wool; raw silk; silk flock; sisal; slings, not of metal, for handling loads; snares [nets]; straps, not of metal, for handling loads; belts, not of metal, for handling loads; straw for stuffing upholstery; straw wrappers for bottles; bottle envelopes of straw; packing, of straw, for bottles; string; strips for tying-up vines; tarpaulins; tents; textile fibres; textile fibers; thread, not of metal, for wrapping or binding; tow; twine made of paper; twine for nets; upholstery wool [stu-

ffing]; vehicle covers, not fitted; vitreous silica fibres for textile use; vitreous silica fibers for textile use; wadding for filtering; wadding for padding and stuffing upholstery; wax ends; whipcord; wood shavings; wood wool; wool flock; raw or treated wool; wrapping or binding bands, not of metal.

24 – Adhesive fabric for application by heat; baby buntings; banners of textile or plastic; bath linen, except clothing; bath mitts; bed covers; bedspreads; coverlets [bedspreads]; quilts; bed covers of paper; bed linen; bed blankets; bed valances; billiard cloth; blankets for household pets; bolting cloth; brocades; buckram; bunting of textile or plastic; calico; canvas for tapestry or embroidery; cheese cloth; chenille fabric; chevots [cloth]; cloth; cloths for removing make-up; coasters of textile; cot bumpers [bed linen]; crib bumpers [bed linen]; cotton fabrics; covers [loose] for furniture; loose covers for furniture; covers for cushions; crepe [fabric]; crepon; curtain holders of textile material; curtains of textile or plastic; damask; diaper changing cloths for babies; diapered linen; door curtains; drugget; eiderdowns [down coverlets]; elastic woven material; esparto fabric; fabric, impervious to gases, for aeronautical balloons; fabric of imitation animal skins; fabric; fabric for footwear; fabrics for textile use; face towels of textile; felt; fibreglass fabrics for textile use; fiberglass fabrics for textile use; filtering materials of textile; flags of textile or plastic; flannel [fabric]; frieze [cloth]; furniture coverings of plastic; coverings of plastic for furniture; furniture coverings of textile; fustian; dimity; gauze [cloth]; glass cloths [towels]; gummed cloth, other than for stationery purposes; haircloth [sackcloth]; handkerchiefs of textile; hat linings, of textile, in the piece; hemp fabric; hemp cloth; household linen; jersey [fabric]; jute fabric; knitted fabric; labels of textile; linen cloth; lingerie fabric; lining fabric for footwear; linings [textile]; marabouts [cloth]; mattress covers; moleskin [fabric]; mosquito nets; muslin fabric; net curtains; non-woven textile fabrics; oilcloth for use as tablecloths; pillow shams; pillowcases; place mats of textile; plastic material [substitute for fabrics]; printed calico cloth; printers' blankets of textile; ramie fabric; rayon fabric; sheets [textile]; shower curtains of textile or plastic; shrouds; silk fabrics for printing patterns; silk [cloth]; sleeping bag liners; sleeping bags for babies; sleeping bags; table runners, not of paper; table linen, not of paper; table napkins of textile; serviettes of textile; tablecloths, not of paper; tablemats of textile; taffeta [cloth]; textile material; tick [linen]; ticks [mattress covers]; fitted toilet lid covers of fabric; towels of textile; traced cloths for embroidery; traced cloth for embroidery; travelling rugs [lap robes]; trellis [cloth]; tulle; upholstery fabrics; velvet; wall hangings of textile; tapestry [wall hangings], of textile; woollen cloth; woollen fabric; zephyr [cloth].

25 – Albs; ankle boots; aprons [clothing]; ascots; babies' pants [underwear]; bandanas [neckerchiefs]; bath sandals; bath slippers; bath robes; bathing caps; bathing trunks; bathing drawers; bathing suits; swimsuits; beach clothes; beach shoes; belts [clothing]; berets; bibs, not of paper; bibs, sleeved, not of paper; boas [necklets]; bodices [lingerie]; boot uppers; boots; boots for sports; boxer shorts; brassieres; breeches for wear; camisoles; cap peaks; caps [headwear]; chasubles; clothing; clothing for gymnastics; clothing of imitations of leather; clothing of leather; coats; collars [clothing]; combinations [clothing]; corselets; corsets [underclothing]; cuffs; wristbands [clothing]; cyclists' clothing; detachable collars; dress shields; dresses; dressing gowns; ear muffs [clothing]; esparto shoes or sandals; fishing vests; fittings of metal for footwear; football shoes; football boots; footmuffs, not electrically heated; footwear; footwear uppers; fur stoles; furs [clothing]; gabardines [clothing]; galoshes; goloshes; garters; girdles; gloves [clothing]; gymnastic shoes; hairdressing capes; half-boots; hat frames [skeletons]; hats; headbands [clothing]; headgear for wear; heelpieces for stockings; heelpieces for footwear; heels; hoods [clothing]; hosiery; jackets [clothing]; jerseys [clothing]; judo uniforms; jumper dresses; pinafore dresses; karate uniforms; kimonos; knickers; panties; knitwear [clothing]; lace boots; layettes [clothing]; leggings [leg warmers]; leg warmers; leggings [trousers]; leotards; liveries; maniples; mantillas; masquerade costumes; mitres [hats]; miters [hats]; mittens; money belts [clothing]; motorists' clothing; muffs [clothing]; neck scarves [mufflers]; neck scarfs [mufflers]; mufflers [neck scarves]; neckties; non-slipping devices for footwear; outerclothing; overalls; smocks; overcoats; topcoats; paper clothing; paper hats [clothing]; parkas; pelerines; pelisses; petticoats; pocket squares; pockets for clothing; ponchos; pyjamas; pajamas; ready-made clothing; ready-made linings [parts of clothing]; sandals; saris; sarongs; sashes for wear; scarves; scarfs; shawls; shirt fronts; shirt yokes; shirts; shoes; short-sleeve shirts; shower caps; ski boots; ski gloves; skirts; skorts; skull caps; sleep masks; slippers; slips [underclothing]; sock suspenders; socks; inner soles; soles for footwear; spats; gaiters; sports jerseys; sports shoes; sports singlets; stocking suspenders; stockings; studs for football boots; stuff jackets [clothing]; suits; suspenders; braces for clothing [suspenders]; sweat-absorbent stockings; sweat-absorbent underwear; sweat-absorbent underclothing; sweat-absorbent socks; sweaters; pullovers; jumpers [pullovers]; teddies [underclothing]; bodies [underclothing]; tee-shirts; tights; tips for footwear; togas; top hats; trouser straps; gaiter straps; trousers; pants (Am.); turbans; underpants; underwear; underclothing; uniforms; valenki [felted boots]; veils [clothing]; visors [headwear]; waistcoats; vests; waterp-

roof clothing; welts for footwear; wet suits for water-skiing; wimples; wooden shoes.

32 – Preparations for making aerated water; aerated water; aloe vera drinks, non-alcoholic; aperitifs, non-alcoholic; barley wine [beer]; beer; beer wort; beer-based cocktails; preparations for making beverages; cider, non-alcoholic; cocktails, non-alcoholic; energy drinks; essences for making beverages; extracts of hops for making beer; fruit juices; fruit juice; fruit nectars, non-alcoholic; ginger beer; ginger ale; grape must, unfermented; isotonic beverages; kvass [non-alcoholic beverage]; lemonades; essences for making non-alcoholic beverages, not in the nature of essential oils; lithia water; malt beer; malt wort; mineral water [beverages]; must; non-alcoholic fruit extracts; non-alcoholic fruit juice beverages; non-alcoholic beverages; non-alcoholic honey-based beverages; non-alcoholic beverages flavoured with coffee; non-alcoholic beverages flavored with coffee; non-alcoholic beverages flavoured with tea; non-alcoholic beverages flavored with tea; orgeat; pastilles for effervescing beverages; powders for effervescing beverages; protein-enriched sports beverages; rice-based beverages, other than milk substitutes; sarsaparilla [non-alcoholic beverage]; seltzer water; sherbets [beverages]; sorbets [beverages]; smoothies; soda water; soft drinks; soya-based beverages, other than milk substitutes; syrups for beverages; syrups for lemonade; table waters; tomato juice [beverage]; vegetable juices [beverages]; waters [beverages]; whey beverages.

(260) AM 2020 105077 A
 (800) 1488933
 (151) 2019 06 17
 (891) 2019 06 17
 (731) FOREMOST WORLDWIDE CO. LTD
 Flat 8, 4/F, Carbo Mansion, 325 Queen's
 Road Central, HongKong, China
 (540)

rosenberg

(591) Black, white
 (511)
 6 – Fittings of metal for toilet, bathroom and kitchen purposes, namely connection fittings and valves for supplying, distributing, controlling and regulating water; sanitary fittings of metal, namely storage units, holders, handles, brackets, poles, towel hooks and mirrored storage units; pipes and pipe fittings of metal; flexible pipes of metal, accessories of metal for pipes, tubes and flexible pipes, namely valves, spray nozzles, clips, screw fittings, connectors, couplings and manifold pieces.
 11 – Lighting apparatus; apparatus for water supply and sanitary purposes, in particular sanitary fittings of metal and plastic for toilets, bathrooms and

kitchens for water supply, distribution, control and regulation; electric and electronic fittings for supplying, distributing, controlling and regulating water; toilet seats and toilet lids; toilet flushing tanks; WC ceramics, toilets; porcelain for sanitary purposes, including washbasins, bidets, urinals, bath tubs, shower tubs; siphons, showering trim, bath grips; pipes and tubes for sanitary installations.

(260) AM 2020 105078 A
 (800) 1488952
 (151) 2019 07 29
 (891) 2019 07 29
 (731) C.P.C. Creative Perfume Company Holding
 SA
 Rue du Mont-de-Sion 8, c/o Lenhill Partners
 SA, CH-1206 Genève, Switzerland

(540)
VILHELM PARFUMERIE
MOSCOW GRAFFITI

(591) Black, white
 (511)
 3 – Amber [perfume]; aromatics [essential oils]; air fragrancing preparations; cake flavorings [essential oils]; flavorings for beverages [essential oils]; food flavorings [essential oils]; breath freshening sprays; balms, other than for medical purposes; lip glosses; sachets for perfuming linen; scented water; javelle water; lavender water; toilet water; depilatory wax; mustache wax; massage gels, other than for medical purposes; heliotropine; make-up; deodorants for pets; deodorants for human beings or for animals; depilatory preparations; air fragrance reed diffusers; scented wood; perfumes; perfumery; decorative transfers for cosmetic purposes; ionone [perfumery]; eyebrow pencils; cosmetic pencils; adhesives for affixing false eyelashes; adhesives for affixing false hair; hair conditioners; beard dyes; cosmetic dyes; cosmetic creams; skin whitening creams; incense; hair spray; nail polish; hair lotions; lotions for cosmetic purposes; after-shave lotions; beauty masks; oils for perfumes and scents; oils for cosmetic purposes; oils for toilet purposes; essential oils; essential oils of cedarwood; essential oils of lemon; essential oils of citron; oils for cleaning purposes; bergamot oil; gaultheria oil; jasmine oil; lavender oil; almond oil; rose oil; almond milk for cosmetic purposes; cleansing milk for toilet purposes; musk [perfumery]; deodorant soap; shaving soap; soap for brightening textile; cakes of toilet soap; antiperspirant soap; soap for foot perspiration; soap; almond soap; mint for perfumery; cosmetic kits; eau de cologne; bases for flower perfumes; joss sticks; dentifrices; lipstick cases; breath freshening strips; teeth whitening strips; lipsticks; pomades for cosmetic purposes; shaving preparations; cosmetic preparations for baths; bath preparations, not for medical pur-

poses; hair straightening preparations; hair waving preparations; color-removing preparations; leather bleaching preparations; mouthwashes, not for medical purposes; cosmetic preparations for slimming purposes; make-up removing preparations; nail care preparations; collagen preparations for cosmetic purposes; aloe vera preparations for cosmetic purposes; sunscreen preparations; breath freshening preparations for personal hygiene; make-up powder; nail varnish removers; vaginal washes for personal sanitary or deodorant purposes; tissues impregnated with cosmetic lotions; tissues impregnated with make-up removing preparations; massage candles for cosmetic purposes; potpourris [fragrances]; bath salts, not for medical purposes; fumigation preparations [perfumes]; astringents for cosmetic purposes; eyebrow cosmetics; make-up preparations; sun-tanning preparations [cosmetics]; hair dyes; neutralizers for permanent waving; cosmetic preparations for eyelashes; cosmetic preparations for skin care; cosmetics; cosmetics for children; cosmetics for animals; mascara; cleansers for intimate personal hygiene purposes, non medicated; douching preparations for personal sanitary or deodorant purposes [toiletries]; bleaching preparations [decolorants] for cosmetic purposes; antiperspirants [toiletries]; toiletry preparations; phytocosmetic preparations; talcum powder, for toilet use; terpenes [essential oils]; henna [cosmetic dye]; shampoos for animals [non-medicated grooming preparations]; shampoos for pets [non-medicated grooming preparations]; dry shampoos; shampoos; herbal extracts for cosmetic purposes; extracts of flowers [perfumes]; ethereal essences; badian essence; mint essence [essential oil].

4 – Nightlights [candles]; perfumed candles; christmas tree candles; candles.

(260) AM 2020 105084 A

(800) 1489074

(151) 2019 07 29

(891) 2019 07 29

(731) C.P.C. Creative Perfume Company Holding SA

Rue du Mont-de-Sion 8, c/o Lenhill Partners SA, CH-1206 Genève, Switzerland

(540)

CHEEKY CHARLES

(591) Black, white

(511)

3 – Amber [perfume]; aromatics [essential oils]; air fragrancing preparations; cake flavorings [essential oils]; flavorings for beverages [essential oils]; food flavorings [essential oils]; breath freshening sprays; balms, other than for medical purposes; lip glosses; sachets for perfuming linen; scented water; Javelle water; lavender water; toilet water; depilatory wax;

mustache wax; massage gels, other than for medical purposes; heliotropine; make-up; deodorants for pets; deodorants for human beings or for animals; depilatory preparations; air fragrance reed diffusers; scented wood; perfumes; perfumery; decorative transfers for cosmetic purposes; ionone [perfumery]; eyebrow pencils; cosmetic pencils; adhesives for affixing false eyelashes; adhesives for affixing false hair; hair conditioners; beard dyes; cosmetic dyes; cosmetic creams; skin whitening creams; incense; hair spray; nail polish; hair lotions; lotions for cosmetic purposes; after-shave lotions; beauty masks; oils for perfumes and scents; oils for cosmetic purposes; oils for toilet purposes; essential oils; essential oils of cedarwood; essential oils of lemon; essential oils of citron; oils for cleaning purposes; bergamot oil; gaultheria oil; jasmine oil; lavender oil; almond oil; rose oil; almond milk for cosmetic purposes; cleansing milk for toilet purposes; musk [perfumery]; deodorant soap; shaving soap; soap for brightening textile; cakes of toilet soap; antiperspirant soap; soap for foot perspiration; soap; almond soap; mint for perfumery; cosmetic kits; eau de Cologne; bases for flower perfumes; joss sticks; dentifrices; lipstick cases; breath freshening strips; teeth whitening strips; lipsticks; pomades for cosmetic purposes; shaving preparations; cosmetic preparations for baths; bath preparations, not for medical purposes; hair straightening preparations; hair waving preparations; color-removing preparations; leather bleaching preparations; mouthwashes, not for medical purposes; cosmetic preparations for slimming purposes; make-up removing preparations; nail care preparations; collagen preparations for cosmetic purposes; aloe vera preparations for cosmetic purposes; sunscreen preparations; breath freshening preparations for personal hygiene; make-up powder; nail varnish removers; vaginal washes for personal sanitary or deodorant purposes; tissues impregnated with cosmetic lotions; tissues impregnated with make-up removing preparations; massage candles for cosmetic purposes; potpourris [fragrances]; bath salts, not for medical purposes; fumigation preparations [perfumes]; astringents for cosmetic purposes; eyebrow cosmetics; make-up preparations; sun-tanning preparations [cosmetics]; hair dyes; neutralizers for permanent waving; cosmetic preparations for eyelashes; cosmetic preparations for skin care; cosmetics; cosmetics for children; cosmetics for animals; mascara; cleansers for intimate personal hygiene purposes, non medicated; douching preparations for personal sanitary or deodorant purposes [toiletries]; bleaching preparations [decolorants] for cosmetic purposes; antiperspirants [toiletries]; toiletry preparations; phytocosmetic preparations; talcum powder, for toilet use; terpenes [essential oils]; henna [cosmetic dye]; shampoos for animals [non-medicated grooming preparations]; shampoos for pets [non-medicated grooming preparations]; dry shampoos; shampoos;

herbal extracts for cosmetic purposes; extracts of flowers [perfumes]; ethereal essences; badian essence; mint essence [essential oil].

4 – Nightlights [candles]; perfumed candles; Christmas tree candles; candles.

(260) AM 2020 105093 A

(800) 1489302

(151) 2019 07 02

(891) 2019 07 02

(731) ROMANOVA OLGA ALEKSANDROVNA

Beregovoy proezd, 5, korp. 1, kv. 194,

RU-121087 Moscow, Russian Federation

(540)

Romanovamakeup

(591) Black, white

(531) 27.05.01; 27.05.13

(511)

3 – Ambergris [perfume]; antistatic preparations for household purposes; aromatics [essential oils]; breath freshening sprays; balms, other than for medical purposes; lip gloss; petroleum jelly for cosmetic purposes; cotton wool for cosmetic purposes; adhesives for cosmetic purposes; scented water; Javelle water; lavender water; toilet water; depilatory wax; massage gels, other than for medical purposes; dental bleaching gels; makeup; deodorants for human beings or for animals; perfume; greases for cosmetic purposes; perfumery; decorative transfers for cosmetic purposes; ionone [perfumery]; eyebrow pencils; cosmetic pencils; adhesives for affixing false eyelashes; adhesives for affixing false hair; cosmetic dyes; creams for leather; polishing creams; cosmetic creams; skin whitening creams; hair sprays; nail polish; hair lotions; lotions for cosmetic purposes; aftershave lotions; cosmetic masks; perfume oils; cosmetic oils; oils for toilet purposes; essential oils; essential oils of cedarwood; essential oils of lemon; oils for cleaning purposes; bergamot oil; gaultheria oil; jasmine oil; lavender oil; almond oil; rose oil; oil of turpentine for degreasing; almond milk for cosmetic purposes; cleansing milk for toilet purposes; musk [perfumery]; soap; deodorant soap; shaving soap; cakes of toilet soap; antiperspirant soap; soap for foot perspiration; almond soap; mint for perfumery; cosmetic kits; nail art stickers; artificial nails; cologne; bases for flower perfumes; cotton swabs for cosmetic purposes; joss sticks; toothpastes; tooth powders; hydrogen peroxide for cosmetic purposes; breath freshening strips; lipstick; pomades for cosmetic purposes; shaving preparations; cosmetic preparations for baths; non-medicated toiletries; hair waving preparations; douching preparations for personal sanitary or deodorant purposes [toiletries]; bleaching preparations; leather bleaching preparations; mouth-

washes, not for medical purposes; cosmetic preparations for slimming purposes; paint stripping preparations; lacquer-removing preparations; make-up removing preparations; nail care preparations; cleaning preparations; aloe vera preparations for cosmetic purposes; sunscreen preparations; color-brightening chemicals for household purposes [laundry]; shining preparations [polish]; make-up powder; diamantine [abrasive]; stain removers; scouring solutions; artificial eyelashes; tissues impregnated with cosmetic lotions; potpourris [fragrances]; bath salts, not for medical purposes; astringents for cosmetic purposes; eyebrow cosmetics; make-up preparations; sun-tanning preparations [cosmetics]; hair dyes; neutralizers for permanent waving; cosmetics for eyelashes; depilatory preparations; cosmetic skin care products; cosmetics; mascara; bleaching preparations [decolorants] for cosmetic purposes; antiperspirants [toiletries]; terpenes [essential oils]; shampoos; dry shampoos; extracts of flowers [perfumes]; ethereal essences; badian essence; mint essence [essential oil].

35 – Advertising agencies; demonstration of goods; market research; business information; commercial information and advice for consumers [consumer advice shop]; business research; business management and organization consultancy; business organization consultancy; business management advice; marketing; business management of performing artists; organization of exhibitions for commercial or advertising purposes; organization of trade fairs for commercial or advertising purposes; shop window dressing; presentation of goods on communication media, for retail purposes; sales promotion for others; retail sale services; publication of advertising texts; radio advertising; sample distribution; dissemination of advertising matter; advertising; online advertising on a computer network; advertising by mail order; television advertising; administrative processing of purchase orders; procurement services for others [purchasing goods and services for other businesses].

(260) AM 2020 105099 A

(800) 1489415

(151) 2019 03 29

(891) 2019 03 29

(731) OOO "Mir Comforta"

Uralskaya Str., 25, RU-350059 Krasnodar,

Russian Federation

(540)

ROVEX

(591) Green

(531) 27.05.17; 29.01.03

(511)

11 – Steam accumulators; heat accumulators; desiccating apparatus; refrigerating apparatus and machines; drying apparatus and installations; hand drying apparatus for washrooms; tanning apparatus [sun beds]; ionization apparatus for the treatment of air or water; boilers, other than parts of machines; bath tubs; fans [air-conditioning]; fans [parts of air-conditioning installations]; water heaters [apparatus]; waffle irons, electric; electric fans for personal use; water heaters; air reheaters; gas condensers, other than parts of machines; extractor hoods for kitchens; grills [cooking appliances]; showers; hot water bottles; coils [parts of distilling, heating or cooling installations]; shower enclosures; refrigerating chambers; fireplaces, domestic; saucepans, electric; heating apparatus; air-conditioning apparatus; household air-conditioning apparatus, including cold or warm wall split air-conditioner, inverter wall split air-conditioner, window air-conditioner; semi-industrial air-conditioning apparatus, including cartridge air-conditioner, floor-to-ceiling air-conditioner, column air-conditioner, channel air-conditioner; heating boilers; coffee machines, electric; mixer faucets for water pipes; electric lamps; chandeliers; barbecues; immersion heaters; bread baking machines; heating apparatus; sauna bath installations; bath fittings; steam boilers, other than parts of machines; pasteurisers; stoves [heating apparatus]; hot air ovens; bakers' ovens; kitchen ranges [ovens]; microwave ovens [cooking apparatus]; heating plates; cookers; cooking rings; air purifying apparatus and machines; cooling appliances and installations; heating apparatus, electric; hot air apparatus; safety accessories for water or gas apparatus and pipes; regulating and safety accessories for water apparatus; water intake apparatus; radiators [heating]; radiators, electric; heat regenerators; sinks; lamps; sous-vide cookers, electric; air dryers; laundry dryers, electric; hair dryers; heat exchangers, other than parts of machines; bread toasters; toilets [water-closets]; flues for heating boilers; boiler pipes [tubes] for heating installations; toilet bowls; bath installations; air-conditioning installations; cooling installations for water; cooling installations for liquids; water purification installations; heating installations; purification installations for sewage; air filtering installations; ventilation [air-conditioning] installations and apparatus; water supply installations; cooking utensils, electric; fountains; deep fryers, electric; bread-making machines; refrigerators; kettles, electric; refrigerating cabinets; heating elements.

35 – Demonstration of goods; organization of exhibitions for commercial or advertising purposes; organization of trade fairs for commercial or advertising purposes; presentation on communication media, for retail purposes of goods specified in 11 class, namely, steam accumulators, heat accumulators,

desiccating apparatus, refrigerating apparatus and machines, drying apparatus and installations, hand drying apparatus for washrooms, tanning apparatus [sun beds], ionization apparatus for the treatment of air or water, boilers, other than parts of machines, bath tubs, fans [air-conditioning], fans [parts of air-conditioning installations], water heaters [apparatus], waffle irons, electric, electric fans for personal use, water heaters, air reheaters, gas condensers, other than parts of machines, extractor hoods for kitchens, grills [cooking appliances], showers, hot water bottles, coils [parts of distilling, heating or cooling installations], shower enclosures, refrigerating chambers, fireplaces, domestic, saucepans, electric, heating apparatus, air-conditioning apparatus, household air-conditioning apparatus, including cold or warm wall split air-conditioner, inverter wall split air-conditioner, window air-conditioner, semi-industrial air-conditioning apparatus, including cartridge air-conditioner, floor-to-ceiling air-conditioner, column air-conditioner, channel air-conditioner, heating boilers, coffee machines, electric, mixer faucets for water pipes, electric lamps, chandeliers, barbecues, immersion heaters, bread baking machines, heating apparatus, sauna bath installations, bath fittings, steam boilers, other than parts of machines, pasteurisers, stoves [heating apparatus], hot air ovens, bakers' ovens, kitchen ranges [ovens], microwave ovens [cooking apparatus], heating plates, cookers, cooking rings, air purifying apparatus and machines, cooling appliances and installations, heating apparatus, electric, hot air apparatus, safety accessories for water or gas apparatus and pipes, regulating and safety accessories for water apparatus, water intake apparatus, radiators [heating], radiators, electric, heat regenerators, sinks, lamps, sous-vide cookers, electric, air dryers, laundry dryers, electric, hair dryers, heat exchangers, other than parts of machines, bread toasters, toilets [water-closets], flues for heating boilers, boiler pipes [tubes] for heating installations, toilet bowls, bath installations, air-conditioning installations, cooling installations for water, cooling installations for liquids, water purification installations, heating installations, purification installations for sewage, air filtering installations, ventilation [air-conditioning] installations and apparatus, water supply installations, cooking utensils, electric, fountains, deep fryers, electric, bread-making machines, refrigerators, kettles, electric, refrigerating cabinets, heating elements; promoting the goods for others; advertising; on-line advertising on a computer network, also as a domain name; tele-marketing services; procurement services for others [purchasing goods and services for other businesses]; outsourcing services [business assistance]; on-line ordering services for goods specified in 11 class, namely, steam accumulators, heat accumulators, desiccating apparatus, refrigerating apparatus and machines, drying apparatus and installations, hand dry-

ing apparatus for washrooms, tanning apparatus [sun beds], ionization apparatus for the treatment of air or water, boilers, other than parts of machines, bath tubs, fans [air-conditioning], fans [parts of air-conditioning installations], water heaters [apparatus], waffle irons, electric, electric fans for personal use, water heaters, air reheaters, gas condensers, other than parts of machines, extractor hoods for kitchens, grills [cooking appliances], showers, hot water bottles, coils [parts of distilling, heating or cooling installations], shower enclosures, refrigerating chambers, fireplaces, domestic, saucepans, electric, heating apparatus, air-conditioning apparatus, household air-conditioning apparatus, including cold or warm wall split air-conditioner, inverter wall split air-conditioner, window air-conditioner, semi-industrial air-conditioning apparatus, including cartridge air-conditioner, floor-to-ceiling air-conditioner, column air-conditioner, channel air-conditioner, heating boilers, coffee machines, electric, mixer faucets for water pipes, electric lamps, chandeliers, barbecues, immersion heaters, bread baking machines, heating apparatus, sauna bath installations, bath fittings, steam boilers, other than parts of machines, pasteurisers, stoves [heating apparatus], hot air ovens, bakers' ovens, kitchen ranges [ovens], microwave ovens [cooking apparatus], heating plates, cookers, cooking rings, air purifying apparatus and machines, cooling appliances and installations, heating apparatus, electric, hot air apparatus, safety accessories for water or gas apparatus and pipes, regulating and safety accessories for water apparatus, water intake apparatus, radiators [heating], radiators, electric, heat regenerators, sinks, lamps, sous-vide cookers, electric, air dryers, laundry dryers, electric, hair dryers, heat exchangers, other than parts of machines, bread toasters, toilets [water-closets], flues for heating boilers, boiler pipes [tubes] for heating installations, toilet bowls, bath installations, air-conditioning installations, cooling installations for water, cooling installations for liquids, water purification installations, heating installations, purification installations for sewage, air filtering installations, ventilation [air-conditioning] installations and apparatus, water supply installations, cooking utensils, electric, fountains, deep fryers, electric, bread-making machines, refrigerators, kettles, electric, refrigerating cabinets, heating elements; retail or wholesale services for goods specified in 11 class, namely, steam accumulators, heat accumulators, desiccating apparatus, refrigerating apparatus and machines, drying apparatus and installations, hand drying apparatus for washrooms, tanning apparatus [sun beds], ionization apparatus for the treatment of air or water, boilers, other than parts of machines, bath tubs, fans [air-conditioning], fans [parts of air-conditioning installations], water heaters [apparatus], waffle irons, electric, electric fans for personal use, water heaters,

air reheaters, gas condensers, other than parts of machines, extractor hoods for kitchens, grills [cooking appliances], showers, hot water bottles, coils [parts of distilling, heating or cooling installations], shower enclosures, refrigerating chambers, fireplaces, domestic, saucepans, electric, heating apparatus, air-conditioning apparatus, household air-conditioning apparatus, including cold or warm wall split air-conditioner, inverter wall split air-conditioner, window air-conditioner, semi-industrial air-conditioning apparatus, including cartridge air-conditioner, floor-to-ceiling air-conditioner, column air-conditioner, channel air-conditioner, heating boilers, coffee machines, electric, mixer faucets for water pipes, electric lamps, chandeliers, barbecues, immersion heaters, bread baking machines, heating apparatus, sauna bath installations, bath fittings, steam boilers, other than parts of machines, pasteurisers, stoves [heating apparatus], hot air ovens, bakers' ovens, kitchen ranges [ovens], microwave ovens [cooking apparatus], heating plates, cookers, cooking rings, air purifying apparatus and machines, cooling appliances and installations, heating apparatus, electric, hot air apparatus, safety accessories for water or gas apparatus and pipes, regulating and safety accessories for water apparatus, water intake apparatus, radiators [heating], radiators, electric, heat regenerators, sinks, lamps, sous-vide cookers, electric, air dryers, laundry dryers, electric, hair dryers, heat exchangers, other than parts of machines, bread toasters, toilets [water-closets], flues for heating boilers, boiler pipes [tubes] for heating installations, toilet bowls, bath installations, air-conditioning installations, cooling installations for water, cooling installations for liquids, water purification installations, heating installations, purification installations for sewage, air filtering installations, ventilation [air-conditioning] installations and apparatus, water supply installations, cooking utensils, electric, fountains, deep fryers, electric, bread-making machines, refrigerators, kettles, electric, refrigerating cabinets, heating elements.

37 – Heating equipment installation and repair; furnace installation and repair; installation and repair of air-conditioning apparatus; freezing equipment installation and repair; electric appliance installation and repair; kitchen equipment installation.

(260) AM 2020 105167 A

(800) 1489812

(151) 2019 08 07

(891) 2019 08 07

(731) DREIMASTER MODEVERTRIEB GMBH
Osterfeldstrasse 12-14, 22529 Hamburg,
Germany

(540)



(591) Blue, white

(531) 02.01.01; 02.01.19; 02.01.23; 09.07.01;
10.01.11; 29.01.04

(511)

9 – Sunglasses.

14 – Imitation jewellery, namely rings, keyrings, earrings, cuff links, bracelets, charms, brooches, chains, necklaces, tie pins, pins, medallions.

18 – Leather and imitations of leather as well as goods from leather and imitations of leather, namely shopping bags, cross-body bags, shoulder bags, handbags, evening bags, sports bags, beach bags, school satchels, shoulder straps, suitcases, hatboxes, attaché cases, travel garment covers, bags, neck pouches, toiletry bags, shoe bags for travel, sports packs, school backpacks; small leather goods, namely card cases [note cases], identity card cases; bags made of textile, leather and materials similar to leather, included in this class; wallets; rucksacks; suitcases; travelling bags; umbrellas; attaché cases; pocket wallets; college briefcases (included in this class); cosmetic bags and vanity cases, not fitted.

25 – Clothing, in particular women's and men's outer clothing; blouses; costumes; dresses; skirts; jackets; trousers; shirts; pullovers; ties; coats; neck scarfs [mufflers]; gloves; stockings; underwear; t-shirts; polo shirts; sports clothing; bathing suits; leather clothing; headgear; shoes; boots; belts.

(260) AM 2020 105168 A

(800) 1489819

(151) 2019 04 11

(891) 2019 04 11

(731) TEKA INDUSTRIAL, S.A.

Cajo, 17, E-39011 Santander (Cantabria),
Spain

(540)



(591) Red and white

(531) 26.04.05; 26.04.22; 26.04.24; 27.05.09;
27.05.10; 27.05.24; 29.01.12

(511)

6 – Common metals and their alloys; metal building materials; transportable buildings of metal; materials of metal for railway tracks; non-electric cables and wires of common metal; ironmongery; small items of metal hardware; pipes and tubes of metal; ores.

7 – Food and beverage processing and preparation machines and apparatus; packaging machines; sweeping, cleaning, washing and laundering machines; motors and engines (except for land vehicles); machine coupling and transmission components (except for land vehicles); agricultural implements other than hand-operated; incubators for eggs; clothes washing machines; dishwashers and dish dryers; drain cocks; water heaters [parts of machines]; mixers [machines].

11 – Apparatus for lighting, heating, steam generating, cooking, refrigerating, drying, ventilating, water supply and sanitary purposes, in particular for use in commercial kitchens; electric and gas apparatus for kitchen and industrial kitchen installations, namely cookers, bread ovens, hobs, cooking ranges, steam apparatus, microwave ovens, plate warmers, extractor hoods, refrigeration and freezing apparatus, cooking and roasting apparatus, and automatic cooking and roasting machines, deep fryers, electric pressure cookers, pressure cooking saucepans, automatic fermentation apparatus, blast chillers; electrical and gas apparatus for kitchen and industrial kitchen installations, namely blast freezers, cooling tables, grills (kitchen appliances), banquet systems; systems for distributing plates and systems for storing and serving foodstuffs and prepared dishes, formed of apparatus for lighting, heating, steam generating, cooking, refrigerating, drying, ventilating or water supply purposes or fermentation apparatus or deep fryers or electric pressure cookers or electric pressure cooking saucepans; systems for distributing plates and systems for storing and serving foods and prepared dishes, formed of automatic fermentation apparatus or blast chillers or blast freezers or refrigerators and freezers or cooling tables or gas and electrical apparatus; parts and accessories for the aforesaid goods; anti-splash tap nozzles; bath fittings; taps [cocks, spigots] faucets [am] for pipes; feeding apparatus for heating boilers; filters for drinking water; fire bars; ovens (shaped fittings for -); kiln furniture [supports]; loading apparatus for furnaces; mixer taps for water pipes; oven fittings made of fireclay; regulating accessories for water apparatus and pipes; safety accessories for water or gas apparatus and pipes; framework of metal for ovens; taps [faucets]; toilet seats; washers for water taps; water-pipes for sanitary installations; hot air bath

fittings; regulating and safety accessories for water apparatus; extractor hoods; ventilation hoods for stoves; adjustable coated baffle grease filters [parts of cooker hoods]; filters [parts of household or industrial installations].

37 – Repairs of mixers (machines), incubators for eggs, washing machines, dishwashers and tumble dryers, electric door closers, electric door openers, drain cocks, water heaters (parts of machines), apparatus for lighting, heating, steam generating, cooking, refrigerating, drying, ventilating, water supply and sanitary purposes, in particular for industrial kitchens, electric and gas apparatus for kitchen and industrial kitchen installations; repairs of systems for distributing plates and systems for storing and serving foodstuffs and prepared dishes, formed of automatic fermentation apparatus or blast chillers or blast freezers or refrigerators and freezers or cooling tables or gas and electrical apparatus, anti-splash tap nozzles, bath fittings, pipe line cocks [spigots], feeding apparatus for heating boilers, filters for drinking water; repairs of furnace grates, shaped fittings for furnaces, kiln furniture, loading apparatus for furnaces, mixer taps for water pipes, oven fittings made of fireclay, regulating accessories for water apparatus and pipes, safety accessories for water or gas apparatus and pipes, structural plates for ovens, taps, toilet seats, washers for water taps, pipes (parts of sanitary installations), hot air bath fittings, pipe line cocks, furnace grates, fire bars; repairs of aerators for taps, regulating and safety accessories for water apparatus, extractor hoods for kitchens, ventilation hoods for kitchens, adjustable coated baffle grease filters (parts of cooker hoods), filters (parts of household or industrial installations); installation of incubators for eggs, washing machines, dishwashers and tumble dryers, electric door closers, electric door openers, drain cocks, water heaters (parts of machines), apparatus for lighting, heating, steam generating, cooking, refrigerating, drying, ventilating, water supply and sanitary purposes, in particular for industrial kitchens, electric and gas apparatus for kitchen and industrial kitchen installations; installation of systems for distributing plates and systems for storing and serving foodstuffs and prepared dishes, formed of automatic fermentation apparatus or blast chillers or blast freezers or refrigerators and freezers or cooling tables or gas and electrical apparatus, anti-splash tap nozzles, bath fittings, pipe line cocks [spigots], feeding apparatus for heating boilers, filters for drinking water, furnace grates, shaped fittings for furnaces; installation of kiln furniture, loading apparatus for furnaces, mixer taps for water pipes, oven fittings made of fireclay, regulating accessories for water apparatus and pipes, safety accessories for water or gas apparatus and pipes, structural plates for ovens, taps, toilet seats, washers for water taps, pipes (parts of sanitary installations), hot

air bath fittings, pipe line cocks, furnace grates, fire bars, aerators for taps, regulating and safety accessories for water apparatus; installation of extractor hoods for kitchens, ventilation hoods for kitchens, adjustable coated baffle grease filters (parts of cooker hoods), filters (parts of household or industrial installations) and mixers (machines); machinery installation, maintenance and repair; office machines and equipment installation, maintenance and repair; repair information.

(260) AM 2020 105169 A

(800) 1489823

(151) 2019 07 23

(891) 2019 07 23

(731) HUAWEI TECHNOLOGIES CO., LTD.
HUAWEI ADMINISTRATION BUILDING,
BANTIAN, LONGGANG DISTRICT,
SHENZHEN, 518129 GUANGDONG,
China

(540)

HUAWEI Mate V

(591) Black, white

(531) 27.05.01

(511)

9 – Notebook computers; laptop computers; wearable computers; computer software for creating and editing music and sound; personal digital assistants [PDAs]; computer memory devices; computer keyboards; interactive touch screen terminals; thin client computers; humanoid robots with artificial intelligence; computer software applications, downloadable; downloadable mobile applications; tablet computers; downloadable graphics for mobile phones; computer screen saver software, recorded or downloadable; computer software platforms, recorded or downloadable; computer programmes [programs], recorded; hand-held electronic dictionaries; smart rings; smart watches; smart glasses; face recognition device; handprint reading machines; scales; scales with body mass analyzers; wearable activity trackers; switchboards; selfie sticks [hand-held monopods]; stands for mobile phones; telecommunication apparatus in the form of jewelry; equipment for communication network; smartphones; protective films adapted for smartphones; cases for smartphones; covers for smartphones; security surveillance robots; portable media players; wearable video display monitors; television apparatus; earphones; microphones; camcorders; sound transmitting apparatus; video monitoring devices; virtual reality headsets; loudspeakers; cabinets for loudspeakers; cameras [photography]; selfie lenses; teaching robots; gas testing instruments; biochips; laboratory robots; digital weather stations; optical lenses; USB cables; USB cables for mobile phone; plugs, sockets and other

contacts [electric connections]; touch screen; electronic chips; integrated circuits; video screens; batteries, electric.

(260) AM 2020 105170 A

(800) 1489844

(151) 2019 07 23

(891) 2019 07 23

(731) HUAWEI TECHNOLOGIES CO., LTD.
HUAWEI ADMINISTRATION BUILDING,
BANTIAN, LONGGANG DISTRICT,
SHENZHEN, 518129 GUANGDONG,
China

(540)

HUAWEI Mate Fold

(591) Black, white

(531) 27.05.01

(511)

9 – Notebook computers; laptop computers; wearable computers; computer software for creating and editing music and sound; personal digital assistants [PDAs]; computer memory devices; computer keyboards; interactive touch screen terminals; thin client computers; humanoid robots with artificial intelligence; computer software applications, downloadable; downloadable mobile applications; tablet computers; downloadable graphics for mobile phones; computer screen saver software, recorded or downloadable; computer software platforms, recorded or downloadable; computer programmes [programs], recorded; hand-held electronic dictionaries; smart rings; smart watches; smart glasses; face recognition device; handprint reading machines; scales; scales with body mass analyzers; wearable activity trackers; switchboards; selfie sticks [hand-held monopods]; stands for mobile phones; telecommunication apparatus in the form of jewelry; equipment for communication network; smartphones; protective films adapted for smartphones; cases for smartphones; covers for smartphones; security surveillance robots; portable media players; wearable video display monitors; television apparatus; earphones; microphones; camcorders; sound transmitting apparatus; video monitoring devices; virtual reality headsets; loudspeakers; cabinets for loudspeakers; cameras [photography]; selfie lenses; teaching robots; gas testing instruments; biochips; laboratory robots; digital weather stations; optical lenses; USB cables; USB cables for mobile phone; plugs, sockets and other contacts [electric connections]; touch screen; electronic chips; integrated circuits; video screens; batteries, electric.

(260) AM 2020 105171 A

(800) 1489850

(151) 2019 07 23

(891) 2019 07 23

(731) HUAWEI TECHNOLOGIES CO., LTD.
HUAWEI ADMINISTRATION BUILDING,
BANTIAN, LONGGANG DISTRICT,
SHENZHEN, 518129 GUANGDONG,
China

(540)

HUAWEI Mate F

(591) Black, white

(531) 27.05.01

(511)

9 – Notebook computers; laptop computers; wearable computers; computer software for creating and editing music and sound; personal digital assistants [PDAs]; computer memory devices; computer keyboards; interactive touch screen terminals; thin client computers; humanoid robots with artificial intelligence; computer software applications, downloadable; downloadable mobile applications; tablet computers; downloadable graphics for mobile phones; computer screen saver software, recorded or downloadable; computer software platforms, recorded or downloadable; computer programmes [programs], recorded; hand-held electronic dictionaries; smart rings; smart watches; smart glasses; face recognition device; handprint reading machines; scales; scales with body mass analyzers; wearable activity trackers; switchboards; selfie sticks [hand-held monopods]; stands for mobile phones; telecommunication apparatus in the form of jewelry; equipment for communication network; smartphones; protective films adapted for smartphones; cases for smartphones; covers for smartphones; security surveillance robots; portable media players; wearable video display monitors; television apparatus; earphones; microphones; camcorders; sound transmitting apparatus; video monitoring devices; virtual reality headsets; loudspeakers; cabinets for loudspeakers; cameras [photography]; selfie lenses; teaching robots; gas testing instruments; biochips; laboratory robots; digital weather stations; optical lenses; USB cables; USB cables for mobile phone; plugs, sockets and other contacts [electric connections]; touch screen; electronic chips; integrated circuits; video screens; batteries, electric.

(260) AM 2020 105172 A

(800) 1489883

(151) 2019 06 24

(891) 2019 06 24

(731) LISTER PETER IPR HOLDINGS LIMITED
Wessex House, Teign Road, Newton
Abbot, Devon TQ12 4AA, United
Kingdom

(540)



(591) Black, white
 (531) 26.04.04; 26.04.11; 27.05.19
 (511)
 7 – Internal combustion engines for power generation, other than for land vehicles; electric current generators; pumps; parts and fittings for all the aforesaid goods.
 12 – Engines for land vehicles; internal combustion engines for land vehicles.

(260) AM 2020 105174 A
 (800) 1490020
 (151) 2019 08 15
 (891) 2019 08 15
 (731) FORMULA ONE LICENSING B.V.
 Beursplein 37, NL-3011 AA Rotterdam,
 Netherlands

(540)



(591) Black, white
 (531) 26.03.23; 27.05.01; 27.05.17; 27.05.22;
 27.07.01
 (511)
 10 – Ear defenders; ear plugs; ear protection devices; protective ear plugs; ear plugs for protection against noise; ear plugs for sleeping; ear plugs for sound-proofing; noise protection means in the form of deformable ear plugs; hearing protectors; hearing protection devices; hearing protectors without the ability to reproduce or transmit sound.

(260) AM 2020 105175 A
 (800) 1490026
 (151) 2019 07 09
 (891) 2019 07 09
 (731) GRINDEKS, AS
 Krustpils iela 53, LV-1057 Rīga, Latvia

(540)

Разорви замкнутый
 круг! ВЕНЛАКСОР

(591) Black, white
 (531) 28.05
 (511)
 5 – Pharmaceutical preparations; veterinary preparations.
 35 – Advertising.

(260) AM 2020 105177 A
 (800) 1490064
 (151) 2019 08 01
 (891) 2019 08 01
 (731) LVMH FRAGRANCE BRANDS
 77 rue Anatole France, F-92300 Levallois-
 Perret, France

(540)

IRRESISTIBLE GIVENCHY

(591) Black, white
 (511)
 3 – Toilet soaps; perfumes; eaux de parfum; eaux de Cologne; eaux de toilette; cosmetic products; essential oils for personal use; face and body milks, lotions, creams, emulsions, gels for cosmetic use; deodorants for personal use.

(260) AM 2020 105180 A
 (800) 1490099
 (151) 2019 08 21
 (891) 2019 08 21
 (731) GUANGZHOU HAVIT TECHNOLOGY
 COMPANY LIMITED
 RMS. 1307, Poly World Trade Center, Phase
 2, No. 1000 Xingang Dong Road, Haizhu
 District, Guangzhou City, China

(540)

Hakii

(591) Black, white
 (511)
 9 – Smartwatches [data processing]; protective films adapted for smartphones; portable media players; covers for smartphones; cell phone straps; microphones; mobile power [rechargeable batteries]; wearable activity trackers; couplers [data processing equipment]; camcorders; computer peripheral devices; virtual reality headsets; selfie sticks [hand-held monopods]; audio- and video-receivers; cabinets for loudspeakers; earphones; chargers for electric batteries; sockets, plugs and other contacts [electric connectors].

(260) AM 2020 105181 A
 (800) 1490130
 (151) 2019 07 18
 (891) 2019 07 18
 (731) S-Oil Corporation
 Baekbeom-ro 192 (Gongduk-dong), Mapo-gu,
 Seoul, Republic of Korea
 (540)



(591) Yellow and Green
 (531) 01.03.02; 01.15.15; 01.15.23; 04.05.05;
 27.05.01; 29.01.12

(511)
 4 – Industrial oil; industrial grease; lubricating oil;
 fuels; candles and wicks for lighting; industrial oils
 and fats; dust removing preparations; lubricants;
 grease for boots; oils for the preservation of leather;
 lamp wicks; electrical energy; solid fuels; gas fuels;
 liquid fuels; wax featuring of raw material; illumina-
 ting wax; fuel for lighters; tinder.

35 – Import-export agencies; sales promotion for oth-
 ers; administrative processing of purchase orders;
 marketing; demonstration of goods; business inter-
 mediary and advisory services; retail store services
 featuring liquid fuels.

(260) AM 2020 105186 A
 (800) 1490278
 (151) 2019 05 13
 (891) 2019 05 13
 (731) VIENNA INSURANCE GROUP AG Wiener
 Versicherung Gruppe
 Schottenring 30, A-1010 Wien, Austria
 (540)



MyGPI

(591) White, red and black

(531) 05.01.03; 05.01.05; 05.01.16; 26.03.07;
 26.03.15; 26.04.15; 26.11.08; 28.19; 29.01.13
 (511)
 36 – Safe deposit services; insurance services; fund-
 raising and sponsorship; real estate services; fundrai-
 sing and financial sponsorship, valuation services;
 financial and monetary services and banking; safe
 deposit services; issuance of prepaid cards and to-
 kens of value.

(260) AM 2020 105189 A
 (800) 1490326
 (151) 2018 12 14
 (891) 2018 12 14
 (731) CHRISTIAN LAURENT Sp. z o.o.
 ul. PIĘKNA 24/26A /1, PL-00-549 Warszawa,
 Poland
 (540)



(591) Gold and black
 (531) 03.11.07; 03.11.24; 27.05.10; 29.01.12
 (511)

3 – Non-medicated beauty preparations; body
 scrubs; creams for cellulite reduction; artificial tan-
 ning preparations; exfoliants; body cleaning and
 beauty care preparations; after-sun lotions; nail var-
 nish for cosmetic purposes; sun-tanning oils; lotions
 for cellulite reduction; after sun moisturisers; exfo-
 liants for the care of the skin; make-up removing
 preparations; hair preparations and treatments; nail
 hardeners [cosmetics]; creams for firming the skin;
 sun-tanning gels; slimming aids [cosmetics], other
 than for medical use; soaps for body care; hair pre-
 parations and treatments; cosmetics for use on the
 hair; cosmetic moisturisers; cuticle oil; creams for
 tanning the skin; cosmetics for use in the treatment
 of wrinkled skin; washing creams; nail varnish re-
 movers; douching preparations for personal sanitary
 or deodorant purposes [toiletries]; cosmetics; tooth
 care preparations; washing liquids; wipes impregna-
 ted with a skin cleanser; after-sun oils [cosmetics];
 skin conditioners; nail care preparations; soap free
 washing emulsions for the body; hair nourishers;
 skin cleansers [cosmetic]; make-up preparations;
 skin care preparations; cakes of toilet soap; cosmetic
 preparations for skin care; nail varnish; sun-tanning
 gels; non-medicated toilet soaps; exfoliant creams;

skin whitening creams; styling lotions; hair styling lotions; shampoos; hair moisturisers.

(260) AM 2020 105190 A
 (800) 1490328
 (151) 2019 08 15
 (891) 2019 08 15
 (731) DVA International GmbH
 Valentinskamp 70, 20355 Hamburg, Germany
 (540)

DVA

(591) Black, white
 (511)
 1 – Agricultural chemicals; horticultural chemicals; industrial chemicals; chemical preservatives for the food industry; food preserving chemicals; chemical fertilizers; chemicals for use in agriculture, horticulture and forestry; plastics (unprocessed); dispersions of plastics.
 5 – Pharmaceuticals; veterinary preparations; adjuvants for veterinary purposes; herbicides; vitamins.

(260) AM 2020 105194 A
 (800) 1490488
 (151) 2019 07 04
 (891) 2019 07 04
 (731) SHENZHEN KTC TECHNOLOGY CO., LTD
 Floor 1-5, Building 1, No. 4023 Wuhe Avenue, Gangtou Community, Bantian Street, Longgang District, Shenzhen, Guangdong, China
 (540)

Horion

(591) Black, white
 (531) 27.05; 27.05.01
 (511)
 9 – Animated cartoons; remote control apparatus; wires, electric; computer peripheral devices; video screens; pedometers; electronic tags for goods; television apparatus; ticket dispensers; cameras [photography]; electronic interactive whiteboards; interactive touch screen terminals; computer software, recorded; computer software applications, downloadable; cabinets for loudspeakers; wearable video display monitors; microphones; transparency projection apparatus; projection screens; electronic numeric displays; monitors [computer hardware]; monitors [computer programs]; electronic pens [visual display units]; audio- and video-receivers; headphones.

(260) AM 2020 105203 A
 (800) 1248737
 (151) 2015 04 09
 (891) 2019 08 12
 (731) BASF SE
 Carl-Bosch-Strasse 38, 67063 Ludwigshafen am Rhein, Germany
 (540)

REVYSOL

(591) Black, white
 (511)
 5 – Fungicides, herbicides.

(260) AM 2020 105204 A
 (800) 1391348
 (151) 2017 06 27
 (891) 2019 08 21
 (731) MAMMOET HOLDING B.V.
 Van Deventerlaan 30-40, NL-3528 AE UTRECHT, Netherlands
 (540)

MAMMOET

(591) Black, white
 (511)
 28 – Toys and models, including reproductions of machines and vehicles, (driving) toy cars, not being tractive toys, pedal quads, skelters, trailers for skelters, tractive cars, trikes, duo-trikes (side spans), shuttles, steps, cargo bikes, steering cars, buggy carts; toy wheelbarrows, toy dump trucks, toy excavators, toy winches, toy cranes, towing, walking and push toys.

(260) AM 2020 105206 A
 (800) 1418048
 (151) 2018 02 16
 (891) 2019 08 05
 (731) H.S.A. HAIR STYLING APPLICATIONS SPA
 Via dei Carantani, 1, I-21100 VARESE, Italy
 (540)

GUUDCURE

(591) Black, white
 (531) 27.05.01
 (511)
 3 – Toilet water; hair conditioners; make-up powder; hair dyes; colorants for toilet purposes; cosmetics; cosmetic creams; dentifrices; deodorants for human beings or for animals; hair spray; cleansing milk for toilet purposes; after-shave lotions; hair lotions; lotions for cosmetic purposes; lip glosses; mascara; beauty masks; eyebrow pencils; cosmetic pencils; decorative transfers for cosmetic purposes; cosmetic

kits; oils for toilet purposes; essential oils; oils for cosmetic purposes; cotton wool for cosmetic purposes; pomades for cosmetic purposes; potpourris [fragrances]; sun-tanning preparations [cosmetics]; cosmetic preparations for baths; collagen preparations for cosmetic purposes; douching preparations for personal sanitary or deodorant purposes [toilettries]; bath preparations, not for medical purposes; hair straightening preparations; hair waving preparations; cosmetic preparations for slimming purposes; cosmetic preparations for skin care; depilatory preparations; perfumery; antiperspirants [toilettries]; make-up preparations; nail care preparations; make-up removing preparations; lacquer-removing preparations; color-removing preparations; perfumes; lipsticks; air fragrancing preparations; bath salts, not for medical purposes; tissues impregnated with make-up removing preparations; shaving soap; cakes of toilet soap; soap; soap for foot perspiration; antiperspirant soap; deodorant soap; shampoos; dry shampoos; nail polish; talcum powder, for toilet use; cosmetic dyes; tissues impregnated with cosmetic lotions; make-up; false nails; massage gels, other than for medical purposes; balms, other than for medical purposes; toiletry preparations.

(260) AM 2020 105261 A

(800) 1490721

(151) 2019 07 12

(891) 2019 07 12

(731) ŠKODA AUTO a.s.

Tř. Václava Klementa 869, Mladá Boleslav II,
CZ-293 01 Mladá Boleslav, Czech Republic

(540)



(591) Black, white

(531) 24.15.21; 26.03.23

(511)

9 – Recorded content; information technology and audiovisual equipment; magnets, magnetizers and demagnetizers; apparatus, instruments and cables for electricity; optical devices, enhancers and correctors; safety, security, protection and signaling devices; diving equipment; navigation, guidance, tracking, targeting and map making devices; measuring, detecting and monitoring instruments, indicators and controllers; scientific research and laboratory apparatus, educational apparatus and simulators; scientific, nautical, surveying, photographic, cinematographic, electric weighing, measuring, signaling, checking (supervision), life-saving apparatus and instruments,

included in this class; contact lenses; spectacles; spectacle cases; binoculars; magnifying glasses; sunglasses; vehicle breakdown warning triangles; vehicle breakdown warning lamps other than parts of vehicles; electric batteries and their parts; electric accumulators and their parts; fuel cells and their parts; solar batteries; electric batteries for vehicles; electric accumulators for vehicles; chargers for electric batteries; burglar alarms; fire alarms; smoke alarms; gas alarms; anti-theft warning apparatus; fire extinguishing apparatus; scales; spirit levels; compasses [measuring instruments]; rulers (measuring instruments), acid hydrometers; quantity indicators; electronic control mechanisms and power and voltage supply units for vehicle headlights and their parts; light-emitting diodes [LEDs]; electronic power controllers; electrical and electronic control apparatus and instruments; simulators for the steering and control of vehicles; voltage regulators for vehicles; speed indicators; revolution counters; measuring apparatus and instruments; lifesaving apparatus and equipment, namely life-saving rafts, fire escapes, safety nets, safety tarpaulins, life belts, life buoys, life jackets; electric fuses; electric relays; lasers not for medical purposes; laser pointers; remote controlling apparatus; remote controls; aerials; navigation apparatus for vehicles; mobile telephones; telephone apparatus; television apparatus; video telephones; radios; compasses; navigation systems; navigational instruments; telematic apparatus; telematic terminal apparatus; apparatus and instruments for conducting, switching, transforming, accumulating, regulating and controlling electricity; apparatus for recording, transmission and/or reproduction of sound and images; magnetic, electronic and optical data carriers; phonograph records; compact discs; DVDs; digital recording apparatus; sound carriers; coin-operated juke-boxes; compact discs [read-only memory]; downloadable music files; audio headphones; loudspeakers; cabinets for loudspeakers; illuminated signs; compact disc players; DVD players; video telephones; phototelegraphy apparatus; projection apparatus; cameras [photography]; exposed films; cinematographic cameras; photocopiers; electronic translation apparatus (computer); pocket translators, electronic; encoded magnetic cards; integrated circuit cards (smart cards); encoded telephone cards; mechanisms for coin operated apparatus; automatic banking machines; cash registers; calculators; data processing apparatus; computers; electronic calendars and organizers; facsimile apparatus; monitors (computer hardware and computer programs for); computer peripheral devices; computer programs for use in autonomous driving of vehicles; computer programs for use in the autonomous navigation of vehicles; computer programs for use in autonomous control of vehicles; recorded and downloadable computer programs, especially collected data recorded on data carriers; computer software; application software; poc-

ket calculators; downloadable electronic publications; downloadable image files; crash test dummies; microscopes; electric cables; sockets, plugs and other contacts [electric connections]; igniting apparatus, electric, for igniting at a distance; radiological apparatus for industrial purposes; protective helmets; electric locks; electronic controllers; electronic control systems; parts and fittings of all aforesaid goods, included in this class.

12 – Vehicles and conveyances; vehicles for locomotion by land, air, water or rail and their parts; motorized land vehicles; driverless cars [autonomous cars]; motors and engines for land vehicles; propulsion mechanisms for land vehicles; vehicle chassis; vehicle bodies; couplings for land vehicles; suspension shock absorbers for vehicles; shock absorbing springs for vehicles; pneumatic tires; tires for vehicle wheels; rims for vehicle wheels; tires, solid, for vehicle wheels; wheels for vehicles; hubs for vehicle wheels; inner tubes for pneumatic tires; repair outfits for inner tubes; adhesive rubber patches for repairing inner tubes; spikes for tires; anti-skid chains; non-skid devices for vehicle tires; vehicle seats; rearview mirrors; head-rests for vehicle seats; anti-theft alarms for land vehicles; anti-theft devices for vehicles; cigar lighters for automobiles; motor cars; automobiles; trucks; trailers and semi-trailers for vehicles; trailer hitches for vehicles; omnibuses; motorcycles; mopeds; bicycles; cable transport apparatus and installation; carts; trolleys; air vehicles; boats; ships; locomotives; motorbuses; caravans; tractors; cycles, scooters [vehicles]; chairlifts; funiculars; wheelchairs; parts and fittings of all the aforesaid goods, included in this class.

36 – Insurance services; pawn brokerage; issuance of prepaid cards and tokens of value; safe deposit services; financial and monetary services and banking; fundraising and sponsorship; valuation services; insurance brokerage; financial affairs; monetary affairs; issuance of credit cards; loans (financing); installment loans; credit bureaus; financial consultancy; banking; financing services; finance-leasing, finance-leasing of vehicles; financial sponsorship; repair costs evaluation [financial appraisal]; installment loans for land vehicles; saving bank services; services of an insurance agent; services of a financing broker; services of an estate agent; stocks and bonds brokerage; brokerage of carbon credits; insurance consultancy; health insurance underwriting; accident insurance underwriting; antique appraisal; brokerage; surety services; charitable fund raising; factoring; lending against security; advice, consultancy and information for the aforesaid, included in this class; all aforementioned services not in the field of real estate.

37 – Building, construction and demolition; rental of tools, plant and equipment for construction and de-

molition; mining, oil and gas extraction; extermination and pest control (except for agriculture, horticulture and forestry purposes) as well as disinfection; reconstruction, repair, dismantling, maintenance and servicing of vehicles; vehicle repair in the course of vehicle breakdown service; customized carrying out of alterations on body, chassis and motor of motor vehicles (tuning), included in this class; varnishing of vehicles; vehicle polishing; anti-rust treatments for vehicles; vehicle maintenance; vehicle cleaning; retreading of tires; boiler and burner maintenance, cleaning and repair; repair information; construction information; installation of doors and windows; quarrying services; machinery installation, maintenance and repair; airplane maintenance and repair; shipbuilding; photographic apparatus repair; clock and watch repair; repair of security locks; rust proofing; furniture maintenance; leather care, cleaning and repair; disinfecting; burglar alarm installation and repair; advice, consultancy and information for the aforesaid, included in this class.

38 – Telecommunication services; telecommunication; collecting and providing news [news agencies]; services of news agencies; telecommunication via platforms and portals and the Internet; provision of access to the Internet; electronic exchange of news via chatlines, chatrooms and electronic bulletin boards, email-services; rental of telecommunication equipment; radio and television broadcasting; electronic mail; information about telecommunication; providing access to a worldwide computer network; providing telecommunications connections to a global computer network; providing access to computer programs on data networks; providing chatrooms on the internet; videoconferencing; wireless mobile phone services; computer aided transmission of messages and images; paging services by radio, telephone or other electronic communications systems; satellite transmission; telephone services; telephone exchange services; message transmission services; rental of telecommunications equipment; leasing access time to global computer networks; providing access to databases; telematics services; telematic communication services; telematic data transmission and file transfer; advice, consultancy and information for the aforesaid, included in this class.

39 – Transport; packaging and storage of goods; travel arrangement; towing; taxi transport; car transport; transportation logistics; rental of vehicles, especially automobiles; transport of people, especially by motor buses; services of a freight agent; delivery of goods and parcels; traffic information services; controlling of fleet vehicles using navigational and positioning apparatus.

(260) AM 2020 105262 A
 (800) 1490746
 (151) 2019 05 13
 (891) 2019 05 13
 (731) VIENNA INSURANCE GROUP AG, Wiener
 Versicherung Gruppe
 Schottenring 30, A-1010 Wien, Austria
 (540)



(591) White, blue, red and black
 (531) 05.01.05; 05.01.16; 26.03.15; 26.11.08;
 27.05.10; 27.05.11; 29.01.14
 (511)
 36 – Safe deposit services; insurance services; fund-
 raising and sponsorship; real estate services; fund-
 raising and financial sponsorship; valuation services;
 financial and monetary services, and banking; safe
 deposit services; issuance of prepaid cards and to-
 kens of value.

(260) AM 2020 105263 A
 (800) 1490763
 (151) 2019 05 13
 (891) 2019 05 13
 (731) VIENNA INSURANCE GROUP AG Wiener
 Versicherung Gruppe
 Schottenring 30, A-1010 Wien, Austria
 (540)



(591) White, blue, red and black
 (531) 05.01.05; 05.01.16; 26.03.01; 26.03.15;
 26.11.08; 28.19; 29.01.14
 (511)
 36 – Safe deposit services; insurance services; fund-
 raising and sponsorship; real estate services; fund-
 raising and financial sponsorship; valuation services;
 financial and monetary services, and banking; safe
 deposit services; issuance of prepaid cards and to-
 kens of value.

(260) AM 2020 105265 A
 (800) 1490780
 (151) 2019 07 16
 (891) 2019 07 16
 (731) ÖMER ALAETTİNOĞLU

Osmanağa Mahallesi, Osmancık Sokak,
 Tavukçuoğlu İş Apartmanı, No: 13/15,
 Kadıköy, İstanbul, Turkey

(540)



(591) Purple and black
 (531) 26.04.04; 26.04.09; 26.13.25; 27.05.01;
 29.01.13
 (511)
 43 – Temporary accommodation.

(260) AM 2020 105273 A
 (800) 1490923
 (151) 2019 05 17
 (891) 2019 05 17
 (731) ADP GAUSELMANN GMBH
 Merkur-Allee 1-15, 32339 Espelkamp,
 Germany

(540)

Witch Gone Wild

(591) Black, white
 (511)
 9 – Computer software; coin-operated mechanisms;
 computer and video game software; games software
 in particular for use on any computer platform, in-
 cluding electronic entertainment and games consoles;
 computer game programs; video games (software);
 computer games provided through a global computer
 network or supplied by means of multi-media elec-
 tronic broadcast or through telecommunications or
 electronic transmission or via the internet; computer
 games, leisure and recreational software, video ga-
 mes and computer software, all being provided in
 the form of storage media; programs for operating
 electric and electronic apparatus for games, enterta-
 inment and/or amusement purposes; computer soft-
 ware for computer games on the internet; online ga-
 mes (software), in particular for online betting ga-
 mes, online prize games, online gambling games,
 online games of skill and online casino games; co-
 mputer software in the form of an app for mobile de-
 vices and computers; calculating apparatus in coin-
 operated machines and parts for the aforesaid goods;
 electric, electronic, optical or automatic apparatus,
 for identifying data carriers, identity cards and credit
 cards, bank notes and coins; software in particular
 for casino and/or amusement arcade games, for ga-
 ming machines and/or slot machines each one with
 or without prize payouts; gaming software that gene-
 rates or displays wager outcomes of gaming machi-
 nes; operational computer games software; computer
 software for managing of games (game collection);

computer programs for video games; computer video game software.

28 – Games; toys; gaming apparatus (including coin-operated apparatus); coin-operated arcade games (machines); games for amusement arcades (included in this class); coin-operated video gaming apparatus; video games apparatus adapted for use with external screens or monitors only; casino fittings, namely roulette tables, roulette wheels; coin-operated automatic gaming machines and gaming machines, in particular for gaming arcades, with or without a prize payout; electronic or electrotechnical gaming apparatus, automatic gaming machines, gaming machines, slot machines operated by coins, tokens, banknotes, tickets or by means of electronic, magnetic or biometric storage media, in particular for commercial use in casinos and amusement arcades, with or without a prize payout; automatic gaming machines and gaming machines, in particular for commercial use in casinos and gaming arcades, with or without a prize payout; coin-operated gaming machines and/or electronic money-based gaming apparatus (machines), with or without prizes; housings adapted for gaming machines, gaming apparatus and automatic gaming machines, operated by means of coins, tokens, tickets or by means of electronic, magnetic or biometric storage media, in particular for commercial use in casinos and gaming arcades, with or without a prize payout; electronic games; electronic game entertainment apparatus and parts thereof; video output game machines; drawing apparatus for prize games and lotteries, draws or raffles; housings of metal, plastic and/or wood adapted for coin-operated automatic amusement machines; apparatus for games (including video games), other than adapted for use with external screens or monitors only; electro-pneumatic and electric slot machines with pulling handles (gaming machines); gaming tables, in particular for table football, billiards, sliding games; flying discs (toys) and darts; gaming machines, namely electric, electronic or electromechanical apparatus for bingo games, lotteries or video lottery games and for betting offices, connected or unconnected to a computer network; LCD games consoles; automatic gaming machines; all the aforesaid automatic machines operating in networks; apparatus and devices for accepting and storing money, being fittings for the aforesaid automatic machines, included in this class; automatic lottery machines.

(260) AM 2020 105275 A

(800) 1490959

(151) 2019 08 02

(891) 2019 08 02

(731) Huawei Technologies Co., Ltd.

ADMINISTRATION BUILDING, HUAWEI TECHNOLOGIES CO., LTD., BANTIAN,

LONGGANG DISTRICT, SHENZHEN,
China

(540)

HUAWEI AIR Glass

(591) Black, white

(511)

9 – Computer memory devices; computer programs recorded; computer keyboards; mouse [computer peripheral]; integrated circuit cards [smart cards]; notebook computers; laptop computers; bags adapted for laptops; sleeves for laptops; computer software applications downloadable; tablet computers; pedometers; scales; modems; transponders; smartphones; network communication equipment; cabinets for loudspeakers; loudspeakers; microphones; sound transmitting apparatus; television apparatus; camcorders; headphones; portable media players; digital photo frames; earphones; cameras [photography]; air analysis apparatus; gas testing instruments; integrated circuits; video screens; sensors; electronic chips; eyeglasses; eyeglass cases; 3D spectacles; batteries electric; computer hardware; smartglasses [data processing]; smart watches [data processing]; wearable activity trackers; covers for smartphones; cases for smartphones; large-screen liquid crystal displays (LCDs); electronic diary; flat panel displays; liquid crystal display screens; intercoms; touch screens; polarizing eyeglasses; electronic pens; flexible flat panel displays for computers; stands adapted for tablet computers; USB cables; USB cables for cellphones; safety goggles; digital door locks; central alarms; theatre glasses; covers for tablet computers; black boxes [data recorders]; interactive touch screen terminals; humanoid robots with artificial intelligence; electronic sheet music downloadable; smart rings [data processing]; downloadable software applications for mobile phones; facial recognition apparatus; scales with body mass analyzers; bathroom scales; protective films adapted for smartphones; audio interfaces; virtual reality headsets; car video recorders; set-top boxes; thermal imaging cameras; infrared detectors; digital weather stations; biochips; sports glasses; personal digital assistants [PDAs]; computer software platforms recorded or downloadable; thin client computers; hand-held electronic dictionaries; computer screen saver software recorded or downloadable; downloadable graphics for mobile phones; wearable computers; telecommunication apparatus in the form of jewelry; selfie sticks used as smartphone accessories; security surveillance robots; wearable video display monitors; selfie lenses; laboratory robots; teaching robots; downloadable emoticons for mobile phones; electric plugs; electric sockets; portable digital electronic scales; computer programs downloadable; computer operating programs recorded; stands adapted for mobile phones; smartphones in the shape of a wristband;

video image printer; touch screen pens; computer programs [downloadable software]; stylus for computer; computer software recorded; car televisions.

(260) AM 2020 105277 A

(800) 1490985

(151) 2019 08 02

(891) 2019 08 02

(731) FLO MAĞAZACILIK VE PAZARLAMA
NONİM ŞİRKETİ

Merkez Mah. Taşocağı Cad., N:24 Kat:3

Mahmutbey Bağcılar, İstanbul, Turkey

(540)



(591) Red, brown, white

(531) 04.05.21; 21.03.01; 27.03.02; 29.01.12

(511)

25 – Clothing, including underwear and outerclot-
hing, other than special purpose protective clothing;
socks, mufflers [clothing], shawls, bandanas, scar-
ves, belts [clothing]; footwear, namely, shoes ex-
cluding orthopedic shoes, sandals, waterproof boots,
walking boots, booties, sporting shoes, slippers; shoe
parts, namely, heelpieces, insoles for footwear, foot-
wear uppers; headgear, hats, caps with visors, berets,
caps [headwear], skull caps.

(260) AM 2020 105278 A

(800) 1491025

(151) 2019 05 15

(891) 2019 05 15

(731) "DAN KING" Limited Liability Partnership
Samal-1 microdistrict, house 21, office 12,
Almaty city, Kazakhstan

(540)



(591) Brown, orange, dark orange and light orange

(531) 05.07.27; 26.01.02; 29.01.12

(511)

21 – Crystal [glassware]; cooking pots; earthenware;
pots; porcelain ware; pottery; services [dishes]; tea
services [tableware]; tableware, other than knives,
forks and spoons; painted glassware; coffee services
[tableware]; glass bulbs [receptacles]; glass flasks
[containers]; drinking vessels; refrigerating bottles;
vessels of metal for making ices and iced drinks;
glasses [receptacles]; cups of paper or plastic; drin-
king glasses; heat-insulated containers for bevera-

ges; heat-insulated containers; containers for house-
hold or kitchen use; kitchen containers; mugs; coffee
grinders, hand-operated; coffee filters, non-electric;
coffee percolators, non-electric; coffeepots, non-el-
ectric; table plates; disposable table plates.

29 – Albumen for culinary purposes; seaweed ex-
tracts for food; gelatine; edible fats; anchovy, not li-
ve; peanut butter; butter; cocoa butter for food; co-
conut butter; buttercream; white of eggs; black pud-
ding [blood sausage]/black pudding/blood sausage;
bouillon/broth; preparations for making bouillon; ca-
viar; fruit, preserved; charcuterie; potato chips/po-
tato crisps; sauerkraut; coconut, desiccated; colza oil
for food/rape oil for food; bouillon concentra-
tes/broth concentrates; jams; frozen fruits; soups;
raisins; gherkins; vegetables, preserved; vegetables,
cooked; vegetables, dried; oils for food; cream [dairy
products]; cheese; crystallized fruits/frosted fruits;
croquettes; crustaceans, not live; dates; milk; cray-
fish, not live; fish fillets; rennet; fruit, stewed; fruit
jellies; fruit pulp; meat; fish, not live; jellies for
food; meat jellies; game, not live; ginger jam; soya
beans, preserved, for food; fatty substances for the
manufacture of edible fats; fat-containing mixtures
for bread slices; herrings, not live; lobsters, not live;
corn oil for food/maize oil for food; palm kernel oil
for food; sesame oil for food; oysters, not live; isin-
glass for food; ham; yolk of eggs; yogurt/yoghurt;
vegetable soup preparations; vegetable juices for
cooking; meat extracts; kefir [milk beverage]/kefir
[milk beverage]; kumys [kumyss] [milk bevera-
ge]/koumiss [koumiss] [milk beverage]; milk bevera-
ges, milk predominating; whey; milk products; spiny
lobsters, not live; bacon; lentils, preserved; margari-
ne; marmalade; animal marrow for food; shellfish,
not live; mussels, not live; palm oil for food; nuts,
prepared; eggs; powdered eggs; liver pâté/liver pas-
tes; onions, preserved; olives, preserved; olive oil for
food; bone oil for food; pectin for culinary purposes;
pickles; peas, preserved; sausages; salted meats; pre-
parations for making soup; tomato purée; vegetable
salads; lard; fruit salads; sardines, not live; salmon,
not live; suet for food; tuna, not live; tomato juice
for cooking; sunflower oil for food; tripe; truffles,
preserved; poultry, not live; fruit peel; alginates for
culinary purposes; almonds, ground; peanuts, prepa-
red; mushrooms, preserved; coconut fat; coconut oil
for food; beans, preserved; liver; fish-based foods-
tuffs; fruit chips; clams, not live; fruit preserved in
alcohol; pollen prepared as foodstuff; prawns, not
live; fish, preserved; meat, preserved; shrimps, not
live; snail eggs for consumption; tofu; whipped cre-
am; pork; edible birds' nests; fish, tinned [canned
(Am.)]; fish meal for human consumption; fruits,
tinned [canned (Am.)]; meat, tinned [canned (Am.)];
potato fritters; salted fish; sea-cucumbers, not live;
silkworm chrysalis for human consumption; vege-
tables, tinned [canned (Am.)]; sausages in batter; po-

tato flakes; apple purée; cranberry compote; tahini [sesame seed paste]; hummus [chickpea paste]; laver, preserved; fruit-based snack food; curd; kimchi [fermented vegetable dish]; soya milk; milk shakes; ajvar [preserved peppers]; sunflower seeds, prepared; fish mousses; non-alcoholic eggnog; vegetable mousses; fish roe, prepared; seeds, prepared; aloe vera prepared for human consumption; preserved garlic; albumin milk/protein milk; linseed oil for food; low-fat potato chips/low-fat potato crisps; lecithin for culinary purposes; milk ferments for culinary purposes; compotes; condensed milk; smetana [sour cream]; ryazhenka [fermented baked milk]; prostokvasha [soured milk]; tomato purée; vegetable marrow paste; eggplant paste/aubergine paste; peanut milk for culinary purposes; almond milk for culinary purposes; rice milk; artichokes, preserved; arrangements of processed fruit; powdered milk; yakitori; bulgogi [Korean beef dish]; candied nuts; flavoured nuts/flavored nuts; hazelnuts, prepared; berries, preserved; guacamole [mashed avocado]; onion rings; falafel; lemon juice for culinary purposes; freeze-dried meat/lyophilized meat/lyophilised meat; oat milk; vegetable-based cream; freeze-dried vegetables/lyophilized vegetables/lyophilised vegetables; extra virgin olive oil for food; galbi [grilled meat dish]; escamoles [edible ant larvae, prepared]; edible insects, not live; sweet corn, processed; nut-based spreads; potato-based dumplings; hot dog sausages; corn dogs; soya bean oil for food; milk substitutes; almond milk; peanut milk; coconut milk; coconut milk for culinary purposes; coconut milk-based beverages; rice milk for culinary purposes; almond milk-based beverages; peanut milk-based beverages; sausage casings, natural or artificial; klipfish [salted and dried cod]; cottage cheese fritters; pressed fruit paste; yuba [tofu skin]; soya patties; tofu patties.

30 – Seaweed [condiment]; pasta; almond paste; aniseed; star aniseed; confectionery for decorating Christmas trees; infusions, not medicinal; coffee flavourings/coffee flavorings; aromatic preparations for food; seasonings; unleavened bread; salt for preserving foodstuffs; rusks; cookies/biscuits; malt biscuits; peppermint sweets; sweetmeats [candy]; waffles; buns; cocoa; coffee; unroasted coffee; vegetal preparations for use as coffee substitutes; cakes; cinnamon [spice]; capers; caramels [candy]; curry [spice]; cereal preparations; chewing gum; chicory [coffee substitute]; tea; chocolate; marzipan; cloves [spice]; condiments; confectionery/sugar confectionery; corn flakes/maize flakes; popcorn; preparations for stiffening whipped cream; ice cream; pancakes; essences for foodstuffs, except etheric essences and essential oils; cooking salt; thickening agents for cooking foodstuffs; turmeric; natural sweeteners; spices; gingerbread; pastries; petit-beurre biscuits; bread rolls; peppers [seasonings]; pizzas; pepper; potato flour; puddings; pralines; ravioli; liquorice [confectionery];

rice; saffron [seasoning]; sago; sauces [condiments]; celery salt; semolina; sherbets [ices]/sorbets [ices]; spaghetti; tapioca; tapioca flour; tarts; vanilla flavourings for culinary purposes/vanilla flavorings for culinary purposes; vanillin [vanilla substitute]; vermicelli [noodles]; meat pies; pâtés en croûte; meat tenderizers for household purposes; edible ices; powders for making ice cream; almond confectionery; peanut confectionery; food flavorings, other than essential oils/food flavourings, other than essential oils; flavourings, other than essential oils, for beverages/flavorings, other than essential oils, for beverages; crushed oats; husked oats; oat-based food; oat flakes; oatmeal; stick liquorice [confectionery]; beer vinegar; coffee-based beverages; cocoa-based beverages; chocolate-based beverages; artificial coffee; candy; chips [cereal products]; chow-chow [condiment]; couscous [semolina]; malt extract for food; malt for human consumption; propolis/bee glue; relish [condiment]; royal jelly; sea water for cooking; sushi; tomato sauce; mayonnaise; crackers; custard; fruit jellies [confectionery]; muesli; rice cakes; soya sauce; frozen yogurt [confectionery ices]/frozen yoghurt [confectionery ices]; chutneys [condiments]; spring rolls; tacos; tortillas; iced tea; tea-based beverages; dressings for salad; breadcrumbs; tabbouleh; halvah; quiches; meat gravies; miso [condiment]/soya bean paste [condiment]; cereal-based snack food; rice-based snack food; hominy; hominy grits; baking powder; baking soda [bicarbonate of soda for cooking purposes]/bicarbonate of soda for cooking purposes [baking soda]; garden herbs, preserved [seasonings]; noodle-based prepared meals; cake frosting [icing]; chocolate mousses; dessert mousses [confectionery]; fruit coulis [sauces]; marinades; cheeseburgers [sandwiches]; pesto [sauce]; ham glaze; linseed for culinary purposes [seasoning]/flaxseed for culinary purposes [seasoning]; wheat germ for human consumption; high-protein cereal bars; cream of tartar for culinary purposes; gluten additives for culinary purposes; pasta sauce; cereal bars; palm sugar; dough; flowers or leaves for use as tea substitutes; pastry dough; vare-niki [stuffed dumplings]; pelmeni [dumplings stuffed with meat]; chocolate decorations for cakes; candy decorations for cakes; chocolate-coated nuts; rice pudding; nut flours; minced garlic [condiment]; baozi [stuffed buns]; rice pulp for culinary purposes; jiaozi [stuffed dumplings]; ramen [Japanese noodle-based dish]; okonomiyaki [Japanese savoury pancakes]/okonomiyaki [Japanese savory pancakes]; batter mixes for okonomiyaki [Japanese savoury pancakes]/batter mixes for okonomiyaki [Japanese savory pancakes]; burritos; gimbap [Korean rice dish]; edible paper; edible rice paper; chocolate-based spreads; chocolate spreads containing nuts; flour-based dumplings; agave syrup [natural sweetener]; mirror icing [mirror glaze]; freeze-dried dishes with main ingredient being rice/lyophilized dishes with

main ingredient being rice/lyophilised dishes with main ingredient being rice; freeze-dried dishes with main ingredient being pasta/lyophilized dishes with main ingredient being pasta/lyophilised dishes with main ingredient being pasta; chamomile-based beverages; dulce de leche; bibimbap [rice mixed with vegetables and beef]; onigiri [rice balls]; instant rice; hot dog sandwiches; ice cubes; processed seeds for use as a seasoning; sesame seeds [seasonings]; piccalilli; quinoa, processed; bulgur; buckwheat, processed; buckwheat flour; cranberry sauce [condiment]; apple sauce [condiment]; croûtons; lomper [potato-based flatbread]; zephyr [confectionery]; pastila [confectionery]; senbei [rice crackers]; kimchijeon [fermented vegetable pancakes]; shaved ice with sweetened red beans; mints for breath freshening; chewing gum for breath freshening; udon noodles; soba noodles.

32 – Non-alcoholic fruit extracts; beer; ginger beer/ginger ale; malt beer; beer wort; non-alcoholic fruit juice beverages; whey beverages; preparations for making beverages; essences for making beverages; fruit juices/fruit juice; syrups for beverages; waters [beverages]; preparations for making aerated water; lithia water; mineral water [beverages]; seltzer water; table waters; must; lemonades; extracts of hops for making beer; vegetable juices [beverages]; syrups for lemonade; essences for making non-alcoholic beverages, not in the nature of essential oils; malt wort; grape must, unfermented; orgeat; soda water; sherbets [beverages]/sorbets [beverages]; tomato juice [beverage]; non-alcoholic beverages; pastilles for effervescing beverages; powders for effervescing beverages; aerated water; sarsaparilla [non-alcoholic beverage]; aperitifs, non-alcoholic; cocktails, non-alcoholic; fruit nectars, non-alcoholic; isotonic beverages; cider, non-alcoholic; kvass [non-alcoholic beverage]; non-alcoholic honey-based beverages; smoothies; aloe vera drinks, non-alcoholic; beer-based cocktails; soya-based beverages, other than milk substitutes; protein-enriched sports beverages; rice-based beverages, other than milk substitutes; non-alcoholic beverages flavoured with coffee/non-alcoholic beverages flavored with coffee; non-alcoholic beverages flavoured with tea/non-alcoholic beverages flavored with tea; soft drinks; barley wine [beer]; energy drinks.

35 – Marketing research; marketing; telemarketing services; targeted marketing; bill-posting/outdoor advertising; dissemination of advertising matter; direct mail advertising; updating of advertising material; publicity material rental; publication of publicity texts; advertising/publicity; radio advertising; television advertising; advertising agencies/publicity agencies; modelling for advertising or sales promotion; organization of exhibitions for commercial or advertising purposes; rental of advertising space; advertising by mail order; organization of trade fairs

for commercial or advertising purposes; online advertising on a computer network; rental of advertising time on communication media; writing of publicity texts; layout services for advertising purposes; organization of fashion shows for promotional purposes; production of advertising films; pay per click advertising; design of advertising materials; rental of billboards [advertising boards]; web indexing for commercial or advertising purposes; scriptwriting for advertising purposes; compiling indexes of information for commercial or advertising purposes; consultancy regarding advertising communication strategies; bill-posting; sales promotion for others; search engine optimization for sales promotion/search engine optimisation for sales promotion; promotion of goods and services through sponsorship of sports events; demonstration of goods; distribution of samples; presentation of goods on communication media, for retail purposes; import-export agency services; shop window dressing; provision of an online marketplace for buyers and sellers of goods and services.

43 – Café services; cafeteria services; restaurant services; self-service restaurant services; bar services; snack-bar services; food and drink catering; canteen services; tourist home services; washoku restaurant services; udon and soba restaurant services.

(260) AM 2020 105279 A

(800) 1491069

(151) 2019 04 02

(891) 2019 04 02

(731) FACEBOOK, INC.

1601 Willow Road, Menlo Park CA 94025,
USA

(540)



(591) Black, white

(531) 24.17.17; 27.05.21

(511)

9 – Software development tools; software intended to be used as an application programming interface (API); application programming interface (API) for computer software facilitating on-line services for social networking, development of social networking applications and enabling retrieval, uploading, downloading, accessing and managing data; software enabling electronic content or information to be uploaded, downloaded, accessed, published, displayed, tagged, blogged, broadcast, linked, shared or

provided via other means via computer and communication networks; downloadable e-commerce software that enables users to conduct electronic business transactions via global computer and communication networks; computer software for sending electronic message alerts and reminders via the Internet; software for transmission of orders and transmitting and receiving electronic messages via the Internet; downloadable software for modifying the appearance and enabling transmission of images, audiovisual and video content; software for the collection, publishing, organization, modification, transmission, storage and sharing of data and information; search engine software.

38 – Services for photograph sharing and video sharing, especially, electronic transmission of digital photo, video, audio-visual content files among Internet users; provision of access to electronic, computer and online databases; telecommunication services, especially electronic transmission of data, messages, graphics, images, video, audio content and information; providing on-line communication forums on topics of general interest; provision of on-line communication links which transfer the website user to other local and global web pages; providing access to web sites or other electronic content of others via a universal identifier; providing on-line discussion boards, e-mail and instant messaging and electronic bulletin boards services; dissemination of audio, text and video content over computer or other communication networks, especially uploading, publication, displaying, modifying, marking and electronic transmission of data, information, audio and video content; communication of voice over Internet protocol; communications by telephone; provision of access to computer databases in the fields of social networking, dating and social meetings.

42 – Computer services, namely design of software for virtual communities for registered users to organize groups and events, take part in discussions, obtain feedback from their peers and participate in social, business and community networking; computing services, namely hosting electronic infrastructure for others for the arranging and conducting of interactive meetings, events and discussions via communication networks; application service provider [ASP], namely hosting of third-party application software; application service provider (ASP) featuring computer software enabling or facilitating the uploading, downloading, dissemination, publication, displaying, blogging, linking, modification, sharing or otherwise providing electronic content or information over communication networks; providing an on-line network featuring technology enabling on-line users to create personal profiles presenting social and professional data and to transfer and share such information on line over multiple infrastructures; providing access to on-line content from searchable

indexes and databases, including texts, electronic documents, databases, graphics, photographic images and audiovisual information, over computer and communication networks; providing temporary use of non-downloadable software applications for social networking, creating a virtual community and transmitting audio content, video content, photographic images, texts, graphics and data; computer services in the nature of customized on-line pages featuring information defined or specified by the user, personal profiles, audio content, video content, photographic images, texts, graphics and data; computer services, namely, providing search engines for recovery of data on global computer and communication networks; providing downloadable e-commerce software that enables users to conduct electronic business transactions via global computer and communication networks; software as a service (SaaS) proposing software for sending electronic message alerts, transmission of orders and for the sending and receiving of messages, and enabling users to conduct electronic business transactions by means of a global computer network; computer platform as a service [PAAS] featuring technology that enables businesses, organizations and individuals to create and manage an on-line presence and to communicate information and messages to on-line users in the field of their activities, goods and services, and engage in social and business networking; provision of search engines for obtaining data via communication networks; providing on-line networks enabling users to upload, modify and share audio content, video content, photographic images, texts, graphics and data; administration of search engines; computer services, namely, providing on-line interactive networks for others featuring technology that enables users to manage their audio and video on line and their social and business network network accounts; providing on-line non-downloadable software for modifying the appearance and enabling transmission of audio, video content, photographic images, texts, graphics and data; file sharing services, namely, providing on-line interface for others featuring technology enabling users to upload and download electronic files.

45 – Social introduction and social networking services on the Internet; providing social services and information in the field of personal development, especially personal improvement, self-fulfillment, charitable, philanthropic, volunteer, public and community services, and humanitarian activities; providing user authentication services in e-commerce transactions; providing user authentication services in the field of electronic funds transfer, transaction, credit card, debit card and electronic check transactions via a global computer network.

- (260) AM 2020 105280 A
 (800) 1491078
 (151) 2019 09 04
 (891) 2019 09 04
 (731) REAL TROPICAL FOOD BESLOTEN
 VENNOOTSCHAP
 Osdorperweg 590, NL-1067 SZ Amsterdam,
 Netherlands
 (540)



- (591) Different shades of red, different shades of green, different shades of yellow, different shades of blue, different shades of orange, grey, brown, black and white
 (531) 01.15.15; 05.07.21; 05.07.22; 05.07.24;
 26.13.01; 27.05.02; 29.01.15
 (511)
 32 – Mineral and aerated waters and other non-alcoholic drinks.

- (260) AM 2020 105292 A
 (800) 1491608
 (151) 2019 08 20
 (891) 2019 08 20
 (731) MGL MY.COM (CYPRUS) LIMITED
 28 Oktovriou, 365 VASHIOTIS SEAFRONT,
 office 402, Neapoli, CY-3107 Limassol,
 Cyprus
 (540)



- (591) Black, white
 (531) 27.05.01; 27.05.22
 (511)
 9 – Video cassettes; sound recording discs; disks, magnetic; optical discs; electronic interactive whiteboards; electronic notice boards; interfaces for computers; video game cartridges; memory cards for video game machines; compact discs [audio-video]; monitors [computer programs]; sound recording carriers; magnetic data media; optical data media; computer software, recorded; computer software applica-

tions, downloadable; computer programs, recorded; computer game software, downloadable; computer game software, recorded; computer programs, downloadable; computer operating programs, recorded; computer screen saver software, recorded or downloadable; electronic publications, downloadable; downloadable image files; USB flash drives; compact discs [read-only memory].

16 – Albums; almanacs; atlases; pamphlets; booklets; newsletters; newspapers; engravings; magazines [periodicals]; periodicals; printed publications; graphic representations; calendars; geographical maps; catalogues; books; comic books; lithographs; graphic prints; greeting cards; postcards; printed matter; manuals [handbooks]; photographs [printed]; posters.

28 – Video game machines; gaming machines for gambling; amusement machines, automatic and coin-operated; jigsaw puzzles; toy mobiles; toys; portable games and toys incorporating telecommunication functions; parlor games; board games; games; building games; trading cards for games; playing cards; scale model kits [toys]; portable games with liquid crystal displays; video game consoles; handheld consoles for playing video games; apparatus for games.

35 – Rental of advertising space; computerized file management; demonstration of goods; opinion polling; market studies; business investigations; marketing research; news clipping services; updating and maintenance of information in registries; updating and maintenance of data in computer databases; updating of advertising material; organization of exhibitions for commercial or advertising purposes; organization of trade fairs for commercial or advertising purposes; shop window dressing; design of advertising materials; data search in computer files for others; commercial or industrial management assistance; provision of an online marketplace for buyers and sellers of goods and services; presentation of goods on communication media, for retail purposes; auctioneering; sales promotion for others; production of advertising films; rental of advertising time on communication media; publicity material rental; publication of publicity texts; radio advertising; billposting; dissemination of advertising matter; direct mail advertising; advertising; online advertising on a computer network; advertising by mail order; television advertising; compilation of information into computer databases; systemization of information into computer databases; administrative processing of purchase orders; public relations.

38 – News agency services; wireless broadcasting; television broadcasting; cable television broadcasting; electronic bulletin board services [telecommunications services]; information about telecommunication; providing user access to global computer

networks; providing access to databases; providing telecommunications connections to a global computer network; providing telecommunication channels for teleshopping services; message sending; computer aided transmission of messages and images; transmission of digital files; providing online forums; rental of access time to global computer networks; radio broadcasting; transmission of electronic mail; communications by fiber optic networks; communications by cellular phones; communications by computer terminals; communications by telephone; streaming of data; telephone services; providing internet chatrooms; transmission of greeting cards online.

41 – Rental of sports grounds; booking of seats for shows; videotaping; gambling services; publication of books; education information; recreation information; entertainment information; layout services, other than for advertising purposes; videotape editing; practical training [demonstration]; training services provided via simulators; providing recreation facilities; arranging and conducting of conferences; arranging and conducting of workshops [training]; organization of competitions [education or entertainment]; organization of cosplay entertainment events; organization of lotteries; organization of sports competitions; television entertainment; providing amusement arcade services; film production, other than advertising films; rental of videotapes; rental of sound recordings; games equipment rental; electronic desktop publishing; online publication of electronic books and journals; publication of texts, other than publicity texts; radio entertainment; entertainer services; entertainment services; writing of texts; news reporters services; film directing, other than advertising films; game services provided online from a computer network; club services [entertainment or education]; teaching; ticket agency services [entertainment]; photography; production of shows; health club services [health and fitness training]; organization of exhibitions for cultural or educational purposes.

42 – Computer system analysis; recovery of computer data; computer virus protection services; installation of computer software; computer security consultancy; information technology [IT] consultancy; consultancy in the design and development of computer hardware; internet security consultancy; computer software consultancy; updating of computer software; monitoring of computer systems to detect breakdowns; monitoring of computer systems by remote access; software as a service [SaaS]; maintenance of computer software; providing information on computer technology and programming via a web site; providing search engines for the internet; conversion of computer programs and data, other than physical conversion; computer system design; rental

of web servers; computer rental; rental of computer software; development of computer platforms; computer software design; creating and maintaining web sites for others; computer programming; copying of computer programs; outsource service providers in the field of information technology; off-site data backup; computer technology consultancy; electronic data storage; server hosting; platform as a service [PaaS].

(260) AM 2020 105293 A

(800) 1491627

(151) 2019 07 23

(891) 2019 07 23

(731) SHANXI JIAHE PHYTOCHEM CO., LTD.
A-6TH FLOOR, NO.66 JINYE 1ST ROAD,
HIGH-TECH ZONE, XI'AN, SHAANXI,
China

(540)



(591) Black, white

(531) 05.05.18; 05.05.20; 26.04.05; 26.04.15;
27.05.02

(511)

1 – Acetone; catechu; alkaloids; chemicals used for food preservation; acid; glucoside; saponin; ester.

(260) AM 2020 105294 A

(800) 1491629

(151) 2019 07 24

(891) 2019 07 24

(731) QIBU CORPORATION LIMITED
No.3 Chiyan Road, Qiaoxiang Industry Zone,
Youzhu New Area, Qingtian County, Lishui
City, 323900 Zhejiang Province, China

(540)

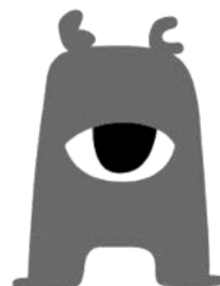

(591) Black, white

(531) 04.05.05

(511)

25 – Clothing; shirts; baby layettes for clothing; waterproof clothing; hats; hosiery; gloves as clothing; scarves; girdles; footwear.

(260) AM 2020 105305 A
 (800) 1491782
 (151) 2019 07 01
 (891) 2019 07 01
 (731) INMAXO HOLDINGS LTD.
 Amathountos 5, Pirilides Building, CY-3105
 Limassol, Cyprus
 (540)

KORVUS

(591) Black, white
 (531) 27.05.01; 27.05.17
 (511)
 9 – Measuring instruments; protective helmets; surveying chains; rulers [measuring instruments]; solderers' helmets; protective masks; rules [measuring instruments]; carpenters' rules; micrometers; kneepads for workers; headphones; plumb lines; gloves for protection against accidents; respirators for filtering air; protection devices for personal use against accidents; levels [instruments for determining the horizontal]; spirit levels; filters for respiratory masks.
 16 – House painters' rollers; paint trays.

(260) AM 2020 105307 A
 (800) 1491822
 (151) 2019 08 13
 (891) 2019 08 13
 (731) DIGI-KEY CORPORATION
 701 Brooks Ave. South, Thief River Falls
 MN 56701, USA
 (540)

DIGI-KEY

(591) Black, white
 (511)
 9 – Software, namely, a downloadable mobile application used to check the inventory and pricing of, and to purchase, electronic components and hardware.

(260) AM 2020 105308 A
 (800) 1491824
 (151) 2019 08 19
 (891) 2019 08 19
 (731) APPLE INC.
 One Apple Park Way, Cupertino CA 95014, USA
 (540)

MPX

(591) Black, white
 (511)
 9 – Computer hardware, computer peripheral devices, graphics accelerators, and graphics processor units.

(260) AM 2020 105310 A
 (800) 1491924
 (151) 2019 08 06
 (891) 2019 08 06
 (731) AFTERSHOKZ, LLC
 1801 Burnet Avenue, Suite 102, Syracuse
 NY 13206, USA
 (540)



(591) Black, white
 (531) 26.11.03; 26.11.22; 27.03.01
 (511)
 9 – 3D spectacles; Anti-glare glasses; Batteries, electric; Earbuds; Eyeglass frames; Headphones; Lithium ion batteries; Microphones; MP3 players; Music headphones; Spectacles; Sunglasses; USB cables; Wireless speakers; Chargers for batteries; Cyclists' glasses; Frames for spectacles and sunglasses; Goggles for sports; Horns for loudspeakers; Memory modules; Portable media players; Spectacle cases; Spectacle frames; Sports glasses.

(260) AM 2020 105311 A
 (800) 1491927
 (151) 2019 08 19
 (891) 2019 08 19
 (731) APPLE INC.
 One Apple Park Way, Cupertino CA 95014,
 USA
 (540)

MPX MODULE

(591) Black, white
 (511)
 9 – Computer hardware, computer peripheral devices, graphics accelerators, and graphics processor units.

(260) AM 2020 105313 A
 (800) 1491936
 (151) 2019 06 03
 (891) 2019 06 03
 (731) INNER MONGOLIA YILI INDUSTRIAL
 GROUP CO., LTD.
 No.1 Jinshan Road, Jinshan Development
 Zone, Hohhot, China
 (540)



(591) Black, white
 (531) 27.05.01
 (511)
 5 – Tonics [medicines]; mineral water for medical purposes; medicinal drinks; dietary fiber; medical

preparations for slimming purposes; nutraceutical preparations for therapeutic or medical purposes; medicines for human purposes; vitamin preparations; radioactive substances for medical purposes; gases for medical purposes; chemical conductors for electrocardiograph electrodes; semen for artificial insemination; disinfectants; solutions for contact lenses; bacteriological culture mediums; candy, medicated; protein dietary supplements; lecithin dietary supplements; albuminous dietary supplements; nutritional supplements; mineral food supplements; dietetic beverages adapted for medical purposes; dietetic substances adapted for medical use; dietetic foods adapted for medical purposes; lacteal flour for babies; food for babies; infant formula; powdered milk for babies; air purifying preparations; medicated animal feed; dietary supplements for animals; pesticides; babies' diapers; breast-nursing pads; dental abrasives; diapers for pets.

29 – Meat; seaweed extracts for food; fish, not live; fruits, tinned [canned (Am.)]; fruit, preserved; vegetable-based snack; areca-nut, prepared; vegetables, preserved; eggs; butter; cream [dairy products]; milk; milk products; yoghurt; whipped cream; powdered milk; milk beverages, milk predominating; soya milk; milk shakes; milk tea (milk based); almond milk; soybean milk; smetana [sour cream]; peanut milk; soya milk powder; soya milk extracts; coconut milk; rice milk; coconut milk-based beverages; almond milk-based beverages; peanut milk-based beverages; cheese; edible fats; fruit jellies; nuts, prepared; dried edible mushroom; bean curd products; sausage casings, natural or artificial; lactic acid beverage containing fruit juice.

30 – Coffee-based beverages; chocolate beverages with milk; coffee; cocoa, roasted, powered, granule, for beverages; chocolate-based beverages; tea; tea-based beverages; sugar; candy; milk powder candy; honey; golden syrup; pastries; bread; confectionery; oat flakes; instant rice; cereal preparations; soya flour; rice; sago; wheat flour; instant noodle; rice flour (strip); cereal-based snack food; rice-based snack food; starch for food; ice cream; edible ices; ice pops; cooking salt; vinegar; soya sauce; condiments; mustard; fish sauce; yeast; leaven; aromatic preparations for food; essences for foodstuffs, except etheric essences and essential oils; preparations for stiffening whipped cream; meat tenderizers, for household purposes; gluten prepared as foodstuff.

32 – Beer; rice-based beverages, other than milk substitutes; non-alcoholic beverages flavored with beer; sports beverages; energy drinks; non-alcoholic carbonated beverage; non-alcoholic fruit juice beverages; whey beverages; waters [beverages]; lithia water; mineral water [beverages]; seltzer water; table waters; lemonades; soda water; non-alcoholic beverages; aerated water; isotonic beverages; kvass [non-

alcoholic beverage]; smoothies; soya-based beverages, other than milk substitutes; protein-enriched sports beverages; non-alcoholic beverages flavored with coffee; non-alcoholic beverages flavored with tea; soft drinks; cola; milk (not of the main components) tea; distilled water (beverage); drinking distilled water; purified water (beverage); plant drink; legume drink; fermented drink made from ground beans; preparations for making beverages.

(260) AM 2020 105314 A

(800) 1491970

(151) 2019 08 12

(891) 2019 08 12

(731) ADP GAUSELMANN GMBH

Merkur-Allee 1-15, 32339 Espelkamp,
Germany

(540)

Zhong Guo Long

(591) Black, white

(511)

9 – Computer software; coin-operated mechanisms; computer and video game software; games software in particular for use on any computer platform, including electronic entertainment and games consoles; computer game programs; video games (software); computer games provided through a global computer network or supplied by means of multimedia electronic broadcast or through telecommunications or electronic transmission or via the internet; computer games, leisure and recreational software, video games and computer software, all being provided in the form of storage media; programs for operating electric and electronic apparatus for games, entertainment and/or amusement purposes; computer software for computer games on the internet; online games (software), in particular for online betting games, online prize games, online gambling games, online games of skill and online casino games; computer software in the form of an app for mobile devices and computers; calculating apparatus in coin-operated machines and parts for the aforesaid goods; electric, electronic, optical or automatic apparatus, for identifying data carriers, identity cards and credit cards, bank notes and coins; software in particular for casino and/or amusement arcade games, for gaming machines and/or slot machines each one with or without prize payouts; gaming software that generates or displays wager outcomes of gaming machines; operational computer games software; computer software for managing of games (games collection); computer programs for video games; computer video game software.

28 – Games; toys; gaming apparatus (including coin-operated apparatus); coin-operated arcade games (machines); games for amusement arcades (included

in this class); coin-operated video gaming apparatus; video games apparatus adapted for use with external screens or monitors only; casino fittings, namely roulette tables, roulette wheels; coin-operated automatic gaming machines and gaming machines, in particular for gaming arcades, with or without a prize payout; electronic or electrotechnical gaming apparatus, automatic gaming machines, gaming machines, slot machines operated by coins, tokens, banknotes, tickets or by means of electronic, magnetic or biometric storage media, in particular for commercial use in casinos and amusement arcades, with or without a prize payout; automatic gaming machines and gaming machines, in particular for commercial use in casinos and gaming arcades, with or without a prize payout; coin-operated gaming machines and/or electronic money-based gaming apparatus (machines), with or without prizes; housings adapted for gaming machines, gaming apparatus and automatic gaming machines, operated by means of coins, tokens, tickets or by means of electronic, magnetic or biometric storage media, in particular for commercial use in casinos and gaming arcades, with or without a prize payout; electronic games; electronic game entertainment apparatus and parts thereof; video output game machines; drawing apparatus for prize games and lotteries, draws or raffles; housings of metal, plastic and/or wood adapted for coin-operated automatic amusement machines; apparatus for games (including video games), other than adapted for use with external screens or monitors only; electro-pneumatic and electric slot machines with pulling handles (gaming machines); gaming tables, in particular for table football, billiards, sliding games; flying discs (toys) and darts; gaming machines, namely electric, electronic or electromechanical apparatus for bingo games, lotteries or video lottery games and for betting offices, connected or unconnected to a computer network; LCD games consoles; automatic gaming machines; all the aforesaid automatic machines operating in networks; apparatus and devices for accepting and storing money, being fittings for the aforesaid automatic machines, included in this class; automatic lottery machines.

(260) AM 2020 105315 A

(800) 1491976

(151) 2019 08 22

(891) 2019 08 22

(731) Viaservice SA

La Voie-Creuse 16, CH-1202 Genève, Switzerland

(540)

VIASERVICE

(591) Black, white

(511)

36 – Financial affairs; financial services; financial risk management; transport insurance brokerage ser-

vices; services provided by consultants relating to transport insurance; information relating to transport insurance; warranty insurance services; provision of financial guarantees.

38 – Digital data transfer; transmission services for digital data; digital network telecommunication services; transmission of digital data; transmission of digital files; wireless transfer of data via digital mobile telephones; digital transmission of messages; information transmission services via digital networks; automatic transmission of digital data via telecommunications channels; document delivery online by means of a global computer network; telecommunications.

39 – Transport; computerized information services relating to transport; organization of transport services; providing information about transport matters; road transport; advisory services relating to transportation; inspection of vehicles prior to transport; information relating to transport via websites; planning and booking of travel and transport via electronic means; supply chain logistics and reverse logistics services comprising storage, transport and delivery of goods for third parties by plane, railway, ship or truck; provision of advice relating to merchandise delivery; advisory services relating to the storage and transportation of goods, freight or cargo; freight forwarding services other than customs clearance of products for third parties; providing online information in the field of transport, packaging and storage of goods; inspection of merchandise prior to transport; collection, transport and delivery of merchandise; transport information; information and advice regarding or in connection with all the aforesaid services.

(260) AM 2020 105316 A

(800) 1491980

(151) 2019 09 10

(891) 2019 09 10

(731) XIAOYONG WANG

NO. F3-16935, INTERNATIONAL TRADE CITY, CHINA COMMODITIES CITY, YIWU CITY, ZHEJIANG PROVINCE, China

(540)

ALWAYS

(591) Black, white

(531) 26.03.05; 27.05.17

(511)

21 – Vacuum bottles; toothbrushes; heat-insulated containers; thermally insulated containers for food; coolers [ice pails]; insulating flasks; cages for household pets; mouse traps.

(260) AM 2020 105317 A
 (800) 1492078
 (151) 2019 07 18
 (891) 2019 07 18
 (731) ASTELLAS PHARMA INC.
 5-1, Nihonbashi-Honcho 2-chome, Chuo-ku,
 Tokyo 103-8411, Japan
 (540)



(591) Dark purple, purple, light purple and gold
 (531) 26.03.02; 26.04.04; 26.04.05; 26.07.25;
 29.01.13
 (511)
 5 – Pharmaceutical preparations for the treatment of
 cancer.

(260) AM 2020 105318 A
 (800) 1492082
 (151) 2019 07 16
 (891) 2019 07 16
 (731) SHAOU YU
 ROOM 304, TWENTY-EIGHTH DONGHAI
 WEST ROAD, 2002, GOU SHAN STREET,
 PUTUO DISTRICT, ZHOUSHAN CITY,
 316000 ZHEJIANG PROVINCE, China
 (540)



(591) Black, white
 (531) 26.03.01; 26.03.24; 27.05.08; 27.05.15;
 27.05.17
 (511)
 18 – Pelts; bags; trunks [luggage]; leather trimmings
 for furniture; umbrellas; alpenstocks; backpacks;
 collars for animals; clothing for pets; pocket wallets.
 25 – Shoes; hats; clothing; hosiery; gloves [cloth-
 ing]; underwear; scarfs; girdles; boots; sandals.

(260) AM 2020 105319 A
 (800) 1492099
 (151) 2019 07 31
 (891) 2019 07 31
 (731) Obshchestvo s ogranichennoy
 otvetstvennost'yu "LAKRA SINTEZ"
 ul. Dorozhnaya, d. 5, g. Staraya Kupavna,
 Noginskiy r-n, RU-142450 Moskovskaya obl.,
 Russian Federation
 (540)

ЛАКРА

(591) Black, white
 (531) 28.05
 (511)
 7 – Holding devices for machine tools; electric hand
 drills; hand-held tools, other than hand-operated; ag-
 ricultural implements, other than hand-operated;
 blenders, electric, for household purposes; mixers
 [machines]; pneumatic hammers; tilt hammers; she-
 ars, electric; scissors, electric; soldering irons, gas-
 operated; soldering irons, electric; drilling machines;
 glue guns, electric; compressed air guns for the ex-
 trusion of mastics; pneumatic transporters; loom
 shafts; gears for weaving looms; whisks, electric, for
 household purposes; pigs for cleaning pipes; glazi-
 ers' diamonds [parts of machines]; adhesive tape dis-
 pensers [machines]; screwdrivers, electric; air brus-
 hes for applying colour; machines and apparatus for
 wax-polishing, electric; machines and apparatus for
 cleaning, electric; machines and apparatus for polis-
 hing [electric].
 8 – Glaziers' diamonds [parts of hand tools]; shar-
 pening steels; gimlets [hand tools]; borers; augers
 [hand tools]; weeding forks [hand tools]; rakes [hand
 tools]; cutter bars [hand tools]; cutlery; edge tools
 [hand tools]; abrading instruments [hand instru-
 ments]; numbering punches; sharpening instruments;
 tube cutting instruments; wire strippers [hand tools];
 riveters [hand tools]; expanders [hand tools]; cutting
 tools [hand tools]; hand tools, hand-operated; stam-
 ping-out tools [hand tools]; mallets [hand instru-
 ments]; pliers; punch pliers [hand tools]; jig-saws;
 blades [hand tools]; fullers [hand tools]; stone ham-
 mers; masons' hammers; riveting hammers [hand
 tools]; hammers [hand tools]; files [tools]; emery
 files; knives; braiders [hand tools]; box cutters; scis-
 sors; shears; screwdrivers, non-electric; stirring
 sticks for mixing paint; perforating tools [hand
 tools]; drill holders [hand tools]; saws [hand tools];
 guns, hand-operated, for the extrusion of mastics;
 guns [hand tools]; dies [hand tools]; rasps [hand
 tools]; cutters; handles for hand-operated hand tools;
 planes; hatchets; vices; bench vices [hand imple-
 ments]; hoop cutters [hand tools]; squares [hand to-
 ols]; embossers [hand tools]; spatulas [hand tools];
 wallpaper smoothers [hand tools]; wallpaper seam

rollers [hand tools]; palette knives; knife handles; sharpening tools and instruments, hand-operated.

16 – Paint rollers; house painters' rollers; paint roller handles; paint roller covers; paint boxes and brushes; painting mitts for applying paint; pencils; paintbrushes; paper tapes; self-adhesive tapes for stationery or household purposes; adhesive bands for stationery or household purposes; adhesive tapes for stationery or household purposes; glue for stationery or household purposes; adhesives [glues] for stationery or household purposes; adhesive tape dispensers [office requisites].

21 – Cosmetic spatulas; paint bucket grids; animal bristles [brushware]; polishing apparatus and machines, for household purposes, non-electric.

35 – Presentation of goods on communication media, for retail purposes; sales promotion for others; procurement services for others [purchasing goods and services for other businesses]; demonstration of goods; sales promotions at point of purchase or sale, for others; retail and wholesale services; retail store services, wholesale of goods; services of retail sale of goods in the catalog by mailings; services of retail sale of goods using television stores or Internet sites.

(260) AM 2020 105320 A

(800) 747921

(151) 2000 12 07

(891) 2019 09 05

(731) DAIICHI SANKYO COMPANY LIMITED
3-5-1, Nihonbashi Honcho, Chuo-ku, Tokyo
103-8426, Japan

(540)

OLMETEC

(591) Black, white

(531) 27.05.01; 27.05.17

(511)

5 – Pharmaceutical preparations for the treatment of cardiovascular diseases including high blood pressure, congestive heart failure, diabetic nephropathy, atherosclerosis and stroke, being available by doctor's prescription only and being for oral administration in tablet form only.

(260) AM 2020 105321 A

(800) 903151

(151) 2006 08 14

(891) 2019 08 30

(731) URBAN, WERNER

Großgeschwenda 51, 07330 Probstzella,
Germany

(540)

**PRO
TEC** 

(591) Blue

(531) 01.13.01; 29.01.04

(511)

1 – Chemicals used in industry, science and photography, as well as in agriculture, horticulture and forestry; unprocessed artificial resins, unprocessed plastics; adhesives used in industry; oil-cleaning preparations.

4 – Engine additives and engine additive oils, including fuel system cleaners for petrol engines and diesel engines, oil performance enhancers; industrial oils and greases; lubricants; dust absorbing, wetting and binding compositions; fuel (including motor spirits).

(260) AM 2020 105332 A

(800) 1484295

(151) 2019 04 16

(891) 2019 08 27

(731) DENTSU GROUP INC.

1-8-1, Higashi-Shimbashi, Minato-ku, Tokyo
105-7050, Japan

(540)

DENTSU GROUP

(591) Black, white

(511)

35 – Advertising and publicity services; on-line advertising on a computer network; television advertising; radio advertising; magazine advertising; direct mail advertising; outdoor advertising; agencies, intermediary or brokerage for advertising; information services relating to advertising; advertising consultancy; layout services for advertising purposes; publicity columns preparation; updating of advertising materials; publication of publicity materials; dissemination of advertising matter; planning and production of advertising media; planning and organization of exhibitions and trade fairs for commercial or advertising purposes; organization of fashion shows for promotional purposes; planning and organization of sales promotion events and marketing events; distribution of samples; public relations; public relations agencies; shop window dressing; rental or provision of advertising space; brokerage for provision of advertising space; publicity material rental; marketing; sales promotion for others; sales promotion of goods and services for others, and provision of

advice thereon; sponsorship search; economic forecasting; marketing research, studies, analysis and assessment; opinion polling; compilation of statistics; price comparison services; research and analysis of advertising effectiveness, and provision of information relating thereto; marketing research in relation to computer network, such as trends of accesses to websites by Internet users, and providing analysis and information on results of the research; provision of business or commercial information; business management and organization consultancy; business management analysis and consultancy; consultancy and advisory services regarding business strategy; business research and data analysis; administrative processing of purchase orders; providing information concerning commercial sales; arranging of contracts for the purchase and sale of goods, for others; business administration of the licensing of the goods and services of others; business management of entertainers; consultation relating to brand strategy; consultancy on various business planning, product developments and corporate images; collecting, management and analysis of information on customers of companies, and providing information thereon; arranging of technical, sales and manufacturing cooperation of companies; providing information relating to financial statement preparation; providing employment information and recruitment information; job placement services; job placement consultancy; compilation of mailing lists; office functions, namely filing, in particular documents or magnetic tape; agency services of office functions; agency services of office functions in relation to purchase orders for goods; computerized file management; agency services of calculating copyright royalties for others; news clipping services; data search in computer files for others; input processing, systemization and compilation of information into computer databases; agency services of office functions relating to data processing; arranging newspaper subscriptions for others; search engine optimisation services; promotion of goods and services through sponsorship of sports events; administration of frequent flyer programmes that allow members to redeem miles for points or awards offered by other loyalty programmes; presentation of companies and their goods and services on the Internet; promoting the goods and services of others through the administration of sales and promotional incentive schemes involving trading stamps; issuance and management of point cards; arranging and conducting auctions; import agency services; compilation and systemization of written communications and data; business management assistance in the operation of computer systems or advice, consultancy and information thereof; reception services for visitors in buildings; providing information and advice to consumers regarding the selection of products and items to be purchased; rental of office machinery and equ-

ipment; providing employment information and providing information relating thereto; providing business information on newspaper articles; rental of vending machines; arranging subscriptions to a tele-matics, telephone or computer service for others.

(260) AM 2020 105486 A

(800) 1494009

(151) 2019 08 26

(891) 2019 08 26

(731) APPLE INC.

One Apple Park Way, Cupertino CA 95014,
USA

(540)

NEW YORK

(591) Black, white

(511)

9 – Typeface fonts recorded on computer software.

(260) AM 2020 105490 A

(800) 1494056

(151) 2019 08 13

(891) 2019 08 13

(731) Djtol Grinding Machine Group Co., LTD

East NO.1, Weiyi Road, Wuhu Machinery and
Industrial Zone, Wanzhi Town, Wuhu County,
Wuhu City, Anhui Province 241100, China

(540)

DJTOL

(591) Black, white

(531) 27.05.01; 27.05.17

(511)

7 – Clippers [machines]; tools [parts of machines]; drilling heads [parts of machines]; blades [parts of machines]; hole cutting tool; milling cutter; gear cutting tool; broaching tool; grinding machine for metal working; knives [parts of machines].

(260) AM 2020 105491 A

(800) 1494087

(151) 2019 09 06

(891) 2019 09 06

(731) LTD "VALENTA-INTELLEKT"

ul. Generala Dorokhova, d. 18, str. 2,
RU-119530 Moscow, Russian Federation

(540)

ГИПОКСЕН

(591) Black, white

(531) 28.05

(511)
5 – Pharmaceutical preparations; dietetic substances adapted for medical use; medical plasters; materials for dressings.

(260) AM 2020 105492 A

(800) 1494127

(151) 2019 04 18

(891) 2019 04 18

(731) IDEATION

216 Bd Zerktoni, CASABLANCA, Morocco

(540)

MAJOREL

(591) Black, white

(531) 27.05.01

(511)

9 – Equipment for processing data; software; process automation software; downloadable computer software applications; computer programs enabling a conversation with one or more humans to be simulated by vocal or text exchange (chatbot); downloadable graphic elements for mobile telephones; game software; recorded or downloadable screensaver software for computers; computer platforms in the nature of recorded or downloadable software; processors [central processing units], central processing units [processors]; recorded computer programs; recorded computer operating system programs; computer programs [downloadable software]; downloadable electronic publications.

35 – Advertising; organizing, implementing and managing advertising campaigns by all means of communication; production of advertising films; writing of advertising texts; commercial business management; commercial administration; office functions; assistance services in operating or managing a commercial enterprise; mail processing services; administrative processing services for incoming and outgoing emails; assistance services in management of business or commercial functions of an industrial or commercial company; risk management services related to social media; bringing together on behalf of third parties, by means of retail stores, wholesale stores, vending machines, mail-order catalogs or via electronic means such as web sites or tele-shopping programs, various products (excluding the transport thereof) enabling customers to conveniently view and purchase those goods; services for recording, transcription, composition, compilation or systemization of information, data, written communications and recordings; administrative and business management services for social networks (moderation); distribution and dissemination of advertising material [messages, leaflets, prospectuses, printed matter, samples]; subscription services; subscriptions to te-

lecommunication services for third parties; commercial administration of the licensing of the goods and services of others; administration of frequent flyer programs; administration of consumer loyalty programs; bill-posting; commercial information agency services; advertising agency services; business management assistance; commercial or industrial company management assistance; cost price analysis; procurement services for others [purchasing goods and services for other businesses]; administrative assistance for responding to calls for tenders; accounting and financial auditing; company audits [commercial analyses]; employment agency services; price comparison services; accounting/book-keeping/accounting keeping; design of advertising materials; business management and organization consultancy; consulting services relating to personnel management; advice regarding communication [public relations]; business management consultancy; professional business consultancy; consulting and advisory services relating to business; typing services; preparation and filing of tax declarations; demonstration of goods; registration of gift lists; provision of sales areas online for sellers and buyers of goods and services; commercial business appraisal; market studies; company efficiency expert services; invoicing; production of advertising films; administrative management of hotels; computerized file management services; outsourced administrative management of companies; administrative management services for loss in the context of insurance contracts; outsourced management of after-sale services; business management of reimbursement programs for others; administrative management of user complaints; business information; commercial information and advice for consumers relating to choice of goods and services; commercial information via websites; advisory services for improving customer experience; commercial intermediary services in the context of connecting prospective private investors with entrepreneurs looking for financing; searches for sponsorship; commercial intermediation services; business investigations; change management; marketing; targeted marketing; marketing in the context of software editing; telemarketing; digital marketing; updating of advertising material; layout services for advertising purposes; updating and maintenance of data in computer databases; updating and maintenance of data in registers; negotiation and conclusion of commercial transactions for others; negotiation of business contracts for third parties; search engine optimization for sales promotion purposes; optimization of traffic for web sites, photocopying services; document reproduction; business management for freelance service providers; payroll preparation; presentation of goods on all communication media, for retail purposes; appointment scheduling services [office functions]; appointment reminder services [office functions]; telephone answering for unavail-

lable subscribers; sales promotion for others; advertising by mail order; online advertising on a computer network; data search in computer files for others; business research; marketing research; personnel recruitment; outsourced management services for human resources; writing of advertising texts; referencing of web sites for commercial or advertising purposes; public relations; drawing up of statements of accounts; business inquiries; news clipping services; management services for discussion forums; production of tele-shopping programs; secretarial services; psychological testing for the selection of personnel; opinion polling; compilation of statistics; shorthand services; systematization of information in computer databases; telemarketing services; outsourcing services [business assistance]; word processing; layout services for advertising purposes; administrative processing of purchase orders; transcription of communications [office functions]; news clipping services; competitive intelligence services; commercial intelligence services; account verification; consulting services in the field of outsourcing business services; sectoral analyses [economic analyses].

36 – Insurance services; financial affairs; monetary affairs; real estate affairs; stock and asset brokerage services; insurance brokerage services; insurance underwriting services; actuarial services; factoring; debt collection agency services; housing agency services; financial analysis; attributing discounts in third-party member institutions by means of a membership card; banking services; on-line banking services; surety services; preparation of credit files; salary payment services; issuance of travelers' checks; charitable fundraising services; organization of collections; financial consultancy; insurance consultancy; fiscal valuation services; financial evaluation [insurance, banking, real estate]; financial estimates of repair costs; financial evaluations for responding to calls for tender; financing services; financial management; financial management of reimbursement payments for others; financial information; insurance information; financial information by means of websites; installment loans; rent collection; underwriting of insurance contracts; processing of payments by credit or debit cards; check verification.

38 – Telecommunications; telecommunication routing and junction services; electronic bulletin board services [telecommunications services]; news agency services; paging services [radio, telephone or other means of electronic communication]; provision of telecommunication channels for teleshopping services; mobile telephone communication services; telephone communications; communications by computer terminals; radio communications; provision of chat rooms on the Internet; provision of on-line forums; provision of user access to global computer networks; provision of access to databases; information on telecommunications; voice messaging servi-

ces; rental of modems and apparatus for telecommunications; connection by telecommunications to a global computer network; teleconferencing services; television broadcasting; telephone services; computer-aided transmission of messages and images; transmission of emails; transmission of digital files, transmission of continuous flow data [streaming]; transmission of video-on-demand footage; videoconferencing services.

39 – Organization of travel; franking of mail; distribution and delivery of letters and parcels; physical storage of electronically-stored data or documents; rescue operations [transport]; towing services in case of vehicle breakdowns; ambulance transport; chauffeur services; transport brokerage; organization of cruises; packaging of products / wrapping of products; transport information; delivery of merchandise, distribution [delivery] of goods; logistics services relating to transport; messaging [mail or goods]; collection of recyclable products; booking of seats for travel; transport reservations; travel reservations.

41 – Academies [education]; training services intended for businesses; vocational guidance [education or training advice]; calligraphy services; coaching [training]; organizing and conducting colloquiums, conferences, congresses, seminars, symposiums, training workshops, non-virtual educational forums; organization of competitions [education or entertainment]; correspondence courses; teaching/ education/ instruction; educational examination services; practical training [demonstration]; training services by means of simulators; organization and conducting of non-virtual educational forums; information relating to education; vocational guidance [education or training advice]; photography services; photographic reporting; vocational retraining; production of radio and television programs; provision of non-downloadable television programs via video-on-demand services; translation services; tutoring; videotaping; provision of non-downloadable films via video-on-demand services; editing and desktop publishing; microfilming, assembly of video strips; party planning [entertainment]; dubbing; photographic reporting; booking of seats for shows.

42 – Scientific and technological services as well as research and design services relating thereto; industrial analysis and research services; design and development of computers, software and applications for mobile telephones; infographic design services; services provided by engineers and scientists in charge of assessments, estimates, research and reporting in the scientific and technological fields (including technology advisory services); computer system analysis; handwriting analysis [graphology]; data encryption services; graphic arts design services; computer graphics services; graphic design services; computer system design; conducting of technical project studi-

es; services provided by consultants relating to computer hardware design and development; services provided by consultants relating to Internet security; services provided by consultants relating to data security; advice regarding website design; information technology (IT) consultancy; technological consultancy services; information technology consultancy services; telecommunication technology consultancy services; software consultancy; computer security consultancy; quality control; vehicle roadworthiness testing; conversion of data or documents from physical to electronic media; creation and maintenance of websites for third parties; creation and design of information directories based on websites for third parties [information technology services]; unlocking mobile telephone sim cards; industrial design; packaging design services; software development in the context of software editing; duplication of computer programs; surveying [engineering work]; outsourced services relating to information technology; hosting of computer sites [Web sites]; hosting of servers; information relating to information technology and programming by means of websites; engineering; software installation; software as a service [SaaS]; rental of computer software; maintenance of computer software; updating of software; digitization of documents [scanning]; computer rental; computer platform as a service [PaaS]; programming for computers; computer virus protection services; research and development of new products for third parties; technical research; scientific research; computer data recovery; technical writing; off-site data backup; rental of web servers; electronic data storage; monitoring of computer systems to detect breakdowns; monitoring of computer systems for the detection of unauthorized access or data protection breaches; electronic monitoring of personal identification information for the detection of identity theft via the Internet; electronic monitoring of credit card transactions for the detection of fraud via the Internet; monitoring of computer systems by remote access; technical assistance and support in the field of computer equipment, multimedia products.

43 – Accommodation reservation for travelers; temporary hosting welcome services [entrance and exit management]; rental of temporary accommodation; rental of meeting rooms.

45 – Legal services; security services for the physical protection of material goods; legal administration of licenses; computer software licensing [legal services]; licensing [legal services] in the context of software publishing; legal advice for responding to calls for tender; litigation services; development services for legal documents, registration of domain names [legal services]; legal services in relation to contract negotiation for third parties; rental of domain

names on the Internet; legal research; online social networking services; legal intelligence services.

(260) AM 2020 105493 A

(800) 1494130

(151) 2019 05 10

(891) 2019 05 10

(731) EURO GAMES TECHNOLOGY LTD.

"Maritsa" Str., 4, "Vranya-Lozen-Triugulnika", BG-1151 Sofia, Bulgaria

(540)



(591) White, yellow, orange, blue and black

(531) 03.07.17; 27.05.03; 27.05.04; 29.01.15

(511)

9 – Software; computer gaming software; computer software packages; computer operating system software; computer software, recorded; software drivers; virtual reality software; games software; entertainment software for computer games; computer programs for network management; operating computer software for main frame computers; monitors (computer hardware); computer hardware; apparatus for recording images; monitors (computer programs); computer game programs; computer programs for recorded games; apparatus for recording, transmission or reproduction of sound or images; communications servers [computer hardware]; electronic components for gambling machines; computer application software featuring games and gaming; computer software for the administration of on-line games and gaming; computer hardware for games and gaming; electronic components and computer software for gambling, gambling machines, gambling games on the internet and via telecommunication network.

28 – Gaming machines for gambling; chips for gambling; mah-jong; arcade games; gambling machines operating with coins, notes and cards; games; electronic games; parlor games; gaming chips; gaming tables; slot machines [gaming machines]; LCD game machines; slot machines and gaming devices; coin-operated amusement machines; roulette chips; poker chips; chips and dice [gaming equipment]; equipment for casinos; roulette tables; gaming roulette wheels; casino games; gambling machines and amusement machines, automatic and coin-operated; coin-operated amusement machines and/or electronic coin-operated amusement machines with or without the possibility of gain; boxes for coin-operated machines, slot machines and gaming machines; electronic or electrotechnical amusement machines and apparatus, gaming machines, coin-operated entertainment machines; housings for coin-operated machines, gaming equipment, gaming machines, ma-

chines for gambling; electropneumatic and electrical gambling machines (slot machines).

41 – Gambling; services related to gambling; gaming services for entertainment purposes; casino, gaming and gambling services; training in the development of software systems; provision of equipment for gambling halls; providing casino equipment [gambling]; gaming machine entertainment services; providing casino facilities [gambling]; gaming hall services; amusement arcade services; games equipment rental; rental of gaming machines; providing amusement arcade services; rental of gaming machines with images of fruits; editing or recording of sounds and images; sound recording and video entertainment services; hire of sound reproducing apparatus; provision of gaming equipment for casinos; providing of casino facilities; online gambling services; casino, gaming and gambling services; provision of gaming establishments, gaming halls, internet casinos, online gaming services.

(260) AM 2020 105494 A

(800) 1494139

(151) 2019 09 10

(891) 2019 09 10

(731) JAPAN TOBACCO INC.

2-2-1 Toranomon, Minato-ku, Tokyo, Japan

(540)

WINSTON MIX

(591) Black, white

(511)

34 – Tobacco, raw or manufactured; smoking tobacco, pipe tobacco, rolling tobacco, chewing tobacco, snus; cigarettes, electronic cigarettes, cigars, cigarettos; snuff; smokers' articles included in this class; cigarette paper, cigarette tubes and matches.

(260) AM 2020 105495 A

(800) 1494145

(151) 2019 04 30

(891) 2019 04 30

(731) MAGNETI MARELLI S.P.A.

Viale Aldo Borletti 61/63, I-20011

CORBETTA (MI), Italy

(540)

MARELLI

(591) Black, white

(511)

7 – Igniting devices for internal combustion engines; electronic ignitions for vehicles; couplings for machines; shaft couplings for machines; camshafts for vehicle engines; axles for machines; carburettor feeders; bearing housings for machines; alternators; alternators for land vehicles; shock absorbers for machines; grease rings [parts of machines]; piston seg-

ments; ball rings for bearings; high-frequency motor spindles with high frequency electric converters and power supply units; push rods for motors and engines; connecting rods for land vehicle engines; automotive engine blocks; calenders; sparking plugs for internal combustion engines; glow plugs for diesel engines; carburettors; crankcases for machines, motors and engines; engine cylinders for vehicles; engine cylinders for land vehicles; cylinders for machines; cylinders for motors and engines; fan belts for land vehicle engines; timing belts for motors and engines; timing belts for land vehicle engines; fan belts for motors and engines; transmission belts, other than for land vehicles; belts for motors and engines; cowlings [parts of machines]; headers being parts of vehicle exhaust systems; automotive intake manifolds; intake manifolds for motors and engines; exhaust manifold for engines; scale collectors for machine boilers; hydraulic controls for machines, motors and engines; pneumatic controls for machines, motors and engines; air compressors for vehicles; compressors [machines]; compressors for air conditioners; air condensers; steam condensers [parts of machines]; catalytic converters; fuel conversion apparatus for internal combustion engines; automobile oil pans; rack and pinion jacks; brake pads, other than for vehicles; roller bearings; ball-bearings; self-oiling bearings; bearings [parts of machines]; bearings for transmission shafts; engine bearings; dynamos; ignition devices for land vehicle engines; fuel injection devices for internal combustion engines; fuel economisers for motors and engines; mechanical lifts for moving, parking and storing land vehicles; air cleaners [parts of engines]; air filters for automobile engines; oil filters; oil filters for motors and engines; filters being parts of machines or engines; fuel filters; filters for cleaning cooling air, for engines; generators for land vehicles; joints [parts of engines]; gaskets of metal for vehicle engines; gaskets, not of metal, for vehicle engines; injectors for engines; washing installations for vehicles; lubricators [parts of machines]; igniting magnetos; igniting magnetos for engines; exhausts for motors and engines; pump diaphragms; engines and motors for model vehicles; mechanical engine parts for land vehicles; shock absorber plungers [parts of machines]; pistons for cylinders; pistons for engines; pistons [parts of machines or engines]; pistons for vehicle engines; pistons for land vehicle engines; self-regulating fuel pumps; water pumps for land vehicle engines; oil pumps for land vehicle engines; fuel pumps for land vehicle engines; lubricating pumps; pumps for cooling engines; pumps for land vehicle engines; radiators [cooling] for motors and engines; speed governors for machines, engines and motors; pressure reducers [parts of machines]; water heaters [parts of machines]; industrial robots; mufflers for motors and engines; exhaust systems for diesel engines; automotive exhaust pipes; exhaust pi-

pes for land vehicle engines; control valves for regulating the flow of gases and liquids [parts of machines]; fans for motors and engines; heat exchangers [parts of machines].

9 – Accumulators [batteries]; accumulators, electric; accumulators, electric, for vehicles; electronic power supplies; residual gas analyzers; car antennas; electrical and electronic control apparatus and instruments; electrical and electronic control apparatus for use with apparatus of installations for air-conditioning; electrical and electronic control apparatus for use with apparatus or installations for heating; electrical and electronic control apparatus for use with apparatus of installations for ventilation; measuring and control apparatus and instruments; electronic navigational, tracking and positioning apparatus and instruments; data communication apparatus and instruments; apparatus and instruments for recording, transmission or reproduction of sound or images; satellite broadcast receiving and decoding apparatus and instruments; apparatus and instruments for transferring, receiving and storing sound, images and data, both in digital and analog form; speed checking apparatus for vehicles; navigation apparatus for vehicles [on-board computers]; satellite navigational apparatus; signal transmission apparatus; regulating apparatus, electric; measuring devices, electric; signalling apparatus and instruments; apparatus and installations for conducting, switching, transforming, accumulating, regulating or controlling the distribution or use of electricity; Global Positioning System [GPS] apparatus; distance recording apparatus; data processing apparatus; distance measuring apparatus; apparatus for testing vehicle brakes; apparatus for testing vehicle transmissions; vehicle radios; computer software applications, downloadable; audio books; emergency light bars for vehicles [luminous signals]; batteries; batteries for lighting; batteries, electric; batteries for vehicles; electric wire harnesses for automobiles; battery chargers; cables, electric; starter cables for motors; photovoltaic cells; electronic circuits; integrated circuits; power connectors; electric cable connectors; connectors [electricity]; counters; contacts, electric; light-emitting diodes [LED]; quantum dot light-emitting diodes [QLED]; organic light-emitting diodes [OLED]; vehicle tracking devices; igniting apparatus, electric, for igniting at a distance; electronic personal alarm devices; wires, electric; sheaths for electric cables; automatic indicators of low pressure in vehicle tires; quantity indicators; temperature indicators; water level indicators; fuel gauges; gasoline gauges; electric loss indicators; pressure indicators; speed indicators; interfaces for computers; circuit closers; power switches; circuit breakers; inverters [electricity]; measuring and testing machines and instruments; vehicle wheel alignment machines; tire balancing machines for land vehicles; magnets; junction sleeves for electric

cables; pressure gauges; measuring apparatus; pressure measuring apparatus; electrical cells and batteries; plates for batteries; electric sockets; data processors; digital signal processors; computer software products; computer programs, downloadable; electronic publications, downloadable; control panels [electricity]; switchboards; distribution boards [electricity]; radios for vehicles; voltage regulators for vehicles; resistances, electric; audio- and video-receivers; cell switches [electricity]; combination carbon monoxide and smoke detectors; heat detectors; smoke alarms; fire detectors; black boxes [data recorders]; semi-conductors; infrared sensors; acceleration sensors; distance sensors; level sensors; gas sensors; motion sensors; motion sensors for security lights; position sensors; pressure sensors; proximity sensors; timing sensors; temperature sensors; coolant-temperature sensors; vibration sensors; velocity sensors; optical sensors; locks, electric; power locks for motor vehicles; locks for vehicles, electric; vehicle driving simulators for training purposes; sirens for vehicles; fire extinguishing systems; satellite navigation systems; Global Positioning Systems; computer software for data processing; graphical user interface software; software for diagnostics and troubleshooting; software for satellite navigation systems; computer software for Global Positioning Systems [GPS]; downloadable computer software for remote monitoring and analysis; charging stations for electric vehicles; alarms; measuring instruments; navigational instruments; speedometers for vehicles; tachometers; pressure indicator plugs for valves; thermostats for vehicle engines; thermostats for vehicles; battery testers; transformers [electricity]; step-down transformers; backup drives for computers; voltage monitoring units; battery jars.

11 – Lighting apparatus for vehicles; lights for vehicles; vehicle headlights; taillights for vehicles; vehicle reflectors; map-reading lights for vehicles; running lights for land vehicles; backup lights for land vehicles; taillights for land vehicles; anti-glare devices for vehicles [lamp fittings]; light bulbs for directional signals for vehicles; lights for automobiles; headlights for automobiles; heaters for vehicles; defrosters for vehicles; ventilating fans for use in vehicles; air conditioners for vehicles; ventilation [air-conditioning] installations for vehicles; heating apparatus for defrosting vehicle windows; heat exchangers, other than parts of machines.

12 – Electric cigarette lighters for land vehicles; cigar lighters for automobiles; couplings for land vehicles; air bags [safety devices for automobiles]; air bags for vehicles; cardan shafts for vehicles; transmission shafts for land vehicles; sun-blinds adapted for automobiles; anti-theft alarms for vehicles; suspension shock absorbers for vehicles; shock absorbers for automobiles; shock absorbers for vehicles; brake segments for vehicles; anti-theft devices for

vehicles; apparatus for locomotion by land; headrests for vehicle seats; vehicle roll bars; axles for land vehicles; trailer hitches for vehicles; electric cars; robotic cars; cars; sway bars for land vehicle suspensions; vehicle joysticks; tow bars for vehicles; torsion bars for automobiles; torsion bars for land vehicle suspensions; torsion bars for vehicles; connecting rods for land vehicles, other than parts of motors and engines; signal arms for vehicles; gear boxes for land vehicles; inner tubes for pneumatic tires; inner tubes for vehicle tires; trucks; hoods for vehicles; bodies for vehicles; automobile bodies; coachwork for motor vehicles; driving chains for land vehicles; transmission chains for land vehicles; automobile chains; tire chains for land vehicles; brake shoes for automobiles; brake shoes for vehicles; rims for vehicle wheels; tires for vehicle wheels; spikes for tires; brake cylinders for vehicles; brake cylinders for land vehicles; security harness for vehicle seats; transmission belts for land vehicles; safety belts for vehicle seats; hydraulic circuits for automobiles; hydraulic circuits for vehicles; clips adapted for fastening automobile parts to automobile bodies; torque converters for automobiles; torque converters for land vehicles; transmission top covers for land vehicles; casings for pneumatic tyres; fitted dashboard covers for vehicles; hoods for vehicle engines; wheel bearings for land vehicles; axle bearings for land vehicles; lug nuts for vehicle wheels; reduction gears for land vehicles; hub caps; brake discs for vehicles; anti-glare devices for vehicles; anti-theft devices for automobiles; non-skid devices for vehicle tires; vehicle bonnet pins; license plate fasteners; fender flares for land vehicles; windows for automobiles; interior trim for automobiles; block brakes for land vehicles; brakes for automobiles; brakes for vehicles; brakes for land vehicles; universal joints for land vehicles; solid tires for vehicle wheels; brake linings for automobiles; brake linings for vehicles; clutch linings for land vehicles; upholstery for vehicles; differential gears for land vehicles; reversing gears for land vehicles; drive gears for land vehicles; gearing for land vehicles; gear shifts for automobiles; gear shifts for land vehicles; driving motors for land vehicles; handles for automobile doors; clutch mechanisms for automobiles; clutch mechanisms for land vehicles; propulsion mechanisms for land vehicles; transmissions for land vehicles; leaf springs for land vehicle suspensions; shock absorbing springs for automobiles; shock absorbing springs for vehicles; suspension springs for automobiles; vehicle suspension springs; jet engines for land vehicles; automobile engines; diesel engines for land vehicles; electric motors for automobiles; motors, electric, for land vehicles; engines for land vehicles; hubs for vehicle wheels; roof panels for land vehicles; door panels for vehicles; door panels for land vehicles; windscreens; windshields for automobiles; windshields for vehicles; mudgu-

ards for automobiles; mudguards for land vehicles; sun visors for automobiles; mud flaps for vehicles; vehicle bumpers; bumpers for automobiles; structural parts for automobiles; structural parts for vans; structural parts for trucks; brake pads for automobiles; brake pads for vehicles; brake pedals for vehicles; brake calipers for vehicles; balance weights for vehicle wheels; pneumatic tires; automobile tires; air pumps [vehicle accessories]; roof racks for automobiles; luggage carriers for vehicles; license plate holders; doors for vehicles; doors for automobiles; ashtrays for automobiles; vehicle running boards; vehicle wheel spokes; rearview mirrors; tire liners; fitted liners for the cargo area of vehicles; gear wheels for land vehicles; wheels for automobiles; vehicle wheels; transmission cases for land vehicles; vehicle seats; car seats for children; brake segments for automobiles; brake segments for land vehicles; horns for vehicles; reversing alarms for vehicles; fuel tanks for land vehicles; gas tanks for vehicles; brake systems for vehicles; suspension systems for automobiles; suspension systems for land vehicles; wheel suspensions; windshield wiper blades for vehicles; side view mirrors for vehicles; rearview mirrors for automobiles; spoilers for vehicles; engine mounts for land vehicles; mud flap hangers; spare tire carriers for vehicles; brake drums for vehicles; brake drums for land vehicles; caps for vehicle fuel tanks; caps for automobile gas tanks; valve stem caps for vehicle tires; vehicle chassis; automobile chassis; windshield wipers; headlight wipers; sunroofs for automobiles; convertible tops for automobiles; convertible tops for vehicles; gear boxes for automobiles; steering units for land vehicles; valves for vehicle tires; electric vehicles; driverless cars [autonomous cars].

37 – Fuelling of vehicles; vehicle washing; vehicle greasing; vehicle polishing; vehicle maintenance; repair of water vehicles; consultancy relating to vehicle repair; tuning of engines for motor vehicles; maintenance of motor vehicles; maintenance of vehicles and machines; maintenance, servicing and repair of vehicles; vehicle battery charging; repair of land vehicles; repair and maintenance of vehicles; emergency vehicle repair services; repair of brake systems for vehicles; repair and maintenance of engines for motor vehicles; repair and maintenance of motor vehicles and their engines; recharging services for electric vehicles; fuelling, washing, cleaning, maintenance and repair of vehicles; repair and maintenance of motor vehicles and parts thereof; information and consultancy services relating to vehicle repair; garage services for the maintenance and repair of motor vehicles; repair, maintenance, servicing, dismantling, rebuilding and cleaning of vehicle engines and parts thereof; repair of automobiles; tuning of motors and engines for automobiles; motor vehicle maintenance and repair; providing information relating to the repair or maintenance of automobiles; inspec-

tion of automobiles and parts thereof prior to maintenance and repair.

(260) AM 2020 105496 A

(800) 1494160

(151) 2019 09 10

(891) 2019 09 10

(731) Huawei Technologies Co., Ltd.

ADMINISTRATION BUILDING, HUAWEI TECHNOLOGIES CO., LTD., BANTIAN, LONGGANG DISTRICT, SHENZHEN, China

(540)

HUAWEI 3D Live Maker

(591) Black, white

(531) 27.05.01

(511)

9 – Humanoid robots with artificial intelligence; downloadable graphic design templates; downloadable mobile applications; computer software applications, downloadable; computer programs [downloadable software]; image scanners; graphics accelerators; central processing units for processing information, data, sound or images; computer screen saver software, recorded or downloadable; computer operating programs, recorded; computer programs, recorded; tablet computers; digital signal processors; data processing apparatus; memory devices for use with data processing apparatus; smartphones; downloadable graphics for mobile phones; computer memory devices; computer hardware; computer programs [downloadable software]; computer software, recorded.

(260) AM 2020 105497 A

(800) 1494165

(151) 2019 08 09

(891) 2019 08 09

(731) SHENZHEN SOUNDSOUL INFORMATION TECHNOLOGY CO., LTD

20L, Building 5, Mingjin Plaza, No.1 Yuheng Road, Yunong Community, Futian Street, Futian District, Shenzhen City, 518000 Guangdong Province, China

(540)

soundsoul

(591) Black, white

(531) 27.05.01

(511)

9 – Sound transmitting apparatus; cameras [photography]; loudspeakers; earphone; headphones; sonars; portable media players; couplers [data processing equipment]; diaphragms [acoustics]; batteries, electric.

(260) AM 2020 105498 A

(800) 1494199

(151) 2019 06 03

(891) 2019 06 03

(731) INNER MONGOLIA YILI INDUSTRIAL GROUP CO., LTD.

NO. 1 JINSHAN ROAD, JINSHAN DEVELOPMENT ZONE, HOHHOT, China

(540)

安慕希
AMBROSIAL

(591) Black, white

(531) 27.05.01; 28.03

(511)

5 – Tonics [medicines]; mineral water for medical purposes; medicinal drinks; dietary fiber; medical preparations for slimming purposes; nutraceutical preparations for therapeutic or medical purposes; medicines for human purposes; vitamin preparations; radioactive substances for medical purposes; gases for medical purposes; chemical conductors for electrocardiograph electrodes; semen for artificial insemination; disinfectants; solutions for contact lenses; bacteriological culture mediums; candy, medicated; protein dietary supplements; lecithin dietary supplements; albuminous dietary supplements; nutritional supplements; mineral food supplements; dietetic beverages adapted for medical purposes; dietetic substances adapted for medical use; dietetic foods adapted for medical purposes; lacteal flour for babies; food for babies; infant formula; powdered milk for babies; air purifying preparations; medicated animal feed; dietary supplements for animals; pesticides; babies' diapers; breast-nursing pads; dental abrasives; diapers for pets.

29 – Meat; seaweed extracts for food; fish, not live; fruits, tinned [canned (am.)]; fruit, preserved; vegetable-based snack; areca-nut, prepared; vegetables, preserved; eggs; butter; cream [dairy products]; milk; milk products; yoghurt; whipped cream; powdered milk; milk beverages, milk predominating; soya milk; milk shakes; milk tea (milk based); almond milk; soybean milk; smetana [sour cream]; peanut milk; soya milk powder; soya milk extracts; coconut milk; rice milk; coconut milk-based beverages; almond milk-based beverages; peanut milk-based beverages; cheese; edible fats; fruit jellies; nuts, prepared; dried edible mushroom; bean curd products; sausage casings, natural or artificial.

30 – Coffee-based beverages; chocolate beverages with milk; coffee; cocoa, roasted, powdered or granulated, for beverages; chocolate-based beverages; tea; tea-based beverages; sugar; candy; milk powder candy being confectionery; honey; golden syrup;

pastries; bread; confectionery; oat flakes; instant rice; cereal preparations; soya flour; rice; sago; wheat flour; instant noodle; rice flour porridge; cereal-based snack food; rice-based snack food; starch for food; ice cream; edible ices; ice pops; cooking salt; vinegar; soya sauce; condiments; mustard; fish sauce; yeast; leaven; aromatic preparations for food; essences for foodstuffs, except etheric essences and essential oils; preparations for stiffening whipped cream; meat tenderizers, for household purposes; gluten prepared as foodstuff; tea beverages with milk.

32 – Beer; rice-based beverages, other than milk substitutes; non-alcoholic beverages flavored with beer; sports beverages; energy drinks; non-alcoholic carbonated beverage; non-alcoholic fruit juice beverages; whey beverages; waters [beverages]; lithia water; mineral water [beverages]; seltzer water; table waters; lemonades; soda water; non-alcoholic beverages; aerated water; isotonic beverages; kvass [non-alcoholic beverage]; smoothies; soya-based beverages, other than milk substitutes; protein-enriched sports beverages; non-alcoholic beverages flavored with coffee; non-alcoholic beverages flavored with tea; soft drinks; cola; lactic acid fruit beverages, other than milk based beverages; distilled water (beverage); drinking distilled water; purified water (beverage); plant-based beverages; legume-based beverages, other than milk substitutes; fermented drink made from ground beans, other than milk substitutes; preparations for making beverages.

(260) AM 2020 105499 A

(800) 1494241

(151) 2019 07 31

(891) 2019 07 31

(731) SMITH & NEPHEW PLC

Building 5, Croxley Park, Hatters Lane,
WATFORD, Hertfordshire WD18 8YE,
United Kingdom

(540)



The logo consists of the letters 'S' and 'N' in a bold, black, sans-serif font. A small black cross is positioned between the two letters, centered vertically and horizontally.

(591) Black, white

(531) 24.13.01; 24.17.05; 27.03.15; 27.05.01;
27.05.08; 27.05.22

(511)

3 – Cosmetic preparations for skin care; skin cream; moisture protection cream; skin lotion; moisturising lotions.

5 – Surgical and medical wound dressings and bandages; plasters; gels, ointments and powders for the treatment of wounds; bone cement for medical purposes; adhesive bands and tapes for medical use; gauze for dressings; medicated skin care preparations;

pharmaceutical preparations for the treatment of wounds; medicated cotton wipes for medical use; medicated cotton swabs for medical use.

9 – Computer software and hardware for medical use; computer hardware and software for use in operating orthopaedic and endoscopic devices for medical purposes; computer software and hardware for evaluating wound treatment protocols for medical purposes; computer software and hardware for use in computer assisted surgery and medical record keeping; apparatus for capturing, storing, displaying and printing images in electronic format for use in the medical and surgical industry; computer software and hardware for monitoring, detecting, tracking and recording patient movement and activity.

10 – Surgical and medical apparatus and instruments; surgical instruments for use in endoscopic, orthopaedic and ear, nose and throat surgery; orthopaedic implants and prostheses; artificial hip implants; artificial knee implants; sterilised cases for instruments used in orthopaedic surgery; orthopaedic fixation devices; bone fixation appliances for surgical use; internal and external bone fracture fixators; bone plates; bone screws; bone cement mixers; endoscopes; light sources for use in endoscopic surgery; video cameras for attachment for an arthroscope or endoscope; fluid management systems for medical use; medical devices for electrosurgery and electron plasma assisted surgery; probes, catheters, generators and electrodes for use in electrosurgery; surgical sutures; surgical suture anchors; suture materials; negative pressure wound therapy devices; adhesive surgical incise drapes; elastic, suspensory and support bandages and stockings; bandages for joints, elastic bandages; personal monitoring sensor systems for medical purposes; medical devices for detecting, tracking, and recording a person's position and activity; surgical robots; surgical drapes.

41 – Medical education services; medical training and teaching.

44 – Healthcare services; medical information services; medical services.

(260) AM 2020 105681 A

(800) 1496005

(151) 2019 07 19

(891) 2019 07 19

(731) Joint Stock Company "AKOM"

22, Otvazhniy street, Zhigulevsk, RU-445359
Samara region, Russian Federation

(540)



(591) White, light grey, shades of blue and shades of yellow
 (531) 24.17.07; 25.03.01; 25.03.03; 27.05.08; 27.05.17; 29.01.14
 (526) + -
 (511)
 9 – Accumulators, electric; accumulators, electric, for vehicles; batteries, electric, for vehicles; battery jars; accumulator jars; batteries for lighting; batteries, electric; current rectifiers; inverters [electricity]; battery boxes; accumulator boxes; plates for batteries; converters, electric; regulating apparatus, electric; wires, electric; grids for batteries; charging stations for electric vehicles; battery chargers; chargers for electric batteries.

(260) AM 2020 105688 A
 (800) 1496146
 (151) 2019 08 29
 (891) 2019 08 29
 (731) OAKNORTH (SG) PTE. LIMITED
 137 Telok Ayer Street, #08-01 Singapore
 068602, Singapore

(540)



(591) Black, brown, green
 (531) 05.01.05; 05.01.16; 27.05.01; 29.01.13
 (511)
 9 – Computer programs [downloadable software]; computer software applications, downloadable; computer software for producing financial models.
 36 – Financial services; commercial lending; money lending; commercial lending services; financing of loans; banking services; capital investment services; financial strategy consultancy services; consultation services relating to investment; financial analysis and research services.
 42 – Software as a service [SaaS].

(260) AM 2020 105689 A
 (800) 1496177
 (151) 2019 06 25
 (891) 2019 06 25
 (731) PANASONIC LIFE SOLUTIONS
 ELEKTRİK SAN. VE TİC. A.Ş.
 Abdurrahmangazi Mah. Ebubekir Cad., No:44
 Sancaktepe, TR-34887 İstanbul, Turkey

(540)

(591) Black, light brown
 (531) 27.05.09; 27.05.10; 29.01.12
 (511)
 9 – Scientific, nautical, surveying, photographic, cinematographic, optical, weighing, measuring, signaling, checking (supervision), life-saving and teaching apparatus and instruments; apparatus and instruments for conducting, switching, transforming, accumulating, regulating, or controlling electricity, electric plugs, junction boxes [electricity], electric switches, circuit breakers, fuses, lighting ballasts, battery starter cables, electrical circuit boards, electric resistances, electric sockets, transformers [electricity], electrical adapters, battery chargers, electric door bells, electric and electronic cables, batteries, electric accumulators, solar panels for production of electricity; apparatus for recording, transmission or reproduction of sound or images; magnetic data carriers, recording discs, compact discs, DVDs and other digital recording media; mechanisms for coin-operated apparatus; cash registers, calculating machines, data processing equipment, computers; computer software; fire-extinguishing apparatus.

(260) AM 2020 105848 A
 (800) 1499380
 (151) 2019 07 19
 (891) 2019 07 19
 (731) Товариство з обмеженою відповідальністю
 "KHARKIVSKE FARMATSEVITYCHNE
 PIDPRYIEMSTVO "ZDOROVIA NARODU"
 vul. Shevchenka, 22, m. Kharkiv 61013,
 Ukraine

(540)

МОРФИН-ЗН

(591) Black, white
 (531) 28.05
 (511)
 5 – Adjuvants for medical purposes; cooling sprays for medical purposes; acaricides; aconitine; alkaloids for medical purposes; albumin dietary supplements; alginates for pharmaceutical purposes; alginate dietary supplements; algicides; aldehydes for pharmaceutical purposes; amino acids for veterinary purposes; amino acids for medical purposes; analgesics; anaesthetics; antibacterial handwashes; antibiotics; vermifuges; anti-uric preparations; antiseptics; antiseptic cotton; first-aid boxes, filled; aluminium acetate for pharmaceutical purposes; acetates for pharmaceutical purposes; germicides; bacterial preparations for medical and veterinary use; bacteriological preparations for medical and veterinary use; balms for medical purposes, balsamic preparations for medical purposes; royal jelly for pharmaceutical purposes; tobacco-free cigarettes for medical purposes; bandages for dressings; bicarbonate of soda for pharmaceutical purposes; albuminous preparations for

medical purposes; albuminous foodstuffs for medical purposes; biological preparations for veterinary purposes; biological preparations for medical purposes; biocides; bismuth subnitrate for pharmaceutical purposes; flour for pharmaceutical purposes; linseed meal for pharmaceutical purposes; meal for pharmaceutical purposes; bracelets impregnated with insect repellent; bromine for pharmaceutical purposes; bronchodilating preparations; vaginal washes for medical purposes; petroleum jelly for medical purposes; vaccines; absorbent cotton; absorbent wadding; aseptic cotton; cotton for medical purposes; wadding for medical purposes; cotton swabs for medical purposes; veterinary preparations; tartar for pharmaceutical purposes; decoctions for pharmaceutical purposes; vitamin preparations; mineral waters for medical purposes; hydrated chloral for pharmaceutical purposes; dietary fibre; charcoal for pharmaceutical purposes; astringents for medical purposes; gases for medical purposes; gallic acid for pharmaceutical purposes; guaiacol for pharmaceutical purposes; sexual stimulant gels; haematogen; haemoglobin; haemostatic pencils; herbicides; sanitary tampons; hydrastine; hydrastinine; mustard for pharmaceutical purposes; mustard oil for medical purposes; mustard plasters; glycerine for medical purposes; glycerophosphates; glucose for medical purposes; homogenized food adapted for medical purposes; hormones for medical purposes; mud for baths; medicinal mud; vulnerary sponges; rubber for dental purposes; gamboge for medical purposes; gurgun balsam for medical purposes; disinfectants; disinfectants for chemical toilets; disinfectants for hygiene purposes; deodorants for clothing and textiles; deodorants, other than for human beings or for animals; cedar wood for use as an insect repellent; detergents for medical purposes; digitalin; infant formula; diagnostic preparations for veterinary purposes; diagnostic preparations for medical purposes; diastase for medical purposes; dietary supplements for animals; royal jelly dietary supplements; glucose dietary supplements; pollen dietary supplements; dietary supplements with a cosmetic effect; linseed dietary supplements; linseed oil dietary supplements; acai powder dietary supplements; propolis dietary supplements; wheat germ dietary supplements; dietetic beverages adapted for medical purposes; dietetic substances adapted for medical use; dietetic foods adapted for medical purposes; yeast for pharmaceutical purposes; yeast dietary supplements; eucalyptus for pharmaceutical purposes; eucalyptol for pharmaceutical purposes; plant extracts for pharmaceutical purposes; herbal extracts for medical purposes; extracts of hops for pharmaceutical purposes; elixirs [pharmaceutical preparations]; enzymes for veterinary purposes; enzymes for medical purposes; enzyme dietary supplements; enzyme preparations for medical purposes; esters for pharmaceutical purposes; cellulose esters for pharmaceutical purposes; ethers for pharmaceuti-

cal purposes; cellulose ethers for pharmaceutical purposes; febrifuges; gelatine for medical purposes; milking grease; greases for veterinary purposes; greases for medical purposes; nicotine gum for use as an aid to stop smoking; chewing gum for medical purposes; nervines; bunion pads; isotopes for medical purposes; immunostimulants; reagent paper for veterinary purposes; reagent paper for medical purposes; insecticides; insecticidal veterinary washes; irish moss for medical purposes; iodine for pharmaceutical purposes; alkaline iodides for pharmaceutical purposes; iodides for pharmaceutical purposes; iodoform; casein dietary supplements; calomel [fungicide]; gum for medical purposes; camphor for medical purposes; camphor oil for medical purposes; capsules for medicines; capsules made of dendrimer-based polymers, for pharmaceuticals; carbolineum [parasiticide]; caustics for pharmaceutical purposes; caustic pencils; cachou for pharmaceutical purposes; quassia for medical purposes; quebracho for medical purposes; oxygen for medical purposes; acids for pharmaceutical purposes; oxygen baths; bone cement for surgical and orthopaedic purposes; fly glue; adhesive tapes for medical purposes; adhesive bands for medical purposes; adhesives for dentures; cocaine; collagen for medical purposes; collodion for pharmaceutical purposes; compresses; chemical contraceptives; angostura bark for medical purposes, condurango bark for medical purposes; croton bark; mangrove bark for pharmaceutical purposes; myrobalan bark for pharmaceutical purposes; barks for pharmaceutical purposes; quinquina for medical purposes; rhubarb roots for pharmaceutical purposes; lint for medical purposes; collyrium; cream of tartar for pharmaceutical purposes; creosote for pharmaceutical purposes; blood for medical purposes; depuratives; styptic preparations; dill oil for medical purposes; starch for dietetic or pharmaceutical purposes; biological tissue cultures for veterinary purposes; biological tissue cultures for medical purposes; cultures of microorganisms for medical or veterinary use; curare; dental lacquer; breast-nursing pads; milk sugar for pharmaceutical purposes; adhesive plasters; lecithin for medical purposes; lecithin dietary supplements; fly catching paper; medicines for alleviating constipation; medicines for human purposes; medicines for veterinary purposes; drugs for medical purposes; medicines for dental purposes; medicinal roots; medicated animal feed; medicinal tea; corn remedies; remedies for perspiration; remedies for foot perspiration; medicated dentifrices; medicated hair lotions; medicated after-shave lotions; medicinal drinks; medicinal infusions; medicinal oils; medicated toiletry preparations; medicinal hair growth preparations; medicated eye-washes; medicinal herbs; liniments; liquorice for pharmaceutical purposes; lotions for veterinary purposes; lotions for pharmaceutical purposes; personal sexual lubricants; lupulin for pharmaceutical purposes; magnesia for pharmaceuti-

cal purposes; sunburn ointments; ointments for pharmaceutical purposes; frostbite salve for pharmaceutical purposes; gauze for dressings; massage candles for therapeutic purposes; dental impression materials; teeth filling material, medicinal alcohol; medicine cases, portable, filled; medical preparations for slimming purposes; melissa water for pharmaceutical purposes; menstruation tampons; menthol; almond milk for pharmaceutical purposes; dog washes [insecticides]; animal washes [insecticides]; cattle washes [insecticides]; antibacterial soap; disinfectant soap; medicated soap; mineral food supplements; moulding wax for dentists; moleskin for medical purposes; powdered milk for babies; lacteal flour for babies; milk ferments for pharmaceutical purposes; sea water for medicinal bathing; mint for pharmaceutical purposes; vitamin supplement patches; nicotine patches for use as aids to stop smoking; scapulars for surgical purposes; vesicants; narcotics; linseed for pharmaceutical purposes; tincture of iodine; tinctures for medical purposes; nutraceutical preparations for therapeutic or medical purposes; fumigating sticks; fumigation preparations for medical purposes; fumigating pastilles; cachets for pharmaceutical purposes; wart pencils; oil of turpentine for pharmaceutical purposes; opiates; opium; opodeldoc; mouthwashes for medical purposes; rat poison; poisons; bacterial poisons; stick liquorice for pharmaceutical purposes; sanitary pants; paper for mustard plasters; mothproofing paper; parasiticides; pastilles for pharmaceutical purposes; pectin for pharmaceutical purposes; babies' diapers; pepsins for pharmaceutical purposes; peptones for pharmaceutical purposes; dressings, medical; hydrogen peroxide for medical purposes; pearl powder for medical purposes; pesticides; antioxidant pills; tanning pills; appetite suppressant pills; slimming pills; diapers for pets; babies' napkins; diapers for incontinence; babies' diaper-pants; blood plasma; by-products of the processing of cereals for dietetic or medical purposes; eyepatches for medical purposes; nutritional supplements; nutritive substances for microorganisms; bouillons for bacteriological cultures; pomades for medical purposes; powder of cantharides; pyrethrum powder; porcelain for dental prostheses; laxatives; bismuth preparations for pharmaceutical purposes, pre-filled syringes for medical purposes; haemorrhoid preparations; preparations for callouses; chilblain preparations; bath preparations for medical purposes; air deodorizing preparations; mothproofing preparations; preparations for reducing sexual activity; preparations for destroying dry rot fungus; larvae exterminating preparations; preparations for destroying mice; fly destroying preparations; slug exterminating preparations; preparations for destroying noxious plants; preparations for destroying noxious animals; vermin destroying preparations; acne treatment preparations; preparations for the treatment of burns; lice treatment preparations

[pediculicides]; ophotherapy preparations; air purifying preparations; appetite suppressants for medical purposes; sterilizing preparations; soil-sterilizing preparations; contact lens cleaning preparations; aloe vera preparations for pharmaceutical purposes; preparations of trace elements for human and animal use; preparations of microorganisms for medical or veterinary use; preparations to facilitate teething; poultices; chemical conductors for electrocardiograph electrodes; food for babies; sanitary towels; purgatives; propolis for pharmaceutical purposes; protein dietary supplements; protein supplements for animals; asthmatic tea; corn rings for the feet; anti-parasitic collars for animals; antiparasitic preparations; anticryptogamic preparations; leeches for medical purposes; radium for medical purposes; radioactive substances for medical purposes; diagnostic biomarker reagents for medical purposes; radiological contrast substances for medical purposes; insect repellents; insect repellent incense; repellents for dogs; digestives for pharmaceutical purposes; fish meal for pharmaceutical purposes; cod liver oil; castor oil for medical purposes; ergot for pharmaceutical purposes; solutions for contact lenses; solvents for removing adhesive plasters; mercurial ointments; sarsaparilla for medical purposes; lead water; sedatives; tissues impregnated with pharmaceutical lotions; serotherapeutic medicines; siccatives [drying agents] for medical purposes; serums; syrups for pharmaceutical purposes; sulfur sticks [disinfectants]; turpentine for pharmaceutical purposes; soporifics; salts for mineral water baths; bath salts for medical purposes; smelling salts; potassium salts for medical purposes; mineral water salts; salts for medical purposes; sodium salts for medical purposes; malt for pharmaceutical purposes; malted milk beverages for medical purposes; semen for artificial insemination; alcohol for pharmaceutical purposes; alloys of precious metals for dental purposes; douching preparations for medical purposes; steroids; stem cells for veterinary purposes; stem cells for medical purposes; dental abrasives; dental amalgams; dental amalgams of gold; dental mastics; dental cements; strychnine; freeze-dried meat adapted for medical purposes; freeze-dried food adapted for medical purposes; sulfonamides [medicines]; suppositories; lozenges for pharmaceutical purposes; therapeutic preparations for the bath; thermal water; thymol for pharmaceutical purposes; gentian for pharmaceutical purposes; tonics [medicines]; smoking herbs for medical purposes; herbal teas for medicinal purposes; tranquillizers; transplants [living tissues]; pants, absorbent, for incontinence; sanitary panties; tobacco extracts [insecticides]; pharmaceutical preparations; pharmaceutical preparations for treating dandruff; pharmaceutical preparations for skin care; pharmaceutical preparations for treating sunburn; lime-based pharmaceutical preparations; pharmaceuticals; phenol for pharmaceutical purposes; fennel for me-

dical purposes; ferments for pharmaceutical purposes; enzyme preparations for veterinary purposes; injectable dermal fillers; phytotherapy preparations for medical purposes; formic aldehyde for pharmaceutical purposes; phosphates for pharmaceutical purposes; fungicides; chemico-pharmaceutical preparations; chemical preparations for the diagnosis of pregnancy; chemical preparations for treating wheat blight; chemical preparations for treating mildew; chemical preparations for treating phylloxera; chemical preparations for treating diseases affecting vine plants; chemical preparations for treating diseases affecting cereal plants; chemical preparations for veterinary purposes; chemical preparations for medical purposes; chemical preparations for pharmaceutical purposes; chemical reagents for medical or veterinary purposes; quinine for medical purposes; chinoline for medical purposes; surgical implants comprised of living tissues; surgical glues; surgical dressings; diabetic bread adapted for medical use; chloroform; flowers of sulfur for pharmaceutical purposes; cement for animal hooves; candy, medicated; candy for medical purposes; sugar for medical purposes; medicated shampoos for pets; insecticidal animal shampoos; medicated shampoos; pediculicidal shampoos; medicated dry shampoos; panty liners [sanitary]; jujube, medicated; jalap.

(260) AM 2020 105959 A
 (800) 1293373
 (151) 2016 01 28
 (891) 2019 10 22
 (731) FIRST GRADE INTERNATIONAL LIMITED
 Coconut House, Tay Court, Isidore Road,
 Bromsgrove Enterprise Park, Bromsgrove,
 Worcestershire B60 3FQ, United Kingdom
 (540)



(591) Black, white
 (531) 05.01.12; 27.05.17
 (511)
 32 – Coconut water.

(260) AM 2020 105995 A
 (800) 1501104
 (151) 2019 08 14
 (891) 2019 08 14
 (731) EURO GAMES TECHNOLOGY LTD.
 "Maritsa" Str. 4, "Vranya-Lozen-
 Triugulnika", BG-1151 Sofia, Bulgaria

(540)



(591) Yellow, red, black and white
 (531) 27.05.03; 29.01.14
 (511)

9 – Software; computer gaming software; computer software packages; computer operating system software; computer software, recorded; software drivers; virtual reality software; games software; entertainment software for computer games; computer programs for network management; operating computer software for main frame computers; monitors (computer hardware); computer hardware; apparatus for recording images; monitors (computer programs); computer game programs; computer programs for recorded games; apparatus for recording, transmission or reproduction of sound or images; communications servers [computer hardware]; electronic components for gambling machines; computer application software featuring games and gaming; computer software for the administration of on-line games and gaming; computer hardware for games and gaming; hardware and software for gambling, gambling machines, gambling games on the Internet and via telecommunication network.

28 – Gaming machines for gambling; chips for gambling; mah-jong; arcade games; gambling machines operating with coins, notes and cards; games; electronic games; parlor games; gaming chips; gaming tables; slot machines [gaming machines]; LCD game machines; slot machines and gaming devices; coin-operated amusement machines; roulette chips; poker chips; chips and dice [gaming equipment]; equipment for casinos; roulette tables; gaming roulette wheels; casino games; automats and gambling machines; coin-operated machines and/or electronic coin-operated machines with or without the possibility of gain; boxes for coin-operated machines, slot machines and gaming machines; electronic or electro-technical gaming devices, automats and machines, coin-operated machines; housings for coin-operated machines, gaming equipment, gaming machines, machines for gambling; electropneumatic and electrical gambling machines (slot machines).

41 – Gambling; services related to gambling; gaming services for entertainment purposes; casino, gaming and gambling services; training in the development of software systems; provision of equipment for gambling halls; providing casino equipment [gambling]; gaming machine entertainment services; providing casino facilities [gambling]; halls with gaming machines; amusement arcade services; games equipment rental; rental of gaming machines; providing amusement arcade services; rental of gaming machines with images of fruits; editing or recording of sounds and images; sound recording and video

entertainment services; hire of sound reproducing apparatus; provision of gaming equipment for casinos; providing of casino facilities; online gambling services; casino, gaming and gambling services; operation of gaming establishments, gaming halls, Internet casinos, online gambling sites.

(260) AM 2020 105996 A

(800) 1501182

(151) 2019 10 16

(891) 2019 10 16

(731) APPLE INC.

One Apple Park Way, Cupertino CA 95014, USA

(540)

**APPLE PRO DISPLAY
XDR**

(591) Black, white

(526) DISPLAY

(511)

9 – Computer monitors.

(260) AM 2020 105997 A

(800) 1501192

(151) 2019 08 26

(891) 2019 08 26

(731) CHAOZHOU CHAO'AN JINDEFU FOOD CO., LTD.

QIQIAO INDUSTRIAL ZONE, WENLI VILLIAGE, ANBU TOWN, CHAO'AN DISTRICT, CHAOZHOU CITY, GUANG DONG PROVINCE, China

(540)



(591) Black, white

(531) 01.05.01; 03.07.17; 27.05.01

(511)

28 – Play balloons; props for dancing; spinning tops [toys]; soap bubbles [toys]; kaleidoscopes; masks [playthings]; intelligent toys; toy fireworks [non-explosive]; Christmas party table bombs; Christmas tree stands.

(260) AM 2020 106000 A

(800) 1501227

(151) 2019 09 05

(891) 2019 09 05

(731) Sovmestnoe belorussko-polskoe predpriyatie "KAMAKO PLYUS" v forme obshchestva s ogranichennoy otvetstvennostyu ul. Morozova, d. 87, cabinet 1, liter B1/b, g. Borisov, 222514 Minskaya oblast, Belarus

(540)



(591) Black-blue, dark-blue, white, violet, lilac, gold, yellow and orange

(531) 01.03.02; 01.03.17; 25.01.19; 28.05; 29.01.15 (511)

30 – Sauces; mayonnaise.

(260) AM 2020 106016 A

(800) 1501634

(151) 2019 08 27

(891) 2019 08 27

(731) "NEW MAX HOLDING" Mas'uliyati

Cheklangan Jamiyati

Bldg. 50 Sayram Avenue 7, M. Ulugbek District, Tashkent 100170, Uzbekistan

(540)

**TSUNAMI
ЦУНАМИ**

(591) Black, white

(531) 27.05.01; 28.05

(511)

32 – Beers; non-alcoholic beverages; mineral and aerated waters; fruit beverages and fruit juices; syrups and other non-alcoholic preparations for making beverages.

33 – Alcoholic beverages; vodka.

35 – Advertising; business management; business administration; office functions.

(260) AM 2020 106020 A

(800) 1501778

(151) 2019 10 10

(891) 2019 10 10

(731) SYLENCO GMBH

Baumwall 7, 20459 Hamburg, Germany

(540)

Syleaf

(591) Black, white
(511)

1 – Mineral fertilising preparations; potassium fertilizers; foliar fertiliser for application to crops during periods of stress; foliar fertiliser for application to crops during periods of rapid growth; chemically converted compound fertilizers; nutrients for plants; fused phosphate fertilizers; multi-nutrient fertilizers; liquid manure substitute; nitrogenous fertilizers.

(260) AM 2020 106021 A

(800) 1501780

(151) 2019 10 24

(891) 2019 10 24

(731) Henkel AG & Co. KgaA

Henkelstraße 67, 40589 Düsseldorf, Germany

(540)



SCALP
CLINIX

(591) Black, white

(531) 02.01.01; 02.01.16; 02.03.01; 02.03.02;
27.05.09; 27.05.10

(511)

3 – Preparations for the conditioning, cleaning, tinting, dyeing, bleaching, fixing and waving of hair, hair lotions and shampoos for cosmetic purposes.

(260) AM 2020 106287 A

(800) 1497313

(151) 2019 07 26

(891) 2019 07 26

(731) The Bulldog Trademark B.V.

Kabelweg 86, NL-1014 BC Amsterdam,
Netherlands

(540)



THE BULLDOG

(591) Black, white

(531) 03.01.09; 03.01.16; 26.01.15; 27.05.17

(511)

34 – Articles for smokers, including rolling paper, filters, filter tips and sleeves for cigarettes and joints, ashtrays, grinders, lighters, cigarette cases, pipes for smoking, e- cigarettes, storage tubes for cigarettes

and joints, rolling apparatus for cigarettes and joints; pouches for smoking products; herbs for smoking.

35 – Retail and wholesale services in the field of clothing, footwear and headgear; retail and wholesale services in the field of, legally allowed sales of soft drugs, including cannabis and marijuana and oils and preparations made thereof; retail services in the field of cannabis seeds; retail services in the field of food and drinks containing cannabis or cbd; retail services in the field of cosmetics, toiletries, perfumeries, soaps and deodorants containing cannabis or cbd; retail service in the field of medical products and food supplements containing cbd; retail services in the field of food and supplements for animals containing cannabis or cbd; retail services in the field of products and apparatus for smoking or inhaling cannabis or cbd (not including tobacco and tobacco containing products); retail and wholesale services in the field of food and drinks.

43 – Services of coffee shops namely establishments where one is legally allowed to smoke soft drugs including cannabis and marijuana; hotel, bar, restaurant and café services; services for providing food and drink; temporary accommodation services; provision of event facilities.

(260) AM 2020 106359 A

(800) 1505771

(151) 2019 10 17

(891) 2019 10 17

(731) IRED THERMAL GROUP LTD.

11330-143 Street, Edmonton AB T5M 1V5,
Canada

(540)



(591) Black, white

(531) 26.03.05; 26.03.24; 26.04.03; 26.04.04;
26.04.09; 26.07.15; 26.15.09

(511)

42 – Mechanical engineering in the field of fired equipment; inspection services in the field of oil and natural gas production equipment and infrastructure, namely, API inspection services; inspection services in the field of industrial gas fired equipment and appliances; infrared inspection services; 3D laser imaging services [digitalisation and scanning of images]; research services in the field of finite element analysis (FEA) and computational fluid dynamic (CFD) simulation; refractory testing services; refractory design services; design consultation services relating to the design support and review for refractory

design and installation; testing, analysis, and evaluation of the in-house fire equipment and in-house fire equipment parts and components of others to determine conformity with certification standards; testing, analysis, and evaluation of process heaters and fire equipment parts and components of others to determine conformity with certification standards.

(260) AM 2020 106425 A

(800) 1498572

(151) 2019 09 13

(891) 2019 09 13

(731) "Saratov-Lavr" obshchestvo s ogranichennoj otvetstvennost'yu
Arbatskaya str., 28, RU-410053 Saratov,
Russian Federation

(540)



(591) Burgundy, light brown and black

(531) 05.13.08; 26.01.02; 26.01.15; 26.01.18;
27.01.12; 28.05; 29.01.12

(511)

29 – Ajvar [preserved peppers]; aloe vera prepared for human consumption; alginates for culinary purposes; anchovy, not live; peanuts, prepared; artichokes, preserved; albumen for culinary purposes; white of eggs; beans, preserved; soya beans, preserved, for food; bouillon; ginger jam; ham; fatty substances for the manufacture of edible fats; laver, preserved; edible birds' nests; sea-cucumbers, not live; peas, preserved; mushrooms, preserved; guacamole [mashed avocado]; game, not live; gelatine; meat jellies; jellies for food; fruit jellies; yolk of eggs; coconut fat; bone oil for food; lard; suet for food; edible fats; curd; fruit-based snack food; milk substitutes; soya patties; tofu patties; charcuterie; cottage cheese fritters; raisins; caviar; eggplant paste; vegetable marrow paste; fish roe, processed; yogurt; galbi [grilled meat dish]; sauerkraut; kefir [milk beverage]; kimchi [fermented vegetable dish]; isinglass for food; clams, not live; potato-based dumplings; klipfish [salted and dried cod]; milk shakes; black pudding; onion rings; arrangements of processed fruit; compotes; meat, tinned; vegetables, tinned; fish, tinned; fruits, tinned; bouillon concentrates; corn dogs; gherkins; shrimps, not live; prawns, not live; buttercream; croquettes; silkworm chrysalis for human consumption; sweet corn, processed; kumys [milk beverage]; spiny lobsters, not live; lecithin for culinary purposes; salmon, not live; onions, preserved; mar-

garine; marmalade; oils for food; peanut butter; cocoa butter for food; coconut oil for food; coconut butter; corn oil for food; sesame oil for food; linseed oil for food; extra virgin olive oil for food; olive oil for food; palm oil for food; palm kernel oil for food; sunflower oil for food; colza oil for food; butter; soya bean oil for food; shellfish, not live; almonds, ground; animal marrow for food; mussels, not live; milk; peanut milk; peanut milk for culinary purposes; coconut milk; coconut milk for culinary purposes; almond milk; almond milk for culinary purposes; oat milk; rice milk; rice milk for culinary purposes; albumin milk; condensed milk; soya milk; powdered milk; fish meal for human consumption; vegetable mousses; fish mousses; fruit pulp; meat; meat, preserved; freeze-dried meat; milk beverages, milk predominating; peanut milk-based beverages; coconut milk-based beverages; almond milk-based beverages; sausage casings, natural or artificial; vegetables, preserved; freeze-dried vegetables; vegetables, dried; vegetables, cooked; potato fritters; olives, preserved; lobsters, not live; flavored nuts; candied nuts; coconut, desiccated; nuts, prepared; tomato purée; pressed fruit paste; liver pâté; pectin for culinary purposes; liver; pickles; jams; powdered eggs; milk products; fish-based foodstuffs; prostokvasha [sour milk]; poultry, not live; bulgogi [Korean beef dish]; pollen prepared as foodstuff; cranberry compote; apple purée; crayfish, not live; crustaceans, not live; fish, preserved; fish, not live; salted fish; ryazhenka [fermented baked milk]; vegetable salads; fruit salads; bacon; sardines, not live; pork; herrings, not live; seeds, prepared; sunflower seeds, prepared; cream [dairy products]; whipped cream; vegetable-based cream; fat-containing mixtures for bread slices; smetana [sour cream]; lemon juice for culinary purposes; tomato juice for cooking; vegetable juices for cooking; salted meats; sausages; sausages in batter; hot dog sausages; preparations for making bouillon; preparations for making soup; nut-based spreads; tripe; soups; vegetable soup preparations; whey; cheese; tahini [sesame seed paste]; tofu; truffles, preserved; tuna, not live; oysters, not live; falafel; milk ferments for culinary purposes; rennet; fish fillets; dates; crystallized fruits; frozen fruits; fruit, preserved; fruit preserved in alcohol; fruit, stewed; hazelnuts, prepared; potato flakes; hummus [chickpea paste]; fruit peel; preserved garlic; lentils, preserved; potato chips; low-fat potato chips; fruit chips; non-alcoholic eggnog; seaweed extracts for food; meat extracts; yuba [tofu skin]; berries, preserved; snail eggs for consumption; eggs; yakitori.

(260) AM 2020 106429 A

(800) 788486

(151) 2002 09 06

(891) 2019 05 10

(731) SGS Group Management SA

Place des Alpes 1, CH-1201 Genève,
Switzerland

(540)



(591) Black, white

(531) 26.01.01; 26.01.03; 26.01.10; 26.03.23;
26.11.01; 26.11.06; 26.11.12; 27.05.23

(511)

42 – Services checking the conformity of the management systems of agricultural, agro-industrial and industrial companies and services to national or international quality standards, in particular ISO standards, for the purposes of issuing conformity certificates.

**INTERNATIONAL TRADEMARKS PROTECTED
IN GEORGIA**

(260) AM 2020 100341 A
(800) 1433032
(151) 2018 06 08
(181) 2028 06 08
(891) 2018 06 08
(511) 01, 05, 30

(260) AM 2020 103148 A
(800) 1466752
(151) 2019 04 08
(181) 2029 04 08
(891) 2019 04 08
(511) 33

(260) AM 2020 100708 A
(800) 1437399
(151) 2018 09 20
(181) 2028 09 20
(891) 2018 09 20
(511) 01, 04, 31, 33, 34, 35, 43

(260) AM 2020 103236 A
(800) 1467519
(151) 2019 04 03
(181) 2029 04 03
(891) 2019 04 03
(511) 09

(260) AM 2020 101432 A
(800) 1446609
(151) 2017 05 19
(181) 2027 05 19
(891) 2017 05 19
(511) 09, 35, 38, 41

(260) AM 2020 103237 A
(800) 1467526
(151) 2019 04 17
(181) 2029 04 17
(891) 2019 04 17
(511) 05

(260) AM 2020 102617 A
(800) 1460043
(151) 2018 12 21
(181) 2028 12 21
(891) 2018 12 21
(511) 05

(260) AM 2020 103240 A
(800) 1467589
(151) 2019 04 12
(181) 2029 04 12
(891) 2019 04 12
(511) 03

(260) AM 2020 102802 A
(800) 1265605
(151) 2014 10 29
(181) 2024 10 29
(891) 2019 03 21
(511) 39, 41, 43

(260) AM 2020 103367 A
(800) 1468736
(151) 2019 03 26
(181) 2029 03 26
(891) 2019 03 26
(511) 03

(260) AM 2020 102863 A
(800) 1462696
(151) 2018 10 05
(181) 2028 10 05
(891) 2018 10 05
(511) 10

(260) AM 2020 103395 A
(800) 1469096
(151) 2019 03 26
(181) 2029 03 26
(891) 2019 03 26
(511) 03

(260) AM 2020 102884 A
(800) 1463167
(151) 2018 10 12
(181) 2028 10 12
(891) 2018 10 12
(511) 09, 35, 38

(260) AM 2020 103521 A
(800) 1470676
(151) 2019 04 25
(181) 2029 04 25
(891) 2019 04 25
(511) 09, 35, 37

(260) AM 2020 103522 A
(800) 1470687
(151) 2018 11 06
(181) 2028 11 06
(891) 2018 11 06
(511) 35, 37, 42

(260) AM 2020 103523 A
(800) 1470703
(151) 2019 01 16
(181) 2029 01 16
(891) 2019 01 16
(511) 25, 28, 41

(260) AM 2020 103525 A
(800) 1470794A
(151) 2018 12 20
(181) 2028 12 20
(891) 2018 12 20
(511) 32

(260) AM 2020 103530 A
(800) 1470915
(151) 2019 01 24
(181) 2029 01 24
(891) 2019 01 24
(511) 09, 11, 12, 17, 35, 37

(260) AM 2020 103540 A
(800) 1471032
(151) 2019 04 23
(181) 2029 04 23
(891) 2019 04 23
(511) 38

(260) AM 2020 103547 A
(800) 959904
(151) 2007 12 29
(181) 2027 12 29
(891) 2019 05 20
(511) 03, 05, 16

(260) AM 2020 103556 A
(800) 1449120
(151) 2018 11 20
(181) 2028 11 20
(891) 2019 05 17
(511) 33

(260) AM 2020 103593 A
(800) 1471238
(151) 2019 04 24
(181) 2029 04 24

(891) 2019 04 24
(511) 33

(260) AM 2020 103594 A
(800) 1471244
(151) 2019 03 01
(181) 2029 03 01
(891) 2019 03 01
(511) 33

(260) AM 2020 103596 A
(800) 1471329
(151) 2019 05 03
(181) 2029 05 03
(891) 2019 05 03
(511) 05

(260) AM 2020 103597 A
(800) 1471341
(151) 2019 05 03
(181) 2029 05 03
(891) 2019 05 03
(511) 05

(260) AM 2020 103602 A
(800) 1471493
(151) 2019 05 06
(181) 2029 05 06
(891) 2019 05 06
(511) 12, 37

(260) AM 2020 103603 A
(800) 1471546
(151) 2019 01 11
(181) 2029 01 11
(891) 2019 01 11
(511) 05, 10, 11, 16, 18, 20, 21, 22, 24, 25

(260) AM 2020 103614 A
(800) 1471826
(151) 2019 04 17
(181) 2029 04 17
(891) 2019 04 17
(511) 03, 05

(260) AM 2020 103621 A
(800) 1472014
(151) 2019 02 13
(181) 2029 02 13
(891) 2019 02 13
(511) 08

(260) AM 2020 103622 A
(800) 1472019
(151) 2019 04 11
(181) 2029 04 11
(891) 2019 04 11
(511) 05, 10

(260) AM 2020 103637 A
(800) 1472307
(151) 2019 02 20
(181) 2029 02 20
(891) 2019 02 20
(511) 09

(260) AM 2020 103641 A
(800) 693321
(151) 1998 04 17
(181) 2028 04 17
(891) 2019 05 24
(511) 28

(260) AM 2020 103643 A
(800) 787099
(151) 2002 07 23
(181) 2022 07 23
(891) 2019 05 07
(511) 03

(260) AM 2020 103644 A
(800) 920788
(151) 2007 01 26
(181) 2027 01 26
(891) 2019 05 24
(511) 09, 22, 25, 28

(260) AM 2020 103646 A
(800) 972653
(151) 2007 12 07
(181) 2027 12 07
(891) 2019 05 08
(511) 11

(260) AM 2020 103704 A
(800) 1472511
(151) 2019 05 02
(181) 2029 05 02
(891) 2019 05 02
(511) 05

(260) AM 2020 103709 A
(800) 1472665
(151) 2018 10 03
(181) 2028 10 03

(891) 2018 10 03
(511) 01, 02, 03, 04, 06, 07, 08, 09, 11, 12, 16, 17,
18, 19, 20, 21, 22, 24, 25, 26, 27, 28, 35, 37

(260) AM 2020 103710 A
(800) 1472667
(151) 2019 05 13
(181) 2029 05 13
(891) 2019 05 13
(511) 11

(260) AM 2020 103711 A
(800) 1472669
(151) 2019 03 13
(181) 2029 03 13
(891) 2019 03 13
(511) 09, 35, 42, 44

(260) AM 2020 103721 A
(800) 1473067
(151) 2019 02 20
(181) 2029 02 20
(891) 2019 02 20
(511) 18, 25, 35

(260) AM 2020 103722 A
(800) 1473068
(151) 2019 02 20
(181) 2029 02 20
(891) 2019 02 20
(511) 18, 25, 35

(260) AM 2020 103725 A
(800) 1473180
(151) 2019 04 09
(181) 2029 04 09
(891) 2019 04 09
(511) 05, 09, 10, 35, 37, 41

(260) AM 2020 103726 A
(800) 1473188
(151) 2019 04 05
(181) 2029 04 05
(891) 2019 04 05
(511) 03, 35

(260) AM 2020 103727 A
(800) 1473203
(151) 2019 04 03
(181) 2029 04 03
(891) 2019 04 03
(511) 09, 35, 42

(260) AM 2020 103729 A
(800) 1473230
(151) 2019 04 09
(181) 2029 04 09
(891) 2019 04 09
(511) 05, 09, 10, 35, 37, 41

(260) AM 2020 103735 A
(800) 1473328
(151) 2019 04 17
(181) 2029 04 17
(891) 2019 04 17
(511) 09

(260) AM 2020 103738 A
(800) 1473435
(151) 2019 02 15
(181) 2029 02 15
(891) 2019 02 15
(511) 30, 35

(260) AM 2020 103739 A
(800) 1473486
(151) 2019 04 05
(181) 2029 04 05
(891) 2019 04 05
(511) 30

(260) AM 2020 103740 A
(800) 1473513
(151) 2019 04 23
(181) 2029 04 23
(891) 2019 04 23
(511) 35

(260) AM 2020 103741 A
(800) 1473518
(151) 2019 03 20
(181) 2029 03 20
(891) 2019 03 20
(511) 09

(260) AM 2020 103747 A
(800) 1211069
(151) 2014 06 04
(181) 2024 06 04
(891) 2019 05 08
(511) 05

(260) AM 2020 103748 A
(800) 1394886
(151) 2018 01 17
(181) 2028 01 17

(891) 2019 05 29
(511) 01, 09, 10

(260) AM 2020 103749 A
(800) 1455136
(151) 2018 10 31
(181) 2028 10 31
(891) 2019 05 31
(511) 30, 35, 41, 43

(260) AM 2020 103790 A
(800) 1473566
(151) 2019 03 29
(181) 2029 03 29
(891) 2019 03 29
(511) 06

(260) AM 2020 103791 A
(800) 1473588
(151) 2018 12 07
(181) 2028 12 07
(891) 2018 12 07
(511) 33

(260) AM 2020 103792 A
(800) 1473611
(151) 2019 03 21
(181) 2029 03 21
(891) 2019 03 21
(511) 09, 28

(260) AM 2020 103801 A
(800) 1473734
(151) 2019 01 14
(181) 2029 01 14
(891) 2019 01 14
(511) 05

(260) AM 2020 103802 A
(800) 1473743
(151) 2019 02 11
(181) 2029 02 11
(891) 2019 02 11
(511) 30

(260) AM 2020 103803 A
(800) 1473776
(151) 2019 02 27
(181) 2029 02 27
(891) 2019 02 27
(511) 32

(260) AM 2020 103804 A
(800) 1473790
(151) 2019 05 16
(181) 2029 05 16
(891) 2019 05 16
(511) 18

(260) AM 2020 103805 A
(800) 1473796
(151) 2019 01 23
(181) 2029 01 23
(891) 2019 01 23
(511) 34

(260) AM 2020 103808 A
(800) 1473870
(151) 2018 12 07
(181) 2028 12 07
(891) 2018 12 07
(511) 40, 44, 45

(260) AM 2020 103809 A
(800) 1473878
(151) 2019 04 26
(181) 2029 04 26
(891) 2019 04 26
(511) 30

(260) AM 2020 103824 A
(800) 1474172
(151) 2019 03 06
(181) 2029 03 06
(891) 2019 03 06
(511) 05

(260) AM 2020 103826 A
(800) 1474201
(151) 2019 01 07
(181) 2029 01 07
(891) 2019 01 07
(511) 09, 35, 36

(260) AM 2020 103831 A
(800) 1474392
(151) 2019 05 02
(181) 2029 05 02
(891) 2019 05 02
(511) 09

(260) AM 2020 103836 A
(800) 1440147
(151) 2018 09 14
(181) 2028 09 14

(891) 2019 05 24
(511) 03

(260) AM 2020 103885 A
(800) 1474472
(151) 2019 04 01
(181) 2029 04 01
(891) 2019 04 01
(511) 03

(260) AM 2020 103888 A
(800) 1474636
(151) 2019 05 06
(181) 2029 05 06
(891) 2019 05 06
(511) 25

(260) AM 2020 103889 A
(800) 1474645
(151) 2019 05 03
(181) 2029 05 03
(891) 2019 05 03
(511) 34

(260) AM 2020 103890 A
(800) 1474648
(151) 2018 12 07
(181) 2028 12 07
(891) 2018 12 07
(511) 33

(260) AM 2020 103891 A
(800) 1474654
(151) 2019 05 08
(181) 2029 05 08
(891) 2019 05 08
(511) 05

(260) AM 2020 103892 A
(800) 1474660
(151) 2018 10 23
(181) 2028 10 23
(891) 2018 10 23
(511) 04

(260) AM 2020 103896 A
(800) 1474760
(151) 2019 04 01
(181) 2029 04 01
(891) 2019 04 01
(511) 03

(260) AM 2020 103906 A
(800) 1475033
(151) 2019 02 12
(181) 2029 02 12
(891) 2019 02 12
(511) 30

(260) AM 2020 103908 A
(800) 1475122
(151) 2019 01 11
(181) 2029 01 11
(891) 2019 01 11
(511) 03, 09, 14, 18, 25

(260) AM 2020 103909 A
(800) 1475148
(151) 2019 03 29
(181) 2029 03 29
(891) 2019 03 29
(511) 02, 08, 16, 17

(260) AM 2020 103910 A
(800) 1475162
(151) 2019 04 02
(181) 2029 04 02
(891) 2019 04 02
(511) 09, 28

(260) AM 2020 103911 A
(800) 1475191
(151) 2019 02 07
(181) 2029 02 07
(891) 2019 02 07
(511) 09, 35

(260) AM 2020 103913 A
(800) 1475238
(151) 2019 04 11
(181) 2029 04 11
(891) 2019 04 11
(511) 34

(260) AM 2020 103914 A
(800) 1475266
(151) 2019 02 13
(181) 2029 02 13
(891) 2019 02 13
(511) 03

(260) AM 2020 103917 A
(800) 1475345
(151) 2019 04 18
(181) 2029 04 18

(891) 2019 04 18
(511) 09, 37, 38, 39, 42

(260) AM 2020 103926 A
(800) 1475662
(151) 2019 02 21
(181) 2029 02 21
(891) 2019 02 21
(511) 03, 14, 16, 18, 22, 24, 25, 26, 31

(260) AM 2020 103929 A
(800) 1475694
(151) 2019 05 21
(181) 2029 05 21
(891) 2019 05 21
(511) 05

(260) AM 2020 103936 A
(800) 1475740
(151) 2019 05 21
(181) 2029 05 21
(891) 2019 05 21
(511) 05

(260) AM 2020 103993 A
(800) 1475941
(151) 2019 04 03
(181) 2029 04 03
(891) 2019 04 03
(511) 09, 35, 38, 41, 42

(260) AM 2020 103994 A
(800) 1475947
(151) 2019 04 03
(181) 2029 04 03
(891) 2019 04 03
(511) 09, 35, 38, 41, 42

(260) AM 2020 103995 A
(800) 1475951
(151) 2019 04 11
(181) 2029 04 11
(891) 2019 04 11
(511) 09

(260) AM 2020 103996 A
(800) 1475962
(151) 2019 04 01
(181) 2029 04 01
(891) 2019 04 01
(511) 06, 09, 16, 35, 39, 40

(260) AM 2020 103997 A
(800) 1475963
(151) 2019 04 01
(181) 2029 04 01
(891) 2019 04 01
(511) 06, 09, 16, 35, 39, 40

(260) AM 2020 103998 A
(800) 1475965
(151) 2019 04 01
(181) 2029 04 01
(891) 2019 04 01
(511) 06, 09, 16, 35, 39, 40

(260) AM 2020 103999 A
(800) 1475966
(151) 2019 04 01
(181) 2029 04 01
(891) 2019 04 01
(511) 06, 09, 16, 35, 39, 40

(260) AM 2020 104000 A
(800) 1475968
(151) 2019 04 01
(181) 2029 04 01
(891) 2019 04 01
(511) 06, 09, 16, 35, 39, 40

(260) AM 2020 104001 A
(800) 1475970
(151) 2019 04 01
(181) 2029 04 01
(891) 2019 04 01
(511) 06, 09, 16, 35, 39, 40

(260) AM 2020 104003 A
(800) 1476014
(151) 2019 05 27
(181) 2029 05 27
(891) 2019 05 27
(511) 14

(260) AM 2020 104005 A
(800) 1476111
(151) 2019 04 12
(181) 2029 04 12
(891) 2019 04 12
(511) 01, 05, 09, 10, 42

(260) AM 2020 104006 A
(800) 1476136
(151) 2019 05 03
(181) 2029 05 03

(891) 2019 05 03
(511) 04, 34, 43

(260) AM 2020 104008 A
(800) 1476185
(151) 2019 04 01
(181) 2029 04 01
(891) 2019 04 01
(511) 06, 09, 16, 35, 39, 40

(260) AM 2020 104009 A
(800) 1476196
(151) 2019 04 01
(181) 2029 04 01
(891) 2019 04 01
(511) 36

(260) AM 2020 104010 A
(800) 1476226
(151) 2019 01 30
(181) 2029 01 30
(891) 2019 01 30
(511) 07, 09, 11

(260) AM 2020 104013 A
(800) 1476313
(151) 2019 06 10
(181) 2029 06 10
(891) 2019 06 10
(511) 03

(260) AM 2020 104018 A
(800) 1476383
(151) 2019 06 07
(181) 2029 06 07
(891) 2019 06 07
(511) 05

(260) AM 2020 104021 A
(800) 1476489
(151) 2019 05 15
(181) 2029 05 15
(891) 2019 05 15
(511) 29, 30, 43

(260) AM 2020 104037 A
(800) 1477001
(151) 2019 02 05
(181) 2029 02 05
(891) 2019 02 05
(511) 07

(260) AM 2020 104038 A
(800) 1477019
(151) 2018 12 14
(181) 2028 12 14
(891) 2018 12 14
(511) 09

(260) AM 2020 104039 A
(800) 1477028
(151) 2019 02 15
(181) 2029 02 15
(891) 2019 02 15
(511) 35, 36, 39

(260) AM 2020 104041 A
(800) 1477063
(151) 2018 12 17
(181) 2028 12 17
(891) 2018 12 17
(511) 06, 40

(260) AM 2020 104049 A
(800) 944615
(151) 2007 10 22
(181) 2027 10 22
(891) 2019 05 29
(511) 18, 25, 28

(260) AM 2020 104050 A
(800) 1051604
(151) 2010 06 21
(181) 2020 06 21
(891) 2019 06 03
(511) 43

(260) AM 2020 104053 A
(800) 1213338
(151) 2014 03 28
(181) 2024 03 28
(891) 2019 06 13
(511) 10, 44

(260) AM 2020 104054 A
(800) 1316878
(151) 2016 05 13
(181) 2026 05 13
(891) 2019 06 14
(511) 09, 25, 38, 41

(260) AM 2020 104129 A
(800) 1477229
(151) 2019 05 27
(181) 2029 05 27

(891) 2019 05 27
(511) 25, 26

(260) AM 2020 104141 A
(800) 1477485
(151) 2019 04 24
(181) 2029 04 24
(891) 2019 04 24
(511) 07, 09

(260) AM 2020 104142 A
(800) 1477517
(151) 2019 03 12
(181) 2029 03 12
(891) 2019 03 12
(511) 07, 35, 37

(260) AM 2020 104143 A
(800) 1477530
(151) 2019 05 28
(181) 2029 05 28
(891) 2019 05 28
(511) 32, 33

(260) AM 2020 104145 A
(800) 1477637
(151) 2019 04 24
(181) 2029 04 24
(891) 2019 04 24
(511) 30

(260) AM 2020 104147 A
(800) 1477753
(151) 2019 05 20
(181) 2029 05 20
(891) 2019 05 20
(511) 01, 16, 17

(260) AM 2020 104149 A
(800) 1477787
(151) 2019 05 21
(181) 2029 05 21
(891) 2019 05 21
(511) 30

(260) AM 2020 104150 A
(800) 1477788
(151) 2019 05 21
(181) 2029 05 21
(891) 2019 05 21
(511) 30

(260) AM 2020 104162 A
(800) 1478045
(151) 2019 02 05
(181) 2029 02 05
(891) 2019 02 05
(511) 01, 17

(260) AM 2020 104163 A
(800) 1478156
(151) 2018 06 04
(181) 2028 06 04
(891) 2018 06 04
(511) 01, 05, 09, 10, 35, 37, 41, 42, 44

(260) AM 2020 104164 A
(800) 1478175
(151) 2019 02 20
(181) 2029 02 20
(891) 2019 02 20
(511) 08, 09, 11, 14, 16, 18, 21, 24, 25, 26, 28, 29,
30, 32, 41

(260) AM 2020 104165 A
(800) 1478246
(151) 2019 05 21
(181) 2029 05 21
(891) 2019 05 21
(511) 44

(260) AM 2020 104252 A
(800) 1478897
(151) 2017 12 12
(181) 2027 12 12
(891) 2017 12 12
(511) 05, 10, 35, 42, 44

(260) AM 2020 104253 A
(800) 1478999
(151) 2019 02 19
(181) 2029 02 19
(891) 2019 02 19
(511) 25

(260) AM 2020 104254 A
(800) 1479003
(151) 2019 06 20
(181) 2029 06 20
(891) 2019 06 20
(511) 09

(260) AM 2020 104256 A
(800) 1479025
(151) 2019 06 04

(181) 2029 06 04
(891) 2019 06 04
(511) 09, 42

(260) AM 2020 104272 A
(800) 1479233
(151) 2019 04 17
(181) 2029 04 17
(891) 2019 04 17
(511) 06

(260) AM 2020 104274 A
(800) 1479235
(151) 2019 05 21
(181) 2029 05 21
(891) 2019 05 21
(511) 30

(260) AM 2020 104275 A
(800) 1479240
(151) 2019 02 01
(181) 2029 02 01
(891) 2019 02 01
(511) 29

(260) AM 2020 104276 A
(800) 1479267
(151) 2019 04 17
(181) 2029 04 17
(891) 2019 04 17
(511) 09, 35, 42

(260) AM 2020 104292 A
(800) 1479556
(151) 2019 05 21
(181) 2029 05 21
(891) 2019 05 21
(511) 42

(260) AM 2020 104334 A
(800) 1479660
(151) 2019 05 08
(181) 2029 05 08
(891) 2019 05 08
(511) 03, 04

(260) AM 2020 104350 A
(800) 1479914
(151) 2019 05 08
(181) 2029 05 08
(891) 2019 05 08
(511) 03, 04

(260) AM 2020 104351 A
(800) 1479918
(151) 2019 05 08
(181) 2029 05 08
(891) 2019 05 08
(511) 03, 04

(260) AM 2020 104352 A
(800) 1479944
(151) 2019 03 20
(181) 2029 03 20
(891) 2019 03 20
(511) 20, 35

(260) AM 2020 104353 A
(800) 1479945
(151) 2018 10 22
(181) 2028 10 22
(891) 2018 10 22
(511) 36

(260) AM 2020 104354 A
(800) 1479946
(151) 2019 04 24
(181) 2029 04 24
(891) 2019 04 24
(511) 07, 12, 17, 20, 28

(260) AM 2020 104394 A
(800) 1017171
(151) 2009 07 10
(181) 2029 07 10
(891) 2019 07 11
(511) 06

(260) AM 2020 104470 A
(800) 1480922
(151) 2019 03 18
(181) 2029 03 18
(891) 2019 03 18
(511) 11, 28, 36

(260) AM 2020 104479 A
(800) 1480963
(151) 2018 12 10
(181) 2028 12 10
(891) 2018 12 10
(511) 31

(260) AM 2020 104480 A
(800) 1480989
(151) 2019 05 16
(181) 2029 05 16

(891) 2019 05 16
(511) 32, 33

(260) AM 2020 104481 A
(800) 1481008
(151) 2019 04 05
(181) 2029 04 05
(891) 2019 04 05
(511) 02, 03, 06, 07, 08, 09, 11, 12, 18, 19, 22, 24, 28

(260) AM 2020 104482 A
(800) 1481051
(151) 2019 04 19
(181) 2029 04 19
(891) 2019 04 19
(511) 09, 28, 41

(260) AM 2020 104483 A
(800) 1481090
(151) 2019 02 13
(181) 2029 02 13
(891) 2019 02 13
(511) 31

(260) AM 2020 104520 A
(800) 1482039
(151) 2019 05 13
(181) 2029 05 13
(891) 2019 05 13
(511) 01, 02, 17, 35

(260) AM 2020 104522 A
(800) 884089
(151) 2006 04 19
(181) 2026 04 19
(891) 2019 06 18
(511) 07

(260) AM 2020 104523 A
(800) 1170382
(151) 2013 06 24
(181) 2023 06 24
(891) 2019 05 10
(511) 03, 05

(260) AM 2020 104569 A
(800) 1482068
(151) 2019 05 07
(181) 2029 05 07
(891) 2019 05 07
(511) 30

(260) AM 2020 104589 A
(800) 1482583
(151) 2019 05 21
(181) 2029 05 21
(891) 2019 05 21
(511) 09, 42

(260) AM 2020 104590 A
(800) 1482611
(151) 2019 06 11
(181) 2029 06 11
(891) 2019 06 11
(511) 07, 11

(260) AM 2020 104591 A
(800) 1482615
(151) 2019 06 10
(181) 2029 06 10
(891) 2019 06 10
(511) 05, 30

(260) AM 2020 104592 A
(800) 1482645
(151) 2019 05 16
(181) 2029 05 16
(891) 2019 05 16
(511) 17, 19, 35

(260) AM 2020 104593 A
(800) 1482694
(151) 2019 06 17
(181) 2029 06 17
(891) 2019 06 17
(511) 13

(260) AM 2020 104594 A
(800) 1482697
(151) 2019 05 15
(181) 2029 05 15
(891) 2019 05 15
(511) 32

(260) AM 2020 104595 A
(800) 1482705
(151) 2019 07 09
(181) 2029 07 09
(891) 2019 07 09
(511) 03

(260) AM 2020 104596 A
(800) 1482801
(151) 2019 03 22
(181) 2029 03 22

(891) 2019 03 22
(511) 29, 30, 31, 32, 33, 35, 43

(260) AM 2020 104653 A
(800) 1484060
(151) 2019 07 24
(181) 2029 07 24
(891) 2019 07 24
(511) 07

(260) AM 2020 104655 A
(800) 1484084
(151) 2019 03 22
(181) 2029 03 22
(891) 2019 03 22
(511) 41

(260) AM 2020 104656 A
(800) 1484143
(151) 2019 07 05
(181) 2029 07 05
(891) 2019 07 05
(511) 01, 05, 42

(260) AM 2020 104660 A
(800) 1484272
(151) 2019 07 05
(181) 2029 07 05
(891) 2019 07 05
(511) 35, 38, 41

(260) AM 2020 104683 A
(800) 1484371
(151) 2019 05 28
(181) 2029 05 28
(891) 2019 05 28
(511) 03, 04, 07

(260) AM 2020 104685 A
(800) 1484452
(151) 2019 05 29
(181) 2029 05 29
(891) 2019 05 29
(511) 30

(260) AM 2020 104691 A
(800) 1484571
(151) 2019 06 17
(181) 2029 06 17
(891) 2019 06 17
(511) 20, 35

(260) AM 2020 104693 A
(800) 1484590
(151) 2019 06 28
(181) 2029 06 28
(891) 2019 06 28
(511) 36

(260) AM 2020 104701 A
(800) 1484829
(151) 2019 03 01
(181) 2029 03 01
(891) 2019 03 01
(511) 06, 19

(260) AM 2020 104702 A
(800) 1484885
(151) 2019 07 08
(181) 2029 07 08
(891) 2019 07 08
(511) 43

(260) AM 2020 104703 A
(800) 1484888
(151) 2019 04 12
(181) 2029 04 12
(891) 2019 04 12
(511) 03, 04, 05, 09, 11, 21

(260) AM 2020 104777 A
(800) 1485434
(151) 2019 05 31
(181) 2029 05 31
(891) 2019 05 31
(511) 12

(260) AM 2020 104781 A
(800) 1485671
(151) 2019 04 19
(181) 2029 04 19
(891) 2019 04 19
(511) 05, 10, 35, 42, 44

(260) AM 2020 104782 A
(800) 1485685
(151) 2019 04 19
(181) 2029 04 19
(891) 2019 04 19
(511) 05, 10, 35, 42, 44

(260) AM 2020 104841 A
(800) 1486256
(151) 2019 07 01
(181) 2029 07 01

(891) 2019 07 01
(511) 41, 42

(260) AM 2020 104842 A
(800) 1486311
(151) 2019 06 05
(181) 2029 06 05
(891) 2019 06 05
(511) 35, 45

(260) AM 2020 104849 A
(800) 1486406
(151) 2019 07 17
(181) 2029 07 17
(891) 2019 07 17
(511) 12

(260) AM 2020 104850 A
(800) 1486418
(151) 2019 07 04
(181) 2029 07 04
(891) 2019 07 04
(511) 05

(260) AM 2020 104851 A
(800) 1486464
(151) 2019 05 14
(181) 2029 05 14
(891) 2019 05 14
(511) 03, 09, 14, 18, 25, 35

(260) AM 2020 104859 A
(800) 1486796
(151) 2019 04 01
(181) 2029 04 01
(891) 2019 04 01
(511) 06, 09, 16, 35, 39, 40

(260) AM 2020 104963 A
(800) 1487597
(151) 2019 07 29
(181) 2029 07 29
(891) 2019 07 29
(511) 34

(260) AM 2020 104965 A
(800) 1487647
(151) 2019 02 22
(181) 2029 02 22
(891) 2019 02 22
(511) 35, 36, 39, 42, 45

(260) AM 2020 104966 A
(800) 1487669
(151) 2019 04 16
(181) 2029 04 16
(891) 2019 04 16
(511) 05

APPELLATION OF ORIGIN OF GOODS

PROTECTED INTERNATIONAL APPELLATION OF ORIGIN OF GOODS

(800) 1134
(151) 2019 12 07
(540)

Gerdo e toyserkan e Iran

(732) Producer or groups of producers benefiting from the appellation of origin concerned:
Walnut Farmers Cooperative of Tuyserkan /Region of Tuyserkan County, Iran
(511) 31

OFFICIAL NOTIFICATIONS

INVENTIONS

EXPIRATION OF PATENTS RESTORATION

(21) AP 2014 14124

(11) P 2019 6952 B

(73) MERCK SHARP & DOHME CORP.

(54) **SUBSTITUTED QUINOLIZINE DERIVATIVES USEFUL AS HIV INTEGRASE INHIBITORS**

DATE OF CANCELLATION OF PATENT: 2019 09 26

PATENT RESTRICTION DATE: 2020 07 27

(21) AP 2015 14392

(11) P 2019 7034 B

(73) MACROGENICS INC.

(54) **COVALENTLY BONDED DIABODIES HAVING IMMUNOREACTIVITY WITH PD-1 AND LAG-3, AND METHODS OF USE THEREOF**

DATE OF CANCELLATION OF PATENT: 2020 06 19

PATENT RESTRICTION DATE: 2020 07 27

ABOLITION OF PATENTS WITH THE RIGHT TO RESTORE

(21) AP 2007 10171

(11) P 2009 4645 B

(73) Liana Rurua

(54) **VEGETATIVE MEDICAL MEANS**

DATE OF CANCELLATION OF PATENT: 2020 07 09

THE TERM OF RESTORATION OF PATENT: 2021 07 09

(21) AP 2012 12766

(11) P 2013 5987 B

(73) Sarkis Markaryan

(54) **METHOD OF WATER COMPLEX DEACTIVATION AND MODULE FOR EXECUTION THEREOF**

DATE OF CANCELLATION OF PATENT: 2020 06 27

THE TERM OF RESTORATION OF PATENT: 2021 06 27

(21) AP 2012 12769

(11) P 2014 6020 B

(73) General Electric Company

(54) **METHOD OF BORON POWDERING BY PRESSURE MILL WITH INERT GAS USAGE TO SATISFY CLEANNESS NEED**

DATE OF CANCELLATION OF PATENT: 2020 06 27

THE TERM OF RESTORATION OF PATENT: 2021 06 27

(21) AP 2013 13150

(11) P 2017 6751 B

(73) Avtandil Metreveli

(54) **SUSPENDED FALSEWORK WITH LIFTERS**
DATE OF CANCELLATION OF PATENT: 2020 07 03
THE TERM OF RESTORATION OF PATENT: 2021 07 03

(21) AP 2012 13365
(11) P 2015 6399 B
(73) SYNGENTA PARTICIPATIONS AG
(54) **MICROBIOCIDAL HETEROCYCLES**
DATE OF CANCELLATION OF PATENT: 2020 06 27
THE TERM OF RESTORATION OF PATENT: 2021 06 27

(21) AP 2012 13378
(11) P 2017 6592 B
(73) H. Lundbeck A/S
(54) **POSITIVE ALLOSTERIC MODULATORS OF NICOTINIC ACETYLCHOLINE RECEPTOR**
DATE OF CANCELLATION OF PATENT: 2020 07 06
THE TERM OF RESTORATION OF PATENT: 2021 07 06

(21) AP 2012 13999
(11) P 2018 6802 B
(73) H. Lundbeck A/S
(54) **POSITIVE ALLOSTERIC MODULATORS OF NICOTINIC ACETYLCHOLINE RECEPTOR**
DATE OF CANCELLATION OF PATENT: 2020 07 06
THE TERM OF RESTORATION OF PATENT: 2021 07 06

(21) AP 2015 14362
(11) P 2019 7010 B
(73) GORDON MURRAY DESIGN LIMITED
(54) **VEHICLE CHASSIS STRUCTURES**
DATE OF CANCELLATION OF PATENT: 2020 06 25
THE TERM OF RESTORATION OF PATENT: 2021 06 25

(21) AP 2015 14395
(11) P 2019 7047 B
(73) MILLENNIUM PHARMACEUTICALS INC.
(54) **HETEROARYL COMPOUNDS USEFUL AS INHIBITORS OF SUMO ACTIVATING ENZYME**
DATE OF CANCELLATION OF PATENT: 2020 06 30
THE TERM OF RESTORATION OF PATENT: 2021 06 30

(21) AP 2015 14401
(11) P 2019 6942 B
(73) TAKEDA PHARMACEUTICAL COMPANY LIMITED
(54) **HETEROCYCLIC COMPOUNDS AND THEIR USE AS RETINOIDRELATED ORPHAN RECEPTOR (ROR) GAMMA-T INHIBITORS**
DATE OF CANCELLATION OF PATENT: 2020 06 30

(21) AP 2015 14408
(11) P 2018 6934 B
(73) LUPIN LIMITED
(54) **QUINOLIZINONE DERIVATIVES AS PI3K INHIBITORS**
DATE OF CANCELLATION OF PATENT: 2020 07 01
THE TERM OF RESTORATION OF PATENT: 2021 07 01

(21) AP 2015 14411

(11) P 2020 7096 B

(73) R-PHARM OVERSEAS INC.

(54) **SUBSTITUTED 2-THIOXO-IMIDAZOLIDIN-4-ONES AND SPIRO ANALOGUES THEREOF, ACTIVE ANTI-CANCER INGREDIENT, PHARMACEUTICAL COM-POSITION, MEDICINAL PREPARA-TION, METHOD FOR TREATING PROSTATE CANCER**

DATE OF CANCELLATION OF PATENT: 2020 06 26

THE TERM OF RESTORATION OF PATENT: 2021 06 26

(21) AP 2015 14415

(11) P 2019 6944 B

(73) ARVEN ILAC SANAYI VE TICARET A.S.

(54) **PROCESS FOR PREPARING THE INHALATION FORMULATIONS**

DATE OF CANCELLATION OF PATENT: 2020 07 08

THE TERM OF RESTORATION OF PATENT: 2021 07 08

(21) AP 2017 14530

(11) P 2018 6895 B

(73) Giorgi Ghambashidze;

Shalva Liparteliani

(54) **THE METHOD FOR CONDUCTING A LOTTERY ON PUBLIC TRANSPORT**

DATE OF CANCELLATION OF PATENT: 2020 06 28

THE TERM OF RESTORATION OF PATENT: 2021 06 28

(21) AP 2003 8601

(11) P 2011 5296 B

(73) GEOX S.P.A..

(54) **WATERPROOF AND BREATHABLE SOLE FOR SHOES**

DATE OF CANCELLATION OF PATENT: 2020 07 07

THE TERM OF RESTORATION OF PATENT: 2021 07 07

(21) AP 2004 9844

(11) P 2008 4556 B

(73) BANKINTER S.A.;

CAJA DE AHORROS DE GALICIA

(54) **METHOD FOR OBTAINING CASH AT CARDLESS TELLER MACHINES WITHOUT CARD USING A PAYMENT ORDER VIA SMS**

DATE OF CANCELLATION OF PATENT: 2020 07 05

THE TERM OF RESTORATION OF PATENT: 2021 07 05

EXPIRATION OF TERM OF RESTORATION OF PATENTS

(21) AP 2009 11351

(11) P 2011 5367 B

(73) NATURIN GMBH & CO.

(54) **STABILIZED LONGLIFE NON-EDIBLE COLLAGEN CASING READY-TO-STUFF**

DATE OF CANCELLATION OF PATENT: 2019 07 06

THE TERM OF RESTORATION OF PATENT VALIDITY HAS EXPIRED: 2020 07 06

(21) AP 2011 12986

(11) P 2014 6049 B

(73) NOVARTIS AG

(54) **PHARMACEUTICAL COMPOSITIONS COMPRISING 4-AMINO-5-FLUORO-3- [6-(4-METHYLPIPERAZIN-1-YL)-1H-BENZIMIDAZOL-2-YL]-1H-QUINOLIN- 2-ONE LACTATE MONOHYDRATE**

DATE OF CANCELLATION OF PATENT: 2019 06 29

THE TERM OF RESTORATION OF PATENT VALIDITY HAS EXPIRED: 2020 06 29

(21) AP 2013 14033

(11) P 2018 6859 B

(73) KNAUF GIPS KG

(54) **GYPSUM PLASTERBOARD PRODUCTION PLANT AND METHOD FOR PRODUCING A GYPSUM PLASTERBOARD**

DATE OF CANCELLATION OF PATENT: 2019 06 26

THE TERM OF RESTORATION OF PATENT VALIDITY HAS EXPIRED: 2020 06 26

(21) AP 2000 6316

(11) P 2004 3287 B

(73) Laboratoires des Produits Ethiques Ethypharm

(54) **PHARMACEUTICAL COMPOSITION CONTAINING FENOFIBRATE AND METHOD FOR ITS PRODUCTION**

DATE OF CANCELLATION OF PATENT: 2019 07 07

THE TERM OF RESTORATION OF PATENT VALIDITY HAS EXPIRED: 2020 07 07

(21) AP 2003 8456

(11) P 2006 3988 B

(73) Interdigital Technology Corporation

(54) **RADIO NETWORK CONTROLLER EXCHANGE OF USER EQUIPMENT MEASUREMENT INFORMATION**

DATE OF CANCELLATION OF PATENT: 2019 06 25

THE TERM OF RESTORATION OF PATENT VALIDITY HAS EXPIRED: 2020 06 25

(21) AP 2003 9269

(11) P 2009 4678 B

(73) Interdigital Technology Corporation

(54) **RADIO NETWORK CONTROLLER EXCHANGE OF EQUIPMENT INFORMATION**

DATE OF CANCELLATION OF PATENT: 2019 06 25

THE TERM OF RESTORATION OF PATENT VALIDITY HAS EXPIRED: 2020 06 25

CHANGES OF NAMES AND/OR ADDRESS OF PATENTOWNER

(21) AP 2018 14849

(11) P 2020 7123 B

(54) METHOD FOR CLADDING OF NANOSTRUCTURAL POWDER MATERIALS AND THEIR MIXTURE

New name and/or address: LTD "Scientific-Industrial Association Composite Materials" (GE)
Esma Oniani St. 6, 0159, Tbilisi, Georgia (GE)

Former name and / or address: LTD "Scientific-Industrial Association Composite Materials" (GE)
Esma Oniani St. 6, 0159, Tbilisi, Georgia (GE)

DATE OF REGISTRATION: 08 07 2020

(21) AP 2018 14850

(11) P 2020 7115 B

(54) METHOD FOR OBTAINING METALLIC COPPER FROM INDUSTRIAL WASTEWATER

New name and/or address: LTD "Scientific-Industrial Association Composite Materials" (GE)
Esma Oniani St. 6, 0159, Tbilisi, Georgia (GE)

Former name and / or address: LTD "Scientific-Industrial Association Composite Materials" (GE)
Esma Oniani St. 6, 0159, Tbilisi, Georgia (GE)

DATE OF REGISTRATION: 08 07 2020

UTILITY MODELS

EXPIRATION OF PATENTS RESTORATION

(21) AU 2015 13872

(11) U 2016 1898 Y

(73) Giorgi Jighauri

(54) METHOD FOR KAKHETIAN TATARA PREPARATION

DATE OF CANCELLATION OF PATENT: 2020 06 30

PATENT RESTRICTION DATE: 2020 07 27

ABOLITION OF PATENTS WITH THE RIGHT TO RESTORE

(21) AU 2015 13872

(11) U 2016 1898 Y

(73) Giorgi Jighauri

(54) METHOD FOR KAKHETIAN TATARA PREPARATION

DATE OF CANCELLATION OF PATENT: 2020 06 30

(21) AU 2015 13873

(11) U 2017 1916 Y

(73) Nodar Gasviani

(54) METHOD FOR POLYMERIC COMPOSITE MATERIALS ELECTROCHEMICAL ALUMINIZATION

DATE OF CANCELLATION OF PATENT: 2020 06 30

THE TERM OF RESTORATION OF PATENT: 2021 06 30

EXPIRATION OF TERM OF RESTORATION OF PATENT

(21) AU 2015 13868

(11) U 2016 1896 Y

(73) Giorgi Chechelashvili;
Ivane Chkhaidze

(54) **WINDOW**

DATE OF CANCELLATION OF PATENT: 2019 06 25

THE TERM OF RESTORATION OF PATENT VALIDITY HAS EXPIRED: 2020 06 25

DESIGNS

CANCELLATION OF DESIGN REGISTRATION

(11) D 2015 616 S

(73) Gocha Pipia (GE)

Budapeshti St. 11, app. 55, 0160, Tbilisi, Georgia (GE)

(54) **ADVERTISING DEVICE WITH COLUMNS**

(18) 2020 01 09

(58) 2020 07 17

EXTENSION OF REGISTRATION OF INTERNATIONAL DESIGNS

(11) DM/65117

(73) SWATCH AG (SWATCH SA) (SWATCH LTD.)

94, Rue Jakob Stämpfli BIENNE CH-2502 (CH)

(15) 2004 03 17

(24) 2004 03 17

(18) 2024 03 17

(28) 1

(28') 1

(54) Wristwatch

(11) DM/65296

(73) MONTRES BREGUET S.A.

L'ABBAYE CH-1344 (CH)

(15) 2004 04 02

(24) 2004 04 02

(18) 2024 04 02

(28) 2

(28') 2

(54) Watches

(11) DM/73677

(73) LIU, QINGSHAN C/O MR. COLE

Winklerring 33, 85630 Grasbrunn/Neukeferloh (DE)

(15) 2010 03 18

(24) 2010 03 18
(18) 2025 03 18
(28) 1
(28') 1
(54) Fitness apparatus

(11) DM/73837
(73) SOREMARTEC S.A.
Rue Joseph Netzer 5, B-6700 ARLON (BE) FERRERO OFFENE HANDELSGESELLSCHAFT MBH,
Rheinstrasse 3-7, 35260 STADTALLENDORF (BX)
(15) 2010 03 31
(24) 2010 03 31
(18) 2025 03 31
(28) 4
(28') 4
(54) Display units

CANCELLATION OF REGISTRATION OF INTERNATIONAL DESIGNS

(11) DM/67231
(73) SWATCH AG (SWATCH SA) (SWATCH LTD.)
94, Rue Jakob Stämpfli, CH-2502 BIENNE (CH)
Date of cancellation of registration: 2015 12 06
(58) 2020 07 08

(11) DM/71848
(73) SWATCH AG (SWATCH SA)(SWATCH LTD)
Jakob-Stämpfli-Strasse 94, CH-2502 BIEL/BIENNE (CH)
Date of cancellation of registration: 2019 05 25
(58) 2020 07 10

(11) DM/72271
(73) THE SWATCH GROUP MANAGEMENT SERVICES AG (THE SWATCH GROUP MANAGEMENT
SERVICES SA) (THE SWATCH GROUP MANAGEMENT SERVICES LTD.)
Seevorstadt 6, CH-2501 BIEL/BIENNE (CH)
Date of cancellation of registration: 2019 08 28
(58) 2020 07 10

TRADEMARKS

COMPLETE TRANSFER OF RIGHTS

(111) M 2020 32513 R
 (732) LTD "Cordial Hospitality"
 V. Dolidze St., corp. 26, app. 39, Saburtalo district, Tbilisi, Georgia
 (770) LLC "Georgian Hotels Management Group"
 Kazbegi Av. 15, corp. "d", Floor 5, Tbilisi, Georgia
 (580) 2020 06 12

(111) M 2020 32514 R
 (732) LTD "Cordial Hospitality"
 V. Dolidze St., corp. 26, app. 39, Saburtalo district, Tbilisi, Georgia
 (770) LLC "Georgian Hotels Management Group"
 Kazbegi Av. 15, corp. "d", Floor 5, Tbilisi, Georgia
 (580) 2020 06 12

(111) M 1998 10060 R
 (732) L'OREAL
 14, Rue Royale, 75008 PARIS, France
 (770) Lancome Parfums Et Beaute & Cie
 Societe en Nom Collectif
 14, rue Royale, 75008 Paris, France
 (580) 2020 06 24

(111) M 2000 13282 R
 (732) Yaşar Holding Anonim Şirketi
 Şehit Fethibey Caddesi No: 120 Konak/İzmir, Turkey
 (770) Durmus Yasar Ve Ogullari Boya,
 Vernik Ve Recine Fabrikalari Anonim Sirketi
 Sanayi Caddesi, No.37 Bornova, Izmir, Turkey
 (580) 2020 07 02

(111) M 1996 3149 R
 (732) L'OREAL
 14, Rue Royale, 75008 Paris, France
 (770) Lancome Parfums et Beaute & Cie
 14, rue Royale, 75008 Paris, France
 (580) 2020 06 24

(111) M 1996 3154 R
 (732) L'OREAL
 14, Rue Royale, 75008 PARIS, France
 (770) Lancome Parfums et Beaute & Cie
 14, rue Royale, 75008 Paris, France
 (580) 2020 06 24

(111) M 1996 3158 R
 (732) L'OREAL
 14, Rue Royale, 75008 PARIS, France
 (770) Lancome Parfums et Beaute & Cie
 14, rue Royale, 75008 Paris, France
 (580) 2020 06 24

(111) M 1996 3159 R
 (732) L'OREAL
 14, Rue Royale, 75008 PARIS, France
 (770) Lancome Parfums et Beaute & Cie
 14, rue Royale, 75008 Paris, France
 (580) 2020 06 24

(111) M 1996 3161 R
 (732) L'OREAL
 14, Rue Royale, 75008 PARIS, France
 (770) Lancome Parfums et Beaute & Cie
 14, rue Royale, 75008 Paris, France
 (580) 2020 06 24

(111) M 1996 3163 R
 (732) L'OREAL
 14, Rue Royale, 75008 PARIS, France
 (770) Lancome Parfums et Beaute & Cie
 14, rue Royale, 75008 Paris, France
 (580) 2020 06 24

(111) M 2012 23140 R
 (732) CDS CANADA 3 L.P.
 8400 av. du Cirque, Montreal, Quebec, H1Z 4M6, Canada
 (770) CDS Canada 2 SCSP
 9, Allée Scheffer, L-2520 Grand-Duché de Luxembourg, Luxembourg
 (580) 2020 07 03

(111) M 2012 23140 R
 (732) CDS Canada 2 SCSP
 9, Allée Scheffer, L-2520 Grand-Duché de Luxembourg, Luxembourg
 (770) CDS Canada 1 SCSP
 9, Allée Scheffer, L-2520 Grand-Duché de Luxembourg, Luxembourg
 (580) 2020 07 03

(111) M 2012 23140 R
 (732) CDS CANADA 4 L.P.
 8400 av. du Cirque, Montreal, Quebec, H1Z 4M6, Canada

(770) CDS CANADA 3 L.P.
8400 av. du Cirque, Montreal, Quebec, H1Z
4M6, Canada
(580) 2020 07 03

(111) M 2012 23140 R
(732) CDS Canada 1 SCSP
9, Allée Scheffer, L-2520 Grand-Duché
de Luxembourg, Luxembourg
(770) CIRQUE DU SOLEIL CANADA INC.
8400 av. du Cirque, Montreal, Quebec, H1Z
4M6, Canada
(580) 2020 07 03

(111) M 2012 23142 R
(732) CDS Canada 1 SCSP
9, Allée Scheffer, L-2520 Grand-Duché
de Luxembourg, Luxembourg
(770) CIRQUE DU SOLEIL CANADA INC.
8400 av. du Cirque, Montreal, Quebec, H1Z
4M6, Canada
(580) 2020 07 03

(111) M 2012 23142 R
(732) CDS Canada 2 SCSP
9, Allée Scheffer, L-2520 Grand-Duché
de Luxembourg, Luxembourg
(770) CDS Canada 1 SCSP
9, Allée Scheffer, L-2520 Grand-Duché
de Luxembourg, Luxembourg
(580) 2020 07 03

(111) M 2012 23142 R
(732) CDS CANADA 3 L.P.
8400 av. du Cirque, Montreal, Quebec, H1Z
4M6, Canada
(770) CDS Canada 2 SCSP
9, Allée Scheffer, L-2520 Grand-Duché
de Luxembourg, Luxembourg
(580) 2020 07 03

(111) M 2012 23142 R
(732) CDS CANADA 4 L.P.
8400 av. du Cirque, Montreal, Quebec, H1Z
4M6, Canada
(770) CDS CANADA 3 L.P.
8400 av. du Cirque, Montreal, Quebec, H1Z
4M6, Canada
(580) 2020 07 03

(111) M 2015 26495 R
(732) ATTERBURY PROPERTY
(PROPRIETARY) LIMITED

2nd Floor, Di Klubhuis Building, Corner
18th Street And Pinaster Avenue,
Hazelwood, Pretoria, 0081, Gauteng,
South Africa

(770) ATTERBURY IP COMPANY
(PROPRIETARY) LIMITED
The Atterbury Building, Lynnwood
Bridge, 4 Daventry Street, Lynnwood Manor,
0081, Gauteng, South Africa
(580) 2020 06 02

(111) M 2017 28577 R
(732) RIMZA MAISURADZE
26 Maisi St. 20, 2200, Telavi, Georgia
(770) IRAKLI SHIOSHVILI
daba tskneti, al.chavchavadzis II shesakhvevi,
sakhli 4, 0181, Tbilis, Georgia
(580) 2020 07 08

(111) M 2017 28896 R
(732) Rimza Maisuradze
26 Maisi St. 20, 2200, Telavi, Georgia
(770) Irakli Shioshvili
al. Chavchavadze St., II Lane, house 4, 0181,
Tbilisi, Georgia
(580) 2020 07 08

(111) M 2018 30174 R
(732) Saqartvelos Fermerta Asociacia
Ak. Khorava St. 4, Old Tbilisi district, Tbilisi,
Georgia
(770) LTD Georgian Farmers Distribution Company
VII mkr., 8, app. 14, 3700, Rustavi, Georgia
(580) 2020 06 26

CHANGES OF NAMES AND/OR ADDRESS OF OWNERS

- (111) M 2003 15195 R
 (732) "HELLENIC FUELS AND LUBRICANTS SINGLE MEMBER INDUSTRIAL AND COMMERCIAL SOCIETE ANONYME" also trading as "EKO ABEE"
 8A Cheimarras street, 151 25 Marousi, Greece
 (770) HELLENIC FUELS AND LUBRICANTS INDUSTRIAL AND COMMERCIAL S.A".
 Also trading as "EKO ABEE"
 8A Cheimarras street, 151 25 Marousi, Greece
 (580) 2020 06 22
-
- (111) M 2003 15199 R
 (732) "HELLENIC FUELS AND LUBRICANTS SINGLE MEMBER INDUSTRIAL AND COMMERCIAL SOCIETE ANONYME" also trading as "EKO ABEE"
 8A Cheimarras street, 151 25 Marousi, Greece
 (770) HELLENIC FUELS AND LUBRICANTS INDUSTRIAL AND COMMERCIAL S.A".
 also trading as "EKO ABEE"
 8A Cheimarras street, 151 25 Marousi, Greece
 (580) 2020 06 22
-
- (111) M 2003 15200 R
 (732) "HELLENIC FUELS AND LUBRICANTS SINGLE MEMBER INDUSTRIAL AND COMMERCIAL SOCIETE ANONYME" also trading as "EKO ABEE"
 8A Cheimarras street, 151 25 Marousi, Greece
 (770) "HELLENIC FUELS AND LUBRICANTS INDUSTRIAL AND COMMERCIAL S.A".
 also trading as "EKO ABEE"
 8A Cheimarras street, 151 25 Marousi, Greece
 (580) 2020 06 22
-
- (111) M 2012 23140 R
 (732) CIRQUE DU SOLEIL CANADA INC.
 8400 av. du Cirque, Montreal, Quebec, H1Z 4M6, Canada
 (770) CIRQUE DU SOLEIL CANADA INC.
 8400, 2 Avenue, Montreal, quebec, H1Z 4M6, Canada
 (580) 2020 07 03
-
- (111) M 2012 23141 R
 (732) CIRQUE DU SOLEIL CANADA INC.
 8400 av. du Cirque, Montreal, Quebec, H1Z 4M6, Canada
 (770) CIRQUE DU SOLEIL CANADA INC.
- 8400, 2 Avenue, Montreal, quebec, H1Z 4M6, Canada
 (580) 2020 07 03
-
- (111) M 1998 10028 R
 (732) SANTEN PHARMACEUTICAL CO., LTD.
 4-20 Ofuka-cho, Kita-ku, Osaka-shi, Osaka, 530-8552, Japan
 (770) SANTEN PHARMACEUTICAL CO., LTD.
 9-19, Shimoshinjo 3-chome,
 Higashiyodogawa-ku, Osaka-fu, 533-8651, Japan
 (580) 2020 06 30
-
- (111) M 2019 32057 R
 (732) "HELLENIC FUELS AND LUBRICANTS SINGLE MEMBER INDUSTRIAL AND COMMERCIAL SOCIETE ANONYME" also trading as "EKO ABEE"
 8A Cheimarras street, 15125 Marousi, Greece
 (770) "HELLENIC FUELS AND LUBRICANTS INDUSTRIAL AND COMMERCIAL S.A.
 also trading as "EKO ABEE"
 8A Cheimarras street, 15125 Marousi, Greece
 (580) 2020 06 22
-
- 8400, 2 Avenue, Montreal, quebec, H1Z 4M6, Canada
 (580) 2020 07 03

TERMINATION OF TRADEMARKS REGISTRATION

(111) M 2009 20113 R (151) 2009 12 28 (732) Harrington Development Inc. Arango-Orillac Bldg. East 54 th street, Republic of Panama (141) 2020 07 13	Wrigley Building 410, North Michigan Avenue, Chicago, Illinois 60611, USA (141) 2020 07 13
(111) M 2009 20118 R (151) 2009 12 28 (732) LTD "Candy Land" Gamrekeli St. 19, 0160, Tbilisi, Georgia (141) 2020 07 13	(111) M 2009 20126 R (151) 2009 12 28 (732) Bank of America Corporation 100 North Tryon Street, Charlotte, North Carolina 28255, USA (141) 2020 07 13
(111) M 2009 20120 R (151) 2009 12 28 (732) JSC "HALYCHPHARM" Opryshkivska St. 6/8, 79024, Lviv, Ukraine (141) 2020 07 13	(111) M 2009 20127 R (151) 2009 12 28 (732) Harrington Development Inc. Arango-Orillac Bldg. East 54th street, Republic of Panama (141) 2020 07 13
(111) M 2009 20121 R (151) 2009 12 28 (732) JSC "HALYCHPHARM" Opryshkivska St. 6/8, 79024, Lviv, Ukraine (141) 2020 07 13	(111) M 2009 20131 R (151) 2009 12 28 (732) DELICOM Nucubidze Plateau, II mkr., I kvart., corp. 3a, 0183, Tbilisi, Georgia (141) 2020 07 13
(111) M 2009 20122 R (151) 2009 12 28 (732) Harrington Development Inc. Arango-Orillac Bldg. East 54th Street, Republic of Panama (141) 2020 07 13	(111) M 2012 23141 R (151) 2012 11 29 H1Z 4M6, Canada (732) CIRQUE DU SOLEIL CANADA INC. 8400 av. du Cirque, Montreal, Quebec, H1Z 4M6, Canada (141) 2020 07 08
(111) M 2009 20123 R (151) 2009 12 28 (732) Harrington Development Inc. Ivira Mendez Street, Vallarino bldg., 3rd Floor, Panama, Republic of Panama (141) 2020 07 13	
(111) M 2009 20124 R (151) 2009 12 28 (732) Sony Corporation 1-7-1 Konan, Minato-ku, Tokyo, Japan (141) 2020 07 13	
(111) M 2009 20125 R (151) 2009 12 28 (732) Wm. Wrigley Jr. Company	

CLASSIFICATION INDEXES

INVENTIONS

CONCORDANCE TABLE OF INTERNATIONAL CLASSIFICATION INDEX AND PUBLICATION NUMBERS

INTERNATIONAL CLASSIFICATION INDEXES (51)	NUMBER OF PUBLISHED APPLICATION (10)
A 01 N 35/04; A 01 N 53/00; A 01 P 7/04; A 01 P 7/02	AP 2020 15137 A
A 01 N 59/02; C 05 D 9/00; C 05 D 9/02	AP 2020 14997 A
A 61 K 9/08; A 61 K 9/19; A 61 K 47/26; A 61 K 31/675	AP 2020 14974 A
A 61 K 31/355; A 61 K 47/14; A 61 K 47/24; A 61 P 31/04; A 61 P 31/10	AP 2020 15201 A
A 61 K 31/436; A 61 P 27/02	AP 2020 14989 A
A 61 K 31/7076; A 61 P 31/18	AP 2020 14873 A
A 61 K 31/7084; A 61 P 35/00; C 07 H 21/00	AP 2020 14726 A
B 65 D 81/20	AP 2020 15081 A
C 08 K 5/098; C 09 D 167/08	AP 2020 14587 A
E 01 B 9/02; E 01 B 9/10; E 01 B 9/30; F 16 B 5/02; F 16 B 35/04	AP 2020 15022 A
E 01 F 7/04	AP 2020 14926 A
E 02 D 5/02	AP 2020 14645 A
E 02 B 3/06; E 02 D 29/02	AP 2020 15059 A
G 21 B 3/00	AP 2020 15152 A

CONCORDANCE TABLE OF PUBLICATION NUMBERS AND INTERNATIONAL CLASSIFICATION INDEX

NUMBER OF PUBLISHED APPLICATION (10)	INTERNATIONAL CLASSIFICATION INDEXES (51)
AP 2020 14587 A	C 08 K 5/098; C 09 D 167/08
AP 2020 14645 A	E 02 D 5/02
AP 2020 14726 A	A 61 K 31/7084; A 61 P 35/00; C 07 H 21/00
AP 2020 14873 A	A 61 K 31/7076; A 61 P 31/18
AP 2020 14926 A	E 01 F 7/04
AP 2020 14974 A	A 61 K 9/08; A 61 K 9/19; A 61 K 47/26; A 61 K 31/675
AP 2020 14989 A	A 61 K 31/436; A 61 P 27/02
AP 2020 14997 A	A 01 N 59/02; C 05 D 9/00; C 05 D 9/02
AP 2020 15022 A	E 01 B 9/02; E 01 B 9/10; E 01 B 9/30; F 16 B 5/02; F 16 B 35/04
AP 2020 15059 A	E 02 B 3/06; E 02 D 29/02
AP 2020 15081 A	B 65 D 81/20
AP 2020 15137 A	A 01 N 35/04; A 01 N 53/00; A 01 P 7/04; A 01 P 7/02
AP 2020 15152 A	G 21 B 3/00
AP 2020 15201 A	A 61 K 31/355; A 61 K 47/14; A 61 K 47/24; A 61 P 31/04; A 61 P 31/10

**CONCORDANCE TABLE OF INTERNATIONAL CLASSIFICATION INDEX,
PATENT NUMBERS AND PUBLICATION NUMBERS**

INTERNATIONAL CLASSIFICATION INDEX (51)	NUMBER OF PATENT (11)	NUMBER OF PUBLISHED APPLICATION (10)
A 21 D 13/066; A 21 D 13/06; A 23 L 7/10; A 23 L 5/20; A 23 L 7/196; A 23 L 5/30; C 12 C 1/02	P 2020 7133 B	AP 2020 14809 A
A 23 L 2/8	P 2020 7135 B	AP 2020 14846 A
A 61 B 17/00; A 61 M 25/10; A 61 M 25/00	P 2020 7132 B	AP 2020 15041 A
A 61 K 31/79; A 61 K 31/10; A 61 K 31/517; A 61 K 31/14; A 61 K 45/06; A 61 K 31/235; A 61 K 9/70; A 61 K 47/42; A 61 K 9/06; A 61 K 9/00; A 61 K 31/167; A 61 K 31/185; A 61 K 31/047; A 61 P 17/02	P 2020 7136 B	AP 2020 15119 A
A 61 K 31/047; A 61 K 31/10; A 61 K 31/167; A 61 K 31/185; A 61 K 31/235; A 61 K 31/498; A 61 K 31/734; A 61 K 33/20; A 61 K 33/38; A 61 K 38/014; A 61 K 47/42; A 61 K 9/0014; A 61 K 9/06; A 61 K 9/7007; A 61 P 17/02	P 2020 7137 B	AP 2020 15120 A
A 61 K 47/26; A 61 K 47/02; A 61 K 38/48; A 61 K 47/18; A 61 K 31/506; A 61 K 31/405	P 2020 7139 B	AP 2020 14939 A
B 01 D 53/58; C 05 C 13/00	P 2020 7138 B	AP 2020 14836 A
H 01 L 31/0224	P 2020 7134 B	AP 2020 14975 A

**CONCORDANCE TABLE OF PATENT NUMBERS,
PUBLICATION NUMBERS AND INTERNATIONAL CLASSIFICATION INDEX**

NUMBER OF PATENT (11)	NUMBER OF PUBLISHED APPLICATION (10)	INTERNATIONAL CLASSIFICATION INDEX (51)
P 2020 7132 B	AP 2020 15041 A	A 61 B 17/00; A 61 M 25/10; A 61 M 25/00
P 2020 7133 B	AP 2020 14809 A	A 21 D 13/066; A 21 D 13/06; A 23 L 7/10; A 23 L 5/20; A 23 L 7/196; A 23 L 5/30; C 12 C 1/02
P 2020 7134 B	AP 2020 14975 A	H 01 L 31/0224
P 2020 7135 B	AP 2020 14846 A	A 23 L 2/8
P 2020 7136 B	AP 2020 15119 A	A 61 K 31/79; A 61 K 31/10; A 61 K 31/517; A 61 K 31/14; A 61 K 45/06; A 61 K 31/235; A 61 K 9/70; A 61 K 47/42; A 61 K 9/06; A 61 K 9/00; A 61 K 31/167; A 61 K 31/185; A 61 K 31/047; A 61 P 17/02
P 2020 7137 B	AP 2020 15120 A	A 61 K 31/047; A 61 K 31/10; A 61 K 31/167; A 61 K 31/185; A 61 K 31/235; A 61 K 31/498; A 61 K 31/734; A 61 K 33/20; A 61 K 33/38; A 61 K 38/014; A 61 K 47/42; A 61 K 9/0014; A 61 K 9/06; A 61 K 9/7007; A 61 P 17/02
P 2020 7138 B	AP 2020 14836 A	B 01 D 53/58; C 05 C 13/00
P 2020 7139 B	AP 2020 14939 A	A 61 K 47/26; A 61 K 47/02; A 61 K 38/48; A 61 K 47/18; A 61 K 31/506; A 61 K 31/405

**CONCORDANCE TABLE OF APPLICATION NUMBERS, PUBLICATION NUMBERS
AND PATENTS**

NUMBER OF APPLICATION (21)	NUMBER OF PUBLISHED APPLICATION (10)	NUMBER OF PATENT (11)
AP 2016 14809	AP 2020 14809 A	P 2020 7133 B
AP 2016 14836	AP 2020 14836 A	P 2020 7138 B
AP 2018 14846	AP 2020 14846 A	P 2020 7135 B
AP 2017 14939	AP 2020 14939 A	P 2020 7139 B
AP 2018 14975	AP 2020 14975 A	P 2020 7134 B
AP 2019 15041	AP 2020 15041 A	P 2020 7132 B
AP 2017 15119	AP 2020 15119 A	P 2020 7136 B
AP 2017 15120	AP 2020 15120 A	P 2020 7137 B

UTILITY MODELS

**CONCORDANCE TABLE OF INTERNATIONAL CLASSIFICATION INDEX
AND PUBLICATION NUMBERS**

INTERNATIONAL CLASSIFICATION INDEXES (51)	NUMBER OF PUBLISHED APPLICATION (10)
A 41 D 13/11	AU 2020 15312 U
E 04 C 2/16	AU 2020 15167 U

**CONCORDANCE TABLE OF PUBLICATION NUMBERS
AND INTERNATIONAL CLASSIFICATION INDEX**

NUMBER OF PUBLISHED APPLICATION (10)	INTERNATIONAL CLASSIFICATION INDEXES (51)
AU 2020 15167 U	E 04 C 2/16
AU 2020 15312 U	A 41 D 13/11

**CONCORDANCE TABLE OF INTERNATIONAL CLASSIFICATION INDEX,
PATENT NUMBERS AND PUBLICATION NUMBERS**

INTERNATIONAL CLASSIFICATION INDEX (51)	NUMBER OF PATENT (11)	NUMBER OF PUBLISHED APPLICATION (10)
C 12 G 1/02	U 2020 2046 Y	AU 2020 15197 U

CONCORDANCE TABLE OF PATENT NUMBERS,
PUBLICATION NUMBERS AND INTERNATIONAL CLASSIFICATION INDEX

NUMBER OF PATENT (11)	NUMBER OF PUBLISHED APPLICATION (10)	INTERNATIONAL CLASSIFICATION INDEX (51)
U 2020 2046 Y	AU 2020 15197 U	C 12 G 1/02

CONCORDANCE TABLE OF APPLICATION NUMBERS, PUBLICATION NUMBERS
AND PATENTS

NUMBER OF APPLICATION (21)	NUMBER OF PUBLISHED APPLICATION (10)	NUMBER OF PATENT (11)
AU 2019 15197	AU 2020 15197 U	U 2020 2046 Y

TRADEMARKS

CONCORDANCE TABLE OF REGISTRATION NUMBERS, APPLICATION NUMBERS, PUBLICATION NUMBERS AND BULLETIN NUMBERS

NUMBER OF REGISTRATION (111)	NUMBER OF APPLICATIONS (210)	NUMBER OF PUBLISHED APPLICATIONS (260)	NUMBER OF BULLETIN
1	2	3	4
M 2020 32842 R	AM 108789	–	14(546)2020
M 2020 32843 R	AM 108867	–	14(546)2020
M 2020 32844 R	AM 108874	–	14(546)2020
M 2020 32845 R	AM 108877	–	14(546)2020
M 2020 32846 R	AM 108513	–	14(546)2020
M 2020 32847 R	AM 108776	–	14(546)2020
M 2020 32841 R	AM 108873	–	14(546)2020
M 2020 32849 R	AM 108864	–	14(546)2020
M 2020 32850 R	AM 108847	–	14(546)2020
M 2020 32851 R	AM 100771	AM 2020 100771 A	6(538)2020
M 2020 32852 R	AM 100874	AM 2020 100874 A	6(538)2020
M 2020 32853 R	AM 102718	AM 2019 102718 A	24(532)2019
M 2020 32854 R	AM 103099	AM 2020 103099 A	1(533)2020
M 2020 32855 R	AM 103306	AM 2019 103306 A	24(532)2019
M 2020 32856 R	AM 103307	AM 2019 103307 A	24(532) 2019
M 2020 32857 R	AM 103325	AM 2020 103325 A	3(535)2020
M 2020 32858 R	AM 03429	AM 2019 103429 A	24(532)2019
M 2020 32859 R	AM 103485	AM 2020 103485 A	6(538)2020
M 2020 32860 R	AM 103560	AM 2020 103560 A	2(534)2020
M 2020 32861 R	AM 103562	AM 2020 103562 A	2(534)2020
M 2020 32862 R	AM 103563	AM 2020 103563 A	2(534)2020
M 2020 32863 R	AM 103589	AM 2020 103589 A	1(533)2020
M 2020 32864 R	AM 103942	AM 2020 103942 A	6(538)2020
M 2020 32865 R	AM 103954	AM 2020 103954 A	6(538)2020
M 2020 32866 R	AM 103955	AM 2020 103955 A	6(538)2020
M 2020 32867 R	AM 108779	–	14(546)2020
M 2020 32868 R	AM 103985	AM 2020 103985 A	3(535)2020
M 2020 32869 R	AM 104085	AM 2020 104085 A	6(538)2020
M 2020 32870 R	AM 104176	AM 2020 104176 A	6(538)2020
M 2020 32871 R	AM 104207	AM 2020 104207 A	5(537)2020
M 2020 32872 R	AM 104321	AM 2020 104321 A	4(536)2020
M 2020 32873 R	AM 104406	AM 2020 104406 A	6(538)2020
M 2020 32874 R	AM 104444	AM 2020 104444 A	6(538)2020
M 2020 32875 R	AM 104447	AM 2020 104447 A	6(538)2020
M 2020 32876 R	AM 104530	AM 2020 104530 A	6(538)2020
M 2020 32877 R	AM 104557	AM 2020 104557 A	6(538)2020
M 2020 32878 R	AM 104752	AM 2020 104752 A	6(538) 2020
M 2020 32879 R	AM 104753	AM 2020 104753 A	6(538) 2020
M 2020 32880 R	AM 104756	AM 2020 104756 A	6(538) 2020
M 2020 32881 R	AM 104758	AM 2020 104758 A	6(538) 2020
M 2020 32882 R	AM 98992	AM 2019 98992 A	24(532) 2019
M 2020 32883 R	AM 99947	AM 2019 99947 A	15(523)2019
M 2020 32883 R	AM 99947	AM 2020 99947 A	6(538)2020
M 2020 32884 R	AM 99950	AM 2020 99950 A	6(538)2020
M 2020 32884 R	AM 99950	AM 2019 99950 A	15(523)2019
M 2020 32885 R	AM 108888	–	14(546)2020

1	2	3	4
M 2020 32886 R	AM 108941	–	14(546)2020
M 2020 32887 R	AM 108754	–	14(546)2020
M 2020 32888 R	AM 108952	–	14(546)2020
M 2020 32889 R	AM 108751	–	14(546)2020
M 2020 32890 R	AM 108854	–	14(546)2020
M 2020 32891 R	AM 108498	–	14(546)2020
M 2020 32892 R	AM 108523	–	14(546)2020
M 2020 32893 R	AM 108963	–	14(546)2020
M 2020 32894 R	AM 103013	AM 2019 103013 A	24(532)2019
M 2020 32895 R	AM 103193	AM 2019 103193 A	24(532)2019
M 2020 32896 R	AM 103316	AM 2020 103316 A	1(533)2020
M 2020 32897 R	AM 103657	AM 2020 103657 A	3(535)2020
M 2020 32898 R	AM 103767	AM 2020 103767 A	3(535)2020
M 2020 32899 R	AM 103970	AM 2020 103970 A	5(537)2020
M 2020 32900 R	AM 104063	AM 2020 104063 A	3(535)2020
M 2020 32901 R	AM 104064	AM 2020 104064 A	3(535)2020
M 2020 32902 R	AM 104065	AM 2020 104065 A	3(535)2020
M 2020 32903 R	AM 104206	AM 2020 104206 A	6(538)2020
M 2020 32904 R	AM 104554	AM 2020 104554 A	7(539)2020
M 2020 32905 R	AM 104672	AM 2020 104672 A	7(539)2020
M 2020 32906 R	AM 104675	AM 2020 104675 A	7(539)2020
M 2020 32907 R	AM 104743	AM 2020 104743 A	7(539)2020
M 2020 32908 R	AM 104744	AM 2020 104744 A	7(539)2020
M 2020 32909 R	AM 104751	AM 2020 104751 A	7(539)2020
M 2020 32910 R	AM 104769	AM 2020 104769 A	7(539)2020
M 2020 21911 R	AM 104815	AM 2020 104815 A	7(539)2020
M 2020 32912 R	AM 104904	AM 2020 104904 A	7(539)2020
M 2020 32913 R	AM 104926	AM 2020 104926 A	7(539)2020
M 2020 32914 R	AM 104927	AM 2020 104927 A	7(539)2020
M 2020 32915 R	AM 104928	AM 2020 104928 A	7(539)2020

**CONCORDANCE TABLE OF PUBLICATION NUMBERS
AND APPLICATION NUMBERS**

NUMBER OF PUBLISHED APPLICATION (260)	NUMBER OF APPLICATION (210)	1	2
1	2		
AM 2020 103464 A	AM 103464	AM 2020 106088 A	AM 106088
AM 2020 105249 A	AM 105249	AM 2020 106089 A	AM 106089
AM 2020 105982 A	AM 105982	AM 2020 106090 A	AM 106090
AM 2020 105986 A	AM 105986	AM 2020 106158 A	AM 106158
AM 2020 105988 A	AM 105988	AM 2020 106159 A	AM 106159
AM 2020 105989 A	AM 105989	AM 2020 106160 A	AM 106160
AM 2020 105994 A	AM 105994	AM 2020 106161 A	AM 106161
AM 2020 106046 A	AM 106046	AM 2020 106163 A	AM 106163
AM 2020 106047 A	AM 106047	AM 2020 106166 A	AM 106166
AM 2020 106049 A	AM 106049	AM 2020 106168 A	AM 106168
AM 2020 106050 A	AM 106050	AM 2020 106172 A	AM 106172
AM 2020 106062 A	AM 106062	AM 2020 106182 A	AM 106182
AM 2020 106064 A	AM 106064	AM 2020 106188 A	AM 106188
AM 2020 106065 A	AM 106065	AM 2020 106189 A	AM 106189
AM 2020 106066 A	AM 106066	AM 2020 106279 A	AM 106279
AM 2020 106067 A	AM 106067	AM 2020 106283 A	AM 106283
AM 2020 106073 A	AM 106073	AM 2020 106285 A	AM 106285
AM 2020 106074 A	AM 106074	AM 2020 106300 A	AM 106300
AM 2020 106076 A	AM 106076	AM 2020 106328 A	AM 106328
AM 2020 106078 A	AM 106078	AM 2020 106412 A	AM 106412
AM 2020 106085 A	AM 106085	AM 2020 106418 A	AM 106418
AM 2020 106087 A	AM 106087	AM 2020 106419 A	AM 106419
		AM 2020 106420 A	AM 106420
		AM 2020 106436 A	AM 106436
		AM 2020 106437 A	AM 106437
		AM 2020 106523 A	AM 106523

CONCORDANCE TABLE OF INDEX OF GOODS AND/OR SERVICES
AND APPLICATION NUMBERS

INDEX OF GOODS AND/OR SERVICES (511)	NUMBER OF PUBLISHED APPLICATIONS (26)	1	2
1	2	21	AM 2020 105994 A
1	AM 2020 105982 A	25	AM 2020 106062 A
1	AM 2020 106074 A	25	AM 2020 106182 A
1	AM 2020 106283 A	29	AM 2020 106168 A
1	AM 2020 106412 A	30	AM 2020 106065 A
3	AM 2020 105994 A	30	AM 2020 106085 A
3	AM 2020 106064 A	30	AM 2020 106088 A
3	AM 2020 106182 A	31	AM 2020 106168 A
3	AM 2020 106418 A	32	AM 2020 105249 A
3	AM 2020 106420 A	32	AM 2020 106285 A
5	AM 2020 105982 A	33	AM 2020 105986 A
5	AM 2020 106046 A	33	AM 2020 106050 A
5	AM 2020 106047 A	33	AM 2020 106168 A
5	AM 2020 106066 A	33	AM 2020 106172 A
5	AM 2020 106067 A	33	AM 2020 106188 A
5	AM 2020 106076 A	33	AM 2020 106328 A
5	AM 2020 106078 A	33	AM 2020 106523 A
5	AM 2020 106166 A	34	AM 2020 105988 A
5	AM 2020 106283 A	34	AM 2020 105989 A
5	AM 2020 106300 A	34	AM 2020 106089 A
5	AM 2020 106412 A	34	AM 2020 106090 A
7	AM 2020 106073 A	34	AM 2020 106158 A
7	AM 2020 106189 A	34	AM 2020 106161 A
8	AM 2020 106073 A	35	AM 2020 105986 A
8	AM 2020 106189 A	35	AM 2020 106062 A
9	AM 2020 103464 A	35	AM 2020 106087 A
9	AM 2020 106158 A	35	AM 2020 106168 A
9	AM 2020 106161 A	35	AM 2020 106172 A
9	AM 2020 106419 A	35	AM 2020 106188 A
9	AM 2020 106436 A	35	AM 2020 106285 A
9	AM 2020 106437 A	37	AM 2020 106159 A
12	AM 2020 103464 A	37	AM 2020 106160 A
14	AM 2020 106062 A	43	AM 2020 106049 A
18	AM 2020 106062 A	43	AM 2020 106050 A
		43	AM 2020 106163 A
		43	AM 2020 106168 A
		44	AM 2020 106087 A
		44	AM 2020 106279 A

CONCORDANCE TABLE OF INDEX OF GOODS AND/OR SERVICES
AND NUMBERS OF TRADEMARKS REGISTERED ACCORDING
TO THE ACCELERATED PROCEDURE

INDEX OF GOODS AND/OR SERVICES (511)	NUMBERS OF REGISTERED ACCORDING TO THE ACCELERATED PROCEDURE (111)
5	M 2020 32890 R
9	M 2020 32842 R
9	M 2020 32844 R
9	M 2020 32848 R
9	M 2020 32867 R
9	M 2020 32886 R
9	M 2020 32888 R
16	M 2020 32842 R
16	M 2020 32887 R
16	M 2020 32889 R
22	M 2020 32847 R
23	M 2020 32887 R
23	M 2020 32889 R
24	M 2020 32887 R
24	M 2020 32889 R
25	M 2020 32885 R
25	M 2020 32887 R
25	M 2020 32889 R
33	M 2020 32845 R
33	M 2020 32846 R
33	M 2020 32891 R
33	M 2020 32892 R
33	M 2020 32893 R
35	M 2020 32842 R
35	M 2020 32843 R
35	M 2020 32850 R
35	M 2020 32887 R
35	M 2020 32889 R
36	M 2020 32850 R
36	M 2020 32886 R
38	M 2020 32842 R
38	M 2020 32844 R
38	M 2020 32848 R
40	M 2020 32847 R
41	M 2020 32842 R
43	M 2020 32845 R
43	M 2020 32849 R
45	M 2020 32844 R
45	M 2020 32848 R

OFFICIAL BULLETIN OF THE INDUSTRIAL PROPERTY

INVENTIONS
UTILITY MODELS
DESIGNS
TRADEMARKS
APPELATION OF ORIGIN OF GOODS

14(546)

EDITOR-IN-CHIEF: N. Bebrishvili

EDITOR-TRANSLATOR: E. Gabunia

PROOFREADER: A. Shikhashvili

COMPUTER LAYOUT: M. Ordenidze
K. Svanidze

www.sakpatenti.gov.ge

E-mail: info@sakpatenti.org.ge

**LIST OF CODES, IN ALPHABETIC SEQUENCE, AND THE CORRESPONDING (SHORT) NAMES OF STATES, OTHER ENTITIES AND INTERGOVERNMENTAL ORGANIZATIONS
(WIPO STANDARD ST.3)**

AD	Andorra				
AE	United Arab Emirates	GD	Grenada	NE	Niger
AF	Afghanistan	GG	Guernsey	NG	Nigeria
AG	Antigua and Barbuda	GH	Ghana	NI	Nicaragua
AI	Anguilla	GI	Gibraltar	NL	Netherlands
AL	Albania	GT	Guatemala	NO	Norway
AM	Armenia	GW	Guinea- Bissau	NP	Nepal
AN	Netherlands Antilles	GY	Guyana	NR	Nauru
AO	Angola	HK	The Hong Kong Special Administrative Region of the People's Republic of China	NZ	New Zealand
AP	African Regional Intellectual Property Organization (ARIPO)	HN	Honduras	OA	African Intellectual Property Organization (OAPI)
AR	Argentina	HR	Croatia	OM	Oman
AT	Austria	HT	Haiti	PA	Panama
AU	Australia	HU	Hungary	PE	Peru
AW	Aruba	IB	International Bureau of the World Intellectual Property Organization (WIPO)	PG	Papua New Guinea
AZ	Azerbaijan	ID	Indonesia	PH	Philippines
BA	Bosnia and Herzegovina	IE	Ireland	PK	Pakistan
BB	Barbados	IL	Israel	PL	Poland
BD	Bangladesh	IM	Isle of Man	PT	Portugal
BE	Belgium	IN	India	PW	Palau
BF	Burkina Faso	IQ	Iraq	PY	Paraguay
BG	Bulgaria	IR	Iran (Islamic Republic of)	QA	Qatar
BH	Bahrain	IS	Iceland	QZ	Community Plant Variety Office (European Community) (CPVO)
BI	Burundi	IT	Italy	RO	Romania
BJ	Benin	JE	Jersey	RS	Serbia
BM	Bermuda	JM	Jamaica	RU	Russian Federation
BN	Brunei Darussalam	JO	Jordan	RW	Rwanda
BO	Bolivia	JP	Japan	SA	Saudi Arabia
BR	Brazil	KE	Kenya	SB	Solomon Islands
BS	Bahamas	KG	Kyrgyzstan	SC	Seychelles
BT	Bhutan	KH	Cambodia	SD	Sudan
BV	Bouvet Island	KI	Kiribati	SG	Singapore
BW	Botswana	KM	Saint Kitts and Nevis	SH	Saint Helena
BX	Benelux Office for Intellectual Property (BOIP)	KP	Democratic People's Republic of Korea	SI	Slovenia
BY	Belarus	KR	Republic of Korea	SK	Slovakia
BZ	Belize	KW	Kuwait	SL	Sierra Leone
CA	Canada	KY	Cayman Islands	SM	San Marino
CD	Democratic Republic of the Congo	KZ	Kazakhstan	SN	Senegal
CF	Central African Republic	LA	Lao People's Democratic Republic	SO	Somalia
CG	Congo	LB	Lebanon	SR	Suriname
CH	Switzerland	LC	Saint Lucia	ST	Sao Tome and Principe
CI	Cote d'Ivoire	LI	Liechtenstein	SV	El Salvador
CK	Cook Islands	LK	Sri Lanka	SY	Syrian Arab Republic
CL	Chile	LR	Liberia	SZ	Swaziland
CM	Cameroon	LS	Lesotho	TC	Turks and Caicos Islands
CN	China	LT	Lithuania	TD	Chad
CO	Colombia	LU	Luxembourg	TG	Togo
CR	Costa Rica	LV	Latvia	TH	Thailand
CU	Cuba	LY	Libyan Arab Jamahiriya	TJ	Tajikistan
CV	Cape Verde	MA	Morocco	TL	Timor-Leste
CY	Cyprus	MC	Monaco	TM	Turkmenistan
CZ	Czech Republic	MD	Republic of Moldova	TN	Tunisia
DE	Germany	ME	Montenegro	TO	Tonga
DJ	Djibouti	MG	Madagascar	TR	Turkey
DM	Dominica	MK	The former Yugoslav Republic of Macedonia	SE	Sweden
DO	Dominican Republic	ML	Mali	TT	Trinidad and Tobago
DZ	Algeria	MM	Myanmar	TV	Tuvalu
EA	Eurasian Patent Organization (EAPO)	MN	Mongolia	TW	Taiwan, Province of China
EC	Ecuador	MO	Macao	TZ	United Republic of Tanzania
EE	Estonia	MP	Northern Mariana Islands	UA	Ukraine
EG	Egypt	MR	Mauritania	UG	Uganda
EH	Western Sahara	MS	Montserrat	US	United States of America
EM	Office for Harmonization in the Internal Market (Trademarks and Designs)(OHIM)	MT	Malta	UY	Uruguay
EP	European Patent Office (EPO)	MU	Mauritius	UZ	Uzbekistan
ER	Eritrea	MV	Maldives	VA	Holy See
ES	Spain	MW	Malawi	VC	Saint Vincent and the Grenadines
ET	Ethiopia	MX	Mexico	VE	Venezuela
FI	Finland	MY	Malaysia	VG	Virgin Islands (British)
FJ	Fiji	MZ	Mozambique	VN	Viet Nam
FK	Falkland Islands (Malvinas)	NA	Namibia	VU	Vanuatu
FO	Faroe Islands			WO	World Intellectual Property Organization (WIPO)
FR	France			WS	Samoa
GA	Gabon			XN	Nordic Patent Institute (NPI)
GB	United Kingdom			YE	Yemen
GC	Patent Office of the Cooperation Council for the Arab States of the Gulf (GCC)			ZA	South Africa
				ZM	Zambia
				ZW	Zimbabwe