



**NATIONAL INTELLECTUAL PROPERTY CENTER OF GEORGIA  
SAKPATENTI**

**OFFICIAL BULLETIN  
OF THE INDUSTRIAL PROPERTY**

**15(427)**

**2015  
TBILISI**

# INID CODES FOR IDENTIFICATION OF BIBLIOGRAPHIC DATA

## INVENTIONS, UTILITY MODELS

- (10) Number of publication for application, which has been examined
- (11) Number of patent and kind of document
- (21) Serial number of application
- (22) Date of filing of the application
- (23) Date of exhibition or the date of the earlier filing and the number of application, if any
- (24) Date from which patent may have effect
- (31) Number of priority application
- (32) Date of filing of priority application
- (33) Code of the country or regional organization allotting priority application number
- (44) Date of publication of application not granted, but examined and number of bulletin
- (45) Date of publication of registered document
- (51) International Patent Classification Index
- (54) Title of the invention
- (57) Abstract
- (60) Number of examined patent document granted by foreign patent office, date from which patent has effect and country code
- (62) Number of the earlier application and in case of divided application, date of filing an application
- (71) Name, surname and address of applicant (country code)
- (72) Name, surname of inventor (country code)
- (73) Name, surname and address of patent owner (country code)
- (74) Name, surname of representative or patent attorney
- (85) Date of commencement of the national phase of International Application
- (86) Number and date of filing of international application
- (87) Number and date of publication of international application

## DESIGNS

- (10) Number of publication for application
- (11) Number of patent and kind of document or number of registration
- (15) Date of registration/Date of patent renewal
- (18) Expected expiration date of patent or registration
- (21) Serial number of application
- (22) Date of filing of the application
- (23) Date of exhibition or the date of the earlier filing and the number of application, if any
- (24) Date from which patent may have effect
- (28) Number of designs included in the application
- (30) Data relating to priority (number of application, date of filing of application, two-letter code identifying the authority with whom the priority application was made)
- (31) Number of priority application
- (32) Date of filing of priority application
- (33) Code of the country or regional organization allotting priority application number
- (34) Two-letter code according to WIPO St.3 identifying the authority with which the priority application was made
- (44) Date of publication of design and number of bulletin (the first publication)
- (45) Date of publication of design registered by WIPO and number of bulletin
- (51) International Classification for designs (class and subclass of the Locarno Classification)
- (54) Title of the invention
- (55) Reproduction of the design
- (57) Description of characteristic features of the design including indication of colors
- (58) Date of recording of any kind of amendment in the Register
- (62) Number of the earlier application, registration and document number and if available the date of filing an application in case of divided application
- (71) Name, surname and address of applicant (country code)
- (72) Name, surname of creator (country code)
- (73) Name, surname and address of patent owner (country code)
- (74) Name, surname of representative or patent attorney
- (81) Contracting states concerned
  - II designated contracting states according to the 1960 Act
  - III designated contracting states according to the 1999 Act
- (85) Owner's permanent address
- (86) Owner's nationality
- (87) Owner's residence
- (88) State in which the owner has a real and effective industrial or commercial establishment

## TRADEMARKS

- (111) – Number of registration
- (151) – Date of registration
- (156) – Date of the renewal
- (181) – Expected expiration date of registration
- (186) – Renewal expiration date of registration
- (141) – Date of cancel of duration of the mark
- (210) – Serial number of application
- (220) – Date of filing of the application
- (230) – Data concerning exhibition
- (260) – Number of application, for which favorable decision of examination about registration has been taken (publication number)
- (310) – Number of the first application
- (320) – Date of filing of the first application
- (330) – Code, identifying national or regional Office where the first application was made
- (511) – International Classification of Goods and Services for the purposes of registration of trade marks and/or list of goods and/or services classified according thereto
- (531) – Description of figurative elements of Trade Marks according to the International Classification of the Figurative Elements of Marks
- (540) – Reproduction of Trade Mark
- (550) – Nature and kind of Trade Mark
- (580) – Date of recording of any kind changes in respect of applications or registrations
- (591) – Information concerning colors claimed
- (731) – Name and address of the applicant
- (732) – Name and address of the holder of the registration
- (740) – Name and address of the representative
- (750) – Address for correspondence
- (770) – Name and address of the previous applicant or holder in case of change in ownership
- (771) – Previous name and address of the applicant or holder in case of change in ownership
- (791) – Name and address of the licensee
- (793) – Indication of conditions and/or restrictions under the license (Type of license, number of license agreement, data of license, data of validity of license)
- (800) – Certain data relating to the international registration of Trade Marks under the Protocol Relating to Madrid Agreement (International registration number)

## CODES FOR PUBLICATION IN BULLETIN

- (21) AP 0000 000000 – serial number of application for invention
- (10) AP 0000 0000 A – number of published application for invention (first publication)
- (11) P 0000 0000 B – number of patent for invention (second publication)
- (21) API 0000 000000 – number of application for imported patent
- (11) PI 0000 0000 A – number of imported patent (first publication)
- (21) AU 0000 000000 – serial number of application for utility model
- (10) AU 0000 000 U – number of published application for utility model (first publication)
- (11) U 0000 000 Y – number of patent for utility model (second publication)
- (21) AD 0000 000000 – serial number of application for design
- (10) AD 0000 000 S – number of published application for design (first publication)
- (11) D 0000 000 S – number of patent for design (second publication)

## INTERNATIONAL PATENT CLASSIFICATION FOR INVENTIONS AND UTILITY MODELS

- SECTION A – HUMAN NECESSITIES
- SECTION B – PERFORMING OPERATIONS; TRANSPORTING
- SECTION C – CHEMISTRY; METALLURGY
- SECTION D – TEXTILES; PAPER
- SECTION E – FIXED CONSTRUCTIONS
- SECTION F – MECHANICAL ENGINEERING; LIGHTING; HEATING; WEAPONS; BLASTING
- SECTION G – PHYSICS
- SECTION H – ELECTRICITY

- 
- M – Trade Mark
  - (210) AM 0000 000000 – Serial number of application;
  - (260) AAM 0000 00000 A – Publication number of application;
  - (111) M 0000 00000 R – Number of registration;
  - (111) MMM0000 00000 Rn – Number of renewals, in which n=1,2,3;
  - (111) M 0000 00000 R(P) – Number of registration under partial assignment of rights
-

**LIST OF CODES, IN ALPHABETIC SEQUENCE, AND THE CORRESPONDING (SHORT) NAMES OF STATES, OTHER ENTITIES AND INTERGOVERNMENTAL ORGANIZATIONS**  
(WIPO STANDARD ST.3)

AD	Andorra				
AE	United Arab Emirates				
AF	Afghanistan				
AG	Antigua and Barbuda				
AI	Anguilla				
AL	Albania				
AM	Armenia				
AN	Netherlands Antilles				
AO	Angola				
AP	African Regional Intellectual Property Organization (ARIPO)				
AR	Argentina				
AT	Austria				
AU	Australia				
AW	Aruba				
AZ	Azerbaijan				
BA	Bosnia and Herzegovina				
BB	Barbados				
BD	Bangladesh				
BE	Belgium				
BF	Burkina Faso				
BG	Bulgaria				
BH	Bahrain				
BI	Burundi				
BJ	Benin				
BM	Bermuda				
BN	Brunei Darussalam				
BO	Bolivia				
BR	Brazil				
BS	Bahamas				
BT	Bhutan				
BV	Bouvet Island				
BW	Botswana				
BX	Benelux Office for Intellectual Property (BOIP)				
BY	Belarus				
BZ	Belize				
CA	Canada				
CD	Democratic Republic of the Congo				
CF	Central African Republic				
CG	Congo				
CH	Switzerland				
CI	Cote d'Ivoire				
CK	Cook Islands				
CL	Chile				
CM	Cameroon				
CN	China				
CO	Colombia				
CR	Costa Rica				
CU	Cuba				
CV	Cape Verde				
CY	Cyprus				
CZ	Czech Republic				
DE	Germany				
DJ	Djibouti				
DM	Dominica				
DO	Dominican Republic				
DZ	Algeria				
EA	Eurasian Patent Organization (EAPO)				
EC	Ecuador				
EE	Estonia				
EG	Egypt				
EH	Western Sahara				
EM	Office for Harmonization in the Internal Market (Trademarks and Designs)(OHIM)				
EP	European Patent Office (EPO)				
ER	Eritrea				
ES	Spain				
ET	Ethiopia				
FI	Finland				
FJ	Fiji				
FK	Falkland Islands (Malvinas)				
FO	Faroe Islands				
FR	France				
GA	Gabon				
GB	United Kingdom				
GC	Patent Office of the Cooperation Council for the Arab States of the Gulf (GCC)				
GD	Grenada				
GG	Guernsey				
GH	Ghana				
GI	Gibraltar				
GT	Guatemala				
GW	Guinea- Bissau				
GY	Guyana				
HK	The Hong Kong Special Administrative Region of the People's Republic of China				
HN	Honduras				
HR	Croatia				
HT	Haiti				
HU	Hungary				
IB	International Bureau of the World Intellectual Property Organization (WIPO)				
ID	Indonesia				
IE	Ireland				
IL	Israel				
IM	Isle of Man				
IN	India				
IQ	Iraq				
ID	Indonesia				
IE	Ireland				
IL	Israel				
IM	Isle of Man				
IN	India				
IQ	Iraq				
IR	Iran (Islamic Republic of)				
IS	Iceland				
IT	Italy				
JE	Jersey				
JM	Jamaica				
JO	Jordan				
JP	Japan				
KE	Kenya				
KG	Kyrgyzstan				
KH	Cambodia				
KI	Kiribati				
KM	Saint Kitts and Nevis				
KP	Democratic People's Republic of Korea				
KR	Republic of Korea				
KW	Kuwait				
KY	Cayman Islands				
KZ	Kazakhstan				
LA	Lao People's Democratic Republic				
LB	Lebanon				
LC	Saint Lucia				
LI	Liechtenstein				
LK	Sri Lanka				
LR	Liberia				
LS	Lesotho				
LT	Lithuania				
LU	Luxembourg				
LV	Latvia				
LY	Libyan Arab Jamahiriya				
MA	Morocco				
MC	Monaco				
MD	Republic of Moldova				
ME	Montenegro				
MG	Madagascar				
MK	The former Yugoslav Republic of Macedonia				
ML	Mali				
MM	Myanmar				
MN	Mongolia				
MO	Macao				
MP	Northern Mariana Islands				
MR	Mauritania				
MS	Montserrat				
MT	Malta				
MU	Mauritius				
MV	Maldives				
MW	Malawi				
MX	Mexico				
MY	Malaysia				
MZ	Mozambique				
NA	Namibia				
NE	Niger				
NG	Nigeria				
NI	Nicaragua				
NL	Netherlands				
NO	Norway				
NP	Nepal				
NR	Nauru				
NZ	New Zealand				
OA	African Intellectual Property Organization (OAPI)				
OM	Oman				
PA	Panama				
PE	Peru				
PG	Papua New Guinea				
PH	Philippines				
PK	Pakistan				
PL	Poland				
PT	Portugal				
PW	Palau				
PY	Paraguay				
QA	Qatar				
QZ	Community Plant Variety Office (European Community) (CPVO)				
RO	Romania				
RS	Serbia				
RU	Russian Federation				
RW	Rwanda				
SA	Saudi Arabia				
SB	Solomon Islands				
SC	Seychelles				
SD	Sudan				
SG	Singapore				
SH	Saint Helena				
SI	Slovenia				
SK	Slovakia				
SL	Sierra Leone				
SM	San Marino				
SN	Senegal				
SO	Somalia				
SR	Suriname				
ST	Sao Tome and Principe				
SV	El Salvador				
SY	Syrian Arab Republic				
SZ	Swaziland				
TC	Turks and Caicos Islands				
TD	Chad				
TG	Togo				
TH	Thailand				
TJ	Tajikistan				
TL	Timor-Leste				
TM	Turkmenistan				
TN	Tunisia				
TO	Tonga				
TR	Turkey				
SE	Sweden				
TT	Trinidad and Tobago				
TV	Tuvalu				
TW	Taiwan, Province of China				
TZ	United Republic of Tanzania				
UA	Ukraine				
UG	Uganda				
US	United States of America				
UY	Uruguay				
UZ	Uzbekistan				
VA	Holy See				
VC	Saint Vincent and the Grenadines				
VE	Venezuela				
VG	Virgin Islands (British)				
VN	Viet Nam				
VU	Vanuatu				
WO	World Intellectual Property Organization (WIPO)				
WS	Samoa				
XN	Nordic Patent Institute (NPI)				
YE	Yemen				
ZA	South Africa				
ZM	Zambia				
ZW	Zimbabwe				

**NATIONAL INTELLECTUAL PROPERTY CENTER OF GEORGIA  
SAKPATENTI**

**OFFICIAL BULLETIN  
OF THE INDUSTRIAL PROPERTY**

**15(427)**

**INVENTIONS**

**UTILITY MODELS**

**DESIGNS**

**TRADEMARKS**

**APPELLATIONS OF ORIGIN AND GEOGRAPHICAL  
INDICATIONS OF GOODS**

DATE OF PUBLICATION

2015 08 10

# CONTENTS

<b>PUBLISHED TITLES OF PROTECTION</b> .....	3
<b>INVENTIONS</b>	
▪ APPLICATIONS APPROVED FOR GRANTING PATENTS .....	4
▪ PATENTED INVENTIONS .....	6
<b>UTILITY MODELS</b>	
▪ APPLICATIONS APPROVED FOR GRANTING PATENT .....	9
▪ PATENTED UTILITY MODEL .....	10
<b>DESIGNS</b>	
▪ APPLICATIONS APPROVED FOR REGISTRATION .....	11
▪ REGISTERED DESIGN .....	12
▪ DESIGNS REGISTERED ACCORDING TO THE ACCELERATED PROCEDURE .....	13
▪ DESIGNS REGISTERED WITH THE INTERNATIONAL BUREAU CLAIMING PRIORITY ON THE TERRITORY OF GEORGIA .....	15
<b>TRADEMARKS</b>	
▪ APPLICATIONS FILED UNDER THE NATIONAL PROCEDURE APPROVED FOR REGISTRATION .....	38
▪ REGISTERED TRADEMARKS .....	46
▪ TRADEMARKS REGISTERED ACCORDING TO THE ACCELERATED PROCEDURE .....	53
▪ INTERNATIONAL TRADEMARKS FOR WHICH A DECISION ON GANTING PROTECTION IS TAKEN .....	57
▪ INTERNATIONAL TRADEMARKS PROTECTED IN GEORGIA .....	100
<b>APPELLATIONS OF ORIGIN AND GEOGRAPHICAL INDICATIONS OF GOODS</b>	
▪ APPELLATIONS OF ORIGIN OF GOODS FILED IN GEORGIA FOR EXAMINATION UNDER LISBON AGREEMENT, ON THE BASIS OF THE INTERNATIONAL REGISTRATION .....	109
<b>OFFICIAL NOTIFICATIONS</b>	
<b>INVENTIONS</b>	
▪ COMPLETE TRANSFER OF RIGHTS .....	112
▪ CHANGES IN NAMES AND/OR ADDRESSES OF PATENTOWNERS .....	112
▪ RENEWAL OF A PATENTS .....	113
▪ CORRECTION OF PUBLISHED INFORMATIONS .....	114
<b>CLASSIFICATION INDEXES</b>	
INVENTIONS .....	115
UTILITY MODELS .....	116
DESIGNS .....	118
TRADEMARKS .....	120

## **PUBLISHED TITLES OF PROTECTION**

### **INVENTIONS**

- **APPLICATIONS APPROVED FOR GRANTING PATENTS:**  
13602; 13672; 13205; 13406
- **PATENTED INVENTIONS:**  
6338-6347

### **UTILITY MODELS**

- **APPLICATIONS APPROVED FOR GRANTING PATENTS:**  
13762; 13741
- **PATENTED UTILITY MODEL:**  
1863

### **DESIGNS**

- **APPLICATION APPROVED FOR REGISTRATION:**  
849
- **REGISTERED DESIGN:**  
635
- **DESIGNS REGISTERED ACCORDING TO THE ACCELERATED PROCEDURE:**  
633, 634
- **DESIGNS REGISTERED WITH THE INTERNATIONAL BUREAU CLAIMING PRIORITY ON THE TERRITORY OF GEORGIA:**  
83478; 84790, 84791; 84840; 84847; 84832, 84833; 86307; 86312; 86385; 86410; 85023; 86492

### **TRADEMARKS**

- **APPLICATIONS FILED UNDER THE NATIONAL PROCEDURE APPROVED FOR REGISTRATION:**  
68048\*; 77451; 77816; 78138; 78141, 78142; 78149; 78238; 78378; 78704; 78813; 78846; 78848; 78887; 78889; 78909; 79051; 79060; 79070, 79071; 79123; 79136; 79140; 79196; 79268; 79290; 79308; 79337; 79352; 79389; 79406; 79451; 79481, 79482; 79498; 79612; 79614; 79669; 79747-79751; 79956; 79974; 79979; 80007; 80011; 80013; 80110; 80112
- **REGISTERED TRADEMARKS:**  
26075-26089; 26091-26135; 26154-26173
- **TRADEMARKS REGISTERED ACCORDING TO THE ACCELERATED PROCEDURE:**  
26139-26153; 26174-26178
- **INTERNATIONAL TRADEMARKS FOR WHICH A DECISION ON GRANTING PROTECTIONS IS TAKEN:**  
75332\*; 77542; 77649; 77655, 77656; 77660; 78094; 78100; 78345; 78348; 78354; 78463, 78464; 78467; 78471; 78478; 78551; 78672; 78724-78727; 78729; 78731; 78758, 78759; 78761-78765; 78767-78772; 78791; 78793-78795; 78798; 78818, 78819; 78822-78824; 78827; 78830-78832; 78837; 78839; 78847; 78860; 78862-78872; 78874-78878; 78881, 78882; 78884-78886; 78890; 78892; 78894; 78900-78903; 79143; 79147-79155; 79159-79161; 79166; 79347; 79458, 79459; 79461; 79463, 79464; 79468; 79707; 79712; 79716-79719; 79721-79723; 79726; 79728, 79729; 79805, 79806
- **INTERNATIONAL TRADEMARKS PROTECTED IN GEORGIA:**  
76359; 76361; 76363; 76372; 76374; 76487; 76816; 76836; 76839; 76854; 76856-76859; 76864; 77153; 77160; 77173, 77174; 77176; 77219; 77241; 77247; 77250-77252; 77301; 77332; 77335; 77363; 77366; 77375; 77377, 77378; 77383; 77385; 77387, 77388; 77390; 77391; 77409; 77411-77418; 77421; 77423-77427; 77499, 77500; 77502; 77509, 77510; 77563; 77567; 77588; 77590-77592; 77594; 77603, 77604; 77607; 77611; 77613; 77638; 77642, 77643; 77716-77719; 77729-77732; 77735-77739; 77748, 77749; 77751; 77753-77756; 77758, 77759; 77762; 77838; 78043-78045; 78054-78064; 78067, 78068; 78075; 78324, 78325; 78329, 78330; 78337-78339; 78341, 78342; 78344

### **APPELLATIONS OF ORIGIN AND GEOGRAPHICAL INDICATIONS OF GOODS**

- **APPELLATIONS OF ORIGIN OF GOODS FILED IN GEORGIA FOR EXAMINATION UNDER LISBON AGREEMENT, ON THE BASIS OF THE INTERNATIONAL REGISTRATION:**  
1205-1207; 1221-1226

---

# INVENTIONS

## APPLICATIONS APPROVED FOR GRANTING PATENTS

The decision can be appealed at the Chamber of Appeal of Sakpatenti within 3 months from the publication or at the Mtskheta District Court Administrative Cases Board (Address: №17, Samkhedro str., Mtskheta), within 1 month following the publication.

### PART A

#### A 61

(10) AP 2015 13602 A (51) Int. Cl. (2006)

A 61 K 33/26

A 61 K 33/04

A 61 K 36/00

(21) AP 2014 013602 (22) 2014 10 20

(71) Merab Lekveishvili (GE)

Sop. Ianeti, 39112, Samtredia (GE)

(72) Merab Lekveishvili (GE)

(74) Nugzar Ksovreli

(54) **DRUG FOR TREATMENT OF CONDITIONS RELATED TO OXIDATIVE STRESS**

(57) Composition containing iron, sulfur, horse gowan – Matricaria chamomilla flowers, immortelle – Helichrusum arenari, plantain – Plantago major and nettle – Urtica urens foliage are applied for the treatment and/or prevention of conditions related to oxidative stress. At that, said conditions are selected from following group: old age and related thereto neurodegenerative conditions, cardiovascular diseases, eclampsia, preeclampsia, and erectile dysfunction.

Claims: 1 independent

8 dependent

---

(10) AP 2015 13672 A (51) Int. Cl. (2006)

A 61 K 33/26

A 61 K 33/04

(21) AP 2014 013672 (22) 2014 12 24

(71) Merab Lekveishvili (GE)

Sop. Ianeti, 39112, Samtredia (GE)

(72) Merab Lekveishvili (GE)

(74) Nugzar Ksovreli

(54) **TREATING-PREVENTING COMPOSITION FOR TREATMENT OF CONDITIONS RELATED TO OXIDATIVE STRESS**

(57) Composition contains iron sulphide as active ingredient and pharmaceutically acceptable carrier. Composition is applied for the treatment and/or prevention of conditions related to oxidative stress. At that, said conditions are selected from following group: old age and related thereto neurodegenera-

tive conditions, cardiovascular diseases, eclampsia, preeclampsia, and erectile dysfunction.

Claims: 2 independent

6 dependent

---

(10) AP 2015 13205 A (51) Int. Cl. (2006)

A 61 K 36/00

A 61 K 31/00

(21) AP 2013 013205 (22) 2013 08 23

(71) JSC "PHARMA START" (UA)

8, Ivana Lapse bulv., Kyiv 03680 (UA)

(72) LUKIC, Dragan (RS)

(74) Davit Dzamukashvili

(54) **SOLID DRUG OF SEDATIVE, SPASMOLYTIC AND HYPNOTIC ACTION**

(57) A tablet contains Passiflora incarnate extract, complexes of essences and vegetable oils ethers with cyclodextrin and adjuvants.

Claims: 1 independent

4 dependent

---

### PART B

#### B 60

(10) AP 2015 13406 A (51) Int. Cl. (2006)

B 60 P 3/40

B 60 P 3/41

(21) AP 2014 013406 (22) 2014 03 05

(71) Zaur Chitidze (GE)

Tarkhnishvilis q. 16, 0179, Tbilisi (GE);

Zaur Balamtsarashvili (GE)

Sulkhan Tsintsadzis q. 7, 0160, Tbilisi (GE);

Davit Mosulishvili (GE)

Megobrobis Gamz., korp. 41, b. 64, 3700,

Rustavi (GE);

Natia Chelidze-Tkeshelashvili (GE)

Sop. Pirveli Tola, 0418, Ambrolauris

raioni (GE);

Ramaz Tkemaladze (GE)

Sop. Etseri, 5510, Chiaturis R-ni (GE);

Vakhtang Abaishvili (GE)

Shartavas q. 6, b. 53, 0160, Tbilisi (GE);

Maia Gogotishvili (GE)  
Galisi q. 23, 0179, Tbilisi (GE)

- (72) Zaur Chitidze (GE);  
Zaur Balamtsarashvili (GE);  
Davit Mosulishvili (GE);  
Natia Chelidze-Tkeshelashvili (GE);  
Ramaz Tkemaladze (GE);  
Vakhtang Abaishvili (GE);  
Maia Gogotishvili (GE)

(54) **AUTOMATED SKIDDING  
SELF-LOADING AGGREGATE**

(57) An aggregate includes a body 3 hinged onto crawler tractor 1 chassis 2, a boom hingedly installed on the body, hinge-lever mechanisms thereof and the booms. The boom is executed as U-shape 10 and  $\Pi$ -shape 16 and 17 frames connected to each other.

Claims: 1 independent

Fig.: 4

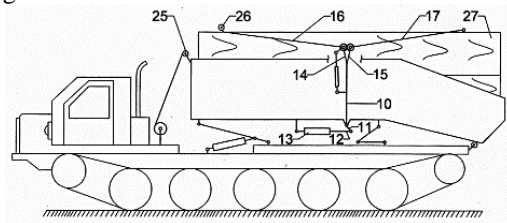

Fig. 3



## PATENTED INVENTIONS

### PART A

#### A 61

**(11) P 2015 6343 B**      **(51) Int. Cl. (2006)**  
**A 61 K 9/00**  
**A 61 K 31/44**  
**A 61 P 11/06**

(10) AP 2015 12988 A      (44) 8(420)/2015  
 (21) AP 2011 012988  
 (22) 2011 07 27  
 (24) 2011 07 27  
 (31) 10171748.6  
 (32) 2010 08 03  
 (33) EP  
 (86) PCT/EP2011/062872, 2011 07 27  
 (73) CHIESI FARMACEUTICI S.p.A. (IT)  
 Via Palermo, 26/A I-43100 Parma (IT)  
 (72) COCCONI, Daniela (IT);  
 SCHIARETTI, Francesca (IT);  
 BILZI, Roberto (IT)  
 (74) Tamaz Shilakadze  
 (54) **DRY POWDER FORMULATION**  
**COMPRISING A PHOSPHODIESTE-**  
**RASE INHIBITOR**

**(11) P 2015 6342 B**      **(51) Int. Cl. (2006)**  
**A 61 K 9/50**  
**A 61 K 31/495**

(10) AP 2015 12984 A      (44) 8(420)/2015  
 (21) AP 2013 012984  
 (22) 2013 01 29  
 (24) 2013 01 29  
 (31) 12.00322  
 (32) 2012 02 03  
 (33) FR  
 (73) LES LABORATOIRES SERVIER (FR)  
 35, rue de Verdun, 92284 Suresnes  
 Cedex (FR)  
 (72) GENTY, Patric (FR);  
 HERMELIN, Christophe (FR);  
 PEAN, Jean-Manuel (FR)  
 (74) Tamaz Shilakadze  
 (54) **PHARMACEUTICAL COMPOSI-**  
**TION FOR TRIMETAZIDINE RELEASE**  
**PROLONGATION**

**(11) P 2015 6341 B**      **(51) Int. Cl. (2006)**  
**A 61 K 39/00**  
**C 07 K 16/44**

(10) AP 2015 12836 A      (44) 8(420)/2015  
 (21) AP 2011 012836

(22) 2011 01 20  
 (24) 2011 01 20  
 (31) 10151239.0; 61/383,914  
 (32) 2010 01 20; 2010 09 17  
 (33) EP; US  
 (86) PCT/EP2011/050749, 2011 01 20  
 (73) BOEHRINGER INGELHEIM  
 INTERNATIONAL GMBH (DE)  
 Binger Str. 173, 55216 Ingelheim  
 am Rhein (DE)  
 (72) VAN RYN, Joanne (CA);  
 PARK, John Edward (DE);  
 HAUDEL, Norbert (DE);  
 KUNZ, Ulrich (DE);  
 LITZENBURGER, Tobias (DE);  
 CANADA, Keith (US);  
 SINGH, Sanjaya (US);  
 WATERMAN, Alisa (US)  
 (74) Tamar Kochlamazashvili  
 (54) **ANTICOAGULANT ANTIDOTES**

### PART B

#### B 01

**(11) P 2015 6340 B**      **(51) Int. Cl. (2006)**  
**B 01 D 24/10**  
**B 01 D 53/02**

(10) AP 2015 12776 A      (44) 8(420)/2015  
 (21) AP 2010 012776  
 (22) 2010 12 03  
 (24) 2010 12 03  
 (31) 61/266,423  
 (32) 2009 12 03  
 (33) US  
 (86) PCT/US2010/058948, 2010 12 03  
 (73) RED LEAF RESOURCES, INC. (US)  
 200 West Civic Center Drive, Suite 190,  
 Sandy, UT 84070 (US)  
 (72) PATTEN, James, W. (US)  
 (74) Shalva Gvaramadze  
 (54) **METHODS AND SYSTEMS FOR**  
**REMOVING FINES FROM HYDRO-**  
**CARBON-CONTAINING FLUIDS**

#### B 03

**(11) P 2015 6338 B**      **(51) Int. Cl. (2006)**  
**B 03 B 13/00**

(10) AP 2015 12697 A      (44) 4(416)/2015  
 (21) AP 2012 012697

- (22) 2012 05 04  
 (24) 2012 05 04  
 (73) Mikheil Gamtsemlidze (GE);  
 Panaskertelis q. 15a, b. 43, 0194, Tbilisi (GE);  
 Roin Enageli (GE)  
 Chonkadzis q. 14, 0165, Rustavi (GE);  
 Asmat Shekiladze (GE)  
 Temka Xb kvart., korp. 2, b. 12, 0178,  
 Tbilisi (GE)  
 (72) Mikheil Gamtsemlidze (GE);  
 Roin Enageli (GE);  
 Asmat Shekiladze (GE)  
 (54) **METHOD FOR FLOTATION PROCESS  
 CONTROL**

## PART C

### C 07

- (11) P 2015 6339 B (51) Int. Cl. (2006)  
 C 07 C 231/12  
 C 07 C 233/18  
 A 61 K 31/165  
 A 61 P 25/16  
 A 61 P 25/18  
 A 61 P 25/28  
 A 61 P 3/00  
 (10) AP 2015 12736 A (44) 8(420)/2015  
 (21) AP 2012 012736  
 (22) 2012 06 05  
 (24) 2012 06 05  
 (31) 11.01766; 201110245039.6  
 (32) 2011 06 09; 2011 08 25  
 (33) FR; CN  
 (73) LES LABORATOIRES SERVIER (FR)  
 35, rue de Verdun, 92284 Suresnes  
 Cedex (FR)  
 (72) LETELLIER, Philippe (FR);  
 LYNCH, Michael (GB);  
 PEAN, Jean-Manuel (FR)  
 (74) Tamaz Shilakadze  
 (54) **NEW CO-CRYSTALS OF AGOMELATINE,  
 PROCESS FOR THEIR PREPARATION  
 AND PHARMACEUTICAL COMPOSITI-  
 ONS CONTAINING THEM**
- (11) P 2015 6347 B (51) Int. Cl. (2006)  
 C 07 D 319/20  
 C 07 D 405/10  
 C 07 D 487/10  
 C 07 D 405/12  
 C 07 D 405/14  
 A 61 K 31/357  
 A 61 P 29/00  
 A 61 P 19/00  
 (10) AP 2015 13259 A (44) 8(420)/2015

- (21) AP 2012 013259  
 (22) 2012 03 13  
 (24) 2012 03 13  
 (31) 61/452,329  
 (32) 2011 03 14  
 (33) US  
 (86) PCT/US2012/028843, 2012 03 13  
 (73) BOEHRINGER INGELHEIM  
 INTERNATIONAL GMBH (DE)  
 Binger Strasse 173, 55216 Ingelheim am  
 Rhein (DE)  
 (72) ABEYWARDANE, Asitha (LK);  
 BURKE, Michael J. (CA);  
 KIRRANE, Thomas Martin, Jr. (US);  
 NETHERTON, Matthew Russell (CA);  
 PADYANA, Anil Kumar (IN);  
 SMITH KEENAN, Lana Louise (CA);  
 TAKAHASHI, Hidenori (JP);  
 TURNER, Michael Robert (US);  
 ZHANG, Qiang (CA);  
 ZHANG, Qing (CN)  
 (74) Tamar Kochlamazashvili  
 (54) **BENZODIOXANE INHIBITORS OF  
 LEUKOTRIENE PRODUCTION**

- (11) P 2015 6346 B (51) Int. Cl. (2006)  
 C 07 D 519/00  
 A 61 K 31/519  
 A 61 P 25/00  
 A 61 P 25/18  
 A 61 P 25/24  
 (10) AP 2015 13117 A (44) 8(420)/2015  
 (21) AP 2011 013117  
 (22) 2011 11 18  
 (24) 2011 11 18  
 (31) PA2010 01045; 61/415,356  
 (32) 2010 11 19; 2010 11 19  
 (33) DK; US  
 (86) PCT/DK2011/000136, 2011 11 18  
 (73) H. LUNDBECK A/S (DK)  
 Ottiliavej 9, DK-2500 Valby (DK)  
 (72) KEHLER, Jan (DK);  
 NIELSEN, Jacob (DK);  
 MARIGO, Mauro (IT);  
 KILBURN, John, Paul (GB);  
 LANGGÅRD, Morten (DK)  
 (74) Shalva Gvaramadze  
 (54) **IMIDAZOLE DERIVATIVES  
 AS PDE10A ENZYME INHIBITORS**

## PART F

### F 01

- (11) P 2015 6344 B (51) Int. Cl. (2006)  
F 01 B 17/02  
F 02 G 1/02  
F 24 J 2/42
- (10) AP 2015 13075 A (44) 8(420)/2015  
(21) AP 2011 013075  
(22) 2011 10 03  
(24) 2011 10 03  
(31) 1058005  
(32) 2010 10 04  
(33) FR  
(86) PCT/EP2011/067211, 2011 10 03  
(73) MOTOR DEVELOPMENT  
INTERNATIONAL S.A. (LU)  
17 rue des Bains L-1212 Luxembourg (LU)  
(72) NEGRE, Guy (FR);  
NEGRE, Cyril (FR)  
(74) Shalva Gvaramadze  
(54) **METHOD OF WORKING OF  
MONO-ENERGY AND/OR DUAL-  
ENERGY ENGINE WITH COMPRESSED  
AIR AND/OR ADDITIONAL ENERGY,  
COMPRISES AN ACTIVE CHAMBER  
INCLUDED IN THE CYLINDER**
- 

### F 02

- (11) P 2015 6345 B (51) Int. Cl. (2006)  
F 02 B 21/00  
F 02 M 31/04  
F 02 M 31/16  
F 01 B 17/02  
F 01 D 13/02
- (10) AP 2015 13076 A (44) 8(420)/2015  
(21) AP 2011 013076  
(22) 2011 10 03  
(24) 2011 10 03  
(31) 1058037  
(32) 2010 10 05  
(33) FR  
(86) PCT/EP2011/067212, 2011 10 03  
(73) MOTOR DEVELOPMENT  
INTERNATIONAL S.A. (LU)  
17 rue des Bains L-1212 Luxembourg (LU)  
(72) NEGRE, Guy (FR);  
NEGRE, Cyril (FR)  
(74) Shalva Gvaramadze  
(54) **METHOD OF WORKING OF SELF-  
PRESSURE-REGULATING  
COMPRESSED AIR ENGINE  
COMPRISES AN INTEGRATED  
ACTIVE CHAMBER**
-

---

# UTILITY MODELS

## APPLICATIONS APPROVED FOR GRANTING PATENT

The decision can be appealed at the Chamber of Appeal of Sakpatenti within 3 months from the publication or at the Mtskheta District Court Administrative Cases Board (Address: №17, Samkhedro str., Mtskheta), within 1 month following the publication.

### PART G

#### G 01

(10) AU 2015 13762 U (51) Int. Cl. (2006)  
G 01 N 27/22

(21) AU 2015 013762 (22) 2015 03 12

(71) Zurab Dzhokharidze (GE)  
Vazha-Pshavelas III kvart., korp. 24, b. 21,  
0186, Tbilisi (GE);  
Naira Dzhokharidze (GE)  
Shevardenidzis q. 11, b. 16, 0160,  
Tbilisi (GE);  
Sophia Kolomikova (GE)  
Khornabujis q. 19, 0110, Tbilisi (GE)

(72) Zurab Dzhokharidze (GE);  
Naira Dzhokharidze (GE);  
Sophia Kolomikova (GE)

(54) **THERMOHYGROMETER**

(57) There is represented a thermohygrometer comprising humidity measuring unit, temperature measuring unit, stabilizing and reinforcing unit, microprocessor unit and indicator unit functionally connected to each other.

Claims: 1 independent

Fig.: 2

---

#### G 06

(10) AU 2015 13741 U (51) Int. Cl. (2006)  
G 06 Q 90/00  
H 04 M 3/42

(21) AU 2015 013741 (22) 2015 02 23

(71) Zurab Katsitadze (GE)  
Tornike Eristavis q. 34, 5500,  
Chiatura (GE);  
Davit Kakulia (GE)  
Tornike Eristavis q. 34, 5500,  
Chiatura (GE)

(72) Zurab Katsitadze (GE);  
Davit Kakulia (GE)

(54) **METHOD FOR TELEPHONE  
ADVERTISING SUPPORT**

(57) A method provides following operations: receiving connection service by provider; ordering one or more audio advertising, at least from one advertising customer through telecommunication

circuit; making choice with circuit service at least of one received audio advertising by provider for each subscriber; its installation as tonal signal in this system for this, that subscriber at trying to connect with another one could hear chosen audio advertising as tonal signal; payments calculation for advertising assignment; crediting telephone account of subscriber.

Claims: 1 independent

3 dependent

Fig.: 2

---

## PATENTED UTILITY MODEL

### PART E

#### E 04

(11) U 2015 1863 Y (51) Int. Cl. (2006)

E 04 G 9/00

(10) AU 2015 13452 U (44) 8(420)/2015

(21) AU 2014 013452

(22) 2014 04 29

(24) 2014 04 29

(73) LTD "SBC" (GE)

Tetrikhevis Das., Samgoris II Shes., 0109,  
Tbilisi (GE)

(72) Erik Ovakimov (GE);

Zaur Tughushi (GE)

(74) Tamaz Shilakadze

(54) **FORM PANEL**

---

---

# DESIGNS

## APPLICATION APPROVED FOR REGISTRATION

The decision can be appealed at the Chamber of Appeal of Sakpatenti within 3 months from the publication or at the Mtskheta District Court Administrative Cases Board (Address: №17, Samkhedro str., Mtskheta), within 1 month following the publication.

(10) AD 2015 849 S      (51) 05-06  
(21) AD 2015 000849    (22) 2015 04 24

(28) 2

(71) LTD "DAFNA" (GE)

Lilos das., Plot 05/004, 0198, Tbilisi (GE)

(72) Zainal Abidin Alkaish (GE)

(74) Vakhtang Torotadze

(54) ARTIFICIAL OR NATURAL LEAF MATERIAL FOR TOILET PAPER OR NAPKIN

(55)

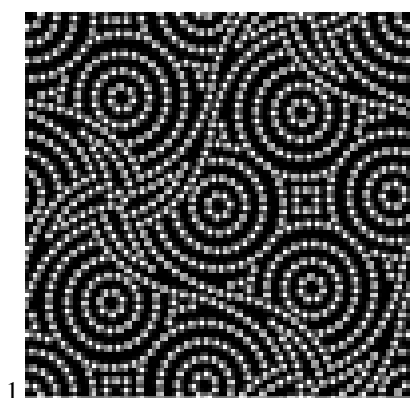

---

# DESIGNS

## REGISTERED DESIGN

- (11) **D 2015 635 S**                      (51) **32-00**  
(10) AD 2015 843 S                      (44) 8(420)/2015  
(21) AD 2015 000843  
(22) 2015 03 02  
(24) 2015 03 02  
(28) 1  
(18) 2020 03 02  
(73) Eldar Mamaladze (GE)  
    Aghmasheneblis q. 101, 3300, Mtskheta (GE)  
(72) Eldar Mamaladze (GE)  
(54) **RAISED FINISH FOR POTTERY**  
    **WORKS**
-

## DESIGNS REGISTERED ACCORDING TO THE ACCELERATED PROCEDURE

The decision can be appealed at the Chamber of Appeal of Sakpatenti within 3 months from the publication.

- (11) **D 2015 633 S** (51) **19-08**  
(21) AD 2015 000858 (22) 2015 06 25  
(24) 2015 06 25  
(28) 1  
(18) 2020 06 25  
(73) JSC "LOGOTEK" (RU)  
9, Perovskoe Shosse, 1<sup>st</sup> bldg., 3<sup>rd</sup> floor, room 7.10.18 (RU)  
(72) Nikolay Valerievich Shutov (RU)  
(74) Aleksandre Gegechkori  
(54) **LABEL**  
(55)





- (11) **D 2015 634 S**      (51) **32-00**
- (21) AD 2015 000860    (22) 2015 07 06
- (24) 2015 07 06
- (28) 2
- (18) 2020 07 06
- (73) HARRINGTON DEVELOPMENT INC. (PA)  
Elvira Mendez St., Vallarino bldg., 3<sup>rd</sup> floor, Panama (PA)
- (72) Ketevan Chkheidze (GE)
- (74) Givi Akopashvili
- (54) **GRAPHICAL SYMBOL**
- (55)

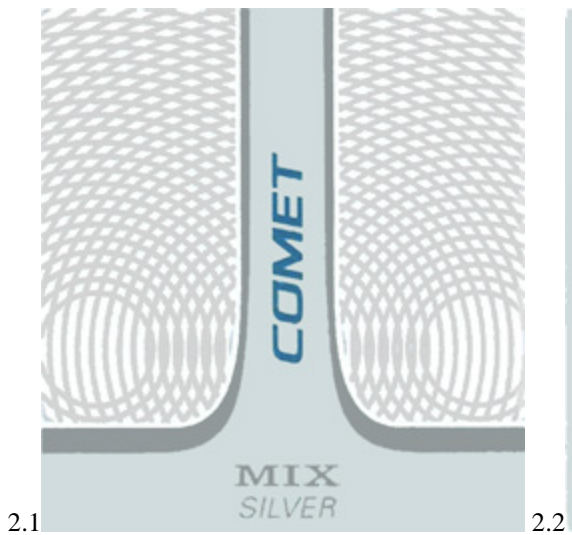
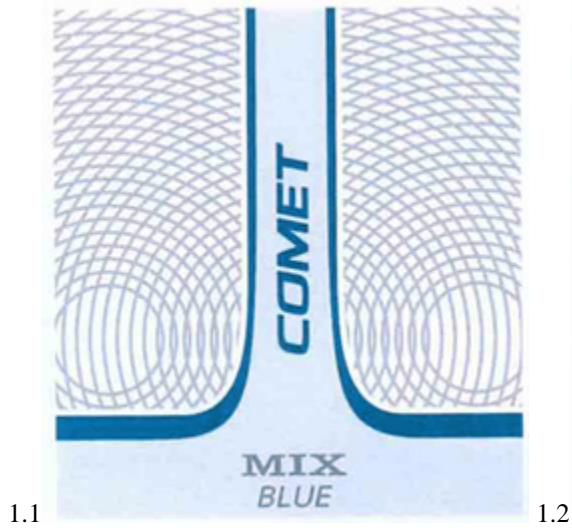

**DESIGNS, WHICH HAVE BEEN REGISTERED WITH THE INTERNATIONAL  
BUREAU CLAIMING PRIORITY ON THE TERRITORY OF GEORGIA**

The decision can be appealed at the Chamber of Appeal of Sakpatenti within 3 months from the publication or at the Mtskheta District Court Administrative Cases Board (Address: №17, Samkhedro Str., Mtskheta), within 1 month following the publication.

**(11) DM/083478****(51) 21-02**

(15) 2014 04 30

(45) 2015/17 (2015 05 01)

(22) 2014 04 30

(28) 8

(73) MAGIC PRODUCTION GROUP S.A.

Findel Business Center, Complexe B, Rue de Trèves, L-2632 (LU)

(85) --

(86) BX, EM

(87) BX, EM

(88) BX, EM

(89) EM

(81) II. BZ, KP, MA, SR. III. AL, AM, AZ, BA, BN, BW, CH, EG, EM, GE, GH, KG, LI, MD, ME, MK, MN, NA, OA, OM, RS, RW, ST, SY, TJ, TN, TR

(72) 1-8: ZILIANI

Valentina, Via Bogino, 18, I-10123 Torino, Italy;

1-8: MAFFIOTTI

Enrico, Via Palazzotto, 8, I-10025 Pino Torinese (TO), Italy

(54) 1.-8. Toy balls

(55)

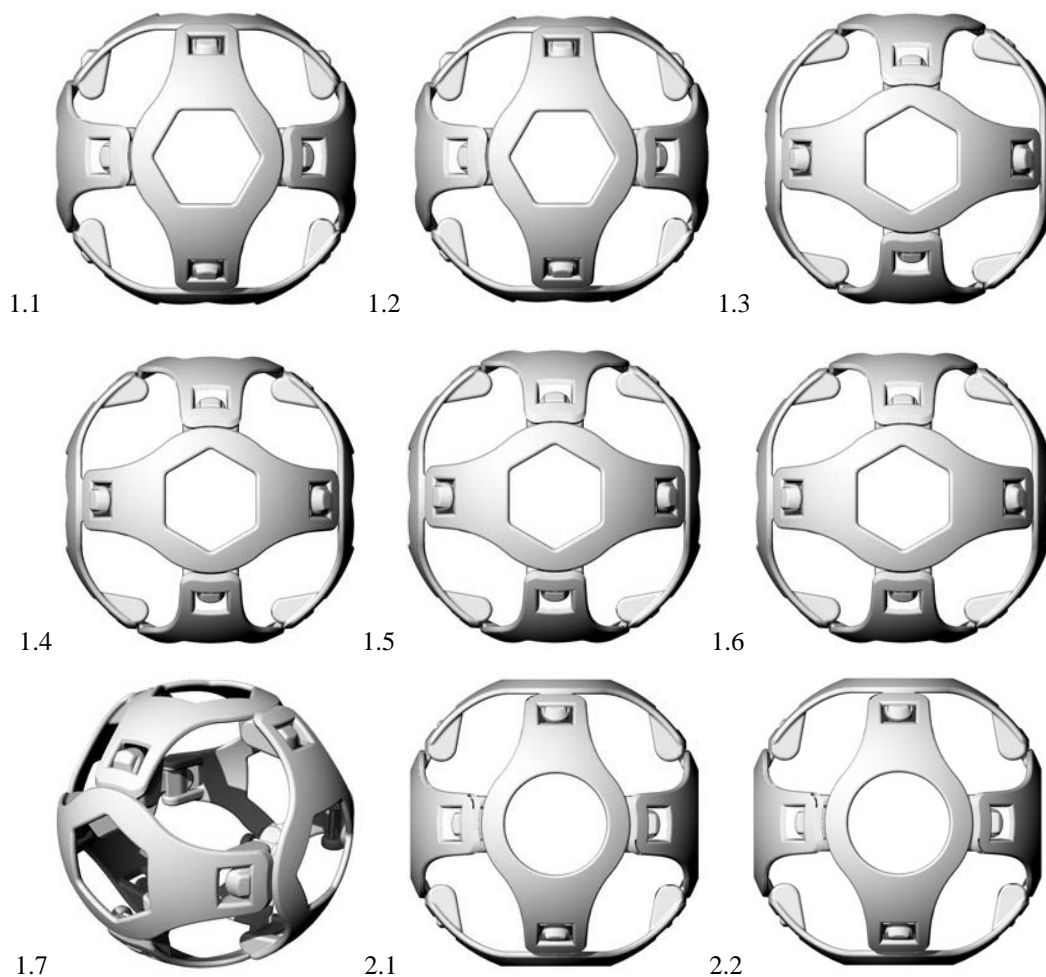

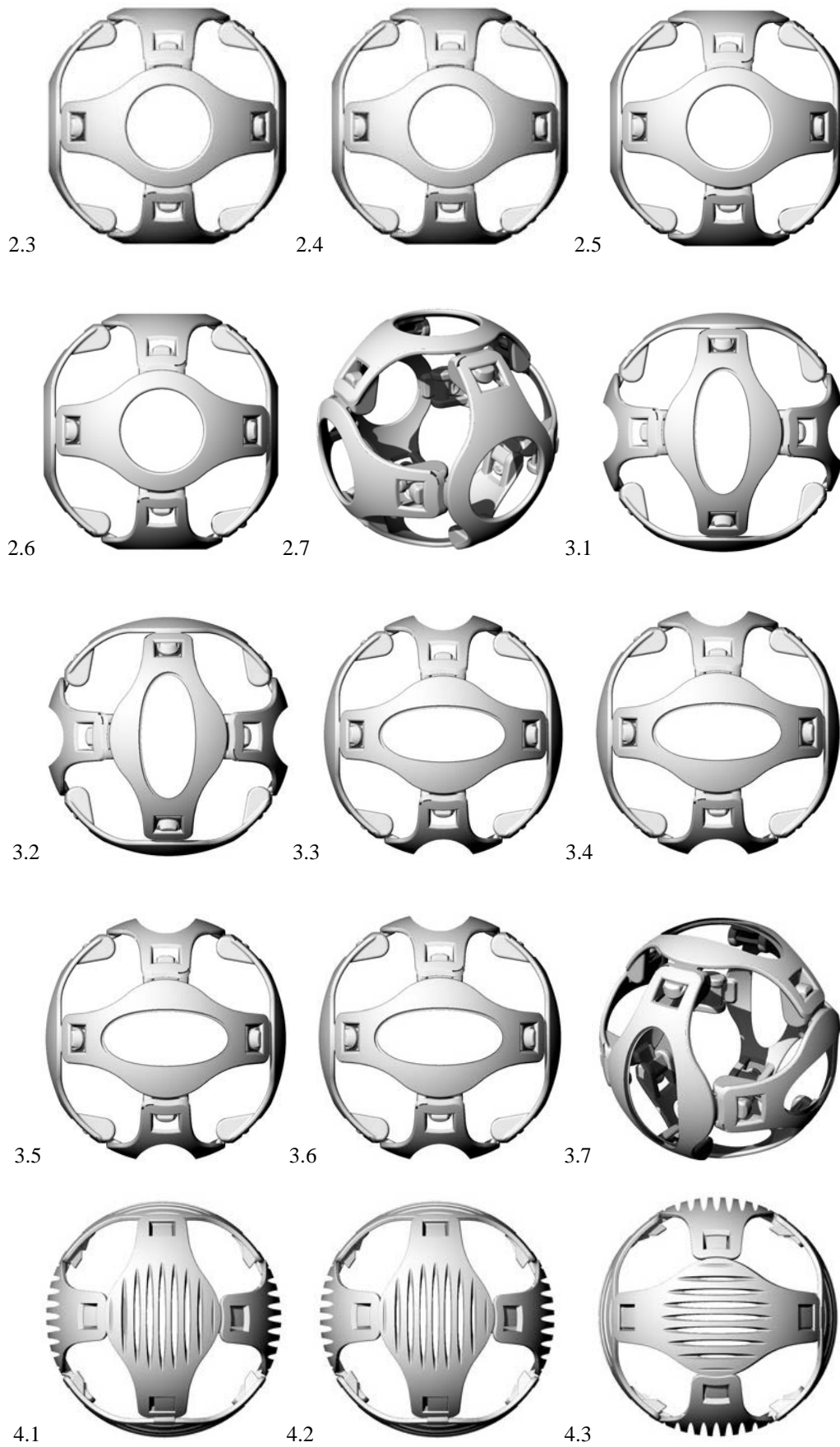



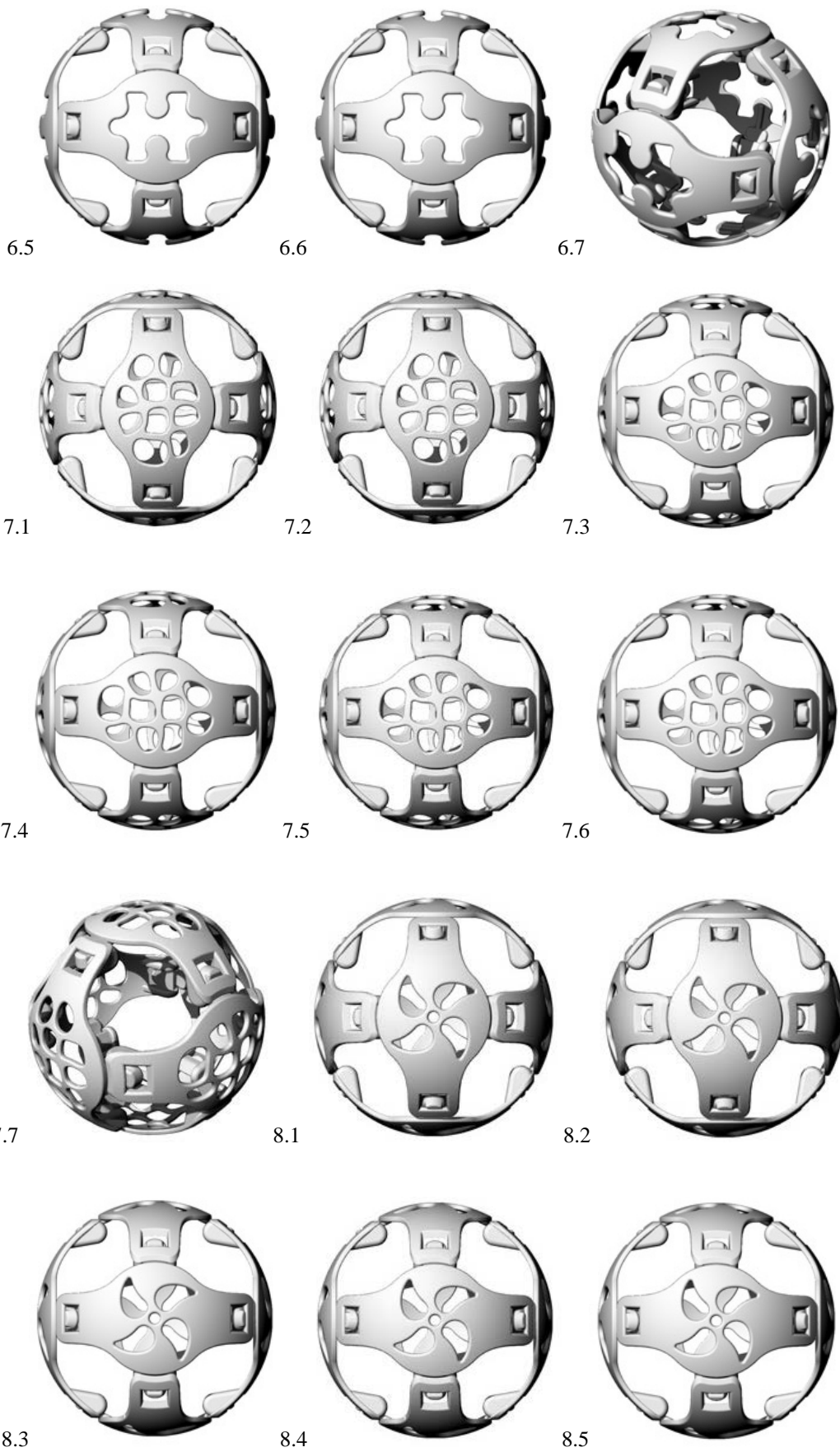

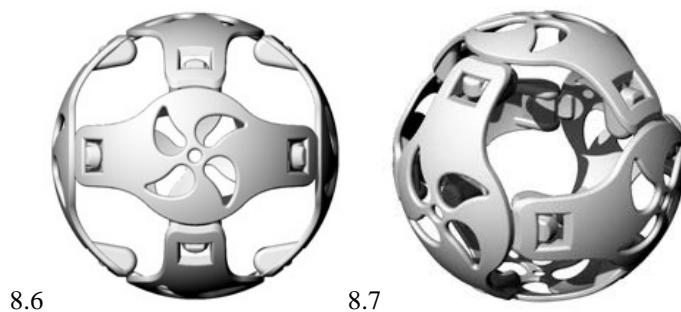

8.6

8.7

**(11) DM/084790**

(15) 2014 10 28

(22) 2014 10 28

(28) 1

(73) HARRY WINSTON SA

Chemin du Tourbillon 8, CH-1228 Plan-les-Ouates (CH)

(85) CH

(86) CH

(87) CH

(88) CH

(89) CH

(81) II. BZ, MA. III. AL, AM, AZ, BA, CH, EM, GE, KG, KR, LI, MC, MD, ME, MK, MN, NO, OM, SG, TN, TR, UA

(72) 1: Maurice GALLI

25-10 31st Avenue, Apt. N 2J, 11106 Long Island City (NY), États-Unis d'Amérique

(54) 1. Charm

(55)



1.1

1.2

1.3

1.4

1.5

1.6

1.7

1.8



(11) DM/084791

(51) 10-07

(15) 2014 10 28

(45) 2015/17 (2015 05 01)

(22) 2014 10 28

(28) 3

(73) TISSOT SA (TISSOT AG) (TISSOT LTD)

Chemin des Tourelles 17, CH-2400 Le Locle (CH)

(85) CH

(86) CH

(87) CH

(88) CH

(89) CH

(81) II. BZ, MA. III. AL, AM, AZ, BA, CH, EM, GE, KG, KR, LI, MC, MD, ME, MK, MN, NO, OM, SG, TN, TR, UA

(72) 1-3: Jérémie SENNGEN

Avenue de Montchoisi 25, 1006 Lausanne, Suisse

(54) 1.Watch case; 2.Watch strap; 3.Watch case with strap

(55)

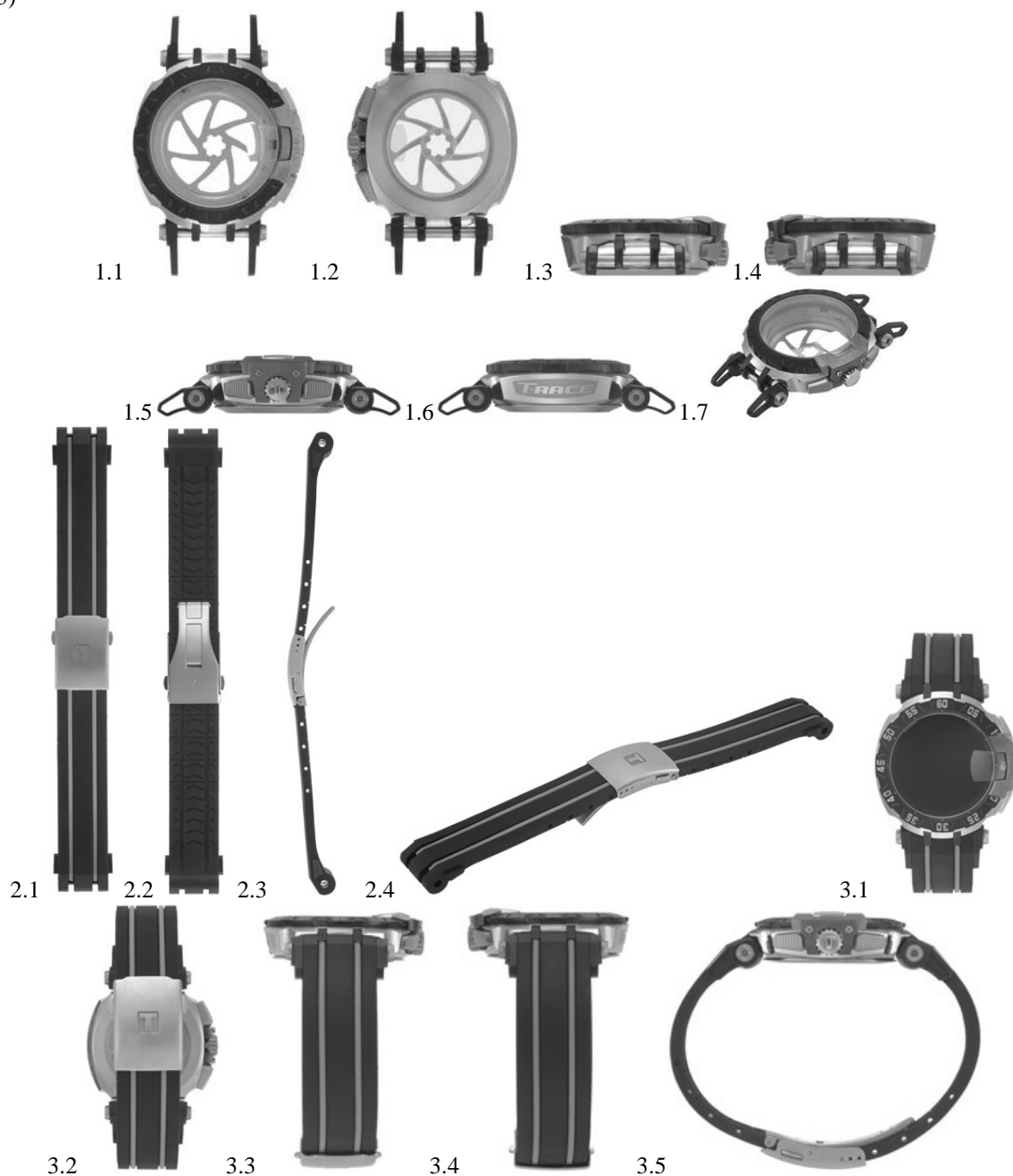

**(11) DM/084840**

(15) 2014 10 28

(22) 2014 10 28

(28) 2

(73) SWATCH AG (SWATCH SA) (SWATCH LTD.)

Jakob-Stämpfli-Strasse 94, CH-2502 Biel/Bienne (CH)

(85) CH

(86) CH

(87) CH

(88) CH

(89) CH

(81) II. BZ, MA. III. AL, AM, AZ, BA, CH, EM, GE, KG, KR, LI, MC, MD, ME, MK, MN, NO, OM, SG, TN, TR, UA

(72) 1-2: Antonio FAZIO

"Ato" Avenue de Cour 40, 1007 Lausanne, Suisse

(54) 1. Wristwatch; 2. Clock hands (set)

(55)





(11) DM/084847

(51) 08-07

(15) 2014 11 05

(45) 2015/18 (2015 05 08)

(22) 2014 11 05

(28) 10

(30) 17.07.2014; DM/084025; WO

(73) IBLUE AG

Metallstraße 8, CH-6300 Zug (CH)

(85) --

(86) --

(87) CH

(88) --

(89) CH

(81) III. EG, GE, KG, LI, MC, MD, NO, TR, UA

(54) 1.-10. Locks

(55)



**(11) DM/084832**

(15) 2014 11 10

(22) 2014 11 10

(28) 1

(73) SWATCH AG (SWATCH SA) (SWATCH LTD.)

Jakob-Stämpfli-Strasse 94, CH-2502 Biel/Bienne (CH)

(85) CH

(86) CH

(87) CH

(88) CH

(89) CH

(81) II. BZ, MA, III. AL, AM, AZ, BA, CH, EM, GE, KG, KR, LI, MC, MD, ME, MK, MN, NO, OM, SG, TN, TR, UA

(72) 1: Margherita TAGLIA

Zahiringenstrasse 24, 8001 Zürich, Suisse

(54) 1. Wristwatch

(55)

**(51) 10-02**

(45) 2015/19 (2015 05 15)



1.1.



1.2.



1.3.

(11) DM/084833

(51) 11-01

(15) 2014 11 10

(45) 2015/19 (2015 05 15)

(22) 2014 11 10

(28) 1

(73) HARRY WINSTON SA

Chemin du Tourbillon 8, CH-1228 Plan-les-Ouates (CH)

(85) CH

(86) CH

(87) CH

(88) CH

(89) CH

(81) II. BZ, MA. III. AL, AM, AZ, BA, CH, EM, GE, KG, KR, LI, MC, MD, ME, MK, MN, NO, OM, SG, TN, TR, UA

(72) 1: Rie YATSUGI-KANG

272 Highland St., 07626 Cresskill N.J., États-Unis d'Amérique

(54) 1. Finger ring

(55)



**(11) DM/086307****(51) 25-02, 03**

(15) 2014 08 02

(45) 2015/19 (2015 05 15)

(22) 2014 08 02

(28) 4

(73) PATROIS GUILLAUME

55 avenue Marceau, F-75016 Paris (FR)

(85) FR

(86) FR

(87) FR

(88) FR

(89) FR

(81) II. BX, BZ, GR, KP, MA, SR. III. AL, AM, AZ, BA, BN, BW, CH, EG, EM, GE, GH, IS, KG, LI, LV, MC, MD, ME, MK, MN, NA, NO, OA, OM, RS, RW, SG, ST, SY, TJ, TN, TR, UA

(72) Patrois guillaume

55 ave Marceau, 75016 paris, France

(54) 1.-2. Modular loft structures; 3. multi-purpose block interior furnishing element;

4. modular loft structure placed on a plateau building or villa

(55)

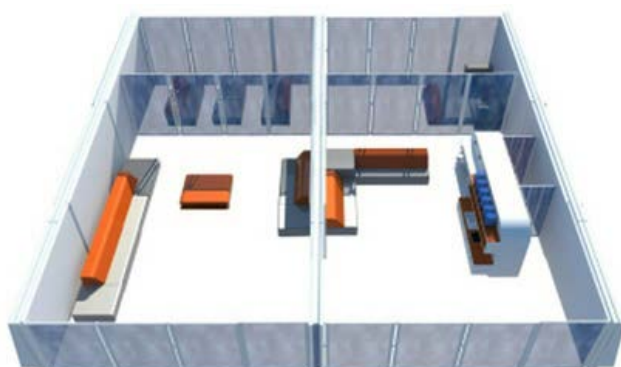

1.1

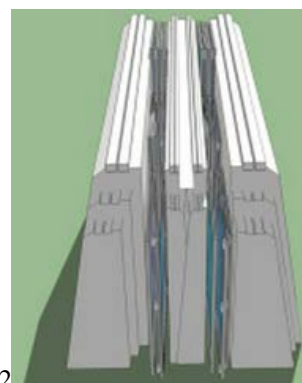

1.2

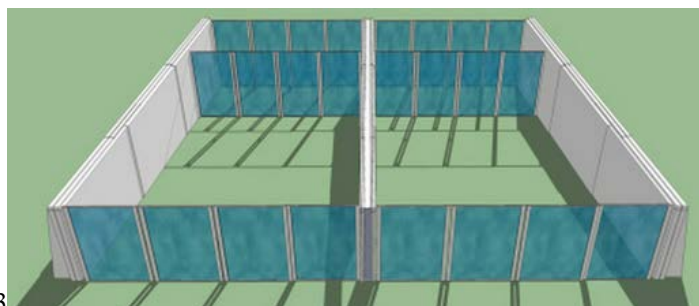

1.3

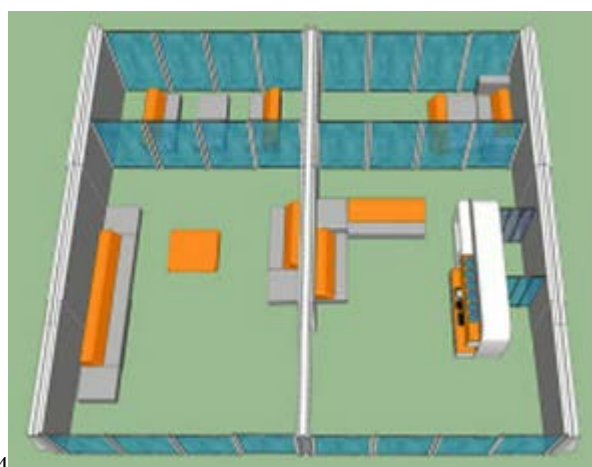

1.4

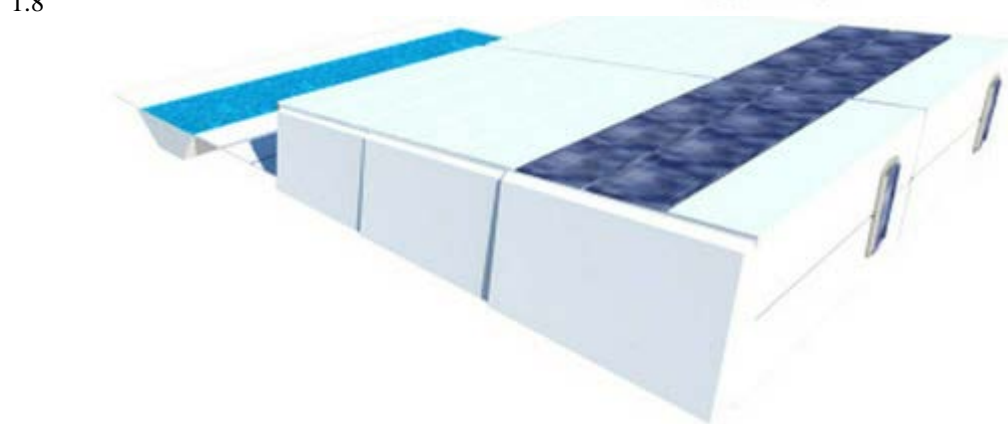
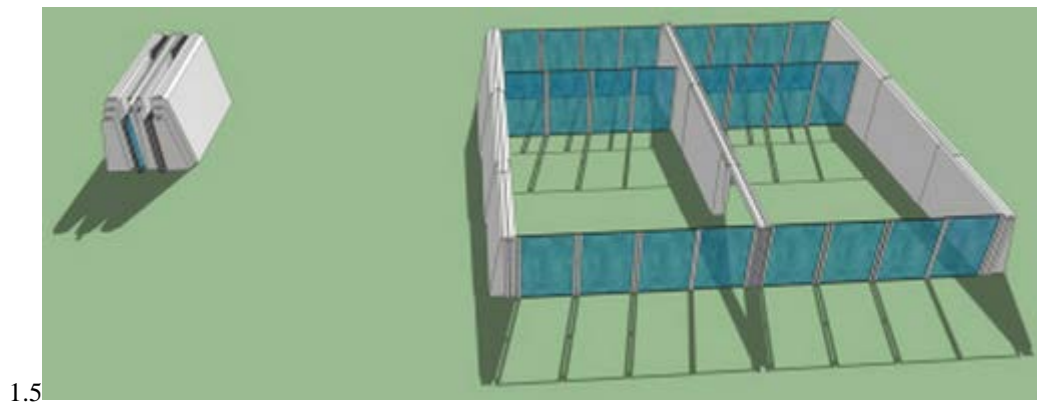

1.10

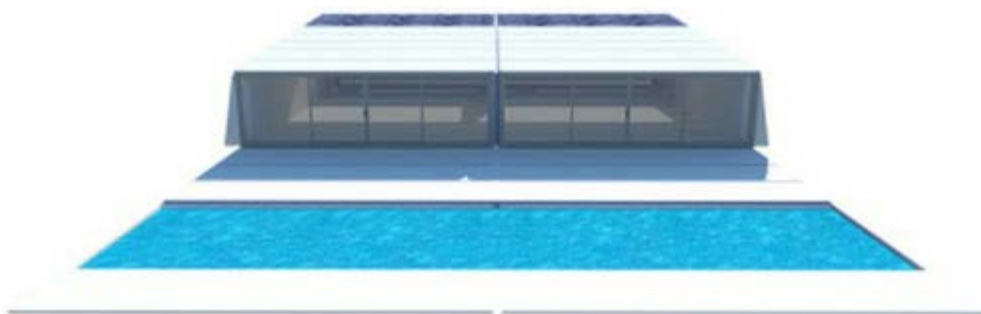

1.11



1.12



1.13

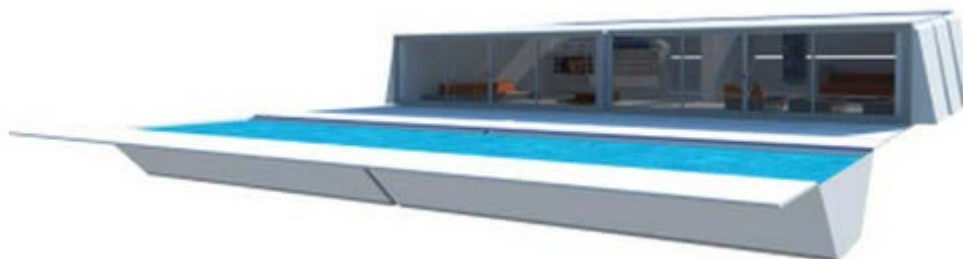

1.14

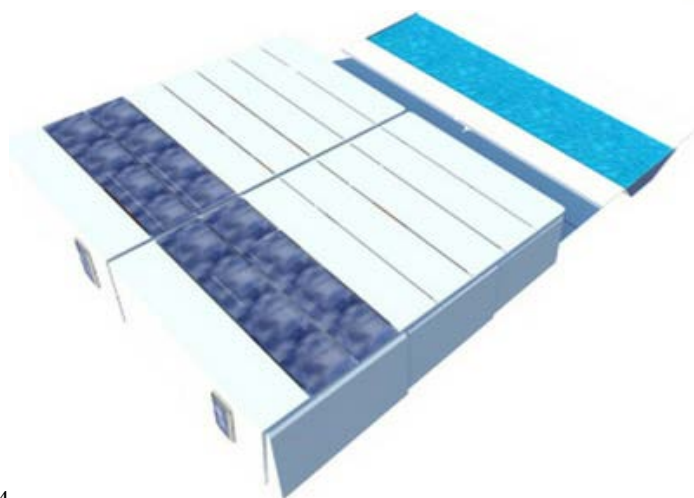



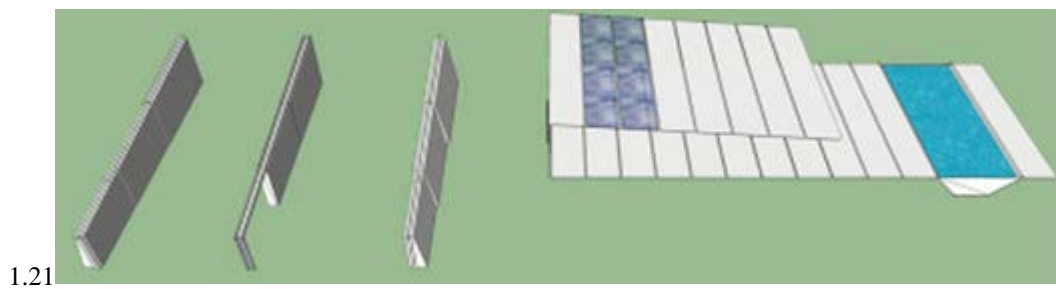
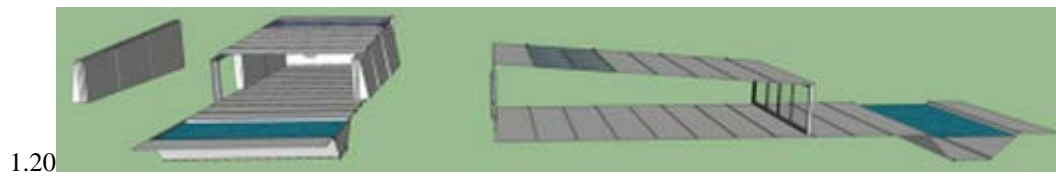
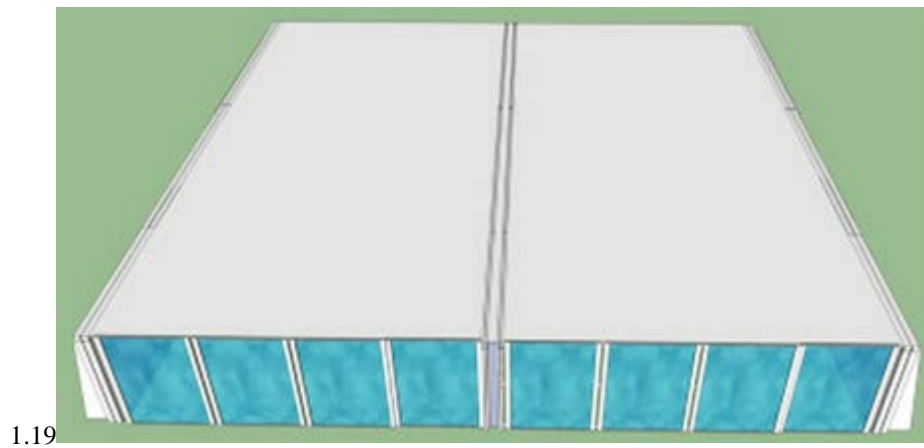
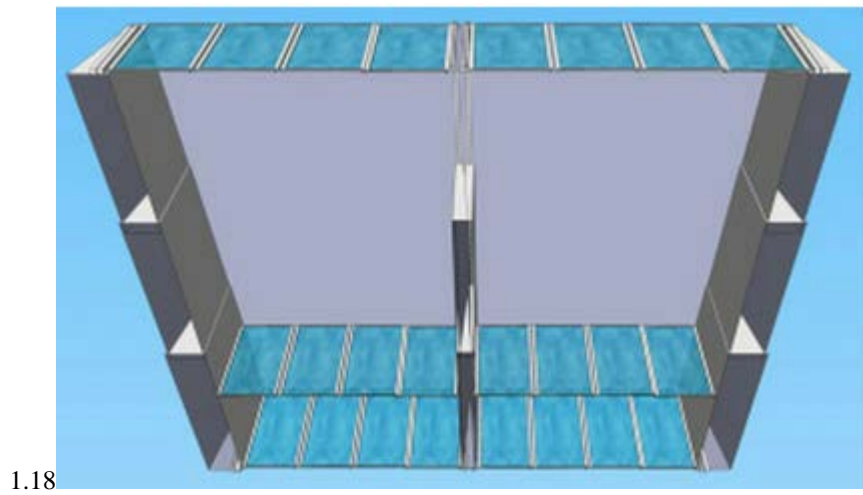
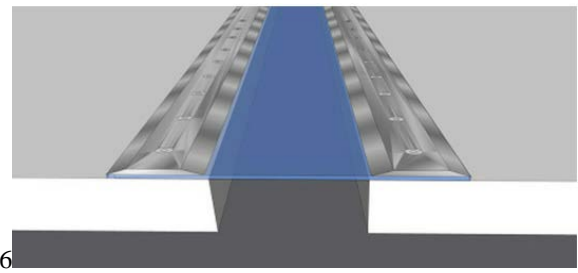
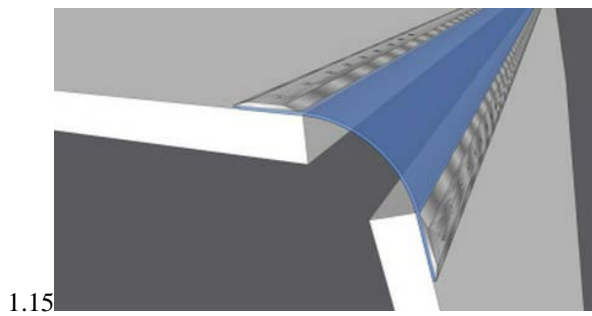



2.1

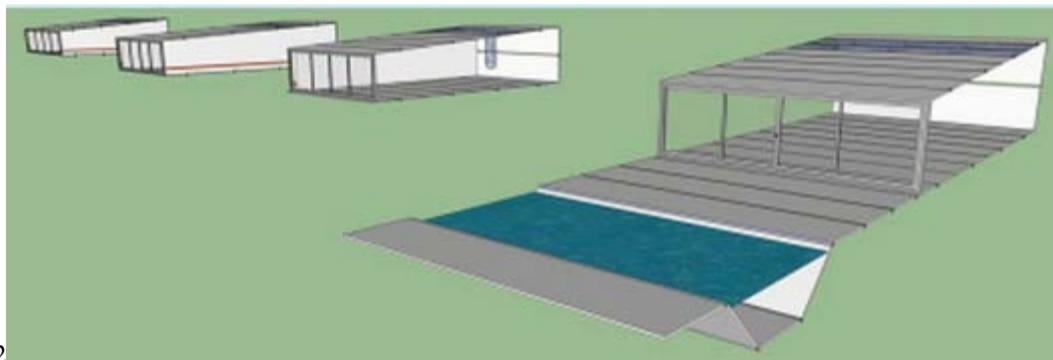

2.2

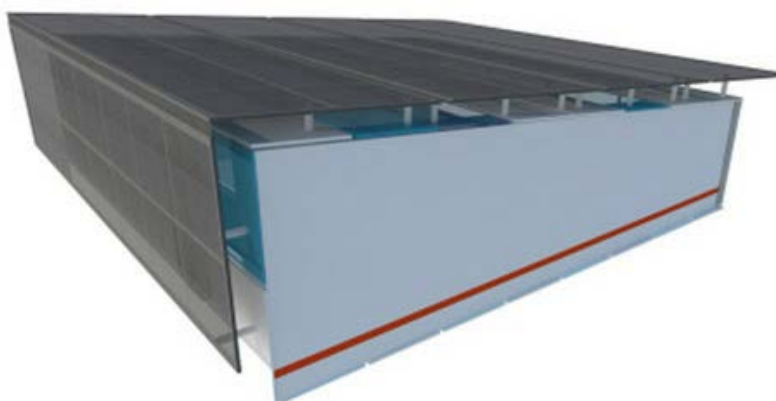

2.3

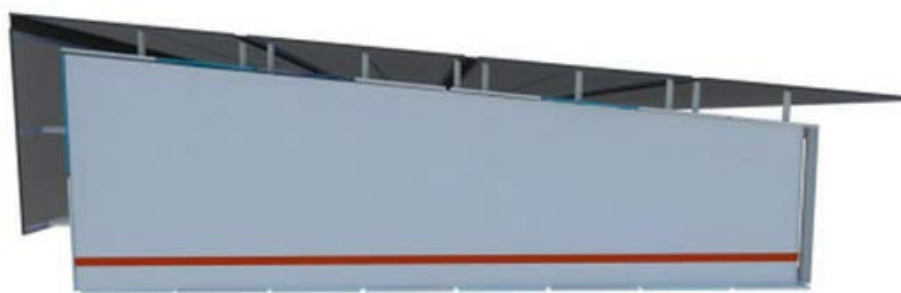

2.4

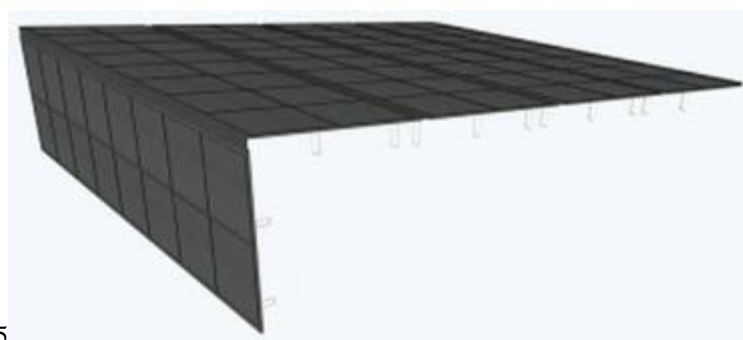

2.5



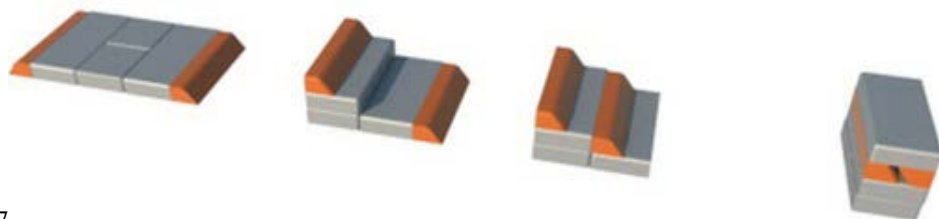
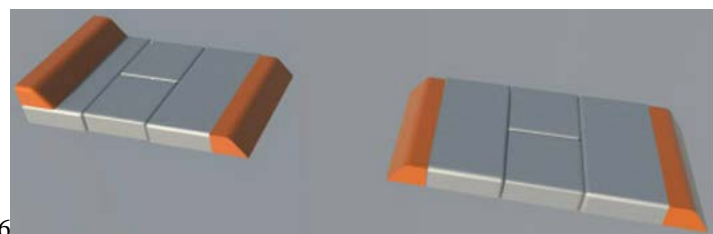
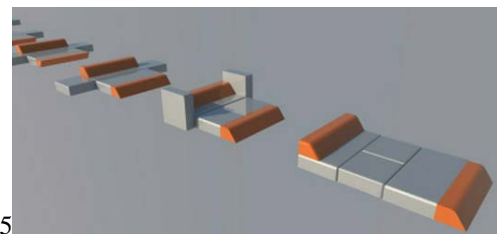
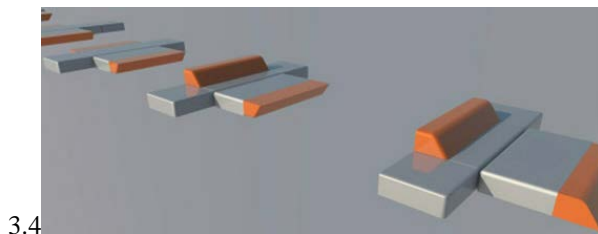
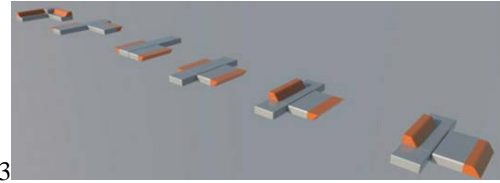
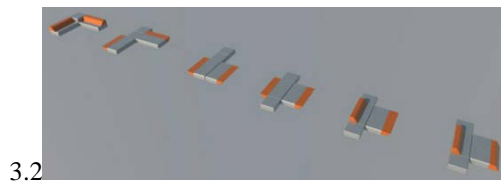
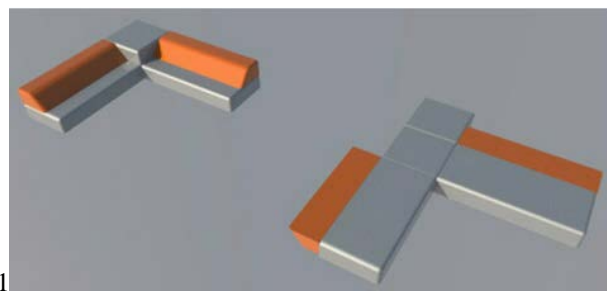
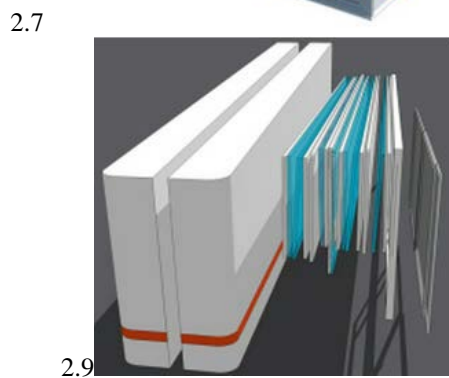

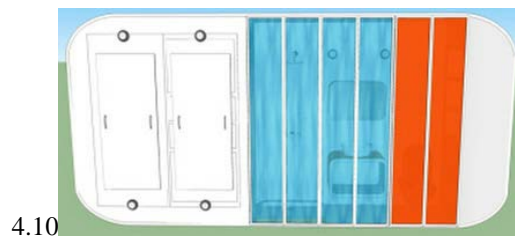
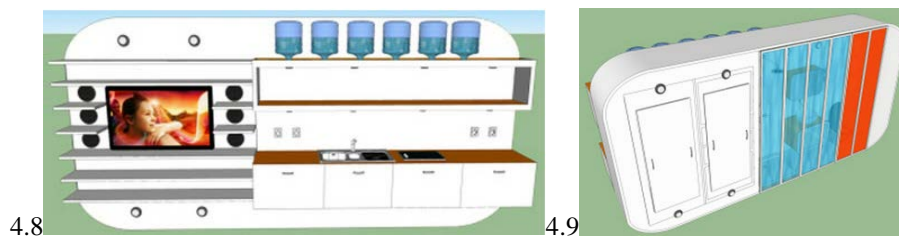
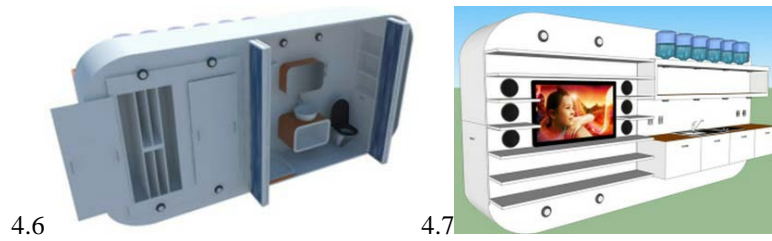
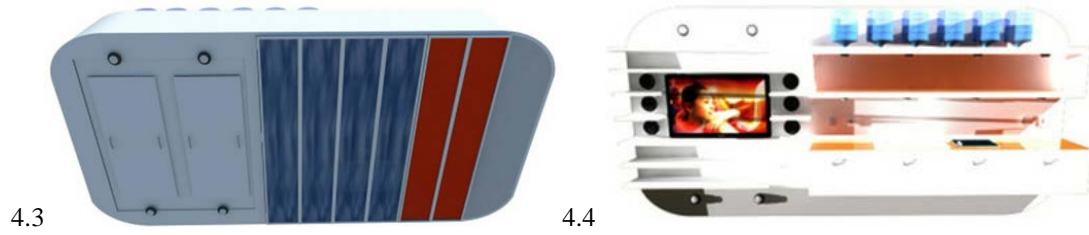
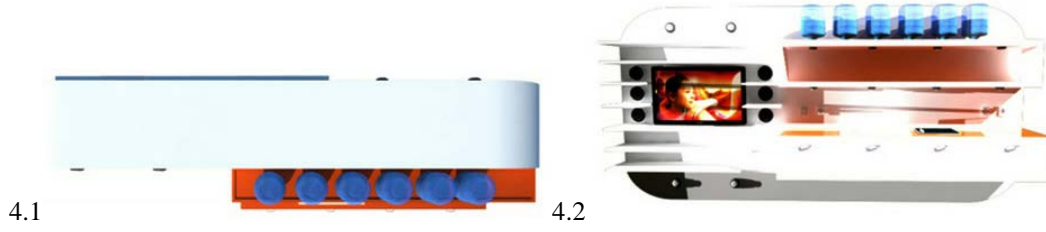
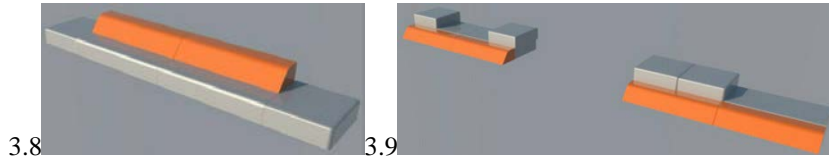

**(11) DM/086312**

(15) 2014 10 27

(22) 2014 10 27

(28) 12

(30) for designs No(s) 1: 03.07.2014; S201401272; UA; for designs No(s) 3: 10.07.2014; s201401326; UA; for designs No(s) 4: 10.07.2014; s201401327; UA; for designs No(s) 2: 28.07.2014; s201401447; UA; for designs No(s) 5: 28.07.2014; s201401448; UA; for designs No(s) 6: 28.07.2014; s201401450; UA; for designs No(s) 8: 20.08.2014; s201401826; UA; for designs No(s) 9: 20.08.2014; s201401828; UA; for designs No(s) 7: 20.08.2014; s201401830; UA; for designs No(s) 10: 24.09.2014; s201402023; UA; for designs No(s) 11: 20.10.2014; S201402171; UA; for designs No(s) 12: 20.10.2014; S201402172; UA

(73) BORYSENKO VITALII MYKOLAIOVYCH

vul. Horianska, bud. 25, Kharkiv 61107 (UA)

(85) UA

(86) UA

(87) UA

(88) UA

(89) UA

(81) II. BX, GA, KP, MA, ML. III. AZ, BA, CH, EM, GE, GH, HR, IS, KR, LI, MC, MD, ME, MK, NO, OA, OM, RS, RW, SG, TR

(72) Borysenko Vitalii

Goryanskaya Str. 25, 61107, Kharkiv, Ukraine

(54) 1. Lock for fixing external devices on a boat;

2. Adapter for fixing devices having splined and ball joint ends;

3. Adopting universal mounting platform; 4. Universal holder for splined and ball joint;

5. Mounting platform for installation on inflatable products;

6. Mounting platform for installation on C-like profile; 7. Mounting platform for a pipe;

8. Mounting platform for a boat electrical equipment; 9. Inclining connecting node for pipes;

10. Targa for additional equipment mounting; 11. Locking unit; 12. Anchor node

(55)

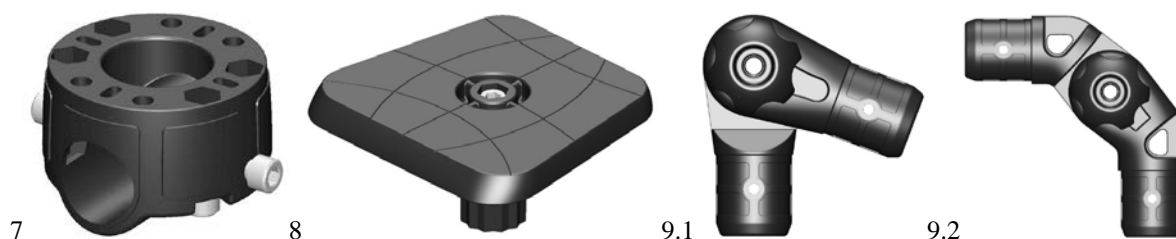
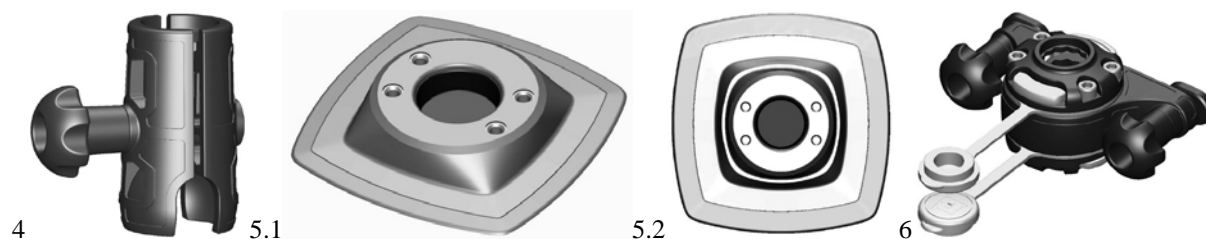
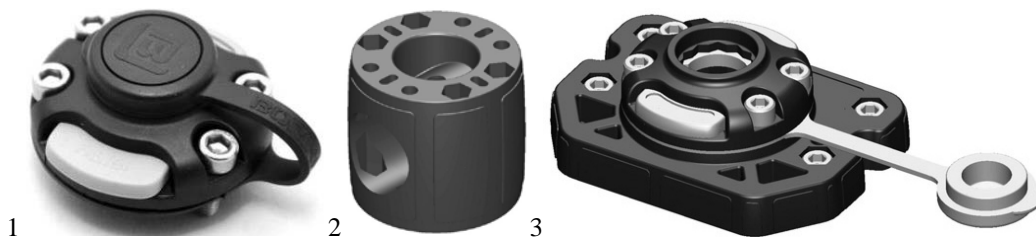

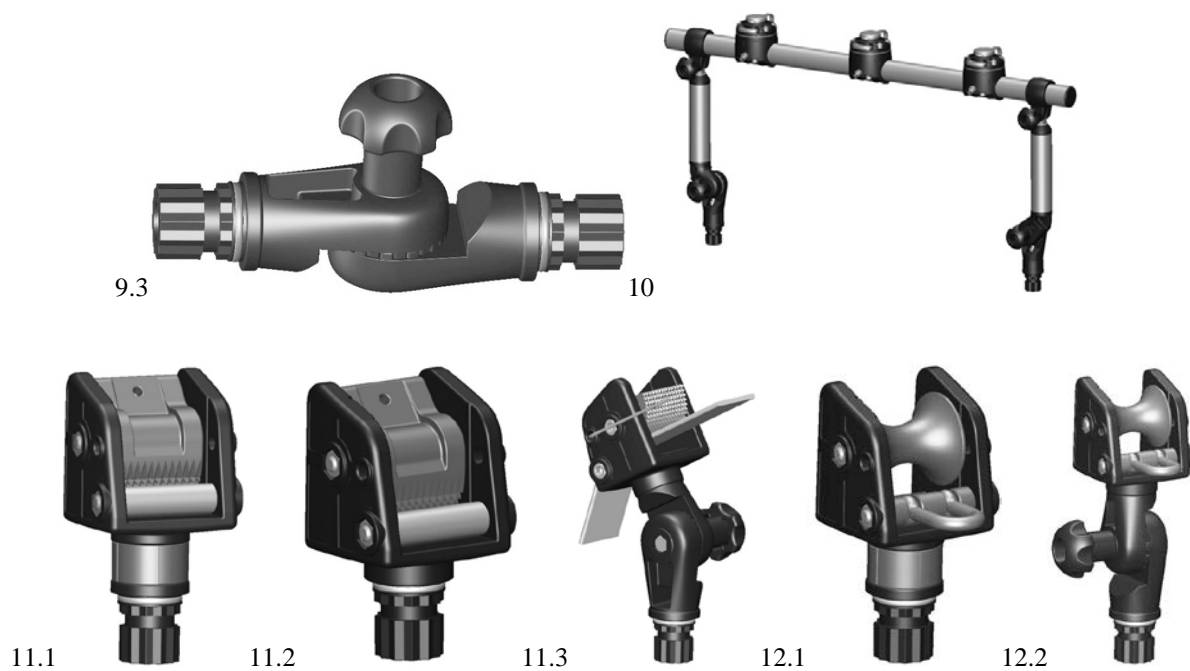
**(11) DM/086385**

(15) 2015 03 30

(22) 2015 03 30

(28) 1

(30) 30.09.2014; MI2014O000141; IT

(73) VALENTINO S.P.A.

Via Turati, 16/18, I-20121 MILANO (IT)

(85) --

(86) EM, IT

(87) EM, IT

(88) EM, IT

(89) EM

(81) III. AZ, EM, GE, KG, ME, RS, TJ, TR, UA

(72) 1: SASSI Stefano

c/o VALENTINO S.p.A. Via Turati, 16/18, I-20121 MILANO, Italy

(54) 1. Bag

(55)

**(51) 03-01**

(45) 2015/20 (2015 05 22)

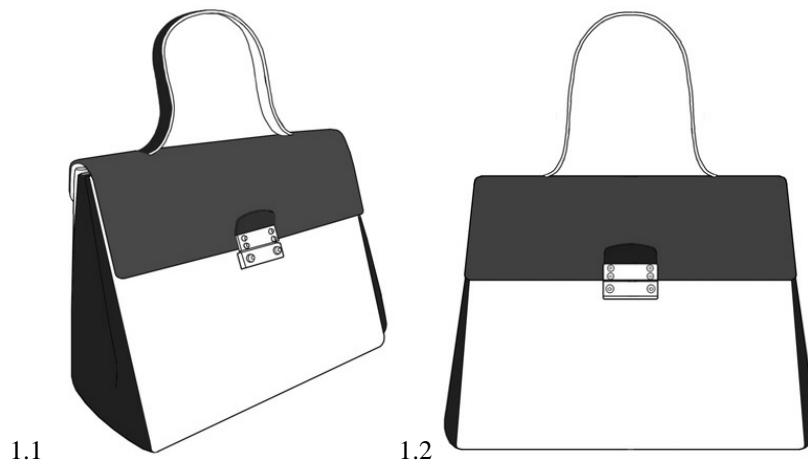

1.1

1.2

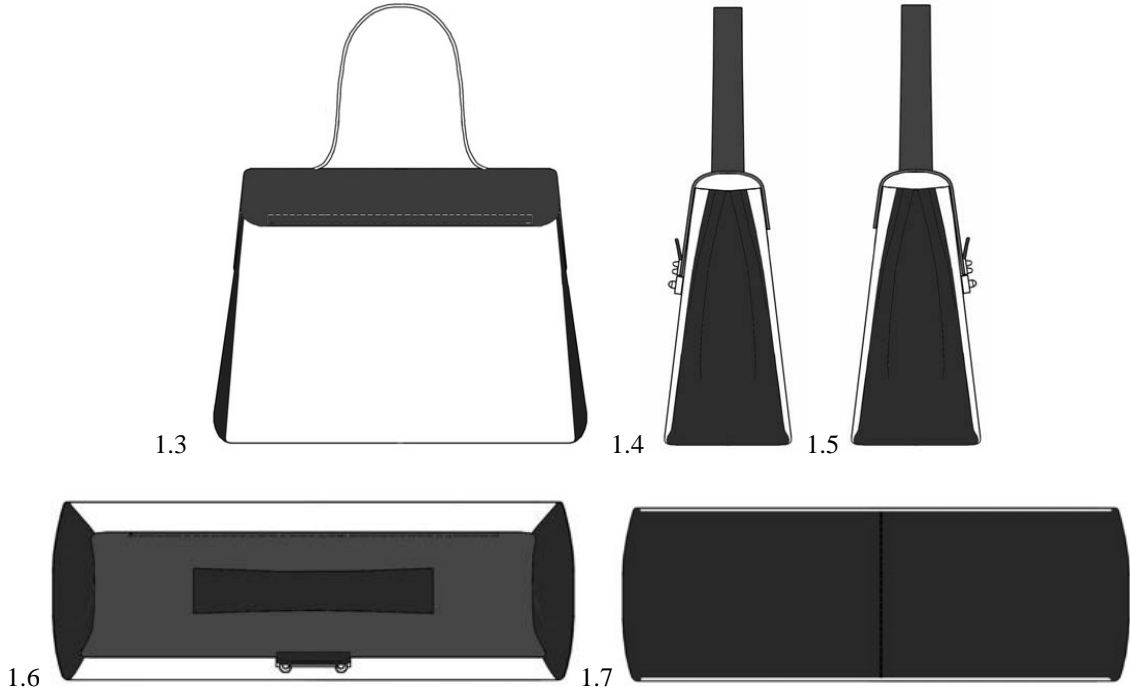

(11) DM/086410

(15) 2015 05 11

(22) 2015 05 11

(28) 1

(73) PRATİK İTHALAT İHRACAT GIDA SANAYİ VE TİCARET LİMİTED ŞİRKETİ

Topçular Mahallesi Kasımpati Sokak No: 2, TR-76000 İĞDIR (TR)

(85) --

(86) -

(87) -

(88) TR

(89) TR

(81) III. AZ, EM, GE

(72) 1: Mustafa KARTAL

Topçular Mahallesi Kasımpati Sokak No: 2, 76000 İGDIR, Turkey

(54) 1. Drinking cup

(55)





**(11) DM/085023 (51) 10-07**

(15) 2014 12 05 (45) 2015/22 (2015 06 05)

(22) 2014 12 05 (28) 4

(73) MONTRES JAQUET DROZ SA (MONTRES JAQUET DROZ AG)  
(MONTRES JAQUET DROZ LTD.)

Allée du Tourbillon 2, CH-2300 La Chaux-de-Fonds (CH)

(85) CH

(86) CH

(87) CH

(88) CH

(89) CH

(81) II. BZ, MA. III. AL, AM, AZ, BA, CH, EM, GE, KG, KR, LI, MC, MD, ME, MK, MN, NO, OM, SG,  
TN, TR, UA

(72) 1-4: Yann LEIGGENER, Rue du Soleil 16, 2300 La Chaux-de-Fonds, Suisse;

1-4: Maamar BOULARAS, Route de Buchilles 44A, 2017 Boudry, Suisse

(54) 1.-4. Dials

(55)

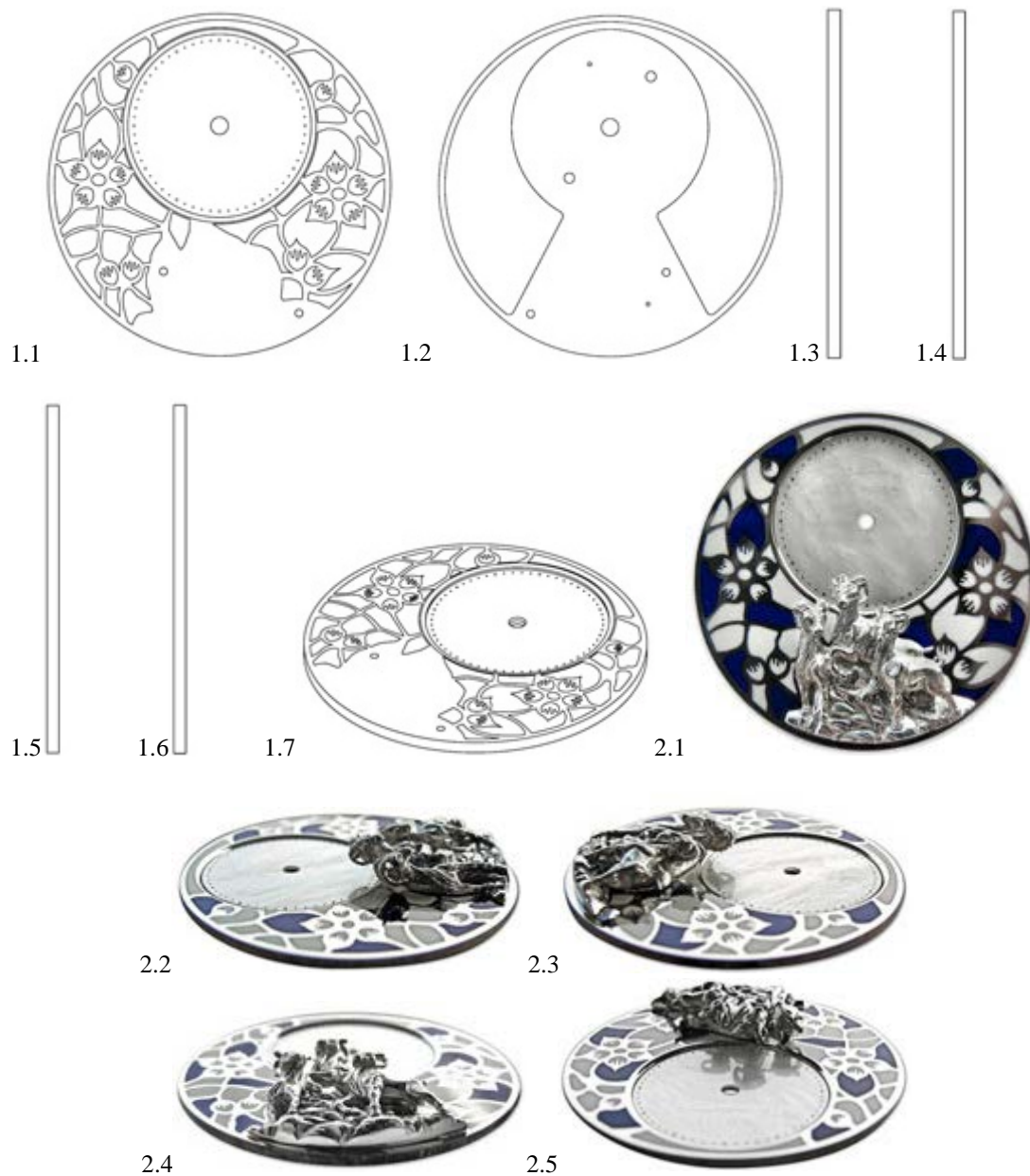



2.6

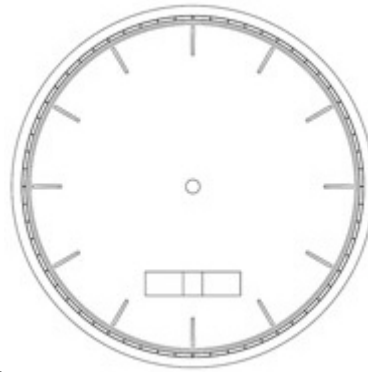

3.1



3.2



3.3



3.4



3.5



3.6



3.7

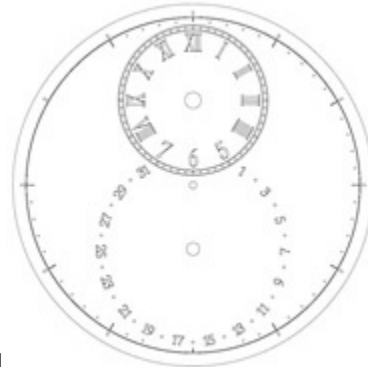

4.1

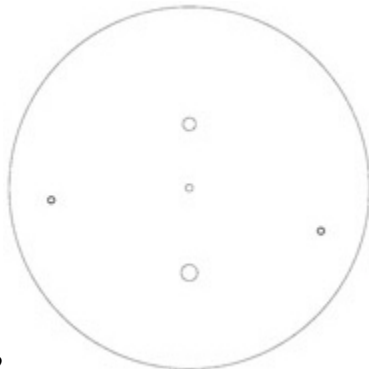

4.2



4.3



4.4



4.5



4.6

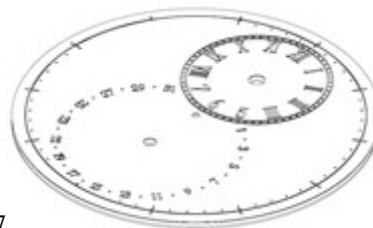

4.7

**(11) DM/086492**

(15) 2015 05 04

(22) 2015 05 04

(28) 1

(30) 07.11.2014; ITTV2014O00020; IT

(73) P.E.T. ENGINEERING SRL

Via Celtica, 26, I-31020 SAN VENDEMIANO (TV) (IT)

(85) --

(86) IT, EM

(87) -

(88) -

(89) EM

(81) III. GE

(72) MORENO BAREL

Via Celtica, 26, 31020 SAN VENDEMIANO (TV), ITALY

(54) 1. Bottle

(55)

**(51) 09-01**

(45) 2015/22 (2015 06 05)





---

# TRADEMARKS

## APPLICATIONS FILED UNDER THE NATIONAL PROCEDURE APPROVED FOR REGISTRATION

The decision can be appealed at the Chamber of Appeal of Sakpatenti within 3 months from the publication or at the Mtskheta District Court Administrative Cases Board (Address: №17, Samkhedro St., Mtskheta), within 1 month following the publication.

(260) AM 2015 68048 A\*\*  
(210) AM 068048  
(220) 2012 07 12  
(731) LTD "G-M-P"  
Ponichala 65, 0165, Tbilisi, Georgia  
(740) Nugzar Ksovreli  
(540)

**ლორანექსი**

**ЛОРАНЕКС**

**LORANEX**

(591) Black-white  
(511) 5

---

(260) AM 2015 77451 A  
(210) AM 77451  
(220) 2014 06 06  
(731) Ranbaxy Laboratories Limited  
Plot No. 90, Sector-32, Gurgaon-122001,  
Haryana, India  
(740) Larisa Amirkhanyan  
(540)

**SKINBENZ**

(591) Black-white  
(531) 27.05.01  
(511) 5

---

(260) AM 2015 77816 A  
(210) AM 77816  
(220) 2014 07 04  
(731) LTD "MARNISKARI"  
Sh. Askuravas q. 17, Tbilisi, Georgia  
(740) Davit Lortkipanidze  
(540)

**მარისკონი**

**MARISKONI**

**МАРИСКОНИ**

(511) 33

---

(260) AM 2015 78138 A  
(210) AM 78138  
(220) 2014 07 30

(731) Old Navy (ITM) Inc.  
2 Folsom Street, San Francisco,  
CA 94105, USA

(740) Tamar Kochlamazashvili  
(540)

**OLD NAVY**

(511) 14

---

(260) AM 2015 78141 A  
(210) AM 78141  
(220) 2014 07 30  
(731) Old Navy (ITM) Inc.  
2 Folsom Street, San Francisco,  
CA 94105, USA

(740) Tamar Kochlamazashvili  
(540)

**OLD NAVY**

(511) 16

---

(260) AM 2015 78142 A  
(210) AM 78142  
(220) 2014 07 30  
(731) Old Navy (ITM) Inc.  
2 Folsom Street, San Francisco,  
CA 94105, USA

(740) Tamar Kochlamazashvili  
(540)

**OLD NAVY**

(511) 28

---

(260) AM 2015 78149 A  
(210) AM 78149  
(220) 2014 07 30  
(731) Old Navy (ITM) Inc.  
2 Folsom Street, San Francisco,  
CA 94105, USA

(740) Tamar Kochlamazashvili  
(540)

**OLD NAVY**

(511) 24

---

(260) AM 2015 78238 A  
 (210) AM 78238  
 (220) 2014 08 07  
 (731) Shorena Gzirishvili  
 Mshenebelta q. 32/14, Rustavi, Georgia  
 (540)

**MAROBABO**

**მარობაბო**

(591) red, brown  
 (511) 29, 30

(260) AM 2015 78378 A  
 (210) AM 78378  
 (220) 2014 08 25  
 (731) Old Navy (ITM) Inc.  
 2 Folsom Street, San Francisco,  
 CA 94105, USA  
 (740) Tamar Kochlamazashvili  
 (540)



(591) Black-white  
 (531) 26.11.12, 24.15.01, 26.03.23  
 (511) 25

(260) AM 2015 78704 A  
 (210) AM 78704  
 (220) 2014 09 16  
 (731) LTD "PRIME MARKET GROUP"  
 Paliashvilis q. 108, 1<sup>st</sup> fl, b. 13,  
 Vake-Saburtalos raioni, Tbilisi,  
 Georgia  
 (740) Davit Kukhalashvili  
 (540)



(591) Light green, blue, red, yellow, sky-blue, green,  
 orange  
 (531) 05.09.15, 03.09.01, 08.01.01, 08.05.15,  
 08.05.01, 05.07.13, 11.03.02, 26.04.16,  
 27.05.02, 29.01.15  
 (526) The trademark is protected as a whole.  
 "GROCERY" shall not be subject to independent  
 legal protection.  
 (511) 35

(260) AM 2015 78813 A  
 (210) AM 78813  
 (220) 2014 09 26  
 (731) Gocha Pipia  
 Budapeshtis q. 11, b. 55, 0160, Tbilisi,  
 Georgia  
 (740) Aleksandre Kvernadze  
 (540)

**ზეარის**  
**Zearis**  
**Зearис**

(511) 32, 33

(260) AM 2015 78846 A  
 (210) AM 78846  
 (220) 2014 09 29  
 (731) Kentucky Fried Chicken International  
 Holdings, Inc.  
 1441 Gardiner Lane, Louisville, Kentucky  
 40213, USA  
 (740) Tamar Kochlamazashvili  
 (540)

**HOT WINGS**

(511) 29

(260) AM 2015 78848 A  
 (210) AM 78848  
 (220) 2014 09 29  
 (731) Kentucky Fried Chicken International  
 Holdings, Inc.  
 1441 Gardiner Lane, Louisville, Kentucky  
 40213, USA  
 (740) Tamar Kochlamazashvili  
 (540)

**ცხარე ურთიშბი**

(511) 29

(260) AM 2015 78887 A  
 (210) AM 78887  
 (220) 2014 09 30  
 (731) LTD "GEOFERT"  
 Ilia Chavchvadzis gamz. 39a,  
 Vake-Saburtalos raioni, Tbilisi,  
 Georgia  
 (540)

**ჯეო Si**  
**Джео Si**  
**Geo Si**

(511) 1

(260) AM 2015 78889 A  
 (210) AM 78889  
 (220) 2014 09 30  
 (731) Airbnb, Inc.  
 (a Delaware corporation)  
 Brannan Street, 4th Floor, San Francisco,  
 California 94103, USA

(740) Giorgi Taktakishvili  
 (540)

**ნებისმიერ ქვეყანაში, როგორც  
 საკუთარ სახელში**

(511) 9, 35, 41, 42, 43, 45

(260) AM 2015 78909 A  
 (210) AM 78909  
 (220) 2014 10 01  
 (731) Euro Parfums FZE  
 P.O. Box 49138, Sharjah, United Arab  
 Emirates

(740) Larisa Amirkhanyan  
 (540)



PARFUMS de MARLY

(591) Black-white  
 (531) 03.03.01, 03.03.17, 24.01.15, 27.05.05,  
 27.07.01

(526) Present number "1743" isn't subject to protection. The trademark is protected as a whole. "PARFUMS" shall not be subject to independent legal protection.

(511) 3

(260) AM 2015 79051 A  
 (210) AM 79051  
 (220) 2014 10 10  
 (731) Spirits International B.V.  
 3, rue du Fort Rheinsheim, L-2419  
 Luxembourg, Luxembourg

(740) Davit Zurabishvili  
 (540)



(591) Black, grey, white  
 (531) 19.07.01, 19.07.12, 19.07.09,  
 (511) 33

(260) AM 2015 79060 A  
 (210) AM 79060  
 (220) 2014 10 13  
 (731) NOVARTIS AG  
 4002 Basel, Switzerland  
 (740) Shalva Gvaramadze  
 (540)

**ფორსპირო**

(531) 28.19  
 (511) 5, 10

(260) AM 2015 79070 A  
 (210) AM 79070  
 (220) 2014 10 13  
 (731) BARILLA FRANCE S.A.S.  
 Rue de Grenelle, 75007 Paris, France  
 (740) Pavle Meipariani  
 (540)



(591) Blue, red, yellow, light brown, sky-blue,  
 green, white, pink, grey  
 (531) 08.01.06, 05.07.02, 25.01.05, 25.07.21,  
 28.05, 29.01.14

(526) Applicant requires that owner's exclusive right wouldn't extent on following parts of trademark: "American Sandwich", "Сандвичный хлеб", "ПШЕНИЧНЫЙ".

(511) 30

(260) AM 2015 79071 A  
 (210) AM 79071  
 (220) 2014 10 13  
 (731) Gela Potskhishvili  
 M. Balanchivadzis q. 69, Tbilisi, Georgia  
 (540)



(591) Black-white  
 (531) 24.09.01, 26.11.13, 27.05.11

(526) The trademark is protected as a whole.  
"NATIONAL" and "BALLET" shall not be subject to  
independent legal protection.  
(511) 35, 41

(260) AM 2015 79123 A  
(210) AM 79123  
(220) 2014 10 16  
(731) LTD Ukraine-English Joint Venture  
with Foreign Investment "SOLOMIA"  
Ul. Krasnoarmeisskaya 143/2, Kiyiv,  
03150, Ukraine  
(740) Davit Dzumukashvili  
(540)



(591) Green, yellow, red, white  
(531) 05.03.14, 11.03.04, 26.11.08, 28.05, 29.01.13  
(511) 30, 35

(260) AM 2015 79136 A  
(210) AM 79136  
(220) 2014 10 20  
(731) Giorgi Chelidze  
Dighmis mas., kv. I, korp. 13, b. 21,  
Tbilisi, Georgia  
(540)



(591) White, red, black, blue, violet  
(531) 02.09.04, 11.03.04, 16.01.06, 16.01.08,  
29.01.15  
(511) 30

(260) AM 2015 79140 A  
(210) AM 79140  
(220) 2014 10 20  
(731) Maia Arveladze  
Mtskhets q. 8, b. 40, Tbilisi, Georgia  
(540)

**FullFarm**  
**ფულფარმი**  
**ФулФарм**

(511) 35

(260) AM 2015 79196 A  
(210) AM 79196  
(220) 2014 10 24  
(731) DD IP Holder LLC  
Royall Street, Canton, Massachusetts  
02021, USA  
(740) Pavle Meipariani  
(540)



(591) Orange, pink, brown, white  
(531) 28.19, 29.01.14, 11.03.02, 27.05.17,  
(526) The trademark is protected as a whole.  
„დონატსი“ and "DONUTS" shall not be subject to  
independent legal protection.  
(511) 43

(260) AM 2015 79268 A  
(210) AM 79268  
(220) 2014 10 30  
(731) N(N)LE "OZHIOS MARANI"  
S. Ozho, 0906, Akhmeta, Georgia  
(740) Aleksandre Kvernadze  
(540)

**ღვინის ცვარი**

(526) The trademark is protected as a whole.  
„ღვინის“ shall not be subject to independent legal  
protection.  
(511) 33

(260) AM 2015 79290 A  
(210) AM 79290  
(220) 2014 10 31  
(731) LTD "Sity 12"  
Krtsanisi q. 7, 0114, Tbilisi, Georgia  
(740) Giorgi Taktakishvili  
(540)

**DEZOTEC**  
**დეზოტეკო**  
**ДЕЗОТЕК**

(511) 1, 3, 5, 35, 37, 40, 41, 42, 43, 44, 45

(260) AM 2015 79308 A  
(210) AM 79308  
(220) 2014 11 03  
(731) RFE/RL, Inc.  
Connecticut Avenue, NW, Washington,  
DC 20036, USA  
(740) Giorgi Meipariani

(540)

**Настоящее время**

(511) 9, 35, 38, 41

(260) AM 2015 79337 A

(210) AM 79337

(220) 2014 11 04

(731) LTD "SIGMA"

Ul. Prishvina, dom 16, Moscow,  
127549, Russian Federation

(740) Shalva Gvaramadze

(540)

**Ноев ковчег**

(511) 14, 29, 30, 31, 39

(260) AM 2015 79352 A

(210) AM 79352

(220) 2014 11 04

(731) LTD "AutoMaxx"

B. Khmel'nitskis q. 153a, b. 60, Tbilisi,  
Georgia

(740) Nugzar Ksovreli

(540)



(591) Orange, black, red

(531) 26.01.19, 26.01.04, 26.02.03, 27.05.05,  
29.01.13

(511) 12

(260) AM 2015 79389 A

(210) AM 79389

(220) 2014 11 06

(731) Procter &amp; Gamble Company Holding GmbH.

Sulzbacher Str. 40, 6584 Svhwabach  
am Taunus, Germany

(740) Davit Kakabadze

(540)

(591) Sky-blue, blue, white

(531) 29.01.04, 27.05.19

(511) 16

(260) AM 2015 79406 A

(210) AM 79406

(220) 2014 11 07

(731) Meda AB

Pipers Väg 2A, Box 906 SE-170 09 Solna,  
Sweden

(740) Shalva Gvaramadze

(540)

**Protamin ME**

(511) 5

(260) AM 2015 79451 A

(210) AM 79451

(220) 2014 11 11

(310) 907831168

(320) 2014 06 12

(330) BR

(731) GENERAL MOTORS LLC

Renaissance Center, City of Detroit,  
State of Michigan 48265-3000, USA

(740) Giorgi Taktakishvili

(540)

**CADILLAC CT2**

(511) 12

(260) AM 2015 79481 A

(210) AM 79481

(220) 2014 11 13

(310) 907830536

(320) 2014 06 12

(330) BR

(731) GENERAL MOTORS LLC

Renaissance Center, City of Detroit,  
State of Michigan 48265-3000, USA

(740) Giorgi Taktakishvili

(540)

**XT5**

(511) 12

(260) AM 2015 79482 A

(210) AM 79482

(220) 2014 11 13

(310) 907830560

(320) 2014 06 12

(330) BR

(731) GENERAL MOTORS LLC

Renaissance Center, City of Detroit,  
State of Michigan 48265-3000, USA

(740) Giorgi Taktakishvili

(540)

**XT6**

(511) 12

(260) AM 2015 79498 A

(210) AM 79498

(220) 2014 11 14

(731) Sony Corporation

Konan Minato-ku, Tokyo, Japan

(740) Merab Kvimsadze  
(540)

## Sony Centre

(591) Black-white  
(531) 27.05.05  
(511) 35

(260) AM 2015 79612 A  
(210) AM 79612  
(220) 2014 11 24  
(731) Orange Brand Services Limited  
3 More London Riverside, London,  
SE1 2AQ, United Kingdom  
(740) Tamar Kochlamazashvili  
(540)

## ORANGE

(511) 9, 35, 36, 37, 38, 41, 42, 44

(260) AM 2015 79614 A  
(210) AM 79614  
(220) 2014 11 24  
(731) Orange Brand Services Limited  
3 More London Riverside, London,  
SE1 2AQ, United Kingdom  
(740) Tamar Kochlamazashvili  
(540)



(591) Orange, white  
(531) 26.04.01, 26.04.22, 27.05.24, 29.01.12  
(511) 9, 35, 36, 37, 38, 41, 42, 44

(260) AM 2015 79669 A  
(210) AM 79669  
(220) 2014 11 26  
(731) LTD "DISTRIT"  
M. Kostavas q. 47/57, Tbilisi, Georgia  
(740) Shota Ghvedadze  
(540)



(591) Blue, green, light grey, yellow, black  
(531) 26.04.22, 26.11.13, 28.19, 29.01.15,  
26.04.04, 26.04.06  
(526) The trademark is protected as a whole. „კკმ“  
shall not be subject to independent legal protection.  
(511) 16, 35

(260) AM 2015 79747 A  
(210) AM 79747  
(220) 2014 12 02  
(731) LTD "NPF" Materia Media Holding  
3<sup>th</sup> Samotechnii pereulok 9, Moscow,  
127473, Russian Federation  
(740) Tamaz Shilakadze  
(540)

## იმპაზა

(511) 5

(260) AM 2015 79748 A  
(210) AM 79748  
(220) 2014 12 02  
(731) LTD "NPF" Materia Media Holding  
3<sup>th</sup> Samotechnii pereulok 9, Moscow,  
127473, Russian Federation  
(740) Tamaz Shilakadze  
(540)

## ანაფერონი

(511) 5

(260) AM 2015 79749 A  
(210) AM 79749  
(220) 2014 12 02  
(731) LTD "NPF" Materia Media Holding  
3<sup>th</sup> Samotechnii pereulok 9, Moscow,  
127473, Russian Federation  
(740) Tamaz Shilakadze  
(540)

## ანაფერონი საბავშვო

(526) „საბავშვო“.  
(511) 5

(260) AM 2015 79750 A  
(210) AM 79750  
(220) 2014 12 02  
(731) LTD "NPF" Materia Media Holding  
3<sup>th</sup> Samotechnii pereulok 9, Moscow,  
127473, Russian Federation  
(740) Tamaz Shilakadze  
(540)

## აფალა

(511) 5



(260) AM 2015 79751 A  
 (210) AM 79751  
 (220) 2014 12 02  
 (731) LTD "NPF" Materia Media Holding  
 3<sup>th</sup> Samotechnii pereulok 9, Moscow,  
 127473, Russian Federation  
 (740) Tamaz Shilakadze  
 (540)

**ტენოტენი**

(511) 5

(260) AM 2015 79956 A  
 (210) AM 79956  
 (220) 2014 12 17  
 (731) Super Brands Company Pte. Ltd.  
 No. 438 Alexandra Road, N05-01 Alexandra  
 Point, Singapore 119958, Singapore  
 (740) Liliana Darakhvelidze  
 (540)



(591) Black-white  
 (531) 03.03.01, 03.03.17, 24.01.05, 24.09.01,  
 25.01.19, 25.07.15, 27.05.24  
 (511) 33

(260) AM 2015 79974 A  
 (210) AM 79974  
 (220) 2014 12 22  
 (731) Serta, Inc  
 Forbs Avenue, Hoffman Estates,  
 IL 60192, USA  
 (740) Shalva Gvaramadze  
 (540)

**ISERIES**

(511) 20, 24

(260) AM 2015 79979 A  
 (210) AM 79979  
 (220) 2014 12 22  
 (731) LTD "Coordinate Centre of International  
 Investment"  
 S. Sioni, Kazbegis raioni, Complex Dariali,  
 Georgia  
 (740) Davit Orjonikidze

(540)



(591) White, golden  
 (531) 27.01.13, 29.01.12, 01.03.15  
 (511) 33

(260) AM 2015 80007 A  
 (210) AM 80007  
 (220) 2014 12 26  
 (731) LTD "A-B-C" Pharmacy  
 Sanapiros q. 10, Tbilisi, Georgia  
 (740) Salome Jeladze  
 (540)



(591) Bluish, mottom blue  
 (531) 29.01.04, 02.03.01, 27.05.01,  
 (526) The trademark is protected as a whole.  
 "Aesthetic Room" shall not be subject to  
 independent legal protection.:  
 (511) 35, 44

(260) AM 2015 80011 A  
 (210) AM 80011  
 (220) 2014 12 29  
 (731) Steven Madden Ltd.  
 52-16 Barnett Avenue, Long Island City,  
 New York 11104, USA  
 (740) Tamaz Shilakadze  
 (540)

**MADDEN GIRL**

(591) Black-white  
 (511) 18, 25

(260) AM 2015 80013 A  
 (210) AM 80013  
 (220) 2014 12 29  
 (731) LTD "UNIPAY"  
 Bakos q. 16, Didubis raioni, Tbilisi, Georgia  
 (740) Tamar kharazishvili  
 (540)

**UniPAY**

(591) Magenta  
 (531) 29.01.11, 27.05.17  
 (511) 9, 35, 36

(260) AM 2015 80110 A  
(210) AM 80110  
(220) 2015 01 06  
(731) LTD "Joker Plastic"  
Iv. Javakhishvilis q. 78/10, Batumi, Georgia  
(540)

**VERTAK**  
**BEPTAK**  
**ვერტაკო**

(511) 7, 8, 19, 35

---

(260) AM 2015 80112 A  
(210) AM 80112  
(220) 2015 01 06  
(731) LTD "Joker Plastic"  
Iv. Javakhishvilis q. 78/10, Batumi, Georgia  
(540)

**ROYAL BABY**  
**РОИАЛ БЕБИ**  
**როიალ ბები**

(511) 12, 28, 35

---



**REGISTERED TRADEMARKS**

(111) M 2015 026075 R

(151) 2015 07 16

(181) 2025 07 16

(260) AM 2015 67596 A

(220) 2012 06 08

(732) E.I. du Pont de Nemours and Company  
1007 Market Street, Wilmington,  
DE 19898, USA

---

(111) M 2015 026076 R

(151) 2015 07 16

(181) 2025 07 16

(260) AM 2015 68212 A

(220) 2013 10 10

(732) LTD "KURORTI SAIRME"  
Kurorti Sairme, 1000, Baghdatis raioni,  
Georgia

---

(111) M 2015 026077 R

(151) 2015 07 16

(181) 2025 07 16

(260) AM 2015 71153 A

(220) 2013 03 01

(732) JSC "SMARTEXI"  
I. Chavchavadzis gamz. 74, 0162, Tbilisi,  
Georgia

---

(111) M 2015 026078 R

(151) 2015 07 16

(181) 2025 07 16

(260) AM 2015 72155 A

(220) 2013 05 08

(732) Teavana Corporation  
a Georgia corporation  
3630 Peachtree Road NE, Suite 1480,  
Atlanta, Georgia 30326, USA

---

(111) M 2015 026079 R

(151) 2015 07 16

(181) 2025 07 16

(260) AM 2015 72196 A

(220) 2014 03 28

(732) Hongta Tobacco (Group) Co., Ltd  
No.118, Hongta Avenue, Hongta District,  
Yuxi, Yunnan, CN

---

(111) M 2015 026080 R

(151) 2015 07 16

(181) 2025 07 16

(260) AM 2015 73488 A

(220) 2013 08 12

(732) Kraft Foods Schweiz Holding GmbH  
Chollerstrasse 4, 6301 Zug, CH

---

(111) M 2015 026081 R

(151) 2015 07 16

(181) 2025 07 16

(260) AM 2015 73916 A

(220) 2013 09 12

(732) MANICA S.p.A.  
Via All'Adige, 4, 38068-Rovereto (TN), Italy

---

(111) M 2015 026082 R

(151) 2015 07 16

(181) 2025 07 16

(260) AM 2015 73917 A

(220) 2013 09 12

(732) MANICA S.p.A.  
Via All'Adige, 4, 38068-Rovereto (TN), Italy

---

(111) M 2015 026083 R

(151) 2015 07 16

(181) 2025 07 16

(260) AM 2015 73933 A

(220) 2013 09 16

(732) LINC PEN AND PLASTICS LIMITED  
Satyam Towers, 3, Alipore Road 1st Floor,  
Kolkata-700 027, State of West Bengal, India

---

(111) M 2015 026084 R

(151) 2015 07 16

(181) 2025 07 16

(260) AM 2015 74591 A

(220) 2013 11 04

(732) JSC "IVERIA"  
Gudautis q. 7, Didubis raioni, 0119, Tbilisi,  
Georgia

---

(111) M 2015 026085 R

(151) 2015 07 16

(181) 2025 07 16

(260) AM 2015 74755 A

(220) 2013 11 15

(732) LTD "GEO-ALKO"  
Lilos 51, 0198, Tbilisi, Georgia

---

(111) M 2015 026086 R

(151) 2015 07 16

(181) 2025 07 16

(260) AM 2014 74874 A  
(220) 2013 11 25  
(732) LTD "FOODSERVICE"  
Marshal Gelovanis gamz. 2, 0159, Tbilisi,  
Georgia

---

(111) M 2015 026087 R  
(151) 2015 07 16  
(181) 2025 07 16  
(260) AM 2014 74875 A  
(220) 2013 11 25  
(732) LTD "FOODSERVICE"  
Marshal Gelovanis gamz. 2, 0159, Tbilisi,  
Georgia

---

(111) M 2015 026088 R  
(151) 2015 07 16  
(181) 2025 07 16  
(260) AM 2015 74899 A  
(220) 2014 07 04  
(732) LTD "GEORGIAN LEMONADE"  
Zhiuli Shartavas q. 16, b. 22, 0160, Tbilisi,  
Georgia

---

(111) M 2015 026089 R  
(151) 2015 07 16  
(181) 2025 07 16  
(260) AM 2015 75090 A  
(220) 2013 12 09  
(732) LTD "SILDA ESTATE"  
Erekle II av. 1, 2200, Telavi, Georgia

---

(111) M 2015 26091 R  
(151) 2015 07 17  
(181) 2025 07 17  
(260) AM 2015 76710 A  
(220) 2014 04 15  
(732) LTD "PITUSAKO"  
Tsereteli av. 77, Tbilisi, Georgia

---

(111) M 2015 26092 R  
(151) 2015 07 17  
(181) 2025 07 17  
(260) AM 2015 76720 A  
(220) 2014 04 16  
(732) LTD "GEORGIAN WINES CORPORATION"  
Simon Chikovani st. 35, 0171, Tbilisi, Georgia

---

(111) M 2015 26093 R  
(151) 2015 07 17  
(181) 2025 07 17  
(260) AM 2014 76730 A  
(220) 2014 04 16

(732) LTD "SHALWINE"  
Bakhtrioni st., korp. 1, b. 10, 0160, Tbilisi,  
Georgia

---

(111) M 2015 26094 R  
(151) 2015 07 17  
(181) 2025 07 17  
(260) AM 2014 76796 A  
(220) 2014 04 24  
(732) LTD "MOTORSTAR"  
Leonidze st., korp. 24, b. 100, 0504, Rustavi,  
Georgia

---

(111) M 2015 26095 R  
(151) 2015 07 17  
(181) 2025 07 17  
(260) AM 2014 76797 A  
(220) 2014 04 24  
(732) LTD "MOTORSTAR"  
Leonidze st., korp. 24, b. 100, 0504, Rustavi,  
Georgia

---

(111) M 2015 26096 R  
(151) 2015 07 17  
(181) 2025 07 17  
(260) AM 2014 76798 A  
(220) 2014 04 24  
(732) LTD "MOTORSTAR"  
Leonidze st., korp. 24, b. 100, 0504, Rustavi,  
Georgia

---

(111) M 2015 26097 R  
(151) 2015 07 17  
(181) 2025 07 17  
(260) AM 2014 76801 A  
(220) 2014 04 25  
(732) Ranbaxy Laboratories Limited  
Plot No. 90, Sector-32, Gurgaon 122001,  
Haryana, India

---

(111) M 2015 26098 R  
(151) 2015 07 17  
(181) 2025 07 17  
(260) AM 2014 76803 A  
(220) 2014 04 25  
(732) Ranbaxy Laboratories Limited  
Plot No. 90, Sector-32, Gurgaon 122001,  
Haryana, India

---

(111) M 2015 26099 R  
(151) 2015 07 17  
(181) 2025 07 17  
(260) AM 2015 76814 A

(220) 2014 04 25  
(732) LTD "PSP"  
D. Agmashenebeli av. 148, Tbilisi, Georgia

---

(111) M 2015 26100 R  
(151) 2015 07 17  
(181) 2025 07 17  
(260) AM 2015 76818 A  
(220) 2014 04 25  
(732) Mattel, Inc.  
333 Continental Boulevard, El Segundo,  
California 90245-5012, USA

---

(111) M 2015 26101 R  
(151) 2015 07 17  
(181) 2025 07 17  
(260) AM 2014 76953 A  
(220) 2014 05 01  
(732) The Procter & Gamble Company  
One Procter & Gamble Plaza, Cincinnati  
Ohio  
45202, USA

---

(111) M 2015 26102 R  
(151) 2015 07 17  
(181) 2025 07 17  
(260) AM 2015 76975 A  
(220) 2014 05 05  
(732) PT. SANTOS JAYA ABADI  
Jl. Raya Gilang 159, Sidoarjo, Indonesia

---

(111) M 2015 26103 R  
(151) 2015 07 17  
(181) 2025 07 17  
(260) AM 2015 76987 A  
(220) 2014 05 05  
(732) Avon Products, Inc.  
777 Third Avenue, New York, 10017, USA

---

(111) M 2015 26104 R  
(151) 2015 07 17  
(181) 2025 07 17  
(260) AM 2015 77079 A  
(220) 2014 05 12  
(732) Reemtsma Cigarettenfabriken GmbH  
Max-Born Strasse 4, 22761 Hamburg,  
Germany

---

(111) M 2015 26105 R  
(151) 2015 07 17  
(181) 2025 07 17  
(260) AM 2015 77218 A  
(220) 2014 05 21

(732) Best Foods Limited  
Village Norta Tehsil-Indri, District-Karnal  
132041 (Haryana), India

---

(111) M 2015 26106 R  
(151) 2015 07 17  
(181) 2025 07 17  
(260) AM 2014 77287 A  
(220) 2014 05 27  
(732) LTD "KAPILONI"  
Mtskhetis raioni, S. Misaktsieli, 3308,  
Georgia

---

(111) M 2015 26107 R  
(151) 2015 07 17  
(181) 2025 07 17  
(260) AM 2015 77348 A  
(220) 2014 05 30  
(732) AD SOLUTION MEDIA ASSOCIATES  
LIMITED LIABILITY PARTNERSHIP  
Suite 303, Princess House, 50-60 Eastcastle  
street, London, W1W 8EA, United Kingdom

---

(111) M 2015 26108 R  
(151) 2015 07 17  
(181) 2025 07 17  
(260) AM 2015 77370 A  
(220) 2014 06 02  
(732) H. Lundbeck A/S.  
Ottiliavej 9 2500 Valby, Denmark

---

(111) M 2015 26109 R  
(151) 2015 07 17  
(181) 2025 07 17  
(260) AM 2015 77448 A  
(220) 2014 06 06  
(732) Alandalus for flavored Tobacco  
and molasses Company  
Free Zone, Zarqa, Jordan

---

(111) M 2015 26110 R  
(151) 2015 07 17  
(181) 2025 07 17  
(260) AM 2015 77450 A  
(220) 2014 06 06  
(732) Alandalus for flavored Tobacco  
and molasses Company  
Free Zone, Zarqa, Jordan

---

(111) M 2015 26111 R  
(151) 2015 07 17  
(181) 2025 07 17  
(260) AM 2015 77465 A  
(220) 2014 06 09

---

(732) LTD "EFKO-KASKAD"  
Ul. Frunze, d. 4, Alekseevka, 309850,  
Belgorodskaya oblast, Russian Federation

---

(111) M 2015 26112 R  
(151) 2015 07 17  
(181) 2025 07 17  
(260) AM 2015 77466 A  
(220) 2014 06 09  
(732) LTD "EFKO-KASKAD"  
Ul. Frunze, d. 4, Alekseevka, 309850,  
Belgorodskaya oblast, Russian Federation

---

(111) M 2015 26113 R  
(151) 2015 07 17  
(181) 2025 07 17  
(260) AM 2015 77467 A  
(220) 2014 06 09  
(732) LTD "EFKO-KASKAD"  
Ul. Frunze, d. 4, Alekseevka, 309850,  
Belgorodskaya oblast, Russian Federation

---

(111) M 2015 26114 R  
(151) 2015 07 17  
(181) 2025 07 17  
(260) AM 2015 77524 A  
(220) 2014 06 12  
(732) QURAMAX LIMITED  
Artisans House, 7 Queensbridge Northampton  
NN4 7BF, Great Britain, United Kingdom

---

(111) M 2015 26115 R  
(151) 2015 07 17  
(181) 2025 07 17  
(260) AM 2015 77531 A  
(220) 2014 06 12  
(732) Titan International, Inc.  
2701 Spruce Street, Quincy, Illinois,  
62301, USA

---

(111) M 2015 26116 R  
(151) 2015 07 17  
(181) 2025 07 17  
(260) AM 2015 77547 A  
(220) 2014 06 13  
(732) GENERAL MOTORS LLC  
300 Renaissance Center, City of Detroit,  
State of Michigan 48265-3000, USA

---

(111) M 2015 26117 R  
(151) 2015 07 17  
(181) 2025 07 17  
(260) AM 2015 77552 A  
(220) 2014 06 13

---

(732) The Procter & Gamble Company  
One Procter & Gamble Plaza, Cincinnati  
Ohio 45202, USA

---

(111) M 2015 26118 R  
(151) 2015 07 17  
(181) 2025 07 17  
(260) AM 2015 77639 A  
(220) 2014 06 20  
(732) IPEK KAGIT SANAYI VE TICARET  
ANONIM SIRKETI  
Kanyon Ofis Buyukdere Cad., No: 185 Levent  
Istanbul, Turkey

---

(111) M 2015 26119 R  
(151) 2015 07 17  
(181) 2025 07 17  
(260) AM 2015 77814 A  
(220) 2014 07 04  
(732) LTD "MARNISKARI"  
Sh. Askuravas q. 17, 0119, Tbilisi, Georgia

---

(111) M 2015 26120 R  
(151) 2015 07 17  
(181) 2025 07 17  
(260) AM 2015 77815 A  
(220) 2014 07 04  
(732) LTD "MARNISKARI"  
Sh. Askuravas q. 17, 0119, Tbilisi, Georgia

---

(111) M 2015 26121 R  
(151) 2015 07 17  
(181) 2025 07 17  
(260) AM 2015 77890 A  
(220) 2014 07 10  
(732) LTD "AGRO TRADING GEORGIA"  
Rustavis gzatk. 68a, 0165, Tbilisi,  
Georgia

---

(111) M 2015 26122 R  
(151) 2015 07 17  
(181) 2025 07 17  
(260) AM 2015 77891 A  
(220) 2014 07 10  
(732) LTD "AGRO TRADING GEORGIA"  
Rustavis gzatk. 68a, 0165, Tbilisi, Georgia

---

(111) M 2015 26123 R  
(151) 2015 07 17  
(181) 2025 07 17  
(260) AM 2015 77892 A  
(220) 2014 07 10

---

(732) LTD "AGRO TRADING GEORGIA" Rustavis gzatk. 68a, 0165, Tbilisi, Georgia	5959 Las Colinas Boulevard, Irving, Texas 75039-2298, USA
(111) M 2015 26124 R (151) 2015 07 17 (181) 2025 07 17 (260) AM 2015 78052 A (220) 2014 07 23 (732) NGK SPARK PLUG CO., LTD Takatsuji-cho, Mizuho-ku, Nagoya City, 467-8525, Japan	(111) M 2015 26130 R (151) 2015 07 17 (181) 2025 07 17 (260) AM 2015 76956 A (220) 2014 05 02 (732) Olga Belyacova Dubosari, Stamati st. 9, Republic of Moldova
(111) M 2015 26125 R (151) 2015 07 17 (181) 2025 07 17 (260) AM 2015 75703 A (220) 2014 01 28 (732) Bensusan Restaurant Corporation 131 West 3rd Street, New York, NY 10012, USA	(111) M 2015 26131 R (151) 2015 07 17 (181) 2025 07 17 (260) AM 2015 77329 A (220) 2014 05 29 (732) "ACCOR" 110 avenue de France, 75013 Paris, France
(111) M 2015 26126 R (151) 2015 07 17 (181) 2025 07 17 (260) AM 2015 76307 A (220) 2014 03 19 (732) AstraZeneca AB. SE-151 85 Södertälje, Sweden	(111) M 2015 26132 R (151) 2015 07 17 (181) 2025 07 17 (260) AM 2015 77347 A (220) 2014 05 30 (732) AD SOLUTION MEDIA ASSOCIATES LIMITED LIABILITY PARTNERSHIP Suite 303, Princess House, 50-60 Eastcastle street, London, W1W 8EA, United Kingdom
(111) M 2015 26127 R (151) 2015 07 17 (181) 2025 07 17 (260) AM 2015 76421 A (220) 2014 03 26 (732) Icon Health & Fitness Inc. 1500 south 1000 west, Logan, Utah 84321, USA	(111) M 2015 26133 R (151) 2015 07 17 (181) 2025 07 17 (260) AM 2015 77863 A (220) 2014 07 08 (732) DEBİ ULUSLARARASI GIDA TEKSTİL ELEKTRONİK VE OTOMOTİV SAN.TİC.LTD.ŞTİ Bağlariçi district AliAy street Orchid apparttemant no:3 office 4 K.Bakkalköy- Ataşehir-İstanbul, Turkey
(111) M 2015 26128 R (151) 2015 07 17 (181) 2025 07 17 (260) AM 2015 76739 A (220) 2014 04 22 (732) LG Life Sciences, Ltd. 58 Jongno-gu, Saemunan-ro, Seoul, Republic of Korea	(111) M 2015 26134 R (151) 2015 07 17 (181) 2025 07 17 (260) AM 2015 78022 A (220) 2014 07 21 (732) DSM IP Assets B.V. Het Overloon 1, 6411 TE, Heerlen, Netherlands
(111) M 2015 26129 R (151) 2015 07 17 (181) 2025 07 17 (260) AM 2015 76847 A (220) 2014 04 28 (732) Exxon Mobil Corporation	(111) M 2015 26135 R (151) 2015 07 17 (181) 2025 07 17

---

(260) AM 2015 78048 A  
 (220) 2014 07 28  
 (732) Societe Nationale d'Exploitation Industrielle  
 des Tabacs et Allumettes, SASU  
 143 Boulevard Romen Rolan, France

---

(111) M 2015 26154 R  
 (151) 2015 07 28  
 (181) 2025 07 28  
 (260) AM 2015 75221 A  
 (220) 2013 12 20  
 (732) Wm. WRIGLEY Jr. Company  
 1132 West Blackhawk Street, Chicago,  
 Illinois  
 60642, USA

---

(111) M 2015 26155 R  
 (151) 2015 07 28  
 (181) 2025 07 28  
 (260) AM 2015 75736 A  
 (220) 2014 01 30  
 (732) British American Tobacco (Brands) Inc.  
 (a Delaware corporation)  
 2711 Centerville Road, Suite 300,  
 Wilmington,  
 Delaware 19808, USA

---

(111) M 2015 26156 R  
 (151) 2015 07 28  
 (181) 2025 07 28  
 (260) AM 2014 75768 A  
 (220) 2014 02 04  
 (732) "New York Film Academy" Inc.  
 100 East 17th Street, New York City,  
 10003, USA

---

(111) M 2015 26157 R  
 (151) 2015 07 28  
 (181) 2025 07 28  
 (260) AM 2015 75932 A  
 (220) 2014 02 17  
 (732) Eleonora Archaia  
 Mtskhetis q., korp. 8, b. 73, 0179, Tbilisi,  
 Georgia

---

(111) M 2015 26158 R  
 (151) 2015 07 28  
 (181) 2025 07 28  
 (260) AM 2015 76177 A  
 (220) 2014 03 06  
 (732) Seacret Spa Ltd  
 Arlozerov 128, Tel Aviv, 62097, Israel

---

(111) M 2015 26159 R  
 (151) 2015 07 28  
 (181) 2025 07 28  
 (260) AM 2015 76460 A  
 (220) 2014 03 28  
 (732) Toyota Jidosha Kabushiki Kaisha  
 (also trading as Toyota Motor Corporation)  
 1, Toyota-cho, Toyota-shi, Aichi-ken, Japan

---

(111) M 2015 26160 R  
 (151) 2015 07 28  
 (181) 2025 07 28  
 (260) AM 2015 76601 A  
 (220) 2014 04 07  
 (732) Visa International Service Association  
 900 Metro Center Boulevard, Foster City,  
 California 94404, USA

---

(111) M 2015 26161 R  
 (151) 2015 07 28  
 (181) 2025 07 28  
 (260) AM 2015 76736 A  
 (220) 2014 04 22  
 (732) Harington Development Inc.  
 Elivira Mendez Street, Valerino Bldg,  
 3rd Floor, Panama

---

(111) M 2015 26162 R  
 (151) 2015 07 28  
 (181) 2025 07 28  
 (260) AM 2015 76781 A  
 (220) 2014 04 24  
 (732) LTD "MUKADO WINES"  
 N. Kipshidzis q., b. 4, Vake-Saburtalo,  
 Tbilisi, Georgia

---

(111) M 2015 26163 R  
 (151) 2015 07 28  
 (181) 2025 07 28  
 (260) AM 2015 77021 A  
 (220) 2014 05 06  
 (732) Intersun Holding FZCO  
 PO Box 61051, J̧Jebel Ali Fri Zoun,  
 United Arab Emirates

---

(111) M 2015 26164 R  
 (151) 2015 07 28  
 (181) 2025 07 28  
 (260) AM 2015 77073 A  
 (220) 2014 05 08  
 (732) LTD "RADIO IMEDI"  
 Aleksidzis q. 3, Tbilisi, Georgia

---

(111) M 2015 26165 R  
(151) 2015 07 28  
(181) 2025 07 28  
(260) AM 2015 77098 A  
(220) 2014 05 13  
(732) GIGI COSMETIC LABORATORIES LTD  
7 HAMIFALIM ST., P.O.BOX 10225,  
PETAH TIKVA 49002, Israel

---

(111) M 2015 26166 R  
(151) 2015 07 28  
(181) 2025 07 28  
(260) AM 2015 77263 A  
(220) 2014 05 23  
(732) Koppert B.V.  
Veilingweg 14, 2651 BE Berkel en Rodenrijs,  
The Netherlands

---

(111) M 2015 26167 R  
(151) 2015 07 29  
(181) 2025 07 29  
(260) AM 2015 77574 A  
(220) 2014 06 17  
(732) LTD "METRA DEVELOPMENT"  
Ilia Chavchavadzis gamz. 80, Tbilisi, Georgia

---

(111) M 2015 26168 R  
(151) 2015 07 29  
(181) 2025 07 29  
(260) AM 2015 77693 A  
(220) 2014 06 25  
(732) Alexandre Gongadze  
Ioane Petrirsis q. 2, b. 74, Tbilisi, Georgia

---

(111) M 2015 26169 R  
(151) 2015 07 29  
(181) 2025 07 29  
(260) AM 2015 77782 A  
(220) 2014 07 02  
(732) LTD "CHIATURMANGANUM GEORGIA"  
S. Nakhshirghele, Chiatura, Georgia

---

(111) M 2015 26170 R  
(151) 2015 07 29  
(181) 2025 07 29  
(260) AM 2015 78000 A  
(220) 2014 07 18  
(732) NISAN JIDOSHA KABUSHIKI  
KAISHA  
(Also Trading as Nisan Motor co., ltd)  
2 Takara-cho, Kanagawa-ku, Yokohama-shi,  
Kanagawa-ken, Japan

---

(111) M 2015 26171 R  
(151) 2015 07 29  
(181) 2025 07 29  
(260) AM 2015 78005 A  
(220) 2014 07 18  
(732) Gela Mikadze  
Lalionis shesakhvevi 5, 0101, Tbilisi, Georgia

---

(111) M 2015 26172 R  
(151) 2015 07 29  
(181) 2025 07 29  
(260) AM 2015 78017 A  
(220) 2014 07 21  
(732) NOBEL ILAC SANAYII VE TICARET  
ANONIM SIKRETI Representative in  
Georgia  
Tavisuplebis Moedani 4, Tbilisi, Georgia

---

(111) M 2015 26173 R  
(151) 2015 07 29  
(181) 2025 07 29  
(260) AM 2015 78053 A  
(220) 2014 07 23  
(732) HONDA MOTOR CO., LTD  
1-1, Minami-Aoyama 2- chome, Minato-Ku,  
Tokyo 107-8556, Japan

---

## TRADEMARKS REGISTERED ACCORDING TO THE ACCELERATED PROCEDURE

The decision can be appealed at the Chamber of Appeal of Sakpatenti within 3 months from the publication.

(111) M 2015 26139 R  
(151) 2015 07 22  
(181) 2025 07 22  
(210) AM 82657  
(220) 2015 06 24  
(732) LTD "BROTHERS"  
Tbeti str. 3, 6000, Batumi, Georgia  
(740) Levan Siamashvili  
(540)



(591) Sky-blue, white  
(531) 05.05.20, 26.04.03, 26.11.07, 28.19, 29.01.04  
(526) The trademark is protected as a whole.  
„ბათუმის საერთაშორისო საუნივერსიტეტო ჰოსპიტალი“ shall not be subject to independent legal protection.  
(511) 35, 44

(111) M 2015 26140 R  
(151) 2015 07 22  
(181) 2025 07 22  
(210) AM 82761  
(220) 2015 07 01  
(732) Terraco Holdings Limited  
Nafpliou 15, 1st Floor, Office 102 3025,  
Limassol, Cyprus  
(740) Vakhtang Torotadze  
(540)

### Terraco

(511) 1, 2, 19

(111) M 2015 26141 R  
(151) 2015 07 23  
(181) 2025 07 23  
(210) AM 82660  
(220) 2015 06 24  
(732) LTD "DUTY FREE ALLIANCE"  
I. Chavchavadzis gamz. 74b, 0162, Tbilisi,  
Georgia  
(740) Salome Polikashvili

(540)



(591) White, black, cornel-red  
(531) 26.04.09, 27.05.10, 27.05.24, 29.01.13,  
26.04.03  
(526) The trademark is protected as a whole.  
"DUTY FREE" shall not be subject to independent legal protection.  
(511) 35

(111) M 2015 26142 R  
(151) 2015 07 23  
(181) 2025 07 23  
(210) AM 82663  
(220) 2015 06 24  
(732) LTD "DUTY FREE ALLIANCE"  
I. Chavchavadzis gamz. 74b, 0162, Tbilisi,  
Georgia  
(740) Salome Polikashvili  
(540)

### THE PRICES YOU LOVE

(511) 35

(111) M 2015 26143 R  
(151) 2015 07 23  
(181) 2025 07 23  
(210) AM 82661  
(220) 2015 06 24  
(732) LTD "DUTY FREE ALLIANCE"  
I. Chavchavadzis gamz. 74b, 0162, Tbilisi,  
Georgia  
(740) Salome Polikashvili  
(540)

### EVERYWHERE WITH YOU

(511) 35



(111) M 2015 26144 R  
 (151) 2015 07 23  
 (181) 2025 07 23  
 (210) AM 82826  
 (220) 2015 07 06  
 (732) LTD "MEGVINEOBA KHAREBA"  
 D. Agmasheneblis Kheivani 6<sup>th</sup> km., 0131,  
 Tbilisi, Georgia  
 (740) Akaki Piolia  
 (540)

**შატო ლიპარტიანი**  
**Chateua Lipartiani**  
**Шато Липартиани**

(511) 35

(111) M 2015 26145 R  
 (151) 2015 07 24  
 (181) 2025 07 24  
 (210) AM 82464  
 (220) 2015 06 10  
 (732) JSC "KHRAMHESI-1"  
 Khramhesis dasakh., Tsalkis raioni, Georgia  
 (740) Irakli Gvilia  
 (540)



(591) White, blue, golden  
 (531) 01.17.11, 01.03.16, 28.05, 29.01.13  
 (526) The trademark is protected as a whole. "ГЭС"  
 shall not be subject to independent legal protection.  
 (511) 4, 40

(111) M 2015 26146 R  
 (151) 2015 07 24  
 (181) 2025 07 24  
 (210) AM 82465  
 (220) 2015 06 10  
 (732) JSC "KHRAMHESI-1"  
 Khramhesis dasakh., Tsalkis raioni, Georgia  
 (740) Irakli Gvilia  
 (540)



(591) White, blue, golden  
 (531) 01.03.16, 01.17.11, 27.05.17, 29.01.13  
 (511) 4, 40

(111) M 2015 26147 R  
 (151) 2015 07 24  
 (181) 2025 07 24  
 (210) AM 82467  
 (220) 2015 06 10  
 (732) JSC "KHRAMHESI-1"  
 Khramhesis dasakh., Tsalkis raioni, Georgia  
 (740) Irakli Gvilia  
 (540)



(591) White, blue, golden  
 (531) 01.17.11, 28.19, 29.01.13, 01.03.16  
 (511) 4, 40

(111) M 2015 26148 R  
 (151) 2015 07 24  
 (181) 2025 07 24  
 (210) AM 82468  
 (220) 2015 06 10  
 (732) JSC "KHRAMHESI-2"  
 Daba Khramhesis-2, Dmanisis raioni, Georgia  
 (740) Irakli Gvilia  
 (540)



(591) White, blue, golden  
 (531) 01.17.11, 28.19, 29.01.13, 01.03.16  
 (511) 4, 40

(111) M 2015 26149 R  
 (151) 2015 07 24  
 (181) 2025 07 24  
 (210) AM 82469  
 (220) 2015 06 10  
 (732) JSC "KHRAMHESI-2"  
 Daba Khramhesis-2, Dmanisis raioni, Georgia  
 (740) Irakli Gvilia  
 (540)



(591) White, blue, golden  
 (531) 01.03.16, 01.17.11, 28.05, 29.01.13

(526) The trademark is protected as a whole. "ГЭС" shall not be subject to independent legal protection.  
(511) 4, 40

(111) M 2015 26150 R

(151) 2015 07 24

(181) 2025 07 24

(210) AM 82470

(220) 2015 06 10

(732) JSC "KHRAMHESI-2"

Daba Khramhesis-2, Dmanisis raioni,  
Georgia

(740) Irakli Gvilia

(540)



(591) White, blue, golden

(531) 01.03.16, 01.17.11, 27.05.17, 29.01.13

(511) 4, 40

(111) M 2015 26151 R

(151) 2015 07 24

(181) 2025 07 24

(210) AM 82472

(220) 2015 06 10

(732) JSC "MTKVARI ENERGETIKA"

D. Agmasheneblis q. 2, Gaqrdabani,  
Georgia

(740) Irakli Gvilia

(540)



(591) White, blue, golden

(531) 28.05, 29.01.13, 01.17.11, 01.03.16

(526) The trademark is protected as a whole. "ЭНЕРГЕТИКА" shall not be subject to independent legal protection.

(511) 4, 40

(111) M 2015 26152 R

(151) 2015 07 24

(181) 2025 07 24

(210) AM 82473

(220) 2015 06 10

(732) JSC "MTKVARI ENERGETIKA"

D. Agmasheneblis q. 2, Gaqrdabani,  
Georgia

(740) Irakli Gvilia

(540)



(591) White, blue, golden

(531) 01.17.11, 28.19, 01.03.16, 29.01.13

(526) The trademark is protected as a whole. „ენერგეტიკა“ shall not be subject to independent legal protection.

(511) 4, 40

(111) M 2015 26153 R

(151) 2015 07 24

(181) 2025 07 24

(210) AM 82474

(220) 2015 06 10

(732) JSC "MTKVARI ENERGETIKA"

D. Agmasheneblis q. 2, Gaqrdabani, Georgia

(740) Irakli Gvilia

(540)



(591) White, blue, golden

(531) 01.17.11, 27.05.17, 29.01.13, 01.03.16,

(526) The trademark is protected as a whole. "ENERGY" shall not be subject to independent legal protection.

(511) 4, 40

(111) M 2015 26174 R

(151) 2015 07 29

(181) 2025 07 29

(210) AM 82983

(220) 2015 07 14

(732) LTD "TBILCEMENT GROUP"

Zahesi, 3306, Mtskheta, Georgia

(740) Giorgi Taktakishvili

(540)



(591) White, yellow, black  
 (531) 26.04.01, 26.04.09, 26.04.24, 28.19, 29.01.12  
 (511) 19

(111) M 2015 26175 R  
 (151) 2015 07 29  
 (181) 2025 07 29  
 (210) AM 82984  
 (220) 2015 07 14  
 (732) LTD "TBILCEMENT GROUP"  
 Zahesi, 3306, Mtskheta, Georgia  
 (740) Giorgi Taktakishvili  
 (540)



(591) White, yellow, black  
 (531) 26.04.01, 26.04.09, 26.04.24, 27.05.05,  
 29.01.12  
 (511) 19

(111) M 2015 26176 R  
 (151) 2015 07 29  
 (181) 2025 07 29  
 (210) AM 82985  
 (220) 2015 07 14  
 (732) LTD "TBILCEMENT GROUP"  
 Zahesi, 3306, Mtskheta, Georgia  
 (740) Giorgi Taktakishvili  
 (540)



(591) White, yellow, black  
 (531) 26.04.24, 28.19, 29.01.12, 26.04.09, 26.04.01  
 (511) 19

(111) M 2015 26177 R  
 (151) 2015 07 29  
 (181) 2025 07 29  
 (210) AM 82986  
 (220) 2015 07 14  
 (732) LTD "TBILCEMENT GROUP"  
 Zahesi, 3306, Mtskheta, Georgia

(740) Giorgi Taktakishvili  
 (540)



(591) White, yellow, black  
 (531) 26.04.09, 26.04.24, 27.05.24,  
 29.01.12, 26.04.01  
 (511) 19

(111) M 2015 26178 R  
 (151) 2015 07 30  
 (181) 2025 07 30  
 (210) AM 82830  
 (220) 2015 07 06  
 (732) LTD "Portal"  
 D. Gamrekeli str. 19, 6<sup>th</sup> Fl., Room 606, 0169,  
 Tbilisi, Georgia  
 (740) Shalva Khukhashvili  
 (540)



(591) White, blue, grey, red  
 (531) 27.01.06, 28.19, 29.01.14, 01.15.05, 26.11.12  
 (526) The trademark is protected as a whole.  
 „ნავთობპროდუქტების სადისტრიბუციო კომ-  
 პანია“ shall not be subject to independent legal  
 protection.  
 (511) 35, 37

## INTERNATIONAL TRADEMARKS FOR WHICH A DECISION ON GRANTING PROTECTIONS IS TAKEN

The decision can be appealed at the Chamber of Appeal of Sakpatenti within 3 months from the publication or at the Mtskheta District Court Administrative Cases Board (Address: №17, Samkhedro str., Mtskheta), within 1 month following the publication.

(260) AM 2015 75332 A\*

(800) 1185689

(891) 2013 06 22

(731) Guangzhou City Baiyun Lianjia Fine Chemical Factory  
No. 6-1, Yongxing Industrial Zone, Chentai Road, Taihe Town, Baiyun District, Guangzhou City, Guangdong; China

(540)



(591) Black, white

(511)

3 – Sunscreen preparations (cosmetics); cosmetic preparations for slimming purposes; macule-removing cream; hair treatment cream; talcum powder; cream for whitening the skin; hair spray; cosmetic preparations for skin care; acne cream; boot cream; essential oils; cosmetics; lipsticks; beauty masks; hair dyes; cosmetic creams; perfumes; toilet water; depilatories; soap; hair lotions; shampoos; cakes of soap; shampoos; hair conditioner; facial cleanser; cosmetic hand lotions with antibacterial properties; washing preparations.

(260) AM 2015 77542 A

(800) 1205154

(891) 2014 04 02

(731) Limited Liability Company "AvantaScience"  
Krzhizhanovskogo street, 24/35, building 4, RU-117218 Moscow; Russian Federation

(540)

ATOPIC

(511)

3 – Bleaching preparations and other substances for laundry use; cleaning, polishing, scouring and abrasive preparations; soaps; perfumery, essential oils, cosmetics, hair lotions; dentifrices.

(260) AM 2015 77649 A

(800) 1205929

(891) 2014 03 12

(731) OTKRYTOE AKTSIONERNOE

OBSHCHESTVO "COSMETICHESKOE

OBYEDINENIE "SVOBODA"

ul. Vyatskaya, D. 47, RU-127015

Moscow, Russian Federation

(540)

KRASIVA  
COSMETICS

(540) KRASIVA COSMETICS

(591) Black, white

(526) The trademark is protected as a whole. "COSMETICS" shall not be subject to independent legal protection.

(511)

3 – Cosmetic creams; skin whitening creams; lotions for cosmetic purposes; cosmetic masks; cosmetic oils; soap; cosmetic kits; cosmetic preparations for baths; hair dyes; cosmetic preparations for skin care; cosmetics; shampoos

(260) AM 2015 77655 A

(800) 1206025

(891) 2014 04 25

(731) Galina Viktorovna Bubyrenko  
Guryevskiy pr-d, 29, korp. 1, kv. 470,  
RU-115597 Moscow, Russian Federation

(540)



АЛПИНА  
ПЛАСТ

(591) Dark-gray, white, blue, dark-azure, azure

(511)

10 – Medical apparatus and instruments, including rectal coionic tubes, plastisol vaginal syringes; nasal aspirators (appliances for cleaning and rinsing nasal cavity); feeding bottles; breast pumps; nursing appliances; babies' pacifiers [teats]; feeding bottle teats; catheters; cupping glasses; arterial blood pressure measuring apparatus; receptacles for applying medicines, including receptacles for breast milk collection and storage; abdominal pads; cushions for medical purposes; pads [pouches] for preventing pressure sores on patient bodies; heating

cushions [pads], electric, for medical purposes; brushes for cleaning body cavities; appliances for washing body cavities.

28 – Balls, including exercise balls.

(260) AM 2015 77656 A

(800) 1206037

(891) 2014 04 29

(731) SHANDONG FENGYUAN TYRE MANUFACTURE LIMITED COMPANY  
Economic Development Zone, Yicheng  
District, Zaozhuang City, Shandong; China

(540)

远路  
FAR ROAD

(591) Black, white

(511)

12 – Inner tubes for pneumatic tires; tires for vehicle wheels; cover tire tread for vehicles (belts for wheels); spikes for tires; casings for pneumatic tires [tyres]; car tires; auto tires; solid tires for vehicle wheels; treads for retreading tires [tyres].

(260) AM 2015 77660 A

(800) 1206148

(891) 2014 03 18

(731) KRONOPOL Spółka z ograniczoną odpowiedzialnością  
Ul. Serbska 56, PL-68-200 Żary; Poland

(540)



(591) Red

(511)

19 – Woodwork, tiles for building not made of metal, non-metallic tiles, non-metallic cornice, parquet floor boards, laminated wooden flooring, mosaics for building, non-metallic cornice moldings, non-metallic door panels, non-metallic panels for building, parquet flooring, wood paving, wood veneers, non-metallic floors, planks [timber], non-metallic coatings [building], non-metallic wall coverings [building], non-metallic thresholds.

(260) AM 2015 78094 A

(800) 1209748

(891) 2014 04 15

(731) GUCCIO GUCCI S.P.A.  
Via Tornabuoni, 73/R, I-50123 FIRENZE,  
Italy

(540)

**HANDMASTER**

(511)

14 – Wrist and pocket watches, jewelry, earrings, rings, chains, bracelets, wall clocks, table clocks, chronometers, chronographs.

(260) AM 2015 78100 A

(800) 1002033

(891) 2014 05 07

(731) Società Agricola Innocenti e Mangoni  
Piante di Innocenti Agostino e C. s.s.  
Via del Girone, 17, I-51100 Chianciano PT,  
Italy

(540)



INNOCENTI  
& MANGONI  
PIANTE

(591) Light green, dark green, yellow and white  
(511)

31 – Agricultural, horticultural and forestry products and grains not included in other classes; live animals; fresh fruits and vegetables; seeds, natural plants and flowers; foodstuffs for animals, malt; ornamental plants, namely conifers, trees and shrubs evergreen, trees and shrubs of caducous leaves, palmaceous trees, creepers, rose-gardens, fruit-bearing trees and herbaceous plants.

(260) AM 2015 78345 A

(800) 1211155

(891) 2014 04 16

(731) Efes Breweries International N.V.  
Strawinskylaan 1227, NL-1077  
XX AMSTERDAM; Netherlands

(540)





(591) Red, different shades of brown, yellow, white  
(511)

32 – Beers; mineral and aerated waters and other non-alcoholic drinks; fruit drinks and fruit juices; syrups and other preparations for making beverages; carbonated non-alcoholic drinks, carbonated beer-based low-alcoholic drinks, drinks consisting principally of juices.

33 – Alcoholic beverages (except beers), including vodka, brandy, Armenian brandy, wines, sparkling wines; carbonated low-alcoholic drinks, other than beer-based.

(260) AM 2015 78348 A

(800) 1211199

(891) 2014 04 11

(731) Università Cattolica del Sacro Cuore  
Largo Gemelli n. 1, I-20123 Milano; Italy

(540)

**UNIVERSITÀ CATTOLICA del Sacro Cuore**

(591) Grey – Pantone Cool Grey 11C

(526) The trademark is protected as a whole. "UNIVERSITÀ CATTOLICA NECT" shall not be subject to independent legal protection.

(511)

41 – Education; providing of training; entertainment; sporting and cultural activities.

(260) AM 2015 78354 A

(800) 1211288

(891) 2014 03 20

(731) CHINA TOBACCO HENAN  
INDUSTRIAL CO., LTD.  
No.29 Nongye East Road, Zhengzhou City  
Henan Province; China

(540)



(591) Black, white

(511)

34 – Tobacco; cigars; cigarettes; shredded tobacco; cigarette cases; ashtrays for smokers; matches; lighters for smokers; cigarette filters; filter tow for cigarettes.

(260) AM 2015 78463 A

(800) 1212654

(891) 2014 05 26

(731) Zakrytoe aktsionernoe obshchestvo

"Vostok-Servis-Spetskomplekt"

Rabochaya ul., d. 46-a, Noginsky r-n,  
Moskovskaya obl., RU-142400 Noginsk,  
Russian Federation

(540)

## Восточные тигры

(511)

9 – Measuring instruments; solderers' helmets; protective masks; headphones; shoes for protection against accidents, irradiation and fire; clothing for protection against accidents, irradiation and fire; clothing for protection against fire; asbestos clothing for protection against fire; gloves for protection against accidents; asbestos gloves for protection against accidents; gloves for protection against X-rays for industrial purposes; respirators for filtering air; respiratory masks, other than for artificial respiration; filters for respiratory masks; safety tarpaulins; bullet-proof waistcoats [vests (Am.)]; life jackets; protective helmets; anti-glare visors; protective suits for aviators; logs [measuring instruments]; spectacles [optics]; life belts; measuring apparatus.

25 – Underwear; sweat-absorbent underwear; half-boots; breeches for wear; trousers; vests; hoods [clothing]; combinations [clothing]; suits; jackets [clothing]; fishing vests; ear muffs [clothing]; outerclothing; ready-made clothing; clothing of imitations of leather; clothing of leather; knitwear [clothing]; gloves [clothing]; lace boots; belts [clothing]; shirts; koma-geta [low wooden clogs]; aprons [clothing]; dressing gowns.

(260) AM 2015 78464 A

(800) 1212658

(891) 2014 07 02

(731) Obshchestvo s ogranichennoy  
otvetstvennostyu "Parafarm"  
ul. Sverdlova, d. 4, RU-440026 g. Penza,  
Russian Federation

(540)

## OSTEOFILLER

(511)

5 – Pharmaceutical and veterinary preparations; sanitary preparations for medical purposes; dietetic food and substances adapted for medical or veterinary use, food for babies; nutritional supplements for humans and animals; material for stopping teeth, dental wax; amino acids for medical purposes; analgesics; anaesthetics; antibiotics; antiseptics; balms for medical purposes; biologically active food supplements; dietetic substances adapted for medical use; hormones for medical purposes; mineral food supplements; nutritional supplements; albumin dietary supplements; dietary supplements for animals; alginate dietary supplements; glucose

dietary supplements; casein dietary supplements; lecithin dietary supplements; linseed oil dietary supplements; propolis dietary supplements; protein dietary supplements; protein supplements for animals; royal jelly dietary supplements; pollen dietary supplements; wheat germ dietary supplements; linseed dietary supplements; enzyme dietary supplements; teeth filling material; drugs for medical purposes; medicines for human purposes; medicines for dental purposes; royal jelly for pharmaceutical purposes; milk ferments for pharmaceutical purposes; biological preparations for medical purposes; vitamin preparations; preparations for callouses; preparations of lime for pharmaceutical purposes; pharmaceutical preparations; chemico-pharmaceutical preparations; albuminous foodstuffs for medical purposes; dietetic foods adapted for medical purposes; tonics [medicines]; nervines; antioxidant pills.

(260) AM 2015 78467 A  
(800) 1212710  
(891) 2014 02 14  
(731) Bestway Inflatables & Material Corp.  
3065 Cao An Road, 201812 Shanghai, China  
(540)

## COMFORT CELL TECH

(511)  
19 – Non-metallic beams.  
20 – Inflatable pillows, inflatable chairs, inflatable lounges and other furniture.  
28 – Inflatable toys, floats and pleasure facilities, namely: inflatable mats for recreational use, lounges, islands, boats, rafts, kayaks, inflatable pools, play swimming pools, water slides, play centers and activity centers; floating mattresses, mats armchairs, seats, all of them for recreational use: jumping tube gym.

(260) AM 2015 78471 A  
(800) 1212762  
(891) 2014 02 26  
(731) Vadym Oleksandrovykh Dubov  
vul. Dovbusha, 18/4, m. Lviv 79008,  
Ukraine  
(540)

## ЦИАКРИН 90

(591) Black, white  
(511)  
1 – Adhesives for industrial purposes; cement for mending broken articles.  
16 – Adhesives for household purposes.

(260) AM 2015 78478 A  
(800) 1212840  
(891) 2014 04 23  
(731) Ahmad Tea Limited  
Winchester Road, Chandlers Ford,  
Hampshire SO53 2PZ (United Kingdom),  
United Kingdom  
(540)



(591) Black, white  
(511)  
30 – Coffee, tea, cocoa, sugar, rice, tapioca, sago, artificial coffee; flour and preparations made from cereals; bread, pastry and confectionery, ices; honey; treacle; yeast, baking-powder; salt; mustard; vinegar, sauces (condiments); spices; ice; freeze dried coffee; beverages made of coffee; coffee beans; ground coffee beans; beverages made with a base of espresso; beverages made with a base of tea, powdered chocolate and vanilla; fruit sauces; baked goods, namely, muffins, scones, biscuits, cookies, pastries, pies, pasties and breads, sandwiches and granola; snack foods; prepared meals consisting primarily of pasta, or rice, or cereals; ready-to-drink coffee, ready-to-drink tea, ice cream, frozen confectionery; chocolate, candy and confections; flavouring syrups for making coffee, tea and herbal tea-based beverages.

(260) AM 2015 78551 A  
(800) 1213660  
(891) 2014 04 14  
(731) "Amalgama Luxe" Ltd.  
Gromodyanska, 119, of. 109, Mykolayiv  
54017, Ukraine  
(540)

## У ПЕРХОТИ НЕТ ШАНСОВ

(511)  
3 – Abrasive paper; abrasives; adhesives for affixing false hair; adhesives for affixing false eyelashes; adhesives for cosmetic purposes; after-shave lotions; air fragranting preparations; almond soap; almond milk for cosmetic purposes; almond oil; aloe vera preparations for cosmetic purposes; alum stones [astringents]; amber [perfume]; ammonia [volatile alkali] [detergent]; antiperspirant soap; antiperspirants [toiletries]; antistatic preparations for household purposes; aromatics [essential oils]; astringents for cosmetic purposes; badian essence; balms other

than for medical purposes; bases for flower perfumes; bath salts, not for medical purposes; beard dyes; beauty masks; bergamot oil; bleaching preparations [decolorants] for cosmetic purposes; bleaching salts; bleaching soda; breath freshening sprays; breath freshening strips; cake flavourings [essential oils]; cakes of toilet soap; canned pressurized air for cleaning and dusting purposes; carbides of metal [abrasives]; preparations for cleaning dentures; cleaning preparations; cleaning chalk; cleansing milk for toilet purposes; cloths impregnated with a detergent for cleaning; cobblers' wax; color- [colour-] brightening chemicals for household purposes [laundry]; colorants for toilet purposes; colour-removing preparations; corundum [abrasive]; cosmetic pencils; cosmetic preparations for eyelashes; cosmetic preparations for baths; cosmetic preparations for skin care; cosmetic dyes; cosmetic creams; cosmetic kits; cosmetic preparations for slimming purposes; cosmetics; cosmetics for animals; cotton wool for cosmetic purposes; creams for leather; decorative transfers for cosmetic purposes; degreasers other than for use in manufacturing processes; dental bleaching gels; dentifrices; denture polishes; deodorant soap; deodorants for human beings or for animals; deodorants for pets; depilatory preparations; depilatory wax; detergents other than for use in manufacturing operations and for medical purposes; diamantine [abrasive]; disinfectant soap; douching preparations for personal sanitary or deodorant purposes [toiletries]; dry shampoos; dry-cleaning preparations; drying agents for dishwashing machines; eau de Cologne; emery paper; emery cloth; emery; essential oils of cedarwood; essential oils of citron; essential oils of lemon; ethereal essences; ethereal oils; extracts of flowers [perfumes]; eyebrow pencils; eyebrow cosmetics; fabric softeners for laundry use; false eyelashes; false nails; flavorings [flavourings] for beverages [essential oils]; floor wax removers [scouring preparations]; fumigation preparations [perfumes]; furbishing preparations; gaultheria oil; geraniol; glass cloth; greases for cosmetic purposes; grinding preparations; hair lotions; hair dyes; hair waving preparations; hair spray; heliotropine; henna [cosmetic dye]; hydrogen peroxide for cosmetic purposes; incense; ionone [perfumery]; jasmine oil; javelle water; joss sticks; lacquer-removing preparations; laundry bleach; laundry preparations; laundry blueing; laundry glaze; laundry wax; laundry soaking preparations; lavender water; lavender oil; leather bleaching preparations; leather preservatives [polishes]; lip glosses; lipsticks; lotions for cosmetic purposes; make-up preparations; make-up; mascara; massage gels other than for medical purposes; medicated soap; mint for perfumery; mint essence [essential oil]; moustache wax; mouth washes, not for medical purposes; musk

[perfumery]; nail varnish; nail care preparations; nail art stickers; neutralizers for permanent waving; non-slipping wax for floors; non-slipping liquids for floors; oil of turpentine for degreasing; oils for cosmetic purposes; oils for toilet purposes; oils for perfumes and scents; oils for cleaning purposes; paint stripping preparations; parquet floor wax; pastes for razor strops; perfumery; perfumes; petroleum jelly for cosmetic purposes; polish for furniture and flooring; polishing preparations; polishing wax; polishing creams; polishing rouge; polishing stones; polishing paper; pomades for cosmetic purposes; potpourris [fragrances]; make-up powder; pumice stone; quillaia bark for washing; make-up removing preparations; rose oil; rust removing preparations; sachets for perfuming linen; safrol; sandcloth; scale removing preparations for household purposes; scented water; scented wood; scouring solutions; shampoos; shampoos for pets; shaving soap; shaving preparations; shaving stones [astringents]; shining preparations [polish]; preparations to make shiny the leaves of plants; shoe cream; shoe polish; shoe wax; shoemakers' wax; silicon carbide [abrasive]; skin whitening creams; smoothing preparations [starching]; smoothing stones; soap; soap for foot perspiration; soap for brightening textile; soda lye; stain removers; starch glaze for laundry purposes; starch for laundry purposes; sun-tanning preparations [cosmetics]; sunscreen preparations; swabs [toiletries]; tailors' wax; talcum powder, for toilet use; terpenes [essential oils]; tissues impregnated with cosmetic lotions; toilet water; toiletries; tripoli stone for polishing; turpentine, for degreasing; preparations for unblocking drain pipes; varnish-removing preparations; volcanic ash for cleaning; wallpaper cleaning preparations; washing soda, for cleaning; whitening; windscreen cleaning liquids.

(260) AM 2015 78672 A

(800) 1214873

(891) 2013 12 24

(731) Salini Impregilo S.p.A.

Via dei Missaglia, 97, I-20142 Milano; Italy

(540)



(591) Red and white

(511)

19 – Building materials not of metal; non-metallic rigid pipes for building; asphalt, pitch and bitumen;



non-metallic transportable buildings; monuments not of metal.

37 – Building; repairing; installation services.

40 – Treatment of materials.

42 – Scientific and technological services and research and design services relating thereto; industrial research and analysis; design and development of hardware and software.

(260) AM 2015 78724 A

(800) 1215652

(891) 2014 06 16

(731) SHIONOGI & CO., LTD.

1-8, Doshomachi 3-chome, Chuo-ku,  
Osaka-shi, Osaka 541-0045; Japan

(540)

**SENSHIO**

(591) Black, white

(511)

5 – Pharmaceutical preparations; pharmaceutical preparations for use in the treatment of menopausal disorders and other disorders of aging women.

(260) AM 2015 78725 A

(800) 1215653

(891) 2014 06 16

(731) SHIONOGI & CO., LTD.

1-8, Doshomachi 3-chome, Chuo-ku,  
Osaka-shi, Osaka 541-0045; Japan

(540)

**JOLIEVE**

(591) Black, white

(511)

5 – Pharmaceutical preparations; pharmaceutical preparations for use in the treatment of menopausal disorders and other disorders of aging women.

(260) AM 2015 78726 A

(800) 1215683

(891) 2014 04 25

(731) Peter VANHECKE

Bogdana Khmel'nitskogo, Street 80 app. 14,  
Kiev 01030; Ukraine

(540)



(591) Red, yellow, green, white and black

(511)

3 – Perfumery, essential oils, cosmetics, hair lotions; soap; dentifrices; bleaches; cleaning, polishing, scouring and abrasive.

14 – Jewelry, including bracelets and necklaces, all made of leather or imitation leather.

18 – Leather and imitation leather; animal skins; trunks and suitcases; umbrellas, parasols and walking sticks; whips, harness and saddlery; bags, purses, briefcases, luggage tags, hat boxes, bags, handbags, wallets, shoulder straps, cases for credit cards, holders for credit cards, garment bags [holdalls], wallets for credit cards, key cases, sports bags, all of leather or composition leather.

25 – Clothing, footwear, headgear; belts [clothing].

35 – Advertisement; business management; business administration; retail services in the field of clothing, footwear and headgear; wholesale services in the field of clothing, footwear and headgear; business mediation in the sale (by electronic means such as the internet) of clothing, footwear and headgear.

(260) AM 2015 78727 A

(800) 1215693

(891) 2014 06 02

(731) Apple Inc.

1 Infinite Loop, Cupertino CA 95014; USA

(540)

**MACBOOK PRO**

(511)

9 – Computers; notebook computers; computer hardware; computer operating system software; electrical power adaptors; electrical power cords; computer batteries; remote controls for use with computers; cables and connectors for use with computers and computer peripherals; downloadable electronic publications in the nature of instruction manuals in the field of computers, notebook computers, computer hardware, computer operating system software, computer batteries and other computer accessories and peripherals.

(260) AM 2015 78729 A

(800) 1215725

(891) 2014 01 24

(731) Limited Liability Company Scientific-production association "StarLine"  
ul. Komissara Smirnova, 9, RU-194044  
Saint-Petersburg; Russian Federation

(540)

**StarLine®**

(591) Blue and white

(526) The trademark is protected as a whole. "®" shall not be subject to independent legal protection.

(511)

11 – Defrosters for vehicles; air conditioners for vehicles; gas lamps for vehicles, including xenon and bi-xenon lamps for vehicles; halogen light bulbs for vehicles; light bulbs for directional signals for vehicles; heating apparatus for defrosting windows of vehicles; vehicle reflectors; lighting apparatus for vehicles; heating apparatus for vehicles, electric, including heaters for vehicle seats and heating covers for vehicle seats; anti-dazzle devices for automobiles [lamp fittings]; anti-glare devices for vehicles [lamp fittings]; air conditioning installations for vehicles; heaters for vehicles; headlights for automobiles, including xenon and bi-xenon headlights; vehicle headlights; lights for vehicles.

12 – Anti-theft devices for vehicles, including immobilisers, gear box blockers, rudder blockers; non-skid devices for vehicle tires [tyres]; luggage nets for vehicles; anti-theft alarms for vehicles; reversing alarms for vehicles, including satellite alarms; safety seats for children, for vehicles; anti-skid chains for vehicles; covers for vehicle steering wheels; seat covers for vehicles.

(260) AM 2015 78731 A

(800) 1215731

(891) 2014 03 13

(731) Keysight Technologies, Inc.

1400 Fountaingrove Parkway, Santa Rosa  
CA 95403; USA

(540)

**KEYSIGHT**

(511)

9 – Electronic test, signaling and measurement apparatus, systems, and equipment, and parts and components therefor; optical and imaging apparatus, instruments, and equipment, and parts and components therefor; scientific and laboratory apparatus, instruments, and equipment, and parts and components therefor; electronic and electrical apparatus, instruments, and equipment, and parts and components therefor; lasers; microscopes; monitoring apparatus; recording apparatus; processors; microprocessors; detectors; sensors; transmitters; receivers; remote control apparatus; motion control apparatus; computers; computer hardware; computer peripherals; computer software; computer programs; data storage device; data processing apparatus; power supplies and power systems; semiconductors; semiconductor devices; opto-electronic, photonic, and nano-scale test, signaling, imaging and measurement apparatus, instruments, systems, and equipment, and parts, components and accessories therefor; monolithic optical assemblies and laser combiners for electronic

and scientific apparatus, instruments, and systems; source measure analyzers; power quality monitors for electronic and industrial apparatus, instruments, and systems.

(260) AM 2015 78758 A

(800) 1215767

(891) 2014 05 07

(731) Egis Gyógyszergyár Zrt.

Keresztúri út 30-38, H-1106 Budapest;  
Hungary

(540)

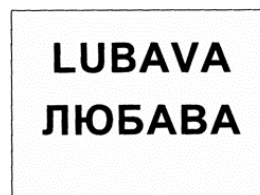

(591) Black, white

(511)

5 – Pharmaceutical preparations for human use.

(260) AM 2015 78759 A

(800) 1215768

(891) 2014 05 07

(731) Egis Gyógyszergyár Zrt.

Keresztúri út 30-38, H-1106 Budapest;  
Hungary

(540)



(591) Black, white

(511)

5 – Pharmaceutical preparations for human use.

(260) AM 2015 78761 A

(800) 1215784

(891) 2014 07 14

(731) Lodestar Anstalt

(a Liechtenstein company)

Lova-Center, PO Box 1150, FL-9490  
Vaduz; Liechtenstein

(540)

**UNTAMEABLE**

(511)

32 – Non-alcoholic beverages; soft drinks; energy drinks; fruit drinks and fruit juices; mineral water; preparations for making beverages; beers; lagers; non-alcoholic beers; non-alcoholic lagers; preparations for making beers, lagers, non-alcoholic beers and non-alcoholic lagers.

33 – Alcoholic beverages (except beer); rum; whiskey; vodka; gin; distilled beverages; distilled spirits; liqueurs; cocktails.

(260) AM 2015 78762 A

(800) 1215792

(891) 2014 05 15

(731) SANOFI PASTEUR

2, avenue Pont Pasteur, F-69007 LYON;

France

(540)



(591) Blue, white, red

(511)

5 – Pharmaceutical preparations, vaccines.

(260) AM 2015 78763 A

(800) 1215798

(891) 2014 06 30

(731) Société Jas Hennessy & Co.

Rue de la Richonne, F-16100 Cognac;

France

(540)

**CRAFTING THE FUTURE SINCE 1765**

(511)

33 – Alcoholic beverages (except beers); alcoholic cocktails.

(260) AM 2015 78764 A

(800) 1215805

(891) 2014 05 07

(731) SANOFI

54 rue La Boétie, F-75008 Paris; France

(540)

**GOFURLO**

(511)

5 – Pharmaceutical products.

(260) AM 2015 78765 A

(800) 1215832

(891) 2013 01 30

(731) Agilent Technologies, Inc.

5301 Stevens Creek Blvd., Santa Clara,

CA 95051; USA

(540)

**AGILENT**

(511)

5 – Clinical medical reagents, namely, collection fluids for preserving and preparing samples for clinical presentation and evaluation; diagnostic

reagent kits comprising nucleic acids, nucleotides, enzymes, labels, and buffers, and microscopic carrier beads with attached biomolecules for medical diagnostic purposes; enzymes, oligonucleotides, nucleic acids, natural and modified nucleotides, buffers, labels, and substrates for medical diagnostic purposes; medical and forensic diagnostic test kits used for clinical and medical uses consisting of reagents, extraction cartridges, test cards, pipettes and swabs for the analysis of drugs and alcohol in human fluids; medical diagnostic reagents and assays for testing of body fluids, genetics research, and nucleic acid analysis and sizing for medical and therapeutic use; chemical reagents and diagnostic preparations for clinical or medical laboratory and veterinary use; biological cell and tissue cultures for medical research use; fabricated polymer films and tapes for use in medical testing.

9 – Laboratory equipment, namely microarrays; DNA chips for use in medical testing.

10 – Filters for medical purposes, namely, plastic, glass or metal tubes, columns, and cartridges for use in medical testing; fabricated films and slides for performing PCR reactions for medical testing; apparatus for use in radiology for medical research, namely, magnetic resonance imagers and consoles sold as a unit; medical test kits for clinical and medical diagnosis and medical research purposes; diagnostic apparatus and instruments for medical use, namely, apparatus for staining of tissue or cell based samples for diagnostic or medical use; medical test kits comprised of spectra analysis equipment, serum media devices, cell and tissue cultures for medical research, medical diagnostic purposes and for laboratory uses.

(260) AM 2015 78767 A

(800) 1215837

(891) 2013 11 22

(731) Zakrytoe aktsionernoe obshchestvo

"Starodvorskie kolbasy"

ul. Poliny Osipenko, 41, RU-600009

Vladimir; Russian Federation

(540)



(591) Dark orange, orange, bronze, dark-red, red-wine colour, green, apple-green, beige, white-beige and blue

(511)

29 – Meat, fish, poultry and game; meat extracts; preserved, frozen, dried and cooked fruits and vegetables; jellies, jams, compotes; eggs; milk and milk products; edible oils and fats; ajvar [preserved peppers]; aloe vera prepared for human consumption; alginates for culinary purposes; anchovy; peanuts, processed; albumen for culinary purposes; white of eggs; beans, preserved; soya beans, preserved, for food; bouillon; ginger jam; ham; fatty substances for the manufacture of edible fats; toasted laver; edible birds' nests; peas, preserved; mushrooms, preserved; gelatine; meat jellies; jellies for food; fruit jellies; yolk of eggs; coconut fat; bone oil, edible; lard for food; suet for food; fruit-based snack food; charcuterie; raisins; caviar; processed fish spawn; yoghurt; sauerkraut; kefir [milk beverage]; isinglass for food; clams, not live; milk shakes; black pudding; meat, tinned; vegetables, tinned; fish, tinned; fruits, tinned; bouillon concentrates; gherkins; shrimps, not live; prawns, not live; buttercream; croquettes; silkworm chrysalis, for human consumption; kumys [kumyss] [milk beverage]; spiny lobsters, not live; lecithin for culinary purposes; salmon; onions, preserved; margarine; piccalilli; marmalade; peanut butter; chocolate nut butter; colza oil for food; coconut butter; corn oil; sesame oil; flaxseed oil for culinary purposes; palm oil for food; palm kernel oil for food; sunflower oil for food; coconut oil; butter; shellfish, not live; almonds, ground; animal marrow for food; mussels, not live; albumin milk; soya milk [milk substitute]; fishmeal for human consumption; vegetable mousses; fish mousses; fruit pulp; meat, preserved; milk beverages, milk predominating; potato fritters; olives, preserved; lobsters, not live; coconut, desiccated; nuts, prepared; tomato purée; liver pâté; pectin for culinary purposes; liver; pickles; jams; powdered eggs; kimchi [fermented vegetable dish]; food products made from fish; prostokvasha [soured milk]; poultry, not live; pollen prepared as foodstuff; cranberry sauce [compote]; apple purée; crayfish, not live; crustaceans, not live; fish, preserved; salted fish; vegetable salads; fruit salads; bacon; sardines; pork; herrings; processed seeds; processed sunflower seeds; cream [dairy products]; whipped cream; fat-containing mixtures for bread slices; tomato juice for cooking; vegetable juices for cooking; salted meats; sausages; sausages in batter; preparations for making bouillon; preparations for making soup; tripe; soups; vegetable soup preparations; whey; cheese; tahini [sesame seed paste]; tofu; sea-cucumbers, not live; truffles, preserved; tuna fish; oysters, not live; milk ferments for culinary purposes; rennet; fish fillets; dates; crystallized fruits; frozen fruits; fruit preserved in alcohol; fruit, stewed; potato flakes; hummus [chickpea paste]; fruit peel; preserved garlic; lentils, preserved; potato chips; low-fat potato

chips; fruit chips; non-alcoholic eggnog; seaweed extracts for food; snail eggs for consumption.

30 – Coffee; tea; cocoa; sugar; rice; tapioca; sago; artificial coffee; flour and preparations made from cereals; bread, pastry and confectionery; edible ices; sugar, honey, treacle; yeast, baking-powder; salt; mustard; vinegar, sauces [condiments]; spices; ice; aromatic preparations for food; flavorings [flavourings], other than essential oils, for cakes; flavorings [flavourings], other than essential oils, for beverages; coffee flavorings; flavorings, other than essential oils; star aniseed; high-protein cereal bars; pancakes; noodle-based prepared meals; buns; bread rolls; vanillin [vanilla substitute]; vanilla [flavoring]; waffles; vermicelli [noodles]; natural sweeteners; sausage binding materials; binding agents for edible ices; sea water for cooking; seaweed [condiment]; malt biscuits; cloves [spice]; cake frosting [icing]; glucose for culinary purposes; gluten additives for culinary purposes; yeast; thickening agents for cooking foodstuffs; leaven; rice-based snack food; cereal-based snack food; vegetal preparations for use as coffee substitutes; dressings for salad; fruit jellies [confectionery]; confectionery for decorating Christmas trees; cakes; pastries; peanut confectionery; almond confectionery; farinaceous food pastes; pasties; ginger [spice]; frozen yoghurt [confectionery ices]; capers; caramels [candy]; curry [spice]; gruel, with a milk base, for food; quiches; gluten prepared as foodstuff; sweetmeats [candy]; liquorice [confectionery]; peppermint sweets; cinnamon [spice]; unroasted coffee; starch for food; crackers; custard; hominy grits; semolina; oatmeal; crushed barley; groats for human food; corn, milled; corn, roasted; meat pies; turmeric for food; couscous [semolina]; farinaceous foods; noodles; ice for refreshment; ice, natural or artificial; edible ices; candy; rice cakes; mayonnaise; macaroons [pastry]; macaroni; maltose; hominy; marinades; marzipan; honey; royal jelly; ice cream; bean meal; tapioca flour for food; potato flour for food; corn flour; wheat flour; soya flour; barley meal; dessert mousses [confectionery]; chocolate mousses; muesli; mint for confectionery; cocoa beverages with milk; coffee beverages with milk; coffee-based beverages; tea-based beverages; chocolate beverages with milk; chocolate-based beverages; cocoa-based beverages; infusions, not medicinal; crushed oats; husked oats; nutmegs; stick liquorice [confectionery]; soya bean paste [condiment]; lozenges [confectionery]; molasses for food; pepper; allspice; peppers [seasonings]; pesto; biscuits; petit-beurre biscuits; pies; pizzas; meat gravies; fondants [confectionery]; pop corn; powder for edible ices; mustard meal; pralines; condiments; meat tenderizers, for household purposes; cereal preparations; flour-milling products; oat-based food; bee glue; gingerbread; petits fours [cakes]; puddings; cake powder; fruit coulis [sauces]; ravioli; chewing gum;

relish [condiment]; wheat germ for human consumption; spring rolls; aniseed; flaxseed for human consumption; golden syrup; cake paste; baking soda [bicarbonate of soda for cooking purposes]; malt for human consumption; salt for preserving foodstuffs; cooking salt; celery salt; sherbets [ices]; ham glaze; soya sauce; tomato sauce; spaghetti; seasonings; preparations for stiffening whipped cream; rusks; breadcrumbs; sushi; sandwiches; tabbouleh; tacos; cream of tartar for culinary purposes; tarts; almond paste; tortillas; garden herbs, preserved [seasonings]; vinegar; beer vinegar; ferments for pastes; halvah; bread; unleavened bread; chips [cereal products]; corn flakes; oat flakes; chicory [coffee substitute]; iced tea; chutneys.

43 – Services for providing food and drink; temporary accommodation; accommodation bureaux [hotels, boarding houses]; rental of temporary accommodation; rental of meeting rooms; tourist homes; hotel reservations; boarding house bookings; temporary accommodation reservations; hotels; retirement homes; snack-bars; cafés; cafeterias; motels; boarding houses; boarding for animals; rental of cooking apparatus; rental of chairs, tables, table linen, glassware; rental of tents; rental of transportable buildings; rental of drinking water dispensers; restaurants; self-service restaurants; canteens; holiday camp services [lodging]; bar services; providing campground facilities; food and drink catering; day-nurseries [crèches].

(260) AM 2015 78768 A  
(800) 1215879  
(891) 2014 05 26  
(731) Nemiroff Intellectual Property  
Establishment  
Städtle 31, FL-9490 Vaduz; Liechtenstein  
(540)



(591) Green, white, beige, black, grey and brown  
(511)  
33 – Alcoholic beverages (except beers).

35 – Advertising; business management; business administration; office functions; import-export agencies of alcoholic beverages; retail and wholesale services with alcoholic beverages.

(260) AM 2015 78769 A  
(800) 1215880  
(891) 2014 05 26  
(731) Nemiroff Intellectual Property  
Establishment  
Städtle 31, FL-9490 Vaduz; Liechtenstein  
(540)



(591) Green, yellow, white, black, grey and beige  
(511)

33 – Alcoholic beverages (except beers).

35 – Advertising; business management; business administration; office functions; import-export agencies of alcoholic beverages; retail and wholesale services with alcoholic beverages.

(260) AM 2015 78770 A  
(800) 880319  
(891) 2014 03 18  
(731) GAJA S.S. (Società Semplice)  
Via Torino, 18, I-12050 Barbaresco (CN),  
Italy  
(540)

## GAJA

(511)  
33 – Wines, sparkling wines, vermouths, wine spirits, liqueurs.

(260) AM 2015 78771 A  
(800) 1045345  
(891) 2014 06 02  
(731) "NATURA SIBERICA" Ltd.  
ul. Yuzhnobutovskaya, Komnata 18a,  
dom 101, RU-117042 Moscow; Russian  
Federation  
(540)

## NATURASIBERICA

(511)  
3 – Abrasives; amber (perfume); scale removing preparations for household purposes; antistatic preparations for household purposes; breath freshening sprays; shaving stones, antiseptic; polishing stones; abrasive paper; emery paper; polishing paper; petroleum jelly for cosmetic purposes; cotton wool for cosmetic purposes; cotton sticks for cosmetic purposes; swabs (toiletries); aromatics (essential oils); cake flavourings (essential

oils); flavourings for cakes (essential oils); flavourings for beverages (essential oils); sachets for perfuming linen; scented water; potassium hypochloride; javelle water; lavender water; toilet water; laundry wax; floor wax; parquet floor wax; moustache wax; mustache wax; tailors' wax; polish for furniture and flooring; cobblers' wax; shoe wax; shoemakers' wax; heliotropine; geraniol; make-up; deodorants for personal use; scented wood; perfumes; windscreen cleaning liquids; windshield cleaning liquids; greases for cosmetic purposes; volcanic ash for cleaning; perfumery; decorative transfers for cosmetic purposes; ionone (perfumery); smoothing stones; eyebrow pencils; cosmetic pencils; silicon carbide (abrasive); carbides of metal (abrasives); alum stones (antiseptic); Tripoli stone for polishing; adhesives for affixing false eyelashes; adhesives for affixing false hair; Quillaia bark for washing; corundum (abrasive); blueing for laundry; bluing for laundry; laundry blueing; beard dyes; colorants for toilet purposes; cosmetic dyes; laundry starch; starch for laundry purposes; cosmetic creams; skin whitening creams; cream for whitening the skin; creams for leather; waxes for leather; jewellers' rouge; polishing rouge; incense; hair spray; nail polish; nail varnish; after-shave lotions; hair lotions; lotions for cosmetic purposes; beauty masks; oils for perfumes and scents; oils for cosmetic purposes; oils for toilet purposes; essential oils; ethereal oils; essential oils of cedar wood; essential oils of citron; oils for cleaning purposes; bergamot oil; gaultheria oil; jasmine oil; lavender oil; almond oil; rose oil; oil of turpentine for degreasing; adhesives for cosmetic purposes; whitening; cleaning chalk; almond milk for cosmetic purposes; cleansing milk for toilet purposes; musk (perfumery); soap; disinfectant soap; deodorant soap; shaving soap; soap for brightening textile; cakes of toilet soap; cakes of soap; medicated soap; antiperspirant soap; soap for foot perspiration; almond soap; mint for perfumery; cosmetic kits; emery; false nails; eau de Cologne; bases for flower perfumes; polishing creams; polishing wax; pastes for razor strops; dentifrices; pumice stone; hydrogen peroxide for cosmetic purposes; abrasive cloth; emery cloth; sandcloth; glass cloth; lipsticks; pomades for cosmetic purposes; shaving preparations; cosmetic preparations for baths; toiletries; hair waving preparations; waving preparations for the hair; laundry soaking preparations; preparations for soaking laundry; grinding preparations; sharpening preparations; smoothing preparations (starching); leather bleaching preparations; denture polishes; refurbishing preparations; polishing preparations; shining preparations (polish); mouth washes, not for medical purposes; cosmetic preparations for slimming purposes; laundry glaze; starch glaze for laundry purposes; fabric softeners for laundry use;

bleaching preparations (laundry); laundry bleach; laundry preparations; washing preparations; dry-cleaning preparations; make-up removing preparations; color-removing preparations; colour-removing preparations; paint stripping preparations; lacquer-removing preparations; varnish-removing preparations; floor wax removers (scouring preparations); rust removing preparations; nail care preparations; cleaning preparations; preparations for cleaning dentures; wallpaper cleaning preparations; clearing blocked drains preparations; preparations for cleaning waste pipes; color-brightening chemicals for household purposes (laundry); colour-brightening chemicals for household purposes (laundry); make-up powder; diamantine (abrasive); scouring solutions; false eyelashes; tissues impregnated with cosmetic lotions; safrol; turpentine, for degreasing; potpourris (fragrances); bleaching soda; washing soda, for cleaning; bath salts, not for medical purposes; bleaching salts; leather preservatives (polishes); preservatives for leather (polishes); fumigation preparations (perfumes); ammonia (volatile alkali) (detergent); volatile alkali (ammonia) (detergent); astringents for cosmetic purposes; eyebrow cosmetics; stain removers; make-up preparations; sunscreen preparations; sun-tanning preparations (cosmetics); hair colorants; hair dyes; neutralizers for permanent waving; cosmetic preparations for eyelashes; depilatories; depilatory preparations; depilatory wax; cosmetic preparations for skin care; boot cream; boot polish; shoe cream; shoe polish; cosmetics; cosmetics for animals; mascara; detergents other than for use in manufacturing operations and for medical purposes; degreasers other than for use in manufacturing processes; bleaching preparations (decolorants) for cosmetic purposes; antiperspirants (toiletries); talcum powder, for toilet use; terpenes (essential oils); shampoos; shampoos for pets; glass paper; sandpaper; soda lye; extracts of flowers (perfumes); ethereal essences; Badian essence; mint essence (essential oil).

(260) AM 2015 78772 A

(800) 1051055

(891) 2014 06 02

(731) "NATURA SIBERICA" Ltd.

ul. Yuzhnobutovskaya, Komnata 18a,  
dom 101, RU-117042 Moscow; Russian  
Federation

(540)



(591) Black, white

(511)

3 – Abrasives; amber (perfume); scale removing preparations for household purposes; antistatic preparations for household purposes; breath freshening sprays; shaving stones, antiseptic; polishing stones; abrasive paper; emery paper; polishing paper; petroleum jelly for cosmetic purposes; cotton wool for cosmetic purposes; cotton sticks for cosmetic purposes; swabs (toiletries); aromatics (essential oils); cake flavourings (essential oils); flavourings for cakes (essential oils); flavourings for beverages (essential oils); sachets for perfuming linen; scented water; potassium hypochloride; javelle water; lavender water; toilet water; laundry wax; floor wax; parquet floor wax; moustache wax; tailors' wax; polish for furniture and flooring; cobblers' wax; shoe wax; shoemakers' wax; heliotropine; geraniol; make-up; deodorants for personal use; scented wood; perfumes; windscreen cleaning liquids; windshield cleaning liquids; greases for cosmetic purposes; volcanic ash for cleaning; perfumery; decorative transfers for cosmetic purposes; ionone (perfumery); smoothing stones; eyebrow pencils; cosmetic pencils; silicon carbide (abrasive); carbides of metal (abrasives); alum stones (antiseptic); Tripoli stone for polishing; adhesives for affixing false eyelashes; adhesives for affixing false hair; quillaia bark for washing; corundum (abrasive); laundry blueing; beard dyes; colorants for toilet purposes; cosmetic dyes; laundry starch; starch for laundry purposes; cosmetic creams; skin whitening creams; cream for whitening the skin; creams for leather; waxes for leather; jewellers' rouge; polishing rouge; incense; hair spray; nail polish; nail varnish; after-shave lotions; hair lotions; lotions for cosmetic purposes; beauty masks; oils for perfumes and scents; oils for cosmetic purposes; oils for toilet purposes; essential oils; ethereal oils; essential oils of cedarwood; essential oils of citron; oils for cleaning purposes; bergamot oil; gaultheria oil; jasmine oil; lavender oil; almond oil; rose oil; oil of turpentine for degreasing; adhesives for cosmetic purposes; whitening; cleaning chalk; almond milk for cosmetic purposes; cleansing milk for toilet purposes; musk (perfumery); soap; disinfectant soap; deodorant soap; shaving soap; soap for brightening textile; cakes of toilet soap; cakes of soap; medicated soap; antiperspirant soap; soap for foot perspiration; almond soap; mint for perfumery; cosmetic kits; emery; false nails; eau de Cologne; bases for flower perfumes; polishing creams; polishing wax; pastes for razor strops; dentifrices; pumice stone; hydrogen peroxide for cosmetic purposes; abrasive cloth; emery cloth; sandcloth; glass cloth; lipsticks; pomades for cosmetic purposes; shaving preparations; cosmetic preparations for baths; toiletries; hair waving preparations; laundry soaking preparations;

grinding preparations; sharpening preparations; smoothing preparations (starching); leather bleaching preparations; denture polishes; refurbishing preparations; polishing preparations; shining preparations (polish); mouth washes, not for medical purposes; cosmetic preparations for slimming purposes; laundry glaze; starch glaze for laundry purposes; fabric softeners for laundry use; bleaching preparations (laundry); laundry bleach; laundry preparations; washing preparations; dry-cleaning preparations; make-up removing preparations; colour-removing preparations; paint stripping preparations; lacquer-removing preparations; varnish-removing preparations; floor wax removers (scouring preparations); rust removing preparations; nail care preparations; cleaning preparations; preparations for cleaning dentures; wallpaper cleaning preparations; clearing blocked drains preparations; preparations for cleaning waste pipes; colour-brightening chemicals for household purposes (laundry); make-up powder; diamantine (abrasive); scouring solutions; false eyelashes; tissues impregnated with cosmetic lotions; saffrol; turpentine, for degreasing; potpourris (fragrances); bleaching soda; washing soda, for cleaning; bath salts, not for medical purposes; bleaching salts; leather preservatives (polishes); fumigation preparations (perfumes); ammonia (volatile alkali) (detergent); volatile alkali (ammonia) (detergent); astringents for cosmetic purposes; eyebrow cosmetics; stain removers; make-up preparations; sunscreen preparations; sun-tanning preparations (cosmetics); hair colorants; hair dyes; neutralizers for permanent waving; cosmetic preparations for eyelashes; depilatories; depilatory preparations; depilatory wax; cosmetic preparations for skin care; boot cream; boot polish; shoe cream; shoe polish; cosmetics; cosmetics for animals; mascara; detergents other than for use in manufacturing operations and for medical purposes; degreasers other than for use in manufacturing processes; bleaching preparations (decolorants) for cosmetic purposes; antiperspirants (toiletries); talcum powder, for toilet use; terpenes (essential oils); shampoos; shampoos for pets; glass paper; sandpaper; soda lye; extracts of flowers (perfumes); ethereal essences; badian essence; mint essence (essential oil).

(260) AM 2015 78791 A

(800) 1215900

(891) 2014 05 28

(731) Škoda Auto a.s.

Tř. Václava Klementa 869, CZ-293 60  
Mladá Boleslav; Czech Republic

(540)

**h-tec**



(511)  
12 – Automobiles and their parts, all included in this class.

(260) AM 2015 78793 A

(800) 1215903

(891) 2014 02 26

(731) Li Mian Jun

Room 601, Unit 1, Building 6, N37  
Lanshan Road, Lanshan District, Linyi  
City, Shandong Province; China

(540)



(591) Black, white, orange, brown

(511)

41 – Academies; teaching; educational services; organization of competitions; publication of books (non-advertising material); publication of books; providing on-line electronic publications, not downloadable; publication of electronic books and journals on-line; video releases (terms considered too vague by the International Bureau – rule 13.2.b) of the Common Regulations); club services [entertainment or education].

(260) AM 2015 78794 A

(800) 1215916

(891) 2014 04 25

(731) ÖZ METAL İŞ SANAYİ VE  
TİCARET LİMİTED ŞİRKETİ

İkitelli Organize Sanayi, Bölgesi Pik  
Dökümcüler, Sanayi Sitesi A-3 Blok,  
No:10 Küçükçekmece, İSTANBUL;  
Turkey

(540)



(591) Green and blue

(511)

6 – Doors, windows, shutters, jalousies and their cases and fittings of metal; ironmongery, small hardware of metal.

35 – Advertising and business services; the bringing together, for the benefit of others, of a variety of

goods (excluding the transport thereof) enabling customers to conveniently view and purchase those goods; retail or wholesale services relating to doors, windows, shutters, jalousies and their cases and fittings of metal, ironmongery, small hardware of metal.

(260) AM 2015 78795 A

(800) 1215924

(891) 2014 05 28

(731) DC Comics

1700 Broadway, New York NY 10019, USA

(540)

## VERTIGO

(511)

9 – Downloadable publications, namely, comic books and graphic novels.

16 – Comic books.

(260) AM 2015 78798 A

(800) 1215927

(891) 2014 07 23

(731) MEGA HAFIZA EGİTİM

HİZMETLERİ VE GIDA URUNLERİ  
LIMITED SİRKETİ

Esat Cad. No:37/B Kucukesat, ANKARA;  
Turkey

(540)



(591) Red, dark blue, dark purple

(526) The trademark is protected as a whole. "vitamin" shall not be subject to independent legal protection.

(511)

5 – Drugs for human beings and animals, chemical preparations for medical use, natural products and chemical elements for pharmaceuticals; dietetic substances for medical use; medical preparations for slimming products; food for babies; medicinal herbs and herbal drinks; products for dentistry (excluding apparatus and devices); sanitary products including sanitary pads, sanitary tampons, plasters, materials for dressings; pesticides, insecticides, herbicides and fungicides; air deodorizers, deodorants except for personal use; disinfectants, antiseptics, detergents for medical purposes.

35 – The bringing together of vitamins and food supplement products enabling customers to conveniently view and purchase those goods (all the



aforementioned services may be provided by retail stores, wholesale outlets through mail order catalogues or by means of electronic media).

(260) AM 2015 78818 A

(800) 1215964

(891) 2013 12 24

(731) CARLO POLETTI S.r.l.

Via Tancognino, 134, I-28024

GOZZANO (NO); Italy

(540)



(591) Black, white

(511)

11 – Manual and thermostatic decorative valves for design radiators, fittings and components; decorative fittings for plastic, copper and iron pipe connections being parts of sanitary installations; parts of heating and sanitary installations, namely decorative valves, namely air vent valves and fittings for radiators with o-ring; sanitary mixers; sanitary and heating manifolds; thermostatic and manual valves for radiators; fittings for plastic, copper and iron pipes connections being parts of sanitary installations; valves and fittings for solar systems, namely solar thermal collectors (heating); safety, mixing and regulating valves for thermic sanitary and solar systems; radiant heating and air conditioning systems.

(260) AM 2015 78819 A

(800) 1215992

(891) 2014 02 07

(731) Wilhelmsen Ships Service AS

Strandveien 20, N-1366 Lysake; Norway

(540)



(591) Black, white

(511)

1 – Chemicals used in industry and science; chemicals and gases for use in marine and/or maritime industry; industrial gases and refrigerants; cleaning and de-greasing chemicals; chemicals for treating water; chemicals for treating oils and gases; inert gases; unprocessed artificial resins, unprocessed plastics; fire extinguishing compositions, including fire extinguishing gases, foams, powders and

liquids; fireproofing and flame resistant preparations; chemical spill solutions; surface-active chemical agents; chemical products for industrial removal of corrosion and contamination; preparations to break down and decompose oil; chemical products for marine and industrial treatment of bunker oil and heavy fuel oil; tempering and soldering preparations, welding preparations; chemical substances for preserving foodstuffs; tanning substances; adhesives used in industry.

2 – Paints, varnishes and lacquers; preservatives against corrosion and rust and against deterioration of wood.

3 – Bleaching preparations and other substances for laundry use; cleaning, polishing, scouring, degreasing and abrasive preparations; paint and rust removing preparations; industrial abrasives; soaps; perfumery; essential oils; cosmetics; hair lotions; dentifrices; polishing paper, abrasive paper, grinding paper.

41 – Education; providing of training; providing of training in the use and operation of safety equipment and installations; safety regulation training; information and consultancy related to all the aforementioned services.

42 – Scientific and technological services and research, including design and analysis; services for water and oil analysis, on board ship and/or in laboratory; industrial analysis and research services; design and development of computer hardware and software; information and consultancy related to all the aforementioned services.

(260) AM 2015 78822 A

(800) 1216002

(891) 2014 05 05

(731) C4IP IP Holding 1 S.A.

35a, boulevard John F. Kennedy, L-1855

Luxembourg; Luxembourg

(540)



(591) Black, white

(511)

35 – Business management; business administration; dissemination of advertisements; sales promotion for others; rental of advertising space; retailing of beverages, perfumes, cosmetics, clothing and fashion accessories, smokers' articles, books, audiovisual material, leather goods, electronics, confectionery, food products; procurement services for others; business management consultancy; assi-

stance in management of business activities; organisation of events for commercial or advertising purposes; relocation for businesses; business management of hotels; public relations.

36 – Purchasing and financing of co-owned or multi-owned real estate; arranging the provision of finance; mutual funds; fund investments; lease-purchase financing; management of co-owned or multi-owned real estate.

37 – Construction and repair; installation services; maintenance and repair of aeroplanes and aeroplane engines; washing of aeroplanes; de-snowing and de-icing of aeroplanes; cleaning of aeroplanes and vehicles; installation services; maintenance and repair of instruments; reconstruction of used or partly destroyed engines and machines.

39 – Transport; airline transport; transport information; transport reservation; coach transport; packaging and storage of goods; rental of storage containers; freight brokerage [forwarding (Am.)]; transport brokerage; rental of warehouses; aircraft rental; travel and passenger transportation; piloting; rental of parking places; travel arrangement; tourist offices (except hotel and guest house reservations); organising of excursions; travel reservation; travel and passenger transportation; escorting of travellers; air hostess services (escorting travellers); shipping services; freight (shipping of goods); reservations for transporting passengers, goods and animals; reservations for rental of vehicles; registration of luggage, goods and passengers; loading and unloading of aeroplanes; provision of aircraft; representation of airlines and car hire companies; car rental, rental of storage containers; salvaging; transport rescue operations; loaning and rental of aeroplanes; professional consultancy in the field of air transport; marine transport; transport by land; transport of valuables; organisation of travel tours and cruises; rental of warehouses; chauffeur services; piloting services.

41 – Providing of training; entertainment; entertainment information; organisation and holding of colloquia and conferences; organisation of shows; organization of exhibitions for cultural or educational purposes; arranging of contests.

43 – Provision of food and drink; self-services restaurant services; snack-bars; cafés; cafeterias; catering; hotel and boarding house reservations.

45 – Security control of persons and luggage in airports.

---

(260) AM 2015 78823 A

(800) 1216119

(891) 2014 03 03

(731) Merkur Gaming GmbH

Borsigstraße 26, 32312 Lübbecke; Germany  
(540)

## Awards Awards

(511)

9 – Scientific, nautical, surveying, photographic, cinematographic, optical, weighing, measuring, signalling, checking (supervision), life-saving and teaching apparatus and instruments; apparatus and instruments for conducting, switching, transforming, accumulating, regulating or controlling electricity; apparatus for recording, transmission or reproduction of sound or images; magnetic data carriers, recording discs; compact discs, DVDs and other digital recording media; cash registers, calculating machines, data processing equipment, computers; computer software; fire-extinguishing apparatus; musical juke boxes and parts for the aforesaid automatic machines; automatic cash dispensers, automatic money counting and money changing machines; mechanisms for coin-operated apparatus; computer and video games software; games software for use on any computer platform, including electronic entertainment and games consoles; programs for computer games; computer games; video games (software); computer games provided through a global computer network or supplied by means of multi-media electronic broadcast or through telecommunications or electronic transmission or via the internet; computer games, leisure and recreational software, video games and computer software, all provided in the form of storage media; programs for operating electric and electronic apparatus for games, amusement and/or entertainment purposes; electronic terminals for generating lottery tickets; computer software for computer games on the internet; online games (software); computer software in the form of an app for mobile devices and computers; calculating apparatus in coin-operated machines and parts for the aforesaid goods; apparatus for recording, transmission, processing or reproduction of data, including sound or images, including parts for all the aforesaid goods, except radio sets, television receivers, hi-fi systems, video recorders, telephone apparatus, fax machines and telephone answering machines; computer hardware and software for casino and amusement arcade games, for gaming machines, slot machines or video lottery gaming machines or games of chance via the internet; electric, electronic, optical or automatic apparatus, for identifying data carriers, identity cards and credit cards, bank notes and coins; electric, electronic or optical alarm and monitoring installations, including video cameras and apparatus for image transmission and image processing; data processing equipment and computers, including data processing apparatus and computers being components for data networks and parts facilitating data network communications; electric wire

harnesses; circuit boards, printed board assemblies (electronic components) and combinations thereof being assemblies and equipment parts, included in this class.

28 – Games; toys; gymnastics and sporting articles not included in other classes; decorations for christmas trees; gaming apparatus (including coin-operated apparatus); coin-operated arcade games (machines); games for amusement arcades (included in this class); coin-operated video gaming apparatus; video games adapted for use with external screens or monitors only; casino fittings, namely roulette tables, roulette wheels; coin-operated automatic gaming machines and gaming machines, in particular for gaming arcades, with or without a prize payout; electronic or electrotechnical gaming apparatus, gaming machines, gaming machines and slot machines operated by coins, tokens, banknotes, tickets or by means of electronic, magnetic or biometric storage media, in particular for commercial use in casinos and amusement arcades, with or without a prize payout; automatic gaming machines and gaming machines, in particular for commercial use in casinos and gaming arcades, with or without a prize payout; coin-operated gaming machines and/or electronic money-based gaming apparatus (machines), with or without prizes; housings adapted for gaming machines, gaming apparatus and automatic gaming machines, operated by means of coins, tokens, tickets or by means of electronic, magnetic or biometric storage media, in particular for commercial use in casinos and gaming arcades, with or without a prize payout; electronic games; apparatus for electronic games and accessories; video output game machines; drawing apparatus for prize games and lotteries, draws or raffles; housings of metal, plastic and/or wood for coin-operated automatic machines; apparatus for games (including video games), other than adapted for use with external screens or monitors only; electropneumatic and electric pulling machines (gaming machines); gaming tables, in particular for table football, billiards, sliding games; quoits (playthings) and darts; electric, electronic or electromechanical apparatus for bingo games, lotteries or video lottery games and for betting offices, networked or unnetworked; LCD games consoles; automatic gaming machines; including all the aforesaid automatic machines, machines and apparatus operating in networks; apparatus and devices for accepting and storing money, being fittings for the aforesaid automatic machines, included in this class.

(260) AM 2015 78824 A  
(800) 1216120  
(891) 2014 03 18  
(731) 247 Secure Pay

DSL R NOTARIES (SUITE 732)  
FTIEH STREET, BIRKIRKARA BYPASS,  
BIRKIRKARA BKR 2940; Malta

(540)



(591) Black, white  
(511)

9 – Scientific, nautical, surveying, photographic, cinematographic, optical, weighing, measuring, signalling, checking (supervision), life-saving and teaching apparatus and instruments; apparatus and instruments for conducting, switching, transforming, accumulating, regulating or controlling electricity; apparatus for recording, transmission or reproduction of sound or images; magnetic data carriers, recording discs; compact discs, DVDs and other digital recording media; mechanisms for coin-operated apparatus; cash registers, calculating machines, data processing equipment, computers; computer software; fire-extinguishing apparatus; electronic publications, downloadable; programs for computer games; video game software; interactive video apparatus; lottery ticket dispensing apparatus; joysticks for video games.

28 – Games and playthings; gymnastic and sporting articles not included in other classes; decorations for Christmas trees; hand held video games; hand-held electronic video games; hand held units for playing video games; free-standing video game machines; coin-operated video game machines; stand alone video output game machines; video game machines; arcade video game machines; scratch cards for playing lottery games.

35 – Advertising; business management; business administration; office functions; updating of advertising material; business management and organization consultancy; procurement services for others [purchasing goods and services for other businesses]; import-export agencies; publicity agencies; management of businesses (for others); publication of publicity texts; commercial or industrial management assistance; public relations; on-line advertising in computer networks; organization of exhibitions for commercial or advertising purposes; business organization consultancy; presentation of goods on communications media for retail purposes; systemization of information into computer databases; business advice and consultancy; sales promotion (for others); rental of vending machines; rental of sales stands; rental of advertising space; providing advertising space on the internet; publicity material rental; rental of advertising time on communication media; arranging newspaper subscriptions for others; advertising by mail order; distribution of samples; direct mail advertising; compilation of information into computer databases;

electronic commerce, namely consumer consultancy via telecommunication networks for advertising and sales purposes; commercial trade and consumer information; advertising services for the promotion of e-commerce; business management consultancy in relation to strategy, marketing, production, staff and retail sales; retailing of cosmetics in department stores, toiletries, machines for household purposes, hand tools, optical goods, electric and electronic household equipment; retail services of a stationer's outlet in relation to stationery, printed matter, computer equipment and computer peripheral devices, and home entertainment products; business management of retail companies, for others; planning of retail and external trade services with advertising spaces; provision of auctioneering services on the internet; dissemination of advertising for others via the internet.

41 – Education; providing of training; entertainment; sporting and cultural activities; providing casino facilities [gambling]; providing amusement arcade services; gambling; game services provided on-line from a computer network; operating lotteries; photography; desktop publishing (design of publications supported by computers); on-line publishing of electronic books and magazines; layout services, other than for advertising purposes; providing electronic publications (not downloadable); organization of competitions [education or entertainment]; education information; recreation information; providing recreation facilities; photographic reporting; production of entertainment in the form of films; publication of texts, other than publicity texts; orchestra services; production of music; training; theatre productions; organization of sports competitions; arranging and conducting of colloquiums; organization of exhibitions for cultural or educational purposes; videotape film production; providing museum facilities [presentation, exhibitions]; practical training [demonstration]; video arcade services; video game entertainment services; entertainment with computer games and video games; rental of video games; electronic libraries for providing electronic information (including archive information) in the form of text, audio and/or video information; conducting lotteries for others; providing of raffle services; organising and conducting lotteries; gambling services; organisation of sporting events and competitions; conducting of competitions by telephone; arranging and conducting of conferences, exhibitions and competitions; organization of quizzes, games and competitions; organisation of games and competitions; organisation of sports competitions; electronic game services and competitions provided by means of the internet; operation of casinos and amusement arcades.

(260) AM 2015 78827 A  
(800) 1216157  
(891) 2014 02 11  
(731) Obschestvo s ogranichennoy  
otvetstvennostiu "Panorama"  
ul. Borisovskie prudy, 24/2, RU-115612  
Moscow, Russian Federation

(540)

## ГРИНБЕТ

(511)

36 – Reward payment services; Internet banking; electronic funds transfer.

41 – Operating lotteries; game betting services; providing amusement arcade services; providing casino facilities [gambling]; gaming; entertainment information; club services [entertainment or education]; night clubs; game services provided on-line from a computer network; practical training [demonstration]; organization of exhibitions for cultural or educational purposes; providing recreation facilities; arranging and conducting of workshops [training]; organization of competitions [education or entertainment]; holiday camp services [entertainment]; organization of sports competitions; rental of show scenery; rental of sports equipment, except vehicles; electronic desktop publishing; publication of electronic books and journals on-line; publication of texts, other than publicity texts; radio entertainment; entertainer services; entertainment; production of shows; betting services.

(260) AM 2015 78830 A  
(800) 1216181  
(891) 2014 03 14  
(731) KAESER KOMPRESSOREN SE  
Carl-Kaesler-StraÙe 26, 96450 COBURG;  
Germany

(540)

## Hybritec

(511)

07 – Machines and mechanical apparatus for the generation of compressed air, vacuum and air flow, included in class 7; compressors (machines), including reciprocating compressors and screw compressors; blowers for the compression, exhaustion and transport of gases; blowing machines; air suction machines; vacuum pumps being machines; parts of the aforesaid goods (included in class 7), including central screw compressor units or central reciprocating compressor units; air machines; pneumatic transporters; compressed air machines; compressed air motors; compressed air pumps; compressed air vessels being parts of machines; pressure tanks being parts of machines; pumps being parts of machines, motors or engines; turbines, other than for land vehicles; machine tools; pneumatic tools; filters being parts of machines, motors or engines; air

filters for motors and/or compressors; catalytic converters for the adsorption of hydrocarbon vapors (gas catalytic converters); activated carbon absorbers and catalytic converters, being parts of machines; activated carbon filters for use in compressed air systems, being parts of machines; high pressure filters being parts of machines; condensate separators being parts of machines; automatic cleaners; cooling devices, included in class 7; coolers for motors, compressors or blowers; air condensers; condenser installations; de-aerators being parts of machines; oil separators being parts of machines, including de-oilers for separating oil from air; fittings for compressors and machines; fittings for engine boilers; taps being parts of machines or motors; seals being parts of machines; compressed air main charging systems (control devices for the regulation of compressed air, being parts of machines); compressed air reservoirs being parts of machines; regulators being parts of machines; speed governors for machines and motors; pressure regulators being parts of machines; valves being parts of machines, including pressure valves; pressure reduction valves being parts of machines; pneumatic controls for machines and motors; motors, other than motors for land vehicles; electric motors, other than for land vehicles; generators of electricity; machine housings; mounts for machines; stands for machines; tables for machines; couplings and driving belts, other than for land vehicles; gear boxes, other than for land vehicles; ball-bearings; shaft couplings being machines; cranks being parts of machines; crank shafts; machine wheels; axles for machines; pump diaphragms; superchargers; turbo compressors; fans for motors; anti-pollution devices for motors and/or compressors, being parts of machines and motors; heat exchangers being parts of machines; parts of all the aforesaid goods, included in class 7; safety accessories for compressors, namely safety valves, regulating valves; compressed air reservoirs being parts of compressors, machines and motors; regulating and safety accessories for compressors.

11 – Apparatus, devices and machines for air treatment, including for compressed air conditioning, mainly for the separation and deposition of solid and/or liquid contamination of the compressed air; air filtering installations; air purifying apparatus and air purifying machines; air dryers, including compressed air dryers; desiccant (adsorption) dryers; refrigeration dryers; membrane dryers; drying apparatus and drying installations; drying devices; refrigerating apparatus, refrigerating machines and refrigerating installations; air cooling devices; air coolers, including compressed air coolers; condensate drains for compressed air applications being parts of refrigerating devices; heat exchangers, included in class 11; apparatus and machines for the treatment of condensate water by means of

purification and/or filtration; air filters for air conditioning; filters being parts of household or industrial installations; filter systems, including air filtering installations; compressed air filters; dust filters for use in compressed air installations; air purifying lamps having a germicidal effect; apparatus and devices for the sterilization of air; regulating and safety accessories for gas devices; taps for pipes; safety accessories for compressors, namely protective switches, pressure switches; compressed air reservoirs being parts of the aforesaid goods of class 11; parts of all the aforesaid goods, included in class 11.

---

(260) AM 2015 78831 A

(800) 1216182

(891) 2014 03 14

(731) KAESER KOMPRESSOREN SE

Carl-Kaesar-Straße 26, 96450 COBURG;  
Germany

(540)

## **Kryosec**

(511)

7 – Machines and mechanical apparatus for the generation of compressed air, vacuum and air flow, included in class 7; compressors (machines), including reciprocating compressors and screw compressors; blowers for the compression, exhaustion and transport of gases; blowing machines; air suction machines; vacuum pumps being machines; parts of the aforesaid goods (included in class 7), including central screw compressor units or central reciprocating compressor units; air machines; pneumatic transporters; compressed air machines; compressed air motors; compressed air pumps; compressed air vessels being parts of machines; pressure tanks being parts of machines; pumps being parts of machines, motors or engines; turbines, other than for land vehicles; machine tools; pneumatic tools; filters being parts of machines, motors or engines; air filters for motors and/or compressors; catalytic converters for the adsorption of hydrocarbon vapors (gas catalytic converters); activated carbon absorbers and catalytic converters, being parts of machines; activated carbon filters for use in compressed air systems, being parts of machines; high pressure filters being parts of machines; condensate separators being parts of machines; automatic cleaners; cooling devices, included in class 7; coolers for motors, compressors or blowers; air condensers; condenser installations; de-aerators being parts of machines; oil separators being parts of machines, including de-oilers for separating oil from air; fittings for compressors and machines; fittings for engine boilers; taps being parts of machines or motors; seals being parts of machines; compressed air main charging systems (control devices for the regulation of compressed air,

being parts of machines); compressed air reservoirs being parts of machines; regulators being parts of machines; speed governors for machines and motors; pressure regulators being parts of machines; valves being parts of machines, including pressure valves; pressure reduction valves being parts of machines; pneumatic controls for machines and motors; motors, other than motors for land vehicles; electric motors, other than for land vehicles; generators of electricity; machine housings; mounts for machines; stands for machines; tables for machines; couplings and driving belts, other than for land vehicles; gear boxes, other than for land vehicles; ball-bearings; shaft couplings being machines; cranks being parts of machines; crank shafts; machine wheels; axles for machines; pump diaphragms; superchargers; turbo compressors; fans for motors; anti-pollution devices for motors and/or compressors, being parts of machines and motors; heat exchangers being parts of machines; parts of all the aforesaid goods, included in class 7; safety accessories for compressors, namely safety valves, regulating valves; compressed air reservoirs being parts of compressors, machines and motors; regulating and safety accessories for compressors.

11 – Apparatus, devices and machines for air treatment, including for compressed air conditioning, mainly for the separation and deposition of solid and/or liquid contamination of the compressed air; air filtering installations; air purifying apparatus and air purifying machines; air dryers, including compressed air dryers; desiccant (adsorption) dryers; refrigeration dryers; membrane dryers; drying apparatus and drying installations; drying devices; refrigerating apparatus, refrigerating machines and refrigerating installations; air cooling devices; air coolers, including compressed air coolers; condensate drains for compressed air applications being parts of refrigerating devices; heat exchangers, included in class 11; apparatus and machines for the treatment of condensate water by means of purification and/or filtration; air filters for air conditioning; filters being parts of household or industrial installations; filter systems, including air filtering installations; compressed air filters; dust filters for use in compressed air installations; air purifying lamps having a germicidal effect; apparatus and devices for the sterilization of air; regulating and safety accessories for gas devices; taps for pipes; safety accessories for compressors, namely protective switches, pressure switches; compressed air reservoirs being parts of the aforesaid goods of class 11; parts of all the aforesaid goods, included in class 11.

(260) AM 2015 78832 A  
(800) 1216183  
(891) 2014 03 14

(731) KAESER KOMPRESSOREN SE  
Carl-Kaesler-StraÙe 26, 96450 COBURG;  
Germany

(540)

## Secotec

(511)

7 – Machines and mechanical apparatus for the generation of compressed air, vacuum and air flow, included in class 7; compressors (machines), including reciprocating compressors and screw compressors; blowers for the compression, exhaustion and transport of gases; blowing machines; air suction machines; vacuum pumps being machines; parts of the aforesaid goods (included in class 7), including central screw compressor units or central reciprocating compressor units; air machines; pneumatic transporters; compressed air machines; compressed air motors; compressed air pumps; compressed air vessels being parts of machines; pressure tanks being parts of machines; pumps being parts of machines, motors or engines; turbines, other than for land vehicles; machine tools; pneumatic tools; filters being parts of machines, motors or engines; air filters for motors and/or compressors; catalytic converters for the adsorption of hydrocarbon vapors (gas catalytic converters); activated carbon absorbers and catalytic converters, being parts of machines; activated carbon filters for use in compressed air systems, being parts of machines; high pressure filters being parts of machines; condensate separators being parts of machines; automatic cleaners; cooling devices, included in class 7; coolers for motors, compressors or blowers; air condensers; condenser installations; de-aerators being parts of machines; oil separators being parts of machines, including de-oilers for separating oil from air; fittings for compressors and machines; fittings for engine boilers; taps being parts of machines or motors; seals being parts of machines; compressed air main charging systems (control devices for the regulation of compressed air, being parts of machines); compressed air reservoirs being parts of machines; regulators being parts of machines; speed governors for machines and motors; pressure regulators being parts of machines; valves being parts of machines, including pressure valves; pressure reduction valves being parts of machines; pneumatic controls for machines and motors; motors, other than motors for land vehicles; electric motors, other than for land vehicles; generators of electricity; machine housings; mounts for machines; stands for machines; tables for machines; couplings and driving belts, other than for land vehicles; gear boxes, other than for land vehicles; ball-bearings; shaft couplings being machines; cranks being parts of machines; crank shafts; machine wheels; axles for machines; pump diaphragms; superchargers; turbo compressors; fans for motors; anti-pollution devices for motors and/or

compressors, being parts of machines and motors; heat exchangers being parts of machines; parts of all the aforesaid goods, included in class 7; safety accessories for compressors, namely safety valves, regulating valves; compressed air reservoirs being parts of compressors, machines and motors; regulating and safety accessories for compressors.

11 – Apparatus, devices and machines for air treatment, including for compressed air conditioning, mainly for the separation and deposition of solid and/or liquid contamination of the compressed air; air filtering installations; air purifying apparatus and air purifying machines; air dryers, including compressed air dryers; desiccant (adsorption) dryers; refrigeration dryers; membrane dryers; drying apparatus and drying installations; drying devices; refrigerating apparatus, refrigerating machines and refrigerating installations; air cooling devices; air coolers, including compressed air coolers; condensate drains for compressed air applications being parts of refrigerating devices; heat exchangers, included in class 11; apparatus and machines for the treatment of condensate water by means of purification and/or filtration; air filters for air conditioning; filters being parts of household or industrial installations; filter systems, including air filtering installations; compressed air filters; dust filters for use in compressed air installations; air purifying lamps having a germicidal effect; apparatus and devices for the sterilization of air; regulating and safety accessories for gas devices; taps for pipes; safety accessories for compressors, namely protective switches, pressure switches; compressed air reservoirs being parts of the aforesaid goods of class 11; parts of all the aforesaid goods, included in class 11.

(260) AM 2015 78837 A

(800) 1216205

(891) 2014 05 06

(731) BARFAB

No. 16, 13th St, Gandhi Ave, 1517753714

Tehran; Iran (Islamic Republic of)

(540)



(591) Red, blue and white

(511)

7 – Washing machines.

11 – Air cooling apparatus, refrigerators, freezers, air reheaters, water heaters (gas, electric).

35 – Export agencies.

36 – Issuing letter of guarantee.

37 – Repair, installation.

39 – Transportation, packing of all aforementioned goods, warehousing.

(260) AM 2015 78839 A

(800) 1216207

(891) 2014 05 09

(731) QUILATE SERVICES SA

Via Livio 1, CH-6830 Chiasso; Switzerland

(540)

# Ла Мартина

(591) Black, white

(511)

3 – Soaps; perfumery, essential oils, cosmetics, hair lotions.

9 – Correcting spectacles, sunglasses, spectacle cases; chains for spectacles, spectacle frames, spectacle lenses, pince-nez; safety helmets, protective helmets for sports; protective masks; clothing and footwear for protection against accidents.

18 – Leather and imitation leather, goods made of these materials not included in other classes; animal skins; trunks and cases, including handbags; sports bags; luggage; shoulder bags; backpacks; document holders; envelopes-style handbags; key cases (leather goods); vanity cases; bumbags; holdalls; shopping bags; umbrellas, parasols and walking sticks; whips, harness for animals and saddlery

25 – Clothing, including shirts, tee-shirts, work overalls, skirts, dresses, pullovers, Cardigans, jackets, coats, vests, Jeans, shorts (clothing), belts (clothing), bathing suits, socks and stockings, scarves, sashes for wear; pajamas, underwear, suspenders, underpants, ties, waterproof pant and jacket suits, overcoats, wind-cheaters, ski jackets, quilted coats, down jacket; ski pants, fur jackets, gloves (clothing), robes, bath robes: footwear; boots; sports shoes, in particular for polo; bonnets; headgear; visors.

35 – Retail Services, on-line retail services and mail order services, all the said services in the field of beauty products, beauty accessories, skin care products, skin care accessories, toiletries, perfumes, cosmetics, perfumed candles, deodorizing room sprays, leather goods, jewelry, jewelry articles, timepieces (horological articles), optical goods, stationery, pens, umbrellas, sports articles, clothing and footwear; advertising; shop window dressing; import-export agencies; sales promotion for others; market research services; promotion of products via the Internet using sales offers; organization of events for commercial purposes; commercial and admi-

nistrative business management; business administration; commercial or industrial management assistance; consultancy in organizing and managing business; the bringing together, for the benefit of others, of beauty products, beauty accessories, skin care products, skin care accessories, toiletries, perfumes, cosmetics, perfumed candles, deodorizing room sprays, leather goods, jewelry, jewelry articles, timepieces (horological articles), optical goods, stationery, pens, umbrellas, sports articles, clothing and footwear; services enabling customers to conveniently view and purchase the aforesaid products in shops, including department stores, retail clothing stores, retail shoe stores, bag and leather goods retail stores, retail stores selling sports clothing and equipment; the bringing together, for the benefit of others, of leather goods, jewelry, jewelry articles, timepieces (horological articles), optical goods, stationery, pens, umbrellas, sports articles, clothing and footwear, beauty products, beauty accessories, skin care products, skin care accessories, toiletries, perfumes, cosmetics, perfumed candles, deodorizing room sprays, to enable consumers to see such goods on a website and to purchase them easily.

(260) AM 2015 78847 A

(800) 1216273

(891) 2014 07 01

(731) L&O Hunting Group GmbH  
Ziegelstadel 1, 88316 Isny; Germany

(540)

## S15

(511)

13 – Firearms; ammunition and projectiles; explosives; accessories for the aforesaid goods [included in this class], in particular gun bags, gun cases, cartridge belts, gun slings, cartridge cases.

25 – Clothing; footwear; headgear, all aforementioned goods limited to hunting clothes.

28 – Hand-held guns [toys]; model guns and replica guns [unarmed models or replicas of weapons]; bullets and ammunition for model weapons and replica weapons [unarmed models or replicas of weapons]; model guns and replica guns [unarmed models or replicas of weapons] for virtual shooting; model guns and replica guns [unarmed models or replicas of weapons] for use with electronic targets and/or electronic displays; games apparatus, adapted for use with replica guns for virtual shooting; parts for the aforesaid goods [included in this class].

(260) AM 2015 78860 A

(800) 1216296

(891) 2014 01 15

(731) VİKİNG KAĞIT VE SELÜLOZ

ANONİM ŞİRKETİ

Hürriyet Caddesi No:474 Aliğa, İzmir;  
Turkey

(540)

## PREMIA

(511)

3 – Bleaching preparations and other substances for laundry use; cleaning, polishing, scouring and abrasive preparations; soaps; perfumery, essential oils, cosmetics, hair lotions; dentifrices.

5 – Pharmaceutical and veterinary preparations; sanitary preparations for medical purposes; dietetic food and substances adapted for medical or veterinary use, food for babies; dietary supplements for humans and animals; plasters, materials for dressings; material for stopping teeth, dental wax; disinfectants; preparations for destroying vermin; fungicides, herbicides.

16 – Paper, cardboard and goods made from these materials, not included in other classes; printed matter; bookbinding material; photographs; stationery; adhesives for stationery or household purposes; artists' materials; paint brushes; typewriters and office requisites (except furniture); instructional and teaching material (except apparatus); plastic materials for packaging (not included in other classes); printers' type; printing blocks.

(260) AM 2015 78862 A

(800) 1216359

(891) 2014 05 09

(731) Devely Holding GmbH & Co.  
Beteiligungs KG Ottobrunner  
Straße 45, 82008 Unterhaching; Germany

(540)

## SPECHT

(511)

29 – Fruit and vegetable preserves; vinegar pickled fruits and vegetables; pickled gherkins and sauerkraut.

(260) AM 2015 78863 A

(800) 1216377

(891) 2014 03 14

(731) Photoflex, Inc.  
97 Hangar Way, Watsonville CA 95076; USA

(540)

## PHOTOFLEX

(511)

9 – Photographic equipment; namely, light stands, light domes, strobe connectors, reflecting discs, photographic umbrellas, photographic equipment bags and camera cases, and equipment clamps; photography lighting equipment, namely, reflectors,



strobe connectors, reflecting discs, light domes, soft boxes, clamps specially adapted for use with photography lighting equipment, light stands and supports, and bags specially adapted for these goods; strobe light apparatus for use in professional quality photography.

(260) AM 2015 78864 A

(800) 1216396

(891) 2014 04 16

(731) BESTWAY INFLATABLES & MATERIAL CORP.

3065 Cao An Road, Shanghai 201812; China

(540)

**H2O GO**

(511)

28 – Inflatable toys, floats and pleasure facilities, namely: inflatable and floating mats [inflatable play articles], inflatable lounges [inflatable play articles], islands, inflatable boats, rafts and kayaks [inflatable play articles], inflatable pools, play swimming pools, water slides, play centers and activity centers; floating mattresses, armchairs and seats [inflatable play articles], jumping castles [inflatable play equipment].

(260) AM 2015 78865 A

(800) 1216430

(891) 2014 06 17

(731) YILDIZ HOLDİNG A.Ş.

Kisikli Mah.Ferah Cad. Kisikli, Cesme Sk.No:2/4 B.Camlica, Uskudar/Istanbul; Turkey

(540)

**ÜLKER**

**KREMİNİ**

(591) Black, white

(526) The trademark is protected as a whole. "KREMİNİ" shall not be subject to independent legal protection.

(511)

30 – Biscuits, chocolate, confectionery.

(260) AM 2015 78866 A

(800) 1216431

(891) 2014 05 07

(731) VALENTINO S.P.A.

Via Turati, 16/18, I-20121 MILANO; Italy

(540)

**CAMU BUTTERFLY**

(511)

18 – Leather and imitations of leather, and goods made of these materials and not included in other classes; purses, school bags, school satchels, card cases, travelling trunks, backpacks, rucksacks, wallets, shopping bags, attaché cases, beach bags, bags, travelling bags, handbag frames, pouches, briefcases, cases of leather, vanity cases not fitted, leather key cases, suitcases, bags for sports, hat boxes of leather, garment bags for travel, leather shoulder belts, leather straps, fur, raw skins, dog collars, clothing for pets, umbrellas, walking sticks; whips, saddlery, harness fittings.

25 – Clothing, overalls, underwear, sweaters, shirts, jumpers, suits, ready-made clothing, trousers, outer clothing, knitwear, coats, skirts, petticoats, pullovers, overcoats, jackets, stuff jackets, ski jackets, ski pants, parkas, clothing of leather, T-shirts, blouses, pants, dressing gowns, formal dresses, vests, jerseys, pajamas, bathrobes, brassieres, camisoles, corselets, slips, children's clothing, layettes, bathing caps, bathing suits, clothing for gymnastics, waterproof clothing, raincoats, masquerade costumes; footwear, slippers, bath slippers, boots, sport boots, horse-riding boots, galoshes, shoes, beach shoes, sandals, sport shoes, gymnastic shoes, overshoes; headgear, hats, caps, cap peaks; socks, sock suspenders, stockings, garters, gloves, mittens, muffs, shawls, ties, neckties, scarves and foulards (clothing article), veils, bandanas, fur stoles, furs (clothing); belts; wedding dresses.

(260) AM 2015 78867 A

(800) 1216464

(891) 2014 06 25

(731) Kalleh dairy Co. (Sherkate Tolide

faravardehaye Labani Kalleh)

Sharghi Azarbayjan No. 103, Beyne

Daneshgah and Farvardin St., Tehran;

Iran (Islamic Republic of)

(540)

**SHAMS**

شمس

(591) Black, white

(511)

29 – Meat, fish, poultry and game, jellies, jams, milk powder (for food industry).

30 – Salt, mustard, vinegar, sauces (condiments), spices.

31 – Malt, grains.

32 – Beers (non alcoholic), mineral aerated waters and other non-alcoholic beverages, fruit beverages

and fruit juices and other preparations for making beverages.

(260) AM 2015 78868 A

(800) 1216486

(891) 2014 02 21

(731) Fonterra Co-operative Group Limited  
9 Princes Street, Auckland ; New Zealand  
(540)



(591) Black, white

(511)

1 – Chemical substances; chemical materials; chemical preparations; casein for industrial purposes; compositions for use in food and beverages; casein for the food industry; lactose for the food industry; milk ferments for chemical purposes; milk ferments for the food industry; protein [raw material].

5 – Pharmaceuticals; pharmaceutical preparations; veterinary preparations; probiotic preparations; bacterial preparations for medical use; biological preparations for medical use; bacterial preparations for nutritional purposes; biological preparations for nutritional purposes; cultures of micro-organisms for medical and veterinary use; dietetic foods adapted for medical use; dietetic substances adapted for medical use; dietetic beverages adapted for medical use; meal replacements adapted for medical use; dietetic foods adapted for veterinary use; dietetic substances adapted for veterinary use; dietetic beverages adapted for veterinary use; food for babies; food for infants; milk powder for babies; milk powder for infants; dietary supplements; protein dietary supplements; protein supplements for animals; casein dietary supplements; dietary supplements for humans; dietary supplements for animals; vitamins for human consumption; vitamin formulations for human consumption; mineral supplements; mineral supplements for foodstuffs; dietary supplements intended to supplement a normal diet; dietary supplements intended to have health benefits; nutritional additives; nutritional supplements; nutritional cultures (cultures of micro-organisms for medical and veterinary use); probiotic cultures; probiotic substances; sanitary preparations for medical purposes; probiotic preparations for veterinary use; dietetic foods adapted for animal use; dietetic substances adapted for animal use; dietetic beverages adapted for animal use; vitamins for animal consumption; vitamin formulations for animal consumption; feed additives for animals; probiotic cultures for veterinary use; probiotic substances for veterinary use; bacterial cultures; bacteriological preparations for medical and

veterinary use; bacterial preparations for medical and veterinary use; vitamin preparations; albuminous preparations for medical purposes; food preparations adapted for medical purposes; food preparations adapted for medical use; lacteal flour; milk sugar (lactose for pharmaceutical purposes); lactose for pharmaceutical purposes; lacteal flour for babies; malted milk beverages for medical purposes; albuminous foodstuffs for medical purposes; nutritional additives for medical purposes; biological preparations for veterinary purposes; amino acids for veterinary purposes; teething (preparations to facilitate).

29 – Milk; milk products; dairy products included in this class; dairy-based beverages; dairy-based powders; UHT (ultra high temperature) milk; ESL (extended shelf life) milk; milk substitutes included in this class; milk concentrate; milk powder; milk protein; cream (dairy products); butter; yoghurt; dessert products included in this class (dairy products predominating); edible oils; edible fats; cheese; whey; meat; fish; poultry; game; preserved fruits; frozen fruits; dried fruits; cooked fruits; preserved vegetables; frozen vegetables; dried vegetables; cooked vegetables; jellies; jams; compotes; meat extracts; eggs; condensed milk; flavoured milk; flavoured milk powder; food spreads consisting principally of dairy products; margarine; blends of butter; milk protein products; milk beverages (milk predominating); flavoured milk beverages (milk predominating); fortified milk beverages (milk predominating); milk powder containing nutritional additives (milk powder predominating); milk powder containing nutritional supplements (milk powder predominating); yoghurt beverages; flavoured yoghurt; yoghurt based desserts; cheddar cheese; ricotta cheese; parmesan cheese; feta cheese; havarti cheese; haloumi cheese; cottage cheese; cream cheese; soft cheese; hard cheese; cheese products; processed cheese; cheese spreads; blends of edible oils; blends of edible fats; albumin milk; gelatine for food; albumen for food; tofu; bean curd products; cream (whipped); acidophilus milk; kumys (milk beverage); kefir (milk beverage); buttercream; curd; rennet; koumiss (milk beverage); protein for human consumption; fatty substances for the manufacture of edible fats; soya milk; cocoa milk.

(260) AM 2015 78869 A

(800) 1216493

(891) 2014 06 24

(731) Laurent Destailleur

11 rue Raymond Queneau, F-92500 Rueil  
Malmaison; France

(540)

**dolibarr**

(511)  
9 – Software (recorded programs).  
42 – Computer system design.

(260) AM 2015 78870 A  
(800) 1216550  
(891) 2014 03 13  
(731) Colgate-Palmolive Company  
300 Park Avenue, New York,  
NY 10022; USA

(540)



(540) Colgate  
(591) Red and white  
(511)  
3 – Cosmetic oral care preparations; toothpaste; mouthwash; dental rinses; dentifrices; tooth whitening preparations; medicated toothpaste.

5 – Medicated oral care preparations; medicines for dental purposes; medicated oral care products; medicated mouthwash; medicated dental rinses; dental lacquer.

10 – Dental apparatus and instruments; apparatus for care of teeth, gums and mouth; an applicator cartridge pen pre-filled with a tooth whitening preparation; syringes for applying dental preparations; a professional tooth whitening system consisting of whitening preparations, syringes and mouth trays; pre-filled dental trays for applying dental compositions to teeth.

21 – Toothbrushes; electric toothbrushes; dental floss; interdental cleaners; dental applicator brushes.

(260) AM 2015 78871 A  
(800) 1216552  
(891) 2014 03 24  
(731) Premier Beverages P.B. Limited  
Arch. Makariou III, 2-4, Capital Center,  
9-th floor, CY-1065 Nicosia; Cyprus

(540)



(591) White, blue, beige, red, black, orange-brown, light yellow and orange  
(526) The trademark is protected as a whole. "Пиво" and "5%" shall not be subject to independent legal protection.  
(511)  
32 – Beers.

(260) AM 2015 78872 A  
(800) 1216601  
(891) 2014 06 11  
(731) Offhand LLC  
1209 Orange Street, Wilmington  
DE 19801, USA

(540)

## TAPTUATOR

(511)  
9 – Computers; computer peripheral devices; computer hardware; telecommunications apparatus and instruments; mobile digital electronic devices; global positioning system (GPS) devices; wireless communication devices for voice, data or image transmission; sound recording and reproducing apparatus; radio transmitters and receivers; computer software; parts for the aforesaid goods.

14 – Horological instruments; watches; timepieces.

(260) AM 2015 78874 A  
(800) 568001  
(891) 2014 02 17  
(731) MEDICE Arzneimittel Pütter GmbH & Co. KG  
Kuhloweg 37, 58638 Iserlohn; Germany

(540)

## Nephrotrans

(511)  
5 – Pharmaceutical and sanitary products, dietetic foods for children and the sick.

(260) AM 2015 78875 A  
(800) 837673  
(891) 2014 05 09  
(731) GAERNE S.p.A.  
Via Caldiroro, 81, Località Coste,  
I-31010 Maser (Treviso); Italy

(540)

## GAERNE

(591) Black, white  
(511)  
25 – Clothing, footwear, headgear, in particular clothing articles for sports and free time, including T-shirts, sweatshirts, jumpsuits, stockings and socks, gloves, clothing articles for cycling and motorcycling, shoes and boots, footwear for sports and free time, footwear for cycling, shoes, ankle boots and boots for motorcycling, galoshes, headgear for sports.

(260) AM 2015 78876 A  
(800) 956777  
(891) 2014 04 01  
(731) ALEXANDER SCHÄRF & SÖHNE

GESELLSCHAFT M.B.H.  
Dr. Alexander Schärf Platz 1, A-7100  
Neusiedl am See; Austria

(540)



(591) Red, black and white

(511)

30 – Coffee, tea, artificial coffee.

(260) AM 2015 78877 A

(800) 1171193

(891) 2014 04 29

(731) FOLIES DOUCES

19 Impasse Lou Haou, Zi Auguste V,  
F-33610 CESTAS; France

(540)

**ADOPT'**

(511)

3 – Soaps; perfumes; essential oils; cosmetics; hair lotions; make-up removing products; lipstick; beauty masks; all perfumery products; all beauty products; eau de parfum, eau de toilette, perfume sticks; fragrance-derived toiletries; cosmetic products; deodorants for personal use; lotions, creams and emulsions for cosmetic use for the face and body; room fragrances, perfumed deodorizers, perfumed air-freshening articles, perfumed air freshening sprays.

9 – Computer software; computer applications downloadable via the Internet for personal and portable computers, portable telephones, digital tablets for online access to a site featuring cosmetic products and used for creating make-up application simulations.

14 – Jewelry; jewelry products; precious stones; timepieces and chronometric instruments; precious metals and alloys thereof; works of art of precious metal; jewelry case (casket); boxes of precious metal; watch cases, bracelets, chains, springs or glasses; key rings [trinkets or fobs]; statues or figurines (statuettes) of precious metals; cases or presentation cases for timepieces; medals.

(260) AM 2015 78878 A

(800) 1171828

(891) 2014 06 17

(731) Joint Stock Company Gazprom neft  
ul. Galernaya, 5, lit. A, RU-190000  
Sankt-Peterburg; Russian Federation

(540)



(591) White, orange, grey and black

(526) The trademark is protected as a whole. "ENERGY", "SERVICE" shall not be subject to independent legal protection.

(511)

4 – Additives, non-chemical, to motor fuel; alcohol [fuel]; anthracite; beeswax; belting wax; benzene; benzol; blocks of peat [fuel]; bone oil for industrial purposes; carnauba wax; castor oil for technical purposes; ceresine; charcoal [fuel]; Christmas tree candles; perfumed candles; coal briquettes; coal dust [fuel]; coal naphtha; coal tar oil; coal; coke; combustible oil; cutting fluids; diesel oil; dust binding compositions for sweeping; dust laying compositions; dust removing preparations; electrical energy; ethanol [fuel]; firelighters; firewood; fish oil, not edible; fuel gas; fuel with an alcoholic base; fuel; gas for lighting; gasoline; grease for arms [weapons]; grease for belts; non-slipping preparations for belts; grease for boots; combustible briquettes; grease for leather; illuminating grease; illuminating wax; industrial grease; industrial oil; industrial wax; kerosene; lamp wicks; lighting fuel; lignite; ligroin; lubricants; lubricating grease; lubricating oil; mazut; methylated spirit; mineral fuel; moistening oil; motor fuel; motor oil; naphtha; nightlights [candles]; oil for the preservation of leather; oil for the preservation of masonry; oil-gas; oils for paints; oils for releasing form work [building]; oleine; ozocerite [ozokerite]; paper spills for lighting; wood spills for lighting; paraffin; peat [fuel]; peat briquettes [fuel]; petrol; petroleum ether; petroleum jelly for industrial purposes; petroleum, raw or refined; preservatives for leather [oils and greases]; producer gas; rape oil for industrial purposes; solidified gases [fuel]; soya bean oil preparations for non-stick treatment of cooking utensils; stearine; sunflower oil for industrial purposes; tallow; tapers; textile oil; tinder; vaporized fuel mixtures; wax [raw material]; wicks for candles; wood briquettes; wool grease; xylene; xylol.

37 – Airplane maintenance and repair; anti-rust treatment for vehicles; artificial snow-making services; asphaltting; boiler cleaning and repair; bricklaying; building construction supervision; building insulating; building of fair stalls and shops; building sealing; vehicle service stations [refuelling and maintenance]; burglar alarm installation and repair; burner maintenance and repair; cabinet making

[repair]; car wash; carpentry services; chimney sweeping; cleaning of buildings [exterior surface]; cleaning of buildings [interior]; cleaning of clothing; clock and watch repair; installation, maintenance and repair of computer hardware; construction consultation; construction information; construction; demolition of buildings; diaper cleaning; disinfecting; drilling of deep oil or gas-wells; drilling of wells; dry cleaning; electric appliance installation and repair; interference suppression in electrical apparatus; factory construction; film projector repair and maintenance; fire alarm installation and repair; freezing equipment installation and repair; fur care, cleaning and repair; furnace installation and repair; furniture maintenance; furniture restoration; harbour construction; heating equipment installation and repair; installation of doors and windows; irrigation devices installation and repair; kitchen equipment installation; knife sharpening; laundering; leather care, cleaning and repair; lift installation and repair; linen ironing; machinery installation, maintenance and repair; clothing repair; masonry; mending clothing; mining extraction; motor vehicle maintenance and repair; installation, maintenance and repair of office machines and equipment; painting or repair of signs; paper hanging; parasol repair; photographic apparatus repair; pier breakwater building; pipeline construction and maintenance; plastering; plumbing; pressing of clothing; pumicing; pump repair; quarrying services; rat exterminating; re-tinning; rebuilding engines that have been worn or partially destroyed; rebuilding machines that have been worn or partially destroyed; refilling of toner cartridges; renovation of clothing; rental of bulldozers; rental of cleaning machines; rental of construction equipment; rental of cranes [construction equipment]; rental of excavators; rental of road sweeping machines; repair information; repair of security locks; restoration of musical instruments; restoration of works of art; retreading of tires [tyres]; riveting; road paving; roofing services; rustproofing; safe maintenance and repair; sanding; scaffolding; shipbuilding; shoe repair; street cleaning; strong-room maintenance and repair; swimming-pool maintenance; telephone installation and repair; umbrella repair; underwater construction; underwater repair; upholstering; upholstery repair; varnishing; vehicle breakdown assistance [repair]; vehicle cleaning; vehicle lubrication [greasing]; vehicle maintenance; vehicle polishing; vehicle wash; vermin exterminating, other than for agriculture; vulcanization of tires [repair]; warehouse construction and repair; washing of linen; washing; window cleaning.

(260) AM 2015 78881 A  
(800) 1216664  
(891) 2014 05 20

(731) Changzhou Trina Solar Energy Co., Ltd.  
No. 2 Trina Road, Trina PV Park, Xinbei  
District, Changzhou, 213031 Jiangsu; China  
(540)



(591) Bright blue and red  
(511)

4 – Electrical energy; atomic energy, energy produced by nuclear fusion; candles; tapers; lamp wicks; fuel gas; lubricating oil; motor fuel; fuel; petroleum, raw or refined.

9 – Galvanic cells; single crystal silicon wafers; polysilicon wafers; semiconductor apparatus; solar batteries; junction boxes (electricity); accumulators, electric; battery chargers; chips (integrated circuits); inverters (electricity); cell switches (electricity); reducers (electricity); alternating current controllers; direct current controllers; thunder defending junction boxes; distribution boxes (electricity).

11 – Street lamps; standard lamps; solar thermal collectors (heating); solar water heaters; lighting apparatus and installations; water heaters; pocket warmers; solar furnaces; heater for baths; lamp mantles, lamp casings.

19 – Roofing, not of metal, incorporating solar cells; luminous paving; lighting slabs; cement; building timber; lumber; posts, not of metal, for electric power lines; poles, not of metal, for electric power lines; felt for building; wooden floors.

(260) AM 2015 78882 A  
(800) 1216666  
(891) 2008 10 27

(731) KRKA, tovarna zdravil, d.d.  
Šmarješka cesta 6, SI-8501 Novo mesto;  
Slovenia

(540)

**ВИТАСКИН**

(591) Black, white  
(511)

3 – Cosmetic preparations for skin care and body care, beauty care preparations, perfumery, soap and shampoos, preparations for hair care, sunscreen preparations contain substances that protect the skin against UVA and UVB radiation [for cosmetic use]; after-sun creams and preparations [for cosmetic use]; sun-tanning cosmetic preparations; cosmetic preparations containing components for skin care and body care, cosmetic preparations.

5 – Pharmaceutical preparations for medical purposes, sanitary preparations (included in this class), dietetic preparations for medical purposes, food supplements for medical use and food supplement products (included in this class),

preparations containing vitamins, minerals and enzymes for medical purposes, all sorts of vitamins preparations and food supplements on the basis of amino acids.

(260) AM 2015 78884 A

(800) 1216675

(891) 2014 05 26

(731) Kabushiki Kaisha Miyake Design Jimusho  
(also trading as Miyake Design Studio)  
1-23 Ohyamacho, Shibuya-ku, Tokyo  
151-0065; Japan

(540)

## NUIT D'ISSEY

(511)

3 – Soaps and detergents; dentifrices; make-up powders; toilet water; cosmetic creams; cheek colors; cosmetic rouges; hair care cosmetics preparations; liquid perfumes; perfumes; cleansing cosmetic creams; cold creams; cosmetic lotions; skin cosmetic preparations; bath cosmetics; hair lotions; eye cosmetics; eyebrow cosmetics; talcum powders for toilet use; depilatories; body deodorant cosmetics; perfumery; fragrances and incenses; abrasive paper; abrasive cloth; abrasive sand; artificial pumice stones; polishing paper; false nails; false eyelashes.

(260) AM 2015 78885 A

(800) 1216683

(891) 2014 05 22

(731) Richter Gedeon Nyrt.  
Gyömrői út 19-21, H-1103 Budapest;  
Hungary

(540)

## SYMVENU

(511)

5 – Pharmaceutical preparations.

(260) AM 2015 78886 A

(800) 1216700

(891) 2014 07 21

(731) Lodestar Anstalt  
(a Liechtenstein company)  
Lova-Center, PO Box 1150, FL-9490 Vaduz;  
Liechtenstein

(540)

## SCOTT AND BURNS

(511)

33 – Alcoholic beverages (except beer); distilled spirits; rum; whiskey; vodka; gin; distilled beverages; liqueurs; cocktails.

(260) AM 2015 78890 A

(800) 1216702

(891) 2014 07 09

(731) uniQure IP B.V.  
Meibergdreef 61, NL-1105 BA Amsterdam;  
Netherlands

(540)

**Glybera**

(591) Black, white

(511)

5 – Pharmaceutical products; biological preparations for use in medical and clinical gene therapy and cell therapy; clinical medical reagents for use in gene therapy, gene diagnosis, and gene testing; pharmaceutical preparations, vaccines for use in gene therapy; gene therapy and prophylaxis products, all the aforementioned goods exclusively in the treatment of metabolic disorders including such disorders which are single gene disorders and disorders which are a result of one more mutations within the lipoprotein lipase gene.

(260) AM 2015 78892 A

(800) 1216704

(891) 2014 07 07

(731) Lodestar Anstalt (a Liechtenstein company)  
Lova-Center, PO Box 1150, FL-9490 Vaduz;  
Liechtenstein

(540)

## FIRE AND FURY

(511)

33 – Alcoholic beverages (except beer); distilled spirits; rum; whiskey; vodka; gin; distilled beverages; liqueurs; cocktails.

(260) AM 2015 78894 A

(800) 1216705

(891) 2014 07 07

(731) Lodestar Anstalt (a Liechtenstein company)  
Lova-Center, PO Box 1150, FL-9490 Vaduz;  
Liechtenstein

(540)

## LORNA DOONE

(511)

33 – Alcoholic beverages (except beer); distilled spirits; rum; whiskey; vodka; gin; distilled beverages; liqueurs; cocktails.

(260) AM 2015 78900 A

(800) 1216709

(891) 2014 03 05

(731) DINECT SARL  
49, rue Glesener, L-1631 Luxembourg;  
Luxembourg

(540)

**DINECT**

(511)

9 – Computer software and hardware; downloadable computer software; downloadable mobile phone applications; computer software that allows users to access coupons, rebates, price-comparison informations, product reviews, links to the websites of others, and discount informations; downloadable video recordings; computer software allowing users to exchange bonus points for goods and services; downloadable sound recordings; downloadable ring tones and graphics for mobile phones; downloadable electronic publications; downloadable images; electronic and magnetic cards; downloadable discount vouchers provided via the Internet.

35 – Advertising; business management; business administration; promoting the goods and services of others; organisation, operation and supervision of loyalty and incentive schemes; advertising services provided via the Internet; advertisement services provided via mobile phone networks; provision of business information; promoting the goods and services of others through the distribution of downloadable and non-downloadable discount cards; electronic retailing services via computer featuring a variety of consumer goods, namely, clothing, footwear, headgear, clothing accessories, bags, luggage, umbrellas, personal care and grooming related goods, cosmetics, perfumery, mobile phones, tablets, computers, televisions, cameras and other home and office electronic equipment, namely, radio receivers, mp3 players, video recorders, DVD and optical disc players, video game consoles, stereos, projectors, speakers, washing machines, tumble dryers, dish washers, refrigerators, freezers, fridge-freezers, cookers, microwaves, monitors, fax machines, printers, photocopiers, scanners, home lighting, heating and cooking products, jewellery, watches and clocks, printer matter, books, stationery, furniture, bed and table linen, ornaments, household utensils and containers, games and playthings, computer games, sporting articles, decorations, food products, alcoholic and non-alcoholic beverages; providing marketplace information; promoting the goods and services of others by providing a website featuring coupons, rebates, price-comparison information, product reviews, links to the retail websites of others, and discount information.

36 – Downloadable and non-downloadable electronic payment discount card services; issuing of tokens of value in relation to bonus and loyalty schemes; provision of downloadable and non-downloadable discount cards for use at retail stores, restaurants, service stations, shops and leisure outlets, in connection with loyalty, bonus and reward schemes; downloadable and non-downloadable

discount electronic payment card services provided to payment card users for retail, leisure, travel and cultural purposes; credit and debit card transaction processing services.

(260) AM 2015 78901 A

(800) 1216710

(891) 2014 03 05

(731) DINECT SARL

49, rue Glesener, L-1631 Luxembourg;  
Luxembourg

(540)



(591) Black, white

(511)

9 – Computer software and hardware; downloadable computer software; downloadable mobile phone applications; computer software that allows users to access coupons, rebates, price-comparison informations, product reviews, links to the websites of others, and discount informations; downloadable video recordings; computer software allowing users to exchange bonus points for goods and services; downloadable sound recordings; downloadable ring tones and graphics for mobile phones; downloadable electronic publications; downloadable images; electronic and magnetic cards; downloadable discount vouchers provided via the Internet.

35 – Advertising; business management; business administration; promoting the goods and services of others; organisation, operation and supervision of loyalty and incentive schemes; advertising services provided via the Internet; advertisement services provided via mobile phone networks; provision of business information; promoting the goods and services of others through the distribution of downloadable and non-downloadable discount cards; electronic retailing services via computer featuring a variety of consumer goods, namely, clothing, footwear, headgear, clothing accessories, bags, luggage, umbrellas, personal care and grooming related goods, cosmetics, perfumery, mobile phones, tablets, computers, televisions, cameras and other home and office electronic equipment, namely, radio receivers, mp3 players, video recorders, DVD and optical disc players, video game consoles, stereos, projectors, speakers, washing machines, tumble dryers, dish washers, refrigerators, freezers, fridge-freezers, cookers, microwaves, monitors, fax machines, printers, photocopiers, scanners, home lighting, heating and cooking products, jewellery, watches and clocks, printer matter, books, stationery, furniture, bed and table linen, ornaments, household utensils and containers, games and playthings, computer games, sporting articles, decorations, food products, alcoholic and non-alcoholic beverages; providing



marketplace information; promoting the goods and services of others by providing a website featuring coupons, rebates, price-comparison information, product reviews, links to the retail websites of others, and discount information.

36 – Downloadable and non-downloadable electronic payment discount card services; issuing of tokens of value in relation to bonus and loyalty schemes; provision of downloadable and non-downloadable discount cards for use at retail stores, restaurants, service stations, shops and leisure outlets, in connection with loyalty, bonus and reward schemes; downloadable and non-downloadable discount electronic payment card services provided to payment card users for retail, leisure, travel and cultural purposes; credit and debit card transaction processing services.

(260) AM 2015 78902 A

(800) 1216714

(891) 2013 12 31

(731) La Quinta Worldwide, LLC

909 Hidden Ridge, Suite 600, Irving,  
TX 75038; USA

(540)

**LQ HOTEL**

(591) Black, white

(526) The trademark is protected as a whole. "HOTEL" shall not be subject to independent legal protection.

(511)

9 – Downloadable mobile applications for making hotel and motel reservations; downloadable mobile applications for informing consumers that their hotel and/or motel accommodations are ready; computer application software for mobile phones and mobile devices, namely software for facilitation of reservations for hotel and motel accommodations and hotel and motel services; computer application software for desktop, tablets, mobile phones and other mobile devices for informing consumers that their hotel accommodations are ready.

35 – Advertising, marketing and promotional services for hotels and motels; hotel and motel management services, hotel and motel operation services, business administration and management; hotel and motel business direction and administration; business management assistance in the establishment and operation of hotels and motels; hotel and motel franchising services; provision and management of incentive programs, loyalty programs and member benefits related to hotel and motel services.

41 – Providing facilities for recreation activities.

43 – Hotel and motel services; services for providing food and drink; restaurants; rental of

temporary accommodation, catering and bar services; room rental; rental of meeting rooms and facilities, provision of conference, exhibition, banquet, social function and meeting facilities, booking of hotel accommodation; hotel and motel accommodation and hotel and motel reservation services; provision of information relating to hotel and motel services; provision of information via communication and computer networks, and via mobile devices relating to hotel and motel services; providing information via a global communication network relating to hotel and motel services.

(260) AM 2015 78903 A

(800) 1216722

(891) 2013 12 04

(731) Sovmestnoye obshchestvo s

ogranichennoy otvetstvennostyu

"BELOR-DESIGN"

kom. 210A, 22, ul. P. Brovki, 220013

Minsk; Belarus

(540)



(591) Black and pink

(511)

3 – Bleaching preparations and other substances for laundry use; cleaning, polishing, scouring and abrasive preparations; soaps; perfumery, essential oils, cosmetics, hair lotions; dentifrices; antistatic preparations for household purposes; breath freshening sprays; aromatics [essential oils]; scented water; toilet water; make-up; deodorants for human beings or for animals; perfumes; decorative transfers for cosmetic purposes; eyebrow pencils; cosmetic pencils; adhesives for affixing false eyelashes; adhesives for affixing false hair; cosmetic dyes; cosmetic creams; skin whitening creams; hair spray; nail polish; after-shave lotions; lotions for cosmetic purposes; beauty masks; oils for cosmetic purposes; oils for toilet purposes; essential oils of cedarwood; essential oils of lemon; bergamot oil; gaultheria oil; jasmine oil; lavender oil; almond oil; rose oil; oil of turpentine for degreasing; adhesives for cosmetic purposes; almond milk for cosmetic purposes; cleansing milk for toilet purposes; musk [perfumery]; disinfectant soap; deodorant soap; shaving soap; cakes of toilet soap; medicated soap; antiperspirant soap; soap for foot perspiration; almond soap; mint for perfumery; cosmetic kits; emery; false nails; eau de cologne; bases for flower perfumes; joss sticks; pumice stone; lipsticks; pomades for cosmetic purposes; shaving preparations; cosmetic preparations for baths; toiletries; hair waving preparations; leather bleaching preparations; shining preparations; mouth washes, not for medical purposes; cosmetic preparations for slim-



ming purposes; make-up removing preparations; paint stripping preparations; lacquer-removing preparations; nail care preparations; make-up powder; scouring solutions; false eyelashes; tissues impregnated with cosmetic lotions; potpourris [fragrances]; bath salts, not for medical purposes; bleaching salts; leather preservatives [polishes]; fumigation preparations [perfumes]; astringents for cosmetic purposes; eyebrow cosmetics; make-up preparations; sun-tanning preparations [cosmetics]; hair colorants; neutralizers for permanent waving; cosmetic preparations for eyelashes; depilatories; cosmetic preparations for skin care; cosmetics; cosmetics for animals; mascara; detergents other than for use in manufacturing operations and for medical purposes; degreasers other than for use in manufacturing processes; bleaching preparations [decolorants] for cosmetic purposes; antiperspirants [toiletries]; talcum powder, for toilet use; terpenes [essential oils]; shampoos; shampoos for pets; extracts of flowers [perfumes]; ethereal essences; badian essence; mint essence [essential oil].

5 – Pharmaceutical and veterinary preparations; sanitary preparations for medical purposes; dietetic substances adapted for medical use; food for babies; plasters, materials for dressings; material for stopping teeth, dental wax; disinfectants; preparations for destroying vermin; fungicides, herbicides; balms for medical purposes; oxygen baths; aseptic cotton; antiseptic cotton; absorbent cotton; wadding for medical purposes; thermal water; mud for baths; medicinal mud; deodorants, other than for human beings or for animals; deodorants for clothing and textiles; lotions for pharmaceutical purposes; liniments; ointments for pharmaceutical purposes; sunburn ointments; oils for protection from gadflies; medicinal oils; drugs for medical purposes; menthol; stick liquorice for pharmaceutical purposes; sulphur sticks [disinfectants]; bunion pads; pomades for medical purposes; balsamic preparations for medical purposes; vitamin preparations; therapeutic preparations for the bath; preparations for the treatment of burns; air deodorising preparations; air purifying preparations; corn remedies; pharmaceutical preparations for treating dandruff; pharmaceutical preparations for skin care; bath preparations, medicated; medicinal hair growth preparations; preparations of trace elements for human and animal use; sunburn preparations for pharmaceutical purposes; chemico-pharmaceutical preparations; chemical preparations for medical purposes; collyrium; solvents for removing adhesive plasters; insect repellent incense; insect repellents; repellents for dogs; sanitary napkins; tissues impregnated with pharmaceutical lotions; salts for mineral water baths; bath salts for medical purposes; salts for medical purposes; antiseptics; analgesics; adjuvants for medical purposes; styptic preparations; disinfectants for

hygiene purposes; animal washes; detergents for medical purposes; remedies for perspiration; remedies for foot perspiration; ionics (medicines); herbal teas for medicinal purposes; slimming tea for medical purposes; eucalyptus for pharmaceutical purposes.

8 – Hand tools and implements (hand-operated); cutlery; side arms; razors, electric or non-electric; depilation appliances, electric and non-electric; nail clippers, electric or non-electric; glazing irons; ear-piercing apparatus; razor blades; beard clippers; hair clippers for personal use, electric and non-electric; manicure sets; manicure sets, electric; pedicure sets; shaving cases; knives, included in this class; shearers [hand instruments]; scissors, included in this class; nail files; nail files, electric; hand implements for hair curling; fingernail polishers, electric or non-electric; razor cases; nippers; curling tongs; cuticle nippers; nail nippers; eyelash curlers.

16 – Paper, cardboard and goods made from these materials, not included in other classes; printed matter; bookbinding material; photographs; stationery; adhesives for stationery or household purposes; artists' materials; paint brushes; typewriters and office requisites (except furniture); instructional and teaching material (except apparatus); plastic materials for packaging (not included in other classes); printers' type; printing blocks; pencils; pencil lead holders; pictures; decalcomanias; paintbrushes; writing brushes; glue for stationery or household purposes; comic books; writing chalk; marking chalk; steel pens; mats for beer glasses; stands for pens and pencils; photograph stands; writing cases [sets]; labels, not of textile.

21 – Household or kitchen utensils and containers; combs and sponges; brushes (except paint brushes); brush-making materials; articles for cleaning purposes; steelwool; unworked or semi-worked glass (except glass used in building); glassware, porcelain and earthenware not included in other classes; combs; abrasive sponges for scrubbing the skin; sponges for household purposes; toilet sponges; deodorising apparatus for personal use; sponge holders; toothpick holders; soap holders; shaving brush stands; brush goods; shaving brushes; insect traps; polishing materials for making shiny, except, preparations, paper and stone; soap boxes; fitted picnic baskets, including dishes; toilet cases; floss for dental purposes; gloves for household purposes; boot jacks; powder compacts; perfume sprayers; powder puffs; soap dispensers; electric combs; griddles [cooking utensils]; comb cases; toothbrushes; toothbrushes, electric; animal bristles [brushware]; brushes for footwear; toilet brushes; electric brushes, except parts of machines; eyebrow brushes; nail brushes.

24 – Textiles and textile goods, not included in other classes; bed blankets; bed and table covers; washing

mitts; handkerchiefs of textile; napkins for removing make-up [cloth]; face towels of textile; mosquito nets; labels of cloth.

(260) AM 2015 79143 A  
(800) 1218609  
(891) 2014 02 11  
(731) PARTY FIESTA, S.A.

Juan Ramón Jiménez, 15, Hospitalet del Llobregat, E-08908 Barcelona; Spain

(540)



(591) Gray, dark blue, yellow, dark green, mustard and red

(511)

35 – Sale services for paper and cardboard articles and objects for parties via global computer networks, import and export services, sale services for paper and cardboard articles and objects for parties, wholesale and retail sale services; commercial advisory services relating to the establishment and operation of franchises.

(260) AM 2015 79147 A  
(800) 1218656  
(891) 2014 05 26  
(731) SMARTBUY GURU ENTERPRISES LTD.

c/o ABI Trust Ltd., N156 Redcliffe Street, ST. JOHN'S; Antigua and Barbuda

(540)



(591) Orange, light orange and black

(511)

35 – Retail services in relation to eye glasses, spectacles, contact lenses, sunglasses, eye care products and preparations, and accessories for all the aforesaid goods; online retail services in relation to eye glasses, spectacles, contact lenses, sunglasses, eye care products and preparations, and accessories for all the aforesaid goods; mail order retail services in relation to eye glasses, spectacles, contact lenses, sunglasses, eye care products and preparations, and accessories for all the aforesaid goods; distributorship services in relation to eye glasses, spectacles, contact lenses, sunglasses, eye care products and preparations, and accessories for all the aforesaid goods; procurement services in relation to eye glasses, spectacles, contact lenses, sunglasses, eye care products and preparations, and accessories for all the aforesaid goods.

(260) AM 2015 79148 A  
(800) 1218657  
(891) 2014 05 26  
(731) SMARTBUY GURU ENTERPRISES LTD.  
c/o ABI Trust Ltd., N156 Redcliffe Street,  
ST. JOHN'S; Antigua and Barbuda  
(540)

## ARISE COLLECTIVE

(511)

5 – Eye care products and preparations, namely solutions for contact lenses; eye drops.

9 – Eyewear, namely spectacles, prescription eyewear, anti-glare glasses, glasses and sunglasses and their parts and accessories, namely replacement lenses, frames, ear stems and nose pieces; eyewear and parts for eyewear; cases for spectacles and sunglasses and their parts and accessories; cyclists' glasses, reading glasses, ski glasses, sports glasses; correcting lenses [optics], contact lenses, containers for contact lenses; glasses laces.

25 – Clothing; footwear; headgear.

(260) AM 2015 79149 A  
(800) 1218679  
(891) 2014 08 04  
(731) Nemiroff Intellectual Property Establishment  
Städtle 31, FL-9490 Vaduz; Liechtenstein  
(540)



(591) White, yellow, brown, black, red, green, beige  
(511)

33 – Alcoholic beverages (except beers).

35 – Advertising; business management; business administration; office functions; importation and exportation of alcoholic beverages; retail and wholesale services with alcoholic beverages.

(260) AM 2015 79150 A  
(800) 1218689  
(891) 2014 08 05  
(731) Bayer Intellectual Property GmbH  
40789 Monheim am Rhein; Germany

(540)

**JOZERVE**

(511)

5 – Pharmaceutical preparations.

(260) AM 2015 79151 A

(800) 1218700

(891) 2014 07 16

(731) WIDE MARKS CORPORATION LTD  
Dimosthenous 20, CY-1101 NICOSIA;  
Cyprus

(540)

**PONY EXPRESS**

(511)

39 – Transport; storage of goods.

(260) AM 2015 79152 A

(800) 1218710

(891) 2014 05 26

(731) SMARTBUY GURU ENTERPRISES LTD.  
c/o ABI Trust Ltd., 156 Redcliffe Street,  
ST. JOHN'S; Antigua and Barbuda

(540)

**КАП COLLECTIVE**

(511)

5 – Eye care products and preparations namely solutions for contact lenses; eye drops.

9 – Eyewear, namely spectacles; prescription eyewear, anti-glare glasses, glasses and sunglasses and their parts and accessories, namely replacement lenses, frames, ear stems and nose pieces; eyewear and parts for eyewear; cases for spectacles and sunglasses and their parts and accessories; cyclists' glasses, reading glasses, ski glasses, sports glasses; correcting lenses (optics), contact lenses, containers for contact lenses; glasses laces.

25 – Clothing; footwear; headgear.

(260) AM 2015 79153 A

(800) 1218744

(891) 2014 07 30

(731) Obshchestvo s ogranichennoy  
otvetstvennostyu "TD Skarlet-21 vek"  
ul. Akad. Koroleva, 9, korp. 5 RU-129515  
Moscow; Russian Federation

(540)

**СЕРДЕЧКО**

(591) Black, white

(511)

3 – Bleaching preparations and other substances for laundry use; cleaning, polishing, scouring and abrasive preparations; soaps; perfumery, essential oils, cosmetics, hair lotions.

(260) AM 2015 79154 A

(800) 1218745

(891) 2014 07 30

(731) Obshchestvo s ogranichennoy  
otvetstvennostyu "TD Skarlet-21 vek"  
ul. Akad. Koroleva, 9, korp. 5 RU-129515  
Moscow; Russian Federation

(540)

**Железный коготь**

(511)

3 – Bleaching preparations and other substances for laundry use; cleaning, polishing, scouring and abrasive preparations; soaps; perfumery, essential oils, cosmetics, hair lotions; nail care preparations; false nails.

(260) AM 2015 79155 A

(800) 1218746

(891) 2014 07 30

(731) Obshchestvo s ogranichennoy  
otvetstvennostyu "TD Skarlet-21 vek"  
ul. Akad. Koroleva, 9, korp. 5 RU-129515  
Moscow; Russian Federation

(540)

**Железная твёрдость**

(511)

3 – Bleaching preparations and other substances for laundry use; cleaning, polishing, scouring and abrasive preparations; soaps; perfumery, essential oils, cosmetics, hair lotions; nail care preparations; false nails.

(260) AM 2015 79159 A

(800) 1218747

(891) 2014 04 17

(731) Otkrytoe Aktsionernoe Obshchestvo  
"Nizhegorodsky khimiko-farmatsevtichesky  
zavod"  
GSP-459, Ul. Salganskaya, 7 Nizhny  
Novgorod, RU-603950 Nizhegorodskaya obl.,  
Russian Federation

(540)

**Аквалор**

(511)

5 – Pharmaceutical preparations, including preparations for irrigation and lavage of nasal cavity, larynx and throat for medical purpose; analgesics; anaesthetics; antibiotics; balms for medical purposes; melissa water for pharmaceutical purposes; sea water for medicinal bathing; mineral waters for medical purposes; thermal water; sea water and thermal water in the form of sprays; mineral food supplements; nutritional supplements; albumin dietary supplements; alginate dietary supplements; capsules for medicines; cachets for pharmaceutical purposes; ointments for pharma-

ceutical purposes; medicines for human purposes; medicinal drinks; medicinal infusions; tinctures for medical purposes; bacterial preparations for medical use; biological preparations for medical purposes; vitamin preparations; eye-washes; bronchodilating preparations; preparations of trace elements for human, including preparations for irrigation and lavage of nasal cavity, larynx and throat; chemico-pharmaceutical preparations; collyrium; vaginal washes; solutions for contact lenses; syrups for pharmaceutical purposes; douching preparations for medical purposes; mouthwashes for medical purposes.

10 – Surgical, medical, dental and veterinary apparatus and instruments; testing apparatus for medical purposes; physiotherapy apparatus; diagnostic apparatus for medical purposes; inhalers; water bags for medical purposes; pumps for medical purposes; medical instruments, including aerosol dispensers for medical purposes, inhalers, injectors for medical purposes, sprayers for medical purposes; brushes for cleaning body cavities; appliances for washing body cavities; sprayers for medical purposes; receptacles for applying medicines; ear plugs [ear protection devices]; syringes for injections; syringes for medical purposes.

(260) AM 2015 79160 A  
(800) 1218752  
(891) 2014 06 20  
(731) Carlsberg Breweries A/S  
Ny Carlsberg Vej 100, DK-1799  
Copenhagen V; Denmark  
(540)



(591) Gold, black and pink  
(511)  
32 – Beer.

(260) AM 2015 79161 A  
(800) 1218756  
(891) 2014 04 17  
(731) Otkrytoe aktsionerное obshchestvo  
"Nizhegorodsky khimiko-farmatsevtichesky  
zavod"  
GSP-459, ul.Salganskaya, d.7, RU-603950  
g. Nizhny Novgorod; Russian Federation  
(540)

**Aqualor**

(511)  
5 – Pharmaceutical preparations, including preparations for irrigation and lavage of nasal cavity, larynx and throat for medical purpose; analgesics; anaesthetics; antibiotics; balms for medical purposes; melissa water for pharmaceutical purposes; sea water for medicinal bathing; mineral waters for medical purposes; thermal water; sea water and thermal water in the form of sprays; mineral food supplements; nutritional supplements; albumin dietary supplements; alginate dietary supplements; capsules for medicines; cachets for pharmaceutical purposes; ointments for pharmaceutical purposes; medicines for human purposes; medicinal drinks; medicinal infusions; tinctures for medical purposes; bacterial preparations for medical use; biological preparations for medical purposes; vitamin preparations; eye-washes; bronchodilating preparations; preparations of trace elements for human, including preparations for irrigation and lavage of nasal cavity, larynx and throat; chemico-pharmaceutical preparations; collyrium; vaginal washes; solutions for contact lenses; syrups for pharmaceutical purposes; douching preparations for medical purposes; mouthwashes for medical purposes.

10 – Surgical, medical, dental and veterinary apparatus and instruments; testing apparatus for medical purposes; physiotherapy apparatus; diagnostic apparatus for medical purposes; inhalers; water bags for medical purposes; pumps for medical purposes; medical instruments, including aerosol dispensers for medical purposes, inhalers, injectors for medical purposes, sprayers for medical purposes; brushes for cleaning body cavities; appliances for washing body cavities; sprayers for medical purposes; receptacles for applying medicines; ear plugs [ear protection devices]; syringes for injections; syringes for medical purposes.

(260) AM 2015 79166 A  
(800) 1218784  
(891) 2014 04 08  
(731) Apple Inc.  
1 Infinite Loop, Cupertino CA 95014; USA  
(540)



(591) Black, purple and blue

(511)

35 – Business management; data processing services; advertising agency services; advertising, marketing, and promotion services; advertising and marketing consultation; sales promotion services; promoting the goods and services of others; conducting market research; analysis of advertising response and market research; design, creation, preparation, production, and dissemination of advertisements and advertising material for others; media planning services; administration of consumer loyalty programs; arranging and conducting incentive rewards programs to promote the sale of goods and services; providing business, consumer, and commercial information over computer networks and global communication networks; business services, namely, providing computer databases regarding the purchase and sale of a wide variety of products and services of others; retail store services; online retail store services provided via the internet and other electronic and communications networks; arranging and conducting of commercial, trade, and business conferences, shows, and exhibitions; information, advisory business management; data processing services; advertising agency services; advertising, marketing, and promotion services; advertising and marketing consultation; sales promotion services; promoting the goods and services of others; conducting market research; analysis of advertising response and market research; design, creation, preparation, production, and dissemination of advertisements and advertising material for others; media planning services; administration of consumer loyalty programs; arranging and conducting incentive rewards programs to promote the sale of goods and services; providing business, consumer, and commercial information over computer networks and global communication networks; business services, namely, providing computer databases regarding the purchase and sale of a wide variety of products and services of others; retail store services; online retail store services provided via the internet and other electronic and communications networks; arranging and conducting of commercial, trade, and business conferences, shows, and exhibitions; information, advisory and consultancy services relating to all the aforesaid and consultancy services relating to all the aforesaid.

(260) AM 2015 79347 A

(800) 1220490

(891) 2014 05 22

(731) Tovarystvo z obmezheniou, vidpovidalnistiu "Simferopolskyi vyno – koniachnyi zavod"  
vul. Marshala Malynovskoho, bud. 14 A,  
m. Dnipropetrovsk 49000; Ukraine

(540)



(591) Black, white

(526) The trademark is protected as a whole. "УКРАЇНСЬКИЙ СТАНДАРТ", "UKRAINIAN STANDART", "УКРАЇНСЬКИЙ СТАНДАРТ" shall not be subject to independent legal protection.

(511)

33 – Alcoholic beverages, except beer; aperitifs; arak; brandy; wine; whisky; anisette; anise [liqueur]; hydromel; vodka; kirsch; perry; gin; cocktails; curacao; liqueurs; peppermint liqueurs; pre-mixed alcoholic beverages, other than beer-based; distilled beverages; alcoholic beverages containing fruit; bitters; piquette; rice alcohol; rum; sake; cider; spirits [beverages]; alcoholic extracts; alcoholic essences; digesters [liqueurs and spirits]; fruit extracts, alcoholic.

(260) AM 2015 79458 A

(800) 1221758

(891) 2014 09 25

(731) Jiangsu Artsdon Garments&Ornaments Co., Ltd  
Mogan Road, Yushan Town, Changshu  
City, Jiangsu Province; China

(540)

## ARTSDON

(511)

25 – Clothing; jackets (clothing); tee-shirts; layettes (clothing); shoes; sports shoes; Hats; hosiery; gloves (clothing); neckties.

(260) AM 2015 79459 A

(800) 683188

(891) 2014 07 02

(731) DESSANGE INTERNATIONAL

(Société anonyme)

39, avenue Franklin D. Roosevelt, F-75008  
PARIS; France

(540)

## PHYTODESS

(511)

3 – Perfumes, shampoos, hair lotions, cosmetic products, cosmetic beauty products, hair dyes and bleaching products, face and body creams and lotions, make-up products.

(260) AM 2015 79461 A  
 (800) 730114  
 (891) 2014 07 24  
 (731) CALZATURIFICIO FRAU S.P.A.  
 Via Torino, 18-20 I-37035  
 SAN GIOVANNI ILARIONE (VR); Italy  
 (540)

## FRAU

(511)  
 25 – Clothing, footwear, headgear.

(260) AM 2015 79463 A  
 (800) 865625  
 (891) 2014 07 30  
 (731) Mitsubishi Fuso Truck and Bus  
 Corporation  
 1-1-2, Kashimada, Saiwai-ku,  
 Kawasaki-shi, Kanagawa 212-0058; Japan  
 (540)

## CANTER

(591) Black, white  
 (511)  
 12 – Automobiles and their parts and fittings; two-wheeled motor vehicles, bicycles and their parts and fittings; machine elements for land vehicles; anti-theft alarms for vehicles.

(260) AM 2015 79464 A  
 (800) 907298  
 (891) 2014 07 16  
 (731) ZV HOLDING  
 55/57 rue Saint-Roch, F-75001 PARIS;  
 France  
 (540)

## ZADIG & VOLTAIRE

(511)  
 3 – Soaps; perfumery, cosmetics, hair lotions.  
 14 – Jewellery, timepieces and chronometric instruments; watches.  
 16 – Posters, scrapbooks, almanacs, catalogues, printed matter, newspapers, books, handbooks, printed publications, prospectuses, fountain pens; paper table linen.  
 18 – Trunks and suitcases; umbrellas, school bags, card cases (wallets), key cases (leatherware), unfitted vanity cases, briefcases, college satchels, suitcases, wallets, purses not of precious metal, rucksacks, handbags, shopping bags, roller bags, beach bags, travelling bags, garment bags (for travel), travelling sets (leatherware), travelling trunks.  
 20 – Furniture.  
 24 – Household linen, furniture coverings of textile, furniture fabrics, textile wall hangings, face towels

(of textile material), table linen of textile, fabrics for textile use.

25 – Clothing, footwear, headgear.

35 – Retailing in connection with all the above goods.

43 – Providing of food and drink, bar services, cafés, restaurants, cafeterias, catering services.

(260) AM 2015 79468 A  
 (800) 1044340  
 (891) 2014 08 05  
 (731) Rücker GmbH  
 Egelser Straße 111, 26605 Aurich; Germany  
 (540)

## EDINA

(511)  
 29 – Eggs, milk and milk products, namely butter, cheese, cheese preparations, cream, yoghurt, quark, kefir, mixed milk beverages (milk predominating) and with non-alcoholic components, powdered milk for food; food preparations mainly consisting of skimmed milk and vegetable fat and/or vegetable oil.

(260) AM 2015 79707 A  
 (800) 1223403  
 (891) 2014 06 26  
 (731) UNION DES ASSOCIATIONS  
 EUROPEENNES DE FOOTBALL (UEFA)  
 Route de Genève 46, CH-1260 Nyon;  
 Switzerland  
 (540)

## UEFA NATIONS LEAGUE

(511)  
 4 – Lubricants; engine oils and fuels, including gasoline, diesel oil, gases and bio-fuels; candles; waxes; greases; natural gas; liquid gases; industrial oils and greases; lubricating oils and greases; carburants; liquefied petroleum gas; non-chemical additives for fuel, lubricants and greases; dust absorbing, wetting and binding compositions; lighting fuel; lubricants, oils and greases, and lubricating preparations for industrial use; cutting oils for industrial purposes; milling oils.

9 – Exposed films, slides, video game disks; software (recorded programs), including game software; computer databases and programs; recorded or downloaded sounds, images or data; videotapes, magnetic tapes, magnetic disks, DVDs, mini-disks, diskettes, optical discs, compact discs, CD-ROMs, videodiscs, memory cards, USB flash drives, blank or prerecorded with music, sound or images (possibly including animated cartoons); holograms; electronic publications provided by

means of CD-ROMs, databases and the Internet; spectacles, sunglasses, diving and swimming goggles; cases, cords and chains for sunglasses and spectacles; binoculars; magnets and decorative magnets; directional compasses; apparatus for the recording, transmission and reproduction of sound and images; satellite dishes; decoders, namely electronic software and hardware capable of converting, supplying and transmitting audio and video data; television sets; flat screens, liquid crystal display screens, high-definition screens and plasma screens; radios; home cinema systems; video recorders; cD players; DVD drives; mP3 players; cassette players; mini-disc players; digital music players; loudspeakers; headphones, earphones; computers, including laptop computers and electronic tablets; karaoke systems; systems for editing sounds and for mixing sounds; systems for editing video images, and for mixing video images; apparatus for computer data processing; computer keyboards; computer screens; modems; accessories for computers included in this class; computer mice, mouse pads; navigation apparatus; personal digital assistants (PDAs); electronic pocket translators; dictating machines; electronic agendas; scanners; printers; photocopiers; facsimile machines; telephones; answering machines; video telephones; cellular telephones; accessories for cellular telephones, included in this class, namely cases for cellular telephones, hands-free kits for cellular telephones, earphones and headsets for cellular telephones, keypads for cellular telephones, lanyards for cellular telephones, special cases for carrying cellular telephones, photographic cameras and video cameras integrated in cellular telephones; remote controls for television sets and video systems; teleconferencing systems; calculating machines; card readers for credit cards; currency converting machines; automated teller machines; video cameras, portable video cameras with built-in videocassette recorders (camcorders); photographic equipment, photographic apparatus, cameras (cinematographic apparatus), projectors, flash lamps, special cases and cords for photographic apparatus and instruments, electric cells and batteries; screen saver programs for computers; magnetic, digital or analog recording media, recorded or not, for sounds or images; magnetic cards (encoded); memory cards; integrated circuit cards (smart cards); microchip or magnetic credit cards, microchip or magnetic telephone cards, microchip or magnetic cards for cash dispensers, microchip or magnetic cards for automated teller machines and money exchange machines, prepaid microchip or magnetic cards for cellular telephones, microchip or magnetic travel and show admission cards, microchip or magnetic check guarantee cards and microchip or magnetic debit cards; alarms; wind socks (for indicating wind direction); distance measuring equipment; equip-

ment for measuring and displaying speed; protective gloves; audio receivers, sound amplifiers; television tubes; cathode ray tubes; decoders, namely computer software and hardware capable of converting, supplying and transmitting audio and video data; disk drives for computers; protected semi-conductors; integrated circuits containing programs for processing audio, visual or computer data; rechargeable batteries; audio and video data processors and converters; cables for data transmission; payment apparatus for electronic commerce; protective helmets for sports; magnetic encoded identification bracelets; electronic instrument assemblies; fuel/air coefficient analyzers; remote controls for locking cars; photovoltaic cells; video game cassettes.

12 – Bicycles, motorcycles, motor cars, trucks, vans, utility vehicles, buses, camper vans, refrigerated vehicles; airplanes and boats; air balloons, dirigible balloons [airships]; vehicle accessories, namely sun visors, pneumatic tires, tire covers, luggage racks, ski racks, rims and hub caps for wheels; seat linings, vehicle covers, baby carriages, strollers, safety seats for infants and children (for vehicles); engines and motors for land vehicles; safari bars; headlamp covers; steering wheels for vehicles; trailers.

14 – Jewelry, necklaces; jewelry products; watches; wristwatches, clocks; chronographs; wall clocks; medallions, pendants, brooches; bracelets; pins (jewelry); lapel pins (jewelry); tie clips and tie pins; cuff links; commemorative medals of precious metal; prize cups, commemorative plates, trophies, statues, sculptures, all of precious metal; decorative hat pins, key rings (trinkets or fobs), printed metal disks for collection purposes (pogs), all made of precious metal; decorative key holders; coins; medals for clothing; cases for watches; badges of precious metal; alarm clocks; badges and pins (jewelry); leather bracelets; bracelets of plastic materials; ornamental key rings of plastic materials.

16 – Coloring and drawing books; activity books; magazines; newspapers; books and journals, including those concerning sportsmen, sportswomen or sports events; bookmarks; printed teaching material; score sheets; event programs; albums for events; photograph albums; autograph books; printed timetables; pamphlets; collectible photographs of players; bumper stickers, stickers, albums, sticker albums; posters; photographs; tablecloths of paper; paper napkins; paper bags; invitation cards; greeting cards; gift wrapping paper; coasters and place mats of paper; garbage bags of paper or of plastics; food wrapping paper; small bags for preserving foodstuffs; coffee filters of paper; labels (not of textile); towels of paper; wet hand-wipes of paper; toilet paper; napkins for removing make-up; handkerchief boxes of paper and cardboard; tissues of paper; stationery and instructional and teaching



material (except apparatus); typewriter paper; copying paper; envelopes; notepads; folders for papers; tissue paper; writing books; paper sheets for note-taking; writing paper; binder paper; files; covering paper; luminous paper; adhesive paper for notes; paperweights; crêpe paper; tissue paper; badges or insignia of paper; flags of paper; pennants (flags) of paper; writing instruments; fountain pens; pencils; ballpoint pens; ball-point pen and pencil sets; felt-tip pens (marking pens); fiber-tip pens and felt-tip pens; marking pens; ink, inking pads, rubber stamps; typewriters (electric or non-electric); lithograph prints, lithographic works of art; paintings (pictures), framed or unframed; paint boxes, paints and colored pencils; chalks; pencil ornaments [stationery]; printing blocks; address books; diaries (planners); personal organizers of paper; road maps; tickets, entry tickets, checks; comic books; calendars; postcards; advertising boards, banners and material included in this class; transfers [decalcomanias]; sticking labels; office requisites (except furniture); correction fluids; rubber erasers; pencil sharpeners; stands and containers for office articles; paper clips; thumbtacks; rulers; adhesive tapes for stationery purposes, adhesive tape dispensers; staples; stencils; document holders (stationery); paper-clips; holders for notepads; bookends; stamps (seals); postage stamps; credit cards, telephone cards, ATM cards, cards for traveling and for shows, check guarantee cards and debit cards, non-magnetic, and of paper or cardboard; baggage tags of paper; passport cases; travelers' checks; holders for checkbooks; money clips of metal; letter trays; identity card holders.

25 – Clothing; shoes and footwear; headgear; shirts; knitwear (clothing); pullovers; slipovers; Tee shirts; vests; singlets; sleeveless jerseys, dresses; skirts; underwear; swimsuits; bath robes; shorts; trousers; sweaters; caps (bonnets); caps; hats; sashes for wear; scarves, shawls; caps with visors; tracksuits; sweatshirts; jackets, sports jackets, stadium jackets (bibs); blazers; waterproof clothing; coats; uniforms; neckties; wrist bands; headbands; gloves; aprons; bibs (not of paper); pajamas; play suits for infants and children; socks and stockings; garters; belts; suspenders.

28 – Games and toys; sports balls; play balloons; board games; tables for indoor football; dolls and plush toys; vehicles (toys); jigsaw puzzles; balloons; inflatable toys; play disks (pogs); playing cards; confetti; articles for gymnastics and sports; football equipment, namely balls for football, gloves, knee guards, elbow guards, shoulder guards, shin guards; football goals; sports bags and containers (adapted to objects) for carrying sports articles; party hats (toys); small electronic games designed for use with a television set; video game apparatus; game consoles; electronic games other than those designed to be

used only with a television set; steering wheels for video games and mats for video games (for dancing upon); hands made of rubber or foam (toys); entertainment robots; appliances for gymnastics; kites; roller skates; scooters [toys]; skateboards; coin-operated video games for game halls (arcade games); electronic games with liquid crystal display; video game accessories; joysticks, voice-activated or manually operated joysticks.

32 – Non-alcoholic beverages; syrups and powders for making non-alcoholic beverages; mineral and aerated waters; isotonic beverages; fruit and vegetable beverages; fruit and vegetable juices; frozen fruit beverages; beers; strong dark beers; lagers and ales; non-alcoholic or low-alcohol beers.

35 – Employment agencies; personnel recruitment; advertising services; services provided by an agency publishing advertising texts; advertising agency services; advertising agency services on a global computer network (the Internet) or via wireless electronic communication devices; dissemination of advertisements; rental of advertising space; rental of advertising time in film credits; television advertising, radio advertising; advertising in the form of animated cartoons; promotion agency services, promotion agency services for sports and public relations; promotion of football events; market study services; market research services; opinion polling services; organization of exhibitions for commercial or advertising purposes; organization of advertising for trade fairs; compilation and systematization of data in data banks; data bank management services; compilation of statistics; advertising for sports events in the field of football; retail sale services for and bringing together of various goods for the benefit of others (excluding the transport thereof), namely clothing, footwear, headgear, sports articles, stationery, apparatus for recording, transmission and reproduction of sound and images, books, newspapers, magazines, publications, video games, toys, dolls, badges of all kinds, key rings, tickets, watches and jewelry, souvenir items in connection with football, bags, luggage, briefcases, umbrellas, flags and pennants, alcoholic and non-alcoholic beverages, confectionery, medical apparatus and instruments, vehicles and accessories for motor cars; retail sale services for solvents, paraffin, waxes, bitumen and petroleum; bringing together of the following goods for the benefit of others (excluding transport thereof) to enable customers to conveniently view and purchase these goods in a store or on a global computer network (the Internet) or via wireless electronic communication devices, namely clothing, footwear, headgear, sports articles, stationery, apparatus for recording, transmission and reproduction of sound and images, books, newspapers, magazines, publications, video games, toys, dolls, badges of all

kins, key rings, tickets, watches and jewelry, souvenir items in connection with football, bags, luggage, briefcases, umbrellas, flags and pennants, alcoholic and non-alcoholic beverages, confectionery, medical apparatus and instruments, vehicles and accessories for motor cars; advertising and promotion services, information services with regard to advertising and promotion, commercial information agencies, all the aforesaid services provided on-line from a computer database or via a global computer network (the Internet) or via wireless electronic communication devices; design and compilation of advertisements for use as a web site on a global computer network (the Internet) or via wireless electronic communication devices; provision of space on web sites, for advertising of goods and services; auctioneering on a global computer network (the Internet) or via wireless electronic communication devices; collection of directories for publication on the Internet and on a wireless electronic communication network; business administration services for processing commercial services on a global computer network (Internet) or via wireless electronic communication devices; compilation, creation and management of databases, namely collection of domain names in a register; promotion of sales, namely creation of preferential programs for customers; implementation of bonus programs for customers in stadiums by distributing encoded loyalty and membership cards able to contain the personal data of the user; development, launch and administration of loyalty programs, namely issuing loyalty cards to fans, containing personal information on the identity of the card holder; electronic commerce (e-commerce) services, namely provision of information on goods via telecommunication networks for advertising or sales purposes; compilation of data into a computer database, especially still or animated images; e-commerce services, namely online services for providing contracts for the purchase and sale of goods on behalf of others; promotion of football-related sports events; promotion of the goods and services of others, through contractual agreements, particularly partnership (sponsoring) and licensing agreements, providing them with increased notoriety and enhanced image derived from cultural and sporting events, particularly international events; compilation and recording of data and information on sporting performances; provision of personnel, particularly for selling beverages and foods; promotion of football events; retail sale of interactive educational and entertainment products, interactive compact disks, CD-ROMs and computer games; retail sale services, particularly on a global computer network, of interactive entertainment and education products, interactive compact disks, CD-ROMs and computer games; presentation of computer programs for retail sale purposes;

procurement services for others [purchasing goods and services for other businesses]; procurement services for others [purchasing goods and services for other businesses] for sports events or entertainment; promotion of the goods and services of others, through contractual agreements, particularly partnership (sponsoring) and licensing agreements, providing them with increased notoriety and/or enhanced image and/or affinity derived from cultural and sporting events, particularly international events; financial sponsorship search for football competitions.

36 – Issuance and management of credit cards and travelers' checks; financial services; banking, credit and investment services; insurance underwriting; hire-purchase financing; hire-purchase services; financial sponsorship of sports events; information services related to finance and insurance, provided online from a computer database or the Internet or on wireless electronic communication networks; home banking services; banking services over the Internet or over wireless electronic communication networks; payment services, including services provided on-line from a computer database or via the Internet or via mobile telephones; safe deposit services; issue of vouchers, namely issue of loyalty cards to fans, which contain personal data on the identity of the cardholder and are used for access control at sports stadiums; financial promotion of in the field of football; financial payment services for electronic commerce, namely transfer of funds, all via electronic communication networks; financial payment services for electronic commerce in connection with the purchase of goods and services provided by others, all via electronic communication networks, and clearing and settlement of financial transactions via electronic communication networks; issue of vouchers in the form of travel vouchers.

38 – Telecommunication services; communication by mobile telephones; communication by telex; communication via electronic computer terminals linked to telecommunication networks, data banks and the Internet or via wireless electronic communication devices; communication by telegraphs; communication by telephones; communications by facsimile; paging services; telephone or video conferencing services; television program broadcasting; broadcasting of cable television programs; radio program broadcasting; radio and television broadcasting of sports and sporting events; news and press agency services; other message transmission services; rental of telephones, facsimile machines and other telecommunication apparatus; transmission of commercial Internet pages online or via wireless electronic communication devices; services for transmitting and broadcasting television and radio programs provided via the Internet or via any wireless electronic

communication network; electronic transmission of messages; simultaneous broadcasting of film recordings and sound and video recordings; provision of access to telematic servers and real-time chat forums; computer-aided transmission of messages and images; telecommunication via fiber-optic networks; provision of access to a global computer network or interactive communication technologies for access to private and commercial purchasing and ordering services; transmission of information and other data via websites and computers; transmission of information (including sites by telematic means) via telecommunication, computer programs and other data; transmission of information, computer programs and other data by telematic means; electronic mail services; provision of access via the Internet or on any wireless electronic communication network (telecommunication services); providing connections for telecommunications with a global computer network (the Internet) or data banks; provision of access to websites offering digital music on the Internet by means of a global computer network or via wireless electronic communication devices; rental of access time to MP3 websites on the Internet, via a global computer network or via wireless electronic communication devices; rental of access time to a database server center (telecommunication services); rental of access time to a computer database (telecommunication services); transmission of digital music by telecommunications; online transmission of electronic publications; digital music transmission via the Internet or on any wireless electronic communication network; digital music transmission via MP3 Internet sites; simultaneous broadcasting and/or netcasting of film recordings and sound and video recordings (telecommunications); simultaneous broadcasting and/or netcasting of interactive educational and entertainment products, interactive compact disks, CD-Roms, computer programs and computer games (telecommunications); provision of access to blackboards (notice and advertisement boards) and chat rooms in real time via a global computer network; rental and provision of access time to blackboards (boards for displaying information and advertisements) and to chat rooms in real time by means of a global computer network (communication services); telecommunication services dedicated to retail sale by means of interactive communications with customers; multimedia telecommunication; videotext and teletext transmission services; information transmission via communication satellite, microwave or by electronic, digital or analog means; transmission of digital information by cable, wire or fiber; transmission of information by mobile telephones, telephones, facsimile and telex; telecommunication services for receiving and exchanging information, messages, images and data; telecommunication

services for setting up discussion groups on the Internet and on any wireless electronic communication network; provision of access to search engines for obtaining data and information on global networks.

39 – Operating travel agencies, namely travel arrangement and reservations; ticket reservation and information services for travel; transport by airplane, railway, bus and truck; boat transport; boat travel services; tourist travel services; vehicle rental; rental of parking spaces; taxi services; boat transport services for goods; distribution of water, heat, gas or electricity; distribution of newspapers, magazines and books; postal services, mail delivery and courier services; storage of goods; delivery of solvents, paraffins, waxes, bitumens and oil products, excluding liquid gas; distribution (delivery) of films and sound and image recordings; distribution (delivery) of interactive educational and entertainment products, interactive compact disks, CD-ROMs, computer programs and computer games; advice relating to power and electricity distribution.

41 – Education; training; entertainment; organization of lotteries, raffles and competitions; betting and gaming services in connection with sports; hospitality services (sports, entertainment), namely providing entry tickets and information brochures for sports for VIPs, as well as guiding and gathering VIPs during sports or entertainment events; hospitality services, namely customer reception services (entertainment services), including providing access tickets during sports or entertainment events; entertainment services relating to sporting events; entertainment services in the form of public gatherings during the retransmission of sports events; sporting and cultural activities; organization of sporting and cultural events and activities; organization of sports competitions; organization of events in the field of football; sports camp services; operation of sports facilities; rental of video and audiovisual installations; production, presentation, distribution and/or rental of film recordings and sound and video recordings; presentation, distribution and/or rental of interactive educational and entertainment products, interactive compact disks, CD-ROMs, and computer games; radio and television coverage of sporting events; production services for radio, television programs and video films; ticket reservation services and information services for sports or entertainment events; sports events timing services; organization of beauty contests; interactive entertainment; on-line betting and gaming services on the Internet or on any wireless electronic communication network; information in the field of entertainment (including in the field of sports), provided on-line from a computer database or via the Internet or via any wireless electronic communication network;

electronic game services transmitted via the Internet or on mobile telephones; book publishing; publication of books and electronic journals on-line; audio and video recording services; production of animated cartoons for movies, production of animated cartoons for television; rental of sound and image recordings for entertainment purposes; information in the field of education provided on-line from a computer database or via the Internet or any wireless electronic communication network; translation services; photography services; provision of entertainment infrastructure; ticket agencies in connection with sports events.

43 – Providing food and drink, snack-bars; hospitality services, namely providing of food and drink; food and drink catering; hotel services; providing accommodation and food and drink, booking hotels and temporary accommodation; hospitality services, namely providing food and drink during sports or entertainment events.

(260) AM 2015 79712 A

(800) 1223509

(891) 2014 08 13

(731) Obshchestvo s ogranichennoi  
otvetstvennostyu "UTA-NN"  
ul. Kojevennaia, 1A, RU-603005 Nizhniy  
Novgorod; Russian Federation

(540)

**SKLANKA**

(591) Black, white

(511)

33 – Aperitifs; arrack; brandy; wine; piquette; whisky; vodka; gin; digesters [liqueurs and spirits]; cocktails; liqueurs; alcoholic beverages, except beer; alcoholic beverages containing fruit; pre-mixed alcoholic beverages, other than beer-based; spirits [beverages]; distilled beverages; hydromel [mead]; peppermint liqueurs; rum; sake; cider; rice alcohol; alcoholic extracts; fruit extracts, alcoholic; alcoholic essences.

(260) AM 2015 79716 A

(800) 1223566

(891) 2014 03 10

(731) SONY CORPORATION  
1-7-1 Konan, Minato-ku, Tokyo 108-0075;  
Japan

(540)

**BE MOVED**

(591) Black, white

(511)

35 – Advertising and publicity services; post-production editing services for advertisements; providing consulting services relating to advertising media in the field of facilitating the planning for

selling goods; planning and production of advertising media; advertising agency services, namely, promoting the goods and services of others; advertising for promoting the goods and services; advertising, marketing and promotion services; marketing; marketing design services and talent agencies; management of entertainers; entertainer referral; commercial administration of the licensing of the goods and services of others; commercial administration of the licensing of computers and computer programs of others; commercial administration of intellectual property rights; import-export agencies; retail services or wholesale services for electrical machinery and apparatuses; retail services or wholesale services for musical instruments and records; retail services or wholesale services for sound-recorded or video-recorded media.

41 – Provision of entertainment; organization of entertainment events of dancing, shows, plays, musical performances; direction or presentation of dancing, shows, plays, musical performances; providing information in the fields of entertainment, movies, and music over computer networks and global communication networks; providing information on a website over a global computer network on musical artists, tours of musical artists, sound recordings popular culture and events and musical based entertainment; providing entertainment information on a website via global computer networks; arranging and planning of concerts or musical performances; providing streaming, and wireless entertainment content in the nature of audiovisual works, motion pictures, trailers, television programming, music, and games by means of an interactive global computer and communications networks; production of film, audio master tape and disk; recording, modifying or editing services for film, sound and video; production of animation television programs; production of videotape film in the field of education, culture, entertainment or sports featuring animation programs [not for movies or television programs and not for advertising or publicity]; production of master CD-ROMs recorded with music and video; post-production editing services in the field of music, videos and films; editing films, music and image in the post-production process; production of sound and music video recordings; providing online entertainment, namely, production of sound and audiovisual recordings in the field of music and musical based entertainment; providing facilities for producing video, cinema and photography productions; operation of video and audio equipment for production of radio and television programs; motion picture studio services; television studio services; providing audio or video studio services; provision of cinema or theatre facilities; providing facilities for movies, shows,

plays, music or educational training; rental of motion pictures; rental of cinematographic machines and apparatus; rental of audio frequency devices and apparatus and video frequency devices and apparatus; rental of sound-recorded or video-recorded video discs, magnetic tapes, magnetic discs, optical discs, magneto-optical discs, CD-ROMs and DVD-ROMs; rental of videotapes.

(260) AM 2015 79717 A  
 (800) 1223587  
 (891) 2014 05 20  
 (731) ZF Friedrichshafen AG  
 Graf-von-Soden Platz 1, 88046  
 Friedrichshafen; Germany  
 (540)



(591) Black, white  
 (511)  
 12 – Axial joints, axle struts, suspension joints, A-arms, four-point control arms, pitman arms, thrust rods, intermediate knuckler arms, steering rods, hinged supports, tie rods, control arms, ball joints, steering shafts, wheel studs, stabilizer rods.

16 – Printed materials, in particular magazines for driveline and chassis technology; instructional and teaching material (except apparatus); photographs.

17 – Caoutchouc, rubber and goods made of these materials if they are not contained in other classes; plastic products (semi-finished products); hoses (not made of metal); shock absorbing buffers of rubber for vehicles, chassis systems, engines, drives and their components.

(260) AM 2015 79718 A  
 (800) 1223625  
 (891) 2014 07 16  
 (731) Smile Train, Inc.  
 41 Madison Avenue, 28th Floor, New York  
 NY 10010; USA  
 (540)



(591) Blue, black, red, gray, and white  
 (511)  
 41 – Charitable services, namely providing funding for, and assistance with, health care and professional

training programs in the field of treatment and correction of facial deformities and related care, including cranial, facial, and plastic surgical procedures, post-operative care and counseling.

(260) AM 2015 79719 A  
 (800) 1223641  
 (891) 2014 07 01  
 (731) Sea Maester B.V.  
 Podium 9, NL-3826 PA Amersfoort;  
 Netherlands  
 (540)

## SEAWALKER

(511)  
 6 – Offshore access system, namely a metal telescopic gangway.

(260) AM 2015 79721 A  
 (800) 1223695  
 (891) 2014 09 02  
 (731) Shandong Kerui Group Holding Co. Ltd.  
 Shengli Industrial Park, Dongying City,  
 Shandong Province; China  
 (540)



(591) Blue and green  
 (526) The trademark is protected as a whole. "GROUP" shall not be subject to independent legal protection.  
 (511)  
 35 – Marketing studies; marketing research; import-export agencies; auctioneering; sales promotion for others.

37 – Repair information; construction; underwater repair; mining extraction; drilling of wells; boiler cleaning and repair; burner maintenance and repair; machinery installation, maintenance and repair; electric appliance installation and repair.

42 – Technical research; technical project studies; engineering; quality control; analysis for oil-field exploitation; oil-well testing; geological surveys; oil-field surveys; oil prospecting; computer system analysis; creating and maintaining web sites for others.

(260) AM 2015 79722 A  
 (800) 1223720  
 (891) 2014 07 29  
 (731) BOMA ENGINEERING SRL  
 VIA G. LEOPARDI, 8, I-20123 MILANO;  
 Italy

(540)

**ARVELL**

(511)

7 – Machine tools for the production of yarns and non-woven fabric.

16 – Paper products, cardboard and cellulose.

24 – Non-woven fabrics.

(260) AM 2015 79723 A

(800) 1223732

(891) 2014 09 11

(731) FROMAGERIES BEL

16 boulevard Maiesherbes, F-75008 PARIS;  
France

(540)

**Весёлая коровка**

(511)

29 – Eggs, milk (in all its forms), butter, cream, cheese and specialty cheese products, yogurts, lactic proteins and whey and other dairy products; milk-based beverages.

30 – Coffee, tea, cocoa, sugar, rice, tapioca, sago, artificial coffee; flours and preparations made from cereals, bread, pastry and confectionery, edible ices; honey, treacle; yeast, baking powder; salt, mustard; vinegar; sauces (condiments); spices; ices for refreshment, milk-based gruel for food, frozen yoghurt (edible ices).

43 – Services for providing food and drink, namely self-service restaurants, coffee houses, cafeterias, bar services; temporary accommodation.

(260) AM 2015 79726 A

(800) 1223733

(891) 2014 09 11

(731) FROMAGERIES BEL

16 boulevard Maiesherbes, F-75008 PARIS;  
France

(540)

**VESJOLAJA KOROVKA**

(591) Black, white

(511)

29 – Eggs, milk (in all its forms), butter, cream, cheese and specialty cheese products, yogurts, lactic proteins and whey and other dairy products; milk-based beverages.

30 – Coffee, tea, cocoa, sugar, rice, tapioca, sago, artificial coffee; flours and preparations made from cereals, bread, pastry and confectionery, edible ices; honey, treacle; yeast, baking powder; salt, mustard; vinegar; sauces (condiments); spices; ices for refreshment, milk-based gruel for food, frozen yoghurt (edible ices).

43 – Services for providing food and drink namely self-service restaurants, coffee houses, cafeterias, bar services; temporary accommodation.

(260) AM 2015 79728 A

(800) 370187

(891) 2014 10 31

(731) Astellas Pharma Europe B.V.

Sylviusweg 62, NL-2333 BE Leiden;  
Netherlands

(540)

**UNIDOX**

(511)

5 – Pharmaceutical, veterinary and sanitary preparations; dietetic products for children and the sick; plasters, materials for dressings; materials for dental fillings and dental impressions; disinfectants; preparations for weed and pest control.

(260) AM 2015 79729 A

(800) 591153

(891) 2014 08 14

(731) L. Molteni &amp; C. dei F.lli Alitti Società

di Esercizio S.p.A.

S.S. 67 – Località Granatieri I-50018  
Scandicci (FI); Italy

(540)

**NORMASE**

(511)

5 – Pharmaceutical preparations for the treatment of constipation and of hepatic encephalopathy.

(260) AM 2015 79805 A

(800) 1224315

(891) 2014 09 02

(731) Shanghai Banggo Information

Technology Co., Ltd.

Building 3, No. 800 East Kangqiao Road,  
Pudong District, Shanghai; China

(540)

**美邦邦购**

(591) Black, white

(511)

18 – Leather, unworked or semi-worked; backpacks; briefcases; valises; pocket wallets; trimmings of leather for furniture; leather laces; umbrellas; clothing for pets; gut for making sausages.

25 – Clothing; layettes (clothing); bathing suits; shoes; caps (headwear); hosiery; gloves (clothing); neckties; scarfs; girdles.

35 – Outdoor advertising; demonstration of goods; advertising; radio advertising; television advertising;

business management assistance; import-export agencies; marketing; office machines and equipment rental; accounting.

40 – Abrasion; applying finishes to textiles; bookbinding; taxidermy; dressmaking; clothing alteration; leather working; printing; air purification; engraving.

---

(260) AM 2015 79806 A

(800) 1224323

(891) 2014 08 13

(731) Zakrytoe aktsionernoe obshchestvo  
"Moskovskaya pivovarennaya kompaniya"  
Vokzalnaya pl., 2, RU-141009 Mytichtchi,  
Moskovskaya oblast; Russian Federation

(540)

## **Лосиный берег**

(511)

32 – Beers; mineral and aerated waters and other non-alcoholic beverages; fruit beverages and fruit juices; syrups and other preparations for making beverages.

---



**INTERNATIONAL TRADEMARKS PROTECTED IN GEORGIA**

(260) AM 2015 76359 A  
(800) 1194291  
(151) 2013 09 04  
(181) 2023 09 04  
(891) 2013 09 04  
(511) 05

---

(260) AM 2015 76361 A  
(800) 1194339  
(151) 2013 12 19  
(181) 2023 12 19  
(891) 2013 12 19  
(511) 03, 05

---

(260) AM 2015 76363 A  
(800) 1194389  
(151) 2013 09 04  
(181) 2023 09 04  
(891) 2013 09 04  
(511) 05

---

(260) AM 2015 76372 A  
(800) 1194394  
(151) 2013 10 10  
(181) 2023 10 10  
(891) 2013 10 10  
(511) 06, 07, 20, 37

---

(260) AM 2015 76374 A  
(800) 1194398  
(151) 2013 09 14  
(181) 2023 09 14  
(891) 2013 09 14  
(511) 05, 16

---

(260) AM 2015 76487 A  
(800) 1166887  
(151) 2013 05 06  
(181) 2023 05 06  
(891) 2013 07 12  
(511) 44

---

(260) AM 2015 76816 A  
(800) 1198189  
(151) 2014 02 19  
(181) 2024 02 19  
(891) 2014 02 19  
(511) 16, 41

---

(260) AM 2015 76836 A  
(800) 1198247  
(151) 2013 12 10  
(181) 2023 12 10  
(891) 2013 12 10  
(511) 36

---

(260) AM 2015 76839 A  
(800) 1198288  
(151) 2014 02 07  
(181) 2024 02 07  
(891) 2014 02 07  
(511) 09, 11

---

(260) AM 2015 76854 A  
(800) 1198417  
(151) 2014 02 06  
(181) 2024 02 06  
(891) 2014 02 06  
(511) 18

---

(260) AM 2015 76856 A  
(800) 1198428  
(151) 2013 12 20  
(181) 2023 12 20  
(891) 2013 12 20  
(511) 01, 02, 38, 42

---

(260) AM 2015 76857 A  
(800) 1198455  
(151) 2013 11 18  
(181) 2023 11 18  
(891) 2013 11 18  
(511) 02

---

(260) AM 2015 76858 A  
(800) 1198459  
(151) 2013 11 18  
(181) 2023 11 18  
(891) 2013 11 18  
(511) 02

---

(260) AM 2015 76859 A  
(800) 1198474  
(151) 2014 02 07  
(181) 2024 02 07  
(891) 2014 02 07  
(511) 30

---

(260) AM 2015 76864 A  
(800) 1198551  
(151) 2014 01 14  
(181) 2024 01 14  
(891) 2014 01 14  
(511) 36

---

(260) AM 2015 77153 A  
(800) 1180630  
(151) 2013 10 01  
(891) 2014 03 10  
(511) 34

---

(260) AM 2015 77160 A  
(800) 1193954  
(151) 2013 12 18  
(891) 2014 03 20  
(511) 12, 35, 37

---

(260) AM 2015 77173 A  
(800) 1201360  
(151) 2013 08 22  
(181) 2023 08 22  
(891) 2013 08 22  
(511) 16, 35, 41, 42

---

(260) AM 2015 77174 A  
(800) 1201480  
(151) 2014 03 10  
(181) 2024 03 10  
(891) 2014 03 10  
(511) 41

---

(260) AM 2015 77176 A  
(800) 1201508  
(151) 2014 01 24  
(181) 2024 01 24  
(891) 2014 01 24  
(511) 09, 16, 28, 35, 38, 41, 42, 45

---

(260) AM 2015 77219 A  
(800) 1201883  
(151) 2014 02 13  
(181) 2024 02 13  
(891) 2014 02 13  
(511) 37

---

(260) AM 2015 77241 A  
(800) 1202153  
(151) 2013 11 07  
(181) 2023 11 07  
(891) 2013 11 07  
(511) 07, 20, 32

---

(260) AM 2015 77247 A  
(800) 1201402  
(151) 2013 12 05  
(181) 2023 12 05  
(891) 2013 12 05  
(511) 07, 11, 37

---

(260) AM 2015 77250 A  
(800) 1202303  
(151) 2014 02 11  
(181) 2024 02 11  
(891) 2014 02 11  
(511) 03, 05

---

(260) AM 2015 77251 A  
(800) 1202331  
(151) 2013 11 07  
(181) 2023 11 07  
(891) 2013 11 07  
(511) 07, 20, 32

---

(260) AM 2015 77252 A  
(800) 1202332  
(151) 2013 11 27  
(181) 2023 11 27  
(891) 2013 11 27  
(511) 09, 41

---

(260) AM 2015 77301 A  
(800) 1202878  
(151) 2013 11 27  
(181) 2023 11 27  
(891) 2013 11 27  
(511) 30

---

(260) AM 2015 77332 A  
(800) 1203113  
(151) 2014 02 27  
(181) 2024 02 27  
(891) 2014 02 27  
(511) 03

---

(260) AM 2015 77335 A  
(800) 1203163  
(151) 2014 02 27  
(181) 2024 02 27  
(891) 2014 02 27  
(511) 09

---

(260) AM 2015 77363 A  
(800) 1203514  
(151) 2013 11 22

---

(181) 2023 11 22  
 (891) 2013 11 22  
 (511) 29

---

(260) AM 2015 77366 A  
 (800) 1203550  
 (151) 2014 01 24  
 (181) 2024 01 24  
 (891) 2014 01 24  
 (511) 30

---

(260) AM 2015 77375 A  
 (800) 1203638  
 (151) 2013 12 17  
 (181) 2023 12 17  
 (891) 2013 12 17  
 (511) 10, 11, 37

---

(260) AM 2015 77377 A  
 (800) 1203650  
 (151) 2013 11 22  
 (181) 2023 11 22  
 (891) 2013 11 22  
 (511) 29

---

(260) AM 2015 77378 A  
 (800) 1203656  
 (151) 2014 01 16  
 (181) 2024 01 16  
 (891) 2014 01 16  
 (511) 30

---

(260) AM 2015 77383 A  
 (800) 824195  
 (151) 2004 03 16  
 (891) 2014 03 17  
 (511) 35, 41

---

(260) AM 2015 77385 A  
 (800) 972704  
 (151) 2008 05 23  
 (891) 2013 12 20  
 (511) 05

---

(260) AM 2015 77387 A  
 (800) 1166496  
 (151) 2013 05 29  
 (891) 2014 03 05  
 (511) 05

---

(260) AM 2015 77388 A  
 (800) 1168724  
 (151) 2013 06 07  
 (891) 2014 04 24  
 (511) 36

---

(260) AM 2015 77390 A  
 (800) 1180932  
 (151) 2013 10 04  
 (891) 2014 03 11  
 (511) 34

---

(260) AM 2015 77391 A  
 (800) 1184215  
 (151) 2013 10 22  
 (891) 2014 01 21  
 (511) 16, 28

---

(260) AM 2015 77409 A  
 (800) 1203887  
 (151) 2014 04 10  
 (181) 2024 04 10  
 (891) 2014 04 10  
 (511) 03, 05

---

(260) AM 2015 77411 A  
 (800) 1203914  
 (151) 2014 04 03  
 (181) 2024 04 03  
 (891) 2014 04 03  
 (511) 33

---

(260) AM 2015 77412 A  
 (800) 1203934  
 (151) 2014 03 24  
 (181) 2024 03 24  
 (891) 2014 03 24  
 (511) 09

---

(260) AM 2015 77413 A  
 (800) 1203937  
 (151) 2014 03 25  
 (181) 2024 03 25  
 (891) 2014 03 25  
 (511) 09

---

(260) AM 2015 77414 A  
 (800) 1203947  
 (151) 2013 11 13  
 (181) 2023 11 13

---

---

(891) 2013 11 13  
(511) 07, 11

---

(260) AM 2015 77415 A  
(800) 1203967  
(151) 2013 10 22  
(181) 2023 10 22  
(891) 2013 10 22  
(511) 09, 28, 41

---

(260) AM 2015 77416 A  
(800) 1203971  
(151) 2013 12 04  
(181) 2023 12 04  
(891) 2013 12 04  
(511) 09, 28, 42

---

(260) AM 2015 77417 A  
(800) 1203981  
(151) 2013 11 19  
(181) 2023 11 19  
(891) 2013 11 19  
(511) 20

---

(260) AM 2015 77418 A  
(800) 1203990  
(151) 2013 12 24  
(181) 2023 12 24  
(891) 2013 12 24  
(511) 03, 05, 21, 35

---

(260) AM 2015 77421 A  
(800) 1204052  
(151) 2014 04 01  
(181) 2024 04 01  
(891) 2014 04 01  
(511) 35

---

(260) AM 2015 77423 A  
(800) 1204084  
(151) 2013 05 15  
(181) 2023 05 15  
(891) 2013 05 15  
(511) 19, 20, 35

---

(260) AM 2015 77424 A  
(800) 1204087  
(151) 2014 01 22  
(181) 2024 01 22  
(891) 2014 01 22  
(511) 05

---

(260) AM 2015 77425 A  
(800) 1204088  
(151) 2014 01 22  
(181) 2024 01 22  
(891) 2014 01 22  
(511) 05

---

(260) AM 2015 77426 A  
(800) 1204089  
(151) 2014 01 22  
(181) 2024 01 22  
(891) 2014 01 22  
(511) 05

---

(260) AM 2015 77427 A  
(800) 1204090  
(151) 2014 01 22  
(181) 2024 01 22  
(891) 2014 01 22  
(511) 05

---

(260) AM 2015 77499 A  
(800) 1204823  
(151) 2014 03 12  
(181) 2024 03 12  
(891) 2014 03 12  
(511) 25

---

(260) AM 2015 77500 A  
(800) 1204826  
(151) 2014 02 04  
(181) 2024 02 04  
(891) 2014 02 04  
(511) 03

---

(260) AM 2015 77502 A  
(800) 1204852  
(151) 2014 02 28  
(181) 2024 02 29  
(891) 2014 02 28  
(511) 34

---

(260) AM 2015 77509 A  
(800) 1204936  
(151) 2013 08 23  
(181) 2023 08 23  
(891) 2013 08 23  
(511) 01, 03, 05, 09, 10, 16, 21, 29, 35, 41, 42, 44

---

(260) AM 2015 77510 A  
(800) 1204966  
(151) 2014 01 24

---

(181) 2024 01 24  
(891) 2014 01 24  
(511) 09, 16, 36, 41

---

(260) AM 2015 77563 A  
(800) 1205461  
(151) 2014 04 11  
(181) 2024 04 11  
(891) 2014 04 11  
(511) 02

---

(260) AM 2015 77567 A  
(800) 1205486  
(151) 2014 03 27  
(181) 2024 03 27  
(891) 2014 03 27  
(511) 32

---

(260) AM 2015 77588 A  
(800) 1205581  
(151) 2014 02 18  
(181) 2024 02 18  
(891) 2014 02 18  
(511) 05

---

(260) AM 2015 77590 A  
(800) 1205594  
(151) 2014 04 01  
(181) 2024 04 01  
(891) 2014 04 01  
(511) 05

---

(260) AM 2015 77591 A  
(800) 1205625  
(151) 2014 04 16  
(181) 2024 04 16  
(891) 2014 04 16  
(511) 16, 41, 44

---

(260) AM 2015 77592 A  
(800) 1205628  
(151) 2014 03 21  
(181) 2024 03 21  
(891) 2014 03 21  
(511) 29

---

(260) AM 2015 77594 A  
(800) 1205637  
(151) 2014 03 17  
(181) 2024 03 17

(891) 2014 03 17  
(511) 05, 10

---

(260) AM 2015 77603 A  
(800) 383302  
(151) 1971 11 18  
(891) 2014 03 14  
(511) 01

---

(260) AM 2015 77604 A  
(800) 545599  
(151) 1989 11 06  
(891) 2014 05 23  
(511) 05

---

(260) AM 2015 77607 A  
(800) 815129  
(151) 2003 10 09  
(891) 2014 05 21  
(511) 05

---

(260) AM 2015 77611 A  
(800) 881066  
(151) 2006 03 02  
(891) 2014 05 21  
(511) 05

---

(260) AM 2015 77613 A  
(800) 927327  
(151) 2007 01 15  
(891) 2014 05 05  
(511) 03, 14

---

(260) AM 2015 77638 A  
(800) 1203748  
(151) 2014 02 28  
(181) 2024 02 29  
(891) 2014 05 22  
(511) 07, 08, 09, 10, 11, 21

---

(260) AM 2015 77642 A  
(800) 1205812  
(151) 2014 02 18  
(181) 2024 02 18  
(891) 2014 02 18  
(511) 11

---

(260) AM 2015 77643 A  
(800) 1205816  
(151) 2014 02 19  
(181) 2024 02 19

---

(891) 2014 02 19  
(511) 03

---

(260) AM 2015 77716 A  
(800) 1177474  
(151) 2013 08 28  
(891) 2014 05 21  
(511) 09

---

(260) AM 2015 77717 A  
(800) 1177889  
(151) 2013 08 28  
(891) 2014 05 22  
(511) 09

---

(260) AM 2015 77718 A  
(800) 1184265  
(151) 2013 09 13  
(891) 2014 03 03  
(511) 05

---

(260) AM 2015 77719 A  
(800) 1202906  
(151) 2013 10 30  
(891) 2014 05 19  
(511) 09, 41, 42

---

(260) AM 2015 77729 A  
(800) 1206527  
(151) 2013 12 23  
(181) 2023 12 23  
(891) 2013 12 23  
(511) 09, 16, 35, 36, 38, 41, 42

---

(260) AM 2015 77730 A  
(800) 1206544  
(151) 2014 04 01  
(181) 2024 04 01  
(891) 2014 04 01  
(511) 09

---

(260) AM 2015 77731 A  
(800) 1206580  
(151) 2013 09 14  
(181) 2023 09 14  
(891) 2013 09 14  
(511) 05, 16

---

(260) AM 2015 77732 A  
(800) 1206583  
(151) 2013 12 03

(181) 2023 12 03  
(891) 2013 12 03  
(511) 12

---

(260) AM 2015 77735 A  
(800) 1206629  
(151) 2014 03 18  
(181) 2024 03 18  
(891) 2014 03 18  
(511) 29

---

(260) AM 2015 77736 A  
(800) 1206640  
(151) 2014 03 18  
(181) 2024 03 18  
(891) 2014 03 18  
(511) 12

---

(260) AM 2015 77737 A  
(800) 1206646  
(151) 2014 04 22  
(181) 2024 04 22  
(891) 2014 04 22  
(511) 12

---

(260) AM 2015 77738 A  
(800) 1206647  
(151) 2014 04 22  
(181) 2024 04 22  
(891) 2014 04 22  
(511) 11

---

(260) AM 2015 77739 A  
(800) 1206660  
(151) 2014 04 30  
(181) 2024 04 30  
(891) 2014 04 30  
(511) 25

---

(260) AM 2015 77748 A  
(800) 1206732  
(151) 2013 12 31  
(181) 2023 12 31  
(891) 2013 12 31  
(511) 28

---

(260) AM 2015 77749 A  
(800) 1206737  
(151) 2013 11 27  
(181) 2023 11 27  
(891) 2013 11 27  
(511) 30

---

(260) AM 2015 77751 A  
(800) 1206783  
(151) 2014 03 18  
(181) 2024 03 18  
(891) 2014 03 18  
(511) 12

---

(260) AM 2015 77753 A  
(800) 1206826  
(151) 2014 04 10  
(181) 2024 04 10  
(891) 2014 04 10  
(511) 37

---

(260) AM 2015 77754 A  
(800) 1206836  
(151) 2014 02 13  
(181) 2024 02 13  
(891) 2014 02 13  
(511) 35, 36, 40, 41, 42, 45

---

(260) AM 2015 77755 A  
(800) 1206855  
(151) 2014 03 19  
(181) 2024 03 19  
(891) 2014 03 19  
(511) 03, 05, 10

---

(260) AM 2015 77756 A  
(800) 1206858  
(151) 2013 10 09  
(181) 2023 10 09  
(891) 2013 10 09  
(511) 05, 35

---

(260) AM 2015 77758 A  
(800) 1206864  
(151) 2013 12 31  
(181) 2023 12 31  
(891) 2013 12 31  
(511) 35

---

(260) AM 2015 77759 A  
(800) 1206866  
(151) 2013 12 31  
(181) 2023 12 31  
(891) 2013 12 31  
(511) 25

---

(260) AM 2015 77762 A  
(800) 1206909  
(151) 2014 03 17

(181) 2024 03 17  
(891) 2014 03 17  
(511) 32

---

(260) AM 2015 77838 A  
(800) 1152997  
(151) 2013 01 23  
(891) 2014 06 10  
(511) 03

---

(260) AM 2015 78043 A  
(800) 1209052  
(151) 2014 04 22  
(181) 2024 04 22  
(891) 2014 04 22  
(511) 03, 16

---

(260) AM 2015 78044 A  
(800) 1209072  
(151) 2014 05 13  
(181) 2024 05 13  
(891) 2014 05 13  
(511) 12

---

(260) AM 2015 78045 A  
(800) 1209077  
(151) 2014 03 05  
(181) 2024 03 05  
(891) 2014 03 05  
(511) 05, 10

---

(260) AM 2015 78054 A  
(800) 1209090  
(151) 2014 05 23  
(181) 2024 05 23  
(891) 2014 05 23  
(511) 30

---

(260) AM 2015 78055 A  
(800) 1209102  
(151) 2013 04 22  
(181) 2023 04 22  
(891) 2013 04 22  
(511) 08, 21, 35

---

(260) AM 2015 78056 A  
(800) 1209104  
(151) 2013 08 19  
(181) 2023 08 19  
(891) 2013 08 19  
(511) 03, 05, 10, 28

---



(260) AM 2015 78057 A  
(800) 1209122  
(151) 2013 12 25  
(181) 2023 12 25  
(891) 2013 12 25  
(511) 21

---

(260) AM 2015 78058 A  
(800) 1209126  
(151) 2013 12 11  
(181) 2023 12 11  
(891) 2013 12 11  
(511) 17, 19, 24

---

(260) AM 2015 78059 A  
(800) 1209214  
(151) 2014 01 20  
(181) 2024 01 20  
(891) 2014 01 20  
(511) 03, 05, 16, 21, 35

---

(260) AM 2015 78060 A  
(800) 1209217  
(151) 2014 02 24  
(181) 2024 02 24  
(891) 2014 02 24  
(511) 03, 05, 16, 21

---

(260) AM 2015 78061 A  
(800) 1209231  
(151) 2014 04 18  
(181) 2024 04 18  
(891) 2014 04 18  
(511) 33

---

(260) AM 2015 78062 A  
(800) 1209236  
(151) 2014 02 14  
(181) 2024 02 14  
(891) 2014 02 14  
(511) 05, 07, 09

---

(260) AM 2015 78063 A  
(800) 1209246  
(151) 2014 05 26  
(181) 2024 05 26  
(891) 2014 05 26  
(511) 33, 35

---

(260) AM 2015 78064 A  
(800) 1209247  
(151) 2014 05 26

(181) 2024 05 26  
(891) 2014 05 26  
(511) 33, 35

---

(260) AM 2015 78067 A  
(800) 1209268  
(151) 2014 04 30  
(181) 2024 04 30  
(891) 2014 04 30  
(511) 09, 11

---

(260) AM 2015 78068 A  
(800) 1209295  
(151) 2013 04 08  
(181) 2023 04 08  
(891) 2013 04 08  
(511) 07, 09, 10, 11, 12, 17, 35, 36, 37, 40,  
41, 42, 44

---

(260) AM 2015 78075 A  
(800) 1209518  
(151) 2014 03 28  
(181) 2024 03 28  
(891) 2014 03 28  
(511) 18, 25, 28

---

(260) AM 2015 78324 A  
(800) 1210960  
(151) 2013 12 16  
(181) 2023 12 16  
(891) 2013 12 16  
(511) 29, 30, 32

---

(260) AM 2015 78325 A  
(800) 1210964  
(151) 2014 04 07  
(181) 2024 04 07  
(891) 2014 04 07  
(511) 34

---

(260) AM 2015 78329 A  
(800) 1211000  
(151) 2014 04 25  
(181) 2024 04 25  
(891) 2014 04 25  
(511) 05

---

(260) AM 2015 78330 A  
(800) 1211040  
(151) 2014 03 31  
(181) 2024 03 31

(891) 2014 03 31  
(511) 05

---

(260) AM 2015 78337 A  
(800) 1211079  
(151) 2013 10 16  
(181) 2023 10 16  
(891) 2013 10 16  
(511) 09, 13, 18

---

(260) AM 2015 78338 A  
(800) 1211088  
(151) 2013 12 05  
(181) 2023 12 05  
(891) 2013 12 05  
(511) 39, 41

---

(260) AM 2015 78339 A  
(800) 1211094  
(151) 2013 12 02  
(181) 2023 12 02  
(891) 2013 12 02  
(511) 29, 30, 43

---

(260) AM 2015 78341 A  
(800) 1211137  
(151) 2014 03 07  
(181) 2024 03 07  
(891) 2014 03 07  
(511) 11, 14, 19

---

(260) AM 2015 78342 A  
(800) 1211146  
(151) 2014 03 21  
(181) 2024 03 21  
(891) 2014 03 21  
(511) 05

---

(260) AM 2015 78344 A  
(800) 1211151  
(151) 2014 04 29  
(181) 2024 04 29  
(891) 2014 04 29  
(511) 29, 30

---

---

# APPELLATIONS OF ORIGIN AND GEOGRAPHICAL INDICATIONS OF GOODS

## APPELLATIONS OF ORIGIN OF GOODS FILED IN GEORGIA FOR EXAMINATION UNDER LISBON AGREEMENT, ON THE BASIS OF THE INTERNATIONAL REGISTRATION

The decision can be appealed at the Chamber of Appeal of Sakpatenti within 3 months from the publication or at the Mtskheta District Court Administrative Cases Board (Address: №17, Samkhedro str., Mtskheta), within 1 month following the publication.

Number of Indication: 1205/06

Number of International Registration: 937

Data of International Registration: 2014 05 05

Application Filing Date: 2014 10 20

Appellation of Origin of Good: **PROSCIUTTO TOSCANO**

The Goods for which the Registration of Appellation of Origin is Required: 29 – Ham.

Name and Address of Applicant:

1. Ministero delle Politiche Alimentari e Forestali  
Via XX Settembre, 20, 00187- Roma, Italy;
2. Consorzio del Prociutto Toscano  
Via Giovanni dei Marignolli, 50127- Firenze, Italy

---

Number of Indication: 1206/06

Number of International Registration: 938

Data of International Registration: 2014 05 05

Application Filing Date: 2014 10 20

Appellation of Origin of Good: **RASCHERA**

The Goods for which the Registration of Appellation of Origin is Required: 29 – Cheese.

Name and Address of Applicant:

1. Ministero delle Politiche Agricole Alimentari e Forestali  
Via XX Settembre, 20, 00187- Roma, Italy;
2. Consorzio per la tutela del Formaggio a D.O. Raschera  
Via Mondovi Piazza, 1/d, 12080-Vicoforte (CN), Italy

---

Number of Indication: 1207/06

Number of International Registration: 939

Data of International Registration: 2014 05 05

Application Filing Date: 2014 10 20

Appellation of Origin of Good: **RIVIERA LIGURE**

The Goods for which the Registration of Appellation of Origin is Required: 29 – Oil.

Name and Address of Applicant:

1. Ministero delle Politiche Agricole Alimentari e Forestali  
Via XX Settembre, 20, 00187- Roma, Italy;
2. Consorzio per la tutela dell'Olio Extra Vergine di Oliva D.O.P. Riviera Ligure  
Viale Matteotti, 48, 18100-Imperia, Italy

---

Number of Indication: 1221/06

Number of International Registration: 940

Data of International Registration: 2014 05 05

Application Filing Date: 2014 12 24

Appellation of Origin of Good: **SALAMINI ITALIANI ALLA CACCIATORA**

The Goods for which the Registration of Appellation of Origin is Required: 29 – Meat Products

Name and Address of Applicant: 1. Ministero delle Politiche Agricole Alimentari e Forestali  
Via XX Settembre, 20, 00187- Roma, Italy;  
2. Consorzio Cacciatore - Salamini Italiani alla Cacciatora  
Strada 4, Palazzo Q8, Milanofiori 20089 Rozzano (MI), Italy

---

Number of Indication: 1222/06

Number of International Registration: 941

Data of International Registration: 2014 05 05

Application Filing Date: 2014 12 24

Appellation of Origin of Good: **SPECK ALTO ADIGE SUDTIROLER MARKENSPECK  
SUDTIROLER SPECK**

The Goods for which the Registration of Appellation of Origin is Required: 29 – Meat Products

Name and Address of Applicant: 1. Ministero delle Politiche Agricole Alimentari e Forestali  
Via XX Settembre, 20, 00187- Roma, Italy;  
2. Consorzio Tutela Speck Alto Adige  
Via Renon 33/A, 39100 - Bolzano, Italy

---

Number of Indication: 1223/06

Number of International Registration: 942

Data of International Registration: 2014 05 05

Application Filing Date: 2014 12 24

Appellation of Origin of Good: **STELVIO STILFSEK**

The Goods for which the Registration of Appellation of Origin is Required: 29 – Cheese

Name and Address of Applicant: 1. Ministero delle Politiche Agricole Alimentari e Forestali  
Via XX Settembre, 20, 00187- Roma, Italy;  
2. Consorzio Formaggio Stelvio;  
Via Campiglio, 13/ 39100 -Bolzano, Italy

---

Number of Indication: 1224/06

Number of International Registration: 943

Data of International Registration: 2014 05 05

Application Filing Date: 2014 12 24

Appellation of Origin of Good: **TERRA DI BARI**

The Goods for which the Registration of Appellation of Origin is Required: 29 – Oil.

Name and Address of Applicant: 1. Ministero delle Politiche Agricole Alimentari e Forestali  
Via XX Settembre, 20, 00187- Roma, Italy;  
2. Consorzio per la Valorizzazione e la Tutela dell' Olio  
Extravergine di Oliva a D.O.P. "Terra di Bari"  
Corso Cavour 2 c/o Camera di Commercio di Bari  
70121 - Bari , Italy

---

Number of Indication: 1225/06

Number of International Registration: 944

Data of International Registration: 2014 05 05

Application Filing Date: 2014 12 24

Appellation of Origin of Good: **TOMA PIEMONTESE**

The Goods for which the Registration of Appellation of Origin is Required: 29 – Cheese

Name and Address of Applicant: 

1. Ministero delle Politiche Agricole Alimentari e Forestali  
Via XX Settembre, 20, 00187- Roma, Italy;
2. Consorzio di Tutela del Formaggio "Toma Piemontese" D.O.P.  
Via Silvio Pellico, 10 10022 - Carmagnola (TO), Italy

---

Number of Indication: 1226/06

Number of International Registration: 945

Data of International Registration: 2014 05 05

Application Filing Date: 2014 12 24

Appellation of Origin of Good: **ZAMPONE MODENA**

The Goods for which the Registration of Appellation of Origin is Required: 29 – Meat products

Name and Address of Applicant: 

1. Ministero delle Politiche Agricole Alimentari e Forestali  
Via XX Settembre, 20, 00187- Roma, Italy;
2. Consorzio Zampone Modena  
Strada 4, Palazzo Q8, Milanofiori 20089 - Rozzano (MI), Italy

---

---

# OFFICIAL NOTIFICATIONS

## INVENTIONS

### TRANSFER OF RIGHTS

(II quarter of 2015 years)

NUMBER OF PATENT	OLD PATENTOWNERS (Transfer of Rights)	NEW PATENTOWNERS (Recipient of Rights)	DATE OF TRANSFER
5273/1	LTD "WPHT" Zheneva pleis, Voterpront Draivi, PO Box 3469 Roud Taun, Tortola VG	Tengiz Gelashvili Agladzis q. 38/91, 0119, Tbilisi (GE)	5/1/2015
5274/1	Zheneva pleis, Voterpront Draivi, PO Box 3469 Roud Taun, Tortola VG	Tengiz Gelashvili Agladzis q. 38/91, 0119, Tbilisi (GE)	5/1/2015
4097/1	GLAXO GROUP LIMITED Glaxo Wellcome House, Berkley Avenue, Greenford, Middlesex UB6 0NN, GB	Aspen Global Incorporated GBS Plaza, Cnr. La Salette & Royal Roads, Grand Bay, MU	5/11/2015

### CHANGES IN NAMES AND/OR ADDRESSES OF PATENTOWNERS

(II quarter of 2015 years)

NUMBER OF PATENT	OLD NAMES AND/OR ADDRESSES	NEW NAMES AND/OR ADDRESSES	DATE OF CHANGES
1	2	3	4
4927/1	Bristol-Myers Squibb Holdings Ireland Newhopsstrasse 6, CH-6340 Bery, CH	Bristol-Myers Squibb Holdings Ireland Hinterbergstrasse 16, 6312 Steinhausen, Switzerland, CH	4/7/2015
3026/1	Bristol-Myers Squibb Holdings Ireland Newhopsstrasse 6, CH-6340 Bery, CH	Bristol-Myers Squibb Holdings Ireland Hinterbergstrasse 16, 6312 Steinhausen, Switzerland, CH	4/7/2015
3504/1	Bristol-Myers Squibb Holdings Ireland Newhopsstrasse 6, CH-6340 Bery, CH	Bristol-Myers Squibb Holdings Ireland Hinterbergstrasse 16, 6312 Steinhausen, Switzerland, CH	4/7/2015
4234/1	Bristol-Myers Squibb Holdings Ireland Newhopsstrasse 6, CH-6340 Bery, CH	Bristol-Myers Squibb Holdings Ireland Hinterbergstrasse 16, 6312 Steinhausen, Switzerland, CH	4/7/2015
5596/1	Nycomed Pharma AS Drammensveien 852, NO-1385 Asker, NO	Takeda Nycomed AS Drammensveien 852, 1372 Asker, NO	5/1/2015
4896/1	Nycomed Pharma AS Drammensveien 852, H-1372 Asker, NO	Takeda Nycomed AS Drammensveien 852, 1372 Asker, NO	5/1/2015
4681/1	Nycomed Pharma AS Drammensveien 852, H-1372 Asker, NO	Takeda Nycomed AS Drammensveien 852, 1372 Asker, NO	5/1/2015

1	2	3	4
5215/1	STIFTUNG ALFRED-WEGENER-INSTITUT FÜR POLAR-UND MEERESFORSCHUNG Am Handelshafen 12, 27570 Bremerhaven, DE	ALFRED-WEGENER-INSTITUT Helmholtz-Zentrum FÜR POLAR- UND MEERESFORSCHUNG Am Handelshafen 12, 27570 Bremerhaven, DE	5/11/2015
5432/1	UNIMED PHARMACEUTICALS, LLC 901 Sawyer Road, Marietta, Georgia 30062, US; Basins Healthcare Luxembourg Sarl 67. Boulevard Grande-Douche- se Charlotte L-1331 Louxem- burg, LU	UNIMED PHARMACEUTICALS, LLC 901 Sawyer Road, Marietta, Georgia 30062, US; Basins Healthcare Luxembourg Sarl 2-8, rue Julien Vesque, L-2668 Luxembourg, LU	6/24/2015
4889/1	Basins Healthcare Luxembourg Sarl 67. Boulevard Grande-Douche- se Charlotte L-1331 Louxem- burg, LU	Basins Healthcare Luxembourg Sarl 2-8, rue Julien Vesque, L-2668 Luxembourg, LU	6/24/2015

## RENEWAL OF A PATENTS INVENTION

**(11) P 2012 5654 B**

(73) Anzor Chachua (GE)

**(54) AIRLINE SERVICE COMPLEX**

DATE OF RENEWAL: 2015 08 10

---

## UTILITY MODELS

**(11) U 2012 1727 Y B**

(73) Vili Pachkoria (GE)

**(54) DISPOSABLE HYGIENIC BEDDING FOR WC SCAT**

DATE OF RENEWAL: 2015 08 10

---

**(11) U 2013 1760 Y**

(73) Ketevan Imdeshavili (GE)

**(54) METHOD OF OBTAINING AVAILABLE SOLUTION FROM GRAPEVINE WASTE**

DATE OF RENEWAL: 2015 08 10

---



# CORRECTION OF PUBLIC INFORMATIONS

BULLETIN 9(325) 2011

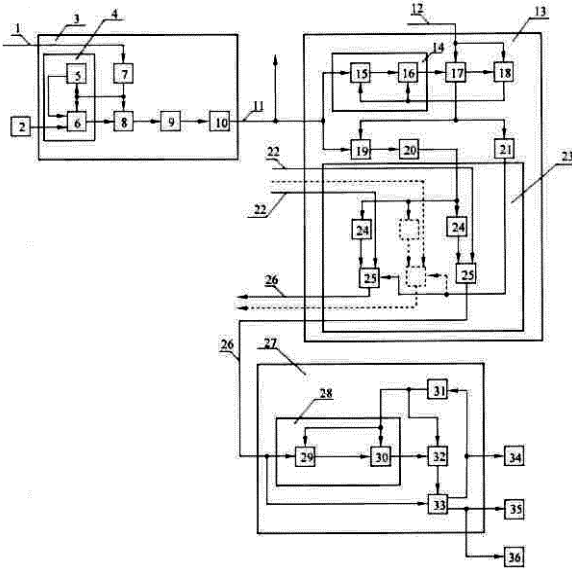
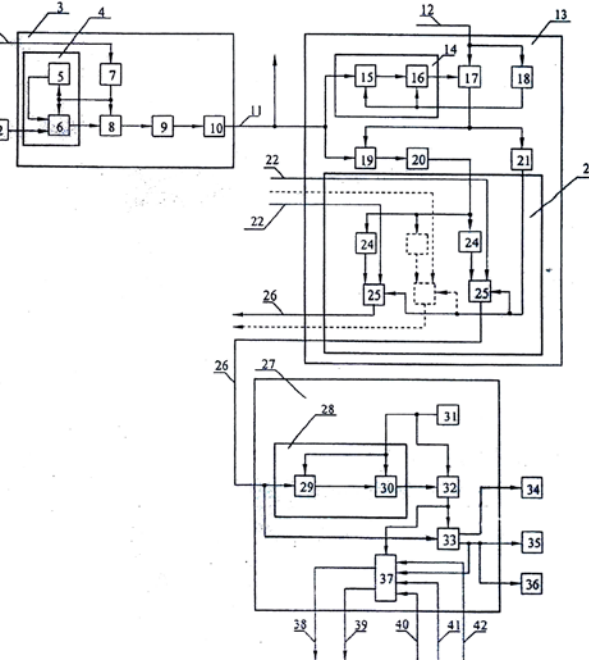
NUMBER OF PUBLICATION (10)	PG.	CL.	TITLE OF THE INVENTION (54)
AP 2011 11256 A	20	II	NOTIFICATION SYSTEM OF AIR-RAID PRECAUTIONS
PUBLISHED			MUST BE
 <p style="text-align: center;">fig. 1</p>			 <p style="text-align: center;">fig. 1</p>

---

# CLASSIFICATION INDEXES

## INVENTIONS

### CONCORDANCE TABLE OF INTERNATIONAL CLASSIFICATION INDEX AND PUBLICATION NUMBERS

INTERNATIONAL CLASSIFICATION INDEXES (51)	NUMBER OF PUBLISHED APPLICATION (10)
A 61 K 33/26, 33/04, 36/00	AP 2015 13602 A
A 61 K 33/26, 33/04	AP 2015 13672 A
A 61 K 36/00; A 61 K 31/00	AP 2015 13205 A
B 60 P 3/40; B 60 P 3/41	AP 2015 13406 A

### CONCORDANCE TABLE OF PUBLICATION NUMBERS AND INTERNATIONAL CLASSIFICATION INDEX

NUMBER OF PUBLISHED APPLICATION (10)	INTERNATIONAL CLASSIFICATION INDEXES (51)
AP 2015 13205 A	A 61 K 36/00; A 61 K 31/00
AP 2015 13406 A	B 60 P 3/40; B 60 P 3/41
AP 2015 13602 A	A 61 K 33/26, 33/04, 36/00
AP 2015 13672 A	A 61 K 33/26, 33/04

### CONCORDANCE TABLE OF INTERNATIONAL CLASSIFICATION INDEX, PATENT NUMBERS AND PUBLICATION NUMBERS

INTERNATIONAL CLASSIFICATION INDEX (51)	NUMBER OF PATENT (11)	NUMBER OF PUBLISHED APPLICATION (10)
A 61 K 9/00; A 61 K 31/44; A 61 P 11/06	P 2015 6343 B	AP 2015 12988 A
A 61 K 9/50, 31/495	P 2015 6342 B	AP 2015 12984 A
A 61 K 39/00; C 07 K 16/44	P 2015 6341 B	AP 2015 12836 A
B 01 D 24/10; B 01 D 53/02	P 2015 6340 B	AP 2015 12776 A
B 03 B 13/00	P 2015 6338 B	AP 2015 12697 A
C 07 C 231/12; C 07 C 233/18; A 61 K 31/165; A 61 P 25/16; A 61 P 25/18; A 61 P 25/28; A 61 P 3/00	P 2015 6339 B	AP 2015 12736 A
C 07 D 319/20; C 07 D 405/10; C 07 D 487/10; C 07 D 405/12; C 07 D 405/14; A 61 K 31/357; A 61 P 29/00; A 61 P 19/00	P 2015 6347 B	AP 2015 13259 A
C 07 D 519/00; A 61 K 31/519; A 61 P 25/00; A 61 P 25/18; A 61 P 25/24	P 2015 6346 B	AP 2015 13117 A
F 01 B 17/02; F 02 G 1/02; F 24 J 2/42	P 2015 6344 B	AP 2015 13075 A
F 02 B 21/00; F 02 M 31/04; F 02 M 31/16; F 01 B 17/02; F 01 D 13/02	P 2015 6345 B	AP 2015 13076 A

**CONCORDANCE TABLE OF PATENT NUMBERS,  
PUBLICATION NUMBERS AND INTERNATIONAL CLASSIFICATION INDEX**

NUMBER OF PATENT (11)	NUMBER OF PUBLISHED APPLICATION (10)	INTERNATIONAL CLASSIFICATION INDEX (51)
P 2015 6338 B	AP 2015 12697 A	B 03 B 13/00
P 2015 6339 B	AP 2015 12736 A	C 07 C 231/12; C 07 C 233/18; A 61 K 31/165; A 61 P 25/16; A 61 P 25/18; A 61 P 25/28; A 61 P 3/00
P 2015 6340 B	AP 2015 12776 A	B 01 D 24/10; B 01 D 53/02
P 2015 6341 B	AP 2015 12836 A	A 61 K 39/00; C 07 K 16/44
P 2015 6342 B	AP 2015 12984 A	A 61 K 9/50, 31/495
P 2015 6343 B	AP 2015 12988 A	A 61 K 9/00; A 61 K 31/44; A 61 P 11/06
P 2015 6344 B	AP 2015 13075 A	F 01 B 17/02; F 02 G 1/02; F 24 J 2/42
P 2015 6345 B	AP 2015 13076 A	F 02 B 21/00; F 02 M 31/04; F 02 M 31/16; F 01 B 17/02; F 01 D 13/02
P 2015 6346 B	AP 2015 13117 A	C 07 D 519/00; A 61 K 31/519; A 61 P 25/00; A 61 P 25/18; A 61 P 25/24
P 2015 6347 B	AP 2015 13259 A	C 07 D 319/20; C 07 D 405/10; C 07 D 487/10; C 07 D 405/12; C 07 D 405/14; A 61 K 31/357; A 61 P 29/00; A 61 P 19/00

**CONCORDANCE TABLE OF APPLICATION NUMBERS, PUBLICATION NUMBERS  
AND PATENTS**

NUMBER OF APPLICATION (21)	NUMBER OF PUBLISHED APPLICATION (10)	NUMBER OF PATENT (11)
AP 2012 012697	AP 2015 12697 A	P 2015 6338 B
AP 2012 012736	AP 2015 12736 A	P 2015 6339 B
AP 2010 012776	AP 2015 12776 A	P 2015 6340 B
AP 2011 012836	AP 2015 12836 A	P 2015 6341 B
AP 2013 012984	AP 2015 12984 A	P 2015 6342 B
AP 2011 012988	AP 2015 12988 A	P 2015 6343 B
AP 2011 013075	AP 2015 13075 A	P 2015 6344 B
AP 2011 013076	AP 2015 13076 A	P 2015 6345 B
AP 2011 013117	AP 2015 13117 A	P 2015 6346 B
AP 2012 013259	AP 2015 13259 A	P 2015 6347 B

## UTILITY MODELS

**CONCORDANCE TABLE OF INTERNATIONAL CLASSIFICATION INDEX  
AND PUBLICATION NUMBERS**

INTERNATIONAL CLASSIFICATION INDEXES (51)	NUMBER OF PUBLISHED APPLICATION (10)
G 01 N 27/22	AU 2015 13762 U
G 06 Q 90/00; H 04 M 3/42	AU 2015 13741 U

**CONCORDANCE TABLE OF PUBLICATION NUMBERS  
AND INTERNATIONAL CLASSIFICATION INDEX**

NUMBER OF PUBLISHED APPLICATION (10)	INTERNATIONAL CLASSIFICATION INDEXES (51)
AU 2015 13741 U	G 06 Q 90/00; H 04 M 3/42
AU 2015 13762 U	G 01 N 27/22

**CONCORDANCE TABLE OF INTERNATIONAL CLASSIFICATION INDEX,  
PATENT NUMBERS AND PUBLICATION NUMBERS**

INTERNATIONAL CLASSIFICATION INDEX (51)	NUMBER OF PATENT (11)	NUMBER OF PUBLISHED APPLICATION (10)
E 04 G 9/00	U 2015 1863 Y	AU 2015 13452 U

**CONCORDANCE TABLE OF PATENT NUMBERS,  
PUBLICATION NUMBERS AND INTERNATIONAL CLASSIFICATION INDEX**

NUMBER OF PATENT (11)	NUMBER OF PUBLISHED APPLICATION (10)	INTERNATIONAL CLASSIFICATION INDEX (51)
U 2015 1863 Y	AU 2015 13452 U	E 04 G 9/00

**CONCORDANCE TABLE OF APPLICATION NUMBERS, PUBLICATION NUMBERS  
AND PATENTS**

NUMBER OF APPLICATION (21)	NUMBER OF PUBLISHED APPLICATION (10)	NUMBER OF PATENT (11)
AU 2014 013452	AU 2015 13452 U	U 2015 1863 Y

**DESIGNS****CONCORDANCE TABLE OF INTERNATIONAL CLASSIFICATION INDEX  
AND PUBLICATION NUMBERS**

INTERNATIONAL CLASSIFICATION INDEXES (51)	NUMBER OF PUBLISHED APPLICATION (10)
05-06	AD 2015 849 S

**CONCORDANCE TABLE OF PUBLICATION NUMBERS  
AND INTERNATIONAL CLASSIFICATION INDEX**

NUMBER OF PUBLISHED APPLICATION (10)	INTERNATIONAL CLASSIFICATION INDEXES (51)
AD 2015 849 S	05-06

**CONCORDANCE TABLE OF INTERNATIONAL CLASSIFICATION INDEX,  
PATENT NUMBERS AND PUBLICATION NUMBERS**

INTERNATIONAL CLASSIFICATION INDEX (51)	NUMBER OF PATENT (11)	NUMBER OF PUBLISHED APPLICATION (10)
32-00	D 2015 635 S	AD 2015 843 S

**CONCORDANCE TABLE OF PATENT NUMBERS,  
PUBLICATION NUMBERS AND INTERNATIONAL CLASSIFICATION INDEX**

NUMBER OF PATENT (11)	NUMBER OF PUBLISHED APPLICATION (10)	INTERNATIONAL CLASSIFICATION INDEX (51)
D 2015 635 S	AD 2015 843 S	32-00

**CONCORDANCE TABLE OF APPLICATION NUMBERS, PUBLICATION NUMBERS  
AND PATENTS**

NUMBER OF APPLICATION (21)	NUMBER OF PUBLISHED APPLICATION (10)	NUMBER OF PATENT (11)
AD 2015 000843	AD 2015 843 S	D 2015 635 S

**DESIGN REGISTERED ACCORDING TO THE  
ACCELERATED PROCEDURE**

**CONCORDANCE TABLE OF INTERNATIONAL CLASSIFICATION INDEX  
AND PATENTS NUMBERS**

INTERNATIONAL CLASSIFICATION INDEX (51)	NUMBER OF PATENT (11)
19-18	D 2015 633 S
32-00	D 2015 634 S

**CONCORDANCE TABLE OF PATENT NUMBERS AND INTERNATIONAL  
CLASSIFICATION INDEX**

NUMBER OF PATENT (11)	INTERNATIONAL CLASSIFICATION INDEX (51)
D 2015 633 S	19-18
D 2015 634 S	32-00

**CONCORDANCE TABLE OF APPLICATION NUMBERS  
AND PATENT NUMBERS**

NUMBER OF APPLICATION (21)	NUMBER OF PATENT (11)
AD 2015 000858	D 2015 633 S
AD 2015 000860	D 2015 634 S

## TRADEMARKS

### CONCORDANCE TABLE OF REGISTRATION NUMBERS, APPLICATION NUMBERS, PUBLICATION NUMBERS AND BULLETIN NUMBERS

NUMBER OF REGISTRATION (111)	NUMBER OF APPLICATIONS (210)	NUMBER OF PUBLISHED APPLICATIONS (260)	NUMBER OF BULLETIN
1	2	3	4
M 2015 26075 R	AM 67596	AM 2015 67596 A	3(415) 2015
M 2015 26076 R	AM 68212	AM 2015 68212 A	5(417) 2015
M 2015 26077 R	AM 71153	AM 2015 71153 A	4(416) 2015
M 2015 26078 R	AM 72155	AM 2015 72155 A	4(416) 2015
M 2015 26079 R	AM 72196	AM 2015 72196 A	6(418) 2015
M 2015 26080 R	AM 73488	AM 2015 73488 A	5(417) 2015
M 2015 26081 R	AM 73916	AM 2015 73916 A	2(414) 2015
M 2015 26082 R	AM 73917	AM 2015 73917 A	2(414) 2015
M 2015 26083 R	AM 73933	AM 2015 73933 A	2(414) 2015
M 2015 26084 R	AM 74591	AM 2015 74591 A	5(417) 2015
M 2015 26085 R	AM 74755	AM 2015 74755 A	4(416) 2015
M 2015 26086 R	AM 74874	AM 2014 74874 A	24(412) 2014
M 2015 26087 R	AM 74875	AM 2014 74875 A	24(412) 2014
M 2015 26088 R	AM 74899	AM 2015 74899 A	1(413) 2015
M 2015 26089 R	AM 75090	AM 2015 75090 A	4(416) 2015
M 2015 26091 R	AM 76710	AM 2015 76710 A	4(416) 2015
M 2015 26092 R	AM 76720	AM 2015 76720 A	5(417) 2015
M 2015 26093 R	AM 76730	AM 2014 76730 A	1(413) 2015
M 2015 26094 R	AM 76796	AM 2014 76796 A	1(413) 2015
M 2015 26095 R	AM 76797	AM 2014 76797 A	1(413) 2015
M 2015 26096 R	AM 76798	AM 2014 76798 A	1 (413) 2015
M 2015 26097 R	AM 76801	AM 2014 76801 A	23 (411) 2014
M 201526098 R	AM 76803	AM 2014 76803 A	23 (411) 2014
M 2015 26099 R	AM 76814	AM 2015 76814 A	5 (417) 2015
M 2015 26100 R	AM 76818	AM 2015 76818 A	5 (417) 2015
M 2015 26101 R	AM 76953	AM 2014 76953 A	1 (413) 2015
M 2015 26102 R	AM 76975	AM 2015 76975 A	2 (414) 2015
M 2015 26103 R	AM 76987	AM 2015 76987 A	2 (414) 2015
M 2015 26104 R	AM 77079	AM 2015 77079 A	2 (414) 2015
M 2015 26105 R	AM 77218	AM 2015 77218 A	2 (414) 2015
M 2015 26106 R	AM 77287	AM 2014 77287 A	23 (411) 2014
M 2015 26107 R	AM 77348	AM 2015 77348 A	4 (416) 2015
M 2015 26108 R	AM 77370	AM 2015 77370 A	4 (416) 2015
M 2015 26109 R	AM 77448	AM 2015 77448 A	3 (415) 2015
M 2015 26110 R	AM 77450	AM 2015 77450 A	3 (415) 2015
M 2015 26111 R	AM 77465	AM 2015 77465 A	3 (415) 2015
M 2015 26112 R	AM 77466	AM 2015 77466 A	4 (416) 2015
M 2015 26113 R	AM 77467	AM 2015 77467 A	3 (415) 2015
M 2015 26114 R	AM 77524	AM 2015 77524 A	5 (417) 2015
M 2015 26115 R	AM 77531	AM 2015 77531 A	4 (416) 2015
M 2015 26116 R	AM 77547	AM 2015 77547 A	3 (415) 2015
M 2015 26117 R	AM 77552	AM 2015 77552 A	3 (415) 2015
M 2015 26118 R	AM 77639	AM 2015 77639 A	3 (415) 2015
M 2015 26119 R	AM 77814	AM 2015 77814 A	5 (417) 2015
M 2015 26120 R	AM 77815	AM 2015 77815 A	5 (417) 2015

1	2	3	4
M 2015 26121 R	AM 77890	AM 2015 77890 A	5 (417) 2015
M 2015 26122 R	AM 77891	AM 2015 77891 A	5 (417) 2015
M 2015 26123 R	AM 77892	AM 2015 77892 A	5 (417) 2015
M 2015 26124 R	AM 78052	AM 2015 78052 A	5 (417) 2015
M 2015 26125 R	AM 75703	AM 2015 75703 A	4 (416) 2015
M 2015 26126 R	AM 76307	AM 2015 76307 A	4 (416) 2015
M 2015 26127 R	AM 76421	AM 2015 76421 A	4 (416) 2015
M 2015 26128 R	AM 76739	AM 2015 76739 A	4 (416) 2015
M 2015 26129 R	AM 76847	AM 2015 76847 A	4 (416) 2015
M 2015 26130 R	AM 76956	AM 2015 76956 A	4 (416) 2015
M 2015 26131 R	AM 77329	AM 2015 77329 A	4 (416) 2015
M 2015 26132 R	AM 77347	AM 2015 77347 A	4 (416) 2015
M 2015 26133 R	AM 77863	AM 2015 77863 A	4 (416) 2015
M 2015 26134 R	AM 78022	AM 2015 78022 A	4 (416) 2015
M 2015 26135 R	AM 78048	AM 2015 78048 A	4 (416) 2015
M 2015 26139 R	AM 82657	–	15 (427) 2015
M 2015 26140 R	AM 82761	–	15 (427) 2015
M 2015 26141 R	AM 82660	–	15 (427) 2015
M 2015 26142 R	AM 82663	–	15 (427) 2015
M 2015 26143 R	AM 82661	–	15 (427) 2015
M 2015 26144 R	AM 82826	–	15 (427) 2015
M 2015 26145 R	AM 82464	–	15 (427) 2015
M 2015 26146 R	AM 82465	–	15 (427) 2015
M 2015 26147 R	AM 82467	–	15 (427) 2015
M 2015 26148 R	AM 82468	–	15 (427) 2015
M 2015 26149 R	AM 82469	–	15 (427) 2015
M 2015 26150 R	AM 82470	–	15 (427) 2015
M 2015 26151 R	AM 82472	–	15 (427) 2015
M 2015 26152 R	AM 82473	–	15 (427) 2015
M 2015 26153 R	AM 82474	–	15 (427) 2015
M 2015 26154 R	AM 75221	AM 2015 75221 A	5 (417) 2015
M 2015 26155 R	AM 75736	AM 2015 75736 A	5 (417) 2015
M 2015 26156 R	AM 75768	AM 2014 75768 A	1 (413) 2015
M 2015 26157 R	AM 75932	AM 2015 75932 A	5 (417) 2015
M 2015 26158 R	AM 76177	AM 2015 76177 A	5 (417) 2015
M 2015 26159 R	AM 76460	AM 2015 76460 A	4 (416) 2015
M 2015 26160 R	AM 76601	AM 2015 76601 A	5 (417) 2015
M 2015 26161 R	AM 76736	AM 2015 76736 A	4 (416) 2015
M 2015 26162 R	AM 76781	AM 2015 76781 A	9 (421) 2015
M 2015 26163 R	AM 77021	AM 2015 77021 A	5 (417) 2015
M 2015 26164 R	AM 77073	AM 2015 77073 A	2 (414) 2015
M 2015 26165 R	AM 77098	AM 2015 77098 A	4 (416) 2015
M 2015 26166 R	AM 77263	AM 2015 77263 A	5 (417) 2015
M 2015 26167 R	AM 77574	AM 2015 77574 A	5 (417) 2015
M 2015 26168 R	AM 77693	AM 2015 77693 A	7 (419) 2015
M 2015 26169 R	AM 77782	AM 2015 77782 A	5 (417) 2015
M 2015 26170 R	AM 78000	AM 2015 78000 A	6 (418) 2015
M 2015 26171 R	AM 78005	AM 2015 78005 A	5 (417) 2015
M 2015 26172 R	AM 78017	AM 2015 78017 A	5 (417) 2015
M 2015 26173 R	AM 78053	AM 2015 78053 A	4 (416) 2015
M 2015 26174 R	AM 82983	–	15 (427) 2015
M 2015 26175 R	AM 82984	–	15 (427) 2015
M 2015 26176 R	AM 82985	–	15 (427) 2015
M 2015 26177 R	AM 82986	–	15 (427) 2015
M 2015 26178 R	AM 82830	–	15 (427) 2015



**CONCORDANCE TABLE OF PUBLICATION NUMBERS  
AND APPLICATION NUMBERS**

NUMBER OF PUBLISHED APPLICATION (260)	NUMBER OF APPLICATION (210)	1	2
1	2		
AM 2015 68048 A**	AM 68048	AM 2015 79196 A	AM 79196
AM 2015 77451 A	AM 77451	AM 2015 79268 A	AM 79268
AM 2015 77816 A	AM 77816	AM 2015 79290 A	AM 79290
AM 2015 78138 A	AM 78138	AM 2015 79308 A	AM 79308
AM 2015 78141 A	AM 78141	AM 2015 79337 A	AM 79337
AM 2015 78142 A	AM 78142	AM 2015 79352 A	AM 79352
AM 2015 78149 A	AM 78149	AM 2015 79389 A	AM 79389
AM 2015 78238 A	AM 78238	AM 2015 79406 A	AM 79406
AM 2015 78378 A	AM 78378	AM 2015 79451 A	AM 79451
AM 2015 78704 A	AM 78704	AM 2015 79481 A	AM 79481
AM 2015 78813 A	AM 78813	AM 2015 79482 A	AM 79482
AM 2015 78846 A	AM 78846	AM 2015 79498 A	AM 79498
AM 2015 78848 A	AM 78848	AM 2015 79612 A	AM 79612
AM 2015 78887 A	AM 78887	AM 2015 79614 A	AM 79614
AM 2015 78889 A	AM 78889	AM 2015 79669 A	AM 79669
AM 2015 78909 A	AM 78909	AM 2015 79747 A	AM 79747
AM 2015 79051 A	AM 79051	AM 2015 79748 A	AM 79748
AM 2015 79060 A	AM 79060	AM 2015 79749 A	AM 79749
AM 2015 79070 A	AM 79070	AM 2015 79750 A	AM 79750
AM 2015 79071 A	AM 79071	AM 2015 79751 A	AM 79751
AM 2015 79123 A	AM 79123	AM 2015 79956 A	AM 79956
AM 2015 79136 A	AM 79136	AM 2015 79974 A	AM 79974
AM 2015 79140 A	AM 79140	AM 2015 79979 A	AM 79979
		AM 2015 80007 A	AM 80007
		AM 2015 80011 A	AM 80011
		AM 2015 80013 A	AM 80013
		AM 2015 80110 A	AM 80110
		AM 2015 80112 A	AM 80112

**CONCORDANCE TABLE OF INDEX OF GOODS AND/OR SERVICES  
AND APPLICATION NUMBERS**

INDEX OF GOODS AND/OR SERVICES (511)	NUMBER OF PUBLISHED APPLICATIONS (260)	1	2
1	2		
1	AM 2015 78887 A	5	AM 2015 79751 A
1	AM 2015 79290 A	7	AM 2015 80110 A
3	AM 2015 78909 A	8	AM 2015 80110 A
3	AM 2015 79290 A	9	AM 2015 78889 A
5	AM 2015 68048 A**	9	AM 2015 79308 A
5	AM 2015 77451 A	9	AM 2015 79612 A
5	AM 2015 79060 A	9	AM 2015 79614 A
5	AM 2015 79290 A	9	AM 2015 80013 A
5	AM 2015 79406 A	10	AM 2015 79060 A
5	AM 2015 79747 A	12	AM 2015 79352 A
5	AM 2015 79748 A	12	AM 2015 79451 A
5	AM 2015 79749 A	12	AM 2015 79481 A
5	AM 2015 79750 A	12	AM 2015 79482 A
5	AM 2015 79751 A	12	AM 2015 80112 A
5	AM 2015 79956 A	14	AM 2015 78138 A
5	AM 2015 79974 A	14	AM 2015 79337 A
5	AM 2015 79979 A	16	AM 2015 78141 A
5	AM 2015 80007 A	16	AM 2015 79389 A

1	2	1	2
16	AM 2015 79669 A	35	AM 2015 79614 A
18	AM 2015 80011 A	35	AM 2015 79669 A
19	AM 2015 80110 A	35	AM 2015 80007 A
20	AM 2015 79974 A	35	AM 2015 80013 A
24	AM 2015 78149 A	35	AM 2015 80110 A
24	AM 2015 79974 A	35	AM 2015 80112 A
25	AM 2015 78378 A	36	AM 2015 79612 A
25	AM 2015 80011 A	36	AM 2015 79614 A
28	AM 2015 78142 A	36	AM 2015 80013 A
28	AM 2015 80112 A	37	AM 2015 79290 A
29	AM 2015 78238 A	37	AM 2015 79612 A
29	AM 2015 78846 A	37	AM 2015 79614 A
29	AM 2015 78848 A	38	AM 2015 79308 A
29	AM 2015 79337 A	38	AM 2015 79612 A
30	AM 2015 78238 A	38	AM 2015 79614 A
30	AM 2015 79070 A	39	AM 2015 79337 A
30	AM 2015 79123 A	40	AM 2015 79290 A
30	AM 2015 79136 A	41	AM 2015 78889 A
30	AM 2015 79337 A	41	AM 2015 79071 A
31	AM 2015 79337 A	41	AM 2015 79290 A
32	AM 2015 78813 A	41	AM 2015 79308 A
33	AM 2015 77816 A	41	AM 2015 79612 A
33	AM 2015 78813 A	41	AM 2015 79614 A
33	AM 2015 79051 A	42	AM 2015 78889 A
33	AM 2015 79268 A	42	AM 2015 79290 A
33	AM 2015 79956 A	42	AM 2015 79612 A
33	AM 2015 79979 A	42	AM 2015 79614 A
35	AM 2015 78704 A	43	AM 2015 78889 A
35	AM 2015 78889 A	43	AM 2015 79196 A
35	AM 2015 79071 A	43	AM 2015 79290 A
35	AM 2015 79123 A	44	AM 2015 79290 A
35	AM 2015 79140 A	44	AM 2015 79612 A
35	AM 2015 79290 A	44	AM 2015 79614 A
35	AM 2015 79308 A	44	AM 2015 80007 A
35	AM 2015 79498 A	45	AM 2015 78889 A
35	AM 2015 79612 A	45	AM 2015 79290 A

CONCORDANCE TABLE OF INDEX OF GOODS AND/OR SERVICES  
AND NUMBERS OF TRADEMARKS REGISTERED ACCORDING  
TO THE ACCELERATED PROCEDURE

INDEX OF GOODS AND/OR SERVICES (511)	NUMBERS OF REGISTERED ACCORDING TO THE ACCELERATED PROCEDURE (111)
1	M 2015 26140 R
2	M 2015 26140 R
4	M 2015 26145 R
4	M 2015 26146 R
4	M 2015 26147 R
4	M 2015 26148 R
4	M 2015 26149 R
4	M 2015 26150 R
4	M 2015 26151 R
4	M 2015 26152 R
4	M 2015 26153 R
19	M 2015 26140 R
19	M 2015 26174 R
19	M 2015 26175 R
19	M 2015 26176 R
19	M 2015 26177 R
35	M 2015 26139 R
35	M 2015 26141 R
35	M 2015 26143 R
35	M 2015 26142 R
35	M 2015 26144 R
35	M 2015 26178 R
37	M 2015 26178 R
40	M 2015 26145 R
40	M 2015 26146 R
40	M 2015 26147 R
40	M 2015 26148 R
40	M 2015 26149 R
40	M 2015 26150 R
40	M 2015 26151 R
40	M 2015 26152 R
40	M 2015 26153 R
44	M 2015 26139 R

# OFFICIAL BULLETIN OF THE INDUSTRIAL PROPERTY

## 15(427)

EDITOR-IN-CHIEF: N. Bebrishvili

EDITORS-TRANSLATORS: E. Gabunia

PROOFREADER: A. Shikhashvili

COMPUTER LAYOUT: M. Ordenidze

[www.sakpatenti.org.ge](http://www.sakpatenti.org.ge)

E-mail: [info@sakpatenti.org.ge](mailto:info@sakpatenti.org.ge)