



საქართველოს ინტელექტუალური საკუთრების ეროვნული ცენტრი
NATIONAL INTELLECTUAL PROPERTY CENTER OF GEORGIA

საქპატენტი
SAKPATENTI

**OFFICIAL BULLETIN
OF THE INDUSTRIAL PROPERTY**

16(524)

2019
TBILISI

INID CODES FOR IDENTIFICATION OF BIBLIOGRAPHIC DATA

INVENTIONS, UTILITY MODELS

- (10) Number of publication for application, which has been examined
- (11) Number of patent and kind of document
- (21) Serial number of application
- (22) Date of filing of the application
- (23) Date of exhibition or the date of the earlier filing and the number of application, if any
- (24) Date from which patent may have effect
- (31) Number of priority application
- (32) Date of filing of priority application
- (33) Code of the country or regional organization allotting priority application number
- (44) Date of publication of application not granted, but examined and number of bulletin
- (45) Date of publication of registered document
- (51) International Patent Classification Index
- (54) Title of the invention
- (57) Abstract
- (60) Number of examined patent document granted by foreign patent office, date from which patent has effect and country code
- (62) Number of the earlier application and in case of divided application, date of filing an application
- (71) Name, surname and address of applicant (country code)
- (72) Name, surname of inventor (country code)
- (73) Name, surname and address of patent owner (country code)
- (74) Name, surname of representative or patent attorney
- (85) Date of commencement of the national phase of International Application
- (86) Number and date of filing of international application
- (87) Number and date of publication of international application

DESIGNS

- (10) Number of publication for application
- (11) Number of patent and kind of document or number of registration
- (15) Date of registration/Date of patent renewal
- (18) Expected expiration date of patent or registration
- (21) Serial number of application
- (22) Date of filing of the application
- (23) Date of exhibition or the date of the earlier filing and the number of application, if any
- (24) Date from which patent may have effect
- (28) Number of designs included in the application
- (30) Data relating to priority (number of application, date of filing of application, two-letter code identifying the authority with whom the priority application was made)
- (31) Number of priority application
- (32) Date of filing of priority application
- (33) Code of the country or regional organization allotting priority application number
- (34) Two-letter code according to WIPO St.3 identifying the authority with which the priority application was made
- (44) Date of publication of design and number of bulletin (the first publication)
- (45) Date of publication of design registered by WIPO and number of bulletin
- (51) International Classification for designs (class and subclass of the Locarno Classification)
- (54) Title of the invention
- (55) Reproduction of the design
- (57) Description of characteristic features of the design including indication of colors
- (58) Date of recording of any kind of amendment in the Register
- (62) Number of the earlier application, registration and document number and if available the date of filing an application in case of divided application
- (71) Name, surname and address of applicant (country code)
- (72) Name, surname of creator (country code)
- (73) Name, surname and address of patent owner (country code)
- (74) Name, surname of representative or patent attorney
- (81) Contracting states concerned
 - II designated contracting states according to the 1960 Act
 - III designated contracting states according to the 1999 Act
- (85) Owner's permanent address
- (86) Owner's nationality
- (87) Owner's residence
- (88) State in which the owner has a real and effective industrial or commercial establishment

TRADEMARKS

- (111) – Number of registration
- (151) – Date of registration
- (156) – Date of the renewal
- (181) – Expected expiration date of registration
- (186) – Renewal expiration date of registration
- (141) – Date of cancel of duration of the mark
- (210) – Serial number of application
- (220) – Date of filing of the application
- (230) – Date concerning exhibition
- (260) – Number of application, for which favorable decision of examination about registration has been taken (publication number)
- (310) – Number of the first application
- (320) – Date of filing of the first application
- (330) – Code, identifying national or regional Office where the first application was made
- (511) – International Classification of Goods and Services for the purposes of registration of trade marks and/or list of goods and/or services classified according thereto
- (531) – Description of figurative elements of Trade Marks according to the International Classification of the Figurative Elements of Marks
- (540) – Reproduction of Trade Mark
- (550) – Nature and kind of Trade Mark
- (580) – Date of recording of any kind changes in respect of applications or registrations
- (591) – Information concerning colors claimed
- (731) – Name and address of the applicant
- (732) – Name and address of the holder of the registration
- (740) – Name and address of the representative
- (750) – Address for correspondence
- (770) – Name and address of the previous applicant or holder in case of change in ownership
- (771) – Previous name and address of the applicant or holder in case of change in ownership
- (791) – Name and address of the licensee
- (793) – Indication of conditions and/or restrictions under the license (Type of license, number of license agreement, data of license, data of validity of license)
- (800) – Certain data relating to the international registration of Trade Marks under the Protocol Relating to Madrid Agreement (International registration number)

CODES FOR PUBLICATION IN BULLETIN

- (21) AP 0000 000000 – serial number of application for invention
- (10) AP 0000 0000 A – number of published application for invention (first publication)
- (11) P 0000 0000 B – number of patent for invention (second publication)
- (21) API 0000 000000 – number of application for imported patent
- (11) PI 0000 0000 A – number of imported patent (first publication)
- (21) AU 0000 000000 – serial number of application for utility model
- (10) AU 0000 000 U – number of published application for utility model (first publication)
- (11) U 0000 000 Y – number of patent for utility model (second publication)
- (21) AD 0000 000000 – serial number of application for design
- (10) AD 0000 000 S – number of published application for design (first publication)
- (11) D 0000 000 S – number of patent for design (second publication)

INTERNATIONAL PATENT CLASSIFICATION FOR INVENTIONS AND UTILITY MODELS

- SECTION A – HUMAN NECESSITIES
- SECTION B – PERFORMING OPERATIONS; TRANSPORTING
- SECTION C – CHEMISTRY; METALLURGY
- SECTION D – TEXTILES; PAPER
- SECTION E – FIXED CONSTRUCTIONS
- SECTION F – MECHANICAL ENGINEERING; LIGHTING; HEATING; WEAPONS; BLASTING
- SECTION G – PHYSICS
- SECTION H – ELECTRICITY

-
- M – Trade Mark
 - (210) AM 0000 000000 – Serial number of application;
 - (260) AAM 0000 00000 A – Publication number of application;
 - (111) M 0000 00000 R – Number of registration;
 - (111) MMM0000 00000 Rn – Number of renewals, in which n=1,2,3;
 - (111) M 0000 00000 R(P) – Number of registration under partial assignment of rights
-

**OFFICIAL BULLETIN
OF THE INDUSTRIAL PROPERTY**

16(524)

**INVENTIONS
UTILITY MODELS
DESIGNS
TRADEMARKS**

DATE OF PUBLICATION: 2019 08 26

CONTENTS

PUBLISHED TITLES OF PROTECTION	3
INVENTIONS	
▪ APPLICATIONS APPROVED FOR GRANTING PATENTS	4
▪ PATENTED INVENTIONS	6
UTILITY MODELS	
▪ APPLICATIONS APPROVED FOR GRANTING PATENTS	7
▪ PATENTED UTILITY MODEL	8
DESIGNS	
▪ DESIGNS, WHICH HAVE BEEN REGISTERED WITH THE INTERNATIONAL BUREAU CLAIMING PRIORITY ON THE TERRITORY OF GEORGIA	9
TRADEMARKS	
▪ APPLICATIONS FILED UNDER THE NATIONAL PROCEDURE APPROVED FOR REGISTRATION	27
▪ REGISTERED TRADEMARKS	37
▪ TRADEMARKS REGISTERED ACCORDING TO THE ACCELERATED PROCEDURE	46
▪ INTERNATIONAL TRADEMARKS FOR WHICH A DECISION ON GRANTING PROTECTION IS TAKEN	47
▪ INTERNATIONAL TRADEMARKS PROTECTED IN GEORGIA	94
OFFICIAL NOTIFICATIONS	
INVENTION	
▪ ISSUING ADDITIONAL CERTIFICATE OF PROTECTION	101
▪ CORRECTION OF PUBLISHED INFORMATION	101
TRADEMARKS	
▪ RENEWAL OF REGISTRATIONS	102
▪ CHANGES OF NAMES AND/OR ADDRESSES OF OWNERS	104
▪ TERMINATION OF TRADEMARKS REGISTRATION	106
CLASSIFICATION INDEXES	
INVENTIONS	108
UTILITY MODELS	109
TRADEMARKS	111

PUBLISHED TITLES OF PROTECTION

INVENTIONS

- **APPLICATIONS APPROVED FOR GRANTING PATENTS:**
14100; 14618; 14214
- **PATENTED INVENTIONS:**
7013-7016

UTILITY MODELS

- **APPLICATIONS APPROVED FOR GRANTING PATENTS:**
14468; 15003; 14928
- **PATENTED UTILITY MODEL:**
2017

DESIGNS

- **DESIGNS WHICH HAVE BEEN REGISTERED WITH THE INTERNATIONAL BUREAU CLAIMING PRIORITY ON THE TERRITORY OF GEORGIA:**
201469; 200537; 201476; 201511; 200546; 200135; 200536; 200543; 201514

TRADEMARKS

- **APPLICATIONS FILED UNDER THE NATIONAL PROCEDURE APPROVED FOR REGISTRATION:**
98682; 99063; 99326; 99524, 99525; 99527; 100434; 100814; 100816; 100859-100864; 100897; 100899; 100905; 100907; 100921-100924; 101215; 101230; 101234, 101235; 101237, 101238; 101240; 101243-101249; 101253; 101255; 101257, 101258; 101286-101288; 101294; 101297-101300; 101304; 101306; 101371; 101374-101376; 101382; 101393-101395; 101414; 101422; 101492; 101507; 101511; 101513; 101524; 101600; 101604; 101679
- **REGISTERED TRADEMARKS:**
31549-31608; 31613-31635
- **TRADEMARKS REGISTERED ACCORDING TO THE ACCELERATED PROCEDURE:**
31548; 31609-31612
- **INTERNATIONAL TRADEMARKS FOR WHICH A DECISION ON GRANTING PROTECTIONS IS TAKEN:**
95729*; 96849*; 97147*; 98333*; 98335*; 98626*; 99281; 99738; 99812, 99813; 100107; 100117; 100143; 100146; 100173, 100174; 100178-100181; 100242; 100245, 100246; 100248; 100250, 100251; 100257, 100258; 100261; 100263-100265; 100267; 100269; 100271, 100272; 100277; 100281; 100283-100287; 100289; 100291-100293; 100296-100299; 100301-100304; 100362-100365; 100367; 100470-100474, 100475; 100482; 100504; 100507, 100508; 100510-100513; 100539-100544; 100560-100563; 100634, 100635; 100646; 100649, 100650; 100656; 101045, 101046; 101049, 101050; 101052, 101053
- **INTERNATIONAL TRADEMARKS PROTECTED IN GEORGIA:**
95251; 97576; 97916; 98135; 98463, 98464; 98466, 98467; 98496; 98502; 98504; 98507; 98509-98511; 98514-98522; 98526-98528; 98531; 98533-98538; 98540; 98542, 98543; 98622-98625; 98628-98633; 98700; 98705; 98707, 98708; 98711; 98715; 98717; 98719-98722; 98724-98726; 98728-98732; 98734; 98750; 98753, 98754; 98834-98836; 98913, 98914; 98922-98927; 98929-98932; 98934-98937; 98939-98941; 99098; 99217; 99536

INVENTIONS

APPLICATIONS APPROVED FOR GRANTING PATENTS

The decision can be appealed at the Chamber of Appeal of Sakpatenti within 3 months from the publication or at the Mtskheta District Court Administrative Cases Board (Address: №17, Samkhedro str., Mtskheta), within 1 month following the publication.

PART A

A 61

- (10) AP 2019 14100 A (51) Int. Cl. (2006)
A 61 K 39/395
C 07 K 16/28
C 07 K 17/14
- (21) AP 2014 14100 (22) 2014 08 20
(31) 61/990,475; 13198784; 61/907,749;
61/869,510
(32) 2014 05 08; 2013 12 20; 2013 11 22;
2013 08 23
(33) US; EP; US; US
(71) MACROGENICS INC. (US)
9640 Medical Center Drive Rockville,
MD 20850 (US)
(72) BONVINI, Ezio (US);
JOHNSON, Leslie, S. (US);
HUANG, Ling (US);
MOORE, Paul, A (US);
CHICHILI, Gurunadh, Reddy (US);
ALDERSON, Ralph, Froman (US)
(74) Tamaz Shilakadze
(85) 2016 03 22
(86) PCT/US2014/051790, 2014 08 20
(54) **BI-SPECIFIC MONOVALENT
DIABODIES THAT ARE CAPABLE OF
BINDING CD123 AND CD3, AND USES
THEROF**
(57) Present invention relates to sequence-
optimized CD 123 x CD3 bi-specific antibodies
used for the treatment of hematologic malignancies.
Claims: 8 independent
18 dependent
Fig.: 37
-

PART B

B 22

- (10) AP 2019 14618 A (51) Int. Cl. (2006)
B 22 F 1/00
B 22 F 7/02
B 22 F 7/00
B 22 F 3/23
B 22 F 3/2
C 22 C 14/00
C 22 C 1/04
C 22 C 1/00
C 22 C 38/14
C 22 C 29/14
- (21) AP 2017 14618 (22) 2017 10 27
(71) Zurab Aslamazashvili (GE)
Davit Tavkheldzis q. 1, sad. 3, sart. 4, b. 58,
0186, Tbilisi (GE);
Giorgi Oniashvili (GE)
Bazaletis q. 7, b. 6, 0179, Tbilisi (GE);
Geregin Zakharov (GE)
Ertsov q. 11, b. 9, 0192, Tbilisi (GE);
Giorgi Tavadze (GE)
D. Uznadzis 4, b. 77, 0102, Tbilisi (GE);
Alex Berner (IL)
32682, Haifa, Mitspe St. 8, Israel (IL)
(72) Zurab Aslamazashvili (GE);
Giorgi Oniashvili (GE);
Geregin Zakharov (GE);
Giorgi Tavadze (GE);
Alex Berner (IL)
(54) **METHOD FOR PRODUCTION OF
GRADIENT MATERIAL RESISTANT
TO DYNAMIC LOAD OF HIGH
INTENSITY WITH METHOD OF SELF-
PROPAGATING HIGH-TEMPERATURE
SYNTHESIS IN TI-B-N-C-ME AND
TI-CR-C-ME SYSTEMS**
(57) Material consists of two or more layers,
wherefrom at least one is executed with ceramic or
cermet material; at that, received gradient material
shall meet the conditions: strength engaging of
layers to each other shall be no less than ceramic or
cermet layer werewith consists gradient material
resistance, those layers include minimum one same
or similar phases, and inert metallic layer werewith
consists gradient material shall meet following
conditions: composition thereof shall be choisen so

that angle of moisture situated directly in the engagement with ceramic, cermet material shall be no more than 90^0 and at the same time it wouldn't create fragile, easily crushing chemical compounds of low resistance or composition similar to metallic compositions with consist furnaces of ceramic, cermet layers or similar composition of metallic binders; or it shall meet following condition: at gradient material production the synthesis parameters with consist exothermal layers, particularly the speeds of synthesis shall be equal or the layers include minimum one same or similar phases and at the same time the speeds of exothermal layers synthesis shall be equal.

Claims: 1 independent

2 dependent

Fig.: 7

PART C

C 05

(10) AP 2019 14214 A (51) Int. Cl. (2006)

C 05 G 3/04

C 05 G 3/06

C 05 D 9/02

(21) AP 2014 14214 (22) 2014 12 22

(31) P13 00753

(32) 2013 12 23

(33) HU

(71) INVENTION CENTER KFT. (HU)

Lipthay u.9. H-1027 Budapest (HU)

(72) VATTAY, Antal (HU);

VATTAY, Rikárd (HU);

POSTA, Katalin Andrea (HU);

PÓTI, Péter (HU);

VARGA, Imre (HU);

ZÁRAY, Gyula (HU);

LÓCZI, Miklós (HU);

SZUROP, Gábor Miklós (HU)

(74) Tamaz Shilakadze

(85) 2016 07 20

(86) PCT/HU2014/000129, 2014 12 22

(54) **IRON (III) OXIDE CONTAINING**

SOIL-BINDING COMPOSITION

(57) The invention relates to compositions for retaining soil moisture and improving plant growth in dry soils, which together with one or more moisture retaining materials and wetting agents comprises iron(III)oxides with microparticles of no more than 50 mkm, and not necessarily potassium metabisulfite. Other aspects of the invention relate to binding the moisture content of soils.

Claims: 3 independent

6 dependent

Fig.: 17

PATENTED INVENTIONS

PART A

A 43

- (11) P 2019 7015 B (51) Int. Cl. (2006)
A 43 B 7/12
A 43 B 23/02
A 43 B 23/07
A 43 B 7/08
- (10) AP 2019 14375 A (44) 7(515)/2019
(21) AP 2015 14375
(22) 2015 06 17
(24) 2015 06 17
(31) PD2014A000148
(32) 2014 06 17
(33) IT
(86) PCT/EP2015/063623, 2015 06 17
(73) GEOX S.P.A. (IT)
Via Feltrina Centro 16 I-31044 Montebelluna,
Frazione Biadene (IT)
(72) POLEGATO MORETTI, Mario (IT);
POLONI, Livio (IT)
(74) Aleksandre Gegechkori
(54) **VENTILATED SHOE**

A 61

- (11) P 2019 7016 B (51) Int. Cl. (2006)
A 61 K 31/5377
A 61 P 35/00
C 07 D 495/04
- (10) AP 2019 14539 A (44) 6(514)/2019
(21) AP 2014 14539
(22) 2014 12 11
(24) 2014 12 11
(86) PCT/IN2014/000770, 2014 12 11
(73) NATCO PHARMA LIMITED (IN)
Natco House, Road No:2, Banjara Hills,
Telangana, India Hyderabad 500034 (IN)
(72) NANNAPANENI, Venkaiah Chowdary (IN);
ADIBHATLA, Kali Satya Bhujanga Rao (IN);
MUDDASANI, Pulla Reddy (IN);
THOOTA, Sandeep Kumar (IN);
KONDURI, Srinivasa Krishna Murthy (IN);
PILLI, Rama Krishna (IN);
VUPPALAPATI, Naga Vasanta Srinivas (IN);
RAVI, Janaki Rama Rao (IN);
KONAKANCHI, Durga Prasad (IN);
PULA, Subba Rao (IN);
MADDULA, Lakshmana Viswa Venkata
Pavan Kumar (IN)
(74) Tamar Kochlamazashvili
(54) **7-(MORPHOLINYL)-2-(N-PIPERAZINYL)
METHYL THIENO [2, 3-C] PYRIDINE**

DERIVATIVES AS ANTICANCER DRUGS

PART B

B 02

- (11) P 2019 7014 B (51) Int. Cl. (2006)
B 02 C 18/30
- (10) AP 2019 14434 A (44) 3(511)/2019
(21) AP 2017 14434
(22) 2017 02 27
(24) 2017 02 27
(73) Tengiz Chkhaidze (GE)
Tashkentis q., shes. 4, b. 6, 0160,
Tbilisi (GE);
Revaz Varsimashvili (GE)
Vazha-Pshavelas V kvart., korp. 4, b. 82,
0186, Tbilisi (GE);
Nino Chkhaidze (GE)
Tashkentis q., shes. 4, b. 6, 0160,
Tbilisi (GE)
(71) Tengiz Chkhaidze (GE);
Revaz Varsimashvili (GE);
Nino Chkhaidze (GE)
(54) **DEVICE FOR BREAKING PRODUCTS**

B 67

- (11) P 2019 7013 B (51) Int. Cl. (2006)
B 67 D 7/04
G 06 Q 10/08
G 06 Q 50/28
- (10) AP 2019 14558 A (44) 7(515)/2019
(21) AP 2015 14558
(22) 2015 12 31
(24) 2015 12 31
(31) 2015/00108
(32) 2015 01 06
(33) TR
(86) PCT/TR2015/000396, 2015 12 31
(73) MEGA INDUSTRI KONTROL
SISTEMLERI TIC. LTD STI. (TR)
Yasamkent Mah. 3207 Cad. 3204 Sok. No: 8
Cayyolu Ankara (TR)
(72) SAHINER, Bulent (TR)
(74) Khatuna Imnadze
(54) **ELECTRONIC SYSTEM FOR PRODUCT
IDENTIFICATION AND FILLING
MANAGEMENT**

UTILITY MODELS

APPLICATIONS APPROVED FOR GRANTING PATENT

The decision can be appealed at the Chamber of Appeal of Sakpatenti within 3 months from the publication or at the Mtskheta District Court Administrative Cases Board (Address: №17, Samkhedro str., Mtskheta), within 1 month following the publication.

PART A

A 61

(10) AU 2019 14468 U (51) Int. Cl. (2006)
A 61 H 15/00

(21) AU 2017 14468 (22) 2017 04 05
(71) Nino Kapanadze (GE)
Darialis shes. 12, 0162, Tbilisi, Georgia (GE);
Lamzira Todua (GE)
Radianis q. 17, 0179, Tbilisi, Georgia (GE);
Tinatin Shatilova (GE)
Romis q. 4, 0102, Tbilisi, Georgia (GE);
Giorgi Shukakidze (GE)
Kipshidzis q. 6, b. 60, 0162, Tbilisi,
Georgia (GE)

(72) Nino Kapanadze (GE);
Lamzira Todua (GE);
Tinatin Shatilova (GE);
Giorgi Shukakidze (GE)

(54) **MECHANICAL MASSAGER FOR EYES**
(57) Mechanical massager for eyes includes wood handle 4 and polished rotating massaging component 1 installed on the axis 2; at that, massaging component is barrel-shaped and made of brass (yellow metal).

Claims: 1 independent
Fig.: 3

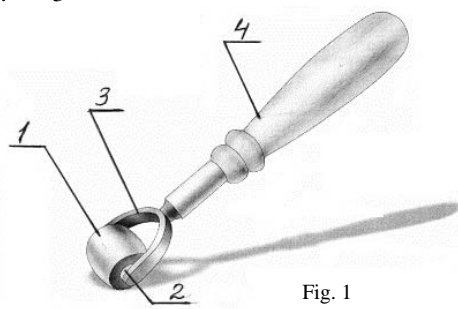

Fig. 1

(10) AU 2019 15003 U (51) Int. Cl. (2006)
A 61 K 9/06
A 61 K 35/57
A 61 K 36/00

(21) AU 2019 15003 (22) 2019 02 14
(71) Bezhan Khabeishvili (GE)
Sop. Dablatsikhe, 4907, Chokhatauri r-ni, Georgia (GE)

(72) Bezhan Khabeishvili (GE)

(54) **OINTMENT KHABEISHVILI**
"SALBUNI" – OINTMENT FOR SKIN
PATHOLOGY, OSTEOARTICULAR
AND SEX SYSTEMS AND
HEMORRHOID

(57) An ointment contains Circassian walnut oil, camphor oil, sea-buckthorn oil, camphor spirit, goat's fat, olive oil, maize oil, and beeswax.

Claims: 1 independent

Fig.: 1

(10) AU 2019 14928 U (51) Int. Cl. (2006)
A 61 P 5/48

(21) AU 2018 14928 (22) 2018 11 20
(71) Marine Nikolaishvili (GE)
Shevardzenidzis q. 9, b. 13, 0160, Tbilisi,
Georgia (GE);
Tea Museliani (GE)
Kostavas q. 1, Lentekhis r-ni, Georgia (GE);
Elene Giorgadze (GE)
D. Aghmasheneblis gamz. 181, b. 17,
Tbilisi, Georgia (GE);
Natia Chkheidze (GE)
Chikovani q. 85b, Tbilisi, Georgia (GE)

(72) Marine Nikolaishvili (GE)

(54) **THERAPEUTIC AGENT FOR TYPE II**
DIABETES

(57) Mineral water "Tskaltubo" is used for inhalation at the treatment of type II (pancreatic) diabetes.

Claims: 1 independent

Fig.: 1

PATENTED UTILITY MODEL

PART G

G 08

(11) U 2019 2017 Y (51) Int. Cl. (2006)
G 08 B 21/10
G 08 B 31/00

(10) AU 2019 14838 U (44) 8(516)/2019

(21) AU 2018 14838

(22) 2018 07 19

(24) 2018 07 19

(73) Tengiz Kiria (GE)

Al. Kazbegis gamz. 31, b. 3, 0160,

Tbilisi, Georgia (GE);

Tamaz Tchelidze (GE)

Mitskevichis q. 5, b. 6, 0194, Tbilisi,

Georgia (GE);

Nugzar Ghlonti (GE)

Nutsubidzis q. 77b, b. 71, 0177, Tbilisi,

Georgia (GE);

Zurab Tchelidze (GE)

M. Aleksidzis q. 1, korp. 6, b. 10, 0193,

Tbilisi, Georgia (GE);

Nodar Varamashvili (GE)

Titsian Tabidzis q. 66, 0179, Tbilisi,

Georgia (GE);

Jemal Kiria (GE)

Nutsubidzis q. 77b, b. 37, 0177, Tbilisi,

Georgia (GE)

(72) Tengiz Kiria (GE);

Tamaz Tchelidze (GE);

Nugzar Ghlonti (GE);

Zurab Tchelidze (GE);

Nodar Varamashvili (GE);

Jemal Kiria (GE)

(54) **TELEMETRIC MONITORING
SYSTEM OF DISEASES AND EARLY
WARNINGS**

DESIGNS

DESIGNS, WHICH HAVE BEEN REGISTERED WITH THE INTERNATIONAL BUREAU CLAIMING PRIORITY ON THE TERRITORY OF GEORGIA

The decision can be appealed at the Chamber of Appeal of Sakpatenti within 3 months from the publication or at the Mtskheta District Court Administrative Cases Board (Address: №17, Samkhedro Str., Mtskheta), within 1 month following the publication.

(11) **DM/201 469**

(15) 2019 03 28

(22) 2019 03 28

(28) 2

(73) Valentino S.p.A.

Via Turati, 16/18, 20121 MILANO (IT)

(85) –

(86) IT, EM

(87) IT, EM

(88) IT, EM

(89) EM

(81) III. GE, TR, KG, UA, AZ, EM, KR, JP, TJ, RU

(72) Stefano SASSI

C/o VALENTINO S.p.A. Via Turati, 16/18, 20121 Milano (IT)

(74) Matteo MOZZI

C/o Jacobacci & Partners S.p.A. Via Senato, 8, 20121 MILANO (IT)

(54) 1.-2. Bag

(55)

(51) **03-01**

(44) 25/2019 (2019 06 21)



1.1



1.2



1.3

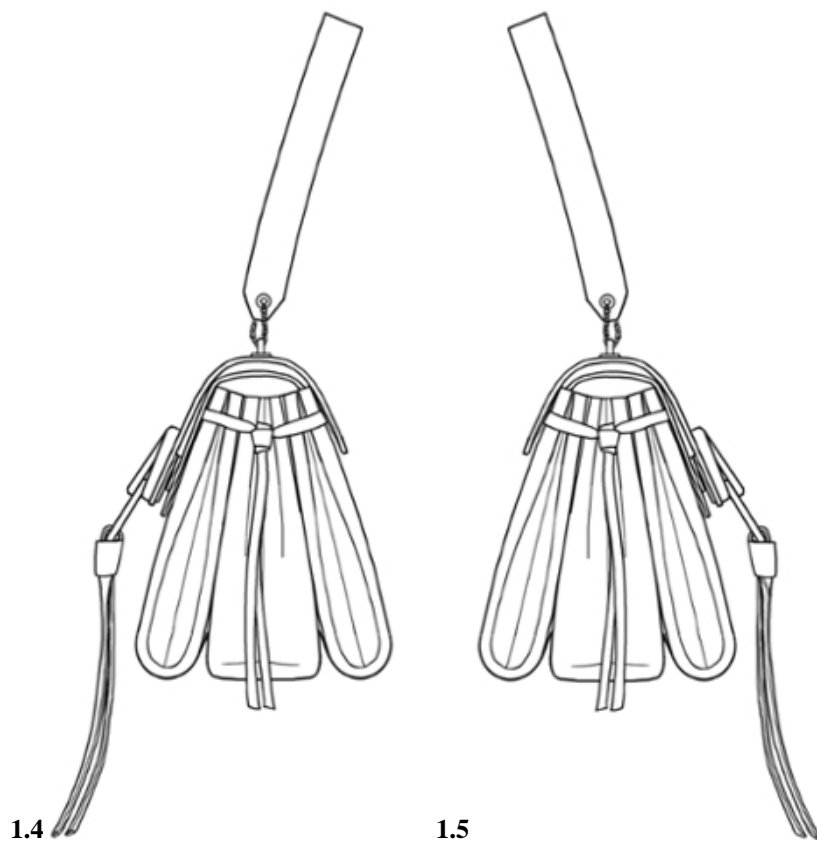

1.4

1.5

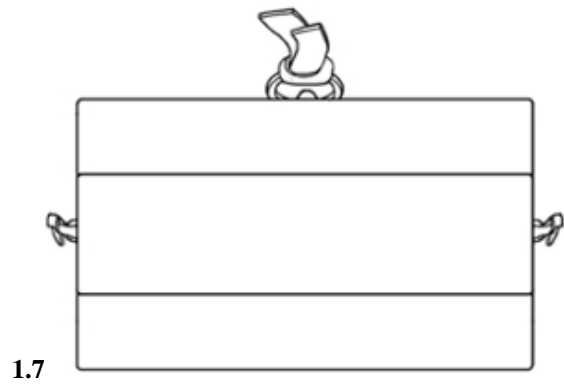
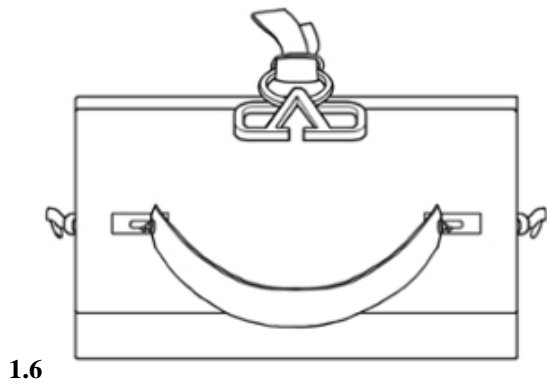



2.3

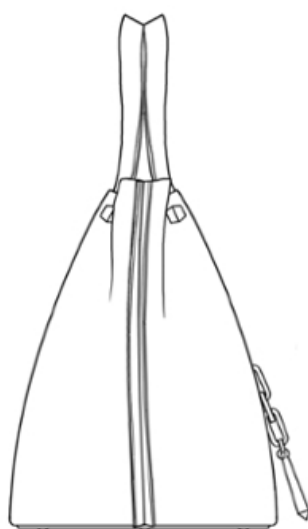

2.4

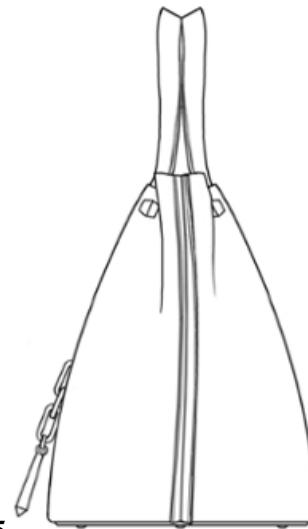

2.5

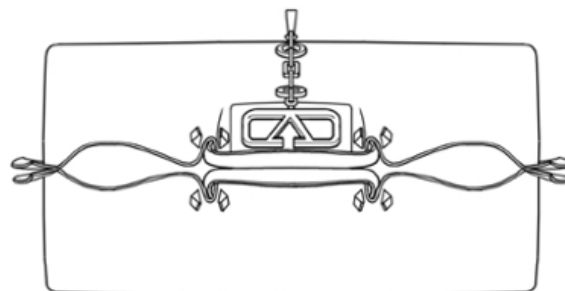

2.6

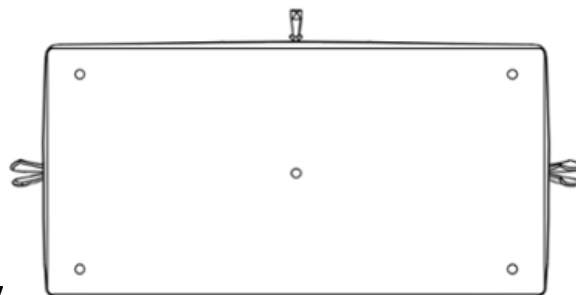

2.7

(11) DM/200 537**(51) 10-02**

(15) 2018 12 14

(44) 25/2019 (2019 06 21)

(22) 2018 12 14

(28) 1

(73) OMEGA SA (OMEGA AG) (OMEGA LTD.)

Jakob-Stämpfli-Strasse 96, 2502 BIEL/BIENNE (CH)

(85) CH

(86) CH

(87) CH

(88) CH

(89) CH

(81) II. BZ, MA III. UA, AM, AL, AZ, ME, MD, MC, SG, MN, NO, BA, GE, TR, OM, MK, LI, KG, GB, TN, EM, CH

(72) Jean-Claude Monachon

Rue Alice-de-Chambrier 1, 2022 Bevaix (CH)

(74) The Swatch Group AG (The Swatch Group SA) (The Swatch Group Ltd.)

6, Faubourg Du Lac, 2501 BIEL/BIENNE (CH)

(54) 1. Watch

(55)

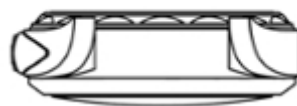
1.1**1.2****1.3****1.4****1.5****1.6****1.7****1.8**

(11) DM/201 476

(15) 2018 09 04

(22) 2018 09 04

(28) 5

(85) –

(86) –

(87) –

(88) US

(89) US

(81) III. AM, IS, MD, TJ, BW, MN, GH, ST, TR, KH, GB, TN, KR, JP, KP, CH, BN, UA, AL, AZ, TM, ME, MC, SG, NA, OA, RS, NO, BA, MK, GE, OM, US, LI, KG, EM, SY, RW, RU, EG

(72) Yi-Ting Huang

2F., No. 9, Ln. 27, Xinxing Rd., 302 Zhubei City (CN);

Feng-Shuen Huang

11F., No. 166 Wanda Rd., Yangmei Dist., 326 Taoyuan City (CN)

(74) Elizabeth L. Neal

13845 Bishop's Dr, Suite 300, 53005 Brookfield, WI (US)

(54) 1.-5. Graphical user interface for a display screen or portion thereof

(55)

(51) 14-04

(44) 25/2019 (2019 06 21)

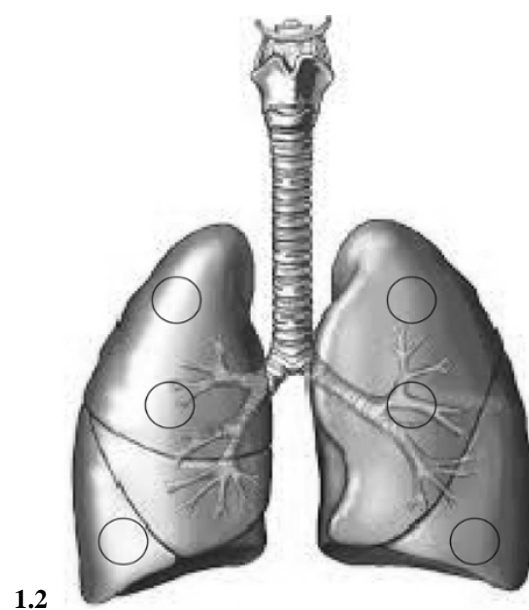
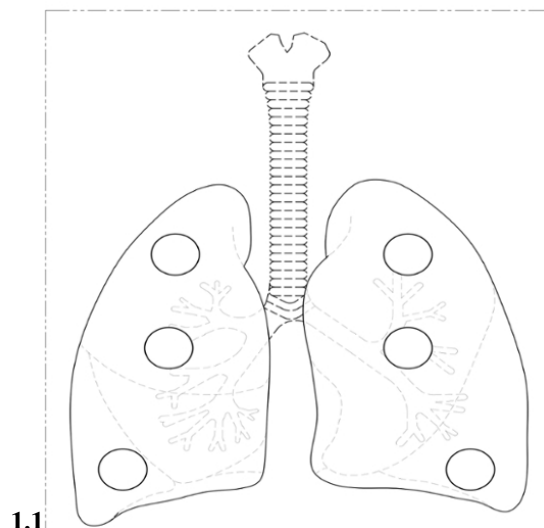

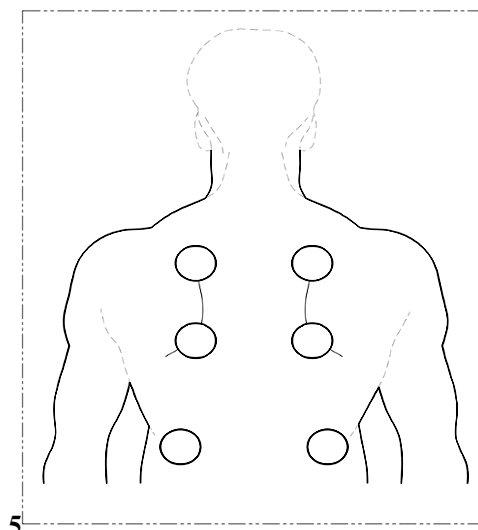
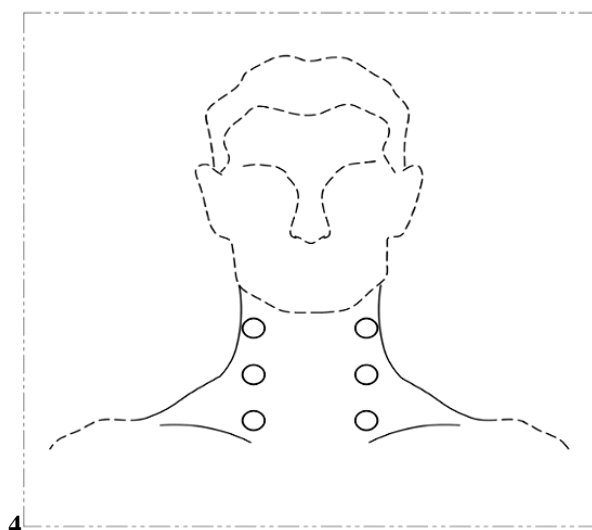
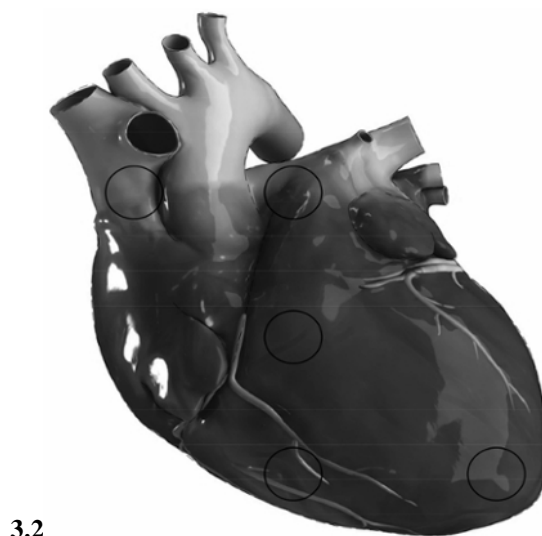
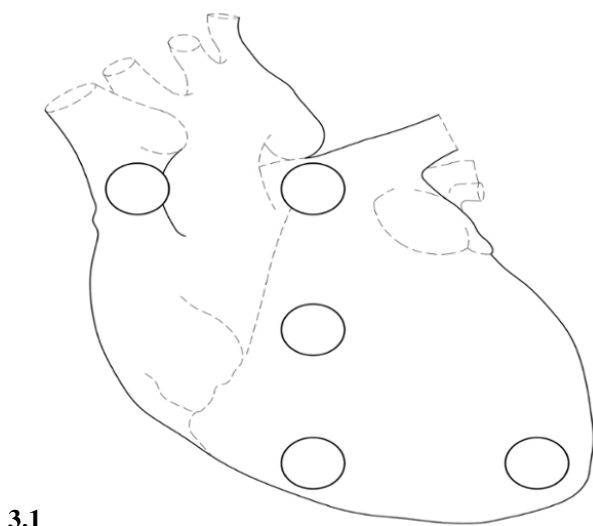
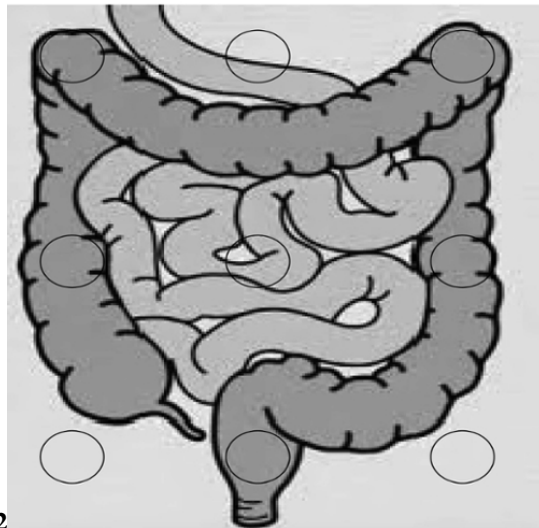
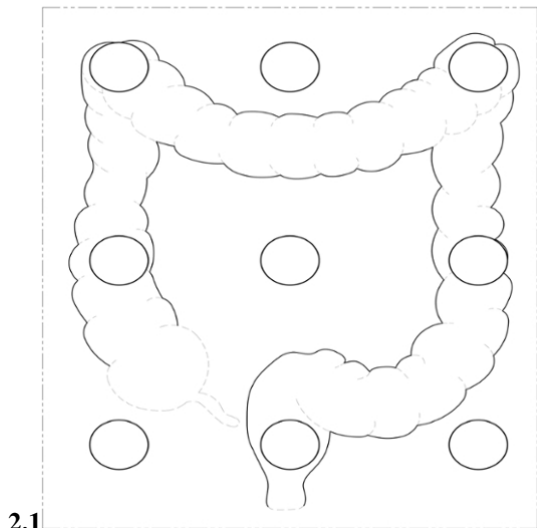

(11) DM/201 511

(15) 2019 03 22

(22) 2019 03 22

(28) 1

(30) No1: 29.10.2018; 005812062-0001; EM

(73) SAVERGLASS

3, Rue De La Gare, 60960 FEUQUIERES (FR)

(85) FR

(86) FR

(87) FR

(88) FR

(89) FR

(81) III. NO, GE, TR, UA, AM, GB, KR, MC, JP, CH, SG

(74) NOVAGRAAF FRANCE

2, Rue Sarah Bernhardt, CS 90017, 92665 ASNIERES-SUR-SEINE (FR)

(54) 1. Bottle

(55)

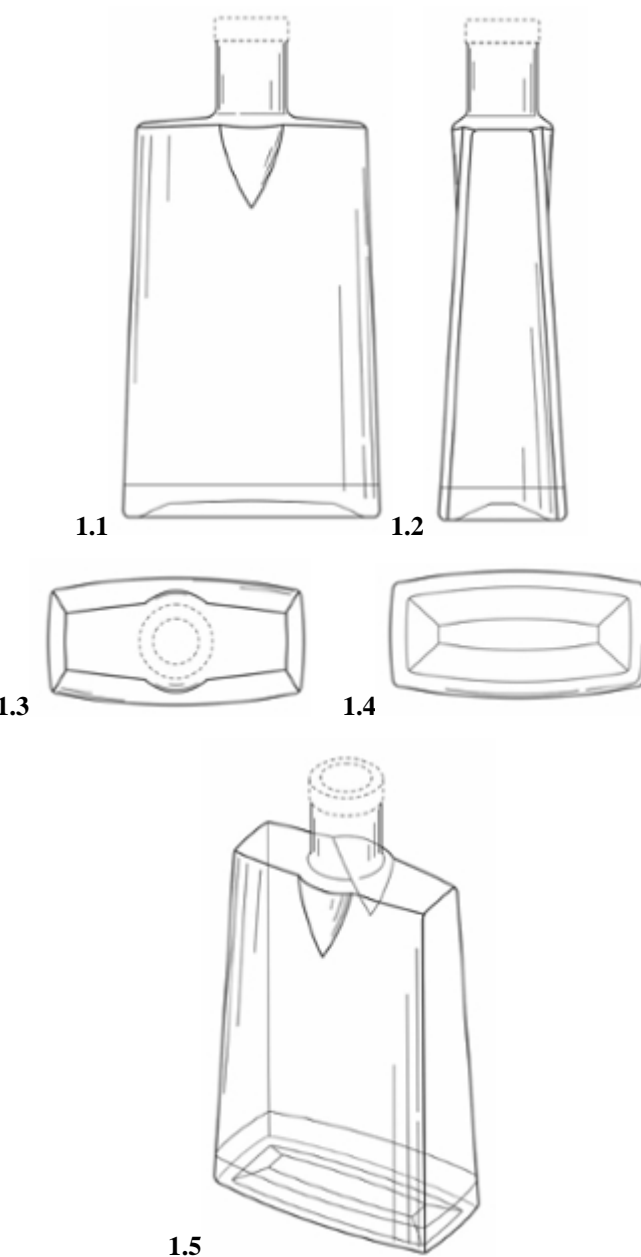

(11) DM/200 546**(51) 10-02**

(15) 2018 12 21

(44) 26/2019 (2019 06 28)

(22) 2018 12 21

(28) 6

(73) Hamilton International AG (Hamilton International SA) (Hamilton International Ltd)
Mattenstrasse 149, 2503 Biel/Bienne (CH)

(85) CH

(86) CH

(87) CH

(88) CH

(89) CH

(81) II. BZ, MA III. AM, UA, AL, AZ, ME, MD, MC, SG, NO, MN, BA, OM, TR, MK, GE, LI, KG, GB,
TN, EM, JP, CH

(72) 1 Fabrice DUPORT

4, Avenue De La Gare, 2000 Neuchâtel (CH);

2-5 Julien Luc BERNARD

C/o Super 150 Route Du Château 18, 2520 La Neuveville (CH);

6 Sébastien PERRET

Route De Neuchâtel 5, 2019 Rochefort (CH);

6 Arnaud BIJU-DUVAL

Avenue De Alpes 20, 2000 Neuchâtel (CH)

(74) The Swatch Group AG (The Swatch Group SA) (The Swatch Group Ltd.)

6, Faubourg Du Lac, Biel/Bienne 2501 (CH)

(54) 1. dial, 2. watch, 3.-6. dial

(55)



1.1



1.2



2.1



2.2



2.3



2.4



2.5



3.1



3.2



4.1

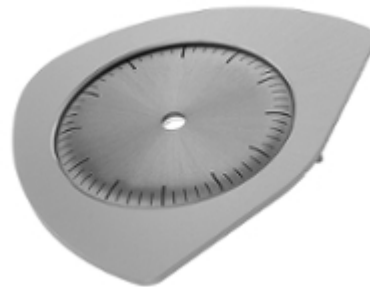

4.2

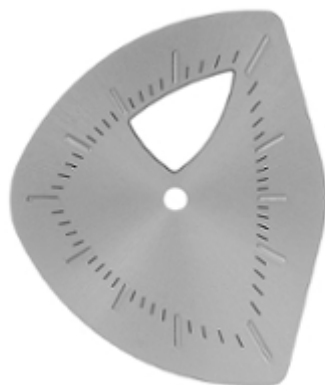

5.1



5.2



6.1



6.2

(11) DM/200 135

(15) 2018 12 21

(22) 2018 12 21

(28) 2

(73) MONTRES JAQUET DROZ SA (Montres Jaquet Droz AG) (Montres Jaquet Droz Ltd.)

Allée Du Tourbillon 2, 2300 La Chaux-de-Fonds (CH)

(85) CH

(86) CH

(87) CH

(88) CH

(89) CH

(81) IL, BZ, MA III, UA, AM, AL, AZ, ME, MD, MC, SG, MN, NO, BA, OM, MK, GE, TR, LI, KG, GB, TN, EM, CH

(72) Christian Lattmann

Chemin Du Château-Neuf 17, 1125 Monnaz (CH);

Yann Leiggener

Rue Du Nord 47, 2300 La Chaux-de-Fonds (CH)

(74) The Swatch Group AG (The Swatch Group SA) (The Swatch Group Ltd.)

Faubourg Du Lac 6, 2501 BIEL/BIENNE (CH)

(54) 1.-2. Dial

(55)

(51) 10-07

(44) 26/2019 (2019 06 28)

1.1



1.2

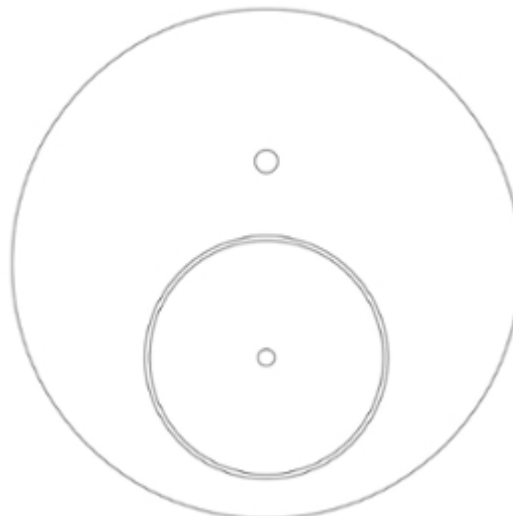

1.3

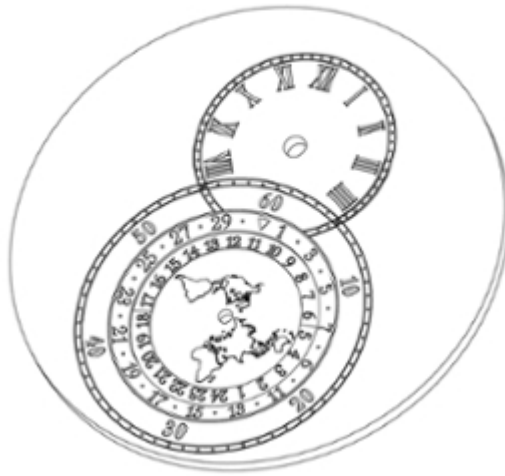

2.1



2.2



2.3



- (11) **DM/200 536** (51) **10-07**
(15) 2018 12 14 (44) 26/2019 (2019 06 28)
(22) 2018 12 14
(28) 1
(73) MONTRES JAUQUET DROZ SA (Montres Jaquet Droz AG) (Montres Jaquet Droz Ltd.)
Allée Du Tourbillon 2, 2300 La Chaux-de-Fonds (CH)
(85) CH
(86) CH
(87) CH
(88) CH
(89) CH
(81) II. BZ, MA III. AM, UA, AL, AZ, ME, MD, MC, SG, NO, MN, BA, GE, OM, TR, MK, LI, KG, GB,
TN, EM, CH
(72) Perrolle Simon
Rue Du Mont D'Amin 7, 2300 La Chaux-de-Fonds (CH);
Leiggener Yann
Rue Du Nord 47, 2300 La Chaux-de-Fonds (CH);
Lattmann Christian
Chemin De Château-Neuf 17, 1125 Monnaz (CH)
(74) The Swatch Group AG (The Swatch Group SA) (The Swatch Group Ltd.)
Faubourg Du Lac 6, 2501 BIEL/BIENNE (CH)
(54) 1. Watch dial
(55)

1



(11) DM/200 543

(15) 2018 12 14

(22) 2018 12 14

(28) 4

(73) MONTRES JAQUET DROZ SA (Montres Jaquet Droz AG) (Montres Jaquet Droz Ltd.)

Allée Du Tourbillon 2, 2300 La Chaux-de-Fonds (CH)

(85) CH

(86) CH

(87) CH

(88) CH

(89) CH

(81) II. BZ, MA III. UA, AM, AL, AZ, ME, MD, MC, SG, NO, MN, BA, TR, GE, MK, OM, LI, KG, GB, TN, EM, CH

(72) 1-4 Christian Lattmann

Chemin Du Château-Neuf 17, 1125 Monnaz (CH);

1-2 Simon Perrolle

Rue Du Mont D'Amin 7, 2300 La Chaux-de-Fonds (CH);

1-4 Yann Leiggener

Rue Du Nord 47, 2300 La Chaux-de-Fonds (CH)

(74) The Swatch Group AG (The Swatch Group SA) (The Swatch Group Ltd.)

Faubourg Du Lac 6, 2501 BIEL/BIENNE (CH)

(54) 1. Dial, 2. Oscillating weight, 3. Dial , 4. Dial

(55)

(51) 10-07

(44) 26/2019 (2019 06 28)

1.1



1.2

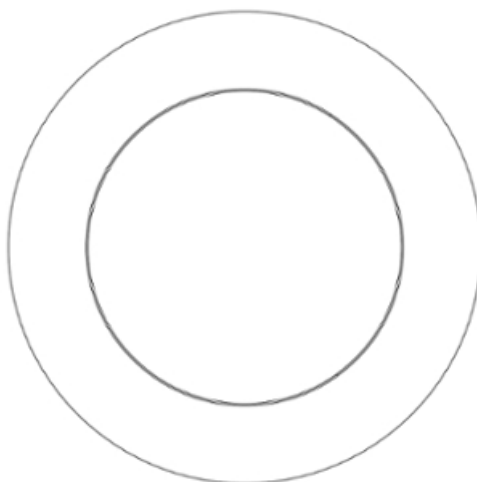

2.1



2.2

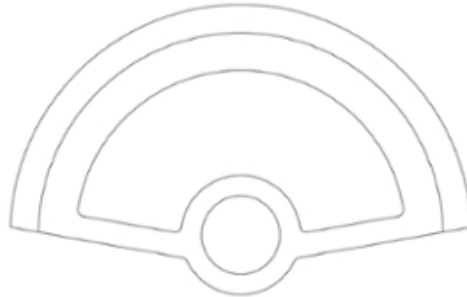

2.3



3.1

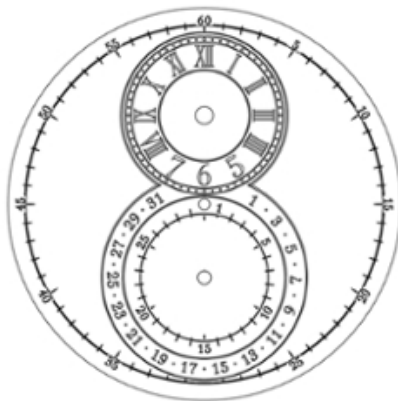

3.2

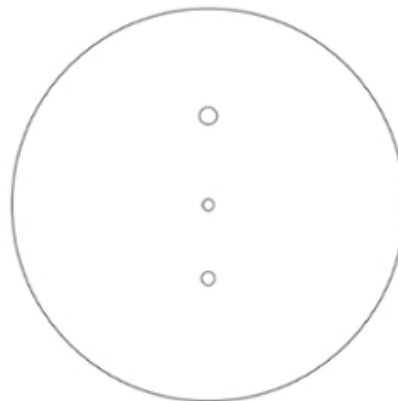

3.3

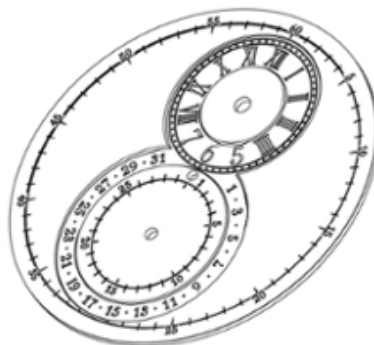

4.1

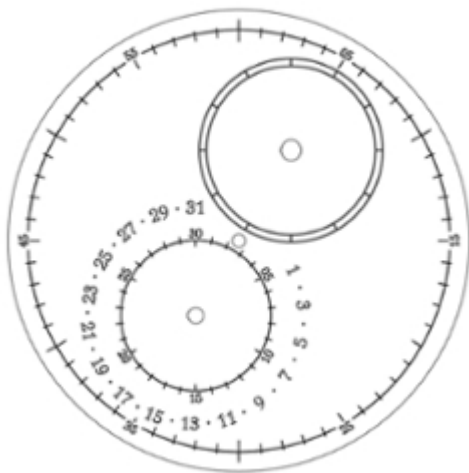

4.2

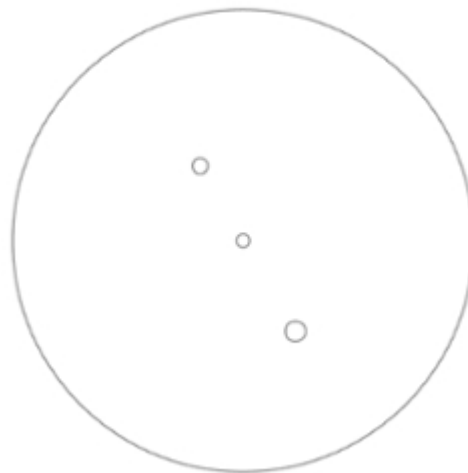

4.3

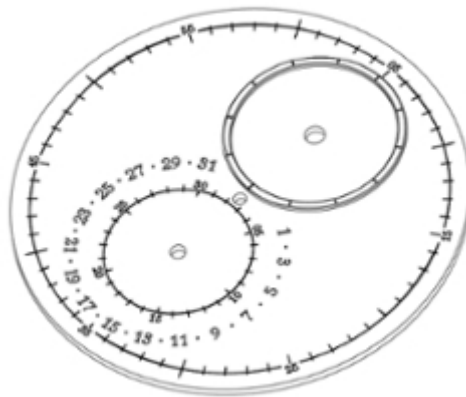

(11) DM/201 514

(51) 15-03

(15) 2018 08 10

(44) 26/2019 (2019 06 28)

(22) 2018 08 10

(28) 2

(30) No1: 26.07.2018; 005515079-0001; EM; No2: 26.07.2018; 005515079-0002; EM

(73) OMP Trade GmbH

Ruthensteinstraße 6, 4522 Sierning, AT (EM)

(85) EM

(86) EM

(87) EM

(88) EM

(89) EM

(81) III. UA, AL, IS, TM, ME, MD, SG, NO, RS, MN, BA, US, GE, LI, TN, KR, JP, CH, RU, EG

(72) Norbert Obermayr

Ruthensteinstraße 6, 4522 Sierning (AD)

(74) Hintermayr Burgstaller & Partner

Landstraße 12, 4020 Linz (AT)

(54) 1.-2. Accessory for agricultural machines

(55)



1.1



1.2



1.3



2.1



2.2

TRADEMARKS

APPLICATIONS FILED UNDER THE NATIONAL PROCEDURE APPROVED FOR REGISTRATION

The decision can be appealed at the Chamber of Appeal of Sakpatenti within 3 months from the publication or at the Mtskheta District Court Administrative Cases Board (Address: №17, Samkhedro St., Mtskheta), within 1 month following the publication.

(260) AM 2019 98682 A

(210) AM 98682

(220) 2019 02 01

(731) Ana Tsintskiladze

Paliashvili St. 90-92, 0162, Tbilisi, Georgia;

Ana Odishelidze

Lvov St. 13, 0160, Tbilisi, Georgia

(540)



(591) Black, white

(531) 26.04.01; 26.04.22; 26.04.24; 27.05.15;
27.05.24

(511) 25, 35

(260) AM 2019 99063 A

(210) AM 99063

(220) 2019 01 10

(731) LTD "FORMOSA"

R. Mamisashvili St. 31a, 0182, Tbilisi,
Georgia

(540)



(591) Black, white

(531) 06.01.01; 06.01.04; 27.05.01

(511) 12, 25

(260) AM 2019 99326 A

(210) AM 99326

(220) 2018 09 12

(731) Genadi Vasilevich Zhuravliov

Federation Av., Bl. 28, Ap. 47,

Moscow, 111399, Russian

Federation

(740) Shalva Gvaramadze

(540)

Грузинский характер

Georgian character

ქართული ხასიათი

(591) Black, white

(511) 33, 35

(260) AM 2019 99524 A

(210) AM 99524

(220) 2018 09 26

(731) Obshestvo s Ogranichennoy Otvetstvennostiu

Coordination-Distribution Center

"EFKO-CASCAD"

Frunze St., Bl. 4, Alekseevka, 309850,

Belgorodskaya District, Russian Federation

(740) Tamaz Shilakadze

(540)

ნატურაბალანსი

(591) Black, white

(511) 30, 35

(260) AM 2019 99525 A

(210) AM 99525

(220) 2018 09 26

(731) Obshestvo s Ogranichennoy Otvetstvennostiu

Coordination-Distribution Center

"EFKO-CASCAD"

Frunze St., Bl. 4, Alekseevka, 309850,

Belgorodskaya District, Russian Federation

(740) Tamaz Shilakadze

(540)

Naturabalance

(591) Black, white

(511) 30, 35

(260) AM 2019 99527 A

(210) AM 99527

(220) 2018 09 26

(731) Obshestvo s Ogranichennoy Otvetstvennostiu

Coordination-Distribution Center

"EFKO-CASCAD"

Frunze St., Bl. 4, Alekseevka, 309850,
Belgorodskaya District, Russian Federation
(740) Tamaz Shilakadze
(540)

Натурабаланс

(591) Black, white
(511) 30, 35

(260) AM 2019 100434 A
(210) AM 100434
(220) 2018 11 20
(731) INPHA LLP Representative Office in
Georgia
Besiki St. 4 Nearby, (plot 46/10), 0108,
Tbilisi Georgia
(540)

Проект პროექტი Progest

(591) Black, white
(511) 5

(260) AM 2019 100814 A
(210) AM 100814
(220) 2018 12 19
(731) LTD "DIVINO"
Dighomi Massive, IV quarter, Bl. 23,
Ap. 51, 0159, Tbilisi, Georgia
(740) Giorgi Taktakishvili
(540)

ღოზოვო DIVINO

(591) Black, white
(511) 35, 43

(260) AM 2019 100816 A
(210) AM 100816
(220) 2018 12 20
(731) HARINGTON DEVELOPMENT INC.
Elvira Mendez St., Vallarino Bldg, 3rd
floor, Panama, Republic of Panama
(740) Givi Akopashvili
(540)

VP
VICTORY PROMINENT

(591) Black, white
(531) 27.05.01; 27.05.10
(511) 34

(260) AM 2019 100859 A
(210) AM 100859
(220) 2018 12 21
(731) JSC "m² Real Estate"
Ilia Chavchavadze Av. 29, Fl. 3, Tbilisi,
Georgia
(740) Nikoloz Jalaghania
(540)

ბიქვი კონსტრუქშენი

(591) Black, white
(511) 35, 36, 37, 40

(260) AM 2019 100860 A
(210) AM 100860
(220) 2018 12 21
(731) JSC "m² Real Estate"
Ilia Chavchavadze Av. 29, Fl. 3, Tbilisi,
Georgia
(740) Nikoloz Jalaghania
(540)

BK Construction

(591) Black, white
(511) 35, 36, 37, 40

(260) AM 2019 100861 A
(210) AM 100861
(220) 2018 12 21
(731) JSC "m² Real Estate"
Ilia Chavchavadze Av. 29, Fl. 3, Tbilisi,
Georgia
(740) Nikoloz Jalaghania
(540)



BK CONSTRUCTION

(591) Red, blue
(531) 26.04.18; 27.05.22; 29.01.13
(511) 35, 36, 37, 40

(260) AM 2019 100862 A
(210) AM 100862
(220) 2018 12 21
(731) JSC "m² Real Estate"
Ilia Chavchavadze Av. 29, Fl. 3, Tbilisi,
Georgia

(740) Nikoloz Jalaghania
(540)



ბიჯი კონსტრუქციონი

(591) Red, blue
(531) 26.04.18; 27.05.22; 28.19; 29.01.13
(511) 35, 36, 37, 40

(260) AM 2019 100863 A
(210) AM 100863
(220) 2018 12 21
(731) JSC "m² Real Estate"
Ilia Chavchavadze Av. 29, Fl. 3, Tbilisi,
Georgia
(740) Nikoloz Jalaghania
(540)

კონსტრუქტ2

(591) Black, white
(511) 35, 36, 37, 40

(260) AM 2019 100864 A
(210) AM 100864
(220) 2018 12 21
(731) JSC "m² Real Estate"
Ilia Chavchavadze Av. 29, Fl. 3, Tbilisi,
Georgia
(740) Nikoloz Jalaghania
(540)

Construct2

(511) 35, 36, 37, 40

(260) AM 2019 100897 A
(210) AM 100897
(220) 2018 12 28
(731) ALIBABA GROUP HOLDING LIMITED
Fourth Floor, One Capital Place, P. O. Box
847, George Town, Grand Cayman, Cayman
Islands
(740) Tamaz Shilakadze
(540)



(591) Black, white
(531) 26.04.04; 26.04.06; 26.04.22
(511) 9, 16, 25, 28, 35, 38, 39, 41, 42

(260) AM 2019 100899 A
(210) AM 100899
(220) 2018 12 28
(731) ALIBABA GROUP HOLDING LIMITED
Fourth Floor, One Capital Place, P. O. Box
847, George Town, Grand Cayman, Cayman
Islands
(740) Tamaz Shilakadze
(540)

TMALL

(591) Black, white
(511) 9, 16, 35, 38, 41, 42

(260) AM 2019 100905 A
(210) AM 100905
(220) 2018 12 28
(731) LTD "MISO RIKO EXPRESS"
Ilia Chavchavadze Av. 70, 0162, Tbilisi,
Georgia
(540)

სგს რიკო კრედიტი

(591) Black, white
(511) 36

(260) AM 2019 100907 A
(210) AM 100907
(220) 2018 12 28
(731) LTD "MISO RIKO EXPRESS"
Ilia Chavchavadze Av.70, 0162, Tbilisi,
Georgia
(540)

სგს LTD რიკო კრედიტი

(591) Black, white
(511) 36

(260) AM 2019 100921 A
(210) AM 100921
(220) 2019 01 07
(731) NSAR GENERAL TRADING L.L.C.
1502 Green Tower, Baniyas Street, P.O. Box
171611, Dubai, United Arab Emirates
(740) Pavle Meipariani
(540)



(591) Black, white
(531) 03.03.01; 03.03.17; 24.01.09
(511) 34

(260) AM 2019 100922 A
 (210) AM 100922
 (220) 2019 01 07
 (731) NSAR GENERAL TRADING L.L.C.
 1502 Green Tower, Baniyas Street, P.O. Box
 171611, Dubai, United Arab Emirates
 (740) Pavle Meipariani
 (540)



(591) Black, white
 (531) 24.01.15; 24.01.17; 24.01.18; 24.01.19;
 27.05.01; 27.05.21
 (511) 34

(260) AM 2019 100923 A
 (210) AM 100923
 (220) 2019 01 07
 (731) NSAR GENERAL TRADING L.L.C.
 1502 Green Tower, Baniyas Street, P.O. Box
 171611, Dubai, United Arab Emirates
 (740) Pavle Meipariani
 (540)



(591) Black, white
 (531) 26.11.03; 26.11.06; 26.11.12; 26.13.25
 (511) 34

(260) AM 2019 100924 A
 (210) AM 100924
 (220) 2019 01 07
 (731) NSAR GENERAL TRADING L.L.C.
 1502 Green Tower, Baniyas Street, P.O. Box
 171611, Dubai, United Arab Emirates
 (740) Pavle Meipariani
 (540)



(591) Black, white
 (531) 26.04.03; 26.04.18; 27.05.17; 27.05.21;
 27.05.24
 (511) 34

(260) AM 2019 101215 A
 (210) AM 101215
 (220) 2019 01 10
 (731) LTD "I-DI DEVELOPMENT"
 G. Kvinitadze St. 8, Old Tbilisi District,
 Tbilisi, Georgia
 (740) Vakhtang Torotadze
 (540)



(591) Black, white
 (531) 26.13.25; 27.05.01; 27.05.10
 (511) 43

(260) AM 2019 101230 A
 (210) AM 101230
 (220) 2019 01 12
 (731) LTD "G-M-P"
 Vill. Ponitchala 65, 0165, Tbilisi, Georgia
 (740) Nugzar Ksovreli
 (540)



(591) Black, white
 (511) 5

(260) AM 2019 101234 A
 (210) AM 101234
 (220) 2019 01 16
 (731) COLGATE-PALMOLIVE COMPANY
 a Delaware corporation
 300 Park Avenue, New York, New York
 10022, USA
 (740) Natela Otardidze
 (540)



(591) Black, white, grey
 (531) 05.05.01; 05.05.16; 05.05.19; 05.05.20;
 05.05.22; 05.07.07; 05.07.22; 26.04.22;
 26.04.24; 27.05.10; 27.05.24
 (511) 3

(260) AM 2019 101235 A
 (210) AM 101235
 (220) 2019 01 16
 (731) COLGATE-PALMOLIVE COMPANY
 a Delaware corporation
 300 Park Avenue, New York, New York
 10022, USA
 (740) Natela Otariidze
 (540)



(591) Black, white, grey
 (531) 05.05.02; 05.05.03; 05.05.20; 05.07.11;
 05.07.12; 05.07.22; 25.01.01; 26.04.22;
 26.04.24; 27.05.10; 27.05.24
 (511) 3

(260) AM 2019 101237 A
 (210) AM 101237
 (220) 2019 01 16
 (731) SANRIO COMPANY, LTD.
 1-6-1 Osaki, Shinagawa-ku, Tokyo, Japan
 (740) Giorgi Taktakishvili
 (540)



(591) Black, white
 (531) 04.02.20; 04.05.12; 04.05.15
 (511) 3, 9, 14, 16, 18, 25, 28, 29, 30, 35, 41, 42, 43

(260) AM 2019 101238 A
 (210) AM 101238
 (220) 2019 01 16
 (731) SANRIO COMPANY, LTD.
 1-6-1 Osaki, Shinagawa-ku, Tokyo, Japan
 (740) Giorgi Taktakishvili
 (540)



(591) Black, white
 (531) 03.01.14; 03.01.17; 03.01.25; 27.05.02;
 27.05.09
 (511) 3, 9, 14, 16, 18, 25, 28, 29, 30, 35, 41, 42, 43

(260) AM 2019 101240 A
 (210) AM 101240
 (220) 2019 01 17
 (731) LTD "CHACHA"
 G. Lortkipanidze St. 11/P. Iashvili St. 17,
 Area 16, Mtatsminda District, Tbilisi,
 Georgia
 (540)



(591) Black, Yellow, sky-blue
 (531) 26.04.01; 26.04.22; 26.04.24; 27.05.25;
 29.01.13
 (511) 35

(260) AM 2019 101243 A
 (210) AM 101243
 (220) 2019 01 17
 (731) KIA MOTORS CORPORATION
 12, Heolleung-ro, Seocho-gu, Seoul, Republic
 of Korea
 (740) Shalva Gvaramadze
 (540)

OPTIMA

(591) Black, white
 (511) 12

(260) AM 2019 101244 A
 (210) AM 101244
 (220) 2019 01 17
 (731) KIA MOTORS CORPORATION
 12, Heolleung-ro, Seocho-gu, Seoul, Republic
 of Korea
 (740) Shalva Gvaramadze
 (540)

CADENZA

(591) Black, white
 (511) 12

(260) AM 2019 101245 A
 (210) AM 101245
 (220) 2019 01 17
 (731) KIA MOTORS CORPORATION
 12, Heolleung-ro, Seocho-gu, Seoul, Republic
 of Korea
 (740) Shalva Gvaramadze
 (540)

MOHAVE

(591) Black, white
 (511) 12

(260) AM 2019 101246 A
 (210) AM 101246
 (220) 2019 01 17
 (731) KIA MOTORS CORPORATION
 12, Heolleung-ro, Seocho-gu, Seoul, Republic
 of Korea
 (740) Shalva Gvaramadze
 (540)

SOUL

(591) Black, white
 (511) 12

(260) AM 2019 101247 A
 (210) AM 101247
 (220) 2019 01 17
 (731) JSC "m² Real Estate"
 Ilia Chavchavadze Av. 29, Fl. 3, Tbilisi,
 Georgia
 (740) Nikoloz Jalaghania
 (540)

კმბსოიჯჯო 

(591) White, grey, orange
 (531) 26.04.01; 26.04.17; 28.19; 29.01.13
 (511) 35, 36, 37, 41

(260) AM 2019 101248 A
 (210) AM 101248
 (220) 2019 01 17
 (731) JSC "m² Real Estate"
 Ilia Chavchavadze Av. 29, Fl. 3, Tbilisi,
 Georgia
 (540)

CONSTRUCT 

(591) Grey, white, orange
 (531) 26.04.01; 26.04.17; 27.05.01; 29.01.13
 (511) 35, 36, 37, 41

(260) AM 2019 101249 A
 (210) AM 101249
 (220) 2019 01 17
 (731) KIA MOTORS CORPORATION
 12, Heolleung-ro, Seocho-gu, Seoul, Republic
 of Korea
 (740) Shalva Gvaramadze
 (540)

CARNIVAL

(591) Black, white
 (511) 12

(260) AM 2019 101253 A
 (210) AM 101253
 (220) 2019 01 18
 (731) Agro Live Science Corporation
 1115, Fl. 11, Hemkunt Tower (Modi Tower)
 98, Nehru, Niu Deli, 110019, India
 (740) Lia Shalikashvili
 (540)

BYTE

ბაიტი

БАИТ

(591) Black, white
 (511) 5

(260) AM 2019 101255 A
 (210) AM 101255
 (220) 2019 01 18
 (731) Agro Live Science Corporation
 1115, Fl. 11, Hemkunt Tower (Modi Tower)
 98, Nehru, Niu Deli, 110019, India
 (740) Lia Shalikashvili
 (540)

SAHEB

საჰებ

САХЕБ

(591) Black, white
(511) 5

(260) AM 2019 101257 A
(210) AM 101257
(220) 2019 01 18
(731) Agro Live Science Corporation
1115, Fl. 11, Hemkunt Tower (Modi Tower)
98, Nehru, Niu Deli, 110019, India
(740) Lia Shalikashvili
(540)

HERO 70
ჰერო 70
ХИРО 70

(591) Black, white
(511) 5

(260) AM 2019 101258 A
(210) AM 101258
(220) 2019 01 18
(731) Agro Live Science Corporation
1115, Fl. 11, Hemkunt Tower (Modi Tower)
98, Nehru, Niu Deli, 110019, India
(740) Lia Shalikashvili
(540)

LOCK 5
ლოკ 5
ЛОК 5

(591) Black, white
(511) 5

(260) AM 2019 101286 A
(210) AM 101286
(220) 2019 01 18
(731) Agro Live Science Corporation
1115, Fl. 11, Hemkunt Tower (Modi Tower)
98, Nehru, Niu Deli, 110019, India
(740) Lia Shalikashvili
(540)

RELAX
რელაქს
РЕЛАКС

(591) Black, white
(511) 5

(260) AM 2019 101287 A
(210) AM 101287
(220) 2019 01 18

(731) Agro Live Science Corporation
1115, Fl. 11, Hemkunt Tower (Modi Tower)
98, Nehru, Niu Deli, 110019, India
(740) Lia Shalikashvili
(540)

MIST
მისტი
МИСТ

(591) Black, white
(511) 5

(260) AM 2019 101288 A
(210) AM 101288
(220) 2019 01 18
(731) LTD "Georgia Travel"
Eg. Ninoshvili St. 66, 1400, Gori, Georgia
(540)



(591) Red, white
(531) 19.09.02; 24.13.01; 24.13.17; 24.13.24;
29.01.12
(511) 33, 39

(260) AM 2019 101294 A
(210) AM 101294
(220) 2019 01 21
(731) LTD "TSKARO №8"
O. Thiladze St. 4, Ap. 22, 0160, Tbilisi,
Georgia
(540)



(591) Light green, dark green, dark blue, turquoise,
green, sky-blue, light sky-blue, black
(531) 01.13.01; 01.13.15; 01.15.15; 27.05.10;
29.01.13
(511) 32

(260) AM 2019 101297 A
 (210) AM 101297
 (220) 2019 01 22
 (731) LTD "QOSHER CORNER"
 Tabidze St. 108, ap. 10, 0162, Tbilisi,
 Georgia
 (540)



(591) White, blue
 (531) 01.01.10; 05.05.20; 25.01.01; 25.01.10;
 25.01.25; 26.01.10; 26.04.02; 26.04.05;
 26.04.24; 27.05.01; 27.05.24; 29.01.12
 (511) 33, 43

(260) AM 2019 101298 A
 (210) AM 101298
 (220) 2019 01 23
 (310) 88/053,768
 (320) 26 07 2018
 (330) US
 (731) SANOFI PASTEUR INC.
 One Discovery Drive, SWIFTWATER, PA
 18370, USA
 (740) Shalva Gvaramadze
 (540)

MENQUADFI

(591) Black, white
 (511) 5

(260) AM 2019 101299 A
 (210) AM 101299
 (220) 2019 01 23
 (310) 88/053,738
 (320) 26 07 2018
 (330) US
 (731) SANOFI PASTEUR INC.
 One Discovery Drive, SWIFTWATER, PA
 18370, USA
 (740) Shalva Gvaramadze
 (540)

NUQUADMEN

(591) Black, white
 (511) 5

(260) AM 2019 101300 A
 (210) AM 101300
 (220) 2019 01 23
 (310) 88/053,749
 (320) 26 07 2018
 (330) US
 (731) SANOFI PASTEUR INC.
 One Discovery Drive, SWIFTWATER, PA
 18370, USA
 (740) Shalva Gvaramadze
 (540)

MENQUADTT

(591) Black, white
 (511) 5

(260) AM 2019 101304 A
 (210) AM 101304
 (220) 2019 01 24
 (731) COLGATE-PALMOLIVE COMPANY
 a Delaware corporation
 300 Park Avenue, New York, New York
 10022, USA
 (740) Natela Otardidze
 (540)



(591) Red, light blue
 (531) 26.04.02; 26.04.05; 26.04.12; 26.04.24;
 26.11.12; 29.01.12
 (511) 3

(260) AM 2019 101306 A
 (210) AM 101306
 (220) 2019 01 24
 (731) LTD WHITE FARM
 Mtatsminda Lane 7a, Ap. 16, Tbilisi, Georgia
 (540)

თეთრი ფერმა



WHITE FARM

(591) Black, white
 (531) 07.01.09; 07.01.24; 26.11.11; 27.05.01; 28.11
 (511) 29, 31, 35

(260) AM 2019 101371 A
 (210) AM 101371
 (220) 2019 01 25
 (731) JIM BIM BRENDZ CO.
 222 West Merchandise Mart Plaza, Suit 1600,
 Chikago, Illinois State, 60654, USA
 (740) Shalva Gvaramadze
 (540)

KNOB CREEK

(591) Black, white
 (511) 33

(260) AM 2019 101374 A
 (210) AM 101374
 (220) 2019 01 25
 (731) COLGATE-PALMOLIVE COMPANY
 a Delaware corporation
 300 Park Avenue, New York, New York
 10022, USA
 (740) Natela Otardidze
 (540)



(591) Red, white, orange, gold, green, light blue,
 blue
 (531) 24.15.13; 26.01.01; 26.01.03; 26.01.17;
 26.11.02; 26.11.06; 29.01.15
 (511) 3

(260) AM 2019 101375 A
 (210) AM 101375
 (220) 2019 01 25
 (731) COLGATE-PALMOLIVE COMPANY
 a Delaware corporation
 300 Park Avenue, New York, New York
 10022, USA
 (740) Natela Otardidze
 (540)



(591) Red, light green, green
 (531) 26.04.02; 26.04.05; 26.04.10; 26.04.12;
 26.04.24
 (511) 3

(260) AM 2019 101376 A
 (210) AM 101376
 (220) 2019 01 25
 (731) THE BODY SHOP INTERNATIONAL
 LIMITED

Watersmead, Littlehampton, West Sussex,
 BN17 6LS, United Kingdom
 (740) Tamar Kochlamazashvili
 (540)

WHITE MUSK

(591) Black, white
 (511) 3

(260) AM 2019 101382 A
 (210) AM 101382
 (220) 2019 01 28
 (731) LTD "KIMILI"
 Sh. Mikatadze St. 20, 0101, Tbilisi, Georgia
 (540)

KIMILI

(591) Black, white
 (531) 27.05.01
 (511) 14

(260) AM 2019 101393 A
 (210) AM 101393
 (220) 2019 01 29
 (731) JSC "Georgian Beer Company"
 Vill. Saguramo, 3311, Mtskheta, Georgia
 (540)

წვოს чайа chaia

(591) Black, white
 (511) 32, 33

(260) AM 2019 101394 A
 (210) AM 101394
 (220) 2019 01 29
 (731) JSC "Georgian Beer Company"
 Vill. Saguramo, 3311, Mtskheta, Georgia
 (540)

წაშო чаши chashi

(591) Black, white
 (511) 32, 33

(260) AM 2019 101395 A
 (210) AM 101395
 (220) 2019 01 29
 (731) JSC "Georgian Beer Company"
 Vill. Saguramo, 3311, Mtskheta, Georgia

(540)

გურიანა
Гуриана
Guriana

(591) Black, white
(511) 32, 33

(260) AM 2019 101414 A
(210) AM 101414
(220) 2019 01 30
(731) SKIN CODE
Z. Paliashvili St. 66, 0179, Tbilisi,
Georgia

(540)

სკინ კოდი  **SKIN CODE**
ესთეტიკური მედიცინის კლინიკა **Clinic of Aesthetic Medicine**

(591) Black, green
(531) 26.11.12; 27.05.01; 27.05.10; 28.19; 29.01.12
(511) 44

(260) AM 2019 101422 A
(210) AM 101422
(220) 2019 01 31
(731) LTD "KIMILI"
Sh. Mikatadze St. 20, 0101, Tbilisi, Georgia

(540)

Wearable Art

(591) Black, white
(511) 14

(260) AM 2019 101492 A
(210) AM 101492
(220) 2019 02 01
(731) LTD "Bolero & Company"
Marshal Gelovani Av. 13, Fl. 9, 0159, Tbilisi,
Georgia

(540)

ბერიკონი
BERIKONI
БЕРИКОНИ

(591) Black, white
(511) 33

(260) AM 2019 101507 A
(210) AM 101507
(220) 2019 02 04
(731) LTD "G-M-P"
Vill. Ponitchala 65, 0165, Tbilisi, Georgia

(740) Nugzar Ksovreli
(540)

ოტოსანო
ОТОСАН
OTOSAN

(591) Black, white
(511) 5

(260) AM 2019 101511 A
(210) AM 101511
(220) 2019 02 05
(731) JSC "Cotekhi-Gurjaani Wine Factory"
Koroghlishvili St. 38, 1500, Gurjaani,
Georgia

(740) Dimitri Dzamukashvili
(540)

ლაზი
Lazi

(591) Black, white
(511) 33

(260) AM 2019 101513 A
(210) AM 101513
(220) 2019 02 05
(731) VIVO MOBILE COMMUNICATION CO.,
LTD.
283, BBK Road, Wusha, Chang'An,
Dongguan, Guangdong, China

(740) Merab Kvimsadze
(540)

VIVO

(591) Black, white
(511) 9

(260) AM 2019 101524 A
(210) AM 101524
(220) 2019 02 07
(731) LTD "G-M-P"
Vill. Ponitchala 65, 0165, Tbilisi, Georgia
(740) Nugzar Ksovreli
(540)

იქსატი
ИКСАТ
IXAT

(591) Black, white
(511) 5

(260) AM 2019 101600 A
(210) AM 101600
(220) 2019 02 08
(731) LTD "N Plus"
Queen Tamar's Shore 42, 6200, Kobuleti,
Georgia
(540)

Pearl of Sea

(591) Black, white
(511) 43

(260) AM 2019 101604 A
(210) AM 101604
(220) 2019 02 08
(731) LTD "Georgian Wine House"
Vill. Zegani, 1500, Gurjaani district,
Georgia
(740) Sopio Vacheishvili
(540)

Грузинская Принцесса
Georgian Princess

(591) Black, white
(511) 33

(260) AM 2019 101679 A
(210) AM 101679
(220) 2019 02 19
(731) LTD "Bolero & Company"
Kuchishvili St. 12-14-16, Fl. 6, 0179,
Tbilisi, Georgia
(540)

გორცხე
Gortsikhe
Горцихе

(591) Black, white
(511) 33

REGISTERED TRADEMARKS

(111) M 2019 31549 R
(151) 2019 08 12
(181) 2029 08 12
(260) AM 2018 97408 A
(220) 2018 04 26

(732) LLC "UNISET-M"
Ul. Iskri, dom 31, stroenie 5, Moskow,
Russian Federation

(111) M 2019 31550 R
(151) 2019 08 12
(181) 2029 08 12
(260) AM 2018 97897 A
(220) 2018 05 30

(732) LTD "Georgian Wine House"
Vil. Zeggani, 1500, Gurjaani District,
Georgia

(111) M 2019 31551 R
(151) 2019 08 12
(181) 2029 08 12
(260) AM 2018 98168 A
(220) 2018 06 19

(732) JSC "LIBERTY BANK"
I. Chavchavadze Ave. 74, 0162, Tbilisi,
Georgia

(111) M 2019 31552 R
(151) 2019 08 12
(181) 2029 08 12
(260) AM 2018 98371 A
(220) 2018 07 03

(732) LTD "MIKADO GEORGIA"
Dosaaf Adjacent Territory, 3700, Rustavi,
Georgia

(111) M 2019 31553 R
(151) 2019 08 12
(181) 2029 08 12
(260) AM 2018 98395 A
(220) 2018 07 06

(732) COUTURE TECH LIMITED
Trident Chambers P.o. Boqs 146, Road Town,
Tortola, VG1110, Virgin Islands (British)

(111) M 2019 31554 R
(151) 2019 08 12
(181) 2029 08 12
(260) AM 2018 98409 A
(220) 2018 07 10

(732) VWR INTERNATIONAL HOLDINGS, INC.
2751 Centerville Road, Suite 358,
Wilmington, Delaware 19808, USA

(111) M 2019 31555 R
(151) 2019 08 12
(181) 2029 08 12
(260) AM 2018 98411 A
(220) 2018 07 10

(732) VWR INTERNATIONAL HOLDINGS, INC.
2751 Centerville Road, Suite 358,
Wilmington, Delaware 19808, USA

(111) M 2019 31556 R
(151) 2019 08 12
(181) 2029 08 12
(260) AM 2018 98413 A
(220) 2018 07 11

(732) YAGMUR PVC MUTEAHHITLIK MAKINE
INSAAT ITHALAT IHRACAT SANAYI VE
TICARET LIMITED SIRKETI
KUSGET HALICILAR SITESI, 176 NOLU
CADDE, NO: 43, SEHITKAMIL/ AZIANTEP,
Turkey

(111) M 2019 31557 R
(151) 2019 08 12
(181) 2029 08 12
(260) AM 2018 98433 A
(220) 2018 07 13

(732) JSC "LIBERTY BANK"
I. Chavchavadze Ave. 74, 0162, Tbilisi,
Georgia

(111) M 2019 31558 R
(151) 2019 08 12
(181) 2029 08 12
(260) AM 2018 98559 A
(220) 2018 07 18

(732) EKA KOPALEISHVILI
Ostazhenka St. 25, Ap. 41, Moskow,
Russian Federation

(111) M 2019 31559 R
(151) 2019 08 12
(181) 2029 08 12
(260) AM 2018 98564 A
(220) 2018 07 19

(732) EKA KOPALEISHVILI
Ostazhenka St. 25, Ap. 41, Moskow,
Russian Federation

(111) M 2019 31560 R
(151) 2019 08 12
(181) 2029 08 12
(260) AM 2018 98765 A
(220) 2018 08 01
(732) BIOCON LIMITED
20th K.M., Hosur Road, Electronic City P.O.,
Bangalore - 560100, India

(111) M 2019 31561 R
(151) 2019 08 12
(181) 2029 08 12
(260) AM 2018 98766 A
(220) 2018 08 01
(732) BIOCON LIMITED
20th K.M., Hosur Road, Electronic City P.O.,
Bangalore - 560100, India

(111) M 2019 31562 R
(151) 2019 08 12
(181) 2029 08 12
(260) AM 2018 98768 A
(220) 2018 08 01
(732) BIOCON LIMITED
20th K.M., Hosur Road, Electronic City P.O.,
Bangalore - 560100, India

(111) M 2019 31563 R
(151) 2019 08 12
(181) 2029 08 12
(260) AM 2018 98798 A
(220) 2018 08 03
(732) SUPER 8 WORLDWIDE INC.
22 Sylvan Way, Parsippany, New Jersey
07054, USA

(111) M 2019 31564 R
(151) 2019 08 12
(181) 2029 08 12
(260) AM 2018 98799 A
(220) 2018 08 03
(732) SUPER 8 WORLDWIDE INC.
22 Sylvan Way, Parsippany, New Jersey
07054, USA

(111) M 2019 31565 R
(151) 2019 08 12
(181) 2029 08 12
(260) AM 2018 98800 A
(220) 2018 08 03
(732) RAMADA INTERNATIONAL INC.
22 Sylvan Way, Parsippany, New Jersey
07054, USA

(111) M 2019 31566 R
(151) 2019 08 12
(181) 2029 08 12
(260) AM 2018 98894 A
(220) 2018 08 06
(732) ZTE Corporation
ZTE Plaza, Keji Road South, Hi-Tech
Industrial Park, Nanshan District, Shenzhen,
China

(111) M 2019 31567 R
(151) 2019 08 12
(181) 2029 08 12
(260) AM 2018 98994 A
(220) 2018 08 16
(732) JSC "Hualing International Special Economic
Zone"
J. Lezhava St. 22, 0162, Isani-Samgori
district, Tbilisi, Georgia

(111) M 2019 31568 R
(151) 2019 08 12
(181) 2029 08 12
(260) AM 2018 98995 A
(220) 2018 08 16
(732) JSC "Hualing International Special Economic
Zone"
J. Lezhava St. 22, 0162, Isani-Samgori
district, Tbilisi, Georgia

(111) M 2019 31569 R
(151) 2019 08 12
(181) 2029 08 12
(260) AM 2018 98996 A
(220) 2018 08 16
(732) JSC "Hualing International Special Economic
Zone"
J. Lezhava St. 22, 0162, Isani-Samgori
district, Tbilisi, Georgia

(111) M 2019 31570 R
(151) 2019 08 12
(181) 2029 08 12
(260) AM 2018 99060 A
(220) 2018 08 21
(732) LTD "INO-LAB"
M Brose St. 2, 0108, Tbilisi, Georgia

(111) M 2019 31571 R
(151) 2019 08 12
(181) 2029 08 12
(260) AM 2018 99164 A
(220) 2018 08 29
(732) ZTE CORPORATION

ZTE Plaza, Keji Road South, Hi-Tech
Industrial Park, Nanshan District, Shenzhen,
China

(111) M 2019 31572 R
(151) 2019 08 12
(181) 2029 08 12
(260) AM 2018 99166 A
(220) 2018 08 29
(732) Hilton Worldwide Manage Limited
Maple Court Central Park, Reeds Crescent,
Watford WD24 4QQ, United Kingdom

(111) M 2019 31573 R
(151) 2019 08 12
(181) 2029 08 12
(260) AM 2018 99196 A
(220) 2018 09 06
(732) Philip Morris Brands Sàrl
Ke Janreno 3, 2000 Nevshateli,
Quai Jeanrenaud 3, 2000 Neuchâtel,
Switzerland

(111) M 2019 31574 R
(151) 2019 08 12
(181) 2029 08 12
(260) AM 2018 99333 A
(220) 2018 09 12
(732) LTD "AVERSI-PHARMA"
D. Aghmashenebeli Ave. 148/2, 0112,
Tbilisi, Georgia

(111) M 2019 31575 R
(151) 2019 08 12
(181) 2029 08 12
(260) AM 2018 99339 A
(220) 2018 09 12
(732) LTD "AVERSI-PHARMA"
D. Aghmashenebeli Ave. 148/2, 0112,
Tbilisi, Georgia

(111) M 2019 31576 R
(151) 2019 08 12
(181) 2029 08 12
(260) AM 2018 99340 A
(220) 2018 09 12
(732) LTD "AVERSI-PHARMA"
D. Aghmashenebeli Ave. 148/2, 0112,
Tbilisi, Georgia

(111) M 2019 31577 R
(151) 2019 08 12
(181) 2029 08 12
(260) AM 2018 99341 A

(220) 2018 09 12
(732) LTD "AVERSI-PHARMA"
D. Aghmashenebeli Ave. 148/2, 0112,
Tbilisi, Georgia

(111) M 2019 31578 R
(151) 2019 08 12
(181) 2029 08 12
(260) AM 2018 99343 A
(220) 2018 09 12
(732) LTD "AVERSI-PHARMA"
D. Aghmashenebeli Ave. 148/2, 0112,
Tbilisi, Georgia

(111) M 2019 31579 R
(151) 2019 08 12
(181) 2029 08 12
(260) AM 2018 99344 A
(220) 2018 09 12
(732) LTD "AVERSI-PHARMA"
D. Aghmashenebeli Ave. 148/2, 0112,
Tbilisi, Georgia

(111) M 2019 31580 R
(151) 2019 08 12
(181) 2029 08 12
(260) AM 2018 99345 A
(220) 2018 09 12
(732) LTD "AVERSI-PHARMA"
D. Aghmashenebeli Ave. 148/2, 0112,
Tbilisi, Georgia

(111) M 2019 31581 R
(151) 2019 08 12
(181) 2029 08 12
(260) AM 2018 99347 A
(220) 2018 09 12
(732) LTD "AVERSI-PHARMA"
D. Aghmashenebeli Ave. 148/2, 0112,
Tbilisi, Georgia

(111) M 2019 31582 R
(151) 2019 08 12
(181) 2029 08 12
(260) AM 2018 99348 A
(220) 2018 09 12
(732) LTD "AVERSI-PHARMA"
D. Aghmashenebeli Ave. 148/2, 0112,
Tbilisi, Georgia

(111) M 2019 31583 R
(151) 2019 08 12
(181) 2029 08 12
(260) AM 2018 99351 A

(220) 2018 09 13
(732) LTD G-M-P
Vil. Ponitchala 65, 0165, Tbilisi, Georgia

D. Gamrekeli St. 19 (512), 0160, Tbilisi,
Georgia

(111) M 2019 31584 R
(151) 2019 08 12
(181) 2029 08 12
(260) AM 2018 99464 A
(220) 2018 09 21
(732) LTD "FINANCIAL SOLUTIONS GROUP"
Al. Kazbegi Ave. 2, ap. 27, Tbilisi, Georgia

(111) M 2019 31590 R
(151) 2019 08 12
(181) 2029 08 12
(260) AM 2018 99663 A
(220) 2018 10 03
(732) TEMUR KOMETIANI
I. Jebashvili St. 16, 0177, Tbilisi, Georgia
IOSEB GHUDUSHAURI
Zestaponi St. 3, ap. 1, 0180, Tbilisi, Georgia

(111) M 2019 31585 R
(151) 2019 08 12
(181) 2029 08 12
(260) AM 2018 99483 A
(220) 2018 09 24
(732) JSC "LIBERTY BANK"
I. Chavchavadze Ave. 74, 0162, Tbilisi,
Georgia

(111) M 2019 31591 R
(151) 2019 08 12
(181) 2029 08 12
(260) AM 2018 99915 A
(220) 2018 10 19
(732) LTD "AVERSI-PHARMA"
D. Aghmashenebeli Ave. 148/2, 0112,
Tbilisi, Georgia

(111) M 2019 31586 R
(151) 2019 08 12
(181) 2029 08 12
(260) AM 2018 99513 A
(220) 2018 09 25
(732) LTD "GLOBAL BEER GEORGIA"
Vill. Tsilkani, 3319, Mtskheta, Georgia

(111) M 2019 31592 R
(151) 2019 08 12
(181) 2029 08 12
(260) AM 2018 99916 A
(220) 2018 10 19
(732) LTD "AVERSI-PHARMA"
D. Aghmashenebeli Ave. 148/2, 0112,
Tbilisi, Georgia

(111) M 2019 31587 R
(151) 2019 08 12
(181) 2029 08 12
(260) AM 2018 99531 A
(220) 2018 09 27
(732) LTD "AVERSI-PHARMA"
D. Aghmashenebeli Ave. 148/2, 0112,
Tbilisi, Georgia

(111) M 2019 31593 R
(151) 2019 08 12
(181) 2029 08 12
(260) AM 2018 99917 A
(220) 2018 10 19
(732) LTD "AVERSI-PHARMA"
D. Aghmashenebeli Ave. 148/2, 0112,
Tbilisi, Georgia

(111) M 2019 31588 R
(151) 2019 08 12
(181) 2029 08 12
(260) AM 2018 99532 A
(220) 2018 09 27
(732) LTD "AVERSI-PHARMA"
D. Aghmashenebeli Ave. 148/2, 0112,
Tbilisi, Georgia

(111) M 2019 31594 R
(151) 2019 08 12
(181) 2029 08 12
(260) AM 2018 99918 A
(220) 2018 10 19
(732) LTD "AVERSI-PHARMA"
D. Aghmashenebeli Ave. 148/2, 0112,
Tbilisi, Georgia

(111) M 2019 31589 R
(151) 2019 08 12
(181) 2029 08 12
(260) AM 2018 99649 A
(220) 2018 10 01
(732) LTD "ARTPHARMA"

(111) M 2019 31595 R
(151) 2019 08 12
(181) 2029 08 12
(260) AM 2018 99919 A

(220) 2018 10 19
(732) LTD "AVERSI-PHARMA"
D. Aghmashenebeli Ave. 148/2, 0112,
Tbilisi, Georgia

(111) M 2019 31596 R
(151) 2019 08 12
(181) 2029 08 12
(260) AM 2018 99920 A
(220) 2018 10 19
(732) LTD "AVERSI-PHARMA"
D. Aghmashenebeli Ave. 148/2, 0112,
Tbilisi, Georgia

(111) M 2019 31597 R
(151) 2019 08 12
(181) 2029 08 12
(260) AM 2018 99921 A
(220) 2018 10 19
(732) LTD "AVERSI-PHARMA"
D. Aghmashenebeli Ave. 148/2, 0112,
Tbilisi, Georgia

(111) M 2019 31598 R
(151) 2019 08 12
(181) 2029 08 12
(260) AM 2018 99922 A
(220) 2018 10 19
(732) LTD "AVERSI-PHARMA"
D. Aghmashenebeli Ave. 148/2, 0112,
Tbilisi, Georgia

(111) M 2019 31599 R
(151) 2019 08 12
(181) 2029 08 12
(260) AM 2018 99923 A
(220) 2018 10 19
(732) LTD "AVERSI-PHARMA"
D. Aghmashenebeli Ave. 148/2, 0112,
Tbilisi, Georgia

(111) M 2019 31600 R
(151) 2019 08 12
(181) 2029 08 12
(260) AM 2018 99924 A
(220) 2018 10 19
(732) LTD "AVERSI-PHARMA"
D. Aghmashenebeli Ave. 148/2, 0112,
Tbilisi, Georgia

(111) M 2019 31601 R
(151) 2019 08 12
(181) 2029 08 12

(260) AM 2018 99925 A
(220) 2018 10 19
(732) LTD "AVERSI-PHARMA"
D. Aghmashenebeli Ave. 148/2, 0112,
Tbilisi, Georgia

(111) M 2019 31602 R
(151) 2019 08 12
(181) 2029 08 12
(260) AM 2018 99926 A
(220) 2018 10 19
(732) LTD "AVERSI-PHARMA"
D. Aghmashenebeli Ave. 148/2, 0112,
Tbilisi, Georgia

(111) M 2019 31603 R
(151) 2019 08 12
(181) 2029 08 12
(260) AM 2018 99928 A
(220) 2018 10 19
(732) LTD "AVERSI-PHARMA"
D. Aghmashenebeli Ave. 148/2, 0112,
Tbilisi, Georgia

(111) M 2019 31604 R
(151) 2019 08 12
(181) 2029 08 12
(260) AM 2018 99929 A
(220) 2018 10 19
(732) LTD "AVERSI-PHARMA"
D. Aghmashenebeli Ave. 148/2, 0112,
Tbilisi, Georgia

(111) M 2019 31605 R
(151) 2019 08 12
(181) 2029 08 12
(260) AM 2018 99930 A
(220) 2018 10 19
(732) LTD "AVERSI-PHARMA"
D. Aghmashenebeli Ave. 148/2, 0112,
Tbilisi, Georgia

(111) M 2019 31606 R
(151) 2019 08 12
(181) 2029 08 12
(260) AM 2018 99931 A
(220) 2018 10 19
(732) LTD "AVERSI-PHARMA"
D. Aghmashenebeli Ave. 148/2, 0112,
Tbilisi, Georgia

(111) M 2019 31607 R
 (151) 2019 08 12
 (181) 2029 08 12
 (260) AM 2018 99933 A
 (220) 2018 10 19
 (732) LTD "AVERSI-PHARMA"
 D. Aghmashenebeli Ave. 148/2, 0112,
 Tbilisi, Georgia

(111) M 2019 31617 R
 (151) 2019 08 16
 (181) 2029 08 16
 (260) AM 2018 97171 A
 (220) 2018 03 30
 (732) BENIHANA HOLDINGS PTE. LTD
 10 Anson Road, 33-07/08 International
 Plaza, 079903, Singapore

(111) M 2019 31608 R
 (151) 2019 08 12
 (181) 2029 08 12
 (260) AM 2018 99935 A
 (220) 2018 10 19
 (732) LTD "AVERSI-PHARMA"
 D. Aghmashenebeli Ave. 148/2, 0112,
 Tbilisi, Georgia

(111) M 2019 31618 R
 (151) 2019 08 16
 (181) 2029 08 16
 (260) AM 2018 97434 A
 (220) 2018 05 01
 (732) NIKA GVARAMIA
 Abuladzis q. 32, 0162, Tbilisi, Georgia

(111) M 2019 31613 R
 (151) 2019 08 16
 (181) 2029 08 16
 (260) AM 2017 95359 A
 (220) 2017 12 05
 (732) LTD "MISO LIDERCREDIT"
 Queen Tamara Av. 11, 0112, Tbilisi,
 Georgia

(111) M 2019 31619 R
 (151) 2019 08 16
 (181) 2029 08 16
 (260) AM 2018 97474 A
 (220) 2018 05 08
 (732) LTD "GOLIATI"
 Makhaldianis q. 16, 0101, Tbilisi, Georgia

(111) M 2019 31614 R
 (151) 2019 08 16
 (181) 2029 08 16
 (260) AM 2018 97167 A
 (220) 2018 03 30
 (732) BENIHANA HOLDINGS PTE. LTD
 10 Anson Road, 33-07/08 International
 Plaza, 079903, Singapore

(111) M 2019 31620 R
 (151) 2019 08 16
 (181) 2029 08 16
 (260) AM 2018 97475 A
 (220) 2018 05 08
 (732) LTD "GOLIATI"
 Makhaldianis q. 16, 0101, Tbilisi, Georgia

(111) M 2019 31615 R
 (151) 2019 08 16
 (181) 2029 08 16
 (260) AM 2018 97168 A
 (220) 2018 03 30
 (732) BENIHANA HOLDINGS PTE. LTD
 10 Anson Road, 33-07/08 International
 Plaza, 079903, Singapore

(111) M 2019 31621 R
 (151) 2019 08 16
 (181) 2029 08 16
 (260) AM 2018 98180 A
 (220) 2018 06 21
 (732) IMPERIAL TOBACCO LIMITED
 121 Winterstoke Road, Bristol BS3 2LL,
 United Kingdom

(111) M 2019 31616 R
 (151) 2019 08 16
 (181) 2029 08 16
 (260) AM 2018 97169 A
 (220) 2018 03 30
 (732) BENIHANA HOLDINGS PTE. LTD
 10 Anson Road, 33-07/08 International
 Plaza, 079903, Singapore

(111) M 2019 31622 R
 (151) 2019 08 16
 (181) 2029 08 16
 (260) AM 2018 98418 A
 (220) 2018 07 11
 (732) LAWAND GENERAL TRADING FZE.
 JAFZA VIEW - LOB 19 – 2603, JEBEL
 ALI, P.O. Box:113518, Dubai, United Arab
 Emirates

(111) M 2019 31623 R
(151) 2019 08 16
(181) 2029 08 16
(260) AM 2018 98432 A
(220) 2018 07 13
(732) OFRA Cosmetics LLC
2141 Blaunt Roud, Pompano Bich, Florida
33069, USA

(111) M 2019 31624 R
(151) 2019 08 16
(181) 2029 08 16
(260) AM 2018 98554 A
(220) 2018 07 17
(732) NATELA SHEKLASHVILI
P. Iashvili Str., Deadlock 3, Sachkhere,
Georgia

(111) M 2019 31625 R
(151) 2019 08 16
(181) 2029 08 16
(260) AM 2018 98674 A
(220) 2018 07 24
(732) ADAMA AGAN Ltd
P.O. Box 262, Northern Industrial Zone,
Ashdod 7710201, Israel

(111) M 2019 31626 R
(151) 2019 08 16
(181) 2029 08 16
(260) AM 2018 98675 A
(220) 2018 07 24
(732) ADAMA AGAN Ltd
P.O. Box 262, Northern Industrial Zone,
Ashdod 7710201, Israel

(111) M 2019 31627 R
(151) 2019 08 16
(181) 2029 08 16
(260) AM 2018 98975 A
(220) 2018 08 14
(732) ROTHMANS OF PALL MALL LIMITED
Route de France 17, Boncourt, 2926,
Switzerland

(111) M 2019 31628 R
(151) 2019 08 16
(181) 2029 08 16
(260) AM 2018 99163 A
(220) 2018 08 29
(732) Grigor Chakhmakhchyan
Tbilisi St. 29, 0700, Akhalkalaki, Georgia

(111) M 2019 31629 R
(151) 2019 08 16
(181) 2029 08 16
(260) AM 2018 99185 A
(220) 2018 09 04
(732) Kaane American International Tobacco
Company FZE
P.o. Boqs 61021, Jebel Ali Fri Zoun, Dubai,
United Arab Emirates

(111) M 2019 31630 R
(151) 2019 08 16
(181) 2029 08 16
(260) AM 2018 99477 A
(220) 2018 09 24
(732) LTD "GALA"
S. Tsintsadze St. 63, Space 12, Vake-
Saburtalo district, Tbilisi, Georgia

(111) M 2019 31631 R
(151) 2019 08 16
(181) 2029 08 16
(260) AM 2018 99519 A
(220) 2018 09 26
(732) Alifard Co. (PJS)
№15, 12 Strit, Nors Kheradmand Ave.,
Teirani, 1585877814, Iran (Islamic Republic
of Iran)

(111) M 2019 31632 R
(151) 2019 08 16
(181) 2029 08 16
(260) AM 2018 99522 A
(220) 2018 09 26
(732) Alifard Co. (PJS)
№15, 12 Strit, Nors Kheradmand Ave.,
Teirani, 1585877814, Iran (Islamic Republic
of Iran)

(111) M 2019 31633 R
(151) 2019 08 16
(181) 2029 08 16
(260) AM 2018 99533 A
(220) 2018 09 27
(732) Alifard Co. (PJS)
№15, 12 Strit, Nors Kheradmand Ave.,
Teirani, 1585877814, Iran (Islamic Republic
of Iran)

(111) M 2019 31634 R
(151) 2019 08 16
(181) 2029 08 16
(260) AM 2018 99755 A
(220) 2018 10 08

(732) LTD "A1"

D. Aghmashenebeli St. 1, 1200, Tsaghveri,
Borjomi, Georgia

(111) M 2019 31635 R

(151) 2019 08 16

(181) 2029 08 16

(260) AM 2018 99756 A

(220) 2018 10 08

(732) GODIVA BELGIUM B.V.B.A./S.P.R.L.

Uapenstilstendstrat 5 (riu De L'armistis 5)
B-1080 Briuseli, Belgium

TRADEMARKS REGISTERED ACCORDING TO THE ACCELERATED PROCEDURE

The decision can be appealed at the Chamber of Appeal of Sakpatenti within 3 months from the publication.

(111) M 2019 31548 R

(151) 2019 08 09

(181) 2029 08 09

(210) AM 104221

(220) 2019 07 25

(732) JSC "TBC"

K. Marjanishvili St. 7, 0102, Tbilisi, Georgia

(740) Archil Gabatashvili

(541)

თიბისი კონცეპტი

(591) Black, white

(511) 36

(220) 2019 08 05

(732) JSC "Friends Cellar"

Village Shilda, 4816, Kvareli district,

Georgia

(541)

ცხრა კარი

Nine Gates

Девять Ворот

(591) Black, white

(511) 33

(111) M 2019 31609 R

(151) 2019 08 13

(181) 2029 08 13

(210) AM 104451

(220) 2019 08 08

(732) LTD XINYI AUTOMOBILE PARTS

COMPANY LIMITED

Xinyi Glass Industrial Zone, Guangyuan

Road, Wuqing Development Zone, Tianjin,

People's Republic of China, 301700, China

(740) Irakli Gvilia

(541)

SYG

(591) Black, white

(511) 12

(111) M 2019 31612 R

(151) 2019 08 15

(181) 2029 08 15

(210) AM 104405

(220) 2019 08 02

(732) LTD "Livu Salebrig Import&Exrport Co"

Police St. 13, Ap. 4a, Samgori District,

Tbilisi, Georgia

(540)



(591) Pink, green, white

(531) 26.01.18; 26.04.02; 26.04.07; 26.04.10;
26.04.22; 27.01.06; 29.01.15

(511) 35

(111) M 2019 31610 R

(151) 2019 08 14

(181) 2029 08 14

(210) AM 103958

(220) 2019 07 09

(732) LTD "GLOBAL BEER GEORGIA"

Vill. Tsilkani, 3319, Mtskheta Distict,

Georgia

(541)

ახალი დღე ახალი ისტორია

(591) Black, white

(511) 32, 35

(111) M 2019 31611 R

(151) 2019 08 15

(181) 2029 08 15

(210) AM 104422

INTERNATIONAL TRADEMARKS FOR WHICH A DECISION ON GRANTING PROTECTIONS IS TAKEN

The decision can be appealed at the Chamber of Appeal of Sakpatenti within 3 months from the publication or at the Mtskheta District Court Administrative Cases Board (Address: №17, Samkhedro str., Mtskheta), within 1 month following the publication.

(260) AM 2019 95729 A*
 (800) 1379458
 (151) 2017 10 21
 (891) 2017 10 21
 (731) adp Gauselmann GmbH
 Merkur-Allee 1-15,32339 Espelkamp,
 Germany
 (540)

Big Buck Bunny

(591) Black, white
 (511)
 9 – automatic lottery machines;

(260) AM 2019 96849 A*
 (800) 731115
 (151) 2000 03 08
 (891) 2018 02 08
 (731) Asclepion Laser Technologies GmbH
 Brüsseler Strasse 10, 07747 Jena, Germany
 (540)

ASCLEPION

(591) Black, white
 (511)
 9 – Lasers and laser devices not for medical purposes, accessories and parts for these laser devices, included in this class.

(260) AM 2019 97147 A*
 (800) 1104137
 (151) 2011 09 29
 (891) 2018 03 13
 (731) MUNICH, S.L.
 Camí de la Serra, s/n., (Vilanova d'Espoia),
 E-08789 Torre de Claramunt
 (BARCELONA), Spain
 (540)



MUNICH

(591) Black, white
 (531) 05.05.20; 24.13.09; 27.05.11

(511)
 25 – Sports and beach footwear; footwear; slippers; shoes; sports shoes; gymnastic shoes; half-boots; boots; boot uppers; football boots; studs for football boots; footwear uppers; soles for footwear; heels; non-slipping devices for shoes and boots; fittings of metal for shoes and boots; tips for footwear; welts for boots and shoes; heelpieces for boots and shoes; headgear; caps; hats; stockings; socks; sock suspenders; tee-shirts; short sleeve tee-shirts; jerseys (clothing); pull-overs; sweaters; clothing for gymnastics; outer clothing; items of clothing; suits.

(260) AM 2019 98333 A*
 (800) 1409699
 (151) 2018 01 26
 (891) 2018 01 26
 (731) Richter Gedeon Nyrt.
 Gyömrői út 19-21, H-1103 Budapest, Hungary
 (540)

ЭМИО

(591) Black, white
 (531) 28.05
 (511)
 5 – Pharmaceutical preparations.

(260) AM 2019 98335 A*
 (800) 1409710
 (151) 2018 04 11
 (891) 2018 04 11
 (731) Richter Gedeon Nyrt.
 Gyömrői út 19-21, H-1103 Budapest, Hungary
 (540)

МИАЛВА

(591) Black, white
 (531) 28.05
 (511)
 5 – Pharmaceutical preparations.

(260) AM 2019 98626 A*
 (800) 1413533
 (151) 2018 04 19
 (891) 2018 04 19
 (731) Piasten GmbH
 Piastenstraße 1, 91301 Forchheim, Germany

(540)

Treets
 THE PEANUT
 COMPANY

(591) Black, white

(531) 05.07.06; 26.01.06; 26.13.25; 27.05.09;
27.05.10

(511)

30 – Flavourings, other than essential oils, for beverages; baking powder; pastries; cookies; sweetmeats [candy]; sherbet lollipops (class 30); buns; bread; bread rolls; petit-beurre biscuits; corn flakes; dietetic foods not adapted for medical use, based on carbohydrates, with added dietary fibres, vitamins, minerals or trace elements, either singly or in combination, included in this class; ice cream; iced tea; peanut confectionery; fondants [confectionery]; fruit gum; fruit sauces; fruit jellies [confectionery]; groats for human food; tea-based beverages; spices; honey; frozen yoghurt [confectionery ices]; coffee; cocoa-based ingredients for confectionery products, cocoa, cocoa mixes, cocoa powder, cocoa spreads; cocoa-based beverages; candy for food; caramels [candy]; chewing gum (not for medical purposes); biscuits; crackers; cakes; cake powder; liquorice [confectionery]; stick liquorice [confectionery]; gingerbread; ice lollies; macaroons [pastry]; maltose; almond confectionery; marzipan; chocolate beverages with milk; lozenges [confectionery]; petit fours [cakes]; mint for confectionery; puddings; popcorn; chocolate; chocolate-based beverages; sherbet mixes ices; sherbets [ices]; edible ices; confectionery; foam gum [confectionery]; glucose for food, in the form of powder or pastilles; waffles; wine gum; sugared almonds; confectioneries; confectionery for decorating Christmas trees; rusks; chocolate confectionery; sugarcoated candy; coated nuts; coated almonds; coated chocolate.

(260) AM 2019 99281 A

(800) 1421851

(151) 2018 04 09

(891) 2018 04 09

(731) FUJIAN NEW YIFA GROUP CO., Ltd.
Xinhan Industrial Area, Hanjiang District,
Putian City, Fujian Province, China

(540)

Palmloye

(591) Black, white

(531) 27.03.01; 27.05.11

(511)

5 – Food for babies.

16 – copying paper [stationery]; paper sheets [stationery]; wrapping paper.

(260) AM 2019 99738 A

(800) 1426875

(151) 2018 07 02

(891) 2018 07 02

(731) Voronin Oleg Gennadyevich
ul. Valovaya, 21, korp. 125, kv. 25,
RU-115054 Moscow, Russian Federation

(540)

I AM STUDIO

(591) Black, white

(531) 27.05.01

(511)

14 – Jewelry, precious stones; amulets [jewelry]; bracelets [jewelry]; bracelets made of embroidered textile [jewellery]; jewellery charms; brooches [jewelry]; ornamental pins; beads for making jewelry; pearls made of ambroid [pressed amber]; key rings [split rings with trinket or decorative fob]; clasps for jewelry; necklaces [jewelry]; rings [jewelry]; presentation boxes for jewelry; lockets [jewelry]; earrings; paste jewelry [costume jewelry]; hat jewelry; chains [jewelry].

18 – Leather and imitations of leather; animal skins; travelling trunks; umbrellas; parasols; pocket wallets; business card cases; credit card cases [wallets]; chamois leather, other than for cleaning purposes; handbag frames; card cases [notecases]; cases of leather or leatherboard; valves of leather; imitation leather; leather, unworked or semi-worked; purses; chain mesh purses; bags [envelopes, pouches] of leather, for packaging; moleskin [imitation of leather]; travelling sets [leatherware]; garment bags for travel; shoulder belts [straps] of leather; briefcases; leather straps; straps of leather [saddlery]; rucksacks; travelling bags; handbags; beach bags; bags for sports; bags for campers; shopping bags; bags; suitcases; suitcases with wheels; valises; attaché cases; leather laces.

25 – Clothing, footwear, headgear; bandanas [neckerchiefs]; berets; overalls; boas [necklets]; boxer shorts; ankle boots; boots for sports; breeches for wear; trousers; valenki [felted boots]; collars [clothing]; detachable collars; shirt yokes; veils [clothing]; gabardines [clothing]; neckties; ascots; leggings [leg warmers]; gaiters; jerseys [clothing]; vests; sports jerseys; hosiery; heels; hoods [clothing]; hat frames [skeletons]; pockets for clothing; neck scarfs [mufflers]; kimonos; visors [headwear]; combinations [clothing]; suits; bathing suits; beach clothes; jackets [clothing]; stuff jackets [clothing]; leggings [trousers]; camisoles; sports singlets; coats; furs [clothing]; mittens; heelpieces for footwear; fur stoles; socks; sports shoes; outerclothing; ready-made clothing; clothing of imitations of leather; clothing of leather; waterproof clothing; fittings of metal for footwear; overcoats; parkas; pelerines; gloves [clothing]; pajamas; bat-

hing trunks; scarfs; pocket squares; dresses; headbands [clothing]; ready-made linings [parts of clothing]; dress shields; soles for footwear; half-boots; lace boots; sweaters; ponchos; belts [clothing]; money belts [clothing]; welts for footwear; shirts; wooden shoes; sandals; bath sandals; boots; jumper dresses; bath slippers; togas; knitwear [clothing]; slippers; shoes; tee-shirts; bath robes; tips for footwear; shawls; caps [headwear]; sashes for wear; hats; trouser straps; pelisses; esparto shoes or sandals; skirts; petticoats; skorts.

35 – Advertising; business management; rental of advertising space; demonstration of goods; marketing; updating of advertising material; provision of an on-line marketplace for buyers and sellers of goods and services; presentation of goods on communication media, for retail purposes; sales promotion for others, including retail or wholesale services; bill-posting; advertising by mail order; television advertising; procurement services for others [purchasing goods and services for other businesses], including retail or wholesale services.

(260) AM 2019 99812 A

(800) 1427337

(151) 2018 09 06

(891) 2018 09 06

(731) DAVINES S.p.A.

Via Ravasini, 9/A, I-43100 PARMA, Italy

(540)

LIQUID SPELL

(591) Black, white

(511)

3 – Hair care preparations; hair care solutions.

(260) AM 2019 99813 A

(800) 1427347

(151) 2018 02 08

(891) 2018 02 08

(731) Tovarishchestvo s ogranichennoi

otvetstvennostyu "Shine-Line"

Soultan Beibarys St., 24, selo Baiserke,

Ilyyskiy rayon, 040704 Almatinskaya oblast,

Kazakhstan

(540)



(591) Red and moutarde.

(531) 03.01.04; 03.04.07; 25.01.06; 25.05.05;

26.01.15; 29.01.12

(511)

29 – Eggs, milk and milk products; oils and fats for food; ajvar [preserved peppers]; aloe vera prepared for human consumption; alginates for culinary purposes; anchovy, not live; anchovies, processed; peanuts, prepared; albumen for culinary purposes; white of eggs; beans, preserved; soya beans, preserved, for food; bouillon; ginger jam; ham; fatty substances for the manufacture of edible fats; toasted laver; edible birds' nests; peas, preserved; mushrooms, preserved; game, not live; gelatine; meat jellies; jellies for food; fruit jellies; yolk of eggs; coconut fat; bone oil for food; lard; suet for food; edible fats; fruit-based snack food; charcuterie; raisins; caviar; fish roe, processed; yogurt; sauerkraut; kephir [milk beverage]; isinglass for food; clams, not live; milk shakes; black pudding; compotes; meat, tinned; vegetables, tinned; fish, tinned; fruits, tinned; bouillon concentrates; gherkins; shrimps, not live; prawns, not live; buttercream; croquettes; silkworm chrysalis for human consumption; kumys [milk beverage]; spiny lobsters, not live; lecithin for culinary purposes; salmon, not live; onions, preserved; margarine; marmalade; oils for food; peanut butter; cocoa butter for food; coconut oil for food; coconut butter; corn oil for food; sesame oil for food; linseed oil for food; olive oil for food; palm oil for food; palm kernel oil for food; sunflower oil for food; colza oil for food; butter; shellfish, not live; almonds, ground; animal marrow for food; mussels, not live; milk; condensed milk; albumin milk; soya milk; fish meal for human consumption; vegetable mousses; fish mousses; fruit pulp; meat; meat, preserved; milk beverages, milk predominating; vegetables, preserved; vegetables, dried; vegetables, cooked; potato fritters; olives, preserved; lobsters, not live; coconut, desiccated; nuts, prepared; tomato purée; liver pâté; pectin for culinary purposes; liver; pickles; jams; powdered eggs; milk products; kimchi [fermented vegetable dish]; food products made from fish; rennet; prostokvasha [soured milk]; poultry, not live; pollen prepared as foodstuff; cranberry compote; apple purée; crayfish, not live; crustaceans, not live; fish, preserved; fish, not live; salted fish; ryazhenka [fermented baked milk]; vegetable salads; fruit salads; bacon; sardines, not live; pork; herrings, not live; prepared seeds; sunflower seeds, prepared; cream [dairy products]; whipped cream; fat-containing mixtures for bread slices; smetana [sour cream]; tomato juice for cooking; vegetable juices for cooking; salted meats; sausages; sausages in batter; preparations for making bouillon; preparations for making soup; tripe; soups; vegetable soup preparations; whey; cheese; tahini [sesame seed paste]; tofu; sea-cucumbers, not live; truffles, preserved; tuna, not live; oysters, not live; milk

ferments for culinary purposes; rennet; fish fillets; dates; crystallized fruits; frozen fruits; fruit, preserved; fruit preserved in alcohol; fruit, stewed; potato flakes; hummus [chickpea paste]; fruit peel; preserved garlic; lentils, preserved; potato chips; low-fat potato chips; fruit chips; non-alcoholic eggnog; seaweed extracts for food; meat extracts; snail eggs for consumption; eggs; peanut milk-based beverages; almond milk-based beverages.

30 – Coffee, tea, cocoa, sugar, rice, tapioca and sago, artificial coffee; flour and preparations made from cereals, bread, pastries and confectionery, ice cream; honey, treacle; yeast, baking-powder; salt, mustard; vinegar, condiments; spices; edible ices; aromatic preparations for food; flavorings, other than essential oils, for cakes; flavorings, other than essential oils, for beverages; coffee flavorings; star aniseed; cereal bars; high-protein cereal bars; pancakes; noodle-based prepared meals; buns; bread rolls; vanillin [vanilla substitute]; vanilla flavorings for culinary purposes; waffles; vermicelli [noodles]; natural sweeteners; sausage binding materials; binding agents for ice cream; sea water for cooking; seaweed [condiment]; malt biscuits; cloves [spice]; cake frosting [icing]; glucose for culinary purposes; gluten additives for culinary purposes; yeast; thickening agents for cooking foodstuffs; leaven; rice-based snack food; cereal-based snack food; artificial coffee; vegetal preparations for use as coffee substitutes; dressings for salad; fruit jellies [confectionery]; confectionery for decorating Christmas trees; cakes; pastries; peanut confectionery; almond confectionery; pasta; ginger [spice]; frozen yogurt [confectionery ices]; cocoa; capers; caramels [candy]; curry [spice]; gruel, with a milk base, for food; ketchup [sauce]; quiches; gluten prepared as foodstuff; sweetmeats [candy]; liquorice [confectionery]; peppermint sweets; cinnamon [spice]; coffee; unroasted coffee; starch for food; crackers; custard; hominy grits; semolina; oatmeal; crushed barley; groats for human food; corn, milled; corn, roasted; meat pies; turmeric for food; couscous [semolina]; noodles; ice for refreshment; ice, natural or artificial; candy; rice cakes; mayonnaise; macarons [pastry]; macaroni; maltose; hominy; marinades; marzipan; honey; royal jelly; ice cream; bean meal; tapioca flour; potato flour; corn flour; flour; wheat flour; soya flour; barley meal; dessert mousses [confectionery]; chocolate mousses; muesli; mint for confectionery; cocoa beverages with milk; coffee beverages with milk; coffee-based beverages; tea-based beverages; chocolate beverages with milk; chocolate-based beverages; cocoa-based beverages; infusions, not medicinal; crushed oats; husked oats; nutmegs; stick liquorice [confectionery]; soya bean paste [condiment]; pastilles [confectionery]; molasses for food; pepper; allspice; peppers [seasonings]; pesto [sauce]; cookies; petit-beurre biscuits; pies; pizzas; meat gravies; fondants [confectionery];

popcorn; powders for making ice cream; baking powder; mustard meal; pralines; meat tenderizers for household purposes; cereal preparations; oat-based food; propolis; gingerbread; petits fours [cakes]; puddings; cake powder; fruit coulis [sauces]; ravioli; chewing gum; relish [condiment]; rice; wheat germ for human consumption; spring rolls; sago; sugar; palm sugar; aniseed; linseed for culinary purposes [seasoning]; golden syrup; golden syrup; cake dough; confectionery; baking soda [bicarbonate of soda for cooking purposes]; malt for human consumption; salt for preserving foodstuffs; cooking salt; celery salt; sherbets [ices]; ham glaze; soya sauce; tomato sauce; pasta sauce; sauces [condiments]; spaghetti; seasonings; preparations for stiffening whipped cream; rusks; breadcrumbs; sushi; sandwiches; tabbouleh; tacos; tapioca; cream of tartar for culinary purposes; cream of tartar for culinary purposes; tarts; dough; almond paste; tortillas; garden herbs, preserved [seasonings]; vinegar; beer vinegar; ferments for pastes; halvah; bread; unleavened bread; chips [cereal products]; corn flakes; oat flakes; chicory [coffee substitute]; tea; iced tea; chutneys [condiments]; cheeseburgers [sandwiches]; chow-chow [condiment]; saffron [seasoning]; chocolate; malt extract for food; essences for foodstuffs, except etheric essences and essential oils; husked barley; piccalilli.

31 – Grain and agricultural, horticultural and forestry products, not included in other classes; live animals; fresh fruits and vegetables; seeds; natural plants and flowers; animal foodstuffs; malt; algarovilla for animal consumption; oranges, fresh; peanuts, fresh; draff; beans, fresh; wreaths of natural flowers; grapes, fresh; algae for human consumption; algae for animal consumption; fruit residue [marc]; dog biscuits; peas, fresh; mushroom spawn for propagation; mushrooms, fresh; trees; palm trees; turf, natural; unsawn timber; undressed timber; yeast for animal consumption; Christmas trees; edible chews for animals; live animals; menagerie animals; oil cake; peanut cake for animals; maize cake for cattle; rape cake for cattle; bagasses of cane [raw material]; cereal seeds, unprocessed; grains [cereals]; grains for animal consumption; lime for animal forage; fish spawn; cocoa beans, raw; potatoes, fresh; chestnuts, fresh; copra; raw barks; rough cork; pet food; stall food for animals; bird food; strengthening animal forage; chicory roots; roots for animal consumption; nettles; groats for poultry; maize; edible sesame, unprocessed; shrubs; rose bushes; spiny lobsters, live; lemons, fresh; vine plants; onions, fresh; flower bulbs; leeks, fresh; olives, fresh; materials for animal bedding; bran mash for animal consumption; shellfish, live; almonds [fruits]; mussels, live; peanut meal for animals; linseed meal for animal consumption; meal for animals; flax meal [fodder]; rice meal for forage; fish meal for animal consumption;

straw mulch; beverages for pets; oats; vegetables, fresh; cucumbers, fresh; lobsters, live; nuts [fruits]; coconuts; kola nuts; bran; distillery waste for animal consumption; residue in a still after distillation; palms [leaves of the palm tree]; cuttle bone for birds; peppers [plants]; aromatic sand [litter] for pets; locust beans, raw; locust beans, raw; locust beans, raw; citrus fruit, fresh; mash for fattening livestock; animal fattening preparations; preparations for egg laying poultry; fishing bait, live; by-products of the processing of cereals, for animal consumption; seed germ for botanical purposes; poultry, live; wheat; pollen [raw material]; crayfish, live; crustaceans, live; seedlings; plants; aloe vera plants; plants, dried, for decoration; rhubarb, fresh; rice, unprocessed; rye; wheat germ for animal consumption; fish, live; lettuce, fresh; beet, fresh; linseed for animal consumption; hay; coconut shell; bred stock; sanded paper [litter] for pets; malt for brewing and distilling; straw [forage]; straw litter; salt for cattle; trunks of trees; wood chips for the manufacture of wood pulp; litter peat; garden herbs, fresh; sea-cucumbers, live; sugarcane; truffles, fresh; squashes, fresh; oysters, live; fruit, fresh; hazelnuts, fresh; fodder; hops; flowers, natural; flowers, dried, for decoration; chicory, fresh; silkworms; lentils, fresh; pine cones; hop cones; spinach, fresh; berries, fresh; juniper berries; eggs for hatching, fertilized; silkworm eggs; barley.

32 – Mineral and aerated waters and other non-alcoholic beverages; fruit beverages and fruit juices; syrups and other preparations for making beverages; aperitifs, non-alcoholic; lithia water; seltzer water; soda water; waters [beverages]; aerated water, mineral water [beverages]; table waters; kvass [non-alcoholic beverage]; cocktails, non-alcoholic; lemonades; non-alcoholic beverages; isotonic beverages; non-alcoholic honey-based beverages; aloe vera drinks, non-alcoholic; whey beverages; non-alcoholic fruit juice beverages; fruit nectars, non-alcoholic; orgeat; beer, ginger beer; malt beer; powders for effervescing beverages; sarsaparilla [non-alcoholic beverage]; syrups for lemonade; syrups for beverages; smoothies; tomato juice [beverage]; cider, non-alcoholic; vegetable juices [beverages]; fruit juices; preparations for making aerated water; preparations for making liqueurs; preparations for making mineral enriched water [beverages]; must; grape must, unfermented; beer wort; malt wort; pastilles for effervescing beverages; sherbets [beverages]; non-alcoholic fruit extracts; hop extracts for making beer; essences for making beverages.

35 – Advertising; business management; business administration; office functions; arranging subscriptions to telecommunication services for others; import-export agency services; commercial information agency services; advertising agency services; cost price analysis; rental of advertising space;

business auditing; employment agency services; computerized file management; book-keeping; invoicing; demonstration of goods; transcription of communications [office functions]; opinion polling; market studies; business information; business investigations; business research; marketing research; personnel recruitment; business organization consultancy; consultancy relating to business management and organization; personnel management consultancy; professional business consultancy; advertising and marketing services; marketing; business management of performing artists; business management of sports people; news clipping services; updating of advertising material; word processing; organization of exhibitions for commercial or advertising purposes; arranging newspaper subscriptions for others; organization of fashion shows for promotional purposes; organization of trade fairs for commercial or advertising purposes; shop window dressing; business appraisals; payroll preparation; data search in computer files for others; sponsorship search; business management assistance; commercial or industrial management assistance; presentation of goods on communication media, for retail purposes; economic forecasting; auctioneering; wholesale services for pharmaceutical, veterinary and sanitary preparations and medical supplies; retail services for pharmaceutical, veterinary and sanitary preparations and medical supplies; sales promotion for others; production of advertising films; office machines and equipment rental; rental of advertising time on communication media; publicity material rental; rental of vending machines; rental of photocopying machines; publication of publicity texts; radio advertising; bill-posting; bill-posting, distribution of samples; dissemination of advertising matter; direct mail advertising; writing of publicity texts; on-line advertising on a computer network; advertising by mail order; television advertising; document reproduction; compilation of statistics; compilation of information into computer databases; business inquiries; systemization of information into computer databases; business management consultancy services; tax preparation; drawing up of statements of accounts; advertising in periodicals, brochures and newspapers; telemarketing services; psychological testing for the selection of personnel; business management of hotels; commercial administration of the licensing of the goods and services of others; administrative processing of purchase orders; public relations; modelling for advertising or sales promotion; typing; relocation services for businesses; price comparison services; secretarial services; procurement services for others [purchasing goods and services for other businesses]; shorthand; outsourcing services [business assistance]; telephone answering for unavailable subscribers; photocopying services; business efficiency expert services.

(260) AM 2019 100107 A

(800) 1428654

(151) 2018 06 11

(891) 2018 06 11

(731) HELIOS Tovarna Barv,

Lakov In Umetnih Smol Količevo d.o.o.

Količevo 65, SI-1230 Domžale, Slovenia

(540)

Helios Refinish Communicator

(591) Black, white

(511)

2 – Acrylic and poliurethane coatings for waterproofing of roofs; epoxy primer; water-based epoxy primer; solvent-free epoxy coating; coatings, paints, varnish, lacquers, resin mixtures, colorants for floor coverings; glue dye; coloured paints for facades; dyestuffs; synthetic dyes; colorants for use in formulating paints; polymer colours; natural dyes; pigments; electrically conductive pigments for use in the manufacture of lacquers; organic pigments for the production of colouring matters; water dispersed pigments for use in colouring concrete; liquid colours; processed minerals for use as additives to colorants; colouring substances; mordants for use in industry; mordants [fixatives] in the nature of varnishes; paints and washes; varnishes; preservatives against rust and against deterioration of wood; materials for colouring ceramic substrates; materials for the decoration [coloration] of wood; coating materials for protection of surfaces exposed to galvanic corrosion; coating materials in the nature of oils; coating compositions for preserving stonework [paints]; coating compositions for preserving concrete [paints]; coating compositions for preserving masonry [paints]; coating compositions for application to concrete [paints or oils]; coating compositions for application to stonework [paints]; coating compositions for application to brickwork [paints or oils]; coating compositions having waterproofing properties [paints or oils]; coating compositions in the nature of oils; floor sealing compounds [paints and oils]; anti-weathering compositions; ingot mould coatings; coatings for the finishing of concrete; coatings for the finishing of surfaces [paints or oils]; coatings for the finishing of masonry [paints or oils]; coatings to protect stone from water [paints or oils]; coatings to protect concrete from water [paints or oils]; coatings for preventing staining [other than chemicals]; elastomer coatings for oil pipes; epoxy coatings; ground coatings [paints and oil]; coatings being intumescent [paints or oils, other than building materials]; finishing preparations for treating wood; corrosion inhibitors in the form of a coating, namely, resinous coatings for masonry surfaces; protective preparations for metals; antiquing treatments; coating preparations for protection against friction; coating preparations for protection against wear; coating

preparations having water repellent properties [paints or oils]; stabilising preparations in the nature of coatings; finishing products for waxes; powders in the nature of paint for use as coatings; silver paste; drying agents for paints; organic binding agents for paints; solvent dyes for wood; preparations for thinning lacquer; thinning preparations for paints and for coatings; thinners for dyestuffs; thinners for paints; thinners for varnishes; thinners for lacquers; primer thinners; binding agents for paints; bonding agents for lacquers; agglutinants for paints; sealant primers; thickeners for colours; thickeners for lacquers; UV-cured lacquers.

42 – Development, creation and installation of computer software application for web, Internet, and smart telephones; advising on the choice of decor, the design of decor, the choice of decorative products and the choice of colours for paints, varnishes, lacquers and wood stains; drawing up color schemes being design service; colour matching; design services; design consultancy; advisory services relating to interior design; information services relating to the combination of colours, paint and furnishings; software development; software creation; installation of computer software; maintenance of computer software; computer software design; software as a service; development and maintenance of computer software; consultancy relating to the updating of software; consultancy in the field of security software; software design for others; computer software development for others; consultancy relating to software maintenance; design, development and programming of computer software; computer software consultancy; quality assessment; quality control testing; quality control; certification [quality control]; product quality testing; quality control for others; product quality evaluation; quality control of manufactured goods; quality control testing services for industrial machinery; environmental hazard assessment; development of industrial processes; services for monitoring industrial processes.

(260) AM 2019 100117 A

(800) 1428926

(151) 2018 03 29

(891) 2018 03 29

(731) B&P I P Engineering Spółka Z Ograniczoną
Odpowiedzialnością Spółka Komandytowa
ul. Lubomirskich 1E, PL-37-200 Przeworsk,
Poland

(540)



(591) Blue and white.

(531) 24.17.09; 26.04.18; 27.05.19; 29.01.12

(511)

6 – Storage tanks of metal, juice storage metal tanks, concentrate storage metal tanks, aseptic metal tanks, metal pipes, steel structures.

7 – Food manufacturing machinery, machinery, machines and lines for the production of juices and juice concentrates made of fruits and vegetables, separators, presses, extruders, conveyors, mills, pumps, machines and lines for beverage manufacturing, filtration machines, ultrafiltration stations, tobacco processing machinery.

9 – Dispensers fining agents.

11 – Machinery and lines for pasteurization, sterilization, evaporators, pulp warmers, beverage cooling machines, steam generators and steam tanks, tobacco drying machines.

(260) AM 2019 100143 A

(800) 1429407

(151) 2018 05 10

(891) 2018 05 10

(731) Obshchestvo S Ogranichennoy
Otvetstvennostyu "TM Agromaster"
Proezd Severnyi (Kirovskiy rayon), 3/5,
ofis 1, Novosibirsk, RU-630088
Novosibirskaya oblast, Russian Federation

(540)



(591) Red, white, dark red and vinous.

(531) 26.04.03; 26.04.04; 26.04.12; 26.04.24;
26.11.02; 26.11.13; 28.05; 29.01.12

(511)

30 – Vermicelli [noodles]; pasta; cocoa; cocoa-based products; gruel, with a milk base, for food; coffee; hominy grits; semolina; oatmeal; crushed barley; groats for human food; corn, milled; corn, roasted; couscous [semolina]; noodles; macaroni; bean meal; potato flour; corn flour; flour; wheat flour; soya flour; barley meal; muesli; crushed oats; husked oats; cereal preparations; oat-based food; rice; wheat germ for human consumption; sugar; baking soda [bicarbonate of soda for cooking purposes]; malt for human consumption; cooking salt; spaghetti; tapioca; ferments for pastes; bread; unleavened bread; chips [cereal products]; corn flakes; oat flakes; tea; husked barley.

35 – Import-export agency services; commercial information agency services; advertising agency services; rental of advertising space; computerized

file management; demonstration of goods; opinion polling; market studies; business information; commercial information and advice for consumers [consumer advice shop]; business investigations; marketing research; business management and organization consultancy; business organization consultancy; business management consultancy; professional business consultancy; layout services for advertising purposes; business management of performing artists; news clipping services; updating of advertising material; word processing; organization of exhibitions for commercial or advertising purposes; arranging newspaper subscriptions for others; organization of trade fairs for commercial or advertising purposes; shop window dressing; data search in computer files for others; business management assistance; commercial or industrial management assistance; presentation of goods on communication media, for retail purposes; economic forecasting; auctioneering; promoting the goods and services of others; wholesale and retail sales services, including via Internet; publication of publicity texts; distribution of samples; dissemination of advertising matter; writing of publicity texts; advertising; on-line advertising on a computer network; advertising by mail order; television advertising; compilation of information into computer databases; the bringing together, for the benefit of others, of a variety of goods (excluding the transport thereof), enabling customers to conveniently view and purchase those goods provided by retail and wholesale stores, pharmacies, mail order catalogues or by means of electronic media, including through web sites or television shopping programmes; business inquiries; systemization of information into computer databases; copywriting for newspapers; administrative processing of purchase orders; price comparison services; procurement services for others [purchasing goods and services for other businesses].

39 – Rental of warehouses; delivery of goods; delivery of goods by mail order; hauling; lighterage services; ferry-boat transport; armored-car transport of valuables; bus transport; car transport; barge transport; boat transport; railway transport; marine transport; passenger transport; river transport; portering; stevedoring; unloading cargo; packaging of goods; wrapping of goods; storage of goods; storage.

(260) AM 2019 100146 A

(800) 1429527

(151) 2018 08 03

(891) 2018 08 03

(731) Joint Stock Company United Chemical
Company Uralchem
Presnenskaya nab., 6, bld. 2, Moscow,
RU-123112, Russian Federation

(540)

SOLAR

(591) Black, white

(531) 05.07.11; 05.07.22; 05.07.24; 05.09.03;
05.09.15; 05.09.17; 05.09.24; 05.09.24;
27.03.11; 27.05.01; 27.05.08

(511)

1 – Fertilizers.

(260) AM 2019 100173 A

(800) 1430166

(151) 2018 06 05

(891) 2018 06 05

(731) LAARA INTERPRISES LIMITED

Suite 1003, Khalid Al Attar Tower, P.O. Box
No 71241, Sheikh Zayed Road, Dubai, United
Arab Emirates

(540)



(591) Red, yellow and green.

(531) 05.05.20; 05.05.21; 29.01.13

(511)

3 – Depilatory preparations; non-medicated dentifrices; perfumery; bleaching preparations and other substances for laundry use; scouring preparations; abrasive preparations; abrasives; cosmetics; amber [perfume]; descaling preparations for household purposes; antistatic preparations for household purposes; aromatics [essential oils]; air fragrancing preparations; cake flavorings [essential oils]; flavorings for beverages [essential oils]; food flavourings [essential oils]; breath freshening sprays; canned pressurized air for cleaning and dusting purposes; balms, other than for medical purposes; lip glosses; polishing stones; abrasive paper; emery paper; polishing paper; petroleum jelly for cosmetic purposes; shoe polish; cobblers' wax; cotton wool for cosmetic purposes; sachets for perfuming linen; drying agents for dishwashing machines; adhesives for cosmetic purposes; scented water; Javelle water; lavender water; toilet water; wax for parquet floors; floor wax; non-slipping wax for floors; depilatory wax; mustache wax; tailors' wax; creams for leather; waxes for leather; polish for furniture and flooring;

shoemakers' wax; polishing wax; massage gels, other than for medical purposes; heliotropine; dental bleaching gels; geraniol; make-up; deodorants for pets; deodorants for human beings or for animals; scented wood; perfumes; non-slipping liquids for floors; windshield cleaning liquids; greases for cosmetic purposes; volcanic ash for cleaning; decorative transfers for cosmetic purposes; ionone [perfumery]; shaving stones [astringents]; smoothing stones; eyebrow pencils; cosmetic pencils; silicon carbide [abrasive]; carbides of metal [abrasives]; alum stones [astringents]; tripoli stone for polishing; adhesives for affixing false eyelashes; adhesives for affixing false hair; hair conditioners; quillaia bark for washing; corundum [abrasive]; beard dyes; colorants for toilet purposes; cosmetic dyes; laundry starch; laundry glaze; shoe cream; polishing creams; cosmetic creams; skin whitening creams; polishing rouge; incense; hair spray; nail polish; hair lotions; lotions for cosmetic purposes; after-shave lotions; beauty masks; oils for perfumes and scents; oils for cosmetic purposes; oils for toilet purposes; essential oils; essential oils of cedarwood; essential oils of lemon; essential oils of citron; oils for cleaning purposes; bergamot oil; gaultheria oil; jasmine oil; lavender oil; almond oil; rose oil; oil of turpentine for degreasing; whiting; cleaning chalk; almond milk for cosmetic purposes; cleansing milk for toilet purposes; musk [perfumery]; deodorant soap; shaving soap; soap for brightening textile; cakes of toilet soap; antiperspirant soap; soap for foot perspiration; soap; almond soap; mint for perfumery; cosmetic kits; emery; nail art stickers; false nails; eau de Cologne; bases for flower perfumes; joss sticks; pastes for razor strops; pumice stone; lipstick cases; hydrogen peroxide for cosmetic purposes; breath freshening strips; teeth whitening strips; abrasive cloth; glass cloth [abrasive cloth]; lipsticks; pomades for cosmetic purposes; shaving preparations; cosmetic preparations for baths; bath preparations, not for medical purposes; hair straightening preparations; hair waving preparations; laundry soaking preparations; grinding preparations; smoothing preparations [starching]; color-removing preparations; leather bleaching preparations; polishing preparations; denture polishes; mouthwashes, not for medical purposes; cosmetic preparations for slimming purposes; starch glaze for laundry purposes; refurbishing preparations; eye-washes, not for medical purposes; fabric softeners for laundry use; laundry bleach; dry-cleaning preparations; paint stripping preparations; lacquer-removing preparations; make-up removing preparations; floor wax removers [scouring preparations]; varnish-removing preparations; rust removing preparations; nail care preparations; cleaning preparations; preparations for cleaning dentures; wallpaper cleaning preparations; preparations for unblocking drain pipes; collagen preparations for cosmetic purposes; laundry prepara-

tions; aloe vera preparations for cosmetic purposes; sunscreen preparations; color- [colour-] brightening chemicals for household purposes [laundry]; shining preparations [polish]; make-up powder; diamantine [abrasive]; stain removers; nail varnish removers; vaginal washes for personal sanitary or deodorant purposes; scouring solutions; false eyelashes; tissues impregnated with cosmetic lotions; tissues impregnated with make-up removing preparations; safrol; laundry blueing; turpentine for degreasing; potpourris [fragrances]; bleaching soda; washing soda, for cleaning; bath salts, not for medical purposes; bleaching salts; fumigation preparations [perfumes]; preservatives for leather [polishes]; ammonia [volatile alkali] [detergent]; astringents for cosmetic purposes; eyebrow cosmetics; make-up preparations; sun-tanning preparations [cosmetics]; hair dyes; neutralizers for permanent waving; preparations to make the leaves of plants shiny; cosmetic preparations for eyelashes; cosmetic preparations for skin care; shoe wax; cosmetics for animals; mascara; cleansers for intimate personal hygiene purposes, non medicated; detergents, other than for use in manufacturing operations and for medical purposes; degreasers, other than for use in manufacturing processes; bleaching preparations [decolorants] for cosmetic purposes; antiperspirants [toiletries]; toiletry preparations; phytocosmetic preparations; talcum powder, for toilet use; cotton sticks for cosmetic purposes; terpenes [essential oils]; emery cloth; cloths impregnated with a detergent for cleaning; henna [cosmetic dye]; shampoos for animals [non-medicated grooming preparations]; shampoos for pets [non-medicated grooming preparations]; dry shampoos; shampoos; sandpaper; soda lye; herbal extracts for cosmetic purposes; extracts of flowers [perfumes]; ethereal essences; badian essence; mint essence [essential oil]; douching preparations for personal sanitary or deodorant purposes [toiletries]; chemical cleaning preparations for household purposes; air fragrance reed diffusers; bleaching preparations [decolorants] for household purposes; massage candles for cosmetic purposes; cosmetics for children; breath freshening preparations for personal hygiene.

(260) AM 2019 100174 A

(800) 1430187

(151) 2018 07 12

(891) 2018 07 12

(731) CHINA KWEICHOW MOUTAI
DISTILLERY (GROUP) CO., LTD.
No. 4 East Mountain Lane, East Road of
Outside Loop, Guiyang City, Guizhou
Province, China

(540)

MOUTAI

(591) Black, white

(511)

33 – Fruit extracts, alcoholic; alcoholic liquid; alcoholic beverages; alcoholic beverages [except beers]; aperitifs; bitters; cooking wine; wine; edible alcohol; digesters [liqueurs and spirits].

(260) AM 2019 100178 A

(800) 1430256

(151) 2018 07 30

(891) 2018 07 30

(731) MULLER ET CIE

107 boulevard Ney, F-75018 PARIS, France

(540)

AIRELEC

(591) Gray and raspberry

(531) 27.05.01; 29.01.12

(511)

9 – Apparatus for the control, remote control and regulation of heating apparatus; electric and electronic enclosures for the regulation of heating apparatus; thermostats; apparatus and instruments for regulating and controlling electricity; electric power failure devices, electric resistors, electric switches; temperature monitoring devices for household and industrial use; wireless controllers for remote monitoring and controlling of the operating and condition of heating and water heater apparatus; thermostat control apparatus; automatic, electronic and electric control apparatus and devices for heating and water heater apparatus; thermostat controllers; heat-sensitive identification indicators; electric and electronic programming units for heating apparatus and water heaters.

11 – Apparatus and installations for heating, lighting, steam generating, cooking, refrigerating, drying, ventilation, air conditioning, water supply and sanitary facilities; heat pumps; apparatus for the recovery, concentration and/or separation of heat and/or cold; boilers, water heaters; pressure regulators for water heaters; radiators, heating panels, convectors; air-conditioning installations and apparatus; heating cables; drying apparatus and installations; towel driers; hair driers; hand driers; radiators for heating in the form of panels; heat and steam accumulators; temperature regulators for heating radiators; hydraulic network for heating or cooling (panels or boards); apparatus for producing heat or cooling using the magnetocaloric effect.

37 – Advice and information relating to air conditioning and heating installations; installation, maintenance and repair of apparatus for heating, air-conditioning, steam generation, cooking, refrigerating, drying, ventilation, water supply and sanitary facilities.

(260) AM 2019 100179 A

(800) 1430281

(151) 2018 06 26

(891) 2018 06 26

(731) LVMH Swiss Manufactures SA

Rue Louis-Joseph Chevrolet 6a, CH-2300 La
Chaux-de-Fonds, Switzerland

(540)



(591) Green and red

(531) 24.01.05; 24.01.15; 27.05.24; 29.01.14

(511)

9 – Scientific (other than for medical use), nautical, surveying, photographic, cinematographic, optical, weighing, measuring, signaling, checking (supervision), life-saving and teaching apparatus and instruments; apparatus for recording, transmission, reproduction or processing of sound or images; digital recording media; calculating machines, equipment for data processing and computers; timing instruments; counters; timers; chronographs; game software; software (recorded programs); computer peripheral devices; telephones, tablet computers, MP3 players; accessories for computers, telephones, tablet computers, MP3 players; covers for tablet computers; communication apparatus and computers; wearable computers; wearable computers; connected watches; smartwatches; wearable digital electronic devices comprised of a wristwatch, wrist band or bracelet and also featuring a telephone, software and display screens for viewing, sending and receiving sound, electronic mails and messages, texts, data, pictures and information from and/or to personal digital assistants, smart phones, tablets, and computers and other telecommunication machines, software applications for wearable electronic devices; smartphones featuring a watch; wearable electronic devices in the form of watch straps, bracelets or cuffs also providing the functions of a watch enabling access to the Internet and/or any other communication system and the sending and receiving of telephone calls, e-mails and electronic messages and enabling the reception, storage and wireless transmission of data and messages; accessories for such wearable electronic devices including casings, batteries, chargers, microphones, video cameras, all included in class 9; spectacles (optics), sunglasses; optical goods; spectacle cases; diagnostic apparatus not for medical use; integrated circuit cards [smart cards]; downloadable electronic publications; sensors, monitors and displays in the field of health, fitness, exercise and wellness,

sporting and cultural activities, entertainment, education and training, tourism and security, other than for medical use; covers for tablet computers other than of precious metal; connected bracelets and connected cuffs (measuring apparatus) that also have a function of transmitting, sending and/or receiving data to and/or from personal digital assistants, tablets, smart phones and personal computers through Internet websites and other computer and electronic communication networks.

38 – Telecommunications; information on telecommunications; communications by computer terminals or by fiber-optic networks; electronic bulletin board services (telecommunication services).

41 – Providing information in the fields of sporting and cultural activities, fitness, exercise, sports, entertainment, education and training; timing of sports events; services for timing of sports events.

42 – Evaluations, assessments and research in the fields of science and technology provided by engineers; design and development of computers and software; research and development of new products for others; technical project studies; architectural services; design of interior decor; development (design), installation, maintenance, updating or rental of software; computer programming; consultancy relating to computers; conversion of computer programs and data, other than physical conversion; conversion of data or documents from physical to electronic media; vehicle roadworthiness testing; graphic arts designing; styling (industrial design).

(260) AM 2019 100180 A

(800) 1430354

(151) 2018 08 15

(891) 2018 08 15

(731) Apple Inc.

One Apple Park Way, Cupertino CA
95014, USA

(540)

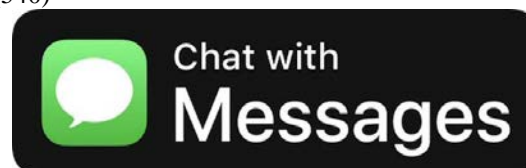

(591) The color(s) green, white and black is/are claimed as a feature of the mark.

(531) 01.15.21; 26.04.07; 26.04.18; 29.01.13

(526) Messages

(511)

38 – Communication services, namely, transmission of text, data, images, video and other digital content by wireless communication networks and the Internet; electronic messaging and wireless digital messaging services.

(260) AM 2019 100181 A

(800) 1430388

(151) 2018 05 08

(891) 2018 05 08

(731) FOOD COMMERCE S.R.L.

Via Livatino, 6/III, I-84083 CASTEL SAN
GIORGIO, Italy

(540)



(591) Green (100% cyan and 100% yellow), white,
red (100% magenta and 100% yellow), blue
(pantone 289 C) and gold (pantone 871 U).

(531) 24.07.23; 25.01.06; 26.04.06; 26.04.22;
26.04.24; 27.05.11; 27.05.24; 29.01.15

(511)

29 – Meat, fish, poultry and game; meat extracts;
preserved, frozen, dried and cooked fruits and
vegetables; jellies, jams, compotes; eggs; milk and
milk products; edible oils and fats.

30 – Coffee, tea, cocoa and artificial coffee; rice;
tapioca and sago; flour and preparation made from
cereals; bread, pastries and confectionery; edible
ices; sugar, honey, treacle; yeast, baking-powder;
salt; mustard; vinegar, sauces (condiments); spices;
ice.

(260) AM 2019 100242 A

(800) 1431347

(151) 2018 06 05

(891) 2018 06 05

(731) Public Joint Stock Company «GAZ»

Prospect Lenina, 88, RU-603004 Nizhny
Novgorod, Russian Federation

(540)



(591) Black, white

(531) 03.04.07; 03.04.24; 27.05.17

(511)

16 – Fountain pens; albums; scrapbooks; almanacs;
posters; tickets; forms, printed; announcement cards
[stationery]; loose-leaf binders; pads [stationery];
wristbands for the retention of writing instruments;
pamphlets; booklets; wrapping paper; packing paper;

filter paper; newsletters; signboards of paper or
cardboard; newspapers; document holders
[stationery]; pencil holders; page holders; holders for
checkbooks [cheque books]; advertisement boards of
paper or cardboard; magazines [periodicals]; money
clips; tags for index cards; pen clips; bookmarkers;
printed publications; graphic representations; calen-
dars; tracing patterns; pencils; pencil lead holders;
pictures; transfers [decalcomanias]; decalcomanias;
paintings [pictures], framed or unframed; cards;
charts; trading cards, other than for games;
catalogues; paintbrushes; printing blocks; books;
manifolds [stationery]; comic books; envelopes
[stationery]; boxes of paper or cardboard; gummed
tape [stationery]; adhesive bands for stationery or
household purposes; self-adhesive tapes for
stationery or household purposes; flyers; humidity
control sheets of paper or plastic for foodstuff
packaging; viscose sheets for wrapping; sheets of
reclaimed cellulose for wrapping; plastic bubble
packs for wrapping or packaging; lithographs;
postage stamps; graphic prints; teaching materials
[except apparatus]; sealing compounds for stationery
purposes; packing [cushioning, stuffing] materials of
paper or cardboard; filtering materials [paper]; bags
[envelopes, pouches] of paper or plastics, for
packaging; stickers [stationery]; bottle envelopes of
paper or cardboard; covers [stationery]; wrappers
[stationery]; plastic cling film, extensible, for
palletization; greeting cards; etchings; conical paper
bags; folders for papers; jackets for papers; pen
cases; boxes for pens; seals [stamps]; sealing
stamps; clipboards; plastic film for wrapping; desk
mats; mats for beer glasses; stands for pens and
pencils; paperweights; writing cases [sets]; writing
materials; printed matter; prospectuses; rubber
erasers; graphic reproductions; penholders; marking
pens [stationery]; placards of paper or cardboard;
writing or drawing books; fabrics for bookbinding;
transparencies [stationery]; stencil plates; bottle
wrappers of paper or cardboard; manuals [hand-
books]; handbooks [manuals]; flags of paper; photo-
engravings; photographs [printed]; stencil cases;
blueprints; plans; stencils; shields [paper seals].

28 – Toy vehicles; jigsaw puzzles; toys; stuffed toys;
mobiles [toys]; practical jokes [novelties]; parlor
games; parlour games; board games; games;
building games; kaleidoscopes; playing cards;
fairground ride apparatus; swings; toy models; scale
model kits [toys]; scale model vehicles; ornaments
for Christmas trees, except illumination articles and
confectionery; apparatus for games; play balloons.

35 – Arranging subscriptions to telecommunication
services for others; rental of advertising space; book-
keeping; accounting; demonstration of goods;
organization of exhibitions for commercial or adver-
tising purposes; organization of trade fairs for com-
mercial or advertising purposes; shop window dres-

sing; design of advertising materials; presentation of goods on communication media, for retail purposes; sales promotion for others; production of advertising films; rental of billboards [advertising boards]; billposting; outdoor advertising; distribution of samples; dissemination of advertising matter; direct mail advertising; advertising; publicity; on-line advertising on a computer network; television advertising; commercial administration of the licensing of the goods and services of others; procurement services for others [purchasing goods and services for other businesses].

37 – Rebuilding engines that have been worn or partially destroyed; rebuilding machines that have been worn or partially destroyed; vehicle battery charging; vehicle washing; rustproofing; anti-rust treatment for vehicles; vehicle maintenance; vehicle polishing; vehicle breakdown repair services; rental of bulldozers; motor vehicle maintenance and repair; vehicle lubrication [greasing]; vehicle greasing; vehicle lubrication; installation, maintenance and repair of computer hardware; machinery installation, maintenance and repair.

39 – Motor coach rental; parking place rental; delivery of goods; wrapping of goods; car parking; storage of goods.

41 – Game services provided on-line from a computer network; film production, other than advertising films; on-line publication of electronic books and journals.

42 – Research and development of new products for others; engineering; technical research; calibration [measuring]; technological consultancy; vehicle roadworthiness testing; creating and maintaining web sites for others; outsource service providers in the field of information technology; packaging design; surveying.

(260) AM 2019 100245 A
 (800) 1431439
 (151) 2018 07 26
 (891) 2018 07 26
 (731) SAILUN JINYU GROUP CO., LTD.
 No. 588, Maoshan Road, Huangdao District,
 Qingdao City, Shandong, China
 (540)



(591) Black, white
 (531) 26.03.23; 26.05.10
 (511)
 12 – Inner tubes for pneumatic tires; tires for vehicle wheels; casings for pneumatic tires [tyres]; spikes

for tyres; treads for retreading tires; pneumatic tyres; automobile tires; solid tyres for vehicle wheels; inner tubes for bicycle tires; repair outfits for inner tubes.

(260) AM 2019 100246 A
 (800) 1431442
 (151) 2018 09 26
 (891) 2018 09 26
 (731) DAW SE
 Roßdörfer Str. 50, 64372 Ober-Ramstadt,
 Germany
 (540)

Histolith PremiumSilikat

(591) Black, white
 (511)
 1 – Industrial chemicals; preservative and damp-proofing preparations for masonry, roofing tiles, cement and concrete, except paints and oils; artificial resins; synthetic resins and unprocessed plastics; solvents (chemicals); solvents for varnishes and lacquers; adhesives used in industry; adhesives for wallpaper; adhesives used in building; filler for the treatment of subsurfaces for paints (not included in other classes).

2 – Paints; varnishes; lacquers; glazes; coatings; preservatives against rust; primers; colorants; dyestuffs; dye pastes; mordants; paint thickeners; fixatives; siccatives for paints; raw natural resins; thinning and binding preparations for paints and lacquers; solvents for thinning paints; preparations for preserving wood; wood mordants and wood preserving oils; paints, including structuring paints; bactericidal and/or fungicidal paints; anti-corrosion preparations; protective preparations for metals; metals in foil and powder form for painters, decorators, printers and artists.

19 – Building materials, not of metal or mainly not of metal, in particular profile rails and corner irons, finishing profiles; adjusting and levelling parts, spacers for building, sills, all not of metal or mainly not of metal; natural and artificial stone; mortar (building materials); quartz; plaster [building materials]; coatings; wall and ceiling panels (not of metal or mainly not of metal, for building); fabric embedding compounds for building; fillers (building materials); fabrics for building, not of metal or mainly not of metal, in particular stabilising fabrics.

(260) AM 2019 100248 A
 (800) 1431460
 (151) 2018 09 26
 (891) 2018 09 26
 (731) DAW SE
 Roßdörfer Str. 50, 64372 Ober-Ramstadt,
 Germany

(540)

Histolith Sol-Silikat

(591) Black, white

(511)

1 – Industrial chemicals; preservative and damp-proofing preparations for masonry, roofing tiles, cement and concrete, except paints and oils; artificial resins; synthetic resins and unprocessed plastics; solvents (chemicals); solvents for varnishes and lacquers; adhesives used in industry; adhesives for wallpaper; adhesives used in building; filler for the treatment of subsurfaces for paints (not included in other classes).

2 – Paints; varnishes; lacquers; glazes; coatings; preservatives against rust; primers; colorants; dyestuffs; dye pastes; mordants; paint thickeners; fixatives; siccatives for paints; raw natural resins; thinning and binding preparations for paints and lacquers; solvents for thinning paints; preparations for preserving wood; wood mordants and wood preserving oils; paints, including structuring paints; bactericidal and/or fungicidal paints; anti-corrosion preparations; protective preparations for metals; metals in foil and powder form for painters, decorators, printers and artists.

19 – Building materials, not of metal or mainly not of metal, in particular profile rails and corner irons, finishing profiles; adjusting and levelling parts, spacers for building, sills, all not of metal or mainly not of metal; natural and artificial stone; mortar (building materials); quartz; plaster [building materials]; coatings; wall and ceiling panels (not of metal or mainly not of metal, for building); fabric embedding compounds for building; fillers (building materials); fabrics for building, not of metal or mainly not of metal, in particular stabilising fabrics.

(260) AM 2019 100250 A

(800) 1431468

(151) 2018 09 26

(891) 2018 09 26

(731) DAW SE

Roßdörfer Str. 50, 64372 Ober-Ramstadt,
Germany

(540)

Histolith Kristallin

(591) Black, white

(511)

1 – Industrial chemicals; preservative and damp-proofing preparations for masonry, roofing tiles, cement and concrete, except paints and oils; artificial resins; synthetic resins and unprocessed plastics; solvents (chemicals); solvents for varnishes and lacquers; adhesives used in industry; adhesives for wallpaper; adhesives used in building; filler for the

treatment of subsurfaces for paints (not included in other classes).

2 – Paints; varnishes; lacquers; glazes; coatings; preservatives against rust; primers; colorants; dyestuffs; dye pastes; mordants; paint thickeners; fixatives; siccatives for paints; raw natural resins; thinning and binding preparations for paints and lacquers; solvents for thinning paints; preparations for preserving wood; wood mordants and wood preserving oils; paints, including structuring paints; bactericidal and/or fungicidal paints; anti-corrosion preparations; protective preparations for metals; metals in foil and powder form for painters, decorators, printers and artists.

19 – Building materials, not of metal or mainly not of metal, in particular profile rails and corner irons, finishing profiles; adjusting and levelling parts, spacers for building, sills, all not of metal or mainly not of metal; natural and artificial stone; mortar (building materials); quartz; plaster [building materials]; coatings; wall and ceiling panels (not of metal or mainly not of metal, for building); fabric embedding compounds for building; fillers (building materials); fabrics for building, not of metal or mainly not of metal, in particular stabilising fabrics.

(260) AM 2019 100251 A

(800) 1431472

(151) 2018 09 27

(891) 2018 09 27

(731) UAB ATLANTIC DUTY FREE

Mokyklos G1, Mokuolu K. Sunsku Sen.,
LT-68461 Marijampoles Sav, Lithuania

(540)

FUERST POTEMKIN

(591) Black, white

(511)

33 – Alcoholic beverages (except beers).

(260) AM 2019 100257 A

(800) 1431520

(151) 2018 07 11

(891) 2018 07 11

(731) ARCOS HERMANOS, S.A.

Poligono Industrial Campollano, C/B Num. 7,
E-02006 ALBACETE, Spain

(540)



(591) Black, white
 (531) 11.01.01; 11.01.03; 28.05
 (511)
 37 – Knife sharpening; sharpening of scissors and kitchen knives; providing information relating to the sharpening of scissors and kitchen knives.

(260) AM 2019 100258 A
 (800) 1431522
 (151) 2018 09 24
 (891) 2018 09 24
 (731) Limited Liability Company «ORIMI»
 1-st Microrayon Street, 15/4 plot,
 Vsevolozhsk district, Sverdlov factory
 settlement, RU-188682 Leningrad oblast,
 Russian Federation

(540)
**PRINCESS
 JAVA**

(591) Black, white
 (511)
 30 – Tea; iced tea; tea-based beverages.

(260) AM 2019 100261 A
 (800) 1431541
 (151) 2018 09 24
 (891) 2018 09 24
 (731) Limited Liability Company «ORIMI»
 1-st Microrayon Street, 15/4 plot,
 Vsevolozhsk district, Sverdlov factory
 settlement, RU-188682 Leningrad oblast,
 Russian Federation

(540)
**ПРИНЦЕССА
 КАНДИ**

(591) Black, white
 (531) 28.05
 (511)
 30 – Tea; iced tea; tea-based beverages.

(260) AM 2019 100263 A
 (800) 1431564
 (151) 2018 09 24
 (891) 2018 09 24
 (731) Limited Liability Company «ORIMI»
 1-st Microrayon Street, 15/4 plot,
 Vsevolozhsk district, Sverdlov factory
 settlement, RU-188682 Leningrad oblast,
 Russian Federation

(540)
**ПРИНЦЕССА
 ЯВА**

(591) Black, white
 (531) 28.05
 (511)
 30 – Tea; iced tea; tea-based beverages.

(260) AM 2019 100264 A
 (800) 1431603
 (151) 2018 05 14
 (891) 2018 05 14
 (731) Limited Liability Company Wine
 and Brandy Factory "Alliance-1892"
 Gogolya st., 9A, Chernyakhovsk, RU-238150
 Kaliningrad region, Russian Federation

(540)

(591) Black, white
 (531) 01.01.02; 01.01.10; 28.05
 (511)
 32 – Beer; mineral and aerated waters and other non-alcoholic beverages; fruit beverages and fruit juices; syrups and other preparations for making beverages; aperitifs, non-alcoholic; waters; kvass [non-alcoholic beverage]; cocktails, non-alcoholic; lemonades; non-alcoholic beverages; isotonic beverages; whey beverages; fruit juice beverages; fruit nectars; orgeat; powders for effervescing beverages; sarsaparilla [non-alcoholic beverage]; syrups for lemonade; syrups for beverages; tomato juice; cider, non-alcoholic; vegetable juices; fruit juices; preparations for making aerated water; preparations for making liqueurs; essences for making flavoured mineral water; preparations for making beverages; must; unfermented grape must; beer wort; malt wort; pastilles for effervescing beverages; non-alcoholic fruit extracts; extracts of hops for making beer; essences for making beverages.

33 – Alcoholic beverages (except beers); aperitifs; arrack [arak]; brandy; wine; piquette; whisky; vodka; gin; digesters; cocktails; liqueurs; alcoholic beverages; alcoholic beverages containing fruit; spirits [beverages]; distilled beverages; mead; peppermint liqueurs; bitters; rum; sake; cider; rice alcohol; alcoholic extracts; fruit extracts, alcoholic; alcoholic essences.

(260) AM 2019 100265 A
 (800) 1431611
 (151) 2018 09 25
 (891) 2018 09 25
 (731) RAHMANI GROUP S.p.A.
 Largo Guido Donegani, 2, I-20121 MILANO,
 Italy

(540)
GOLVERDI

(591) Black, white

(511)

30 – Pasta; deep frozen pasta; alimentary paste [dough]; instant noodles; fresh pasta; puff pastry; almond paste; pasta containing stuffings; pasta salad; pasta sauce; bread doughs; ready-made dishes containing pasta; spaghetti; prepared meals containing [principally] pasta; vinegar; flavoured vinegar; wine vinegar; fruit vinegar; tomato sauce; canned spaghetti in tomato sauce; sauces; sauces [condiments]; food dressings [sauces]; meat pies; meat gravies; canned sauces; canned pasta foods; boxed lunches consisting of rice, with added meat, fish or vegetables; pre-packaged lunches consisting primarily of rice, and also including meat, fish or vegetables; vegetal preparations for use as coffee substitutes; vegetable concentrates used for seasoning; vegetable pies; vegetable purees [sauces]; frozen pastry stuffed with vegetables; stir-fried noodles with vegetables (japchae); filled yeast dough with fillings consisting of vegetables; bibimbap [rice mixed with vegetables and beef]; frozen pastry stuffed with meat and vegetables; frozen prepared rice with seasonings and vegetables; pizzas; fresh pizza; pizzas [prepared]; preserved pizzas; frozen pizzas; chilled pizzas; uncooked pizzas; pizza dough; pizza crust; pizza bases; bread; wholemeal bread; malt biscuits; rusks; crackers; brioches; tarts; pastries; cream pies; apple tarts; dumplings; cake batter; candy cake; fresh pies; fruit cakes; salted tarts; cakes; ice cream stick bars; ice cream confectionery; chilled desserts; edible ices; sour dough; wholemeal pasta; ice confectionery; chocolate extracts for the preparation of beverages; coffee essences; essences for foodstuffs, except etheric essences and essential oils; spices; seasoning mixes; fruit jellies [confectionery]; caramels [candy]; yeast powder; baking powder; yeast and leavening agents; spiced salt; salt; yeast; sugar; chili oil for use as a seasoning or condiment; prepared rice dishes; prepared pizza meals; dry and liquid ready-to-serve meals, mainly consisting of pasta; candy; bakery goods; biscotti dough; cereal bars and energy bars; snack bars containing a mixture of grains, nuts and dried fruit [confectionery]; gingerbread nuts; food mixtures consisting of cereal flakes and dried fruits; sweet rice with nuts and jujubes (yaksik); ginger puree; ginger [spice]; preserved ginger; ginger tea; cereal-based snack food; cereals; pastries, cakes, tarts and biscuits (cookies); cereal powders; cereal bars; cereal preparations; processed grains; breakfast cereals, porridge and grits; breakfast cereals; chips [cereal products]; cereal based food bars; cereal based energy bars; preparations made from cereals; muesli; muesli consisting predominantly of cereals; snacks manufactured from muesli; muesli bars; muesli desserts; processed corn; corn, roasted; sugars, natural sweeteners, sweet coatings and fillings, bee products; sweets (candy), candy bars and chewing gum; tea; tea essences; tea mixtures;

darjeeling tea; black tea; tea leaves; mate [tea]; oolong tea; black tea [english tea]; white tea; fruit teas; ginseng tea; tea extracts; flavourings of tea; infusions, not medicinal; herbal infusions; tea for infusions; tea-based beverages; earl grey tea; red ginseng tea; tea bags (non-medicated -); packaged tea [other than for medicinal use]; instant tea [other than for medicinal purposes]; coffee, teas and cocoa and substitutes therefor; herb teas, other than for medicinal use; aromatic teas [other than for medicinal use]; coffee; decaffeinated coffee; artificial coffee; mixtures of coffee; coffee flavorings [flavourings]; coffee-based beverages; beverages (coffee-based -); coffee based drinks; ground coffee; honey; natural honey; sugar, honey, treacle; honey substitutes; natural ripe honey; raw honeycombs; truffle honey; honey glazes for ham; herbal honey; cereal preparations coated with sugar and honey; breakfast cereals flavoured with honey.

(260) AM 2019 100267 A

(800) 1431633

(151) 2018 07 26

(891) 2018 07 26

(731) DELI GROUP CO., LTD.

Deli Industrial Park, Ninghai County, Ningbo, Zhejiang, China

(540)



(591) Black, white

(531) 27.05.01; 27.05.02; 27.05.03

(511)

8 – Scissors; knives; hobby knives [scalpels]; hand tools, hand-operated; manicure sets; blades [hand tools]; table cutlery [knives, forks and spoons].

16 – Writing instruments; pencil leads; pencil sharpening machines, electric or non-electric; rubber erasers; drawing rulers; compasses for drawing; correcting fluids [office requisites]; correcting tapes [office requisites]; self-adhesive tapes for stationery or household purposes; adhesives [glues] for stationery or household purposes; glue for stationery or household purposes; stickers [stationery]; pads [stationery]; labels of paper or cardboard; files [office requisites]; wrappers [stationery]; cabinets for stationery [office requisites]; pen cases; marking pens [stationery]; stationery; paper; carbon paper; toilet paper; signboards of paper or cardboard; printed publications; magazines [periodicals]; garbage bags of paper or of plastics; office requisites, except furniture; school supplies [stationery]; drawing materials; polymer modelling clay.

(260) AM 2019 100269 A

(800) 1431652

(151) 2018 06 19

(891) 2018 06 19

(731) Товариство З Обмеженою Відповідальністю
"FRANCHISE-GROUP"
vul. B.Khmelnyskoho, 172, m. Lviv, Lvivska
obl. 79024, Ukraine

(540)



FRANCHISE GROUP

(591) Black, white

(531) 02.07.23

(511)

35 – Administrative assistance in responding to requests for proposals [RFPs]; administrative assistance in responding to calls for tenders; administrative processing of purchase orders; administration of consumer loyalty programs; cost price analysis; business auditing; financial auditing; auctioneering; outsourced administrative management for companies; book-keeping; accounting; negotiation of business contracts for others; market studies; opinion polling; invoicing; payroll preparation; tax preparation; demonstration of goods; business inquiries; business management assistance; commercial or industrial management assistance; advisory services for business management; business research; economic forecasting; providing business information via a web site; compilation of information into computer databases; compilation of statistics; business information; business management for freelance service providers; business management of hotels; interim business management; commercial information and advice for consumers in the choice of products and services; commercial administration of the licensing of the goods and services of others; personnel management consultancy; business management consultancy; consultancy regarding advertising communication strategies; consultancy regarding public relations communication strategies; business organization consultancy; marketing; marketing in the framework of software publishing; targeted marketing; marketing research; provision of commercial and business contact information; provision of an on-line marketplace for buyers and sellers of goods and services; writing of publicity texts; word processing; updating of advertising material; updating and maintenance of data in computer databases; updating and maintenance of information in registries; web site traffic optimization; organization of exhibitions for commercial or advertising purposes; organization of fashion shows for promotional purposes; organization of trade fairs for commercial or advertising purposes; rental of advertising space; shop window dressing; business appraisals; personnel recruitment;

business management and organization consultancy; business intermediary services relating to the matching of potential private investors with entrepreneurs needing funding; commercial information agency services; employment agency services; business efficiency expert services; outsourcing services [business assistance]; business project management services for construction projects; commercial intermediation services; competitive intelligence services; layout services for advertising purposes; appointment reminder services [office functions]; news clipping services; price comparison services; relocation services for businesses; market intelligence services; procurement services for others [purchasing goods and services for other businesses]; appointment scheduling services [office functions]; import-export agency services; modelling for advertising or sales promotion; advertising agency services; public relations; wholesale services for pharmaceutical, veterinary and sanitary preparations and medical supplies; data search in computer files for others; sponsorship search; search engine optimization for sales promotion; presentation of goods on communication media, for retail purposes; publicity material rental; rental of advertising time on communication media; rental of vending machines; rental of sales stands; direct mail advertising; publication of publicity texts; radio advertising; advertising; pay per click advertising; outdoor advertising; advertising by mail order; on-line advertising on a computer network; bill-posting; distribution of samples; dissemination of advertising matter; design of advertising materials; systemization of information into computer databases; drawing up of statements of accounts; sales promotion for others; promotion of goods and services through sponsorship of sports events; production of teleshopping programmes; production of advertising films; transcription of communications [office functions]; television advertising; telemarketing services; negotiation and conclusion of commercial transactions for third parties; negotiation and conclusion of sub-contracts for third parties; professional business consultancy.

41 – Academies [education]; teaching; videotaping; arranging and conducting of congresses; arranging and conducting of colloquiums; arranging and conducting of conferences; arranging and conducting of concerts; arranging and conducting of in-person educational forums; arranging and conducting of workshops [training]; arranging and conducting of seminars; arranging and conducting of symposiums; electronic desktop publishing; nursery schools; dubbing; providing on-line videos, not downloadable; providing on-line electronic publications, not downloadable; providing sports facilities; providing recreation facilities; booking of seats for shows; correspondence courses; recreation information; education information; entertainment information;

microfilming; videotape editing; tutoring; writing of texts; organization of balls; organization of shows [impresario services]; organization of exhibitions for cultural or educational purposes; organization of competitions [education or entertainment]; educational services; educational services provided by schools; party planning [entertainment]; entertainer services; lending library services; calligraphy services; layout services, other than for advertising purposes; language interpreter services; coaching [training]; club services [entertainment or education]; translation; mobile library services; photographic reporting; practical training [demonstration]; presentation of live performances; presentation of variety shows; rental of audio equipment; rental of show scenery; rental of video cameras; rental of videotapes; rental of sound recordings; rental of cinematographic apparatus; rental of motion pictures; vocational retraining; vocational guidance [education or training advice]; on-line publication of electronic books and journals; publication of books; publication of texts, other than publicity texts; entertainment services; production of shows; production of radio and television programmes; film production, other than advertising films; subtitling; television entertainment; photography.

45 – Arbitration services; intellectual property consultancy; physical security consultancy; leasing of Internet domain names; licensing [legal services] in the framework of software publishing; licensing of intellectual property; licensing of computer software [legal services]; mediation; monitoring intellectual property rights for legal advisory purposes; personal letter writing; legal watching services; legal document preparation services; litigation services; on-line social networking services; alternative dispute resolution services; legal research; registration of domain names [legal services]; personal background investigations; escorting in society [chaperoning]; copyright management; legal advice in responding to requests for proposals [RFPs]; legal advice in responding to calls for tenders; legal services in relation to the negotiation of contracts for others.

(260) AM 2019 100271 A
 (800) 1431711
 (151) 2018 09 17
 (891) 2018 09 17
 (731) Biogen MA, Inc.
 225 Binney Street, Cambridge MA
 02142, USA
 (540)

BRAYADU

(591) Black, white

(511)
 5 – Pharmaceutical preparations for the treatment of neurological disorders.

(260) AM 2019 100272 A
 (800) 1431754
 (151) 2018 03 29
 (891) 2018 03 29
 (731) Tradiční pivovar v Rakovníku a.s.
 Havlíčkova 69, Rakovník, CZ-269
 01 Rakovník I, Czech Republic
 (540)

1454
Bakalář
Dobré pivo.

(591) Black, white
 (531) 26.11.08; 27.05.01; 27.05.11; 28.17
 (511)
 32 – Beer, hop extracts for making beer, non-alcoholic beverages, preparations for making non-alcoholic beverages.
 43 – Services for providing food and drink.

(260) AM 2019 100277 A
 (800) 1431857
 (151) 2018 08 06
 (891) 2018 08 06
 (731) Limited Liability Company «ORIMI»
 Sverdlov factory settlement, 1-st Microrayon
 Street, 15/4 plot, Vsevolozhsk district,
 RU-188682 Leningrad oblast, Russian
 Federation
 (540)

PIAZZA
del CAFFÈ

(591) Black, white
 (531) 27.05.10
 (511)
 30 – Coffee flavorings; artificial coffee; vegetal preparations for use as coffee substitutes; coffee; unroasted coffee; coffee beverages with milk; coffee-based beverages; coffee extracts.

(260) AM 2019 100281 A
 (800) 1432001
 (151) 2018 08 13
 (891) 2018 08 13

(731) Aktsionernoe obshchestvo
«Slavyanka-luks»
ul. 1-y Konnoy Armii, 65, g.Stariy Oskol,
RU-309506 Belgorodskaya obl., Russian
Federation

(540)



(591) Blue, brown, white, red, pink and gray.

(531) 02.09.01; 05.07.08; 07.05.02; 08.01.22;
20.05.21; 25.01.25; 26.04.05; 26.04.16;
26.04.18; 26.04.24; 27.05.02; 27.05.09;
27.05.10; 28.05; 29.01.15

(526) Французский зефир

(511)

30 – Flavorings [flavourings], other than essential oils, for cakes; flavorings, other than essential oils, for cakes; flavourings, other than essential oils, for cakes; fruit jellies [confectionery]; confectionery for decorating Christmas trees; sweetmeats [candy]; pastilles [confectionery]; lozenges [confectionery]; confectionery; sugar confectionery; chocolate.

(260) AM 2019 100283 A

(800) 1432024

(151) 2018 09 26

(891) 2018 09 26

(731) SHANDONG HONGSHENG RUBBER
TECHNOLOGY CO., LTD.
EAST OF SHENGLI ROAD, WEST OF
XINGGONG ROAD, DAWANG TOWN,
GUANGRAO COUNTY, DONGYING
CITY, 257300 SHANDONG PROVINCE,
China

(540)

Headking

(591) Black, white

(531) 27.05.01

(511)

12 – Automobile tires; casings for pneumatic tires [tyres]; spikes for tires; repair outfits for inner tubes; cars; automobile wheel; moped; tires for vehicle wheels; vehicle chassis; trolleys.

(260) AM 2019 100284 A

(800) 1432046

(151) 2018 09 26

(891) 2018 09 26

(731) SHANDONG HONGSHENG RUBBER
TECHNOLOGY CO., LTD.
EAST OF SHENGLI ROAD, WEST OF
XINGGONG ROAD, DAWANG TOWN,
GUANGRAO COUNTY, DONGYING CITY
257335, 250014 SHANDONG PROVINCE,
China

(540)

Rassurer

(591) Black, white

(531) 27.05.01

(511)

12 – Tires for vehicle wheels; automobile tires; casings for pneumatic tires [tyres]; spikes for tires; repair outfits for inner tubes; cars; automobile wheel; moped; trolleys; vehicle chassis.

(260) AM 2019 100285 A

(800) 1432050

(151) 2018 09 26

(891) 2018 09 26

(731) SHANDONG HONGSHENG RUBBER
TECHNOLOGY CO., LTD.
EAST OF SHENGLI ROAD, WEST OF
XINGGONG ROAD, DAWANG TOWN,
GUANGRAO COUNTY, DONGYING CITY
257335, 250014 SHANDONG PROVINCE,
China

(540)

Papide

(591) Black, white

(531) 27.05.01

(511)

12 – Tires for vehicle wheels; automobile tires; casings for pneumatic tires [tyres]; spikes for tires; repair outfits for inner tubes; cars; automobile wheel; moped; trolleys; vehicle chassis.

(260) AM 2019 100286 A

(800) 1432064

(151) 2018 05 04

(891) 2018 05 04

(731) Teletek Electronics JSC
14A Srebarna Str., BG-1142 Sofia, Bulgaria

(540)

TELETEK ELECTRONICS

(591) Black, white

(511)

9 – 3D spectacles; DVD players; USB flash drives; fire escapes; solenoid valves [electromagnetic]

switches]; automatic indicators of low pressure in vehicle tires; aerometers; asbestos screens for firemen; asbestos clothing for protection against fire; asbestos gloves for protection against accidents; azimuth instruments; accelerometers; actinometers; accumulators, electric; accumulators, electric, for vehicles; accumulator boxes; acoustic alarms; acoustic couplers; acoustic conduits; horns for loudspeakers; alarm bells, electric; alarms; alidades; altimeters; ammeters; anemometers; animated cartoons; anodes; anode batteries; antennas [aerials]; anticathodes; air analysis apparatus; food analysis apparatus; intercommunication apparatus; glazing apparatus for photographic prints; global positioning systems [GPS] apparatus; breathing apparatus for underwater swimming; breathing apparatus, except for artificial respiration; distance recording apparatus; apparatus for measuring the thickness of leather; pressure measuring apparatus; speed measuring apparatus [photography]; distance measuring apparatus; testing apparatus not for medical purposes; ionization apparatus, not for the treatment of air or water; boiler control instruments; speed checking apparatus for vehicles; egg-candlers; magnetic resonance imaging [MRI] apparatus, not for medical purposes; monitoring apparatus, other than for medical purposes; apparatus to check stamping mail; apparatus to check franking; X-ray photographs, other than for medical purposes; teleprompters; lift control panels; satellite navigational apparatus; apparatus for fermentation [laboratory apparatus]; apparatus and installations, for the production of X-rays, not for medical purposes; weighing apparatus and instruments; apertometers [optics]; audiovisual teaching apparatus; audio- and video-receivers; audio interfaces; audio mixers; acidimeters for batteries; rods for water diviners; automated teller machines [ATM]; barometers; batteries, electric; batteries, electric, for vehicles; high tension batteries; batteries for electronic cigarettes; batteries for lighting; baby monitors; baby scales; video baby monitors; cordless telephones; betatrons; ticket dispensers; binoculars; biochips; coils, electric; locks, electric; bullet-proof vests; bullet-proof clothing; counters; thread counters; money counting and sorting machines; push buttons for bells; vacuum gauges; washing trays [photography]; variometers; scales; scales with body mass analyzers; spectacle chains; wind socks [for indicating wind direction]; video screens; video cassettes; video recorders; video telephones; viewfinders, photographic; screw-tapping gauges; viscosimeters; loudspeakers; high-frequency apparatus; breathing apparatus for underwater swimming; divers' masks; naval signalling apparatus; solderers' helmets; voltmeters; time recording apparatus; cell phone straps; wavemeters; gasometers; discharge tubes, electric, other than for lighting; galvanic batteries; galvanic cells; galvanometers; surveying apparatus

and instruments; surveying instruments; graduated glassware; record players; phonograph records; downloadable graphics for mobile phones; encoded identification bracelets, magnetic; lightning rods; range finders; flowmeters; decompression chambers; decorative magnets; densimeters; stills for laboratory experiments; distillation apparatus for scientific purposes; detectors; counterfeit coin detectors; smoke detectors; pocket calculators; joysticks for use with computers, other than for video games; juke boxes [for computers]; diagnostic apparatus, not for medical purposes; slides [photography]; diaphragms [photography]; diaphragms for scientific apparatus; digital photo frames; dictating machines; dynamometers; disks [magnetic]; disk drives [for computers]; diffraction apparatus [microscopy]; respiratory masks [other than for artificial respiration]; DNA chips; dosimeters; speaking tubes; choking coils [impedance]; carpenters' rules; holders for electric coils; carriers for dark plates [photography]; equalizers [audio apparatus]; electric and electronic effects units for musical instruments; electrified fences; electrified rails for mounting spot lights; electrical adapters; electric apparatus for commutation; electric door bells; electric installations for the remote control of industrial operations; electric wire harnesses for automobiles; electronic key fobs being remote control apparatus; fuses; flashing lights [luminous signals]; electro-dynamic apparatus for the remote control of signals; electro-dynamic apparatus for the remote control of railway points; electricity conduits; electrolyzers; electromagnetic coils; electronic agendas; electronic pocket translators; electronic tags for goods; electronic interactive whiteboards; amplifying tubes; vacuum tubes [radio]; electronic collars to train animals; electronic sheet music, downloadable; electronic pens [visual display units]; electronic publications [downloadable]; light-emitting electronic pointers; electronic access control systems for interlocking doors; electronic notice boards; electronic numeric displays; epidiascopes; test tubes; ergometers; temperature indicator labels, not for medical purposes; sound locating instruments; security tokens [encryption devices]; mercury levels; life-saving apparatus and equipment; wires, electric; coin-operated musical automata [juke boxes]; coin-operated mechanisms for operating gates for car parking lots; coin-operated mechanisms for television sets; electric apparatus for remote ignition; igniting apparatus, electric, for igniting at a distance; charging stations for electric vehicles; battery chargers; chargers for electric batteries; chargers for electronic cigarettes; shutters [photography]; saccharometers; protective helmets; protective suits for aviators; protective masks; protective films adapted for smartphones; workmen's protective face-shields; protection devices for personal use against accidents; protection devices against X-rays, not for medical

purposes; protective films adapted for computer screens; sound alarms; sound reproduction apparatus; sound recording apparatus; sound recording discs; sound recording strips; sound recording carriers; sounding apparatus and machines; sounding leads; sound transmitting apparatus; bells [warning devices]; signs, luminous; buzzers; needles for record players; identification threads for electric wires; identification sheaths for electric wires; measures; measuring glassware; measuring apparatus; surveying chains; jigs [measuring instruments]; gauges; measuring devices, electric; satellite finder meters; data processing apparatus; inverters [electricity]; quantity indicators; electric loss indicators; water level indicators; electric loss indicators; pressure indicators; inductors [electricity]; incubators for bacteria culture; theft prevention installations, electric; gas testing instruments; observation instruments; levelling instruments; material testing instruments and machines; instruments containing eyepieces; integrated circuits; interactive touch screen terminals; interfaces [for computers]; infrared detectors; starter cables for motors; cables, electric; ducts [electricity]; calibrating rings; calorimeters; sleeves for laptops; spectacle cases; covers for personal digital assistants [PDAs]; cases for smartphones; covers for tablet computers; lens hoods; rearview cameras for vehicles; weighing machines; bathroom scales; covers for electric outlets; capillary tubes; integrated circuit cards [smart cards]; video game cartridges; memory cards for video game machines; cassette players; riding helmets; accounting machines; cathodes; cathodic anti-corrosion apparatus; kilometer recorders for vehicles; cinematographic cameras; cinematographic film, exposed; oxygen transvasing apparatus; cellular phones; coaxial cables; encoded key cards; encoded magnetic cards; collectors, electric; compact disc players; compact discs [audio-video]; compact discs [read-only memory]; comparators; directional compasses; compasses for measuring; computers; computer software [recorded]; computer screen saver software, recorded or downloadable; computer hardware; notebook computers; computer keyboards; computer peripheral devices; computer programs [downloadable software]; computer programs, recorded; computer software platforms, recorded or downloadable; computer software applications, downloadable; commutators; converters, electric; capacitors; condensers [capacitors]; contacts, electric; contact lenses; traffic cones; nautical apparatus and instruments; correcting lenses [optics]; cosmographic instruments; diving suits; pedometers; galena crystals [detectors]; circular slide rules; battery boxes; cabinets for loudspeakers; cases especially made for photographic apparatus and instruments; laboratory trays; ovens for laboratory use; laboratory robots; laboratory centrifuges; logs [measuring instruments]; lasers, not for medical

purposes; lactometers; darkroom lamps [photography]; flash-bulbs [photography]; laptop computers; videotapes; head cleaning tapes [recording]; lenses for astrophotography; spectacle lenses; lens hoods; rulers [measuring instruments]; squares for measuring; identity cards, magnetic; slide-rules; sounding lines; magnifying glasses [optics]; magic lanterns; magnets; magnetic encoders; magnetic tapes; magnetic tape units [for computers]; magnetic data media; magnetic wires; tape recorders; crash test dummies; resuscitation mannequins [teaching apparatus]; manometers; marking gauges [joinery]; surveyors' levels; mathematical instruments; material for electricity mains [wires, cables]; masts for wireless aerials; invoicing machines; mechanical signs; beacons, luminous; megaphones; copper wire, insulated; diaphragms [acoustics]; tone arms for record players; plane tables [surveying instruments]; measuring spoons; measuring glassware, measuring cups, measuring buckets, measuring bowls; metal detectors for industrial or military purposes; meteorological balloons; meteorological instruments; metronomes; mechanisms for counter-operated apparatus; mechanisms for coin-operated apparatus; blinkers [signaling lights]; micrometers; micrometer screws for optical instruments; microprocessors; microscopes; microtomes; microphones; mouse [computer peripheral]; modems; parking meters; monitors [computer hardware]; monitors [computer programs]; apparatus for editing cinematographic film; marine compasses; weighbridges; nets for protection against accidents; downloadable music files; navigation apparatus for vehicles [on-board computers]; navigational instruments; knee-pads for workers; neon signs; levels [instruments for determining the horizontal]; spirit levels; levelling staffs [surveying instruments]; rods [surveying instruments]; verniers; sheaths for electric cables; safety restraints [other than for vehicle seats and sports equipment]; objectives [lenses] [optics]; selfie lenses; furniture especially made for laboratories; clothing for protection against accidents, irradiation and fire; clothing for protection against fire; clothing especially made for laboratories; marking buoys; revolution counters; shoes for protection against accidents, irradiation and fire; teaching apparatus; teaching robots; mirrors [optics]; mirrors for inspecting work; limiters [electricity]; ozonisers [ozonators]; octants; eyepieces; ohmmeters; computer operating programs, recorded; optical apparatus and instruments; optical fibers [light conducting filaments]; optical discs; fiber optic cables; optical condensers; optical lamps; optical lenses; telescopic sights for artillery; sighting telescopes for firearms; optical data media; optical glass; optical lanterns; optical character readers; oscillographs; plumb lines; reflecting discs for wear, for the prevention of accidents; spectacles; sunglasses; goggles for sports; eyewear; radio pagers; pince-nez; periscopes;

personal digital assistants [PDAs]; punched card machines for offices; printed circuit boards; printed circuits; pipettes; pyrometers; planimeters; plates for batteries; wafers for integrated circuits; plotters; grids for batteries; step-up transformers; mouse pads; wrist rests for use with computers; fire alarms; fire boats; fire beaters; fire hose; fire extinguishers; fire extinguishing apparatus; fire blankets; semi-conductors; polarimeters; wearable video display monitors; wearable computers; portable media players; walkie-talkies; personal stereos; wearable activity trackers; retorts' stands; cleaning apparatus for phonograph records; cleaning apparatus for sound recording discs; cell switches [electricity]; switches, electric; switchboxes [electricity]; switchboards; transmitters of electronic signals; transmitting sets [telecommunication]; teeth protectors; spark-guards; protective helmets for sports; safety nets; safety tarpaulins; vehicle breakdown warning triangles; anti-theft warning apparatus; circuit breakers; precision balances; precision measuring apparatus; prisms [optics]; printers for use with computers; hemline markers; pressure indicator plugs for valves; conductors, electric; projection apparatus; slide projectors; projection screens; head guards for sports; mouth guards for sports; anti-dazzle shades; anti-glare glasses; fire engines; fire pumps; sprinkler systems for fire protection; road signs, luminous or mechanical; radar apparatus; radiological apparatus for industrial purposes; radiology screens for industrial purposes; transmitters [telecommunication]; radios; vehicle radios; radiotelegraphy sets; radiotelephony sets; branch boxes [electricity]; demagnetizing apparatus for magnetic tapes; camcorders; distribution consoles [electricity]; distribution boxes [electricity]; distribution boards [electricity]; gasoline gauges; spectacle frames; frames for photographic transparencies; screens for photoengraving; stage lighting regulators; voltage surge protectors; voltage regulators for vehicles; light regulators [dimmers] [electric]; speed regulators for record players; regulating apparatus, electric; reducers [electricity]; film cutting apparatus; resistances, electric; downloadable ring tones for mobile phones; time switches, automatic; relays, electric; X-ray apparatus not for medical purposes; X-ray tubes not for medical purposes; X-ray films, exposed; rheostats; respirators for filtering air; retorts; refractometers; refractors; security surveillance robots; spools [photography]; armatures [electricity]; gloves for divers; gloves for protection against accidents; gloves for protection against X-rays for industrial purposes; hand-held electronic dictionaries; steelyards [lever scales]; flashlights [photography]; exposure meters [light meters]; reflective safety vests; screens [photography]; light-emitting diodes [LED]; traffic-light apparatus [signaling devices]; whistle alarms; dog whistles; connected bracelets [measuring instruments]; sex-

tants; fog signals, non-explosive; signals, luminous or mechanical; signaling whistles; signaling panels, luminous or mechanical; signaling buoys; signal bells; rescue laser signalling flares; signal lanterns; sirens; scanners [data processing equipment]; speed indicators; headphones; solar batteries; solar panels for the production of electricity; smartglasses; smart rings; smartphones; smartwatches; abacuses; calculating machines; salinometers; sonars; probes for scientific purposes; computer game software; life jackets; life-saving capsules for natural disasters; life nets; life belts; life-saving rafts; life buoys; spectrograph apparatus; spectrometers; alcoholmeters; sports whistles; satellites for scientific purposes; lighting ballasts; stereoscopes; stereoscopic apparatus; selfie sticks [hand-held monopods]; stands for photographic apparatus; fuse wire; needles for surveying compasses; stroboscopes; fire hose nozzles; subwoofers; sulfimeters; drying apparatus for photographic prints; drainers for use in photography; drying racks [photography]; spherometers; accumulator jars; battery jars; containers for contact lenses; containers for microscope slides; connectors [electricity]; couplers [data processing equipment]; connections for electric lines; wire connectors [electricity]; connections, electric; junction boxes [electricity]; junction sleeves for electric cables; control panels [electricity]; tablet computers; taximeters; ear plugs; ear plugs for divers; tachometers; balancing apparatus; balances [steelyards]; weights; television apparatus; telegraphs [apparatus]; telegraph wires; telecommunication apparatus in the form of jewelry; telemeters; telerupters; telescopes; teletypewriters; telephone receivers; telephone apparatus; telephone transmitters; telephone wires; answering machines; temperature indicators; theodolites; terminals [electricity]; thermal imaging cameras; thermionic valves; thermometers, not for medical purposes; thermostats; thermostats for vehicles; thermo-hygrometers; crucibles [laboratory]; T-squares for measuring; current rectifiers; toner cartridges, unfilled, for printers and photocopiers; heat regulating apparatus; totalizers; transistors [electronic]; transponders; protractors [measuring instruments]; transformers [electricity]; simulators for the steering and control of vehicles; resuscitation training simulators; tripods for cameras; triodes; pitot tubes; darkrooms [photography]; thin client computers; enlarging apparatus [photography]; steering apparatus, automatic, for vehicles; ring sizers; acid hydrometers; finger sizers; marine depth finders; slope indicators; lactodensimeters; densitometers; apparatus and instruments for astronomy; urinometers; amplifiers; particle accelerators; railway traffic safety appliances; voting machines; remote control apparatus; computer memory devices; shutter releases [photography]; egg timers [sandglasses]; anti-interference devices [electricity]; apparatus for changing record player

needles; hands-free kits for phones; downloadable image files; facsimile machines; apparatus and instruments for physics; films, exposed; filters [photography]; filters for respiratory masks; filters for ultraviolet rays, for photography; floppy disks; fluorescent screens; cameras [photography]; photovoltaic cells; photographic racks; photocopiers [photographic, electrostatic, thermic]; photometers; phototelegraphy apparatus; heliographic apparatus; hygrometers; hydrometers; chemistry apparatus and instruments; holograms; chromatography apparatus for laboratory use; chronographs [time recording apparatus]; humanoid robots with artificial intelligence; central processing units [processors]; centering apparatus for photographic transparencies; cyclotrons; digital signs; digital weather stations; bags for laptops; time clocks [time recording devices]; black boxes [data recorders]; frequency meters; electronic book readers; readers [data processing equipment]; bar code readers; petri dishes; chips [integrated circuits]; dressmakers' measures; virtual reality headsets; snorkels; spectacle cords; peepholes [magnifying lenses] for doors; letter scales; calipers; plugs, sockets and other contacts [electric connections]; nose clips for divers and swimmers.

35 – Arranging newspaper subscriptions [for others]; arranging subscriptions to telecommunication services [for others]; administrative processing of purchase orders; outsourced administrative management for companies; administration of consumer loyalty programs; administration of frequent flyer programs; business management of hotels; updating and maintenance of data in computer databases; updating and maintenance of information in registries; updating of advertising material; cost price analysis; business management of sports people; business auditing; business efficiency expert services; business intermediary services relating to the matching of potential private investors with entrepreneurs needing funding; business management for freelance service providers; business management of reimbursement programmes for others; public relations; document reproduction; design of advertising materials; payroll preparation; compilation of statistics; invoicing; market studies; business investigations; economic forecasting; web indexing for commercial or advertising purposes; personnel management consultancy; advisory services for business management; business organization consultancy; business management and organization consultancy; consultancy regarding public relations communications strategy; consultancy regarding advertising communications strategy; marketing; typing; personnel recruitment; sponsorship search; sales promotion [for others]; organization of fashion shows for promotional purposes; on-line advertising on a computer network; search engine optimisation for

sales promotion; web site traffic optimisation; organization of exhibitions for commercial or advertising purposes; auctioneering; organization of trade fairs for commercial or advertising purposes; provision of an on-line marketplace for buyers and sellers of goods and services; rental of vending machines; office machines and equipment rental; rental of billboards [advertising boards]; publicity material rental; rental of advertising time on communication media; rental of advertising space; rental of sales stands; rental of photocopying machines; pay per click advertising; scriptwriting for advertising purposes; outsourcing services [business assistance]; business management assistance; shop window dressing; commercial or industrial management assistance; tax preparation; news clipping services; providing business information via a web site; provision of commercial and business contact information; commercial information and advice for consumers [consumer advice shop]; demonstration of goods; presentation of goods on communication media, for retail purposes; telephone answering [for unavailable subscribers]; production of teleshopping programs; production of advertising films; opinion polling; marketing research; business research; professional business consultancy; psychological testing for the selection of personnel; publication of publicity texts; radio advertising; distribution of samples; dissemination of advertising matter; direct mail advertising; registration of written communications and data; advertising; publicity; outdoor advertising; bill-posting; advertising by mail order; television advertising; secretarial services; systemization of information into computer databases; procurement services for others [purchasing goods and services for other businesses]; shorthand; accounting; book-keeping; compilation of information into computer databases; writing of publicity texts; writing of curriculum vitae for others; drawing up of statements of accounts; compiling indexes of information for commercial or advertising purposes; word processing; telemarketing services; transcription [office functions]; retail or wholesale services for pharmaceutical, veterinary and sanitary preparations and medical supplies; business information; business appraisals; commercial intermediation services; business inquiries; commercial administration of the licensing of the goods and services of others; data search in computer files [for others]; business project management services for construction projects; computerized file management; business management of performing artists; negotiation of business contracts for others; appointment reminder services [office functions]; tax filing services; appointment scheduling services [office functions]; layout services for advertising purposes; import-export agency services; commercial information agency services; modelling for advertising or sales promotion; publicity agency services; employment

agency services; price comparison services; negotiation and conclusion of commercial transactions for third parties; relocation services for businesses; photocopying services.

37 – Anti-rust treatment for vehicles; asphaltting; tyre balancing; painting or repair of signs; painting, interior and exterior; plumbing; vulcanization of tires [repair]; retreading of tires; rebuilding engines that have been worn or partially destroyed; rebuilding machines that have been worn or partially destroyed; linen ironing; carpentry services; riveting; vehicle battery charging; bricklaying; masonry; building of fair stalls and shops; vehicle polishing; furnace installation and repair; elevator installation and repair; electric appliance installation and repair; installation and repair of air-conditioning apparatus; heating equipment installation and repair; irrigation devices installation and repair; fire alarm installation and repair; telephone installation and repair; freezing equipment installation and repair; kitchen equipment installation; office machines and equipment installation, maintenance and repair; installation, maintenance and repair of computer hardware; machinery installation, maintenance and repair; re-tinning; quarrying services; shipbuilding; wallpapering; plastering; vehicle washing; cleaning of buildings [exterior surface]; mining extraction; burglar alarm installation and repair; installation of doors and windows; scaffolding; building construction supervision; tuning of musical instruments; knife sharpening; disinfecting; rustproofing; rental of bulldozers; rental of drainage pumps; rental of excavators; rental of cranes [construction equipment]; rental of dish drying machines; rental of laundry washing machines; rental of cleaning machines; rental of road sweeping machines; rental of construction equipment; rental of dishwashing machines; interference suppression in electrical apparatus; road paving; pressing of clothing; burner maintenance and repair; motor vehicle maintenance and repair; safe maintenance and repair; airplane maintenance and repair; strong-room maintenance and repair; vehicle maintenance; swimming-pool maintenance; leather care, cleaning and repair; furniture maintenance; renovation of clothing; laying of cable; varnishing; repair of security locks; clothing repair; shoe repair; umbrella repair; clock and watch repair; sanding; fur care, cleaning and repair; boiler cleaning and repair; vehicle cleaning; cleaning of clothing; chimney sweeping; diaper cleaning; window cleaning; cleaning of buildings [interior]; street cleaning; pumicing; artificial snow-making services; laundering; washing; refilling of toner cartridges; drilling of deep oil or gas wells; drilling of wells; demolition of buildings; vehicle breakdown repair services; repair of power lines; underwater repair; pump repair; parasol repair; photographic apparatus repair; film projector repair and maintenance; restoration of works of art;

furniture restoration; restoration of musical instruments; vehicle service stations [refuelling and maintenance]; vehicle greasing; sterilization of medical instruments; building insulating; construction consultancy; construction; pipeline construction and maintenance; warehouse construction and repair; pier breakwater building; factory construction; underwater construction; harbour construction; upholstery repair; upholstering; vermin exterminating, other than for agriculture, aquaculture, horticulture and forestry; rat exterminating; building sealing; pest control services, other than for agriculture, aquaculture, horticulture and forestry; washing of linen; hydraulic fracturing services; fracking services; roofing services; damp-proofing [building]; dry cleaning.

38 – Wireless broadcasting; telecommunications routing and junction services; providing telecommunications connections to a global computer network; transmission of electronic mail; electronic bulletin board services [telecommunications services]; video-on-demand transmission; message sending; information about telecommunication; communications by cellular phones; communications by computer terminals; communications by telegrams; communications by telephone; communications by fibre optic networks; transmission of greeting cards online; providing online forums; providing access to databases; rental of message sending apparatus; rental of access time to global computer networks; rental of modems; rental of telecommunication equipment; rental of telephones; rental of facsimile apparatus; computer aided transmission of messages and images; transmission of telegrams; facsimile transmission; transmission of digital files; satellite transmission; cable television broadcasting; providing Internet chatrooms; providing user access to a global computer network; providing telecommunication channels for teleshopping services; radio communications; radio broadcasting; paging services [radio, telephone or other means of electronic communication]; streaming of data; television broadcasting; telegraph services; teleconferencing services; telex services; telephone services; videoconferencing services; news agency services; voice mail services.

42 – Water analysis; computer system analysis; analysis for oil-field exploitation; bacteriological research; biological research; recovery of computer data; off-site data backup; design of interior decor; geological surveys; geological research; geological prospecting; urban planning; graphic arts design; handwriting analysis [graphology]; dress designing; packaging design; monitoring of computer systems by remote access; electronic monitoring of credit card activity to detect fraud via the Internet; electronic monitoring of personally identifying information to detect identity theft via the Internet;

electronic data storage; energy auditing; land surveying; material testing; textile testing; oil-well testing; cosmetic research; mechanical research; physics [research]; cloud computing; engineering; installation of computer software; interior design; meteorological information; cartography services; quality control; clinical trials; computer software consultancy; computer programming; conversion of data or documents from physical to electronic media; conversion of computer programs and data, other than physical conversion; information technology [IT] consultancy; computer technology consultancy; consultancy in the field of energy-saving; consultancy in the design and development of computer hardware; web site design consultancy; architectural consultancy; Internet security consultancy; computer security consultancy; data security consultancy; weather forecasting; monitoring of computer systems for detecting unauthorized access or data breach; monitoring of computer systems to detect breakdowns; calibration [measuring]; computer software design; computer system design; industrial design; research and development of new products for others; oil-field surveys; conducting technical project studies; research in the field of environmental protection; software development in the framework of software publishing; software as a service [SaaS]; styling [industrial design]; construction drafting; creating and maintaining web sites for others; creating and designing website-based indexes of information for others [information technology services]; server hosting; technical research; vehicle roadworthiness testing; surveying; technical writing; technological consultancy; telecommunications technology consultancy; oil prospecting; chemistry services; computer virus protection services; data encryption services; architectural services; scientific laboratory services; outsource service providers in the field of information technology; authenticating works of art; chemical analysis; chemical research; digitization of documents [scanning].

45 – Adoption agency services; litigation services; arbitration services; astrology consultancy; lost property return; genealogical research; babysitting; pet sitting; rental of fire extinguishers; rental of fire alarms; missing person investigations; dating services; intellectual property consultancy; physical security consultancy; crematorium services; leasing of Internet domain names; licensing [legal services] in the framework of software publishing; licensing of computer software [legal services]; mediation; monitoring of burglar and security alarms; monitoring intellectual property rights for legal advisory purposes; house sitting; organization of religious meetings; evening dress rental; clothing rental; rental of safes; opening of security locks; personal letter writing; personal body guarding; personal wardrobe styling consultancy; planning and

arranging of wedding ceremonies; funerary undertaking; conducting funeral ceremonies; fire-fighting; legal administration of licences; legal advice in responding to calls for tenders; legal advice in responding to requests for proposals [RFPs]; chaperoning; escorting in society [chaperoning]; conducting religious ceremonies; inspection of factories for safety purposes; security screening of baggage; tracking of stolen property; releasing doves for special occasions; registration of domain names [legal services]; spiritual consultancy; personal background investigations; horoscope casting; copyright management; burial services; kimono dressing assistance; cartomancy services; alternative dispute resolution services; legal document preparation services; night guard services; on-line social networking services; guard services; legal watching services; dog walking services; marriage agency services; detective agency services; embalming services; licensing of intellectual property; legal research; legal services in relation to the negotiation of contracts for others.

(260) AM 2019 100287 A

(800) 1432182

(151) 2018 01 24

(891) 2018 01 24

(731) Smile Expo s.r.o.

Kaprova 42/14, CZ-110 00 Praha,
Czech Republic

(540)



**Blockchain & Bitcoin
Conference**

(591) Black, white

(531) 25.07.03; 26.04.02; 26.04.06; 26.04.18;

27.05.01

(511)

35 – Advertising, marketing and promotional services; event marketing; organisation and holding of fairs for commercial or advertising purposes; organisation and conducting of product presentations; organisation of exhibitions for business or commerce (term considered too vague by the International Bureau – Rule 13.2.b) of the Common Regulations); arranging of trade fairs; organisation of exhibitions and trade fairs for business and promotional purposes; sales promotion; business promotion; trade promotional services; publicity and sales promotion services; online advertising; advertising and marketing; promotion [advertising] of business; advertising; arranging of exhibitions for business purposes.

41 – Education, entertainment and sports; organisation of conferences, exhibitions and competitions; arranging, conducting and organisation of seminars; arranging, conducting and organisation of congresses; arranging, conducting and organisation of

conferences; arranging of seminars relating to trade; arranging of seminars relating to entertainment; arrangement of seminars for educational purposes; arranging of conferences relating to trade; arranging of conferences relating to business; arrangement of conventions for educational purposes; arranging and conducting of commercial, trade and business conferences; organising of education exhibitions.

(260) AM 2019 100289 A
 (800) 1432230
 (151) 2018 05 21
 (891) 2018 05 21
 (731) TRAVCO Group International
 Holding Company – S.A.E.
 TRAVCO Center, 26 July Corridor,
 Sheikh Zayed City – 6 October, Egypt
 (540)



(591) Grey and black colors.
 (531) 26.13.25; 27.05.01; 28.01
 (511) 3
 9 – Transport; packaging and storage of goods; travel arrangement.
 41 – Education; providing of training; entertainment; sporting and cultural activities.
 43 – Services for providing food and drink; temporary accommodation.

(260) AM 2019 100291 A
 (800) 1432354
 (151) 2018 09 05
 (891) 2018 09 05
 (731) Bras N Things Pty Ltd
 Level 2, Building 1, 75-85 O'Riordan Street,
 Alexandria NSW 2015, Australia
 (540)

bras N things

(591) Black, white
 (531) 27.05.01; 27.05.09
 (511)
 25 – Clothing, footwear, headgear.
 35 – Retail services relating to clothing, footwear and headgear; retail store services relating to clothing, footwear and headgear; on-line retail services relating to clothing, footwear and headgear;

mail order retail services relating to clothing, footwear and headgear.

(260) AM 2019 100292 A
 (800) 1432370
 (151) 2018 04 11
 (891) 2018 04 11
 (731) CORNELIANI S.P.A.
 Via Panizza, 5, I-46100 MANTOVA, Italy
 (540)



(591) Black, white
 (531) 03.01.01; 03.01.02; 03.01.26; 05.01.03;
 05.01.05; 05.01.16; 24.01.05; 24.01.09;
 24.01.10
 (511)
 3 – Abrasive paper; abrasives; adhesives for affixing false eyelashes; adhesives for affixing false hair; adhesives for cosmetic purposes; after-shave balms; aftershave cologne; after-shave creams; after-shave emulsions; after-shave gel; after-shave lotions; after-sun creams for cosmetic use; after-sun milk; air fragrance reed diffusers; air fragrancing preparations; almond milk for cosmetic purposes; almond oil; almond soap; aloe vera preparations for cosmetic purposes; amber [perfume]; ammonia [volatile alkali] [detergent]; antiperspirants; antiperspirants [toiletries]; antiperspirants for personal use; antistatic preparations for household purposes; anti-wrinkle creams; aromatics [essential oils]; astringents for cosmetic purposes; badian essence; balms, other than for medical purposes; bases for flower perfumes; bath foam; bath preparations, not for medical purposes; bath salts, not for medical purposes; beard dyes; beauty masks; bergamot oil; bleaching preparations [decolorants] for cosmetic purposes; bleaching preparations [decolorants] for household purposes; breath freshening preparations for personal hygiene; breath freshening sprays; cake flavorings [essential oils]; cakes of toilet soap; canned pressurized air for cleaning and dusting purposes; chemical cleaning preparations for household purposes; cleaning preparations; cleansers for intimate personal hygiene purposes, non medicated; cleansing milk for toilet purposes; cloths impregnated with a detergent for cleaning; cloths impregnated with a detergent for cleaning spectacles; collagen preparations for cosmetic purposes; colorants for toilet purposes; color-brightening chemicals for household purposes [laundry]; cosmetic creams; cosmetic dyes; cosmetic kits; cosme-

tic pencils; cosmetic preparations for baths; cosmetic preparations for eyelashes; cosmetic preparations for shower; cosmetic preparations for skin care; cosmetic preparations for slimming purposes; cosmetics; cosmetics for animals; cotton sticks for cosmetic purposes; cotton wool for cosmetic purposes; decorative transfers for cosmetic purposes; degreasers, other than for use in manufacturing processes; dentifrices; deodorant soap; deodorants for human beings or for animals; deodorants for pets; depilatory creams; depilatory preparations; depilatory wax; detergents, other than for use in manufacturing operations and for medical purposes; disposable wipes impregnated with cleansing chemicals or compounds for personal hygiene; douching preparations for personal sanitary or deodorant purposes [toiletries]; dry-cleaning preparations; eau de Cologne; emery paper; essential oils; essential oils of lemon; ethereal essences; extracts of flowers [perfumes]; eyebrow cosmetics; eyebrow pencils; eye-washes, not for medical purposes; fabric softeners for laundry use; face and body beauty creams; false eyelashes; false nails; floor wax; food flavorings [essential oils]; fragrances for personal use; fumigation preparations [perfumes]; greases for cosmetic purposes; grinding preparations; hair conditioners; hair dyes; hair gel; hair lotions; hair spray; hair straightening preparations; hair waving preparations; henna [cosmetic dye]; herbal extracts for cosmetic purposes; incense; jasmine oil; Javelle water; joss sticks; lacquer-removing preparations; laundry bleach; laundry glaze; laundry soaking preparations; lavender oil; lavender water; lip glosses; lipstick cases; lipsticks; lotions for cosmetic purposes; make-up; make-up powder; make-up preparations; make-up removing gels, lotions and creams; make-up removing preparations; mascara; massage candles for cosmetic purposes; massage gels, other than for medical purposes; mint essence [essential oil]; mint for perfumery; mouthwashes, not for medical purposes; musk [perfumery]; mustache wax; nail art stickers; nail care preparations; nail polish; nail varnish removers; neutralizers for permanent waving; non-medicated balms for use on hair; non-medicated toiletry preparations; non-slipping wax for floors; oils for cleaning purposes; oils for cosmetic purposes; oils for perfumes and scents; oils for toilet purposes; paint stripping preparations; perfumed extracts of flowers for perfumes; perfumery; perfumes; phytocosmetic preparations; polishing creams; polishing paper; polishing preparations; polishing stones; polishing wax; pomades for cosmetic purposes; potpourris [fragrances]; preparations to make the leaves of plants shiny; preservatives for leather [polishes]; rose oil; sachets for perfuming linen; scented linen water; scented water; scented wood; scouring solutions; shampoos; shampoos for animals [non-medicated grooming preparations];

shaving preparations; shaving soap; shaving stones [astringents]; shining preparations [polish]; shoe cream; shoe polish; shoe wax; shoemakers' wax; shower gels, creams and oils; skin bronzer; skin soap; skin whitening creams; soap; stain removers; sunscreen preparations; sun-tanning preparations [cosmetics]; tailors' wax; talcum powder, for toilet use; teeth whitening strips; tissues impregnated with cosmetic lotions; tissues impregnated with essential oils, for cosmetic use; tissues impregnated with make-up removing preparations; toilet water; toiletry preparations; vaginal washes for personal sanitary or deodorant purposes; wallpaper cleaning preparations; bleaching preparations and other substances for laundry use; cleaning, polishing, scouring and abrasive preparations.

9 – 3D spectacles; abacuses; accumulators, electric; acoustic alarms; adding machines; air analysis apparatus; alarm bells, electric; amplifiers; animated cartoons; anodes; antennas; anti-glare glasses; apparatus and instruments for astronomy; apparatus and instruments for physics; asbestos clothing for protection against fire; baby monitors; bags adapted for laptops; bar code readers; barometers; bathroom scales; batteries, electric; battery chargers; binoculars; biochips; breathing apparatus for underwater swimming; breathing apparatus, except for artificial respiration; bullet-proof clothing; buzzers; cabinets for loudspeakers; calculating machines; camcorders; carpenters' rules; cases especially made for photographic apparatus and instruments; cases for smartphones; cash registers; cassette players; CD cases; CDs; chemistry apparatus and instruments; chronographs [time recording apparatus]; close-up lenses; clothing for protection against fire; coin-operated musical automata [juke boxes]; commutators; compact disc players; compact discs [audio-video]; compasses for measuring; computer game programs; computer hardware; computer programs [downloadable software]; computer programs, recorded; computer software applications, downloadable; computer software, recorded; computers; contact lenses; containers for contact lenses; correcting lenses [optics]; counters; covers for mobile telephones; covers for personal digital assistants [PDAs]; covers for smartphones; covers for tablet computers; data processing apparatus; decorative magnets; digital photo frames; digital weather stations; directional compasses; disk drives for computers; disks, magnetic; distance recording apparatus; distribution boxes [electricity]; distribution consoles [electricity]; divers' masks; DNA chips; downloadable image files; downloadable music files; downloadable ring tones for mobile phones; dressmakers' measures; DVD players; ear plugs for divers; egg timers [sandglasses]; electric and electronic effects units for musical instruments; electric apparatus for commutation; electrical adapters; electronic agendas; electronic book readers;

electronic notice boards; electronic publications, downloadable; electronic tags for goods; encoded key cards; encoded magnetic cards; enlarging apparatus [photography]; eyeglass cases; eyeglass chains; eyeglass clips; eyeglass cords; eyeglass frames; eyeglass lenses; eyepieces; eyewear; fire blankets; fire extinguishers; flash-bulbs [photography]; floppy disks; food analysis apparatus; frames for lenses; Global Positioning System [GPS] apparatus; gloves for divers; gloves for protection against accidents; goggles for skiing; goggles for sports; hands-free kits for telephones; head guards for sports; headphones; hemline markers; holograms; humanoid robots with artificial intelligence; identity cards, magnetic; integrated circuit cards [smart cards]; interactive touch screen terminals; intercommunication apparatus; interfaces for computers; joysticks for use with computers, other than for video games; laptop computers; laptops carrying cases; life belts; life buoys; life jackets; life-saving rafts; light-emitting electronic pointers; lorgnettes; loudspeakers; magnetic tapes; magnets; magnifying glasses; mechanisms for coin-operated apparatus; megaphones; microscopes; mobile phone straps; mobile phones; mobile telephones; monitors [computer hardware]; monocles; mouse [computer peripheral]; mouse pads; nose clips for divers and swimmers; notebook computers; objectives [lenses] [optics]; optical character readers; optical discs; optical lenses; parts, fittings and accessories for all the aforesaid goods (included in this class); pedometers; personal digital assistants [PDAs]; phototelegraphy apparatus; pince-nez; pocket calculators; portable media players; projection apparatus; projection screens; protective films adapted for computer screens; protective films adapted for smartphones; protective goggles; protective helmets; protective helmets for sports; quantity indicators; radio pagers; radios; readers [data processing equipment]; reading spectacles; record players; remote control apparatus; riding helmets; safety restraints, other than for vehicle seats and sports equipment; satellite navigational apparatus; scales; screen savers; security tokens [encryption devices]; selfie lenses; shoes for protection against accidents, irradiation and fire; signalling whistles; signs, luminous; smart rings; smartglasses; smartphones; smartwatches; snorkels; sound recording discs; spectacle cases; spectacle chains; spectacle cords; spectacle frames; spectacle glasses; spectacles; sports whistles; stands for photographic apparatus; stills for laboratory experiments; sunglasses; tablet computers; teaching apparatus; teaching robots; telecommunication apparatus in the form of jewellery; telephone apparatus; television apparatus; temperature indicators; testing apparatus not for medical purposes; theft prevention installations, electric; ticket dispensers; time clocks [time recording

devices]; time recording apparatus; transparencies [photography]; USB flash drives; video baby monitors; video cassettes; video screens; video telephones; videotapes; virtual reality headsets; visors for helmets; walkie-talkies; weighing apparatus and instruments; wrist rests for use with computers; scientific, nautical, surveying, photographic, cinematographic, optical, weighing, measuring, signalling, checking (supervision), life-saving and teaching apparatus and instruments; apparatus and instruments for conducting, switching, transforming, accumulating, regulating or controlling electricity; apparatus for recording, transmission or reproduction of sound or images; magnetic data carriers, recording discs; DVDs and other digital recording media; data processing equipment.

14 – Alarm clocks; alloys of precious metal; amulets; atomic clocks; automatic watches; badges of precious metal; boxes of precious metal; bracelets; brooches; buckles for watch straps; cases adapted for holding watches; cases for clock and watchmaking; cases for clocks and watches; chains; charms as personal jewelry; charms for jewellery; chronographs; chronometers; chronometric apparatus and instruments; chronoscopes; clasps for jewelry; clock and watch hands; clock and watchmaking anchors; clock and watchmaking clock hands; clock and watchmaking pendulums; clock barrels for watchmaking; clock cases; clock dials; clock housings; clocks; clocks electric; clocks incorporating radios; clockworks being clock parts; collectible coins; commemorative coins; control clocks, namely, mechanical and automatic watches featuring built-in remote controls functions, master clocks; costume jewelry; cuff links; dials for clock and watchmaking; diamonds; earrings; electric watches; figurines of precious metal; gold, unwrought or beaten; hat ornaments of precious metal; ingots of precious metals; jewel cases of precious metal; jewellery; jewelry; jewelry brooches; jewelry cases; jewelry ornaments; jewelry rolls; key rings of precious metals; medals; movements for clocks and watches; necklaces; ornamental pins made of precious metal; parts for clocks; paste jewelry; pearls; pins being jewelry; pocket watches; precious metals and their alloys; precious metals, unwrought or semi-wrought; precious stones; rings; rough precious stones; scarf rings being jewelry; shoe ornaments of precious metal; silver, unwrought or beaten; sports watches; statues of precious metal; sundials; threads of precious metal; tie clips; tie pins; watch bands; watch bracelets; watch cases; watch chains; watch clasps; watch crowns; watch glasses; watch movements; watch pouches; watch springs; watch straps; watches; watches containing a game function; watches made of precious metals or coated therewith; works of art of precious metal; wrist-

watches; semi-precious stones; horological instruments.

18 – Artificial fur; attaché cases; backpacks; bags for sports; beach bags; briefcases; business card cases; calling card cases; canes; canvas shopping bags; credit card cases; dog collars; faux fur; fur pelts; furs sold in bulk; garment bags for travel; handbag frames; handbags; harness fittings; hat boxes of leather; leather and imitation leather; leather cases; leather key cases; leather shopping bags; leather shoulder belts; leather straps; mesh shopping bags; name card cases; pet clothing; pouches made from imitation leather; pouches made out of cloth; pouches of leather; pouches of textile; purses; raw skins; reusable shopping bags; rucksacks; saddlery; school bags; school satchels; suitcases; synthetic fur; textile shopping bags; traveling bags; travelling trunks; umbrellas; unfitted vanity cases; waist pouches; walking sticks; wallets; whips; animal skins; bags; boxes of animal skins; boxes of imitation leather; carry-on-bags; cases of leather for containing shoe polishing apparatus; clothing for pets; collars for animals; document cases; fur; gym bags; harnesses straps; key cases of leather or animal skins or their imitations; leather credit card cases; leather leads; leather, unworked or semi-worked; luggage; overnight cases; parasols; pocket wallets; shopping bags; shoulder bags; sports bags; tie cases; tote bags; trimmings of leather for furniture; trunks (luggage); wheeled luggage; saddles; harness; moleskin (imitation of leather); boxes of leather; boxes of vulcanized fibre; tool bags of leather, empty; book bags; valises; wheeled shopping bags; travelling garment bags; garment bags; overnight bags; card cases (notecases); belt bags of leather; cases, of leather or leatherboards; music cases; alpenstocks; pouch baby carriers; saddlery; furniture coverings of leather; pouches, of leather, for packaging; harness for animals.

25 – Anoraks (parkas); anti-sweat-underwear; aprons (clothing); ascots; babies' pants; ballroom dancing shoes; ballroom dancing uniforms; bandanas; bath sandals; bath slippers; bathing drawers; bathing suits; bathing trunks; bathrobes; beach clothes; beach coverups; beach shoes; beanies; belts; belts (money) (cloting); belts made from imitation leather; berets; bibs not of paper; bikinis; blouses; blousons; boas (necklets); bodices; body linen; bomber jackets; boot uppers; boots; boots (ski); boots for sport; bow ties; boxer shorts; braces for clothing (suspenders); brasseries; breeches for wear; camisoles; cap peaks; caps; caps (headwear); cardigans; chasubles; children's clothing; cloaks; cloth bibs; clothing; clothing for gymnastics; clothing of imitations of leather; clothing of leather; coats; collar protectors for wear; collars (clothing); combinations (clothing); corselets; corsets (underclothing); coveralls; crop tops; cuffs; cyclists'

clothing; dance costumes; dance shoes; dance slippers; denims; detachable collars; down clothing; down jackets; down leather clothing; drawers; dress shields; dress shirts; dresses; dressing gowns; dungarees; dust coats; ear muffs (clothing); esparto shoes or sandals; fishing vests; fittings of metal for footwear; fleece bottoms; fleece pullovers; fleece tops; fleece vests; flip flops; football boots; football shoes; footmuffs, not electrically headed; footwear; footwear uppers; foulards; foundation garments; fur stoles; furs (clothing); gabardines (clothing); gaiter straps; gaiters; gaiters of leather; galoshes; garters; girdles; gloves; golf pants, shirts and skirts; gowns; gymnastic shoes; hair shawl; half boots; hat frames (skeletons); hats; head bands (clothing); headgear for wear; headwear; heelpieces for footwear; heelpieces for stockings; heels; hooded sweatshirts; hoods (clothing); hosiery; inner soles; insoles; jackets; Japanese style sandals of leather; jeans; jeans clothing; jerseys; jumper dresses; knitwear (clothing); lace boots; layettes; leather belts; leather boots; leather coats; leather hats; leather headwear; leather jackets; leather shirts; leather shoes; leather skirts; leather slippers; leather spats; leather vests; leg warmers; leggings; leotards; liveries; long underwear; loungewear; maniples; mantillas; masquerade costumes; mitres (hats); mittens; money belts (clothing); motorists' clothing; muffs; neckties; night shirts; non-slipping devices for footwear; outerclothing; overalls; overcoats; padded jackets; pajamas; pants; paper clothing; paper hats; peaks (hat); pelerines; pelisses; petticoats; pinafore dresses; pocket squares; pockets for clothing; polo shirts; ponchos; pullovers; rain jackets; raincoats; ready-made clothing; ready-made linings (parts of clothing); religion clothing; reversible jackets; rugby shirts; running shoes; sandals; saris; sarongs; sashes for wear; scarfs; shawls; shirt fronts; shirt yokes; shirts; shoes; shorts; short-sleeve shirts; shoulder wraps; shower caps; singlets; ski gloves; skirts; skiwear; skorts; skull caps; sleep masks; sleeping garments; sleeved or sleeveless jackets; slippers; slips (undergarments); smocks; sneakers; sock suspenders; socks; soles for footwear; spats; sport bras; sport pants; sport shoes; sports jackets; sports jerseys; stockings; stocking suspenders; studs for football boots; stuff jackets; stylish shirts; suits; suits of leather; sun visors; suspenders; sweat pants; sweat shirts; sweat shorts; sweat-absorbent stockings; sweat-absorbent underclothing; sweaters; swim suits; tank tops; teddies; thermal underwear; ties; tights; tips for footwear; togas; top hats; topcoats; tops; track suits; trouser straps; trousers; trousers of leather; T-shirts; turbans; underclothing; underpants; undershirts; underwear; uniforms; veils (clothing); vests; visors; waistcoats; waterproof clothing; waterproof footwear; waterproof jackets; waterproof pants; wedding dresses; welts for footwear; wet suits

for water-skiing; wimples; wind resistant jackets; windcheaters; wooden shoes; wristbands.

(260) AM 2019 100293 A

(800) 1432405

(151) 2018 03 28

(891) 2018 03 28

(731) IPCO AB

2453 Västra Verken, SE-811 81 Sandviken,
Sweden

(540)



(591) Black, white

(531) 24.17.08; 27.05.19; 27.05.22; 27.05.24

(511)

6 – Steel belts for manufacturing wood based panels, chemicals, paper, thin film, bread, biscuits, chocolate, tiles, laminates, composites, paper board; steel belts for test equipment and wind tunnels; sintered metallic bodies; sheets and plates of metal for use in construction and transportation, manufactured in scattering and pressing processes with temperature, pressure and residence time.

7 – Sulphur (sulfur) forming, wet prilling, granulating and handling machinery; sulphur (sulfur) remelting machine and contaminant remover; power operated cutting and welding tools for treating of metallic sheet material; power operated machines for chemical-, food- and agrochemical production of granulates or pastilles; machines and machine tools for treatment of materials and for manufacturing; machines for processing food stuffs and pulp; machines and parts thereof for treatment of liquid chemicals, petrochemicals, sulphur (sulfur) and food stuff, goods sold as a process solution therefor; machines and parts thereof for transforming liquid chemicals, petrochemicals, sulphur (sulfur) and food stuff into solid form, goods sold as a process solution therefor; shaping and moulding machines; drying machines; mechanical winders; spray moulding machines; conveyors and conveyors belts.

11 – Heating apparatus and parts thereof in this class; furnaces (not for experimental purposes); steam generating, boiling, cooling, freezing, drying, ventilation and casting apparatus; thick film heating elements; drying machines, not laundry tumblers [heat dryers] or laundry drier cabinets; electrical furnaces in the form of electrically heated resistance elements and apparatus for the destruction of gaseous impurities; electrical furnaces and refractory

supports and bricks for insulation of resistance heating elements; thick film heating elements, radiation elements; parts and fittings included in this class for all the aforesaid goods.

37 – Rental, installation, maintenance and repair services relating to steel belts, machines and machine tools for treatment of materials and for manufacturing, power operated machines, drying machines and dryers.

42 – Engineering design, development and integration in the areas of sulphur (sulfur) forming, granulating and handling machinery, and technical consultancy relating thereto.

(260) AM 2019 100296 A

(800) 337016

(151) 1967 06 16

(891) 2018 07 02

(731) KARL STORZ SE & Co. KG

Dr.-Karl-Storz-Str. 34, 78532 TUTTLINGEN,
Germany

(540)

HOPKINS

(591) Black, white

(531) 27.05.01; 27.05.17

(511)

10 – Optical medical apparatus, namely optical systems for endoscopes.

(260) AM 2019 100297 A

(800) 898683

(151) 2006 07 12

(891) 2018 10 15

(731) Yara International ASA

Drammensveien 131, P.O. Box 343, Skøyen,
N-0213 Oslo, Norway

(540)

YARAVITA

(591) Black, white

(511)

1 – Fertilizers.

44 – Rental of farming equipment; professional consultancy and advisory services in the field of agriculture, horticulture and forestry.

(260) AM 2019 100298 A

(800) 921295

(151) 2007 03 21

(891) 2018 10 15

(731) Yara International ASA

Drammensveien 131, P.O. Box 343, Skøyen,
N-0213 Oslo, Norway

(540)



(591) Black, white
 (531) 02.09.14; 26.04.03
 (511)
 1 – Chemicals used in agriculture, horticulture and forestry; fertilizers.

(260) AM 2019 100299 A
 (800) 970825
 (151) 2008 02 08
 (891) 2018 10 15
 (731) Yara International ASA
 Drammensveien 131, P.O. Box 343, Skøyen,
 N-0213 Oslo, Norway

(540)

KNOWLEDGE GROWS

(591) Black, white
 (511)
 1 – Chemical products for use in industry, agriculture, horticulture and forestry; fertilizers, industrial chemicals, namely nitrogen based chemicals, including ammonia, ammonium bicarbonate, ammonium nitrate, dinitrogen tetroxide, nitric acid, hydrochloric acid, phosphoric acid, urea, calcium carbonate, calcium nitrate, potassium nitrate and sodium nitrate; formic acid and salts thereof; flocculants; industrial gases, speciality gases and welding gases, including acetylene, methyl acetylene, oxygen, nitrogen, argon, carbon dioxide, carbon monoxide, helium, hydrogen, neon, krypton, xenon, methane, deuterium and mixtures of said gases, all in gaseous, liquid or solid state; catalysts; cryogenic preparations.

13 – Ammonium nitrate explosives, including emulsion explosives and ammonium nitrate fuel oil explosives (ANFO), all for civil purposes.

44 – Rental of farming equipment; professional consultancy and advisory services in the field of agriculture, horticulture and forestry.

(260) AM 2019 100301 A
 (800) 1197577
 (151) 2014 02 26
 (891) 2018 09 14
 (731) CERAMICA DE BELLAVISTA, S.A.
 Avda. de Andalucía, 228, E-41700
 Dos Hermanas (Sevilla), Spain

(540)

BELLAVISTA

(591) Black, white
 (511)
 19 – Non-metallic building materials; rigid pipes, not of metal, for building; asphalt, pitch and bitumen; transportable buildings, not of metal; monuments, not of metal.

(260) AM 2019 100302 A
 (800) 1291809
 (151) 2015 10 15
 (891) 2018 10 16
 (731) Alfred Kärcher SE & Co. KG
 Alfred-Kärcher-Strasse 28-40, 71364
 Winnenden, Germany

(540)

KÄRCHER CLEAN PARK

(591) Black, white
 (531) 27.05.10
 (511)
 1 – Chemical products for cleaning and maintenance of motor vehicles.

7 – Mechanically-operated motor vehicle cleaning apparatus and cleaning installations.

37 – Cleaning and maintenance of motor vehicles; provision of information relating to the rental of motor vehicle cleaning installations and motor vehicle maintenance installations; provision of self-service washing installations in return for payment.

(260) AM 2019 100303 A
 (800) 1328834
 (151) 2016 10 14
 (891) 2018 10 15
 (731) Yara International ASA
 P.O. Box 343 Skøyen, N-0213 Oslo, Norway

(540)

YaraTera

(591) Black, white
 (511)
 1 – Chemicals for use in agriculture, horticulture and forestry; fertilizers and manures; compost, plant growth regulators; seed and seed grain treatment preparations; soil treatment preparations; chemicals for coating of fertilizers and seeds and seed grain; granulated lime; chemical additives; nitrates.

(260) AM 2019 100304 A
 (800) 1336749
 (151) 2016 10 19
 (891) 2018 05 23
 (731) Dimitar Hristov BALEV

Blvd. Vitosha No.137, apt. 17, BG-1408
Sofia, Bulgaria

(540)



(591) Black, white

(531) 26.04.18; 26.04.24; 27.05.10; 27.05.24

(511)

3 – Soaps; perfumery; essential oils; aromatics [essential oils]; ionone [perfumery]; extracts of flowers [perfumes]; cosmetics and cosmetic preparations; potpourris [fragrances]; air fragrancing preparations; fragrances for household purposes; canned pressurized air for cleaning and dusting purposes; cleaning preparations; fragrances for automobiles; sachets for perfuming linen; scented wood; scented water; incense sticks; tissues impregnated with cosmetic lotions; cloths impregnated with a detergent for cleaning; cleaning preparations for automobiles; bath salts, not for medical purposes.

5 – Salts for mineral water baths; air purifying preparations; air deodorizers; deodorants for clothing and textiles; air deodorising preparations; deodorants, other than for human beings or for animals; moist wipes impregnated with a pharmaceutical lotion; disposable sanitizing wipes; babies' napkins [diapers]; sanitary napkins.

(260) AM 2019 100362 A

(800) 789180

(151) 2002 10 09

(891) 2018 10 05

(731) H & M Hennes & Mauritz AB

Mäster Samuelsgatan 46 A, SE-106
38 Stockholm, Sweden

(540)

L.O.G.G.

(591) Black, white

(511)

18 – Leather and imitations of leather, and goods made of these materials and not included in other classes; animal skins, hides; trunks and travelling bags; umbrellas, parasols and walking sticks; whips, harness and saddlery.

25 – Clothing, footwear, headgear.

(260) AM 2019 100363 A

(800) 987225

(151) 2008 09 27

(891) 2018 10 16

(731) PROBIOTICAL S.P.A.

Via Mattei, 3, I-28100 NOVARA, Italy

(540)

BIFIBABY

(591) Black, white

(511)

5 – Micro-organisms and cultures of micro-organisms, in particular probiotic lactic bacteria, probiotic bifid bacteria to be administered to human beings and reared animal species, for medical or veterinary purposes; micro-organisms and cultures of micro-organisms, in particular probiotic lactic bacteria, anallergic probiotic bifid bacteria which has beneficial activity on the intestinal microflora of babies; proprietary medicine containing micro-organisms and cultures of micro-organisms, in particular probiotic lactic bacteria, probiotic bifid bacteria for treating the intestinal bacterial flora, for restoring the balance of the intestinal bacterial flora when changed in the course of treatment with antibiotics or chemotherapy, for treating acute and chronic gastro-intestinal diseases caused by a change in the intestinal bacterial flora, for treating intestinal dismicrobic syndromes, in particular in diseases linked to changes in the bacterial flora such as diarrhea, gastroenteritis, non-specific enteritis, colitis, ulcerous colitis and Crohn's disease, to be taken orally, in particular in the form of capsules, tablets, solutions, suspensions, granules and granules in dried or freeze-dried form; food supplements, food supplements for medical use containing micro-organisms or cultures of micro-organisms, in particular probiotic lactic bacteria, probiotic bifid bacteria to be administered to human beings; dietary supplements; food supplements containing micro-organisms and cultures of micro-organisms, in particular probiotic lactic bacteria, probiotic bifid bacteria to be administered to human beings and reared animal species, not for medical or veterinary use; symbiotic supplements containing micro-organisms or cultures of micro-organisms, in particular probiotic lactic bacteria, probiotic bifid bacteria and prebiotic fibres; food supplements for animals, not for medical use.

(260) AM 2019 100364 A

(800) 1104829

(151) 2011 12 07

(891) 2018 10 02

(731) CAUSSADE SEMENCES

ZI de Meaux, F-82300 Caussade, France

(540)

CAUSSADE

(591) Black, white

(511)

31 – Agricultural products and grains not included in other classes; grains (seeds); grains of corn, sunflower, sorghum, cereals, canola, soya, wheat, barley, oats, winter barley, triticale, rye; grains of high-protein crops and other forage seeds.

42 – Scientific and technological services and research and design relating thereto; research services in biotechnology namely variety research.

(260) AM 2019 100365 A

(800) 1379843

(151) 2017 05 15

(891) 2018 09 20

(731) Limited Liability Company «ORIMI»

15/4 plot, 1-st Microrayon Street, Sverdlov factory settlement, Vsevolozhsk district, RU-188682 Leningrad oblast, Russian Federation

(540)

(591) Black, white

(531) 27.05.02; 27.05.19

(511)

30 – Tea; iced tea; tea-based beverages.

(260) AM 2019 100367 A

(800) 1423274

(151) 2018 03 23

(891) 2018 09 20

(731) Vodafone Group Public Limited Company

Vodafone House, The Connection, Newbury, Berks RG14 2FN, United Kingdom

(540)



(591) Black, white

(531) 01.15.15; 26.01.03; 26.01.16; 26.01.24

(511)

9 – Scientific, nautical, surveying, photographic, cinematographic, optical, weighing, measuring, signalling, checking [supervision], life-saving and teaching apparatus and instruments; apparatus and instruments for conducting, switching, transforming, accumulating, regulating or controlling electricity; apparatus for recording, transmission or reproduction of sound or images; magnetic data carriers,

recording discs; compact discs, DVDs and other digital recording media; mechanisms for coin-operated apparatus; cash registers, calculating machines, data processing equipment, computers; computer software; telecommunications, telephonic and communications apparatus and instruments; radio telephones, mobile and fixed telephones; mobile phones; portable telecommunications apparatus; smartphones; cases for telephones; headsets for telephones; handheld, mobile and tablet computers; wearable electronic telecommunication and computing devices; data communication apparatus and instruments; voice processing systems; computer networking and data communications equipment; mobile data apparatus; data processing systems; electronic databases; digital telephone platforms and software; computer hardware for telecommunications; telecommunication networks; modems; network routers; broadband installations; decoders; set-top box apparatus including apparatus having an interactive viewing guide and/or a recorder for recording television and audio programmes; electrical and electronic apparatus for use in the reception of satellite, terrestrial or cable broadcasts; apparatus and instruments for the processing, transmission, storage, logging, reception and retrieval of data being in the form of encoded data, text, audio, graphic images or video or a combination of these formats; wireless handheld units and devices, namely, tablets, mobile phones, smart phones, computers, portable telephones, video telephones, radios, smart watches, USB dongles, GPS trackers, wearable activity trackers, video cameras, cameras; remote controls for electric and electronic devices; personal digital assistants; electronic sensors including pedometers, altimeters and weighing scales; barcode and quick response code readers and scanners; audio and video recordings; media for storing information, data, images and sound; digital media content (downloadable), including films, television programmes, radio programmes, videos, images, music, text, data, images, graphics and ringtones, provided from a computer database, the Internet or other electronic network; satellite receiving and transmission apparatus and instruments; computer and video game programs, including downloadable computer games; electronic publications (downloadable) provided on-line from computer databases, the Internet or other electronic networks; machine readable media; downloadable digital audio, video and data provided from a computer database, or the Internet or other electronic network; battery chargers for use with telecommunications apparatus; batteries; battery back-up power supply; peripheral equipment for televisions and computers; computers including laptop and notebook computers; electronic personal organisers; electronic and satellite navigational and positional apparatus and instruments

including global positioning systems; desk or car mounted units incorporating a loud speaker which permits hands-free use of a telephone handset; in-car telephone handset cradles; teaching apparatus and instruments; metering apparatus; smart meters; blank and pre-recorded magnetic cards; cards containing microprocessors; telephone cards; credit, debit and payment cards; telephone credit cards; encoded cards; computer software, including computer software supplied from a computer database, the Internet or other electronic network; data communications software; application software, including application software for mobile devices; downloadable computer software applications; computer software for wireless data communication; computer software and application software for the synchronization, transmission and sharing of voice, data, calendar and content between one or more electronic devices, for purchasing applications handheld electronic devices and for secure, encrypted purchases; operating system software; computer software for the streaming transmission and encryption and storage, of audio, video, graphics, text and data on and over communication networks; computer software to enable peer-to-peer networking and file sharing; search engine software; computer software for conducting and co-ordinating communications among computer users sharing information and audio data via electronic communications networks; software for interactive televisions; image and video editing software including software applications for use on mobile devices; software for the identification of persons; software for access control, video control and detecting the presence of persons; software for computer security, including antivirus, firewalls, antispam, anti-spyware, web filtering; intrusion detection software; virtual private network software; computer software for receiving, processing, transmitting and displaying information relating to fitness, body fat, body mass index, sleep patterns, locations, attitude, weather and temperature; computer software for managing information regarding tracking, compliance and motivation with a health and fitness program; anti-theft devices not for vehicles; anti-collision sensors for vehicles; devices and apparatus for locating movable property; apparatus for sending and receiving information from movable property; devices and apparatus for remote control of electrical apparatus and household appliances; alarm devices and installations; satellite location and navigation systems; systems for the downloading and updating of computer software to and from electronic apparatus; electronic and biometric apparatus and installations for access control; apparatus for identifying persons; closed circuit television systems; cameras, television cameras and video recorders for closed-circuit television; optical and photographic apparatus; electronic speedometers; electronic odometers;

electronic tachometers; speed checking apparatus for vehicles; kilometre recorders for vehicles; electric or electronic sensors for vehicles; electronic sensors; sirens; electric locks for vehicles; remote control apparatus; electronic keys for vehicles; electronic keyless vehicle access and starter systems; remote control apparatus for the opening and closing of vehicle doors, boot, bonnet and roof; electrical and electronic control apparatus and instruments for use with systems for the automatic opening and closing of vehicle doors, boot, bonnet and roof; communication apparatus integrated into motorcycle helmets; gps apparatus; apparatus for vehicles for determining or signalling vehicle location, locations of site, travel routes, time, traffic conditions, presence of emergency vehicles and hazard conditions; systems for communication between vehicles and road infrastructures; road marking detection devices; vehicle teleguidance systems and instruments; blind spot and lane changing assistance monitoring systems; vehicle on-board computers; on-board electric, electronic or optical equipment for vehicles, including land vehicles; on-board diagnostic systems and remote-controlled diagnostic systems for vehicles; systems for the downloading and updating of computer software to and from vehicles; devices to detect and/or exchange data between a vehicle and a remote unit for security purposes; parking aids, obstacle detection devices; parking assistance, reversing and blind spot detection systems and alarms; pre-collision detection and collision avoidance systems; electronic immobilisers for vehicles; in vehicle touch screen computer systems; devices for remote location of vehicles; smart wristbands that communicate data to smartphones; downloadable software for promotional and demonstration purposes, for customised display screens on telecommunications apparatus; sim cards; telematics apparatus; telematics software; haptic sensors, equipment and apparatus, namely tactile monitors, screens, electronic displays, switches, sensors, smart glasses and virtual or augmented reality glasses and headsets and holographic projectors; software for use with haptic sensors, equipment and apparatus; virtual reality software and hardware; augmented reality software and hardware; computer hardware modules for use with the Internet of Things [IoT]; computer hardware modules for use in electronic devices using the Internet of Things [IoT]; software for use in implementing the Internet of Things [IoT]; communications software; computer software and application software for secure, encrypted purchases; software for computer security, including antivirus, firewalls, antispam, anti-spyware, web filtering and intrusion detection software; customer support and customer service computer software and application software; voice command and recognition software, speech to text conversion software, and voice-

enabled software applications; messaging software; personal assistant software; computer software for personal information management; computer software for use to connect and control Internet of Things (IoT) electronic devices; chatbot computer software and application software; computer software and application software in the field of artificial intelligence (AI); artificially intelligent chatbot computer software and application software for providing customer support and customer services; customer service chat robot software; humanoid robots with artificial intelligence; electrical and electronic control apparatus making use of artificial intelligence technology for use in connecting, operating, and managing networked devices, appliances, machinery and installations in the Internet of Things (IoT); electronic controllers; electronic controllers to impart sensory feedback, namely, sounds and vibrations that are perceptible to the user; computer software for use in connection with the transmission of voice and data; computer software, and peripherals for personalized, interactive television (TV) programming and for use in displaying and manipulating visual media, graphic images, text, photographs, illustrations, digital animation, video clips, film footage and audio data, and for social networking; wireless controllers to monitor and control the functioning of other electronic devices; touchscreens; parental control software; network apparatus; e-commerce software; computer software and application software for connecting, operating, and managing networked devices, appliances, machinery and systems in the Internet of Things (IoT).

38 – Telecommunications; mobile and fixed telecommunication and telephone, satellite telecommunication, cellular telecommunication, radio and cellular telephone, radio facsimile, radio paging and radio communication services; voice transmission services; voice messaging and voicemail services; electronic mail services for data and voice; hire, leasing and rental of telecommunications, radio, radio telephone and radio facsimile apparatus; rental of telecommunication facilities; leasing of telephone circuits; communication of data by radio, telecommunications and by satellite; transmission and receiving by radio; communications services by satellite, television and/or radio; transmission and reception of voice communication services; voice over IP services; communication, telecommunication services via a global computer network or the Internet; telephone and mobile telephone message collection and transmission; delivery and reception of sound, data and images; personal numbering services (telephony services); loan of replacement telecommunications apparatus in the case of breakdown, loss or theft; provision of Internet services, namely Internet access services; Internet service provider (ISP) services; telecommunication

of information (including web pages), computer programmes and any other data; electronic mail services; wireless broadband communication services; providing Internet access via wireless broadband networks; providing Internet access via optical fibre broadband networks; wireless communication services; wireless telephony; digital network telecommunications services; providing access to portals on the Internet; telephone call completion services for directory assistance customers; provision of location based telecommunications services for telecommunications apparatus; provision of wireless application protocol services including those utilising a secure communications channel; provision of information relating to or identifying telephone and telecommunications apparatus and instruments; telecommunications routing and junction services; data interchange services; transfer of data by telecommunications; data streaming; streaming of digital media content, including films, television programmes, radio programmes, videos, music, text, data, images, graphics and ringtones, via the Internet or a telecommunications network; delivery of digital media content, including films, television programmes, radio programmes, videos, music, text, data, images, graphics and ringtones, via the Internet or a telecommunications network; data transmission services; broadcasting services; data broadcasting services; broadcast or transmission of radio or television programmes; transmission of digital audio, video and multimedia content by telecommunications; electronic transmission of audio and video files via computer and other electronic communications networks; transmission of news and current affairs information; delivery of digital music by telecommunications; providing access to social networking websites; video text services, videotex services, telex services, video communication services, interactive video text services; messaging services, namely, sending, receiving and forwarding messages in the form of text, audio, graphic images or video or a combination of these formats; unified messaging services; voicemail services; network transmission services of data; data transmission via telecommunication networks; data transmission via telematics networks; video conferencing services; video telephone services; providing telecommunications connections to the Internet or databases; computer aided transmission of messages, data and images; computer communication services; provision of electronic conferencing; providing and leasing access time to computer databases, computer bulletin boards, computer networks, interactive computer communications networks, electronic publications in various fields, merchandising and service catalogues and information and computerised research and reference materials; providing access to educational content, websites and portals; communication servi-

ces for the remote control of electronic devices; communications via wireless and cable networks for systems of smart metering; communication services for the delivery of emergency messages and calls; electronic transmission of data and documents via computer terminals and electronic devices; signal transmission for electronic commerce via telecommunications systems and data communication systems; providing access to electronic communications networks and electronic databases; provision of communication facilities for the interchange of digital data; communication of data by means of telecommunications; transmission of data, including by audio-visual apparatus; transmission of sound, picture, video and data signals; providing access to databases; data bank interconnection services; electronic data exchange services; email data services; data broadcasting and communications services; providing third party users with access to telecommunication infrastructure; provision of information relating to telecommunications, providing electronic telecommunications connections; telecommunication gateway services; interactive telecommunications services; telecommunication network services; telecommunications consultancy services; telecommunications services for aircraft passengers; providing access to electronic databases, Internet or web platforms and Internet or web portals for the purposes of facilitating electronic payments and electronic fund transfers; providing telecommunications connections and networks for use with the Internet of Things [IoT]; providing access to e-commerce platforms on the Internet; telephone communication services provided for hotlines and call centres; automated telephone call screening services; automated telephone voice message services.

(260) AM 2019 100470 A
(800) 1433787
(151) 2018 07 12
(891) 2018 07 12
(731) Xiaomi Inc.

Floor 13, Rainbow City Shopping Mall II,
of China Resources, NO. 68, Qinghe Middle
Street, Haidian District, Beijing, China

(540)

Mi Cloud

(591) Black, white
(531) 27.05.01
(511)

9 – Computer software applications, downloadable; intercommunication apparatus; portable media players; cameras [photography]; video screens; remote control apparatus; measuring instruments; sensors; chips [integrated circuits]; transparencies

[photography]; theft prevention installations, electric; batteries, electric.

35 – Advertising; accounting; sponsorship search; provision of space on websites for advertising goods and services; providing business information via a web site; provision of an on-line marketplace for buyers and sellers of goods and services; sales promotion for others; personnel management consultancy; relocation services for businesses; updating and maintenance of data in computer databases.

38 – Message sending; communications by computer terminals; computer aided transmission of messages and images; providing user access to global computer networks; providing access to databases; providing Internet chatrooms; providing online forums; video-on-demand transmission; paid television program broadcasting; television broadcasting.

42 – Monitoring of computer systems by remote access; computer software design; electronic data storage; conversion of data or documents from physical to electronic media; cloud computing; software as a service [SaaS]; hosting computer sites [web sites]; technical research; industrial design; design of interior decor.

(260) AM 2019 100471 A
(800) 1433807
(151) 2018 08 09
(891) 2018 08 09
(731) BYD COMPANY LIMITED
No.1 Yan'an Road, Kuichong Street, Dapeng
New District, Shenzhen, China
(540)



SKY SHUTTLE

(591) Black, white
(531) 18.01.11; 18.01.23; 26.13.25
(511)

12 – Motor coaches; motor buses; trolleys; civilian drones; automobile tires; electric vehicles; cable cars; bodies for vehicles; boats; vehicle chassis; vehicles for locomotion by land, air, water or rail; sleighs [vehicles].

(260) AM 2019 100472 A
(800) 1433809
(151) 2018 09 21
(891) 2018 09 21
(731) MIDEA GROUP CO., LTD.
B26-28F, MIDEA HEADQUARTER

BUILDING, NO. 6 MIDEA AVENUE,
BEIJIAO, SHUNDE, FOSHAN,
GUANGDONG, China

(540)

COLMO

(591) Black, white

(511)

7 – Compressors [machines]; washing machines [laundry]; dry-cleaner; wringing machines for laundry; turbocompressors; machines and apparatus for cleaning, electric; handling machines, automatic [manipulators]; industrial robots; dishwashers; household soybean milk machine; fruit presses, electric, for household purposes; compressors for refrigerators; vacuum cleaners.

11 – Ice machines and apparatus; water purifying apparatus and machines; microwave ovens [cooking apparatus]; radiators, electric; air purifying apparatus and machines; kettles, electric; air conditioning installations; air conditioning apparatus; refrigerators; pressure cookers, electric; extractor hoods for kitchens; hearths; heaters for baths; laundry dryers, electric; fabric steamers; electric lamps; water dispenser; water filtering apparatus; electric fans for personal use; cooking utensils, electric; disinfectant apparatus; heat pumps; gas boilers.

37 – Air conditioning apparatus installation and repair; installation and repair bathroom facility; machinery installation, maintenance and repair; furniture restoration; construction; installation and repair lighting facility; burglar alarm installation and repair; air conditioning apparatus cleaning; electric appliance installation and repair; motor vehicle maintenance and repair; repair information; installation and repair sanitation facility.

(260) AM 2019 100474 A

(800) 1433837

(151) 2018 06 27

(891) 2018 06 27

(731) GW Cosmetics GmbH

Achauerstr. 49a, A-2333 Leopoldsdorf,
Austria

(540)

REFECTOIL

(591) Black, white

(511)

3 – Mascara; eyelashes (false -); eyebrow cosmetics; eyebrow pencils; make-up removing preparations; mascara removing preparations, preparations for removing eye make-up; make-up removing milks; eyelash and eyebrow dyes; dyes (cosmetic -); oxidation preparations for use in dyeing hair, eyelashes and eyebrows; beard dyes; bleaching preparations [decolorants] for cosmetic purposes;

depilatory preparations; wax (depilatory -); adhesives for cosmetic purposes; eyelashes (adhesives for affixing false -); skin cream; skin care preparations; cotton wool and cotton sticks for cosmetic purposes; cosmetics; cosmetic pencils; eyelid shadow; concealers; liners [cosmetics] for the eyes; lip stains [cosmetics]; lip stains [cosmetics]; cosmetic kits; powder compact refills [cosmetics]; make-up preparations; make-up foundations; make-up foundations; powder for make-up; make-up pencils; make-up for the face; make-up kits; make-up foundations; powder for make-up; compacts containing make-up; make-up for compacts; skin make-up; make-up for the face; eyelid doubling makeup; eye make-up; eyelid shadow; eyelid shadow; cosmetics in the form of eye shadow; eyebrow powder; eyebrow mascara; eyebrow colors in the form of pencils and powders; cosmetics for eyelashes; rouges; blush pencils; cosmetic rouges; liquid rouge; cosmetic rouges; cosmetic rouges; cosmetics in the form of rouge; lipstick; dusting powder; powder for make-up; solid powder for compacts [cosmetics]; perfumed powder [for cosmetic use]; cosmetics in the form of powders; cosmetic face powders; eyelid shadow; make-up for the face and body; cosmetic eye pencils; make-up preparations for the face and body.

9 – Training guides in electronic format; downloadable educational course materials; training software; instruction manuals in electronic format; training manuals in the form of a computer program; e-books; books recorded on tape; books recorded on disc; digital books downloadable from the internet; dvds; interactive dvds; prerecorded exercise dvds; compact discs [read-only memory]; video compact discs; compact discs; audio compact discs.

16 – Paper tissues for cosmetic use; tissues of paper for removing make-up; instructional manuals for teaching purposes; books.

21 – Cosmetic trays of plastic or glass, applicators of plastic for cosmetic purposes; cosmetic brushes; cosmetic sponges; cosmetic powder compacts; applicators for cosmetics; cosmetic brushes; dispensers for cosmetics; cosmetic brushes; cosmetic brushes; applicators for cosmetics; applicators for cosmetics; applicators for cosmetics; applicators for cosmetics; containers for cosmetics; cosmetic brushes; cosmetic brushes; cosmetic brushes; eye make-up applicators; facial sponges for applying make-up; applicator sticks for applying make-up; applicators for applying eye make-up; dusting brushes.

35 – Mail order retail services for cosmetics; mail order retail services for cosmetics; advertising services relating to cosmetics; providing consumer product advice relating to cosmetics; online retail store services relating to cosmetic and beauty products; providing consumer product information rela-

ting to cosmetics; commercial information and advice services for consumers in the field of make-up products.

41 – Providing of training; training; vocational training services; coaching [training]; education services relating to vocational training; training; educational instruction; staff training services; educational services in the nature of beauty schools; training and instruction; provision of training courses; provision of training courses; conducting of exhibitions for training purposes (education); organisation of training courses; provision of training facilities; hire of teaching materials; setting of training standards; educational seminars; conducting of instructional seminars; definition of training standards for a training institute; organisation of seminars relating to training; arrangement of conferences for educational purposes; providing of education; organisation of training courses; arrangement of conferences for educational purposes; dissemination of educational material; provision of training facilities; recreation and training services; educational services provided by institutes of further education; instructional and training services; education services provided by television; provision of training facilities for young people; organising of competitions for education; organisation of seminars relating to education; organising of education exhibitions; provision of training courses; arranging of exhibitions for educational purposes; provision of online training; computer education training services; entertainment, education and instruction services; conducting instructional courses; provision of training courses; education services provided by television programmes; provision of training and education; management of education services; provision of education courses; arranging of competitions for education or entertainment; workshops for educational purposes; arrangement of seminars for educational purposes; arranging of presentations for educational purposes; planning of seminars for educational purposes; arranging of exhibitions for educational purposes; conducting of exhibitions for educational purposes; arranging of demonstrations for training purposes; arranging and conducting of educational courses; preparation of educational courses and examinations; planning of lectures for educational purposes; conducting of instructional seminars; arranging of festivals for training purposes; organising of competitions for education; arranging of displays for training purposes (education); arranging of displays for educational purposes; workshops (arranging and conducting of -) [training]; arranging for students to participate in educational activities; organisation of youth training schemes; educational services in the nature of correspondence courses; educational services relating to beauty therapy; vocational skills training;

workshops (arranging and conducting of -) [training]; arranging professional workshop and training courses; provision of education courses; organisation of seminars relating to training; conducting of instructional seminars; arranging and conducting of seminars and workshops; educational and training services relating to healthcare; educational services for providing courses of instruction; educational services for providing courses of education; provision of education on-line from a computer database or via the internet or extranets; conducting of instructional, educational and training courses for young people and adults; providing on-line information and news in the field of employment training; consultancy and information services relating to arranging, conducting and organisation of workshops; conducting of classes; provision of training courses; organisation of courses using distance learning methods; provision of training courses; conducting of educational courses; arranging of workshops and seminars; conducting courses, seminars and workshops; production of course material distributed at professional seminars; production of course material distributed at professional lectures; production of course material distributed at professional courses; provision of training courses; providing computer assisted courses of instruction; computer training; beauty arts instruction; vocational training services and vocational training; provision of training courses; arranging of courses of instruction; arranging of training courses; conducting instructional courses; provision of training courses; organisation of training courses; practical training [demonstration]; hire of teaching materials; conducting of courses; conducting of instructional seminars; provision of training courses; provision of training courses; publication of instructional literature; hire of teaching materials; provision of training courses; publication of training manuals; publication of instructional literature; provision of facilities for tuition; conducting workshops [training]; training relating to employment skills; vocational training courses (provision of -); teaching of cosmetic skills and teaching of beauty skills; conducting instructional courses; workshops for training purposes (education); providing courses of instruction for young people; workshops (arranging and conducting of -) [training]; arranging and conducting of training courses; coaching; provision of training courses; provision of training courses; beauty school services; hairdressing instruction; publication of books; publication of books; publishing services for books and magazines; publishing services for books and magazines; publishing services for books and magazines; electronic online publication of periodicals and books; publication of electronic books and journals on-line; publication of electronic books and perio-

dicals on the internet; publication of periodicals and books in electronic form; on-line publication of electronic books and journals (non-downloadable).

(260) AM 2019 100475 A
 (800) 1433848
 (151) 2018 04 27
 (891) 2018 04 27
 (731) LABORATORIOS PHERGAL, S.A.
 Hierro, 79; E-28850 TORREJON DE ARDOZ
 (MADRID), Spain
 (540)



(591) Green
 (531) 05.01.03; 05.01.05; 27.05.01; 27.05.11;
 29.01.03
 (511)
 3 – Cosmetic dyes, shampoos, hair lotions, hair dyes, hair waving preparations, cosmetics, perfumery, non-medicinal soaps, essential oils, non-medicinal cosmetics, baby oils, non-medicinal hair lotions, cosmetic creams for skin and body care, emulsions, gels and lotions for skin care, non-medicinal dentifrices, cotton balls for cosmetic use, disposable wipes impregnated with cleansing compounds or chemical products for personal hygiene.

(260) AM 2019 100482 A
 (800) 1433978
 (151) 2018 08 22
 (891) 2018 08 22
 (731) AS 24
 1 boulevard du Zenith, Parc Tertiaire Ar Mor,
 F-44800 Saint-Herblain, France
 (540)



(591) Blue Pantone 286 C and yellow Pantone Yellow C
 (531) 26.03.01; 26.03.17; 29.01.12
 (511)
 9 – Apparatus for storage, transmission and archiving of data relating in particular to automobile fleet management, fuel expenditure management, invoice tracking; apparatus for storage, transmission and archiving of data relating to vehicle and driver control, vehicle mileage and consumption, driving

time; navigation apparatus for vehicles (on-board computers); software for processing electronic payments; magnetic identity cards; software used for securing, identifying and authenticating orders given by computer.

36 – Banking, financial services; electronic payment services; online banking operations.

38 – Secure transmission of data, particularly with access codes; data downloading services by means of an access code; data communication services accessible by access code; computer transmission of information accessible by means of a code or a terminal; provision of a secure space online.

39 – Transport; packaging and storage of merchandise; transport information; transport logistics services.

42 – Securing, electronic storage and hosting of data; development of software for secure network operations.

(260) AM 2019 100504 A
 (800) 1434572
 (151) 2018 09 07
 (891) 2018 09 07
 (731) Apple Inc.
 One Apple Park Way, Cupertino CA 95014,
 USA

(540)



(591) Medium blue and light blue.
 (531) 02.01.01; 02.01.23; 02.01.24; 29.01.04
 (511)
 42 – Electronic data storage; cloud computing services; computer security and data security consultancy; data encryption services.

(260) AM 2019 100507 A
 (800) 1206530
 (151) 2014 03 11
 (891) 2018 10 30
 (731) ALIMENTARY HEALTH LIMITED
 Building 2800, Cork Airport Business Park,
 Kinsale Road, Cork, Ireland
 (540)

ALFLOREX

(591) Black, white
 (511)
 5 – Dietetic food and substances adapted for medical use; medicinal drinks; medicinal food supplements;

health food supplements; dietary supplements; vitamin preparations; dietetic nutritive substances for medical use; protein dietary supplements; vitamin and mineral supplements; mineral food supplements; dietetic yoghurts, for medical use; food for babies; bacteriological cultures, bacteria and preparations of bacteria.

(260) AM 2019 100508 A

(800) 1248177

(151) 2015 03 20

(891) 2018 10 29

(731) Antiseptica Dr. Hans-Joachim Molitor GmbH
Carl-Friedrich-Gauß-Strasse 7, 50259
Pulheim, Germany

(540)



ANTISEPTICA

(591) White, black and light green
"(Pantone: 381 C)".

(531) 26.01.03; 26.04.02; 26.04.10; 26.04.18;
27.05.10; 29.01.13

(511)

3 – Cosmetics, in particular skin care preparations.

5 – Pharmaceutical preparations; disinfectants and antiseptics.

11 – Dispensers, namely dispensing apparatus for disinfectants and antiseptics.

(260) AM 2019 100510 A

(800) 1359377

(151) 2017 04 28

(891) 2018 10 19

(731) GREEN CROSS CORPORATION
107, Ihyeon-ro 30 beon-gil, Giheung-gu,
Yongin-si, Gyeonggi-do 16924, Republic
of Korea

(540)

GCFLU

(591) Black, white

(511)

5 – Pharmaceutical preparations for central nerve treatment; pharmaceutical preparations for diagnosis; pharmaceutical preparations for anus; antibiotic preparations; hypoglycemic agents; pharmaceutical preparations for blood; blood plasma; serums; serotherapeutic medicines; pharmaceutical preparations for respiratory organs; biological preparations for medical or veterinary purposes; microorganisms for medical purposes, except for yeast; pharmaceutical preparations for treatment; pharmaceutical preparation for skin care; human vaccine preparations; vaccines against flu; pharmaceutical agents

affecting sensory organs; pharmaceutical agents affecting metabolism; veterinary preparations; pharmaceutical agents affecting peripheral nervous system; pharmaceutical preparations for immunity adjustment; pharmaceutical preparations for urogenital organs; vitamin preparations; preparations of trace elements for human and animal use; crude medicines; anti-inflammatory preparations; pharmaceutical agents affecting digestive organs; cardiovascular pharmaceutical preparations; steroids; allergy medications; nutritional supplements, namely, tonics and alteratives for medical purposes; pharmaceutical preparations for tumor treatment; pharmaceutical preparations acting on the central nervous system.

(260) AM 2019 100511 A

(800) 1375106

(151) 2017 10 10

(891) 2018 10 01

(731) London Dollar Ltd
Kemp House, 160 City Road, London EC1V
2NX, United Kingdom

(540)

MALIMBO

(591) Black, white

(511)

34 – Tobacco; cigarettes; smokers' articles; matches.

(260) AM 2019 100512 A

(800) 1407292

(151) 2018 02 06

(891) 2018 10 25

(731) Closed joint-stock company «Four zero four»
Moskovsky pr., d. 151a, liter A, pom. 15-N,
RU-196128 Saint Petersburg, Russian
Federation

(540)

Binomo

(591) Black, white

(511)

36 – Financial analysis; capital investment; financial information; financial consultancy; stock exchange quotations; brokerage; financial management; financial evaluation [insurance, banking, real estate]; electronic funds transfer; securities brokerage; providing financial information via a web site; stock brokerage services; financing services.

(260) AM 2019 100513 A

(800) 1414436

(151) 2017 10 09

(891) 2018 10 02

(731) BIODOM 27 d.o.o.
 proizvodnja, trgovina in storitve
 OIC – HRPELJE 14A, SI-6240 KOZINA,
 Slovenia

(540)

(591) Red.
 (531) 27.05.01; 29.01.01
 (511)

9 – Measuring, detecting and monitoring instruments, indicators and controllers; monitoring instruments; controllers (regulators); visual monitoring apparatus; monitoring units [electric]; monitoring apparatus, electric; monitoring control apparatus [electric]; electronic carbon dioxide monitors [other than for medical purposes]; electronic monitoring instruments, other than for medical use; electronic temperature monitors, other than for medical use; remote control apparatus; fuel regulating apparatus; heat regulating apparatus; time regulating apparatus; process controlling apparatus [electric]; thermostat control apparatus; temperature controlling apparatus; automatic control apparatus; process control digital controllers; electrical controls; electric control apparatus; electronic control units; process controlling apparatus [electronic]; electronic regulators; infrared remote control apparatus; control stations (remote, electric or electronic -); energy control devices; central heating programmers; energy regulators; thermal controls [thermostats]; water temperature regulators; pressure regulators [gauges]; thermal controls; thermostat controllers; all the aforesaid goods included in this class being intended for the field of heating.

11 – Flues and installations for conveying exhaust gases; burners, boilers and heaters; fireplaces; central heating apparatus; space heating apparatus; automatic temperature regulators for central heating radiators; installations for central heating; installations for controlling the flow of gases; heating apparatus and installations; burner control apparatus; loading apparatus for furnaces; heat generating apparatus; heating apparatus for solid, liquid or gaseous fuels; heating apparatus for furnaces; central heating boilers; control units [thermostatic valves] for heating installations; boilers; boilers for central heating installations; boilers for hot water supply installations; furnace boilers; boilers for use in heating systems; valves (temperature sensitive controls for automatically operating -) [parts of heating installations]; feeding apparatus for heating boilers; heating apparatus for use in the home; pavement heating apparatus; fittings, shaped, for ovens; stoves; all the aforesaid goods included in this class being intended for the field of heating.

(260) AM 2019 100539 A
 (800) 1435329
 (151) 2018 08 10
 (891) 2018 08 10
 (731) Zhongshan Shenghuowuyou Department
 Store Co., Ltd.
 5 F Plant, Bldg.A, No.76 XingGong Rd.,
 Shaxi Town, Zhongshan, Guangdong, China

(540)

(591) Black, white
 (531) 27.05.10
 (511)
 35 – Advertising and publicity services; business management assistance; import-export agency services; demonstration of goods; business management of hotels; computerized file management; drug retail or wholesale services; outdoor advertising; personnel recruitment; invoicing.

(260) AM 2019 100540 A
 (800) 1435351
 (151) 2018 10 16
 (891) 2018 10 16
 (731) PopSockets LLC
 5757 Central Ave Boulder CO 80301, USA
 (540)



(591) Black, white
 (531) 27.01.01; 27.01.06
 (511)
 9 – Hand grips, stands, and mounts adapted for handheld electronic devices, namely, smartphones, tablet computers, cameras, and portable sound and video players.

(260) AM 2019 100541 A
 (800) 1435357
 (151) 2018 10 16
 (891) 2018 10 16
 (731) PopSockets LLC
 5757 Central Ave Boulder CO 80301, USA
 (540)



(591) Black, white
 (531) 26.01.05
 (511)
 9 – Hand grips, stands, and mounts adapted for handheld electronic devices, namely, smartphones, tablet computers, cameras, and portable sound and video players.

(260) AM 2019 100542 A
 (800) 1435368
 (151) 2018 10 22
 (891) 2018 10 22
 (731) Siemens Healthcare GmbH
 Henkestraße 127, 91052 Erlangen, Germany
 (540)

FlexForce

(591) Black, white
 (511)
 35 – Job and personnel placement; hiring out of employees as temporary workers; consultancy and advisory services relating to personnel placement; arranging and providing of temporary staff; compilation of business information in connection with job and staff placement.

(260) AM 2019 100543 A
 (800) 1435408
 (151) 2018 06 19
 (891) 2018 06 19
 (731) Limited Liability Company
 "TRAVEL LINE SYSTEMS"
 Leninskiy pr-kt, 56 A, g. Yoshkar-Ola,
 RU-424003 Respublika Mariy El, Russian
 Federation

(540)

(591) White, black, blue and dark blue.
 (531) 24.17.02; 26.04.04; 26.04.16; 26.04.24;
 27.05.01; 29.01.13
 (511)
 35 – Arranging subscriptions to telecommunication services for others; import-export agency services; commercial information agency services; advertising agency services; cost price analysis; rental of advertising space; business auditing; financial auditing; business intermediary services relating to the matching of potential private investors with entrepreneurs needing funding; employment agency services; computerized file management; book-keeping; invoicing; demonstration of goods; transcription of communications [office functions]; opinion polling; market studies; business information; commercial information and advice for consumers in the choice of products and services; business investigations; business research; marketing rese-

arch; personnel recruitment; business management and organization consultancy; business organization consultancy; business management consultancy; personnel management consultancy; professional business consultancy; consultancy regarding advertising communication strategies; consultancy regarding public relations communication strategies; layout services for advertising purposes; marketing; marketing in the framework of software publishing; targeted marketing; business management of performing artists; business management of sports people; writing of résumés for others; scriptwriting for advertising purposes; news clipping services; updating and maintenance of information in registries; updating and maintenance of data in computer databases; updating of advertising material; word processing; online retail services for downloadable and pre-recorded music and movies; online retail services for downloadable ring tones; online retail services for downloadable digital music; organization of exhibitions for commercial or advertising purposes; arranging newspaper subscriptions for others; organization of fashion shows for promotional purposes; organization of trade fairs for commercial or advertising purposes; shop window dressing; design of advertising materials; business appraisals; payroll preparation; data search in computer files for others; sponsorship search; administrative assistance in responding to calls for tenders; business management assistance; commercial or industrial management assistance; commercial intermediation services; providing business information via a web site; provision of commercial and business contact information; provision of an on-line marketplace for buyers and sellers of goods and services; web indexing for commercial or advertising purposes; presentation of goods on communication media, for retail purposes; economic forecasting; auctioneering; retail services for works of art provided by art galleries; sales promotion for others; promotion of goods and services through sponsorship of sports events; production of teleshopping programmes; production of advertising films; office machines and equipment rental; rental of advertising time on communication media; publicity material rental; rental of signs for advertising purposes; rental of vending machines; rental of sales stands; rental of photocopying machines; publication of publicity texts; radio advertising; bill-posting; distribution of samples; dissemination of advertising matter; direct mail advertising; registration of written communications and data; writing of publicity texts; on-line advertising on a computer network; advertising by mail order; television advertising; document reproduction; compilation of statistics; compilation of information into computer databases; business inquiries; systemization of information into computer databases; advisory services for business management; negotiation of

business contracts for others; negotiation and conclusion of commercial transactions for third parties; compiling indexes of information for commercial or advertising purposes; tax preparation; drawing up of statements of accounts; telemarketing services; psychological testing for the selection of personnel; wholesale services for pharmaceutical, veterinary and sanitary preparations and medical supplies; retail services for pharmaceutical, veterinary and sanitary preparations and medical supplies; interim business management; outsourced administrative management for companies; business management of hotels; business management for freelance service providers; business project management services for construction projects; commercial administration of the licensing of the goods and services of others; business management of reimbursement programs for others; administration of consumer loyalty programs; administration of frequent flyer programs; administrative processing of purchase orders; public relations; competitive intelligence services; modelling for advertising or sales promotion; typing; market intelligence services; appointment reminder services [office functions]; web site traffic optimization; relocation services for businesses; tax filing services; search engine optimization for sales promotion; appointment scheduling services [office functions]; gift registry services; price comparison services; pay per click advertising; secretarial services; procurement services for others [purchasing goods and services for other businesses]; shorthand; outsourcing services [business assistance]; telephone answering for unavailable subscribers; photocopying services; business efficiency expert services.

39 – Air transport; motor coach rental; boat rental; garage rental; rental of vehicle roof racks; aircraft rental; parking place rental; rental of warehouses; rental of tractors; booking of seats for travel; travel reservation; transport reservation; towing; vehicle breakdown towing services; bottling services; water distribution; delivery of newspapers; message delivery; parcel delivery; delivery of goods; delivery of goods by mail order; flower delivery; launching of satellites for others; traffic information; transportation information; storage information; transportation logistics; rescue operations [transport]; arranging of cruises; arranging of transportation for travel tours; armored-car transport; hauling; carting; transport and storage of trash; transporting furniture; lighterage services; ferry-boat transport; removal services; transport of travellers; guarded transport of valuables; bus transport; car transport; barge transport; boat transport; railway transport; marine transport; passenger transport; river transport; ambulance transport; streetcar transport; portering; refloating of ships; cash replenishment of automated teller machines; shipbrokerage; transport brokerage; freight brokerage [forwarding (Am.)]; providing

driving directions for travel purposes; car rental; railway truck rental; rental of diving bells; rental of diving suits; rental of motor racing cars; rental of aircraft engines; railway coach rental; rental of wheelchairs; rental of storage containers; horse rental; rental of freezers; rental of navigational systems; refrigerator rental; vehicle rental; stevedoring; unloading cargo; electricity distribution; distribution of energy; packaging of goods; collection of recyclable goods [transport]; ice-breaking; piloting; water supplying; escorting of travellers; transport by pipeline; wrapping of goods; operating canal locks; car parking; chauffeur services; pleasure boat transport; car sharing services; courier services [messages or merchandise]; salvaging; salvage of ships; underwater salvage; taxi transport; transport; transport services for sightseeing tours; franking of mail; freight [shipping of goods]; freighting; physical storage of electronically stored data or documents; boat storage; storage of goods; storage; freight forwarding.

42 – Water analysis; computer system analysis; handwriting analysis [graphology]; chemical analysis; energy auditing; recovery of computer data; interior design; industrial design; graphic arts design; computer virus protection services; oil-field surveys; geological surveys; engineering; installation of computer software; meteorological information; clinical trials; material testing; textile testing; bacteriological research; biological research; geological research; research in the field of environmental protection; cosmetic research; mechanical research; chemical research; research and development of new products for others; scientific research; analysis for oil-field exploitation; underwater exploration; technical research; calibration [measuring]; web site design consultancy; computer security consultancy; information technology [IT] consultancy; consultancy in the design and development of computer hardware; architectural consultancy; internet security consultancy; computer software consultancy; data security consultancy; technological consultancy; oil-well testing; quality control; vehicle roadworthiness testing; land surveying; dress designing; updating of computer software; monitoring of computer systems to detect breakdowns; monitoring of computer systems for detecting unauthorized access or data breach; monitoring of computer systems by remote access; software as a service [SaaS]; maintenance of computer software; authenticating works of art; design of interior decor; quality evaluation of standing timber; quality evaluation of wool; digitization of documents [scanning]; conversion of data or documents from physical to electronic media; urban planning; providing information on computer technology and programming via a web site; provision of scientific information, advice and consultancy in relation to carbon offsetting;

providing search engines for the internet; platform as a service [PaaS]; conversion of computer programs and data, other than physical conversion; conducting technical project studies; computer system design; rental of web servers; computer rental; rental of computer software; unlocking of mobile phones; geological prospecting; oil prospecting; hosting computer sites [web sites]; server hosting; construction drafting; computer software design; software development in the framework of software publishing; cloud seeding; consultancy in the field of energy-saving; creating and designing website-based indexes of information for others [information technology services]; creating and maintaining web sites for others; computer programming; technical writing; copying of computer programs; cloud computing; architectural services; chemistry services; outsource service providers in the field of information technology; packaging design; off-site data backup; computer technology consultancy; telecommunications technology consultancy; scientific laboratory services; weather forecasting; styling [industrial design]; cartography services; data encryption services; physics [research]; electronic data storage; surveying; electronic monitoring of credit card activity to detect fraud via the internet; electronic monitoring of personally identifying information to detect identity theft via the internet.

43 – Accommodation bureau services [hotels, boarding houses]; rental of temporary accommodation; rental of meeting rooms; tourist home services; hotel reservations; boarding house bookings; temporary accommodation reservations; hotel services; retirement home services; snack-bar services; café services; cafeteria services; motel services; boarding house services; boarding for animals; rental of cooking apparatus; rental of chairs, tables, table linen, glassware; rental of lighting apparatus; rental of tents; rental of transportable buildings; rental of drinking water dispensers; restaurant services; self-service restaurant services; reception services for temporary accommodation [management of arrivals and departures]; food sculpting; canteen services; holiday camp services [lodging]; bar services; providing campground facilities; food and drink catering; washoku restaurant services; udon and soba restaurant services; day-nursery [crèche] services.

45 – Marriage agency services; detective agency services; night guard services; adoption agency services; arbitration services; leasing of internet domain names; rental of safes; embalming services; funerary undertaking; lost property return; releasing doves for special occasions; security screening of baggage; genealogical research; legal research; intellectual property consultancy; physical security consultancy; legal advice in responding to requests for proposals [RFPs]; monitoring intellectual property rights for legal advisory purposes; monitoring of

burglar and security alarms; crematorium services; licensing [legal services] in the framework of software publishing; licensing of intellectual property; licensing of computer software [legal services]; organization of religious meetings; opening of security locks; planning and arranging of wedding ceremonies; missing person investigations; kimono dressing assistance; litigation services; babysitting; pet sitting; conducting religious ceremonies; conducting funeral ceremonies; inspection of factories for safety purposes; evening dress rental; rental of fire extinguishers; clothing rental; rental of fire alarms; registration of domain names [legal services]; personal letter writing; personal background investigations; fire-fighting; astrology consultancy; spiritual consultancy; personal wardrobe styling consultancy; escorting in society [chaperoning]; horoscope casting; copyright management; legal administration of licences; cartomancy services; dating services; guard services; alternative dispute resolution services; dog walking services; tracking of stolen property; legal document preparation services; house sitting; mediation; burial services; on-line social networking services; personal body guarding; legal services in relation to the negotiation of contracts for others; legal watching services.

(260) AM 2019 100544 A

(800) 1435439

(151) 2018 10 17

(891) 2018 10 17

(731) So.Farma.Morra S.p.a.

Via Lambretta, 2, I-20090 Segrate, Italy

(540)

SANDRO

(591) Black, white

(511)

5 – Pharmaceuticals; dietary supplements and dietetic preparations; food for babies.

(260) AM 2019 100560 A

(800) 1435709

(151) 2018 09 04

(891) 2018 09 04

(731) Chateau Lion Investment Holding (Beijing)

Group Co., Ltd

west of Changzhou Road, No.1 Village,

Daotian, Changyang town, Fangshan District,

Beijing, China

(540)

Chateau Lion

(591) Black, white

(511)

33 – Fruit extracts, alcoholic; aperitifs; distilled beverages; cocktails; wine; spirits [beverages];

brandy; alcoholic extracts; alcoholic beverages, except beer; alcoholic beverages containing fruit.

(260) AM 2019 100561 A

(800) 1435726

(151) 2018 08 09

(891) 2018 08 09

(731) Fujian Nanping Nanfu Battery CO., LTD.
N109, Industry Rd, Yanping District,
Nanping, 353000 Fujian Province, China

(540)

NANFU

(591) Black, white

(531) 27.05.01

(511)

9 – Plugs, sockets and other contacts [electric connections]; accumulators, electric; chargers for electric batteries; batteries, electric; batteries, electric, for vehicles; materials for electricity mains [wires, cables]; voltage surge protectors; rechargeable batteries (portable battery pack); wireless charger; power adapter.

(260) AM 2019 100562 A

(800) 1435771

(151) 2018 05 22

(891) 2018 05 22

(731) Yekalon Industry, Inc.
3rd Floor, Jinxiu Bldg., Wen Jin Middle Road,
Luohu District, 518003 Shenzhen, China

(540)

BuildMost

(591) Black, white

(531) 27.05.01

(511)

35 – On-line advertising on a computer network; presentation of goods on communication media, for retail purposes; organization of trade fairs for commercial or advertising purposes; commercial administration of the licensing of the goods and services of others; negotiation and conclusion of commercial transactions for third parties; business project management services for construction projects; import-export agency services; sales promotion for others; procurement services for others [purchasing goods and services for other businesses]; provision of an on-line marketplace for buyers and sellers of goods and services.

(260) AM 2019 100563 A

(800) 1435800

(151) 2018 09 23

(891) 2018 09 23

(731) Apple Inc.

One Apple Park Way, Cupertino
CA 95014, USA

(540)



(591) Red, white and black.

(531) 02.09.01; 29.01.13

(511)

9 – Computer software in the field of health care, medicine, patient care, and medical records; computer software for the downloading, storage, transmission, evaluation, and review of medical records.

(260) AM 2019 100634 A

(800) 1437124

(151) 2018 06 15

(891) 2018 06 15

(731) Apple Inc.

One Apple Park Way, Cupertino
CA 95014, USA

(540)



(591) Black, white

(531) 05.07.13; 05.07.23; 26.04.04; 26.04.15;
26.04.22

(511)

28 – Toys; games and playthings; electronic hand-held game units; musical toys, games and playthings; toy audio apparatus; toy musical instruments; musical games; battery operated toys; electronic toys; electric computer games, other than those adapted for use with television receivers, namely, floor-standing units for playing electronic games other than in conjunction with television receivers and tabletop units for playing electronic games other than in conjunction with television receivers; gymnastic and sporting articles; body-building apparatus; body rehabilitation apparatus; body-training apparatus; stationary exercise bicycles; parts and fittings for all the aforesaid goods.

(260) AM 2019 100635 A

(800) 1437133

(151) 2018 06 15

(891) 2018 06 15

(731) Apple Inc.

One Apple Park Way, Cupertino
CA 95014, USA

(540)



(591) Black, white

(531) 05.07.13; 05.07.23; 26.04.04; 26.04.22

(511)

28 – Toys; games and playthings; electronic hand-held game units; musical toys, games and playthings; toy audio apparatus; toy musical instruments; battery operated toys; electronic toys; electrical and electronic amusement apparatus (automatic, coin/counter freed).

(260) AM 2019 100646 A

(800) 1437387

(151) 2018 09 19

(891) 2018 09 19

(731) Stöckli Swiss Sports AG

Kommetsrüti 3, CH-6110 Wolhusen,
Switzerland

(540)



(591) Black, white

(531) 27.05.01; 27.05.21

(511)

9 – Ski goggles, sunglasses, ski helmets, clothing for protection against accidents.

12 – Bicycles, mountain bikes, electric bicycles.

18 – Articles of leather and imitations of leather, namely sports bags, umbrellas, parasols, trunks and traveling bags, backpacks.

25 – Clothing, namely sportswear, footwear, ski boots, headgear, waist belts, ski gloves.

28 – Sporting articles, namely skis, ski bindings, ski poles, snowboards, ski bags.

(260) AM 2019 100649 A

(800) 332474

(151) 1967 01 13

(891) 2018 09 17

(731) Bionorica SE

Kerschensteinerstrasse 11-15, 92318
Neumarkt, Germany

(540)

Mastodynnon

(591) Black, white

(531) 27.05.01; 27.05.17

(511)

5 – Medicines.

(260) AM 2019 100650 A

(800) 741353

(151) 2000 07 25

(891) 2018 11 12

(731) Ferring B.V.

Polarisavenue 144, NL-2132 JX
HOOFDDORP, Netherlands

(540)

ENDOMETRIN

(591) Black, white

(531) 27.05.01

(511)

5 – Pharmaceutical products.

(260) AM 2019 100656 A

(800) 1312206

(151) 2016 05 18

(891) 2018 07 10

(731) SANTA FARMA İLAÇ SANAYİİ

ANONİM ŞİRKETİ

Okmeydani, BoruÇiçegi Sk., No. 16 Kat:4
Şişli, TR-34382 ISTANBUL, Turkey

(540)

SANTA FER

(591) Black, white

(531) 27.05.24

(511)

5 – Pharmaceuticals.

(260) AM 2019 101045 A

(800) 1441392

(151) 2018 11 16

(891) 2018 11 16

(731) Public Joint-Stock Company

"Krasnyj Ocyabr"

ul. Malaya Krasnoselskaya, d. 7, str. 24,
RU-107140 Moscow, Russian Federation

(540)

СТАРИННАЯ ОТКРЫТКА

(591) Black, white

(531) 28.05

(511)

30 – Waffles; malt biscuits; confectionery for decorating Christmas trees; cakes; almond confectionery; peanut confectionery; cocoa; caramels [candy]; sweetmeats [candy]; peppermint sweets; liquorice [confectionery]; marzipan; ice cream; muesli; pastila [confectionery]; cookies; fondants [confectionery]; pralines; gingerbread; zephyr [confectionery]; halvah; chips [cereal products]; tea-based beverages; chocolate.

(260) AM 2019 101046 A

(800) 1441421

(151) 2018 10 16

(891) 2018 10 16

(731) Limited Liability Company «ORIMI»
1-st Microrayon street, 15/4 plot, Sverdlov
factory settlement, Vsevolozhsk district,
RU-188682 Leningrad oblast, Russian
Federation

(540)



(591) White, black, red, beige and golden.

(531) 05.07.27; 26.04.18; 26.11.02; 27.05.10;
27.05.24; 29.01.14

(526) BRAZILIA

(511)

30 – Coffee; unroasted coffee; artificial coffee;
coffee-based beverages; coffee beverages with milk.

(260) AM 2019 101049 A

(800) 1441536

(151) 2018 07 06

(891) 2018 07 06

(731) Future Enterprises Pte. Ltd.
31 Harrison Road, N08-01, Food Empire
Business Suites, Singapore 369649, Singapore

(540)

MACCHOCOLATE

(591) Black, white

(511)

30 – Cocoa and preparations based on cocoa; cocoa
beverages, chocolate beverages, chocolate beverages
containing milk; chocolate, confectionery containing
chocolate.

(260) AM 2019 101050 A

(800) 1441599

(151) 2018 08 24

(891) 2018 08 24

(731) DISARMCO HOLDINGS LIMITED
Jindal House, 35 Progress Road, Leigh-on-Sea
Essex SS9 5PR, United Kingdom

(540)

DRAGON

(591) Black, white

(511)

13 – Explosive substances and devices, other than
arms; pyrotechnics; pyrotechnic flares; Roman
candles.

(260) AM 2019 101052 A

(800) 1441631

(151) 2018 07 18

(891) 2018 07 18

(731) BOYNER HOLDING ANONIM SIRKETI
Eski Büyükdere cad. No.14, Park Plaza K.
15-16 Maslak, Sarıyer, İstanbul, Turkey

(540)



(591) Green, pink, orange and blue.

(531) 26.01.01; 26.01.06; 26.01.24; 27.05.17;
29.01.15

(511)

9 – Magnetic and optic data carriers and computer
software and programmes recorded thereto; downlo-
adable and recordable electronic publications;
encoded magnetic and optic cards; application
software; downloadable software applications;
application software for cell phones, mobile phones,
computers and other mobile devices.

35 – Advertising, marketing and public relations;
organization of exhibitions and trade fairs for
commercial or advertising purposes; office functi-
ons; secretarial services; compilation of statistics;
systemization of information into computer databa-
ses; business management; business administration
and business consultancy; accounting; commercial
consultancy services; import-export agencies; arran-
ging commercial transactions for others via online
shops; advertising services to promote public aware-
ness of the benefits of shopping; retail department
stores featuring a bonus incentive program for
customers; business management and consultation in
the field of fee refund to customers; business consul-
ting related to commerce and e-commerce, business
management consultancy services; commercial inter-
mediation services; commercial information agency
services; commercial or industrial management
assistance; provision of commercial and business
contact information; web indexing for commercial or
advertising purposes; commercial information and
advice for consumers; administration of consumer
loyalty programs; administrative processing of
purchase orders; business management of reimbur-
sement programmes for others; compilation of
information into computer databases; computerized

file management; cost price analysis; market studies; marketing research; provision of on-line marketplace for buyers and sellers of goods and services; price comparison services; sales promotion for others; search engine optimization for sales promotion; telemarketing services.

36 – Financial and monetary affairs; online financial planning services; online banking services by means of downloadable online applications.

42 – Computer services, namely, computer programming, computer virus protection services, computer system design, creating, maintaining and updating websites for others; computer software design; updating and rental of computer software; computer system analysis and design; electronic data storage; providing search engines for the internet; hosting websites; computer hardware and software consultancy; information technology consultancy; installation and maintenance of computer software; monitoring of computer systems by remote access; hosting computer software application for others; hosting multimedia and interactive applications; providing temporary use of web-based applications; design and development of computer hardware/software for industrial applications; online provision of non-downloadable web based applications; providing temporary use of online applications and software tools; temporary use of online downloadable computer software platform that allows users to manager loyalty programs between business and customers; research and development of new products for others; software as a service.

(260) AM 2019 101053 A

(800) 1441651

(151) 2018 11 14

(891) 2018 11 14

(731) Evolution Malta Limited

Level 1, The Centre, Tigne Point, TPO 0001
Sliema, Malta

(540)

DREAM CATCHER

(591) Black, white

(511)

28 – Games; card games; markers for games.

41 – Education, entertainment and sports; organisation of conferences, exhibitions and competitions; arranging and conducting of games; casino, gaming and gambling services; providing casino services and facilities (gambling); recording, film, video and television studio services; provision of non-downloadable games on the Internet; electronic games services provided from a computer database or by means of the internet; providing on-line poker games.

INTERNATIONAL TRADEMARKS PROTECTED IN GEORGIA

(260) AM 2019 95251 A
(800) 1375168
(151) 2017 08 30
(181) 2027 08 30
(891) 2017 08 30
(511) 12, 17, 35, 37, 39

(260) AM 2019 97576 A
(800) 1372858
(151) 2016 11 23
(181) 2026 11 23
(891) 2018 02 08
(511) 09, 10, 14, 16, 18, 20, 24, 25, 35, 38, 41, 45

(260) AM 2019 97916 A
(800) 1404096
(151) 2017 12 01
(181) 2027 12 01
(891) 2017 12 01
(511) 05, 16, 29, 30, 43, 44

(260) AM 2019 98135 A
(800) 681379
(151) 1997 10 10
(181) 2027 10 10
(891) 2018 03 30
(511) 25

(260) AM 2019 98463 A
(800) 1410506
(151) 2018 01 19
(181) 2028 01 19
(891) 2018 01 19
(511) 12

(260) AM 2019 98464 A
(800) 1410517
(151) 2017 12 21
(181) 2027 12 21
(891) 2017 12 21
(511) 35, 41

(260) AM 2019 98466 A
(800) 1410588
(151) 2018 04 03
(181) 2028 04 03

(891) 2018 04 03
(511) 05

(260) AM 2019 98467 A
(800) 1410607
(151) 2018 05 15
(181) 2028 05 15
(891) 2018 05 15
(511) 14

(260) AM 2019 98496 A
(800) 1169270
(151) 2013 06 17
(181) 2023 06 17
(891) 2018 06 21
(511) 34

(260) AM 2019 98502 A
(800) 1411464
(151) 2017 10 31
(181) 2027 10 31
(891) 2017 10 31
(511) 09, 35, 39

(260) AM 2019 98504 A
(800) 1411484
(151) 2018 02 13
(181) 2028 02 13
(891) 2018 02 13
(511) 09, 28

(260) AM 2019 98507 A
(800) 1411579
(151) 2018 04 04
(181) 2028 04 04
(891) 2018 04 04
(511) 09

(260) AM 2019 98509 A
(800) 1411734
(151) 2018 04 09
(181) 2028 04 09
(891) 2018 04 09
(511) 35

(260) AM 2019 98510 A
(800) 1411743
(151) 2018 04 06
(181) 2028 04 06
(891) 2018 04 06
(511) 33

(260) AM 2019 98511 A
(800) 1411789
(151) 2018 03 27
(181) 2028 03 27
(891) 2018 03 27
(511) 30

(260) AM 2019 98514 A
(800) 1411900
(151) 2018 04 19
(181) 2028 04 19
(891) 2018 04 19
(511) 05

(260) AM 2019 98515 A
(800) 1411919
(151) 2018 05 16
(181) 2028 05 16
(891) 2018 05 16
(511) 36

(260) AM 2019 98516 A
(800) 1411927
(151) 2017 11 27
(181) 2027 11 27
(891) 2017 11 27
(511) 10, 16, 18, 20, 24, 25, 28, 35, 36, 39, 41, 43

(260) AM 2019 98517 A
(800) 1411979
(151) 2017 12 12
(181) 2027 12 12
(891) 2017 12 12
(511) 30

(260) AM 2019 98518 A
(800) 1412138
(151) 2018 04 11
(181) 2028 04 11
(891) 2018 04 11
(511) 33, 35

(260) AM 2019 98519 A
(800) 1412172
(151) 2018 06 14

(181) 2028 06 14
(891) 2018 06 14
(511) 03

(260) AM 2019 98520 A
(800) 1412177
(151) 2018 06 19
(181) 2028 06 19
(891) 2018 06 19
(511) 30

(260) AM 2019 98521 A
(800) 1412213
(151) 2018 01 10
(181) 2028 01 10
(891) 2018 01 10
(511) 14, 18, 25, 26, 35

(260) AM 2019 98522 A
(800) 1412311
(151) 2018 04 06
(181) 2028 04 06
(891) 2018 04 06
(511) 06, 08, 09, 11, 12, 25

(260) AM 2019 98526 A
(800) 1412413
(151) 2018 06 05
(181) 2028 06 05
(891) 2018 06 05
(511) 05

(260) AM 2019 98527 A
(800) 1412423
(151) 2018 06 05
(181) 2028 06 05
(891) 2018 06 05
(511) 05

(260) AM 2019 98528 A
(800) 1412436
(151) 2018 06 05
(181) 2028 06 05
(891) 2018 06 05
(511) 05

(260) AM 2019 98531 A
(800) 945586
(151) 2007 10 02
(181) 2027 10 02

(891) 2018 06 01
(511) 44

(260) AM 2019 98533 A
(800) 1231067
(151) 2014 11 26
(181) 2024 11 26
(891) 2018 06 25
(511) 25

(260) AM 2019 98534 A
(800) 1279766
(151) 2015 10 06
(181) 2025 10 06
(891) 2018 06 27
(511) 11, 37, 42

(260) AM 2019 98535 A
(800) 1286933
(151) 2015 12 01
(181) 2025 12 01
(891) 2018 06 25
(511) 25

(260) AM 2019 98536 A
(800) 1325116
(151) 2016 08 30
(181) 2026 08 30
(891) 2018 05 31
(511) 14

(260) AM 2019 98537 A
(800) 1325493
(151) 2016 09 13
(181) 2026 09 13
(891) 2018 05 31
(511) 09

(260) AM 2019 98538 A
(800) 1351143
(151) 2017 04 26
(181) 2027 04 26
(891) 2018 06 25
(511) 25

(260) AM 2019 98540 A
(800) 1373722
(151) 2017 08 08
(181) 2027 08 08
(891) 2018 05 31
(511) 09

(260) AM 2019 98542 A
(800) 1375184
(151) 2017 06 21
(181) 2027 06 21
(891) 2018 05 15
(511) 03, 05

(260) AM 2019 98543 A
(800) 1380059
(151) 2017 06 09
(181) 2027 06 09
(891) 2018 06 22
(511) 02

(260) AM 2019 98622 A
(800) 1413423
(151) 2017 12 18
(181) 2027 12 18
(891) 2017 12 18
(511) 01, 04, 06, 07, 09, 11, 16, 35, 36, 37, 39,
40, 41, 42

(260) AM 2019 98623 A
(800) 1413450
(151) 2018 04 18
(181) 2028 04 18
(891) 2018 04 18
(511) 43

(260) AM 2019 98624 A
(800) 1413495
(151) 2018 05 01
(181) 2028 05 01
(891) 2018 05 01
(511) 05, 42

(260) AM 2019 98625 A
(800) 1413520
(151) 2016 10 12
(181) 2026 10 12
(891) 2016 10 12
(511) 03, 05, 10, 35, 44

(260) AM 2019 98628 A
(800) 1413571
(151) 2018 03 19
(181) 2028 03 19
(891) 2018 03 19
(511) 18, 25, 35

(260) AM 2019 98629 A
(800) 1413592
(151) 2018 04 19
(181) 2028 04 19
(891) 2018 04 19
(511) 35, 43

(260) AM 2019 98630 A
(800) 1413593
(151) 2018 02 15
(181) 2028 02 15
(891) 2018 02 15
(511) 03, 21

(260) AM 2019 98631 A
(800) 1413599
(151) 2018 03 27
(181) 2028 03 27
(891) 2018 03 27
(511) 09, 38

(260) AM 2019 98632 A
(800) 1413737
(151) 2018 06 15
(181) 2028 06 15
(891) 2018 06 15
(511) 42

(260) AM 2019 98633 A
(800) 1413743
(151) 2018 05 22
(181) 2028 05 22
(891) 2018 05 22
(511) 20

(260) AM 2019 98700 A
(800) 1414222
(151) 2018 02 07
(181) 2028 02 07
(891) 2018 02 07
(511) 09, 16, 42

(260) AM 2019 98705 A
(800) 1414390
(151) 2017 11 28
(181) 2027 11 28
(891) 2017 11 28
(511) 03, 35

(260) AM 2019 98707 A
(800) 1414433
(151) 2018 04 27

(181) 2028 04 27
(891) 2018 04 27
(511) 03

(260) AM 2019 98708 A
(800) 1414444
(151) 2018 04 06
(181) 2028 04 06
(891) 2018 04 06
(511) 16, 36, 41, 43

(260) AM 2019 98711 A
(800) 1414475
(151) 2018 04 23
(181) 2028 04 23
(891) 2018 04 23
(511) 43

(260) AM 2019 98715 A
(800) 1414576
(151) 2018 05 24
(181) 2028 05 24
(891) 2018 05 24
(511) 10

(260) AM 2019 98717 A
(800) 1414614
(151) 2018 04 18
(181) 2028 04 18
(891) 2018 04 18
(511) 07, 09, 11

(260) AM 2019 98719 A
(800) 1414659
(151) 2017 10 06
(181) 2027 10 06
(891) 2017 10 06
(511) 41, 42

(260) AM 2019 98720 A
(800) 1414692
(151) 2018 03 16
(181) 2028 03 16
(891) 2018 03 16
(511) 29, 30

(260) AM 2019 98721 A
(800) 1414706
(151) 2018 05 10
(181) 2028 05 10

(891) 2018 05 10
(511) 03, 25, 35, 41

(260) AM 2019 98722 A
(800) 1414707
(151) 2018 06 08
(181) 2028 06 08
(891) 2018 06 08
(511) 01, 05, 44

(260) AM 2019 98724 A
(800) 1414746
(151) 2018 05 04
(181) 2028 05 04
(891) 2018 05 04
(511) 30

(260) AM 2019 98725 A
(800) 1414751
(151) 2018 03 29
(181) 2028 03 29
(891) 2018 03 29
(511) 06

(260) AM 2019 98726 A
(800) 1414865
(151) 2018 04 06
(181) 2028 04 06
(891) 2018 04 06
(511) 02

(260) AM 2019 98728 A
(800) 1414907
(151) 2018 05 23
(181) 2028 05 23
(891) 2018 05 23
(511) 30

(260) AM 2019 98729 A
(800) 1414925
(151) 2018 03 19
(181) 2028 03 19
(891) 2018 03 19
(511) 38, 41

(260) AM 2019 98730 A
(800) 1414927
(151) 2018 05 03
(181) 2028 05 03
(891) 2018 05 03
(511) 42, 45

(260) AM 2019 98731 A
(800) 1414945
(151) 2018 06 26
(181) 2028 06 26
(891) 2018 06 26
(511) 39

(260) AM 2019 98732 A
(800) 1414950
(151) 2018 03 12
(181) 2028 03 12
(891) 2018 03 12
(511) 03, 08, 21, 35

(260) AM 2019 98734 A
(800) 1414989
(151) 2018 02 26
(181) 2028 02 26
(891) 2018 02 26
(511) 09, 12, 17

(260) AM 2019 98750 A
(800) 1333647
(151) 2016 11 11
(181) 2026 11 11
(891) 2018 06 19
(511) 03, 05, 35

(260) AM 2019 98753 A
(800) 1390712
(151) 2017 10 16
(181) 2027 10 16
(891) 2018 06 20
(511) 29, 30, 31, 32, 35, 43

(260) AM 2019 98754 A
(800) 1398748
(151) 2018 01 04
(181) 2028 01 04
(891) 2018 06 19
(511) 01, 35

(260) AM 2019 98834 A
(800) 1415853
(151) 2018 03 30
(181) 2028 03 30
(891) 2018 03 30
(511) 05

(260) AM 2019 98835 A
(800) 1415868
(151) 2018 02 27

(181) 2028 02 27
(891) 2018 02 27
(511) 29, 30

(260) AM 2019 98836 A
(800) 1415878
(151) 2018 04 28
(181) 2028 04 28
(891) 2018 04 28
(511) 30

(260) AM 2019 98913 A
(800) 1416423
(151) 2018 04 02
(181) 2028 04 02
(891) 2018 04 02
(511) 35, 37

(260) AM 2019 98914 A
(800) 1416447
(151) 2018 04 18
(181) 2028 04 18
(891) 2018 04 18
(511) 32

(260) AM 2019 98922 A
(800) 1416591
(151) 2018 06 15
(181) 2028 06 15
(891) 2018 06 15
(511) 30

(260) AM 2019 98923 A
(800) 1416596
(151) 2017 11 27
(181) 2027 11 27
(891) 2017 11 27
(511) 03, 21

(260) AM 2019 98924 A
(800) 1416624
(151) 2018 05 08
(181) 2028 05 08
(891) 2018 05 08
(511) 05, 10, 35

(260) AM 2019 98925 A
(800) 1416695
(151) 2018 06 08
(181) 2028 06 08

(891) 2018 06 08
(511) 12, 35, 36, 39

(260) AM 2019 98926 A
(800) 1416705
(151) 2018 06 20
(181) 2028 06 20
(891) 2018 06 20
(511) 09, 10

(260) AM 2019 98927 A
(800) 1416721
(151) 2018 03 01
(181) 2028 03 01
(891) 2018 03 01
(511) 06, 07, 09, 17

(260) AM 2019 98929 A
(800) 1416736
(151) 2018 01 31
(181) 2028 01 31
(891) 2018 01 31
(511) 38

(260) AM 2019 98930 A
(800) 1416759
(151) 2018 04 30
(181) 2028 04 30
(891) 2018 04 30
(511) 05

(260) AM 2019 98931 A
(800) 1416823
(151) 2018 03 22
(181) 2028 03 22
(891) 2018 03 22
(511) 36

(260) AM 2019 98932 A
(800) 1416835
(151) 2018 05 29
(181) 2028 05 29
(891) 2018 05 29
(511) 06, 11, 17, 19

(260) AM 2019 98934 A
(800) 1416953
(151) 2018 02 21
(181) 2028 02 21
(891) 2018 02 21
(511) 16

(260) AM 2019 98935 A
(800) 1416954
(151) 2018 06 13
(181) 2028 06 13
(891) 2018 06 13
(511) 24, 25, 28

(260) AM 2019 98936 A
(800) 1417004
(151) 2018 04 24
(181) 2028 04 24
(891) 2018 04 24
(511) 09

(260) AM 2019 98937 A
(800) 1417015
(151) 2018 05 29
(181) 2028 05 29
(891) 2018 05 29
(511) 38, 41, 44

(260) AM 2019 98939 A
(800) 1417058
(151) 2018 01 12
(181) 2028 01 12
(891) 2018 01 12
(511) 11

(260) AM 2019 98940 A
(800) 1417062
(151) 2018 07 11
(181) 2028 07 11
(891) 2018 07 11
(511) 05, 32

(260) AM 2019 98941 A
(800) 1417134
(151) 2018 05 25
(181) 2028 05 25
(891) 2018 05 25
(511) 05

(260) AM 2019 99098 A
(800) 1419020
(151) 2018 05 03
(181) 2028 05 03
(891) 2018 05 03
(511) 03, 05, 35

(260) AM 2019 99217 A
(800) 1420450
(151) 2018 01 23

(181) 2028 01 23
(891) 2018 01 23
(511) 39, 43

(260) AM 2019 99536 A
(800) 1423465
(151) 2018 08 03
(181) 2028 08 03
(891) 2018 08 03
(511) 10

OFFICIAL NOTIFICATIONS

INVENTION

ISSUING ADDITIONAL CERTIFICATE OF PROTECTION

(10) AP 2006 6308 A

(21) AP 2000 6308

(22) 2000 06 30

(11) P 2006 3885 B

(54) **INDAZOLE COMPOUNDS AND PHARMACEUTICAL COMPOSITIONS FOR INHIBITING PROTEIN KINASES, AND METHODS FOR THEIR USE**

(94) 2025 06 30

CORRECTION OF PUBLISHED INFORMATION

BULLETIN N8(516) 2019 04 25

NUMBER OF APPLICATION (10) and NUMBER OF PATENT (11)	Pg.	PUBLISHED	MUST BE
(10) AD 2019 1065 S	11	(71) KYUNG DONG NAVIEN CO., LTD (KR) 95, Suwolam-gil, Seotan- myeon, Pyeongtaek-si, Gyeonggi-do, 17704 South Korea (72) Gun Sang JUNG (KR)	(71) KYUNG DONG NAVIEN CO., LTD. (KR) 95, Suworam-gil, Seotan- myeon, Pyeongtaek-si, Gyeonggi-do 17704, Republic of Korea (72) JUNG Gyu Sang (KR)
BULLETIN N15(523) 2019 08 12			
(11) D 2019 815 S	17	(73) KYUNG DONG NAVIEN CO., LTD (KR) 95, Suwolam-gil, Seotan- myeon, Pyeongtaek-si, Gyeonggi-do, 17704 South Korea (72) Gun Sang JUNG (KR)	(71) KYUNG DONG NAVIEN CO., LTD. (KR) 95, Suworam-gil, Seotan- myeon, Pyeongtaek-si, Gyeonggi-do 17704, Republic of Korea (72) JUNG Gyu Sang (KR)

TRADEMARKS**RENEWAL OF REGISTRATIONS**

(111) M 1999 12698 R2

(156) 1999 08 24

(186) 2029 08 24

(732) STMICROELECTRONICS INC.

750 Cenyon Drive, Suite 300, Coppell, Texas
75019, USA

(111) M 1999 12221 R2

(156) 1999 05 14

(186) 2029 05 14

(732) POTOMAC TOBACCO COMPANY LTD

Mill Mall, Suite 6, Wickhams Cay 1, P.O.Box
3085, Road Town, Tortola, Virgin Islands
(British)

(111) M 1999 12587 R2

(156) 1999 08 23

(186) 2029 08 23

(732) MARIE CLAIRE ALBUM, Société par

Actions Simplifiée
10 Boulevard des freres Voisin, 92792 Issy-
les-Moulineaux cedex 09, France

(111) M 1999 12703 R2

(156) 1999 08 24

(186) 2029 08 24

(732) THE PROCTER & GAMBLE COMPANY

One Procter & Gamble Plaza, Cincinnati,
Ohio, USA

(111) M 1999 12876 R2

(156) 1999 10 25

(186) 2029 10 25

(732) INTEL CORPORATION, a Delaware

corporation
2200 Mission College Boulevard, Santa
Clara, California 95052-8119, USA

(111) M 1999 12521 R2

(156) 1999 07 12

(186) 2029 07 12

(732) IRIDIUM SATELLITE LLC

1750 Tysons Boulevard, Suite 1400, McLean,
Virginia 22102, USA

(111) M 2009 19126 R1

(156) 2009 03 16

(186) 2029 03 16

(732) DAN-FOAM, APS

Holmelund 43, DK-5560 Aarup, Denmark,
Denmark

(111) M 2009 19419 R1

(156) 2009 06 16

(186) 2029 06 16

(732) HEGO LIMITED

Leontiou 163, CLERIMOS BUILDING, 3022,
Limassol, Cyprus

(111) M 2009 19588 R1

(156) 2009 07 24

(186) 2029 07 24

(732) Aktsionernoe obshchestvo "FACTORY

RUSSIAN CHOCOLATE"
29 Vereyskaya St., Bl. 143, Fl. 1, Offece III,
Room 1, Moscow, 121357, Russian
Federation

(111) M 2009 19559 R1

(156) 2009 07 20

(186) 2029 07 20

(732) Publichnoe Aktsionernoe Obshchestvo

"Moskow Confectionary Factory
"KRASNIY OKTIABR"
Ul. Malaya Krasnoselskaya, d.7, str. 24,
RU-107140, Moscow, Russian Federation

(111) M 2009 19630 R1

(156) 2009 07 31

(186) 2029 07 31

(732) Otkritoe aktsionernoe obshchestvo

"Konditerskiy Kontsern Babaevskiy"
Ul. Malaia Krasnoselskaya, dom 7, Moscow,
107140, Russian Federation

(111) M 2009 19764 R1

(156) 2009 09 11

(186) 2029 09 11

(732) LTD "Georgian Distribution-Marketing

Company"
Giorgi Mdivnis q. 3a, Isnis raioni, Tbilisi,
Georgia

(111) M 2009 19768 R1

(156) 2009 09 11

(186) 2029 09 11

(732) LTD "Georgian Distribution-Marketing Company"
Giorgi Mdivnis q. 3a, Isnis raioni, Tbilisi, Georgia

(111) M 2009 19957 R1
(156) 2009 11 18
(186) 2029 11 18

(732) LTD "Georgian Distribution-Marketing Company"
Giorgi Mdivnis q. 3a, Isnis raioni, Tbilisi, Georgia

(111) M 2009 19784 R1
(156) 2009 09 11
(186) 2029 09 11

(732) LTD "Georgian Distribution-Marketing Company"
Giorgi Mdivnis q. 3a, Isnis raioni, Tbilisi, Georgia

(111) M 2009 20117 R1
(156) 2009 12 28
(186) 2029 12 28

(732) JOKER, INC.
333 Continental Boulevard, El Segundo, California 90245, USA

(111) M 2009 19797 R1
(156) 2009 09 11
(186) 2029 09 11

(732) "St. Papaioannou Societe Anonyme Industrial and Commercial of Children clothes and relevant Products" with distinctive title "LAPIN HOUSE"
Styl Gonata 4, Peristeri, Athens, 12133, Greece

(111) M 2009 20051 R1
(156) 2009 11 27
(186) 2029 11 27

(732) DOMPE' FARMACEUTICI SPA
Via San Martino Della Battalia, 12-20122 Milano, Italy

(111) M 2010 20204 R1
(156) 2010 01 26
(186) 2030 01 26

(732) MARRIOTT WORLDWIDE CORPORATION
10400 Fernwood Road, Bethesda, Maryland 20817, USA

(111) M 1999 12536 R2

(156) 1999 07 12

(186) 2029 07 12

(732) KABUSHIKI KAISHA HITACHI SEISAKUSHO (ALSO TRADING AS HITACHI LTD)
6 Kanda-Surugadai, 4, Chome Chiyoda-ku, Tokyo, Japan

(111) M 1999 12537 R2

(156) 1999 07 12

(186) 2029 07 12

(732) KABUSHIKI KAISHA HITACHI SEISAKUSHO (ALSO TRADING AS HITACHI LTD)
6 Kanda-Surugadai, 4, Chome Chiyoda-ku, Tokyo, Japan

(111) M 1999 12538 R2

(156) 1999 07 12

(186) 2029 07 12

(732) KABUSHIKI KAISHA HITACHI SEISAKUSHO (ALSO TRADING AS HITACHI LTD)
6 Kanda-Surugadai, 4, Chome Chiyoda-ku, Tokyo, Japan

(111) M 1999 12970 R2

(156) 1999 11 09

(186) 2029 11 09

(732) SAMSUNG C&T CORPORATION
123, Olympic-ro, 35-gil, Songpa-gu, Seoul, Republic of Korea

CHANGES OF NAMES AND/OR ADDRESS OF OWNERS

(111) M 1999 12698 R
 (732) STMicroelectronics, Inc.
 750 Canyon Drive, Suite 300, Coppell, Texas
 75019, USA
 (770) STMicroelectronics, Inc.
 1310 Electronics Drive, Carrollton, Texas
 75006, USA
 (580) 18 07 2019

29 Vereyskaya Street, Bldg. 143, Floor 1,
 Office III, Room 1, Moscow, 121357,
 Russian Federation
 (770) Zakritoe aktsionernoe obshchestvo
 "FACTORY RUSSIAN CHOCOLATE"
 Ulica Vereiskaia 29, Stroenie 143, Moskovi
 121357, Russian Federation
 (580) 05 08 2019

(111) M 1999 12587 R
 (732) MARIE CLAIRE ALBUM, Société par
 Actions Simplifiée
 10 Boulevard des freres Voisin, 92792 Issy-
 les-Moulineaux cedex 09, France
 (770) MARIE CLAIRE ALBUM
 10 Boulevard des freres Voisin, 92792 Issy-
 les-Moulineaux cedex 09, France
 (580) 25 07 2019

(111) M 2009 19559 R
 (732) Publichnoe Aktsionernoe Obshchestvo
 "Moskow Confectionary Factory
 "KRASNIY OKTIABR"
 Ul. Malaya Krasnoselskaya, d.7, str. 24,
 RU-107140, Moscow, Russian Federation
 (770) Otkritoe aktsionernoe obshchestvo
 "Moskow Confectionary Factory
 "KRASNIY OKTIABR"
 Bersenevskaja naberezhnaia 6, Moskovi
 119072, Russian Federation
 (580) 05 08 2019

(111) M 1997 6655 R
 (732) BEROL CORPORATION
 6655 Peachtree Dunwoody Road, Atlanta,
 Georgia, USA
 (770) BEROL CORPORATION
 29 E. Stephenson Street, Freeport, IL 61032,
 USA
 (580) 03 07 2019

(111) M 2009 19764 R
 (732) LTD "Georgian Distribution-Marketing
 Company"
 Giorgi Mdivnis q. 3a, Isnis Raioni, Tbilisi,
 Georgia
 (770) LTD "Georgian Distribution-Marketing
 Company"
 Davit Agmasheneblis gamz.78, 0102, Tbilisi,
 Georgia
 (580) 24 07 2019

(111) M 1999 12521 R
 (732) IRIDIUM SATELLITE LLC
 1750 Tysons Boulevard, Suite 1400, McLean,
 Virginia 22102, USA
 (770) IRIDIUM SATELLITE LLC
 6707 Democracy Blvd. Suite 300, Bethesda,
 MD 20817, USA
 (580) 18 07 2019

(111) M 2009 19768 R
 (732) LTD "Georgian Distribution-Marketing
 Company"
 Giorgi Mdivnis q. 3a, Isnis Raioni, Tbilisi,
 Georgia
 (770) LTD "Georgian Distribution-Marketing
 Company"
 Davit Agmasheneblis gamz.78, 0102, Tbilisi,
 Georgia
 (580) 24 07 2019

(111) M 2009 19419 R
 (732) HEGO LIMITED
 Leontiou 163, CLERIMOS BUILDING, 3022,
 Limassol, Cyprus
 (770) HEGO LIMITED
 Leoforos Spyrou Kyprianou 67,
 KYRIAKIDES BUISINESS CENTER, 4003,
 Limassol, Cyprus
 (580) 05 08 2019

(111) M 2009 19957 R
 (732) LTD "Georgian Distribution-Marketing
 Company"
 Giorgi Mdivnis q. 3a, Isnis Raioni, Tbilisi,
 Georgia
 (770) LTD "Georgian Distribution-Marketing
 Company"

(111) M 2009 19588 R
 (732) Aktsionernoe obshchestvo "FACTORY
 RUSSIAN CHOCOLATE"

(770) LTD "Georgian Distribution-Marketing
 Company"

Davit Agmasheneblis gamz.78, 0102, Tbilisi,
Georgia
(580) 24 07 2019

(111) M 2009 19784 R
(732) LTD "Georgian Distribution-Marketing
Company"
Giorgi Mdivnis q. 3a, Isnis Raioni, Tbilisi,
Georgia
(770) LTD "Georgian Distribution-Marketing
Company"
Davit Agmasheneblis gamz.78, 0102, Tbilisi,
Georgia
(580) 24 07 2019

(111) M 2009 20117 R
(732) JOKER INC.
333 Continental Boulevard, El Segundo,
California 90245, USA
(770) JOKER, INC.
830 S. Greenville Avenue, Allen, Texas
75002, USA

(111) M 2009 20051 R
(732) DOMPE' FARMACEUTICI SPA
Via San Martino Della Battalia, 12-20122
Milano, Italy
(770) DOMPE' FARMACEUTICI SPA
Via San Martino 12-12/a, 20122 Milano, Italy
(580) 30 07 2019

(111) M 2016 27021 R
(732) LTD "BB COMPANY"
Katolikosi Abraham I-is q. 29, Tbilisi, Georgia
(770) LTD "BB COMPANY"
Akaki Shanidzis q. 11, 0179, Tbilisi, Georgia
(580) 01 08 2019

(111) M 1999 12970 R
(732) SAMSUNG C&T CORPORATION
123, Olympic-ro, 35-gil, Songpa-gu, Seoul,
Republic of Korea
(770) SAMSUNG C&T CORPORATION
67, Sejong-daero, Jung-gu, Seoul, (Taepyung-
ro 2-ka), Republic of Korea
(580) 19 07 2019

TERMINATION OF TRADEMARKS REGISTRATION

(111) M 1999 11440 R
(151) 1999 01 29
(732) Firma "AIA"
Nikeas q. 8, Kutaisi, 384016, Georgia

(111) M 1999 11382 R
(151) 1999 01 26
(732) LOWE INTERNATIONAL LIMITED
60 Sloane Ave, London SW3 3XB, United Kingdom

(111) M 1999 11384 R
(151) 1999 01 26
(732) BIOFARMA
22, rue Garnier, 92200 Neuilly-Sur-Seine, France

(111) M 1999 11386 R
(151) 1999 01 26
(732) BIOFARMA
50, rue Carnot, 92284 Suresnes cedex, France

(111) M 1999 11387 R
(151) 1999 01 26
(732) EUROPE BRANDS S.À R.L.
412F, route d'Esch, L-2086, Luxembourg

(111) M 1999 11367 R
(151) 1999 01 26
(732) BIG STAR LIMITED SP.Z O.O.
21/21A, ul. Aleja Wojska Polskiego, 62-800 Kalisz, Poland

(111) M 1999 11368 R
(151) 1999 01 26
(732) VALLOUREC & MANNESMANN TUBES
27 Avenue du General Leclerc - 92100 Boulogne Billancourt, France

(111) M 1999 11369 R
(151) 1999 01 26
(732) VALLOUREC & MANNESMANN TUBES
27 Avenue du General Leclerc - 92100 Boulogne Billancourt, France

(111) M 1999 11427 R
(151) 1999 01 26
(732) ARZNEIMITTELWERK DRESDEN GMBH
Meissner strasse 35, 01445 Radebeul, Germany

(111) M 1999 11429 R
(151) 1999 01 26
(732) MEDA Pharma GmbH & Co. KG
Benzstrasse 1, D-61352 Bad Homburg, Germany

(111) M 1999 11430 R
(151) 1999 01 26
(732) MEDA Pharma GmbH & Co. KG
Benzstrasse 1, D-61352 Bad Homburg, Germany

(111) M 1999 11395 R
(151) 1999 01 26
(732) ABIC BIOLOGICAL LABORATORIES LTD
3 Hamelacha St. Western Industrial Zone Beit Shemesh POB 489, 99100, Israel

(111) M 1999 11397 R
(151) 1999 01 26
(732) BIOFARMA
50, rue Carnot, 92284 Suresnes cedex, France

(111) M 1999 11436 R
(151) 1999 01 26
(732) MEDA Pharma GmbH & Co. KG
Benzstrasse 1, D-61352 Bad Homburg, Germany

(111) M 1999 11437 R
(151) 1999 01 26
(732) MEDA Pharma GmbH & Co. KG
Benzstrasse 1, D-61352 Bad Homburg, Germany

(111) M 2009 19053 R
(151) 2009 01 28
(732) Cape North Company AB
Box 78, 178 02 Drottningholm, Sweden

(111) M 2009 19054 R (151) 2009 01 28 (732) LELA BEDENASHVILI Mgaloblishvilis q. 3, b. 20, 0160, Tbilisi, Georgia	500 North Field Drive, LAKE FOREST, IL 60045, USA
(111) M 2009 19055 R (151) 2009 01 28 (732) LTD "ST COMPANY" M. Laghidzis q. 4, 0108, Tbilisi, Georgia	(111) M 2009 19062 R (151) 2009 01 28 (732) FRANGO FORTE PRODUTOS AVÍCOLAS LTDA Rua Vila Nova, 1995 - Sala 1, Tietê, São Paulo, Brazil
(111) M 2009 19056 R (151) 2009 01 28 (732) LTD "BATPHARMA" I. Noneshvilis q. 65, 6007, Batumi, Georgia	(111) M 2009 19063 R (151) 2009 01 28 (732) GlaxoSmithKline Consumer Healthcare (UK) IP Limited 980 Great West Road, Brentford, Middlesex TW8 9GS, United Kingdom
(111) M 2009 19057 R (151) 2009 01 28 (732) LTD "AVITA" Gabashvilis q. 7/6, 0177, Tbilisi, Georgia	(111) M 2009 19065 R (151) 2009 01 28 (732) VALID ARFUSH Ul. Kruglouniversitetskaya, dom 14, kv. 21, Kiyv, Ukraine
(111) M 2009 19058 R (151) 2009 01 28 (732) Amerikan-Cigarette Compani (Oversaes) Limited Zaehlerweg 4, Zug CH 6300, Switzerland	(111) M 2009 19071 R (151) 2009 02 03 (732) LTD "AEA" Meunargias q. 71, b. 23, 0101, Tbilisi, Georgia
(111) M 2009 19059 R (151) 2009 01 28 (732) Amerikan-Cigarette Compani (Oversaes) Limited Zaehlerweg 4, Zug CH 6300, Switzerland	(111) M 2009 19072 R (151) 2009 02 03 (732) LTD "AEA" Meunargias q. 71, b. 23, 0101, Tbilisi, Georgia
(111) M 2009 19060 R (151) 2009 01 28 (732) Amerikan-Cigarette Compani (Oversaes) Limited Zaehlerweg 4, Zug CH 6300, Switzerland	(111) M 2009 19073 R (151) 2009 02 03 (732) LTD "AEA" Meunargias q. 71, b. 23, 0101, Tbilisi, Georgia
(111) M 2009 19069 R (151) 2009 01 28 (732) LTD "GVAVI" Krtsanisis q. 16, korp. 1, b. 26, 0114, Tbilisi, Georgia	
(111) M 2009 19061 R (151) 2009 01 28 (732) TENNECO AUTOMOTIVE OPERATING COMPANY INC.	

CLASSIFICATION INDEXES

INVENTIONS

CONCORDANCE TABLE OF INTERNATIONAL CLASSIFICATION INDEX AND PUBLICATION NUMBERS

INTERNATIONAL CLASSIFICATION INDEXES (51)	NUMBER OF PUBLISHED APPLICATION (10)
A 61 K 39/395; C 07 K 16/28; C 07 K 17/14	AP 2019 14100 A
B 22 F 1/00; B 22 F 7/02; B 22 F 7/00; B 22 F 3/23; B 22 F 3/2; C 22 C 14/00; C 22 C 1/04; C 22 C 1/00; C 22 C 38/14; C 22 C 29/14	AP 2019 14618 A
C 05 G 3/04; C 05 G 3/06; C 05 D 9/02	AP 2019 14214 A

CONCORDANCE TABLE OF PUBLICATION NUMBERS AND INTERNATIONAL CLASSIFICATION INDEX

NUMBER OF PUBLISHED APPLICATION (10)	INTERNATIONAL CLASSIFICATION INDEXES (51)
AP 2019 14100 A	A 61 K 39/395; C 07 K 16/28; C 07 K 17/14
AP 2019 14214 A	C 05 G 3/04; C 05 G 3/06; C 05 D 9/02
AP 2019 14618 A	B 22 F 1/00; B 22 F 7/02; B 22 F 7/00; B 22 F 3/23; B 22 F 3/2; C 22 C 14/00; C 22 C 1/04; C 22 C 1/00; C 22 C 38/14; C 22 C 29/14

CONCORDANCE TABLE OF INTERNATIONAL CLASSIFICATION INDEX, PATENT NUMBERS AND PUBLICATION NUMBERS

INTERNATIONAL CLASSIFICATION INDEX (51)	NUMBER OF PATENT (11)	NUMBER OF PUBLISHED APPLICATION (10)
A 43 B 7/12; A 43 B 23/02; A 43 B 23/07; A 43 B 7/08	P 2019 7015 B	AP 2019 14375 A
A 61 K 31/5377; A 61 P 35/00; C 07 D 495/04	P 2019 7016 B	AP 2019 14539 A
B 02 C 18/30	P 2019 7014 B	AP 2019 14434 A
B 67 D 7/04; G 06 Q 10/08; G 06 Q 50/28	P 2019 7013 B	AP 2019 14558 A

**CONCORDANCE TABLE OF PATENT NUMBERS,
PUBLICATION NUMBERS AND INTERNATIONAL CLASSIFICATION INDEX**

NUMBER OF PATENT (11)	NUMBER OF PUBLISHED APPLICATION (10)	INTERNATIONAL CLASSIFICATION INDEX (51)
P 2019 7013 B	AP 2019 14558 A	B 67 D 7/04; G 06 Q 10/08; G 06 Q 50/28
P 2019 7014 B	AP 2019 14434 A	B 02 C 18/30
P 2019 7015 B	AP 2019 14375 A	A 43 B 7/12; A 43 B 23/02; A 43 B 23/07; A 43 B 7/08
P 2019 7016 B	AP 2019 14539 A	A 61 K 31/5377; A 61 P 35/00; C 07 D 495/04

**CONCORDANCE TABLE OF APPLICATION NUMBERS, PUBLICATION NUMBERS
AND PATENTS**

NUMBER OF APPLICATION (21)	NUMBER OF PUBLISHED APPLICATION (10)	NUMBER OF PATENT (11)
AP 2015 14375	AP 2019 14375 A	P 2019 7015 B
AP 2017 14434	AP 2019 14434 A	P 2019 7014 B
AP 2014 14539	AP 2019 14539 A	P 2019 7016 B
AP 2015 14558	AP 2019 14558 A	P 2019 7013 B

UTILITY MODELS

**CONCORDANCE TABLE OF INTERNATIONAL CLASSIFICATION INDEX
AND PUBLICATION NUMBERS**

INTERNATIONAL CLASSIFICATION INDEXES (51)	NUMBER OF PUBLISHED APPLICATION (10)
A 61 H 15/00	AU 2019 14468 U
A 61 K 9/06; A 61 K 35/57; A 61 K 36/00	AU 2019 15003 U
A 61 P 5/48	AU 2019 14928 U

**CONCORDANCE TABLE OF PUBLICATION NUMBERS
AND INTERNATIONAL CLASSIFICATION INDEX**

NUMBER OF PUBLISHED APPLICATION (10)	INTERNATIONAL CLASSIFICATION INDEXES (51)
AU 2019 14468 U	A 61 H 15/00
AU 2019 14928 U	A 61 P 5/48
AU 2019 15003 U	A 61 K 9/06; A 61 K 35/57; A 61 K 36/00

CONCORDANCE TABLE OF INTERNATIONAL CLASSIFICATION INDEX,
PATENT NUMBERS AND PUBLICATION NUMBERS

INTERNATIONAL CLASSIFICATION INDEX (51)	NUMBER OF PATENT (11)	NUMBER OF PUBLISHED APPLICATION (10)
G 08 B 21/10; G 08 B 31/00	U 2019 2017 Y	AU 2019 14838 U

CONCORDANCE TABLE OF PATENT NUMBERS,
PUBLICATION NUMBERS AND INTERNATIONAL CLASSIFICATION INDEX

NUMBER OF PATENT (11)	NUMBER OF PUBLISHED APPLICATION (10)	INTERNATIONAL CLASSIFICATION INDEX (51)
U 2019 2017 Y	AU 2019 14838 U	G 08 B 21/10; G 08 B 31/00

CONCORDANCE TABLE OF APPLICATION NUMBERS, PUBLICATION NUMBERS
AND PATENTS

NUMBER OF APPLICATION (21)	NUMBER OF PUBLISHED APPLICATION (10)	NUMBER OF PATENT (11)
AU 2018 14838	AU 2019 14838 U	U 2019 2017 Y

TRADEMARKS

CONCORDANCE TABLE OF REGISTRATION NUMBERS, APPLICATION NUMBERS, PUBLICATION NUMBERS AND BULLETIN NUMBERS

NUMBER OF REGISTRATION (111)	NUMBER OF APPLICATIONS (210)	NUMBER OF PUBLISHED APPLICATIONS (260)	NUMBER OF BULLETIN
M 2019 31548 R	AM 104221	–	16(524)/2019
M 2019 31549 R	AM 97408	AM 2019 97408 A	1(509)/2019
M 2019 31550 R	AM 97897	AM 2019 97897 A	2(510)/2019
M 2019 31551 R	AM 98168	AM 2019 98168 A	2(510)/2019
M 2019 31552 R	AM 98371	AM 2019 98371 A	4(512)/2019
M 2019 31553 R	AM 98395	AM 2019 98395 A	4(512)/2019
M 2019 31554 R	AM 98409	AM 2019 98409 A	4(512)/2019
M 2019 31555 R	AM 98411	AM 2019 98411 A	4(512)/2019
M 2019 31556 R	AM 98413	AM 2019 98413 A	3(511)/2019
M 2019 31557 R	AM 98433	AM 2019 98433 A	5(513)/2019
M 2019 31558 R	AM 98559	AM 2019 98559 A	4(512)/2019
M 2019 31559 R	AM 98564	AM 2019 98564 A	5(513)/2019
M 2019 31560 R	AM 98765	AM 2019 98765 A	7(515)/2019
M 2019 31561 R	AM 98766	AM 2019 98766 A	6(514)/2019
M 2019 31562 R	AM 98768	AM 2019 98768 A	6(514)/2019
M 2019 31563 R	AM 98798	AM 2019 98798 A	7(515)/2019
M 2019 31564 R	AM 98799	AM 2019 98799 A	7(515)/2019
M 2019 31565 R	AM 98800	AM 2019 98800 A	6(514)/2019
M 2019 31566 R	AM 98894	AM 2019 98894 A	6(514)/2019
M 2019 31567 R	AM 98994	AM 2019 98994 A	8(516)/2019
M 2019 31568 R	AM 98995	AM 2019 98995 A	8(516)/2019
M 2019 31569 R	AM 98996	AM 2019 98996 A	6(514)/2019
M 2019 31570 R	AM 99060	AM 2019 99060 A	7(515)/2019
M 2019 31571 R	AM 99164	AM 2019 99164 A	7(515)/2019
M 2019 31572 R	AM 99166	AM 2019 99166 A	7(515)/2019
M 2019 31573 R	AM 99196	AM 2019 99196 A	7(515)/2019
M 2019 31574 R	AM 99333	AM 2019 99333 A	8(516)/2019
M 2019 31575 R	AM 99339	AM 2019 99339 A	8(516)/2019
M 2019 31576 R	AM 99340	AM 2019 99340 A	8(516)/2019
M 2019 31577 R	AM 99341	AM 2019 99341 A	8(516)/2019
M 2019 31578 R	AM 99343	AM 2019 99343 A	8(516)/2019
M 2019 31579 R	AM 99344	AM 2019 99344 A	8(516)/2019
M 2019 31580 R	AM 99345	AM 2019 99345 A	8(516)/2019
M 2019 31581 R	AM 99347	AM 2019 99347 A	8(516)/2019
M 2019 31582 R	AM 99348	AM 2019 99348 A	8(516)/2019
M 2019 31583 R	AM 99351	AM 2019 99351 A	8(516)/2019
M 2019 31584 R	AM 99464	AM 2019 99464 A	8(516)/2019
M 2019 31585 R	AM 99483	AM 2019 99483 A	7(515)/2019
M 2019 31586 R	AM 99513	AM 2019 99513 A	8(516)/2019
M 2019 31587 R	AM 99531	AM 2019 99531 A	8(516)/2019
M 2019 31588 R	AM 99532	AM 2019 99532 A	8(516)/2019
M 2019 31589 R	AM 99649	AM 2019 99649 A	8(516)/2019
M 2019 31590 R	AM 99663	AM 2019 99663 A	8(516)/2019
M 2019 31591 R	AM 99915	AM 2019 99915 A	8(516)/2019
M 2019 31592 R	AM 99916	AM 2019 99916 A	8(516)/2019
M 2019 31593 R	AM 99917	AM 2019 99917 A	8(516)/2019
M 2019 31594 R	AM 99918	AM 2019 99918 A	8(516)/2019

1	2	3	4
M 2019 31595 R	AM 99919	AM 2019 99919 A	8(516)/2019
M 2019 31596 R	AM 99920	AM 2019 99920 A	8(516)/2019
M 2019 31597 R	AM 99921	AM 2019 99921 A	8(516)/2019
M 2019 31598 R	AM 99922	AM 2019 99922 A	8(516)/2019
M 2019 31599 R	AM 99923	AM 2019 99923 A	8(516)/2019
M 2019 31600 R	AM 99924	AM 2019 99924 A	8(516)/2019
M 2019 31601 R	AM 99925	AM 2019 99925 A	8(516)/2019
M 2019 31602 R	AM 99926	AM 2019 99926 A	8(516)/2019
M 2019 31603 R	AM 99928	AM 2019 99928 A	8(516)/2019
M 2019 31604 R	AM 99929	AM 2019 99929 A	8(516)/2019
M 2019 31605 R	AM 99930	AM 2019 99930 A	8(516)/2019
M 2019 31606 R	AM 99931	AM 2019 99931 A	8(516)/2019
M 2019 31607 R	AM 99933	AM 2019 99933 A	8(516)/2019
M 2019 31608 R	AM 99935	AM 2019 99935 A	8(516)/2019
M 2019 31609 R	AM 104451	–	16(524)/2019
M 2019 31610 R	AM 103958	–	16(524)/2019
M 2019 31611 R	AM 104422	–	16(524)/2019
M 2019 31612 R	AM 104405	–	16(524)/2019
M 2019 31613 R	AM 95359	AM 2019 95359 A	8(516)/2019
M 2019 31614 R	AM 97167	AM 2019 97167 A	7(515)/2019
M 2019 31615 R	AM 97168	AM 2019 97168 A	7(515)/2019
M 2019 31616 R	AM 97169	AM 2019 97169 A	7(515)/2019
M 2019 31617 R	AM 97171	AM 2019 97171 A	7(515)/2019
M 2019 31618 R	AM 97434	AM 2018 97434 A	24(508)/2018
M 2019 31619 R	AM 97474	AM 2019 97474 A	6(514)/2019
M 2019 31620 R	AM 97475	AM 2019 97475 A	6(514)/2019
M 2019 31621 R	AM 98180	AM 2019 98180 A	3(511)/2019
M 2019 31622 R	AM 98418	AM 2019 98418 A	4(512)/2019
M 2019 31623 R	AM 98432	AM 2019 98432 A	4(512)/2019
M 2019 31624 R	AM 98554	AM 2019 98554 A	7(515)/2019
M 2019 31625 R	AM 98674	AM 2019 98674 A	5(513)/2019
M 2019 31626 R	AM 98675	AM 2019 98675 A	5(513)/2019
M 2019 31627 R	AM 98975	AM 2019 98975 A	6(514)/2019
M 2019 31628 R	AM 99163	AM 2019 99163 A	8(516)/2019
M 2019 31629 R	AM 99185	AM 2019 99185 A	6(514)/2019
M 2019 31630 R	AM 99477	AM 2019 99477 A	8(516)/2019
M 2019 31631 R	AM 99519	AM 2019 99519 A	8(516)/2019
M 2019 31632 R	AM 99522	AM 2019 99522 A	8(516)/2019
M 2019 31633 R	AM 99533	AM 2019 99533 A	8(516)/2019
M 2019 31634 R	AM 99755	AM 2019 99755 A	8(516)/2019
M 2019 31635 R	AM 99756	AM 2019 99756 A	8(516)/2019

**CONCORDANCE TABLE OF PUBLICATION NUMBERS
AND APPLICATION NUMBERS**

NUMBER OF PUBLISHED APPLICATION (260)	NUMBER OF APPLICATION (210)	1	2
1	2		
AM 2019 98682 A	AM 98682	AM 2019 101245 A	AM 101245
AM 2019 99063 A	AM 99063	AM 2019 101246 A	AM 101246
AM 2019 99326 A	AM 99326	AM 2019 101247 A	AM 101247
AM 2019 99524 A	AM 99524	AM 2019 101248 A	AM 101248
AM 2019 99525 A	AM 99525	AM 2019 101249 A	AM 101249
AM 2019 99527 A	AM 99527	AM 2019 101253 A	AM 101253
AM 2019 100434 A	AM 100434	AM 2019 101255 A	AM 101255
AM 2019 100814 A	AM 100814	AM 2019 101257 A	AM 101257
AM 2019 100816 A	AM 100816	AM 2019 101258 A	AM 101258
AM 2019 100859 A	AM 100859	AM 2019 101286 A	AM 101286
AM 2019 100860 A	AM 100860	AM 2019 101287 A	AM 101287
AM 2019 100861 A	AM 100861	AM 2019 101288 A	AM 101288
AM 2019 100862 A	AM 100862	AM 2019 101294 A	AM 101294
AM 2019 100863 A	AM 100863	AM 2019 101297 A	AM 101297
AM 2019 100864 A	AM 100864	AM 2019 101298 A	AM 101298
AM 2019 100897 A	AM 100897	AM 2019 101299 A	AM 101299
AM 2019 100899 A	AM 100899	AM 2019 101300 A	AM 101300
AM 2019 100905 A	AM 100905	AM 2019 101304 A	AM 101304
AM 2019 100907 A	AM 100907	AM 2019 101306 A	AM 101306
AM 2019 100921 A	AM 100921	AM 2019 101371 A	AM 101371
AM 2019 100922 A	AM 100922	AM 2019 101374 A	AM 101374
AM 2019 100923 A	AM 100923	AM 2019 101375 A	AM 101375
AM 2019 100924 A	AM 100924	AM 2019 101376 A	AM 101376
AM 2019 101215 A	AM 101215	AM 2019 101382 A	AM 101382
AM 2019 101230 A	AM 101230	AM 2019 101393 A	AM 101393
AM 2019 101234 A	AM 101234	AM 2019 101394 A	AM 101394
AM 2019 101235 A	AM 101235	AM 2019 101395 A	AM 101395
AM 2019 101237 A	AM 101237	AM 2019 101414 A	AM 101414
AM 2019 101238 A	AM 101238	AM 2019 101422 A	AM 101422
AM 2019 101240 A	AM 101240	AM 2019 101492 A	AM 101492
AM 2019 101243 A	AM 101243	AM 2019 101507 A	AM 101507
AM 2019 101244 A	AM 101244	AM 2019 101511 A	AM 101511
		AM 2019 101513 A	AM 101513
		AM 2019 101524 A	AM 101524
		AM 2019 101600 A	AM 101600
		AM 2019 101604 A	AM 101604
		AM 2019 101679 A	AM 101679

CONCORDANCE TABLE OF INDEX OF GOODS AND/OR SERVICES
AND APPLICATION NUMBERS

INDEX OF GOODS AND/OR SERVICES (511)	NUMBER OF PUBLISHED APPLICATIONS (26)	1	2
1	2	28	AM 2019 100897 A
3	AM 2019 101234 A	28	AM 2019 101237 A
3	AM 2019 101235 A	28	AM 2019 101238 A
3	AM 2019 101237 A	29	AM 2019 101237 A
3	AM 2019 101238 A	29	AM 2019 101238 A
3	AM 2019 101304 A	29	AM 2019 101306 A
3	AM 2019 101374 A	30	AM 2019 101237 A
3	AM 2019 101375 A	30	AM 2019 101238 A
3	AM 2019 101376 A	30	AM 2019 99524 A
5	AM 2019 100434 A	30	AM 2019 99525 A
5	AM 2019 101230 A	30	AM 2019 99527 A
5	AM 2019 101253 A	31	AM 2019 101306 A
5	AM 2019 101255 A	32	AM 2019 101294 A
5	AM 2019 101257 A	32	AM 2019 101393 A
5	AM 2019 101258 A	32	AM 2019 101394 A
5	AM 2019 101286 A	32	AM 2019 101395 A
5	AM 2019 101287 A	33	AM 2019 101288 A
5	AM 2019 101298 A	33	AM 2019 101297 A
5	AM 2019 101299 A	33	AM 2019 101371 A
5	AM 2019 101300 A	33	AM 2019 101393 A
5	AM 2019 101507 A	33	AM 2019 101394 A
5	AM 2019 101524 A	33	AM 2019 101395 A
9	AM 2019 100897 A	33	AM 2019 101492 A
9	AM 2019 100899 A	33	AM 2019 101511 A
9	AM 2019 101237 A	33	AM 2019 101604 A
9	AM 2019 101238 A	33	AM 2019 101679 A
9	AM 2019 101513 A	33	AM 2019 99326 A
12	AM 2019 101243 A	34	AM 2019 100816 A
12	AM 2019 101244 A	34	AM 2019 100921 A
12	AM 2019 101245 A	34	AM 2019 100922 A
12	AM 2019 101246 A	34	AM 2019 100923 A
12	AM 2019 101249 A	34	AM 2019 100924 A
12	AM 2019 99063 A	35	AM 2019 100814 A
14	AM 2019 101237 A	35	AM 2019 100859 A
14	AM 2019 101238 A	35	AM 2019 100860 A
14	AM 2019 101382 A	35	AM 2019 100861 A
14	AM 2019 101422 A	35	AM 2019 100862 A
16	AM 2019 100897 A	35	AM 2019 100863 A
16	AM 2019 100899 A	35	AM 2019 100864 A
16	AM 2019 101237 A	35	AM 2019 100897 A
16	AM 2019 101238 A	35	AM 2019 100899 A
18	AM 2019 101237 A	35	AM 2019 101237 A
18	AM 2019 101238 A	35	AM 2019 101238 A
25	AM 2019 100897 A	35	AM 2019 101240 A
25	AM 2019 101237 A	35	AM 2019 101247 A
25	AM 2019 101238 A	35	AM 2019 101248 A
25	AM 2019 98682 A	35	AM 2019 101306 A
25	AM 2019 99063 A	35	AM 2019 98682 A
		35	AM 2019 99326 A
		35	AM 2019 99524 A
		35	AM 2019 99525 A
		35	AM 2019 99527 A

1	2
36	AM 2019 100859 A
36	AM 2019 100860 A
36	AM 2019 100861 A
36	AM 2019 100862 A
36	AM 2019 100863 A
36	AM 2019 100864 A
36	AM 2019 100905 A
36	AM 2019 100907 A
36	AM 2019 101247 A
36	AM 2019 101248 A
37	AM 2019 100859 A
37	AM 2019 100860 A
37	AM 2019 100861 A
37	AM 2019 100862 A
37	AM 2019 100863 A
37	AM 2019 100864 A
37	AM 2019 101247 A
37	AM 2019 101248 A
38	AM 2019 100897 A
38	AM 2019 100899 A
39	AM 2019 100897 A
39	AM 2019 101288 A
40	AM 2019 100859 A

1	2
40	AM 2019 100860 A
40	AM 2019 100861 A
40	AM 2019 100862 A
41	AM 2019 100863 A
41	AM 2019 100864 A
41	AM 2019 100897 A
41	AM 2019 100899 A
41	AM 2019 101237 A
41	AM 2019 101238 A
41	AM 2019 101247 A
41	AM 2019 101248 A
42	AM 2019 100897 A
42	AM 2019 100899 A
42	AM 2019 101237 A
42	AM 2019 101238 A
43	AM 2019 100814 A
43	AM 2019 101215 A
43	AM 2019 101237 A
43	AM 2019 101238 A
43	AM 2019 101297 A
43	AM 2019 101600 A
44	AM 2019 101414 A

CONCORDANCE TABLE OF INDEX OF GOODS AND/OR SERVICES
AND NUMBERS OF TRADEMARKS REGISTERED ACCORDING
TO THE ACCELERATED PROCEDURE

INDEX OF GOODS AND/OR SERVICES (511)	NUMBERS OF REGISTERED ACCORDING TO THE ACCELERATED PROCEDURE (111)
12	M 2019 31609 R
32	M 2019 31610 R
33	M 2019 31611 R
35	M 2019 31610 R
35	M 2019 31612 R
36	M 2019 31548 R

OFFICIAL BULLETIN OF THE INDUSTRIAL PROPERTY

INVENTIONS
UTILITY MODELS
DESIGNS
TRADEMARKS

16(524)

EDITOR-IN-CHIEF: N. Bebrishvili

EDITOR-TRANSLATOR: E. Gabunia

PROOFREADER: A. Shikhashvili

COMPUTER LAYOUT: M. Ordenidze
K. Svanidze

www.sakpatenti.gov.ge

E-mail: info@sakpatenti.org.ge