



**NATIONAL INTELLECTUAL PROPERTY CENTER OF GEORGIA
SAKPATENTI**

**OFFICIAL BULLETIN
OF THE INDUSTRIAL PROPERTY**

17(477)

**2017
TBILISI**

INID CODES FOR IDENTIFICATION OF BIBLIOGRAPHIC DATA

INVENTIONS, UTILITY MODELS

- (10) Number of publication for application, which has been examined
- (11) Number of patent and kind of document
- (21) Serial number of application
- (22) Date of filing of the application
- (23) Date of exhibition or the date of the earlier filing and the number of application, if any
- (24) Date from which patent may have effect
- (31) Number of priority application
- (32) Date of filing of priority application
- (33) Code of the country or regional organization allotting priority application number
- (44) Date of publication of application not granted, but examined and number of bulletin
- (45) Date of publication of registered document
- (51) International Patent Classification Index
- (54) Title of the invention
- (57) Abstract
- (60) Number of examined patent document granted by foreign patent office, date from which patent has effect and country code
- (62) Number of the earlier application and in case of divided application, date of filing an application
- (71) Name, surname and address of applicant (country code)
- (72) Name, surname of inventor (country code)
- (73) Name, surname and address of patent owner (country code)
- (74) Name, surname of representative or patent attorney
- (85) Date of commencement of the national phase of International Application
- (86) Number and date of filing of international application
- (87) Number and date of publication of international application

DESIGNS

- (10) Number of publication for application
- (11) Number of patent and kind of document or number of registration
- (15) Date of registration/Date of patent renewal
- (18) Expected expiration date of patent or registration
- (21) Serial number of application
- (22) Date of filing of the application
- (23) Date of exhibition or the date of the earlier filing and the number of application, if any
- (24) Date from which patent may have effect
- (28) Number of designs included in the application
- (30) Data relating to priority (number of application, date of filing of application, two-letter code identifying the authority with whom the priority application was made)
- (31) Number of priority application
- (32) Date of filing of priority application
- (33) Code of the country or regional organization allotting priority application number
- (34) Two-letter code according to WIPO St.3 identifying the authority with which the priority application was made
- (44) Date of publication of design and number of bulletin (the first publication)
- (45) Date of publication of design registered by WIPO and number of bulletin
- (51) International Classification for designs (class and subclass of the Locarno Classification)
- (54) Title of the invention
- (55) Reproduction of the design
- (57) Description of characteristic features of the design including indication of colors
- (58) Date of recording of any kind of amendment in the Register
- (62) Number of the earlier application, registration and document number and if available the date of filing an application in case of divided application
- (71) Name, surname and address of applicant (country code)
- (72) Name, surname of creator (country code)
- (73) Name, surname and address of patent owner (country code)
- (74) Name, surname of representative or patent attorney
- (81) Contracting states concerned
 - II designated contracting states according to the 1960 Act
 - III designated contracting states according to the 1999 Act
- (85) Owner's permanent address
- (86) Owner's nationality
- (87) Owner's residence
- (88) State in which the owner has a real and effective industrial or commercial establishment

TRADEMARKS

- (111) – Number of registration
- (151) – Date of registration
- (156) – Date of the renewal
- (181) – Expected expiration date of registration
- (186) – Renewal expiration date of registration
- (141) – Date of cancel of duration of the mark
- (210) – Serial number of application
- (220) – Date of filing of the application
- (230) – Date concerning exhibition
- (260) – Number of application, for which favorable decision of examination about registration has been taken (publication number)
- (310) – Number of the first application
- (320) – Date of filing of the first application
- (330) – Code, identifying national or regional Office where the first application was made
- (511) – International Classification of Goods and Services for the purposes of registration of trade marks and/or list of goods and/or services classified according thereto
- (531) – Description of figurative elements of Trade Marks according to the International Classification of the Figurative Elements of Marks
- (540) – Reproduction of Trade Mark
- (550) – Nature and kind of Trade Mark
- (580) – Date of recording of any kind changes in respect of applications or registrations
- (591) – Information concerning colors claimed
- (731) – Name and address of the applicant
- (732) – Name and address of the holder of the registration
- (740) – Name and address of the representative
- (750) – Address for correspondence
- (770) – Name and address of the previous applicant or holder in case of change in ownership
- (771) – Previous name and address of the applicant or holder in case of change in ownership
- (791) – Name and address of the licensee
- (793) – Indication of conditions and/or restrictions under the license (Type of license, number of license agreement, data of license, data of validity of license)
- (800) – Certain data relating to the international registration of Trade Marks under the Protocol Relating to Madrid Agreement (International registration number)

CODES FOR PUBLICATION IN BULLETIN

- (21) AP 0000 000000 – serial number of application for invention
- (10) AP 0000 0000 A – number of published application for invention (first publication)
- (11) P 0000 0000 B – number of patent for invention (second publication)
- (21) API 0000 000000 – number of application for imported patent
- (11) PI 0000 0000 A – number of imported patent (first publication)
- (21) AU 0000 000000 – serial number of application for utility model
- (10) AU 0000 000 U – number of published application for utility model (first publication)
- (11) U 0000 000 Y – number of patent for utility model (second publication)
- (21) AD 0000 000000 – serial number of application for design
- (10) AD 0000 000 S – number of published application for design (first publication)
- (11) D 0000 000 S – number of patent for design (second publication)

INTERNATIONAL PATENT CLASSIFICATION FOR INVENTIONS AND UTILITY MODELS

- SECTION A – HUMAN NECESSITIES
- SECTION B – PERFORMING OPERATIONS; TRANSPORTING
- SECTION C – CHEMISTRY; METALLURGY
- SECTION D – TEXTILES; PAPER
- SECTION E – FIXED CONSTRUCTIONS
- SECTION F – MECHANICAL ENGINEERING; LIGHTING; HEATING; WEAPONS; BLASTING
- SECTION G – PHYSICS
- SECTION H – ELECTRICITY

-
- M – Trade Mark
 - (210) AM 0000 000000 – Serial number of application;
 - (260) AAM 0000 00000 A – Publication number of application;
 - (111) M 0000 00000 R – Number of registration;
 - (111) MMM0000 00000 Rn – Number of renewals, in which n=1,2,3;
 - (111) M 0000 00000 R(P) – Number of registration under partial assignment of rights
-

LIST OF CODES, IN ALPHABETIC SEQUENCE, AND THE CORRESPONDING (SHORT) NAMES OF STATES, OTHER ENTITIES AND INTERGOVERNMENTAL ORGANIZATIONS
(WIPO STANDARD ST.3)

AD	Andorra				
AE	United Arab Emirates				
AF	Afghanistan				
AG	Antigua and Barbuda				
AI	Anguilla				
AL	Albania				
AM	Armenia				
AN	Netherlands Antilles				
AO	Angola				
AP	African Regional Intellectual Property Organization (ARIPO)				
AR	Argentina				
AT	Austria				
AU	Australia				
AW	Aruba				
AZ	Azerbaijan				
BA	Bosnia and Herzegovina				
BB	Barbados				
BD	Bangladesh				
BE	Belgium				
BF	Burkina Faso				
BG	Bulgaria				
BH	Bahrain				
BI	Burundi				
BJ	Benin				
BM	Bermuda				
BN	Brunei Darussalam				
BO	Bolivia				
BR	Brazil				
BS	Bahamas				
BT	Bhutan				
BV	Bouvet Island				
BW	Botswana				
BX	Benelux Office for Intellectual Property (BOIP)				
BY	Belarus				
BZ	Belize				
CA	Canada				
CD	Democratic Republic of the Congo				
CF	Central African Republic				
CG	Congo				
CH	Switzerland				
CI	Cote d'Ivoire				
CK	Cook Islands				
CL	Chile				
CM	Cameroon				
CN	China				
CO	Colombia				
CR	Costa Rica				
CU	Cuba				
CV	Cape Verde				
CY	Cyprus				
CZ	Czech Republic				
DE	Germany				
DJ	Djibouti				
DM	Dominica				
DO	Dominican Republic				
DZ	Algeria				
EA	Eurasian Patent Organization (EAPO)				
EC	Ecuador				
EE	Estonia				
EG	Egypt				
EH	Western Sahara				
EM	Office for Harmonization in the Internal Market (Trademarks and Designs)(OHIM)				
EP	European Patent Office (EPO)				
ER	Eritrea				
ES	Spain				
ET	Ethiopia				
FI	Finland				
FJ	Fiji				
FK	Falkland Islands (Malvinas)				
FO	Faroe Islands				
FR	France				
GA	Gabon				
GB	United Kingdom				
GC	Patent Office of the Cooperation Council for the Arab States of the Gulf (GCC)				
GD	Grenada				
GG	Guernsey				
GH	Ghana				
GI	Gibraltar				
GT	Guatemala				
GW	Guinea- Bissau				
GY	Guyana				
HK	The Hong Kong Special Administrative Region of the People's Republic of China				
HN	Honduras				
HR	Croatia				
HT	Haiti				
HU	Hungary				
IB	International Bureau of the World Intellectual Property Organization (WIPO)				
ID	Indonesia				
IE	Ireland				
IL	Israel				
IM	Isle of Man				
IN	India				
IQ	Iraq				
ID	Indonesia				
IE	Ireland				
IL	Israel				
IM	Isle of Man				
IN	India				
IQ	Iraq				
IR	Iran (Islamic Republic of)				
IS	Iceland				
IT	Italy				
JE	Jersey				
JM	Jamaica				
JO	Jordan				
JP	Japan				
KE	Kenya				
KG	Kyrgyzstan				
KH	Cambodia				
KI	Kiribati				
KM	Saint Kitts and Nevis				
KP	Democratic People's Republic of Korea				
KR	Republic of Korea				
KW	Kuwait				
KY	Cayman Islands				
KZ	Kazakhstan				
LA	Lao People's Democratic Republic				
LB	Lebanon				
LC	Saint Lucia				
LI	Liechtenstein				
LK	Sri Lanka				
LR	Liberia				
LS	Lesotho				
LT	Lithuania				
LU	Luxembourg				
LV	Latvia				
LY	Libyan Arab Jamahiriya				
MA	Morocco				
MC	Monaco				
MD	Republic of Moldova				
ME	Montenegro				
MG	Madagascar				
MK	The former Yugoslav Republic of Macedonia				
ML	Mali				
MM	Myanmar				
MN	Mongolia				
MO	Macao				
MP	Northern Mariana Islands				
MR	Mauritania				
MS	Montserrat				
MT	Malta				
MU	Mauritius				
MV	Maldives				
MW	Malawi				
MX	Mexico				
MY	Malaysia				
MZ	Mozambique				
NA	Namibia				
NE	Niger				
NG	Nigeria				
NI	Nicaragua				
NL	Netherlands				
NO	Norway				
NP	Nepal				
NR	Nauru				
NZ	New Zealand				
OA	African Intellectual Property Organization (OAPI)				
OM	Oman				
PA	Panama				
PE	Peru				
PG	Papua New Guinea				
PH	Philippines				
PK	Pakistan				
PL	Poland				
PT	Portugal				
PW	Palau				
PY	Paraguay				
QA	Qatar				
QZ	Community Plant Variety Office (European Community) (CPVO)				
RO	Romania				
RS	Serbia				
RU	Russian Federation				
RW	Rwanda				
SA	Saudi Arabia				
SB	Solomon Islands				
SC	Seychelles				
SD	Sudan				
SG	Singapore				
SH	Saint Helena				
SI	Slovenia				
SK	Slovakia				
SL	Sierra Leone				
SM	San Marino				
SN	Senegal				
SO	Somalia				
SR	Suriname				
ST	Sao Tome and Principe				
SV	El Salvador				
SY	Syrian Arab Republic				
SZ	Swaziland				
TC	Turks and Caicos Islands				
TD	Chad				
TG	Togo				
TH	Thailand				
TJ	Tajikistan				
TL	Timor-Leste				
TM	Turkmenistan				
TN	Tunisia				
TO	Tonga				
TR	Turkey				
SE	Sweden				
TT	Trinidad and Tobago				
TV	Tuvalu				
TW	Taiwan, Province of China				
TZ	United Republic of Tanzania				
UA	Ukraine				
UG	Uganda				
US	United States of America				
UY	Uruguay				
UZ	Uzbekistan				
VA	Holy See				
VC	Saint Vincent and the Grenadines				
VE	Venezuela				
VG	Virgin Islands (British)				
VN	Viet Nam				
VU	Vanuatu				
WO	World Intellectual Property Organization (WIPO)				
WS	Samoa				
XN	Nordic Patent Institute (NPI)				
YE	Yemen				
ZA	South Africa				
ZM	Zambia				
ZW	Zimbabwe				

**NATIONAL INTELLECTUAL PROPERTY CENTER OF GEORGIA
SAKPATENTI**

**OFFICIAL BULLETIN
OF THE INDUSTRIAL PROPERTY**

17(477)

**INVENTIONS
UTILITY MODELS
DESIGNS
TRADEMARKS
APPELLATION OF ORIGIN**

**DATE OF PUBLICATION
2017 09 11**

CONTENTS

PUBLISHED TITLES OF PROTECTION	2
INVENTIONS	
▪ APPLICATION APPROVED FOR GRANTING PATENT	4
▪ PATENTED INVENTIONS	5
UTILITY MODELS	
▪ PATENTED UTILITY MODEL	6
DESIGNS	
▪ DESIGN REGISTERED ACCORDING TO THE ACCELERATED PROCEDURE	8
▪ DESIGNS REGISTERED WITH THE INTERNATIONAL BUREAU CLAIMING PRIORITY ON THE TERRITORY OF GEORGIA	22
TRADEMARKS	
▪ APPLICATIONS FILED UNDER THE NATIONAL PROCEDURE APPROVED FOR REGISTRATION	48
▪ REGISTERED TRADEMARKS	54
▪ TRADEMARKS REGISTERED ACCORDING TO THE ACCELERATED PROCEDURE	57
▪ INTERNATIONAL TRADEMARKS FOR WHICH A DECISION ON GANTING PROTECTION IS TAKEN	59
▪ INTERNATIONAL TRADEMARKS PROTECTED IN GEORGIA	105
APPELLATIONS OF ORIGIN	
▪ APPELLATIONS OF ORIGIN OF GOODS FILED IN GEORGIA FOR EXAMINATION UNDER LISBON AGREEMENT, ON THE BASIS OF THE INTERNATIONAL REGISTRATION	107
OFFICIAL NOTIFICATIONS	
INVENTIONS	
▪ RENEWAL OF PATENTS	109
UTILITY MODELS	
▪ RENEWAL OF PATENTS	111
TRADEMARKS	
▪ RENEWAL OF REGISTRATIONS	112
▪ COMPLETE TRANSFER OF RIGHTS	126
▪ CHANGES IN NAMES AND/OR ADDRESSES OF OWNERS	133
▪ INVALIDATION OF TRADEMARKS REGISTRATION	142
CLASSIFICATION INDEXES	
INVENTIONS	147
UTILITY MODELS	148
DESIGNS	149
TRADEMARKS	150

PUBLISHED TITLES OF PROTECTION

INVENTIONS

- **APPLICATION APPROVED FOR GRANTING PATENT:**
13974
- **PATENTED INVENTIONS:**
6727-6732

UTILITY MODELS

- **PATENTED UTILITY MODELS:**
1945, 1946

DESIGNS

- **DESIGNS REGISTERED ACCORDING TO THE ACCELERATED PROCEDURE:**
721
- **DESIGNS REGISTERED WITH THE INTERNATIONAL BUREAU CLAIMING PRIORITY ON THE TERRITORY OF GEORGIA:**
93847, 93848; 93960; 94372; 94671; 96290; 96398; 94087, 94088; 94093; 94101; 96527

TRADEMARKS

- **APPLICATIONS FILED UNDER THE NATIONAL PROCEDURE APPROVED FOR REGISTRATION:**
87631-87633; 88283; 89901; 89996; 90060; 90096; 90098; 90102, 90103; 90106, 90107; 90143; 90389; 90400; 90412; 90414, 90415; 90479; 90482; 90488; 90494; 90504; 90546; 90553; 90642; 90645-90647; 90651; 90664; 90675; 90677
- **REGISTERED TRADEMARKS:**
28751; 28837-28870
- **TRADEMARKS REGISTERED ACCORDING TO THE ACCELERATED PROCEDURE:**
28827-28836
- **INTERNATIONAL TRADEMARKS FOR WHICH A DECISION ON GRANTING PROTECTIONS IS TAKEN:**
84991*; 86774; 86949; 87203; 87602; 87604, 87605; 87764; 87837; 88142; 88148; 88151; 88265; 88281; 88444; 88832; 88871; 88878; 88920, 88921; 89248; 89267; 89353-89355; 89357, 89358; 89365; 89369; 89373; 89382; 89390; 89392; 89394-89398; 89433, 89434; 89436; 89438-89440; 89442; 89446-89452; 89459-89463; 89465; 89467-89471; 89473-89475; 89482; 89485-89488; 89490-89498; 89500-89506; 89508, 89509; 89550; 89553; 89565, 89566; 89571; 89573, 89574; 89577; 89582; 89590; 89594; 89613, 89614; 89619; 89621, 89622; 89625; 89627, 89628; 89636; 89650; 89656, 89657; 89662-89666; 89668; 89672; 89719-89723; 89725; 89727; 89729; 89731-89733; 89804, 89805; 90272; 90275; 90278; 90281; 90283; 90285-90289; 90293-90295; 90298, 90299
- **INTERNATIONAL TRADEMARKS PROTECTED IN GEORGIA:**
80883; 82511; 83313; 83888-83891; 83894, 83895; 84575; 84918; 85060; 85741; 85991; 86051; 86221; 87118; 87928; 88033-88035; 88037, 88038; 88041; 88051; 88162

APPELLATIONS OF ORIGIN OF GOODS

- **APPELLATIONS OF ORIGIN OF GOODS FILED GEORGIA FOR EXAMINATION UNDER LISBON AGREEMENT, ON THE BASIS OF THE INTERNATIONAL REGISTRATION:**
1400-1404

INVENTIONS

APPLICATION APPROVED FOR GRANTING PATENT

The decision can be appealed at the Chamber of Appeal of Sakpatenti within 3 months from the publication or at the Mtskheta District Court Administrative Cases Board (Address: №17, Samkhedro str., Mtskheta), within 1 month following the publication.

PART A

A 61

(10) AP 2017 13974 A (51) Int. Cl. (2006)
A 61 M 5/315

(21) AP 2014 013974 (22) 2014 03 26

(31) 1305489.5

(32) 2013 03 26

(33) GB

(71) CONSORT MEDICAL PLC (GB)
Ground Floor, Suite D, Breakspear Park,
Breakspear Way, Hemel Hempstead
HP2 4TZ (GB)

(72) ANDERSON, Ian (GB);

EKMAN, Matt (GB);

GLOVER, Robert (GB);

KOPPELMAN, Rachel (GB)

(74) Tamar Kochlamazashvili

(85) 2015 10 26

(86) PCT/GB2014/050965, 2014 03 26

(54) **IMPROVED MIXING SYRINGE
ASSEMBLY**

(57) A syringe assembly comprising a barrel 12 for containing one or more medicaments; at that, the barrel has front outlet 12a for allowing the expulsion from the said barrel through said outlet, and a first stopper 14 disposed in the barrel and axially moveable therein and defining a first volume 16 in the barrel axially forwards of the first stopper and a second volume 18 in the barrel axially rearwards of the first stopper. At that, the two way valve is moveable from the sealing configuration to the open configuration by an increase in fluid pressure in either of the first and second volumes. The syringe assembly additionally comprises a second stopper 20 disposed in the barrel axially rearward of the first stopper and axially moveable therein, the second stopper providing a fluid tight seal at a rear end of the second volume. The syringe assembly further comprises a first plunger rod 22 connected to the first stopper and extending axially rearwardly through the second stopper, the second stopper sealingly engaging with the first plunger rod but permitting axial sliding of the first plunger rod therethrough. At that, the first plunger rod is axially moveable so as to axially move the first stopper and

pressurise either of the first volume and second volume causing the two way valve to move into the open configuration and fluidly connect the first volume and second volume.

Claims: 1 independent

16 dependent

Fig.: 10

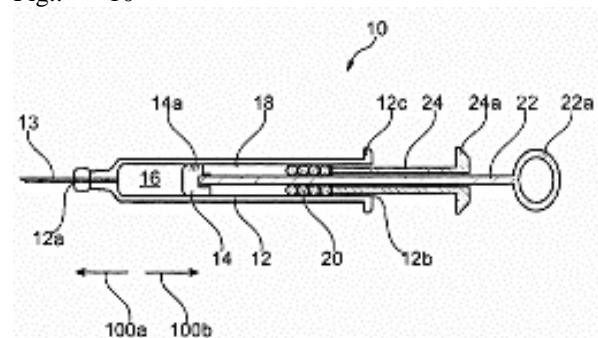

Fig. 1A

PATENTED INVENTIONS

PART A

A 01

- (11) P 2017 6728 B (51) Int. Cl. (2006)
 A 01 N 47/40
 A 01 N 37/18
 A 01 N 43/40
 A 01 N 43/54
 A 01 N 43/78
 A 01 N 47/04
 A 01 N 47/12
 A 01 N 47/28
 A 01 N 51/00
 A 01 N 57/32
 A 01 P 7/02
 A 01 P 7/04
 A 61 K 31/341
 A 61 K 31/381
 A 61 K 31/426
 A 61 K 31/44
 A 61 K 31/4427
 A 61 K 31/443
 A 61 K 31/4436
 A 61 K 31/4439
 A 61 K 31/50
 C 07 C 233/05
 C 07 C 233/12
 C 07 C 261/04
 C 07 C 271/12
 C 07 C 311/09
 C 07 D 213/36
 C 07 D 213/42
 C 07 D 237/12
 C 07 D 277/20
 C 07 D 277/32
 C 07 D 307/14
 C 07 D 333/20
 C 07 D 401/12
 C 07 D 405/12
 C 07 D 409/12
 C 07 D 417/12
- (10) AP 2017 13043 A (44) 10(470)/2017
 (21) AP 2011 013043
 (22) 2011 08 26
 (24) 2011 08 26
 (31) 2010-194584; PCT/JP2011/069352
 (32) 2010 08 31; 2011 08 26
 (33) JP; IB
 (86) PCT/JP2011/069352, 2011 08 26
 (73) MEIJI SEIKA PHARMA CO., LTD. (JP)
 4-16, Kyobashi 2-chome, Chuo-ku, Tokyo
 1048002 (JP)

- (72) KAGABU, Shinzo (JP);
 MITOMI, Masaaki (JP);
 KITSUDA, Shigeki (JP);
 HORIKOSHI, Ryo (JP);
 NOMURA, Masahiro (JP);
 ONOZAKI, Yasumichi (JP)
- (74) Tamar Kochlamazashvili
- (54) **NOXIOUS ORGANISM CONTROL AGENT**

PART B

B 64

- (11) P 2017 6732 B (51) Int. Cl. (2006)
 B 64 D 27/10
 F 02 K 3/077
- (10) AP 2017 14074 A (44) 10(470)/2017
 (21) AP 2016 014074
 (22) 2016 02 29
 (24) 2016 02 29
 (73) Andro Maisuradze (GE)
 M. Meskhis q. 18, 0101, Tbilisi (GE);
 Lasha Maisuradze (GE)
 V. Bagrationis q. 11, 0154, Tbilisi (GE)
- (72) Andro Maisuradze (GE);
 Lasha Maisuradze (GE)
- (54) **THREE-FLOW TURBOJET ENGINE**

PART C

C 07

- (11) P 2017 6731 B (51) Int. Cl. (2006)
 C 07 D 223/16
 C 07 D 233/38
- (10) AP 2017 13425 A (44) 10(470)/2017
 (21) AP 2014 013425
 (22) 2014 03 21
 (24) 2014 03 21
 (31) 13.52741
 (32) 2013 03 26
 (33) FR
 (73) LES LABORATOIRES SERVIER (FR)
 35, rue de Verdun, 92284 Suresnes
 Cedex (FR)

- (72) LE FLOHIC, Alexandre (FR)
 (74) Tamaz Shilakadze
 (54) **PROCESS FOR SYNTHESIS OF 7,8-DIMETHOXY-1,3-DIHYDRO-2H-3-BENZAZEPIN-2-ONE COMPOUNDS AND APPLICATION THEREIN SYNTHESIS OF IVABRADINE**

PART F

F 25

- (11) P 2017 6729 B (51) Int. Cl. (2006)
F 25 B 27/00
F 25 B 30/06
- (10) AP 2017 13322 A (44) 10(470)/2017
 (21) AP 2013 013322
 (22) 2013 12 12
 (24) 2013 12 12
 (73) Vazha Jamarjashvili (GE)
 Paliashvilis q. 50, b. 9, 0179,
 Tbilisi (GE);
 Merab Lortkipanidze (GE)
 Ir. Abashidzis q. 40, 0179, Tbilisi (GE);
 Aleksii Mirianashvili (GE)
 Tamarashvilis q. 4a, 0162, Tbilisi (GE);
 Endi Tumanishvili (GE)
 Paliashvilis q. 50, b. 9, 0179,
 Tbilisi (GE);
 Niko Chakhvashvili (GE)
 Gudauris q. 2, 0179, Tbilisi (GE)
- (72) Vazha Jamarjashvili (GE);
 Merab Lortkipanidze (GE);
 Aleksii Mirianashvili (GE);
 Endi Tumanishvili (GE);
 Niko Chakhvashvili (GE)
- (54) **HEAT AND COOL SUPPLY ENERGY SAVING SYSTEM BASED ON LOW TEMPERATURE WATER USAGE**

PART G

G 01

- (11) P 2017 6730 B (51) Int. Cl. (2006)
G 01 N 33/569
A 23 L 1/30
A 61 K 35/74
- (10) AP 2017 13351 A (44) 10(470)/2017
 (21) AP 2012 013351
 (22) 2012 07 20
 (24) 2012 07 20
 (31) 61/572,742; 13/552,686
 (32) 2011 07 21; 2011 07 19
 (33) US; US
 (86) PCT/EP2012/064351, 2012 07 20
 (73) BIOGAIA AB (SE)
 Kungsbrogatan 3A, P.O. Box 3242, S-103
 64 Stockholm (SE)
- (72) VERSALOVIC, James (US);
 THOMAS, Carissa Michelle (US);
 CONNOLLY, Eamonn (GB)
- (74) Shalva Gvaramadze
- (54) **PRODUCTION AND USE OF BACTERIAL HISTAMINE**

PART H

H 01

- (11) P 2017 6727 B (51) Int. Cl. (2006)
H 01 Q 15/16
H 01 Q 1/30
- (10) AP 2017 12873 A (44) 10(470)/2017
 (21) AP 2012 012873
 (22) 2012 10 19
 (24) 2012 10 19
 (73) Leri Datashvili (GE)
 Javakhishvilis q. 21, 0102, Tbilisi (GE)
- (72) Leri Datashvili (GE)
- (74) Tina Chalauri
- (54) **OPENING COSMIC REFLECTOR**

UTILITY MODELS

PATENTED UTILITY MODELS

PART B

B 41

- (11) **U 2017 1945 Y** (51) **Int. Cl. (2006)**
B 41 F 17/00
- (10) AU 2017 14330 U (44) 10(470)/2017
(21) AU 2016 014330
(22) 2016 11 25
(24) 2016 11 25
(73) Irine Ugrekhelidze (GE)
A. Khoravas q. 8, 0179, Tbilisi (GE);
Jumber Uplisashvili (GE)
Dighomi, Didgoris q. 201, 0113,
Tbilisi (GE);
Tea Baramashvili (GE)
Didi Kheivnis q. 75, 0114, Tbilisi (GE);
Giorgi Gabisonia (GE)
Gldani, mkr. V, korp. 3, b. 27, 0107,
Tbilisi (GE)
- (72) Irine Ugrekhelidze (GE);
Jumber Uplisashvili (GE);
Tea Baramashvili (GE);
Giorgi Gabisonia (GE)
- (54) **TAMPON PRINTING FACILITY**
-

PART E

E 02

- (11) **U 2017 1946 Y** (51) **Int. Cl. (2006)**
E 02 B 9/04
- (10) AU 2017 14352 U (44) 10(470)/2017
(21) AU 2016 014352
(22) 2016 12 16
(24) 2016 12 16
(73) LEPL "GEORGIAN TECHNICAL
UNIVERSITY" (GE)
M. Kostavas q. 77, 0175, Tbilisi (GE);
Tarkhan Tevzadze (GE)
S. Chikovanis q. 27a, 0179, Tbilisi (GE);
Giorgi Omsarashvili (GE)
Didi Dighomi, Giorgi Brtskinvales q. 41,
b. 14, 0159, Tbilisi (GE)
- (72) Tarkhan Tevzadze (GE);
Giorgi Omsarashvili (GE)
- (54) **UNDERFLOW WATER INTAKE
FACILITY**
-

DESIGN REGISTERED ACCORDING TO THE ACCELERATED PROCEDURE

The decision can be appealed at the Chamber of Appeal of Sakpatenti within 3 months from the publication.

- (11) **D 2017 721 S** (51) **25-03**
(21) AD 2017 982 (22) 2017 08 23
(24) 2017 08 23
(28) 13
(18) 2022 08 23
(73) Giorgi Lagvilava (GE)
 Dighmis mas., V kv., korp. 20, b. 14, 0159, Tbilisi, Georgia
(74) Giorgi Lagvilava (GE)
(54) **1.-3.-4.-7.-8.-10.-13. FAST FOOD OBJECT,
 2.-5.-6.-9. FRONT OF FAST FOOD OBJECT**
(55)

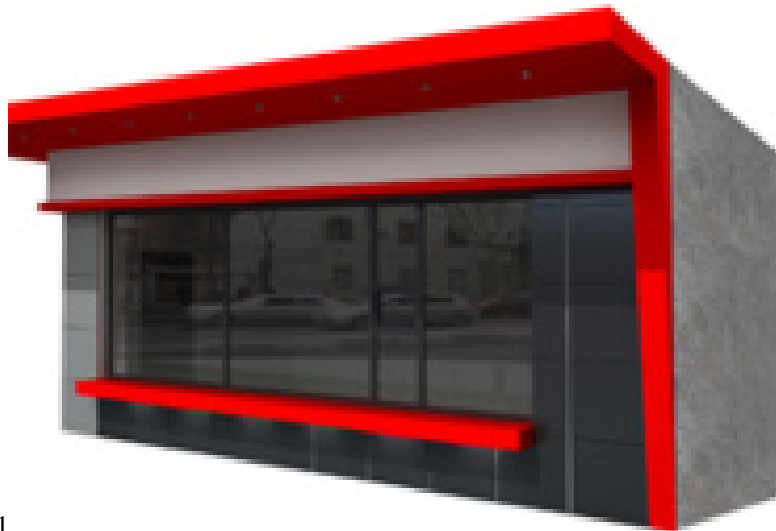

1.1

1.2





1.3



2.1



2.2



3.1

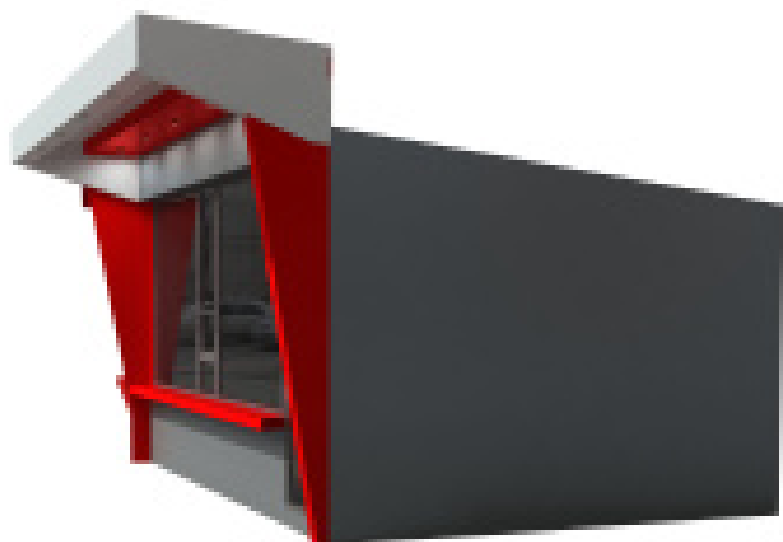

4.1



4.2



4.3



5.1



5.2



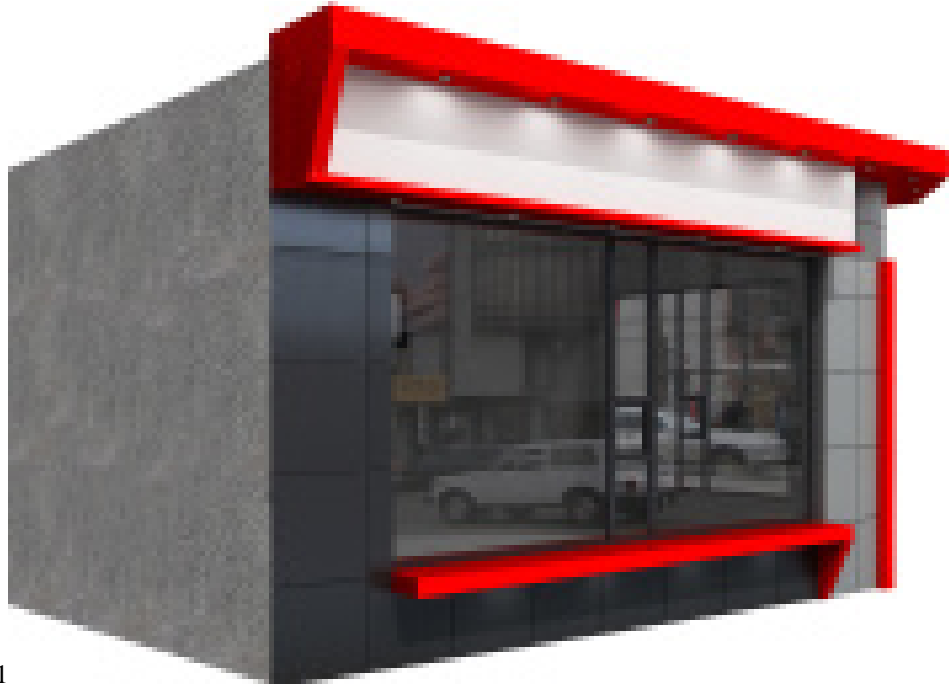

7.1



7.2



7.3



8.1



8.2



8.3



8.4



9.1



10.1



10.2



10.3



11.1



11.2



12.1



12.2



13.1



13.2



13.3

DESIGNS, WHICH HAVE BEEN REGISTERED WITH THE INTERNATIONAL BUREAU CLAIMING PRIORITY ON THE TERRITORY OF GEORGIA

The decision can be appealed at the Chamber of Appeal of Sakpatenti within 3 months from the publication or at the Mtskheta District Court Administrative Cases Board (Address: №17, Samkhedro Str., Mtskheta), within 1 month following the publication.

- (11) **DM/093847** **(51) 20-02**
- (15) 2016 12 12 (45) 2017/23 (2017 06 16)
- (22) 2016 12 12
- (28) 1
- (73) TISSOT SA (TISSOT AG) (TISSOT LTD)
Chemin des Tourelles 17, CH-2400 Le Locle (CH)
- (85) CH
- (86) CH
- (87) CH
- (88) CH
- (89) CH
- (81) II. BZ, MA III. AL, AM, AZ, BA, CH, EM, GE, KG, LI, MC, MD, ME, MK, MN, NO, OM, SG, TN, TR, UA
- (72) Benjamin BOUHAN
24 rue du Village, 25370 Métabief, France; Nicolas ALLEMANN, 31 rue de Baillée, 25500 Montlebon, France
- (54) 1. Display unit
- (55)

1.1

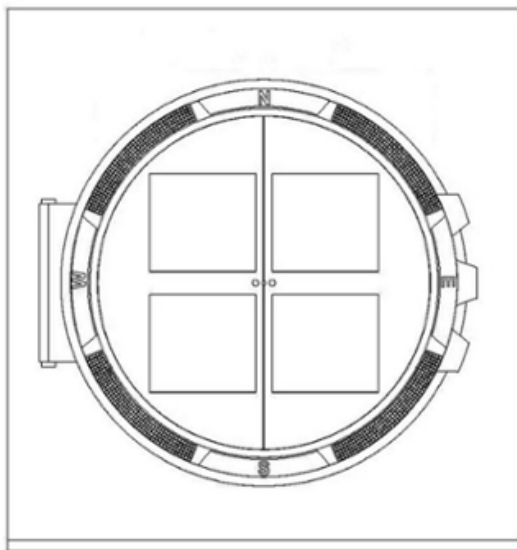

1.2

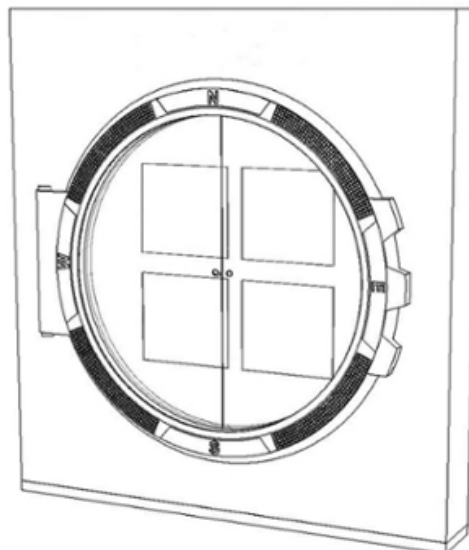

(11) DM/093848**(51) 10-07**

(15) 2016 12 12

(45) 2017/23 (2017 06 16)

(22) 2016 12 12

(28) 3

(73) CERTINA AG (CERTINA SA) (CERTINA LTD.)

17, chemin des Tourelles, CH-2400 LE LOCLE (CH)

(85) CH

(86) CH

(87) CH

(88) CH

(89) CH

(81) II. BZ, MA III. AL, AM, AZ, BA, CH, EM, GE, KG, KR, LI, MC, MD, ME, MK, MN, NO, OM, SG, TN, TR, UA

(72) Marco SCARINZI

Scarinzi S.A., Rue d'Aarberg 107 A, 2501 Biel/Bienne, Suisse; Renato SCARINZI, Scarinzi S.A.,

Rue d'Aarberg 107 A, 2501 Biel/Bienne, Suisse

(54) 1. Watch case; 2.-3. Dials

(55)

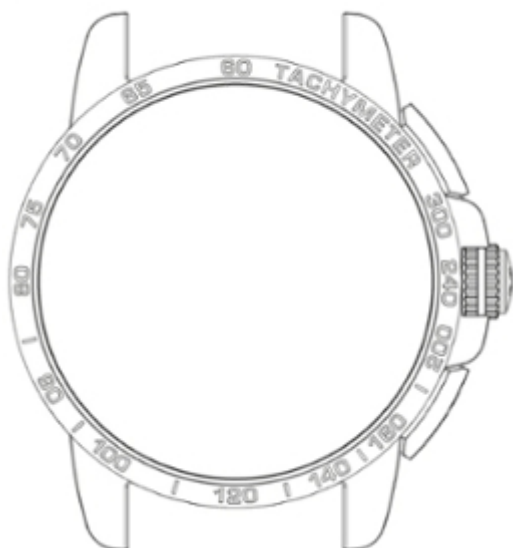
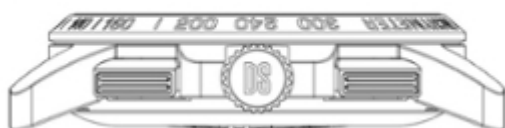
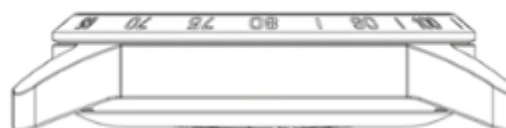
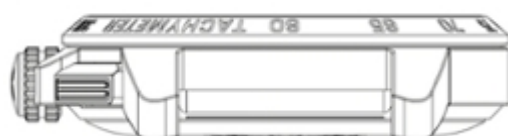
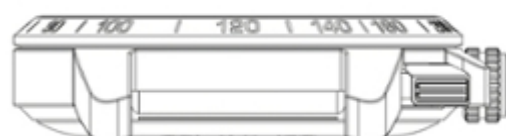
1.1**1.2****1.3****1.4****1.5****1.6**

1.7

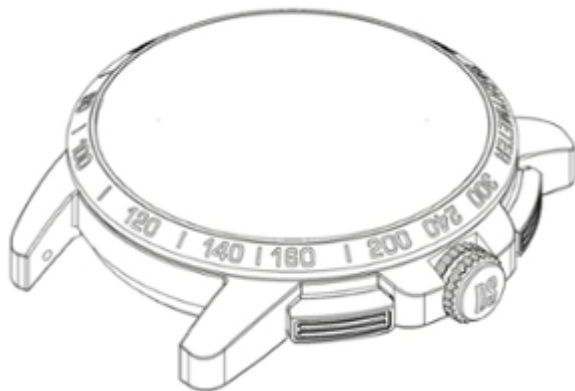

2.1



2.2



3.1



3.2



(11) DM/093960

(15) 2016 12 16

(22) 2016 10 18

(28) 2

(73) PEUGEOT CITROËN AUTOMOBILES SA

Route de Gisy, F-78140 VELIZY-VILLACOUBLAY (FR)

(85) FR

(86) FR

(87) FR

(88) FR

(89) FR

(81) II. BJ, BX, BZ, CI, GA, GR, IT, MA, ML, NE, SN, SR III. AL, AM, AZ, BA, BG, BN, BW, CH, DE, DK, EE, EG, ES, FI, FR, GE, GH, HR, HU, IS, JP, KG, KP, KR, LI, LT, LV, MC, MD, ME, MK, MN, NA, NO, OA, OM, PL, RO, RS, RW, SG, SI, ST, SY, TJ, TM, TN, TR, UA

(72) Jean Pierre PLOUE

Route de Gisy, 78140 VELIZY VILLACOUBLAY, France

(54) 1.-2. Radiator grilles for motor vehicles

(55)

(51) 12-16

(45) 2017/23 (2017 06 16)

1.1



1.2



2.1



2.2



(11) DM/094372

(15) 2016 12 16

(22) 2016 10 18

(28) 9

(73) PEUGEOT CITROËN AUTOMOBILES SA
F-78140 VELIZY-VILLACOUBLAY (FR)

(85) FR, EM

(86) FR, EM

(87) FR, EM

(88) FR, EM

(89) FR

(81) II. BJ, BX, BZ, CI, GA, GR, IT, MA, ML, NE, SN, SR III. AL, AM, AZ, BA, BG, BN, BW, CH, DE, DK, EE, EG, ES, FI, FR, GE, GH, HR, HU, IS, JP, KG, KP, KR, LI, LT, LV, MC, MD, ME, MK, MN, NA, NO, OA, OM, PL, RO, RS, RW, SG, SI, ST, SY, TJ, TM, TN, TR, UA

(72) Jean Pierre PLOUE

Route de Gisy, 78140 VELIZY VILLACOUBLAY, France

(54) 1. Exterior rearview mirror for motor vehicles; 2. Tailgate for motor vehicles;

3. Rear door for motor vehicles; 4. Rear bumper for motor vehicles; 5.-6. Doors for motor vehicles;

7.-8. Front wings for motor vehicles; 9. Hood for motor vehicles

(55)

1



2.1



2.2



3.1



3.2



4.1



4.2



5.1



5.2



6.1



7



8



6.2



9.1



9.2

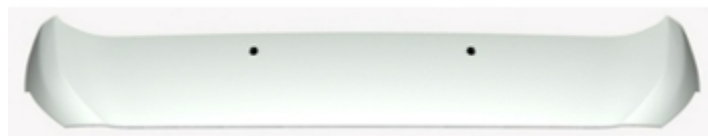

(11) DM/094671

(15) 2016 12 16

(22) 2016 10 18

(28) 9

(73) PEUGEOT CITROËN AUTOMOBILES SA

Route de Gisy, F-78140 VELIZY-VILLACOUBLAY (FR)

(85) FR

(86) FR

(87) FR

(88) FR

(89) FR

(81) II. BJ, BX, BZ, CI, GA, GR, IT, MA, ML, NE, SN, SR III. AL, AM, AZ, BA, BG, BN, BW, CH, DE, DK, EE, EG, ES, FI, FR, GE, GH, HR, HU, IS, JP, KG, KP, KR, LI, LT, LV, MC, MD, ME, MK, MN, NA, NO, OA, OM, PL, RO, RS, RW, SG, SI, ST, SY, TJ, TM, TN, TR, UA

(72) Jean Pierre PLOUE

Route de Gisy, 78140 VELIZY VILLACOUBLAY, France

(54) 1. Vehicle taillight; 2.-9. Vehicle headlights

(55)

(51) 26-06

(45) 2017/23 (2017 06 16)

1.1



1.2



2



3



4



5



6



7



8



9



(11) DM/096290

(15) 2017 06 01

(22) 2017 06 01

(28) 2

(73) VALENTINO S.P.A.

Via Turati, 16/18, I-20121 MILANO (IT)

(85) –

(86) EM, IT

(87) EM, IT

(88) EM, IT

(89) EM

(81) III. AZ, EM, GE, JP, KG, KR, TJ, TR, UA

(72) SASSI Stefano

c/o VALENTINO S.p.A., Via Turati, 16/18, I-20121 Milano, Italy

(54) 1.-2. Shoes

(55)

(51) 02-04

(45) 2017/23 (2017 06 16)

1.1



1.2



1.3

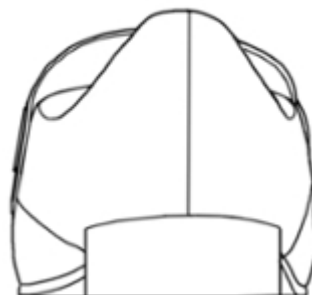

1.4



1.5

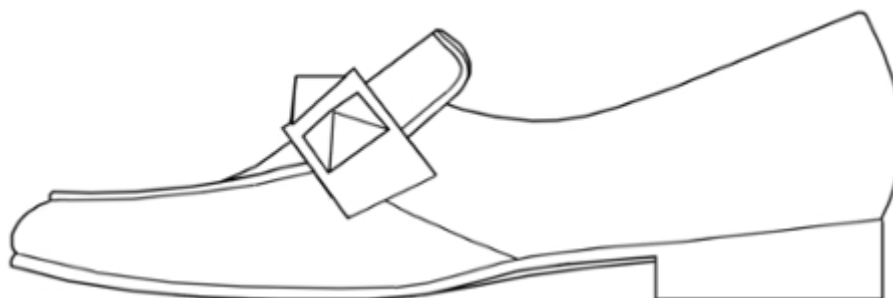

1.6

1.7

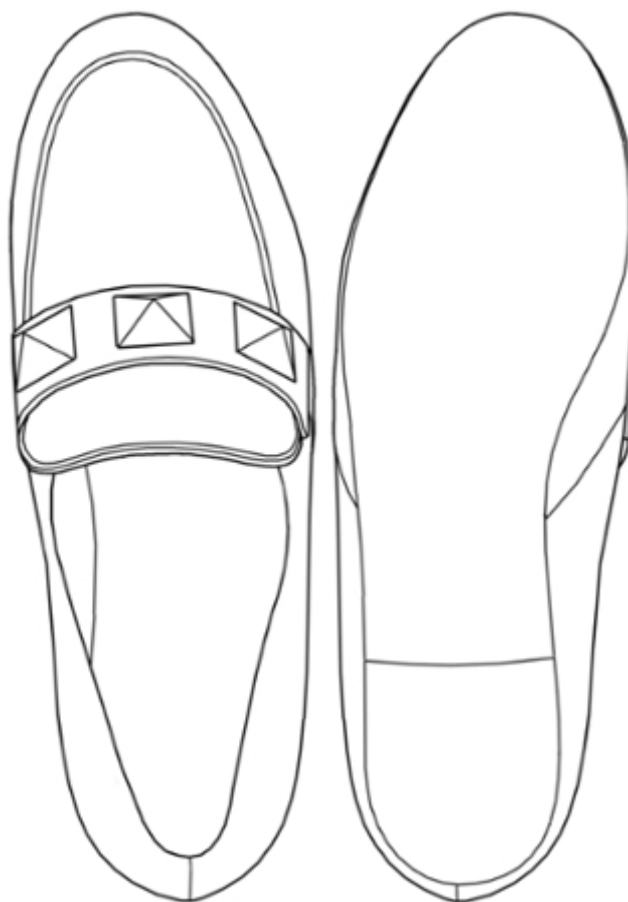

2.1



2.2



2.3

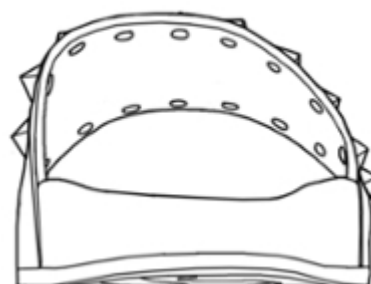

2.4

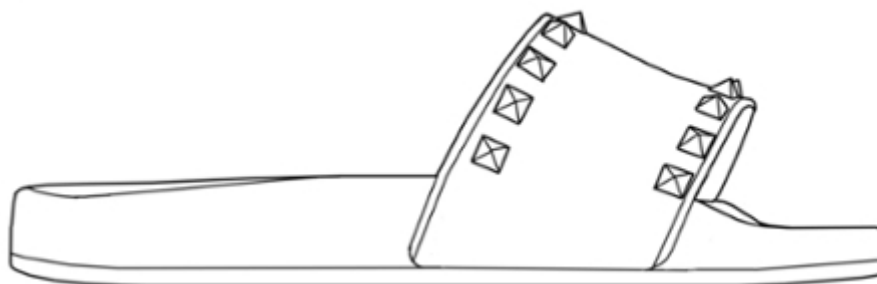

2.5

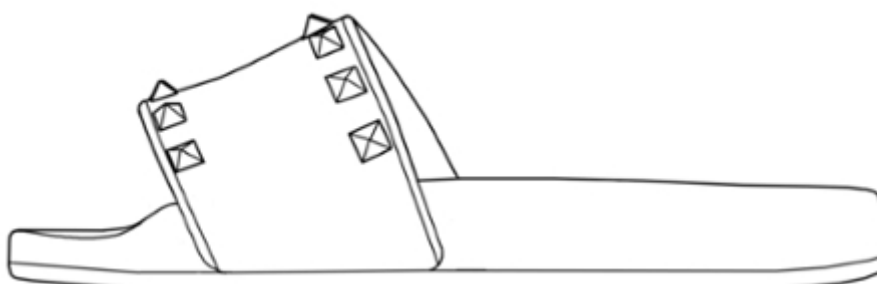

2.6

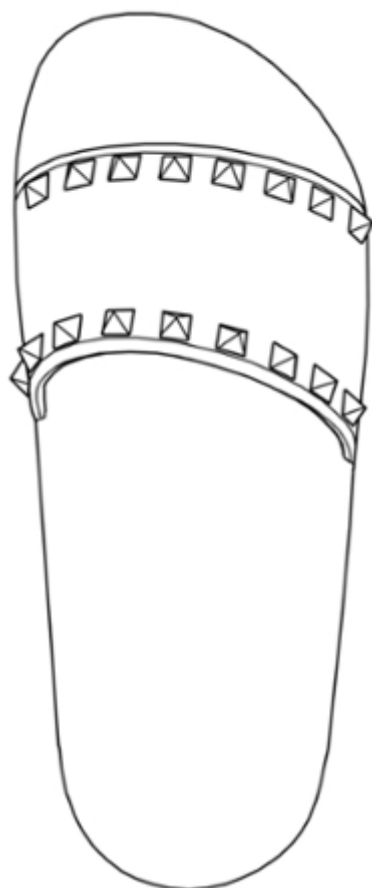

2.7

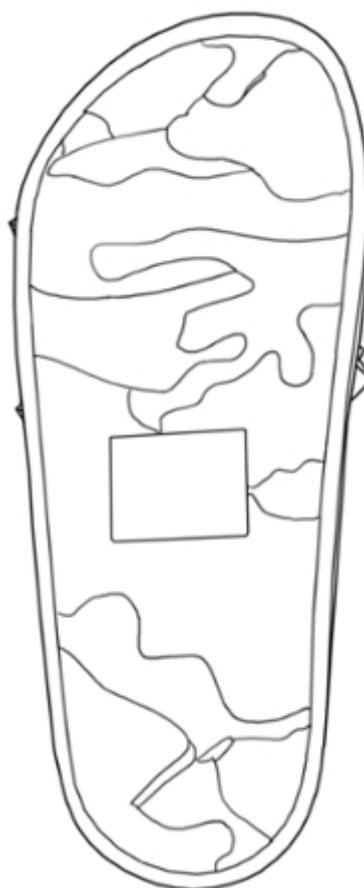

(11) DM/096398

(51) 14-03

(15) 2016 12 13

(45) 2017/24 (2017 06 23)

(22) 2016 12 13

(28) 2

(73) KATMERCILER ARAC USTU EKIPMAN SANAYI VE TICARET ANONIM SIRKETI
10032 Sok. No:10 Atatürk Organize Sanayi Bölgesi, ÇİĞLİ, İZMİR (TR)

(85) TR

(86) TR

(87) TR

(88) TR

(89) TR

(81) III. AZ, EG, EM, GE, TN

(72) YIGIT KOL

10032 Sk. No:10 Atatürk Organize Sanayi Bölgesi Çigli, IZMIR, Turkey;
VOLKAN ERIS

10032 Sk. No:10 Atatürk Organize Sanayi Bölgesi Çigli, IZMIR, Turkey

(54) 1.-2. Portable remote control and indicator units for motor vehicles

(55)

1.1



1.2



1.3



1.5

1.4



1.7

1.6



2.1



2.2



2.3



2.4



2.5



(11) DM/094087

(15) 2016 12 27

(22) 2016 12 27

(28) 2

(73) HAMILTON INTERNATIONAL AG (HAMILTON INTERNATIONAL SA)
(HAMILTON INTERNATIONAL LTD)

Mattenstrasse 149, CH-2503 Biel/Bienne (CH)

(85) CH

(86) CH

(87) CH

(88) CH

(89) CH

(81) II. BZ, MA III. AL, AM, AZ, BA, CH, EM, GE, KG, LI, MC, MD, ME, MK, MN, NO, OM, SG, TN,
TR, UA

(72) Fabrice DUPORT

Avenue de la Gare 4, 2000 Neuchâtel, Suisse

(54) 1.-2. Dials with hands

(55)

(51) 10-07

(45) 2017/25 (2017 06 30)

1



2



(11) DM/094088**(51) 10-02, 07**

(15) 2016 12 28

(45) 2017/25 (2017 06 30)

(22) 2016 12 28

(28) 4

(73) MONTRES JAQUET DROZ SA (MONTRES JAQUET DROZ AG) (MONTRES JAQUET DROZ LTD.)
Allée du Tourbillon 2, CH-2300 La Chaux-de-Fonds (CH)

(85) CH

(86) CH

(87) CH

(88) CH

(89) CH

(81) II. BZ, MA III. AL, AM, AZ, BA, CH, EM, GE, KG, LI, MC, MD, ME, MK, MN, NO, OM, SG, TN,
TR, UA

(72) Christian LATTMANN

Chemin de Château-Neuf 17, 1125 Monnaz, Suisse;

Yann LEIGGENER

Avenue Léopold-Robert 11, 2300 La Chaux-de-Fonds, Suisse

(54) 1. Dial; 2. Watch; 3.-4. Dials

(55)

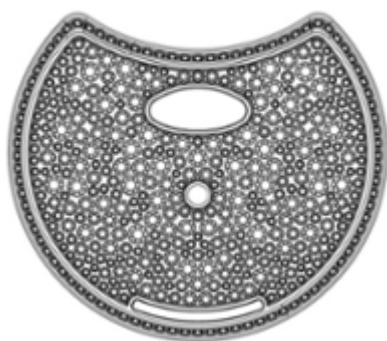
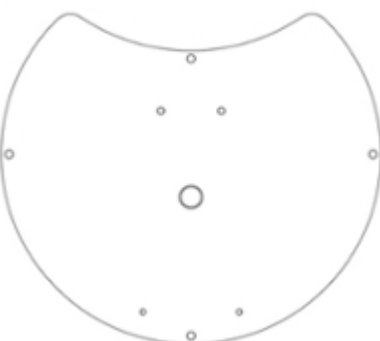
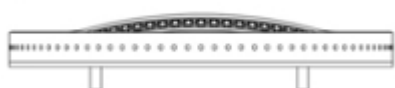
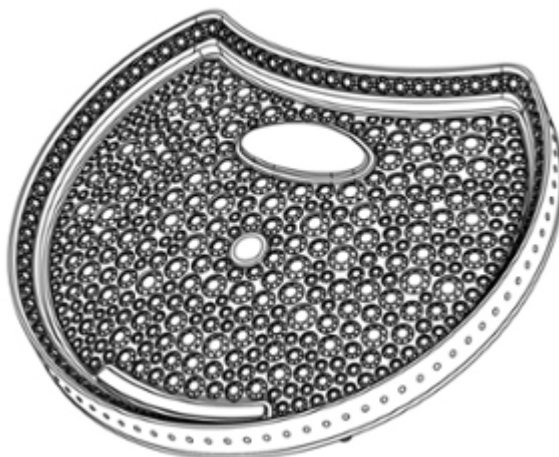
1.1**1.2****1.3****1.4****1.5****1.6****2.1****1.7**

2.2

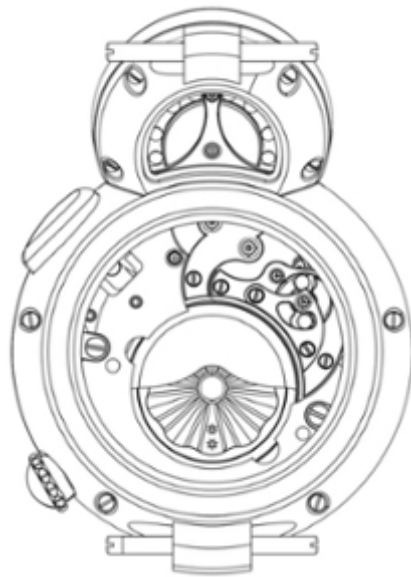

2.3

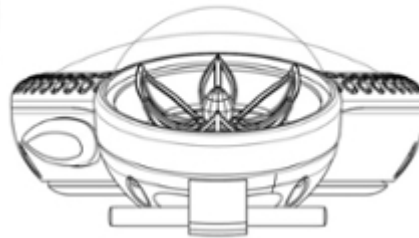

2.5

2.6

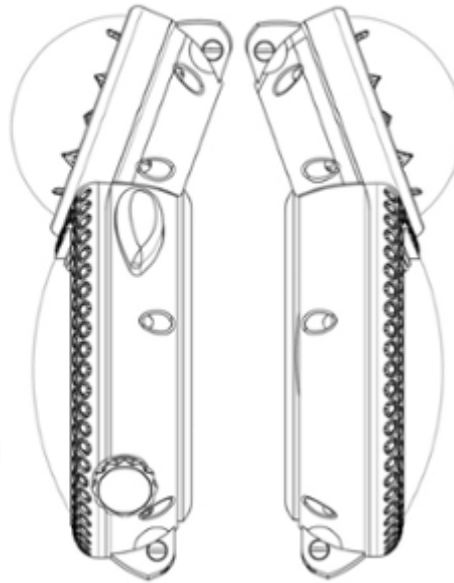

2.4

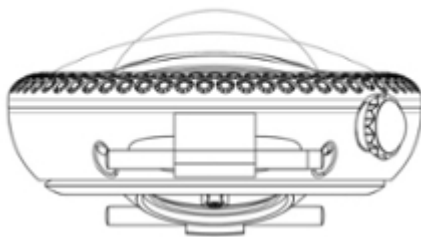

2.7

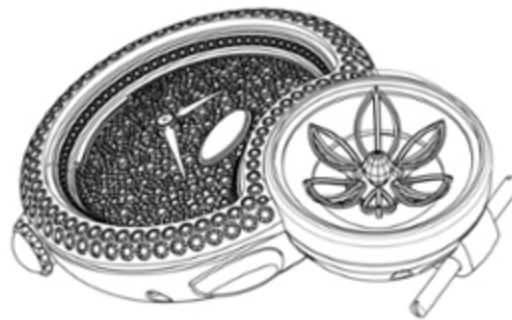

3.1



3.2



4.1



4.2



(11) DM/094093

(51) 20-02

(15) 2016 12 28

(45) 2017/25 (2017 06 30)

(22) 2016 12 28

(28) 4

(73) ETA SA MANUFACTURE HORLOGÈRE SUISSE

Schild-Rust-Strasse 17, CH-2540 Grenchen (CH)

(85) CH

(86) CH

(87) CH

(88) CH

(89) CH

(81) II. MA III. AL, AM, AZ, BA, CH, EM, GE, LI, MC, MD, ME, MK, NO, OM, SG, TN, TR, UA

(72) Roman Curau

Schwalbenweg 4, 3012 Bern, Suisse

(54) 1. Display unit with storage elements; 2. Display unit without storage elements;

3.-4. Storage elements for display unit

(55)

1.1



1.2



2.1

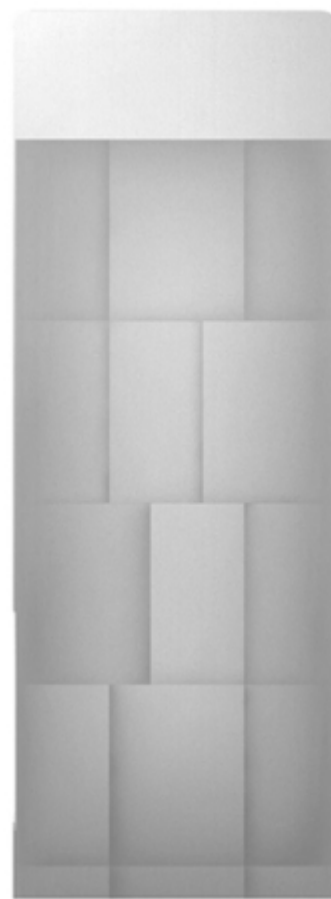

2.2

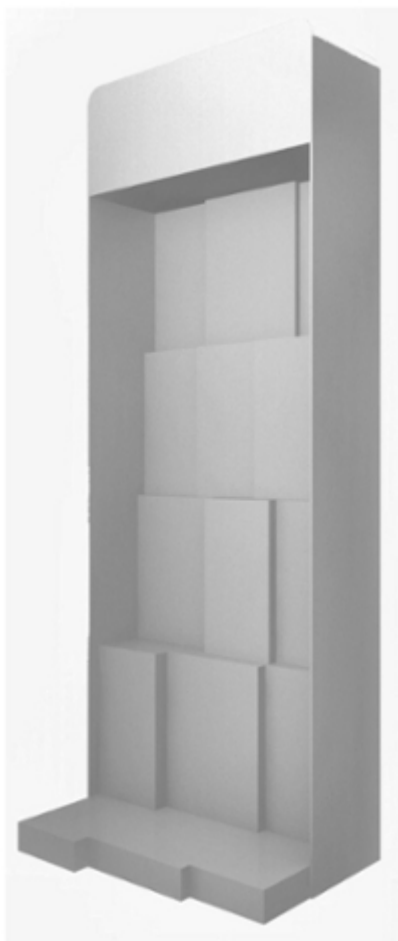

3.1



3.2



4.1



4.2



(11) DM/094101

(51) 10-07

(15) 2016 12 29

(45) 2017/25 (2017 06 30)

(22) 2016 12 29

(28) 2

(73) OMEGA SA (OMEGA AG) (OMEGA LTD.)

Jakob-Stämpfli-Strasse 96, CH-2502 Biel/Bienne (CH)

(85) CH

(86) CH

(87) CH

(88) CH

(89) CH

(81) II. BZ, MA III. AL, AM, AZ, BA, CH, EM, GE, KG, LI, MC, MD, ME, MK, MN, NO, OM, SG, TN, TR, UA

(72) Jean-Claude Monachon

Rue Alice-de-Chambrier 1, 2022 Bevaix, Suisse

(54) 1. Watch case; 2. Dial

(55)

1.1

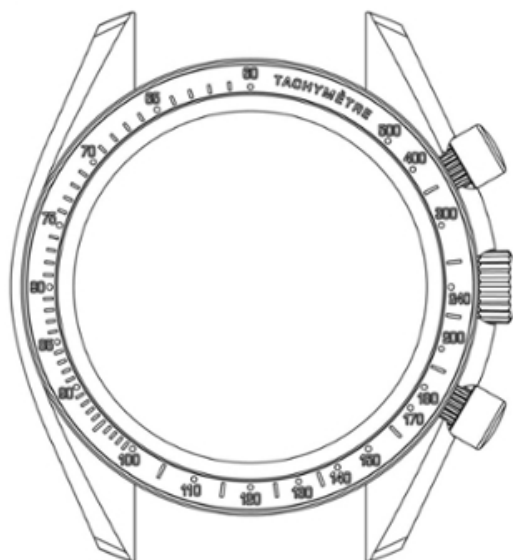

1.2

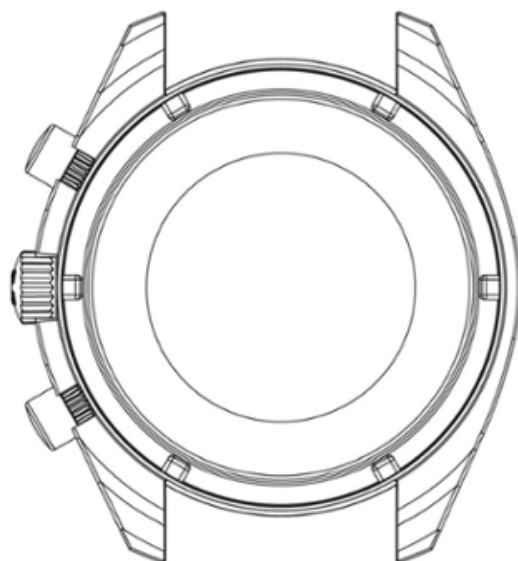

1.3

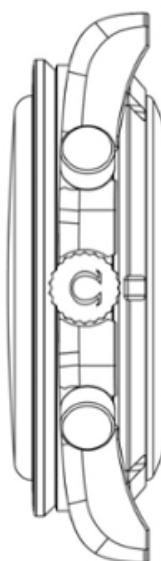

1.4

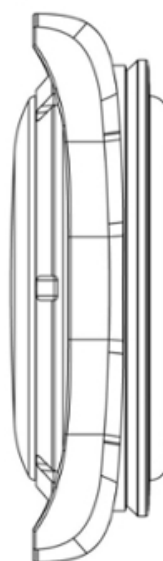

1.5



1.6

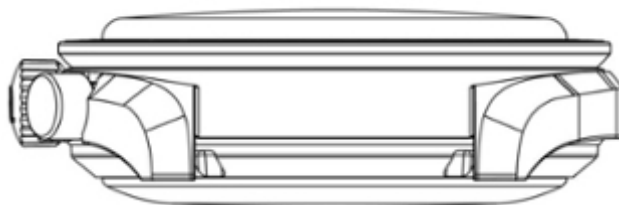

1.7

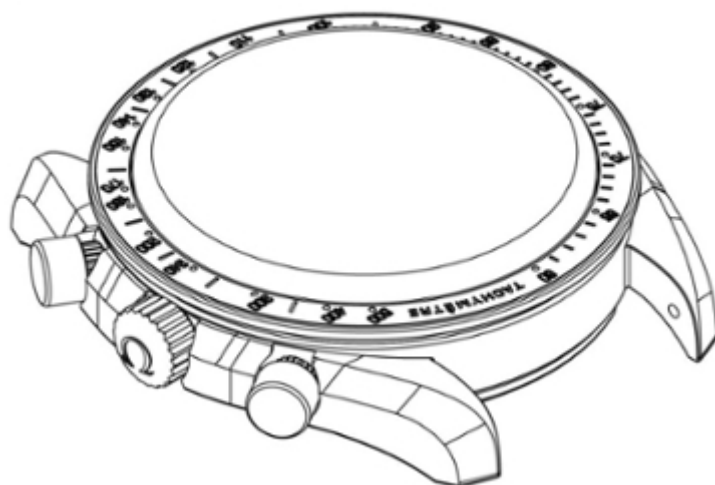

1.8

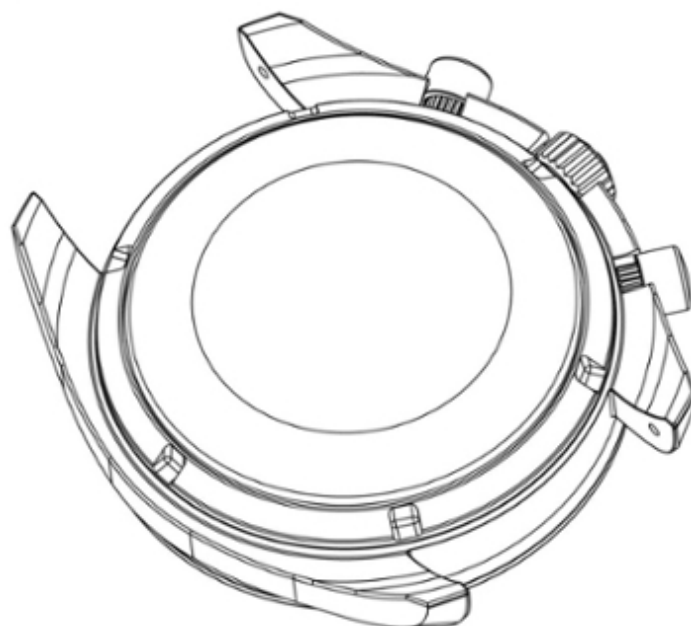

2.1

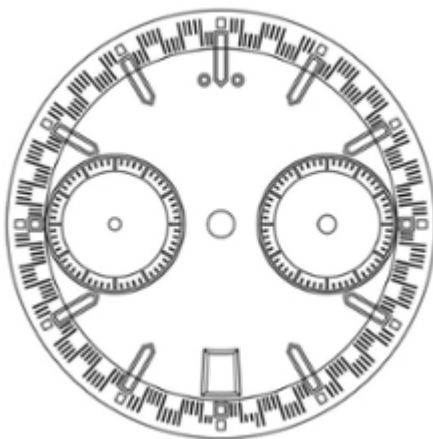

2.2

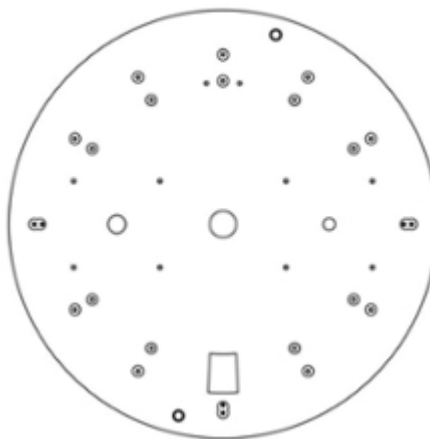

2.3



2.4



2.5



2.6



2.7

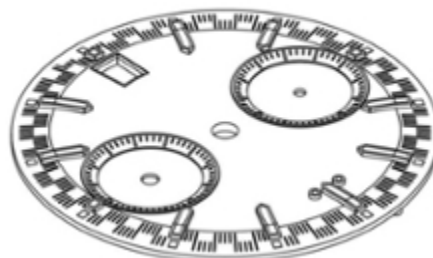

2.8

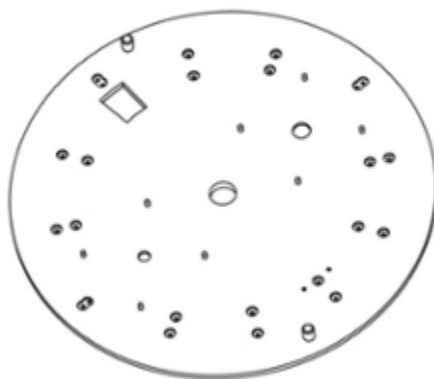

(11) DM/096527

(15) 2017 05 12

(22) 2017 05 12

(28) 1

(30) No. 1: 14.11.2016; 003463090-0002; EM

(73) PRO-AQUA INTERNATIONAL GMBH

Technologiepark 1, 91522 Ansbach (DE)

(85) –

(86) DE, EM

(87) –

(88) –

(89) EM

(81) III. AL, AM, AZ, BA, CH, EG, GE, HR, IS, KG, LI, MC, MD, ME, MK, MN, NO, OM, RS, SG, TJ, TN, TR, UA

(72) Jürgen Wehner

Technologiepark 1, 91522 Ansbach, Germany;

Christoph Böhler

Benno-Strauss-Str. 5, 90763 Fürth, Germany

(54) 1. Air freshening apparatus

(55)

(51) 23-04
(45) 2017/25 (2017 06 30)

1.1



1.2

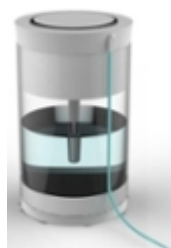

TRADEMARKS

APPLICATIONS FILED UNDER THE NATIONAL PROCEDURE APPROVED FOR REGISTRATION

The decision can be appealed at the Chamber of Appeal of Sakpatenti within 3 months from the publication or at the Mtskheta District Court Administrative Cases Board (Address: №17, Samkhedro St., Mtskheta), within 1 month following the publication.

(260) AM 2017 87631 A
(210) AM 87631
(220) 2016 06 20
(731) LTD "KATEVE HOBBY"
S. Tsintsadzis q. 12, sart. 3, arasatskhov-
rebeli parti 3-6, 0160, Tbilisi, Georgia
(740) Teona Utiashvili
(540)

კოკოლადი
Kokoladi

(511) 30

(260) AM 2017 87632 A
(210) AM 87632
(220) 2016 06 20
(731) LTD "KATEVE HOBBY"
S. Tsintsadzis q. 12, sart. 3, arasatskhov-
rebeli parti 3-6, 0160, Tbilisi, Georgia
(740) Teona Utiashvili
(540)

ქოქოლადი
Cocoladi

(511) 30

(260) AM 2017 87633 A
(210) AM 87633
(220) 2016 06 20
(731) LTD "KATEVE HOBBY"
S. Tsintsadzis q. 12, sart. 3, arasatskhov-
rebeli parti 3-6, 0160, Tbilisi, Georgia
(740) Teona Utiashvili
(540)

სარნალადი
Sarnaladi

(511) 30

(260) AM 2017 88283 A
(210) AM 88283
(220) 2016 08 15

(731) LTD "ZHORZHOLIANI TRADING"
Nutsbidzis IV m/r, korp. 17, Saburtalos
raioni, Tbilisi, Georgia

(540)



(591) Red, blue
(531) 02.09.01, 28.19, 29.01.12
(511) 29, 30, 35, 43

(260) AM 2017 89901 A
(210) AM 89901
(220) 2016 12 12
(731) LTD "ENVOY HOSTEL AND TOURS"
Betlemis q. 45, 0105, Tbilisi, Georgia
(740) Larisa Lobova
(540)



(591) White, yellow and orange
(531) 01.15.09, 06.01.02, 26.01.20, 29.01.12
(511) 39, 43

(260) AM 2017 89996 A
(210) AM 89996
(220) 2016 12 15
(731) CJSC "DOMINANTA-SERVICE"
Ul. Komsomolskaya dom 1, Podolsk,
Moskovskaya Oblast, 142100, Russian
Federation
(740) Nino Bakhtadze
(540)

ACHROMIN АХРОМИН

(511) 35

(260) AM 2017 90060 A
 (210) AM 90060
 (220) 2016 12 23
 (731) N(N)LE Political Union of Citizens
 "United National Movement"
 Kakhetis gzat. 45a, 0198, Tbilisi, Georgia
 (540)



(591) Red, white, blue and grey color combination
 (531) 01.01.05, 01.11.08, 24.07.23, 24.13.01, 28.19,
 29.01.13
 (526) The trademark is protected as a whole. "სა-
 ქართველოს დროშა" shall not be subject to inde-
 pendent legal protection.
 (511) 35

(260) AM 2017 90096 A
 (210) AM 90096
 (220) 2016 12 23
 (731) INDEVCO LIMITED
 Akara Bldg., 24 De Castro Street, Wickhams
 Cay 1, Road Town, Tortola, British Virgin
 Islands
 (740) Giorgi Taktakishvili
 (540)

Sanita BAMBI

(591) White, grey, black
 (531) 27.05.01, 27.05.02
 (511) 5, 16

(260) AM 2017 90098 A
 (210) AM 90098
 (220) 2016 12 23
 (731) INDEVCO LIMITED
 Akara Bldg., 24 De Castro Street, Wickhams
 Cay 1, Road Town, Tortola, British Virgin
 Islands
 (740) Giorgi Taktakishvili
 (540)

Sanita Fam

(591) Black, white
 (531) 27.05.01
 (511) 5

(260) AM 2017 90102 A
 (210) AM 90102
 (220) 2016 12 23
 (731) INDEVCO LIMITED
 Akara Bldg., 24 De Castro Street, Wickhams
 Cay 1, Road Town, Tortola, British Virgin
 Islands
 (740) Giorgi Taktakishvili
 (540)

Sanita

(591) Black, white
 (531) 27.05.07
 (511) 5, 6, 16, 35

(260) AM 2017 90103 A
 (210) AM 90103
 (220) 2016 12 23
 (731) INDEVCO LIMITED
 Akara Bldg., 24 De Castro Street, Wickhams
 Cay 1, Road Town, Tortola, British Virgin
 Islands
 (740) Giorgi Taktakishvili
 (540)

Sanita
 Charm

(591) White, grey, black
 (531) 27.05.01
 (511) 16

(260) AM 2017 90106 A
 (210) AM 90106
 (220) 2016 12 23
 (731) INDEVCO LIMITED
 Akara Bldg., 24 De Castro Street, Wickhams
 Cay 1, Road Town, Tortola, British Virgin
 Islands
 (740) Giorgi Taktakishvili
 (540)

Sanita
 MyBaby

(591) White, grey, black
 (531) 27.05.01, 27.05.02
 (511) 5

(260) AM 2017 90107 A
 (210) AM 90107
 (220) 2016 12 23

(731) INDEVCO LIMITED
Akara Bldg., 24 De Castro Street, Wickhams
Cay 1, Road Town, Tortola, British Virgin
Islands

(740) Giorgi Taktakishvili
(540)

Sanita Elegance

(591) Black, white
(531) 27.05.01
(511) 5

(260) AM 2017 90143 A
(210) AM 90143
(220) 2016 12 27
(731) LTD "HERMES"
Dighmis plato, Didgoris quchis mimdebared,
Tbilisi, Georgia
(740) Mikheil Dzagania
(540)



(591) Black, white
(531) 26.03.04, 26.03.18, 27.05.22, 28.19
(511) 45

(260) AM 2017 90389 A
(210) AM 90389
(220) 2017 01 11
(731) JSC "GEPHA"
Sanapiros q. 6, Tbilisi, Georgia
(740) Salome Jeladze
(540)

GEPHA
გეფა

(511) 35, 44

(260) AM 2017 90400 A
(210) AM 90400
(220) 2017 01 11
(731) LTD "F B D"
Agladzis q. 37a, b. 21, 0119, Tbilisi, Georgia
(740) Irakli Gogiberidze
(540)



(591) Black, white
(531) 02.01.11, 05.07.02, 08.01.03, 25.01.05
(511) 30, 43

(260) AM 2017 90412 A
(210) AM 90412
(220) 2017 01 12
(731) Private JSC "Kyiv Cardboard and Paper Mill "
Ul. Kievskaya 130, Obukhovo, Kievskaya
Oblast, 08700, Ukraina
(740) Shalva Gvaramadze
(540)



(554) Three-dimensional
(591) White, red, grey, different tone sky-blue
and blue
(531) 20.05.25, 26.01.18, 28.05, 29.01.13
(511) 16

(260) AM 2017 90414 A
(210) AM 90414
(220) 2017 01 12
(731) LTD "GEOLINE"
Tamarashvilis q. 13, b. 19, 0177, Tbilisi,
Georgia
(540)



(591) Crimson, yellow, green, sky-blue,
black and white
(531) 03.01.14, 08.01.23, 27.05.02, 29.01.15
(511) 35

(260) AM 2017 90415 A
(210) AM 90415
(220) 2017 01 12
(731) JSC "Georgian Greenhouse Corporation"
M. Kostavas q. 37/39, sart. 5, Tbilisi, Georgia
(740) Luka Mikelaishvili

(540)



(591) Yellow, green
 (531) 05.03.13, 27.05.04, 27.05.21, 29.01.12
 (511) 31

(260) AM 2017 90479 A
 (210) AM 90479
 (220) 2017 01 18
 (731) GRUMA, S.A.B. DE C.V.
 Rio de la Plata №407 Ote., Colonia de Valle,
 San Pedro Garcia Garza, C.P. 66220, N.L.,
 Mexico
 (740) Giorgi Meipariani
 (540)

MASECA

(511) 30

(260) AM 2017 90482 A
 (210) AM 90482
 (220) 2017 01 18
 (731) Shalva Khargelia
 Isakadzis q. 12b, b.44, Tbilisi, Georgia
 (740) Aleksandre Kvernadze
 (540)

შურ დო გურ
SHUR DO GUR

(511) 29, 33

(260) AM 2017 90488 A
 (210) AM 90488
 (220) 2017 01 18
 (731) LTD "CALIBRE"
 Shavi Zghvis q. 20, 0144, Tbilisi, Georgia
 (740) Gocha Archvadze
 (540)

GLOCK

(591) Black, white
 (531) 27.05.17
 (511) 13

(260) AM 2017 90494 A
 (210) AM 90494
 (220) 2017 01 18
 (731) PHILIP MORRIS PRODUCTS S.A.
 Quai Jeanrenaud 3, 2000 Neuchâtel,
 Switzerland
 (740) Shalva Gvaramadze
 (540)

POWER LINE

(511) 34

(260) AM 2017 90504 A
 (210) AM 90504
 (220) 2017 01 18
 (731) WOLVERINE OUTDOORS, INC.
 (a Michigan corporation)
 9341 Courtland Drive NE Rockford,
 Michigan 49351, USA
 (740) Vakhtang Torotadze
 (540)

MERRELL

(511) 25

(260) AM 2017 90546 A
 (210) AM 90546
 (220) 2017 01 20
 (731) LTD "ASPHARMA GEORGIA
 Pharmaceutacall Company"
 Mtskhethis q. 8, 0179, Tbilisi, Georgia
 (740) Maia Samadashvili
 (540)

Locogen
Локоген
ლოკოგენი

(511) 5

(260) AM 2017 90553 A
 (210) AM 90553
 (220) 2017 01 20
 (731) JSC "GEPHA"
 Sanapiros q. 6, Dzveli Tbilisis raioni, Tbilisi,
 Georgia
 (740) Salome Jeladze
 (540)



(591) Turquoise
 (531) 01.01.02, 01.01.10, 26.03.23, 27.05.05,
 29.01.04
 (511) 35, 44

(260) AM 2017 90642 A
 (210) AM 90642
 (220) 2017 01 31
 (731) BRITISH AMERICAN TOBACCO
 (BRANDS) INC. (a Delaware corporation)
 2711 Centerville Road, Suite 300,
 Wilmington, Delaware 19808, USA

(740) Tamar Kochlamazashvili
 (540)



(591) Black, white
 (531) 25.01.01, 25.07.15, 25.07.21, 26.11.08,
 26.11.09
 (511) 34

(260) AM 2017 90645 A
 (210) AM 90645
 (220) 2017 01 31
 (731) FUENTE MARKETING LTD.
 Salt Mills Plaza, Unit 48c, Grace
 Bay Road, Providenciales, Turks and Caicos
 Islands
 (740) Giorgi Meipariani
 (540)

ARTURO FUENTE

(511) 34

(260) AM 2017 90646 A
 (210) AM 90646
 (220) 2017 01 31
 (731) FUENTE MARKETING LTD.
 Salt Mills Plaza, Unit 48c, Grace
 Bay Road, Providenciales, Turks and Caicos
 Islands
 (740) Giorgi Meipariani
 (540)

FUENTE FUENTE OPUS X

(511) 34

(260) AM 2017 90647 A
 (210) AM 90647
 (220) 2017 01 31

(731) FUENTE MARKETING LTD.
 Salt Mills Plaza, Unit 48c, Grace
 Bay Road, Providenciales, Turks and Caicos
 Islands

(740) Giorgi Meipariani
 (540)



(591) Black, white
 (531) 25.01.10, 27.05.02, 27.05.04, 27.05.22
 (511) 34

(260) AM 2017 90651 A
 (210) AM 90651
 (220) 2017 02 01
 (731) TOYOTA JIDOSHA KABUSHIKI KAISHA
 (also trading as Toyota Motor Corporation)
 1, Toyota-cho, Toyota-shi, Aichi-ken., Japan
 (740) Tamar Kochlamazashvili
 (540)

EXCALIBUR

(511) 12

(260) AM 2017 90664 A
 (210) AM 90664
 (220) 2017 02 01
 (731) ALTERA CORPORATION
 101 Innovation drive, San Jose, California
 95134, USA
 (740) Tamaz Shilakadze
 (540)

CYCLONE

(511) 9

(260) AM 2017 90675 A
 (210) AM 90675
 (220) 2017 02 02
 (731) LTD "GR Transit"
 Tamar Mepis gamz. 15, 0112, Tbilisi, Georgia
 (540)



(591) Red, grey
 (531) 26.11.07, 27.05.22, 27.05.23, 29.01.12
 (511) 39

(260) AM 2017 90677 A

(210) AM 90677

(220) 2017 02 02

(731) UNILEVER N.V.

Weena 455, 3013 AL Rotterdam,
Netherlands

(740) Shalva Gvaramadze

(540)

Фишка

(591) Black, white

(531) 28.05

(511) 30

REGISTERED TRADEMARK

(111) M 2017 28751 R

(151) 2017 07 23

(181) 2027 07 23

(260) AM 2017 87835 A

(220) 2016 07 07

(732) MEGA DISPOSABLES S.A.

148 Dekelias street, 13678 Aharnes,

Greece

(111) M 2017 28842 R

(151) 2017 08 30

(181) 2027 08 30

(260) AM 2017 87091 A

(220) 2016 04 21

(732) LTD "K M C WINES"

Dighmis mas. me-3 kv., korp. 31, b. 57, 0159,

Tbilisi, Georgia

(111) M 2017 28837 R

(151) 2017 08 30

(181) 2027 08 30

(260) AM 2016 86855 A

(220) 2016 04 01

(732) JSC "TBILINVEST"

S. Tsintsadzis q. 12, sart. 4, 0160, Tbilisi,

Georgia

(111) M 2017 28843 R

(151) 2017 08 30

(181) 2027 08 30

(260) AM 2017 87366 A

(220) 2016 05 24

(732) BANK PASARGAD

No.430, Mirdamad Boulevard, Teheran, Iran

(Islamic Republic of)

(111) M 2017 28838 R

(151) 2017 08 30

(181) 2027 08 30

(260) AM 2017 86928 A

(220) 2016 04 08

(732) Xiamen Golden Dragon Bus Co., Ltd.

No.69 Huli Street, Huli Industry Zone,

Xiamen 361000, Fujian, China

(111) M 2017 28844 R

(151) 2017 08 30

(181) 2027 08 30

(260) AM 2017 87444 A

(220) 2016 05 30

(732) KIAN BASPAR KARAN CO.

No.229, North Baghestan St., 2nd Phase

of Baharestan Industrial Town, 5th

Km of Karaj-Ghazvin Road, 3197935551

Karaj, Iran, (Islamic Republic of)

(111) M 2017 28839 R

(151) 2017 08 30

(181) 2027 08 30

(260) AM 2017 86966 A

(220) 2016 04 11

(732) LTD "AGROKONSORTSIUM TSEROVANI"

Sop. Tserovani, 3300, Mtskheta, Georgia

(111) M 2017 28845 R

(151) 2017 08 30

(181) 2027 08 30

(260) AM 2017 87445 A

(220) 2016 05 30

(732) KIAN BASPAR KARAN CO.

No.229, North Baghestan St., 2nd Phase

of Baharestan Industrial Town, 5th

Km of Karaj-Ghazvin Road, 3197935551

Karaj, Iran, (Islamic Republic of)

(111) M 2017 28840 R

(151) 2017 08 30

(181) 2027 08 30

(260) AM 2017 87068 A

(220) 2016 04 19

(732) KURARAY CO., LTD.

1621, Sakazu, Kurashiki City, Okayama

Prefecture, Japan

(111) M 2017 28846 R

(151) 2017 08 30

(181) 2027 08 30

(260) AM 2017 87628 A

(220) 2016 06 20

(732) Otar Natchkebia

Mitskevichis q. 28, Tbilisi, Georgia

(111) M 2017 28841 R

(151) 2017 08 30

(181) 2027 08 30

(260) AM 2016 87089 A

(220) 2016 04 21

(732) LTD "MADLOBA"

Ak. Beliashvilis q. 55, 0159, Tbilisi,

Georgia

(111) M 2017 28847 R

(151) 2017 08 30

(181) 2027 08 30

(260) AM 2017 87696 A
 (220) 2016 06 24
 (732) CAMUS LA GRANDE MARQUE
 29, rue Marguerite de Navarre, 16100 Cognac,
 France

(111) M 2017 28848 R
 (151) 2017 08 30
 (181) 2027 08 30
 (260) AM 2017 87762 A
 (220) 2016 06 28
 (732) Tamar Tevdorashvili
 Varketilis me-4 mkr., me-2 rigi, me-6 korp.
 me-7 sad. b.143, 0182, Tbilisi, Georgia

(111) M 2017 28849 R
 (151) 2017 08 30
 (181) 2027 08 30
 (260) AM 2017 87819 A
 (220) 2016 07 05
 (732) TURKCELL İLETİŞİM HİZMETLERİ
 ANONİM ŞİRKETİ
 Aydınevler Mah.İnönü Cad. No:20
 Küçükyalı Ofispark MALTEPE İSTANBUL,
 Turkey

(111) M 2017 28850 R
 (151) 2017 08 30
 (181) 2027 08 30
 (260) AM 2017 87834 A
 (220) 2016 07 06
 (732) SOFBÉY Sárll
 rue de Graman 25, 1241 Puplinge (Geneva),
 Switzerland

(111) M 2017 28851 R
 (151) 2017 08 30
 (181) 2027 08 30
 (260) AM 2017 87885 A
 (220) 2016 07 08
 (732) LTD "ASB"
 F. Khalvashis gamz. 235, 6000, Batumi,
 Georgia

(111) M 2017 28852 R
 (151) 2017 08 30
 (181) 2027 08 30
 (260) AM 2017 87989 A
 (220) 2016 07 20
 (732) COLOMBINI S.P.A.
 Strada Ca Valentino, 124 ,47891 Falciano,
 San-Marino, Italy

(111) M 2017 28853 R
 (151) 2017 08 30
 (181) 2027 08 30
 (260) AM 2017 88125 A
 (220) 2016 08 01
 (732) BIOLOGISCHE HEILMITTEL HEEL GMBH
 Dr.-Reckeweg-Str. 2-4, 76532 Baden-Baden,
 Germany

(111) M 2017 28854 R
 (151) 2017 08 30
 (181) 2027 08 30
 (260) AM 2017 88163 A
 (220) 2016 08 03
 (732) LTD "GEORGIAN HOSPITALITY
 INVESTMENTS"
 Pekinis gamz., kvart. 1, korp. 6a, b. 25, 0171,
 Tbilisi, Georgia

(111) M 2017 28855 R
 (151) 2017 08 30
 (181) 2027 08 30
 (260) AM 2017 88187 A
 (220) 2016 08 08
 (732) MORRISON BOWMORE DISTILLERS
 LIMITED
 Springburn Bond, Carlisle Street, Glasgow
 G21 1EQ, United Kingdom

(111) M 2017 28856 R
 (151) 2017 08 30
 (181) 2027 08 30
 (260) AM 2017 88216 A
 (220) 2016 08 10
 (732) Irakli Shioshvili
 Al. Tchavtchavadzis q., II shesakhvevi 4, 0162,
 daba Tskneti, Tbilisi, Georgia

(111) M 2017 28857 R
 (151) 2017 08 30
 (181) 2027 08 30
 (260) AM 2017 88225 A
 (220) 2016 08 10
 (732) LTD "CORPORATION GEORGIAN WINE"
 S. Chikovanis q. 35, 0171, Tbilisi, Georgia

(111) M 2017 28858 R
 (151) 2017 08 30
 (181) 2027 08 30
 (260) AM 2017 88226 A
 (220) 2016 08 10
 (732) LTD "CORPORATION GEORGIAN WINE"
 S. Chikovanis q. 35, 0171, Tbilisi, Georgia

(111) M 2017 28859 R (151) 2017 08 30 (181) 2027 08 30 (260) AM 2017 88322 A (220) 2016 08 17 (732) CASTROL LIMITED Technology Centre, Whitchurch Hill, Pangbourne, Reading RG8 7QR, United Kingdom	(111) M 2017 28865 R (151) 2017 08 30 (181) 2027 08 30 (260) AM 2017 88503 A (220) 2016 09 07 (732) LTD "PARK GIDA" 5 ubani, q. 46a, 6200, Sop. Khutsubani, Kobuleti, Georgia
(111) M 2017 28860 R (151) 2017 08 30 (181) 2027 08 30 (260) AM 2017 88371 A (220) 2016 08 23 (732) INTERSUN HOLDING FZCO. P.O. Box 61051 Jebel Ali Free Zone, Dubai, United Arab Emirates	(111) M 2017 28866 R (151) 2017 08 30 (181) 2027 08 30 (260) AM 2017 88611 A (220) 2016 09 16 (732) JSC "T B C BANK" Marjanishvilis q. 7, 0102, Tbilisi, Georgia
(111) M 2017 28861 R (151) 2017 08 30 (181) 2027 08 30 (260) AM 2017 88406 A (220) 2016 08 25 (732) HIMALAYA GLOBAL HOLDINGS LTD. 106 Elizabethan Square, P.O. Box 1162, Grand Cayman, KY1-1102, Cayman Islands	(111) M 2017 28867 R (151) 2017 08 30 (181) 2027 08 30 (260) AM 2017 88647 A (220) 2016 09 20 (732) TURNER BROADCASTING SYSTEM, INC. a Georgia corporation One CNN Center, Atlanta GA 30303, USA
(111) M 2017 28862 R (151) 2017 08 30 (181) 2027 08 30 (260) AM 2017 88462 A (220) 2016 08 30 (732) LTD "BIO UNIVERSAL GEORGIA" Pekinis gamz. 31g, 0160, Tbilisi, Georgia	(111) M 2017 28868 R (151) 2017 08 30 (181) 2027 08 30 (260) AM 2017 88671 A (220) 2016 09 23 (732) BEVERAGE MARKETING USA, INC. (A New York, U.S.A. Corporation) 60 Crossways Park Drive West, Woodbury 11797 New York, USA
(111) M 2017 28863 R (151) 2017 08 30 (181) 2027 08 30 (260) AM 2017 88471 A (220) 2016 08 31 (732) BEAM SUNTORY UK LIMITED 2 Longwalk Road, Stockley Park, Uxbridge, Middlesex, England UB11 1BA, United Kingdom	(111) M 2017 28869 R (151) 2017 08 30 (181) 2027 08 30 (260) AM 2017 88681 A (220) 2016 09 26 (732) HEILAN HOME CLOTHING CO., LTD. (NO.8 HUAXIN ROAD), HUASHI TOWN INDUSTRIAL ZONE, JIANGYIN CITY, JIANGSU PROVINCE, PEOPLE'S REPUBLIC OF CHINA
(111) M 2017 28864 R (151) 2017 08 30 (181) 2027 08 30 (260) AM 2017 88486 A (220) 2016 09 05 (732) LTD "GVMT Group" Krtsanisis II gas., 11, Isani-Samgoris raioni, Tbilisi, Georgia	(111) M 2017 28870 R (151) 2017 08 30 (181) 2027 08 30 (260) AM 2017 88682 A (220) 2016 09 26 (732) HEILAN HOME CLOTHING CO., LTD. (NO.8 HUAXIN ROAD), HUASHI TOWN INDUSTRIAL ZONE, JIANGYIN CITY, JIANGSU PROVINCE, PEOPLE'S REPUBLIC OF CHINA

TRADEMARKS REGISTERED ACCORDING TO THE ACCELERATED PROCEDURE

The decision can be appealed at the Chamber of Appeal of Sakpatenti within 3 months from the publication.

(111) M 2017 28827 R
(151) 2017 08 16
(181) 2027 08 16
(210) AM 93564
(220) 2017 07 31
(732) Assan Gıda Sanayi ve Ticaret A.Ş.
Nispetiye Caddesi, Akmerkez Alışveriş
Merkezi B Blok Kat:5 Etiler Beşiktaş 34337
İstanbul,Türkiye
(740) Merab Kvimsadze
(540)



(591) Red, dark red, green, light green, white,
golden
(531) 05.03.14, 26.04.06, 26.04.24, 27.05.07,
27.05.08, 27.05.17, 27.05.25, 29.01.14
(511) 29

(111) M 2017 28828 R
(151) 2017 08 21
(181) 2027 08 21
(210) AM 93769
(220) 2017 08 16
(732) Giorgi Ghambashidze
Usovo-Tupikis Dasakhleba, sakhli 9, b. 33,
Moskovis Olqi, Russian Federation;
Shalva Liparteliani
I. Chavchavadzis gamz. 49b, b.111, 0179,
Tbilisi, Georgia
(740) Davit Dzamukashvili
(540)



(591) Black-white
(531) 21.03.01, 27.01.06, 27.03.15
(511) 41

(111) M 2017 28829 R
(151) 2017 08 21
(181) 2027 08 21

(210) AM 93770
(220) 2017 08 16
(732) Giorgi Ghambashidze
Usovo-Tupikis Dasakhleba, sakhli 9, b. 33,
Moskovis Olqi, Russian Federation;
Shalva Liparteliani
I. Chavchavadzis gamz. 49b, b.111, 0179,
Tbilisi, Georgia
(740) Davit Dzamukashvili
(540)



(591) Black-white
(531) 21.03.01, 27.01.12, 27.03.15, 28.05
(511) 41

(111) M 2017 28830 R
(151) 2017 08 21
(181) 2027 08 21
(210) AM 93771
(220) 2017 08 16
(732) Giorgi Ghambashidze
Usovo-Tupikis Dasakhleba, sakhli 9, b. 33,
Moskovis Olqi, Russian Federation;
Shalva Liparteliani
I. Chavchavadzis gamz. 49b, b.111, 0179,
Tbilisi, Georgia
(740) Davit Dzamukashvili
(540)



(591) Black-white
(531) 21.03.01; 27.01.12; 27.01.25; 27.03.15
(511) 41

(111) M 2017 28831 R
(151) 2017 08 21
(181) 2027 08 21
(210) AM 93772
(220) 2017 08 16
(732) Giorgi Ghambashidze
Usovo-Tupikis Dasakhleba, sakhli 9, b. 33,
Moskovis Olqi, Russian Federation;
Shalva Liparteliani
I. Chavchavadzis gamz. 49b, b.111, 0179,
Tbilisi, Georgia
(740) Davit Dzamukashvili,

(540)

ТрансЛотерея

(591) Black-white

(531) 21.03.01, 27.01.12, 28.05

(511) 41

(111) M 2017 28832 R

(151) 2017 08 22

(181) 2027 08 22

(210) AM 93436

(220) 2017 07 21

(732) LTD "SANTE GMT PRODUCTS"
Kakhetis Gzat., Me-10 km., 0182, Tbilisi,
Georgia

(740) Giorgi Bitsadze



(591) White, sky-blue and dark blue

(531) 03.04.02, 25.01.25, 26.01.02, 26.01.20,
26.11.13, 26.13.25, 28.19, 29.01.13

(511) 29

(111) M 2017 28833 R

(151) 2017 08 25

(181) 2027 08 25

(210) AM 93708

(220) 2017 08 09

(732) ACCOR
82 rue Henri Farman, 92130 Issy-les-
Moulineau, France

(740) Shalva Gvaramadze

(540)



(591) Dark blue (Pantone 2945C), light blue
(Pantone 2915C)

(531) 12.01.04, 26.04.01, 26.04.05, 26.04.06,
26.04.22, 27.05.24, 29.01.12

(511) 35, 43

(111) M 2017 28834 R

(151) 2017 08 25

(181) 2027 08 25

(210) AM 90880

(220) 2017 02 17

(732) Aleksandr Levakov
N. Kipshidzis q. 3b, b. 80, 0162, Tbilisi,
Georgia

(740) Shalva Gvaramadze

(540)

ВЕРХОВНЫЙ

(511) 33

(111) M 2017 28835 R

(151) 2017 08 25

(181) 2027 08 25

(210) AM 93431

(220) 2017 07 20

(732) LTD "NEWPHARM GEORGIA"
Digmis Mas., II kvart., korp. 17, b. 2,
0159, Tbilisi, Georgia

(540)



(591) White, blue and green

(531) 26.13.25, 27.05.10, 27.05.17, 27.05.23,
27.05.24, 29.01.13

(526) The trademark is protected as a whole.
"Georgia" shall not be subject to independent legal
protection.

(511) 5

(111) M 2017 28836 R

(151) 2017 08 30

(181) 2027 08 30

(210) AM 93837

(220) 2017 08 22

(732) Giorgi Mamuchishvili
Iveltis shesakhvevi 8, 0113, Tbilisi, Georgia

(540)

GLBPAY

(591) White, sky-blue, dark grey

(531) 01.05.02, 27.03.01, 27.03.15, 29.01.13

(511) 36

INTERNATIONAL TRADEMARKS FOR WHICH A DECISION ON GRANTING PROTECTIONS IS TAKEN

The decision can be appealed at the Chamber of Appeal of Sakpatenti within 3 months from the publication or at the Mtskheta District Court Administrative Cases Board (Address: №17, Samkhedro str., Mtskheta), within 1 month following the publication.

(260) AM 2017 84991 A*

(800) 1275094

(891) 2015 10 13

(731) HARIBO HOLDING GMBH & CO. KG

Hans-Riegel-Strasse 1, 53129 Bonn, Germany

(540)

MAOAM moves you

(511)

30 – Confectionery.

(260) AM 2017 86774 A

(800) 1293915

(891) 2016 01 18

(731) SALESFORCE. COM, INC.

The Landmark @ One Market Street, Suite

300, San Francisco, CA 94105, USA

(540)

SALESFORCE

(511)

9 – Downloadable software in the nature of a mobile application; computer application software for mobile phones and devices; computer software, namely, downloadable and non-downloadable software development tools for the creation of mobile internet applications, web applications, websites, and client interfaces; web site development software; computer software for use in customer relationship management (CRM); computer software for creating searchable databases of information and data; computer software, namely, an application allowing sales and field service employees to update and receive data stored in an enterprise's computer databases in real time, using a mobile device, with full telephony integration with the telephone and/or software features of the mobile device; computer software for providing an on-line database in the field of transaction processing to upload transactional data, provide statistical analysis, and produce notifications and reports; computer software that provides real-time, integrated business management intelligence by combining information from various databases and presenting it in an easy-to-understand user interface; downloadable software, mobile applications, and cloud computer software for providing data analytics, business analytics, business intelligence and for collecting and analyzing data; computer software for web and mobile applications for providing data analytics, business analytics, business intelligence and

for collecting and analyzing data; enterprise software in the nature of a database for compiling data, customer data and customer interactions for enabling marketers to plan, personalize, optimize and customize communications with customers throughout the marketing, sales, and service lifecycle; downloadable computer programs and computer software for retrieving, tracking, analyzing, testing, measuring and managing data, customer data and customer interactions; downloadable computer programs and computer software for retrieving, tracking, analyzing, testing, measuring and managing data, customer data and customer interactions in the field of marketing, sales and service; downloadable computer programs and computer software recorded on data media for retrieving, tracking, analyzing, testing, measuring and managing data from computer networks and from the Internet in the field of marketing, sales and service; computer application software for mobile phones, portable media players, handheld computers, namely, software for providing data analytics, business analytics, business intelligence and for collecting and analyzing data; downloadable computer software and computer software recorded on data media for the scanning, displaying, processing, measuring and output of data on computer networks, on the Internet, and on mobile terminals and devices in the field of marketing, sales, services, business analytics, data analytics, and business intelligence; downloadable software for generating embeddable code for websites, for the purpose of creating, customizing, deploying, scheduling, tracking, analyzing, testing, measuring and managing online content on users' websites, on social media websites, and other online forums; computer software for computer system and application development, deployment and management; scientific, surveying, photographic, cinematographic, optical, measuring, signaling, checking (supervision), and teaching apparatus and instruments; monitoring apparatus; apparatus for recording, transmission or reproduction of sound or images; magnetic data carriers, recording discs; calculating machines; computers and data-processing apparatus; computer memory devices; modems; facsimile machines; intercommunication apparatus; computer programs (recorded, downloadable); computer operating programs, recorded; games programs for computers; computer software (recorded, downloadable), in particular for the scanning, displaying, processing and output of multimedia data on computer net-

works, including the Internet, and on mobile terminals; machine-readable data carriers of all kinds containing information, and sound and image recording carriers (except unexposed film), data and information pools recorded on data carriers (downloadable); electronic publications (downloadable); interfaces for computers and mobile devices; downloadable music and image files; downloadable ring tones for mobile phones; electric installations for the remote control of industrial operations.

42 – Computer software development in the field of mobile applications; providing temporary use of on-line non-downloadable software development tools; technical consulting services in the field of data management, data analytics, and business intelligence analytics; technical data analytics services; software as a service (SAAS) services featuring software for providing data analytics, business analytics, business intelligence and for collecting and analyzing data; platform as a service (PaaS) software in the nature of a database for compiling data, customer data and customer interactions for enabling marketers to plan, personalize, optimize and customize communications with customers throughout the marketing, sales, and service lifecycle; platform as a service (PaaS) featuring computer software platforms for retrieving, tracking, analyzing, testing, measuring and managing data, customer data and customer interactions; platform as a service (PaaS) featuring computer software platforms for retrieving, tracking, analyzing, testing, measuring and managing data, customer data and customer interactions in the field of marketing, sales and service; platform as a service (PaaS) featuring computer software platforms for enabling marketers to plan, personalize, optimize, monitor, analyze and measure customer interactions across channels and devices; platform as a service (PaaS) featuring computer software platforms for enabling marketers to plan, personalize, optimize, monitor, analyze and measure customer interactions across social media, customer relationship management (CRM) systems, point-of-sale systems, web analytics, web posts, email and mobile devices; consulting services in the field of providing online, non-downloadable software and applications; providing temporary use of on-line non-downloadable software; online hosted computer services, namely, designing, developing, customizing, and maintaining computer software applications for others, and consulting services related thereto; technical research; information technology consulting services; installation of computer software; computer system design and analysis; data conversion of computer programs and data; maintenance of computer software; monitoring of computer systems by remote access; rental of computer software and web servers; scientific and technological services and research and design relating thereto; industrial analysis and research services; design and development of compu-

ter hardware and software; computer software consultancy; computer system design and analysis including for posting images, links, videos, text and other brand content, for retrieving, sorting, filtering and moderating user generated content and online communications, for managing brand content on social media websites and social networks, and for analyzing, retrieving and managing the performance of brand engagement; creating and maintaining web sites for others; data conversion of computer programs and data; maintenance of computer software; monitoring of computer systems by remote access; providing search engines for the internet; styling; technical research; web site design consultancy; consultancy in the design and development of computer hardware; digitization of documents; duplication of computer programs; information technology consulting services; installation of computer software; provision of downloadable software and/or providing temporary use of non-downloadable software for generating embeddable code for websites, for the purpose of creating, customizing, deploying, scheduling, tracking, analyzing and managing online content on users' websites, on social media websites and other online forums, and for analyzing, monitoring and managing the performance of brand engagement of others; provision of downloadable software and/or providing temporary use of non-downloadable software for creating and deploying customized interactive content on social profiles; packaging design / packaging design services; technical project studies; quality control; recovery of computer data; rental of web servers; research and development of new products for others; server hosting.

(260) AM 2017 86949 A

(800) 1294837

(891) 2015 12 01

(731) IMPERIAL SPA

Via Dei Lanaioli, 42, Blocco 11 Centergross,
I-40050 FUNO DI ARGELATO (BO), Italy

(540)



(591) Black, white

(511)

9 – Spectacles, spectacle frames; spectacle cases.

14 – Jewellery, precious stones; horological and chronometric instruments; rings [jewellery]; bracelets [jewellery]; watchstraps; pendants; necklaces; chronographs; timepieces; tie clips; earrings; wat-

ches; key rings [trinkets or fobs]; boxes of precious metal; tie pins; pins being jewelry; ornamental pins.

18 – Bags; clutch bags (hand bags); sling bags; beach bags; hand bags; trunks and travelling bags; travelling sets [leatherware]; bags for sports; holdalls; chain mesh bags; small bags for men; rucksacks; small rucksacks; hip bags; duffle bags; shopping bags; attaché cases; wallets; purses (not of precious metal); business card cases; credit card cases; luggage; suitcases; cosmetic cases sold empty; key cases.

25 – Clothing articles; suits; skirts; trousers; polo shirts; short-sleeved T-shirts; long-sleeved T-shirts; shirts; jackets; sweaters; pullovers; blousons; coats; overcoats; raincoats; furs (clothing); combinations (clothing); windcheaters; scarves; neckerchiefs; shawls; neckties; braces for clothing; gloves; stockings; socks; belts (clothing); swimming costumes; swimming trunks; beach dresses; bath robes; pyjamas; underwear; brassieres; tank tops; vest tops; underpants; hats; bonnets; berets; visors [headwear]; shoes; gymnastic shoes; boots; sandals; flip-flops [footwear]; slippers; clogs.

35 – Exhibitions for commercial or advertising purposes; retailing and wholesaling of a variety of goods for others (excluding the transport thereof), in the fashion, perfumery and cosmetics sectors, spectacles, jewellery, watches, leatherware, including bags, handbags, travelling bags, trunks, rucksacks, small rucksacks, briefcases, suitcases, key rings, clothing, footwear, hats, caps, through shops, department stores; websites for online shopping, mail order and/or catalogues; promotion of events in the fashion industries.

(260) AM 2017 87203 A

(800) 839198

(891) 2016 02 10

(731) CW World Class Global Limited

35, Theklas Lysiotti street, Eagle Star House,
6th floor, office 3030, Limassol, Cyprus

(540)

World Class

(591) Black, white

(511)

41 – Rental of tennis courts, physical education, recreation information, entertainment information, publication of books, handbooks, textbooks, text materials excluding advertising materials, club services, health club services; gymnastic instruction; rental of sports equipment, arranging of beauty contests, organization of competitions (education or entertainment), organization of sports competitions, organization of entertainment and recreation, television entertainment, radio entertainment, film production.

(260) AM 2017 87602 A

(800) 1128094

(891) 2016 01 15

(731) PRIVÉE AG KABUSHIKI KAISHA

(Privée AG CORPORATION)

10-1, Roppongi 6-chome, Minato-ku, Tokyo,
Japan

(540)

Hazuki

(591) Black, white

(511)

9 – Magnifying glasses; magnifying glasses that fit on the user's face in the manner of eyeglasses.

(260) AM 2017 87604 A

(800) 1287677

(891) 2016 02 09

(731) BODEGAS RIOJANAS, S.A.

Calle de la Estación, 1 al 21, E-26350
Cenicero (La Rioja), Spain

(540)

BODEGAS RIOJANAS GRUPO

(511)

35 – Advertising; business management; business administration; office functions; import-export agency; procurement services for others [purchasing goods and services for other businesses]; issue of franchises relating to assistance in running or managing commercial ventures; organization of exhibitions for commercial or advertising purposes; commercial representations and exclusive sales; presentation of goods on communication media for retail purposes; wholesale and retail sale in stores and/or via global computer networks of wines, alcoholic beverages, non-alcoholic beverages, perfumery, essential oils, cosmetics.

(260) AM 2017 87605 A

(800) 1298925

(891) 2015 12 11

(731) ÇİMSA ÇİMENTO SANAYİ VE TİCARET

ANONİM ŞİRKETİ

Toroslar M. Tekke, C. Yenitaşkent Beldesi,
MERSİN, Turkey

(540)



(591) black and navy

(511)

19 – Sand, gravel, crushed stone, asphalt, bitumen, cement, gypsum for use in construction, and road

construction, building materials (as finished products) made of concrete, gypsum, clay, potters' clay, natural or artificial stone, wood, plastics and synthetic materials for building, construction and road construction purposes, included in this class; non-metallic buildings, non-metallic building materials, non-metallic transportable buildings, poles not of metal for power lines, barriers not of metal, doors and windows of wood and synthetic materials, traffic signs not of metal, non-luminous and non-mechanical, for roads, monuments and statuettes of stone, concrete and marble, natural and synthetic surface coatings in the form of panels and sheets, being building materials; heat adhesive synthetic surface coating, being building materials; bitumen cardboard coatings for roofing; bitumen coating for roofing, prefabricated swimming pools not of metal (structures).

(260) AM 2017 87764 A

(800) 1113007

(891) 2016 03 03

(731) Товариство з обмеженою відповідальністю
виробничо-комерційна фірма "ELTA"
вул. Муzychна, 2, Запорізька 69083,
Ukraine

(540)

НОГОТОК

(591) black and white

(511)

3 – Cream for whitening the skin; bleaching preparations (laundry); bleaching preparations (decolorants) for cosmetic purposes; lacquer-removing preparations; cosmetics; cosmetic preparations for skin care; cosmetic creams; lavender oil; oils for cosmetic purposes; oils for toilet purposes; nail care preparations; windscreen cleaning liquids; shampoos; shampoos for pets; cleaning preparations; scouring solutions.

(260) AM 2017 87837 A

(800) 1300461

(891) 2016 02 05

(731) KULDEEP Kumar

52 Brodivska street, Kyiv 03026, Ukraine

(540)

VIAAN MOBILES

(591) Black, white

(511)

9 – Scientific, nautical, surveying, photographic, cinematographic, optical, weighing, measuring, signalling, checking (supervision), life-saving and teaching apparatus and instruments; apparatus and instruments for conducting, switching, transforming,

accumulating, regulating or controlling electricity; apparatus for recording, transmission or reproduction of sound or images; magnetic data carriers, recording discs; compact discs, DVDs and other digital recording media; mechanisms for coin-operated apparatus; cash registers, calculating machines, data processing equipment, computers; computer software; cordless telephones; video telephones; hands-free kits for telephones; electronic pocket translators; computer hardware; computer game software; computer programs [downloadable software]; computer programs, recorded; computer operating programs, recorded; laptop computers; portable media players; cell phones; notebook computers; tablet computers; record players; compact disc players; DVD players; computer software, recorded; cell phone straps; downloadable ring tones for mobile phones; bags adapted for laptops; television apparatus; telephone apparatus; smartphones; sleeves for laptops; sleeves for tablet computers; covers for cell phones.

(260) AM 2017 88142 A

(800) 1222552

(891) 2016 04 13

(731) TNG EUROPE LIMITED

87B Queens Road Leicester, Leicestershire
LE2 1TT, United Kingdom

(540)

CABINZERO

(511)

18 – Luggage; backpacks; travelling bags; suitcases; luggage tags of leather; school bags; leisure bags; luggage label holders.

(260) AM 2017 88148 A

(800) 1303762

(891) 2016 03 14

(731) SLOBOZHANSKY SOAP-BOILER LTD.

вул. Сумський Шлях, 53, с. Подвір'я
Дергачівський р-н, Харківська обл. 62371,
Ukraine

(540)



(591) Red, white, yellow and blue

(511)

3 – Laundry bleaching preparations; laundry soaking preparations; preparations and substances for laundry use; preparations and substances for bleaching purposes; capsules for washing laundry; laundry additives; cakes of soap; detergents other than for

use in manufacturing operations and for medical purposes; soap; dishwashing detergents; detergents for baths and toilet; fabric softeners for laundry use; refurbishing preparations; pastes for laundry use; hands-washing pastes; hand cleaning pastes; washing powder; laundry blueing; laundry glaze; laundry preparations; detergents for household use; cleaning preparations; liquid soap; dry shampoos; laundry tablets; shampoos; shampoos for cleaning of automobiles; hair shampoos and conditioners.

(260) AM 2017 88151 A
 (800) 1303865
 (891) 2016 05 02
 (731) ZINO DAVIDOFF SA
 Rue Faucigny 5, CH-1700 Fribourg,
 Switzerland

(540)

DAVIDOFF HORIZON

(511)
 3 – Bleaching preparations and other substances for laundry use; cleaning, polishing, degreasing and abrasive preparations; soaps; perfumery, essential oils, cosmetics, hair lotions; dentifrices; scented water; liquid perfume, namely eau fraîche; eau de Cologne; toilet water; eau de parfum; perfume; toiletries; shampoos; shower gels; bath gels; bath liquids for cosmetic use; shower liquids for cosmetic use; bath and shower foaming gels; bath and shower foaming liquids; bath salts; skin lotions for cosmetic use; hygiene products for body care; tanning sunscreen products; suntan creams; stimulating products for body care; body lotions for cosmetic use; body moisturizing concentrates; pre-shave cream; shaving soaps; shaving cream; shaving gels; after-shave products, in particular after-shave balms, after-shave cologne, after shave oils, after-shave creams, after-shave gels, after-shave powders, after-shave lotions; deodorant soaps; deodorant sprays for personal use; deodorant sticks for personal use; antiperspirants.

(260) AM 2017 88265 A
 (800) 1305151
 (891) 2016 06 01
 (731) APPLE INC.
 1 Infinite Loop, Cupertino CA 95014, USA

(540)

APPLECARE

(511)
 36 – Insurance and warranty services, namely, underwriting warranty and extended warranty contracts relating to the maintenance, repair, installation and updating of computer hardware, computer peripherals, computer networks and consumer electronic devices; Insurance and warranty services, namely, underwriting warranty and extended warranty con-

tracts relating to the maintenance, installation and updating of computer software; providing extended warranties on computer hardware, computer peripherals, computer networks, consumer electronic devices and computer software.

(260) AM 2017 88281 A
 (800) 1304887
 (891) 2016 03 25
 (731) Obshchestvo s ogranichennoy
 otvetstvennost'yu "EFKO Cosmetic"
 ul. Dorozhnaya, 2B, rabotchy poselok
 Khokholsky, RU-396840 Voronezhskaya obl.,
 Russian Federation

(540)



(591) White, yellow, green and light green

(554) Three-dimensional

(511)

3 – Soaps, including disinfectant soap, deodorant soap, shaving soap, soap for brightening textile, cakes of toilet soap, medicated soap, antiperspirant soap, soap for foot perspiration, almond soap.

35 – Advertising of soaps; sales promotion for others; retail and wholesale services for soaps.

(260) AM 2017 88444 A
 (800) 1306672
 (891) 2016 04 12
 (731) DFDS A/S
 Sundkrogsgade 11 DK-2100 København Ø,
 Denmark

(540)



(591) Black, white

(511)

36 – Customs brokerage; insurance; marine insurance underwriting; underwriting relating to transport insurance; travel insurance.

39 – Arrangement of transportation; packaging and storage of goods; storage; arranging of travel tours and cruises; travel booking agency services; ferry-boat operating; ferry-boat transport; transport brokerage; freighting; freight forwarding; stevedoring; freight and transport brokerage; shipbrokerage; parcel delivery; marina services; rescue, towing and salvage of vehicles; rental of storage containers; transportation information; storage information; boat rental; rental of ships; car rental; rental of parking places and garages for vehicles; rental of vehicle roof racks; rental of warehouses; planning, arranging and booking of travel by electronic means; providing information relating to travel and transport, via electronic means.

(260) AM 2017 88832 A
 (800) 1310930
 (891) 2016 02 25
 (731) "GLOBUS" LLC
 pomeshhenie II, korpus 1619, Moskva,
 RU-124365 Zelenograd, Russian Federation
 (540)

Schreiber

(591) black and white
 (511)
 16 – Fountain pens; aquarelles; albums; paper bows; note books; drawing pads; pads [stationery]; loose-leaf binders; paper sheets [stationery]; carbon paper; copying paper [stationery]; wrapping paper; signboards of paper or cardboard; modelling clay; terrestrial globes; drawing sets; engravings; pencil leads; document holders [stationery]; pencil holders; drawing boards; punches [office requisites]; pen clips; bookmarkers; drawing instruments; calendars; tracing paper; tracing patterns; pencils; pencil lead holders; pictures; transfers [decalcomanias]; paintings [pictures], framed or unframed; cardboard; catalogues; paintbrushes; glue for stationery or household purposes; drawing pins; boxes of cardboard or paper; correcting fluids [office requisites]; paper ribbons; gummed tape [stationery]; adhesive tapes for stationery or household purposes; correcting tapes [office requisites]; adhesive bands for stationery or household purposes; self-adhesive tapes for stationery or household purposes; drawing rulers; plastics for modelling; modelling materials; teaching materials [except apparatus]; adhesives [glues] for stationery or household purposes; pencil sharpening machines, electric or non-electric; writing chalk; writing cases [stationery]; printing sets, portable [office requisites]; stickers [stationery]; paper knives [cutters] [office requisites]; covers [stationery]; conical paper bags; folders for papers; pastels [crayons]; pen cases; bookends; stands for pens and pencils; writing cases [sets]; inkstands; office requisites, except fur-

niture; writing materials; writing instruments; drawing materials; school supplies [stationery]; rubber erasers; elastic bands for offices; marking pens [stationery]; paper clasps; document files [stationery]; paper-clips; staples for offices; stationery; pencil sharpeners, electric or non-electric; stencil plates; drawing squares; stapling presses [office requisites]; compasses for drawing; ink; labels, not of textile.

28 – Novelties for parties, dances [party favors, favours]; toy dolls; stuffed toys; plush toys; building games.

(260) AM 2017 88871 A
 (800) 1311343
 (891) 2016 05 18
 (731) SANTA FARMA İLAÇ SANAYİ ANONİM
 ŞİRKETİ
 Okmeydani, BoruÇiçeği Sk. No. 16 Kat:4
 Şişli, TR-34382 ISTANBUL, Turkey
 (540)

Secita

(511)
 5 – Pharmaceuticals.

(260) AM 2017 88878 A
 (800) 1311509
 (891) 2016 04 15
 (731) AVON PRODUCTS, INC.
 World Headquarters, 777 Third Avenue,
 New York NY 10017, USA
 (540)

mark.

(591) Black, white
 (511)
 3 – Non-medicated toilet preparations; toiletries; skin care preparations; skin moisturizers; body and beauty care preparations; powders, cleansers, creams and lotions, all for the face, hands and body; cosmetic suntan preparations; soaps; shower and bath preparations; beauty masks; talcum powder; nail polish; nail polish remover; enamel for nails; false nails; adhesives for cosmetic purposes; cosmetics; eye cream, eye gel, eye lotion, eye makeup remover, eye shadow, eye liner, mascara, lipstick, lip liner, lip gloss; make-up foundation; blusher; tissues impregnated with cosmetic lotions; cotton sticks for cosmetic purposes; cotton wool for cosmetic purposes; preparations for cleaning the teeth; shaving and aftershave preparations; perfumes, fragrances, toilet waters, cologne; deodorants for human beings; antiperspirants for personal use (toiletries); essential oils (cosmetic).

(260) AM 2017 88920 A
 (800) 1312942
 (891) 2016 07 26
 (731) Arysta LifeScience S.A.S.
 Route d'Artix, B.P. 80, F-64150 NOGUERES,
 France
 (540)

Panarex

(511)
 1 – Chemicals used in industry, science and photography, as well as in agriculture, horticulture and forestry; unprocessed artificial resins, unprocessed plastics; manures; fire extinguishing compositions; tempering and soldering preparations; chemical substances for preserving foodstuffs; tanning substances; adhesives used in industry; fertilizers; plant growth regulators; biostimulants; bionutrients; agricultural biologicals; chemicals for the manufacture of pharmaceuticals, agrochemicals and/or agricultural biologicals; chemicals for making mixtures for end-use applications in agriculture, horticulture, silviculture, turf and ornamental care, and/or home and garden.

5 – Pharmaceuticals, medical and veterinary preparations; sanitary preparations for medical purposes; dietetic food and substances adapted for medical or veterinary use, food for babies; dietary supplements for humans and animals; plasters, materials for dressings; material for stopping teeth, dental wax; disinfectants; preparations for destroying vermin; fungicides, herbicides; fumigants for use in agriculture, horticulture and home and garden; herbicides, fungicides, insecticides, pesticides, biologicals for biocontrol applications, and preparations for destroying vermin, each for use in agriculture, horticulture, silviculture, turf and ornamental care, and/or home and garden.

(260) AM 2017 88921 A
 (800) 1313031
 (891) 2016 05 16
 (731) Limited Liability Company "ASSOCIATION
 "SOYUZPICH SHEPROM"
 pos. Melkombinat-2, uchastok 1, d. 37,
 RU-454080 Chelyabinsk, Russian Federation
 (540)



(591) Light green, green, white
 (511)
 29 – Albumin milk; bouillon concentrates; colza oil for food; corn oil; edible oils; fruit chips; fruit-based snack food; lecithin for culinary purposes; linseed oil for culinary purposes; low-fat potato chips; milk shakes; potato chips; potato flakes; powdered milk; rice milk [milk substitute]; soups; soya beans, preserved, for food; soya milk [milk substitute]; sunflower oil for food; sunflower seeds, prepared; tofu; vegetable soup preparations.

30 – Baking powder; baozi [stuffed buns]; barley meal; batter mixes for okonomiyaki [Japanese savory pancakes]; bread; bread rolls; breadcrumbs; buns; burritos; cake dough; cakes; cereal bars; cereal-based snack food; cheeseburgers [sandwiches]; chips [cereal products]; chocolate beverages with milk; cocoa beverages with milk; coffee beverages with milk; cookies; corn flakes; corn flour; corn, milled; corn, roasted; couscous [semolina]; crackers; crushed barley; crushed oats; dough; edible paper; edible rice paper; ferments for pastes; flour; gimhap [korean rice dish]; gingerbread; gluten additives for culinary purposes; gluten prepared as foodstuff; groats for human food; halvah; high-protein cereal bars; hominy; hominy grits; husked barley; husked oats; jiaozi [stuffed dumplings]; linseed for human consumption; macaroni; macarons [pastry]; malt biscuits; malt extract for food; malt for human consumption; maltose; meat pies; meat tenderizers, for household purposes; molasses for food; muesli; natural sweeteners; noodle-based prepared meals; noodles; oat flakes; oat-based food; oatmeal; okonomiyaki [Japanese savory pancakes]; pancakes; pasta; pasta sauce; pastries; pastry dough; pelmeni [dumplings stuffed with meat]; petit-beurre biscuits; petits fours [cakes]; pies; pizzas; popcorn; potato flour; preparations for stiffening whipped cream; quiches; ramen [Japanese noodle-based dish]; ravioli; rice; rice cakes; rice pudding; rice pulp for culinary purposes; rice-based snack food; rusks; sago; sandwiches; sausage binding materials; semolina; soya flour; spaghetti; spring rolls; starch for food; tacos; tarts; thickening agents for cooking foodstuffs; tortillas; unleavened bread; vareniki [stuffed dumplings]; vermicelli [noodles]; waffles; wheat flour; wheat germ for human consumption; cereal preparations.

(260) AM 2017 89248 A
 (800) 211614
 (891) 2016 08 01
 (731) ENI SPA
 Piazzale Enrico Mattei, 1, I-00144 ROMA,
 Italy
 (540)

AGIP

(511)

1 – Solvents.

4 – Petroleum, liquid fuels in general and their derivatives, benzines, mineral oils and greases for combustion and lubrication in automotive engines, electric motors, marine motors and engines and the like.

(260) AM 2017 89267 A

(800) 1315435

(891) 2016 07 06

(731) NABOKA ANDRII MYKOLAYOVYCH
prov. Samokisha, 3, kv. 22, Kharkiv 61058,
Ukraine

(540)

BIODUR

(591) black and white

(511)

2 – Paints, varnishes, lacquers; preservatives against rust and against deterioration of wood; colorants; mordants; raw natural resins; metals in foil and powder form for use in painting, decorating, printing and art; asbestos paints; alizarine dyes; aluminium powder for painting; aluminium paints; aniline dyes; annatto (dyestuff); auramine; bactericidal paints; toner cartridges, filled, for printers and photocopiers; shoe dyes; ink for leather; wood stains; colorants for liqueurs; ink for skin-dressing; colorants for butter; colorants for beverages; colorants for beer; colouring wood; dyes; bitumen varnish; bronze powder for painting; lime wash; fireproof paints; litharge; primers; gamboge for painting; titanium dioxide (pigment); printers' pastes (ink); printing ink; engraving ink; dyewood extracts; enamel paints; enamels (varnishes); silver emulsions (pigments); thickeners for paints; undercoating for vehicle chassis; protective preparations for metals; indigo (colorant); gum resins; Canada balsam; colophony; caramel (food colorant); carbonyl (wood preservative); ceramic paints; agglutinants for paints; badigeon; copal; copal varnish; cochineal carmine; creosote for wood preservation; turmeric (colorant); black japan; bronzing lacquers; marking ink for animals; mastic (natural resin); metal foil for use in painting, decorating, printing and art; cobalt oxide (colorant); zinc oxide (pigment); oils for the preservation of wood; paper for dyeing Easter eggs; pigments; coatings (paints); wood coatings (paints); glazes (paints, lacquers); silvering powders; anti-fouling paints; anti-rust preparations; anti-rust greases; anti-rust oils; anti-corrosive preparations; anti-corrosive bands; wood preservatives; anti-tarnishing preparations for metals; mordants; mordants for leather; wood mordants; thinners for paints; thinners for lacquers; whitewash; soot (colorant); carbon black (pigment); lamp black (pigment); sandarac; white lead; minium; siccatives (drying agents) for paints; sienna earth; turpentine

(thinner for paints); malt caramel (food colorant); malt colorants; silver paste; sumac for varnishes; distempers; ink (toner) for photocopiers; coatings for roofing felt (paints); repositionable paint patches; fixatives (varnishes); fixatives for watercolors; yellowwood (colorant); food colorants; saffron (colorant); gum-lac.

(260) AM 2017 89353 A

(800) 1317459

(891) 2016 07 12

(731) LABORATOIRES EXPANSCIENCE

10 avenue de l'Arche F-92419 Courbevoie
Cedex, France

(540)



(591) Black, white

(511)

3 – Perfumery products for babies, alcohol-free baby toilet water, baby eau-de-cologne, body splash for babies; non-medicated products for baby skin care, namely shampoos, soaps and creams for the face, soap creams for the body; wipes, wipes for baby diaper changes, newborn shampoos, baby shampoos, cream rinse shampoo, washing gel for body and hair, lipid-enriched soaps, bubble bath for babies, toiletries for babies, bath products for babies, products for protection of babies, creams and milks for the face, creams and milks for the body, creams and milks for the breech, protective sticks for the skin, body creams, moisturizing creams, creams for baby diaper changes, creams and milks for sun protection, anti-mosquito milk, soap-free dermatological bars, soap-free washing gels, shower products.

(260) AM 2017 89354 A

(800) 1317502

(891) 2016 08 01

(731) Otkrytoye aktsionernoye obshchestvo
"EFIRNOE"

ul. Frunze 2, RU-309850 g. Alekseevka,
Belgorodskaya obl., Russian Federation

(540)



(591) White, black, yellow, light yellow, vinous, red, blue, green, light green, olive color, dark moss green color, carrot color and lettuce green color

(511)
30 – Mustard, spices, condiments, sauces including tomato sauce, pasta sauce, as well as mayonnaise, ketchup [sauce], dressings for salad.

35 – Sales promotion for others; retail and wholesale services for mustard, spices, condiments, sauces including tomato sauce, pasta sauce, as well as mayonnaise, ketchup [sauce], dressings for salad.

(260) AM 2017 89355 A

(800) 1317507

(891) 2016 08 04

(731) YEVHENII YEVHENIIIOVYCH KABAN
vul. 23 Serpnia, bud. 59, kv. 89, Kharkiv
61072, Ukraine

(540)

Footbik

(591) Black, white

(511)

41 – Academies [education]; educational services / instruction services / teaching; arranging and conducting of congresses; arranging and conducting of colloquiums; arranging and conducting of conferences; arranging and conducting of workshops [training]; arranging and conducting of seminars; arranging and conducting of symposiums; providing sports facilities, education information; organization of sports competitions; coaching [training]; personal trainer services [fitness training]; sport camp services; conducting fitness classes; rental of sports grounds; rental of sports equipment, except vehicles; rental of stadium facilities; physical education; timing of sports events.

(260) AM 2017 89357 A

(800) 1316650

(891) 2016 02 02

(731) SAPISELCO s.r.l.
Via Irpinia, 43, I-35020 Z.A. Saonara (PD),
Italy

(540)



(591) black and white

(511)

19 – Collars, not of metal, for use in building; non-metallic building materials, namely, spacers; moun-

ting bases, not of metal, for fixing; plates, not of metal, for fixing.

(260) AM 2017 89358 A

(800) 1316663

(891) 2016 03 23

(731) Chanel SARL

Burgstrasse 26, CH-8750 Glarus, Switzerland

(540)

LA PAUSA

(511)

3 – Preparations for skin, scalp, hair or nail care; cosmetic preparations for application on the skin, scalp, hair or nails; soaps; perfumery products; essential oils; cosmetics; toiletries for non-medical use; talcum powder; deodorants and antiperspirants; temporary tattoos for cosmetic use.

(260) AM 2017 89365 A

(800) 1316695

(891) 2016 05 07

(731) GUANGXI YUCHAI MACHINE GROUP
COMPANY LIMITED

West Side, Yuchai Road, Yuchai New City,
Yulin Guangxi, China

(540)



(591) black and white

(511)

7 – Agricultural machines; diesel engines other than for land vehicles; excavators; bulldozers; dynamos; generators of electricity; motors for boats.

12 – Fork lift trucks; cycle cars; electric vehicles; motors, electric, for land vehicles; motors for land vehicles; vans [vehicles].

35 – Advisory services for business management; business management consultancy; marketing research; import-export agencies; marketing; sales promotion for others; procurement services for others [purchasing goods and services for other businesses].

(260) AM 2017 89369 A

(800) 1316756

(891) 2016 08 23

(731) LABORATORIUM KOSMETYCZNE
FLOSLEK FURMANEK SP.J.

ul. Geodetów 154, PL-05-500 Piaseczno, Poland

(540)

FLOSLEK

(511)
3 – Cosmetics, protective and revitalising cosmetics for skin care, creams, emulsions, sprays, gels, balms, toner, lotions, cleansing milks; colouring cosmetics and beauty preparations; perfumery products; toiletries; soaps; ethereal oils; hair-care products; dentifrices.

(260) AM 2017 89373 A

(800) 1316771

(891) 2016 09 11

(731) APPLE INC.

1 Infinite Loop, Cupertino CA 95014, USA

(540)

MACOS

(591) black and white

(511)

9 – Computer operating software; computer software development tools.

(260) AM 2017 89382 A

(800) 1317531

(891) 2016 08 01

(731) E. REMY MARTIN & C° (Société par actions simplifiée)

20 rue de la Société Vinicole F-16100

COGNAC, France

(540)



(591) Gold and burgundy

(554) Three-dimensional

(511)

33 – Alcoholic beverages (except beers); Cognac AOC eau-de-vie; brandy; eaux-de-vie (brandy); rum; whisky; spirits; rice alcohol; vodka; gin; sake; tequila; aquavit; liqueurs; wines; kirsch; anisette [liqueur]; alcoholic extracts; alcoholic essences; aperitifs; digesters; cider and cocktails; alcoholic fruit extracts; baijiu (Chinese distilled alcoholic beverage).

(260) AM 2017 89390 A

(800) 1316810

(891) 2015 06 22

(731) THYSSENKRUPP AG

ThyssenKrupp Allee 1, 45143 Essen,
Germany

(540)

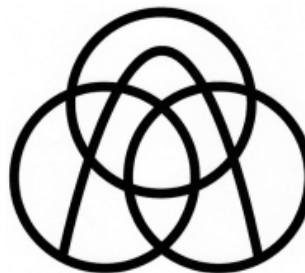

(591) black and white

(511)

1 – Chemicals used in industry; chemical preparations for facilitating the alloying of metals; chemical additives for use in the casting of metals; chemical additives for use in the moulding of metals; manures; foundry sand, foundry moulding preparations and binding substances; adhesives used in industry.

6 – Ores; common metals and their alloys and products made therefrom, included in this class, namely, unwrought and semi-wrought common metals and their alloys and products made therefrom, in particular rods, panels, bands, sheets and plates, in particular tailored blanks, pipes and fittings therefor, tinsplate and blackplate, sleepers, rails and other track parts for railbound vehicles, in particular side guide rails and glide strips for magnetic suspension trains, special profiles, bungs, planks and trench sheets, sheet piling, light sections, sheet pile crossbeams and fittings, flood sheet piling, box sheet piling, steel poles, staves, flat panel and shipbuilding profiles; flat products of stainless steel (corrosion-resistant, acid-resistant, heat-resistant), nickel-based materials, titanium and titanium alloys, grain-oriented or non-grain-oriented electrical and/or magnetic steel materials or sheets; work platforms, temporary bridges, and scaffolding and falsework and parts therefor, namely, formwork, props, beams, wires and ropes, and wire mesh and other wire products, sheet metal goods, weld filler materials, in particular soldering wire, welding rods, and cored wires, storage and transport containers, prefabricated and collapsible transportable buildings and parts therefor, in particular container offices and workshops, houses, halls, garages, bridges, windows, doors, gates, and roof, ceiling and wall construction elements, cast parts of metal, soldering materials, namely, soldering wire, rods of metal for brazing, goods of common metal not included in other classes, namely, containers, construction fittings, roof panels, facade panels, springs, windows, window sills, window frames, grilles, hooks, cramps, supports for propping up ships, runners, nails, profiles, space trusses, rings, loops, locks, screws, silos, pins, gate and door frames, gates and doors, supporting structures, staircases, door panels, door handles, screw-connection

parts, wall panels, brackets, fences and parts therefor, fittings for the aforesaid goods, included in this class, metal building materials, in particular prefabricated sandwich components consisting predominantly of sheet metal for the construction of industrial buildings, halls and homes, ironmongery, small items of metal hardware, pipes and tubes of metal; non-electric cables and wires of common metal, transportable buildings of metal, metal building materials, scaffolding, included in this class and concrete formwork elements and parts therefor of metal for concrete, rails and railway switches of metal, railway material of metal, fixtures of metal for guiding and gripping rail vehicles being parts for railway rails.

7 – Drives for machines; transmission shafts, other than for land vehicles; construction machines; mechanical apparatus and mechanical devices and equipment consisting thereof for manufacturing precursors or products for the medicines and food industry, chemical industry, manures industry, plastics industry and cosmetics industry, including fittings for the aforesaid equipment; mechanical synthetic gas producers, other than gas producers for motor vehicles; machines for the food industry, including fittings; installations consisting of machines for the chemical industry for steam reforming, including fittings; installations consisting of machines for the chemical industry for producing manures, including fittings; gas treatment machines, including fittings; compressors (machines); hydraulic or pneumohydraulic pressure transducers, hydraulic or pneumohydraulic pressure boosters; machines for the textile industry; fittings for engine boilers; lifts, included in this class, mechanical escalators and moving walkways, platform lifts, lifting platforms for people, passenger bridges, moving staircases, stair lifts; parts for lifts, escalators, moving walkways, platform lifts, lifting platforms for people, passenger bridges (machines), moving staircases, stair lifts, included in this class; fluidisers, namely, apparatus for fluidising bulk material using gas flows to promote flow properties, including fittings; generators for generating energy to drive machines; machines for producing energy; electric generators; industrial robots (machines); machines for processing metal, wood and plastics; machine tools; drilling machines and parts therefor; machines for positioning, aligning and holding components; machine-driven elevating apparatus and machines for lifting goods; machines for securing, obtaining, processing and breaking off mineral substances, soil, stone, excavated material, used materials, ores, scree and masonry; machines for loading bulk material and piece goods; machines for producing mortar and concrete, and prefabricated parts made therefrom; excavators; conveying machines; machines for handling molten metals; electric and laser welding apparatus; welding electrodes; flaming machines for flaming cold or warm metal materials,

metal work pieces or semi-finished metal products (like blocks, bars, coils or slabs); gas-operated cutting blow pipes; mixers (machines); mills (machines); presses (machines); pumps (machines), including fittings; electric beaters; motors and engines and parts therefor, other than for land vehicles; turbines and parts therefor, other than for land vehicles; gear boxes and parts therefor, other than for land vehicles; gate drives; tools (parts of machines); piston rods (parts of machines); bearings (parts of machines); centrifuges (machines); railroad constructing machines; drums (parts of machines); electric starter apparatus for motors and engines; electric cold-start systems for motors and engines; ship and aeroplane engines and parts therefor.

12 – Vehicles and apparatus for locomotion by land, air or water; parts for vehicles and apparatus for locomotion by land, air or water, included in this class; bodies of metal for vehicles and apparatus for locomotion by land, air or water; engines for land vehicles.

19 – Cast, pressed, drawn or machined mouldings, not of metal, for building, in particular plastic molding and resin transfer molding components made of polyamide (PA), polycarbonate (PC), polyaryletherketone (PAEK), polyetherimide (PEI), polyethyleneterephthalate (PETP), polyoxymethylene (POM), polyethylmethacrylate (PMMA), polypropylene (PP), polytetrafluoroethylene (PTFE), polyvinylchloride (PVC), polysulfone (PSU), polyvinylidene fluoride (PVDF) plastics.

40 – Treatment of materials, namely, prefabrication of workpieces, production of profiles, production of slit strips, cutting of sheets and plates of metal, boards or trapezoids, curing of materials and surface finishing, in particular by means of hot dip galvanising, hot dip aluminising, zinc plating or organic coating; custom manufacture of bodies for vehicles, chassis parts, components for vehicle undercarriages and components for vehicle drives, in particular internal combustion engines, for others; tool making in the form of custom manufacture, for others; waste, waste water and pollutant treatment, recycling of waste, waste water, scrap and trash; services provided by print shops, namely, printing; services provided by locksmiths (metal treating); services provided by carpenters (woodworking).

42 – Architecture; urban planning; structural engineering; mining engineering; chemistry services; engineering in the field of computer science; engineering; design of interior decor; media consultancy, namely, consultancy and technical research in the field of information technology; physics (research); software programming; stress analysis (construction planning); technical drawing; surveying, included in this class; research, construction of prototypes for research purposes and for technical product deve-

lopment, and research in the field of technology for ships; material testing; technical consultancy in the field of computing; installation and maintenance of computer software; rental of data processing installations and computers; technical analysis of IT infrastructures; technical design and technical planning of installations and apparatus for telecommunications; contaminated site management, namely, technical design of property decontamination projects; computer rental.

(260) AM 2017 89392 A

(800) 1316811

(891) 2016 05 05

(731) "ROMPHARM COMPANY" OOD

street "Boyan Damyanov" No.7, apartment
office 3, floor 1, District "Mladost", BG-1784
Sofia, Bulgaria

(540)

DIAFLEX ROMPHARM

ДИАФЛЕКС РОМФАРМ

(591) black and white

(511)

5 – Pharmaceutical and veterinary preparations; sanitary preparations for medical purposes; dietetic food and substances adapted for medical or veterinary use, food for babies; dietary supplements for humans and animals; plasters, materials for dressings; materials for stopping teeth, dental wax; disinfectants; vermin destroying preparations; fungicides, herbicides; abrasives (dental -); adhesive plaster, adhesives for dentures, adhesives (fly catching -), adhesive bands for medical purposes; acaricides; aconitine; albumin dietary supplements; alginates for pharmaceutical purposes, alginate dietary supplements; algicides; aldehydes for pharmaceutical purposes; alkaline iodides for pharmaceutical purposes; alkaloids for medical purposes; alcohol for pharmaceutical purposes; aluminium acetate for pharmaceutical purposes; amalgams (dental -); amino acids for veterinary purposes, amino acids for medical purposes; analgesics; anaesthetics; antibiotics; anticryptogamic preparations; antioxidant pills; antiparasitic collars for animals, antiparasitic preparations; anti-uric preparations; febrifuges; anti-rheumatism bracelets, anti-rheumatism rings; antiseptics, antiseptic cotton; anthelmintics; vermifuges; medicine cases [portable] [filled]; first-aid boxes [filled]; aseptic cotton; asthmatic tea; acetates for pharmaceutical purposes; almonds (milk of -) for pharmaceutical purposes; bacterial poisons, bacterial preparations for medical and veterinary use, bacteriological cultures (bouillons for -), bacteriological cultures (media for -); bacteriological preparations for medical and veterinary use; germicides; balms

for medical purposes, balsamic preparations for medical purposes; baths (oxygen -), baths (salts for mineral water -), bath (therapeutic preparations for the -); babies' diapers [napkins]; tobacco-free cigarettes for medical purposes; albuminous preparations for medical purposes, albuminous foodstuffs for medical purposes; herbs (medicinal -), herbal teas for medicinal purposes; bandages for dressings; biological preparations for veterinary purposes, biological preparations for medical purposes, biological tissue cultures for veterinary purposes, biological tissue cultures for medical purposes; biocides; bismuth subnitrate for pharmaceutical purposes; bismuth preparations for pharmaceutical purposes; cachou for pharmaceutical purposes; meal for pharmaceutical purposes; pregnancy (chemical preparations for the diagnosis of -); bromine for pharmaceutical purposes; bronchodilating preparations; bouillons for bacteriological cultures; vaginal washes; petroleum jelly for medical purposes; vaccines; lime (preparations of -) for pharmaceutical purposes; wadding for medical purposes; vesicants; veterinary preparations; cream of tartar for pharmaceutical purposes; vitamin preparations; dietary fiber; water (sea -) for medicinal bathing; mouthwashes for medical purposes; waters (mineral -) for medical purposes; hydrogen peroxide for medical purposes; noxious plants (preparations for destroying -); charcoal for pharmaceutical purposes; gases for medical purposes; gallic acid for pharmaceutical purposes; pants, absorbent, for incontinents; knickers (sanitary -), knickers (menstruation -), pants (sanitary -); guaiacol for pharmaceutical purposes; glycerine for medical purposes; glycerophosphates; glucose for medical purposes, glucose dietary supplements; bracelets for medical purposes; skin care (pharmaceutical preparations for -); rubber for dental purposes; gamboge for medical purposes; gurjun [gurjon, gurjan] balsam for medical purposes; dry rot fungus (preparations for destroying -); vulnerary sponges; menstruation bandages; deodorants for clothing and textiles; disinfectants, disinfectants for hygiene purposes, disinfectants for chemical toilets; fumigating pastilles, fumigating sticks; air deodorising preparations; deodorants, other than for human beings or for animals; detergents for medical purposes; diabetic bread adapted for medical use; diagnostic preparations for veterinary purposes, diagnostic preparations for medical purposes, diagnostic biomarker reagents for medical purposes, diastase for medical purposes; digestives for pharmaceutical purposes; digitalin; dietetic substances adapted for medical use, dietetic beverages adapted for medical purposes, dietetic foods adapted for medical purposes; animal feed supplements for veterinary purposes; yeast for pharmaceutical purposes; chewing gum for medical purposes; eucalyptus for pharmaceutical purposes; eucalyptol for pharmaceutical purposes; elixirs [pharmaceutical preparations]; electrodes (chemical conductors for

electrocardiograph -); electrocardiograph electrodes (chemical conductors for -); enzymes for veterinary purposes, enzymes for medical purposes, enzyme preparations for veterinary purposes, enzyme preparations for medical purposes, enzyme dietary supplements; esters for pharmaceutical purposes; ethers for pharmaceutical purposes; enzyme dietary supplements; gelatin(e) for medical purposes; mercurial ointments; animal washes; jujube [medicated]; sugar for medical purposes; dentures (adhesives for -); dental abrasives, dental amalgams; gold (dental amalgams of -); dental lacquer, dental impression materials, dental mastics; isotopes for medical purposes; foot perspiration (remedies for -); insecticides; infusions (medicinal -); Irish moss for medical purposes; iodine for pharmaceutical purposes, iodides for pharmaceutical purposes; tincture of iodine; iodoform; casein dietary supplements; capsules for medicines; collars for animals (antiparasitic -); mud (medicinal -), mud for baths; potassium salts for medical purposes; calomel; camphor for medical purposes; opodeldoc; camphor oil for medical purposes; cantharides (powder of -); cachets for pharmaceutical purposes; quassia for medical purposes; quebracho for medical purposes; cedar wood for use as an insect repellent; tartar for pharmaceutical purposes; acids for pharmaceutical purposes; oxygen for medical purposes, oxygen baths; cotton sticks for medical purposes; cocaine; collyrium; collodion for pharmaceutical purposes; compresses; contact lens cleaning preparations, contact lenses (solutions for use with -); contraceptives (chemical -); hooves (cement for animal -); fennel for medical purposes; dill oil for medical purposes; angostura bark for medical purposes; condurango bark for medical purposes; roots (medicinal -); barks for pharmaceutical purposes; bone cement for surgical and orthopaedic purposes; creosote for pharmaceutical purposes; croton bark; blood for medical purposes, blood plasma; styptic preparations; cultures of microorganisms for medical and veterinary use; curare; dogs (repellents for -); towels (sanitary -); lacquer (dental -); laxatives; lactose for pharmaceutical purposes; poultices; poultices (mustard -); larvae exterminating preparations; sticking plasters; medicines for veterinary purposes; corn remedies; constipation (medicines for alleviating -); medicines for dental purposes; medicines for human purposes; linseed meal for pharmaceutical purposes; linseed oil dietary supplements; linseed for pharmaceutical purposes; bands (adhesive -) for medical purposes; glue (fly -); lecithin for medical purposes, lecithin dietary supplements; medicinal tea, medicinal herbs; medicated animal feed; lint for medical purposes; moss (Irish -) for medical purposes; lozenges for pharmaceutical purposes; lotions (tissues impregnated with pharmaceutical -), lotions for veterinary purposes, dog lotions, lotions for pharmaceutical purposes; personal sexual lubricants; lupulin for pharmaceutical purposes;

magnesia for pharmaceutical purposes; greases for veterinary purposes, greases for medical purposes; callouses (preparations for -); malt for pharmaceutical purposes; mangrove bark for pharmaceutical purposes; gauze for dressings; liniments; oils (medicinal -), oil (cod liver -); teeth filling material; medicinal infusions; medicinal roots; medicinal oils; medicinal drinks; slimming purposes (medical preparations for -); medicinal hair growth preparations; medicinal alcohol; Melissa water for pharmaceutical purposes; mint for pharmaceutical purposes; menthol; frostbite salve for pharmaceutical purposes; sunburn ointments; ointments for pharmaceutical purposes; trace elements (preparations of -) for human and animal use; microorganisms (cultures of -) for medical and veterinary use, microorganisms (preparations of -) for medical and veterinary use, microorganisms (nutritive substances for -); mineral water for medical purposes, mineral water salts, mineral food-supplements; myrobalan bark for pharmaceutical purposes; mice (preparations for destroying -); milk sugar [lactose], milking grease, milk ferments for pharmaceutical purposes, lacteal flour [for babies]; moulding wax for dentists; wart pencils; headache pencils; mothproofing paper; ergot for pharmaceutical purposes; sea water for medicinal bathing; fly glue, fly catching adhesives; moleskin for medical purposes; malted milk beverages for medical purposes; drinks (medicinal -); narcotics, drugs for medical purposes; insect repellents; bicarbonate of soda for pharmaceutical purposes; sodium salts for medical purposes; candy for medical purposes; nervines; starch for dietetic or pharmaceutical purposes; clothing (deodorants for -) and textiles; lead water; opiates; opium; insemination (semen for artificial -); organotherapy preparations; decoctions for pharmaceutical purposes; by-products of the processing of cereals [for medical purposes]; rat poison, poisons; slimming tea for medical purposes; cooling sprays for medical purposes; evacuants; depuratives; eye-washes; cotton for medical purposes; parasiticides; pastilles (fumigating -), pastilles for pharmaceutical purposes; pectin for pharmaceutical purposes; diapers for pets; napkins for incontinents; pepsins for pharmaceutical purposes; peptones for pharmaceutical purposes; pearl powder for medical purposes; pesticides; pyrethrum powder; leeches for medical purposes; plasma (blood -); plasters (mustard -), plasters for medical purposes; mildew (chemical preparations to treat -); breast-nursing pads; bunion pads; panty liners [sanitary]; pomades for medical purposes; porcelain for dental prostheses; cleaning preparations (contact lens -); powder of cantharides; bandages (menstruation -), bandages (hygienic -); dressings (surgical -), dressings [medical]; eyepatches for medical purposes; bath preparations for medical purposes; acne treatment preparations; burns (preparations for the treatment of -); reducing sexual activity (preparations for -); teething

(preparations to facilitate -); opotherapy preparations; soil-sterilising preparations; chilblain preparations; noxious animals (preparations for destroying -); plants (preparations for destroying noxious -); slug exterminating preparations; fly destroying preparations; vermin destroying preparations; sunburn preparations for pharmaceutical purposes; aloe vera preparations for pharmaceutical purposes; hair growth preparations (medicinal -); belts for sanitary napkins [towels]; conductors (chemical -) for electrocardiograph electrodes; cattle washes; dog washes; propolis for pharmaceutical purposes; protein supplements for animals, protein dietary supplements; rings (anti-rheumatism -), corn rings for the feet; stick liquorice for pharmaceutical purposes; purgatives; smoking herbs for medical purposes; royal jelly [for medical purposes]; wheat blight [smut] (chemical preparations to treat -); dandruff (pharmaceutical preparations for treating -); radium for medical purposes; radioactive substances for medical purposes; solutions for contact lenses; solvents for removing adhesive plasters; caustics for pharmaceutical purposes; caustic pencils; scapulars for surgical purposes; dietary fibre; reagents (chemical -) for medical or veterinary purposes, reagent paper for medical or veterinary purposes; rhubarb roots for pharmaceutical purposes; radiological contrast substances for medical purposes; repellents for dogs; repellents (insect -); cod liver oil; fishmeal for pharmaceutical purposes; castor oil for medical purposes; sarsaparilla [for medical purposes]; semen for artificial insemination; flowers of sulfur for pharmaceutical purposes; sulfur sticks [disinfectants]; serotherapeutic medicines; serums; siccatives [drying agents] for medical purposes; mustard for pharmaceutical purposes, mustard poultices, mustard plasters, mustard oil for medical purposes; syrups for pharmaceutical purposes; jalap; candy, medicated; liquorice for pharmaceutical purposes; gum for medical purposes; salts (mineral water -), bath salts for medical purposes, smelling salts, salts for medical purposes, salts for mineral water baths; alloys of precious metals for dental purposes; adjuvants for medical purposes; headache (articles for -); remedies for perspiration, remedies for foot perspiration; appetite suppressants for medical purposes; stem cells for veterinary purposes; stem cells for medical purposes; sterilising (soil-) preparations, sterilising preparations; steroids; sticks (fumigating -); sulfur sticks [disinfectants]; strychnine; sulfonamides [medicines]; suppositories; soporifics; slimming pills, appetite suppressant pills, tanning pills; menstruation tampons; insect repellent incense; textiles (deodorants for clothing and -); thermal water; turpentine for pharmaceutical purposes; oil of turpentine for pharmaceutical purposes; thymol for pharmaceutical purposes; tinctures for medical purposes; gentian for pharmaceutical purposes; tonics [medicine]; tranquillizers; herbs (smoking -) for medical purposes;

tissues impregnated with pharmaceutical lotions; tobacco extracts [insecticides]; sedatives; sediment (medicinal -) [mud]; pharmaceutical preparations; pharmaceutical preparations for treating dandruff; phenol for pharmaceutical purposes; ferments (milk -) for pharmaceutical purposes; ferments for pharmaceutical purposes; phylloxera (chemical preparations for treating -); flour for pharmaceutical purposes; formic aldehyde for pharmaceutical purposes; phosphates for pharmaceutical purposes; fumigation preparations for medical purposes; fungicides; fodder supplements for veterinary purposes; fly catching paper; paper for mustard poultices, paper for mustard plasters, paper (mothproof -); hematogen, hemoglobin, hemorrhoid preparations; hemostatic pencils; herbicides; sanitary knickers; sanitary towels, sanitary pads, sanitary panties, sanitary napkins, hygienic bandages; absorbent cotton, absorbent wadding; hydrastine; hydrastinine; vine disease treating chemicals; chemico-pharmaceutical preparations, chemical preparations for veterinary purposes; diagnosis of pregnancy (chemical preparations for the -), chemical preparations for medical purposes, chemical preparations for pharmaceutical purposes, chemical conductors for electrocardiograph electrodes, chemical reagents for medical or veterinary purposes; quinine for medical purposes, quinquina for medical purposes; chinoline for medical purposes; surgical implants comprised of living tissues; surgical glues; surgical dressings; hydrated chloral for pharmaceutical purposes; carbolineum [parasiticide]; chloroform; hops (extracts of -) for pharmaceutical purposes; hormones for medical purposes; food for babies; nutritive substances for microorganisms; nutritional supplements; dietary supplements for animals; yeast dietary supplements; linseed dietary supplements; pollen dietary supplements; propolis dietary supplements; royal jelly dietary supplements; wheat germ dietary supplements; food preparations (dietetic -) adapted for medical purposes; media for bacteriological cultures; cellulose esters for pharmaceutical purposes, cellulose ethers for pharmaceutical purposes; cigarettes (tobacco-free -) for medical purposes; mastics (dental -); cement for animal hooves; cinchona for medical purposes.

(260) AM 2017 89394 A

(800) 1316836

(891) 2015 12 14

(731) MICHAEL WILSON & PARTNERS, LIMITED
P.O. Box 71, Craigmuir Chambers, Road
Town, Tortola, British Virgin Islands

(540)

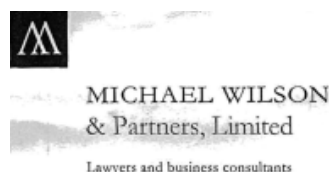

(591) black and white

(511)

35 – Business management; business administration; office functions; business efficiency expert services; market studies; business information; compilation of statistical information; business investigations; marketing investigations; business management and organization consultancy; professional business consultancy; organization of exhibitions for commercial or advertising purposes; business appraisals; business management assistance; commercial or industrial management assistance; assistance in the operation and management of a commercial enterprise; economic forecasting; business inquiries.

36 – Financial analysis; insurance information; financial information; insurance consultancy; financial consultancy; financial evaluation [insurance, banking, real estate]; financial sponsorship.

42 – Environmental protection consultancy.

45 – Arbitration services; intellectual property consultancy; monitoring intellectual property rights; copyright management; legal services; research in the field of law.

(260) AM 2017 89395 A

(800) 1317576

(891) 2016 09 08

(731) JANSSEN PHARMACEUTICA NV

Turnhoutseweg 306 B-2340 Beerse, Belgium

(540)

ПЛИВЕНСИЯ

(591) Black, white

(511)

5 – Human pharmaceutical preparations.

(260) AM 2017 89396 A

(800) 1316875

(891) 2016 04 29

(731) SUDARSHAN CHEMICAL INDUSTRIES LIMITED

162, Welsley Road, Sangam Bridge, Pune 411001, India

(540)

SUDARSHAN

(591) black and white

(511)

2 – Pigments included in this class.

(260) AM 2017 89397 A

(800) 1084535

(891) 2016 09 08

(731) FISKARS CORPORATION

Hämeentie 135 A, FI-00560 Helsinki, Finland

(540)

FISKARS

(511)

7 – Machines and machine tools; motors and engines (except for land vehicles); machine coupling and transmission components (except for land vehicles); agricultural implements other than hand-operated; power operated gardening tools; power operated edgers, power operated blowers, vacuum cleaners, power operated hedge trimmers, power operated tree pruners, power operated grass trimmers, chain saws, power operated ice augers used in ice fishing, snow blowers, chippers, shredders, wood splitters, and electricity generators; lawn mowers; pumps for water sprinklers; electrically operated fruit peelers and citrus presses; gluing machines; printing machines; mechanical stamping tools.

8 – Hand tools and implements (hand operated); cutlery; side arms; saws, trowels, scoops, rakes; agricultural, gardening and landscaping hand tools; cutting, drilling, grinding, sharpening and surface treatment hand tools; garden tools, hand-operated; hand-operated tools for treatment of materials, and for construction, repair and maintenance; flat irons; can openers, non-electric; knives; cutting tools [hand tools]; slicers for food preparation, non-electric; peelers for food preparation, non-electric; scissors; nutcrackers; oyster openers; sharpening tools [hand operated]; table cutlery [knives, forks and spoons]; disposable tableware [cutlery] made of plastics; hand-operated vegetable choppers, fruit and egg slicers, vegetables slicers and vegetable cutters; multi-function hand tools comprising all, or a combination of a knife blade, pliers, screwdrivers, bottle opener, can opener, scissors, wire cutter, file, saw blade, nail puller, wire stripper, ruler; sport knives, hunting knives, fishing knives and camping knives; hatchets, pruners, machetes, and wire cutters; sheaths for knives and multi-function hand tools; sheaths and sharpeners for knives and scissors; lawn and garden hand tools; spades, shovels, axes, hand saws, hatchets, pruners, machetes, and wire cutters; tool sheaths for use with hand held tools; hand-operated drills, shop shears, diagonal craft cutters, hand-held rotary cutters, blades for rotary cutters; craft knives and replacement blades for craft knives; hand-operated craft press machines; hand operated press machines; carpenter's clamps; tool bags (filled); stamping tools (hand operated); punches (hand tools); paper trimmers; eyelet setting tools (hand operated).

11 – Apparatus for lighting, heating, steam generating, cooking, refrigerating, drying, water supply and sanitary purposes; outdoor sprinkler systems; sprinkler system valves and timers; gauges and hoses for watering; flashlights and other outdoor portable lightning products; lightingware, chandeliers, lamps, wall-brackets and their parts and fittings; fireplaces; lanterns.

21 – Kitchen and household utensils and containers; combs and sponges; brushes (except paint brushes); articles for cleaning purposes; steelwool; unworked or semi-worked glass (except glass used in building); glassware, porcelain and earthenware not included in other classes; spatulas, graters, cake servers, salt and pepper mills, salt and pepper shakers, ladles, whisks, basting spoons, serving forks, serving spoons, wine openers, cork screws, tongs, pincers (for kitchen use), pastry wheels, skewers, rolling pins, potato mashers, garlic presses, tea infusers, tea strainers, ice cream scoops, non-electric fruit presses, non-electric citrus presses, napkin holders and napkin rings not of precious metals; dishes, drinking glasses, beverage glassware, figurines of glass or porcelain, decorative bowls, candle holders, serving platters, casseroles, plates, cups, bowls, jars, tea pots, non-electric coffee pots, mugs, saucers, egg cups, pitchers, vases, cake platters, cake pedestals, sugar bowls, creamers, gravy/sauce boats, tureens, baking dishes, pie plates, pie pans, spice jars, spice racks, cruets not of precious metal for oil and vinegar; moulds [kitchen utensils]; stopping materials, namely, glass stoppers, drain stoppers for sinks; flower pots and flower pot holders; watering cans; sprayer nozzles for garden hoses; sprayer wands for garden hoses; sprayers attached to garden hoses; lawn and garden sprinklers; gardening gloves; work gloves; light duty utility gloves; trivets of wood and cork; garden kit for home use comprising growing containers, soil, electronic light, fertilizer and seeds; knife storage blocks; brooms; cookware, namely, pots and pans; dish covers; scoops for kitchen use, kitchen ladles; soap boxes; cheese-dish covers; bottle openers; bottles; candle extinguishers; candle rings; candle holders; ceramics for household purposes; tableware, cookware and containers for household and kitchen use; cleaning instruments, hand-operated; coasters, not of paper and other than table linen; blenders, non-electric, for household purposes; coffee filters, non-electric; coffee percolators, non-electric; coffeepots, non-electric; grinders, non-electric; cooking utensils, non-electric; fruit presses, non-electric for household purposes; kettles, non-electric; mixing machines, non-electric, for household purposes; pastry cutters; saucepan scourers; pins of metal (cooking -); cups and plates of paper or plastic; cutting boards for the kitchen; fitted picnic baskets, including dishes graters [household utensils]; heat-insulated containers; ironing boards; knife rests for the table; menu card holders; napkin holders; napkin rings; tableware, other than knives, forks and spoons; trays for domestic purposes; works of art of porcelain, ceramic, earthenware or glass; oven mitts; decorative boxes and containers of porcelain, earthenware or glass; potholders; watering cans; spray bottles.

35 – Advertising; business management; business administration; commercial information and advice

for consumers [consumer advice shop]; compilation and systemization of information into computer databases; demonstration of goods; dissemination of advertising matter; invoicing; marketing research; organization of exhibitions for commercial or advertising purposes; organization of trade fairs for commercial or advertising purposes; presentation of goods on communication media, for retail purposes; procurement services for others [purchasing goods and services for other businesses]; rental of advertising space; rental of advertising time on communication media; sales promotion for others; updating of advertising material; whole sale, resale and on-line resale of hand tools and instruments, cutlery, knives, scissors, household and kitchen utensils and containers, glassware, porcelain, earthenware, storage wares, lighting apparatus, kitchen and household equipment, interior and exterior decor articles, textile goods, clothing, footwear, headgear, aprons, watering systems and their parts and fittings, hoses, furniture, gardening tools, planting pots.

(260) AM 2017 89398 A

(800) 1272017

(891) 2016 09 29

(731) AUMA Riester GmbH & Co. KG

Aumastr. 1, 79379 Müllheim, Germany

(540)



(591) Blue

(511)

7 – Mechanical, pneumatic, hydraulic control apparatus for machines or engines; actuators (engines) with electronic control for control and regulation of operation of mobile equipment and mechanisms, including control and regulation of operation of valves, motorized blocking devices and similar mechanisms for use in pipelines and ducts; all of the aforesaid goods in particular for industries in the field of power plants and district heating power stations, water supply and sewage water, chemistry and petrochemistry, pharmacy, food, heating engineering, ventilation engineering and air conditioning, paper and cement, ship building and submarine industry as well as in generation of energy; parts and accessories for all aforementioned goods, as far as included in this class.

9 – Electric control apparatus for regulation and control of industrial apparatus and equipment; electronic assemblies, computer hardware and computer software for control and regulation of industrial processes; electric/electronic control apparatus and control equipment for control and regulation of the operation of mobile equipment and mechanical systems, including control and regulation of operation of val-

ves, blocking devices and similar mechanisms for use in pipelines and ducts; analysers (not for medical purpose) for the measurement of physical characteristics and chemical compositions of solid, liquid, and gaseous components; all of the aforesaid goods for the use in industrial processes, particularly in the chemical, pharmaceutical, petrochemical industries and process engineering in the field of production of food, paper, and cement; analysers (not for medical purposes) for emissions monitoring, particularly for the excitation of actuators; parts and accessories for all aforementioned goods, as far as included in this class.

(260) AM 2017 89433 A

(800) 1318494

(891) 2016 06 14

(731) IGOR MIKHAILOVICH MANUILOV

Geologicheskaya Street/Roshchinskaya Street,
No. 28/10/2, RU-350000 Krasnodar, Russian
Federation

(540)



(591) White, burgundy, brown, blue, beige, yellow,
green, red, black

(511)

30 – Noodle-based prepared meals; coffee flavorings; tapioca flour; maltose; almond paste; honey; molasses for food; caramels [candy]; relish [condiment]; cinnamon [spice]; meat tenderizers, for household purposes; mayonnaise; chicory [coffee substitute]; marzipan; corn flakes; powders for making ice cream; cake dough; cocoa beverages with milk; halvah; macarons [pastry]; crushed barley; beer vinegar; chow-chow [condiment]; nutmegs; turmeric; capers; potato flour; mustard meal; pasta; spring rolls; food flavorings, other than essential oils; corn, roasted; flour; tarts; ferments for pastes; baking soda [bicarbonate of soda for cooking purposes]; tea-based beverages; chutneys [condiments]; edible ices; linseed for human consumption; sushi; ice cream; cheeseburgers [sandwiches]; artificial coffee; hominy; dessert mousses [confectionery]; rice-based snack food; rusks; petits fours [cakes]; cooking salt; chewing gum; cocoa; pralines; fruit jellies [confectionery]; rice; cereal-based snack food; cakes; peppers [seasonings]; mustard; thickening agents for

cooking foodstuffs; macaroni; yeast; malt biscuits; tomato sauce; vanillin [vanilla substitute]; cereal preparations; pepper; seasonings; hominy grits; meat pies; tea; pastilles [confectionery]; groats for human food; ice, natural or artificial; golden syrup; flavorings, other than essential oils, for cakes; infusions, not medicinal; seaweed [condiment]; oat flakes; iced tea; barley meal; chocolate beverages with milk; cake frosting [icing]; oat-based food; peanut confectionery; leaven; sandwiches; ham glaze; dressings for salad; custard; soya sauce; glucose for culinary purposes; natural sweeteners; sauces [condiments]; sausage binding materials; malt for human consumption; bean meal; husked barley; unroasted coffee; wheat germ for human consumption; rice cakes; petit-beurre biscuits; saffron [seasoning]; cocoa-based beverages; allspice; sea water for cooking; crackers; dough; vinegar; coffee; fondants [confectionery]; ravioli; frozen yogurt [confectionery ices]; cloves [spice]; popcorn; celery salt; pasta sauce; waffles; liquorice [confectionery]; spices; preparations for stiffening whipped cream; sugar; oatmeal; tortillas; bread-crumbs; cake powder; palm sugar; unleavened bread; corn flour; cream of tartar for culinary purposes; gluten prepared as foodstuff; chips [cereal products]; bread; pastry dough; ice for refreshment; noodles; ginger [spice]; corn, milled; meat gravies; crushed oats; condiments; sherbets [ices]; aromatic preparations for food; spaghetti; buns; confectionery for decorating Christmas trees; star aniseed; sago; candy; tapioca; pies; coffee-based beverages; marinades; chocolate mousses; soya bean paste [condiment]; pancakes; bread rolls; peppermint sweets; vegetal preparations for use as coffee substitutes; baking powder; puddings; pastries; soya flour; malt extract for food; almond confectionery; fruit coulis [sauces]; flowers or leaves for use as tea substitutes; pâtés en croûte; royal jelly; propolis; pizzas; flavorings, other than essential oils, for beverages; wheat flour; couscous [semolina]; ketchup [sauce]; aniseed; vermicelli [noodles]; binding agents for ice cream [edible ices]; curry [spice]; tacos; high-protein cereal bars; chocolate-based beverages; husked oats; garden herbs, preserved [seasonings]; semolina; confectionery; salt for preserving foodstuffs; coffee beverages with milk; sweetmeats [candy]; chocolate; pesto [sauce]; tabbouleh; mint for confectionery; quiches; gingerbread; gluten additives for culinary purposes; essences for foodstuffs, except etheric essences and essential oils; cookies; starch for food; muesli; cereal bars; stick liquorice [confectionery].

(260) AM 2017 89434 A

(800) 1318128

(891) 2016 07 13

(731) FARMAK INTERNATIONAL HOLDING
GMBH

Mariahilferstrasse 136, A-1150 Wien, Austria

(540)

VitalPen

(591) Black, white

(511)

5 – Medicines for human purposes; anti-diabetic preparations; insulin; insulin analogues; insulin sold in prefilled syringes.

10 – Insulin pens; syringes for injections; insulin injectors.

(260) AM 2017 89436 A

(800) 1318160

(891) 2015 12 07

(731) SCA HYGIENE PRODUCTS AB
SE-405 03 Göteborg, Sweden

(540)

REFLEX

(511)

6 – Fixed dispensers (metallic) for hand towels, towels, kitchen rolls, wiping cotton, soap.

16 – Household paper rolls, kitchen towels of paper, hand towels of paper, industrial wiping paper in blocks, rolls or reels.

20 – Fixed dispensers not made of metal for hand towels, towels, paper towels.

21 – Dispensers made of metal or not for toilet paper, cleaning cloths and soap; boxes for dispensing paper towels; dispensers not made of metal for absorbent wiping cotton and soap.

(260) AM 2017 89438 A

(800) 1318220

(891) 2016 03 29

(731) GLOBAL TELİF HAKLARI YAPIMCILIK
TİCARET ANONİM ŞİRKETİ
Harbiye Mah. Abdi İpekçi, Cad. No:19-1
Kat:3 Nisantasi Sisli Istanbul, Turkey

(540)



(591) Black, white, yellow

(511)

9 – Scientific, nautical, surveying, photographic, cinematographic, optical, weighing, measuring, signa-

ling, checking (supervision), life-saving and teaching apparatus and instruments; apparatus and instruments for conducting, switching, transforming, accumulating, regulating or controlling electricity; apparatus for recording, transmission or reproduction of sound or images; magnetic data carriers, recording discs; compact discs, DVDs and other digital recording media; mechanisms for coin-operated apparatus; cash registers, calculating machines, data processing equipment, computers; computer software; fire-extinguishing apparatus.

16 – Paper and cardboard; printed matter; bookbinding material; photographs; stationery; adhesives for stationery or household purposes; artists' materials; paintbrushes; typewriters and office requisites (except furniture); instructional and teaching material (except apparatus); plastic materials for packaging; printers' type; printing blocks.

25 – Clothing, footwear, headgear.

35 – Advertising; business management; business administration; office functions; bringing together for the benefit of others, scientific, nautical, surveying, photographic, cinematographic, optical, weighing, measuring, signalling, checking (supervision), life-saving and teaching apparatus and instruments, apparatus and instruments for conducting, switching, transforming, accumulating, regulating or controlling electricity, apparatus for recording, transmission or reproduction of sound or images, magnetic data carriers, recording discs, compact discs, DVDs and other digital recording media, mechanisms for coin-operated apparatus, cash registers, calculating machines, data processing equipment, computers, computer software, fire-extinguishing apparatus, paper and cardboard, printed matter, bookbinding material, photographs, stationery, adhesives for stationery or household purposes, artists' materials, paintbrushes, typewriters and office requisites (except furniture), instructional and teaching material (except apparatus), plastic materials for packaging, printers' type, printing blocks, clothing, footwear, headgear, enabling customers to conveniently view and purchase those goods, such services may be provided by retail stores, wholesale outlets, through mail order catalogues or by means of electronic media, for example, through web sites or television shopping programmes.

38 – Telecommunications.

41 – Education; providing of training; entertainment; sporting and cultural activities.

(260) AM 2017 89439 A

(800) 1318246

(891) 2016 04 18

(731) CORPORACIÓN DE RADIO Y
TELEVISIÓN ESPAÑOLA, S.A.

Avda. Radio Televisión, 4, Edif. Prado del Rey E-28223 POZUELO DE ALARCÓN (MADRID), Spain

(540)



(591) White and red

(511)

38 – Telecommunication services; communications by radio broadcasting, by satellite, by cable, by fiber-optic networks, by computer terminals, communications via global computer networks; transmission and broadcasting of radio and television programs.

41 – Education and entertainment.

(260) AM 2017 89440 A

(800) 1318267

(891) 2016 05 10

(731) PEDRO ORTUÑO SANTA

Ctra. Jumilla, km. 63 E-30510 YECLA, MURCIA, Spain

(540)



(591) Black, white

(511)

25 – Clothing, footwear, headgear.

(260) AM 2017 89442 A

(800) 1318285

(891) 2016 06 16

(731) LABORATORIOS NORMON, S.A.

Ronda de Valdecarrizo, 6, E-28750 Tres Cantos (Madrid), Spain

(540)

NORMOSTOP

(511)

5 – Pharmaceutical and veterinary products; sanitary products for medical use; dietetic substances for medical use; food for babies; plasters, material for dressings; teeth filling and dental impression materials; disinfectants; products for destroying vermin; fungicides, herbicides.

(260) AM 2017 89446 A

(800) 1318531

(891) 2016 08 01

(731) Otkrytoye aktsionernoye obshchestvo "EFIRNOE"

ul. Frunze 2, g. Alekseevka, RU-309850 Belgorodskaya obl., Russian Federation

(540)



(591) White, black, yellow, vinous, red, blue, green, light green, olive color, dark moss green color, orange and lettuce green color

(526) ВКУШАЯ НОВИНКА PREMIUM QUALITY

(511)

30 – Mustard, spices, condiments, sauces including tomato sauce, pasta sauce, as well as mayonnaise, ketchup [sauce], dressings for salad.

35 – Sales promotion for others; retail and wholesale services for mustard, spices, condiments, sauces including tomato sauce, pasta sauce, as well as mayonnaise, ketchup [sauce], dressings for salad.

(260) AM 2017 89447 A

(800) 1318533

(891) 2016 07 27

(731) BIOFARMA

50 rue Carnot, F-92284 SURESNES Cedex, France

(540)

SOLTANCE

(591) Black, white

(511)

5 – Pharmaceutical products; veterinary products; sanitary products for medical purposes; implants for pharmaceutical use; implantable medicines; dietetic substances for medical use; dietetic substances for veterinary use; food for babies; dietetic preparations and food supplements; food supplements for animals; plasters, materials for dressings; teeth filling material; dental impression materials; disinfectants; products for destroying vermin; fungicides; herbicides.

(260) AM 2017 89448 A
 (800) 1318558
 (891) 2016 08 23
 (731) LIMITED LIABILITY COMPANY
 "PREMIORI"
 Vul. Levanevskogo, 91, Bila Tserkva Kyivska
 oblast 09100, Ukraine

(540)
SNOWGARD-VAN

(591) Black, white
 (511)
 12 – Automobile tires; casings for pneumatic tires;
 inner tubes for pneumatic tires; vehicle wheels; tires
 for vehicle wheels.

(260) AM 2017 89449 A
 (800) 260978
 (891) 2016 07 27
 (731) CONSORZIO CASALASCO DEL
 POMODORO SOCIETA' AGRICOLA
 COOPERATIVA
 Strada Provinciale 32, I-26036 RIVAROLO
 DEL RE ED UNITI (CR), Italy

(540)
POMITO

(511)
 29 – Meat, fish, poultry and game, meat extracts,
 preserved, dried and cooked fruits and vegetables,
 jellies, jams, eggs, milk and other dairy products,
 edible oils and fats, canned foods, pickles.

30 – Coffee, tea, cocoa, sugar, rice, tapioca, sago,
 artificial coffee, flours and cereal preparations, bre-
 ad, biscuits, cookies, cakes, pastry and confectione-
 ry, edible ices, honey, treacle, yeast, baking-powder,
 salt, mustard, pepper, vinegar, sauces, spices, ice.

(260) AM 2017 89450 A
 (800) 419256
 (891) 2016 01 29
 (731) BAYERNLAND EG
 Breslauer Str. 406, 90471 Nürnberg, Germany

(540)
FARMI

(511)
 29 – Milk, butter, cheese, eggs.

(260) AM 2017 89451 A
 (800) 498622
 (891) 2016 10 26
 (731) ANTISEPTICA DR. HANS-JOACHIM
 MOLITOR GMBH
 Carl-Friedrich-Gauß-Strasse 7, 50259
 Pulheim, Germany

(540)

Oxygenon

(511)
 5 – Disinfectants; chemicals for sanitary use.

(260) AM 2017 89452 A
 (800) 582886
 (891) 2016 02 23
 (731) PUMA SE
 Puma Way 1, 91074 Herzogenaurach, Germany

(540)



(591) Black, white
 (511)
 3 – Cleaning, polishing and scouring preparations,
 more specifically for footwear upkeep and care;
 soaps, perfumery, scented waters, essential oils, cos-
 metics, particularly foam bath and shower products,
 body creams and lotions, chemical products and
 preparations for hair care and treatment, particularly
 hair lotions, dentifrices and dental rinses.

(260) AM 2017 89459 A
 (800) 827439
 (891) 2016 10 24
 (731) FERRER INTERNACIONAL, S.A.
 Gran Vía de Carlos III, 94, E-08028
 BARCELONA, Spain

(540)
ANGINOVAG

(511)
 5 – Preparations and especially pharmaceutical pre-
 parations, medicated preparations, veterinary prepa-
 rations, serums, vaccines and disinfectants.

(260) AM 2017 89460 A
 (800) 964123
 (891) 2016 10 26
 (731) LABORATOIRE FRANÇAIS DU
 FRACTIONNEMENT ET DES
 BIOTECHNOLOGIES
 3 avenue des Tropiques, F-91940 Les Ulis, France

(540)

CLOTTAFAC

(511)
 5 – Pharmaceutical products and preparations and in
 particular blood proteins of natural or transgenic,
 synthetic or semi-synthetic origin.

(260) AM 2017 89461 A
 (800) 984101
 (891) 2016 04 24
 (731) APOLLO GAMES k.s.
 V parku 2294/2, CZ-148 00 Prague 4,
 Chodov, Czech Republic
 (540)

Apollo Games

(511)
 41 – Operating lotteries; organization of lotteries; amusement arcade services and provision of casino facilities (gambling); organizing and operating of winning lotteries, tombolas, contests, gaming; operating winning and non-winning gaming machines; entertainment services, in the nature of games, gaming, games of hazard (including the games of hazard on-line), lotteries, casinos.

43 – Services of providing accomodation and food; providing accomodation facilities; restaurants and bar services; bar services in gaming houses; cafeterias; winerrooms; providing buffets and other fast food restaurants.

(260) AM 2017 89462 A
 (800) 1001999
 (891) 2016 08 26
 (731) GLAXO GROUP LIMITED
 980 Great West Road Brentford, Middlesex
 TW8 9GS, United Kingdom
 (540)

TRELEGY

(511)
 5 – Pharmaceutical and medicinal preparations and substances.

(260) AM 2017 89463 A
 (800) 1317601
 (891) 2016 01 28
 (731) APPLIED DATA FINANCE, LLC
 15373 Innovation Drive, Suite 250, San
 Diego CA 92128, USA
 (540)

PERSONIFY

(591) black and white
 (511)
 35 – Intermediary services, namely, facilitating the channeling of funds between lenders and borrowers by connecting those with a financial surplus with those having a financial deficit.
 36 – Financial services, namely, originating, arranging, financing and servicing of loans.

(260) AM 2017 89465 A
 (800) 1317632
 (891) 2016 03 11

(731) NICOS INTERNATIONAL SPA
 Via Bastie, 44 – Z.I., I-31040
 PORTOBUFFOLE' (TV), Italy
 (540)

CERAMILUX

(591) black and white
 (511)

1 – Chemicals used in industry, science and photography, as well as in agriculture, horticulture and forestry; unprocessed artificial resins, unprocessed plastics; manures; fire extinguishing compositions; tempering and soldering preparations; chemical substances for preserving foodstuffs; tanning substances; adhesives used in industry.

11 – Sanitary and hygiene equipment; sanitary installations; sanitary apparatus, sanitary installations and sanitary ware; parts of sanitary installations; wash-hand basins; bathroom installations for sanitary purposes; bathtubs; shower pans.

19 – Building materials (non-metallic), namely semi-finished or finished panels in layered plastic material.

20 – Furniture parts.

35 – Advertising; business management; business administration; office functions; managerial, organizational, sales services, administrative services of points of sale for others of chemicals used in industry, science and photography, as well as in agriculture, horticulture and forestry, unprocessed artificial resins, unprocessed plastics, manures, fire extinguishing compositions, tempering and soldering preparations, chemical substances for preserving foodstuffs, tanning substances, adhesives used in industry, sanitary and hygiene equipment and marble facing or covering, sanitary installations, sanitary apparatus, sanitary installations and sanitary ware, parts of sanitary installations, wash-hand basins, bathroom installations for sanitary purposes, bathtubs, shower pans, building materials (non-metallic), namely semi-finished or finished panels in layered plastic material, furniture parts, wholesale, by retail, on-line sales, mail order, by telephone and by telesales.

(260) AM 2017 89467 A
 (800) 1317634
 (891) 2016 04 21
 (731) JOHN LEMON ROBERT ORSZULAK
 ul. Chorzowska 108, PL-40-101 Katowice,
 Poland
 (540)



(591) black and white
(511)
32 – Beers; mineral and aerated waters and other non-alcoholic beverages; fruit beverages and fruit juices; syrups and other preparations for making beverages; non-alcoholic beverages.

(260) AM 2017 89468 A
(800) 1318365
(891) 2015 11 09
(731) Doustr Marianna" LLC
6/17 Akhtanaki street, Yerevan, Armenia
(540)



(591) Black, white
(511)
29 – Milk and dairy products.

(260) AM 2017 89469 A
(800) 1317666
(891) 2016 05 16
(731) KENNEDE ELECTRONICS MFG. CO., LTD.
No.21, Jintong Road, Tangxia Town,
Pengjiang District, Jiangmen City,
Guangdong Province, China

(540)

ANYBY

(591) black and white
(511)
7 – Mixers [machines]; kitchen machines, electric; food processors, electric; washing machines [laundry]; hand-held tools, other than hand-operated; machines and apparatus for cleaning, electric; beaters, electric; robots [machines]; blowing machines; road sweeping machines [self-propelled].

9 – Computer peripheral devices; battery chargers; batteries, electric; plates for batteries; weighing machines; transformers [electricity]; computer programs [downloadable software]; switches, electric; alarms; signal lanterns.

11 – Lamps; lighting apparatus and installations; torches for lighting; fans [air-conditioning]; air purifying apparatus and machines; radiators, electric; air conditioning installations; hair driers; refrige-

rators; light-emitting diodes [LED] lighting apparatus.

(260) AM 2017 89470 A
(800) 1317689
(891) 2016 05 23
(731) Otkrytoye aktsionernoye obshchestvo
"EFIRNOE"
ul. Frunze 2, g. Alekseevka, RU-309850
Belgorodskaya obl., Russian Federation
(540)



(591) White, black, yellow, vinous, red, blue, green, light green, sandy color, dark moss green collar, orange, carrot collar, lettuce green color, light green and violet

(526) Vkusnaya novinka, Premium Quality.
(511)

30 – Mustard, spices, condiments, sauces including tomato sauce, pasta sauce, as well as mayonnaise, ketchup [sauce], dressings for salad.

35 – Sales promotion for others; retail and wholesale services for mustard, spices, condiments, sauces including tomato sauce, pasta sauce, as well as mayonnaise, ketchup [sauce], dressings for salad.

(260) AM 2017 89471 A
(800) 1318381
(891) 2016 02 09
(731) BMVA ELEKTRONİK SANAYİ TİCARET ANONİM ŞİRKETİ
Gültepe Mah. Türe Sok. No:2, ISTANBUL,
Turkey

(540)

Aprilla

(591) Dark grey and red.

(511)

8 – Forks, spoons, knives and non-electric cutters, slicers, peelers for kitchen use, including those made of precious metals; side arms and blades (weapons); tools and apparatus included in this class for personal beauty care use: tools and apparatus included in this class for shaving, epilation, manicure and pe-

dicure, electric hand implements for straightening and curling hair, scissors; hand-operated [non-electric] hand tools included in this class for the repair of machines, apparatus and vehicles and for use in construction, agriculture, horticultural and forestry, none of them being power tools; electric or non-electric irons; steam irons.

11 – Lighting installations; lights for vehicles and interior-exterior spaces; heating installations using solid, liquid or gas fuels or electricity, central heating boilers, boilers for heating installations, radiators [heating], heat exchangers, not parts of machines, stoves, kitchen stoves, solar thermal collectors [heating]; steam, gas and fog generators, steam boilers, other than parts of machines, acetylene generators, oxygen generators, nitrogen generators; installations for air-conditioning and ventilating; cooling installations and freezers; electric and gas-powered devices, installations and apparatus for cooking, drying and boiling; cookers, electric cooking pots, electric water heaters, barbecues, electric laundry driers; hair driers; hand drying apparatus; sanitary installations, taps [faucets], shower installations, toilets [water-closets], shower and bathing cubicles, bath tubs, toilet seats, sinks, wash-hand basins [parts of sanitary installations]; water softening apparatus; water purification apparatus; water purification installations; waste water purification installations; electric bed warmers and electric blankets, not for medical use; electric pillow warmers; electric or non-electric foot-warmers; hot water bottles; filters for aquariums and aquarium filtration apparatus; industrial type installations for cooking, drying and cooling purposes; pasteurizers and sterilizers.

(260) AM 2017 89473 A
(800) 1317732
(891) 2016 08 19
(731) CAYAGO GMBH
Achenweg 16, A-6370 Kitzbühel, Austria
(540)

JETCART

(511)
7 – Machine drive units.

9 – Remote control mechanisms; accumulators.

12 – Motorised water sports apparatus, namely means of transport on and/or under water; boats; housing claddings for the aforesaid water sports apparatus for boats; transport devices, namely automobile trailers or transport vehicles for boats or water sports apparatus; replacement parts for boats or motorised water sports apparatus.

(260) AM 2017 89474 A
(800) 1317753
(891) 2016 08 18

(731) ASTELLAS PHARMA INC.
5-1, Nihonbashi-Honcho 2-chome, Chuo-ku,
Tokyo 103-8411, Japan

(540)
SUGLAT

(591) black and white

(511)

5 – Pharmaceutical preparations for the treatment of diabetes.

(260) AM 2017 89475 A
(800) 1318399
(891) 2016 03 10
(731) ADP GAUSELMANN GMBH
Mercur-Allee 1-15, 32339 Espelkamp,
Germany
(540)

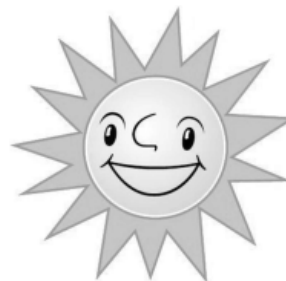

(591) Black, white

(511)

9 – Scientific, nautical, surveying, photographic, cinematographic, optical, weighing, measuring, signalling, checking (supervision), life-saving and teaching apparatus and instruments; apparatus and instruments for conducting, switching, transforming, accumulating, regulating or controlling electricity; apparatus for recording, transmission or reproduction of sound or images; magnetic data carriers, recording discs; CDs, DVDs and other digital recording media; cash registers, calculating machines, hardware for data processing, computers; computer software; fire extinguishers; music machines (cash operated) and parts for the aforesaid machines; ATMs, money counting and money changing machines; mechanisms for coin-operated apparatus; software for computer and video games; games software for use with any computer-based platforms, including consumer electronics and game consoles; game program for computers; computer games; video games (software); computer games provided via a global computer network or by means of electronic multi-media broadcasting or telecommunications or electronic transfer or via the internet; computer games, software for leisure and recreation, video games and computer software, all provided in the form of storage media; programs for operating electric and electronic apparatus for games, amusement and/or entertainment purposes; automatic lottery machines; computer software for computer games on

the internet; online games (software), especially for online gambling, online gambling, online skill games and online casino games; computer software in the form of an application for mobile devices and computers; apparatus for settlement of cash-operated machines and parts for the aforesaid goods; apparatus for recording, transmission, processing and reproduction of data, including sound or images, including parts for all the aforesaid goods, but not including radios, television receivers, HI-FI systems, video recorders, telephones, fax machines and telephone answering machines; computer hardware and computer software for casino and amusement arcade games, for gaming machines or video lottery gaming machines or games of chance via the internet; electrical, electronic, optical or automatic apparatus for identifying data carriers, identity cards and credit cards, bank notes and coins; electric, electronic or optical alarm and monitoring installations, including video cameras and apparatus for image transmission and image processing equipment and computers, including data processing equipment and computers as components of data networks and to participate in the communication in data networks; electric wiring harnesses; boards, printed board assemblies (electronic components) and combinations thereof as assemblies and as parts for equipment, included in this class; computer gaming machines; telecommunications equipment and telecommunications instruments; tablet computers; digital music and/or video players; personal digital assistants, electronic organizers, electronic notebooks; software for portable electronic devices; software for mobile and wireless telephones; computer and video game software for use on console platforms, namely for worldwide communications network suitable and can be connected thereto systems for single player, peer-to-peer games, online games and more players; computer game programs for use in connection with interactive games for multiple players, which will be played over a global communications network; downloadable software for interactive computer, video and electronic games; downloadable computer game software and electronic games for use on wireless devices, namely cellular phones, electronic communication devices, personal digital assistants (PDAs) and wireless devices; programs for computer games and electronic games; plug-in modules, optical discs, DVDs and CDs with entertainment content in the form of games, solution tips for games, facts games and courses of action; sound and video recordings in the field of online games, computer and video games and entertainment; computer game software for the provision of access for multiple players to an electronic on-line computer game environment for several players, namely to an mmo (massively multi-player online) game; electronic user manuals and instructions for online games, computer and video games; recorded on computer media or on the in-

ternet downloadable electronic publications, namely, books, magazines, manuals in the field of online games, computer and video games and entertainment; downloadable multimedia files with graphics, text, sound, video, games and links to internet sites in relation to online games, computer and video games and entertainment; electrical and electronic apparatus, equipment and instruments (included in this class) namely machines for adoption, issuance and exchange of money; coin mechanisms, apparatus for the settlement of money-operated machines, data recording machines, data printers; printed electronic circuits; money-changing machines, with programs provided machine-readable data carriers for the aforesaid apparatus; apparatus for checking bank notes; data carriers, including identity cards and credit cards; devices for storing and archiving digital data; wiring harnesses; printed circuit board assemblies and combinations and stamped parts as assemblies and parts of electronic devices, except for radio and television receivers; computers and computer peripherals; computer hardware namely storage media for data processing equipment and computers; machines for changing or dispensing money and/or currencies; parts for the aforesaid automatic machines; mechanisms for monetary and monetary equivalents operated amusement machines, slot machines, video slot machines, lottery equipment, automatic systems and apparatus and systems formed therefrom.

28 – Games; toys; gymnastic and sporting articles not included in other classes; playground equipment (money operated); cash or coin-operated gaming machines (machines); games for amusement arcades (included in this class); coin-operated video game machines; video games apparatus adapted for external display screen or monitor; casino equipment, namely roulette tables, roulette wheels; coin-operated gaming machines (machines) and gaming machines, in particular for gaming arcades, with or without a prize payout; electronic or electrotechnical gaming apparatus, gaming machines and automatic gaming machines, slot machines, which are operated by coins, tokens, banknotes, tickets or by means of electronic, magnetic or biometric storage media, in particular for commercial use in casinos and amusement arcades, with or without a prize payout; gaming machines, in particular for commercial use in casinos and amusement arcades, with or without a prize payout; coin-operated gaming machines and/or electronic money game apparatus (machines), with or without prizes; adapted housing for operated by coins, tokens, tickets or by means of electronic, magnetic or biometric storage media slot machines, gaming apparatus, gaming machines, in particular for commercial use in casinos and amusement arcades, with or without a prize payout; electronic games; apparatus for electronic games and parts thereof; slot machines with video output; drawing

device for profit and lottery games, lotteries or raffles; housing made of metal, plastic and/or wood for coin-operated machines; apparatus for games (including video games), other than those adapted for external display screen or monitor; electropneumatic and electric slot machines with pulling handles (gaming machines); gaming tables, in particular for table football, billiards; flying discs (toys) and darts; electric, electronic or electromechanical apparatus for bingo games, lotteries or video lottery games and for betting offices, networked or uncrosslinked; lcd game consoles; betting machines (machines); all the aforesaid automatic gaming machines operating in networks; equipment and devices for accepting and storing money as accessories for the aforesaid automatic machines, included in this class; electrical and electronic machinery and apparatus for games, amusement and entertainment purposes; gaming machines, namely, sporting or entertainment gaming machines, coin operated; gaming and entertainment, recreational amusement machines and apparatus; lotteries, sweepstakes tickets; objects for conducting lotteries, namely gambling drums; electrical and electronic apparatus and instruments for conducting lotteries, lotteries, raffles and other contests; electrical and electronic apparatus and equipment for bingo games, lotteries and raffles for betting offices; appliances and machines for gambling and games with and/or without bet; hand-held electronic games other than those adapted for the TV; playing cards; slot machines, slot machines and/or betting machines for use in amusement arcades or betting offices for commercial and non-commercial purposes.

(260) AM 2017 89482 A

(800) 1317782

(891) 2016 09 09

(731) FERRING B.V.

Polaris Avenue 144, NL-2132 JX Hoofddorp,
Netherlands

(540)

CHORAPUR

(511)

5 – Pharmaceutical preparations and substances.

(260) AM 2017 89485 A

(800) 1318438

(891) 2016 05 19

(731) KARELIA TOBACCO COMPANY INC

Athinon Street, GR-241 00 Kalamata, Greece

(540)



(591) Black,white,gzay

(511)

34 – Tobacco, cigars, cigarettes, e-cigarettes, cigarellos, smokers' articles, ashtrays, cigarette cases, cigarette lighters, cigarette papers and matches.

(260) AM 2017 89486 A

(800) 1318463

(891) 2016 06 17

(731) SkyC" limited liability partnership

ul. Sizganova, dom 82, 050059 gorod Almaty,
Kazakstan

(540)



Skybank

(591) Black,white,Blue

(511)

36 – Insurance services; financial affairs; monetary affairs; real estate affairs, including the formation of credit histories and the provision of credit reports based on specialized software, with the possibility of systematization and automation of participants activity in the system of formation of credit histories and their use; credit bureau services; issuance of credit cards; exchanging money; online banking; processing of credit card payments; electronic funds transfer; loans [financing]; providing financial information via a web site; banking; charitable fund raising; financial sponsorship; financing services.

(260) AM 2017 89487 A

(800) 1318473

(891) 2016 05 07

(731) QINGDAO HI-WHEEL INTL TRADING
CO.,LTD.

Room 903, Unit 3, Meijing Tower, Qingdao
Free Trade Zone Shandong Province, China

(540)

JUMBO

(591) Black, white

(511)

12 – Automobile inner tube; tires for bicycles, tricycles; the car tires; automobile tires; inner tubes for bicycles, tricycles; casings for pneumatic tires.

(260) AM 2017 89488 A

(800) 1318474

(891) 2016 05 07

(731) GEELY HOLDING GROUP CO., LTD.
1760 Jiangling Road, Binjiang District,
Hangzhou, Zhejiang, China

(540)



(591) Blue, black and golden.

(511)

12 – Electric vehicles; vehicles for locomotion by land, air, water or rail; cars; propulsion mechanisms for land vehicles; cycle cars; motorcycles; automobile chassis; gear boxes for land vehicles; tires for vehicle wheels; brakes for vehicles.

37 – Electric appliance installation and repair; air conditioning apparatus installation and repair; machinery installation, maintenance and repair; motor vehicle maintenance and repair; cleaning of automobiles; vehicle service stations [refuelling and maintenance]; gas station for vehicle; spraying and coating service for vehicle; repair of rubber tires; burglar alarm installation and repair.

(260) AM 2017 89490 A

(800) 1318478

(891) 2016 05 24

(731) ALLTRANS S.R.L.

Viale delle Industrie, 15 I-20090 SETTALA
(MI), Italy

(540)



(591) Light blue and grey.

(511)

39 – Transport; packaging and storage of goods; travel arrangement.

(260) AM 2017 89491 A

(800) 1009149

(891) 2016 10 26

(731) LABORATOIRE FRANCAIS DU

FRACTIONNEMENT ET DES
BIOTECHNOLOGIES

3 avenue des Tropiques, F-91940 LES ULIS,

France

(540)

YDRALBUM

(511)

5 – Human albumin, used for burn victims, in intensive care when the use of a colloid is necessary.

(260) AM 2017 89492 A

(800) 1059714

(891) 2016 10 25

(731) KNAUF GIPS KG

Am Bahnhof 7, 97346 Iphofen, Germany

(540)

BETOKONTAKT

(511)

1 – Chemical products for the construction industry; chemicals for building.

19 – Building materials, not of metal.

(260) AM 2017 89493 A

(800) 1205643

(891) 2016 10 26

(731) LABORATOIRE FRANCAIS DU

FRACTIONNEMENT ET DES
BIOTECHNOLOGIES

3 avenue des Tropiques 6 F-91940 LES ULIS,
France

(540)

IQYMUNE

(511)

5 – Pharmaceutical products; injectable pharmaceutical products; immunoglobulins; injectable immunoglobulins.

(260) AM 2017 89494 A

(800) 1223490

(891) 2016 06 29

(731) "LEDEL" Limited Liability Company

Sh. Usmanova str., 316 a RU-420095 Kazan,
Russian Federation

(540)



(591) Black and red

(511)

11 – Lamp shades; lampshade holders; light bulbs; light bulbs, electric; lamp globes; lights, electric, for Christmas trees; acetylene flares; safety lamps; gas lamps; curling lamps; germicidal lamps for purifying air; lamps for directional signals of automobiles; light bulbs for directional signals for vehicles; arc lamps; laboratory lamps; oil lamps; ultraviolet ray lamps, not for medical purposes; miners' lamps; electric lamps; chandeliers; filaments for electric lamps; lamp reflectors; lamp casings; sockets for electric lights; lighting apparatus and installations; light diffusers; lamps; standard lamps; ceiling lights; lamp glasses; lamp chimneys; lanterns for lighting.

(260) AM 2017 89495 A
 (800) 1225340
 (891) 2016 06 29
 (731) "LEDEL" Limited Liability Company
 Sh. Usmanova str., 31, a RU-420095 Kazan,
 Russian Federation

(540)



(591) Blue, dark blue, black and white

(511)

11 – Lamp shades; lampshade holders; searchlights; light bulbs; light bulbs, electric; lamp globes; lights, electric, for Christmas trees; acetylene flares; safety lamps; gas lamps; curling lamps; germicidal lamps for purifying air; lamps for directional signals of automobiles; light bulbs for directional signals for vehicles; arc lamps; laboratory lamps; oil lamps; ultraviolet ray lamps, not for medical purposes; miners' lamps; electric lamps; chandeliers; filaments for electric lamps; lamp reflectors; vehicle reflectors; lamp casings; sockets for electric lights; lighting apparatus and installations; lighting apparatus for vehicles; anti-dazzle devices for automobiles [lamp fittings]; diving lights; light diffusers; lamps; standard lamps; ceiling lights; light-emitting diodes [led] lighting apparatus; lighting installations for air vehicles; lamp glasses; discharge tubes, electric, for lighting; lamp chimneys; luminous tubes for lighting; headlights for automobiles; vehicle headlights; automobile lights; bicycle lights; lights for vehicles; pocket searchlights; lanterns for lighting.

(260) AM 2017 89496 A
 (800) 1240945
 (891) 2016 10 25
 (731) KNAUF GIPS KG
 Am Bahnhof 7, 97346 Iphofen, Germany

(540)

Cleaneo

(511)

17 – Packing, stopping and insulating materials; insulating board and insulating boards; insulation board; acoustic tiles (insulating materials); acoustic tiles for ceilings (insulating materials).

19 – Building materials, not of metal; building panels, not of metal; non-metallic building boards having insulating properties.

(260) AM 2017 89497 A
 (800) 1246028
 (891) 2016 06 01
 (731) FIDIA FARMACEUTICI S.P.A.
 Via Ponte della Fabbrica, 3/A, I-35031
 Abano Terme (PD), Italy

(540)

Хаймовис

(591) Black, white

(511)

5 – Pharmaceutical and veterinary preparations; surgical and medical devices for the treatment of traumatic and degenerative joint pathologies and for orthopaedic surgery; hygienic products for medical purposes; dietetic substances for medical use; food for babies; plasters; materials for dressings; disinfectants.

10 – Surgical, medical, dental and veterinary apparatus and instruments; orthopaedic articles; suture materials; syringes and cannulae; applicators and medical devices for the administration of pharmaceutical preparations.

(260) AM 2017 89498 A
 (800) 1252556
 (891) 2016 10 27
 (731) OTSUKA PHARMACEUTICAL CO., LTD.
 2-9, Kanda-Tsukasamachi, Chiyoda-ku,
 Tokyo 101-8535, Japan

(540)

ONMETIO

(591) Black, white

(511)

5 – Pharmaceutical compositions for treating cancer and immune disorders; pharmaceutical preparations.

(260) AM 2017 89500 A
 (800) 1317875
 (891) 2016 04 10
 (731) GUANGZHOU YAKOO CHEMICAL CO., LTD.
 No. 13 Xinghua East Road, Tanbu Town,
 Huadu District, Guangzhou City,
 Guangdong Province, China

(540)



(591) black and white

(511)

2 – Paints; silver paste; badigeon; wood coatings [paints]; undercoating for vehicle chassis; thinners for paints; coatings [paints]; mastic [natural resin].

(260) AM 2017 89501 A
 (800) 1317903
 (891) 2016 06 14
 (731) BAYER OY
 P.O. Box 415, FI-20101 Turku, Finland

(540)



(591) Lilac and green

(511)

5 – Pharmaceutical preparations, namely, hormonal preparations for contraceptive use.

10 – Medical devices, namely, intrauterine devices for contraceptive use.

(260) AM 2017 89502 A

(800) 1317912

(891) 2016 07 27

(731) MENARINI INTERNATIONAL OPERATIONS LUXEMBOURG S.A.
1, avenue de La Gare, L-1611 Luxembourg, Luxembourg

(540)



(591) Red, grey and blue

(511)

5 – Anti-inflammatories; anti-inflammatory preparations; analgesics; pain relief preparations.

(260) AM 2017 89503 A

(800) 1317919

(891) 2016 07 08

(731) ACM
17 Rue de Neuilly – Impasse Passoir, F-92110 CLICHY, France

(540)



(591) black and white

(511)

3 – Soaps; essential oils, cosmetics; gels, creams, milks, lotions, pomades and cosmetic preparations for skin care; hair lotions; astringents for cosmetic

use; balms other than for medical use; cosmetic skin-tanning preparations; hair lotions; shampoos; dry shampoos; cosmetic creams; make-up removing products; oils for cosmetic use; oils for toilet purposes; almond milk for cosmetic use; cleansing milk for toilet purposes; lotions for cosmetic use.

(260) AM 2017 89504 A

(800) 1317951

(891) 2016 08 30

(731) SCHÜLKE & MAYR GMBH
Robert-Koch-Strasse 2, 22851 Norderstedt, Germany

(540)

OCTENISAN

(511)

3 – Antimicrobial body wash lotions for non-medical purposes; single-use wash mitts soaked with cleaning solutions; single-use wash caps soaked with cleaning solutions.

5 – Antimicrobial body wash lotions for medical purposes; single-use wash mitts soaked with cleaning solutions having antimicrobial effect; single-use wash mitts soaked with cleaning solutions having prophylactic effect; single-use wash mitts soaked with cleaning solutions having decontaminating effect; single-use wash caps soaked with cleaning solutions having antimicrobial effect; single-use wash caps soaked with cleaning solutions having prophylactic effect; single-use wash caps soaked with cleaning solutions having decontaminating effect.

(260) AM 2017 89505 A

(800) 1317995

(891) 2016 09 06

(731) ARC HOLDINGS
104 avenue du Général de Gaulle, F-62510 ARQUES, France

(540)

Luminarc

(591) dark blue, purple

(511)

8 – Hand-operated hand tools and implements; cutlery; table forks; spoons; side arms, other than firearms; hand-operated hand tools.

21 – Kitchen utensils; containers for household use; kitchen containers; glass, unworked or semi-worked, except building glass; porcelain ware; earthenware; bottles; works of art of porcelain, ceramic, earthenware or glass; statuettes of porcelain, ceramic, earthenware or glass; figurines (statuettes) of porcelain, ceramic, earthenware or glass; glasses (receptacles); tableware.

(260) AM 2017 89506 A
 (800) 1317996
 (891) 2016 09 20
 (731) C.F.E.B. SISLEY
 16, avenue George V, F-75008 PARIS,
 France
 (540)



sisley

(591) gold and white
 (511)
 3 – Soaps, perfumery products, essential oils, cosmetics, hair lotions.

(260) AM 2017 89508 A
 (800) 1318005
 (891) 2016 09 21
 (731) FLEXFOR S.R.L.
 Corso della Repubblica, 19, I-47121 FORLI
 (FC), Italy
 (540)

DORELAN

(511)
 20 – Mattresses, cushions, furniture.
 24 – Bed blankets, quilts, mattress covers.

(260) AM 2017 89509 A
 (800) 1318069
 (891) 2016 04 21
 (731) DYRDIN SERGIY
 vul. Simferopolska, 11, korp. 2, kv. 58,
 m. Dnipropetrovsk 49005, Ukraine
 (540)



(591) Indigo and blue
 (511)
 11 – Steam accumulators; heat accumulators; framework of metal for ovens; acetylene generators; acetylene burners; swimming pool chlorinating apparatus; bidets; bath tubs; heaters for baths; bath fittings; hot air bath fittings; bath installations; spa baths [vessels]; bath tubs; taps [faucets]; faucets for pipes (Am.); fans [air-conditioning]; fans [parts of air-

conditioning installations]; electric fans for personal use; ventilation [air-conditioning] installations for vehicles; ventilation [air-conditioning] installations and apparatus; kilns; kiln furniture [supports]; evaporators; ventilation hoods; extractor hoods for kitchens; refrigerating containers; water sterilizers; filters for drinking water; pressure water tanks; whirl-pool-jet apparatus; water conduits installations; water heaters [apparatus]; water intake apparatus; water softening apparatus and installations; water heaters; water purification installations; water purifying apparatus and machines; water supply installations; water distribution installations; flushing tanks; flushing apparatus; flushing tanks; water filtering apparatus; regulating accessories for water or gas apparatus and pipes; safety accessories for water or gas apparatus and pipes; regulating and safety accessories for gas apparatus; gas lighters; gas boilers; gas burners; brackets for gas burners; gas condensers, other than parts of machines; gas lamps; gas scrubbers [parts of gas installations]; gas scrubbing apparatus; regulating and safety accessories for gas pipes; hot air apparatus; hot air bath fittings; hydrants; heaters, electric, for feeding bottles; hearths; stoves; disinfectant apparatus; deodorising apparatus, not for personal use; ornamental fountains; chimney flues; stills; distillation apparatus; distillation columns; showers; shower cubicles [enclosures (Am.)]; electrically heated carpets; heating cushions [pads], electric, not for medical purposes; roasters; griddles [cooking appliances]; flues for heating boilers; feeding apparatus for heating boilers; loading apparatus for furnaces; lighters; humidifiers for central heating radiators; coils [parts of distilling, heating or cooling installations]; mixer taps for water pipes; apparatus for dehydrating food waste; ash pits for furnaces; watering installations, automatic; ionization apparatus for the treatment of air or water; heating installations; refrigerating chambers; hot air ovens; oxyhydrogen burners; pocket warmers; sanitary apparatus and installations; level controlling valves in tanks; air valves for steam heating installations; thermostatic valves [parts of heating installations]; glue-heating appliances; blankets, electric, not for medical purposes; fire bars; air conditioning apparatus; fireplaces, domestic; air conditioners for vehicles; drying apparatus for fodder and forage; faucets for pipes (Am.); drip irrigation emitters [irrigation fittings]; cooking rings; kitchen ranges [ovens]; cookers; ice boxes; hot plates; air reheaters; anti-splash tap nozzles; heating installations [water]; heaters for vehicles; heating apparatus; heating apparatus, electric; heating apparatus for solid, liquid or gaseous fuels; heating boilers; boiler pipes [tubes] for heating installations; coolers for furnaces; fuel economisers; burners; germicidal burners; burners for lamps; steam generating installations; steam facial apparatus [saunas]; boilers, other than parts of machines; steam boilers, other than parts of machines; pasteurisers;

washers for water taps; furnaces, other than for laboratory use; fittings, shaped, for furnaces; oven fittings made of fireclay; urinals [sanitary fixtures]; air deodorising apparatus; air purifying apparatus and machines; air conditioning installations; air cooling apparatus; air filtering installations; air sterilisers; air driers; laundry dryers, electric; radiators [heating]; radiator caps; radiators, electric; sinks; heat regenerators; regulating and safety accessories for water apparatus; dampers [heating]; refrigerators; expansion tanks for central heating installations; sauna bath installations; pressure cooking saucepans, electric; incinerators; solar thermal collectors [heating]; solar furnaces; drying apparatus; desiccating apparatus; hair driers; drying apparatus and installations; hand drying apparatus for washrooms; heat pumps; heat exchangers, not parts of machines; friction lighters for igniting gas; pipes [parts of sanitary installations]; toilets [water-closets]; toilet bowls; toilets, portable; Turkish bath cabinets, portable; wash-hand basins [parts of sanitary installations]; installations for processing nuclear fuel and nuclear moderating material; filters for air conditioning; fountains; central heating radiators; fruit roasters; bath installations.

17 – Reinforcing materials, not of metal, for pipes; cellulose acetate, semi-processed; balata; canvas hose pipes; slag wool [insulator]; cotton wool for packing [caulking]; substances for insulating buildings against moisture; waterproof packings; stuffing rings; plastic fibers [fibres], not for textile use; vulcanized fiber; fiberglass for insulation; carbon fibers [fibres], other than for textile use; flexible hoses, not of metal; rubber stoppers; rubber material for recapping tires [tyres]; rubber sleeves for protecting parts of machines; gutta-percha; dielectrics [insulators]; elastic threads, not for use in textiles; junctions, not of metal, for pipes; connecting hose for vehicle radiators; floating anti-pollution barriers; insulators for railway tracks; lute; sealant compounds for joints; expansion joint fillers; draught excluder strips; soundproofing materials; insulators; insulators for electric mains; foils of metal for insulating; insulating felt; insulating plaster; insulating paper; duct tapes; insulating varnish; insulating materials; insulating oils; insulating gloves; insulating bands; insulating fabrics; insulating paints; rubber, raw or semi-worked; latex [rubber]; foam supports for flower arrangements [semi-finished products]; rings of rubber; gaskets; clack valves of rubber; valves of India-rubber or vulcanized fiber [fibre]; self-adhesive tapes, other than stationery and not for medical or household purposes; caulking materials; bark coverings for sound insulation; boiler composition to prevent the radiation of heat; adhesive bands, other than stationery and not for medical or household purposes; asbestos sheets; foil of regenerated cellulose, other than for wrapping; pipe jackets, not of metal; clutch linings; padding materials of rubber or

plastics; brake lining materials, partly processed; compositions to prevent the radiation of heat; threads of rubber, not for use in textiles; soldering threads of plastic; threads of plastic materials, not for textile use; washers of rubber or vulcanized fiber [fibre]; plastic substances, semi-processed; plastic film, other than for wrapping; watering hose; asbestos cloth; artificial resins [semi-finished products]; mica, raw or partly processed; stops of rubber; non-conducting materials for retaining heat; asbestos fabrics; insulating oil for transformers; joint packings for pipes; fittings, not of metal, for compressed air lines; shock-absorbing buffers of rubber; filtering materials [semi-processed foams or films of plastic]; ebonite molds; chemical compositions for repairing leaks; asbestos millboards; hoses of textile material; cords of rubber; asbestos safety curtains.

19 – Swimming pools [structures], not of metal; bird baths [structures], not of metal; diving boards, not of metal; refractory construction materials, not of metal; water-pipe valves, not of metal or plastic; drain traps [valves], not of metal or plastic; water-pipes, not of metal; clay; calcareous marl; potters' clay; fireclay; potters' clay [raw material]; earth for bricks; chimney cowls, not of metal; chimneys, not of metal; chimney shafts, not of metal; lengthening pieces, not of metal, for chimneys; drain pipes, not of metal; safety glass; outdoor blinds, not of metal and not of textile; stone; cornices, not of metal; tiles, not of metal, for building; floor tiles, not of metal; quartz; sandstone pipes; chimney pots, not of metal; stained-glass windows; agglomerated cork for building; raw chalk; building materials, not of metal; mosaics for building; penstock pipes, not of metal; partitions, not of metal; floors, not of metal; props, not of metal; slabs, not of metal, for building; luminous paving blocks; busts of stone, concrete or marble; building panels, not of metal; gutter pipes, not of metal; roof gutters, not of metal; silver sand; statues of stone, concrete or marble; ceilings, not of metal; wall tiles, not of metal; cladding, not of metal, for building; building glass; ducts, not of metal, for ventilating and air-conditioning installations; rigid pipes, not of metal, for building; tufa; works of art of stone, concrete or marble; bricks; artificial stone; linings, not of metal, for building.

40 – Custom assembling of materials for others; tin plating; metal treating; metal tempering; metal treating.

(260) AM 2017 89550 A

(800) 1318602

(891) 2016 03 20

(731) TIME FACTORY (SHENZHEN) CO., LTD
2/F B1 Dong Jiaotou Industrial Area,
Hou Hai Road, Shekou, Nanshan District,
Shenzhen, Guangdong, China

(540)

GRAYTON

(591) Black, white

(511)

14 – Precious metals, unwrought or semi-wrought; boxes of precious metal; jewelry; ornaments (jewelry); pocket watch; cases for watches; chronometrical instruments; chronometers; wrist watches; clocks.

(260) AM 2017 89553 A

(800) 1319255

(891) 2016 08 18

(731) ASTELLAS PHARMA INC.

5-1, Nihonbashi-Honcho 2-chome, Chuo-ku
Tokyo 103-8411, Japan

(540)

Суглат

(591) Black, white

(511)

5 – Pharmaceutical preparations for the treatment of diabetes.

(260) AM 2017 89565 A

(800) 1319393

(891) 2016 03 29

(731) WORLD MEDICINE İLAÇ SANAYİ VE TİCARET ANONİM ŞİRKETİ

Evren Mah. Camiyolu Cad. No.50 Kat 1 B,
Zemin 4-5-6, Güneşli/Bağcılar, İstanbul, Turkey

(540)

**ENTEFIL
ЭНТЕФИЛ**

(591) Black, white

(511)

5 – Medicines for human purposes, medicines for veterinary purposes, vitamin preparations, chemical preparations for medical purposes, dietetic substances adapted for medical use; dietetic foods adapted for medical purposes; baby foods, medicinal herbs, herbal beverages adapted for medical purposes, nutritional supplements, pollen dietary supplements, mineral food supplements, protein dietary supplements; dietary supplements for animals; fodder supplements for veterinary purposes; medicines for dental purposes, hygienic products for medical purposes including sanitary pads, breast-nursing pads and bunion pads, waddings for medical purposes, plasters for medical purposes, dressings for medical purposes, babies' napkins, preparations for destroying noxious plants, preparations for destroying noxious animals, fungicides, deodorants other than for human beings or for animals, air deodorising pre-

parations, disinfectants for hygiene purposes, antiseptics, detergents for medical purposes.

(260) AM 2017 89566 A

(800) 1319407

(891) 2016 03 29

(731) WORLD MEDICINE İLAÇ SANAYİ VE TİCARET ANONİM ŞİRKETİ

Evren Mah. Camiyolu Cad. No.50 Kat 1 B,
Zemin 4-5-6, Güneşli, Bağcılar, İstanbul,
Turkey

(540)

**SPENTEN
СПЕНТЕН**

(591) Black, white

(511)

5 – Medicines for human purposes, medicines for veterinary purposes, vitamin preparations, chemical preparations for medical purposes, dietetic substances adapted for medical use; dietetic foods adapted for medical purposes; baby foods, medicinal herbs, herbal beverages adapted for medical purposes, nutritional supplements, pollen dietary supplements, mineral food supplements, protein dietary supplements; dietary supplements for animals; fodder supplements for veterinary purposes; medicines for dental purposes, hygienic products for medical purposes including sanitary pads, breast-nursing pads and bunion pads, waddings for medical purposes, plasters for medical purposes, dressings for medical purposes, babies' napkins, preparations for destroying noxious plants, preparations for destroying noxious animals, fungicides, deodorants other than for human beings or for animals, air deodorising preparations, disinfectants for hygiene purposes, antiseptics, detergents for medical purposes.

(260) AM 2017 89571 A

(800) 1318681

(891) 2016 02 29

(731) RTL Group Deutschland Markenverwaltungs GmbH

Picassoplatz 1,50679 Köln, Germany

(540)



(591) Red, yellow, blue and white.

(511)

9 – Recorded content; information technology apparatus; audiovisual apparatus; magnets; magnetizers; demagnetisers; apparatus for electricity; instruments for electricity; cables for electricity; optical devices; optical equipment; amplifying apparatus; correctors; fuse apparatus; safety apparatus; protective appa-

ratus; signal appliances; safety equipment; safety equipment; protective gear; signalling equipment; apparatus for navigation; orientation apparatus; location tracking apparatus; target trackers; mapping equipment; measuring instruments; detection instruments; surveillance instruments; meteorology apparatus; detection devices; monitoring apparatus; measurement rulers; detection regulators; monitoring controllers; apparatus for scientific research; apparatus for scientific laboratories; teaching apparatus; instrumentation simulators; parts for all of the aforesaid goods included in this class; accessories for all of the aforesaid goods, included in this class; optical apparatus; apparatus for recording of sound or images; apparatus for transmission of sound or images; apparatus for the reproduction of sound or images; video-on-demand (VOD) apparatus; apparatus for other on-demand services; pay TV apparatus; apparatus for interactive television viewing; apparatus for teleshopping; cinematographic apparatus; cameras; mechanisms for coin-operated apparatus, included in this class; computer software; recording discs; compact discs; DVDs; optical storage discs (sound and images), all the aforesaid goods in recorded and blank form.

16 – Works of art and figurines of paper and cardboard, and architects' models; paper decorations and paper art materials; bags and articles for packaging, wrapping and storage of paper, cardboard or plastics; stationery and educational supplies; adhesives for stationery or household purposes; money holders; disposable paper products; printed matter; paper and cardboard; parts and accessories for all the aforesaid goods, included in this class; books; newspapers; periodicals; paper, cardboard; notepaper, broadsheets, coated paper, coated paper, paper sheets for note taking; signboards of paper or cardboard; place mats of paper; placards of paper; photographs.

38 – Telecommunications services and telecommunications; email services; news agencies; wire service; broadcasting and transmission of television and radio programmes, and transmission of programmes, data and data collections and apps on the internet and other audiovisual media for reception on fixed or mobile terminals; telecommunications in the field of video-on-demand (VOD), interactive television, free TV, pay TV, all the aforesaid services provided using all available means of distribution, in particular terrestrial distribution, distribution via cable, distribution via satellite, DSL, digital distribution; broadcasting of teleshopping programmes; providing access to electronic programme guides on data networks; rental of objects in connection with the providing of the aforesaid services, included in this class; consultancy and information in relation to the aforesaid services, included in this class.

41 – Publishing and reporting; personal development training, education and sport activities; providing of

training; entertainment, namely conducting and presentation of shows, quizzes, music and dance events; organisation of competitions in the fields of training, entertainment and sports; arranging and conducting of cultural, entertainment and sporting events for charitable purposes; talent promotion, namely talent scouting for others by conducting seminars, courses, conferences, training events and shows; advance sale of tickets for cultural and sporting events; conducting prize games; production of television and radio programmes, and of programmes and presentations on media accessible online, in particular the internet and mobile terminals; sporting activities; cultural activities; casting, namely arranging and conducting of shows for cultural and entertainment purposes; screening, hiring and rental of motion pictures, video films and other films.

42 – Design of television and radio programmes, and of programmes and presentations on media accessible online, in particular the internet and mobile terminals.

(260) AM 2017 89573 A

(800) 1318723

(891) 2016 04 07

(731) HEINEKEN ČESKÁ REPUBLIKA, A.S.

U Pivovaru 1, CZ-270 53 Krušovice,
Czech Republic

(540)



(591) Black, white

(511)

21 – Goods from glass included in this class, bottles, drinking glasses, pints, ceramic goblets, ceramic and porcelain coasters, porcelain jugs, vases, plastic jugs, cruets, decanters, coasters, not of paper and other than table linen, cups of paper or plastic, goblets, paper plates, cabarets [trays], bottle gourds, bottle openers, signboards of porcelain or glass, menu card holders, vacuum bottles, thermally insulated containers for food, heat insulated containers for beverages, lunch boxes, coolers.

32 – Non-alcoholic aperitifs, non-alcoholic beverages, beer, beer and non-alcoholic brewed beverages, non-alcoholic beer, shandy, low alcohol beer, malt beer, malt drinks, extracts of hops for making beer, mixed beverages with beer, beer-based beverages, preparations for making beverages, ginger beer, powders for effervescing beverages, essences for making beverages, mineral water, lemonade, juices, energy drinks, effervescing beverages, fruit juice and beverages, syrups for beverages.

43 – Bar services, snack-bars, delicatessens [restaurants], corporate hospitality (provision of food and drink), hotels, hotel reservations, canteens, cafés, consultancy services in the field of food and drink catering, temporary accommodation, providing gourmet services (food and drink catering), accommodation bureaux [hotels, boarding houses], rental of tents, rental of chairs, tables, table linen, glassware, restaurants, pubs, accommodation bureaux [hotels, boarding houses], catering, tapping of beer (serving of beer).

(260) AM 2017 89574 A
 (800) 1318724
 (891) 2016 05 02
 (731) SIRONA Dental Systems GmbH
 Fabrikstr. 31 64625 Bensheim, Germany
 (540)

SPEEDGLAZE

(511)
 5 – Porcelain for dental prostheses; dental mastics; dental lacquer; dental cement; medical adhesives, namely, material for gluing ceramic parts, teeth or parts for teeth or dental prostheses; material for crowns and bridges for dental purposes; dental materials such as ceramics or metal alloys in form of blanks for making models of teeth or parts of teeth; glaze masses for teeth, also in liquid form.

10 – Dental prostheses; shaped parts as model of teeth or parts of teeth.

(260) AM 2017 89577 A
 (800) 1319431
 (891) 2016 04 27
 (731) BIODUE S.P.A.
 Via Lorenzetti, 3/A, I-50028 Tavarnelle
 Val di Pesa (FI), Italy
 (540)

IPOLAC

(511)
 5 – Dietetic food for medical purposes.

(260) AM 2017 89582 A
 (800) 1319475
 (891) 2016 05 16
 (731) WEI NIANYONG
 Group 3 Muguayuan Village, Chengguan
 Town, Nanzhang County, Xiangyang City,
 Hubei, China
 (540)

BAANOOL

(591) Black, white

(511)
 28 – Toys; material for model planes; smart toys; toy vehicles; automatic mahjong table (machine); balls for games; body-building apparatus; skis; ice skates; fishing tackle.

(260) AM 2017 89590 A
 (800) 1318733
 (891) 2016 03 14
 (731) SLOBOZHANSKY SOAP-BOILER LTD.
 vul. Sumskyi Shliakh, 53, s. Podvirky,
 Derhachivskyi r-n, Kharkivska obl. 62371,
 Ukraine
 (540)



(591) Black, white
 (511)
 3 – Laundry bleaching preparations; laundry soaking preparations; preparations and substances for laundry use; preparations and substances for bleaching purposes; capsules for washing laundry; laundry additives; cakes of soap; detergents other than for use in manufacturing operations and for medical purposes; soap; dishwashing detergents; detergents for baths and toilet; fabric softeners for laundry use; refurbishing preparations; pastes for laundry use; hand cleaning preparations; hand cleaning pastes; washing powder; laundry blueing; laundry glaze; laundry preparations; detergents for household use; cleaning preparations; liquid soap; dry shampoos; laundry washing preparations in tablet form; shampoos; shampoos for cleaning of automobiles; hair shampoos and conditioners.

(260) AM 2017 89594 A
 (800) 1318741
 (891) 2016 04 21
 (731) FARDI MEDICALS LLP
 Velocity Tower, 10 St.Mary's Gate,
 SHEFFIELD Sheffield S1 4LS, United
 Kingdom
 (540)



(591) Black, white
 (511)
 3 – Cosmetic oils; cosmetic rouges; pre-moistened cosmetic wipes; artificial nails for cosmetic purposes; cosmetic eye gels; cosmetic eye pencils; cosmetic moisturisers; cosmetic powder; facial cleansers [cosmetic]; facial creams [cosmetic]; facial lotions [cosmetic]; facial moisturisers [cosmetic]; facial

scrubs [cosmetic]; facial toners [cosmetic]; facial washes [cosmetic]; lip coatings [cosmetic]; lip protectors [cosmetic]; mineral oils [cosmetic]; moist wipes impregnated with a cosmetic lotion; moisturising gels [cosmetic]; moisturising skin creams [cosmetic]; moisturising skin lotions [cosmetic]; natural oils for cosmetic purposes; pencils for cosmetic use; self-tanning creams [cosmetic]; self-tanning lotions [cosmetic]; skin balms [cosmetic]; skin care creams [cosmetic]; skin care lotions [cosmetic]; skin cleansers [cosmetic]; skin creams [cosmetic]; tonics [cosmetic]; eyelashes (cosmetic preparations for -); baths (cosmetic preparations for -); cosmetic kits; kits (cosmetic -); pencils (cosmetic -); creams (cosmetic -); jelly (petroleum -) for cosmetic purposes; lotions for cosmetic purposes; oils for cosmetic purposes; lotions (tissues impregnated with cosmetic -); cosmetic preparations for slimming purposes; bath oils for cosmetic purposes; cosmetic hair regrowth inhibiting preparations; cosmetic hand creams; cosmetic nourishing creams; cosmetic oils for the epidermis; cosmetic preparations for body care; cosmetic preparations for nail drying; cosmetic preparations for the hair and scalp; cosmetic products in the form of aerosols for skincare.

(260) AM 2017 89613 A

(800) 1319476

(891) 2016 05 16

(731) KUNMING BAKER NORTON
PHARMACEUTICAL CO., LTD.

Qigongli West suburb, Kunming Yunnan,
China

(540)



(591) Black, white

(511)

5 – Medicines for human purposes; chemico-pharmaceutical preparations; drugs for medical purposes; dietetic foods adapted for medical purposes; dietetic substances adapted for medical use; crude drugs; Chinese medicine nostrum; biochemical drug; tonic (medicines); medicinal drinks.

(260) AM 2017 89614 A

(800) 1319482

(891) 2016 05 16

(731) KENNEDE ELECTRONICS MFG.CO., LTD.

No.21, Jintong Road, Tangxia Town,
Pengjiang District, Jiangmen City,
Guangdong Province, China

(540)



(591) Black, white

(511)

9 – Computer peripheral devices; battery chargers; batteries, electric; plates for batteries; weighing machines; transformers [electricity]; computer programs [downloadable software]; switches, electric; alarms; signal lanterns.

11 – Lamps; lighting apparatus and installations; torches for lighting; fans [air-conditioning]; air purifying apparatus and machines; radiators, electric; air conditioning installations; hair driers; refrigerators; light-emitting diodes [LED] lighting apparatus.

(260) AM 2017 89619 A

(800) 1319493

(891) 2016 06 29

(731) VEKA AG

Dieselstr. 8, 48324 Sendenhorst, Germany

(540)

VEKA Spectral

(511)

17 – Plastic products in the form of profiles, shaped seals for the aforesaid products, semi-finished plastics shaped parts, plastic materials in the form of plates.

19 – Building materials, windows, roller blinds and doors of plastic, plastic window profiles and frames, plastic door profiles and frames and plastic roller blind profiles and frames, folding shutters, roofs, covers and wall coverings of plastic, profiles, seals and plates of plastic, all the aforesaid goods for building; fences, railings, balustrades, floorboards and partitions of plastic, and connectors and fittings therefor, included in this class.

(260) AM 2017 89621 A

(800) 1319533

(891) 2016 04 20

(731) BRAY INTERNATIONAL, INC.

13333 Westland E. Blvd., Houston TX 77041,
USA

(540)



(591) Black, white

(511)

6 – Metal valves not being parts of machines.

(260) AM 2017 89622 A

(800) 1319628

(891) 2016 09 14

(731) ECOMMPAY LIMITED

5th floor, Green Park House 15, Stratton
Street, London W1J 8LQ, United Kingdom

(540)



(591) Blue

(511)

9 – Computer programmes for data processing.

35 – Data processing.

36 – Finance services; online financial transactions; electronic payment services; remote payment services; electronic processing of payments; payment processing; payment administration services.

(260) AM 2017 89625 A

(800) 1319713

(891) 2016 10 19

(731) BEDGEAR, LLC

110 Bi-County Boulevard FARMINGDALE
NY 11735, USA

(540)

PERFORMANCE PILLOW

(526) pillow

(511)

20 – Pillows.

(260) AM 2017 89627 A

(800) 593987

(891) 2016 02 23

(731) PUMA SE

Puma Way 1, 91074 Herzogenaurach,
Germany

(540)



(591) Black, white

(511)

3 – Bleaching preparations and other substances for laundry purposes; cleaning, polishing, scouring and abrasive preparations; soaps; perfumery, essential oils, cosmetics, hair lotions; dentifrices.

(260) AM 2017 89628 A

(800) 599216

(891) 2016 10 31

(731) ALEXANDER BINZEL

Kiesacker 7-9, 35418 Buseck, Germany

(540)



(591) Red, black and white

(511)

9 – Electric soldering blow pipes, electric cutting blow pipes; gas-operated blow pipes (gas-operated electric soldering blow pipes); accessories for these products, namely gas nozzles, flow nozzles, soldering blow pipe couplings for inert gas; apparatus for advancing electrode wires, electrical apparatus for cleaning electric soldering blow pipes, soldering transformers, apparatus for controlling and regulating soldering processes.

(260) AM 2017 89636 A

(800) 1304875

(891) 2016 08 30

(731) HEINEKEN BROUWERIJEN B.V.

Tweede Weteringplantsoen 21, NL-1017
ZD Amsterdam, Netherlands

(540)



(591) White, grey, red, blue, various shades of green

(511)

32 – Beers.

(260) AM 2017 89650 A

(800) 1318900

(891) 2016 07 19

(731) KIDILIZ GROUP

6 bis rue Gabriel Laumain, PARIS, F-75010,
France

(540)



(591) White, zed

(511)

25 – Clothing, t-shirts, thin pullovers, tank tops, shirts, blouses, sweatshirts, vests, cardigans, sweaters, trousers, short and long overalls, shorts and bathing trunks, skirts, dresses, combinations (clothing), bathing suits, jackets; underwear (briefs, undershirts, panties, bodysuits), slippers, socks, tights; lingerie, pajamas, nightgowns, bath robes; bibs, bibs not of paper; footwear (excluding orthopedic footwear), leather and canvas shoes, sneakers, boots, rain boots, sandals, shoes with flexible soles and soles for walking; belts (clothing); headgear, ear muffs, scarves, hats, caps.

(260) AM 2017 89656 A

(800) 1319065

(891) 2016 07 13

(731) REIZIGER PTY LTD

PO Box 1626 Subiaco WA 6904, Australia

(540)

REIZIGER

(511)

1 – Chemical additives for fertilisers; fertilisers; liquid fertilisers; peat (fertiliser); salts (fertilisers); seaweeds (fertilisers); plant nutrients; horticulture growing media; substrates for soil-free growing (agriculture); aquaculture chemicals, except fungicides, herbicides, insecticides and parasiticides; chemical additives for soil; chemical adjuvants for use in horticulture; chemical products for use as fertilizers; chemical products for use in agriculture (other than fungicides, weedkillers, herbicides, insecticides, parasiticides); chemical products for use in horticulture (other than fungicides, weedkillers, herbicides, insecticides, parasiticides); chemically treated peat for use in gardening; chemically treated peat for use in horticulture; chemicals for use in horticulture (other than fungicides, weedkillers, herbicides, insecticides, parasiticides); seaweed extracts for use as a fertilizer; seaweed plant food; planting additives to facilitate rooting; horticultural growing media composts; growth promoters (other than for medical or veterinary use); growth stimulants (other than for medical or veterinary use); plant growth regulators; plant growth stimulants; preparations for promoting the growth of plants; expanded clay for hydroponic plant growing (substrate); coir fibre soil improvers; chlorine-free fertilizers; fertilizers; fertilizers for soil; garden feeds (fertilizers); inorganic fertilizers; mineral fertilizers; multi-nutrient fertilizers; growing media; plant growing media; hydroponic materials; nutrients for flowers; nutrients for plants; growing materials; plant growing substances; chemically treated peat for use in agriculture; mineral preparations for use as nutritional foodstuffs for plants; mineral products for use in growing plants; plant foods; rock fibres for use in horticulture; preparations of trace

elements for plants; trace elements for use in horticulture.

25 – Apparel (clothing, footwear, headgear).

(260) AM 2017 89657 A

(800) 1319075

(891) 2016 07 28

(731) ZÖLLER-KIPPER GmbH

Hans-Zöller-Str. 50-68 55130 Mainz,
Germany

(540)

MEDIUM X4

(511)

7 – Compacting machines or apparatus and loading devices for waste steams, trash and reusable materials, included in class 7, pneumatic-hydraulic lifting devices, namely lifting platforms for motor vehicles and other transportation means, pneumatic-hydraulic working devices on motor vehicles, motor vehicle trailers, trains and air vehicles, pneumatic and/or hydraulic drive units and controllers for tilting equipment; snowplows.

12 – Utility vehicles, namely refuse vehicles, waste collection vehicles, dumpster tippers, tippers for the loading areas of motor vehicles and motor vehicle trailers, municipal vehicles, vans, street cleaning vehicles, sprinkler and washing vehicles and vehicles for washing dustbins and recycling bins; vehicle bodies for refuse vehicles or waste collection vehicles; containers or compacting equipment for use as interchangeable bodies in refuse or waste collection vehicles, in the form of vehicle parts for refuse or waste streams or loading devices for refuse or waste streams.

(260) AM 2017 89662 A

(800) 1319164

(891) 2016 03 17

(731) BB Farma S.r.l.

Viale Europa, 160, I-21017 SAMARATE
(VA), Italy

(540)



(591) Black, white, gzay

(511)

3 – Body cleaning and beauty care preparations; cosmetics and cosmetic preparations; essential oils.

5 – Dietary and nutritional supplements; nutritional supplements; pharmaceutical drugs; chemico-pharmaceutical preparations.

10 – Diagnostic, examination, and monitoring apparatus for medical purposes; pharmaceutical instruments; medical instruments.

35 – Import and export services; business management; retail or wholesale services for pharmaceutical, veterinary and sanitary preparations and medical supplies.

(260) AM 2017 89663 A

(800) 1319172

(891) 2016 05 27

(731) OÜ Good Design

Leiva tn 5, EE-12618 Tallinn, Estonia

(540)



(591) White, black, grey and yellow.

(511)

3 – Grinding preparations; amber (perfume); descaling preparations for household purposes; antistatic preparations for household purposes; aromatics (essential oils); air fragrancing preparations; cake flavorings [essential oils]; flavourings for beverages (essential oils); breath freshening sprays; canned pressurized air for cleaning and dusting purposes; balms other than for medical purposes; lip gloss; polishing stones; abrasive paper; emery paper; polishing paper; vaseline for cosmetic purposes; shoe polishes, creams; shoemakers' wax; cotton wool for cosmetic purposes; sachets for perfuming linen; drying agents for dishwashing machines; adhesives for cosmetic purposes; eau de parfum; potassium hypochlorite, javelle water; lavender water; lotions for cosmetic purposes; laundry wax; parquet floor wax; non-slipping wax for floors; depilatory waxes; moustache wax; tailors' wax; polish for furniture and flooring; shoemakers' wax; polishing wax; massage gels other than for medical purposes; heliotropine; dental bleaching gels; geraniol; make-up preparations; deodorants for pets; deodorants for human beings or for animals; scented wood; perfume; non-slipping liquids for floors; windshield cleaning liquids; greases for cosmetic purposes; volcanic ash for cleaning; perfumery; transfers (decorative -) for cosmetic purposes; ionone (perfumery); shaving stones [astringents]; smoothing stones; eyebrow pencils; cosmetic pencils; silicon carbide [abrasive]; carbides of metal [abrasives]; shaving stones [astringents]; tripoli stone for polishing; eyelashes (adhesives for affixing false -); adhesives for affixing false hair; quillaia bark for washing; corundum (abrasive); beard dyes; colorants for toilet purposes; colour cosmetics; starch for laundry purposes; laundry glaze;

creams for leather; polishing creams; cosmetics in the form of creams; skin whitening creams; cosmetic rouges; incense; hair fixers; nail polish; hair lotions and waters; cosmetic lotions and waters; after shave lotions; beauty masks; oils for perfumes; oils for cosmetic purposes; oils for toilet purposes; essential oils; essential oils of cedarwood; essential oils of lemon; essential oils of lemon tree; oils for cleaning purposes; bergamot oil; gaultheria oil; jasmine oil; lavender oil; almond oil; rose oil; oil of turpentine for degreasing; whitening; cleaning chalk; almond milk for cosmetic purposes; cleansing milk for toilet purposes; musk (perfumery); soaps; disinfectant soaps; deodorant soap; shaving soap; soap for brightening textiles; bar soap, bar soap; medicated soap; antiperspirant soap; soap for foot perspiration; almond soap; mint for perfumery; cosmetic kits; emery; nail art stickers; false nails; cologne; flower perfumes (bases for -); cotton sticks for cosmetic purposes; joss sticks; pastes for razor strops; dentifrice; pumice stone; hydrogen peroxide for cosmetic purposes; breath freshening strips; emery cloth; glass cloth; lipstick; pomades for cosmetic purposes; preparations for use in shaving; cosmetic preparations for baths; toiletries; hair waving preparations; rinsing aids for use when washing clothes; grinding preparations, sharpening preparations, sharpeners; douching preparations for personal sanitary or deodorant purposes (toiletries); smoothing preparations [starching]; color-removing preparations; preparations for skin whitening; polishing preparations; denture polishes; mouthwashes, not for medical purposes; cosmetic preparations for slimming purposes; starch glaze for laundry purposes; polishing preparations; fabric softeners for laundry use, including fabric conditioners; laundry bleaches, including in the form of detergents; dry-cleaning preparations; paint stripping preparations; lacquer-removing preparations; preparations for make-up removal; floor wax remover (washing and scouring preparations); nail polish removing substances; rust removal preparations; nail care preparations; cleaning preparations; preparations for cleaning dentures; wallpaper cleaning preparations; unblocking drain pipes (preparations for -); laundry preparations; aloe vera for cosmetic purposes; sunscreen preparations; color-brightening chemicals for household purposes [laundry]; shining preparations (polish); make-up powder; diamantine (abrasive); stain removing preparations; scouring solutions; false eyelashes; tissues impregnated with cosmetic lotions; safrol; laundry blue; turpentine, for degreasing; potpourris (fragrances); bleaching soda; washing soda, for cleaning; bath salts, not for medical purposes; bleaching salts; fumigation preparations (perfumes); preservatives for leather [polishes]; ammonia [volatile alkali] [detergent]; astringents for cosmetic purposes; eyebrow cosmetics; make-up preparations; cosmetics, sun care preparations; hair dye; neutralizers for permanent

waving; plants (preparations to make shiny the leaves of -); cosmetics preparations for eyelashes; depilatory preparations; cosmetics for use on the skin; shoe wax; creams for shoes; cosmetics; grooming preparations for animals; mascara; detergents other than for use in manufacturing operations and for medical purposes; degreasers other than for use in manufacturing processes; bleaching preparations for cosmetic use; antiperspirants-toiletries; talcum powder, for toilet use; terpenes (essential oils); emery cloth; cloths impregnated with a detergent for cleaning; henna [cosmetic dye]; shampoo; shampoos for pets; dry shampoos; sandpaper; soda lye; extracts of flowers (perfumes); ethereal essences; badian essence; mint essence (essential oil).

(260) AM 2017 89664 A
 (800) 1319180
 (891) 2016 05 31
 (731) KARELIA TOBACCO COMPANY INC.
 Athinon Street, GR-241 00 Kalamata, Greece
 (540)

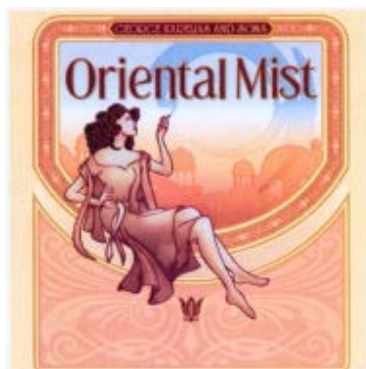

(591) dazk bzown, bzown,ozinge,Light bvlue, Yellow
 (511)
 34 – Tobacco, cigars, cigarettes, e-cigarettes, cigarettos, smokers' articles, ashtrays, cigarette cases, cigarette lighters, cigarette papers and matches.

(260) AM 2017 89665 A
 (800) 1319184
 (891) 2016 06 15
 (731) TEVA PHARMACEUTICAL INDUSTRIES LTD.
 Science Based Industries Campus, Har Hotzvim, P.O. Box 1142 91010 Jerusalem, Israel



(591) Dark blue, real, neon green and dark green

(511)
 5 – Pharmaceutical preparations, medicines, dietetic substances adapted for medical use, dietetic foods adapted for medical purposes, nutritional additives for medical purposes, vitamin preparations, preparations of trace elements, mineral food supplements, bacterial preparations for medical use.

10 – Surgical, medical, dental and veterinary apparatus and instruments.

42 – Research services in the field of pharmaceuticals.

(260) AM 2017 89666 A
 (800) 1319191
 (891) 2016 06 29
 (731) WALMARK, a.s.
 Oldřichovice 44, CZ-739 61 Třinec, Czech Republic
 (540)

VIADERM

(511)
 5 – Pharmaceutical and veterinary preparations, dietetic food and substances adapted for medical or veterinary use, dietary supplements for human and animal consumption.

(260) AM 2017 89668 A
 (800) 1319205
 (891) 2016 06 28
 (731) MDH Management sàrl
 17, Duarrefstrooss, L-9990 Weiswampach, Luxembourg
 (540)



(591) Shades of grey, blue.
 (511)
 37 – Building, construction, installation, maintenance and repair of wind turbines and wind power plants as well as parts and accessories for wind turbines and wind power plants; building, maintenance and repair of power plants; information, advice and consultation regarding the aforesaid services.

(260) AM 2017 89672 A
 (800) 1320418
 (891) 2015 10 23
 (731) BTS ALÜMİNYUM METAL VE PVC AKSESUAR SANAYİ VE TİCARET LİMİTED ŞİRKETİ
 Mermerciler Sanayi Sit. 7.Cad. No:6 Beylikdüzü, Istanbul, Turkey

(540)



(591) Dark blue, light blue, white

(511)

6 – Ores of non-precious metal; common metals and their alloys and semi-finished products made of these materials; goods and materials of common metal used for storage, wrapping, packaging, sheltering and building purposes, containers of metal (storage, transport), fences and transportable buildings made of metal, ladders of metal; doors, windows, shutters, jalousies and their cases and fittings of metal; non-electric cables and wires of metal; ironmongery, small hardware of metal; ventilation ducts, vents, vent covers, pipes, chimney caps, manhole covers, grilles of metal for ventilation, heating, sewage, telephone, underground electricity and air conditioning installations; metal panels or boards (non-luminous and non-mechanical) used for signalling, route showing, publicity purposes, signboards of metal, advertisement columns of metal, signaling panels of metal; pipes of metal for transportation of liquids and gas and their metal fittings, valves of metal, drilling pipes of metal; safes (strong boxes) of metal; metal railway materials; bollards of metal, floating docks of metal, mooring buoys of metal, anchors; metal moulds for casting, other than machine parts; works of art made of common metals or their alloys; metal closures, bottle caps of metal; metal poles; metal pallets and metal ropes for lifting, loading and transportation purposes; metal hangers, ties, straps, tapes and bands used for load-lifting and load-carrying.

(260) AM 2017 89719 A

(800) 1320574

(891) 2016 04 22

(731) Obschestvo s ogranichennoi otvetstvennostyu "SIGMA"

28, prospect Pobedy, Cheljabinskaya oblast,
RU-456604 Kopejsk, Russian Federation

(540)



(591) Brown, dark brown, black, white, red

(511)

29 – Edible fats; margarine; butter; fat-containing mixtures for bread slices; vegetable oils for food; coconut oil.

(260) AM 2017 89720 A

(800) 1320601

(891) 2016 05 18

(731) Salvatore Ferragamo S.p.A.

Via dei Tornabuoni, 2, I-50123 Firenze
(FI), Italy

(540)

FERRAGAMO

(511)

3 – Perfumery; perfumes; eau de parfum; eau de cologne; toilet water; aftershave creams; aftershave lotions; shaving lotions; shaving creams and foams; hair lotions; shampoos; hair conditioners; essential oils for personal use; cosmetics; beauty masks; cold creams; hand creams; body and facial creams; deodorants for personal use; antiperspirants for personal use; skin cleansers; soaps for personal use; toilet soaps; bath soaps; bath and shower foams; bath and shower gel; body oils; body lotions; skin lotions; dentifrices.

9 – Eyeglasses; sunglasses; sports eyewear; lenses, frames, holders, chains, cords and cases for eyeglasses and sunglasses; protective helmets; helmets for motorcyclists; bags, cases and sleeves specially adapted for holding or carrying mobile phones, computers, laptop computers, tablet computers, MP3 players, MP4 players, personal digital assistants, portable media players, digital audio and video players, e-book readers, USB flash drives, headphones, earphones, cameras and video cameras; USB flash drives; lanyards (straps) for mobile phones, MP3 players, MP4 players, cameras, portable media players and digital audio and video players.

14 – Jewellery; imitation jewellery; costume jewellery; earrings; jewelry bracelets; necklaces; jewelry rings; jewelry anklets; pendants; jewelry brooches; jewelry chains; cufflinks; tie pins; boxes of precious metal; jewelry cases; ornamental pins; jewelry ornaments; hat ornaments of precious metal; horological and chronometric instruments; clocks; watches; parts for watches; wristwatches; diving watches; pocket watches; chronometers; chronographs for use as timepieces and for use as watches; watch bands and straps; watch chains; watch cases.

18 – Animal skins and hides; bags; shoulder bags; handbags; boston bags; waist packs; sling bags for carrying infants; shopping bags made of canvas, leather and imitation leather; duffle bags; evening handbags; clutch bags; wallets; purses; leather credit card cases and holders; business card cases; travelling bags; travelling cases of leather; shoe bags for

travel; briefcases; attaché cases; pouches of leather; carrying cases made of leather; school bags; satchels; suitcases; travelling trunks; sports bags; bags and holdalls for sports clothing; garment bags for travel; key cases; backpacks; rucksacks; carry-on bags; wheeled bags; vanity cases sold empty; shaving bags sold empty; beach bags; umbrellas; parasols; walking sticks; whips, harness and saddlery.

25 – Pullovers; cardigans; sweaters; jerseys; jumpers; jackets; sweat shirts; parkas; bathing suits; swimwear; pareos; blouses; shirts; polo shirts; trousers; jeans; waistcoats; blazers; skirts; bermuda shorts; shorts; T-shirts; boleros; dresses; women's dresses; men's suits; women's suits; evening dresses; wedding dresses; wedding suits; cocktail dresses; smoking jackets; tuxedos; coats; blousons; half coats; raincoats; anoraks; down jackets; overcoats; fur coats; fur jackets; tracksuits; overalls; underwear; bathrobes; camisoles; vests; pants; boxer shorts; negligees; brassieres; night gowns; pajamas; dressing gowns; hosiery and panty-hoses; tights; stockings; socks; leg warmers; leggings (trousers); capes; ponchos; sashes for wear; shawls; scarves; neckties; foulards as clothing; bandanas; bow ties; pocket squares; neckerchiefs; gloves as clothing; belts for clothing; braces for clothing; shoes; rain shoes; rain boots; gymnastic shoes; sneakers; boots; half-boots; sandals; flip-flops; slippers; clogs; hats; caps as headwear.

(260) AM 2017 89721 A
(800) 1320605
(891) 2016 05 13
(731) RAVINTORAISIO OY
Raisionkaari 55, FI-21200 Raisio, Finland
(540)



(591) Pink, blue, yellow and white
(511)
29 – Meat; fish; poultry and game; meat extracts; preserved, frozen, dried and cooked fruits and vegetables; jellies; jams; eggs; milk and milk products; edible oils and fats.

30 – Coffee; tea; cocoa; sugar; rice; tapioca; sago; artificial coffee; flour and preparations made from cereals; bread, pastries and confectionery; ice cream; honey; treacle; yeast; baking-powder; salt; mustard; vinegar; sauces [condiments]; spices; edible ices.

31 – Agricultural, horticultural, forestry products and unprocessed cereal seeds, not included in other classes; live animals; fresh fruits and vegetables; seeds, natural plants and flowers.

32 – Beers; mineral and aerated waters and other non-alcoholic beverages; fruit beverages and fruit juices; syrups and other preparations for making beverages.

(260) AM 2017 89722 A
(800) 1320623
(891) 2016 07 15
(731) BAYERISCHE MOTOREN WERKE
AKTIENGESELLSCHAFT
Petuelring 130, 80809 München, Germany
(540)



(591) Black, white
(511)
4 – Industrial oils; industrial greases; lubricants; engine oils; gear oils; petrol additives; additives for fuels for vehicles; fuel for vehicles.

(260) AM 2017 89723 A
(800) 1320638
(891) 2016 06 03
(731) ILKO ILAC SANAYİ VE TİCARET
ANONİM ŞİRKETİ
Veysel Karani Mah, Colakoglu Sok. No: 10,
Kat: 7-8-9 Sancaktepe, Istanbul, Turkey
(540)

CEFDİA

(591) Black, white
(511)
5 – Pharmaceutical and veterinary preparations for medical purposes; chemical preparations for medical and veterinary purposes.

(260) AM 2017 89725 A
(800) 1320641
(891) 2016 07 20
(731) BAYERISCHE MOTOREN WERKE
AKTIENGESELLSCHAFT
Petuelring 130, 80809 München, Germany

(540)



(591) Blue, black, grey, white and silver
(511)

4 – Industrial oils; industrial greases; lubricants; engine oils; gear oils; petrol additives; additives for fuels for vehicles; fuel for vehicles.

(260) AM 2017 89727 A

(800) 1320642

(891) 2016 07 20

(731) BAYERISCHE MOTOREN WERKE
AKTIENGESELLSCHAFT
Petuelring 130, 80809 München, Germany

(540)



(591) Black, white
(511)

4 – Industrial oils; industrial greases; lubricants; engine oils; gear oils; petrol additives; additives for fuels for vehicles; fuel for vehicles.

(260) AM 2017 89729 A

(800) 1320648

(891) 2016 07 15

(731) BAYER INTELLECTUAL PROPERTY
GMBH
Alfred-Nobel-Str. 10, 40789 Monheim am
Rhein, Germany

(540)

Клайра

(591) Black, white
(511)

5 – Pharmaceutical preparations; hormone preparations for medical purposes.

(260) AM 2017 89731 A

(800) 1320690

(891) 2016 08 23

(731) CELGENE CORPORATION

86 Morris Avenue, Summit NJ 07901, USA

(540)

ROVIVZEL

(591) Black, white
(511)

5 – Pharmaceutical preparations for use in the treatment of beta thalassemia and myelodysplastic syndromes, autoinflammatory disease, autoimmune disease, blood disease, cancer, arthritis, musculoskeletal and skin diseases in the fields of oncology, immunology and inflammation; pharmaceutical preparations, namely, cytokine inhibitory drugs; pharmaceutical preparations that modulate the immune system.

(260) AM 2017 89732 A

(800) 1320691

(891) 2016 08 23

(731) CELGENE CORPORATION

86 Morris Avenue, Summit NJ 07901, USA

(540)

CIMLATRI

(591) Black, white
(511)

5 – Pharmaceutical preparations for use in the treatment of beta thalassemia and myelodysplastic syndromes, autoinflammatory disease, autoimmune disease, blood disease, cancer, arthritis, musculoskeletal and skin diseases in the fields of oncology, immunology and inflammation; pharmaceutical preparations, namely, cytokine inhibitory drugs; pharmaceutical preparations that modulate the immune system.

(260) AM 2017 89733 A

(800) 1320692

(891) 2016 08 23

(731) CELGENE CORPORATION

86 Morris Avenue, SUMMIT NJ 07901, USA

(540)

CIZMEDA

(591) Black, white
(511)

5 – Pharmaceutical preparations for use in the treatment of beta thalassemia and myelodysplastic syndromes, autoinflammatory disease, autoimmune disease, blood disease, cancer, arthritis, musculoskeletal and skin diseases in the fields of oncology, immunology and inflammation; pharmaceutical preparations, namely, cytokine inhibitory drugs; pharmaceutical preparations that modulate the immune system.

(260) AM 2017 89804 A

(800) 1321728

(891) 2015 12 10

(731) NEXTEV CO., LTD.
Suite 115, No.569 Anchi Road,
Anting Town, Jiading District, 201805
Shanghai, China

(540)

NEXTEV

(591) Black, white

(511)

12 – Torque converters for land vehicles; cars; motorcycles; motor coaches; shock absorbers for automobiles; crankcases for land vehicle components, other than for engines; gear boxes for land vehicles; motors, electric, for land vehicles; automobile wheels; accumulator vehicles (term considered too vague by the International Bureau – rule 13.2.b) of the Common Regulations).

37 – Motor vehicle maintenance and repair; car wash; anti-rust treatment for vehicles; vehicle service stations [refuelling and maintenance]; vehicle breakdown assistance [repair]; vehicle battery charging; spraying and coating services (term considered too vague by the International Bureau – rule 13.2.b) of the Common Regulations); rubber tire repair; leather care, cleaning and repair; burglar alarm installation and repair.

(260) AM 2017 89805 A
(800) 1321102
(891) 2016 07 07
(731) "KRISTOBAD" LLC
Koryun lane 1, 10 building, 80 basement,
Yerevan, Armenia

(540)



(591) Brown and yellow

(511)

25 – Footwear.

(260) AM 2017 90272 A
(800) 1325708
(891) 2016 08 30
(731) DENKA COMPANY LIMITED
1-1, Nihonbashi-Muromachi 2-chome,
Chuo-ku, Tokyo 103-8338, Japan

(540)

VINI-TAPE

(591) black and white

(511)

17 – Electrical insulating materials; electrical insulating tapes; electrical insulating vinyl chloride adhesive tapes; electrical insulating rubber products; electrical insulating materials in the form of tapes; electrical insulating materials in the form of sheet; electrical insulating materials in the form of adhesive tapes; electrical insulating materials in the form of adhesive sheets.

(260) AM 2017 90275 A
(800) 1325722
(891) 2016 09 23
(731) ANDREAS VETTER
Meersburger Str. 3, 78464 Konstanz, Germany

(540)



(591) black and white

(554) Three-dimensional

(511)

33 – Alcoholic beverages, except beer; alcoholic cocktail mixes; gin; vodka; whisky.

(260) AM 2017 90278 A
(800) 1325811
(891) 2016 05 02
(731) BERKO ILAC VE KIMYA SANAYI A.S.
Yenisehir Mah. Ozgur Sok. No:16-18
Atasehir, Istanbul, Turkey

(540)

Hamazinc

(511)

5 – Pharmaceutical and veterinary preparations for medical purposes; chemical preparations for medical purposes.

(260) AM 2017 90281 A
(800) 1325827
(891) 2016 07 18
(731) MILSING d.o.o.
Velika cesta 99 HR-10020 Zagreb, Croatia

(540)

ERITON

(591) Black, white

(511)

5 – Contraceptive preparations and substances; spermicidal gels, liquids and creams; hygienic lubricants and disinfectants for use in the area of vagina, penis and anus; personal lubricants; lubricants, gels, liquids and creams for sexual health and/or enhancing sexual performance; supplements for sexual health and/or enhancing sexual performance; pharmaceutical preparations and substances all relating to sexual health and/or sexual performance.

10 – Condoms.

(260) AM 2017 90283 A

(800) 1325877

(891) 2016 09 05

(731) "International Masis Tabak" LLC

10, Gortsaranayin street, Industrial zone,
0802 Masis, Ararat Region, Armenia

(540)

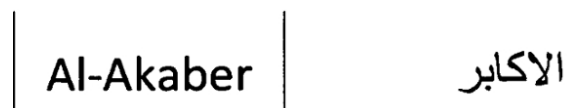

(591) Black, white

(511)

34 – Tobacco; smokers' articles; matches.

(260) AM 2017 90285 A

(800) 1325881

(891) 2016 09 02

(731) Obschestvo s ogranichennoy otvetstvennostyu
"MAY"

Ozernaya, dom 1a, Fryazino, RU-141191
Moskovskaya obl., Russian Federation

(540)



(591) Black, white

(511)

43 – Food and drink catering; café services; cafeteria services; canteen services; restaurant services; self-service restaurant services; snack-bar services; bar services.

(260) AM 2017 90286 A

(800) 1138267

(891) 2016 10 01

(731) JOH. WILH. VON EICKEN GMBH

Drechslerstrasse 1-3, 23556 Lübeck, Germany

(540)

Goldwing

(511)

34 – Tobacco; tobacco products, in particular cigars, cigarettes, cigarillos, smoking tobacco, snuff, water pipe tobacco; cigarette paper; smokers' articles as far as included in this class.

(260) AM 2017 90287 A

(800) 1325895

(891) 2016 11 06

(731) HILLEVI SAPERSTEIN

Unit #393 E, 5100 San Felipe, Houston
TX 77056, USA

(540)



(591) Black, white

(511)

25 – Capri pants; headgear, namely, caps and hats; hosiery; lingerie; t-shirts; underwear; women's clothing, namely, shirts, dresses, skirts, blouses; panties, shorts and briefs.

(260) AM 2017 90288 A

(800) 1141623

(891) 2016 09 01

(731) STEEL COLOR SPA (joint-stock company)

Via per Pieve Terzagni, 15, I-26033
Pescarolo ed Uniti (CR), Italy

(540)



(591) Black, white

(511)

6 – Common metals and their alloys; metal building materials, coverings and metal components for elevators; transportable buildings of metal; ironmongery, small items of metal hardware; pipes and tubes of metal; safes; goods of common metal not included in other classes.

20 – Metal furniture and fittings; street furniture elements made of metal.

40 – Treatment of materials.

(260) AM 2017 90289 A

(800) 1325911

(891) 2016 02 05

(731) Obshchestvo s ogranichennoy

otvetstvennostyou "ARGM"

Leninskii prospect, 4, 1A, RU-119049

Moscow, Russian Federation

(540)

**Agency for Researching of Gas&OilField
Machinebuilding (ARGM)****Агентство развития газонефтепромыслового
машиностроения (АРГМ)**

(591) Black, white

(511)

16 – Printed matter; bookbinding material; photographs; stationery; adhesives for stationery or household purposes; artists' materials; paint brushes; instructional and teaching material (except apparatus); plastic materials for packaging (not included in other classes); printers' type; printing blocks; fountain pens; aquarelles; albums; almanacs; document laminators for office use; mimeograph apparatus and machines; atlases; posters; paper bows; table linen of paper; tickets; forms, printed; announcement cards [stationery]; note books; pads [stationery]; drawing pads; loose-leaf binders; wristbands for the retention of writing instruments; pamphlets; booklets; paper sheets [stationery]; waxed paper; paper for recording machines; paper for radiograms; electrocardiograph paper; drawer liners of paper, perfumed or not; wood pulp paper; carbon paper; copying paper [stationery]; parchment paper; writing paper; luminous paper; Xuan paper for Chinese painting and calligraphy; toilet paper; wrapping paper; filter paper; paper; blotters; newsletters; rollers for typewriters; house painters' rollers; modelling wax, not for dental purposes; signboards of paper or cardboard; patterns for making clothes; patterns for dressmaking; newspapers; electrotypes; hectographs; modelling clay; terrestrial globes; drawing sets; slate pencils; pencil leads; document holders [stationery]; pencil holders; chalk holders; holders for checkbooks [cheque books]; holders for stamps [seals]; diagrams; engraving plates; writing slates; blackboards; galley racks [printing]; drawing boards; advertisement boards of paper or cardboard; duplicators; punches [office requisites]; cream containers of paper; magazines [periodicals]; money clips; tags for index cards; pen clips; bookmarkers; etching needles; tracing needles for drawing purposes; periodicals; printed publications; cardboard articles; paper shredders for office use; graphic representations; credit card imprinters, non-electric; graining combs; drawing instruments; calendars; tracing paper; tracing cloth; tracing patterns; gums [adhesives] for stationery or household purposes; lithographic stones; ink stones [ink reservoirs]; pencils; pencil lead holders; charcoal pencils; pictures; decalcomanias; paintings [pictures], framed or unframed; wood pulp board [stationery]; cardboard; hat boxes of cardboard; files [office requisites]; cards; index cards [stationery]; geographical maps; paper tapes and cards for the recordal of computer programmes; trading cards other than for games; perforated cards for Jacquard looms; catalogues; spools for inking ribbons; covers of paper for flower pots; paintbrushes; painters' brushes; writing

brushes; typewriter keys; glue for stationery or household purposes; isinglass for stationery or household purposes; gluten [glue] for stationery or household purposes; starch paste [adhesive] for stationery or household purposes; books; manifolds [stationery]; comic books; drawing pins; cigar bands; envelopes [stationery]; cases for stamps [seals]; boxes of cardboard or paper; paint boxes [articles for use in school]; correcting fluids [office requisites]; stencils [stationery]; French curves; paper ribbons; typewriter ribbons; gummed tape [stationery]; adhesive bands for stationery or household purposes; correcting tapes [office requisites]; inking ribbons; inking ribbons for computer printers; adhesive tapes for stationery or household purposes; self-adhesive tapes for stationery or household purposes; drawing rulers; square rulers; absorbent sheets of paper or plastic for foodstuff packaging; humidity control sheets of paper or plastic for foodstuff packaging; viscose sheets for wrapping; sheets of reclaimed cellulose for wrapping; plastic bubble packs for wrapping or packaging; steel letters; type [numerals and letters]; lithographs; paint trays; architects' models; postage stamps; plastics for modelling; graphic prints; modelling materials; teaching materials [except apparatus]; sealing compounds for stationery purposes; adhesives [glues] for stationery or household purposes; packaging material made of starches; filtering materials [paper]; addressing machines; pencil sharpening machines, electric or non-electric; bookbinding apparatus and machines [office equipment]; typewriters, electric or non-electric; folders [stationery]; franking machines for office use; chalk for lithography; writing chalk; tailors' chalk; marking chalk; bags [envelopes, pouches] of paper or plastics, for packaging; garbage bags of paper or of plastics; painters' easels; hand-rests for painters; printing sets, portable [office requisites]; bibs of paper; stickers [stationery]; finger-stalls [office requisites]; cords for bookbinding; paper knives [cutters] [office requisites]; numbering apparatus; bottle envelopes of cardboard or paper; sealing wafers; covers [stationery]; passport holders; plastic cling film, extensible, for palletization; embroidery designs [patterns]; handwriting specimens for copying; oleographs; musical greeting cards; greeting cards; postcards; etchings; conical paper bags; bags for microwave cooking; palettes for painters; ink sticks; pantographs [drawing instruments]; folders for papers; papier mâché; pastels [crayons]; modelling paste; pen cases; bookbindings; pen wipers; office perforators; pens [office requisites]; nibs of gold; nibs; steel pens; drawing pens; song books; seals [stamps]; sealing stamps; clipboards; address plates for addressing machines; handkerchiefs of paper; plastic film for wrapping; letter trays; trays for sorting and counting money; coasters of paper; bookends; stamp stands; mats for beer glasses; stands for pens and pencils; photograph stands; inking

pads; stamp pads; binding strips [bookbinding]; towels of paper; inking sheets for document reproducing machines; inking sheets for duplicators; book-binding cloth; gummed cloth for stationery purposes; printers' blankets, not of textile; portraits; paper-weights; writing cases [sets]; inkstands; writing materials; writing instruments; drawing materials; school supplies [stationery]; adhesive tape dispensers [office requisites]; hand labelling appliances; lithographic works of art; prospectuses; printed timetables; ledgers [books]; printers' galleys; indexes; rubber erasers; elastic bands for offices; drawing T-squares; graphic reproductions; penholders; marking pens [stationery]; tissues of paper for removing make-up; face towels of paper; table napkins of paper; place mats of paper; tablemats of paper; tablecloths of paper; paper clasps; document files [stationery]; scrapers [erasers] for offices; paper-clips; staples for offices; erasing products; transparencies [stationery]; stencil plates; cardboard tubes; Indian inks; moisteners [office requisites]; moisteners for gummed surfaces [office requisites]; drawing squares; chart pointers, non-electronic; bottle wrappers of cardboard or paper; envelope sealing machines, for offices; sealing machines for offices; vignetting apparatus; apparatus for mounting photographs; stapling presses [office requisites]; manuals [handbooks]; figurines [statuettes] of papier mâché; paper coffee filters; flags of paper; flyers; silver paper; molds for modelling clays [artists' materials]; photo-engravings; photographs [printed]; stencil cases; canvas for painting; chromolithographs [chromos]; compasses for drawing; numbers [type]; watercolor [water-colour] saucers for artists; correcting ink [heliography]; ink; inkwells; blueprints; rosaries; stencils; erasing shields; balls for ball-point pens; cabinets for stationery [office requisites]; printing type; address stamps; stamps [seals]; shields [paper seals]; prints [engravings]; labels, not of textile.

(260) AM 2017 90293 A
 (800) 1225495
 (891) 2016 11 14
 (731) RAUCH Fruchtsäfte GmbH
 Langgasse 1, A-6830 Rankweil, Austria
 (540)



(591) Yellow and blue
 (511)
 30 – Coffee, tea, cocoa and artificial coffee; coffee based drinks; drinking chocolate; coffee beverages with milk; coffee-based beverages with milk; cappu-

ccino; macchiato; latte-macchiato; iced coffee; rice; tapioca and sago; flour and preparations made from cereals; bread, pastry and confectionery; edible ices; sugar, honey, treacle; yeast, baking-powder; salt; mustard; vinegar, sauces (condiments); fruit sauces; spices; ice; tea-based drinks; tea-based beverages; tea-based beverages; tea-based beverages with fruit flavoring; and tea-based beverages; flavoured tea-based beverages; tea-based beverages.

32 – Beers; mineral and aerated waters; non-alcoholic beverages; fruit beverages and fruit juices; nectars; fruit nectars; fruit nectar beverages; vegetable drinks and vegetable juices; syrups and other preparations for making beverages; energy drinks; lemonades; non-alcoholic beverages, in particular with fruit flavouring; smoothies; flavoured water-based beverages; water-based beverages; coconut juice; coconut water; tomato juice; non-alcoholic beverages made with fruits; non-alcoholic fruit extracts; fruit juice concentrate; cocktails, non-alcoholic; isotonic drinks; must; non-alcoholic aperitifs; non-alcoholic beverages consisting of coconut juice or with coconut juice flavouring or with coconut flavouring; whey beverages; non-alcoholic beverages with fruit flavouring; non-alcoholic beverages containing fruits or fruit extracts; flavoured water-based beverages; non-alcoholic beverages flavoured with tea or tea extracts; coffee-flavoured soft drink; non-alcoholic drinks flavoured with coffee or coffee extracts; non-alcoholic energy drinks flavoured with coffee.

(260) AM 2017 90294 A
 (800) 1226012
 (891) 2016 12 01
 (731) AKZO NOBEL COATINGS
 INTERNATIONAL B.V.
 Velperweg 76, NL-6824 BM Arnhem,
 Netherlands
 (540)

AUTOMATCHIC

(511)
 9 – Spectrophotometers and software for spectrophotometers.

(260) AM 2017 90295 A
 (800) 1325938
 (891) 2016 10 03
 (731) GUERLAIN SOCIETE ANONYME
 68 avenue des Champs-Élysées, F-75008
 PARIS, France
 (540)

TERRACOTTA SUN TRIO

(511)

3 – Perfumes; eau de toilette; eau de parfum; eau de Cologne; soaps; bath or shower gels and salts for cosmetic use; cosmetics for skin, body, face and nail care; creams, milks, lotions, gels and powders for the face, hands and body for cosmetic use; make-up products; body deodorants.

(260) AM 2017 90298 A

(800) 1325943

(891) 2016 09 27

(731) BIOFARMA

Société par actions simplifiée
50 rue Carnot, F-92284 SURESNES cedex,
France

(540)

ДОЛИМ

(591) Black, white

(511)

5 – Pharmaceutical and veterinary products; sanitary products for medical purposes; dietetic food and substances for medical or veterinary use, food for babies; food supplements for humans and animals; plasters, materials for dressings; material for dental fillings and dental impressions; disinfectants; products for destroying vermin; fungicides, herbicides.

(260) AM 2017 90299 A

(800) 1325944

(891) 2016 09 27

(731) BIOFARMA

50 rue Carnot, F-92284 Suresnes cedex,
France

(540)

ДОЛИОН

(591) Black, white

(511)

5 – Pharmaceutical and veterinary products; sanitary products for medical purposes; dietetic food and substances for medical or veterinary use, food for babies; food supplements for humans and animals; plasters, materials for dressings; material for dental fillings and dental impressions; disinfectants; products for destroying vermin; fungicides, herbicides.

INTERNATIONAL TRADEMARKS PROTECTED IN GEORGIA

(260) AM 2017 80883 A

(800) 1234986

(151) 2014 04 29

(181) 2024 04 29

(891) 2014 04 29

(511) 03, 05, 07, 08, 09, 10, 11, 12, 14, 16, 18, 20,
21, 24, 25, 39, 41, 42, 44

(260) AM 2017 82511 A

(800) 1249819

(151) 2015 03 19

(181) 2025 03 19

(891) 2015 03 19

(511) 33

(260) AM 2017 83313 A

(800) 1258763

(151) 2015 04 27

(181) 2025 04 27

(891) 2015 04 27

(511) 01, 02, 16, 17, 19, 35

(260) AM 2016 83888 A

(800) 1264432

(151) 2014 11 13

(181) 2024 11 13

(891) 2014 11 13

(511) 06, 09, 11, 19, 38, 39

(260) AM 2016 83889 A

(800) 1264433

(151) 2014 11 13

(181) 2024 11 13

(891) 2014 11 13

(511) 06, 09, 11, 19, 38, 39

(260) AM 2016 83890 A

(800) 1264434

(151) 2014 11 13

(181) 2024 11 13

(891) 2014 11 13

(511) 06, 09, 11, 19, 38, 39

(260) AM 2016 83891 A

(800) 1264435

(151) 2014 11 13

(181) 2024 11 13

(891) 2014 11 13

(511) 06, 09, 11, 19, 38, 39

(260) AM 2016 83894 A

(800) 1264436

(151) 2014 11 13

(181) 2024 11 13

(891) 2014 11 13

(511) 06, 09, 11, 19, 38, 39

(260) AM 2016 83895 A

(800) 1264437

(151) 2014 11 13

(181) 2024 11 13

(891) 2014 11 13

(511) 06, 09, 11, 19, 38, 39

(260) AM 2017 84575 A

(800) 1271522

(151) 2015 08 25

(181) 2025 08 25

(891) 2015 08 25

(511) 39

(260) AM 2017 84918 A

(800) 1274036

(151) 2015 03 03

(181) 2025 03 03

(891) 2015 03 03

(511) 01, 02, 03, 04, 05, 06, 07, 08, 09, 10, 11, 12,
13, 14, 15, 16, 17, 18, 19, 20, 21, 22, 23, 24,
25, 26, 27, 28, 29, 30, 31, 32, 33, 34, 35, 36,
37, 38, 39, 40, 41, 42, 43, 44, 45

(260) AM 2016 85060 A

(800) 1275579

(151) 2015 08 28

(181) 2025 08 28

(891) 2015 08 28

(511) 05

(260) AM 2016 85741 A

(800) 1282436

(151) 2015 09 03

(181) 2025 09 03

(891) 2015 09 03

(511) 05

(260) AM 2017 85991 A
(800) 1284721
(151) 2015 09 01
(181) 2025 09 01
(891) 2015 09 01
(511) 01, 06, 07, 09, 11, 12, 19, 35, 36, 37, 38, 39,
40, 41, 42, 45

(260) AM 2017 86051 A
(800) 1286258
(151) 2015 10 30
(181) 2025 10 30
(891) 2015 10 30
(511) 07, 12, 37

(260) AM 2017 86221 A
(800) 1287123
(151) 2015 10 22
(181) 2025 10 22
(891) 2015 10 22
(511) 25

(260) AM 2017 87118 A
(800) 1295924
(151) 2015 12 22
(181) 2025 12 22
(891) 2015 12 22
(511) 09, 41

(260) AM 2017 87928 A
(800) 1301964
(151) 2016 02 16
(181) 2026 02 16
(891) 2016 02 16
(511) 29

(260) AM 2017 88033 A
(800) 1302479
(151) 2016 02 06
(181) 2026 02 06
(891) 2016 02 06
(511) 09, 10, 14

(260) AM 2017 88034 A
(800) 1303066
(151) 2016 04 18
(181) 2026 04 18
(891) 2016 04 18
(511) 12, 35

(260) AM 2017 88035 A
(800) 1303071
(151) 2016 04 20

(181) 2026 04 20
(891) 2016 04 20
(511) 05

(260) AM 2017 88037 A
(800) 1303187
(151) 2016 06 02
(181) 2026 06 02
(891) 2016 06 02
(511) 32, 33

(260) AM 2017 88038 A
(800) 566236
(151) 1991 01 29
(181) 2021 01 29
(891) 2016 04 01
(511) 03

(260) AM 2017 88041 A
(800) 880457
(151) 2006 02 23
(181) 2026 02 23
(891) 2016 06 23
(511) 06

(260) AM 2017 88051 A
(800) 1278195
(151) 2015 10 13
(181) 2025 10 13
(891) 2016 05 27
(511) 43

(260) AM 2017 88162 A
(800) 1299897
(151) 2016 02 09
(181) 2026 02 09
(891) 2016 04 18
(511) 05

APPELLATIONS OF ORIGIN

APPELLATIONS OF ORIGIN OF GOODS FILED IN GEORGIA FOR EXAMINATION UNDER LISBON AGREEMENT, ON THE BASIS OF THE INTERNATIONAL REGISTRATION

The decision can be appealed at the Chamber of Appeal of Sakpatenti within 3 months from the publication or at the Mtskheta District Court Administrative Cases Board (Address: №17, Samkhedro str., Mtskheta), within 1 month following the publication.

Number of Indication:1400

Number of International Registration: 1051

Data of International Registration: 2016 03 17

Application Filing Date: 2016 06 06

Appellation of Origin of Goods: **ORVIETO**

The Goods for which the Registration of Appellation of Origin is Required: 33 – Wine.

Name and Address of Applicant: 1. Ministero delle Politiche Agricole, Alimentari e Forestali;
Via XX Settembre 20 – 00187 Roma, Italy;
2. Consorzio tutela dei Vini DOC di Orvieto;
Corso Cavour 36 – 05018 Orvieto, Italy

Number of Indication:1401

Number of International Registration: 1052

Data of International Registration: 2016 03 17

Application Filing Date: 2016 06 06

Appellation of Origin of Goods: **LIMONE DI SIRACUSA**

The Goods for which the Registration of Appellation of Origin is Required: 31 – Fresh Lemons.

Name and Address of Applicant: 1. Ministero delle Politiche Agricole, Alimentari e Forestali;
Via XX Settembre 20 – 00187 Roma, Italy;
2. Consorzio di Tutela del Limone di Siracusa IGP;
Via Teracati 39 – 96100 Siracusa, Italy

Number of Indication:1402

Number of International Registration: 1053

Data of International Registration: 2016 03 17

Application Filing Date: 2016 06 06

Appellation of Origin of Goods: **UMBRIA**

The Goods for which the Registration of Appellation of Origin is Required: 29 – Extra virgin olive oil.

Name and Address of Applicant: 1. Ministero delle Politiche Agricole, Alimentari e Forestali;
Via XX Settembre 20 – 00187 Roma, Italy;
2. Consorzio di Tutela dell'olio extravergine di oliva D.O.P.
Umbria;
Via Arco di Druso 37 – 06049 Spoleto (PG), Italy

Number of Indication:1403

Number of International Registration: 1054

Data of International Registration: 2016 03 17

Application Filing Date: 2016 06 06

Appellation of Origin of Goods: **ARANCIA DI RIBERA**

The Goods for which the Registration of Appellation of Origin is Required: 31 – Oranges.

Name and Address of Applicant:

1. Ministero delle Politiche Agricole, Alimentari e Forestali;
Via XX Settembre 20 – 00187 Roma, Italy;
2. Consorzio di Tutela Arancia di Ribera DOP;
c/o Centro Direzionale per l'Agricoltura –Via Quasimodo –
92016 – Ribera (AG), Italy

Number of Indication:1404

Number of International Registration: 1055

Data of International Registration: 2016 03 17

Application Filing Date: 2016 06 06

Appellation of Origin of Goods: **NOCCIOLA DI GIFFONI**

The Goods for which the Registration of Appellation of Origin is Required: 31 – Hazelnut.

Name and Address of Applicant:

1. Ministero delle Politiche Agricole, Alimentari e Forestali;
Via XX Settembre 20 – 00187 Roma, Italy;
2. Consorzio di Tutela Nocciola di Giffoni I.G.P.;
Via Valentino Fortunato – Zona PIP snc – 84095 GIFFONI
VALLE PIANA (SA), Italy

OFFICIAL NOTIFICATIONS

INVENTIONS

RENEWAL OF PATENTS

(11) P 2007 4025 B

(73) LG LIFE SCIENCES LTD (KR)

(54) **PROCESS FOR PREPARING ACID SALTS OF GEMIFLOXACIN**

DATE OF RENEWAL: 11 09 2017

(11) P 2008 4556 B

(73) Bankinter S.A. (ES)

Kahan de Ahorros de Galicia (ES)

(54) **METHOD FOR OBTAINING CASH AT CARDLESS TELLER MACHINES WITHOUT CARD
USING A PAYMENT ORDER VIA SMS**

DATE OF RENEWAL: 11 09 2017

(11) P 2012 5430 B

(73) Ramzan Goitemirov (GE)

(54) **INTERNAL COMBUSTION ENGINE**

DATE OF RENEWAL: 11 09 2017

(11) P 2013 5743 B

(73) Nora Mamulaishvili (GE)

(54) **METHOD OF WATER SURFACE PURIFICATION FROM OIL AND OIL PRODUCTS**

DATE OF RENEWAL: 11 09 2017

(11) P 2009 4815 B

(73) Nino Kurdadze (GE)

(54) **VEGETATIVE GATHER FOR TREATMENT OF DISEASES OF RESPIRATORY WAYS
AND PHARMACEUTICAL FORMS ON ITS BASIS**

DATE OF RENEWAL: 11 09 2017

(11) P 2011 5355 B

(73) Ramzan Goitemirov (GE);

Aslan Goitemirov (GE)

(54) **INTERNAL COMBUSTION ENGINE**

DATE OF RENEWAL: 11 09 2017

(11) P 2011 5287 B

(73) Ramzan Goitemirov (GE)

(54) **INTERNAL COMBUSTION ENGINE**

DATE OF RENEWAL: 11 09 2017

(11) P 2012 5412 B

(73) Ramzan Goitemirov (GE)

(54) **INTERNAL COMBUSTION ENGINE**

DATE OF RENEWAL: 11 09 2017

(11) P 2008 4412 B

(73) Gela Sulaberidze (GE)

(54) **MEDICAL-PREVENTIVE FOOD COMBINATION AND FOODSTUFF ON ITS BASE**

DATE OF RENEWAL: 11 09 2017

(11) P 2009 4599 B

(73) INTERDIGITAL TECHNOLOGY CORPORATION (US)

(54) **DEVICE FOR TRANSFERRING INFORMATION BETWEEN NETWORK MANAGEMENT ENTITIES OF A WIRELESS COMMUNICATION SYSTEM**

DATE OF RENEWAL: 11 09 2017

(11) P 2004 3287 B

(73) Laboratoires des Produits Ethiques Ethypharm (FR)

(54) **Pharmaceutical Composition Containing Fenofibrate and Method for Its Production**

DATE OF RENEWAL: 11 09 2017

(11) P 2011 5194 B

(73) INTERDIGITAL TECHNOLOGY CORPORATION (US)

(54) **METHOD AND SYSTEM FOR DELIVERY OF ASSISTANCE DATA**

DATE OF RENEWAL: 11 09 2017

(11) P 2010 5135 B

(73) INTERDIGITAL TECHNOLOGY CORPORATION (US)

(54) **METHOD AND DEVICE FOR SIGNALING WLAN NETWORK CONTROL**

DATE OF RENEWAL: 11 09 2017

(11) P 2014 6095 B

(73) EVYAP SABUN YAG GLISERIN SANAYI VE TICARET ANONIM SIRKETI (TR)

(54) **LAYERED ACQUISITION AND DISTRIBUTION COMPONENT**

DATE OF RENEWAL: 11 09 2017

(11) P 2013 5873 B

(73) Manana Shubitidze (GE)

(54) **OINTMENT FOR SKIN SUPPURATIVE DISEASES, WOUNDS AND BURN TREATMENT**

DATE OF RENEWAL: 11 09 2017

(11) P 2013 5874 B

(73) Manana Shubitidze (GE)

(54) **DRUG FOR TUBERCULOSIS (T.B.)**

DATE OF RENEWAL: 11 09 2017

(11) P 2016 6542 B

(73) RICHTER-HELM BIOTEC GMBH & CO. KG (DE)

(54) **RECOMBINANT EXPRESSION OF SOLUBLE INTERFERON**

DATE OF RENEWAL: 11 09 2017

(11) P 2009 4675 B

(73) EURO-CELTIQUE S.A. (LU)

(54) **HETEROARYL- TETRA-HYDROPIPERIDYL COMPOUNDS USEFUL FOR TREATING
OR PREVENTING PAIN**

DATE OF RENEWAL: 11 09 2017

UTILITY MODELS

RENEWAL OF PATENTS

(11) U 2012 1694 Y

(73) Zurab Adamia (GE)

(54) **METHOD OF MEASUREMENT OF ELECTRIC RESISTANCE**

DATE OF RENEWAL: 11 09 2017

(11) U 2016 1898 Y

(73) Giorgi Jighauri (GE)

(54) **METHOD FOR KAKHETIAN TATARA PREPARATION**

DATE OF RENEWAL: 11 09 2017

TRADEMARKS

RENEWAL OF REGISTRATIONS

(111) M 2006 17140 R1
(156) 2017 06 14
(186) 2026 12 14
(732) KMG International N.V.
Strawinskyiaan 807, Tower A-8,
1077XX Amsterdam, Netherlands

(111) M 2007 17579 R1
(156) 2017 07 04
(186) 2027 06 15
(732) GSH TRADEMARKS LIMITED
Afroditis, 25, 2nd floor, office 204, Nicosia,
Cyprus

(111) M 2007 17507 R1
(156) 2017 06 26
(186) 2027 05 08
(732) GENERAL MOTORS LLC
300 Renaissance Center, City of Detroit,
State of Michigan 48265-3000, USA

(111) M 2007 17609 R1
(156) 2017 07 12
(186) 2027 07 12
(732) FORD MOTOR COMPANY
One American Road, Dearborn, Michigan
48126, USA

(111) M 2007 17508 R1
(156) 2017 06 26
(186) 2027 05 08
(732) GENERAL MOTORS LLC
300 Renaissance Center, City of Detroit,
State of Michigan 48265-3000, USA

(111) M 2007 17629 R1
(156) 2017 07 12
(186) 2027 07 12
(732) GSH TRADEMARKS LIMITED
Afroditis, 25, 2nd floor, office 204, Nicosia,
Cyprus

(111) M 2007 17524 R1
(156) 2017 07 04
(186) 2027 05 28
(732) MERCK SHARP & DOHME CORP.
One Merck Drive, Whitehouse Station,
New Jersey 08889, USA

(111) M 2007 17637 R1
(156) 2017 07 12
(186) 2027 07 12
(732) ITALFARMACO SpA
V.le Fulvio Testi 330, 20126 Milan, Italy

(111) M 2007 17545 R1
(156) 2017 06 11
(186) 2027 06 11
(732) DAVIT MAISURADZE
Davit Rektoris q. 21, 2200, Telavi, Georgia

(111) M 2007 17662 R1
(156) 2017 07 25
(186) 2027 07 25
(732) LEO Pharma A/S
Industriparken 55, DK-2750 Ballerup,
Denmark

(111) M 2007 17577 R1
(156) 2017 07 04
(186) 2027 06 15
(732) GSH TRADEMARKS LIMITED
Afroditis, 25, 2nd floor, office 204, Nicosia,
Cyprus

(111) M 2007 17663 R1
(156) 2017 07 25
(186) 2027 07 25
(732) LEO Pharma A/S
Industriparken 55, DK-2750 Ballerup,
Denmark

(111) M 2007 17578 R1
(156) 2017 07 04
(186) 2027 06 15
(732) GSH TRADEMARKS LIMITED
Afroditis, 25, 2nd floor, office 204, Nicosia,
Cyprus

(111) M 2007 17672 R1
(156) 2017 07 25
(186) 2027 07 25
(732) GSH TRADEMARKS LIMITED
Afroditis, 25, 2nd floor, office 204, Nicosia,
Cyprus

(111) M 2007 17673 R1
(156) 2017 07 25
(186) 2027 07 25
(732) GSH TRADEMARKS LIMITED
Afroditis, 25, 2nd floor, office 204, Nicosia,
Cyprus

(111) M 2007 17682 R1
(156) 2017 07 25
(186) 2027 07 25
(732) TRAVELPORT INC.
a Delaware corporation
300 Galleria parkway, Alanta, Georgia
30339, USA

(111) M 2007 17683 R1
(156) 2017 07 25
(186) 2027 07 25
(732) TRAVELPORT INC.
a Delaware corporation
300 Galleria parkway, Alanta, Georgia 3
0339, USA

(111) M 2007 17692 R1
(156) 2017 07 30
(186) 2027 07 30
(732) D-LINK CORPORATION
289, Shinhu 3rd Rd., Neihu District, Taipei
City 114, Taiwan, Province of China

(111) M 2007 17723 R1
(156) 2017 07 30
(186) 2027 07 30
(732) LTD "AVERSI-FARMA"
Davit Agmasheneblis gamz., 148/2, 0112,
Tbilisi, Georgia

(111) M 2007 17724 R1
(156) 2017 07 30
(186) 2027 07 30
(732) LTD "AVERSI-FARMA"
Davit Agmasheneblis gamz., 148/2, 0112,
Tbilisi, Georgia

(111) M 2007 17725 R1
(156) 2017 07 30
(186) 2027 07 30
(732) LTD "AVERSI-FARMA"
Davit Agmasheneblis gamz., 148/2, 0112,
Tbilisi, Georgia

(111) M 2007 17726 R1
(156) 2017 07 30
(186) 2027 07 30
(732) JANSSEN SCIENCES IRELAND UC
Eastgate Village, Eastgate, Little Island,
County Cork, Ireland

(111) M 2007 17727 R1
(156) 2017 07 30
(186) 2027 07 30
(732) JANSSEN SCIENCES IRELAND UC
Eastgate Village, Eastgate, Little Island,
County Cork, Ireland

(111) M 2007 17728 R1
(156) 2017 07 30
(186) 2027 07 30
(732) JANSSEN SCIENCES IRELAND UC
Eastgate Village, Eastgate, Little Island,
County Cork, Ireland

(111) M 2007 17750 R1
(156) 2017 09 18
(186) 2027 09 18
(732) GOCHA GOGILASHVILI
Presis q. 15, 1600, Dedoplistskaro, Georgia

(111) M 2007 17751 R1
(156) 2017 09 18
(186) 2027 09 18
(732) GOCHA GOGILASHVILI
Presis q. 15, 1600, Dedoplistskaro, Georgia

(111) M 2007 17771 R1
(156) 2017 09 18
(186) 2027 09 18
(732) BRIDGESTONE CORPORATION
1-1, Kyobashi 3-Chome, Chuo-ku, Tokyo,
Japan

(111) M 2007 17775 R1
(156) 2017 09 18
(186) 2027 09 18
(732) WYETH LLC
235 East 42nd Street, New York, New York
10017, USA

(111) M 2007 17785 R1
(156) 2017 09 18
(186) 2027 09 18
(732) UNITED PARCEL SERVICE OF
AMERICA, INC.

55 Glenlake Parkway, NE Atlanta, Georgia
30328, USA

Iakob Tsurtavelis q., 54, 1700, Dmanisi,
Georgia

(111) M 2007 17791 R1
(156) 2017 09 18
(186) 2027 09 18
(732) BRISTOL-MYERS SQUIBB HOLDINGS
IRELAND
Hinterbergstrasse 16, 6312 Steinhausen,
Switzerland

(111) M 2007 17830 R1
(156) 2017 09 18
(186) 2027 09 18
(732) "G-M-P" LTD
Zemo Vedzisi St. 103, 0160, Tbilisi, Georgia

(111) M 2007 17792 R1
(156) 2017 09 18
(186) 2027 09 18
(732) BRISTOL-MYERS SQUIBB HOLDINGS
IRELAND
Hinterbergstrasse 16, 6312 Steinhausen,
Switzerland

(111) M 2007 17848 R1
(156) 2017 09 18
(186) 2027 09 18
(732) THE COCA-COLA COMPANY,
a Corporate of the State of Delaware
One Coca-Cola Plaza, Atlanta, Georgia
30313,USA

(111) M 2007 17793 R1
(156) 2017 09 18
(186) 2027 09 18
(732) ABDI İBRAHİM İLAÇ SANAYİ VE
TİCARET ANONİM ŞİRKETİ
Reşitpaşa Mahallesi Eski Büyükdere Caddesi
No:4 34467 Maslak Sarıyer İstanbul, Turkey

(111) M 2007 17868 R1
(156) 2017 09 18
(186) 2027 09 18
(732) YAROSLAV YENİ
Bulvar Druzhby Narodov 8, ap. 52, 01103,
Kyiv, Ukraine

(111) M 2007 17796 R1
(156) 2017 09 18
(186) 2027 09 18
(732) ITALFARMACO SpA
V.le Fulvio Testi 330, 20126 Milan, Italy

(111) M 2007 17921 R1
(156) 2017 10 10
(186) 2027 10 10
(732) "G-M-P" LTD
Zemo Vedzisi Str. 103, 0160, Tbilisi, Georgia

(111) M 2007 17826 R1
(156) 2017 09 18
(186) 2027 09 18
(732) LTD "PSP Pharma"
Iakob Tsurtavelis q., 54, 1700, Dmanisi,
Georgia

(111) M 2007 17922 R1
(156) 2017 10 10
(186) 2027 10 10
(732) "G-M-P" LTD
Zemo Vedzisi Str. 103, 0160, Tbilisi, Georgia

(111) M 2007 17827 R1
(156) 2017 09 18
(186) 2027 09 18
(732) LTD "PSP Pharma"
Iakob Tsurtavelis q., 54, 1700, Dmanisi,
Georgia

(111) M 2007 18017 R1
(156) 2017 11 13
(186) 2027 11 13
(732) HYUNDAI CORPORATION
226, Shinmunro-1ka, Jongno-gu, Seoul,
Republic of Korea

(111) M 2007 17828 R1
(156) 2017 09 18
(186) 2027 09 18
(732) LTD "PSP Pharma"

(111) M 2007 18114 R1
(156) 2017 12 14
(186) 2027 12 14
(732) KENTUCKY FRIED CHICKEN
INTERNATIONAL HOLDINGS, INC.
1441 Gardiner Lane, Louisville, Kentucky,
USA

(111) M 2008 18211 R1
(156) 2018 02 15
(186) 2028 02 15
(732) GOOGLE INC.
1600 Amphitheatre Parkway, Mountain
View, CA 94043, USA

(111) M 2008 18295 R1
(156) 2018 03 17
(186) 2028 03 17
(732) GENERAL MILLS, INC., A DELAWARE
CORPRATION
Number One General Mills Boulevard,
Minneapolis, Minnesota 55426, USA

(111) M 1997 4504 R2
(156) 2017 02 05
(186) 2027 02 05
(732) KOITO MANUFACTURING CO., LTD
4-8-3, Takanawa, Minato-ku Tokyo, Japan

(111) M 1997 4672 R2
(156) 2017 03 06
(186) 2027 03 06
(732) CUMBERLAND PACKING CORP.
2, Cumberland Street, Brooklyn, New York
11205, USA

(111) M 1997 4884 R2
(156) 2017 03 31
(186) 2027 03 31
(732) MERCK SANTE, SAS
37, rue St. Romain, 69008 Lyon, France

(111) M 1997 4978 R2
(156) 2017 04 07
(186) 2027 04 07
(732) Johnson & Johnson;
One Johnson & Johnson Plaza, New
Brunswick, New Jersey 08933, USA

(111) M 1997 4984 R2
(156) 2017 04 07
(186) 2027 04 07
(732) KRAFT FUDS DANMARK
INTELLECTUAL PROPERTY APS
Roskildevej 161, DK-2620 Albertslund,
Denmark

(111) M 1997 5196 R2
(156) 2017 04 25
(186) 2027 04 25

(732) NESTLE SKIN HEALTH S.A.
Avenue Gratta-Paille 2, CH-1018 Lausanne,
Switzerland

(111) M 1997 5307 R2
(156) 2017 05 07
(186) 2027 05 07
(732) RONSON INCORPORATED LIMITED
Station Works, Station Road, Long Buckby,
Northamptonshire NN6 7PF, United
Kingdom

(111) M 1997 5421 R2
(156) 2017 05 30
(186) 2027 05 30
(732) VARTA ALTIENGESELLSCHAFT
Am Leineufer 51, 30419 Hannover, Germany

(111) M 1997 5449 R2
(156) 2017 06 04
(186) 2027 06 04
(732) CARTIER INTERNATIONAL AG
(CARTIER INTERNATIONAL LTD),
(CATRTIER INTERNATIONAL SA)
Hinterbergstrasse 22, Postfach 61, 6312
Steinhausen, Switzerland

(111) M 1997 5466 R2
(156) 2017 06 06
(186) 2027 06 06
(732) CARTIER INTERNATIONAL AG
(CARTIER INTERNATIONAL LTD)
(CATRTIER INTERNATIONAL SA)
Hinterbergstrasse 22, Postfach 61, 6312
Steinhausen, Switzerland

(111) M 1997 5467 R2
(156) 2017 06 06
(186) 2027 06 06
(732) CARTIER INTERNATIONAL AG
(CARTIER INTERNATIONAL LTD)
(CATRTIER INTERNATIONAL SA)
Hinterbergstrasse 22, Postfach 61, 6312
Steinhausen, Switzerland

(111) M 1997 5470 R2
(156) 2017 06 06
(186) 2027 06 06
(732) CARTIER INTERNATIONAL AG
(CARTIER INTERNATIONAL LTD)
(CATRTIER INTERNATIONAL SA)
Hinterbergstrasse 22, Postfach 61, 6312
Steinhausen, Switzerland

(111) M 1997 5658 R2
(156) 2017 06 16
(186) 2027 06 16
(732) LEO Pharma A/S
Industriparken 55, DK-2750 Ballerup,
Denmark

(111) M 1997 5674 R2
(156) 2017 06 19
(186) 2027 06 19
(732) VARTA AKTIENGESELLSCHAFT
Am Leineufer 51, 30419 Hannover,
Germany

(111) M 1997 5769 R2
(156) 2017 06 30
(186) 2027 06 30
(732) Inventio AG
Postfach 6052, Hergiswil, Switzerland

(111) M 1997 5770 R2
(156) 2017 06 30
(186) 2027 06 30
(732) Inventio AG
Postfach 6052, Hergiswil, Switzerland

(111) M 1997 5797 R2
(156) 2017 07 03
(186) 2027 07 03
(732) Berlin-Chemie AG
Glienicke Weg 125, D-12489, Berlin,
Germany

(111) M 1997 5798 R2
(156) 2017 07 03
(186) 2027 07 03
(732) Berlin-Chemie AG
Glienicke Weg 125, D-12489, Berlin,
Germany

(111) M 1997 5799 R2
(156) 2017 07 03
(186) 2027 07 03
(732) Berlin-Chemie AG
Glienicke Weg 125, D-12489, Berlin, Germany

(111) M 1997 5805 R2
(156) 2017 07 03
(186) 2027 07 03
(732) Berlin-Chemie AG
Glienicke Weg 125, D-12489, Berlin, Germany

(111) M 1997 5824 R2
(156) 2017 07 04
(186) 2027 07 04
(732) BRACCO S.P.A.
50, via Egidio Folli, I-20134 Milano, Italy

(111) M 1997 5863 R2
(156) 2017 07 09
(186) 2027 07 09
(732) THE ABSOLUT COMPANY
AKTIEBOLAG
11797 Stockholm, Sweden

(111) M 1997 5864 R2
(156) 2017 07 09
(186) 2027 07 09
(732) THE ABSOLUT COMPANY
AKTIEBOLAG
11797 Stockholm, Sweden

(111) M 1997 5865 R2
(156) 2017 07 09
(186) 2027 07 09
(732) THE ABSOLUT COMPANY
AKTIEBOLAG
11797 Stockholm, Sweden

(111) M 1997 5901 R2
(156) 2017 07 14
(186) 2027 07 14
(732) BOEHRINGER INGELHEIM PHARMA
GMBH & CO. KG
Binger Strasse 173, D-55216 Ingelheim,
Germany

(111) M 1997 5926 R2
(156) 2017 07 15
(186) 2027 07 15
(732) JOHNSON & JOHNSON
One Johnson & Johnson Plaza, New
Brunswick, New Jersey 08933, USA

(111) M 1997 5955 R2
(156) 2017 07 15
(186) 2027 07 15
(732) HERMEN SCHLEIFMITTEL GMBH & CO. KG
Luoper Hauptstrasse 106-122, 22547
Hamburg, Germany

(111) M 1997 5994 R2
(156) 2017 07 22
(186) 2027 07 22

(732) DIAGEO BRANDS B.V.
10-12 Molenwerf, 1014 BG Amsterdam,
Netherlands

(732) BASF SE
Carl-Bosch-Strasse 38, 67056 Ludwigshafen,
Germany

(111) M 1997 6005 R2
(156) 2017 07 22
(186) 2027 07 22

(111) M 1997 6058 R2
(156) 2017 07 23
(186) 2027 07 23

(732) CARTIER INTERNATIONAL AG
(CARTIER INTERNATIONAL LTD)
(CARTIER INTERNATIONAL SA)
Hinterbergstrasse 22, Postfach 61, 6312
Steinhausen, Switzerland

(732) BASF SE
Carl-Bosch-Strasse 38, 67056 Ludwigshafen,
Germany

(111) M 1997 6006 R2
(156) 2017 07 22
(186) 2027 07 22

(111) M 1997 6075 R2
(156) 2017 07 23
(186) 2027 07 23

(732) CARTIER INTERNATIONAL AG
(CARTIER INTERNATIONAL LTD)
(CARTIER INTERNATIONAL SA)
Hinterbergstrasse 22, Postfach 61, 6312
Steinhausen, Switzerland

(732) HUNTSMAN ADVANCED MATERIALS
LICENSING (SWITZERLAND) GMBH
Klybeckstrasse 200, 4057 Basel, Switzerland

(111) M 1997 6033 R2
(156) 2017 07 23
(186) 2027 07 23

(111) M 1997 6101 R2
(156) 2017 07 25
(186) 2027 07 25

(732) BASF SE
Carl-Bosch-Strasse 38, 67056 Ludwigshafen,
Germany

(732) JOHNSON & JOHNSON
One Johnson & Johnson Plaza, New
Brunswick, New Jersey 08933, USA

(111) M 1997 6049 R2
(156) 2017 07 23
(186) 2027 07 23

(111) M 1997 6103 R2
(156) 2017 07 25
(186) 2027 07 25

(732) BASF SE
Carl-Bosch-Strasse 38, 67056 Ludwigshafen,
Germany

(732) JOHNSON & JOHNSON
(a corporation the state of New Jersey);
One Johnson & Johnson Plaza, New
Brunswick, New Jersey, USA

(111) M 1997 6051 R2
(156) 2017 07 23
(186) 2027 07 23

(111) M 1997 6104 R2
(156) 2017 07 25
(186) 2027 07 25

(732) BASF SE
Carl-Bosch-Strasse 38, Ludwigshafen am
Rhein, Germany

(732) JOHNSON & JOHNSON
(a corporation the state of New Jersey)
One Johnson & Johnson Plaza, New
Brunswick, New Jersey, USA

(111) M 1997 6054 R2
(156) 2017 07 23
(186) 2027 07 23

(111) M 1997 6105 R2
(156) 2017 07 25
(186) 2027 07 25

(732) BASF SE
Carl-Bosch-Strasse 38, 67056 Ludwigshafen,
Germany

(732) JOHNSON & JOHNSON
One Johnson & Johnson Plaza, New
Brunswick, New Jersey 08933, USA

(111) M 1997 6057 R2
(156) 2017 07 23
(186) 2027 07 23

(111) M 1997 6127 R2
(156) 2017 07 28
(186) 2027 07 28

(732) MONDELEZ EUROPE GMBH

Lindbergh-Allee 1, 8152 Glattpark, Switzerland	(111) M 1997 6176 R2 (156) 2017 07 30 (186) 2027 07 30 (732) KRAFT FOODS SCHWEIZ HOLDING GMBH Chollerstrasse 4, 6301 Zug, Switzerland
(111) M 1997 6128 R2 (156) 2017 07 28 (186) 2027 07 28 (732) MONDELEZ EUROPE GMBH Lindbergh-Allee 1, 8152 Glattpark, Switzerland	(111) M 1997 6177 R2 (156) 2017 07 30 (186) 2027 07 30 (732) MONDELEZ EUROPE GMBH Lindbergh-Allee 1, 8152 Glattpark, Switzerland
(111) M 1997 6168 R2 (156) 2017 07 29 (186) 2027 07 29 (732) HASBRO, INC. 1027 Newport Avenue, Pawtucket, Rhode Island 02862, USA	(111) M 1997 6178 R2 (156) 2017 07 30 (186) 2027 07 30 (732) MONDELEZ EUROPE GMBH Lindbergh-Allee 1, 8152 Glattpark, Switzerland
(111) M 1997 6170 R2 (156) 2017 07 29 (186) 2027 07 29 (732) HASBRO INTERNATIONAL, INC. 1027 Newport Avenue, Pawtucket, Rhode Island 02862, USA	(111) M 1997 6179 R2 (156) 2017 07 30 (186) 2027 07 30 (732) MONDELEZ EUROPE GMBH Lindbergh-Allee 1, 8152 Glattpark, Switzerland
(111) M 1997 6171 R2 (156) 2017 07 29 (186) 2027 07 29 (732) HASBRO, INC. 1027 Newport Avenue, Pawtucket, Rhode Island 02862, USA	(111) M 1997 6180 R2 (156) 2017 07 30 (186) 2027 07 30 (732) KRAFT FOODS SCHWEIZ HOLDING GMBH Chollerstrasse 4, 6301 Zug, Switzerland
(111) M 1997 6172 R2 (156) 2017 07 29 (186) 2027 07 29 (732) HASBRO INTERNATIONAL, INC. 1027 Newport Avenue, Pawtucket, Rhode Island 02862, USA	(111) M 1997 6181 R2 (156) 2017 07 30 (186) 2027 07 30 (732) COLGATE-PALMOLIVE COMPANY 300 Park Avenue, New York, N.Y. 10022, USA
(111) M 1997 6173 R2 (156) 2017 07 29 (186) 2027 07 29 (732) HASBRO INTERNATIONAL, INC. 1027 Newport Avenue, Pawtucket, Rhode Island 02862, USA	(111) M 1997 6183 R2 (156) 2017 07 30 (186) 2027 07 30 (732) PHARMACIA & UPJOHN COMPANY 7000 Portage Road, Kalamazoo, Michigan 49001, USA
(111) M 1997 6174 R2 (156) 2017 07 29 (186) 2027 07 29 (732) HASBRO INTERNATIONAL, INC. 1027 Newport Avenue, Pawtucket, Rhode Island 02862, USA	(111) M 1997 6225 R2 (156) 2017 08 01 (186) 2027 08 01

(732) EGIS GYOGYSZERGIAR NYRT
30-38 Kereszturi Ut, Budapest, H-1106,
Hungary

(111) M 1997 6265 R2
(156) 2017 08 04
(186) 2027 08 04

(732) THE POLO/LAUREN COMPANY L.P.
650 Madison Avenue, NEW YORK,
NEW YORK 10022, USA

(111) M 1997 6269 R2
(156) 2017 08 04
(186) 2027 08 04

(732) ECCO SKO A/S
Industrivej 5, 6261 Bredebro, Denmark

(111) M 1997 6283 R2
(156) 2017 08 05
(186) 2027 08 05

(732) S.C. JOHNSON & SON, INC.
1525 Howe Street, Racine, Wisconsin
53403-2236, USA

(111) M 1997 6285 R2
(156) 2017 08 05
(186) 2027 08 05

(732) S.C. JOHNSON & SON, INC.
1525 Howe Street, Racine, Wisconsin
53403-2236, USA

(111) M 1997 6291 R2
(156) 2017 08 06
(186) 2027 08 06

(732) DIAVIA S.r.L.
Via Efrem Nobili 2, Molinella (BO), Italy

(111) M 1997 6296 R2
(156) 2017 08 11
(186) 2027 08 11

(732) BASF SE
Carl-Bosch-Strasse 38, 67056 Ludwigshafen,
Germany

(111) M 1997 6297 R2
(156) 2017 08 11
(186) 2027 08 11

(732) BASF SE
Carl-Bosch-Strasse 38, 67056 Ludwigshafen,
Germany

(111) M 1997 6298 R2
(156) 2017 08 11
(186) 2027 08 11
(732) BASF SE

Carl-Bosch-Strasse 38, 67056 Ludwigshafen,
Germany

(111) M 1997 6300 R2
(156) 2017 08 11
(186) 2027 08 11

(732) BASF SE
Carl-Bosch-Strasse 38, 67056 Ludwigshafen,
Germany

(111) M 1997 6307 R2
(156) 2017 08 11
(186) 2027 08 11

(732) THE PILLSBURY COMPANY LLC
Number One General Mills Boulevard,
Minneapolis, Minnesota 55426, USA

(111) M 1997 6308 R2
(156) 2017 08 11
(186) 2027 08 11

(732) THE PILLSBURY COMPANY LLC
Number One General Mills Boulevard,
Minneapolis, Minnesota 55426, USA

(111) M 1997 6309 R2
(156) 2017 08 11
(186) 2027 08 11

(732) THE PILLSBURY COMPANY LLC
Number One General Mills Boulevard,
Minneapolis, Minnesota 55426, USA

(111) M 1997 6319 R2
(156) 2017 08 11
(186) 2027 08 11

(732) VANITY FAIR, INC.
One Fruit of the Loom Drive, Bowling
Green, Kentucky, 42103, USA

(111) M 1997 6337 R2
(156) 2017 08 12
(186) 2027 08 12

(732) KENTUCKY FRIED CHICKEN
INTERNATIONAL HOLDINGS, INC.
1441 Gardiner lane, Louisville, KY 40213, USA

(111) M 1997 6341 R2
(156) 2017 08 12
(186) 2027 08 12

(732) KENTUCKY FRIED CHICKEN
INTERNATIONAL HOLDINGS, INC.
1441 Gardiner lane, Louisville, KY 40213,
USA

(111) M 1997 6361 R2

(156) 2017 08 13

(186) 2027 08 13

(732) JOHNSON & JOHNSON

One Johnson & Johnson Plaza, New
Brunswick, New Jersey 08933, USA

(111) M 1997 6368 R2

(156) 2017 08 14

(186) 2027 08 14

(732) BASF SE

Carl-Bosch-Strasse 38, 67056 Ludwigshafen,
Germany

(111) M 1997 6384 R2

(156) 2017 08 14

(186) 2027 08 14

(732) BAYER CONSUMER CARE AG

Peter Merian-Str. 84, 4052 Basel, Switzerland

(111) M 1997 6460 R2

(156) 2017 08 20

(186) 2027 08 20

(732) TELEDYNE TECHNOLOGIES
INCORPORATED

1049 Camino Dos Rios, Thousand Oaks,
CA 91360, USA

(111) M 1997 6461 R2

(156) 2017 08 20

(186) 2027 08 20

(732) TELEDYNE TECHNOLOGIES
INCORPORATED

1049 Camino Dos Rios, Thousand Oaks,
CA 91360, USA

(111) M 1997 6474 R2

(156) 2017 08 22

(186) 2027 08 22

(732) THE ABSOLUT COMPANY AKTIEBOLAG

11797 Stockholm, Sweden

(111) M 1997 6500 R2

(156) 2017 08 25

(186) 2027 08 25

(732) ASICS CORPORATION

1-1 Minatojima-Nakamachi 7-chome,

Chuo-Ku, Kobe City, Hyogo Prefecture,
Japan

(111) M 1997 6501 R2

(156) 2017 08 25

(186) 2027 08 25

(732) ASICS CORPORATION

1-1 Minatojima-Nakamachi 7-chome, Chuo-Ku,
Kobe City, Hyogo Prefecture, Japan

(111) M 1997 6502 R2

(156) 2017 08 26

(186) 2027 08 26

(732) ASICS CORPORATION

1-1 Minatojima-Nakamachi 7-chome, Chuo-Ku,
Kobe City, Hyogo Prefecture, Japan

(111) M 1997 6503 R2

(156) 2017 08 26

(186) 2027 08 26

(732) ASICS CORPORATION

1-1 Minatojima-Nakamachi 7-chome, Chuo-Ku,
Kobe City, Hyogo Prefecture, Japan

(111) M 1997 6505 R2

(156) 2017 08 26

(186) 2027 08 26

(732) ASICS CORPORATION

1-1 Minatojima-Nakamachi 7-chome, Chuo-Ku,
Kobe City, Hyogo Prefecture, Japan

(111) M 1997 6510 R2

(156) 2017 08 26

(186) 2027 08 26

(732) PARFUMS CARON

99 rue de Faubourg Saint-Honoré, 75008
Paris, France

(111) M 1997 6538 R2

(156) 2017 08 26

(186) 2027 08 26

(732) BULL S.A.S.

Les Clayes Sous Bois, 78340-B.P.68, Rue
Jean Jaures, France

(111) M 1997 6539 R2

(156) 2017 08 26

(186) 2027 08 26

(732) BULL S.A.S.

Les Clayes Sous Bois, 78340-B.P.68, Rue
Jean Jaures, France

(111) M 1997 6540 R2
 (156) 2017 08 26
 (186) 2027 08 26
 (732) EMINENCE (Societe Par Actions
 Simplifíee)
 Route de Gallargues, 30470 Aimargues,
 France

(111) M 1997 6575 R2
 (156) 2017 09 01
 (186) 2027 09 01
 (732) KONINKLIJKE DOUWE EGBERTS B.V.
 Oosterdoksstraat 80, 1011 DK Amsterdam,
 Netherlands

(111) M 1997 6581 R2
 (156) 2017 09 01
 (186) 2027 09 01
 (732) L'OREAL
 14, rue Royale, F-75008 Paris, France

(111) M 1997 6584 R2
 (156) 2017 09 02
 (186) 2027 09 02
 (732) DIAGEO BRANDS B.V.
 Molenwerf 10-12, 1014 BG Amsterdam,
 Netherlands

(111) M 1997 6588 R2
 (156) 2017 09 02
 (186) 2027 09 02
 (732) DIAGEO BRANDS B.V.
 Molenwerf 10-12, 1014 BG Amsterdam,
 Netherlands

(111) M 1997 6589 R2
 (156) 2017 09 02
 (186) 2027 09 02
 (732) DIAGEO BRANDS B.V.
 Molenwerf 10-12, 1014 BG Amsterdam,
 Netherlands

(111) M 1997 6590 R2
 (156) 2017 09 02
 (186) 2027 09 02
 (732) DIAGEO BRANDS B.V.
 Molenwerf 10-12, 1014 BG Amsterdam,
 Netherlands

(111) M 1997 6615 R2
 (156) 2017 09 03
 (186) 2027 09 03

(732) HYUNDAI MOTOR COMPANY
 140-2, Kye-Dong, Jongro-ku, Seoul,
 Republic of Korea

(111) M 1997 6617 R2
 (156) 2017 09 03
 (186) 2027 09 03
 (732) BERLIN-CHEMIE AG
 Glienicker Weg 125, D-12489, Berlin,
 Germany

(111) M 1997 6618 R2
 (156) 2017 09 03
 (186) 2027 09 03
 (732) BERLIN-CHEMIE AG
 Glienicker Weg 125, D-12489, Berlin,
 Germany

(111) M 1997 6661 R2
 (156) 2017 09 05
 (186) 2027 09 05
 (732) BACARDI FRANCE
 19 Avenue Michelet-93400 Saint Ouen,
 France

(111) M 1997 6662 R2
 (156) 2017 09 05
 (186) 2027 09 05
 (732) BACARDI FRANCE
 19 Avenue Michelet-93400 Saint Ouen,
 France

(111) M 1997 6663 R2
 (156) 2017 09 05
 (186) 2027 09 05
 (732) BACARDI FRANCE
 19 Avenue Michelet-93400 Saint Ouen,
 France

(111) M 1997 6718 R2
 (156) 2017 09 10
 (186) 2027 09 10
 (732) GENERALE BISCUIT (Société par Actions
 Simplifiée)
 6 Av Réaumur, 92140 klamart, France

(111) M 1997 6726 R2
 (156) 2017 09 10
 (186) 2027 09 10
 (732) YKK CORPORATION
 1, Kanda Izumi-Cho, Chiyoda-Ku, Tokyo,
 Japan

(111) M 1997 6727 R2
 (156) 2017 09 10
 (186) 2027 09 10
 (732) JOHNSON & JOHNSON
 One Johnson & Johnson Plaza, New
 Brunswick, New Jersey 08933, USA

(111) M 1997 6729 R2
 (156) 2017 09 10
 (186) 2027 09 10
 (732) VIMAR S.P.A.
 Viale Vicenza, 14, 36063 Marostica
 (Vicenza), Italy

(111) M 1997 6735 R2
 (156) 2017 09 10
 (186) 2027 09 10
 (732) THE COCA-COLA COMPANY
 One Coca-Cola Plaza, Atlanta, Georgia
 30313, USA

(111) M 1997 6757 R2
 (156) 2017 09 11
 (186) 2027 09 11
 (732) COGNIS IP MANAGEMENT GmbH
 Henkelstrasse 67, 40589 Dusseldorf,
 Germany

(111) M 1997 6772 R2
 (156) 2017 09 11
 (186) 2027 09 11
 (732) CONVATEC INC.
 200 Headquarters Park Drive, Skillman,
 NJ 08558, USA

(111) M 1997 6779 R2
 (156) 2017 09 12
 (186) 2027 09 12
 (732) ASPEN GLOBAL INCORPORATED
 GBS Plaza, Cnr. La Salette & Royal Roads,
 Grand Bay, Mauritius

(111) M 1997 6781 R2
 (156) 2017 09 12
 (186) 2027 09 12
 (732) WESTERN UNION HOLDINGS, INC.
 12500 E. Belford Ave #M12K3, Englewood,
 Colorado 80112., USA

(111) M 1997 6782 R2
 (156) 2017 09 12
 (186) 2027 09 12

(732) WESTERN UNION HOLDINGS, INC.
 12500 E. Belford Ave #M12K3, Englewood,
 Colorado 80112., USA

(111) M 1997 6788 R2
 (156) 2017 09 15
 (186) 2027 09 15
 (732) THE ABSOLUT COMPANY AKTIEBOLAG
 11797 Stockholm, Sweden

(111) M 1997 6789 R2
 (156) 2017 09 15
 (186) 2027 09 15
 (732) THE ABSOLUT COMPANY AKTIEBOLAG
 11797 Stockholm, Sweden

(111) M 1997 6790 R2
 (156) 2017 09 15
 (186) 2027 09 15
 (732) THE ABSOLUT COMPANY AKTIEBOLAG
 11797 Stockholm, Sweden

(111) M 1997 6817 R2
 (156) 2017 09 18
 (186) 2027 09 18
 (732) McCORMICK & COMPANY, INCORPORATED
 18 Loveton Circle, Sparks, Maryland
 21152-6000,
 USA

(111) M 1997 6822 R2
 (156) 2017 09 18
 (186) 2027 09 18
 (732) TOMMY HILFIGER LICENSING B.V.
 Stadhouderskade 6, 1054 ES Amsterdam,
 Netherlands

(111) M 1997 6823 R2
 (156) 2017 09 18
 (186) 2027 09 18
 (732) TOMMY HILFIGER LICENSING B.V.
 Stadhouderskade 6, 1054 ES Amsterdam,
 Netherlands

(111) M 1997 6824 R2
 (156) 2017 09 18
 (186) 2027 09 18
 (732) TOMMY HILFIGER LICENSING B.V.
 Stadhouderskade 6, 1054 ES Amsterdam,
 Netherlands

(111) M 1997 6827 R2 (156) 2017 09 18 (186) 2027 09 18 (732) JOHNSON & JOHNSON One Johnson & Johnson Plaza, New Brunswick, New Jersey 08933, USA	Henkelstrasse 67, 40589 Dusseldorf, Germany
(111) M 1997 6833 R2 (156) 2017 09 19 (186) 2027 09 19 (732) JOHNSON & JOHNSON One Johnson & Johnson Plaza, New Brunswick, New Jersey 08933, USA	(111) M 1997 6905 R2 (156) 2017 09 23 (186) 2027 09 23 (732) JOHNSON & JOHNSON One Johnson & Johnson Plaza, New Brunswick, New Jersey 08933-7001, USA
(111) M 1997 6835 R2 (156) 2017 09 19 (186) 2027 09 19 (732) JOHNSON & JOHNSON One Johnson & Johnson Plaza, New Brunswick, New Jersey 08933, USA	(111) M 1997 6937 R2 (156) 2017 09 25 (186) 2027 09 25 (732) KRAFT FOODS BELGIUM INTELLECTUAL PROPERTY BVBA (SPRL) Brusselsesteenweg 450, 1500 Halle, Belgium
(111) M 1997 6849 R2 (156) 2017 09 19 (186) 2027 09 19 (732) PARFUMS GUY LAROCHE 16 place Vendome, F-75001 Paris, France	(111) M 1997 6955 R2 (156) 2017 09 25 (186) 2027 09 25 (732) HYUNDAI MOTOR COMPANY 140-2, Kye-Dong, Jongro-ku, Seoul, Republic of Korea
(111) M 1997 6871 R2 (156) 2017 09 22 (186) 2027 09 22 (732) COGNIS IP MANAGEMENT GmbH Henkelstrasse 67, 40589 Dusseldorf, Germany	(111) M 1997 6958 R2 (156) 2017 09 25 (186) 2027 09 25 (732) JOHNSON & JOHNSON One Johnson & Johnson Plaza, New Brunswick, New Jersey 08933-7001, USA
(111) M 1997 6874 R2 (156) 2017 09 22 (186) 2027 09 22 (732) COGNIS IP MANAGEMENT GmbH Henkelstrasse 67, 40589 Dusseldorf, Germany	(111) M 1997 6993 R2 (156) 2017 09 30 (186) 2027 09 30 (732) HARRIS CORPORATION, a Delaware corporation 1025 West NASA Blvd., Melbourne, Florida 32919, USA
(111) M 1997 6875 R2 (156) 2017 09 22 (186) 2027 09 22 (732) COGNIS IP MANAGEMENT GmbH Henkelstrasse 67, 40589 Dusseldorf, Germany	(111) M 1997 7001 R2 (156) 2017 09 30 (186) 2027 09 30 (732) PANASONIC CORPORATION 1006, Oaza- Kadoma, Kadoma-shi, Osaka 571-8501, Japan
(111) M 1997 6877 R2 (156) 2017 09 22 (186) 2027 09 22 (732) COGNIS IP MANAGEMENT GmbH	(111) M 1997 7010 R2 (156) 2017 10 01 (186) 2027 10 01 (732) JACK DANIEL'S PROPERTIES, INC., A CORPORATION ORGANIZED AND

EXISTING UNDER THE LAWS OF THE
STATE OF DELAWARE
4040 Civic Center Drive, Suite 528,
San Rafael, California 94903, USA

Avenue Gratta-Paille 2, CH-1018 Lausanne,
Switzerland

(111) M 1997 7013 R2
(156) 2017 10 01
(186) 2027 10 01
(732) COLGATE-PALMOLIVE COMPANY
300 Park Avenue, New York, NY 10022,
USA

(111) M 1997 7243 R2
(156) 2017 10 20
(186) 2027 10 20
(732) ORACLE AMERICA, INC.
500 Oracle Parkway, Redwood Shores,
California 94065, USA

(111) M 1997 7035 R2
(156) 2017 10 02
(186) 2027 10 02
(732) BROWN-FORMAN POLSKA SP. Z.O.O.
Ul. Postepu 21, 02-676, Warsaw, Poland

(111) M 1997 7244 R2
(156) 2017 10 20
(186) 2027 10 20
(732) ORACLE AMERICA, INC.
500 Oracle Parkway, Redwood Shores,
California 94065, USA

(111) M 1997 7069 R2
(156) 2017 10 08
(186) 2027 10 08
(732) CHAMPAGNE LOUIS ROEDERER (CLR)
21 Boulevard Lundy, 51000 Reims, France

(111) M 1997 7256 R2
(156) 2017 10 20
(186) 2027 10 20
(732) TEHALIT GMBH
Seebergstrasse 37, 67716 heltersberg,
Germany

(111) M 1997 7116 R2
(156) 2017 10 09
(186) 2027 10 09
(732) E. REMY MARTIN & C°, A company
incorporated under the Laws of France
20, rue de la Societe Vinicole, 16100
Cognac, France

(111) M 1997 7322 R2
(156) 2017 10 28
(186) 2027 10 28
(732) DIAGEO BRANDS B.V.
Molenwerf 10-12, 1014 BG Amsterdam,
Netherlands

(111) M 1997 7120 R2
(156) 2017 10 09
(186) 2027 10 09
(732) DIAGEO BRANDS B.V.
Molenwerf 10-12, 1014 BG Amsterdam,
Netherlands

(111) M 1997 7337 R2
(156) 2017 10 29
(186) 2027 10 29
(732) DIAGEO BRANDS B.V.
Molenwerf 10-12, 1014 BG Amsterdam,
Netherlands

(111) M 1997 7134 R2
(156) 2017 10 09
(186) 2027 10 09
(732) CONFEDERATION GENERALE DES
PRODUCTEURS DE LAIT DE BREBIS
ET DES INDUSTRIELS DE ROQUEFORT
36, avenue de la Republique, F-12100
Millau, France

(111) M 1997 7350 R2
(156) 2017 11 03
(186) 2027 11 03
(732) BERLIN-CHEMIE AG
Glienicker Weg 125, D-12489, Berlin,
Germany

(111) M 1997 7228 R2
(156) 2017 10 16
(186) 2027 10 16
(732) NESTLE SKIN HEALTH S.A.

(111) M 1997 7351 R2
(156) 2017 11 03
(186) 2027 11 03
(732) BERLIN-CHEMIE AG
Glienicker Weg 125, D-12489, Berlin,
Germany

(111) M 1997 7361 R2
(156) 2017 11 03
(186) 2027 11 03
(732) BERLIN-CHEMIE AG
Glienicke Weg 125, D-12489, Berlin,
Germany

(111) M 1997 7362 R2
(156) 2017 11 03
(186) 2027 11 03
(732) BERLIN-CHEMIE AG
Glienicke Weg 125, D-12489, Berlin,
Germany

(111) M 1997 7363 R2
(156) 2017 11 03
(186) 2027 11 03
(732) BERLIN-CHEMIE AG
Glienicke Weg 125, D-12489, Berlin,
Germany

(111) M 1997 7364 R2
(156) 2017 11 03
(186) 2027 11 03
(732) BERLIN-CHEMIE AG
Glienicke Weg 125, D-12489, Berlin,
Germany

(111) M 1997 7397 R2
(156) 2017 11 05
(186) 2027 11 05
(732) DIAGEO BRANDS B.V.
Molenwerf 10-12, 1014 BG Amsterdam,
Netherlands

(111) M 1997 7399 R2
(156) 2017 11 05
(186) 2027 11 05
(732) NALCO COMPANY
1601 W. Diehl Road, Naperville, Illinois,
USA

(111) M 1997 7400 R2
(156) 2017 11 05
(186) 2027 11 05
(732) NALCO COMPANY
1601 W. Diehl Road, Naperville, Illinois,
USA

(111) M 1997 7586 R2
(156) 2017 11 19
(186) 2027 11 19

(732) ABBOTT GMBH & CO.KG
Max-Planck-Ring 2, 65205 Wiesbaden,
Germany

(111) M 1997 7594 R2
(156) 2017 11 19
(186) 2027 11 19
(732) ABBOTT GMBH & CO.KG
Max-Planck-Ring 2, 65205 Wiesbaden,
Germany

(111) M 1997 7770 R2
(156) 2017 12 08
(186) 2027 12 08
(732) TELEDYNE TECHNOLOGIES
INCORPORATED
1049 Camino Dos Rios, Thousand Oaks,
CA 91360, USA

(111) M 1997 7772 R2
(156) 2017 12 09
(186) 2027 12 09
(732) TELEDYNE TECHNOLOGIES
INCORPORATED
1049 Camino Dos Rios, Thousand Oaks,
CA 91360, USA

(111) M 1998 9174 R2
(156) 2018 05 04
(186) 2028 05 04
(732) MATTEL, INC.
333 Continental Boulevard el Segundo,
CA 90245, USA

(111) M 1998 9175 R2
(156) 2018 05 04
(186) 2028 05 04
(732) MATTEL, INC.
333 Continental Boulevard el Segundo,
CA 90245, USA

(111) M 1998 9176 R2
(156) 2018 05 04
(186) 2028 05 04
(732) MATTEL, INC.
333 Continental Boulevard el Segundo,
CA 90245, USA

COMPLETE TRANSFER OF RIGHTS

(111) M 1998 010128 R1
(732) GRANISSIMO CONSULTORIA
EMPRESARIAL LTDA
Av. Fernando Cerqueira Cesar Coimbra,
100, sala 1 - Pq. Jubran, City of Barueri,
state of São Paulo, Brazil
(770) COMPANIA CACIQUE DE CAFE
SOLUVEL
Rua Hoçacio Sabino Coimbra, No.100,
Londrina, State of Paraná, Brazil
(580) 2017 07 07

(111) M 1998 010400 R1
(732) AVENTISUB INC.
3711 Kennett Pike, Suite 200, Greenville,
Delaware 19807, USA
(770) AVENTIS INC.
3711 Kennett Pike, Suite 200, Greenville,
Delaware 19807, USA
(580) 2017 08 07

(111) M 1998 010400 R1
(732) AVENTIS HOLDINGS INC.
3711 Kennett Pike, Suite 200, Greenville,
Delaware, 19807, USA
(770) AVENTISUB INC.
3711 Kennett Pike, Suite 200, Greenville,
Delaware 19807, USA
(580) 2017 08 07

(111) M 1998 010400 R1
(732) AVENTISUB II INC.
3711 Kennett Pike, Suite 200, Greenville,
Delaware 19807, USA
(770) AVENTIS HOLDINGS INC.
3711 Kennett Pike, Suite 200, Greenville,
Delaware, 19807, USA
(580) 2017 08 07

(111) M 1998 010400 R1
(732) AVENTIS HOLDINGS INC.
3711 Kennett Pike, Suite 200, Greenville,
Delaware, 19807, USA
(770) AVENTISUB II INC.
3711 Kennett Pike, Suite 200, Greenville,
Delaware 19807, USA
(580) 2017 08 07

(111) M 1998 010400 R1
(732) AVENTISUB INC.
3711 Kennett Pike, Suite 200, Greenville,
Delaware 19807, USA
(580) 2017 08 07

(111) M 1998 010929 R1
(732) ZHS IP Worldwide Sàrl
Avenue Reverdil 14, 1260 Nyon,
Switzerland
(770) SPIRITS INTERNATIONAL B.V.
3, rue du Fort Rheinsheim, L-2419,
Luxembourg, Luxembourg
(580) 2017 07 07

(111) M 1998 010930 R1
(732) ZHS IP Worldwide Sàrl
Avenue Reverdil 14, 1260 Nyon,
Switzerland
(770) SPIRITS INTERNATIONAL B.V.
3, rue du Fort Rheinsheim, L-2419,
Luxembourg, Luxembourg
(580) 2017 07 07

(111) M 1998 010931 R1
(732) ZHS IP Worldwide Sàrl
Avenue Reverdil 14, 1260 Nyon, Switzerland
(770) SPIRITS INTERNATIONAL B.V.
3, rue du Fort Rheinsheim, L-2419,
Luxembourg, Luxembourg
(580) 2017 07 07

(111) M 1998 010932 R1
(732) ZHS IP Worldwide Sàrl
Avenue Reverdil 14, 1260 Nyon,
Switzerland
(770) SPIRITS INTERNATIONAL B.V.
3, rue du Fort Rheinsheim, L-2419,
Luxembourg, Luxembourg
(580) 2017 07 07

(111) M 1998 010933 R1
(732) ZHS IP Worldwide Sàrl
Avenue Reverdil 14, 1260 Nyon,
Switzerland
(770) SPIRITS INTERNATIONAL B.V.
3, rue du Fort Rheinsheim, L-2419,
Luxembourg, Luxembourg
(580) 2017 07 07

-
- (111) M 1999 012838 R1
(732) ANF Pet, Inc.
1500 Whitehall Lane, St. Helena,
California 94574, USA
(770) KODO Inc., a California corporation
1500 Whitehall Lane, St. Helena,
California 94574, USA
(580) 2017 08 29
-
- (111) M 1999 012996 R1
(732) BACARDI & COMPANY LIMITED
Aeulestrasse 5, 9490 Vaduz,
Liechtenstein, Liechtenstein
(770) JOHN DEWAR AND SONS LIMITED
1700 London Road, Glasgow G32 8XR,
United Kingdom
(580) 2017 07 07
-
- (111) M 2001 013854 R1
(732) GOWAN GROP PROTECTION LIMITED
Highlands House Basingstoke Road
Spencers Wood Reading, Berkshire, England
RG7 1NT, United Kingdom
(770) GOWAN-COMÉRCIO INTERNACIONAL
E SERVIÇOS LDA
Rua Ivens No. 3 B Dona Mecia Building,
6th Floor, 9000-046 Funchal, Madeira,
Portugal
(580) 2017 08 09
-
- (111) M 2004 015545 R1
(732) LTD "SAQARTVELOS MTSENAREULI
ZETEBIS KOMPANIA QARVA"
Atonelis q.31, 0105, Tbilisi, Georgia
(770) ELGUJA GVILAVA
Petritsis 6, b.62, 0131, Tbilisi, Georgia;
GIORGI BAQRADZE
Ir. Abashidzis q. 29, me-3 sad., b.8,
0179, Tbilisi, Georgia
(580) 2017 08 08
-
- (111) M 2006 016627 R1
(732) GREENME SA
route de l'Allondon 18, 1242 Satigny,
Switzerland
(770) UNITED NATIONAL INVESTMENTS
COMPANY INC.
Trident Chambers, P.O. Box 146, Road
Town, Tortola, British Virgin Islands
(580) 2017 08 10
-
- (111) M 2007 017400 R1
(732) VICURON HOLDINGS LLC
a Delaware limited liability company
235 East 42 Street, New York,
New York 10017-5755, USA
(770) VICURON PHARMACEUTICALS, INC.
235 East 42 Street, New York,
New York 10017-5755, USA
(580) 2017 08 01
-
- (111) M 2008 018430 R
(732) ZHS IP Worldwide Sàrl
Avenue Reverdil 14, 1260 Nyon,
Switzerland
(770) SPIRITS INTERNATIONAL B.V.
3, rue du Fort Rheinsheim, L-2419,
Luxembourg, Luxembourg
(580) 2017 07 07
-
- (111) M 2008 018431 R
(732) ZHS IP Worldwide Sàrl
Avenue Reverdil 14, 1260 Nyon,
Switzerland
(770) SPIRITS INTERNATIONAL B.V.
3, rue du Fort Rheinsheim, L-2419,
Luxembourg, Luxembourg
(580) 2017 07 07
-
- (111) M 2008 018432 R
(732) ZHS IP Worldwide Sàrl
Avenue Reverdil 14, 1260 Nyon,
Switzerland
(770) SPIRITS INTERNATIONAL B.V.
3, rue du Fort Rheinsheim, L-2419,
Luxembourg, Luxembourg
(580) 2017 07 07
-
- (111) M 2008 018433 R
(732) ZHS IP Worldwide Sàrl
Avenue Reverdil 14, 1260 Nyon,
Switzerland
(770) SPIRITS INTERNATIONAL B.V.
3, rue du Fort Rheinsheim, L-2419,
Luxembourg, Luxembourg
(580) 2017 07 07
-
- (111) M 2008 018434 R
(732) ZHS IP Worldwide Sàrl
Avenue Reverdil 14, 1260 Nyon, Switzerland
(770) SPIRITS INTERNATIONAL B.V.
3, rue du Fort Rheinsheim, L-2419,
Luxembourg, Luxembourg
(580) 2017 07 07
-
- (111) M 2008 018435 R
(732) ZHS IP Worldwide Sàrl
Avenue Reverdil 14, 1260 Nyon, Switzerland
-

(770) SPIRITS INTERNATIONAL B.V.
3, rue du Fort Rheinsheim, L-2419,
Luxembourg, Luxembourg
(580) 2017 07 07

(111) M 1996 001848 R2
(732) NOXELL CORPORATION
11050 York Road, Hunt Valley, Maryland
21030-2098, USA
(770) THE PROCTER & GAMBLE COMPANY
One Procter & Gamble Plaza, Cincinnati,
Ohio, USA
(580) 2017 08 08

(111) M 2009 019064 R
(732) AVENTISUB INC.
3711 Kennett Pike, Suite 200, Greenville,
Delaware 19807, USA
(770) AVENTIS INC.
3711 Kennett Pike, Suite 200, Greenville
DE 19807, USA
(580) 2017 08 07

(111) M 2009 019064 R
(732) AVENTIS HOLDINGS INC.
3711 Kennett Pike, Suite 200, Greenville,
Delaware, 19807, USA
(770) AVENTISUB INC.
3711 Kennett Pike, Suite 200, Greenville,
Delaware 19807, USA
(580) 2017 08 07

(111) M 2009 019064 R
(732) AVENTISUB II INC.
3711 Kennett Pike, Suite 200, Greenville,
Delaware 19807, USA
(770) AVENTIS HOLDINGS INC.
3711 Kennett Pike, Suite 200, Greenville,
Delaware, 19807, USA
(580) 2017 08 07

(111) M 2009 019064 R
(732) AVENTIS HOLDINGS INC.
3711 Kennett Pike, Suite 200, Greenville,
Delaware, 19807, USA
(770) AVENTISUB II INC.
3711 Kennett Pike, Suite 200, Greenville,
Delaware 19807, USA
(580) 2017 08 07

(111) M 2009 019064 R
(732) AVENTISUB INC.
3711 Kennett Pike, Suite 200, Greenville,

Delaware 19807, USA
(770) AVENTIS HOLDINGS INC.,
3711 Kennett Pike, Suite 200, Greenville,
Delaware, 19807, USA
(580) 2017 08 07

(111) M 2009 019392 R
(732) LTD "I. ZHORDANIAS SAKHELOBIS
KLINIKA"
Lublianas q.5, 0159, Tbilisi, Georgia
(770) LTD "TBILISIS TSENTRALURI
SAAVADMKOFO"
Lublianas q.5, 0159, Tbilisi, Georgia
(580) 2017 08 08

(111) M 2009 019393 R
(732) LTD "I. ZHORDANIAS SAKHELOBIS
KLINIKA"
Lublianas q.5, 0159, Tbilisi, Georgia
(770) LTD "TBILISIS TSENTRALURI
SAAVADMKOFO"
Lublianas q.5, 0159, Tbilisi, Georgia
(580) 2017 08 08

(111) M 2009 019765 R
(732) INTERNATIONAL DISTRIBUTION
SYSTEMS LIMITED
Tassou Papadopoulou, 6, Flat/office 22,
Agios Dometios, 2373, Nicosia, Cyprus
(770) MAGICTRIP HOLDINGS LIMITED
Ioanni Stylianou, 6, 2nd Floor, Flat/officce
202, P.C. 2003, Nicosia, Cyprus
(580) 2017 08 22

(111) M 2009 019766 R
(732) INTERNATIONAL DISTRIBUTION
SYSTEMS LIMITED
Tassou Papadopoulou, 6, Flat/office 22,
Agios Dometios, 2373, Nicosia, Cyprus
(770) MAGICTRIP HOLDINGS LIMITED
Ioanni Stylianou, 6, 2nd Floor, Flat/officce
202, P.C. 2003, Nicosia, Cyprus
(580) 2017 08 22

(111) M 2009 019946 R
(732) ZHS IP Worldwide Sàrl
Avenue Reverdil 14, 1260 Nyon, Switzerland
(770) SPIRITS INTERNATIONAL B.V.
3, rue du Fort Rheinsheim, L-2419,
Luxembourg, Luxembourg
(580) 2017 07 07

(111) M 2009 019947 R
(732) ZHS IP Worldwide Sàrl,
Avenue Reverdil 14, 1260 Nyon, Switzerland
(770) SPIRITS INTERNATIONAL B.V.
3, rue du Fort Rheinsheim, L-2419,
Luxembourg, Luxembourg
(580) 2017 07 07

(111) M 2010 020841 R
(732) GIORGI TABAGARI
Larsis q. 3, b.31, 0179, Tbilisi, Georgia
(770) EMZAR BALADZE
VaJa-Pshavela q.7, b.14 , 6000, Batumi,
Georgia
(580) 2017 08 08

(111) M 2010 020847 R
(732) LUTTON ASSOCIATES INC.
50th and Aquilino de la Guardia Streets,
Plaza Banco General, 14 th Floor, Panama,
0823-05789, Panama
(770) CERASUS INC
50th and Aquilino de la Guardia Streets,
Plaza Banco General, 14 th Floor, Panama,
0823-05789, Panama
(580) 2017 08 09

(111) M 2010 020848 R
(732) LUTTON ASSOCIATES INC.
50th and Aquilino de la Guardia Streets,
Plaza Banco General, 14 th Floor, Panama,
0823-05789, Panama
(770) CERASUS INC
50th and Aquilino de la Guardia Streets,
Plaza Banco General, 14 th Floor, Panama,
0823-05789, Panama
(580) 2017 08 09

(111) M 2010 021045 R
(732) NOXELL CORPORATION
11050 York Road, Hunt Valley, Maryland
21030-2098, USA
(770) THE PROCTER & GAMBLE COMPANY
One Procter & Gamble Plaza, Cincinnati,
Ohio 45202, USA
(580) 2017 08 08

(111) M 2011 022064 R
(732) AMBER IP BRANDS SÀRL
Avenue Reverdil 14, 1260 Nyon, Switzerland
(770) SPIRITS INTERNATIONAL B.V.,
3, rue du Fort Rheinsheim, L-2419,
Luxembourg, Luxembourg
(580) 2017 07 07

(111) M 2011 022065 R
(732) AMBER IP BRANDS SÀRL
Avenue Reverdil 14, 1260 Nyon, Switzerland
(770) SPIRITS INTERNATIONAL B.V.,
3, rue du Fort Rheinsheim, L-2419,
Luxembourg, Luxembourg
(580) 2017 07 07

(111) M 2012 022805 R
(732) LTD "MALTI FUDI"
Sop. Dvabzu, Ozurgetis raioni, Georgia
(770) LTD "INDO-GEORGIAN FOOD
SPECIALTIES"
Samtreidiis q. 5, Didube-Chugureti raioni,
0106, Tbilisi, Georgia
(580) 2017 08 10

(111) M 2013 024134 R
(732) LTD "TALISMAN"
Tskhvedadzis q. 28, Vake-Saburtalos raioni,
0162, Tbilisi, Georgia
(770) LTD "AKHALSHENI 2005"
Akaki Tseretlis gamz. 55, 0154, Tbilisi,
Georgia
(580) 2017 08 08

(111) M 2014 025489 R
(732) LG CHEM, LTD.
128, Yeoui-doero, Yeongdeungpo-gu, Seoul,
Republic of Korea
(770) ELJI LAIF SAIENSIZ, LTD.
58, Saemunan-ro, Chonogu, Seuli, Republic
of Korea
(580) 2017 08 07

(111) M 2015 025682 R
(732) AMBER IP BRANDS SÀRL
Avenue Reverdil 14, 1260 Nyon, Switzerland
(770) SPIRITS INTERNATIONAL B.V.
3, rue du Fort Rheinsheim, L-2419,
Luxembourg, Luxembourg
(580) 2017 07 07

(111) M 2015 025752 R
(732) ZHS IP Worldwide Sàrl
Avenue Reverdil 14, 1260 Nyon, Switzerland
(770) SPIRITS INTERNATIONAL B.V.
3, rue du Fort Rheinsheim, L-2419,
Luxembourg, Luxembourg
(580) 2017 07 07

(111) M 2015 025753 R
(732) AMBER IP BRANDS SÀRL,
Avenue Reverdil 14, 1260 Nyon, Switzerland

(770) SPIRITS INTERNATIONAL B.V.,
3, rue du Fort Rheinsheim, L-2419,
Luxembourg, Luxembourg
(580) 2017 07 07

(111) M 2015 025768 R
(732) EXSET LABS B.V.
Schoutstraat 61, 1315 EW Almere,
Netherlands
(770) DOMLEX LIMITED
International House, Castle Hill,
Victoria Road, Isle of Man, Douglas
IM2 4RB, United Kingdom
(580) 2017 08 29

(111) M 1994 000283 R2
(732) NOXELL CORPORATION
11050 York Road, Hunt Valley,
Maryland 21030-2098, USA
(770) THE PROCTER & GAMBLE COMPANY
One Procter & Gamble Plaza, Cincinnati,
Ohio, USA
(580) 2017 08 08

(111) M 1994 000416 R2
(732) GOWAN GROUPE PROTECTION LIMITED
Highlands House Basingstoke
Road Spencers Wood Reading,
Berkshire, England RG7 1NT,
United Kingdom
(770) GOVAN COMÉRCIO INTERNACIONAL
E SERVIÇOS LDA
Rua Ivens No. 3 B Dona Mecia Building,
6th Floor, 9000-046 Funchal, Madeirado
Bom Jesus 18-3 Esq. 9050-028 Funchal,
Portugal
(580) 2017 08 09

(111) M 1994 000416 R2
(732) GOWAN GROUPE PROTECTION LIMITED
Highlands House Basingstoke Road
Spencers Wood Reading, Berkshire,
England RG7 1NT, United Kingdom
(770) GOWAN-COMÉRCIO INTERNACIONAL
E SERVIÇOS LDA
Rua Ivens No. 3 B Dona Mecia Building,
6th Floor, 9000-046 Funchal, Madeira,
Portugal
(580) 2017 08 10

(111) M 1997 004394 R2
(732) FOUR WINNS, LLC,
a Delaware limited liability company
925 Frisbie street, Cadillac, Michigan 49601,
USA

(770) GENMAR IP LLC
company of the State of Delaware
2900 IDS Center, 80 South Eighth
Street, Minneapolis, Minnesota 55402, USA
(580) 2017 08 09

(111) M 1997 004956 R2
(732) CILAG GMBH INTERNATIONAL
Gubelstrasse 34, CH-6300 Zug, Switzerland
(770) ASTRAZENECA AB
Vastra Malarehamnen 9, 15185 Sodertalje,
Sweden
(580) 2017 08 11

(111) M 1997 005037 R2
(732) CEGELEC HOLDINGS
72, avenue de la Liberte, 92000 Nanterre,
France
(770) CEGELEC
72, avenue de la Liberte, 92000 Nanterre,
France
(580) 2017 08 10

(111) M 1997 005037 R2
(732) CEGELEC HOLDINGS
72, avenue de la Liberte, 92000 Nanterre,
France
(770) CEGELEC
72, avenue de la Liberte, 92000 Nanterre,
France
(580) 2017 08 10

(111) M 1997 005037 R2
(732) CEGELEC ENTREPRISE
10, avenue du Stade de France, 93200
SANT-DENIS, France
(770) CEGELEC
10, avenue du Stade de France, 93200
SANT-DENIS, France
(580) 2017 08 10

(111) M 1997 005037 R2
(732) VINCI ENERGIES
280, rue du 8 mai 1945, 78360
MONTESSON, France
(770) CEGELEC ENTREPRISE
10, avenue du Stade de France, 93200
SANT-DENIS, France
(580) 2017 08 10

(111) M 1997 005148 R2
(732) TGI FRIDAY'S INC.
19111 North Dallas Parkway, Suite 165,

Dallas, TX 75287, USA
 (770) TGI FRIDAY'S OF MINNESOTA, INC.
 19111 North Dallas Parkway, Suite 165,
 Dallas, TX 75287, USA
 (580) 2017 08 23

(111) M 1997 005148 R2
 (732) TGIF SPV Guarantor, LLC
 19111 North Dallas Parkway, Suite 165,
 Dallas, TX 75287, USA
 (770) TGI FRIDAY'S INC.,
 19111 North Dallas Parkway, Suite 165,
 Dallas, TX 75287, USA
 (580) 2017 08 23

(111) M 1997 005148 R2
 (732) TGIF Funding, LLC
 19111 North Dallas Parkway, Suite 165,
 Dallas, TX 75287, USA
 (770) TGIF SPV Guarantor, LLC,
 19111 North Dallas Parkway, Suite 165,
 Dallas, TX 75287, USA
 (580) 2017 08 23

(111) M 1997 005148 R2
 (732) TGI Fridays Franchisor, LLC
 19111 North Dallas Parkway, Suite 165,
 Dallas, TX 75287, USA
 (770) TGIF Funding, LLC
 19111 North Dallas Parkway, Suite 165,
 Dallas, TX 75287, USA
 (580) 2017 08 23

(111) M 1997 005149 R2
 (732) TGI FRIDAY'S INC.
 19111 North Dallas Parkway, Suite 165,
 Dallas, TX 75287, USA
 (770) TGI FRIDAY'S OF MINNESOTA, INC.
 19111 North Dallas Parkway, Suite 165,
 Dallas, TX 75287, USA
 (580) 2017 08 23

(111) M 1997 005149 R2
 (732) TGIF SPV Guarantor, LLC
 19111 North Dallas Parkway, Suite 165,
 Dallas, TX 75287, USA
 (770) TGI FRIDAY'S INC.,
 19111 North Dallas Parkway, Suite 165,
 Dallas, TX 75287, USA
 (580) 2017 08 23

(111) M 1997 005149 R2
 (732) TGIF Funding, LLC
 19111 North Dallas Parkway, Suite 165,
 Dallas, TX 75287, USA
 (770) TGIF SPV Guarantor, LLC
 19111 North Dallas Parkway, Suite 165,
 Dallas, TX 75287, USA
 (580) 2017 08 23

(111) M 1997 005149 R2
 (732) TGI Fridays Franchisor, LLC
 19111 North Dallas Parkway, Suite 165,
 Dallas, TX 75287, USA
 (770) TGIF Funding, LLC
 19111 North Dallas Parkway, Suite 165,
 Dallas, TX 75287, USA
 (580) 2017 08 23

(111) M 1997 005294 R2
 (732) ENERGIZER BRANDS, LLC
 533 Maryville University Drive St. Louis,
 Missouri 63141, USA
 (770) EVEREADY BATTERY COMPANY, INC.
 Checkerboard Square, St.Louis, Missouri
 63164, USA
 (580) 2017 08 10

(111) M 1997 005500 R2
 (732) ADAMA AGAN LTD.
 P.O. Box 262, Northen Industrial Zone,
 Ashdod 7710201, Israel
 (770) ADAMA QUENA N.V.
 Pos Cabai Office Park, Unit 13, Curacao,
 Netherlands Antilles
 (580) 2017 08 29

(111) M 1997 005774 R2
 (732) HI-TEC SPORTS INTERNATIONAL
 HOLDINGS B.V.
 Paasheuvelweg 22A, 1105 BJ
 AMSTERDAM ZUIDOOST, Netherlands
 (770) HI-TEC SPORTS PLC
 Aviation Way Southend-on-sea, Essex
 SS2 6GH, United Kingdom
 (580) 2017 07 06

(111) M 1997 005789 R2
 (732) Tyco ELECTRONICS SERVICES GmbH
 Rheinstrasse 20, CH-8200, Schaffhausen,
 Switzerland
 (770) THE WHITAKER LLC
 4550, New Linden Hill Road, Wilmington,
 Delaware, USA
 (580) 2017 08 08

(111) M 1997 005904 R2
(732) HFC PRESTIGE INTERNATIONAL
HOLDING SWITZERLAND SÀRL
Chemin Louis-Hubert 1-3, 1213 Petit-Lancy,
Switzerland
(770) WELLA GMBH
Sulzbacher Strasse 40, 65824 Schwalbach
am Taunus, Germany
(580) 2017 06 28

(111) M 1997 005992 R1
(732) NOXELL CORPORATION
11050 York Road, Hunt Valley, Maryland
21030-2098, USA
(770) THE PROCTER & GAMBLE COMPANY
One Procter & Gamble Plaza, Cincinnati,
Ohio, USA
(580) 2017 08 08

(111) M 1997 006003 R1
(732) NOXELL CORPORATION
11050 York Road, Hunt Valley, Maryland
21030-2098, USA
(770) THE PROCTER & GAMBLE COMPANY
One Procter & Gamble Plaza, Cincinnati,
Ohio, USA
(580) 2017 08 08

(111) M 1997 006215 R2
(732) AMBEV S.A.
Rua Dr.Renato paes de Barros, 1017 3º
Andar Cj 31e 32 ItaimBibi 04530-001São
Paulo, Brazil
(770) COMPANHIA DE BEBIDAS DAS
AMERICAS AMBEV
Rua Dr. Renato Paes de Barros no. 1017-3A
cj31/32-Itaim bibi- São Paulo, Brazil
(580) 2017 08 22

(111) M 1997 006273 R2
(732) HFC PRESTIGE INTERNATIONAL
HOLDING SWITZERLAND SÀRL
Chemin Louis-Hubert 1-3, 1213 Petit-Lancy,
Switzerland
(770) PROCTER AND GAMBLE
INTERNATIONAL OPERATIONS S.A.
47, Route de Saint-Georges, 1213 Petit-
Lancy, Switzerland
(580) 2017 08 23

(111) M 1998 008219 R1
(732) ANF PET, INC.
1500 Whitehall Lane, St. Helena, California
94574, USA

(770) KODO Inc., a California corporation
1500 Whitehall Lane, St. Helena, California
94574, USA
(580) 2017 08 29

(111) M 1998 008220 R1
(732) ANF PET, INC.
1500 Whitehall Lane, St. Helena, California
94574, USA
(770) KODO Inc., a California corporation
1500 Whitehall Lane, St. Helena, California
94574, USA
(580) 2017 08 29

(111) M 1998 008221 R1
(732) ANF Pet, Inc.
1500 Whitehall Lane, St. Helena, California
94574, USA
(770) KODO Inc., a California corporation
1500 Whitehall Lane, St. Helena, California
94574, USA
(580) 2017 08 29

(111) M 1998 008328 R1
(732) NOXELL CORPORATION
11050 York Road, Hunt Valley, Maryland
21030-2098, USA
(770) THE PROCTER & GAMBLE COMPANY
One Procter & Gamble Plaza, Cincinnati,
Ohio, USA
(580) 2017 08 08

(111) M 1998 008988 R1
(732) Citizen Tokei Kabushiki Kaisha
Also Trading As Citizen Watch CO., LTD
1-12,6-Chome, Tanashi-cho, Nishi-Tokyo-
Shi, Tokyo, Japan
(770) Citizen Holdings Kabushiki
Kaisha Also Trading As Citizen Holdings Co., LTD
1-12, 6-Chome, Tanashi-Cho, Nishi-Tokyo-Shi,
Tokyo, Japan
(580) 2017 08 08

(111) M 1998 008989 R1
(732) CITIZEN TOKEI KABUSHIKI KAISHA
also trading as CITIZEN WATCH CO., LTD
1-12,6-Chome, Tanashi-cho, Nishi-tokyo-shi,
Tokyo, Japan
(770) Citizen Holdings Kabushiki
Kaisha Also Trading As Citizen Holdings CO., LTD
1-12, 6-Chome, Tanashi-cho, Nishi-Tokyo-Shi,
Tokyo, Japan
(580) 2017 08 08

(111) M 1998 009285 R1
(732) BACARDI & COMPANY LIMITED
Aeulestrasse 5, 9490 Vaduz, Liechtenstein,
Liechtenstein
(770) JOHN DEWAR AND SONS LIMITED
1700 London Road, Glasgow G32 8XR,
United Kingdom
(580) 2017 07 07

(111) M 1998 009350 R1
(732) AMBER IP BRANDS SÀRL
Avenue Reverdil 14, 1260 Nyon, Switzerland
(770) SPIRITS INTERNATIONAL B.V.
3, rue du Fort Rheinsheim, L-2419,
Luxembourg, Luxembourg
(580) 2017 07 07

(111) M 1998 009351 R1
(732) ZHS IP Worldwide Sàrl
Avenue Reverdil 14, 1260 Nyon, Switzerland
(770) SPIRITS INTERNATIONAL B.V.
3, rue du Fort Rheinsheim, L-2419,
Luxembourg, Luxembourg
(580) 2017 07 07

(111) M 1998 009691 R1
(732) TRULY OPTO-ELECTRONICS LIMITED
2nd Floor, Chung Shun Knitting
Centre, 1-3 Wing Yip Street Kwai
Chung, New Territories, The Hong
Kong Special Administrative Region
of the people's republic of China
(770) TRULY ELECTRONICS
MANUFACTURING LIMITED
2nd Floor, Chung Shun Knitting Centre,
1-3 Wing Yip Street Kwai Chung, New
Territories, The Hong Kong Special
Administrative Region of the people's
republic of China
(580) 2017 08 08

(111) M 1998 009803 R1
(732) CITIZEN TOKEI KABUSHIKI KAISHA
also trading as CITIZEN WATCH CO.,
LTD.,
1-12,6-Chome, Tanashi-cho, Nishi-tokyo-shi,
Tokyo, Japan
(770) CITIZEN HOLDINGS KABUSHIKI
KAISHA ALSO TRADING AS CITIZEN
HOLDINGS CO., LTD.
1-12, 6-Chome, Tanashi-cho, Nishi-tokyo-shi,
Tokyo, Japan
(580) 2017 08 08

(111) M 2016 27705 R
(732) Ivane Adamashvili
Rustavelis q., I shesakhvevi 5, 1200,
Borjomi, Georgia
(770) Marekh Adamashvili
Tskhinvalis gzat. 43, b. 39, 1400, Gori,
Georgia
(580) 2017 08 30

(111) M 2017 28395 R
(732) Picmonkey International Limited
25-28 North Wall Quay, Dublin 1, IE
(770) PicM (Cayman) L.P.
75 Fort Street, P.O. Box 1350, Grand
Cayman KY1-1108, Cayman Islands
(580) 2017 08 30

CHANGES IN NAMES AND/OR ADDRESSES OF OWNERS

-
- (111) M 1998 010400 R1
(732) AVENTISUB LLC
3711 Kennett Pike, Suite 200, Greenville,
Delaware 19807, USA
(770) AVENTISUB INC.
3711 Kennett Pike, Suite 200, Greenville,
Delaware 19807, USA
(580) 2017 08 07
-
- (111) M 1998 010739 R1
(732) OSRAM GESELLSCHAFT MIT
BESCHRANKTER HAFTUNG
Marcel-Breuer-Straße 6, 80809 MUNCHEN,
Germany
(770) OSRAM GESELLSCHAFT MIT
BESCHRANKTER HAFTUNG
Hellabrunerstrasse 1, Munchen, Germany
(580) 2017 08 08
-
- (111) M 1998 010740 R1
(732) OSRAM GESELLSCHAFT MIT
BESCHRANKTER HAFTUNG
Marcel-Breuer-Straße 6, 80809 MUNCHEN,
Germany
(770) OSRAM GESELLSCHAFT MIT
BESCHRANKTER HAFTUNG
Hellabrunerstrasse 1, Munchen, Germany
(580) 2017 08 08
-
- (111) M 1995 001077 R2
(732) MITSUBISHI CHEMICAL
CORPORATION
1-1, Marunouchi 1-chome, Chiyoda-Ku,
Tokyo, Japan
(770) MITSUBISHI RAYON Co., LTD
1-1, Marunouchi 1-chome, Chiyoda-Ku,
Tokyo 100-8253, Japan
(580) 2017 08 08
-
- (111) M 2003 015062 R1
(732) OSRAM GESELLSCHAFT MIT
BESCHRANKTER HAFTUNG
Marcel-Breuer-Straße 6, 80809 MUNCHEN,
Germany
(770) OSRAM GESELLSCHAFT MIT
BESCHRANKTER HAFTUNG
Hellabrunerstrasse 1, Munchen, Germany
(580) 2017 08 08
-
- (111) M 2006 016499 R1
(732) EXELTIS İLAÇ SANAYİİ VE TİCARET
ANONİM ŞİRKETİ
Maslak Mah., Sümer Sokak, Ayazega Tic.
Mer.No.3 K:9, İstanbul, Turkey
(770) EMBİL İLAÇ SANAYİ LIMITED ŞİRKETİ
Maslak Mahallesi Sümer Sokak Ayazağa
Ticaret Merkezi N3/9 Sariyer, İstanbul,
Turkey
(580) 2017 08 03
-
- (111) M 2007 017400 R1
(732) VICURON PHARMACEUTICALS, INC.
235 East 42 Street, New York,
New York 10017-5755, USA
(770) VICURON PHARMACEUTICALS INC.
a Delaware Corporation
455 South Gulph Road, King of Prussia,
Pennsylvania 19406, USA
(580) 2017 08 01
-
- (111) M 2007 017557 R1
(732) LTD "ASFARMA" - SAQARTVELOS
FARMATSEVTULI KOMPANIA
Mtskhetis q. 8, 0179, Tbilisi, Georgia
(770) LTD "ASFARMA" - SAQARTVELOS
FARMATSEVTULI KOMPANIA
Mtskhetis q. 8, 0179, Tbilisi, Georgia
(580) 2017 08 09
-
- (111) M 2007 017562 R1
(732) LTD "ASFARMA" - SAQARTVELOS
FARMATSEVTULI KOMPANIA
Mtskhetis q. 8, 0179, Tbilisi, Georgia
(770) LTD "ASPHARMA" - Saqartvelos
pharmatsevtuli kompania,
Shevchenkos q. 12, 0108, Tbilisi, Georgia
(580) 2017 08 09
-
- (111) M 2007 017589 R1
(732) OTIS ELEVATOR COMPANY
One Carrier Place, Farmington, Connecticut
06032, USA
(770) OTIS ELEVATOR COMPANY
10 Farm Springs, Farmington, Connecticut
06032, New Jersey, USA
(580) 2017 08 08
-
- (111) M 2007 017601 R1
(732) E.I. DU PONT DE NEMOURS AND
COMPANY
Chestnut Run Plaza. 974 Centre Road,
P.O. Box 2915, Wilmington, Delaware
19805, USA
-

(770) E.I. DU PONT DE NEMOURS AND
COMPANY
1007 Market Street, Wilmington,
Delaware 19898, USA
(580) 2017 08 01

(111) M 2007 017630 R1
(732) ÜLKER BİSKÜVİ SANAYİ
ANONİM ŞİRKETİ
Kisikh Mahallesi, Ferah Gaddesi No.1
Büyükçamlıca, Üsküdar, İstanbul, Turkey
(770) ÜLKER GIDA SANAYİ VE TİCARET
A.S.
Davutpasa Caddesi N.10, 34015 Topkapı,
İstanbul, Turkey
(580) 2017 08 08

(111) M 2007 017775 R1
(732) WYETH LLC
235 East 42nd Street, New York,
New York 10017, USA
(770) WYETH LLC
Five Giralda Farms, Madison,
New Jersey, 07940, USA
(580) 2017 07 25

(111) M 2007 017793 R1
(732) ABDİ İBRAHİM İLAÇ SANAYİ VE
TİCARET ANONİM ŞİRKETİ
Reşitpaşa Mahallesi Eski Büyükdere Caddesi
No:4 34467 Maslak Sarıyer İstanbul, Turkey
(770) ABDİ İBRAHİM İLAÇ SANAYİ VE
TİCARET ANONİM ŞİRKETİ
Eski Büyükdere Cad. Ayazağa Yolu 34398
No:5 Maslak, İstanbul, Turkey
(580) 2017 07 25

(111) M 2007 017832 R1
(732) YILDIZ HOLDİNG ANONİM ŞİRKETİ
Kisikli Mahallesi Çeşme Çikmazi, Sokak
No:6/1, Üsküdar İstanbul, Turkey
(770) YILDIZ HOLDİNG A.S.
Kisikli mah. Ferah cad. Cesme sok.N2/4 B.
Camlica, Uskudar, İstanbul, Turkey
(580) 2017 08 08

(111) M 2007 017833 R1
(732) YILDIZ HOLDİNG ANONİM ŞİRKETİ
Kisikli Mahallesi Çeşme Çikmazi, Sokak
No:6/1, Üsküdar İstanbul, Turkey
(770) YILDIZ HOLDİNG A.S.
Kisikli mah. Ferah cad. Cesme sok.N2/4 B.
Camlica, Uskudar, İstanbul, Turkey
(580) 2017 08 08

(111) M 2007 017850 R1
(732) PAKSHOO INDUSTRIAL GROUP
Beheshti ave., Pakistan st., 29, second alley,
Tehran, Iran (Islamic Republic of)
(770) PAKSHOO
N.74 South west of Argentine, Tehran,
Iran (Islamic Republic of)
(580) 2017 08 31

(111) M 2007 017976 R
(732) PAKSHOO INDUSTRIAL GROUP
Beheshti ave., Pakistan st., 29, second alley,
Tehran, Iran (Islamic Republic of)
(770) PAKSHOO
N.74 South west of Argentine, Tehran,
Iran (Islamic Republic of)
(580) 2017 08 31

(111) M 2007 017977 R
(732) PAKSHOO INDUSTRIAL GROUP
Beheshti ave., Pakistan st., 29, second alley,
Tehran, Iran (Islamic Republic of)
(770) PAKSHOO
N.74 South west of Argentine, Tehran,
Iran (Islamic Republic of)
(580) 2017 08 31

(111) M 2009 019064 R
(732) AVENTISUB LLC
3711 Kennett Pike, Suite 200, Greenville,
Delaware 19807, USA
(770) AVENTISUB INC.
3711 Kennett Pike, Suite 200, Greenville,
Delaware 19807, USA
(580) 2017 08 07

(111) M 2009 019392 R
(732) LTD "TBILISIS TSENTRALURI
SAAVADMKOFO"
Lublianas q.5, 0159, Tbilisi, Georgia
(770) LTD "I. Zhordaniyas sakhelobis adamianis
reproduqtsiis sametsniero kvlevit instituti"
Lublianas q.5, 0159, Tbilisi, Georgia
(580) 2017 08 08

(111) M 2009 019393 R
(732) LTD "TBILISIS TSENTRALURI
SAAVADMKOFO"
Lublianas q.5, 0159, Tbilisi, Georgia
(770) LTD "I. Zhordaniyas sakhelobis adamianis
reproduqtsiis sametsniero kvlevit instituti"
Lublianas q.5, 0159, Tbilisi, Georgia
(580) 2017 08 08

(111) M 2010 020302 R
(732) BLOCK DRUG COMPANY, INC.
Corporation Service Company
Princeton South Corporate Center,
Suite 160, 100 Charles Ewing Blvd., Ewing,
New Jersey, 08628, USA
(770) BLOCK DRUG COMPANY, INC.
of Corporation Service Company
830 Bear Tavern Road, West Trenton,
New Jersey 08628, USA
(580) 2017 08 01

(111) M 2010 020847 R
(732) CERASUS INC
50th and Aquilino de la Guardia Streets,
Plaza Banco General, 14 th Floor, Panama,
0823-05789, Panama
(770) CERASUS INC
Calle 50 y Aquilino de la Guardia,
Plaza Banco General, Piso 30,
Panama, 0823-05789, Panama
(580) 2017 08 09

(111) M 2010 020848 R
(732) CERASUS INC,
50th and Aquilino de la Guardia Streets,
Plaza Banco General, 14 th Floor, Panama,
0823-05789, Panama
(770) CERASUS INC
Calle 50 y Aquilino de la Guardia,
Plaza Banco General, Piso 30, Panama,
0823-05789, Panama
(580) 2017 08 09

(111) M 2011 021401 R
(732) HARRINGTON DEVELOPMENT INC.
Mossfon Building. second Floor,
East 54 th street, Panama, Panama
(770) HARRINGTON DEVELOPMENT INC.
Arango-Orillac Bldg. East 54 th street,
Panama, Panama
(580) 2017 08 29

(111) M 2011 021401 R
(732) HARRINGTON DEVELOPMENT INC.
Elvira Mendez Street, Vallarino bldg.,
3rd Floor, Panama, Panama
(770) HARRINGTON DEVELOPMENT INC.
Mossfon Building. second Floor, East 54 th
street, Panama, Panama
(580) 2017 08 29

(111) M 2011 021828 R
(732) LTD "CHEMPIONEBI 111"
I. Chavchavadzis gamz.29, me-5 sart., 0179,
Tbilisi, Georgia

(770) LTD "CHEMPIONEBI"
9 Aprilis q.15, 4200, Signagi, Georgia
(580) 2017 08 07

(111) M 2013 023760 R
(732) ACCOR
82 rue Henri Farman, 92130 Issy-les-
Moulineaux, France
(770) ACCOR
110 Avenue de France, 75013 PARIS, France
(580) 2017 08 25

(111) M 2013 023761 R
(732) ACCOR
82 rue Henri Farman, 92130 Issy-les-
Moulineaux, France
(770) ACCOR
110 Avenue de France, 75013 PARIS, France
(580) 2017 08 25

(111) M 2013 024353 R
(732) ACCOR
82 rue Henri Farman, 92130 Issy-les-
Moulineaux, France
(770) ACCOR
110 Avenue de France, 75013 PARIS, France
(580) 2017 08 25

(111) M 2013 024354 R
(732) ACCOR
82 rue Henri Farman, 92130 Issy-les-
Moulineaux, France
(770) ACCOR
110 Avenue de France, 75013 PARIS, France
(580) 2017 08 25

(111) M 2014 024639 R
(732) JT INTERNATIONAL SA
Rue Kazem-Radjavi 8, 1202 Geneva,
Switzerland
(770) JT INTERNATIONAL SA
Rue de la Gabelle 1, 1211 Geneva 26,
Switzerland
(580) 2017 08 22

(111) M 2014 024640 R
(732) JT INTERNATIONAL SA
Rue Kazem-Radjavi 8, 1202 Geneva,
Switzerland
(770) JT INTERNATIONAL SA
Rue de la Gabelle 1, 1211 Geneva 26,
Switzerland
(580) 2017 08 25

(111) M 2014 024642 R
 (732) JT INTERNATIONAL SA
 Rue Kazem-Radjavi 8, 1202 Geneva,
 Switzerland

(770) JT INTERNATIONAL SA
 Rue de la Gabelle 1, 1211 Geneva 26,
 Switzerland
 (580) 2017 08 25

(111) M 2014 024642 R
 (732) JT INTERNATIONAL SA
 Rue Kazem-Radjavi 8, 1202 Geneva,
 Switzerland

(770) JT INTERNATIONAL SA
 Rue de la Gabelle 1, 1211 Geneva 26,
 Switzerland
 (580) 2017 08 25

(111) M 2014 024710 R
 (732) ACCOR
 82 rue Henri Farman, 92130 Issy-les-
 Moulineaux, France

(770) ACCOR
 110 Avenue de France, 75013 PARIS, France
 (580) 2017 08 25

(111) M 2015 025676 R
 (732) PAX LABS, INC.
 660 Alabama Street, Floor 2, San Francisco,
 California, 94110, USA

(770) PLOOM, INC
 660 Alabama Street, Floor 2, San Francisco,
 California, 94110, USA
 (580) 2015 10 09

(111) M 1997 004663 R2
 (732) LORRILLARD LICENSING COMPANY
 LLC
 327 Hillsborough Street, Raleigh, NC 27603
 Wake, USA

(770) LORRILLARD LICENSING COMPANY
 LLC
 714, Green Valley Road, City of North
 Carolina 27408, USA, USA
 (580) 2017 07 21

(111) M 1997 004663 R2
 (732) LORRILLARD LICENSING COMPANY
 LLC

401 North Main Street, Winston- Salem,
 North Carolina 27102, USA
 (770) LORRILLARD LICENSING
 COMPANY LLC

327 Hillsborough Street, Raleigh, NC 27603
 Wake, USA
 (580) 2017 07 21

(111) M 1997 004664 R2
 (732) LORRILLARD LICENSING COMPANY
 LLC
 327 Hillsborough Street, Raleigh, NC 27603
 Wake, USA

(770) LORRILLARD LICENSING
 COMPANY LLC
 1600 First Union Tower, 300 North Grene
 Street, City of Greensboro, State of North
 Carolina 27401, USA

(580) 2017 07 21

(111) M 1997 004664 R2
 (732) LORRILLARD LICENSING COMPANY
 LLC

401 North Main Street, Winston- Salem,
 North Carolina 27102, USA

(770) LORRILLARD LICENSING
 COMPANY LLC
 327 Hillsborough Street, Raleigh, NC 27603
 Wake, USA

(580) 2017 07 21

(111) M 1997 004665 R2
 (732) LORRILLARD LICENSING COMPANY
 LLC
 327 Hillsborough Street, Raleigh, NC 27603
 Wake, USA

(770) LORRILLARD LICENSING
 COMPANY LLC
 1600 First Union Tower, 300 North Grene
 Street, City of Greensboro, State of North
 Carolina 27401, USA

(580) 2017 07 21

(111) M 1997 004665 R2
 (732) LORRILLARD LICENSING COMPANY
 LLC

401 North Main Street, Winston-Salem,
 North Carolina 27102, USA

(770) LORRILLARD LICENSING COMPANY
 LLC
 327 Hillsborough Street, Raleigh, NC 27603
 Wake, USA

(580) 2017 07 21

(111) M 1997 004898 R2
 (732) PANASONIC CORPORATION
 1006, Oaza Kadoma, Kadoma-Shi,
 Osaka 571-8501, Japan

(770) MATSUSHITA ELECTRIC INDUSTRIAL Co., LTD
1006, Oaza Kadoma, Kadoma-shi,
Osaka Prefecture, Japan
(580) 2017 07 21

(111) M 1997 005005 R2
(732) JOHNSON MATTHEY PUBLIC LIMITED COMPANY
5 TH FLOOR, 25 FARRINGDON STREET,
LONDON EC4A 4AB, United Kingdom
(770) JOHNSON MATTHEY PUBLIC LIMITED COMPAN
40-42 Hatton Garden, London EC1N 8EE,
United Kingdom
(580) 2017 08 25

(111) M 1997 005037 R2
(732) CEGELEC
72, avenue de la Liberte, 92000 Nanterre,
France
(770) CEGELEC HOLDINGS
72, avenue de la Liberte, 92000 Nanterre,
France
(580) 2017 08 10

(111) M 1997 005037 R2
(732) CEGELEC HOLDINGS
10, avenue du Stade de France, 93200
SANT-DENIS, France
(770) CEGELEC HOLDINGS
72, avenue de la Liberte, 92000 Nanterre,
France
(580) 2017 08 10

(111) M 1997 005037 R2
(732) CEGELEC
10, avenue du Stade de France, 93200
SANT-DENIS, France
(770) CEGELEC HOLDINGS
10, avenue du Stade de France, 93200
SANT-DENIS, France
(580) 2017 08 10

(111) M 1997 005044 R2
(732) COMPAGNIE CHAMPENOISE PH-CH.
PIPER-HEIDSIECK
Ancienne maison HEIDSIECK fondee en
1785, 12 Allée du Vignoble, 51100 Reims,
France
(770) PIPER-HEIDSIECK, Ancienne maison
HEIDSIECK
fondee en 1785, COMPAGNIE
CHAMPENOISE 51 Boulevard Henry

Vasnier, F-51100 Reims, France
(580) 2017 08 08

(111) M 1997 005045 R2
(732) PIPER-HEIDSIECK, Ancienne maison
HEIDSIECK fondee en 1785, 12 Allée
du Vignoble, 51100 Reims, France
(770) PIPER-HEIDSIECK, Ancienne maison
HEIDSIECK fondee en 1785, COMPAGNIE
CHAMPENOISE
51 Boulevard Henry Vasnier, F-51100
Reims, France
(580) 2017 08 08

(111) M 1997 005148 R2
(732) TGI FRIDAY'S OF MINNESOTA, INC.
19111 North Dallas Parkway, Suite 165,
Dallas, TX 75287, USA
(770) TGI FRIDAY'S OF MINNESOTA, INC.
4201 Marsh Lane, Carrollton, Texas
75007, USA
(580) 2017 08 23

(111) M 1997 005149 R2
(732) TGI FRIDAY'S OF MINNESOTA, INC.
19111 North Dallas Parkway, Suite 165,
Dallas, TX 75287, USA
(770) TGI FRIDAY'S OF MINNESOTA, INC.
4201 Marsh Lane, Carrollton, Texas
75007, USA
(580) 2017 08 23

(111) M 1997 005150 R2
(732) THE ARMOR ALL/STP PRODUCTS
COMPANY
39 Old Ridgebury Road, Danbury,
Connecticut 06810, USA
(770) THE ARMOR ALL/STP PRODUCTS
COMPANY
1221 Broadway, Oakland, California
94612-1888, USA
(580) 2017 07 25

(111) M 1997 005150 R2
(732) THE ARMOR ALL/STP PRODUCTS
COMPANY
44 Old Ridgebury Road, Danbury,
Connecticut 06810, USA
(770) THE ARMOR ALL/STP PRODUCTS
COMPANY
39 Old Ridgebury Road, Danbury,
Connecticut 06810, USA
(580) 2017 07 25

(111) M 1997 005328 R2
 (732) SUBARU CORPORATION
 1-20-8, Ebisu, Shibuya-ku, Tokyo,
 Japan
 (770) FUJI JUKOGYO KABUSHIKI KAISHA
 (also trading as FUJI HEAVY INDUSTRIES
 LTD)
 1-20-8, Ebisu, Shibuya-ku, Tokyo, Japan
 (580) 2017 08 25

(111) M 1997 005331 R2
 (732) SUBARU CORPORATION
 1-20-8, Ebisu, Shibuya-ku, Tokyo,
 Japan
 (770) FUJI JUKOGYO KABUSHIKI KAISHA
 (also trading as FUJI HEAVY INDUSTRIES
 LTD)
 1-20-8, Ebisu, Shibuya-ku, Tokyo, Japan
 (580) 2017 08 25

(111) M 1997 005500 R2
 (732) ADAMA QUENA N.V.
 Pos Cabai Office Park, Unit 13,
 Curacao, Netherlands Antilles
 (770) QUENA PLANT PROTECTION N.V.
 34 Kaya W.F.G., (Jombi) Mensing,
 Curacao, Netherlands Antilles
 (580) 2017 08 29

(111) M 1997 005578 R2
 (732) ALPS ELECTRIC Co., LTD
 1-7 Yukigaya-otsukamachi, Ota-ku,
 Tokyo, Japan
 (770) ALPS ELECTRIC Co., LTD
 1-7 Yukigaya Ohtsuka-cho, Ohta-ku,
 Tokyo, Japan
 (580) 2017 08 08

(111) M 1997 005682 R2
 (732) GLAXOSMITHKLINE CONSUMER
 HEALTHEARE B.V.
 Huis ter Heideweg 62, 3707 LZ, Zeist,
 Netherlands
 (770) GLAXOSMITHKLINE CONSUMER
 HEALTHEARE B.V.
 6 Handelsweg, 3707 NH Zeist, P.O. Box
 293, 3700 AG Zeist, Netherlands
 (580) 2017 08 25

(111) M 1997 005830 R2
 (732) LA MICROMECCANICA DEL COMM,
 LIBERO BALESTRA & C.S.r.L.
 165, Viala Bologna, I-47 100 FORLI, Italy
 (770) LA MICROMECCANICA DEL COMM

LIBERO BALESTRA & C.S.P.A.
 165, Viala Bologna, I-47 100 FORLI, Italy
 (580) 2017 08 09

(111) M 1997 005830 R2
 (732) LA MICROMECCANICA DEL COMM,
 LIBERO BALESTRA & C.S.r.L.
 Viala Bologna, 165-47121 FORLI' (FO),
 Italy
 (770) LA MICROMECCANICA DEL COMM,
 LIBERO BALESTRA & C.S.r.L.
 165, Viala Bologna, I-47 100 FORLI, Italy
 (580) 2017 08 09

(111) M 1997 005834 R2
 (732) FISONS LIMITED
 Aventis House, 50Kings Hill Avenue,
 Kings Hill, West Malling Kent ME19 4AH,
 United Kingdom
 (770) FISONS LIMITED
 RPR House, 50Kings Hill Avenue,
 Kings Hill, West Malling, Kent , ME19 4AH,
 United Kingdom
 (580) 2017 08 09

(111) M 1997 005834 R2
 (732) FISONS LIMITED
 Aventis House, 50 King Hill Avenue,
 Kings Hill West Malling, Kent ME19 4AH,
 United Kingdom
 (770) FISONS LIMITED
 Aventis House, 50Kings Hill Avenue,
 Kings Hill, West Malling Kent ME19 4AH,
 United Kingdom
 (580) 2017 08 09

(111) M 1997 005834 R2
 (732) FISONS LIMITED
 Aventis House, 50 King Hill Avenue,
 Kings Hill, West Malling, Kent ME19 4AH,
 United Kingdom
 (770) FISONS LIMITED
 Aventis House, 50 King Hill Avenue,
 Kings Hill West Malling, Kent ME19 4AH,
 United Kingdom
 (580) 2017 08 09

(111) M 1997 005935 R2
 (732) DUPONT NUTRITION BIOSCIENCES APS
 Langebrogade 1, P.O. Box 17, DK1001
 Copenhagen K, Denmark
 (770) DANISCO A/S
 Langenbrogade 1, DK-1001 Copenhagen
 K, Denmark
 (580) 2017 08 08

(111) M 1997 005938 R2
(732) CHATEAU DE COGNAC S.AS.,
Bd Denfert Rochereau 16100 Cognac,
FRANCE ET TERRITOIRES, France
(770) CHATEAU DE COGNAC S.A
Bd Denfert Rochereau 16100 Cognac,
FRANCE ET TERRITOIRES, France
(580) 2017 08 31

(111) M 1997 006044 R2
(732) CHEMTURA EUROPE GMBH
Bahnhofplatz 65, Fraunfeld CH-8500,
Switzerland
(770) GREAT LAKESN CHEMICAL (EUROPE)
GMBH (a Swiss corporation),
Bahnhofplatz 65, Fraunfeld CH-8500,
Switzerland
(580) 2017 08 23

(111) M 1997 006044 R2
(732) LANXESS Switzerland GmbH
Bahnhofplatz 65, Fraunfeld CH-8500,
Switzerland
(770) CHEMTURA EUROPE GMBH
Bahnhofplatz 65, Fraunfeld CH-8500,
Switzerland
(580) 2017 08 23

(111) M 1997 006097 R2
(732) SOLAE, LLC
1034 Duncan Avenue, St. Louis, Missouri
63110, USA
(770) SOLAE, LLC
1034 Danforth Drive, St. Louis, Missouri
63102, USA
(580) 2017 08 08

(111) M 1997 006118 R2
(732) BTICINO S.P.A.
Viale Borri, 231, 21100 Varese (VA), Italy
(770) BTICINO S.P.A.
Via Messina 38, 20154 Milano, Italy
(580) 2017 08 09

(111) M 1997 006193 R2
(732) CRAY VALLEY S.A.
16-32 Rue Henri Regnault, La Defense 6,
92400 Courbevoie, France
(770) CRAY VALLEY S.A.
12 place de l'Iris, 92400 Courbevoie, France
(580) 2017 08 23

(111) M 1997 006224 R2
(732) OTIS ELEVATOR COMPANY
One Carrier Place, Farmington,

Connecticut 06032, USA
(770) OTIS ELEVATOR COMPANY
10 Farm Springs, Farmington, Connecticut
06032, USA
(580) 2017 08 29

(111) M 1997 006593 R2
(732) RAYNAL & Cie.
113 Avenue Victor Hugo, 16100 Cognac,
France
(770) RAYNAL & Cie.
58 Avenue du Marchal, Cognac (Charente),
France
(580) 2017 08 08

(111) M 1997 006631 R2
(732) WM. WRIGLEY JR. COMPANY
1132 West Blackhawk Street, Chicago,
Illinois 60642, USA
(770) WM.WRIGLEY JR.COMPANY
Chicago, Illinois, USA
(580) 2017 08 03

(111) M 1997 006632 R2
(732) WM. WRIGLEY JR. COMPANY
1132 West Blackhawk Street, Chicago,
Illinois 60642, USA
(770) WM.WRIGLEY JR.COMPANY,
Chicago, Illinois, USA
(580) 2017 08 03

(111) M 1997 006633 R2
(732) WM. WRIGLEY JR. COMPANY
1132 West Blackhawk Street, Chicago,
Illinois 60642, USA
(770) WM.WRIGLEY JR.COMPANY
Chicago, Illinois, USA
(580) 2017 08 03

(111) M 1997 006634 R2
(732) WM. WRIGLEY JR. COMPANY
1132 West Blackhawk Street, Chicago,
Illinois 60642, USA
(770) WM.WRIGLEY JR.COMPANY
Chicago, Illinois, USA
(580) 2017 08 03

(111) M 1997 006638 R2
(732) WM. WRIGLEY JR. COMPANY
1132 West Blackhawk Street, Chicago,
Illinois 60642, USA
(770) WM.WRIGLEY JR.COMPANY
Chicago, Illinois, USA
(580) 2017 08 03

(111) M 1997 006639 R2
(732) WM. WRIGLEY JR. COMPANY
1132 West Blackhawk Street, Chicago,
Illinois 60642, USA
(770) WM.WRIGLEY JR.COMPANY
Chicago, Illinois, USA
(580) 2017 08 03

(111) M 1997 006759 R1
(732) PANDROL LIMITED,
Osprey House, 63 Station Road, Addlestone,
Weybridge, Surrey, KT15 2AR, United
Kingdom
(770) PANDROL LIMITED
Osprey House, Addlestone, Weybridge,
Surrey, KT15 2BH, United Kingdom
(580) 2017 08 23

(111) M 1997 006841 R2
(732) RCA TRADEMARK MANAGEMENT
1-5 Rue Jeanne d'Are, 92130 ISSY
LES MOULINEAUX, France
(770) RCA TRADEMARK MANAGEMENT
46 rue Alphonse Le Gallo, 92100 Boulogne
Billancourt, France
(580) 2017 08 25

(111) M 1997 006846 R2
(732) RCA TRADEMARK MANAGEMENT
1-5 Rue Jeanne d'Are, 92130 ISSY LES
MOULINEAUX, France
(770) RCA TRADEMARK MANAGEMENT
46 rue Alphonse Le Gallo, 92100 Boulogne
Billancourt, France
(580) 2017 08 25

(111) M 1997 006904 R2
(732) WM. WRIGLEY JR. COMPANY
1132 West Blackhawk Street, Chicago,
Illinois 60642, USA
(770) WM.WRIGLEY JR.COMPANY
410 North Michigan Avenue, Chicago,
Illinois 60611, USA
(580) 2017 08 03

(111) M 1997 006961 R2
(732) SEB S.A.
112 Chemin du Moulin Carron, Campus
SEB, 69130 Ecully, France
(770) SEB S.A.
Les 4 M, Chemin du Petit-Bois, 69130
Ecully, France
(580) 2017 08 08

(111) M 1997 007097 R2
(732) GERD BILLERBECK GESELLSCHAFT
MBH
Fasangasse 18/10, 1030 Vienna, Austria
(770) GERD BILLERBECK GESELLSCHAFT
MBH
Meissauergasse 23, A-1220 Vienna, Austria
(580) 2017 08 29

(111) M 1997 007251 R2
(732) WM. WRIGLEY JR. COMPANY
1132 West Blackhawk Street, Chicago,
Illinois 60642, USA
(770) WM. WRIGLEY JR. COMPANY
410 North Michigan Avenue, Chicago,
60611 Illinois, USA
(580) 2017 08 03

(111) M 1997 007265 R2
(732) WM. WRIGLEY JR. COMPANY
1132 West Blackhawk Street, Chicago,
Illinois 60642, USA
(770) WM. WRIGLEY JR. COMPANY
410 North Michigan Avenue, Chicago,
Illinois 60611, USA
(580) 2017 08 03

(111) M 1994 000084 R2
(732) SUBARU CORPORATION
1-20-8, Ebisu, Shibuya-ku, Tokyo, Japan
(770) FUJI JUKOGYO KABUSHIKI KAISHA
(also trading as FUJI HEAVY INDUSTRIES
LTD)
1-20-8, Ebisu, Shibuya-ku, Tokyo, Japan
(580) 2017 08 25

(111) M 1994 000093 R2
(732) SUBARU CORPORATION
1-20-8, Ebisu, Shibuya-ku, Tokyo, Japan
(770) FUJI JUKOGYO KABUSHIKI KAISHA
(also trading as FUJI HEAVY INDUSTRIES
LTD)
1-20-8, Ebisu, Shibuya-ku, Tokyo, Japan
(580) 2017 08 25

INVALIDATION OF TRADEMARKS REGISTRATION

(111) M 2002 14663 R1
(141) 2017 04 25, On demand of the owner
(732) ALLIED DOMEQ LIMITED
Chivas House, 72 Chancellors Road,
London W6 9RS, United Kingdom

(111) M 2007 17244 R
(141) 2017 04 25, Not payment for prolongation
of registration on the following of 10 years
(732) LTD "BLOK-JORJIA"
Dolidzis q.11, 0171, Tbilisi, Georgia

(111) M 2007 17247 R
(141) 2017 05 01, Not payment for prolongation
of registration on the following of 10 years
(732) DAVIT GVATUA
Rcheulishvilis q.me-3 korp. b.30, 0179,
Tbilisi, Georgia;
GELA MIQADZE
Lalionis shes.5, 0101, Tbilisi, Georgia

(111) M 2007 17248 R
(141) 2017 05 01, Not payment for prolongation
of registration on the following of 10 years
(732) VALODIA FADIURASHVILI
Kakhetis gzat. 36a, b.24, 0190, Tbilisi,
Georgia;
TAMAZ JANASHVILI
Gamrekeli St. 4, 0186, Tbilisi, Georgia

(111) M 2007 17249 R
(141) 2017 05 01, Not payment for prolongation
of registration on the following of 10 years
(732) TEIMURAZ ORTOIDZE
Tabukashvilis q.47, 0118, Tbilisi, Georgia

(111) M 2007 17250 R
(141) 2017 05 01, Not payment for prolongation
of registration on the following of 10 years
(732) LTD "TSENTRI"
Didi Kheivnis q.3, 0114, Tbilisi, Georgia

(111) M 2007 17254 R
(141) 2017 05 01, Not payment for prolongation
of registration on the following of 10 years
(732) ORION CORPORATION
Orionintie 1, 02200 Espoo, Finland

(111) M 2007 17255 R
(141) 2017 05 01, Not payment for prolongation
of registration on the following of 10 years
(732) LTD "PIPKI"
Dolidzis q. 13, 0171 Tbilisi, Georgia

(111) M 2007 17256 R
(141) 2017 05 01 Not payment for prolongation
of registration on the following of 10 years
(732) "UTAH GROUP" Inc.
King Faisal Bin Abdul Aziz St. 63, P.O. Box
840714 Amman, 11181, Jordan

(111) M 2007 17257 R
(141) 2017 05 01, Not payment for prolongation
of registration on the following of 10 years
(732) "UTAH GROUP" Inc.
King Faisal Bin Abdul Aziz St. 63, P.O. Box
840714 Amman, 11181, Jordan

(111) M 2007 17292 R
(141) 2017 05 15, Not payment for prolongation
of registration on the following of 10 years
(732) ESPRIT INTERNATIONAL
1370 Broadway, New York, NY 10012, USA

(111) M 2010 20845 R
(141) 2017 07 12, Court decision
(732) CERASUS INC
Calle 50 y Aquilino de la Guardia, Plaza
Banco General, Piso 30, Panama,
0823-05789, Panama

(111) M 2012 22650 R
(141) 2017 08 08, On demand of the owner
(732) LTD "QROSVEISI"
Saburtalos raioni, 26 maisis moedani, N.1
(sastumro Achara), Tbilisi, Georgia

(111) M 1997 4373 R1
(141) 2007 04 20, Not payment for prolongation
of registration on the following of 10 years
(732) FABERGE LIMITED
Walker House, P.O. Box 908GT, Mary
Street, George Town, Grand Cayman, KY

(111) M 1997 4375 R1
(141) 2007 04 20, Not payment for prolongation
of registration on the following of 10 years

(732) EVE HOLDINGS INC.
209A Baynard Building, 3411 Silverside
Road, Wilmington, Delaware, USA

(111) M 1997 4378 R1
(141) 2007 04 23, Not payment for prolongation
of registration on the following of 10 years

(732) DIAGEO BRANDS B.V.
10-12 Molenwerf, 1014 BG Amsterdam, NL

(111) M 1997 4385 R1
(141) 2007 04 23, Not payment for prolongation
of registration on the following of 10 years
(732) YORK INTERNATIONAL CORPORATION
631 South Richland Avenue, York,
Pennsylvania, USA

(111) M 1997 4409 R1
(141) 2007 04 27, Not payment for prolongation
of registration on the following of 10 years
(732) APTALIS PHARMA SAS
Poute de Bû, La Prévôté 78550 Houdan,
France

(111) M 1997 4417 R1
(141) 2007 04 27, Not payment for prolongation
of registration on the following of 10 years
(732) FMC CORPORATION
a Delaware Corporation
1735 Market Street, Philadelphia,
Pennsylvania 19103, USA

(111) M 1997 4421 R1
(141) 2006 10 30, Not payment for prolongation
of registration on the following of 10 years
(732) SIRVA UK LIMITED
Heritage House, 345 Southbury Road,
Enfield, Middlesex, EN1 1UP, United
Kingdom

(111) M 1997 4427 R1
(141) 2006 10 30, Not payment for prolongation
of registration on the following of 10 years
(732) PETER JACKSON (overseas) LIMITED
Globe House, 4 Temple Place, London,
WC2R 2PG, GB

(111) M 1997 4428 R1
(141) 2006 10 30, Not payment for prolongation
of registration on the following of 10 years
(732) The Procter & Gamble Company
One Procter & Gamble Plaza, Cincinnati,
Ohio, USA

(111) M 1997 4436 R1
(141) 2007 04 30, Not payment for prolongation
of registration on the following of 10 years
(732) DUNHILL TOBACO OF LONDON
LIMITED
Globe House, 4 Temple Place, London
WC2R 2PG, United Kingdom

(111) M 1997 4437 R1
(141) 2007 04 30, Not payment for prolongation
of registration on the following of 10 years
(732) THE STROH BREWERY COMPANY
100 River Place, Detroit, Michigan 48207,
USA

(111) M 1997 4438 R1
(141) 2007 04 30, Not payment for prolongation
of registration on the following of 10 years
(732) Dunhill Tobacco of London Limited
Globe House, 4 Temple Place, London
WC2R 2PG, United Kingdom

(111) M 1997 4461 R1
(141) 2007 05 03, Not payment for prolongation
of registration on the following of 10 years
(732) STANLEY BLACK & DECKER, INC.
1000 Stanley Drive, New Britain,
Connecticut 06053, USA

(111) M 1997 4469 R1
(141) 2007 05 04, Not payment for prolongation
of registration on the following of 10 years
(732) E.R. SQUIBB & SONS, L.L.C.
Lawrenceville-Princeton Road, Princeton,
New Jersey 08540, USA

(111) M 1997 4470 R1
(141) 2007 05 04, Not payment for prolongation
of registration on the following of 10 years
(732) MEAD JOHNSON & COMPANY
2400 West Lloyd Expressway, Evansville,
Indiana 47721, USA

(111) M 1997 4471 R1
(141) 2007 05 04, Not payment for prolongation
of registration on the following of 10 years
(732) MEAD JOHNSON & COMPANY
2400 West Lloyd Expressway, Evansville,
Indiana 47721, USA

(111) M 1997 4472 R1
(141) 2007 05 04, Not payment for prolongation
of registration on the following of 10 years

(732) SOCIETE DES PRODUITS NESTLE S.A.
CH-1800 Vevey, CH

(111) M 1997 4473 R1
(141) 2007 05 04, Not payment for prolongation
of registration on the following of 10 years
(732) MEAD JOHNSON & COMPANY
2400 West Lloyd Expressway, Evansville,
Indiana 47721, USA

(111) M 1997 4474 R1
(141) 2007 05 04, Not payment for prolongation
of registration on the following of 10 years
(732) MEAD JOHNSON & COMPANY
2400 West Lloyd Expressway, Evansville,
Indiana 47721, USA

(111) M 1997 4475 R1
(141) 2007 05 04, Not payment for prolongation
of registration on the following of 10 years
(732) MEAD JOHNSON & COMPANY
2400 West Lloyd Expressway, Evansville,
Indiana 47721, USA

(111) M 1997 4476 R1
(141) 2007 05 04, Not payment for prolongation
of registration on the following of 10 years
(732) BRISTOL-MYERS SQUIBB COMPANY
345 Park Avenue, New York,
New York 10154, USA

(111) M 1997 4477 R1
(141) 2007 05 04, Not payment for prolongation
of registration on the following of 10 years
(732) BRISTOL-MYERS SQUIBB COMPANY
345 Park Avenue, New York,
New York 10154, USA

(111) M 1997 4478 R1
(141) 2007 05 04, Not payment for prolongation
of registration on the following of 10 years
(732) CLINIQUE LABORATORIES, LLC,
a Delaware Limited Liability Company
767, Fifth Avenue, New York,
New York, 10153, USA

(111) M 1997 4479 R1
(141) 2007 05 04, Not payment for prolongation
of registration on the following of 10 years
(732) CLINIQUE LABORATORIES, LLC
a Delaware Limited Liability Company
767, Fifth Avenue, New York, New York,
10153, USA

(111) M 1997 4480 R1
(141) 2007 05 04 Not payment for prolongation
of registration on the following of 10 years
(732) CLINIQUE LABORATORIES, LLC
a Delaware Limited Liability Company
767, Fifth Avenue, New York, New York,
10153, USA

(111) M 1997 4481 R1
(141) 2007 05 04, Not payment for prolongation
of registration on the following of 10 years
(732) CLINIQUE LABORATORIES, LLC
a Delaware Limited Liability Company
767, Fifth Avenue, New York, New York,
10153, USA

(111) M 1997 4482 R1
(141) 2007 05 04, Not payment for prolongation
of registration on the following of 10 years
(732) CLINIQUE LABORATORIES, LLC
a Delaware Limited Liability Company
767, Fifth Avenue, New York, New York,
10153, USA

(111) M 1997 4483 R1
(141) 2007 05 04, Not payment for prolongation
of registration on the following of 10 years
(732) CLINIQUE LABORATORIES, LLC
a Delaware Limited Liability Company
767, Fifth Avenue, New York, New York,
10153, USA

(111) M 1997 4484 R1
(141) 2007 05 04, Not payment for prolongation
of registration on the following of 10 years
(732) CLINIQUE LABORATORIES, LLC
a Delaware Limited Liability Company
767, Fifth Avenue, New York, New York,
10153, USA

(111) M 1997 4485 R1
(141) 2007 05 04, Not payment for prolongation
of registration on the following of 10 years
(732) CLINIQUE LABORATORIES, LLC
a Delaware Limited Liability Company
767, Fifth Avenue, New York, New York,
10153, USA

(111) M 1997 4486 R1
(141) 2007 05 04, Not payment for prolongation
of registration on the following of 10 years
(732) CLINIQUE LABORATORIES, LLC
a Delaware Limited Liability Company
767, Fifth Avenue, New York, New York,
10153, USA

(111) M 1997 4487 R1
(141) 2007 05 04, Not payment for prolongation
of registration on the following of 10 years
(732) E.R. SQUIBB & SONS, L.L.C.
The Corporation Trusy Company
1209 Orange Street, Wilmington, New
Castle Country, 19801 Delaware, USA

(111) M 1997 4489 R1
(141) 2007 05 04, Not payment for prolongation
of registration on the following of 10 years
(732) E.R. SQUIBB & SONS, L.L.C.
The Corporation Trusy Company
1209 Orange Street, Wilmington, New
Castle Country, 19801 Delaware, USA

(111) M 1997 4490 R1
(141) 2007 05 04, Not payment for prolongation
of registration on the following of 10 years
(732) E.R. SQUIBB & SONS, L.L.C.
The Corporation Trusy Company
1209 Orange Street, Wilmington, New
Castle Country, 19801 Delaware, USA

(111) M 1997 4492 R1
(141) 2007 05 04, Not payment for prolongation
of registration on the following of 10 years
(732) E.R. SQUIBB & SONS, L.L.C.
The Corporation Trusy Company
1209 Orange Street, Wilmington, New
Castle Country, 19801 Delaware, USA

(111) M 1997 4493 R1
(141) 2007 05 04 Not payment for prolongation
of registration on the following of 10 years
(732) E.R. SQUIBB & SONS, L.L.C.
The Corporation Trusy Company
1209 Orange Street, Wilmington, New Castle
Country, 19801 Delaware, USA

(111) M 1997 4497 R1
(141) 2007 05 04, Not payment for prolongation
of registration on the following of 10 years
(732) E.R. SQUIBB & SONS, L.L.C.
The Corporation Trusy Company
1209 Orange Street, Wilmington, New
Castle Country, 19801 Delaware, USA

(111) M 1997 4499 R1
(141) 2007 05 04, Not payment for prolongation
of registration on the following of 10 years
(732) ZENITH ELECTRONICS CORPORATION
1000 Milwaukee Avenue, Glenview, Illinois
60025-2493, USA

(111) M 1997 4500 R1
(141) 2007 05 04, Not payment for prolongation
of registration on the following of 10 years
(732) SWIFT BRANDS COMPANY
1770 Promontory Circle, Greeley,
CO 80634-9038, USA

(111) M 1997 4506 R1
(141) 2007 05 07, Not payment for prolongation
of registration on the following of 10 years
(732) HENKEL AG & Co. KGaA
Henkelstrasse 67, 40589 Dusseldorf,
Germany

(111) M 1997 4507 R1
(141) 2007 05 07, Not payment for prolongation
of registration on the following of 10 years
(732) HENKEL AG & Co. KGaA
Henkelstrasse 67, 40589 Dusseldorf,
Germany

(111) M 1997 4508 R1
(141) 2007 05 07, Not payment for prolongation
of registration on the following of 10 years
(732) HENKEL AG & Co. KGaA
Henkelstrasse 67, 40589 Dusseldorf,
Germany

(111) M 1997 4509 R1
(141) 2007 05 07, Not payment for prolongation
of registration on the following of 10 years
(732) HENKEL AG & Co. KGaA
Henkelstrasse 67, 40589 Dusseldorf,
Germany

(111) M 1997 4511 R1
(141) 2007 05 07, Not payment for prolongation
of registration on the following of 10 years
(732) HENKEL AG & Co. KGaA
Henkelstrasse 67, 40589 Dusseldorf,
Germany

(111) M 1997 4513 R1
(141) 2006 11 06, Not payment for prolongation
of registration on the following of 10 years
(732) ARC TRANSISTANCE S.A.
Avenue des Pleiades, 11, 1200 Brussels, BE

(111) M 1997 4514 R1
(141) 2007 05 07, Not payment for prolongation
of registration on the following of 10 years
(732) HENKEL AG & Co. KGaA
Henkelstrasse 67, 40589 Dusseldorf,
Germany

(111) M 1997 4521 R1
(141) 2007 05 07, Not payment for prolongation
of registration on the following of 10 years
(732) FIAT GROUP MARKETING &
CORPORATE COMMUNICATION S.P.A.
Via Nizza 250, 10126 Torino, IT

(111) M 1997 4528 R2
(141) 2007 05 07, Not payment for prolongation
of registration on the following of 10 years
(732) TOMIC AUSTRIA G.m.b.H.
Atomic Straße 1, 5541 Altenmarkt im
Pongau, Austria

(111) M 1997 4531 R1
(141) 2006 11 06, Not payment for prolongation
of registration on the following of 10 years
(732) REEMTSMA CIGARETTENFABRIKEN
GmbH
51, Parkstrasse, D-2000, Hamburg 52,
Germany

(111) M 1997 4532 R1
(141) 2006 11 06, Not payment for prolongation
of registration on the following of 10 years
(732) REEMTSMA CIGARETTENFABRIKEN
GmbH
51, Parkstrasse, D-2000, Hamburg 52,
Germany

(111) M 1997 4535 R1
(141) 2006 11 06, Not payment for prolongation
of registration on the following of 10 years
(732) SUPER RIFLE S.P.A.
Via G. Matteotti 2/b 2/c, BARBERINO
DI MUGELLO (FIRENZE), Italy

(111) M 1997 4550 R1
(141) 2007 05 07, Not payment for prolongation
of registration on the following of 10 years
(732) MERCK SHARP & DOHME CORP.
One Merck Drive, Whitehouse Station,
New Jersey 08889, USA

(111) M 1997 4551 R1
(141) 2007 05 07, Not payment for prolongation
of registration on the following of 10 years
(732) MERCK SHARP & DOHME CORP.
One Merck Drive, Whitehouse Station,
New Jersey 08889, USA

(111) M 1997 4570 R1
(141) 2007 05 07, Not payment for prolongation
of registration on the following of 10 years
(732) BERLIN-CHEMIE AG
Glienicke Weg 125, D-12489, Berlin,
Germany

(111) M 1997 4578 R1
(141) 2007 05 07, Not payment for prolongation
of registration on the following of 10 years
(732) BASF AGRO TRADEMARKS GMBH
Carl-Bosch-Strasse 38, Ludwigshafen
am Rhein, Germany

CLASSIFICATION INDEXES

INVENTIONS

CONCORDANCE TABLE OF INTERNATIONAL CLASSIFICATION INDEX AND PUBLICATION NUMBERS

INTERNATIONAL CLASSIFICATION INDEXES (51)	NUMBER OF PUBLISHED APPLICATION (10)
A 61 M 5/315	AP 2017 13974 A

CONCORDANCE TABLE OF PUBLICATION NUMBERS AND INTERNATIONAL CLASSIFICATION INDEX

NUMBER OF PUBLISHED APPLICATION (10)	INTERNATIONAL CLASSIFICATION INDEXES (51)
AP 2017 13974 A	A 61 M 5/315

CONCORDANCE TABLE OF INTERNATIONAL CLASSIFICATION INDEX, PATENT NUMBERS AND PUBLICATION NUMBERS

INTERNATIONAL CLASSIFICATION INDEX (51)	NUMBER OF PATENT (11)	NUMBER OF PUBLISHED APPLICATION (10)
A 01 N 47/40; A 01 N 37/18; A 01 N 43/40; A 01 N 43/54; A 01 N 43/78; A 01 N 47/04; A 01 N 47/12; A 01 N 47/28; A 01 N 51/00; A 01 N 57/32; A 01 P 7/02; A 01 P 7/04; A 61 K 31/341; A 61 K 31/381; A 61 K 31/426; A 61 K 31/44; A 61 K 31/4427; A 61 K 31/443; A 61 K 31/4436; A 61 K 31/4439; A 61 K 31/50; C 07 C 233/05; C 07 C 233/12; C 07 C 261/04; C 07 C 271/12; C 07 C 311/09; C 07 D 213/36; C 07 D 213/42; C 07 D 237/12; C 07 D 277/20; C 07 D 277/32; C 07 D 307/14; C 07 D 333/20; C 07 D 401/12; C 07 D 405/12; C 07 D 409/12; C 07 D 417/12	P 2017 6728 B	AP 2017 13043 A
B 64 D 27/10; F 02 K 3/077	P 2017 6732 B	AP 2017 14074 A
C 07 D 223/16; C 07 D 233/38	P 2017 6731 B	AP 2017 13425 A
F 25 B 27/00; F 25 B 30/06	P 2017 6729 B	AP 2017 13322 A
G 01 N 33/569; A 23 L 1/30; A 61 K 35/74	P 2017 6730 B	AP 2017 13351 A
H 01 Q 15/16; H 01 Q 1/30	P 2017 6727 B	AP 2017 12873 A

**CONCORDANCE TABLE OF PATENT NUMBERS,
PUBLICATION NUMBERS AND INTERNATIONAL CLASSIFICATION INDEX**

NUMBER OF PATENT (11)	NUMBER OF PUBLISHED APPLICATION (10)	INTERNATIONAL CLASSIFICATION INDEX (51)
P 2017 6727 B	AP 2017 12873 A	H 01 Q 15/16; H 01 Q 1/30
P 2017 6728 B	AP 2017 13043 A	A 01 N 47/40; A 01 N 37/18; A 01 N 43/40; A 01 N 43/54; A 01 N 43/78; A 01 N 47/04; A 01 N 47/12; A 01 N 47/28; A 01 N 51/00; A 01 N 57/32; A 01 P 7/02; A 01 P 7/04; A 61 K 31/341; A 61 K 31/381; A 61 K 31/426; A 61 K 31/44; A 61 K 31/4427; A 61 K 31/443; A 61 K 31/4436; A 61 K 31/4439; A 61 K 31/50; C 07 C 233/05; C 07 C 233/12; C 07 C 261/04; C 07 C 271/12; C 07 C 311/09; C 07 D 213/36; C 07 D 213/42; C 07 D 237/12; C 07 D 277/20; C 07 D 277/32; C 07 D 307/14; C 07 D 333/20; C 07 D 401/12; C 07 D 405/12; C 07 D 409/12; C 07 D 417/12
P 2017 6729 B	AP 2017 13322 A	F 25 B 27/00; F 25 B 30/06
P 2017 6730 B	AP 2017 13351 A	G 01 N 33/569; A 23 L 1/30; A 61 K 35/74
P 2017 6731 B	AP 2017 13425 A	C 07 D 223/16; C 07 D 233/38
P 2017 6732 B	AP 2017 14074 A	B 64 D 27/10; F 02 K 3/077

**CONCORDANCE TABLE OF APPLICATION NUMBERS, PUBLICATION NUMBERS
AND PATENTS**

NUMBER OF APPLICATION (21)	NUMBER OF PUBLISHED APPLICATION (10)	NUMBER OF PATENT (11)
AP 2012 012873	AP 2017 12873 A	P 2017 6727 B
AP 2011 013043	AP 2017 13043 A	P 2017 6728 B
AP 2013 013322	AP 2017 13322 A	P 2017 6729 B
AP 2012 013351	AP 2017 13351 A	P 2017 6730 B
AP 2014 013425	AP 2017 13425 A	P 2017 6731 B
AP 2016 014074	AP 2017 14074 A	P 2017 6732 B

UTILITY MODELS

**CONCORDANCE TABLE OF INTERNATIONAL CLASSIFICATION INDEX,
PATENT NUMBERS AND PUBLICATION NUMBERS**

INTERNATIONAL CLASSIFICATION INDEX (51)	NUMBER OF PATENT (11)	NUMBER OF PUBLISHED APPLICATION (10)
B 41 F 17/00	U 2017 1945 Y	AU 2017 14330 U
E 02 B 9/04	U 2017 1946 Y	AU 2017 14352 U

**CONCORDANCE TABLE OF PATENT NUMBERS,
PUBLICATION NUMBERS AND INTERNATIONAL CLASSIFICATION INDEX**

NUMBER OF PATENT (11)	NUMBER OF PUBLISHED APPLICATION (10)	INTERNATIONAL CLASSIFICATION INDEX (51)
U 2017 1945 Y	AU 2017 14330 U	B 41 F 17/00
U 2017 1946 Y	AU 2017 14352 U	E 02 B 9/04

**CONCORDANCE TABLE OF APPLICATION NUMBERS, PUBLICATION NUMBERS
AND PATENTS**

NUMBER OF APPLICATION (21)	NUMBER OF PUBLISHED APPLICATION (10)	NUMBER OF PATENT (11)
AU 2016 014330	AU 2017 14330 U	U 2017 1945 Y
AU 2016 014352	AU 2017 14352 U	U 2017 1946 Y

DESIGNS

DESIGN REGISTERED ACCORDING TO THE ACCELERATED PROCEDURE

**CONCORDANCE TABLE OF INTERNATIONAL CLASSIFICATION INDEX
AND PUBLICATION NUMBERS**

INTERNATIONAL CLASSIFICATION INDEXES (51)	NUMBER OF PUBLISHED APPLICATION (10)
25-03	D 2017 721 S

**CONCORDANCE TABLE OF PUBLICATION NUMBERS
AND INTERNATIONAL CLASSIFICATION INDEX**

NUMBER OF PUBLISHED APPLICATION (11)	INTERNATIONAL CLASSIFICATION INDEXES (51)
D 2017 721 S	25-03

**CONCORDANCE TABLE OF APPLICATION NUMBERS,
PUBLICATION NUMBERS AND PATENTS**

NUMBER OF APPLICATION (21)	NUMBER OF PATENT (11)
AD 2017 982	D 2017 721 S

TRADEMARKS

CONCORDANCE TABLE OF REGISTRATION NUMBERS, APPLICATION NUMBERS, PUBLICATION NUMBERS AND BULLETIN NUMBERS

NUMBER OF REGISTRATION (111)	NUMBER OF APPLICATIONS (210)	NUMBER OF PUBLISHED APPLICATIONS (260)	NUMBER OF BULLETIN
M 2017 28751 R	AM 87835	AM 2017 87835 A	4(464)2017
M 2017 28827 R	AM 93564	–	17(476)2017
M 2017 28828 R	AM 93769	–	17(476)2017
M 2017 28829 R	AM 93770	–	17(476)2017
M 2017 28830 R	AM 93771	–	17(476)2017
M 2017 28831 R	AM 93772	–	17(476)2017
M 2017 28832 R	AM 93436	–	17(476)2017
M 2017 28833 R	AM 93708	–	17(476)2017
M 2017 28834 R	AM 90880	–	17(476)2017
M 2017 28835 R	AM 93431	–	17(476)2017
M 2017 28836 R	AM 93837	–	17(476)2017
M 2017 28837 R	AM 86855	AM 2016 86855 A	1(461)2017
M 2017 28838 R	AM 86928	AM 2017 86928 A	3(463)2017
M 2017 28839 R	AM 86966	AM 2017 86966 A	3(463)2017
M 2017 28840 R	AM 87068	AM 2017 87068 A	7(467)2017
M 2017 28841 R	AM 87089	AM 2016 87089 A	1(461)2017
M 2017 28842 R	AM 87091	AM 2017 87091 A	5(465)2017
M 2017 28843 R	AM 87366	AM 2017 87366 A	3(463)2017
M 2017 28844 R	AM 87444	AM2017 87444 A	3(463)2017
M 2017 28845 R	AM 87445	AM 2017 87445 A	3(463)2017
M 2017 28846 R	AM 87628	AM 2017 87628 A	7(467)2017
M 2017 28847 R	AM 87696	AM 2017 87696 A	4(464)2017
M 2017 28848 R	AM 87762	AM 2017 87762 A	3(463)2017
M 2017 28849 R	AM 87819	AM 2017 87819 A	5(465)2017
M 2017 28850 R	AM 87834	AM 2017 87834 A	3(463)2017
M 2017 28851 R	AM 87885	AM 2017 87885 A	3(463)2017
M 2017 28852 R	AM 87989	AM 2017 87989 A	7(467)2017
M 2017 28853 R	AM 88125	AM 2017 88125 A	8(468)2017
M 2017 28854 R	AM 88163	AM 2017 88163 A	7(467)2017
M 2017 28855 R	AM 88187	AM 2017 88187 A	7(467)2017
M 2017 28856 R	AM 88216	AM 2017 88216 A	6(466)2017
M 2017 28857 R	AM 88225	AM2017 88225 A	6(466)2017
M 2017 28858 R	AM 88226	AM 2017 88226 A	6(466)2017
M 2017 28859 R	AM 88322	AM 2017 88322 A	8(468)2017
M 2017 28860 R	AM 88371	AM 2017 88371 A	8(468)2017
M 2017 28861 R	AM 88406	AM 2017 88406 A	8(468)2017
M 2017 28862 R	AM 88462	AM 2017 88462 A	6(466)2017
M 2017 28863 R	AM 88471	AM 2017 88471 A	7(467)2017
M 2017 28864 R	AM 88486	AM 2017 88486 A	8(468)2017
M 2017 28865 R	AM 88503	AM 2017 88503 A	7(467)2017
M 2017 28866 R	AM 88611	AM 2017 88611 A	9(469)2017
M 2017 28867 R	AM 88647	AM 2017 88647 A	8(468)2017
M 2017 28868 R	AM 88671	AM 2017 88671 A	8(468)2017
M 2017 28869 R	AM 88681	AM 2017 88681 A	8(468)2017
M 2017 28870 R	AM 88682	AM 2017 88682 A	8(468)2017

**CONCORDANCE TABLE OF PUBLICATION NUMBERS
AND APPLICATION NUMBERS**

NUMBER OF PUBLISHED APPLICATION (260)	NUMBER OF APPLICATION (210)	1	2
1	2		
AM 2017 87631 A	AM 87631 A	AM 2017 90400 A	AM 90400 A
AM 2017 87632 A	AM 87632 A	AM 2017 90412 A	AM 90412 A
AM 2017 87633 A	AM 87633 A	AM 2017 90414 A	AM 90414 A
AM 2017 88283 A	AM 88283 A	AM 2017 90415 A	AM 90415 A
AM 2017 89901 A	AM 89901 A	AM 2017 90479 A	AM 90479 A
AM 2017 89996 A	AM 89996 A	AM 2017 90482 A	AM 90482 A
AM 2017 90060 A	AM 90060 A	AM 2017 90488 A	AM 90488 A
AM 2017 90096 A	AM 90096 A	AM 2017 90494 A	AM 90494 A
AM 2017 90098 A	AM 90098 A	AM 2017 90504 A	AM 90504 A
AM 2017 90102 A	AM 90102 A	AM 2017 90546 A	AM 90546 A
AM 2017 90103 A	AM 90103 A	AM 2017 90553 A	AM 90553 A
AM 2017 90106 A	AM 90106 A	AM 2017 90642 A	AM 90642 A
AM 2017 90107 A	AM 90107 A	AM 2017 90645 A	AM 90645 A
AM 2017 90143 A	AM 90143 A	AM 2017 90646 A	AM 90646 A
AM 2017 90389 A	AM 90389 A	AM 2017 90647 A	AM 90647 A
		AM 2017 90651 A	AM 90651 A
		AM 2017 90664 A	AM 90664 A
		AM 2017 90675 A	AM 90675 A
		AM 2017 90677 A	AM 90677 A

**CONCORDANCE TABLE OF INDEX OF GOODS AND/OR SERVICES
AND APPLICATION NUMBERS**

INDEX OF GOODS AND/OR SERVICES (511)	NUMBER OF PUBLISHED APPLICATIONS (26)	1	2
1	2		
5	AM 2017 90096 A	30	AM 2017 90400 A
5	AM 2017 90098 A	30	AM 2017 90479 A
5	AM 2017 90102 A	30	AM 2017 90677 A
5	AM 2017 90106 A	30	AM 2017 90680 A
5	AM 2017 90107 A	31	AM 2017 90415 A
5	AM 2017 90546 A	33	AM 2017 90482 A
6	AM 2017 90102 A	34	AM 2017 90494 A
9	AM 2017 90664 A	34	AM 2017 90642 A
12	AM 2017 90651 A	34	AM 2017 90645 A
13	AM 2017 90488 A	34	AM 2017 90646 A
16	AM 2017 90096 A	34	AM 2017 90647 A
16	AM 2017 90102 A	35	AM 2017 88283 A
16	AM 2017 90103 A	35	AM 2017 89996 A
16	AM 2017 90412 A	35	AM 2017 90060 A
25	AM 2017 90504 A	35	AM 2017 90102 A
29	AM 2017 88283 A	35	AM 2017 90389 A
29	AM 2017 90482 A	35	AM 2017 90414 A
30	AM 2017 87631 A	35	AM 2017 90553 A
30	AM 2017 87632 A	39	AM 2017 89901 A
30	AM 2017 87633 A	39	AM 2017 90675 A
30	AM 2017 88283 A	43	AM 2017 88283 A
		43	AM 2017 89901 A
		43	AM 2017 90400 A
		44	AM 2017 90553 A
		44	AM 2017 90389 A
		45	AM 2017 90143 A

CONCORDANCE TABLE OF INDEX OF GOODS AND/OR SERVICES
AND NUMBERS OF TRADEMARKS REGISTERED ACCORDING
TO THE ACCELERATED PROCEDURE

INDEX OF GOODS AND/OR SERVICES (511)	NUMBERS OF REGISTERED ACCORDING TO THE ACCELERATED PROCEDURE (111)
5	M 2017 28835 R
29	M 2017 28827 R
29	M 2017 28832 R
33	M 2017 28834 R
35	M 2017 28833 R
36	M 2017 28836 R
41	M 2017 28828 R
41	M 2017 28829 R
41	M 2017 28830 R
41	M 2017 28831 R
43	M 2017 28833 R

OFFICIAL BULLETIN OF THE INDUSTRIAL PROPERTY

17(477)

EDITOR-IN-CHIEF: N. Bebrishvili

EDITORS-TRANSLATORS: E. Gabunia

PROOFREADER: A. Shikhashvili

COMPUTER LAYOUT: M. Ordenidze
K. Svanidze

www.sakpatenti.org.ge

E-mail: info@sakpatenti.org.ge