

Official Bulletin of the Industrial Property

Inventions

Utility Models

Designs

Trademarks

Appellations of Origin of Goods



საქართველოს ინტელექტუალური
საკუთრების ეროვნული ცენტრი

საქპატენტი

SAKPATENTI

NATIONAL INTELLECTUAL PROPERTY
CENTER OF GEORGIA

www.sakpatenti.gov.ge

Date of Publication – 2020 09 10

17(549)

INID CODES FOR IDENTIFICATION OF BIBLIOGRAPHIC DATA

INVENTIONS, UTILITY MODELS

- (10) Number of publication for application, which has been examined
- (11) Number of patent and kind of document
- (21) Serial number of application
- (22) Date of filing of the application
- (23) Date of exhibition or the date of the earlier filing and the number of application, if any
- (24) Date from which patent may have effect
- (31) Number of priority application
- (32) Date of filing of priority application
- (33) Code of the country or regional organization allotting priority application number
- (44) Date of publication of application not granted, but examined and number of bulletin
- (45) Date of publication of registered document
- (51) International Patent Classification Index

- (54) Title of the invention
- (57) Abstract
- (60) Number of examined patent document granted by foreign patent office, date from which patent has effect and country code
- (62) Number of the earlier application and in case of divided application, date of filing an application
- (71) Name, surname and address of applicant (country code)
- (72) Name, surname of inventor (country code)
- (73) Name, surname and address of patent owner (country code)
- (74) Name, surname of representative or patent attorney
- (85) Date of commencement of the national phase of International Application
- (86) Number and date of filing of international application
- (87) Number and date of publication of international application
- (94) Calculated date of expiry of the SPC or the duration of the SPC

DESIGNS

- (10) Number of publication for application
- (11) Number of patent and kind of document or number of registration
- (15) Date of registration/Date of patent renewal
- (18) Expected expiration date of patent or registration
- (21) Serial number of application
- (22) Date of filing of the application
- (23) Date of exhibition or the date of the earlier filing and the number of application, if any
- (24) Date from which patent may have effect
- (28) Number of designs included in the application
- (30) Data relating to priority (number of application, date of filing of application, two-letter code identifying the authority with whom the priority application was made)
- (31) Number of priority application
- (32) Date of filing of priority application
- (33) Code of the country or regional organization allotting priority application number
- (34) Two-letter code according to WIPO St.3 identifying the authority with which the priority application was made
- (44) Date of publication of design and number of bulletin (the first publication)
- (45) Date of publication of design registered by WIPO and number of bulletin

- (51) International Classification for designs (class and subclass of the Locarno Classification)
- (54) Title of the invention
- (55) Reproduction of the design
- (57) Description of characteristic features of the design including indication of colors
- (58) Date of recording of any kind of amendment in the Register
- (62) Number of the earlier application, registration and document number and if available the date of filing an application in case of divided application
- (71) Name, surname and address of applicant (country code)
- (72) Name, surname of creator (country code)
- (73) Name, surname and address of patent owner (country code)
- (74) Name, surname of representative or patent attorney
- (81) Contracting states concerned
 - II designated contracting states according to the 1960 Act
 - III designated contracting states according to the 1999 Act
- (85) Owner's permanent address
- (86) Owner's nationality
- (87) Owner's residence
- (88) State in which the owner has a real and effective industrial or commercial establishment

TRADEMARKS

- (111) - Number of registration
- (151) - Date of registration
- (156) - Date of the renewal
- (181) - Expected expiration date of registration
- (186) - Renewal expiration date of registration
- (141) - Date of cancel of duration of the mark
- (210) - Serial number of application
- (220) - Date of filing of the application
- (230) - Data concerning exhibition
- (260) - Number of application, for which favorable decision of examination about registration has been taken (publication number)
- (310) - Number of the first application
- (320) - Date of filing of the first application
- (330) - Code, identifying national or regional Office where the first application was made
- (511) - International Classification of Goods and Services for the purposes of registration of trade marks and/or list of goods and/or services classified according thereto
- (526) - Disclaimer
- (531) - Description of figurative elements of Trade Marks according to the International Classification of the Figurative Elements of Marks

- (540) - Reproduction of Trade Mark
- (550) - Nature and kind of Trade Mark
- (551) - Indication to the effect that the mark is a collective mark, a certification mark or a guarantee mark
- (554) - Three-dimensional mark
- (580) - Date of recording of any kind changes in respect of applications or registrations
- (591) - Information concerning colors claimed
- (731) - Name and address of the applicant
- (732) - Name and address of the holder of the registration
- (740) - Name and address of the representative
- (750) - Addreses for correspondence
- (770) - Name and address of the previous applicant or holder in case of change in ownership
- (771) - Previous name and address of the applicant or holder in case of change in ownership
- (791) - Name and address of the licensee
- (793) - Indication of conditions and/or restrictions under the license (Type of license, number of license agreement, data of license, data of validity of license)
- (800) - Certain data relating to the international registration of Trade Marks under the Protocol Relating to Madrid Agreement (International registration number
- (852) - Partial cancellation of the list of goods and services
- (891) - Date of subsequent designation

CODES FOR PUBLICATION IN BULLETIN

- (21) AP 0000 000000 - serial number of application for invention
- (10) AP 0000 0000 A - number of published application for invention (first publication)
- (11) P 0000 0000 B - number of patent for invention (second publication)
- (21) API 0000 000000 - number of application for imported patent
- (11) PI 0000 0000 A - number of imported patent (first publication)
- (21) AU 0000 000000 - serial number of application for utility model
- (10) AU 0000 000 U - number of published application for utility model (first publication)
- (11) U 0000 000 Y - number of patent for utility model (second publication)
- (21) AD 0000 000000 - serial number of application for design
- (10) AD 0000 000 S - number of published application for design (first publication)
- (11) D 0000 000 S - registered design

INTERNATIONAL PATENT CLASSIFICATION FOR INVENTIONS AND UTILITY MODELS

- SECTION A - HUMAN NECESSITIES
- SECTION B - PERFORMING OPERATIONS; TRANSPORTING
- SECTION C - CHEMISTRY; METALLURGY
- SECTION D - TEXTILES; PAPER
- SECTION E - FIXED CONSTRUCTIONS
- SECTION F - MECHANICAL ENGINEERING; LIGHTING; HEATING; WEAPONS; BLASTING
- SECTION G - PHYSICS
- SECTION H - ELECTRICITY

-
- M - Trade Mark
 - (210) AM 0000 000000 - Serial number of application;
 - (260) AAM 0000 00000 A - Publication number of application;
 - (111) M 0000 00000 R - Number of registration;
 - (111) MMM0000 00000 Rn - Number of renewals, in which n=1,2,3;
 - (111) M 0000 00000 R(P) - Number of registration under partial assignment of rights
-

Official Bulletin of the Industrial Property

Inventions

Utility Models

Designs

Trademarks

Appellations of Origin of Goods

CONTENTS

PUBLISHED TITLES OF PROTECTION	3
INVENTIONS	
▪ APPLICATIONS APPROVED FOR GRANTING PATENTS	4
▪ PATENTED INVENTIONS	6
UTILITY MODELS	
▪ APPLICATIONS APPROVED FOR GRANTING PATENTS	8
▪ PATENTED UTILITY MODEL	9
DESIGNS	
▪ REGISTERED DESIGNS	10
▪ DESIGN REGISTERED ACCORDING TO THE ACCELERATED PROCEDURE	11
▪ DESIGNS, WHICH HAVE BEEN REGISTERED WITH THE INTERNATIONAL BUREAU CLAIMING PRIORITY ON THE TERRITORY OF GEORGIA	13
TRADEMARKS	
▪ APPLICATIONS FILED UNDER THE NATIONAL PROCEDURE APPROVED FOR REGISTRATION	40
▪ REGISTERED TRADEMARKS	49
▪ TRADEMARKS REGISTERED ACCORDING TO THE ACCELERATED PROCEDURE	54
▪ INTERNATIONAL TRADEMARKS FOR WHICH A DECISION ON GRANTING PROTECTION IS TAKEN	56
▪ INTERNATIONAL TRADEMARKS PROTECTED IN GEORGIA	80
APPELLATIONS OF ORIGIN OF GOODS	
AMENDMENTS ON WINE PRODUCTION SPECIFICATION	86
▪ MUKUZANI	86
▪ TSINANDALI	92
▪ AKHASHENI	98
▪ TELIANI	104
OFFICIAL NOTIFICATIONS	
INVENTIONS	
▪ EXPIRATION OF PATENTS RESTORATION	109
▪ ABOLITION OF PATENTS WITH THE RIGHT TO RESTORE	110
▪ EXPIRATION OF TERM OF RESTORATION OF PATENTS	113
▪ EXPIRATION OF PATENTS	115
▪ CHANGE OF NAME AND/OR ADDRESS OF PATENTOWNER	115
UTILITY MODELS	
▪ ABOLITION OF PATENT WITH THE RIGHT TO RESTORE	116
▪ TRANSFER OF RIGHT	116
DESIGNS	
▪ EXTENSION OF REGISTRATION OF DESIGNS	117
▪ CANCELLATION OF DESIGNS REGISTRATION	117
▪ EXTENSION OF REGISTRATION OF INTERNATIONAL DESIGNS	118
TRADEMARKS	
▪ RENEWAL OF REGISTRATIONS	126
▪ COMPLETE TRANSFER OF RIGHTS	128
▪ CHANGES OF NAMES AND/OR ADDRESSES OF OWNERS	129
▪ TERMINATION OF TRADEMARKS REGISTRATION	130
▪ REGISTRATION OF LICENSE AGREEMENTS	132
CLASSIFICATION INDEXES	
INVENTIONS	133
UTILITY MODELS	134
DESIGNS	136
TRADEMARKS	138

PUBLISHED TITLES OF PROTECTION

INVENTIONS

- **APPLICATIONS APPROVED FOR GRANTING PATENT:**
15052; 14957; 15260; 15190
- **PATENTED INVENTIONS:**
7146-7150

UTILITY MODELS

- **APPLICATIONS APPROVED FOR GRANTING PATENT:**
15177; 14810; 15101
- **PATENTED UTILITY MODELS:**
2051, 2052

DESIGNS

- **REGISTERED DESIGNS:**
858, 859; 863
- **DESIGN REGISTERED ACCORDING TO THE ACCELERATED PROCEDURE:**
862
- **DESIGNS, WHICH HAVE BEEN REGISTERED WITH THE INTERNATIONAL BUREAU CLAIMING PRIORITY ON THE TERRITORY OF GEORGIA:**
208735; 205587; 208289, 208290; 208897; 209000; 208393, 208394; 208421, 208422

TRADEMARKS

- **APPLICATIONS FILED UNDER THE NATIONAL PROCEDURE APPROVED FOR REGISTRATION:**
104563; 105985; 106653; 106656; 106670; 106756-106759; 106773; 106775, 106776; 106779; 106782; 106796-106798; 106802-106808; 106812; 106819, 106820; 106825-106827; 106834; 106932; 106939-106942; 106966; 107029, 107030; 107033, 107034; 107047; 107050; 107052; 107067; 107158; 107174, 107175; 107296; 107299-107301; 107307; 107313
- **REGISTERED TRADEMARKS:**
33028-33047; 33055-33086
- **TRADEMARKS REGISTERED ACCORDING TO THE ACCELERATED PROCEDURE:**
33048-33054; 33087
- **INTERNATIONAL TRADEMARKS FOR WHICH A DECISION ON GRANTING PROTECTIONS IS TAKEN:**
105694; 105705; 105826; 105831, 105832; 105836; 105850; 105863; 105866-105868; 105906-105909; 105911; 105916; 105922; 105927; 105935; 105954; 106006; 106009; 106022, 106023; 106031; 106131, 106132; 106134, 106135; 106149; 106199; 106201; 106220; 106225, 106226; 106291; 106295, 106296; 106307-106311; 106316; 106324; 106326; 106329; 106331; 106416; 106422, 106423; 106549, 106550; 106713; 106715; 106717; 106719-106722; 106741; 106852; 106910-106912; 106917-106919
- **INTERNATIONAL TRADEMARKS PROTECTED IN GEORGIA:**
100564; 100948-100950; 103075; 103168; 103235; 103387; 103396; 103708; 103730; 103924; 104011; 104030; 104032; 104152; 104154; 104224; 104226; 104238; 104262, 104263; 104265; 104267; 104278; 104282-104286; 104300; 104335; 104338; 104345; 104349; 104367-104369; 104375-104378; 104380, 104381; 104383; 104385-104389, 104462, 104469, 104472; 104474-104477; 104484; 104486, 104495; 104515-104518; 104600; 104627; 104667; 104717; 104789; 105109; 105192; 105283; 105285; 105424; 105467; 105469; 105607

APPELLATIONS OF ORIGIN OF GOODS

- **PROTECTED APPELLATIONS OF ORIGIN:**
2-4, 791

INVENTIONS

APPLICATIONS APPROVED FOR GRANTING PATENTS

The decision can be appealed at the Chamber of Appeal of Sakpatenti within 3 months from the publication or at the Mtskheta District Court Administrative Cases Board (Address: №17, Samkhedro str., Mtskheta), within 1 month following the publication.

PART B

B 05

(10) AP 2020 15052 A (51) Int. Cl. (2006)
B 05 B 17/08

(21) AP 2019 15052 (22) 2019 04 19

(71) Nugzar Abzhandadze (GE)
Vill. Sareki, 4010, Sachkhere District,
Georgia (GE)

(72) Nugzar Abzhandadze (GE)

(54) **DEVICE FOR DANCING FOUNTAIN JETS
CONTROL**

(57) A device for dancing fountain jets control is disclosed. The device includes a nozzle creating the jets and executing mechanism having water distributor and placed therein the pipe-like lid connected mechanically to movable solenoid core; at that, water distributor is equipped with double chamber tank having unbalanced reaction forces suppressor, wherein each chamber is connected to the nozzle of corresponding section having common cap of spraying jets; at that, symmetrically relative to each other, each section having the nozzle is connected to corresponding tank chamber suppressing unbalanced reaction forces by means of two or more pipes.

Claims: 1 independent

Fig.: 3

PART C

C 07

(10) AP 2020 14957 A (51) Int. Cl. (2006)
C 07 K 16/18

(21) AP 2017 14957 (22) 2017 07 07

(31) PA201600416; PA201700005;
PA201700008; PA201700179

(32) 2016 07 12; 2017 01 04; 2017 01 04;
2017 03 14

(33) DK; DK; DK; DK

(71) H. LUNDBECK A/S (DK)
Ottliavej 9, Valby, DK-2500, Denmark (DK)

(72) JUHL, Karsten (DK);
DAECHSEL, Justus, Claus, Alfred (DK);
HELBO, Lone (DK);

PEDERSEN, Jan, Torleif (DK);

VOLBRACHT, Christiane (DK);

JENSEN, Thomas (DK);

ROSENQVIST, Nina, Helen (DK);

KJÆRGAARD, Kristian (DK);

PEDERSEN, Lars, Østergaard (DK);

CHRISTENSEN, Søren (DK);

ASUNI, Ayodeji Abdur-Rasheed (DK);

DAVID, Laurent (DK);

MARIGO, Mauro (DK);

TAGMOSE, Lena (DK)

(74) Tamaz Shilakadze

(85) 2018 12 10

(86) PCT/EP2017/067067, 2017 07 07

(54) **ANTIBODIES SPECIFIC FOR
HYPERPHOSPHORYLATED TAU AND
METHODS OF USE THEREOF**

(57) Present invention relates to a class of monoclonal antibody that specifically binds phosphorylated serine 396 residue on pathological hyperphosphorylated (PHF) tau (pS396) with improved affinity, as well as to methods of using these molecules and their tau binding fragments in the treatment of Alzheimers disease and other tauopathies.

Claims: 3 independents

4 dependents

Fig.: 26

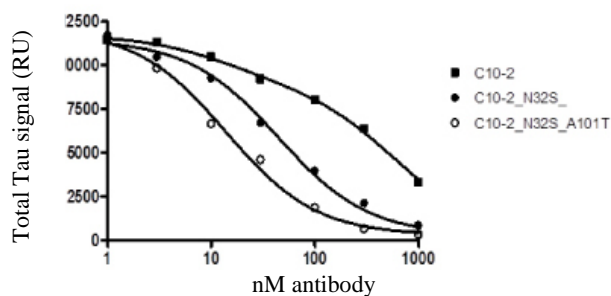

Fig. 1

PART F

F 22

(10) AP 2020 15260 A (51) Int. Cl. (2006)
F 22 B 1/28
H 05 B 6/10

(21) AP 2018 15260 (22) 2018 06 19
(31) 2017121852
(32) 2017 06 21
(33) RU
(71) ASLANOV, Georgiy Sevastiyevich (RU)
Ul. 3-ya Koltsevaya, 58A, qu. 33, Rostov-on-Don,
344004, Russian Federation (RU)
(72) ASLANOV, Georgiy Sevastiyevich (RU)
(74) Shalva Gvaramadze
(85) 2020 01 20
(86) PCT/RU2018/000406, 2018 06 19

(54) **ELECTRIC STEAM GENERATOR**

(57) The invention relates to electric steam generators. Electric steam generator comprises: multi-phase electric transformers with stacked metal cores; primary windings arranged on the cores and electrically insulated therefrom; common tubular secondary winding encompassing all of legs of stacked metal cores of transformers, and divided by electrical inner and outer connectors into regions encompassing each leg of stacked metal cores of transformers and constituting independent short-circuited electromagnetic circuits; and means for forcefeeding a liquid through internal cavity of common tubular secondary winding. The purpose of invention is to increase the amount of heat energy generated per unit of time for heating water and converting it into steam.

Claims: 1 independent
12 dependents

Fig.: 3

PART G

G 01

(10) AP 2020 15190 A (51) Int. Cl. (2006)
G 01 T 1/00

(21) AP 2019 15190 (22) 2019 10 09
(71) LEPL IV. BERITASHVILI CENTER
OF EXPERIMENTAL BIOMEDICINE (GE)
L. Gotua St. 14, 0160, Tbilisi, Georgia (GE)
(72) Gari Grebenchuk (GE);
Nazi Ivanishvili (GE);
Davit Nadareishvili (GE);
Mikheil Gogebashvili (GE)

(74) Gari Grebenchuk

(54) **METHOD FOR DETERMINATION OF
RADIATION DOSAGE ABSORBED BY
BIOLOGICAL OBJECT UNDER
INFLUENCE OF RA LEVEL**

(57) A method provides determination of radiation dosage absorbed by biological object under influence of Ra Level by means of multiplication of generated from Ra Level brakedown the lead Pb210 atoms amount on first triplet energy of α -particles generated from same brakedown. Generated lead Pb210 atoms amount is determined by means of cryogen spectrometric method.

Claims: 1 independent

PATENTED INVENTIONS

PART A

A 01

- (11) P 2020 7148 B** **(51) Int. Cl. (2006)**
A 01 N 35/04
A 01 N 25/00
A 01 N 25/30
A 01 N 43/40
A 01 P 3/00
- (10) AP 2020 14917 A (44) 9(541)/2020
(21) AP 2017 14917
(22) 2017 04 13
(24) 2017 04 13
(31) 2016-081693 2016
(32) 2016 04 15
(33) JP
(86) PCT/JP2017/015187, 2017 04 13
(73) ISHIHARA SANGYO KAISHA, LTD. (JP)
3-15, Edobori 1- chome, Nishi-ku,
Osaka-shi, Osaka, 5500002 (JP)
(72) NISHIMI, Shuko (JP);
OGAWA, Munekazu (JP);
NISHIMURA, Akihiro (JP)
(74) Tamar Kochlamazashvili
(54) **METHOD FOR POTENTIATING
PLANT DISEASE-CONTROLLING
EFFECT OF ARYL PHENYL KETONE
FUNGICIDE AND METHOD FOR
CONTROLLING PLANT DISEASES**

A 61

- (11) P 2020 7147 B** **(51) Int. Cl. (2006)**
A 61 K 31/506
A 61 P 7/02
A 61 P 25/30
A 61 P 9/00
A 61 P 37/00
A 61 P 3/06
A 61 P 3/10
A 61 P 25/02
A 61 P 35/00
C 07 D 403/14
C 07 D 403/04
C 07 D 401/14
- (10) AP 2020 14820 A (44) 5(537)/2020
(21) AP 2016 14820
(22) 2016 12 16
(24) 2016 12 16
(31) 62/272,598; 62/423,549
(32) 2015 12 29; 2016 11 17
(33) US; US

- (86) PCT/IB2016/057728, 2016 12 16
(73) PFIZER INC. (US)
235 East 42nd Street New York, New York
10017 (US)
(72) DOWLING, Matthew (US);
HUARD, Kim (US);
FERNANDO, Dilinie (US);
THUMA, Benjamin (US);
FUTATSUGI, Kentaro (US);
MAGEE, Thomas Victor (US);
TSAI, Andy (US);
SHAVNYA, Andre (US);
RAYMER, Brian (US);
SMITH, Aaron (US);
TU, Meihua (US)
(74) Tamar Kochlamazashvili
(54) **SUBSTITUTED 3-AZABICYCLO [3.1.0]
HEXANES AS KETOHEXOKINASE
INHIBITORS**

- (11) P 2020 7146 B** **(51) Int. Cl. (2006)**
A 61 K 49/10
C 07 C 229/16
C 07 D 257/02
- (10) AP 2020 14664 A (44) 8(540)/2020
(21) AP 2016 14664
(22) 2016 05 30
(24) 2016 05 30
(31) 15170658.7
(32) 2015 06 04
(33) EP
(86) PCT/EP2016/062105, 2016 05 30
(73) SÜLZLE, Detlev (DE);
BERGER, Markus (DE);
PIETSCH, Hubertus (DE);
LOHRKE, Jessica (DE);
HILGER, Christoph-Stephan (DE);
FRENZEL, Thomas (DE);
JOST, Gregor (DE);
PLATZEK, Johannes (DE);
PANKNIN, Olaf (DE)
(74) Tamar Kochlamazashvili
(54) **NEW GADOLINIUM CHELATE
COMPOUNDS FOR USE IN MAGNETIC
RESONANCE IMAGING**

PART B**B 61**

- (11) **P 2020 7150 B** (51) **Int. Cl. (2006)
B 61 B 7/00**
- (10) AP 2020 15002 A (44) 9(541)/2020
 (21) AP 2019 15002
 (22) 2019 02 13
 (24) 2019 02 13
 (73) Giorgi Nozadze (GE)
 Temka, IV mkr., corp. 6, ap. 37, 0178,
 Tbilisi, Georgia (GE);
 Aleksandre Kartvelishvili (GE)
 Vazha-Pshavela Av. 59, ap. 15, 0186, Tbilisi,
 Georgia (GE);
 Davit Pataraiia (GE)
 Shartava St. 18, ო. 16, 0160, Tbilisi,
 Georgia (GE);
 Rusudan Maisuradze (GE)
 Nutsubidze Plateau, IV mkr., corp. 23, ap. 1,
 0183, Tbilisi, Georgia (GE);
 LEPL "Grigol Tsulukidze Mining
 Institute" (GE)
 Mindeli St. 7, 0186, Tbilisi, Georgia (GE)
- (72) Giorgi Nozadze (GE);
 Aleksandre Kartvelishvili (GE);
 Davit Pataraiia (GE);
 Rusudan Maisuradze (GE)
- (74) Giorgi Nozadze
- (54) **SUSPENSION ROPE-WAY WITH
 SELF-PROPELLED CARRIAGE**

- (22) 2017 03 20
 (24) 2017 03 20
 (31) 62/311,888; 62/369,778
 (32) 2016 03 22; 2016 08 02
 (33) US; US
 (86) PCT/US2017/023127, 2017 03 20
 (73) **MERCK SHARP & DOHME CORP. (US)**
 126 East Lincoln Avenue Rahway,
 New Jersey 07065-0907 (US)
- (72) SANDERS, John, M. (US);
 CAMPBELL, Brian, T. (US);
 BELL, Ian, M. (US);
 SUEN, Linda, M. (US);
 SHIPE, William, D. (US);
 RADA, Vanessa, L. (US);
 LEAVITT, Kenneth, J. (US);
 HUFF, Belinda, C. (AU);
 HARVEY, Andrew John (AU);
 GUIADEEN, Deodial, G. (US);
 GRESHOCK, Thomas, J. (US);
 DUFFY, Joseph, L. (US);
 CROWLEY, Brendan, M. (US)
- (74) Tamaz Shilakadze
- (54) **ALLOSTERIC MODULATORS OF
 NICOTINIC ACETYLCHOLINE
 RECEPTORS**

PART C**C 07**

- (11) **P 2020 7149 B** (51) **Int. Cl. (2006)
 C 07 D 231/12
 C 07 D 233/64
 C 07 D 413/04
 C 07 D 413/06
 C 07 D 413/10
 C 07 D 417/04
 C 07 D 249/06
 C 07 D 249/08
 C 07 D 261/08
 C 07 D 263/32
 C 07 D 271/06
 C 07 D 495/04
 C 07 D 277/26
 C 07 D 285/08
 C 07 D 285/12**
- (10) AP 2020 14908 A (44) 5(537)/2020
 (21) AP 2017 14908

UTILITY MODELS

APPLICATIONS APPROVED FOR GRANTING PATENTS

The decision can be appealed at the Chamber of Appeal of Sakpatenti within 3 months from the publication or at the Mtskheta District Court Administrative Cases Board (Address: №17, Samkhedro str., Mtskheta), within 1 month following the publication.

PART A

A 01

(10) AU 2020 15177 U (51) Int. Cl. (2006)

A 01 G 13/02

C 08 J 5/18

(21) AU 2019 15177 (22) 2019 08 26

(71) LLC "GEO MULCH" (GE)

Mtkvari St. 3, 0105, Tbilisi, Georgia (GE)

(72) Mikheil Mestvirishvili (GE);

Kukuri Goginashvili (GE)

(74) Ana Tskhadadze

(54) **EXCLUSIVE TECHNOLOGY FOR
ECOLOGICALLY PURE "BIOORGANIC
MULCH" PRODUCTION**

(57) Utility model relates to organic mulch production methods, particularly, woody plants and/or their parts are crumbled and rested in open area, then organic-bacteriological fertilizer "Organic" 0.7 water solution is mixed with crumbled mass and received mixture is rested, then the mass is kneaded and rested again, after that, organic-bacteriological fertilizer "Organic" 0.3 water solution is mixed with the mass and received mixture is rested again.

Claims: 1 independent

5 dependents

PART B

B 03

(10) AU 2020 14810 U (51) Int. Cl. (2006)

B 03 D 1/001

B 03 D 1/002

(21) AU 2018 14810 (22) 2018 06 13

(31) U 2017 12441

(32) 2017 12 15

(33) UA

(71) ZHULINSKYI, Volodymyr (UA)

Kurchenko St. 23, app. 33, Stakhanov, Lugansk Oblast, Ukraine (UA)

(72) ZHULINSKYI, Volodymyr (UA)

(74) Vakhtang Torotadze

(54) **HEAVY SUSPENSION FOR SOLID
ORE AND UNGRATEFUL MINERALS,
TECHNOLOGICAL AND SECONDARY
ORE SEPARATING AND ENRICHING**

(57) Heavy suspension for solid ore and ungrateful minerals, technological and secondary ore separating and enriching consists of liquid content executed from water and secondary ore silicate-type crumbled dispersed mine clay rock; at that, water and clay rock weight ratio, at suspension 1050-5000 kg/m³ density, is 10:1-1:10; clay rock seed size is 0.01 mcm-1.0 mm; and from silicate-type mine clay rocks the argillite and/or alevrolite is used.

Claims: 1 independent

1 dependent

PART G

G 06

(10) AU 2020 15101 U (51) Int. Cl. (2006)

G 06 F 17/40

G 06 Q 10/00

(21) AU 2019 15101 (22) 2019 06 01

(71) Giorgi Gvenetadze (GE)

Shalva Nutsbidze Plateau, III mcr., III qu., corp. 3, app. 27, Tbilisi, Georgia (GE)

(72) Levan Sharangia (GE);

Giorgi Gvenetadze (GE)

(54) **COMPUTER SYSTEM FOR SCHOOL
ADMINISTRATION**

(57) Utility model provides computer system for school administration. The system includes educational institution manage terminal, set of modules and a server. The server is configured to keep and manage pupils, teachers and other personals, pupils' academic attendances: attends and absences thereof, and pupils' parents data.

Claims: 1 independent

1 dependent

Fig.: 1

PATENTED UTILITY MODELS

PART B

B 01

(11) U 2020 2051 Y (51) Int. Cl. (2006)

A 21 D 2/00

(10) AU 2020 14729 U (44) 9(541)/2020

(21) AU 2018 14729

(22) 2018 03 16

(24) 2018 03 16

(73) Konstantine Maghradze (GE)

Kipshidze St. 12, app. 10, 0162, Tbilisi,
Georgia (GE);

Nugzar Joglidze (GE)

Miminoshvili St. 6, 0103, Tbilisi,
Georgia (GE)

(72) Konstantine Maghradze (GE);

Nugzar Joglidze (GE)

(54) **BAKERY PRODUCT FOR
OSTEOPOROSIS PROLIFERATION**

PART E

E 04

(11) U 2020 2052 Y (51) Int. Cl. (2006)

E 04 H 6/06

(10) AU 2020 14973 U (44) 6(538)/2020

(21) AU 2018 14973

(22) 2018 12 25

(24) 2018 12 25

(73) Sergo Jorbenadze (GE)

R. Tabukashvili St. 46, app. 8, 0108,
Tbilisi, Georgia (GE);

Malkhaz Tsiskarishvili (GE)

S. Meskhi St. 17, 0177, Tbilisi, Georgia (GE);

Nikoloz Melitauri (GE)

Mtskheta St. 28, app. 6, Tbilisi, Georgia (GE);

Aleksandre Shermazanashvili (GE)

Vazha-Pshavela Av. II kvart., korp. 12,
app. 42, Tbilisi, Georgia (GE)

(72) Sergo Jorbenadze (GE);

Malkhaz Tsiskarishvili (GE);

Nikoloz Melitauri (GE);

Aleksandre Shermazanashvili (GE)

(54) **AUTOPARKING ELEVATOR**

DESIGNS

REGISTERED DESIGNS

(11) D 2020 859 S **(51) 09-03**
(10) AD 2020 1123 S (44) 2020 05 11 №9
(21) AD 2019 1123
(22) 2019 12 17
(24) 2019 12 17
(28) 1
(18) 2024 12 17
(73) Mariam Lomtadze (GE)
 Mtatsminda St., Lane 7b, 0108, Tbilisi,
 Georgia (GE)
(72) Mariam Lomtadze (GE)
(54) **GIFT BOX**

(11) D 2020 863 S **(51) 11-01**
(10) AD 2020 1095 S (44) 2020 05 25 №10
(21) AD 2019 1095
(22) 2019 06 26
(24) 2019 06 26
(28) 1
(18) 2024 06 26
(73) Irakli Bilashvili (GE)
 Ir. Abashidze St. 50, 0179, Tbilisi,
 Georgia (GE)
(72) Irakli Bilashvili (GE)
(54) **RING**

(11) D 2020 858 S **(51) 11-02**
(10) AD 2020 1122 S (44) 2020 05 11 №9
(21) AD 2019 1122
(22) 2019 12 17
(24) 2019 12 17
(28) 1
(18) 2024 12 17
(73) Mariam Lomtadze (GE)
 Mtatsminda St., Lane 7b, 0108, Tbilisi,
 Georgia (GE)
(72) Mariam Lomtadze (GE)
(54) **DECORATIVE WARES**

DESIGN REGISTERED ACCORDING TO THE ACCELERATED PROCEDURE

The decision can be appealed at the Chamber of Appeal of Sakpatenti within 3 months from the publication.

- (11) D 2020 862 S (51) 06-02
(21) AD 2020 1163 (22) 2020 07 14
(24) 2020 07 14
(28) 2
(18) 2025 07 14
(73) Giorgi Varsimashvili (GE)
V. Dolidze St. 11, corp. 1, app. 41, 1171, Tbilisi, Georgia (GE)
(72) Giorgi Varsimashvili (GE)
(54) 1.-2. BED
(55)



1.1



1.2



1.3



2.1



2.2

DESIGNS, WHICH HAVE BEEN REGISTERED WITH THE INTERNATIONAL BUREAU CLAIMING PRIORITY ON THE TERRITORY OF GEORGIA

The decision can be appealed at the Chamber of Appeal of Sakpatenti within 3 months from the publication or at the Mtskheta District Court Administrative Cases Board (Address: №17, Samkhedro Str., Mtskheta), within 1 month following the publication.

- (11) **DM/208 735** **(51) 03-01**
(15) 2020 06 05 (44) 26/2020 (2020 06 26)
(22) 2020 06 05
(28) 1
(73) Valentino S.p.A
 Via Turati 16/18, 20121 Milano (IT)
(85) –
(86) IT, EM
(87) IT, EM
(88) IT, EM
(89) EM
(81) III. GE, TR, KG, UA, AZ, EM, KR, TJ, JP, RU
(72) Stefano Sassi
 C/o Valentino S.p.A., Via Turati 16/18, 20121, Milano (IT)
(74) Matteo Mozzi
 C/o Jacobacci & Partners, Via Senato, 8, 20121 Milano (IT)
(54) I. Bag
(55)

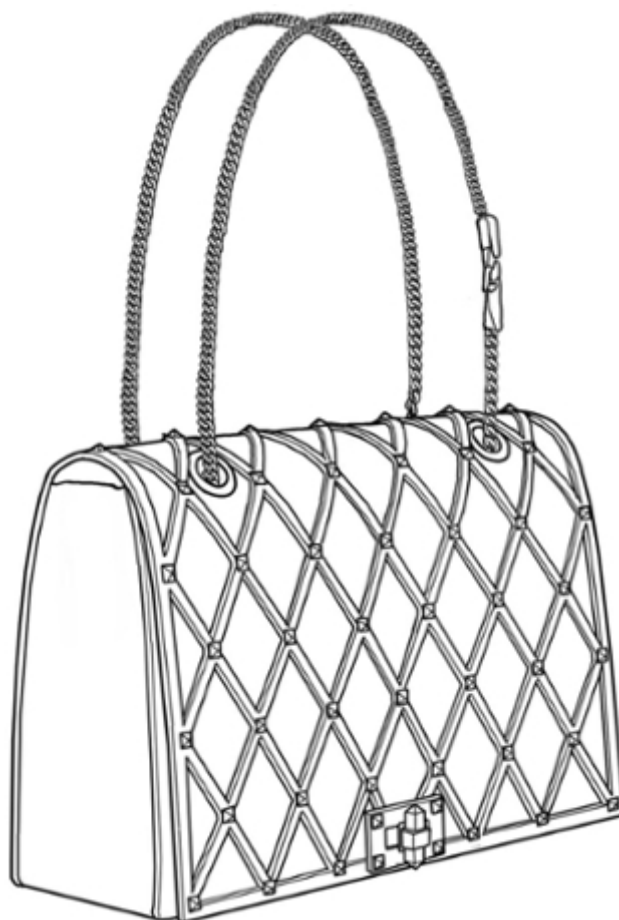
**1.1**



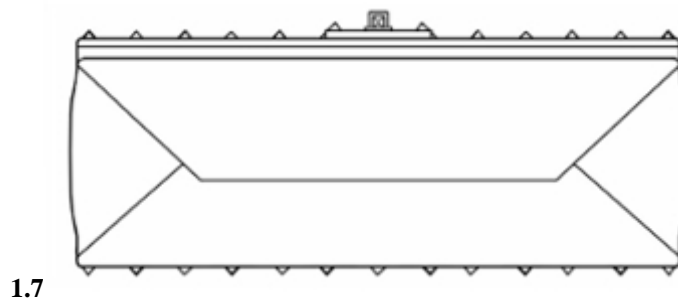
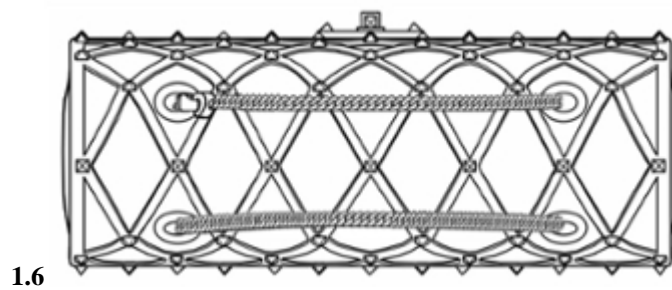
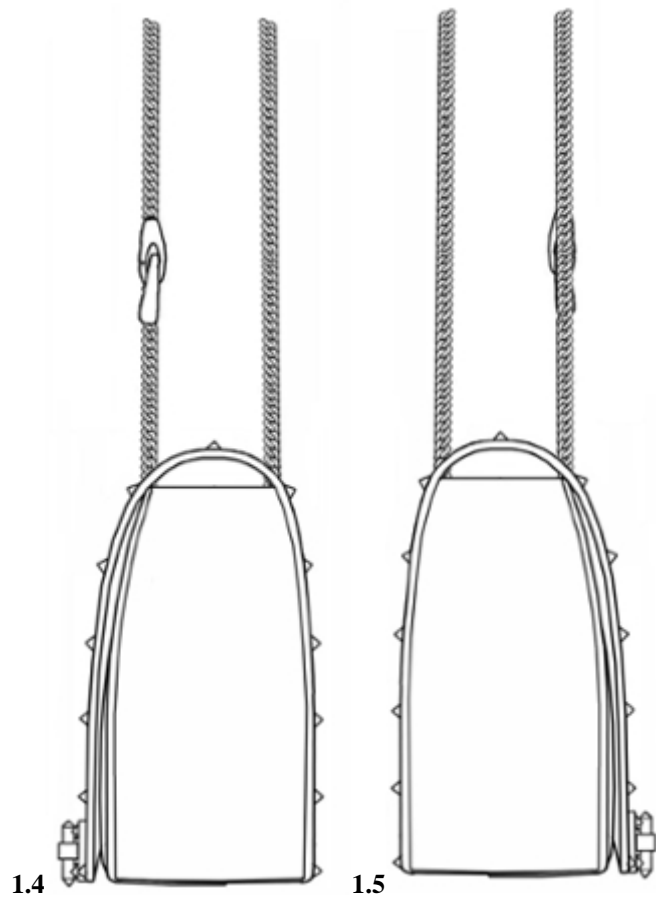

(11) DM/205 587

(15) 2019 12 20

(22) 2019 12 20

(28) 6

(73) HARRY WINSTON SA

Chemin Du Tourbillon 8, 1228 Plan-les-Ouates (CH)

(85) CH

(86) CH

(87) CH

(88) CH

(89) CH

(81) IL, MA, III, AM, UA, AL, AZ, BZ, ME, MD, MC, SG, NO, MN, BA, TR, CA, OM, MK, GE, LI, KG, GB, TN, EM, CH

(72) 1-2 Tobias WUEST

C/o Harry Winston Inc., 718 Fifth Avenue, 10019, New York (US);

3 Delphine ABDOURAHIM

C/o Harry Winston Inc., 718 Fifth Avenue, 10019, New York (US);

4-5 Chaeree KWON

C/o Harry Winston Inc., 718 Fifth Avenue, 10019, New York (US);

6 Dominique RIVIERE

C/o Harry Winston Inc., 718 Fifth Avenue, 10019, New York (US)

(74) The Swatch Group AG (The Swatch Group SA) (The Swatch Group Ltd.)

Faubourg Du Lac 6, 2501 Biel/Bienne (CH)

(54) 1. Necklace, 2. Finger ring, 3. Pair of earrings, 4. Finger ring, 5. Necklace, 6. Finger ring

(55)

1.1



1.2



1.3



1.4



1.5



1.6



1.7



1.8



2.1



2.2



2.3



2.4



2.5



2.6



2.7



2.8



3.1



3.2



3.3



3.4



3.5



3.6



3.8

3.7



4.1



4.2



4.3



4.4



4.5



4.6



4.7



4.8



5.1



5.2



5.3



5.4



5.5



5.6



5.7



5.8



6.1



6.2



6.3



6.4



6.5



6.6



6.7



6.8



(11) DM/208 289

(51) 12-16

(15) 2019 12 20

(44) 26/2020 (2020 06 26)

(22) 2019 12 20

(28) 1

(30) No1: 21.06.2019; 006590071; EM

(73) Group Lotus Limited

Hethel, NR14 8EZ Norwich, Norfolk (GB)

(85) –

(86) –

(87) GB

(88) –

(89) GB

(81) III. AM, IS, MD, TJ, BW, MN, ST, GH, TR, KH, TN, KR, JP, KP, CH, UA, BN, AL, AZ, TM, BZ, ME, MC, SG, NA, OA, RS, NO, BA, CA, GE, OM, MK, LI, KG, SM, SY, RW, RU, EG

(72) Russel Carr

Potash Lane, Hethel, NR14 8EZ, Norwich, Norfolk (GB)

(74) DENNEMEYER & ASSOCIATES

55, Rue Des Bruyères, 1274 Howald (LU)

(54) 1. Vehicle interior

(55)

1.1

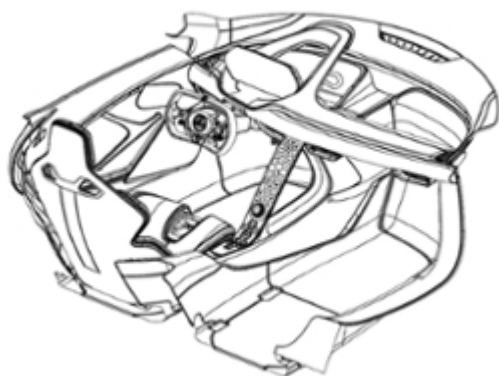

1.2



1.3

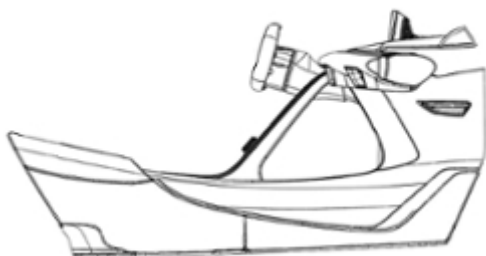

1.4

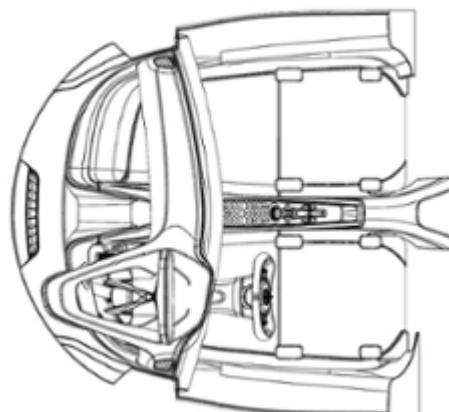

(11) DM/208 290

(15) 2019 12 23

(22) 2019 12 23

(28) 1

(30) No1: 21.06.2019; 006590071; EM

(73) Group Lotus Limited

Hethel, NR14 8EZ Norwich Norfolk (GB)

(85) –

(86) –

(87) GB

(88) –

(89) GB

(81) III. AM, IS, MD, TJ, BW, ST, MN, GH, TR, KH, TN, KR, JP, KP, CH, BN, UA, AL, TM, AZ, BZ, ME, MC, SG, NA, OA, RS, NO, BA, CA, OM, GE, MK, LI, KG, SM, SY, RW, RU, EG

(72) Russel Carr

Potash Lane, Hethel, NR14 8EZ , Norwich, Norfolk (GB)

(74) DENNEMEYER & ASSOCIATES

55, Rue Des Bruyères, 1274 Howald (LU)

(54) 1. Toy car interior

(55)

(51) 21-01

(44) 26/2020 (2020 06 26)

1.1

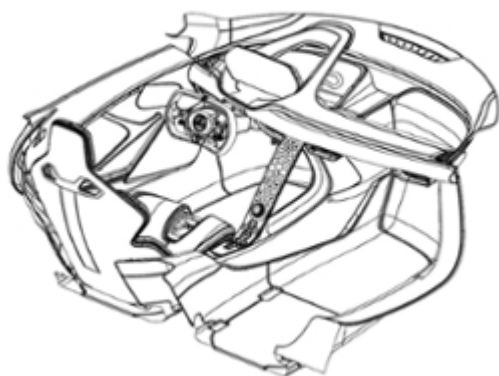

1.2



1.3

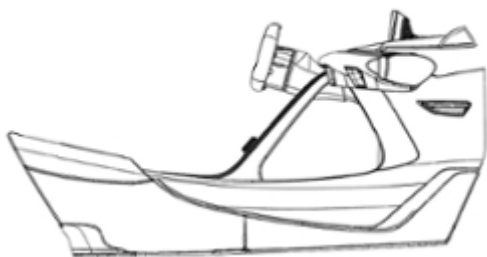

1.4

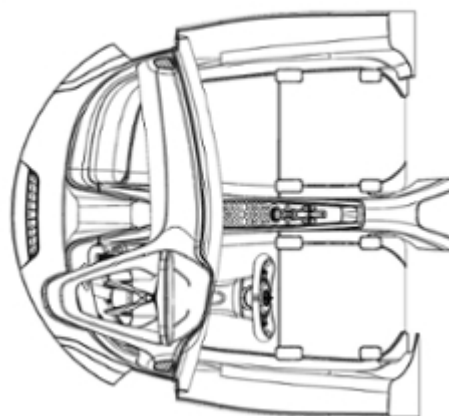

(11) DM/208 897

(51) 09-01

(15) 2019 09 19

(44) 27/2020 (2020 07 03)

(22) 2019 09 19

(28) 3

(73) Obshchestvo S Ogranichennoy Otvetstvennoct'yu "BioMicroGeli"

Ul. Nobelya, D. 7, Et. 4, Chp. 25, Rm. 2, 143026 Moscow (RU)

(85) –

(86) RU

(87) –

(88) RU

(89) RU

(81) III. GE, US, CA, KG, UA, AM, TM, AZ, MD, TJ, RU

(72) Irina Aleksandrovna Korotich

Ul. Shartashskaya, D. 9/2, Kv. 166, 620075, Ekaterinburg (RU)

(74) Obshchestvo S Ogranichennoy Otvetstvennost'yu "Tsarskayu Privilegiyu"

Ul. Konstruktorov, D. 5, Of. 229, 620010 Ekaterinburg (RU)

(54) 1. Bottle for liquids, 2. Bottle for liquids, 3. Bottle for liquids

(55)

1.1

1.2

1.3

1.4

2.1

2.2

2.3

2.4

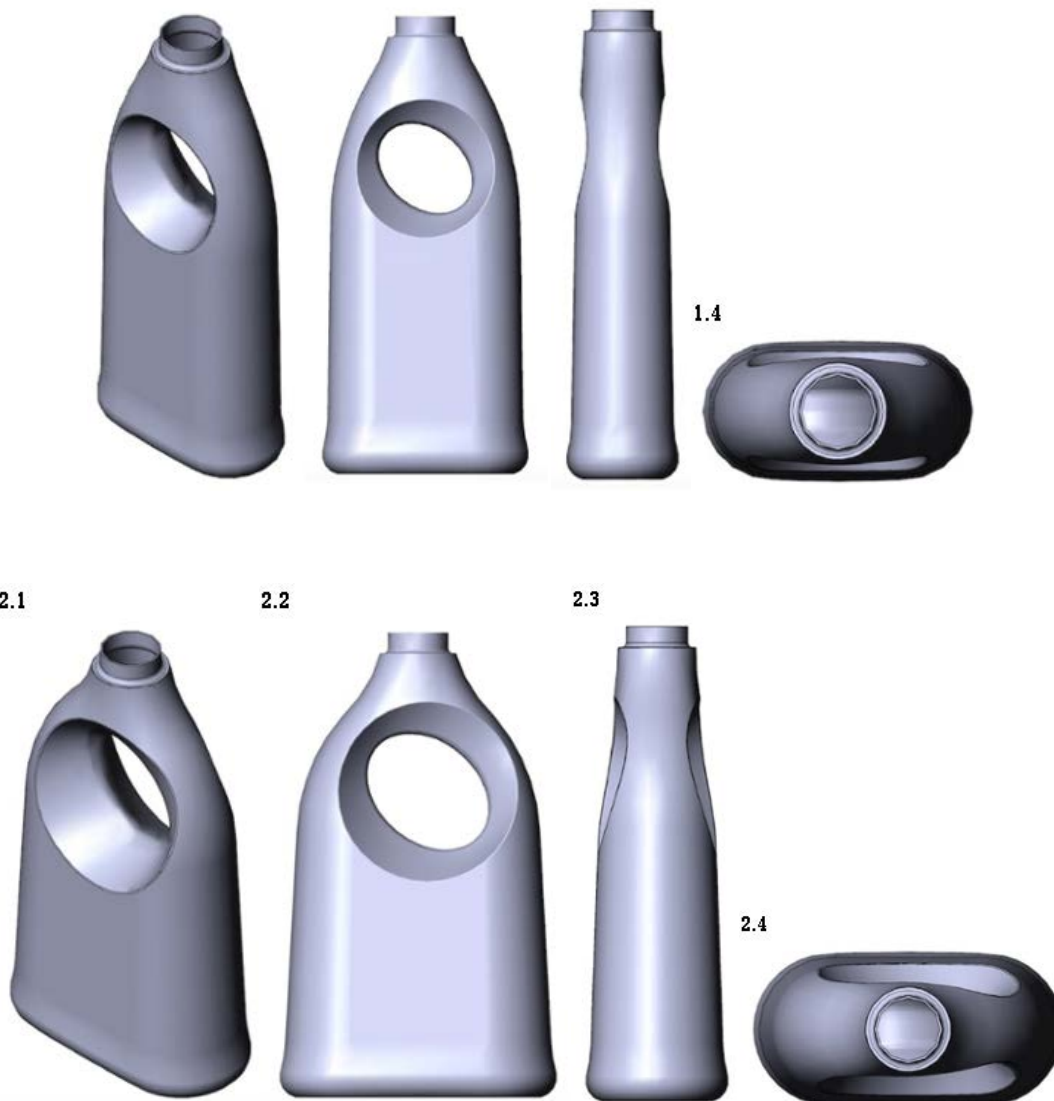

3.1



3.2



3.3



3.4



(11) DM/209 000

(51) 08-05

(15) 2020 01 02

(44) 28/2020 (2020 07 10)

(22) 2020 01 02

(28) 1

(73) Livetec Systems LTD

Building 52, Wrest Park, MK45 4HS Silsoe (GB)

(85) GB

(86) GB

(87) GB

(88) GB

(89) GB

(81) III. AM, IS, MD, TJ, BW, ST, GH, MN, TR, KH, TN, KR, JP, CH, KP, BN, UA, AL, AZ, TM, BZ, ME, MC, SG, NA, OA, RS, NO, BA, OM, MK, CA, GE, US, LI, KG, WS, SM, EM, SY, RW, RU, EG

(72) Julian Sparrey

20 Bridge Street Leighton Buzzard, LU7 1AL, Bedfordshire (GB);

Jessica Elisabeth Martin

The Roslin Institute, University Of Edinburgh, Easter Bush Campus, EH25 9RG, Edinburgh, Scotland (GB)

(54) 1. Device to assist in the cervical neck dislocation of poultry

(55)

1.1

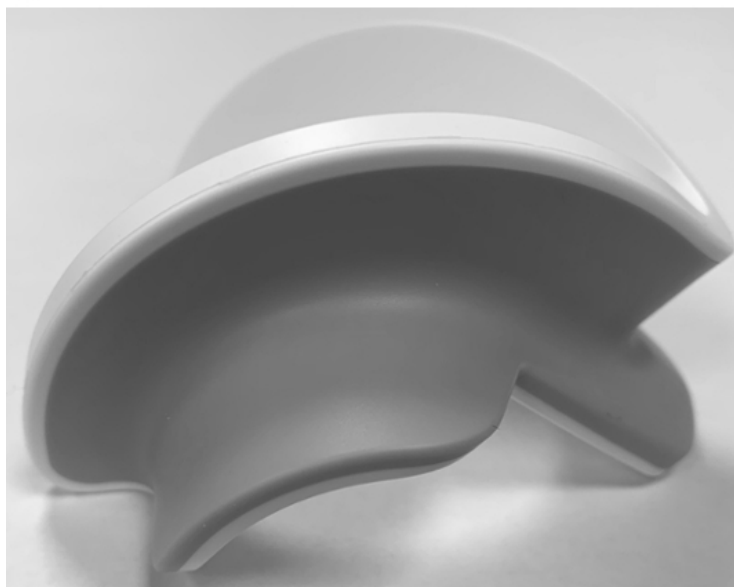

1.2

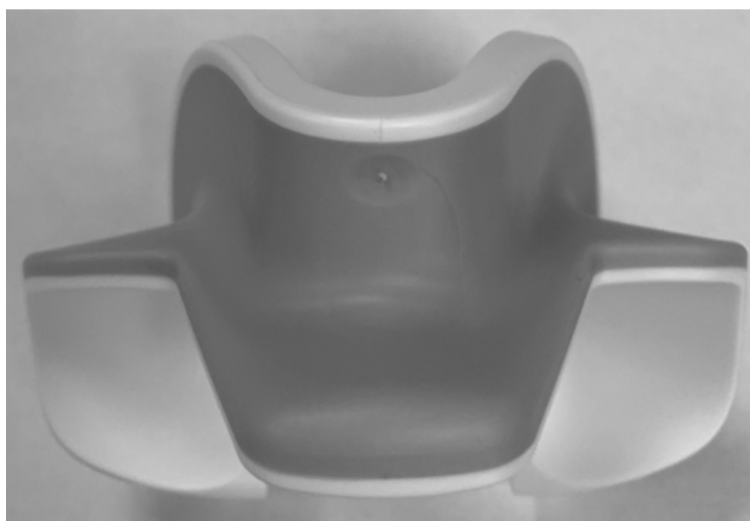

1.3



1.4



1.5

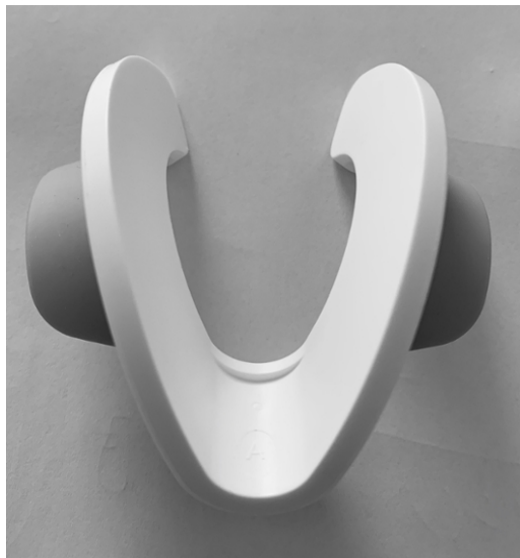

1.6



1.7

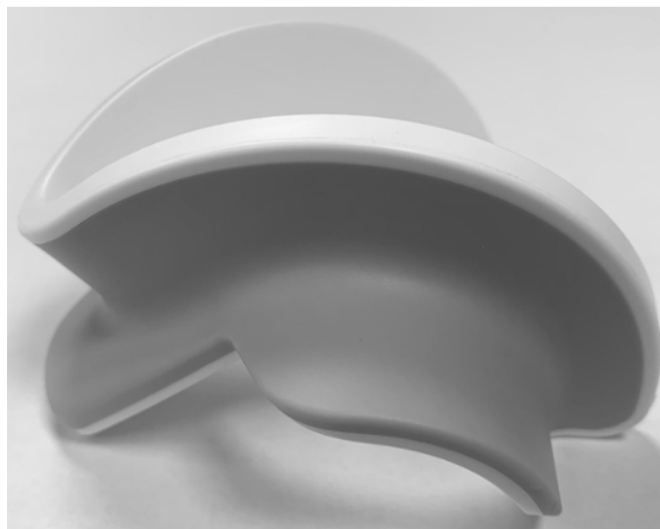

(11) DM/208 393

(51) 12-16

(15) 2020 01 15

(44) 29/2020 (2020 07 17)

(22) 2020 01 15

(28) 1

(30) No1: 15.07.2019; 006628210; EM

(73) Group Lotus Limited

Hethel, NR14 8EZ Norwich Norfolk (GB)

(85) –

(86) –

(87) GB

(88) –

(89) GB

(81) III. AM, IS, VN, MD, TJ, BW, ST, GH, MN, TR, KH, TN, KR, JP, CH, IL, UA, BN, AL, TM, AZ, ME, BZ, MC, NA, OA, NO, RS, BA, MK, GE, OM, CA, LI, WS, KG, SM, RW, RU, EG

(72) Russel Carr

Potash Lane, Hethel, NR14 8EZ, Norwich, Norfolk (GB)

(74) DENNEMEYER & ASSOCIATES

55, Rue Des Bruyères, 1274 Howald (LU)

(54) 1. Instrument panel for a vehicle

(55)



1.1

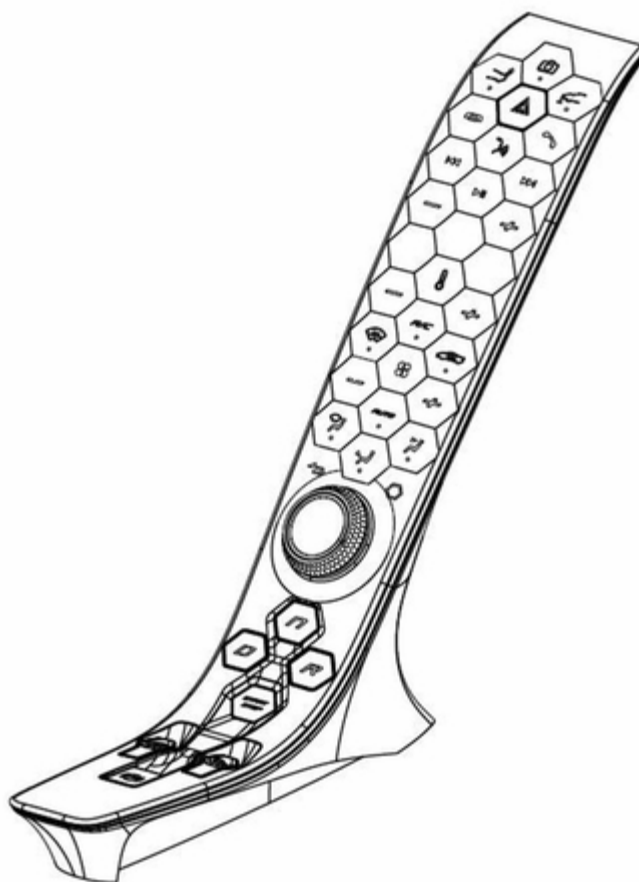

1.2

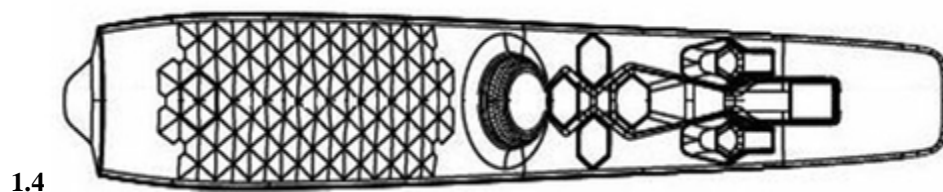
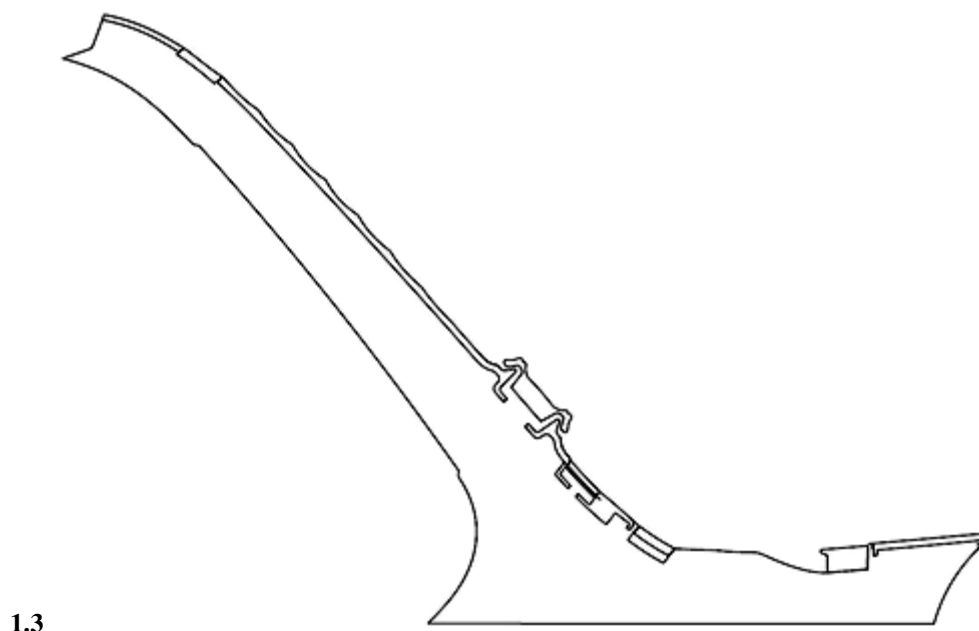

(11) DM/208 394

(15) 2020 01 15

(22) 2020 01 15

(28) 1

(30) No1: 15.07.2019; 006628194; EM

(73) Group Lotus Limited, Hethel

Hethel, NR14 8EZ Norwich, Norfolk (GB)

(85) –

(86) –

(87) GB

(88) –

(89) GB

(81) III. AM, IS, VN, MD, TJ, BW, GH, ST, MN, TR, KH, TN, KR, JP, CH, IL, BN, UA, AL, AZ, TM, BZ, ME, MC, OA, NO, RS, BA, GE, OM, MK, CA, LI, KG, WS, SM, DK, RW, RU, EG

(72) Russel Carr

Potash Lane, Hethel, NR14 8EZ, Norwich, Norfolk (GB)

(74) DENNEMEYER & ASSOCIATES

55, Rue Des Bruyères, 1274 Howald (LU)

(54) 1. Visual display unit for vehicle

(55)

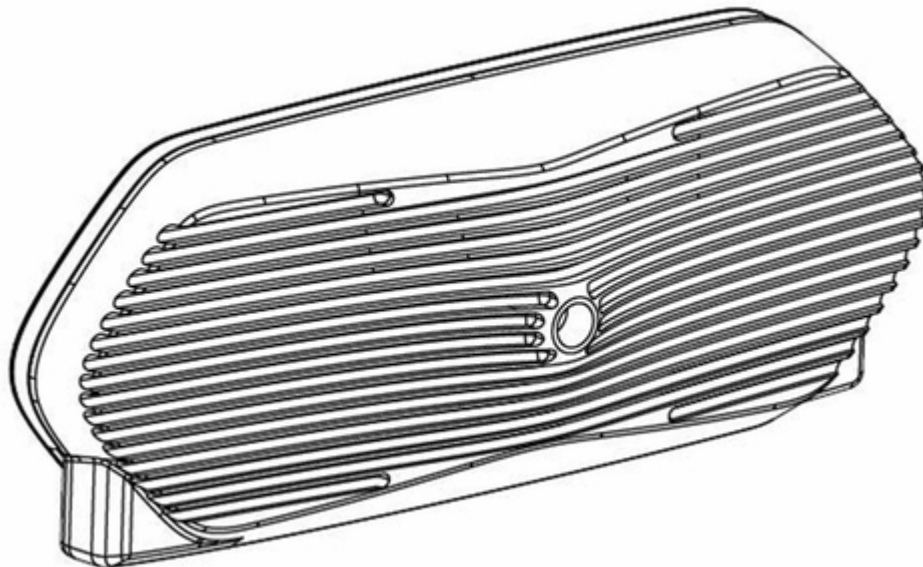

1.1

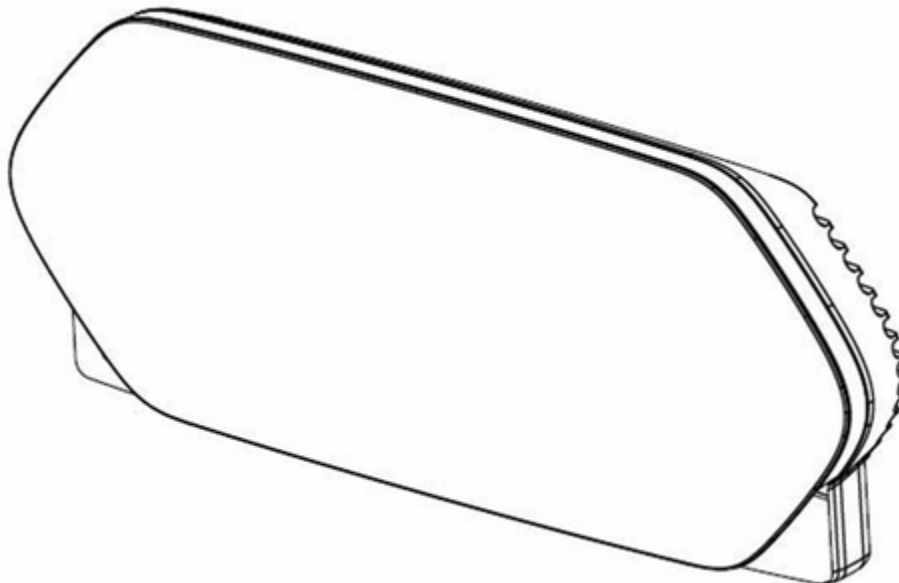

1.2

1.3

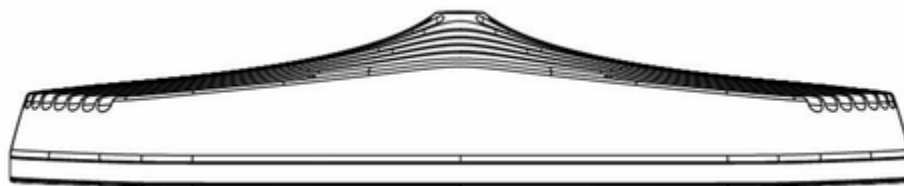

1.4

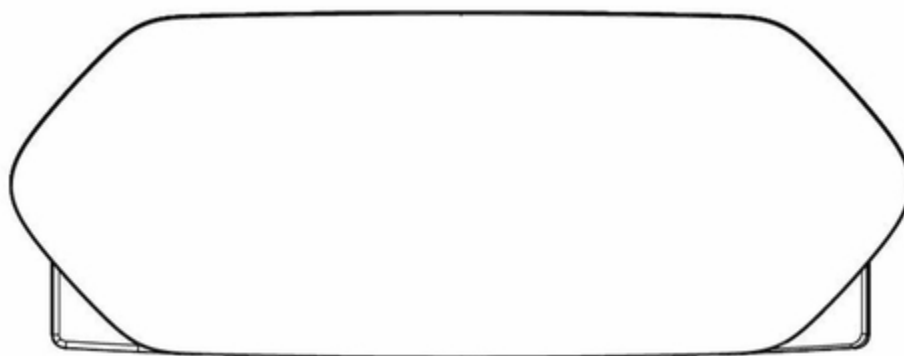

1.5

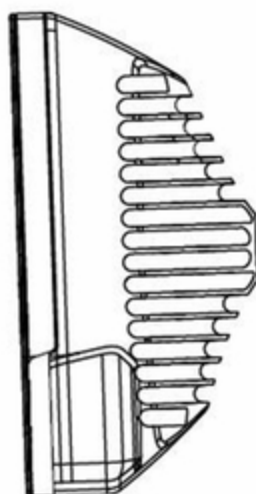

(11) DM/208 421

(15) 2020 01 15

(22) 2020 01 15

(28) 1

(30) No1: 15.07.2019; 006628194; EM

(73) Group Lotus Limited

Hethel, NR14 8EZ Norwich, Norfolk (GB)

(85) –

(86) –

(87) GB

(88) –

(89) GB

(81) III. AM, IS, VN, MD, TJ, BW, MN, ST, GH, TR, KH, TN, KR, JP, CH, IL, BN, UA, AL, AZ, TM, ME, BZ, MC, NA, OA, NO, RS, BA, GE, OM, MK, CA, LI, WS, KG, SM, RW, RU, EG

(72) Russel Carr

Potash Lane, Hethel, NR14 8EZ, Norwich, Norfolk (GB)

(74) DENNEMEYER & ASSOCIATES

55, Rue Des Bruyères, 1274 Howald (LU)

(54) 1. Visual display unit for toys and toy cars

(55)

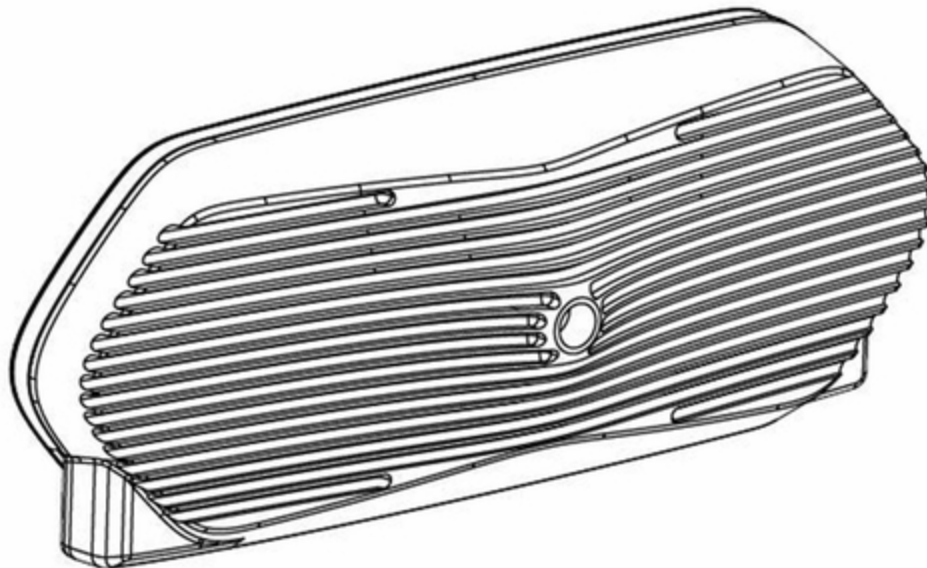

1.1

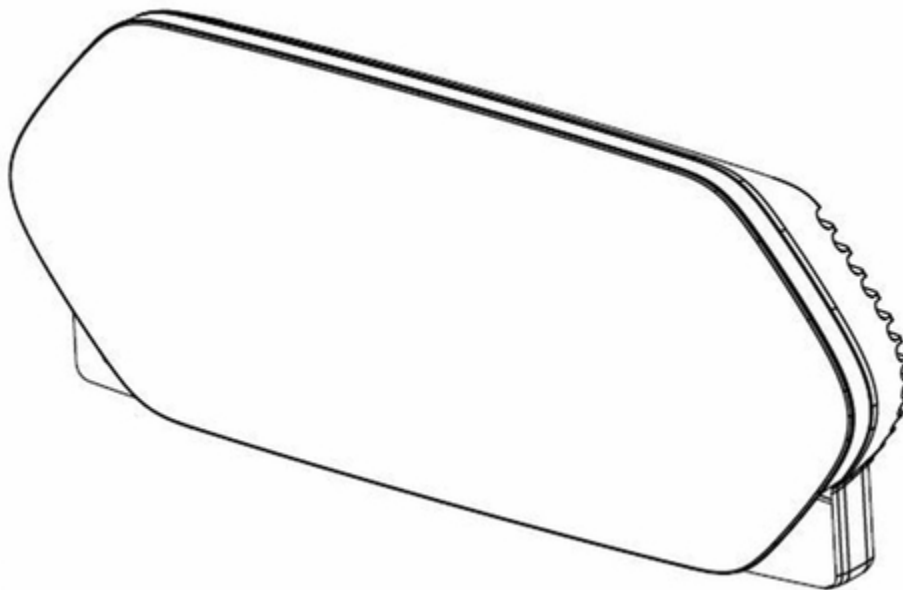

1.2

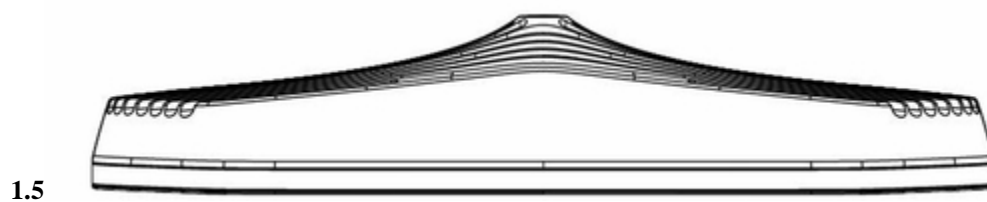
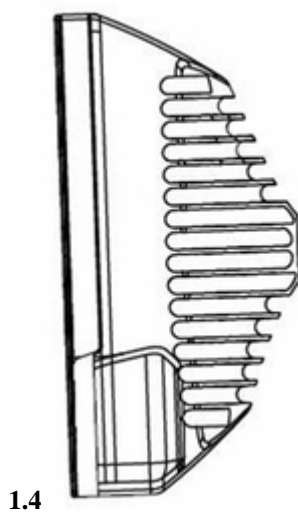
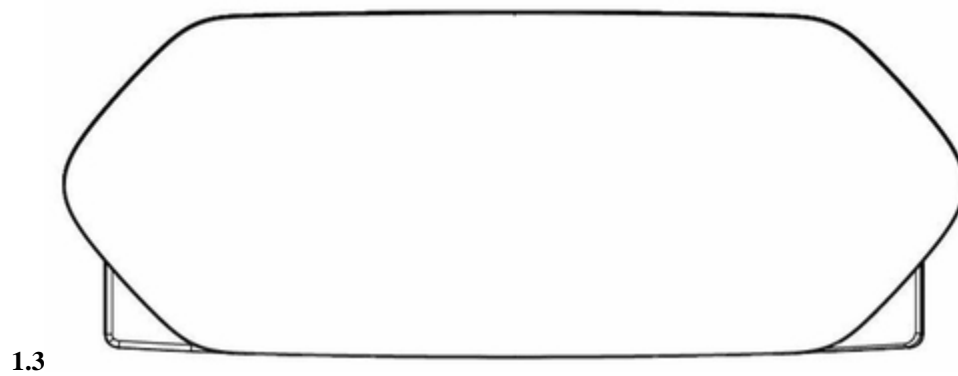

(11) DM/208 422

(51) 21-01

(15) 2020 01 15

(44) 29/2020 (2020 07 17)

(22) 2020 01 15

(28) 1

(30) No1: 15.07.2019; 006628210; EM

(73) Group Lotus Limited

Hethel, NR14 8EZ Norwich, Norfolk (GB)

(85) –

(86) –

(87) GB

(88) –

(89) GB

(81) III. AM, IS, VN, MD, TJ, BW, MN, ST, GH, TR, KH, TN, KR, JP, CH, IL, BN, UA, AL, AZ, TM, BZ, ME, MC, NA, OA, RS, NO, BA, CA, MK, OM, GE, LI, KG, WS, SM, RW, RU, EG

(72) Russel Carr

Potash Lane, Hethel, NR14 8EZ, Norwich, Norfolk (GB)

(74) DENNEMEYER & ASSOCIATES

55, Rue Des Bruyères, 1274 Howald (LU)

(54) 1. Instrument panel for toys and toy cars

(55)



1.1

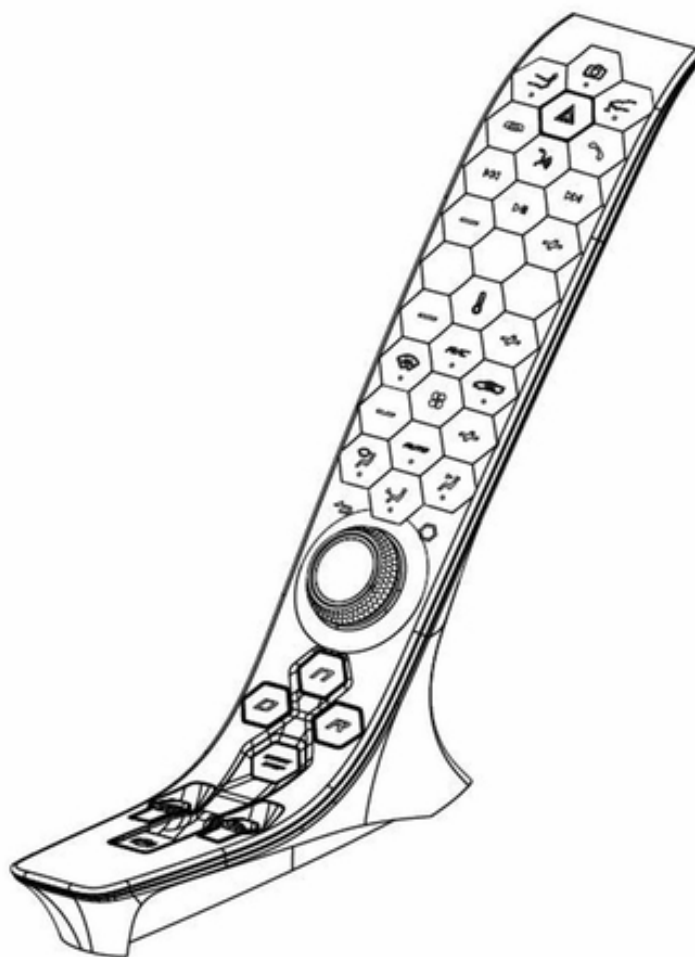

1.2

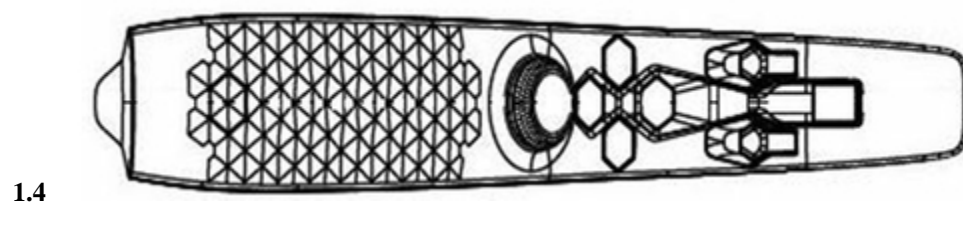
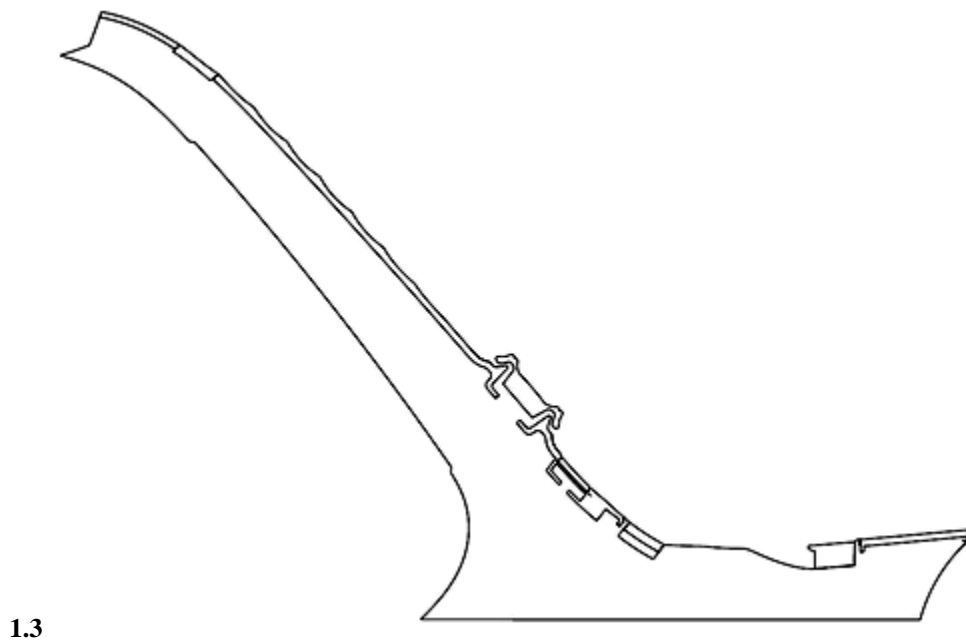

TRADEMARKS

APPLICATIONS FILED UNDER THE NATIONAL PROCEDURE APPROVED FOR REGISTRATION

The decision can be appealed at the Chamber of Appeal of Sakpatenti within 3 months from the publication or at the Mtskheta District Court Administrative Cases Board (Address: №17, Samkhedro St., Mtskheta), within 1 month following the publication.

(260) AM 2020 104563 A
(210) AM 104563
(220) 2019 08 22
(731) FADER ALLIANCE LTD
Of. 101, Regico Offices, The Old Bank, 153 the
Parade high Street, Watford, WD 17 1 NA,
United Kingdom
(740) Irma Kartoziya
(540)

აქსიომა

(591) Black-white
(511) 44

(260) AM 2020 105985 A
(210) AM 105985
(220) 2019 12 05
(731) LTD "MARNISKARI"
Apakidze St. 11, app. 125, Tbilisi, Georgia
(540)

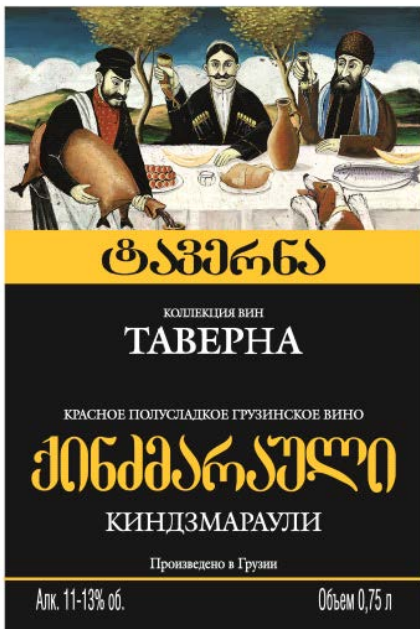

(591) Golden, brown, sky-blue
(531) 02.01.17; 27.05.01; 27.05.10; 28.19; 29.01.15
(526) ქინძმარაული КИНДЗМАРАУЛИ
(511) 33

(260) AM 2020 106653 A
(210) AM 106653
(220) 2020 01 21
(731) GRUPO CACAOLAT S.L.
Avda. Francesc Macia, 225-233 08924 SANTA
COLOMA DE GRAMANET (BARCELONA),
Spain
(740) Merab Kvimsadze
(540)



(591) Yellow, brown
(531) 02.05.02; 02.05.08; 19.07.01; 19.07.12; 27.05.01;
27.05.09; 27.05.10; 27.05.11; 27.05.19; 29.01.12
(526) COCOA MILKSHAKE FROM BARCELONA
SINCE 1933
(511) 30

(260) AM 2020 106656 A
(210) AM 106656
(220) 2020 01 21
(731) LTD "Fragrans World"
Tevdore Mghvdeli St. 7a, 0112, Tbilisi, Georgia
(540)



(591) Black-white
(531) 26.04.02; 26.04.19
(511) 3

(260) AM 2020 106670 A
 (210) AM 106670
 (220) 2020 01 23
 (310) 2019736095
 (320) 2019 07 24
 (330) RU
 (731) JAPAN TOBACCO INC.
 2-2-1 Toranomom, Minato-ku, Tokyo, Japan
 (740) Shalva Gvaramadze
 (540)

FRESH SWIPE

(591) Black-white
 (511) 34

(260) AM 2020 106756 A
 (210) AM 106756
 (220) 2020 01 24
 (731) Advanced New Technologies Co., Ltd
 Cayman Corporate Centre, 27 Hospital Road,
 George Town, Grand Cayman, KY1-9008,
 Cayman Islands
 (740) Tamaz Shilakadze
 (540)

ANTFIN

(591) Black-white
 (511) 9, 36, 42

(260) AM 2020 106757 A
 (210) AM 106757
 (220) 2020 01 24
 (731) INPHA LLP Representative Office in Georgia
 Adjacent to Besiki St. 4, (plot 46/10), 0108,
 Tbilisi, Georgia
 (540)

Лактозим ლაქტოზიმ Lactozim

(591) Black-white
 (511) 5

(260) AM 2020 106758 A
 (210) AM 106758
 (220) 2020 01 24
 (731) INPHA LLP Representative Office in Georgia
 Adjacent to Besiki St. 4, (plot 46/10), 0108,
 Tbilisi, Georgia
 (540)

Нодемокс ნოდემოქს Nodemoks

(591) Black-white
 (511) 5

(260) AM 2020 106759 A
 (210) AM 106759
 (220) 2020 01 24
 (731) INPHA LLP Representative Office in Georgia
 Adjacent to Besiki St. 4, (plot 46/10), 0108,
 Tbilisi, Georgia
 (540)

Офтасиале ოფთასიალე Oftassiale

(591) Black-white
 (511) 5

(260) AM 2020 106773 A
 (210) AM 106773
 (220) 2020 01 28
 (731) Eli Lilly & Company
 Lilly Corporate Center, Indianapolis, Indiana
 46285, USA
 (740) Shalva Gvaramadze
 (540)

LYUMJEV

(591) Black-white
 (511) 5

(260) AM 2020 106775 A
 (210) AM 106775
 (220) 2020 01 29
 (731) LTD "INVET"
 D. Aghmashenebeli Av. 171, Tbilisi, Georgia
 (740) Irine Ioseliani
 (540)



(591) Dark blue, light blue, white
 (531) 01.15.15; 24.13.01; 24.13.24; 26.13.25; 29.01.12
 (511) 35, 44

(260) AM 2020 106776 A
 (210) AM 106776
 (220) 2020 01 29
 (731) LLC "Borjomi Product Company"
 Vill. Zanavi, 1200, Borjomi, Georgia

(540)



(591) Black-white
 (531) 05.07.09; 05.07.21; 26.01.15; 26.01.21; 27.01.06;
 28.19
 (511) 32

(260) AM 2020 106779 A
 (210) AM 106779
 (220) 2020 01 29
 (731) LLC "GEVELLI"
 Sul Khan Tsintsadze St. 59, app. 41, 0160,
 Tbilisi, Georgia
 (740) Avtandil Charbadze
 (540)



(591) Black
 (531) 05.07.10; 27.05.08; 27.05.11
 (511) 33

(260) AM 2020 106782 A
 (210) AM 106782
 (220) 2020 01 29
 (731) Giorgi Dekanozishvili
 I. Chavchavadze Av. 5, app. 21, 0179, Tbilisi,
 Georgia
 (740) Giorgi Imnadze
 (540)

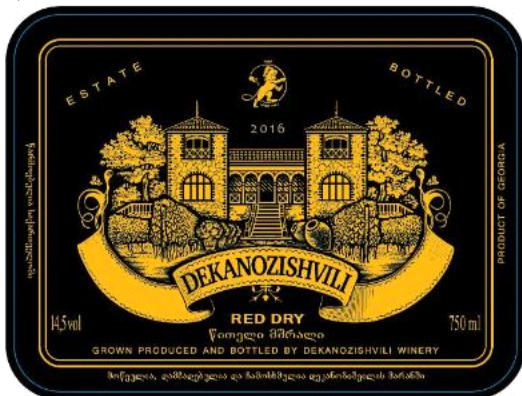

(591) Blzk, golden, sky-blue
 (531) 03.01.02; 03.01.20; 06.19.07; 07.01.01; 19.09.02;
 25.01.05; 25.01.18; 25.01.19; 27.05.01; 29.01.12
 (511) 33

(260) AM 2020 106796 A
 (210) AM 106796
 (220) 2020 01 30
 (731) Spray Moret LLC
 1411 Broadway, 8th Floor, New York,
 NY 10018, USA
 (740) Giorgi Taktakishvili
 (540)

SPRAYGROUND

(591) Black-white
 (511) 18, 25

(260) AM 2020 106797 A
 (210) AM 106797
 (220) 2020 01 30
 (731) Spray Moret LLC
 1411 Broadway, 8th Floor, New York,
 NY 10018, USA
 (740) Giorgi Taktakishvili
 (540)



(591) White, red
 (531) 26.04.02; 26.04.22; 26.04.24; 29.01.12
 (511) 18, 25

(260) AM 2020 106798 A
 (210) AM 106798
 (220) 2020 01 30
 (731) Spray Moret LLC
 1411 Broadway, 8th Floor, New York,
 NY 10018, USA
 (740) Giorgi Taktakishvili
 (540)

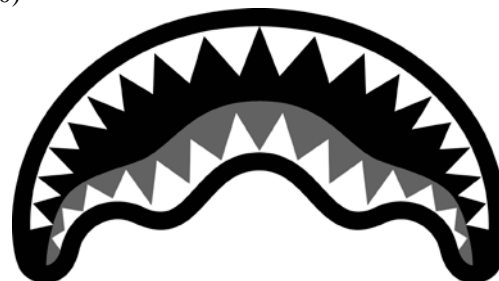

(591) White, grey, black
 (531) 26.13.25
 (511) 18, 25

(260) AM 2020 106802 A
 (210) AM 106802
 (220) 2020 01 30
 (731) LLC "MAGTI"
 Davit Aghmashenebeli Av. 152, 0112, Tbilisi,
 Georgia
 (740) Irakli Sharabidze
 (540)

PUBLICA

(591) Black-white
 (511) 43

(260) AM 2020 106803 A
 (210) AM 106803
 (220) 2020 01 30
 (731) LLC "MAGTI"
 Davit Aghmashenebeli Av. 152, 0112, Tbilisi,
 Georgia
 (740) Irakli Sharabidze
 (540)

კუბელი

(591) Black-white
 (511) 43

(260) AM 2020 106804 A
 (210) AM 106804
 (220) 2020 01 30
 (731) Marriott International, Inc.
 10400 Fernwood Road, Bethesda, Maryland
 20817, USA
 (740) Tamaz Shilakadze
 (540)

**AUTOGRAPH
 COLLECTION**

(591) Black-white
 (511) 36

(260) AM 2020 106805 A
 (210) AM 106805
 (220) 2020 01 30
 (731) LLC "MAGTI"
 Davit Aghmashenebeli Av. 152, 0112, Tbilisi,
 Georgia
 (740) Irakli Sharabidze
 (540)

**საქართველო
 KHARCHO**

(591) Black-white
 (531) 11.01.04; 27.03.15; 27.05.01; 28.19
 (511) 43

(260) AM 2020 106806 A
 (210) AM 106806
 (220) 2020 01 30
 (731) LLC "MAGTI"
 Davit Aghmashenebeli Av. 152, 0112, Tbilisi,
 Georgia
 (740) Irakli Sharabidze
 (540)



(591) Black-white
 (531) 26.03.23; 26.11.03; 26.11.06; 26.11.08; 26.11.09;
 26.11.11; 27.05.10; 27.05.11
 (511) 41

(260) AM 2020 106807 A
 (210) AM 106807
 (220) 2020 01 30
 (731) LLC "MAGTI"
 Davit Aghmashenebeli Av. 152, 0112, Tbilisi,
 Georgia
 (740) Irakli Sharabidze
 (540)



(591) Black-white
 (531) 26.03.23; 26.11.03; 26.11.06; 26.11.08;
 26.11.09; 26.11.11; 28.19
 (511) 41

(260) AM 2020 106808 A
 (210) AM 106808
 (220) 2020 01 30
 (731) Victoria's Secret Stores Brand Management Inc.
 4 Limited Parkway, Reynoldsburg
 OH 43068, USA
 (740) Shalva Gvaramadze

(540)

**VICTORIA'S SECRET
PERFECT ESSENTIALS**(591) Black-white
(511) 3, 25

(260) AM 2020 106812 A

(210) AM 106812

(220) 2020 01 30

(731) KOWA COMPANY LTD

6-29, Nishiki 3-chome, Naka-ku, Nagoya-shi,
Aichi-ken, Japan

(740) Tamaz Shilakadze

(540)

ΛΙΒΑ30

(591) Black-white

(531) 28.05

(511) 5

(260) AM 2020 106819 A

(210) AM 106819

(220) 2020 01 31

(731) Getz Pharma International FZ LLC

Office No. 1307, 13th Floor, Al-Thuraya
Tower 1, Dubai Media City, Dubai, United Arab
Emirates

(740) Merab Kvimsadze

(540)

LINZOGET

(591) Black-white

(531) 27.05.01

(511) 5

(260) AM 2020 106820 A

(210) AM 106820

(220) 2020 01 31

(731) Getz Pharma International FZ LLC

Office No. 1307, 13th Floor, Al-Thuraya
Tower 1, Dubai Media City, Dubai, United Arab
Emirates

(740) Merab Kvimsadze

(540)

ATASART

(591) Black-white

(531) 27.05.01

(511) 5

(260) AM 2020 106825 A

(210) AM 106825

(220) 2020 01 31

(731) LLC "ROKO"

Javakhishvili St. 1, Chughureti District,
basement, Tbilisi, Georgia

(540)

ROKO

(591) Black-white

(531) 26.04.02; 26.04.22; 26.04.24; 27.05.17; 27.05.24

(511) 29, 30, 31, 35

(260) AM 2020 106826 A

(210) AM 106826

(220) 2020 01 31

(731) POWTEK INTERNATIONAL HOLDINGS
LIMITED23 Health Road, National Health Technology
Park, Torch Development Zone, Zhongshan,
Guangdong, 528400, China

(740) Khatuna Imnadze

(540)

KALTEC

(591) Black-white

(511) 11

(260) AM 2020 106827 A

(210) AM 106827

(220) 2020 01 31

(731) POWTEK INTERNATIONAL HOLDINGS
LIMITED23 Health Road, National Health Technology
Park, Torch Development Zone, Zhongshan,
Guangdong, 528400, China

(740) Khatuna Imnadze

(540)

ORBEK

(591) Black-white

(511) 11

(260) AM 2020 106834 A

(210) AM 106834

(220) 2020 02 03

(731) LTD "ZEGVINO"

Taktakishvili St. 7, app. 5, Tbilisi, Georgia

(540)

ზეგვინო
ZEGVINO

(591) Black-white

(531) 26.11.08; 27.05.11; 28.19

(511) 33

(260) AM 2020 106932 A

(210) AM 106932

(220) 2020 02 04

(731) Intercontinental Great Brands LLC
100 Deforest Avenue, East Hanover, New Jersey
07936, USA

(740) Giorgi Taktakishvili
(540)

მეტი ნდობა - მეტი აღმოჩენა

(591) Black-white
(511) 30

(260) AM 2020 106939 A
(210) AM 106939
(220) 2020 02 04
(731) Berlin-Chemie AG
Glienicke Weg 125, Berlin, 12489, Germany
(740) Giorgi Ghvinjilia
(540)

GRIPVIS

(591) Black-white
(511) 5

(260) AM 2020 106940 A
(210) AM 106940
(220) 2020 02 04
(731) Berlin-Chemie AG
Glienicke Weg 125, Berlin, 12489, Germany
(740) Giorgi Ghvinjilia
(540)

ГРИПВИС

(591) Black-white
(511) 5

(260) AM 2020 106941 A
(210) AM 106941
(220) 2020 02 04
(731) Berlin-Chemie AG
Glienicke Weg 125, Berlin, 12489, Germany
(740) Giorgi Ghvinjilia
(540)

STENAVIR

(591) Black-white
(511) 5, 10

(260) AM 2020 106942 A
(210) AM 106942
(220) 2020 02 04
(731) Berlin-Chemie AG
Glienicke Weg 125, Berlin, 12489, Germany
(740) Giorgi Ghvinjilia
(540)

СТЕНАВИР

(591) Black-white
(511) 5, 10

(260) AM 2020 106966 A
(210) AM 106966
(220) 2020 02 06
(731) JSC "GEFA"
Akaki Beliashvili St. 142, 0159, Tbilisi,
Georgia
(740) Salome Jeladze
(540)

JEJU Korean Beauty

(591) Black-white
(511) 3, 5, 35, 44

(260) AM 2020 107029 A
(210) AM 107029
(220) 2020 02 07
(731) LLC "VG"
Isaakyan St. 1, Tbilisi, Georgia
(540)

МОННАВАТ

(591) Black-white
(511) 30

(260) AM 2020 107030 A
(210) AM 107030
(220) 2020 02 07
(731) LLC "VG"
Isaakyan St. 1, Tbilisi, Georgia
(540)

СТОЕВ

(591) Black-white
(511) 30

(260) AM 2020 107033 A
(210) AM 107033
(220) 2020 02 07
(731) LTD "LAZI"
Tskaltubo St. 6, app. 82, Tbilisi, Georgia
(540)



(591) White, golden, black, grey
 (531) 05.01.19; 05.03.19; 26.04.15; 26.04.24; 26.11.08;
 27.05.21; 29.01.14
 (511) 33

(260) AM 2020 107034 A
 (210) AM 107034
 (220) 2020 02 07
 (731) LTD "LAZI"
 Isaakyan St. 1, Tbilisi, Georgia
 (540)

LAFARELLA

(591) Black-white
 (511) 30

(260) AM 2020 107047 A
 (210) AM 107047
 (220) 2020 02 10
 (731) N(N)LE "Georgian Farmers Association"
 Ak. Khorava St. 4, 0179, Tbilisi, Georgia
 (540)



(591) Green, white
 (531) 05.07.24; 05.09.24; 28.19; 29.01.12
 (511) 42

(260) AM 2020 107050 A
 (210) AM 107050
 (220) 2020 02 10
 (731) LTD "Beauty Academy"
 Vazisubani II Mcr, corp. 11, app. 15,
 Isani-Samgori District, Tbilisi, Georgia
 (540)



(591) Black-white
 (531) 27.05.22
 (511) 41, 44

(260) AM 2020 107052 A
 (210) AM 107052
 (220) 2020 02 11
 (731) LTD "BESOUND"
 Akaki Tsereteli Av. 12, app. 61, 0154, Tbilisi,
 Georgia
 (540)

**პოსტ რედ
 Post Red**

(591) Black-white
 (511) 41, 42

(260) AM 2020 107067 A
 (210) AM 107067
 (220) 2020 02 13
 (731) Irine Gvetadze
 Dolidze St., bld. 11, Ent. 2, app. 40, Tbilisi,
 Georgia
 (540)



(591) Black-white
 (531) 26.03.01; 26.03.11; 26.04.03; 26.04.09; 28.19
 (511) 18, 25, 35

(260) AM 2020 107158 A
 (210) AM 107158
 (220) 2020 02 17
 (731) Nino Dolidze
 Simon Chikovani St. 21, app. 38, Tbilisi,
 Georgia
 (540)

Le Chic Radical

(591) Black-white
 (531) 27.05.01
 (511) 14

(260) AM 2020 107174 A
 (210) AM 107174
 (220) 2020 02 20
 (731) LLC "ZUFA"
 6650 South Torrey Pines Drive, Las Vegas,
 Nevada 89118, USA
 (740) Tamaz Shilakadze

(540)

UFC

(591) Black-white
 (531) 27.05.01; 27.05.17
 (511) 29, 32

(260) AM 2020 107175 A
 (210) AM 107175
 (220) 2020 02 20
 (731) LLC "ZUFA"

6650 South Torrey Pines Drive, Las Vegas,
 Nevada 89118, USA

(540)

**ULTIMATE FIGHTING
CHAMPIONSHIP**

(591) Black-white
 (511) 29, 32

(260) AM 2020 107296 A
 (210) AM 107296
 (220) 2020 02 26
 (731) JOHNSON & JOHNSON

One Johnson & Johnson Plaza, New Brunswick,
 New Jersey 08933, USA

(740) Giorgi Taktakishvili

(540)

МОТРИН

(591) Black-white
 (511) 5

(260) AM 2020 107299 A
 (210) AM 107299
 (220) 2020 02 26
 (731) SANUS VITA

Saakadze Descent 6, Commercial Space 11,
 0160,

Tbilisi, Georgia

(740) Monika Kvaratskhelia

(540)

ბათფერონი**Batferon****Батферон**

(591) Black-white
 (511) 5

(260) AM 2020 107300 A
 (210) AM 107300
 (220) 2020 02 26

(731) SANUS VITA

Saakadze Descent 6, Commercial Space 11,
 0160, Tbilisi, Georgia

(740) Monika Kvaratskhelia

(540)

ბათბაქტამი**Batbaktam****Батбактам**

(591) Black-white
 (511) 5

(260) AM 2020 107301 A
 (210) AM 107301
 (220) 2020 02 26

(731) Saleh Abdulaziz Babaker Sons Co. for Trading
& Contracting

Al Furuisia street, Al Marwah, Riyadh, Saudi
 Arabia

(740) Giorgi Kartvelishvili

(540)



(591) White, green

(531) 11.03.01; 27.05.01; 28.01; 29.01.12

(511) 30

(260) AM 2020 107307 A
 (210) AM 107307
 (220) 2020 02 27

(731) Fraser Research Labs. Inc.

25 Sheppard Avenue West, Suite 300, Toronto,
 Ontario, M2N 6S6, Canada

(740) Merab Kvimsadze

(540)

SOaddicted

(591) Black-white

(531) 27.05.01; 27.05.10

(511) 3, 5

(260) AM 2020 107313 A

(210) AM 107313

(220) 2020 02 27

(731) LTD "MULT"

Al. Kazbegi Av. 24g, app. 242, 0177, Tbilisi,
Georgia

(540)



(591) Red, white

(531) 26.04.18; 26.04.24; 27.05.02; 27.05.24; 29.01.12

(511) 42

REGISTERED TRADEMARKS

(111) M 2020 33028 R
(151) 2020 08 21
(181) 2030 08 21
(260) AM 2019 104066 A
(220) 2019 07 12
(732) Enriko Beridze
T. Tabidze St. 10, Lane I, Tbilisi, Georgia

(111) M 2020 33029 R
(151) 2020 08 21
(181) 2030 08 21
(260) AM 2019 104067 A
(220) 2019 07 12
(732) Enriko Beridze
T. Tabidze St. 10, Lane I, Tbilisi, Georgia

(111) M 2020 33030 R
(151) 2020 08 21
(181) 2030 08 21
(260) AM 2019 104071 A
(220) 2019 07 12
(732) Enriko Beridze
T. Tabidze St. 10, Lane I, Tbilisi, Georgia

(111) M 2020 33031 R
(151) 2020 08 21
(181) 2030 08 21
(260) AM 2019 104072 A
(220) 2019 07 12
(732) Enriko Beridze
T. Tabidze St. 10, Lane I, Tbilisi, Georgia

(111) M 2020 33032 R
(151) 2020 08 21
(181) 2030 08 21
(260) AM 2019 104112 A
(220) 2019 07 18
(732) Enriko Beridze
T. Tabidze St. 10, Lane I, Tbilisi, Georgia

(111) M 2020 33033 R
(151) 2020 08 21
(181) 2030 08 21
(260) AM 2019 104113 A
(220) 2019 07 18
(732) Enriko Beridze
T. Tabidze St. 10, Lane I, Tbilisi, Georgia

(111) M 2020 33034 R
(151) 2020 08 21
(181) 2030 08 21
(260) AM 2019 104114 A
(220) 2019 07 18
(732) Enriko Beridze
T. Tabidze St. 10, Lane I, Tbilisi, Georgia

(111) M 2020 33035 R
(151) 2020 08 21
(181) 2030 08 21
(260) AM 2019 104116 A
(220) 2019 07 18
(732) Enriko Beridze
T. Tabidze St. 10, Lane I, Tbilisi, Georgia

(111) M 2020 33036 R
(151) 2020 08 21
(181) 2030 08 21
(260) AM 2019 104117 A
(220) 2019 07 18
(732) Enriko Beridze
T. Tabidze St. 10, Lane I, Tbilisi, Georgia

(111) M 2020 33037 R
(151) 2020 08 21
(181) 2030 08 21
(260) AM 2019 104119 A
(220) 2019 07 18
(732) Enriko Beridze
T. Tabidze St. 10, Lane I, Tbilisi, Georgia

(111) M 2020 33038 R
(151) 2020 08 21
(181) 2030 08 21
(260) AM 2019 104120 A
(220) 2019 07 18
(732) Enriko Beridze
T. Tabidze St. 10, Lane I, Tbilisi, Georgia

(111) M 2020 33039 R
(151) 2020 08 21
(181) 2030 08 21
(260) AM 2019 104121 A
(220) 2019 07 18
(732) Enriko Beridze
T. Tabidze St. 10, Lane I, Tbilisi, Georgia

(111) M 2020 33040 R
(151) 2020 08 21
(181) 2030 08 21
(260) AM 2019 104122 A
(220) 2019 07 19
(732) Enriko Beridze
T. Tabidze St. 10, Lane I, Tbilisi, Georgia

(111) M 2020 33041 R
(151) 2020 08 21
(181) 2030 08 21
(260) AM 2019 104185 A
(220) 2019 07 19
(732) Enriko Beridze
T. Tabidze St. 10, Lane I, Tbilisi, Georgia

(111) M 2020 33042 R
(151) 2020 08 21
(181) 2030 08 21
(260) AM 2019 104186 A
(220) 2019 07 19
(732) Enriko Beridze
T. Tabidze St. 10, Lane I, Tbilisi, Georgia

(111) M 2020 33043 R
(151) 2020 08 21
(181) 2030 08 21
(260) AM 2019 104190 A
(220) 2019 07 19
(732) Enriko Beridze
T. Tabidze St. 10, Lane I, Tbilisi, Georgia

(111) M 2020 33044 R
(151) 2020 08 21
(181) 2030 08 21
(260) AM 2019 104191 A
(220) 2019 07 19
(732) Enriko Beridze
T. Tabidze St. 10, Lane I, Tbilisi, Georgia

(111) M 2020 33045 R
(151) 2020 08 21
(181) 2030 08 21
(260) AM 2019 104674 A
(220) 2019 08 26
(732) LTD "Fermo Fence"
Didi Dighomi, Parnavazi Av., Near the
Autoparking, Tbilisi, Georgia

(111) M 2020 33046 R
(151) 2020 08 21
(181) 2030 08 21
(260) AM 2019 104741 A

(220) 2019 08 30
(732) Andrew Weil
7650 E. Broadway Boulevard, Suite 310,
Tucson, Arizona 85710, USA

(111) M 2020 33047 R
(151) 2020 08 21
(181) 2030 08 21
(260) AM 2020 108876 A
(220) 2020 06 30
(732) adp Gauselmann GmbH
Mercur-Allee 1-15, 32339, Espelkamp,
Germany

(111) M 2020 33055 R
(151) 2020 09 02
(181) 2030 09 02
(260) AM 2019 100410 A
(220) 2019 05 28
(732) LTD "L COMPANY"
Gldani, VII mcr., corp. 15, app. 39,
Tbilisi, Georgia

(111) M 2020 33056 R
(151) 2020 09 02
(181) 2030 09 02
(260) AM 2019 102174 A
(220) 2019 03 14
(732) Giorgi Machavariani
Vazha-Pshavela Av., II kvart., app. 1,
Tbilisi, Georgia

(111) M 2020 33057 R
(151) 2020 09 02
(181) 2030 09 02
(260) AM 2019 102364 A
(220) 2019 03 24
(732) GUIYANG NANMING LAOGANMA
Special Flavour Foodstuffs CO., LTD
138-15N Jianlongdong Road, Longdongbao,
Guiyang, China

(111) M2020 33058 R
(151) 2020 09 02
(181) 2030 09 02
(260) AM 2019 102808 A
(220) 2019 10 30
(732) LTD "FARKONI"
Tamar Mepe St. 51, Kutaisi, Georgia

(111) M 2020 33059 R
(151) 2020 09 02
(181) 2030 09 02

(260) AM 2019 103453 A
(220) 2019 10 30
(732) LTD "FARKONI"
Tamar Mepe St. 51, Kutaisi, Georgia

(111) M 2020 33060 R
(151) 2020 09 02
(181) 2030 09 02
(260) AM 2019 103454 A
(220) 2019 10 30
(732) LTD "FARKONI"
Tamar Mepe St. 51, Kutaisi, Georgia

(111) M 2020 33061 R
(151) 2020 09 02
(181) 2030 09 02
(260) AM 2019 103455 A
(220) 2019 10 30
(732) LTD "FARKONI"
Tamar Mepe St. 51, Kutaisi, Georgia

(111) M 2020 33062 R
(151) 2020 09 02
(181) 2030 09 02
(260) AM 2019 103456 A
(220) 2019 10 30
(732) LTD "FARKONI"
Tamar Mepe St. 51, Kutaisi, Georgia

(111) M 2020 33063 R
(151) 2020 09 02
(181) 2030 09 02
(260) AM 2019 103457 A
(220) 2019 10 30
(732) LTD "FARKONI"
Tamar Mepe St. 51, Kutaisi, Georgia

(111) M 2020 33064 R
(151) 2020 09 02
(181) 2030 09 02
(260) AM 2019 103458 A
(220) 2019 10 30
(732) LTD "FARKONI"
Tamar Mepe St. 51, Kutaisi, Georgia

(111) M 2020 33065 R
(151) 2020 09 02
(181) 2030 09 02
(260) AM 2019 103459 A
(220) 2019 10 30
(732) LTD "FARKONI"
Tamar Mepe St. 51, Kutaisi, Georgia

(111) M 2020 33066 R
(151) 2020 09 02
(181) 2030 09 02
(260) AM 2019 103460 A
(220) 2019 10 30
(732) LTD "FARKONI"
Tamar Mepe St. 51, Kutaisi, Georgia

(111) M 2020 33067 R
(151) 2020 09 02
(181) 2030 09 02
(260) AM 2019 103947 A
(220) 2019 07 08
(732) CALÇADOS PEGADA NORDESTE LTDA.
RUA CRUZEIRO DA ROCHA S/Nº,
BAIRRO CRUZEIRO – RUY BARBOSA/RS
– BRASIL, Brazil

(111) M 2020 33068 R
(151) 2020 09 02
(181) 2030 09 02
(260) AM 2019 104098 A
(220) 2019 07 16
(732) LTD "Zhorzholiani Trading"
Nutsbidze Plateau, II mcr., I kvart.,
corp. 6, app. 6, Tbilisi, Georgia

(111) M 2020 33069 R
(151) 2020 09 02
(181) 2030 09 02
(260) AM 2019 104104 A
(220) 2019 07 18
(732) LTD "Zhorzholiani Trading"
Nutsbidze Plateau, II mcr., I kvart.,
corp. 6, app. 6, Tbilisi, Georgia

(111) M 2020 33070 R
(151) 2020 09 02
(181) 2030 09 02
(260) AM 2019 104106 A
(220) 2019 07 18
(732) LTD "Zhorzholiani Trading"
Nutsbidze Plateau, II mcr., I kvart.,
corp. 6, app. 6, Tbilisi, Georgia

(111) M 2020 33071 R
(151) 2020 09 02
(181) 2030 09 02
(260) AM 2019 104107 A
(220) 2019 07 18
(732) LTD "Zhorzholiani Trading"
Nutsbidze Plateau, II mcr., I kvart.,
corp. 6, app. 6, Tbilisi, Georgia

(111) M 2020 33072 R
(151) 2020 09 02
(181) 2030 09 02
(260) AM 2019 104223 A
(220) 2019 07 26
(732) LTD "Tbilisi Art Center"
Vazha-Pshavela Av. 71, block 4, fl. 4,
office 28, 0186, Tbilisi, Georgia

(111) M 2020 33073 R
(151) 2020 09 02
(181) 2030 09 02
(260) AM 2019 104313 A
(220) 2019 07 30
(732) RAKUTEN INC.
1-14-1 Tamagawa, Setagaya-ku, Tokyo,
158-0094, Japan

(111) M 2020 33074 R
(151) 2020 09 02
(181) 2030 09 02
(260) AM 2019 104454 A
(220) 2019 08 08
(732) MAJID AL FUTTAIM RETAIL LLC
P.O. Box 124441, Dubai, United Arab
Emirates

(111) M 2020 33075 R
(151) 2020 09 02
(181) 2030 09 02
(260) AM 2019 104678 A
(220) 2019 08 27
(732) LTD "IDS Borjomi Beverage Company"
Tori St. 39, 1200, Borjomi, Georgia

(111) M 2020 33076 R
(151) 2020 09 02
(181) 2030 09 02
(260) AM 2019 104822 A
(220) 2019 09 11
(732) LTD "AMERI"
Vill. Karaleti, 1414, Gori district, Georgia

(111) M 2020 33077 R
(151) 2020 09 02
(181) 2030 09 02
(260) AM 2019 105006 A
(220) 2019 09 20
(732) LTD "GORELLI"
Shindisi Road 2nd km, 1400, Gori,
Georgia

(111) M 2020 33078 R
(151) 2020 09 02
(181) 2030 09 02
(260) AM 2019 105216 A
(220) 2019 10 07
(732) FABA INTERNEISHNL FZE
P.O. Box: Office LB04128, Jebel Ali Free
Zone, Dubai, United Arab Emirates

(111) M 2020 33079 R
(151) 2020 09 02
(181) 2030 09 02
(260) AM 2019 105217 A
(220) 2019 10 07
(732) FABA INTERNEISHNL FZE
P.O. Box: Office LB04128, Jebel Ali Free
Zone, Dubai, United Arab Emirates

(111) M 2020 33080 R
(151) 2020 09 02
(181) 2030 09 02
(260) AM 2019 105218 A
(220) 2019 10 07
(732) FABA INTERNEISHNL FZE
P.O. Box: Office LB04128, Jebel Ali Free
Zone, Dubai, United Arab Emirates

(111) M 2020 33081 R
(151) 2020 09 03
(181) 2030 09 03
(260) AM 2019 103780 A
(220) 2019 06 26
(732) JSC "BADAGONI"
Vill. Zemo Khodasheni, Akhmeta District,
Georgia

(111) M 2020 33082 R
(151) 2020 09 03
(181) 2030 09 03
(260) AM 2019 103956 A
(220) 2019 07 09
(732) CILAG GMBH INTERNATIONAL
Gubelstrasse 34, CH-6300, Zug, Switzerland

(111) M 2020 33083 R
(151) 2020 09 03
(181) 2030 09 03
(260) AM 2019 104177 A
(220) 2019 07 19
(732) FERRARI S.P.A.
Via Emilia Est 1163, Modena, Italy

(111) M 2020 33084 R
(151) 2020 09 03
(181) 2030 09 03
(260) AM 2019 104316 A
(220) 2019 07 31
(732) CILAG GMBH INTERNATIONAL
Gubelstrasse 34, CH-6300, Zug, Switzerland

(111) M 2020 33085 R
(151) 2020 09 03
(181) 2030 09 03
(260) AM 2019 104558 A
(220) 2019 08 21
(732) LTD "Nevinnomysskiy Masloekstraktsionniy
Zavod"
ul. Matrosova 8, Nevinnomyssk, Stavropolskiy
kray, 357101, Russian Federation

(111) M 2020 33086 R
(151) 2020 09 03
(181) 2030 09 03
(260) AM 2019 104749 A
(220) 2019 09 02
(732) LTD "Gillia Food Company"
Zemo Vedzisi St. 73, Vake-Saburtalo
district, 0177, Tbilisi, Georgia

TRADEMARKS REGISTERED ACCORDING TO THE ACCELERATED PROCEDURE

The decision can be appealed at the Chamber of Appeal of Sakpatenti within 3 months from the publication.

(111) M 2020 33048 R
(151) 2020 08 24
(181) 2030 08 24
(210) AM 109433
(220) 2020 08 18
(732) Ana Shatakishvili
Giorgi Brtskinvale St. 56, Gori, Georgia
(540)

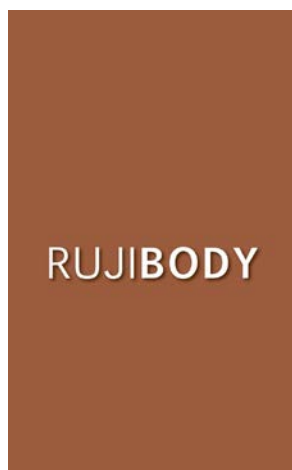

(591) Brown, white
(531) 26.04.02; 26.04.22; 26.04.24; 27.05.24;
29.01.12
(511) 3

(111) M 2020 33049 R
(151) 2020 08 25
(181) 2030 08 25
(210) AM 107162
(220) 2020 02 18
(732) LLC "Formula Construction"
Soprom Mgaloblishvili St. 13, Commercial
Space 2, Tbilisi, Georgia
(540)



(591) Red, white
(531) 26.04.02; 26.04.12; 26.04.16; 26.04.22;
26.04.24; 26.11.08; 26.11.11; 28.19; 29.01.12
(511) 2, 19

(111) M 2020 33050 R
(151) 2020 08 25
(181) 2030 08 25
(210) AM 109367
(220) 2020 08 12
(732) LLC "MY MAIL"
Shalva Nutsubidze St. 129a, Tbilisi, Georgia
(740) Ana Ghambashidze
(540)



(591) Black-white
(531) 24.15.02; 28.19
(511) 39

(111) M 2020 33051 R
(151) 2020 08 25
(181) 2030 08 25
(210) AM 109369
(220) 2020 08 12
(732) LLC "MY MAIL"
Shalva Nutsubidze St. 129a, Tbilisi, Georgia
(740) Ana Ghambashidze

(540)



(591) Black-white
(531) 24.15.02; 27.05.01; 27.05.15
(511) 39

(111) M 2020 33052 R
(151) 2020 08 26
(181) 2030 08 26
(210) AM 109139
(220) 2020 07 22
(732) JSC "SILKNET"
Tsinamdzghvrishvili St. 95, 0112, Tbilisi,
Georgia

(540)



(591) Grey (inscription), blue, sky-blue, lilac
 (531) 26.11.22; 27.05.01; 27.05.10; 29.01.14
 (526) Music
 (511) 38, 41

(111) M 2020 33053 R

(151) 2020 08 27

(181) 2030 08 27

(210) AM 109501

(220) 2020 08 24

(732) LLC "IN VESTA GEORGIA"

V. Jorbenadze St. 15, 0103, Tbilisi, Georgia

(740) Nugzar Ksovreli

(540)

FORLUX

(591) Black-white

(511) 9

(111) M 2020 33054 R

(151) 2020 08 31

(181) 2030 08 31

(210) AM 109508

(220) 2020 08 25

(732) LTD "VICTORIA 98"

Vazha-Pshavela Av. 10, 0160, Tbilisi,
Georgia

(540)

Gentleman

(591) Red, black

(531) 27.05.01; 28.19; 29.01.12

(511) 35

(111) M 2020 33087 R

(151) 2020 09 07

(181) 2030 09 07

(210) AM 109606

(220) 2020 09 03

(732) LTD "TAMILINA"

Lilo Settlement, IV qu., corp. 1, app. 40,
Tbilisi, Georgia

(540)



(591) Yellow, blue, sky-blue, white

(531) 03.07.16; 03.07.24; 05.11.11; 27.05.01;
27.05.10; 29.01.14

(511) 33

INTERNATIONAL TRADEMARKS FOR WHICH A DECISION ON GRANTING PROTECTIONS IS TAKEN

The decision can be appealed at the Chamber of Appeal of Sakpatenti within 3 months from the publication or at the Mtskheta District Court Administrative Cases Board (Address: №17, Samkhedro str., Mtskheta), within 1 month following the publication.

(260) AM 2020 105694 A

(800) 1496295

(151) 2019 05 17

(891) 2019 05 17

(731) adp Gauselmann GmbH

Merkur-Allee 1-15, 32339 Espelkamp,
Germany

(540)

UHURU PEAK

(591) Black, white

(511)

9 – Computer software; coin-operated mechanisms; computer and video game software; games software in particular for use on any computer platform, including electronic entertainment and games consoles; computer game programs; video games (software); computer games provided through a global computer network or supplied by means of multi-media electronic broadcast or through telecommunications or electronic transmission or via the internet; computer games, leisure and recreational software, video games and computer software, all being provided in the form of storage media; programs for operating electric and electronic apparatus for games, entertainment and/or amusement purposes; computer software for computer games on the internet; online games (software), in particular for online betting games, online prize games, online gambling games, online games of skill and online casino games; computer software in the form of an app for mobile devices and computers; calculating apparatus in coin-operated machines and parts for the aforesaid goods; electric, electronic, optical or automatic apparatus, for identifying data carriers, identity cards and credit cards, bank notes and coins; software in particular for casino and/or amusement arcade games, for gaming machines and/or slot machines each one with or without prize payouts; gaming software that generates or displays wager outcomes of gaming machines; operational computer games software; computer software for managing of games (game collection); computer programs for video games; computer video game software.

28 – Games; toys; gaming apparatus (including coin-operated apparatus); coin-operated arcade games (machines); games for amusement arcades (included in this class); coin-operated video gaming apparatus; video games apparatus adapted for use with external

screens or monitors only; casino fittings, namely roulette tables, roulette wheels; coin-operated automatic gaming machines and gaming machines, in particular for gaming arcades, with or without a prize payout; electronic or electrotechnical gaming apparatus, automatic gaming machines, gaming machines, slot machines operated by coins, tokens, banknotes, tickets or by means of electronic, magnetic or biometric storage media, in particular for commercial use in casinos and amusement arcades, with or without a prize payout; automatic gaming machines and gaming machines, in particular for commercial use in casinos and gaming arcades, with or without a prize payout; coin-operated gaming machines and/or electronic money-based gaming apparatus (machines), with or without prizes; housings adapted for gaming machines, gaming apparatus and automatic gaming machines, operated by means of coins, tokens, tickets or by means of electronic, magnetic or biometric storage media, in particular for commercial use in casinos and gaming arcades, with or without a prize payout; electronic games; electronic game entertainment apparatus and parts thereof; video output game machines; drawing apparatus for prize games and lotteries, draws or raffles; housings of metal, plastic and/or wood adapted for coin-operated automatic amusement machines; apparatus for games (including video games), other than adapted for use with external screens or monitors only; electro-pneumatic and electric slot machines with pulling handles (gaming machines); gaming tables, in particular for table football, billiards, sliding games; flying discs (toys) and darts; gaming machines, namely electric, electronic or electromechanical apparatus for bingo games, lotteries or video lottery games and for betting offices, connected or unconnected to a computer network; LCD games consoles; automatic gaming machines; all the aforesaid automatic machines operating in networks; apparatus and devices for accepting and storing money, being fittings for the aforesaid automatic machines, included in this class; automatic lottery machines.

(260) AM 2020 105705 A

(800) 1496464

(151) 2019 10 03

(891) 2019 10 03

(731) Japan Tobacco Inc.

2-2-1 Toranomom, Minato-ku, Tokyo, Japan

(540)

FLOWTECH

(591) Black, white

(511)

34 – Tobacco, raw or manufactured; smoking tobacco, pipe tobacco, rolling tobacco, chewing tobacco, snus; cigarettes, electronic cigarettes, cigars, cigarillos; snuff; smokers' articles included in class 34; cigarette paper, cigarette tubes and matches.

(260) AM 2020 105826 A

(800) 1498862

(151) 2019 09 03

(891) 2019 09 03

(731) SILVANOLS, SIA

Kurbada iela 2a, LV-1009 Rīga, Latvia

(540)



(591) Dark grey, grey, white and light green

(531) 02.01.23; 05.05.20; 29.01.13

(511)

3 – Cosmetic preparations for skin care, other than for medical purposes; non-medicated body care preparations; non medicated face care preparations; cosmetic skin enhancers; body sprays [non-medicated]; cosmetic products in the form of aerosols for skin-care; cosmetic topical skin sprays, other than for medical purposes; nasal cleaning preparations for personal sanitary purposes; throat sprays [non-medicated].

5 – Pharmaceutical and natural remedies; drugs for medical purposes; medicines for human purposes; herbal preparations for medical use; anti-allergy medical preparations; allergy relief medication; pharmaceutical preparations for treating allergies; pharmaceutical preparations for the prevention of allergies; allergy medication; anti-allergy sprays; nasal drops for the treatment of allergies; nose drops; medicinal sprays; nasal sprays for medical purposes; nasal sprays for the treatment of allergies; decongestant nasal sprays; pharmaceutical preparations for treating allergic rhinitis; nasal cleaning preparations for medical purposes; mouth sprays for medical use;

medicated throat sprays; cachets for pharmaceutical purposes; cachets for medicinal purposes; decongestant capsules; allergy capsules; medicinal ointments; balms for medical purposes; balms for pharmaceutical purposes; balsamic preparations for medical purposes; liniments; ointments for pharmaceutical purposes; ointments for medical use; skin care preparations for medical use; body care preparations for medical purposes; face care preparations for medical purposes; medicated products in the form of aerosols for skincare; topical skin sprays for medical purposes.

10 – Medical and veterinary apparatus and instruments; aerosol dispensers for medical purposes; sprayers [hand-operated] for medical use; vaporizers for medical purposes.

(260) AM 2020 105831 A

(800) 1498933

(151) 2019 10 17

(891) 2019 10 17

(731) Zhangjiagang Razorline Manufacturing Co., Ltd
Chenxin village, Yangshe Town,
Zhangjiagang District, Suzhou City,
Jiangsu Province, China

(540)

**RAZORLINE**

(591) Black, white

(531) 14.07.20; 26.04.04; 26.04.05; 26.04.16;
26.04.24; 27.05.01

(511)

8 – Hair clippers for personal use [electric and non-electric]; scissors; curling tongs; pincers; hair clippers for animals [hand instruments]; razor cases; nail clippers [electric or non-electric]; hair curling (hand implements for -); razor blades; razor, electric or non-electric.

(260) AM 2020 105832 A

(800) 1498934

(151) 2019 04 16

(891) 2019 04 16

(731) Glenturret Limited

The Glenturret, Glenturret Distillery The
Hosh, Crieff, Scotland PH7 4HA, United
Kingdom

(540)

GLENTURRET

(591) Black, white

(511)

33 – Wines, spirits and liqueurs; strong alcoholic drinks, except beer; whisky and whisky based liqueurs, namely Scotch whisky and Scotch whisky based liqueurs produced in Scotland.

(260) AM 2020 105836 A

(800) 1499010

(151) 2019 09 23

(891) 2019 09 23

(731) Friesland Campina Germany GmbH
Wimpfener Str. 125 74078 Heilbronn,
Germany

(540)



(591) Black, white and color varies from brown to yellow

(531) 26.01.18; 27.05.24; 29.01.13

(511)

29 – Milk and milk products.

(260) AM 2020 105850 A

(800) 1499411

(151) 2019 10 17

(891) 2019 10 17

(731) ZHEJIANG BENYU TOOLS CO., LTD.
No. 188, Haichang Road, Taizhou City,
Zhejiang Province, China

(540)



(591) Black, white

(531) 24.15.03; 26.03.23; 27.05.10

(526) TOOLS

(511)

7 – Saw benches [parts of machines]; electric planers; lumbering band saws; power-operated jig saws; sanding machines [for woodworking]; circular saws [for woodworking]; engraving machines; hammers [parts of machines]; power hammers; electric ham-

mers; electric hammers [hand-held]; screwdrivers, electric; electric hand drill (excluding electric coal drill); power-driven wrenches; impact wrenches; portable electric grinders; carbon brushes [electricity]; generators; stators [parts of machines]; compressors [machines]; high pressure washers; car washing machines.

(260) AM 2020 105863 A

(800) 961857

(151) 2008 03 11

(891) 2019 11 07

(731) G. Pohl-Boskamp GmbH & Co. KG
Kieler Strasse 11, 25551 Hohenlockstedt,
Germany

(540)

Gelositin

(591) Black, white

(511)

5 – Pharmaceutical preparations, chemical products adapted for medical purposes, drugs, plasters, materials for dressings, preparations for destroying vermin, disinfectants.

(260) AM 2020 105866 A

(800) 1436022

(151) 2018 08 09

(891) 2019 10 14

(731) GUANGDONG OPPO MOBILE
TELECOMMUNICATIONS CORP., LTD.
No. 18 Haibin Road, Wusha, Chang'an,
Dongguan, Guangdong, China

(540)

Find X

(591) Black, white

(531) 27.05.01

(511)

9 – Computer software, recorded; data processing apparatus; interactive touch screen terminals; chronographs [time recording apparatus]; facsimile machines; intercommunication apparatus; cell phones; smartphones; covers for smartphones; protective films adapted for smartphones; selfie sticks for use with cell phones; DVD players; headphones; cameras [photography]; selfie sticks [hand-held monopods]; USB cables; materials for electricity mains [wires, cables]; electrical adapters; batteries, electric; rechargeable batteries; smartwatches; smartphone software applications, downloadable; smart rings; facial recognition apparatus; biometric scanners; neon signs; wireless speakers; teaching apparatus; virtual reality headsets; electronic chips; touch screens; eyeglasses.

(260) AM 2020 105867 A
 (800) 1463252
 (151) 2019 03 04
 (891) 2019 07 12
 (731) REALME CHONGQING MOBILE
 No.178 Yulong Avenue, Yufengshan,
 Yubei District, Chongqing, China
 (540)

realme

(591) Black, white
 (531) 27.05.01
 (511)
 9 – Computers; notebook computers; computer programs [downloadable software]; downloadable applications for use with mobile devices; integrated circuit cards [smart cards]; personal digital assistants [PDAs]; smartwatches; smartglasses; smart rings; interactive touch screen terminals; touch screen pens; fingerprint scanners; humanoid robots with artificial intelligence; wearable computers; optical data media; printers for use with computers; scanners [data processing equipment]; gesture recognition software; virtual reality game software; chronographs [time recording apparatus]; apparatus to check franking; money counting and sorting machines; mechanisms for coin-operated apparatus; dictating machines; face recognition device; biometric scanners; facsimile machines; weighing machines; body fat scales for household use; measures; blinkers [signalling lights]; neon signs; vehicle breakdown warning triangles; aerials; intercommunication apparatus; navigational instruments; modems; optical communication instruments; wearable activity trackers; video telephones; cell phones; smartphones; mobile telephones; smartphones in the shape of a watch; covers for cell phones; cases for cell phones; screen protector for mobile devices; cell phone straps; mobile phone holders; telecommunication apparatus in the form of jewellery; selfie sticks for use with smartphones; wrist-mounted smartphones; keyboards for mobile phones; cabinets for loudspeakers; DVD players; portable media players; headsets; headphones; headsets for mobile phones; wireless headsets for smartphones; learning machine; electronic teaching machine; electronic sounding device with books; camcorders; virtual reality headsets; headsets for virtual reality games; security surveillance robots; wearable video display monitors; cameras; enlarging apparatus [photography]; transparency projection apparatus; speed measuring apparatus [photography]; selfie sticks [hand-held monopods]; selfie lenses; surveying apparatus and instruments; gauges; optical apparatus and instruments; telescopes; materials for electricity mains [wires, cables]; telephone wires; USB cables; semi-conductors; resistance material; printed circuits; electronic chips; electromagnetic coils; semiconductor apparatus; connections, elec-

tric; power adapters; low voltage power supplies; touchscreen sensors; electrical adapters; video screens; touch screens; remote control apparatus; electronic key fobs being remote control apparatus; optical fibers [light conducting filaments]; heat regulating apparatus; lightning arresters; electrolyzers; fire extinguishers; radiological apparatus for industrial purposes; protection devices for personal use against accidents; goggles; theft prevention installations, electric; eyeglasses; sunglasses; batteries, electric; chargers for electric batteries; mobile power (rechargeable battery); animated cartoons; refrigerator magnets; operating system programs; connected bracelets [measuring instruments]; teaching robots; inductors [electricity]; switches, electric; time switches, automatic; electrical controlling devices; biometric fingerprint door locks; television apparatus; set-top boxes.

35 – Advertising; on-line advertising on a computer network; presentation of goods on communication media, for retail purposes; on-line promotion of computer networks and websites; advertising by transmission of on-line publicity for third parties through electronic communications networks; rental of advertising space on websites; business management and organization consultancy; providing business information via a web site; providing business information via internet, the cable network or other forms of data transfer; sales promotion for others provided through the distribution and the administration of privileged user cards; sales promotion for others; provision of an on-line marketplace for buyers and sellers of goods and services; import-export agency services; personnel management consultancy; relocation services for businesses; compiling indexes of information for commercial or advertising purposes; updating and maintenance of data in computer databases; accounting; rental of vending machines; sponsorship search; rental of sales stands; retail services for pharmaceutical, veterinary and sanitary preparations and medical supplies.

(260) AM 2020 105868 A
 (800) 1493260
 (151) 2019 07 16
 (891) 2019 10 25
 (731) AFTERSHOKZ, LLC
 1801 Burnet Avenue, Suite 102, Syracuse
 NY 13206, USA
 (540)

AEROPEX

(591) Black, white
 (511)
 9 – Blank electronic storage media; memory modules; microphones; horns for loudspeakers; headphones; MP3 players; portable media players; music headphones; earbuds; wireless speakers; batteries,

electric; USB cables; chargers for batteries; lithium ion batteries; earphone accessories, namely, earphone cushions, earphone pads, earphone cases, and earphone extension cords; stereo headphones; personal headphones for sound transmitting apparatuses; bone conduction stereo headphones; loudspeakers, headphones, microphones and CD players; personal headphones for sound transmitting apparatuses. Microphones; horns for loudspeakers; headphones; MP3 players; portable media players; music headphones; earbuds; wireless speakers; batteries, electric; usb cables; chargers for batteries; stereo headphones.

(260) AM 2020 105906 A
 (800) 1499897
 (151) 2019 09 24
 (891) 2019 09 24
 (731) Hyundai Motor Company
 12, Heolleung-ro, Seocho-gu, Seoul 06797,
 Republic of Korea

(540)

eG80

(591) Black, white
 (531) 27.05.01; 27.05.10; 27.07.01; 27.07.11
 (511)

12 – Automobiles; passenger cars; vans; sports cars; electric cars; hybrid cars; sport utility vehicles; light trucks; hydrogen fuel cell electric cars.

(260) AM 2020 105907 A
 (800) 1499905
 (151) 2019 10 11
 (891) 2019 10 11
 (731) JT International SA
 8 rue Kazem-Radjavi, CH-1202 Genève,
 Switzerland

(540)



(591) Light brown
 (531) 10.01.01; 10.01.05; 10.01.25; 19.03.01;
 25.07.07; 26.01.01; 26.01.18; 26.01.24;
 26.02.03; 26.02.12; 26.04.05; 26.04.18;
 26.04.24; 26.11.13; 27.05.09; 29.01.07

(511)

9 – Electronic chargers, batteries.

34 – Electronic cigarettes; cases for electronic cigarettes; cases for electronic cigarette accessories; cigarettes; cigars; electronic cigarette tips for smokers; flavorings, other than essential oils, for use in electronic cigarettes; tobacco spraying apparatus; tobacco-related atomizers; oral atomizers for smokers; liquid aromatic cartridges for electronic cigarettes; liquids for electronic cigarettes containing flavorings, other than essential oils, for refilling electronic cigarette cartridges; liquid nicotine solutions for electronic cigarettes; tobacco substitutes; tobacco; cigarettes containing tobacco substances, not for medical purposes; ashtrays; lighters for smokers; smokers' articles, tobacco products.

(260) AM 2020 105908 A
 (800) 1499914
 (151) 2019 10 11
 (891) 2019 10 11
 (731) JT International SA
 8 rue Kazem-Radjavi, CH-1202 Genève,
 Switzerland

(540)



(591) Orange
 (531) 10.01.05; 10.01.07; 10.01.25; 19.03.01;
 25.07.07; 25.07.22; 26.01.01; 26.01.18;
 26.01.24; 26.02.03; 26.02.12; 26.04.05;
 26.04.18; 26.04.24; 26.11.13; 27.05.09;
 29.01.01

(511)

9 – Electronic chargers, batteries.

34 – Electronic cigarettes; cases for electronic cigarettes; cases for electronic cigarette accessories; cigarettes; cigars; electronic cigarette tips for smokers; flavorings, other than essential oils, for use in electronic cigarettes; tobacco spraying apparatus; tobacco-related atomizers; oral atomizers for smokers; liquid aromatic cartridges for electronic cigarettes; liquids for electronic cigarettes containing flavorings, other than essential oils, for refilling electronic cigarette cartridges; liquid nicotine solutions for electronic cigarettes; tobacco substitutes; tobacco; cigarettes containing tobacco substances, not for medical purposes; ashtrays; lighters for smokers; smokers' articles, tobacco products.

(260) AM 2020 105909 A
 (800) 1499917
 (151) 2019 10 11
 (891) 2019 10 11
 (731) JT International SA
 8 rue Kazem-Radjavi, CH-1202 Genève,
 Switzerland
 (540)



(591) Pink
 (531) 10.01.01; 10.01.05; 10.01.25; 19.03.01;
 25.07.07; 26.01.01; 26.01.18; 26.01.24;
 26.02.03; 26.02.12; 26.04.05; 26.04.18;
 26.04.24; 27.05.09; 29.01.05; 29.01.14

(511)
 9 – Electronic chargers, batteries.

34 – Electronic cigarettes; cases for electronic cigarettes; cases for electronic cigarette accessories; cigarettes; cigars; electronic cigarette tips for smokers; flavorings, other than essential oils, for use in electronic cigarettes; tobacco spraying apparatus; tobacco-related atomizers; oral atomizers for smokers; liquid aromatic cartridges for electronic cigarettes; liquids for electronic cigarettes containing flavorings, other than essential oils, for refilling electronic cigarette cartridges; liquid nicotine solutions for electronic cigarettes; tobacco substitutes; tobacco; cigarettes containing tobacco substances, not for medical purposes; ashtrays; lighters for smokers; smokers' articles, tobacco products.

(260) AM 2020 105911 A
 (800) 1499932
 (151) 2019 05 22
 (891) 2019 05 22
 (731) LOUIS VUITTON MALLETIER
 2 rue du Pont-Neuf, F-75001 Paris, France
 (540)



(591) Black, beige
 (531) 09.01.25; 25.07.01; 25.07.03; 25.07.04;
 25.07.08; 26.04.09; 27.05.10; 29.01.12

(511)
 18 – Boxes of leather or of imitations of leather; traveling bags, traveling sets (leather goods), trunks and suitcases, garment and footwear bags for travel; unfitted vanity cases; backpacks, handbags; sports bags; clutches (evening handbags), attache cases and document holders of leather; wallets, purses, card cases (wallets), key cases (leather goods); parasols, umbrellas; clothing for animals, bags for carrying animals.

(260) AM 2020 105916 A
 (800) 1499960
 (151) 2019 08 19
 (891) 2019 08 19
 (731) Open Joint Stock Company, "Mogilevsky zavod liftovogo, mashinostroeniya" (OJSC "Mogilevliftmash")
 Prospekt Mira, 42, 212798 Mogilev, Belarus
 (540)

ВСЕГДА НА ВЫСОТЕ

(591) Black, white
 (531) 28.05

(511)
 7 – Winches; grinding machines; elevators [lifts] and parts thereof; hoists; lifts, other than ski-lifts; wood-working machines; sharpening machines; milling machines; elevator operating apparatus, lift operating apparatus; control mechanisms for machines, engines or motors; elevating apparatus; escalators; agricultural winches; cultivators [machines]; motorized cultivators; moving sidewalks (passenger conveyors), moving walkways (passenger conveyors); automatic multi-level car parking systems, mechanical multi-level car-parking systems; household and industrial shredders [wood chopper, feed chopper]; motors, electric, other than for land vehicles; tables for machines.

12 – Motors, electric, for land vehicles.

37 – Elevator installation and repair, lift installation and repair.

(260) AM 2020 105922 A
 (800) 1500058
 (151) 2019 10 04
 (891) 2019 10 04
 (731) Closed Joint Stock Company, "Holding Company, "United Elements Group"
 Pionerskaya ulitsa, dom 53, liter L;
 RU-197110 Sankt-Peterburg, Russian Federation

(540)

United Elements

(591) Black, white

(531) 27.05.01

(511)

35 – Commercial or industrial management assistance; commercial intermediation services; sales promotion for others; procurement services for others [purchasing goods and services for other businesses]; outsourcing services [business assistance]; on-line ordering services; retail or wholesale store services.

37 – Installation of utilities in construction sites; building construction supervision; installation and repair of air-conditioning apparatus; freezing equipment installation and repair; electric appliance installation and repair; interference suppression in electrical apparatus.

39 – Rental of warehouses; rental of storage containers; storage of goods; storage.

40 – Custom assembling of materials for others.

(260) AM 2020 105927 A

(800) 1500092

(151) 2019 09 11

(891) 2019 09 11

(731) F&I Beverages AG

Baarerstrasse 52, CH-6300 Zug, Switzerland

(540)

LUCKY FLY

(591) Black, white

(531) 27.05.01

(511)

32 – Beer; non-alcoholic beverages; mineral and aerated waters; fruit beverages and fruit juices; syrups and other non-alcoholic preparations for making beverages; aperitifs, non-alcoholic; barley wine [beer]; aerated water; lithia water; seltzer water; soda water; waters [beverages]; mineral water [beverages]; table waters; kvass [non-alcoholic beverage]; cocktails, non-alcoholic; beer-based cocktails; lemonades; isotonic beverages; non-alcoholic honey-based beverages; rice-based beverages, other than milk substitutes; soya-based beverages, other than milk substitutes; aloe vera drinks, non-alcoholic; whey beverages; protein-enriched sports beverages; soft drinks; non-alcoholic beverages flavored with coffee; non-alcoholic beverages flavored with tea; non-alcoholic fruit juice beverages; energy drinks; fruit nectars, non-alcoholic; orgeat; ginger beer; malt beer; powders for effervescing beverages; sarsaparilla [non-alcoholic beverage]; syrups for lemonade; syrups for beverages; smoothies [fruit and vegetable

based beverages]; tomato juice [beverage]; cider, non-alcoholic; vegetable juices [beverages]; fruit juices; non-alcoholic preparations for making beverages; preparations for making aerated water; must; grape must, unfermented; beer wort; malt wort; pastilles for effervescing beverages; sherbets [beverages]; non-alcoholic fruit extracts; extracts of hops for making beer; essences for making beverages.

33 – Spirits [beverages]; alcoholic beverages (except beer); aperitifs; arrack [arak]; baijiu [Chinese distilled alcoholic beverage]; brandy; wine; piquette; whisky; vodka; anisette [liqueur]; kirsch; gin; digesters [liqueurs and spirits]; cocktails; curacao; anise [liqueur]; liqueurs; pre-mixed alcoholic beverages, other than beer-based; alcoholic beverages containing fruit; distilled beverages; mead [hydromel]; peppermint liqueurs; bitters; nira [sugarcane-based alcoholic beverage]; rum; sake; perry; cider; rice alcohol; alcoholic extracts; fruit extracts, alcoholic; alcoholic essences.

(260) AM 2020 105935 A

(800) 1500444

(151) 2019 08 05

(891) 2019 08 05

(731) Claris International Inc.

5201 Patrick Henry Drive, Santa Clara

CA 95054, USA

(540)

CLARIS

(591) Black, white

(511)

42 – Providing online non-downloadable software and software as a service (SaaS) services, namely, hosting software for use by others for developing and accessing other software applications and database management; providing online non-downloadable software and software as a service (SaaS) services featuring software for use in application and database integration; providing online non-downloadable software and platform as a service (PaaS) featuring computer software platforms for use in developing and accessing other software applications and database management; Infrastructure as a Service (IaaS), namely, cloud hosting provider services; providing temporary use of on-line non-downloadable software for use in managing, organizing and sharing data on a global computer network and on local computer networks; providing temporary use of on-line non-downloadable software for viewing, annotating, storing, downloading and distributing electronic files, images, audio, video, data, and documents; providing online non-downloadable software for accessing, viewing, browsing, searching, annotating, hosting, configuring, and managing online databases, electronic files, and personal information,

for web hosting of databases, for automating database functions, and for communication and collaboration via computer networks; providing temporary use of on-line non-downloadable software for viewing, annotating, storing, downloading and distributing electronic files, images, audio, video, data, and documents; providing temporary use of on-line non-downloadable software for personal information management, database management, and database synchronization; providing temporary use of on-line non-downloadable software for accessing, browsing and searching online databases; providing temporary use of on-line non-downloadable software for communication and collaboration via computer networks; providing temporary use of on-line non-downloadable software development tools and templates for data management; cloud hosting provider services; electronic data storage services; computer software consulting services; consultation services for developing computer databases and applications; providing computer software information online; design and development of computer software; technical support services, namely, diagnosing and troubleshooting on-line of computer software problems.

(260) AM 2020 105954 A

(800) 1500932

(151) 2019 09 05

(891) 2019 09 05

(731) Sovmestnoe belorussko-polskoe predpriyatie "KAMAKO PLYUS" v forme obshchestva s ogranichennoy otvetstvennostyu ul. Morozova, d. 87, cabinet 1, liter B1/b, g. Borisov, 222514 Minskaya oblast, Belarus

(540)



(591) Black-blue, dark-blue, blue, white, gold, yellow and orange

(531) 01.03.02; 01.03.17; 25.01.19; 28.05; 29.01.13

(511)

30 – Sauces; mayonnaise.

(260) AM 2020 106006 A

(800) 1501375

(151) 2019 09 25

(891) 2019 09 25

(731) OÜ Good Design

Leiva tn 3, EE-12618 Talinn, Harju maakond, Estonia

(540)



(591) White, black, beige, light-beige, dark-beige, brown, light-brown, dark-brown, gray, light-gray, dark-gray, green, light-green, dark-green, yellow, light-yellow, orange, blue, light-blue, pink, light-pink, dark-pink

(531) 02.03.01; 05.03.16; 05.05.22; 05.05.23;

26.01.04; 26.01.14; 26.01.15; 28.05; 29.01.15

(511)

3 – Abrasives; amber [perfume]; descaling preparations for household purposes; antistatic preparations for household purposes; aromatics [essential oils]; air fragrancing preparations; cake flavorings [essential oils]; flavorings for beverages [essential oils]; food flavorings [essential oils]; breath freshening sprays; canned pressurized air for cleaning and dusting purposes; balms, other than for medical purposes; basma [cosmetic dye]; lip glosses; nail glitter; polishing stones; abrasive paper; emery paper; polishing paper; petroleum jelly for cosmetic purposes; shoe polish; cobblers' wax; cotton wool for cosmetic purposes; sachets for perfuming linen; drying agents for dishwashing machines; adhesives for cosmetic purposes; scented water; Javelle water; lavender water; toilet water; wax for parquet floors; floor wax; non-slipping wax for floors; depilatory wax; mustache wax; tailors' wax; creams for leather; polish for furniture and flooring; shoemakers' wax; polishing wax; massage gels, other than for medical purposes; heliotropine; dental bleaching gels; geraniol; make-up; deodorants for pets; deodorants for human beings or for animals; depilatory preparations; air fragrance reed diffusers; scented wood; perfumes; non-slipping liquids for floors; windshield cleaning liquids; greases for cosmetic purposes; volcanic ash for cleaning; perfumery; decorative transfers for cosmetic purposes; ionone [perfumery]; shaving stones [astringents]; smoothing stones; eyebrow pencils; cosmetic pencils; silicon carbide [abrasive]; carbides of metal [abrasives]; alum stones [astringents]; tripoli stone for polishing; adhesives for affixing false eyelashes; adhesives for affixing false hair; hair conditioners; quillaia bark for washing; corundum [abrasive]; beard dyes; colorants for toilet purposes; cosmetic dyes; laundry starch; laundry glaze; shoe cream; polishing creams; cosmetic creams; skin whitening creams; polishing rouge; incense; hair spray; nail polish; hair lotions; lotions for cosmetic purposes; after-shave lotions; beauty masks; oils for perflu-

mes and scents; oils for cosmetic purposes; oils for toilet purposes; essential oils; essential oils of cedarwood; essential oils of lemon; essential oils of citron; oils for cleaning purposes; bergamot oil; gaultheria oil; jasmine oil; lavender oil; almond oil; rose oil; oil of turpentine for degreasing; whitening; cleaning chalk; almond milk for cosmetic purposes; cleansing milk for toilet purposes; musk [perfumery]; deodorant soap; shaving soap; soap for brightening textile; cakes of toilet soap; antiperspirant soap; soap for foot perspiration; soap; almond soap; mint for perfumery; cosmetic kits; emery; gel eye patches for cosmetic purposes; nail art stickers; false nails; eau de Cologne; bases for flower perfumes; joss sticks; pastes for razor strops; dentifrices; pumice stone; lipstick cases; hydrogen peroxide for cosmetic purposes; breath freshening strips; teeth whitening strips; abrasive cloth; glass cloth [abrasive cloth]; lipsticks; pomades for cosmetic purposes; shaving preparations; cosmetic preparations for baths; bath preparations, not for medical purposes; hair straightening preparations; hair waving preparations; laundry soaking preparations; grinding preparations; smoothing preparations [starching]; color-removing preparations; leather bleaching preparations; polishing preparations; denture polishes; mouthwashes, not for medical purposes; cosmetic preparations for slimming purposes; starch glaze for laundry purposes; preparations to make the leaves of plants shiny; refurbishing preparations; eye-washes, not for medical purposes; fabric softeners for laundry use; laundry bleach; dry-cleaning preparations; paint stripping preparations; lacquer-removing preparations; make-up removing preparations; floor wax removers [scouring preparations]; varnish-removing preparations; rust removing preparations; nail care preparations; cleaning preparations; preparations for cleaning dentures; wallpaper cleaning preparations; preparations for unblocking drain pipes; chemical cleaning preparations for household purposes; collagen preparations for cosmetic purposes; bleaching preparations [decolorants] for household purposes; laundry preparations; aloe vera preparations for cosmetic purposes; sunscreen preparations; color-brightening chemicals for household purposes [laundry]; breath freshening preparations for personal hygiene; shining preparations [polish]; make-up powder; diamantine [abrasive]; stain removers; nail varnish removers; vaginal washes for personal sanitary or deodorant purposes; scouring solutions; false eyelashes; baby wipes impregnated with cleaning preparations; tissues impregnated with cosmetic lotions; tissues impregnated with make-up removing preparations; safrol; massage candles for cosmetic purposes; laundry blueing; turpentine for degreasing; potpourris [fragrances]; bleaching soda; washing soda, for cleaning; bath salts, not for medical purposes; bleaching salts; fumigation preparations [perfumes]; preservatives for leather [polishes]; ammonia [volatile alkali] [de-

tergent]; astringents for cosmetic purposes; eyebrow cosmetics; make-up preparations; sun-tanning preparations [cosmetics]; hair dyes; neutralizers for permanent waving; cosmetic preparations for eyelashes; cosmetic preparations for skin care; shoe wax; cosmetics; cosmetics for children; cosmetics for animals; mascara; cleansers for intimate personal hygiene purposes, non medicated; douching preparations for personal sanitary or deodorant purposes [toiletries]; detergents, other than for use in manufacturing operations and for medical purposes; degreasers, other than for use in manufacturing processes; bleaching preparations [decolorants] for cosmetic purposes; antiperspirants [toiletries]; toiletry preparations; phytocosmetic preparations; talcum powder, for toilet use; cotton sticks for cosmetic purposes; terpenes [essential oils]; emery cloth; cloths impregnated with a detergent for cleaning; henna [cosmetic dye]; shampoos for animals [non-medicated grooming preparations]; shampoos for pets [non-medicated grooming preparations]; dry shampoos; shampoos; sandpaper; soda lye; herbal extracts for cosmetic purposes; extracts of flowers [perfumes]; ethereal essences; badian essence; mint essence [essential oil].

(260) AM 2020 106009 A
 (800) 1501399
 (151) 2019 07 10
 (891) 2019 07 10
 (731) LIMITED LIABILITY COMPANY
 "FRANCHISING GROUP"
 street of Pushkin, 87 D, room 3, Volzhsky,
 RU-404109 Volgograd region, Russian
 Federation

(540)



(591) White, yellow and black
 (531) 26.01.01; 26.01.05; 26.01.06; 26.04.05;
 26.04.10; 26.04.18; 26.04.24; 28.05; 29.01.13
 (511)
 37 – Vehicle washing; anti-rust treatment for vehicles; vehicle polishing.

(260) AM 2020 106022 A
 (800) 1501807
 (151) 2019 08 28
 (891) 2019 08 28

(731) Société à responsabilité limitée "Syrovarnya"
Koutouzovsky prospekt, d. 12, str. 1,
RU-121248 Moscou, Russian Federation

(540)



(591) Black, beige

(531) 26.04.03; 26.04.22; 27.05.09; 27.05.22;
29.01.12

(526) Eatery; cheese factory

(511)

43 – Services for providing food and beverages; snack bar services; coffee shop services; cafeteria services; restaurant services; self-service restaurant services; canteen services; bar services; catering services.

(260) AM 2020 106023 A

(800) 1501847

(151) 2019 10 25

(891) 2019 10 25

(731) AFTERSHOKZ, LLC

1801 Burnet Avenue, Suite 102, Syracuse
NY 13206, USA

(540)

Xtrainerz

(591) Black, white

(511)

9 – 3d spectacles; anti-glare glasses; ear plugs for divers; earphones and headphones; electronically encoded identity wristbands; encoded identification bracelets, magnetic; eyeglass cases; eyeglass frames; eyeglasses; gesture recognition software; goggles for sports; hands-free kits for phones; headphones; iris recognition security devices; optical character recognition apparatus; smart glasses; smart watches; wearable activity trackers; diving goggles; motorcycle goggles; safety goggles; snow goggles; swimming goggles.

(260) AM 2020 106031 A

(800) 1502226

(151) 2019 08 16

(891) 2019 08 16

(731) Open Joint Stock Company "Mogilevsky zavod liftovogo mashinostroeniya" "(OJSC "Mogilevliftmash")
Prospekt Mira, 42, 212798 Mogilev,
Belarus

(540)

ALWAYS ON TOP

(591) Black, white

(511)

7 – Winches; grinding machines; elevators [lifts] and parts thereof; hoists; lifts, other than ski-lifts; wood-working machines; sharpening machines; milling machines; elevator operating apparatus, lift operating apparatus; control mechanisms for machines, engines or motors; elevating apparatus; escalators; agricultural winches; cultivators [machines]; motorized cultivators; moving sidewalks (passenger conveyors); moving walkways (passenger conveyors); automatic multi-level car parking systems, mechanical multi-level car parking systems; household and industrial shredders [wood choppers, feed choppers]; motors, electric, other than for land vehicles; tables for machines.

12 – Motors, electric, for land vehicles.

37 – Elevator installation and repair, lift installation and repair.

(260) AM 2020 106131 A

(800) 1503271

(151) 2019 10 24

(891) 2019 10 24

(731) Richter Gedeon Nyrt.

Gyömrői út 19-21, H-1103 Budapest, Hungary

(540)

МЭДИЛИН

(591) Black, white

(531) 28.05

(511)

5 – Pharmaceutical preparations.

(260) AM 2020 106132 A

(800) 1503273

(151) 2019 10 24

(891) 2019 10 24

(731) Richter Gedeon Nyrt.

Gyömrői út 19-21, H-1103 Budapest, Hungary

(540)

АМАБЕЛЛ

(591) Black, white

(531) 28.05

(511)

5 – Pharmaceutical preparations.

(260) AM 2020 106134 A

(800) 1503279

(151) 2019 10 24

(891) 2019 10 24

(731) Richter Gedeon Nyrt.

Gyömrői út 19-21, H-1103 Budapest, Hungary

(540)

МОЛДЭЛИНА

(591) Black, white

(531) 28.05

(511)

5 – Pharmaceutical preparations.

(260) AM 2020 106135 A

(800) 1503280

(151) 2019 10 24

(891) 2019 10 24

(731) Richter Gedeon Nyrt.

Gyömrői út 19-21, H-1103 Budapest, Hungary

(540)

АЛБАРИН

(591) Black, white

(531) 28.05

(511)

5 – Pharmaceutical preparations.

(260) AM 2020 106149 A

(800) 1120963

(151) 2012 05 23

(891) 2019 11 20

(731) UAB "ME investicija"

Račių g. 1, LT-03154 Vilnius, Lithuania

(540)

GIRTEKA

(591) Black, white

(511)

39 – Transport; packaging and storage of goods; travel arrangement.

(260) AM 2020 106199 A

(800) 1503702

(151) 2019 10 24

(891) 2019 10 24

(731) Richter Gedeon Nyrt.

Gyömrői út 19-21, H-1103 Budapest, Hungary

(540)

ДАЛНАВИЛЛА

(591) Black, white

(531) 28.05

(511)

5 – Pharmaceutical preparations.

(260) AM 2020 106201 A

(800) 1503713

(151) 2019 10 24

(891) 2019 10 24

(731) Richter Gedeon Nyrt.

Gyömrői út 19-21, H-1103 Budapest, Hungary

(540)

ВИТУДИН

(591) Black, white

(531) 28.05

(511)

5 – Pharmaceutical preparations.

(260) AM 2020 106220 A

(800) 1504161

(151) 2019 10 15

(891) 2019 10 15

(731) Brauerei Aying Franz Inselkammer KG

Zornedingstr. 1, 85653 Aying, Germany

(540)

CELEBRATOR

(591) Black, white

(511)

32 – Barley wine [beer], especially doppelbock-beer (double bock beer).

(260) AM 2020 106225 A

(800) 1504228

(151) 2019 11 20

(891) 2019 11 20

(731) Shanghai Lichu Biological Technology Co., Ltd.

14F, Building 1, No. 339, Jiuxin Road, Jiuting

Town, Songjiang District, 201600 Shanghai, China

(540)

VIMOKO

(591) Black, white

(531) 27.05.17

(511)

3 – Essential oils; cosmetics; creams for leather; cosmetics for animals; dentifrices; cakes of toilet soap; shampoos; hair conditioners; laundry preparations.

(260) AM 2020 106226 A

(800) 1504229

(151) 2019 10 29

(891) 2019 10 29

(731) Aktsionernoye obshchestvo "Bayan Sulu"

ul. Borodina, d.198, 110006 g. Kostanay,

Kazakhstan

(540)



(591) Black, yellow and white
 (531) 03.07.16; 03.07.24; 26.01.15; 26.04.18;
 29.01.13

(511)
 29 – Marmalade.

30 – Cereal bars; high-protein cereal bars; waffles; cake frosting [icing]; cereal-based snack food; fruit jellies [confectionery]; confectionery for decorating Christmas trees; cakes; pastries; peanut confectionery; almond confectionery; cocoa; caramels [candy]; sweetmeats [candy]; liquorice [confectionery]; peppermint sweets; crackers; candy; macarons [pastry]; marzipan; dessert mousses [confectionery]; chocolate mousses; muesli; cocoa beverages with milk; cocoa-based beverages; chocolate-based beverages; chocolate beverages with milk; stick liquorice [confectionery]; pastilles [confectionery]; cookies; petit-beurre biscuits; fondants [confectionery]; popcorn; pralines; oat-based food; puddings; chewing gum; confectionery; tortillas; halvah; chocolate.

35 – Advertising.

(260) AM 2020 106291 A
 (800) 1497338
 (151) 2019 01 24
 (891) 2019 01 24
 (731) Wells Fargo & Company
 90 South 7th Street, Minneapolis MN 55402,
 USA
 (540)



(591) Black, white
 (531) 02.01.15; 02.01.20; 18.01.01; 18.01.03
 (511)

35 – Arranging and conducting incentive reward programs to promote the sale of banking services; business information services, namely, providing customized company and industry performance analysis in the field of banking, finance, investments and insurance; providing business information in the field of company and industry performance; accounts receivable management services; accounts receivable billing services; administration and reconciliation of accounts on behalf of others; administration of business payroll for others.

36 – Banking services; business banking services; financial services, namely, credit card and debit card services; credit card, debit card and electronic check transaction processing services; issuing stored value cards; investment consultation, investment brokerage and investment management services; financial investment services in the fields of securities, mutual

funds, certificates of deposit, and portfolio management; accounts payable debiting services; mortgage banking services, mortgage lending services, mortgage brokerage services; commercial lending services; consumer lending services; issuing letters of credit; foreign exchange services, namely, foreign exchange transactions, foreign exchange information services and providing for the exchange of foreign currency; financial consultation for educational financial assistance and student loan services; treasury management services; trust management accounts services; cash management services; online banking services; online business banking services; bill payment services; electronic payment, namely, electronic processing and transmission of ACH, electronic check, electronic payment, invoice, bill, tax, and distribution payment data; tax payment processing services; providing information in the field of banking, credit card and debit card services, credit card, debit card and electronic check transaction processing services, financial management, investment brokerage, investment management, financial portfolio management, insurance, accounts payable services, mortgage banking, mortgage lending, mortgage brokerage, commercial lending, consumer lending, issuing letters of credit, foreign exchange services, treasury management services, trust management accounts services, cash management services, online banking, bill payment services, and tax payment processing services; preparation of financial reports for others, namely, provision of consolidated reports and document images of banking and financial activity.

(260) AM 2020 106295 A
 (800) 1497359
 (151) 2019 08 09
 (891) 2019 08 09
 (731) Otkrytoe aktsionernoe obshchestvo
 "Kobrinskiy maslododelno-syrodельny zavod"
 ul. Sovetskaya, d. 128, 225304 Kobrin,
 Brestskaya oblast, Belarus
 (540)

ЧЕРНЫЙ ГРАФ

(591) Black, white
 (511)
 29 – Cheese.

(260) AM 2020 106296 A
 (800) 1497370
 (151) 2019 03 28
 (891) 2019 03 28
 (731) Joint Stock Company "Egorievsk-obuv"
 Vladimirskaya ul., d. 8, Egorievsk,
 RU-140305 Moscovskaya oblast, Russian
 Federation

(540)



(591) Dark blue

(531) 03.01.06; 03.01.16; 03.01.24; 26.13.25; 28.05; 29.01.04

(511)

3 – Polishing stones; petroleum jelly for cosmetic purposes; shoe wax; shoe polish; cobblers' wax; cotton wool for cosmetic purposes; sachets for perfuming linen; toilet water; creams for leather; shoemakers' wax; polishing wax; tailors' wax; make-up; deodorants for pets; deodorants for human beings or for animals; depilatory preparations; perfumery; decorative transfers for cosmetic purposes; cosmetic pencils; adhesives for affixing false eyelashes; adhesives for affixing false hair; quillaia bark for washing; beard dyes; cosmetic dyes; shoe cream; polishing creams; cosmetic creams; skin whitening creams; hair spray; nail polish; hair lotions; lotions for cosmetic purposes; beauty masks; oils for cleaning purposes; oils for cosmetic purposes; oils for toilet purposes; essential oils; cleaning chalk; cleansing milk for toilet purposes; soap; deodorant soap; shaving soap; soap for brightening textile; cakes of toilet soap; antiperspirant soap; soap for foot perspiration; almond soap; cosmetic kits; nail art stickers; dentifrices; lipstick cases; breath freshening strips; teeth whitening strips; lipsticks; pomades for cosmetic purposes; cosmetic preparations for baths; bath preparations, not for medical purposes; leather bleaching preparations; polishing preparations; mouthwashes, not for medical purposes; starch glaze for laundry purposes; refurbishing preparations; laundry bleach; dry-cleaning preparations; paint stripping preparations; lacquer-removing preparations; make-up removing preparations; nail care preparations; cleaning preparations; chemical cleaning preparations for household purposes; collagen preparations for cosmetic purposes; breath freshening preparations for personal hygiene; laundry preparations; bleaching preparations [decolorants] for household purposes; sunscreen preparations; color-brightening chemicals for household purposes [laundry]; shining preparations [polish]; make-up powder; stain removers; scouring solutions; tissues impregnated with cosmetic lotions; tissues impregnated with make-up removing preparations; laundry blueing; potpourris [fragrances]; bleaching soda; washing soda, for cleaning; bath salts, not for medical purposes; bleaching salts; preservatives for leather [polishes]; ammonia [volatile alkali] [detergent]; make-up preparations; sun-tanning preparations [cosmetics]; cosmetic preparations for skin care; cosmetics; cosmetics for children; cosmetics for animals; cleansers for intimate personal hygiene purposes, non medicated; douc-

hing preparations for personal sanitary or deodorant purposes [toiletries]; detergents, other than for use in manufacturing operations and for medical purposes; toiletry preparations; antiperspirants [toiletries]; phyto-cosmetic preparations; talcum powder, for toilet use; cotton sticks for cosmetic purposes; cloths impregnated with a detergent for cleaning; henna [cosmetic dye]; shampoos; shampoos for animals [non-medicated grooming preparations]; shampoos for pets [non-medicated grooming preparations]; dry shampoos.

16 – Fountain pens; aquarelles; albums; almanacs; atlases; posters; table linen of paper; note books; pads [stationery]; pamphlets; booklets; papers for painting and calligraphy; toilet paper; wrapping paper; filter paper; newsletters; modelling wax, not for dental purposes; signboards of paper or cardboard; sewing patterns; bunting of paper; newspapers; modelling clay; polymer modelling clay; drawing sets; writing slates; blackboards; magazines [periodicals]; bookmarkers; periodicals; printed publications; graphic representations; calendars; tracing cloth; tracing paper; tracing patterns; pencils; pencil lead holders; charcoal pencils; pictures; transfers [decalcomanias]; hat boxes of cardboard; cards; index cards [stationery]; catalogues; glue for stationery or household purposes; books; comic books; envelopes [stationery]; boxes of paper or cardboard; printed coupons; self-adhesive tapes for stationery or household purposes; humidity control sheets of paper or plastic for foodstuff packaging; viscose sheets for wrapping; sheets of reclaimed cellulose for wrapping; plastic bubble packs for wrapping or packaging; plastics for modelling; graphic prints; modelling materials; teaching materials [except apparatus]; sealing compounds for stationery purposes; adhesives [glues] for stationery or household purposes; stuffing of paper or cardboard; packaging material made of starches; packing [cushioning, stuffing] materials of paper or cardboard; filtering materials of paper; writing chalk; tailors' chalk; marking chalk; spray chalk; garbage bags of paper or of plastics; bags [envelopes, pouches] of paper or plastics, for packaging; plastic bags for pet waste disposal; bibs of paper; bibs, sleeved, of paper; stickers [stationery]; writing cases [stationery]; sealing wafers; covers [stationery]; plastic cling film, extensible, for palletization; embroidery designs [patterns]; musical greeting cards; greeting cards; postcards; conical paper bags; folders for papers; modelling paste; pen cases; song books; clipboards; handkerchiefs of paper; plastic film for wrapping; mats for beer glasses; stands for pens and pencils; towels of paper; writing materials; school supplies [stationery]; hand labelling appliances; printed matter; prospectuses; tissues of paper for removing make-up; face towels of paper; table napkins of paper; place mats of paper; tablemats of paper; tablecloths of paper; paper-clips; staples for of-

fices; erasing products; writing board erasers; writing or drawing books; stationery; pencil sharpeners, electric or non-electric; stencil plates; manuals [handbooks]; silver paper; molds for modelling clays [artists' materials]; shields [paper seals]; labels of paper or cardboard.

18 – Mountaineering sticks; slings for carrying infants; luggage tags; pocket wallets; credit card cases [wallets]; reins for guiding children; sling bags for carrying infants; chamois leather, other than for cleaning purposes; umbrellas; parasols; saddlery; card cases [notecases]; cases of leather or leatherboard; imitation leather; leather, unworked or semi-worked; leatherboard; hat boxes of leather; boxes of leather or leatherboard; boxes of vulcanized fiber; purses; bags [envelopes, pouches] of leather, for packaging; moleskin [imitation of leather]; travelling sets [leatherware]; vanity cases, not fitted; clothing for pets; covers for animals; collars for animals; hiking sticks; leather leashes; garment bags for travel; shoulder belts [straps] of leather; briefcases; randsels [Japanese school satchels]; haversacks; leather straps; straps of leather [saddlery]; grips for holding shopping bags; umbrella handles; walking stick handles; suitcase handles; rucksacks; travelling bags; net bags for shopping; bags; bags for climbers; handbags; pouch baby carriers; beach bags; compression cubes adapted for luggage; bags for sports; bags for campers; shopping bags; wheeled shopping bags; school satchels; walking sticks; walking stick seats; key cases; suitcases; trunks [luggage]; motorized suitcases; suitcases with wheels; valises; attaché cases; umbrella covers; labels of leather.

25 – Wimples; bandanas [neckerchiefs]; underwear; sweat-absorbent underwear; berets; overalls; boas [necklets]; teddies [underclothing]; boxer shorts; ankle boots; ski boots; boots for sports; breeches for wear; trousers; football boots; brassieres; valenki [felted boots]; collars [clothing]; detachable collars; shirt yokes; veils [clothing]; gabardines [clothing]; galoshes; neckties; ascots; leggings [leg warmers]; gaiters; boot uppers; corselets; jerseys [clothing]; vests; sports jerseys; hosiery; heels; hoods [clothing]; hat frames [skeletons]; pockets for clothing; neck scarfs [mufflers]; kimonos; cap peaks; visors being headwear; tights; slips [underclothing]; wet suits for water-skiing; combinations [clothing]; bodices [lingerie]; corsets [underclothing]; suits; bathing suits; masquerade costumes; beach clothes; leotards; stuff jackets [clothing]; jackets [clothing]; fishing vests; leggings [trousers]; liveries; camisoles; sports singlets; cuffs; short-sleeve shirts; mantillas; coats; sleep masks; furs [clothing]; fingerless gloves; miters [hats]; footmuffs, not electrically heated; muffs [clothing]; heelpieces for footwear; bibs, not of paper; bibs, sleeved, not of paper; fur stoles; hairdressing capes; ear muffs [clothing]; socks; sweat-absorbent socks; footwear; beach shoes; sports shoes;

clothing; paper clothing; outerclothing; ready-made clothing; motorists' clothing; cyclists' clothing; clothing for gymnastics; clothing of imitations of leather; clothing of leather; waterproof clothing; uniforms; fittings of metal for footwear; maniples; overcoats; panties; pelerines; ski gloves; gloves [clothing]; pajamas; bathing trunks; shirt fronts; scarfs; pocket squares; dresses; headbands [clothing]; garters; sock suspenders; stocking suspenders; ready-made linings [parts of clothing]; dress shields; soles for footwear; braces for clothing [suspenders]; half-boots; lace boots; ponchos; girdles; money belts [clothing]; belts [clothing]; layettes [clothing]; non-slipping devices for footwear; heelpieces for stockings; welts for footwear; chasubles; shirts; wooden shoes; sandals; bath sandals; boots; jumper dresses; saris; sarongs; sweaters; footwear uppers; inner soles; albs; bath slippers; togas; knitwear [clothing]; underpants; shoes; gymnastic shoes; slippers; skull caps; turbans; headwear; aprons [clothing]; judo uniforms; karate uniforms; tee-shirts; dressing gowns; bath robes; top hats; tips for footwear; stockings; sweat-absorbent stockings; shawls; paper hats [clothing]; shower caps; bathing caps; sashes for wear; studs for football boots; hats; babies' pants [underwear]; trouser straps; pelisses; esparto shoes or sandals; skirts; petticoats; skorts.

35 – Rental of advertising space; business auditing; computerized file management; demonstration of goods; commercial information and advice for consumers in the choice of products and services; professional business consultancy; organization of exhibitions for commercial or advertising purposes; organization of trade fairs for commercial or advertising purposes; shop window dressing; provision of an online marketplace for buyers and sellers of goods and services; presentation of goods on communication media, for retail purposes; sales promotion for others; wholesale and retail store services featuring goods of non-medicated cosmetics and toiletry preparations, non-medicated dentifrices, perfumery, essential oils, bleaching preparations and other substances for laundry use, cleaning, polishing, scouring and abrasive preparations, paper and cardboard, printed matter, bookbinding material, photographs, stationery and office requisites, except furniture, adhesives for stationery or household purposes, drawing materials and materials for artists, paintbrushes, instructional and teaching materials, plastic sheets, films and bags for wrapping and packaging, printers' type, leather and imitations of leather, animal skins and hides, luggage and carrying bags, umbrellas and parasols, walking sticks, whips, harness and saddlery, collars, leashes and clothing for animals, clothing, footwear, headwear; wholesale and retail online store services of goods of non-medicated cosmetics and toiletry preparations, non-medicated dentifrices, perfumery, essential oils, bleac-

hing preparations and other substances for laundry use, cleaning, polishing, scouring and abrasive preparations, paper and cardboard, printed matter, bookbinding material, photographs, stationery and office requisites, except furniture, adhesives for stationery or household purposes, drawing materials and materials for artists, paintbrushes, instructional and teaching materials, plastic sheets, films and bags for wrapping and packaging, printers' type, leather and imitations of leather, animal skins and hides, luggage and carrying bags, umbrellas and parasols, walking sticks, whips, harness and saddlery, collars, leashes and clothing for animals, clothing, footwear, headwear; promoting and marketing the goods and services of others via the placement and distribution of advertising; publication of publicity texts; dissemination of advertising matter; online advertising on a computer network; commercial administration of the licensing of the goods and services of others; administrative processing of purchase orders; procurement services for others [purchasing goods and services for other businesses]; business efficiency expert services.

40 – Skin dressing; embroidering; tanning; material treatment information; leather staining; fur dyeing; shoe staining; textile dyeing; cloth dyeing; leather working; cloth edging; fabric waterproofing; crease-resistant treatment for clothing; textile treating; wool treating; sewing of clothes and shoes; cloth cutting; quilting; fulling of cloth; dyeing services; custom tailoring; silkscreen printing.

42 – Industrial design; graphic arts design; interior design; material testing; textile testing; research and development of new products for others; technological consultancy; quality control; dress and shoes designing; packaging design; styling [industrial design].

(260) AM 2020 106307 A

(800) 1497527

(151) 2019 08 28

(891) 2019 08 28

(731) GRINDEKS, AS

Krustpils iela 53, LV-1057 Rīga, Latvia

(540)



(591) Orange, light orange, beige, red, yellow, white and black

(531) 02.01.23; 04.05.02; 26.11.12; 27.05.01; 29.01.13

(511)

3 – Cosmetics and cosmetic preparations; cosmetic patches; cosmetic preparations for body care; skin-care cosmetics.

5 – Pharmaceutical preparations; veterinary preparations; sanitary preparations for medical purposes; plasters; disinfectants; anti-inflammatory ointments; ointments for pharmaceutical purposes; medicated skin creams; medicated patches; therapeutic creams [medical]; therapeutic gels [medical]; therapeutic ointments [medical]; medicated gels; medicated ointments; medical dressings; pharmaceutical preparations for veterinary use; pharmaceutical preparations for skin care; pharmaceutical preparations and substances; pharmaceutical preparations for the prevention of inflammatory disorders; chemical preparations for pharmaceutical purposes; pharmaceutical preparations for the prevention of inflammatory diseases; pharmaceutical preparations for treating epidermal problems; pharmaceutical preparations for treating skeletal diseases; pharmaceutical preparations for treating rheumatic diseases; pharmaceutical preparations and substances with anti-inflammatory properties; pharmaceutical preparations and substances with analgesic properties; pharmaceutical preparations for the prevention of diseases of the musculoskeletal system; pharmaceutical preparations for the prevention of disorders of the muscle-skeletal system; body gels for pharmaceutical use; antiseptic ointments; liniments for medical use; greases for veterinary purposes; medicated ointments for application to the skin; medicated ointments for treating dermatological conditions; transdermal patches; adhesive tapes for medical purposes; anti-inflammatory analgesic plasters; heating patches for medical purposes; adhesive skin patches for medical use; pain relieving creams; pharmaceutical creams; antibiotic creams; body creams [medicated]; topical analgesic creams; skin care creams for medical use; therapeutic creams [medical]; body creams for pharmaceutical use; skin care creams for medical use; multi-purpose medicated antibiotic creams; nutritional supplements; medicated toiletry preparations; medical preparations.

10 – Medical and veterinary apparatus and instruments; medical apparatus for introducing pharmaceutical preparations into the human body; medical apparatus for the relief of pain.

(260) AM 2020 106308 A

(800) 1497538

(151) 2019 07 02

(891) 2019 07 02

(731) Alpro, commanditaire vennootschap op

Aandelen

Vlamingstraat 28, B-8560 Wevelgem, Belgium

(540)



(591) Blue and green

(531) 05.03.13; 05.03.14; 27.05.01; 27.05.17;
29.01.12

(511)

29 – Plant-based and nut-based substitutes for dairy products, including but not limited to soy based beverages, soy milk, almond milk; flavored soybean milk; non-dairy creamer; yogurt; cheese; coconut milk for cooking; rice milk; meat, fish, poultry and game; meat extracts; preserved, frozen, dried and cooked fruits and vegetables; jellies, jams, compotes; eggs, milk and milk products; edible oils and fats; dairy product substitutes; meat substitutes; soy-based desserts; nut-based desserts; coconut milk; almond milk; flavored almond milk; oat milk; the aforementioned goods in as far as they are not included in other classes.

30 – Coffee, tea, cocoa, with the exception of chocolate and chocolate goods, sugar, rice, tapioca, sago, artificial coffee; flour and preparations made from cereals, bread, pastry and confectionery, ices; ice cream, honey, treacle; yeast, baking-powder; crackers, pasta (macaroni); snack foods consisting principally of cereal, nuts, rice and grains; snack foods consisting principally of confectionery; salt, mustard; vinegar, sauces (condiments); spices; chocolate flavored desserts; desserts made of flour; vanilla flavored desserts; caramel flavored desserts; coffee flavored desserts; desserts made from plant-based ingredients; nut-based desserts; coffee based beverages; frozen yogurt; the aforementioned goods in as far as they are not included in other classes.

32 – Coconut drinks; almond drinks; flavored almond drinks; oat drinks; rice drinks; hazelnut drinks; smoothies; light beverages, non-alcoholic beverages; mineral and aerated waters and other non-alcoholic drinks; fruit drinks and fruit juices; syrups and other preparations for making beverages; plant-based beverages; nut-based beverages.

(260) AM 2020 106309 A

(800) 1497548

(151) 2019 10 17

(891) 2019 10 17

(731) Yangtze Optical Fibre and Cable Joint Stock Limited Company
No.9 Optics Valley Avenue, East Lake High-Tech Development Zone, Wuhan, Hubei, China

(540)



(591) Black, white

(531) 25.07.08; 27.05.17

(511)

9 – Sensors; optical apparatus and instruments; optical data media; optical fibres [light conducting filaments]; optical communication equipment; materials for electricity mains [wires, cables]; fiber optic cables; network communication equipment; computer peripheral devices; couplers [data processing equipment].

(260) AM 2020 106310 A

(800) 1497588

(151) 2019 08 09

(891) 2019 08 09

(731) BFF KOZMETİK TEMİZLİK PLASTİK ÜRÜNLERİ VE TURİZM SANAYİ TİCARET ANONİM ŞİRKETİ

Tepeören Mahallesi Kimya Sanayicileri, Organize Sanayi Bölgesi B-07 Parsel, Tuzla, İstanbul, Turkey

(540)



(591) Black, white

(531) 07.01.09; 07.01.24; 27.05.02; 27.05.06; 28.03

(511)

3 – Bleaching and cleaning preparations, detergents other than for use in manufacturing operations and for medical purposes, laundry bleach, fabric softeners for laundry use, stain removers, dishwasher detergents, perfumery; non-medicated cosmetics, fragrances, deodorants for personal use and animals, soaps, shower gels, dental care preparations; dentifrices, denture polishes, tooth whitening preparations, mouth washes, not for medical purposes, abrasive preparations; emery cloth; sandpaper; pumice stone; abrasive pastes, polishing preparations for leather, vinyl, metal and wood, polishes and creams for leather, vinyl, metal and wood, wax for polishing.

(260) AM 2020 106311 A

(800) 1497595

(151) 2019 08 14

(891) 2019 08 14

(731) Euro Games Technology Ltd.
4, "Maritsa" Str., "Vranya-Lozen-Triugulnika", BG-1151 Sofia, Bulgaria

(540)



(591) Yellow, red, orange, white, black, blue and brown

(531) 25.07.08; 25.07.17; 27.05.02; 27.05.03

(511)

9 – Software; computer gaming software; computer software packages; computer operating system software; computer software, recorded; software drivers; virtual reality software; games software; entertainment software for computer games; computer programs for network management; operating computer software for mainframe computers; monitors (computer hardware); computer hardware; apparatus for recording images; monitors (computer programs); computer game programs; computer programs for recorded games; apparatus for recording, transmission or reproduction of sound or images; communications servers [computer hardware]; electronic components for gambling machines; computer application software featuring games and gaming; computer software for the administration of on-line games and gaming; computer hardware for games and gaming; electronic components and computer software for gambling, gambling machines, gambling games on the Internet and via telecommunication network.

28 – Gaming machines for gambling; chips for gambling; mah-jong; arcade games; gambling machines operating with coins, notes and cards; games; electronic games; parlor games; gaming chips; gaming tables; slot machines [gaming machines]; LCD game machines; slot machines and gaming devices; coin-operated amusement machines; roulette chips; poker chips; chips and dice [gaming equipment]; equipment for casinos; roulette tables; gaming roulette wheels; casino games; gambling machines and amusement machines, automatic and coin-operated; coin-operated amusement machines and/or electronic coin-operated amusement machines with or without the possibility of gain; boxes for coin-operated machines, slot machines and gaming machines; electronic or electrotechnical amusement machines and apparatus, gaming machines, coin-operated entertainment machines; housings for coin-operated machines, gaming equipment, gaming machines, machines for gambling; electropneumatic and electrical gambling machines (slot machines).

41 – Gambling; services related to gambling; gaming services for entertainment purposes; casino, gaming and gambling services; training in the deve-

lopment of software systems; provision of equipment for gambling halls; providing casino equipment [gambling]; gaming machine entertainment services; providing casino facilities [gambling]; gaming hall services; amusement arcade services; games equipment rental; rental of gaming machines; providing amusement arcade services; rental of gaming machines with images of fruits; editing or recording of sounds and images; sound recording and video entertainment services; hire of sound reproducing apparatus; provision of gaming equipment for casinos; providing of casino facilities; online gambling services; casino, gaming and gambling services; provision of gaming establishments, gaming halls, Internet casinos, online gaming services.

(260) AM 2020 106316 A

(800) 1497692

(151) 2019 10 16

(891) 2019 10 16

(731) Lao Qunquan

Group 4, Miaoqian Village, Mazhu Town,
Yuyao, Ningbo, Zhejiang Province, China

(540)

The logo for 'HAEGER' consists of the brand name in a bold, black, serif font. The letter 'A' is stylized with a horizontal bar through its center.

(591) Black, white

(531) 27.05.17; 27.05.19

(511)

8 – Goffering irons; flat irons; electric steam irons; razors, electric or non-electric; can openers, non-electric; table cutlery [knives, forks and spoons]; beard clippers; nail polishers, electric or non-electric; epilators, electric or non-electric; eyelash curlers.

(260) AM 2020 106324 A

(800) 1497956

(151) 2019 07 16

(891) 2019 07 16

(731) AYAYDIN TEKSTİL İNŞAAT TURİZM
TİCARET SANAYİ LİMİTED ŞİRKETİ
Yenibosna Merkez Mahallesi, Cemal
Ulusoy Caddesi No: 13, Bahçelievler,
İstanbul, Turkey

(540)

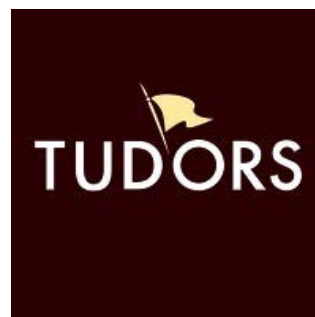

(591) White TUDORS word and a flag in yellow color on a red background

(531) 24.07.01; 24.07.15; 26.04.02; 26.04.24; 27.05.24; 29.01.13

(511)

18 – Unworked or semi-worked leather and animal skins, imitations of leather, stout leather, leather used for linings; goods made of leather, imitations of leather or other materials, designed for carrying items, included in this class; bags, wallets, boxes and trunks made of leather or stout leather; keycases, trunks [luggage], suitcases; umbrellas; parasols; sun umbrellas; walking sticks; whips; harness; saddlery; stirrups; straps of leather (saddlery).

25 – Clothing, including underwear and outer-clothing, other than special purpose protective clothing; socks, mufflers [clothing], shawls, bandanas, scarves, belts [clothing]; footwear, shoes, slippers, sandals; headgear, hats, caps with visors, berets, caps [headwear], skull caps.

(260) AM 2020 106326 A

(800) 1497968

(151) 2019 07 18

(891) 2019 07 18

(731) SILVANOLS, SIA

Kurbada iela 2A, LV-1009 Rīga, Latvia

(540)

silvanols **FARINGOSPRAY**

(591) Black, white

(511)

3 – Cosmetics.

5 – Pharmaceuticals and natural remedies; drugs for medical purposes; medicines for human purposes; herbal preparations for medical use; sprays for medical purposes; mouth sprays for medical use; medicated throat sprays; pharmaceutical preparations for the prevention of inflammatory diseases; pharmaceutical preparations for the prevention of inflammatory disorders; pharmaceutical preparations for the prevention of diseases caused by bacteria; pharmaceutical preparations for the prevention of disorders of the respiratory system; pharmaceutical preparations for the prevention of diseases of the respiratory system; pharmaceutical preparations for the prevention of disorders caused by bacteria; pharmaceutical preparations for the treatment of disorders caused by bacteria; herbal medicine; herbal sprays for medical use; throat lozenges for pharmaceutical and medical purposes; pharmaceutical preparations for immunity adjustment; immunostimulants for pharmaceutical and medical purposes; antibacterial sprays; anti-inflammatory sprays; herbal extracts for medical purposes; breath refreshers for medical purposes; cough

suppressants for pharmaceutical and medical purposes; medicated lozenges; cough tablets; cough pastilles for medical use; herbal throat lozenges for pharmaceutical and medical purposes; dietary supplements for humans; nutraceutical preparations for therapeutic or medical purposes; medicinal oils; vitamin and trace element preparations; vitamins and vitamin preparations; pastilles for pharmaceutical purposes; pharmaceutical sweets; medicated lollipops; medicated drops; medicated mouth freshening lozenges; herbal lozenges for medical purposes; candy, medicated; dietary supplements with a cosmetic effect.

10 – Medical apparatus and instruments; aerosol dispensers for medical purposes; sprayers, hand-operated, for medical use; vaporizers for medical purposes; droppers for medical purposes; apparatus for the alleviation of breathing difficulties.

(260) AM 2020 106329 A

(800) 1498005

(151) 2019 07 23

(891) 2019 07 23

(731) bonprix Handelsgesellschaft mbH

Haldesdorfer Straße 61, 22179 Hamburg, Germany

(540)



(591) Red

(531) 24.17.04; 27.05.01; 27.05.07; 27.05.17; 29.01.01

(511)

35 – Retailing in relation to clothing of all kinds, including footwear and headgear, leather and imitations of leather, bags, household textiles, dishes, cookware and containers, cutlery, cosmetic and toilet utensils, bathroom articles, decorations, articles of porcelain, furniture, lighting articles, lighting, fairy lights, jewellery, clocks, watches, and cosmetics.

(260) AM 2020 106331 A

(800) 1498045

(151) 2019 06 24

(891) 2019 06 24

(731) ABLOY OY

Wahlforssinkatu 20, FI-80100 Joensuu, Finland

(540)

ABLOY

(591) Blue

(531) 27.05.17

(511)

6 – Metal locks and lock boxes; lock cylinders of metal; keys; key blanks; lock bodies; striker plates; handles and fittings (made of metal) for doors and windows; door closers and door openers (non-electric); emergency and panic latches for doors and windows (made of metal); door frames, hinges and handles (made of metal); components and accessories for mentioned goods, all made of metal.

9 – Computer software and applications for locking devices and apparatus, safety, security, protection and signaling devices and apparatus and door opening and closing devices and apparatus; electric and electronic safety, security, protection and signaling devices and apparatus; electric, electronic, electromechanical and magnetic locks and control and decoding apparatus for locks; electric, electronic and electromechanical locking devices and apparatus; electric, electronic and electromechanical lock cylinder devices and apparatus; electric, electronic or optical identification apparatus, card readers and identification equipment and their cards; electronic or magnetic keys; access control cards, key cards, smart cards and their readers; control and monitoring systems, namely access control systems, burglar alarms and video surveillance systems; electric and electronic locking systems and apparatus, gate and door automation systems, access control and time tracking systems, electric and electronic security systems and apparatus.

35 – Wholesale and retail services for locks and lock cases, lock cylinders, keys, key blanks, lock bodies, striker plates, handles and fittings for doors and windows, door closers and door openers, emergency and panic latches for doors and windows, frames, hinges, handles and components and accessories of mentioned goods; wholesale and retail services for key machines and key machine tools, electric door opening apparatus and door closers and their control systems and door actuating apparatus (hydraulic, pneumatic or electronic); wholesale and retail services for computer software and applications for locking devices and apparatus, safety, security, protection and signaling devices and apparatus or door opening and closing devices and apparatus; wholesale and retail services for electric and electronic safety, security, protection and signaling devices and apparatus; wholesale and retail services for electric, electronic, electromechanical and magnetic locks and control and decoding apparatus for locks; wholesale and retail services for electric, electronic and electromechanical locking devices and apparatus and electric, electronic and electromechanical lock cylinder devices

and apparatus; wholesale and retail services for electric, electronic or optical identification apparatus, card readers and identification equipment and their cards; wholesale and retail services for access control cards, key cards, smart cards and their readers; wholesale and retail services for access control systems, burglar alarms and video surveillance systems.

(260) AM 2020 106416 A

(800) 1498435

(151) 2019 05 16

(891) 2019 05 16

(731) Kazan Public Joint Stock Company

"Organichesky sintez"

Belomorskaya str., 101, RU-420051 Kazan,
the Republic of Tatarstan, Russian Federation

(540)

КАЗАНЬОРГСИНТЕЗ

(591) Dark-green

(531) 28.05

(511)

1 – Chemicals used in industry; nitrogen; antistatic preparations, other than for household purposes; antifreeze; argon; acetone; chemicals for the manufacture of paints; getters [chemically active substances]; glycol; glycerine for industrial purposes; detergents for use in manufacturing processes; dispersions of plastics; catalysts; oxygen; acids; plasticizers; plastics, unprocessed; chemical condensation preparations; chemical substances for analyses in laboratories, other than for medical or veterinary purposes; chemical preparations for analyses in laboratories, other than for medical or veterinary purposes; chemical preparations for scientific purposes, other than for medical or veterinary use; benzene derivatives; solvents for varnishes; chemical reagents, other than for medical or veterinary purposes; synthetic resins, unprocessed; alcohol [organic compounds]; sulfates; carbon; industrial chemicals; chlorides; emulsifiers; ethers; esters.

17 – Insulating materials; padding materials of rubber or plastics; stuffing of rubber or plastics; packing [cushioning, stuffing] materials of rubber or plastics; plastic substances, semi-processed; plastic sheeting for agricultural purposes; plastic film, other than for wrapping; synthetic resins, semi-processed; artificial resins, semi-processed; junctions, not of metal, for pipes; flexible hoses, not of metal.

19 – Branching pipes, not of metal; penstock pipes, not of metal; water-pipes, not of metal; gutter pipes, not of metal; drain pipes, not of metal; rigid pipes, not of metal, for building.

20 – Packaging containers of plastic; containers, not of metal [storage, transport].

- (260) AM 2020 106422 A
 (800) 1498455
 (151) 2019 08 20
 (891) 2019 08 20
 (731) Open-Type Joint Stock Company "ROT FRONT"
 2-oy Novokuznetskiy pereulok, d. 13/15,
 RU-115184 Moscow, Russian Federation
 (540)

ECO-BOTANICA SMOOTHIE

- (591) Black, white
 (511)
 30 – Waffles with smoothie or smoothie taste or smoothie flavor; fruit jellies [confectionery] with smoothie or smoothie taste or smoothie flavor; pastries with smoothie or smoothie taste or smoothie flavor; caramels [candy] with smoothie or smoothie taste or smoothie flavor; sweetmeats [candy] with smoothie or smoothie taste or smoothie flavor; dessert mousses [confectionery] with smoothie or smoothie taste or smoothie flavor; muesli with smoothie or smoothie taste or smoothie flavor; biscuits with smoothie or smoothie taste or smoothie flavor; gingerbread with smoothie or smoothie taste or smoothie flavor; chips [cereal products] with smoothie or smoothie taste or smoothie flavor; chocolate with smoothie or smoothie taste or smoothie flavor.

- (260) AM 2020 106423 A
 (800) 1498489
 (151) 2019 08 14
 (891) 2019 08 14
 (731) MOL Petrolkémia Zártkörűen Működő
 Részvénytársaság
 TVK Központi Irodaház, 2119 hrsz. 136 sz.
 épület, TVK Ipartelep, H-3581 Tiszaújváros,
 Hungary
 (540)

TIPPLEN

- (591) Black, white
 (511)
 1 – Chemical products for use in industry, unprocessed plastics (in the form of powder, liquids, pastes and granules); adhesives for industrial use.
 17 – Sheets, plates, bars, pipes, profile forms (semi-processed products) caulking and insulating materials, of plastics.
 20 – Containers and barrels of plastics.
 21 – Utensils for household purposes, portable containers, cans, combs, sponges.

- (260) AM 2020 106549 A
 (800) 1508168
 (151) 2019 12 09
 (891) 2019 12 09
 (731) International Fruit Genetics, LLC
 8224 Espresso Drive, Suite 200, Bakersfield
 CA 93312, USA
 (540)

SWEET CELEBRATION

- (591) Black, white
 (511)
 31 – Fresh fruits and vegetables; grape vines, plants and plant propagating material.

- (260) AM 2020 106550 A
 (800) 1508193
 (151) 2019 10 23
 (891) 2019 10 23
 (731) SHANGHAI TOBACCO GROUP CO., LTD.
 717 CHANG YANG ROAD, YANGPU
 DISTRICT, 200082 SHANGHAI, China
 (540)



- (591) Black, white
 (531) 03.03.17
 (511)
 34 – Liquid solutions for use in electronic cigarettes; electronic cigarettes; cigarette paper; tobacco; chewing tobacco; cigarettes; tobacco pipes; ashtrays for smokers; tobacco jars; cigars; cigarettes containing tobacco substitutes, not for medical purposes; matches; lighters for smokers.

- (260) AM 2020 106713 A
 (800) 1509887
 (151) 2019 11 26
 (891) 2019 11 26
 (731) "Unipharm-Ukraine", LLC
 Moskovskiyi prospect 9-V, Kyiv 04073,
 Ukraine
 (540)

ELANUM

- (591) Black, white
 (511)
 3 – Non-medicated cosmetics and toiletry preparations; non-medicated dentifrices; perfumery, essential

oils; bleaching preparations and other substances for laundry use; cleaning, polishing, scouring and abrasive preparations.

5 – Preparations for destroying vermin; herbicides.

10 – Surgical, medical, dental and veterinary apparatus and instruments; artificial limbs, eyes and teeth; orthopaedic articles; suture materials; therapeutic and assistive devices adapted for the disabled; massage apparatus; apparatus, devices and articles for nursing infants; sexual activity apparatus, devices and articles.

31 – Raw and unprocessed agricultural, aquacultural, horticultural and forestry products; raw and unprocessed grains and seeds; fresh fruits and vegetables, fresh herbs; natural plants and flowers; bulbs, seedlings and seeds for planting; live animals; foodstuffs and beverages for animals; malt.

32 – Beers; non-alcoholic beverages; mineral and aerated waters; fruit beverages and fruit juices; syrups and other non-alcoholic preparations for making beverages.

(260) AM 2020 106715 A

(800) 1509901

(151) 2019 12 04

(891) 2019 12 04

(731) SEAT, S.A.

Autovia A-2 km.585, E-08760 Martorell
(Barcelona), Spain

(540)

SEAT:CODE

(591) Black, white

(531) 24.17.01; 24.17.02; 27.05.12

(511)

9 – Software.

42 – Development of software.

(260) AM 2020 106717 A

(800) 1509961

(151) 2019 11 28

(891) 2019 11 28

(731) Henkel AG & Co. KgaA

Henkelstr. 67, 40589 Düsseldorf, Germany

(540)

ZOTOS

(591) Black, white

(511)

3 – Hair care preparations; hair styling preparations.

(260) AM 2020 106719 A

(800) 1509976

(151) 2019 11 19

(891) 2019 11 19

(731) KIA MOTORS CORPORATION

12, Heolleung-ro, Seocho-gu, Seoul,
Republic of Korea

(540)

KIA K2

(591) Black, white

(511)

12 – Automobiles; sports cars; vans [vehicles]; trucks; motor buses; electric vehicles.

(260) AM 2020 106720 A

(800) 1509987

(151) 2019 10 24

(891) 2019 10 24

(731) Richter Gedeon Nyrt.

Gyömrői út 19-21, H-1103 Budapest, Hungary

(540)

POZABEL

(591) Black, white

(531) 28.05

(511)

5 – Pharmaceutical preparations.

(260) AM 2020 106721 A

(800) 1509999

(151) 2019 12 11

(891) 2019 12 11

(731) Bora Creations S.L.

11, Calle Velázquez (Pto. de Andratx),
E-07157 Andratx, Balearn, Spain

(540)

HELLO, GOOD STUFF

(591) Black, white

(511)

3 – Cosmetics; decorative cosmetics.

(260) AM 2020 106722 A

(800) 1510021

(151) 2019 11 19

(891) 2019 11 19

(731) KIA MOTORS CORPORATION

12, Heolleung-ro, Seocho-gu, Seoul,
Republic of Korea

(540)

KIA K1

(591) Black, white

(511)

12 – Automobiles; sports cars; vans [vehicles]; trucks; motor buses; electric vehicles.

(260) AM 2020 106741 A
 (800) 775729
 (151) 2002 02 06
 (891) 2019 12 06
 (731) UAB "VIČIŪNŲ GRUPĖ"
 V. Krėvės pr.97, LT-50369 Kaunas, Lithuania
 (540)



(591) Red and blue
 (531) 03.07.16; 03.07.17; 25.03.01; 27.05.01;
 29.01.01; 29.01.04
 (511)
 29 – Foods prepared from fish; fish, preserved; fish
 (not live); fish, tinned; salted fish; fish filets.

(260) AM 2020 106852 A
 (800) 1510639
 (151) 2019 11 26
 (891) 2019 11 26
 (731) Richter Gedeon Nyrt.
 Gyömrői út 19-21, H-1103 Budapest, Hungary
 (540)

DALNAVILLA

(591) Black, white
 (511)
 5 – Pharmaceutical preparations.

(260) AM 2020 106910 A
 (800) 1511782
 (151) 2019 11 07
 (891) 2019 11 07
 (731) Samsung Electronics Co., Ltd.
 129, Samsung-ro, Yeongtong-gu, Suwon-si,
 Gyeonggi-do, Republic of Korea
 (540)

DEX

(591) Black, white
 (511)
 9 – Downloadable software; computer application
 software; computer operating system software; com-
 puter operating software; computer software for syn-
 chronizing data between hand-held or portable com-
 puters and host computers; computer software for
 communicating with users of hand-held computers;
 data synchronization programs; computer software
 for use in computer access control; computer soft-
 ware for communicating purposes between micro-

computers; computer software for wireless network
 communications; software with the ability to show
 the screen of a mobile phone to a computer monitor;
 computer hardware and computer peripheral devi-
 ces; mirroring device for mobile phones to show the
 screen of a mobile phone on a computer monitor;
 computer application software for mobile phones to
 display the screen of a mobile phone on a computer
 monitor; adapter for mobile phones to show the scre-
 en of a mobile phone on the computer monitor.

42 – Development of computer software for data
 processing; computer software development; deve-
 lopment of operating system software; data conver-
 sion of computer program data or information (not
 physical conversion); design and development of
 programs for computers; conversion of data or do-
 cuments from physical to electronic media.

(260) AM 2020 106911 A
 (800) 1511805
 (151) 2019 12 06
 (891) 2019 12 06
 (731) DOĞAL KİMYEVİ MADDELER VE ZİRAİ
 İLAÇLAR SANAYİ VE TİCARET ANONİM
 ŞİRKETİ
 Toplarönü Sk. No:16 Anadoluhisarı, Beykoz,
 TR-34810 İstanbul, Turkey
 (540)

RODER

(591) Black, white
 (531) 27.05.17
 (511)
 5 – Substances for destroying weeds, vermin and
 fungus, fungicides (fungus killers), herbicides, ver-
 min catching, killing or repelling substances, animal
 bath substances (for parasite killing), anti-mold pro-
 ducts, anti-moth preparations, rat poison.

(260) AM 2020 106912 A
 (800) 1511819
 (151) 2019 11 05
 (891) 2019 11 05
 (731) Shenzhen Insighters Medical Technology Co.,
 Ltd.
 13/F, Hengtemei Bldg., No. 3 Ganli Rd., Buji
 St., Longgang Dist., Shenzhen, 518000
 Guangdong, China
 (540)

insighters

(591) Black, white

(531) 26.01.05; 27.05.07

(511)

10 – Apparatus for artificial respiration; endoscopy cameras for medical purposes; medical instruments for percutaneous tracheostomy; flexible medical endoscopes; catheters; cannulae; surgical apparatus and instruments; anaesthetic apparatus; gastroscopes; medical apparatus and instruments.

(260) AM 2020 106917 A

(800) 706192

(151) 1998 11 23

(891) 2020 01 16

(731) Vasco Group NV

Kruishoefstraat 50, B-3650 Dilsen,
Belgium

(540)

BRUGMAN

(591) Black, white

(531) 27.05.01; 27.05.17

(511)

6 – Hardware of metal; safes; goods of common metal not included in other classes.

9 – Thermostats; timer switches for heating installations and air-conditioning installations.

11 – Radiators; air-conditioning installations and their parts.

(260) AM 2020 106918 A

(800) 856324

(151) 2004 03 17

(891) 2020 01 09

(731) ECOVIS Europe AG

Ernst-Reuter-Platz 10, 10587 Berlin,
Germany

(540)

ecovis

(591) Black, white

(511)

35 – Advertising; business management; business administration; office functions; accountancy; book-keeping, auditing; internal and external auditing and accounting, business research, provision of commercial and business information, costs analysis and consultancy in relation thereto; consultancy and assistance in business management; secretarial consultancy services, corporate profitability services and marketing personnel management, testing and recruitment consultancy, assistance in the issue of notice of termination to executive personnel (outplacement); consultancy in respect of mergers, acquisitions and franchising; tax preparations; management consultancy, including business management, corpo-

rate planning and development, business project consultancy, corporate risk management, process management, corporate consultation in relation to company sales and acquisitions, taking up of capital for companies and the investigation of companies; accountancy for the purpose of providing attestation, including establishment and research in respect of fraud; organization of office functions; market research and market surveys; all the foregoing services, as far as included in this class.

36 – Consultancy in respect of business liquidations; tax research; corporate financing; consultation in cases of business insolvency; financial risk management information; insolvency administration; insurance; financial affairs; monetary affairs; real estate affairs; consultation in respect of credit and debit note supervision, investments, subsidies and financing of loans; pension services; tax consultation; management and administration of real estate and property; financing of real estate and of property developments; customs clearance; insurance services; financial services; consultation in respect of financial matters and taxation; corporate financing, including consultation in respect of finance matters, financial assessment and financial consultation; services of an actuary; financial risk management; debt collecting agencies; fiscal assessments and estimations; monetary affairs; all the foregoing services, as far as included in this class.

41 – Education; providing of training; entertainment; sporting and cultural activities; formation and training in respect of tax accounting, balance sheet preparation, tax consultation, individual aspects of attorney activity and legal consultation as well as in respect of business management, financial and management matters; publication of texts in respect of tax accounting, balance sheet matters, tax consultation, individual aspects of attorney activity and legal consultation as well as in respect of business, financial, and management matters; organization of conferences, seminars, symposia and meetings in respect of business, financial, and management matters; translation of formal contracts, legal certifications and legal documents (as far as included in this class).

42 – Scientific and technological services and research and design relating thereto; industrial analysis and research services; design and development of computer hardware and software (with the exception of the field of telecommunication); legal services; consultation in the sectors of information technology, expert assessments; services in relation to legal matters, including consultation, representation of interests, legal disputes, and the handling of legal formalities; consultation in questions of taxation law; drafting of formal contracts, legal certifications and

legal documents; the foregoing services, as far as included in this class.

(260) AM 2020 106919 A

(800) 865125

(151) 2005 08 10

(891) 2019 12 12

(731) ALUCOIL, S.A.

Poligono Industrial Bayas -, c/Ircio, parcelas
R72-R77, E-09200 MIRANDA DE EBRO
(Burgos), Spain

(540)

LARCORE

(591) Black, white

(531) 27.05.17

(511)

6 – Composite panels of stainless steel; metal facades, metal roofs and metal partitions.

INTERNATIONAL TRADEMARKS PROTECTED IN GEORGIA

(260) AM 2020 100564 A
(800) 1435874
(151) 2018 08 09
(181) 2028 08 09
(891) 2018 08 09
(511) 03, 06, 08, 11, 20, 21, 29, 30, 37, 42, 43

(260) AM 2020 103387 A
(800) 1469048
(151) 2018 11 16
(181) 2028 11 16
(891) 2018 11 16
(511) 06

(260) AM 2020 100948 A
(800) 1438620
(151) 2018 08 24
(181) 2028 08 24
(891) 2018 08 24
(511) 09, 28

(260) AM 2020 103396 A
(800) 1469104
(151) 2019 02 05
(181) 2029 02 05
(891) 2019 02 05
(511) 12, 16, 21, 35, 37, 38, 39, 41, 45

(260) AM 2020 100949 A
(800) 1438623
(151) 2018 08 24
(181) 2028 08 24
(891) 2018 08 24
(511) 09, 28

(260) AM 2020 103708 A
(800) 1472615
(151) 2019 04 10
(181) 2029 04 10
(891) 2019 04 10
(511) 03

(260) AM 2020 100950 A
(800) 1438636
(151) 2018 08 24
(181) 2028 08 24
(891) 2018 08 24
(511) 09, 28

(260) AM 2020 103730 A
(800) 1473256
(151) 2019 02 11
(181) 2029 02 11
(891) 2019 02 11
(511) 29, 30

(260) AM 2020 103075 A
(800) 1465926
(151) 2018 12 19
(181) 2028 12 19
(891) 2018 12 19
(511) 11

(260) AM 2020 103924 A
(800) 1475635
(151) 2019 05 06
(181) 2029 05 06
(891) 2019 05 06
(511) 05

(260) AM 2020 103168 A
(800) 683939
(151) 1997 07 09
(181) 2027 07 09
(891) 2019 04 12
(511) 07, 08, 09, 25, 36, 37, 42

(260) AM 2020 104011 A
(800) 1476233
(151) 2019 02 01
(181) 2029 02 01
(891) 2019 02 01
(511) 32

(260) AM 2020 103235 A
(800) 1467502
(151) 2019 02 25
(181) 2029 02 25
(891) 2019 02 25
(511) 14, 18, 24, 25

(260) AM 2020 104030 A
(800) 1476733
(151) 2019 05 16
(181) 2029 05 16
(891) 2019 05 16
(511) 30

(260) AM 2020 104032 A
(800) 1476832
(151) 2018 11 16
(181) 2028 11 16
(891) 2018 11 16
(511) 30

(260) AM 2020 104152 A
(800) 1477823
(151) 2019 05 07
(181) 2029 05 07
(891) 2019 05 07
(511) 03

(260) AM 2020 104154 A
(800) 1477868
(151) 2019 05 08
(181) 2029 05 08
(891) 2019 05 08
(511) 03, 04

(260) AM 2020 104224 A
(800) 1478292
(151) 2019 04 25
(181) 2029 04 25
(891) 2019 04 25
(511) 07

(260) AM 2020 104226 A
(800) 1478319
(151) 2019 01 17
(181) 2029 01 17
(891) 2019 01 17
(511) 30, 43

(260) AM 2020 104238 A
(800) 1478528
(151) 2019 05 28
(181) 2029 05 28
(891) 2019 05 28
(511) 09

(260) AM 2020 104262 A
(800) 1479161
(151) 2019 05 13
(181) 2029 05 13
(891) 2019 05 13
(511) 04

(260) AM 2020 104263 A
(800) 1479165
(151) 2019 05 08
(181) 2029 05 08

(891) 2019 05 08
(511) 03, 04

(260) AM 2020 104265 A
(800) 1479168
(151) 2019 05 08
(181) 2029 05 08
(891) 2019 05 08
(511) 03, 04

(260) AM 2020 104267 A
(800) 1479177
(151) 2019 04 18
(181) 2029 04 18
(891) 2019 04 18
(511) 34

(260) AM 2020 104278 A
(800) 1479303
(151) 2019 06 21
(181) 2029 06 21
(891) 2019 06 21
(511) 04

(260) AM 2020 104282 A
(800) 1479352
(151) 2019 06 07
(181) 2029 06 07
(891) 2019 06 07
(511) 03

(260) AM 2020 104283 A
(800) 1479391
(151) 2019 05 16
(181) 2029 05 16
(891) 2019 05 16
(511) 32

(260) AM 2020 104284 A
(800) 1479407
(151) 2019 05 31
(181) 2029 05 31
(891) 2019 05 31
(511) 33

(260) AM 2020 104285 A
(800) 1479417
(151) 2019 05 22
(181) 2029 05 22
(891) 2019 05 22
(511) 18

(260) AM 2020 104286 A
(800) 1479424
(151) 2019 05 22
(181) 2029 05 22
(891) 2019 05 22
(511) 18

(260) AM 2020 104300 A
(800) 1416064
(151) 2018 04 23
(181) 2028 04 23
(891) 2019 07 09
(511) 42, 44

(260) AM 2020 104335 A
(800) 1479668
(151) 2019 06 20
(181) 2029 06 20
(891) 2019 06 20
(511) 34

(260) AM 2020 104338 A
(800) 1479739
(151) 2019 06 19
(181) 2029 06 19
(891) 2019 06 19
(511) 09

(260) AM 2020 104345 A
(800) 1479809
(151) 2019 05 08
(181) 2029 05 08
(891) 2019 05 08
(511) 03, 04

(260) AM 2020 104349 A
(800) 1479909
(151) 2019 07 01
(181) 2029 07 01
(891) 2019 07 01
(511) 05, 32

(260) AM 2020 104367 A
(800) 1480222
(151) 2019 06 03
(181) 2029 06 03
(891) 2019 06 03
(511) 34

(260) AM 2020 104368 A
(800) 1480228
(151) 2019 02 06
(181) 2029 02 06

(891) 2019 02 06
(511) 05

(260) AM 2020 104369 A
(800) 1480239
(151) 2019 04 19
(181) 2029 04 19
(891) 2019 04 19
(511) 05

(260) AM 2020 104375 A
(800) 1480367
(151) 2019 05 28
(181) 2029 05 28
(891) 2019 05 28
(511) 05, 12, 16, 18, 21, 28, 29, 30, 35, 36, 37, 38,
39, 41, 43, 45

(260) AM 2020 104376 A
(800) 1480394
(151) 2018 12 03
(181) 2028 12 03
(891) 2018 12 03
(511) 36

(260) AM 2020 104377 A
(800) 1480402
(151) 2019 05 16
(181) 2029 05 16
(891) 2019 05 16
(511) 32

(260) AM 2020 104378 A
(800) 1480413
(151) 2019 05 22
(181) 2029 05 22
(891) 2019 05 22
(511) 35

(260) AM 2020 104380 A
(800) 1480446
(151) 2019 05 24
(181) 2029 05 24
(891) 2019 05 24
(511) 05

(260) AM 2020 104381 A
(800) 1480457
(151) 2019 05 16
(181) 2029 05 16
(891) 2019 05 16
(511) 32, 33

(260) AM 2020 104383 A
(800) 1480472
(151) 2019 06 13
(181) 2029 06 13
(891) 2019 06 13
(511) 10, 44

(260) AM 2020 104385 A
(800) 1480508
(151) 2019 06 07
(181) 2029 06 07
(891) 2019 06 07
(511) 03

(260) AM 2020 104386 A
(800) 1480575
(151) 2019 03 11
(181) 2029 03 11
(891) 2019 03 11
(511) 03, 04, 06, 08, 16, 21

(260) AM 2020 104387 A
(800) 1480591
(151) 2019 06 13
(181) 2029 06 13
(891) 2019 06 13
(511) 41

(260) AM 2020 104388 A
(800) 1480621
(151) 2019 04 05
(181) 2029 04 05
(891) 2019 04 05
(511) 09, 35, 44

(260) AM 2020 104389 A
(800) 1480623
(151) 2019 06 12
(181) 2029 06 12
(891) 2019 06 12
(511) 35

(260) AM 2020 104462 A
(800) 1480792
(151) 2019 06 26
(181) 2029 06 26
(891) 2019 06 26
(511) 09, 10, 41, 44

(260) AM 2020 104469 A
(800) 1480889
(151) 2019 06 17
(181) 2029 06 17

(891) 2019 06 17
(511) 34

(260) AM 2020 104472 A
(800) 1480939
(151) 2019 03 14
(181) 2029 03 14
(891) 2019 03 14
(511) 09, 42

(260) AM 2020 104474 A
(800) 1480947
(151) 2019 05 24
(181) 2029 05 24
(891) 2019 05 24
(511) 05

(260) AM 2020 104475 A
(800) 1480950
(151) 2019 05 09
(181) 2029 05 09
(891) 2019 05 09
(511) 08, 14, 16, 24

(260) AM 2020 104476 A
(800) 1480951
(151) 2019 07 09
(181) 2029 07 09
(891) 2019 07 09
(511) 09, 42

(260) AM 2020 104477 A
(800) 1480952
(151) 2019 07 09
(181) 2029 07 09
(891) 2019 07 09
(511) 09, 42

(260) AM 2020 104484 A
(800) 1481118
(151) 2019 07 09
(181) 2029 07 09
(891) 2019 07 09
(511) 33

(260) AM 2020 104486 A
(800) 1481172
(151) 2019 06 26
(181) 2029 06 26
(891) 2019 06 26
(511) 03

(260) AM 2020 104495 A
 (800) 1481363
 (151) 2019 05 08
 (181) 2029 05 08
 (891) 2019 05 08
 (511) 03, 04

(260) AM 2020 104515 A
 (800) 1481944
 (151) 2019 01 16
 (181) 2029 01 16
 (891) 2019 01 16
 (511) 37

(260) AM 2020 104516 A
 (800) 1481996
 (151) 2019 06 04
 (181) 2029 06 04
 (891) 2019 06 04
 (511) 20, 35

(260) AM 2020 104517 A
 (800) 1482006
 (151) 2019 06 12
 (181) 2029 06 12
 (891) 2019 06 12
 (511) 35

(260) AM 2020 104518 A
 (800) 1482020
 (151) 2019 07 11
 (181) 2029 07 11
 (891) 2019 07 11
 (511) 06, 09

(260) AM 2020 104600 A
 (800) 1482893
 (151) 2019 07 03
 (181) 2029 07 03
 (891) 2019 07 03
 (511) 09

(260) AM 2020 104627 A
 (800) 1483701
 (151) 2019 04 19
 (181) 2029 04 19
 (891) 2019 04 19
 (511) 09, 28, 41

(260) AM 2020 104667 A
 (800) 1037209
 (151) 2009 08 05
 (181) 2029 08 05

(891) 2019 08 06
 (511) 29, 30, 32

(260) AM 2020 104717 A
 (800) 1485151
 (151) 2019 04 16
 (181) 2029 04 16
 (891) 2019 04 16
 (511) 01

(260) AM 2020 104789 A
 (800) 1485927
 (151) 2019 06 26
 (181) 2029 06 26
 (891) 2019 06 26
 (511) 09, 28

(260) AM 2020 105109 A
 (800) 728896
 (151) 2000 02 24
 (181) 2030 02 24
 (891) 2019 08 05
 (511) 03

(260) AM 2020 105192 A
 (800) 1490410
 (151) 2019 03 22
 (181) 2029 03 22
 (891) 2019 03 22
 (511) 05, 10, 12, 16, 20, 25, 27, 28, 35

(260) AM 2020 105283 A
 (800) 1491303
 (151) 2019 08 20
 (181) 2029 08 20
 (891) 2019 08 20
 (511) 42

(260) AM 2020 105285 A
 (800) 1491349
 (151) 2019 07 08
 (181) 2029 07 08
 (891) 2019 07 08
 (511) 26, 28

(260) AM 2020 105424 A
 (800) 1088821
 (151) 2011 07 11
 (181) 2021 07 11
 (891) 2019 09 04
 (511) 30

(260) AM 2020 105467 A
(800) 1493537
(151) 2019 07 03
(181) 2029 07 03
(891) 2019 07 03
(511) 33

(260) AM 2020 105469 A
(800) 1493591
(151) 2019 04 26
(181) 2029 04 26
(891) 2019 04 26
(511) 42

(260) AM 2020 105607 A
(800) 1495816
(151) 2019 07 15
(181) 2029 07 15
(891) 2019 07 15
(511) 09

APPELLATIONS OF ORIGIN OF GOODS

AMENDMENTS ON WINE PRODUCTION SPECIFICATIONS

PROTECTED APPELLATIONS OF ORIGIN:

Mukuzani (Reg. №2; Date 30.08.2005); Tsinandali (Reg. №3; Date 30.08.2005); Akhasheni (reg. №4; date 30.08.2005) and Teliani (reg. №791; date 10.12.2007).

On the basis of Orders №№9024/06; 9026/06; 9028/06; 9030/06 of 9.09.2020 of the Head of the Department of Trademarks, Geographical Indications and Designs of the LEPL National Intellectual Property Center of Georgia – Sakpatenti the amendments were made to the production specifications of wines of appellations of origin registered at the National Intellectual Property Center of Georgia – Sakpatenti: "Mukuzani", "Tsinandali", "Akhasheni" and "Teliani".

In accordance with the Law of Georgia "On Appellations of Origin of Goods and Geographical Indications", the above-mentioned information shall be published in the Official Bulletin of Industrial Property of the LEPL National Intellectual Property Center of Georgia – Sakpatenti, in one central and one local newspaper.

Notes and additional information, submitted to Sakpatenti within 3 months after publication of the materials, shall be sent for study to the Ministry of Environmental Protection and Agriculture of Georgia. If no information is received by Sakpatenti concerning these materials within 3 months, the published data shall be reflected in the State Register of Appellations of Origin and Geographical Indications.

MUKUZANI

REGISTRATION № 2

DATE OF REGISTRATION: 2005 30 08

APPELLATION OF ORIGIN: MUKUZANI

NAME OF GOOD FOR WHICH THE APPELLATION OF ORIGIN IS REQUIRED: Wine

NAME AND ADDRESS OF APPLICANT: LEPL NATIONAL WINE AGENCY, Marshal Gelovani Ave. 6, 0159, Tbilisi, Georgia (GE)

E-mail: info.georgianwine@georgianwine.gov.ge

1. APPELLATION OF ORIGIN: MUKUZANI

2. PRODUCT DESCRIPTION

2.1. PRODUCT CATEGORY

Wine "Mukuzani" red sec (dry)

2.2. PRODUCT ORGANOLEPTIC CHARACTERISTICS

Wine "Mukuzani" red sec (dry) shall satisfy the following requirements:

- Color – dark garnet (dark red);
- Aroma and taste – perfect, full, extracted, velvet, harmonic, having aroma characterizing the location;
- Intensively expressed bouquet of fruit tones is developed with aging.

2.3. PRODUCT PHYSICO-CHEMICAL CHARACTERISTICS

Wine "Mukuzani" red sec (dry) shall satisfy the following requirements:

- Factual volumetric spirit content – no less than 11 %;
- Total volumetric spirit content – no more than 15 %;
- Sugar content – no more than 4 g/l;
- Titrated acidity calculated on tartar acid – no less than 5 g/l;
- Volatile acidity calculated on acetic acid – no more than 1,2 g/l;
- Sulfur dioxide total mass concentration – no more than 150 mg/l;
- Concentration of sugar free extract mass – no less than 22 g/l.

3. GEOGRAPHICAL AREA AND ZONES OF PRODUCTION

Wine "Mukuzani" micro-zone is located in Inner Kakheti, on the right bank of the River Alazani.

The micro-zone Mukuzani includes Tsiv-Gombori Range slopes continuation until the River Alazani. Tsiv-Gombori Range borders it from the South-West, River Alazani – from the North-East, Akuriskhevi (Akuri Gorge) – from the North-West, and the border begins from Tananaskhevi (Tanana Gorge) mouth from the South-East, it is continued along this gorge towards the South-West until so called "Complex", then – along the way until Alazani Canall (until Kotekhi Bridge) and after the canal – until Khao Cellar. After that, the border is continued along a highway towards the North-West until Vedzirulaskhevi (Vedzirula Gorge), at first towards the West and then – the South-West direction and runs up to Gurjaani-Telavi highway. The border is continued from the highway on Javakhishvili Street until Tsiv-Gombori Range slopes, and then – until Chermiskhevi (Cherami Gorge) in the North-West direction.

The micro-zone includes the territories of following villages: Chumlaki, Akhasheni, Zegaani, Mukuzani, Velistsikhe, Vazisubani, Shashiani, Kalaura, Vachnadziani and Kakhpari.

The grapes intended for wine "Mukuzani" production shall be harvested only from the vineyards cultivated in the micro-zone Mukuzani.

Grape proceeding and winemaking takes place in the territory of the micro-zone Mukuzani, and outside, as well, but within Kakheti viticulture area. (mqonda da irinastan amovarda esec).

4. VINE VARIETIES

Wine "Mukuzani" shall be prepared only from the grapes of Saperavi, usage of other varieties is prohibited at the winemaking.

5. VITICULTURE PRACTICE

- The micro-zone Mukuzani, wine "Mukuzani" vineyards are situated on 350-700 m above sea level;
- Distance between the rows in the vineyards – 1-3 m;
- Distance between the vines in the row – 0,8-1,5 m;
- Height of stem – 60-90 cm;
- Shape of pruning – one-sided or Georgian two-sided or free.

6. GRAPE MATURITY, VINTAGE, TRANSPORTATION

- Wine "Mukuzani" shall be produced only with ripe grapes. Sugar content shall be no less than 19%, at the vintage.
- Grapes transportation is permitted only with wooden or plastic boxes, with bodyworks made of stainless steel or painted with a special dye.
- Usage of polyethylene packages and/or bags is not permitted.

7. VINTAGE AND WINEMAKING

Vintage on 1 ha vineyard shall be no more than 10 tons.

Wine production shall be no more than 650 liters from 1 ton grapes.

8. WINEMAKING PRACTICE

Wine "Mukuzani" is made by complete alcoholic fermentation of must.

Grapes shall be pressed and the stems – removed. The temperature for alcoholic fermentation shall not exceed 30°C. After completion of alcoholic fermentation, apple-lactic acid fermentation takes place, and at the end the sulphitation is carried out.

Wine "Mukuzani" may be aged or it may be bottled without aging. In case of aging the process shall take place in wood barrels, within no less than 6 months.

Wine "Mukuzani" shall be represented on consumer market only packed in the bottles.

9. LINK BETWEEN EXCLUSIVE QUALITY, CHARACTERISTICS AND/OR REPUTATION WITH GEOGRAPHICAL AREA

9.1. NATURAL FACTORES

Climate

Climate formation in the micro-zone Mukuzani is defined by atmospheric processes developed in subtropical and moderate latitudes and moved from the East to the West. No less importance have the processes caused by local relief conditions, in particular, cold air masses flowing down from Caucasus high top glaciers. The climate is moderately humid, with hot summer and mild winter. In the slopes intended for vineyards the horizon is essentially extensible from the East to the West that creates effective radiation regime for vine cultivated on the slopes inclined towards the North-East. Annual duration of sunlight varies within 2150-2200 hours, and during the vegetation period the sunshine continues 1600 hours. Sum of annual radiation is no more than 130 kcal/cm², and 95-100 kcal/cm² – in the vegetation period. Sum of direct annual radiation is 75 kcal/cm², and scattered – 54 kcal/cm².

The average annual air temperature is +12,5°C, +23,6°C – of the warmest months (July and August) and +1,1°C – of the coldest month (January).

Sum of active temperatures in the micro-zone is 4120-3440°C.

The annual sum of atmospheric precipitations in specific zone, during the vegetation period, is 645 mm, and annual – 870 mm. The precipitations are less at fruit formation period (June, July, August), and vineyards need to be additionally irrigated. The soil is moderately humid and does not need irrigation at the times of grape maturity.

Relative air humidity is 71%. Less humidity is in July (63%) and August (60%), relatively more – in the end of autumn (78%) and winter (76-75%).

Snow cover is created in the last decade of December (25.XII), and melting takes place in mid-March. Snowy days amount is 26. Last frosts are finished in 24 March, and once in 10 years can be continued to mid-April. Period without frosts is continued more than 230 days. Air temperature average annual absolute minimum is -9-11°C, and can fall to -15°C once in 10 years.

Annual average value of hailing days is 2.1. May and June are the most hailing months (0,7-0,5).

There are prevailing mostly the Western – (32%) and South-Western (23%) Rumb winds. Days without winds are 21%, averagely. At the night until sunrise the cold air masses flowing down from Caucasus high top glaciers strengthen frosts of winter and spring.

The micro-zone Mukuzani belongs to wind impact III group regions. Average wind speed is 1.4 m/s. In the purpose to protect the area the double-row windshield strips cultivation is recommended.

Soil

In accordance of existed data analyses, there are distinguished brown, alluvial and deluvial varieties of soils with their sub-varieties:

- 1) Dark brown, very thick, slightly leptosol, loamy and clay;
- 2) Dark brown, (old alluvial), very thick, loamy;
- 3) Dark brown, moderately thick, slightly leptosol, moderately and slightly clay.
- 4) Rendzino-brown, moderately thick, slightly leptosol, slightly clay and heavy clay;
- 5) Rendzino-brown, moderately thick, slightly leptosol, loamy and clay;
- 6) Forest brown, very thick, slightly leptosol, stony and heavy clay;
- 7) Deluvial-carbonated, very thick, clay;
- 8) Alluvial-carbonated, very thick clay;
- 9) Alluvial-carbonated, very thick leptosol clay.

Very and moderately thick brown varieties of soils are presented in the main part of territory;

Deluvial carbonated – on the center, creating slightly inclined trails on the North-Eastern foothills of Tsiv-Gombori Range.

Thick profile soils depth varies from 80-100 cm to 110-130 cm, in average thickness soils the depth varies from 60-70 cm to 70-80 cm. Active humus layer in thick soil varies from 50-60 cm to 75-85 cm, and from 3-40 cm to 40-50 cm – in the average soils.

Soil mechanical content is moderately, very or slightly loamy, and in some places is moderately loamy. The structure is changed from grainy-solid (in the upper layers) to solid-pea-like from the topsoil towards the bottom. Soil includes the roots, organic waste, lime dots and pebbles. Calcium carbonates content increases downwards; it is 24% in low layers, but more in rendzino-brown soils low layers.

Humus content is very low everywhere. Hydrolyzed nitrogen, soluble phosphorus and exchange potassium contents are very low. Soil area reaction (pH) is moderately alkaline.

Soil cover represented on inclined trails and developed on the rocks has high content of carbonates. Everything together with exposition, education and climatic conditions give opportunity to produce high quality wine "Mukuzani".

Human Factor

Viticulture and winemaking exist in Mukuzani micro-zone from ancient times. At the beginning of the 19th century, the estate of Aleksandre Chavchavadze became prominent here, being notable for significant capital investments and advanced technologies.

In the second half of the 19th century, the abolition of serfdom gave a powerful impetus to the development of this field and economy, in general. Unpaid laborers were replaced with hired workers, the backward and undeveloped area was quickly engaged in the common capitalist relationship, and the process of creation of capitalist-farming households began.

These processes became more tangible for viticulture and winemaking from the 1880s, when the Princes Estates Department massively purchased Kakhetian nobles' estates, including in Mukuzani and Zegaani, and rapidly began to modernize vineyards and cellars.

Said processes were further strengthened from the 1920s, when Georgian scientific centers started functioning in Tbilisi and Telavi. New vineyards were cultivated with grafted saplings, wineries equipped with modern technics were built in Mukuzani and Zegaani, and new technologies were introduced.

Wine "Mukuzani" is produced since 1888 and is considered to be a flagship of Georgian red dry wines. 13 medals, including 8 gold, 4 silver and 1 bronze medals, were awarded to wine "Mukuzani" at various international competitions and exhibitions, until 1990.

Geographical location of micro-zone Mukuzani, characteristic regional climate: mild winter and hot summer, moderate amount of precipitations, diversity of soils, special features of harvested Saperavi grape variety, characteristic of this zone and local, centuries-old tradition of viticulture and winemaking provide unique organoleptic features of wine "Mukuzani", characterizing only of this wine.

10. SPECIAL LABELING RULES

11. TRANSITIONAL PROVISIONS

12. ACCOUNTING AND NOTIFICATION

Accounting and notification of production and storage technological processes of wine "Mukuzani" is carried out in accordance with the rules established by the legislation of Georgia.

13. MAIN CONTROLLABLE POINTS

During control of the Protected Appellation of Origin wine "Mukuzani" production process the producer shall satisfy the requirements established by LEPL National Wine Agency, and shall comply with the following parameters:

Main Controllable Points	Evaluation Methods
Vineyard location	Cadaster map, control on the place
Area	Vineyard accounting magazine, cadaster
Vine variety	Vineyard accounting journal, control on the place
Cultivation methods	Journal of registration of Agrotechnical Measures, treating journal, control on the place
Vintage and transportation	Vintage journal
Grape harvest per ha	Vintage journal
Grape harvest in total	Vintage journal
Grape processing and winemaking	Grape receiving journal, grape processing journal, product turnover calculation journal, laboratory analysis journals, notifications, control on the place
Wine bottling, packaging and storage place and conditions	Bottling journal, journal for motion of ready product in the storehouse, laboratory analysis journals
Physico-chemical characteristics of the wine at winemaking, before and after bottling	Laboratory analysis journals
Organoleptic characteristics of the wine	Tasting commission protocols
Traceability	Technological and laboratory records

14. CONTROL BODY OF PRODUCTION

State control for observance of production specification and lawful usage of the Protected Appellation of Origin shall be carried out by LEPL National Wine Agency, according to the rules established by the legislation of Georgia.

15. MAP OF THE MICRO-ZONE

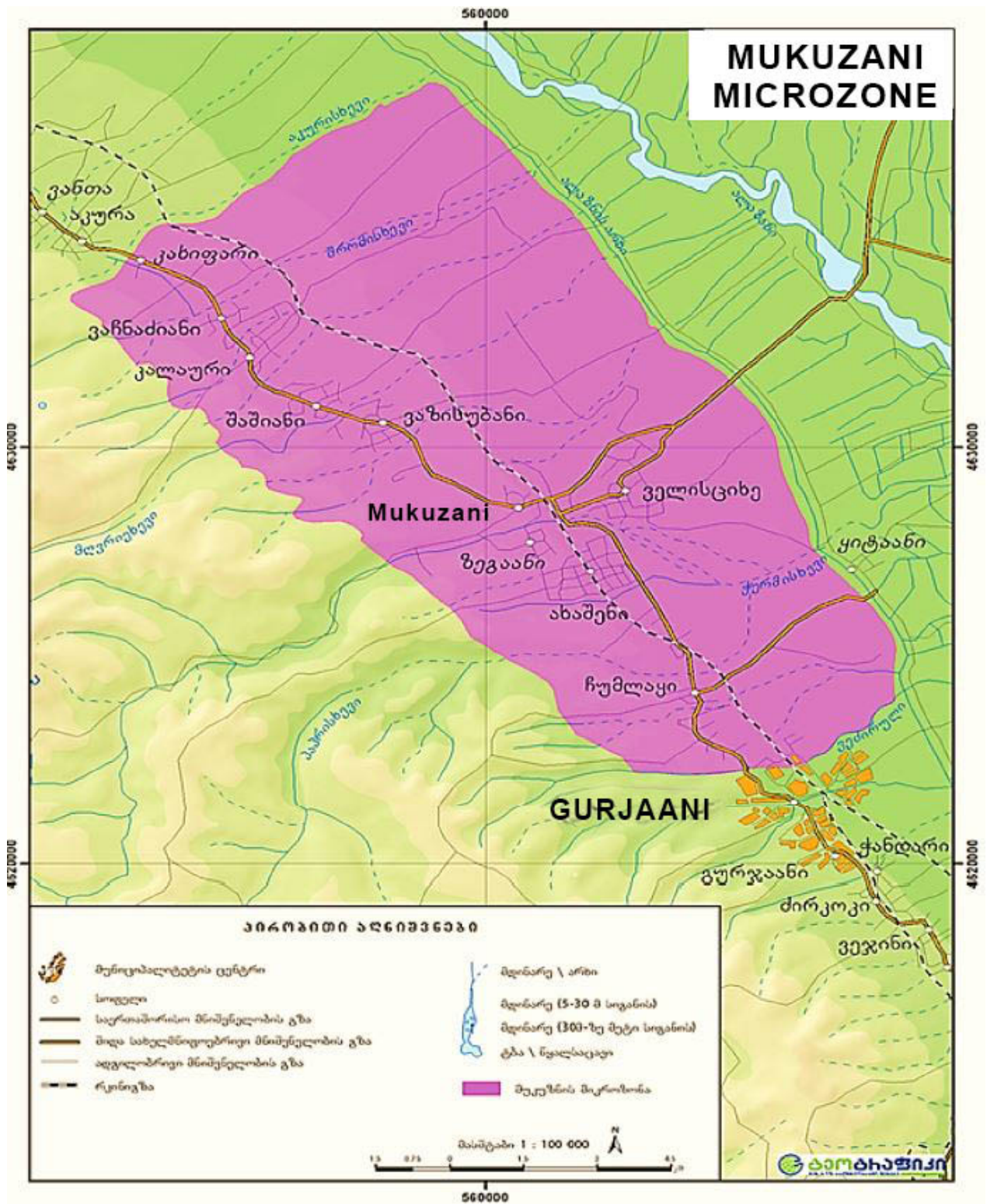

TSINANDALI

REGISTRATION № 3

DATE OF REGISTRATION: 2005 30 08

APPELLATION OF ORIGIN: TSINANDALI

NAME OF GOOD FOR WHICH THE APPELLATION OF ORIGIN IS REQUIRED: Wine

NAME AND ADDRESS OF APPLICANT: LEPL NATIONAL WINE AGENCY, Marshal Gelovani Ave. 6, 0159, Tbilisi, Georgia (GE)

E-mail: info.georgianwine@georgianwine.gov.ge

1. APPELLATION OF ORIGIN: TSINANDALI

2. PRODUCT DESCRIPTION

2.1. PRODUCT CATEGORY

Wine "Tsinandali" shall be:

- white sec (dry);
- red sec (dry).

2.2. PRODUCT ORGANOLEPTIC CHARACTERISTICS

Wine "Tsinandali" white sec (dry) shall satisfy the following requirements:

- Color – light straw;
- Aroma and taste – perfect, delicate, soft, harmonic, cheerful, refined, having aroma characterizing the location, with meadow flowers, fruit and citrus tones;
- Intensively expressed bouquet of fruit tones is developed with aging.

Wine "Tsinandali" red sec (dry) shall satisfy the following requirements:

- Color – dark red;
- Aroma and taste – perfect, full, extracted, velvet, harmonic, having aroma characterizing the location;
- Intensively expressed bouquet of fruit tones is developed with aging.

2.3. PRODUCT PHYSICO-CHEMICAL CHARACTERISTICS

Wine "Tsinandali" white sec (dry) shall satisfy the following requirements:

- Factual volumetric spirit content – no less than 11 %;
- Total volumetric spirit content – no more than 15 %;
- Sugar content – no more than 4 g/l;
- Titrated acidity calculated on tartar acid – no less than 5,0 g/l;
- Volatile acidity calculated on acetic acid – no more than 1 g/l;
- Sulfur dioxide total mass concentration – no more than 200 mg/l;
- Concentration of sugar free extract mass – no less than 16 g/l.

Wine "Tsinandali" red sec (dry) shall satisfy the following requirements:

- Factual volumetric spirit content – no less than 11 %;
- Total volumetric spirit content – no more than 15 %;
- Sugar content – no more than 4 g/l;
- Titrated acidity calculated on tartar acid – no less than 5 g/l;
- Volatile acidity calculated on acetic acid – no more than 1,2;
- Sulfur dioxide total mass concentration – no more than 150 mg/l;
- Concentration of sugar free extract mass – no less than 22 g/l.

3. GEOGRAPHICAL AREA AND ZONES OF PRODUCTION

The micro-zone Tsinandali is located in Telavi Municipality, on the right bank of the River Alazani, on the coordinates – 41°54' of Northern longitude and 45°35' of Eastern latitude.

The micro-zone covers the continuing of the North-Eastern forest slopes of Tsiv-Gombori Range from one side, and foothills and Alazani Valley – from another side. Chumatkhevi (Chuma Gorge) borders it

from the North-West, and Akuriskhevi (Akuri Gorge) – from the South-East.

The micro-zone Tsinandali includes the following villages: Akura, Vanta, Busheti, Kvemo Khodasheni, Tsinandali, Kisiskhevi, Kondoli, Nasamkhrali, Shalaura, Kurdghelauri, Vardisubani, Ruispiri, Karajala, Gulgula and Ikalto.

The grapes intended for wine "Tsinandali" production shall be harvested only from the vineyards cultivated in the micro-zone Tsinandali.

Grape processing and winemaking takes place in the territory of the micro-zone Tsinandali, and outside, as well, but within Kakheti viticulture area.

4. VINE VARIETIES

Wine "Tsinandali" white shall be prepared only with the grapes of:

- Rkatsiteli – no less than 85%;
- Mtsvane Kakhuri (Kakuri Green) – no more than 15%.

In the case of "Tsinandali" white production the usage of other varieties is prohibited.

Wine "Tsinandali" red shall be prepared only from the grapes of Saperavi. Usage of other varieties is prohibited.

5. VITICULTURE PRACTICE

- The micro-zone Tsinandali vineyards are situated on 350-700 m above sea level;
- Distance between the rows in the vineyards – 1-3 m;
- Distance between the vines in the row – 0,8-1,5 m;
- Height of stem – 60-90 cm;
- Shape of pruning – one-sided or Georgian two-sided or free.

6. GRAPE MATURITY, VINTAGE, TRANSPORTATION

- Wine "Tsinandali" shall be produced only with ripe grapes. Sugar content shall be no less than 19%, at the vintage.
- Grapes transportation is permitted only with wooden or plastic boxes, with bodyworks made of stainless steel or painted with a special dye.
- Usage of polyethylene packages and/or bags is not permitted.

7. VINTAGE AND WINEMAKING

Vintage on 1 ha vineyard shall be no more than:

10 tones – for Rkatsiteli;

10 tones – for Saperavi;

8 tones – for Kakhuri Mtsvane.

Wine production shall be no more than 650 liters from 1 tone grapes.

8. WINEMAKING PRACTICE

Wine "Tsinandali" white is made by complete fermentation of flowing under gravity the grape juice. Juice sedimentation is necessary before fermentation executed at no more than 20°C temperature, and after that the sulphitation is carried out.

Wine "Tsinandali" red is produced by complete fermentation of must. The grapes shall be pressed and grape stem – removed. The temperature for alcoholic fermentation shall not exceed 30°C, after that apple-lactic acid fermentation is executed, at the end of that the sulphitation is carried out.

Wine "Tsinandali" can be aged or bottled without aging. At the case of aging the process shall take place in wood barrels within no less than 6 months.

Wine "Tsinandali" shall be represented on consumer market only packed in the bottles.

9. LINK BETWEEN EXCLUSIVE QUALITY, CHARACTERISTICS AND/OR REPUTATION WITH GEOGRAPHICAL AREA

9.1. NATURAL FACTORES

Climate

The climate in the micro-zone is moderately humid, with hot summer and mild winter. Annual duration of sunlight in the micro-zone Tsinandali more than 2300 hours. Direct annual radiation on the perpendicular surface is 76 kcal/cm², and varies within – 92-60 kcal/cm². Scattered annual radiation is 54 kcal/cm², and – 40 kcal/cm² in the vegetation period. Sum of annual radiation is 130 kcal/cm², and 100 kcal/cm² – in the warm period.

The average annual air temperature of the micro-zone is quite high – +12,4°C, in the warmest months – July and August the average temperature is equal to +23,2°C, and that of the coldest month (January) is +0,90°C. Annual absolute minimum is averagely – 10°C, and maximum – +35°C.

Extreme temperatures are change within – 23°C – +38°C. In most parts of the region the temperature above 10°C is in the April I decade (from 8.IV), and below 10°C – in the beginning of November (3.XI).

Vegetation period duration is 208 days, and sum of active temperatures (ct>10°C) is +3930°C, on 550 m level.

In the micro-zone Tsinandali annual number of sunny days (0-2 points) in general, and at lower clouds is equal to 52-82, accordingly. During the vegetation period, this indicator is equal to 36-55 days according to cloudiness. Annual quantity of cloudy days (8-10 points) in general and at lower clouds is equal to 122 and 95, accordingly. During the vegetation period, this indicator is equal to 61-45.

The annual sum of atmospheric precipitations is 845 mm, and 644 mm during the vegetation period, in the micro-zone Tsinandali. Maximum of precipitations (157 mm) take place in May, and minimum (28 mm) – in January.

Vine buds opening starts from mid-April, and the grape maturity begins in the second half of August.

Active heat sum ranges within 4100-3500°C, in Tsinandali micro-zone (on the 300-750 m level).

Hailing days are frequent per year (2.3). May and June are the most hailing months (0,7-0,8) of year and can be even 9 times in the most hailing years.

The relative humidity of air is approximately 70%. The air is less humid (60%) in August, and the most (77%) – in November.

The Western – (33%) and Eastern (23%) Rumb winds are prevailing, in the micro-zone. The average wind speed is 1.7 m/s; amount of annual windy days is not big (10).

Soil

In June-July of 2005, soil specialists of horticulture, Viticulture and Wine Science Research Institute conducted field and workshops on soils research, in order to study the microscopic soil cover. Analysis of soils was conducted at the same in Agrochemical Laboratory of Institute.

On the basis of existing researches, there are distinguished following varieties of soils:

Forest brown, very thick, moderately and very leptosol, heavy clay;

Brown, very thick, somewhere slightly leptosol, loamy and clay;

Brown, moderately thick, slightly leptosol, heavy clay;

Meadow-brown, very thick, heavy clay, loamy;

Meadow-brown, very thick, slightly and moderately leptosol, clay;

Deluvial-proluvial, very thick, slightly and heavy clay;

Alluvial-proluvial, very thick, slightly leptosol, clay;

Alluvial, very thick, heavy clay;
Alluvial, very thick, hard leptosol, clay.

Soils varieties are characterized in accordance of villages.

First – Vanta, Akura (plot nearby ruins), Kisiskhevi (plot "Above Canal").

Second – Busheti (plot bellow railway nearby Tetri Khidi, Shalauri (plot "Bellow the Highway"), Vachnadziani (plot "Khramitsebi").

Third – village Shalauri (plot "Didi Verkhvis Adgilebi").

Fourth – villages: Tsinandali (plot "Teliani"), Kvemo Khodasheni (plot "Naparekhlebi"), Kurdghelauri (plot "Beghanapshebi").

Fifth – Kvemo Khodasheni (plot "Didi Venakhebi").

Sixth and seventh – on the line extended from said villages to Alazani Gorge.

Eighth and ninth – directly on the border of Alazani Terrace.

Brown soils presented in the upper part of the micro-zone (with sub-varieties) are characterized with medium and deep profile. Alluvial, alluvial-proluvial and deluvial-proluvial soils are characterized with deeper profile and various kinds of leptosol.

Soil thickness on upper part, wherein the brown soils are presented is 70-100 cm, and active humus layer is 30-50 cm; bellow, wherein alluvial, alluvial-proluvial and deluvial-proluvial soils are presented the soils are deeper – 100-150 cm, and active humus layer is 40-50 cm;

Soils mechanical content is mainly characterized with medium and heavy clay composition and soils with slightly loamy – on small parts.

Humus is presented in small amount – within 1.0-2.5%, hydrolyzed nitrogen, soluble phosphorus and exchange potassium content is low, calcium carbonate soils contain them in small and medium amounts – within 2.5-16.0%, soil area reaction (pH) is averagely alkaline.

Soils presented in the micro-zone exclusively (mainly in the North-East and the East) with calcium carbonates content, leptosol and with climatic factors create perfect conditions for high quality wines preparation.

Human Factor

History of viticulture and winemaking takes place from the depths of millennium in Kakheti and in the micro-zone Tsinandali, as in other parts of Georgia. In the course of time it was developed, grown and had taken experience.

At the beginning of the XIX century in Kakhetian prince's estates, the viticulture and winemaking were important. Aleksandre Chavchavadze, who had special place among the nobles, borrowed a million rubles from the bank in 1835 to improve the estates. Large wine cellar with laboratory for winemaking was built in the village Tsinandali. Aleksandre Chavchavadze also built steam distillation factories for vodka.

This was the first attempt to move from the feudal rule to capitalistic, which effectively improved wine quality. Aleksandre Chavchavadze's wines were well known in Russia and appreciated in Europe, too.

From the 1880, Princes Estates Department of the Russian Empire intensively purchased Georgian estates, about 2000 hectares of land in the village Tsinandali among them and its suburbs from the nobles – Chavchavadze, Andronikashvili, Zurabashvili, Bakhutov, Rotinyants, Aznaurov, etc. and began making massifs therefrom and reformation-reconstruction process.

Two-storeyed 150000 bucket cellar-factory and a palace were built, and was opened barrel workshop, in Tsinandali, in 1886-1887. New modern equipment was installed: grape presses, wine pumps, rubbles, tubs, barrels and various other inventories. Additionally, prince estates were staffed with professionals trained in Europe – Gogol-Janowski, Speshnev, Massono, Staroselskiy, Heine, Markovich, Ovcharenko, Tushmalishvili, Jorjadze, Dickinson and others.

From 1880, quite high quality wines were already produced there – "Rkatsiteli Tsinandali N13", "Green Tsinandali №14", "Saperavi Tsinandali №16" obtained the highest ratings at the International Exhibition of Chicago, in 1892.

Three-year school was opened in Tsinandali, in 1897, where children were taught viticulture, winemaking and gardening, together with other subjects.

The wine "Tsinandali" produced by Alexander Chavchavadze was very popular in the Russian Empire and European countries, it is still considered to be the flagship of Georgian wines. He has participated in numerous competitions and exhibitions and has won 10 gold and 9 silver medals until the 1990.

The micro-zone Tsinandali geographical location, regional climate: mild winter and hot summer, moderate precipitations, diversity of soils, special features of Rkatsiteli and Saperavi varieties in this zone, and local centuries-old tradition of viticulture and winemaking define the unique organoleptic features of wine "Tsinandali" characterizing only this wine.

10. SPECIAL LABELING RULES

11. TRANSITIONAL PROVISIONS

12. ACCOUNTING AND NOTIFICATION

Accounting and notification of production and storage technological processes of wine "Tsinandali" is carried out in accordance with the rules established by the legislation of Georgia.

13. MAIN CONTROLLABLE POINTS

During control of the Protected Appellation of Origin wine "Tsinandali" production process the producer shall satisfy the requirements established by LEPL National Wine Agency, and shall comply with the following parameters:

Main Controllable Points	Evaluation Methods
Vineyard location	Cadaster map, control on the place
Area	Vineyard accounting magazine, cadaster
Vine variety	Vineyard accounting journal, control on the place
Cultivation methods	Journal of registration of Agrotechnical Measures, treating journal, control on the place
Vintage and transportation	Vintage journal
Grape harvest per ha	Vintage journal
Grape harvest in total	Vintage journal
Grape processing and winemaking	Grape receiving journal, grape processing journal, product turnover calculation journal, laboratory analysis journals, notifications, control on the place
Wine bottling, packaging and storage place and conditions	Bottling journal, journal for motion of ready product in the storehouse, laboratory analysis journals
Physico-chemical characteristics of the wine at winemaking, before and after bottling	Laboratory analysis journals
Organoleptic characteristics of the wine	Tasting commission protocols
Traceability	Technological and laboratory records

14. CONTROL BODY OF PRODUCTION

State control for observance of production specification and lawful usage of the Protected Appellation of Origin shall be carried out by LEPL National Wine Agency, according to the rules established by the legislation of Georgia.

15. MAP OF THE MICRO-ZONE

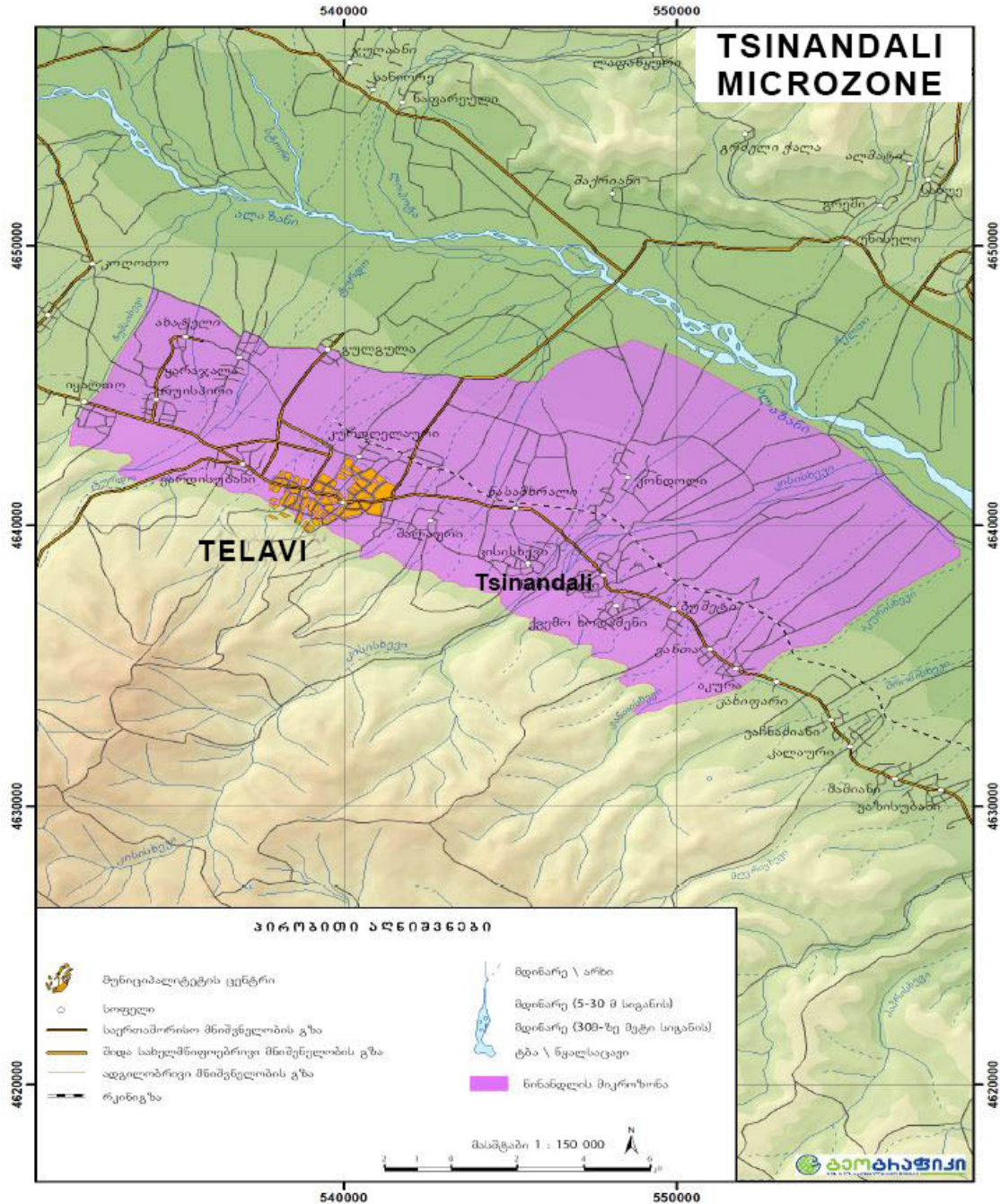

AKHASHENI

REGISTRATION № 4

DATE OF REGISTRATION: 2005 30 08

APPELLATION OF ORIGIN: AKHASHENI

NAME OF GOOD FOR WHICH THE APPELLATION OF ORIGIN IS REQUIRED: Wine

NAME AND ADDRESS OF APPLICANT: LEPL NATIONAL WINE AGENCY, Marshal Gelovani Ave. 6, 0159, Tbilisi, Georgia (GE)

E-mail: info.georgianwine@georgianwine.gov.ge

1. APPELLATION OF ORIGIN: AKHASHENI

2. PRODUCT DESCRIPTION

2.1. PRODUCT CATEGORY

Wine "Akhasheni" red mi doux (semi sweet).

2.2. PRODUCT ORGANOLEPTIC CHARACTERISTICS

Wine "Akhasheni" shall satisfy the following requirements:

- Color – dark red;
- Aroma and taste – perfect, harmonic, velvet, refined, pleasantly sweet with fruity tones, having taste and aroma of Saperavi grapes.

2.3. PRODUCT PHYSICO-CHEMICAL CHARACTERISTICS

Wine "Akhasheni" shall satisfy the following requirements:

- Factual volumetric spirit content – no less than 10,5 %;
- Total volumetric spirit content – no more than 15,6 %;
- Sugar content – no more than 18-45 g/l;
- Titrated acidity calculated on tartar acid – no less than 5 g/l;
- Volatile acidity calculated on acetic acid – no more than 1,2 g/l;
- Sulfur dioxide total mass concentration – no more than 200 mg/l;
- Concentration of sugar free extract mass – no less than 22 g/l.

3. GEOGRAPHICAL AREA AND ZONES OF PRODUCTION

The micro-zone Akhasheni is located in Inner Kakheti, in the middle stream of the River Alazani, on the coordinates – 41°48' of Northern longitude and 45°44' of Eastern latitude.

The micro-zone Akhasheni covers forest edge slopes continuation of Tsiv-Gombori Range to the River Alazani. It includes the part of territory of the following villages: Zegaani, Akhasheni, Chumlaki, Kitaani sowing fields, and Gurjaani region, as well.

A border of the micro-zone is continued along Chermiskhevi (Cherami Gorge) from the North, turns in the South-Eastern suburb of the village Velistsikhe towards the North-East and is continued along the road to the North-Western corner of local industry territory, wherein turns right and is continued along the road at first into the East, and then – the North-East directions to Alazani Channel. Therefrom the border is continued along the channel towards the North direction to the lakes, turns right and is continued along Rtskhiliani Gorge at first into the East, and then the North-East directions to the River Alazani. Then, the border is continued along the river towards the South-East following river stream direction to Tanana Gorge, turns into the South-West and is continued at first along Tanana Gorge, and then – the road to Alazani Cannel (Kotekhi Bridge), and then – Khao Cellar. After that, the border is continued along the highway towards the North-West direction to Vedzirula Gorge at first into the West and then – the South-West directions and arrives Gurjaani-Telavi highway. The border is continued to the South-West from the highway on Javakhishvili Street to Tsiv-Gombori Range slopes, and then – to Chermiskhevi (Cherami

Gorge) towards the North-West direction.

Wine "Akhasheni" shall be prepared only with the grapes cultivated in the vineyards of the micro-zone Akhasheni.

Grape processing and winemaking takes place in the territory of the micro-zone Akhasheni, and outside of the micro-zone Akhasheni, as well, but within Kakheti viticulture area.

4. VINE VARIETIES

Wine "Akhasheni" shall be prepared with the grapes of Saperavi. Usage of other varieties is prohibited.

5. VITICULTURE PRACTICE

- Vineyards intended for wine "Akhasheni" production are situated on 350-700 m-s above sea level.
- Distance between the rows in the vineyards – 1-3 m-s;
- Distance between the vines in the row – 0,8-1,5 m-s;
- Height of stems – 60-90 cm-s;
- Shape of pruning – one-sided or Georgian two-sided or free.

6. GRAPE MATURITY, VINTAGE, TRANSPORTATION

- Wine "Akhasheni" shall be produced only with ripe grapes. Sugar content shall be no less than 22%, at the vintage.
- Grapes transportation is permitted only with wooden or plastic boxes, with bodyworks made of stainless steel or painted with a special dye.
- Usage of polyethylene packages and/or bags is not permitted.

7. VINTAGE AND WINEMAKING

Vintage on 1 ha vineyard shall be no more than 10 tons.

Wine production shall be no more than 650 liters – from 1 ton grapes.

8. WINEMAKING PRACTICE

Wine "Akhasheni" is produced by incomplete alcoholic fermentation of must.

The grapes shall be pressed and grape stems – removed. The temperature for alcoholic fermentation shall not exceed 30°C, the process is terminated naturally and/or as a result of coldness and sulphitation. Apple-lactic acid fermentation does not take place.

Increasing of sugar content in grape juice, must and wine with the sugar, sweet concentrate or other substances is prohibited.

Wine "Akhasheni" shall be represented on consumer market only packed in the bottles.

9. LINK BETWEEN EXCLUSIVE QUALITY, CHARACTERISTICS AND/OR REPUTATION WITH GEOGRAPHICAL AREA

9.1. NATURAL FACTORES

Climate

The formation of weather in the micro-zone is caused by atmospheric processes developed in subtropical and moderate areas and moved from the East and West longitudes. The climate in the micro-zone is moderately humid, with hot summer and mild winter. The direction of the River Alazani has great importance. Cold air masses move from the North-West to South-East on the foothills of the Northwest slopes of Tsiv-Gombori Range, the gorges, and high tops of Kakheti Caucasus glaciers.

In the micro-zone the formation of grape grains (in the second half of June, July and the first half of August), and clear sky (from the second half of August to the end of September) continues, correspondingly, 16 and 8 days during maturity. The number of days without sun in said periods does not exceed 3 and 1.

Annual duration of sunshine in the micro-zone Akhasheni ranges between 2150-2200 hours. During the

vegetation period the sunshine continues 1600 hours. Solar radiation on the right side of the River Alazani, in the micro-zone Akhasheni, is higher than on the left bank of the river, which is due to less cloudiness. Annual radiation in Akhasheni is no more than 130 kcal/cm², but in the vegetation period it varies within 95-100 kcal/cm². Direct radiation on the horizontal surface is 75 kcal/cm², and scattered – 54 kcal/cm².

Depending on the analysis of alluvial carbonate soil temperature, in the depth of 5-50 cm layer, the sustainable transition of temperature above 10°C occurs in the first decade of April. In a relatively deep (50-100 cm) layer, this term will be moved to mid-April.

Activation of root system begins in mid-May, when the soil temperature increases above 15°C in 10-120cm depth of the layer. From the mid-June to the end of September, over three months the soil temperature is above 20°C, and it reaches 24°C from mid-July to the end of August, in the depth of 70 cm. it reaches 24°C from mid-July to the end of August, in the depth of 40 cm.

The average annual air temperature is 12,5°C, at the warmest months (July, August) is 23,7- 23,5°C, and at the coldest month (January) is +1,1°C. In accordance with multiannual data, air annual absolute minimum temperature is averagely -10-11°C, and +35°C – for absolute maximum, and extreme temperatures are +23 and + 38°C.

Autumn frosts in the micro-zone start at the end of November (27.XI) and stop from 24.III. In the middle of April the frosts are expected once during 10 years.

In the micro-zone Akhasheni the sum of temperatures is 3950°C on 450 m level, and 3700°C–on 620 m.

Sustainable transition of air temperature above 10°C on 450 m-s takes place from 5.IV, and it's falling – from 4.XI.

Annual sum of atmospheric precipitations is 860 mm in the micro-zone Akhasheni and 637 mm – during the vegetation period.

Annual relative air humidity is 71%. Air moisture is the lowest at July (63%) and August (60%), and it is much more increased at the end of the autumn (78%) and winter (76-75%).

During warm period hailing days repetition is sharply reduced than in the Northwestern districts of Alazani right bank (Tsinandali, Telavi). Hailing days number is averagely between 1,6-2,1 per year. May (0,7 days) and June (0,5 days) are the the most hailing months during the year.

Saperavi buds opening takes place in the middle of April and flowering – at the end of May, the grape maturity begins in the second half of August. Grape technical ripening takes place at the end of September.

Snow cover is formed in the last decade of December (from 15.XII), melting – in mid-March. Snow cover is unstable – in 74% of years, the number of snowy days in winter is equal to 26.

In the micro-zone the West (32%) and South-West (23%) winds are prevailing. There are approximately 21% windless days, per year.

Average annual wind speed is 1.4 m/s. Wind speed is almost equal during all months, and the number of very windy days is only 4.

Soil

The main part of the territory is consisted with slopes and trails slightly and moderately inclined towards the Southwest, North-East and East, it is passing to slightly wavy surface, and then – to flat land towards the North-East direction and borders the first terrace of Alazani, longwise Chermiskhevi and Papsikhevi.

In the micro-zone there are two types of rendzino-brown soils, two types of alluvial soils and one of

deluvial soils:

- 1) Rendzino-brown, very thick, loamy;
- 2) Rendzino-brown, moderately thick, somewhere slightly leptosol with loam and heavy clay;
- 3) Alluvial carbonated, very thick, clay;
- 4) Alluvial carbonated, very thick, leptosol, clay;
- 5) Deluvial carbonated, very thick, loamy.

Soils of the first two types are found in the extreme Southwestern part of the micro-zone on the North-Eastern slopes of Tsiv-Gombori Range, namely, in the area of Akhasheni on Papari fields and in the South-Western part of the Chumlaki area. The 3rd and 4th varieties of soils are presented in the central and North-Eastern parts of said villages, on the river Alazani second terrace, along the rivers Chermshkevi and Papriskhevi, on inclined and flat relief. The 5th variety of soil is mainly presented in the central part of the micro-zone, on the ends of the Southern slopes of Tsiv-Gombori Range and it creates slightly inclined trails.

First type soil profile thickness is 70-90 cm, and active humus layer is 50-60 cm. Second type – 60-90 cm, and the active humus layer is 40-50 cm; it is characterized with slightly loamy structure. Both soil types are developed on very carbonated clay-lime layers. The 3rd, 4th and 5th types of soils are characterized with deep thickness of profiles – 1.5 m, and active humus layer is 50-60 cm. They consist of alluvial clay-lime and clay-sand layers. First two types of soils are dark brown to black in the active humus layer. In transitional layer it is light brown to beige, and changes to light beige to white, to the bottom. The 3rd, 4th and 5th soils are light brown and less differentiated. The 4th soil has loamy structure, contrary from others.

According to laboratory analysis data, the first two types of soils are characterized with clay and heavy clay mechanical content and the 3rd, 4th and 5th types of soils are clay. Humus content of first and second soil varieties is characterized with moderate index in the active layer – 3,5%, usually, and less – below in the 3rd, 4th and 5th types of soils relatively low and varies within 1,5-3,0% in active layer. It is poor with hydrolyzed nitrogen, soluble phosphorus and exchange potassium. The first and second varieties of soils contain carbonates in average amount, in upper layers, very high amount – more than 40-50%, below, and average amount in the 3rd, 4th and 5th types of soils. Soil area reaction (pH) is characterized with moderate index and mainly varies within 7,5-8,6.

On the basis of conducted studies, agronomic properties of micro-zone soils provide the opportunity to produce high quality material for wine "Akhasheni".

Human Factor

It is known that Georgian wine companies had neither technological nor technical capabilities to make stable demi-doux wines until the 1940s.

On September 3, 1942, a meeting was held in Tbilisi with the participation of wineries, scientific institutions as well as scientists being in evacuation in Georgia (Professors – M.A. Gerasimov, A. A. Egorov, N.F. Saenko, and others) and winemakers representatives, they were entrusted with elaborating activities to provide and introduce modern wine-making technologies for demi-doux, and not only demi-doux wines.

Implementation of the activities planned at the meeting was entrusted to the Department of Agriculture of the Academy of Sciences, which fulfilled the task excellently – new factories equipped with modern technologies and techniques were built in various micro-zones, including village Zegaani.

Naturally demi-doux wine "Akhasheni", created by leading specialists of "Samtresti", has been produced since 1958.

At various international competitions and exhibitions held before 1990, Akhasheni was awarded 11

medals, including 6 gold and 5 silver medals.

Geographical location of Akhasheni micro-zone, the climate characteristic for the region: moderately warm winter and hot summer, moderate amount of atmospheric sediments, diversity of soils, specific features of Saperavi and/or Saperavi Budeshuri-like grape varieties and the centuries-old local tradition of viticulture and winemaking produce the unique organoleptic features of wine Akhasheni, characteristic only of this wine.

10. SPECIAL LABELING RULES

11. TRANSITIONAL PROVISIONS

12. ACCOUNTING AND NOTIFICATION

Accounting and notification of production and storage technological processes of wine "Akhasheni" is carried out in accordance with the rules established by the legislation of Georgia.

13. MAIN CONTROLLABLE POINTS

During control of the Protected Appellation of Origin wine "Akhasheni" production process the producer shall satisfy the requirements established by LEPL National Wine Agency, and shall comply with the following parameters:

Main Controllable Points	Evaluation Methods
Vineyard location	Cadaster map, control on the place
Area	Vineyard accounting magazine, cadaster
Vine variety	Vineyard accounting journal, control on the place
Cultivation methods	Journal of registration of Agrotechnical Measures, treating journal, control on the place
Vintage and transportation	Vintage journal
Grape harvest per ha	Vintage journal
Grape harvest in total	Vintage journal
Grape processing and winemaking	Grape receiving journal, grape processing journal, product turnover calculation journal, laboratory analysis journals, notifications, control on the place
Wine bottling, packaging and storage place and conditions	Bottling journal, journal for motion of ready product in the storehouse, laboratory analysis journals
Physico-chemical characteristics of the wine at winemaking, before and after bottling	Laboratory analysis journals
Organoleptic characteristics of the wine	Tasting commission protocols
Traceability	Technological and laboratory records

14. CONTROL BODY OF PRODUCTION

State control for observance of production specification and lawful usage of the Protected Appellation of Origin shall be carried out by LEPL National Wine Agency, according to the rules established by the legislation of Georgia.

15. MAP OF THE MICRO-ZONE

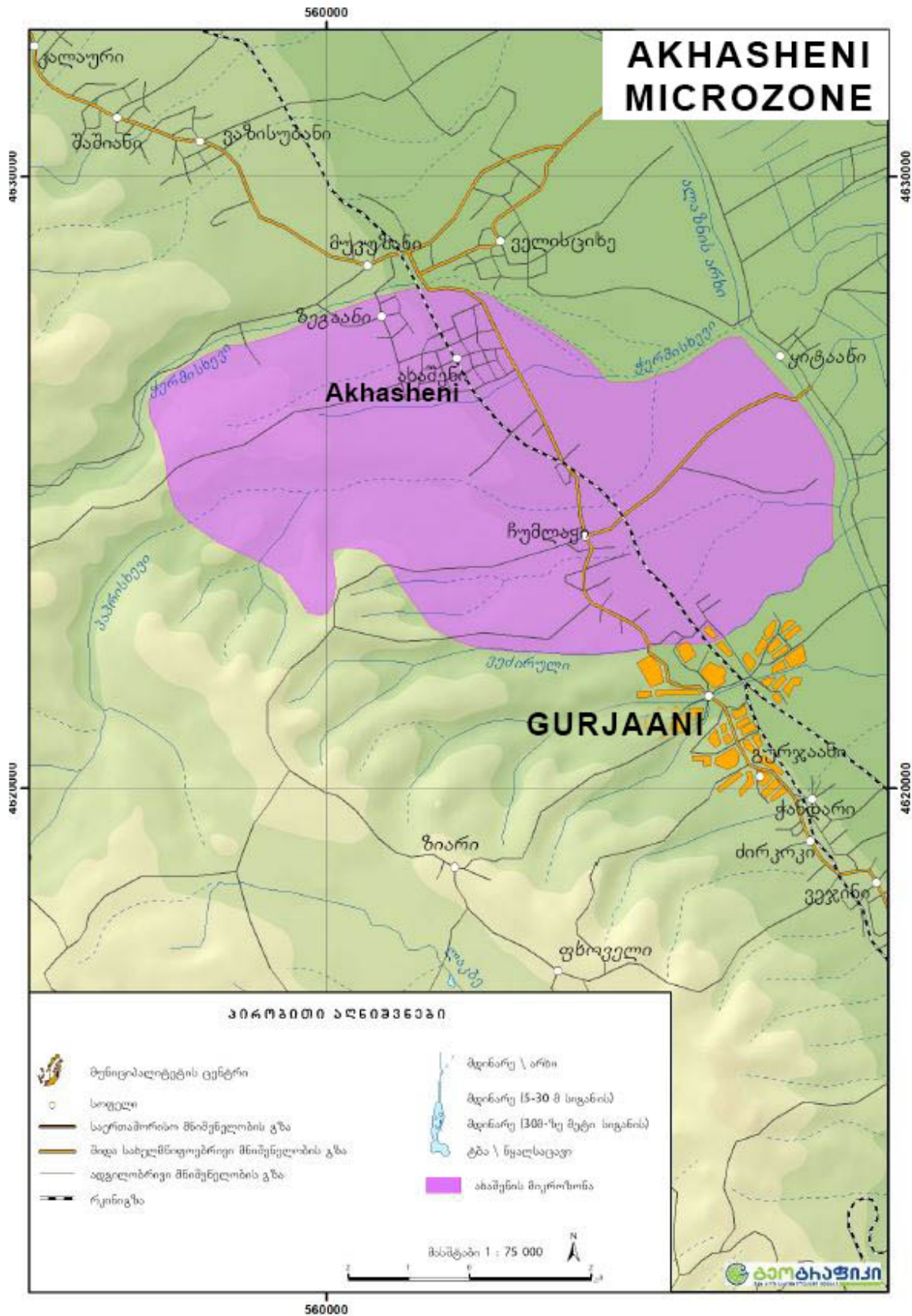

TELIANI

REGISTRATION № 791

DATE OF REGISTRATION: 2007 10 12

APPELLATION OF ORIGIN: TELIANI

NAME OF GOOD FOR WHICH THE APPELLATION OF ORIGIN IS REQUIRED: Wine

NAME AND ADDRESS OF APPLICANT: LEPL NATIONAL WINE AGENCY, Marshal Gelovani Ave. 6, 0159, Tbilisi, Georgia (GE)

E-mail: info.georgianwine@georgianwine.gov.ge

1. APPELLATION OF ORIGIN: TELIANI

2. PRODUCT DESCRIPTION

2.1. PRODUCT CATEGORY

Wine "Teliani" red sec (dry).

2.2. PRODUCT ORGANOLEPTIC CHARACTERISTICS

Wine "Teliani" shall satisfy the following requirements:

- Color – dark ruby;
- Aroma and taste – perfect, full, extracted, velvet, harmonic, having aroma characterizing the location;
- Intensively expressed bouquet with fruit tones is developed with aging

2.3. PRODUCT PHYSICO-CHEMICAL CHARACTERISTICS

Wine "Teliani" shall satisfy the following requirements:

- Factual volumetric spirit content – no less than 11 %;
- Total volumetric spirit content – no more than 15 %;
- Sugar content – no more than 4 g/l;
- Titrated acidity calculated on tartar acid – no less than 5 g/l;
- Volatile acidity calculated on acetic acid – no more than 1,2 g/l;
- Sulfur dioxide total mass concentration – no more than 150 mg/l;
- Concentration of sugar free extract mass – no less than 22 g/l.

3. GEOGRAPHICAL AREA AND ZONES OF PRODUCTION

The micro-zone Teliani is located in the middle stream of the River Alazani, on the coordinates – 41°54' of the Northern longitude and 45°35' of the Eastern latitude. Viticulture areas are extend on the North-Eastern slopes of Tsiv-Gombori Range.

Tbilisi-Telavi railway line borders the micro-zone from the South-West, the way is continued along administrative border of the villages: Tsinandali and Kondoli, from the railway line to the River Alazani – from the North-West, the River Alazani borders it from the North-East, and Vantiskhevi (Vanta Gorge) – from the South-East.

The grapes intended for wine "Teliani" production are harvested from the vineyards cultivated in the micro-zone Teliani.

Grape processing and winemaking takes place in the territory of the micro-zone, and outside, as well, but within Kakheti viticulture area.

4. VINE VARIETIES

Wine "Teliani" shall be prepared from the grapes of Cabernet Sauvignon.

Usage of other varieties is prohibited.

5. VITICULTURE PRACTICE

- Vineyards intended for wine "Teliani" production are situated on 350-600 m above sea level.
- Distance between the rows in the vineyards – 1-3 m-s;
- Distance between the vines in the row – 0,8-1,5 m-s;
- Height of stems – 60-90 cm-s;
- Shape of pruning – one-sided or Georgian two-sided or free.

6. GRAPE MATURITY, VINTAGE, TRANSPORTATION

- Wine "Teliani" shall be produced only with ripe grapes. Sugar content shall be no less than 19 %, at the vintage;
- Grapes transportation is permitted only with wooden or plastic boxes, with bodyworks made of stainless steel or painted with a special dye;
- Usage of polyethylene packages and/or bags is not permitted.

7. VINTAGE AND WINEMAKING

Vintage on 1 ha vineyard shall be no more than 10 tons.

Wine production shall be no more than 650 liters – from 1 ton grapes.

8. WINEMAKING PRACTICE

Wine "Teliani" is produced by complete alcoholic fermentation of must;

The grapes shall be pressed and grape stems – removed. The temperature for alcoholic fermentation shall not exceed 30°C, after that apple-lactic acid fermentation takes place, and at the end of the process the sulphitation is carried out;

Wine "Teliani" can be aged or bottled without aging. At the case of aging the process shall take place in wood barrels, within no less than 6 months;

Wine "Teliani" shall be represented on consumer market only packed in the bottles.

9. LINK BETWEEN EXCLUSIVE QUALITY, CHARACTERISTICS AND/OR REPUTATION WITH GEOGRAPHICAL AREA

9.1. NATURAL FACTORES

Climate

Micro-zone climate is characterized with moderately humid, hot summer and mild winter. Sunlight annual duration is more than 2300 hours, and reaches 1660 hours – at vegetation period. Direct solar radiation on horizontal surface is 75 kcal/cm², scattered – 54,2 kcal/cm², sum – 130 kcal/cm², annually.

Real sunlight amount ratio to its possible amount in the summer and September is averagely 66%. Clear days are 17-19 at grape maturity.

The average annual air temperature is 12,1°C, that of the coldest month (January) is +0,9°C, and of the warmest months (July, August) is similar – 23,2 22,9°C, and that. Air annual absolute minimum temperature averagely is -11°C, absolute minimum – -23°C. Absolute maximum temperature averagely is 35°C, absolute maximum – + 38°C.

Air daily amplitude is high (8,0-9,5°C) in summer, and low – in winter (4,8-5,5°C).

Heat general amount varies depending of years. In the last century in Tsinandali above 10°C it varied within 3300-4250°C, heat sum amplitude reaches 950°C.

In Teliani heat sum 95% is more than 3500°C, per each year.

Autumn first frosts start at 26.XI. In the end of October the frosts are expected once during 10 years, so vine is not damaged because of this.

The annual sum of atmospheric precipitations is 845 mm, and 644 mm during the vegetation period. The

precipitations in the greatest amount occur in May (157 mm) and June (111mm). Sum of precipitations in ripening period (VIII-IX) is averagely 144 mm, the most part of this comes in spring (34%) and summer (31%), less in autumn (23%) and winter (12%).

Air annual average relative humidity is 70%.

Hailing days amount is great and averagely is 2.3 per year; it is more frequent in the May and June (0,7-0,8 days).

Mostly there prevailing the Western (30%) and Eastern (24%) winds, and less – the South-Western (14%), North-Western (11%) and South-Eastern (10%) winds.

Wind annual average speed is 1,7 m/s. Wind speed relatively is increased in the spring and summer (1,7-2,1 m/s) and decreased in the winter (1,3-1,5 m/s). Very windy days amount (≥ 15 m/s) is not great and equal to 10, and – 33, in snowy days.

Soil

There are presented meadow-brown (old alluvial) and alluvial soil varieties different from each other with leptosol quality and mechanical content. Meadow-brown (old alluvial) soils are presented on the North-Eastern ends of slopes of Tsiv-Gombori Range, and alluvials – on the right second terrace of the River Alazani.

There are distinguished the following soil varieties: 2 – Meadow-brown (old alluvial) and 2 – alluvial.

- 1) Meadow-brown (old alluvial) very thick, clay;
- 2) Meadow-brown (old alluvial) very thick, leptosol, loamy;
- 3) Alluvial carbonated, very thick, clay;
- 4) Alluvial carbonated, very thick, leptosol, clay.

Said first two varieties of soils are presented on upper zone of micro-zone on the North-Eastern slope ends of Tsiv-Gombori Range, slightly inclined trails and flat lands, 3rd and 4rd – on right second terrace of the River Alazani bordered with the North-Eastern slopes of Tsiv-Gombori Range, and it is slightly inclined flat land towards the South-Eastern, with slightly waved surface.

Profile thickness of all 4 varieties of soils is more than 1-1,5 m, and active humus layer varies between 50-60 cm. Soil mechanical content is loam 25-50%, and passages onto light loam and sand in depth in some areas.

Humus content in active layer is less than average and mostly varies between 1,5-3,0%, and decreased bellow, contains average amount of calcium carbonates – 5-15%. Soil area reaction (pH) is mostly alkaline – 7,4-8,0.

Content of soluble phosphorus in active layer is 2,5-3,0 in 100 g soil, in low layers it is in small amount. Soil is poor with changeable potassium – 12,0 mg in 100 g soil.

Content of hydrolyzed nitrogen is 5.0-8.5 mg, soluble (adsorbing) phosphorus is 2,5-3,0 and changeable potassium – 12,0 mg, in 100 g soil, averagely.

9.2. Human Factor

Cabernet Sauvignon is a French vine variety. It was brought to Georgia at the end of the 19th century. This vine variety has shown its unique features and high quality on the 3rd period rocky sediment in Teliani, Georgia. This is quite fair when it is said that Georgia is the second homeland of Cabernet Sauvignon.

Bringing and cultivation of Cabernet Sauvignon in Teliani was wholly implemented by the heads of Princes Estates Department of that time – Gogol-Janowski, Speshnev, Masano, Staroselskiy, Haine, Markovich, Ovcharenko, Tushmelashvili, Jorjadze, Deckenson, and the others.

A great contribution to the development of Georgian winemaking was made by A. Egorov, the chief winemaker of Princes Estates Department in those times (1899-1925), to whom belong the words:

"Kakheti is a country of red wines".

Wine "Teliani" has been produced since 1897 and it has been awarded with 4 gold and 6 silver medals.

Geographical location of micro-zone Teliani, its regional climate: mild winter and hot summer, moderate amount of precipitations, diversity of soils, special features of grape variety Cabernet Sauvignon manifested in this area and the centennial experience of its cultivation on this land lead to the unique organoleptic features of wine "Teliani".

10. SPECIAL LABELING RULES

11. TRANSITIONAL PROVISIONS

12. ACCOUNTING AND NOTIFICATION

Accounting and notification of production and storage technological processes of wine "TELIANI" is carried out in accordance with the rules established by the legislation of Georgia.

13. MAIN CONTROLLABLE POINTS

During control of the Protected Appellation of Origin wine "TELIANI" production process the producer shall satisfy the requirements established by LEPL National Wine Agency, and shall comply with the following parameters:

Main Controllable Points	Evaluation Methods
Vineyard location	Cadaster map, control on the place
Area	Vineyard accounting magazine, cadaster
Vine variety	Vineyard accounting journal, control on the place
Cultivation methods	Journal of registration of Agrotechnical Measures, treating journal, control on the place
Vintage and transportation	Vintage journal
Grape harvest per ha	Vintage journal
Grape harvest in total	Vintage journal
Grape processing and winemaking	Grape receiving journal, grape processing journal, product turnover calculation journal, laboratory analysis journals, notifications, control on the place
Wine bottling, packaging and storage place and conditions	Bottling journal, journal for motion of ready product in the storehouse, laboratory analysis journals
Physico-chemical characteristics of the wine at winemaking, before and after bottling	Laboratory analysis journals
Organoleptic characteristics of the wine	Tasting commission protocols
Traceability	Technological and laboratory records

14. CONTROL BODY OF PRODUCTION

State control for observance of production specification and lawful usage of the Protected Appellation of Origin shall be carried out by LEPL National Wine Agency, according to the rules established by the legislation of Georgia.

15. MAP OF THE MICRO-ZONE

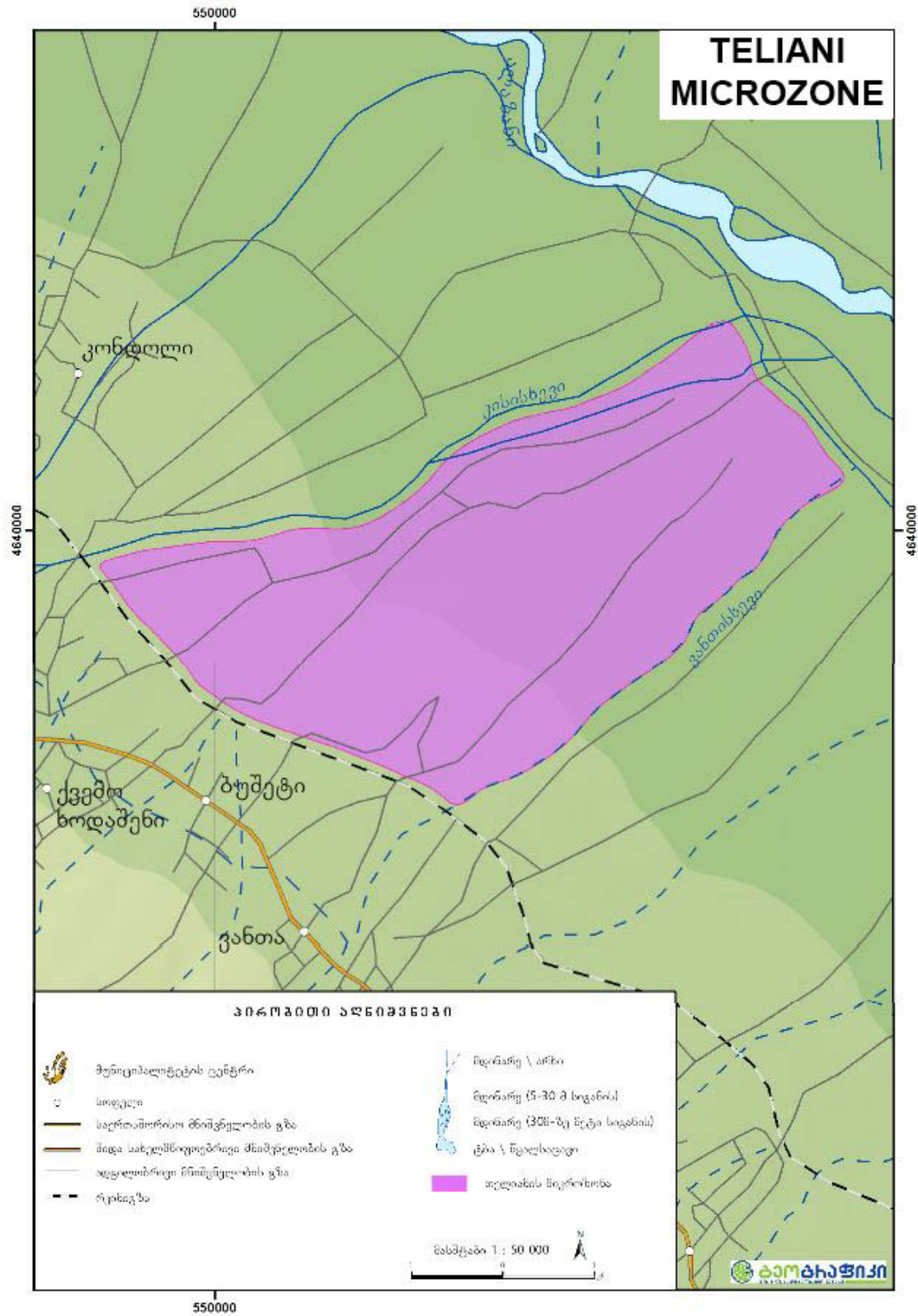

OFFICIAL NOTIFICATIONS

INVENTIONS

EXPIRATION OF PATENTS RESTORATION

(21) AP 2007 10171

(11) P 2009 4645 B

(73) Liana Rurua

(54) **VEGETATIVE MEDICAL MEANS**

DATE OF CANCELLATION OF PATENT: 2020 07 09

PATENT RESTRICTION DATE: 2020 09 10

(21) AP 2010 11918

(11) P 2011 5341 B

(73) Allied Global Tobacco Limited

(54) **CIGARETTES WITHOUT THE FILTER**

DATE OF CANCELLATION OF PATENT: 2020 08 16

PATENT RESTRICTION DATE: 2020 09 10

(21) AP 2010 12443

(11) P 2015 6393 B

(73) GEOX S.P.A.

(54) **WATERPROOF AND VAPOR-PERMEABLE SHOE**

DATE OF CANCELLATION OF PATENT: 2020 03 12

PATENT RESTRICTION DATE: 2020 09 10

(21) AP 2010 12444

(11) P 2015 6394 B

(73) GEOX S.P.A.

(54) **METHOD FOR MANUFACTURING WATERPROOF AND VAPOR-PERMEABLE SHOE**

DATE OF CANCELLATION OF PATENT: 2020 03 12

PATENT RESTRICTION DATE: 2020 09 10

(21) AP 2013 13601

(11) P 2016 6547 B

(73) OFFICINE MACCAFERRI S.P.A.

(54) **GABION**

DATE OF CANCELLATION OF PATENT: 2020 03 07

PATENT RESTRICTION DATE: 2020 09 10

(21) AP 2015 14284

(11) P 2019 6984 B

(73) TAKEDA PHARMACEUTICAL COMPANY LIMITED

(54) **PYRIDAZINE DERIVATIVES FOR USE IN THE PREVENTION OR TREATMENT OF AN ATAXIC DISORDER**

DATE OF CANCELLATION OF PATENT: 2020 03 06

PATENT RESTRICTION DATE: 2020 09 10

(21) AP 2015 14362
(11) P 2019 7010 B
(73) GORDON MURRAY DESIGN LIMITED
(54) **VEHICLE CHASSIS STRUCTURES**
DATE OF CANCELLATION OF PATENT: 2020 06 25
PATENT RESTRICTION DATE: 2020 09 10

ABOLITION OF PATENTS WITH THE RIGHT TO RESTORE

(21) AP 2007 10194
(11) P 2012 5430 B
(73) Ramzan Gaitemirov
(54) **INTERNAL COMBUSTION ENGINE**
DATE OF CANCELLATION OF PATENT: 2020 07 25
THE TERM OF RESTORATION OF PATENT: 2021 07 25

(21) AP 2006 10576
(11) P 2010 5134 B
(73) THE TRUSTEES OF COLUMBIA UNIVERSITY IN THE CITY OF NEW YORK
(54) **AGENTS FOR PREVENTING AND TREATING DISORDERS INVOLVING MODULATION OF THE RYR RECEPTORS**
DATE OF CANCELLATION OF PATENT: 2020 08 17
THE TERM OF RESTORATION OF PATENT: 2021 08 17

(21) AP 2007 11714
(11) P 2012 5599 B
(73) MILLENNIUM PHARMACEUTICALS INC.
(54) **PROTEASOME INHIBITORS**
DATE OF CANCELLATION OF PATENT: 2020 08 06
THE TERM OF RESTORATION OF PATENT: 2021 08 06

(21) AP 2010 11902
(11) P 2012 5548 B
(73) LES LABORATOIRES SERVIER
(54) **NEW DIHIDROINDOLONE COMPOUNDS, A PROCESS FOR ITS PREPARATION AND PHARMACEUTICAL COMPOSITIONS CONTAINING THEM**
DATE OF CANCELLATION OF PATENT: 2020 07 30
THE TERM OF RESTORATION OF PATENT: 2021 07 30

(21) AP 2010 11918
(11) P 2011 5341 B
(73) ALLIED GLOBAL TOBACCO LIMITED
(54) **CIGARETTES WITHOUT THE FILTER**
DATE OF CANCELLATION OF PATENT: 2020 08 16
THE TERM OF RESTORATION OF PATENT: 2022 08 16

(21) AP 2011 12341
(11) P 2013 5990 B
(73) Vladimer Loladze;
Shakh Bakanidze;
Giorgi Loladze;

Nino Mskhiladze;
Vakhtang Pirmisashvili;
Vakhtang Loladze

(54) **POLYLAYER, MULTIFUNCTION ENVELOPE**
DATE OF CANCELLATION OF PATENT: 2020 08 18
THE TERM OF RESTORATION OF PATENT: 2021 08 18

(21) AP 2010 12624
(11) **P 2014 6113 B**
(73) SYNGENTA PARTICIPATIONS AG
(54) **MICROBIOCIDAL HETEROCYCLES**
DATE OF CANCELLATION OF PATENT: 2020 08 06
THE TERM OF RESTORATION OF PATENT: 2021 08 06

(21) AP 2010 12671
(11) **P 2014 6200 B**
(73) HEAT ON-THE-FLY LLC
(54) **WATER HEATING APPARATUS FOR CONTINUOUS HEATED WATER FLOW AND METHOD FOR USE IN HYDRAULIC FRACTURING**
DATE OF CANCELLATION OF PATENT: 2020 08 17
THE TERM OF RESTORATION OF PATENT: 2021 08 17

(21) AP 2012 12817
(11) **P 2014 6126 B**
(73) Tinatin Lezhava
(54) **DRYING EQUIPMENT**
DATE OF CANCELLATION OF PATENT: 2020 08 03
THE TERM OF RESTORATION OF PATENT: 2021 08 03

(21) AP 2011 13171
(11) **P 2015 6364 B**
(73) WUHAN KAIDI ENGINEERING TECHNOLOGY RESEARCH INSTITUTE CO., LTD
(54) **METHOD AND DEVICE FOR PREPARING HIGH TEMPERATURE WATER VAPOR RICH IN ACTIVE PARTICLES USING PLASMA**
DATE OF CANCELLATION OF PATENT: 2020 08 11
THE TERM OF RESTORATION OF PATENT: 2021 08 11

(21) AP 2013 13183
(11) **P 2016 6518 B**
(73) LTD "HEALTHY LIFE"
(54) **LIQUID MEDIUM CONTAINING MICROORGANISMS AND FERTILIZER DERIVED THEREFROM**
DATE OF CANCELLATION OF PATENT: 2020 08 02
THE TERM OF RESTORATION OF PATENT: 2021 08 02

(21) AP 2014 13559
(11) **P 2016 6511 B**
(73) Aleksandre Kvernadze
(54) **DEVICE FOR DISTILLING VODKA**
DATE OF CANCELLATION OF PATENT: 2020 08 25
THE TERM OF RESTORATION OF PATENT: 2021 08 25

(21) AP 2014 14046

(11) P 2018 6876 B

(73) PFIZER INC.

(54) **HETEROBICYCLOARYL RORC2 INHIBITORS AND METHODS OF USE THEREOF**

DATE OF CANCELLATION OF PATENT: 2020 07 24

THE TERM OF RESTORATION OF PATENT: 2021 07 24

(21) AP 2014 14098

(11) P 2018 6834 B

(73) Roberto PISANO

(54) **METAL PALLET WITH ASSEMBLABLE COMPONENTS**

DATE OF CANCELLATION OF PATENT: 2020 08 19

THE TERM OF RESTORATION OF PATENT: 2021 08 19

(21) AP 2014 14099

(11) P 2019 7033 B

(73) MACROGENICS INC.

(54) **BI-SPECIFIC MONOVALENT DIABODIES THAT ARE CAPABLE OF BINDING TO GPA33 AND CD3, AND USES THEREOF**

DATE OF CANCELLATION OF PATENT: 2020 08 20

THE TERM OF RESTORATION OF PATENT: 2021 08 20

(21) AP 2018 14843

(11) P 2020 7093 B

(73) Khatuna Amkoladze;

Tornike Kapanadze;

David Mosulishvili;

Dato Nachkebia;

Tinatin Gogishvili;

Ramaz Tkemaladze;

Zaur Chitidze;

Vakhtang Abaishvili;

Tamaz Mchedlishvili;

Zaur Balamtsarashvili;

Marine Kashibadze

(54) **AUTOMATIC LATHE PITCH CONVEYER CUTTING ORNAMENT**

DATE OF CANCELLATION OF PATENT: 2020 07 26

THE TERM OF RESTORATION OF PATENT: 2021 07 26

(21) AP 2016 14931

(11) P 2020 7060 B

(73) Sergei Aleksandrovich BUCHIK

(54) **FLOW SWITCH FOR A DEVICE FOR MANUALLY POURING FOAMED AND CARBONATED BEVERAGES**

DATE OF CANCELLATION OF PATENT: 2020 07 27

THE TERM OF RESTORATION OF PATENT: 2021 07 27

(21) AP 2003 9205

(11) P 2007 4128 B

(73) VALEANT INTERNATIONAL BERMUDA

(54) **MODIFIED-RELEASE TABLET OF BUPROPION HYDROCHLORIDE**

DATE OF CANCELLATION OF PATENT: 2020 08 08

THE TERM OF RESTORATION OF PATENT: 2021 08 08

(21) AP 2005 9830
(11) P 2012 5380 B
(73) GEOX S.P.A.
(54) **WATERPROOF AND BREATHABLE SOLE FOR SHOES**
DATE OF CANCELLATION OF PATENT: 2020 07 25
THE TERM OF RESTORATION OF PATENT: 2021 07 25

EXPIRATION OF TERM OF RESTORATION OF PATENTS

(21) AP 2008 10846
(11) P 2010 4986 B
(73) Elguja Kutelia;
David Gventsadze;
Olga Tsurtsunia;
Revaz Datiashvili;
Lia Gventsadze;
David Dzneladze
(54) **COMPOSITE FOR FRICTIONAL FACING**
DATE OF CANCELLATION OF PATENT: 2019 07 28
THE TERM OF RESTORATION OF PATENT VALIDITY HAS EXPIRED: 2020 07 28

(21) AP 2009 12125
(11) P 2014 6107 B
(73) ZINFANDEL PHARMACEUTICALS INC.
(54) **METHOD OF IDENTIFYING DISEASE RISK FACTORS**
DATE OF CANCELLATION OF PATENT: 2019 08 11
THE TERM OF RESTORATION OF PATENT VALIDITY HAS EXPIRED: 2020 08 11

(21) AP 2011 12338
(11) P 2013 5725 B
(73) Guram Dgebuadze;
Zaur Berishvili;
Sergo Sikharulidze
(54) **PLANAR MAGNETRON SPRAY DEVICE**
DATE OF CANCELLATION OF PATENT: 2019 08 12
THE TERM OF RESTORATION OF PATENT VALIDITY HAS EXPIRED: 2020 08 12

(21) AP 2011 12340
(11) P 2014 6144 B
(73) Tsiala Gabelia;
Spartak Urotadze;
Leila Japaridze;
Eter Salukvadze
(54) **METHOD OF REMEDY PREPARATION WITH ASKANCLAY**
DATE OF CANCELLATION OF PATENT: 2019 08 16
THE TERM OF RESTORATION OF PATENT VALIDITY HAS EXPIRED: 2020 08 16

(21) AP 2013 13192
(11) P 2015 6274 B
(73) Zurab Tskitishvili

(54) **METHOD OF "NADUGI" PREPARATION**

DATE OF CANCELLATION OF PATENT: 2019 08 13

THE TERM OF RESTORATION OF PATENT VALIDITY HAS EXPIRED: 2020 08 13

(21) AP 2013 13193

(11) P 2015 6275 B

(73) Zurab Tskitishvili

(54) **METHOD FOR COTTAGE CHEESE PRODUCTION WITH RESTORED MILK AND EQUIPMENT EMBODYING THEREOF**

DATE OF CANCELLATION OF PATENT: 2019 08 13

THE TERM OF RESTORATION OF PATENT VALIDITY HAS EXPIRED: 2020 08 13

(21) AP 2012 13424

(11) P 2016 6522 B

(73) MILLENNIUM PHARMACEUTICALS INC.

(54) **INHIBITORS OF NEDD8-ACTIVATING ENZYME**

DATE OF CANCELLATION OF PATENT: 2019 08 23

THE TERM OF RESTORATION OF PATENT VALIDITY HAS EXPIRED: 2020 08 23

(21) AP 2013 13757

(11) P 2017 6748 B

(73) BOEHRINGER INGELHEIM INTERNATIONAL GMBH

(54) **HETEROAROMATIC COMPOUNDS AS BRUTON'S TYROSINE KINASE (BTK) INHIBITORS**

DATE OF CANCELLATION OF PATENT: 2019 08 08

THE TERM OF RESTORATION OF PATENT VALIDITY HAS EXPIRED: 2020 08 08

(21) AP 2014 14052

(11) P 2018 6803 B

(73) OTKRYTOYE AKTSIONERNOE OBSHCHESTVO (JSC) "KRASNOYARS- KIY ZAVOD TSVETNYKH METALLOV IMENI V.N. GULIDOVA"

(54) **PLATINUM ALLOY FOR CATALYST GAUZES**

DATE OF CANCELLATION OF PATENT: 2019 08 06

THE TERM OF RESTORATION OF PATENT VALIDITY HAS EXPIRED: 2020 08 06

(21) AP 2014 14076

(11) P 2017 6794 B

(73) MACROGENICS INC.

(54) **BI-SPECIFIC MONOVALENT FC DIABODIES THAT ARE CAPABLE OF BINDING CD32B AND CD79B AND USES THEREOF**

DATE OF CANCELLATION OF PATENT: 2019 08 06

THE TERM OF RESTORATION OF PATENT VALIDITY HAS EXPIRED: 2020 08 06

(21) AP 2015 14324

(11) P 2018 6894 B

(73) OTKRYTOYE AKTSIONERNOE OBSHCHESTVO (JSC) "KRASNOYARS- KIY ZAVOD TSVETNYKH METALLOV IMENI V.N. GULIDOVA"

(54) **PLATINUM-BASED ALLOY FOR CATALYST GAUZES**

DATE OF CANCELLATION OF PATENT: 2019 08 13

THE TERM OF RESTORATION OF PATENT VALIDITY HAS EXPIRED: 2020 08 13

(21) AP 2017 14569
(11) P 2018 6915 B
(73) LTD "ECOI"
(54) **DEVICE FOR SYNTHETIC GAS PRODUCTION**
DATE OF CANCELLATION OF PATENT: 2019 08 15
THE TERM OF RESTORATION OF PATENT VALIDITY HAS EXPIRED: 2020 08 15

(21) AP 2003 8598
(11) P 2007 4047 B
(73) PHARMACIA CORPORATION
(54) **PRAMIPEXOLE ONCE-DAILY DOSAGE FORM**
DATE OF CANCELLATION OF PATENT: 2019 07 25
THE TERM OF RESTORATION OF PATENT VALIDITY HAS EXPIRED: 2020 07 25

(21) AP 2003 8703
(11) P 2006 3996 B
(73) OTSUKA PHARMACEUTICAL CO., LTD
(54) **ARIPIRAZOLE COMPLEX FORMULATION AND USE THEREOF**
DATE OF CANCELLATION OF PATENT: 2019 08 14
THE TERM OF RESTORATION OF PATENT VALIDITY HAS EXPIRED: 2020 08 14

EXPIRATION OF PATENTS

(21) AP 2000 6371
(11) P 2005 3685 B
(73) BIOGEN INC.;
APOTECH R & D S.A.
(54) **BAFF RECEPTOR (BCMA), AN IMMUNOREGULATORY AGENT**
EXPIRATION DATE OF PATENT: 16 08 2020

(21) AP 2000 6390
(11) P 2005 3582 B
(73) CHAINA PETROLEUM END CHEMICAL CORPORATION
(54) **SORBENT COMPOSITION, PROCESS FOR ITS PRODUCTION AND USE IN
DESULFURIZATION**
EXPIRATION DATE OF PATENT: 09 08 2020

(21) AP 2000 6391
(11) P 2005 3583 B
(73) CHAINA PETROLEUM END CHEMICAL CORPORATION
(54) **SORBENT COMPOSITION, PROCESS FOR ITS PRODUCTION AND USE IN
DESULFURIZATION**
EXPIRATION DATE OF PATENT: 09 08 2020

CHANGES OF NAME AND/OR ADDRESS OF PATENTOWNER

(21) AP 2015 14386

(11) P 2019 7000 B

(54) **FRANCIS TURBINE WITH SHORT BLADE AND SHORT BAND**

New name and/or address: ANDRITZ HYDRO CANADA Inc. (CA)
6100 Trans Canada Highway, Pointe-Claire CANADA H9R 1B9 (CA)

Former name and/or address: ANDRITZ HYDRO LTD
6100 Trans-Canada Highway, Pointe-Claire, Québec H9R 1B9 Canada

DATE OF REGISTRATION: 27 08 2020

UTILITY MODELS

ABOLITION OF PATENT WITH THE RIGHT TO RESTORE

(21) AU 2015 13918

(11) U 2017 1934 Y

(73) LTD "Scientific Technological Pharmaceutical Firm "POLYSAN""

(54) **MEDICINAL PREPARATION FOR ORAL INTAKE**

DATE OF CANCELLATION OF PATENT: 2020 08 25

THE TERM OF RESTORATION OF PATENT: 2021 08 25

(21) AU 2017 14575

(11) U 2018 1986 Y

(73) Elguja Shengelia

(54) **METHOD FOR ART EDITION PRODUCTION**

DATE OF CANCELLATION OF PATENT: 2020 08 18

THE TERM OF RESTORATION OF PATENT: 2021 08 18

TRANSFER OF RIGHT

(21) AU 2019 14985

(11) U 2020 2037 Y

(54) **CURRENCY EXCHANGE TERMINAL**

New name and/or address: LLC "Global Ex" (GE)
Konstantine Stanislavskiy St. 5, app. 27, Didube district, Tbilisi, Georgia (GE)

Former name and/or address: Levan Sharangia
Svanidze Exit 7, Sukhumi, Georgia (GE)

DATE OF REGISTRATION: 27 08 2020

DESIGNS**EXTENSION OF REGISTRATION OF DESIGNS****(11) D 2016 673 S**

(73) Hayat Kimya Sanayi A.Ş. (TR)

Mahir Iz Caddesi No: 25 Altunizade üsküdar, Istanbul, Turkey (TR)

(54) LOGO

(28) 1

(24) 2015 07 27

(18) 2025 07 27

(58) 2020 08 24

(11) D 2016 674 S

(73) Hayat Kimya Sanayi A.Ş. (TR)

Mahir Iz Caddesi No: 25 Altunizade üsküdar, Istanbul, Turkey (TR)

(54) CARTOON CHARACTERS GRAPHICAL IMAGE

(28) 8

(24) 2015 07 27

(18) 2025 07 27

(58) 2020 08 24

CANCELLATION OF DESIGNS REGISTRATION**(11) D 2010 445 S**

(73) FIRAT PLASTIK KAUÇUK SANAYI VE TIKARET ANONİM ŞİRKETİ (TR)

Türkoba Köyü P.K.: 12 Büyükçekmece, 34907 Istanbul, Turkey (TR)

(54) DRAINAGE SYSTEM ELEMENTS

(18) 2020 02 17

(58) 2020 08 27

(11) D 2015 620 S

(73) Bondo Kalandadze (GE)

Larsi Lane 5, app. 12, 0179, Tbilisi, Georgia (GE)

(54) BOTTLE

(18) 2020 02 09

(58) 2020 08 19

(11) D 2015 637 S

(73) JSC "LIBERTY BANK" (GE)

I. Chavchavadze Av. 74, 0162, Tbilisi, Georgia (GE)

(54) EASYPAY TERMINAL

(18) 2020 02 16

(58) 2020 08 27

(11) D 2015 621 S

(73) LTD "Geo Auto 1" (GE)

Near D. Aghmashenebeli Alley 4, 0131, Tbilisi, Georgia (GE)

(54) BOTTLE

(18) 2020 02 20
(58) 2020 09 02

(11) D 2015 639 S

(73) Nodar Chalelishvili (GE)
Vardisubani St. 1, app. 15, 0141, Tbilisi, Georgia (GE)

(54) FESTIVAL CANDLE

(18) 2020 02 24
(58) 2020 09 02

EXTENSION OF REGISTRATION OF INTERNATIONAL DESIGNS

(11) DM/66792
(73) SWATCH AG (SWATCH SA) (SWATCH LTD.)
94, Rue Jakob Stämpfli, CH-2502 BIENNE (CH)
(15) 2005 07 01
(24) 2005 07 01
(18) 2025 07 01
(28) 1
(28') 1
(54) Wristwatch

(11) DM/66793
(73) SWATCH AG (SWATCH SA) (SWATCH LTD.)
94, Rue Jakob Stämpfli, CH-2502 BIENNE (CH)
(15) 2005 07 01
(24) 2005 07 01
(18) 2025 07 01
(28) 5
(28') 5
(54) Wristwatches

(11) DM/66802
(73) SWATCH AG (SWATCH SA) (SWATCH LTD.)
94, Rue Jakob Stämpfli, CH-2502 BIENNE (CH)
(15) 2005 07 01
(24) 2005 07 01
(18) 2025 07 01
(28) 2
(28') 2
(54) Wristwatches

(11) DM/66803
(73) SWATCH AG (SWATCH SA) (SWATCH LTD.)
94, Rue Jakob Stämpfli, CH-2502 BIENNE (CH)
(15) 2005 07 01
(24) 2005 07 01
(18) 2025 07 01
(28) 1
(28') 1
(54) Wristwatch

(11) DM/66805
(73) SWATCH AG (SWATCH SA) (SWATCH LTD.)
94, Rue Jakob Stämpfli, CH-2502 BIENNE (CH)
(15) 2005 07 01
(24) 2005 07 01
(18) 2025 07 01
(28) 1
(28') 1
(54) Watch case

(11) DM/66806
(73) SWATCH AG (SWATCH SA) (SWATCH LTD.)
94, Rue Jakob Stämpfli, CH-2502 BIENNE (CH)
(15) 2005 07 01
(24) 2005 07 01
(18) 2025 07 01
(28) 1
(28') 1
(54) Wristwatch

(11) DM/66807
(73) SWATCH AG (SWATCH SA) (SWATCH LTD.)
94, Rue Jakob Stämpfli, CH-2502 BIENNE (CH)
(15) 2005 07 01
(24) 2005 07 01
(18) 2025 07 01
(28) 2
(28') 2
(54) Wristwatches

(11) DM/66810
(73) SWATCH AG (SWATCH SA) (SWATCH LTD.)
94, Rue Jakob Stämpfli, CH-2502 BIENNE (CH)
(15) 2005 07 01
(24) 2005 07 01
(18) 2025 07 01
(28) 1
(28') 1
(54) Watch case

(11) DM/66811
(73) SWATCH AG (SWATCH SA) (SWATCH LTD.)
94, Rue Jakob Stämpfli, CH-2502 BIENNE (CH)
(15) 2005 07 01
(24) 2005 07 01
(18) 2025 07 01
(28) 1
(28') 1
(54) Wristwatch

(11) DM/66812
(73) SWATCH AG (SWATCH SA) (SWATCH LTD.)
94, Rue Jakob Stämpfli, CH-2502 BIENNE (CH)
(15) 2005 07 01

(24) 2005 07 01
(18) 2025 07 01
(28) 1
(28') 1
(54) Wristwatch

(11) DM/66860
(73) SWATCH AG (SWATCH SA) (SWATCH LTD.)
94, Rue Jakob Stämpfli, CH-2502 BIENNE (CH)
(15) 2005 07 19
(24) 2005 07 19
(18) 2025 07 19
(28) 1
(28') 1
(54) Wristwatch

(11) DM/66861
(73) SWATCH AG (SWATCH SA) (SWATCH LTD.)
94, Rue Jakob Stämpfli, CH-2502 BIENNE (CH)
(15) 2005 07 19
(24) 2005 07 19
(18) 2025 07 19
(28) 1
(28') 1
(54) Wristwatch

(11) DM/66862
(73) SWATCH AG (SWATCH SA) (SWATCH LTD.)
94, Rue Jakob Stämpfli, CH-2502 BIENNE (CH)
(15) 2005 07 19
(24) 2005 07 19
(18) 2025 07 19
(28) 5
(28') 5
(54) Wristwatches

(11) DM/66864
(73) SWATCH AG (SWATCH SA) (SWATCH LTD.)
94, Rue Jakob Stämpfli, CH-2502 BIENNE (CH)
(15) 2005 07 19
(24) 2005 07 19
(18) 2025 07 19
(28) 1
(28') 1
(54) Wristwatch

(11) DM/66874
(73) MONTRES BREGUET S.A.
CH-1344 L'ABBAYE (CH)
(15) 2005 07 26
(24) 2005 07 26
(18) 2025 07 26
(28) 1

(28') 1
(54) Watch

(11) DM/66906
(73) ROLEX SA
rue François-Dussaud 3-5-7, CH-1211 Genève 26 (CH)
(15) 2005 08 12
(24) 2005 08 12
(18) 2025 08 12
(28) 12
(28') 12
(54) 1., 4., 7., 10. Watches; 2., 5., 8., 11. Watch cases; 3., 6., 9., 12. Watch dials

(11) DM/66939
(73) SWATCH AG (SWATCH SA) (SWATCH LTD.)
94, Rue Jakob Stämpfli, CH-2502 BIENNE (CH)
(15) 2005 08 05
(24) 2005 08 05
(18) 2025 08 05
(28) 4
(28') 4
(54) Watch bands

(11) DM/66945
(73) SWATCH AG (SWATCH SA) (SWATCH LTD.)
94, Rue Jakob Stämpfli, CH-2502 BIENNE (CH)
(15) 2005 08 05
(24) 2005 08 05
(18) 2025 08 05
(28) 3
(28') 3
(54) Wristwatches

(11) DM/67042
(73) BRAUN GMBH
Frankfurter Str. 145, 61476 Kronberg (DE)
(15) 2005 08 29
(24) 2005 08 29
(18) 2025 08 29
(28) 1
(28') 1
(54) Handle for an electric toothbrush

(11) DM/72834
(73) MAKEL ELEKTRİK MALZEMELERİ SANAYİ VE TİCARET ANONİM ŞİRKETİ
İstiklal Mahallesi Maresal, Fevzi Çakmak Caddesi No:38, KIRAC ESENYURT-İSTANBUL (TR)
(15) 2009 12 30
(24) 2009 12 30
(18) 2024 12 30
(28) 2
(28') 2
(54) Electric materials

(11) DM/73973
(73) BLANCPAIN SA
Le Rocher 12, CH-1348 LE BRASSUS (CH)
(15) 2010 07 20
(24) 2010 07 20
(18) 2025 07 20
(28) 7
(28') 7
(54) Watches

(11) DM/73974
(73) BLANCPAIN SA
Le Rocher 12, CH-1348 LE BRASSUS (CH)
(15) 2010 07 22
(24) 2010 07 22
(18) 2025 07 22
(28) 1
(28') 1
(54) Watch

(11) DM/73975
(73) SWATCH AG (SWATCH SA) (SWATCH LTD.)
Jakob-Stämpfli-Strasse 94, CH-2502 Biel/Bienne (CH)
(15) 2010 07 22
(24) 2010 07 22
(18) 2025 07 22
(28) 3
(28') 3
(54) Display stands

(11) DM/86492
(73) JOINT STOCK COMPANY LOMISI
Village Natakhtari, Mtskheta Region (GE)
(15) 2015 05 04
(24) 2015 05 04
(18) 2025 05 04
(28) 1
(28') 1
(54) Bottle

(11) DM/86840
(73) SWATCH AG (SWATCH SA) (SWATCH LTD.)
Jakob-Stämpfli-Strasse 94, CH-2502 Biel/Bienne (CH)
(15) 2015 06 30
(24) 2015 06 30
(18) 2025 06 30
(28) 2
(28') 2
(54) Wristwatches

(11) DM/86949
(73) HARRY WINSTON SA
Chemin du Tourbillon 8, CH-1228 Plan-les-Ouates (CH)
(15) 2015 07 08

(24) 2015 07 08
(18) 2025 07 08
(28) 3
(28') 3
(54) 1. Earring,2. Bracelet,3. Earring

(11) DM/87003
(73) SWATCH AG (SWATCH SA) (SWATCH LTD.)
Jakob-Stämpfli-Strasse 94, CH-2502 Biel/Bienne (CH)
(15) 2015 07 17
(24) 2015 07 17
(18) 2025 07 17
(28) 2
(28') 2
(54) Dial,Wristwatch

(11) DM/87044
(73) HARRY WINSTON SA
Chemin du Tourbillon 8, CH-1228 Plan-les-Ouates (CH)
(15) 2015 07 24
(24) 2015 07 24
(18) 2025 07 24
(28) 3
(28') 3
(54) 1.-2. Pendants,3. Earring

(11) DM/87046
(73) SOREMARTEC S.A.
Findel Business Center, Complexe B, Rue de Trèves, L-2632 Findel (BX)
(15) 2015 07 14
(24) 2015 07 14
(18) 2025 07 14
(28) 4
(28') 4
(54) Confectionery products

(11) DM/87060
(73) IZIDA OOD
ul. Angel Stoyanov No.2, BG-9301 Dobrich (BG)
(15) 2015 07 16
(24) 2015 07 16
(18) 2025 07 16
(28) 1
(28') 1
(54) Ice cream

(11) DM/87209
(73) HARRY WINSTON SA
Chemin du Tourbillon 8, CH-1228 Plan-les-Ouates (CH)
(15) 2015 07 31
(24) 2015 07 31
(18) 2025 07 31
(28) 1

(28') 1
(54) Necklace

(11) DM/87275
(73) HARRY WINSTON SA
Chemin du Tourbillon 8, CH-1228 Plan-les-Ouates (CH)
(15) 2015 08 19
(24) 2015 08 19
(18) 2025 08 19
(28) 3

(28') 3
(54) 1. Bracelet, 2. Earring, 3. Bracelet

(11) DM/87393
(73) SWATCH AG (SWATCH SA) (SWATCH LTD.)
Jakob-Stämpfli-Strasse 94, CH-2502 Biel/Bienne (CH)
(15) 2015 08 26
(24) 2015 08 26
(18) 2025 08 26
(28) 3
(28') 3
(54) Wristwatches

(11) DM/87439
(73) HARRY WINSTON SA
Chemin du Tourbillon 8, CH-1228 Plan-les-Ouates (CH)
(15) 2015 08 31
(24) 2015 08 31
(18) 2025 08 31
(28) 1
(28') 1
(54) Bracelet

(11) DM/87598
(73) ROLEX SA
3-5-7 rue François-Dussaud, CH-1211 Genève 26 (CH)
(15) 2015 08 26
(24) 2015 08 26
(18) 2025 08 26
(28) 16
(28') 16
(54) Timepiece movement, Watch, Watch bracelet clasp, Watch cases, Watch dials, Watch rim, Watch rims

(11) DM/87767
(73) FONTINI S.A.
Pol. Ind. Can Bernades-Subira, C/Anoia 15, E-08130 Santa Perpetua de Mogoda (Barcelona) (ES)
(15) 2015 09 22
(24) 2015 09 22
(18) 2025 09 22
(28) 1

(28') 1
(54) Switch

(11) DM/87768
(73) FONTINI S.A.
Pol. Ind. Can Bernades-Subira, C/Anoia 15, E-08130 Santa Perpetua de Mogoda (Barcelona) (ES)
(15) 2015 09 22
(24) 2015 09 22
(18) 2025 09 22
(28) 1
(28') 1
(54) Switch

(11) DM/87769
(73) FONTINI S.A.
Pol. Ind. Can Bernades-Subira, C/Anoia 15, E-08130 Santa Perpetua de Mogoda (Barcelona) (ES)
(15) 2015 09 22
(24) 2015 09 22
(18) 2025 09 22
(28) 1
(28') 1
(54) Switch

(11) DM/88289
(73) SDDS CORPORATION
21 B avenue du Général de Gaulle, F-66000 PERPIGNAN (FR)
(15) 2015 07 11
(24) 2015 07 11
(18) 2025 07 11
(28) 1
(28') 1
(54) Sports training apparatus

TRADEMARKS**RENEWAL OF REGISTRATIONS**

(111) M 2000 13521 R2
(156) 2000 10 10
(186) 2030 10 10
(732) DURACELL BATTERIES BVBA
Nijverheidslaan 7, 3220 Aarschot, Belgium

(111) M 2000 13507 R2
(156) 2000 09 28
(186) 2030 09 28
(732) Danfoss A/S
DK-6430 Nordborg, Denmark

(111) M 2000 13508 R2
(156) 2000 09 28
(186) 2030 09 28
(732) Danfoss A/S
DK-6430 Nordborg, Denmark

(111) M 2000 13423 R2
(156) 2000 07 12
(186) 2030 07 12
(732) SEGAFREDO-ZANETTI S.p.A.,
an Italian joint stock company
Via Puccini 1, Sesto di Rastignano
(province of Bologna), Italy

(111) M 2000 13648 R2
(156) 2000 12 21
(186) 2030 12 21
(732) BAXI HEATING UK LIMITED
Brooks House, Coventry Road, Warwick,
Wareickshire, CV43 4LL,
United Kingdom

(111) M 2001 13680 R2
(156) 2001 01 22
(186) 2031 01 22
(732) PT SUMATRA TOBACCO TRADING
COMPANY
Jalan Pattimura No. 3, Pematang Siantar,
Sumatera Utara, Indonesia

(111) M 2010 20873 R1
(156) 2010 10 27
(186) 2030 10 27

(732) ALTINBAS HOLDING ANONIM SIRKETI
Altinbas Plaza, Mahmutbey Dilmenler Cad.
No:26 34217 Bagcilar Istanbul, Turkey

(111) M 2010 20265 R1
(156) 2010 02 15
(186) 2030 02 15
(732) LTD "PEANI"
Kavtaradze str.27, 0186, Tbilisi,
Georgia

(111) M 2010 20223 R1
(156) 2010 01 29
(186) 2030 01 29
(732) LTD "ALLIANCE KOR"
Kandelaki str. 37, 0160, Tbilisi,
Georgia

(111) M 2010 20269 R1
(156) 2010 02 15
(186) 2030 02 15
(732) LEPL Tbilisi State Medical University
Vazha-Pshavela Av. 33, Tbilisi,
Georgia

(111) M 2010 20636 R1
(156) 2010 08 16
(186) 2030 08 16
(732) Rautaruukki Oyj
Panuntie 11, 00620 Helsinki, Finland

(111) M 2010 20823 R1
(156) 2010 10 15
(186) 2030 10 15
(732) Mikayel Vardanyan
Bairon St. 3, app. 38, Yerevan,
Armenia

(111) M 2010 20757 R1
(156) 2010 09 17
(186) 2030 09 17
(732) JSC "LIBERTY BANK"
Ilia Chavchavadze Av. 74, 0162, Tbilisi,
Georgia

(111) M 2010 20758 R1
(156) 2010 09 17
(186) 2030 09 17
(732) JSC "LIBERTY BANK"
Ilia Chavchavadze Av. 74, 0162, Tbilisi,
Georgia

(111) M 2010 20760 R1
(156) 2010 09 17
(186) 2030 09 17
(732) JSC "LIBERTY BANK"
Ilia Chavchavadze Av. 74, 0162, Tbilisi,
Georgia

COMPLETE TRANSFER OF RIGHTS

(111) M 2010 20269 R
(732) LEPL Tbilisi State Medical University
Vazha-Pshavela Av. 33, Tbilisi, Georgia
(770) LEPL I. Kutateladze Pharmacochemical
Institute
P. Sarajishvili St. 36, 0159, Tbilisi, Georgia
(580) 2020 08 20

(111) M 1997 5377 R
(732) Tungsram Operations Kft.
Váci út 77, H-1044 Budapest, Hungary
(770) GE Hungary Ipari és Kereskedelmi Korlátolt
Felelősségű Társaság (abbrev. - GE Hungary
KFT) (in foreign languages: GE Hungary
Industrial and
Trading Company Limited by Shares (abbrev.
GE Hungary Co. Ltd)
1138 Budapest, Bence utca 1., Váci Greens B.
ép., Hungary
(580) 2020 08 12

CHANGES OF NAMES AND/OR ADDRESS OF OWNERS

(111) M 2000 13596 R
(732) Pfizer Health AB
Vetenskapsvägen 10, 191 90, Sollentuna,
Sweden
(770) Pfizer Health AB
11287 Stockholm, Sweden
(580) 2020 09 02

(111) M 2000 13597 R
(732) Pfizer Health AB
Vetenskapsvägen 10, 191 90, Sollentuna,
Sweden
(770) Pfizer Health AB
11287 Stockholm, Sweden
(580) 2020 09 02

(111) M 2001 13680 R
(732) PT SUMATRA TOBACCO TRADING
COMPANY
Jalan Pattimura No. 3, Pematang Siantar,
Sumatera Utara, Indonesia
(770) N.V. SUMATRA TOBACCO TRADING
COMPANY
Jln. Pattimura No3, Pematang Siantar,
Sumatera Utara, Indonesia
(580) 2020 08 07

(111) M 2010 20636 R
(732) Rautaruukki Oyj
Panuntie 11, 00620 Helsinki, Finland
(770) Rautaruukki Oyj
Suolakivenkatu 1, 00810 Helsinki,
Finland
(580) 2020 08 15

(111) M 1997 5377 R
(732) GE Hungary Ipari és Kereskedelmi Korlátolt
Felelősségű Társaság (abbrev. - GE Hungary
KFT) (in foreign languages: GE Hungary
Industrial and Trading Company Limited by
Shares (abbrev. GE Hungary Co. Ltd)
1138 Budapest, Bence utca 1., Váci Greens B.
ép., Hungary
(770) GE Hungary Ipari és Kereskedelmi Korlátolt
Felelősségű Társaság (abbrev. - GE Hungary
KFT) (in foreign languages: GE Hungary
Industrial and Trading Company Limited by
Shares (abbrev. GE Hungary Co. Ltd)
1044 Budapest, Váci út 77, Hungary
(580) 2020 08 12

(111) M 2015 26335 R
(732) LTD "KANTI"
Shandor Petefi St. 4, 0190, Isani District,
Tbilisi, Georgia
(770) LTD "KANTI"
Samgori Lane 4 (Plot 8/89), 0120, Tbilisi
Georgia
(580) 2020 08 26

(111) M 2015 26628 R
(732) LTD "KANTI"
Shandor Petefi St. 4, 0190, Isani District,
Tbilisi, Georgia
(770) LTD "KANTI"
Samgori Lane 4 (Plot 8/89), 0120, Tbilisi
Georgia
(580) 2020 08 26

(111) M 2018 29365 R
(732) "International Masis Tabak" LLC
10 Hrant Vardanyan str., 0802 Masis, Ararat
region, Armenia
(770) "International Masis Tabak" LLC
10 Gortsaranayin str., Industrial zone, 0802
Masis, Ararat region, Armenia
(580) 2020 08 21

TERMINATION OF TRADEMARKS REGISTRATION

(111) M 2010 20230 R (151) 2010 02 15 (732) Payless ShoeSource Worldwide Inc. Jayhawk Towers, 700 SW Jackson Street, Suite 202, Topeka, KS 66603, USA (141) 2020 09 01	Zazishvili St. 43, 0101, Tbilisi, Georgia (141) 2020 09 01
(111) M 2010 20231 R (151) 2010 02 15 (732) Payless ShoeSource Worldwide Inc. Jayhawk Towers, 700 SW Jackson Street, Suite 202, Topeka, KS 66603, USA (141) 2020 09 01	(111) M 2010 20240 R (151) 2010 02 15 (732) Lasha Babuadze Zazishvili St. 43, 0101, Tbilisi, Georgia (141) 2020 09 01
(111) M 2010 20232 R (151) 2010 02 15 (732) Payless ShoeSource Worldwide Inc. Jayhawk Towers, 700 SW Jackson Street, Suite 202, Topeka, KS 66603, USA (141) 2020 08 31	(111) M 2010 20241 R (151) 2010 02 15 (732) LTD "PARADISE" S. Chikovani St. 20/36, 0177, Tbilisi, Georgia (141) 2020 09 01
(111) M 2010 20235 R (151) 2010 02 15 (732) JSC "TBILCHEMPHARM" Tsuladze St. 34, 0113, Tbilisi, Georgia (141) 2020 09 01	(111) M 2010 20242 R (151) 2010 02 15 (732) LLC "Aleksandrovy cellars" Altufevskoe highway 79 "A", p. 25, Moscow, Russian Federation (141) 2020 09 01
(111) M 2010 20236 R (151) 2010 02 15 (732) Pakshoo Chemical & Manufacturing Co N31, second alley, Pakistan st., Abbas Abad Ave. Tehran, Islamic Republic of Iran (141) 2020 09 01	(111) M 2010 20243 R (151) 2010 02 15 (732) LTD "Business Consulting Company" Tovstonogov St.13, 0112, Tbilisi, Georgia (141) 2020 09 01
(111) M 2010 20237 R (151) 2010 02 15 (732) Lasha Babuadze Zazishvili St. 43, 0101, Tbilisi, Georgia (141) 2020 08 31	(111) M 2010 20245 R (151) 2010 02 15 (732) LTD "TRADE HOUSE" Varketili 3, IV mcr., corp. 413, app. 82, 0163, Tbilisi, Georgia (141) 2020 09 01
(111) M 2010 20238 R (151) 2010 02 15 (732) LTD "YAMUNA GEORGIA" Giorgi Brtskinvale St. 1, corp. 1, Vake- Saburtalo District, Tbilisi, Georgia (141) 2020 09 01	(111) M 2010 20246 R (151) 2010 02 15 (732) Kakhaber Sutidze Cagareli St. 43, 0194, Tbilisi, Georgia (141) 2020 09 01
(111) M 2010 20239 R (151) 2010 02 15 (732) Lasha Babuadze	(111) M 2010 20247 R (151) 2010 02 15 (732) JSC "TBILCHEMPHARM" Tsuladze St. 34, 0113, Tbilisi, Georgia (141) 2020 09 01

(111) M 2010 20248 R
(151) 2010 02 15
(732) JSC "TBILCHEMPHARM"
Tsuladze St. 34, 0113, Tbilisi, Georgia
(141) 2020 08 31

(111) M 2010 20228 R
(151) 2010 02 10
(732) LTD "RAFSODY 11"
Kakheti Highway, Lilo Shop 112a, 0109,
Tbilisi, Georgia
(141) 2020 08 25

(111) M 2010 20227 R
(151) 2010 02 10
(732) LTD "RAFSODY 11"
Kakheti Highway, Lilo Shop 112a, 0109,
Tbilisi, Georgia
(141) 2020 08 25

(111) M 2010 20250 R
(151) 2010 02 15
(732) The Coca-Cola Company
One Coca-Cola Plaza, Atlanta, Georgia
30313, USA
(141) 2020 09 01

(111) M 2010 20251 R
(151) 2010 02 15
(732) LTD "Alliance Media Group"
Baratashvili St., app. 12, 0105, Tbilisi,
Georgia
(141) 2020 08 31

(111) M 2010 20253 R
(151) 2010 02 15
(732) Japan Tobacco Inc.
2-2-1, Toranomom, Minato-ku, Tokyo, Japan
(141) 2020 08 31

(111) M 2010 20254 R
(151) 2010 02 15
(732) Philip Morris Brands SARL
Quai Jeanrenaud 3, 2000 Neuchâtel,
Switzerland
(141) 2020 09 01

(111) M 2010 20256 R
(151) 2010 02 15
(732) GlaxoSmithKline Consumer Healthcare (UK)
IP Limited

980 Great West Road, Brentford, Middlesex
TW8 9GS, United Kingdom
(141) 2020 09 01

(111) M 2010 20258 R
(151) 2010 02 15
(732) Japan Tobacco Inc.
2-2-1, Toranomom, Minato-ku, Tokyo, Japan
(141) 2020 09 01

(111) M 2010 20262 R
(151) 2010 02 15
(732) British American Tobacco (Brands) Inc.
(a Delaware corporation)
251 Little Falls Drive, Suite 100, Delaware,
19808-1674, Wilmington, USA
(141) 2020 09 01

(111) M 2010 20263 R
(151) 2010 02 15
(732) LTD "BEZEKI"
Samgori Lane 5, 0120, Tbilisi, Georgia
(141) 2020 09 01

(111) M 2010 20267 R
(151) 2010 02 15
(732) NOVARTIS AG
4002 Basel, Switzerland
(141) 2020 09 01

(111) M 2010 20268 R
(151) 2010 02 15
(732) LTD "HAMAKI"
Ilia Chavchavadzis Av.75, corp. 10,
app. 46, 0179, Tbilisi, Georgia
(141) 2020 09 01

REGISTRATION OF LICENSE AGREEMENTS

(111) M 2000 13290 R
(732) STADA ARZNEIMITTEL AG
Stadastrasse 2-18, D-61118 Bad Vilbel,
Germany
(791) JSC "Nizhniy Novgorod ChemicalPharmacist
Factory (AO "Nizpharm")
Ul. Salganskaya dom.7, 603950, Nizhniy
Novgorod, Russian Federation
(793) 1606
(793) 20 08 2020 – For the validity of the mark
(793) Special
(793) 5

(111) M 2015 26280 R
(732) LTD "TELAVI DISTILERY"
Sh. Nucubidze St. 14, app. 60, 0186, Tbilisi,
Georgia
(791) LTD "Wine Culture"
T. Tabidze St. 106, Office 2, Vake
District, Tbilisi, Georgia
(793) 1607
(793) 28 05 2020 – For the validity of the mark
(793) Special
(793) 33, 35

(111) M 2017 28239 R
(732) LTD "TELAVI DISTILERY"
Sh. Nucubidze St. 14, app. 60, 0186, Tbilisi,
Georgia
(791) LTD "Wine Culture"
T. Tabidze St. 106, Office 2, Vake
District, Tbilisi, Georgia
(793) 1608
(793) 28 05 2020 – For the validity of the mark
(793) Special
(793) 33, 35

CLASSIFICATION INDEXES

INVENTIONS

CONCORDANCE TABLE OF INTERNATIONAL CLASSIFICATION INDEX AND PUBLICATION NUMBERS

INTERNATIONAL CLASSIFICATION INDEXES (51)	NUMBER OF PUBLISHED APPLICATION (10)
B 05 B 17/08	AP 2020 15052 A
C 07 K 16/18	AP 2020 14957 A
F 22 B 1/28; H 05 B 6/10	AP 2020 15260 A
G 01 T 1/00	AP 2020 15190 A

CONCORDANCE TABLE OF PUBLICATION NUMBERS AND INTERNATIONAL CLASSIFICATION INDEX

NUMBER OF PUBLISHED APPLICATION (10)	INTERNATIONAL CLASSIFICATION INDEXES (51)
AP 2020 14957 A	C 07 K 16/18
AP 2020 15052 A	B 05 B 17/08
AP 2020 15190 A	G 01 T 1/00
AP 2020 15260 A	F 22 B 1/28; H 05 B 6/10

CONCORDANCE TABLE OF INTERNATIONAL CLASSIFICATION INDEX, PATENT NUMBERS AND PUBLICATION NUMBERS

INTERNATIONAL CLASSIFICATION INDEX (51)	NUMBER OF PATENT (11)	NUMBER OF PUBLISHED APPLICATION (10)
A 01 N 35/04; A 01 N 25/00; A 01 N 25/30; A 01 N 43/40; A 01 P 3/00	P 2020 7148 B	AP 2020 14917 A
A 61 K 31/506; A 61 P 7/02; A 61 P 25/30; A 61 P 9/00; A 61 P 37/00; A 61 P 3/06; A 61 P 3/10; A 61 P 25/02; A 61 P 35/00; C 07 D 403/14; C 07 D 403/04; C 07 D 401/14	P 2020 7147 B	AP 2020 14820 A
A 61 K 49/10; C 07 C 229/16; C 07 D 257/02	P 2020 7146 B	AP 2020 14664 A
B 61 B 7/00	P 2020 7150 B	AP 2020 15002 A
C 07 D 231/12; C 07 D 233/64; C 07 D 413/04; C 07 D 413/06; C 07 D 413/10; C 07 D 417/04; C 07 D 249/06; C 07 D 249/08; C 07 D 261/08; C 07 D 263/32; C 07 D 271/06; C 07 D 495/04; C 07 D 277/26; C 07 D 285/08; C 07 D 285/12	P 2020 7149 B	AP 2020 14908 A

**CONCORDANCE TABLE OF PATENT NUMBERS,
PUBLICATION NUMBERS AND INTERNATIONAL CLASSIFICATION INDEX**

NUMBER OF PATENT (11)	NUMBER OF PUBLISHED APPLICATION (10)	INTERNATIONAL CLASSIFICATION INDEX (51)
P 2020 7146 B	AP 2020 14664 A	A 61 K 49/10; C 07 C 229/16; C 07 D 257/02
P 2020 7147 B	AP 2020 14820 A	A 61 K 31/506; A 61 P 7/02; A 61 P 25/30; A 61 P 9/00; A 61 P 37/00; A 61 P 3/06; A 61 P 3/10; A 61 P 25/02; A 61 P 35/00; C 07 D 403/14; C 07 D 403/04; C 07 D 401/14
P 2020 7148 B	AP 2020 14917 A	A 01 N 35/04; A 01 N 25/00; A 01 N 25/30; A 01 N 43/40; A 01 P 3/00
P 2020 7149 B	AP 2020 14908 A	C 07 D 231/12; C 07 D 233/64; C 07 D 413/04; C 07 D 413/06; C 07 D 413/10; C 07 D 417/04; C 07 D 249/06; C 07 D 249/08; C 07 D 261/08; C 07 D 263/32; C 07 D 271/06; C 07 D 495/04; C 07 D 277/26; C 07 D 285/08; C 07 D 285/12
P 2020 7150 B	AP 2020 15002 A	B 61 B 7/00

CONCORDANCE TABLE OF APPLICATION NUMBERS, PUBLICATION NUMBERS AND PATENTS

NUMBER OF APPLICATION (21)	NUMBER OF PUBLISHED APPLICATION (10)	NUMBER OF PATENT (11)
AP 2016 14664	AP 2020 14664 A	P 2020 7146 B
AP 2016 14820	AP 2020 14820 A	P 2020 7147 B
AP 2017 14908	AP 2020 14908 A	P 2020 7149 B
AP 2017 14917	AP 2020 14917 A	P 2020 7148 B
AP 2019 15002	AP 2020 15002 A	P 2020 7150 B

UTILITY MODELS

CONCORDANCE TABLE OF INTERNATIONAL CLASSIFICATION INDEX AND PUBLICATION NUMBERS

INTERNATIONAL CLASSIFICATION INDEXES (51)	NUMBER OF PUBLISHED APPLICATION (10)
A 01 G 13/02; C 08 J 5/18	AU 2020 15177 U
B 03 D 1/001; B 03 D 1/002	AU 2020 14810 U
G 06 F 17/40; G 06 Q 10/00	AU 2020 15101 U

**CONCORDANCE TABLE OF PUBLICATION NUMBERS
AND INTERNATIONAL CLASSIFICATION INDEX**

NUMBER OF PUBLISHED APPLICATION (10)	INTERNATIONAL CLASSIFICATION INDEXES (51)
AU 2020 14810 U	B 03 D 1/001; B 03 D 1/002
AU 2020 15101 U	G 06 F 17/40; G 06 Q 10/00
AU 2020 15177 U	A 01 G 13/02; C 08 J 5/18

**CONCORDANCE TABLE OF INTERNATIONAL CLASSIFICATION INDEX,
PATENT NUMBERS AND PUBLICATION NUMBERS**

INTERNATIONAL CLASSIFICATION INDEX (51)	NUMBER OF PATENT (11)	NUMBER OF PUBLISHED APPLICATION (10)
A 21 D 2/00	U 2020 2051 Y	AU 2020 14729 U
E 04 H 6/06	U 2020 2052 Y	AU 2020 14973 U

**CONCORDANCE TABLE OF PATENT NUMBERS,
PUBLICATION NUMBERS AND INTERNATIONAL CLASSIFICATION INDEX**

NUMBER OF PATENT (11)	NUMBER OF PUBLISHED APPLICATION (10)	INTERNATIONAL CLASSIFICATION INDEX (51)
U 2020 2051 Y	AU 2020 14729 U	A 21 D 2/00
U 2020 2052 Y	AU 2020 14973 U	E 04 H 6/06

**CONCORDANCE TABLE OF APPLICATION NUMBERS, PUBLICATION NUMBERS
AND PATENTS**

NUMBER OF APPLICATION (21)	NUMBER OF PUBLISHED APPLICATION (10)	NUMBER OF PATENT (11)
AU 2018 14729	AU 2020 14729 U	U 2020 2051 Y
AU 2018 14973	AU 2020 14973 U	U 2020 2052 Y

DESIGNS

CONCORDANCE TABLE OF INTERNATIONAL CLASSIFICATION INDEX, PATENT NUMBERS AND PUBLICATION NUMBERS

INTERNATIONAL CLASSIFICATION INDEX (51)	NUMBER OF PATENT (11)	NUMBER OF PUBLISHED APPLICATION (10)
09-03	D 2020 859 S	AD 2020 1123 S
11-01	D 2020 863 S	AD 2020 1095 S
11-02	D 2020 858 S	AD 2020 1122 S

CONCORDANCE TABLE OF PATENT NUMBERS, PUBLICATION NUMBERS AND INTERNATIONAL CLASSIFICATION INDEX

NUMBER OF PATENT (11)	NUMBER OF PUBLISHED APPLICATION (10)	INTERNATIONAL CLASSIFICATION INDEX (51)
D 2020 858 S	AD 2020 1122 S	11-02
D 2020 859 S	AD 2020 1123 S	09-03
D 2020 863 S	AD 2020 1095 S	11-01

CONCORDANCE TABLE OF APPLICATION NUMBERS, PUBLICATION NUMBERS AND PATENTS

NUMBER OF APPLICATION (21)	NUMBER OF PUBLISHED APPLICATION (10)	NUMBER OF PATENT (11)
AD 2019 1095	AD 2020 1095 S	D 2020 863 S
AD 2019 1122	AD 2020 1122 S	D 2020 858 S
AD 2019 1123	AD 2020 1123 S	D 2020 859 S

DESIGN REGISTERED ACCORDING TO THE ACCELERATED PROCEDURE

CONCORDANCE TABLE OF INTERNATIONAL CLASSIFICATION INDEX AND PUBLICATION NUMBERS

INTERNATIONAL CLASSIFICATION INDEXES (51)	NUMBER OF PUBLISHED APPLICATION (11)
06-02	D 2020 862 S

CONCORDANCE TABLE OF PUBLICATION NUMBERS AND INTERNATIONAL CLASSIFICATION INDEX

NUMBER OF PUBLISHED APPLICATION (11)	INTERNATIONAL CLASSIFICATION INDEXES (51)
D 2020 862 S	06-02

CONCORDANCE TABLE OF APPLICATION NUMBERS, PUBLICATION NUMBERS AND PATENTS

NUMBER OF APPLICATION (21)	NUMBER OF PATENT (11)
AD 2020 1163	D 2020 862 S

TRADEMARKS

CONCORDANCE TABLE OF REGISTRATION NUMBERS, APPLICATION NUMBERS, PUBLICATION NUMBERS AND BULLETIN NUMBERS

NUMBER OF REGISTRATION (111)	NUMBER OF APPLICATIONS (210)	NUMBER OF PUBLISHED APPLICATIONS (260)	NUMBER OF BULLETIN
1	2	3	4
M 2020 33028 R	AM 104066	AM 2020 104066 A	3(535)2020
M 2020 33029 R	AM 104067	AM 2020 104067 A	3(535)2020
M 2020 33030 R	AM 104071	AM 2020 104071 A	3(535)2020
M 2020 33031 R	AM 104072	AM 2020 104072 A	3(535)2020
M 2020 33032 R	AM 104112	AM 2020 104112 A	3(535)2020
M 2020 33033 R	AM 104113	AM 2020 104113 A	3(535)2020
M 2020 33034 R	AM 104114	AM 2020 104114 A	3(535)2020
M 2020 33035 R	AM 104116	AM 2020 104116 A	3(535)2020
M 2020 33036 R	AM 104117	AM 2020 104117 A	3(535)2020
M 2020 33037 R	AM 104119	AM 2020 104119 A	3(535)2020
M 2020 33038 R	AM 104120	AM 2020 104120 A	3(535)2020
M 2020 33039 R	AM 104121	AM 2020 104121 A	3(535)2020
M 2020 33040 R	AM 104122	AM 2020 104122 A	3(535)2020
M 2020 33041 R	AM 104185	AM 2020 104185 A	3(535)2020
M 2020 33042 R	AM 104186	AM 2020 104186 A	3(535)2020
M 2020 33043 R	AM 104190	AM 2020 104190 A	3(535)2020
M 2020 33044 R	AM 104191	AM 2020 104191 A	3(535)2020
M 2020 33045 R	AM 104674	AM 2020 104674 A	8(540)2020
M 2020 33046 R	AM 104741	AM 2020 104741 A	8(540)2020
M 2020 33047 R	AM 108876	–	17(549)2020
M 2020 33048 R	AM 109433	–	17(549)2020
M 2020 33049 R	AM 107162	–	17(549)2020
M 2020 33050 R	AM 109367	–	17(549)2020
M 2020 33051 R	AM 109369	–	17(549)2020
M 2020 33052 R	AM 109139	–	17(549)2020
M 2020 33053 R	AM 109501	–	17(549)2020
M 2020 33054 R	AM 109508	–	17(549)2020
M 2020 33055 R	AM 100410	AM 2020 100410 A	1(533)2020
M 2020 33056 R	AM 102174	AM 2019 102174 A	21(529)2019
M 2020 33057 R	AM 102364	AM 2020 102364 A	9(541)2020
M 2020 33058 R	AM 102808	AM 2020 102808 A	9(541)2020
M 2020 33059 R	AM 103453	AM 2020 103453 A	9(541)2020
M 2020 33060 R	AM 103454	AM 2020 103454 A	9(541)2020
M 2020 33061 R	AM 103455	AM 2020 103455 A	9(541)2020
M 2020 33062 R	AM 103456	AM 2020 103456 A	9(541)2020
M 2020 33063 R	AM 103457	AM 2020 103457 A	9(541)2020
M 2020 33064 R	AM 103458	AM 2020 103458 A	9(541)2020
M 2020 33065 R	AM 103459	AM 2020 103459 A	9(541)2020
M 2020 33066 R	AM 103460	AM 2020 103460 A	9(541)2020
M 2020 33067 R	AM 103947	AM 2020 103947 A	4(536)2020
M 2020 33068 R	AM 104098	AM 2020 104098 A	4(536)2020
M 2020 33069 R	AM 104104	AM 2020 104104 A	4(536)2020
M 2020 33070 R	AM 104106	AM 2020 104106 A	5(537)2020
M 2020 33071 R	AM 104107	AM 2020 104107 A	4(536)2020
M 2020 33072 R	AM 104223	AM 2020 104223 A	7(539)2020
M 2020 33073 R	AM 104313	AM 2020 104313 A	6(538)2020

1	2	3	4
M 2020 33074 R	AM 104454	AM 2020 104454 A	6(538)2020
M 2020 33075 R	AM 104678	AM 2020 104678 A	9(541)2020
M 2020 33076 R	AM 104822	AM 2020 104822 A	9(541)2020
M 2020 33077 R	AM 105006	AM 2020 105006 A	9(541)2020
M 2020 33078 R	AM 105216	AM 2020 105216 A	9(541)2020
M 2020 33079 R	AM 105217	AM 2020 105217 A	9(541)2020
M 2020 33080 R	AM 105218	AM 2020 105218 A	9(541)2020
M 2020 33081 R	AM 103780	AM 2020 103780 A	5(537)2020
M 2020 33082 R	AM 103956	AM 2020 103956 A	5(537)2020
M 2020 33083 R	AM 104177	AM 2020 104177 A	5(537)2020
M 2020 33084 R	AM 104316	AM 2020 104316 A	5(537)2020
M 2020 33085 R	AM 104558	AM 2020 104558 A	6(538)2020
M 2020 33086 R	AM 104749	AM 2020 104749 A	9(541)2020
M 2020 33087 R	AM 109606	-	17(549)2020

**CONCORDANCE TABLE OF PUBLICATION NUMBERS
AND APPLICATION NUMBERS**

NUMBER OF PUBLISHED APPLICATION (260)	NUMBER OF APPLICATION (210)	1	2
		1	2
AM 2020 104563 A	AM 104563	AM 2020 106819 A	AM 106819
AM 2020 105985 A	AM 105985	AM 2020 106820 A	AM 106820
AM 2020 106653 A	AM 106653	AM 2020 106825 A	AM 106825
AM 2020 106656 A	AM 106656	AM 2020 106826 A	AM 106826
AM 2020 106670 A	AM 106670	AM 2020 106827 A	AM 106827
AM 2020 106756 A	AM 106756	AM 2020 106834 A	AM 106834
AM 2020 106757 A	AM 106757	AM 2020 106932 A	AM 106932
AM 2020 106758 A	AM 106758	AM 2020 106939 A	AM 106939
AM 2020 106759 A	AM 106759	AM 2020 106940 A	AM 106940
AM 2020 106773 A	AM 106773	AM 2020 106941 A	AM 106941
AM 2020 106775 A	AM 106775	AM 2020 106942 A	AM 106942
AM 2020 106776 A	AM 106776	AM 2020 106966 A	AM 106966
AM 2020 106779 A	AM 106779	AM 2020 107029 A	AM 107029
AM 2020 106782 A	AM 106782	AM 2020 107030 A	AM 107030
AM 2020 106796 A	AM 106796	AM 2020 107033 A	AM 107033
AM 2020 106797 A	AM 106797	AM 2020 107034 A	AM 107034
AM 2020 106798 A	AM 106798	AM 2020 107047 A	AM 107047
AM 2020 106802 A	AM 106802	AM 2020 107050 A	AM 107050
AM 2020 106803 A	AM 106803	AM 2020 107052 A	AM 107052
AM 2020 106804 A	AM 106804	AM 2020 107067 A	AM 107067
AM 2020 106805 A	AM 106805	AM 2020 107158 A	AM 107158
AM 2020 106806 A	AM 106806	AM 2020 107174 A	AM 107174
AM 2020 106807 A	AM 106807	AM 2020 107175 A	AM 107175
AM 2020 106808 A	AM 106808	AM 2020 107296 A	AM 107296
AM 2020 106812 A	AM 106812	AM 2020 107299 A	AM 107299
		AM 2020 107300 A	AM 107300
		AM 2020 107301 A	AM 107301
		AM 2020 107307 A	AM 107307
		AM 2020 107313 A	AM 107313

CONCORDANCE TABLE OF INDEX OF GOODS AND/OR SERVICES
AND APPLICATION NUMBERS

INDEX OF GOODS AND/OR SERVICES (511)	NUMBER OF PUBLISHED APPLICATIONS (26)	1	2
1	2		
3	AM 2020 106656 A	29	AM 2020 107174 A
3	AM 2020 106808 A	29	AM 2020 107175 A
3	AM 2020 106966 A	30	AM 2020 106653 A
3	AM 2020 107307 A	30	AM 2020 106825 A
5	AM 2020 106757 A	30	AM 2020 106932 A
5	AM 2020 106758 A	30	AM 2020 107029 A
5	AM 2020 106759 A	30	AM 2020 107030 A
5	AM 2020 106773 A	30	AM 2020 107034 A
5	AM 2020 106812 A	30	AM 2020 107301 A
5	AM 2020 106819 A	31	AM 2020 106825 A
5	AM 2020 106820 A	32	AM 2020 106776 A
5	AM 2020 106939 A	32	AM 2020 107174 A
5	AM 2020 106940 A	32	AM 2020 107175 A
5	AM 2020 106941 A	33	AM 2020 105985 A
5	AM 2020 106942 A	33	AM 2020 106779 A
5	AM 2020 106966 A	33	AM 2020 106782 A
5	AM 2020 107296 A	33	AM 2020 106834 A
5	AM 2020 107299 A	33	AM 2020 107033 A
5	AM 2020 107299 A	34	AM 2020 106670 A
5	AM 2020 107300 A	35	AM 2020 106775 A
5	AM 2020 107307 A	35	AM 2020 106825 A
9	AM 2020 106756 A	35	AM 2020 106966 A
10	AM 2020 106941 A	35	AM 2020 107067 A
10	AM 2020 106942 A	36	AM 2020 106756 A
11	AM 2020 106826 A	36	AM 2020 106804 A
11	AM 2020 106827 A	41	AM 2020 106806 A
14	AM 2020 107158 A	41	AM 2020 106807 A
18	AM 2020 106796 A	41	AM 2020 107050 A
18	AM 2020 106797 A	41	AM 2020 107052 A
18	AM 2020 106798 A	42	AM 2020 106756 A
18	AM 2020 107067 A	42	AM 2020 107047 A
25	AM 2020 106796 A	42	AM 2020 107052 A
25	AM 2020 106797 A	42	AM 2020 107313 A
25	AM 2020 106798 A	43	AM 2020 106802 A
25	AM 2020 106808 A	43	AM 2020 106803 A
25	AM 2020 107067 A	43	AM 2020 106805 A
29	AM 2020 106825 A	44	AM 2020 104563 A
		44	AM 2020 106775 A
		44	AM 2020 106966 A
		44	AM 2020 107050 A

CONCORDANCE TABLE OF INDEX OF GOODS AND/OR SERVICES
AND NUMBERS OF TRADEMARKS REGISTERED ACCORDING
TO THE ACCELERATED PROCEDURE

INDEX OF GOODS AND/OR SERVICES (511)	NUMBERS OF REGISTERED ACCORDING TO THE ACCELERATED PROCEDURE (111)
2	M 2020 33049 R
3	M 2020 33048 R
9	M 2020 33053 R
19	M 2020 33049 R
33	M 2020 33087 R
35	M 2020 33054 R
38	M 2020 33052 R
39	M 2020 33050 R
39	M 2020 33051 R
41	M 2020 33052 R

OFFICIAL BULLETIN OF THE INDUSTRIAL PROPERTY

INVENTIONS
UTILITY MODELS
DESIGNS
TRADEMARKS
APPELLATIONS OF ORIGIN OF GOODS

17(549)

EDITOR-IN-CHIEF: N. Bebrishvili

EDITOR-TRANSLATOR: E. Gabunia

PROOFREADER: A. Shikhashvili

COMPUTER LAYOUT: M. Ordenidze
K. Svanidze

www.sakpatenti.gov.ge

E-mail: info@sakpatenti.org.ge

**LIST OF CODES, IN ALPHABETIC SEQUENCE, AND THE CORRESPONDING (SHORT) NAMES OF STATES, OTHER ENTITIES AND INTERGOVERNMENTAL ORGANIZATIONS
(WIPO STANDARD ST.3)**

AD	Andorra				
AE	United Arab Emirates	GD	Grenada	NE	Niger
AF	Afghanistan	GG	Guernsey	NG	Nigeria
AG	Antigua and Barbuda	GH	Ghana	NI	Nicaragua
AI	Anguilla	GI	Gibraltar	NL	Netherlands
AL	Albania	GT	Guatemala	NO	Norway
AM	Armenia	GW	Guinea- Bissau	NP	Nepal
AN	Netherlands Antilles	GY	Guyana	NR	Nauru
AO	Angola	HK	The Hong Kong Special Administrative Region of the People's Republic of China	NZ	New Zealand
AP	African Regional Intellectual Property Organization (ARIPO)	HN	Honduras	OA	African Intellectual Property Organization (OAPI)
AR	Argentina	HR	Croatia	OM	Oman
AT	Austria	HT	Haiti	PA	Panama
AU	Australia	HU	Hungary	PE	Peru
AW	Aruba	IB	International Bureau of the World Intellectual Property Organization (WIPO)	PG	Papua New Guinea
AZ	Azerbaijan	ID	Indonesia	PH	Philippines
BA	Bosnia and Herzegovina	IE	Ireland	PK	Pakistan
BB	Barbados	IL	Israel	PL	Poland
BD	Bangladesh	IM	Isle of Man	PT	Portugal
BE	Belgium	IN	India	PW	Palau
BF	Burkina Faso	IQ	Iraq	PY	Paraguay
BG	Bulgaria	ID	Indonesia	QA	Qatar
BH	Bahrain	IE	Ireland	QZ	Community Plant Variety Office (European Community) (CPVO)
BI	Burundi	IL	Israel	RO	Romania
BJ	Benin	IM	Isle of Man	RS	Serbia
BM	Bermuda	IN	India	RU	Russian Federation
BN	Brunei Darussalam	IQ	Iraq	RW	Rwanda
BO	Bolivia	IR	Iran (Islamic Republic of)	SA	Saudi Arabia
BR	Brazil	IS	Iceland	SB	Solomon Islands
BS	Bahamas	IT	Italy	SC	Seychelles
BT	Bhutan	JE	Jersey	SD	Sudan
BV	Bouvet Island	JM	Jamaica	SG	Singapore
BW	Botswana	JO	Jordan	SH	Saint Helena
BX	Benelux Office for Intellectual Property (BOIP)	JP	Japan	SI	Slovenia
BY	Belarus	KE	Kenya	SK	Slovakia
BZ	Belize	KG	Kyrgyzstan	SL	Sierra Leone
CA	Canada	KH	Cambodia	SM	San Marino
CD	Democratic Republic of the Congo	KI	Kiribati	SN	Senegal
CF	Central African Republic	KM	Saint Kitts and Nevis	SO	Somalia
CG	Congo	KP	Democratic People's Republic of Korea	SR	Suriname
CH	Switzerland	KR	Republic of Korea	ST	Sao Tome and Principe
CI	Cote d'Ivoire	KW	Kuwait	SV	El Salvador
CK	Cook Islands	KY	Cayman Islands	SY	Syrian Arab Republic
CL	Chile	KZ	Kazakhstan	SZ	Swaziland
CM	Cameroon	LA	Lao People's Democratic Republic	TC	Turks and Caicos Islands
CN	China	LB	Lebanon	TD	Chad
CO	Colombia	LC	Saint Lucia	TG	Togo
CR	Costa Rica	LI	Liechtenstein	TH	Thailand
CU	Cuba	LK	Sri Lanka	TJ	Tajikistan
CV	Cape Verde	LR	Liberia	TL	Timor-Leste
CY	Cyprus	LS	Lesotho	TM	Turkmenistan
CZ	Czech Republic	LT	Lithuania	TN	Tunisia
DE	Germany	LU	Luxembourg	TO	Tonga
DJ	Djibouti	LV	Latvia	TR	Turkey
DM	Dominica	LY	Libyan Arab Jamahiriya	SE	Sweden
DO	Dominican Republic	MA	Morocco	TT	Trinidad and Tobago
DZ	Algeria	MC	Monaco	TV	Tuvalu
EA	Eurasian Patent Organization (EAPO)	MD	Republic of Moldova	TW	Taiwan, Province of China
EC	Ecuador	ME	Montenegro	TZ	United Republic of Tanzania
EE	Estonia	MG	Madagascar	UA	Ukraine
EG	Egypt	MK	The former Yugoslav Republic of Macedonia	UG	Uganda
EH	Western Sahara	ML	Mali	US	United States of America
EM	Office for Harmonization in the Internal Market (Trademarks and Designs)(OHIM)	MM	Myanmar	UY	Uruguay
EP	European Patent Office (EPO)	MN	Mongolia	UZ	Uzbekistan
ER	Eritrea	MO	Macao	VA	Holy See
ES	Spain	MP	Northern Mariana Islands	VC	Saint Vincent and the Grenadines
ET	Ethiopia	MR	Mauritania	VE	Venezuela
FI	Finland	MS	Montserrat	VG	Virgin Islands (British)
FJ	Fiji	MT	Malta	VN	Viet Nam
FK	Falkland Islands (Malvinas)	MU	Mauritius	VU	Vanuatu
FO	Faroe Islands	MV	Maldives	WO	World Intellectual Property Organization (WIPO)
FR	France	MW	Malawi	WS	Samoa
GA	Gabon	MX	Mexico	XN	Nordic Patent Institute (NPI)
GB	United Kingdom	MY	Malaysia	YE	Yemen
GC	Patent Office of the Cooperation Council for the Arab States of the Gulf (GCC)	MZ	Mozambique	ZA	South Africa
		NA	Namibia	ZM	Zambia
				ZW	Zimbabwe