



**NATIONAL INTELLECTUAL PROPERTY CENTER OF GEORGIA  
SAKPATENTI**

**OFFICIAL BULLETIN  
OF THE INDUSTRIAL PROPERTY**

**20(456)**

**2016  
TBILISI**

# INID CODES FOR IDENTIFICATION OF BIBLIOGRAPHIC DATA

## INVENTIONS, UTILITY MODELS

- (10) Number of publication for application, which has been examined
- (11) Number of patent and kind of document
- (21) Serial number of application
- (22) Date of filing of the application
- (23) Date of exhibition or the date of the earlier filing and the number of application, if any
- (24) Date from which patent may have effect
- (31) Number of priority application
- (32) Date of filing of priority application
- (33) Code of the country or regional organization allotting priority application number
- (44) Date of publication of application not granted, but examined and number of bulletin
- (45) Date of publication of registered document
- (51) International Patent Classification Index
- (54) Title of the invention
- (57) Abstract
- (60) Number of examined patent document granted by foreign patent office, date from which patent has effect and country code
- (62) Number of the earlier application and in case of divided application, date of filing an application
- (71) Name, surname and address of applicant (country code)
- (72) Name, surname of inventor (country code)
- (73) Name, surname and address of patent owner (country code)
- (74) Name, surname of representative or patent attorney
- (85) Date of commencement of the national phase of International Application
- (86) Number and date of filing of international application
- (87) Number and date of publication of international application

## DESIGNS

- (10) Number of publication for application
- (11) Number of patent and kind of document or number of registration
- (15) Date of registration/Date of patent renewal
- (18) Expected expiration date of patent or registration
- (21) Serial number of application
- (22) Date of filing of the application
- (23) Date of exhibition or the date of the earlier filing and the number of application, if any
- (24) Date from which patent may have effect
- (28) Number of designs included in the application
- (30) Data relating to priority (number of application, date of filing of application, two-letter code identifying the authority with whom the priority application was made)
- (31) Number of priority application
- (32) Date of filing of priority application
- (33) Code of the country or regional organization allotting priority application number
- (34) Two-letter code according to WIPO St.3 identifying the authority with which the priority application was made
- (44) Date of publication of design and number of bulletin (the first publication)
- (45) Date of publication of design registered by WIPO and number of bulletin
- (51) International Classification for designs (class and subclass of the Locarno Classification)
- (54) Title of the invention
- (55) Reproduction of the design
- (57) Description of characteristic features of the design including indication of colors
- (58) Date of recording of any kind of amendment in the Register
- (62) Number of the earlier application, registration and document number and if available the date of filing an application in case of divided application
- (71) Name, surname and address of applicant (country code)
- (72) Name, surname of creator (country code)
- (73) Name, surname and address of patent owner (country code)
- (74) Name, surname of representative or patent attorney
- (81) Contracting states concerned
  - II designated contracting states according to the 1960 Act
  - III designated contracting states according to the 1999 Act
- (85) Owner's permanent address
- (86) Owner's nationality
- (87) Owner's residence
- (88) State in which the owner has a real and effective industrial or commercial establishment

## TRADEMARKS

- (111) – Number of registration
- (151) – Date of registration
- (156) – Date of the renewal
- (181) – Expected expiration date of registration
- (186) – Renewal expiration date of registration
- (141) – Date of cancel of duration of the mark
- (210) – Serial number of application
- (220) – Date of filing of the application
- (230) – Date concerning exhibition
- (260) – Number of application, for which favorable decision of examination about registration has been taken (publication number)
- (310) – Number of the first application
- (320) – Date of filing of the first application
- (330) – Code, identifying national or regional Office where the first application was made
- (511) – International Classification of Goods and Services for the purposes of registration of trade marks and/or list of goods and/or services classified according thereto
- (531) – Description of figurative elements of Trade Marks according to the International Classification of the Figurative Elements of Marks
- (540) – Reproduction of Trade Mark
- (550) – Nature and kind of Trade Mark
- (580) – Date of recording of any kind changes in respect of applications or registrations
- (591) – Information concerning colors claimed
- (731) – Name and address of the applicant
- (732) – Name and address of the holder of the registration
- (740) – Name and address of the representative
- (750) – Address for correspondence
- (770) – Name and address of the previous applicant or holder in case of change in ownership
- (771) – Previous name and address of the applicant or holder in case of change in ownership
- (791) – Name and address of the licensee
- (793) – Indication of conditions and/or restrictions under the license (Type of license, number of license agreement, data of license, data of validity of license)
- (800) – Certain data relating to the international registration of Trade Marks under the Protocol Relating to Madrid Agreement (International registration number)

## CODES FOR PUBLICATION IN BULLETIN

- (21) AP 0000 000000 – serial number of application for invention
- (10) AP 0000 0000 A – number of published application for invention (first publication)
- (11) P 0000 0000 B – number of patent for invention (second publication)
- (21) API 0000 000000 – number of application for imported patent
- (11) PI 0000 0000 A – number of imported patent (first publication)
- (21) AU 0000 000000 – serial number of application for utility model
- (10) AU 0000 000 U – number of published application for utility model (first publication)
- (11) U 0000 000 Y – number of patent for utility model (second publication)
- (21) AD 0000 000000 – serial number of application for design
- (10) AD 0000 000 S – number of published application for design (first publication)
- (11) D 0000 000 S – number of patent for design (second publication)

## INTERNATIONAL PATENT CLASSIFICATION FOR INVENTIONS AND UTILITY MODELS

- SECTION A – HUMAN NECESSITIES
- SECTION B – PERFORMING OPERATIONS; TRANSPORTING
- SECTION C – CHEMISTRY; METALLURGY
- SECTION D – TEXTILES; PAPER
- SECTION E – FIXED CONSTRUCTIONS
- SECTION F – MECHANICAL ENGINEERING; LIGHTING; HEATING; WEAPONS; BLASTING
- SECTION G – PHYSICS
- SECTION H – ELECTRICITY

- 
- M – Trade Mark
  - (210) AM 0000 000000 – Serial number of application;
  - (260) AAM 0000 00000 A – Publication number of application;
  - (111) M 0000 00000 R – Number of registration;
  - (111) MMM0000 00000 Rn – Number of renewals, in which n=1,2,3;
  - (111) M 0000 00000 R(P) – Number of registration under partial assignment of rights
-

**LIST OF CODES, IN ALPHABETIC SEQUENCE, AND THE CORRESPONDING (SHORT) NAMES OF STATES, OTHER ENTITIES AND INTERGOVERNMENTAL ORGANIZATIONS**  
(WIPO STANDARD ST.3)

AD	Andorra		for the Arab States of the Gulf (GCC)	NE	Niger
AE	United Arab Emirates	GD	Grenada	NG	Nigeria
AF	Afghanistan	GG	Guernsey	NI	Nicaragua
AG	Antigua and Barbuda	GH	Ghana	NL	Netherlands
AI	Anguilla	GI	Gibraltar	NO	Norway
AL	Albania	GT	Guatemala	NP	Nepal
AM	Armenia	GW	Guinea- Bissau	NR	Nauru
AN	Netherlands Antilles	GY	Guyana	NZ	New Zealand
AO	Angola	HK	The Hong Kong Special Administrative Region of the People's Republic of China	OA	African Intellectual Property Organization (OAPI)
AP	African Regional Intellectual Property Organization (ARIPO)	HN	Honduras	OM	Oman
AR	Argentina	HR	Croatia	PA	Panama
AT	Austria	HT	Haiti	PE	Peru
AU	Australia	HU	Hungary	PG	Papua New Guinea
AW	Aruba	IB	International Bureau of the World Intellectual Property Organization (WIPO)	PH	Philippines
AZ	Azerbaijan	ID	Indonesia	PK	Pakistan
BA	Bosnia and Herzegovina	IE	Ireland	PL	Poland
BB	Barbados	IL	Israel	PT	Portugal
BD	Bangladesh	IM	Isle of Man	PW	Palau
BE	Belgium	IN	India	PY	Paraguay
BF	Burkina Faso	IQ	Iraq	QA	Qatar
BG	Bulgaria	ID	Indonesia	QZ	Community Plant Variety Office (European Community) (CPVO)
BH	Bahrain	IE	Ireland	RO	Romania
BI	Burundi	IL	Israel	RS	Serbia
BJ	Benin	IM	Isle of Man	RU	Russian Federation
BM	Bermuda	IN	India	RW	Rwanda
BN	Brunei Darussalam	IQ	Iraq	SA	Saudi Arabia
BO	Bolivia	IR	Iran (Islamic Republic of)	SB	Solomon Islands
BR	Brazil	IS	Iceland	SC	Seychelles
BS	Bahamas	IT	Italy	SD	Sudan
BT	Bhutan	JE	Jersey	SG	Singapore
BV	Bouvet Island	JM	Jamaica	SH	Saint Helena
BW	Botswana	JO	Jordan	SI	Slovenia
BX	Benelux Office for Intellectual Property (BOIP)	JP	Japan	SK	Slovakia
BY	Belarus	KE	Kenya	SL	Sierra Leone
BZ	Belize	KG	Kyrgyzstan	SM	San Marino
CA	Canada	KH	Cambodia	SN	Senegal
CD	Democratic Republic of the Congo	KI	Kiribati	SO	Somalia
CF	Central African Republic	KM	Saint Kitts and Nevis	SR	Suriname
CG	Congo	KP	Democratic People's Republic of Korea	ST	Sao Tome and Principe
CH	Switzerland	KR	Republic of Korea	SV	El Salvador
CI	Cote d'Ivoire	KW	Kuwait	SY	Syrian Arab Republic
CK	Cook Islands	KY	Cayman Islands	SZ	Swaziland
CL	Chile	KZ	Kazakhstan	TC	Turks and Caicos Islands
CM	Cameroon	LA	Lao People's Democratic Republic	TD	Chad
CN	China	LB	Lebanon	TG	Togo
CO	Colombia	LC	Saint Lucia	TH	Thailand
CR	Costa Rica	LI	Liechtenstein	TJ	Tajikistan
CU	Cuba	LK	Sri Lanka	TL	Timor-Leste
CV	Cape Verde	LR	Liberia	TM	Turkmenistan
CY	Cyprus	LS	Lesotho	TN	Tunisia
CZ	Czech Republic	LT	Lithuania	TO	Tonga
DE	Germany	LU	Luxembourg	TR	Turkey
DJ	Djibouti	LV	Latvia	SE	Sweden
DM	Dominica	LY	Libyan Arab Jamahiriya	TT	Trinidad and Tobago
DO	Dominican Republic	MA	Morocco	TV	Tuvalu
DZ	Algeria	MC	Monaco	TW	Taiwan, Province of China
EA	Eurasian Patent Organization (EAPO)	MD	Republic of Moldova	TZ	United Republic of Tanzania
EC	Ecuador	ME	Montenegro	UA	Ukraine
EE	Estonia	MG	Madagascar	UG	Uganda
EG	Egypt	MK	The former Yugoslav Republic of Macedonia	US	United States of America
EH	Western Sahara	ML	Mali	UY	Uruguay
EM	Office for Harmonization in the Internal Market (Trademarks and Designs)(OHIM)	MM	Myanmar	UZ	Uzbekistan
EP	European Patent Office (EPO)	MN	Mongolia	VA	Holy See
ER	Eritrea	MO	Macao	VC	Saint Vincent and the Grenadines
ES	Spain	MP	Northern Mariana Islands	VE	Venezuela
ET	Ethiopia	MR	Mauritania	VG	Virgin Islands (British)
FI	Finland	MS	Montserrat	VN	Viet Nam
FJ	Fiji	MT	Malta	VU	Vanuatu
FK	Falkland Islands (Malvinas)	MU	Mauritius	WO	World Intellectual Property Organization (WIPO)
FO	Faroe Islands	MV	Maldives	WS	Samoa
FR	France	MW	Malawi	XN	Nordic Patent Institute (NPI)
GA	Gabon	MX	Mexico	YE	Yemen
GB	United Kingdom	MY	Malaysia	ZA	South Africa
GC	Patent Office of the Cooperation Council	MZ	Mozambique	ZM	Zambia
		NA	Namibia	ZW	Zimbabwe

**NATIONAL INTELLECTUAL PROPERTY CENTER OF GEORGIA  
SAKPATENTI**

**OFFICIAL BULLETIN  
OF THE INDUSTRIAL PROPERTY**

**20(456)**

**INVENTIONS  
UTILITY MODELS  
DESIGNS  
TRADEMARKS**

**DATE OF PUBLICATION  
2016 10 25**

# CONTENTS

<b>PUBLISHED TITLES OF PROTECTION</b> .....	2
<b>INVENTIONS</b>	
▪ APPLICATIONS APPROVED FOR GRANTING PATENTS .....	4
▪ PATENTED INVENTIONS .....	10
<b>UTILITY MODELS</b>	
▪ APPLICATION APPROVED FOR GRANTING PATENTS .....	13
<b>DESIGNS</b>	
▪ APPLICATIONS APPROVED FOR REGISTRATION .....	14
<b>TRADEMARKS</b>	
▪ APPLICATIONS FILED UNDER THE NATIONAL PROCEDURE APPROVED FOR REGISTRATION .....	17
▪ REGISTERED TRADEMARKS .....	22
▪ TRADEMARKS REGISTERED ACCORDING TO THE ACCELERATED PROCEDURE .....	26
▪ INTERNATIONAL TRADEMARKS FOR WHICH A DECISION ON GRANTING PROTECTION IS TAKEN .....	29
▪ INTERNATIONAL TRADEMARKS PROTECTED IN GEORGIA .....	124
<b>OFFICIAL NOTIFICATIONS</b>	
<b>INVENTIONS</b>	
▪ RENEWAL OF A PATENTS .....	130
<b>UTILITY MODELS</b>	
▪ RENEWAL OF A PATENTS .....	131
<b>DESIGNS</b>	
▪ INTERNATIONAL DESIGNS APPLICATION, WHICH WAS REGISTERED ON THE TERRITORY OF GEORGIA .....	132
▪ INTERNATIONAL REGISTRATIONS, WHOSE ACTION HAS BEEN CANCELED BECAUSE OF NON PAYMENT FOR EXTENSION ON 5-YEARS .....	135
<b>TRADEMARKS</b>	
▪ RENEWAL OF REGISTRATIONS .....	138
▪ COMPLETE TRANSFER OF RIGHTS .....	149
▪ CHANGES IN NAMES AND/OR ADDRESSES OF OWNERS .....	151
▪ INVALIDATION OF TRADEMARKS REGISTRATION .....	153
<b>CLASSIFICATION INDEXES</b>	
INVENTIONS .....	157
UTILITY MODELS .....	160
DESIGNS .....	160
TRADEMARKS .....	161

# PUBLISHED TITLES OF PROTECTION

## INVENTIONS

- **APPLICATIONS APPROVED FOR GRANTING PATENTS:**  
13943; 9736; 13785; 13396; 13967; 13675; 13859; 13828; 13667; 13326; 13113; 13598; 13363; 13797
- **PATENTED INVENTIONS:**  
6559-6565

## UTILITY MODELS

- **APPLICATIONS APPROVED FOR GRANTING PATENTS:**  
14085

## DESIGNS

- **APPLICATIONS APPROVED FOR REGISTRATION:**  
916; 915

## TRADEMARKS

- **APPLICATIONS FILED UNDER THE NATIONAL PROCEDURE APPROVED FOR REGISTRATION:**  
84259, 84260; 85065; 85810; 85834; 85891; 85902; 85904; 86006; 86129; 86134; 86158, 86159; 86210; 86231, 86232; 86298; 86301, 86302; 86304; 86530; 86664; 86686; 86705; 86849, 86850; 86883; 86885
- **REGISTERED TRADEMARKS:**  
27710-27755
- **TRADEMARKS REGISTERED ACCORDING TO THE ACCELERATED PROCEDURE:**  
27704-27709; 27756-27762
- **INTERNATIONAL TRADEMARKS FOR WHICH A DECISION ON GRANTING PROTECTIONS IS TAKEN:**  
79276\*; 79660\*; 80124\*; 81516\*; 84585; 84596; 84601; 84612; 84614; 84745; 85069; 85146; 85148, 85149; 85152-85156; 85158; 85161; 85166, 85167; 85172; 85174; 85176, 85177; 85179, 85180; 85184; 85198; 85203; 85206; 85208; 85210; 85212; 85214-85216; 85239; 85244; 85250, 85251; 85257; 85261, 85262; 85265; 85267-85269; 85278; 85284; 85292; 85296, 85297; 85323; 85330; 85333; 85337; 85339; 85342; 85344; 85348, 85349; 85356; 85358; 85362; 85368-85370; 85377; 85381-85383; 85386-85390; 85397-85399; 85412-85414; 85428; 85436; 85439; 85441, 85442; 85454; 85465, 85466; 85470; 85472; 85474-85480; 85484, 85485; 85507; 85511-85513; 85515-85521; 85537; 85539, 85540; 85547; 85549-85551; 85562; 85566; 85571; 85575; 85582; 85584-85586; 85588-85590; 85595-85599; 85601; 85603; 85605; 85607-85609; 85611-85613; 85615-85617; 85632; 85635; 85637; 85643; 85647, 85648; 85651; 85654, 85655; 85680; 85683; 85779; 85782; 85785-85788; 85935; 85941-85943; 85946; 86013; 86016-86018; 86022, 86023; 86160; 86163; 86165, 86166; 86282; 86319, 86320; 86595
- **INTERNATIONAL TRADEMARKS PROTECTED IN GEORGIA:**  
80686; 80778; 83221; 83384; 83538; 83599; 83603; 83611, 83612; 83614; 83623; 83625; 83675, 83676; 83680; 83685-83687; 83690; 83693, 83694; 83696; 83745; 83747; 83774-83776; 83847, 83848; 83860, 83861; 83866-83868; 83871, 83872; 83954-83958; 83967-83972; 83977, 83978; 83980-83983; 83986; 83988; 84102; 84105, 84106; 84123; 84127; 84131, 84132; 84134; 84141; 84144; 84181; 84187; 84351; 84356; 84365; 84368; 84376; 84382, 84383; 84386; 84514

# INVENTIONS

## APPLICATIONS APPROVED FOR GRANTING PATENTS

The decision can be appealed at the Chamber of Appeal of Sakpatenti within 3 months from the publication or at the Mtskheta District Court Administrative Cases Board (Address: №17, Samkhedro str., Mtskheta), within 1 month following the publication.

### PART B

#### B 01

- (10) AP 2016 13943 A (51) Int. Cl. (2006)  
B 01 D 1/00  
A 23 L 1/06  
A 23 L 2/00
- (21) AP 2015 013943 (22) 2015 09 24  
(71) LEPL SCIENTIFIC-RESEARCH  
CENTER OF AGRICULTURE (GE)  
Marshal Gelovanis gamz. 6, 0159, Tbilisi (GE)  
(72) Ekaterine Katsitadze (GE);  
Vladimer Miruashvili (GE)  
(54) **AGGREGATE FOR JUICE  
EVAPORATION**

(57) An aggregate includes a case 1 with a nipple 2 for in-process juice supplement and a nipple 7 for ready product withdrawal, heating componentry 6, which are vertical pipes connected together disposed in the case, the nipple 4 and 9 for warm agent supplement and condensate withdrawal, correspondingly. Arched wedge-shaped blades 14 disposed along imaginary spiral line and installed so that largest basis of each blade is shifted up, are fastened to heating componentry.

Claims: 1 independent

Fig.: 3

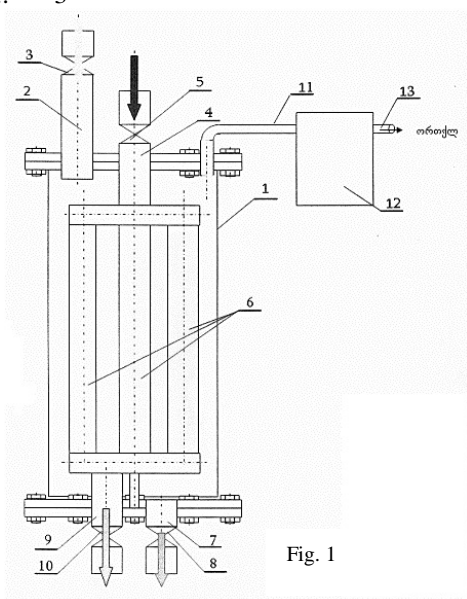
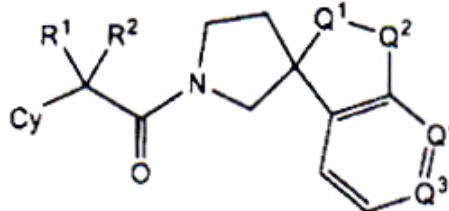

Fig. 1

### PART C

#### C 07

- (10) AP 2016 9736 A (51) Int. Cl. (2006)  
C 07 D 221/00  
C 07 D 223/02  
C 07 D 223/04  
C 07 D 231/04
- (21) AP 2005 009736 (22) 2005 05 04  
(31) 60/569,273; 60/602,051; 60/602,791;  
60/638,803  
(32) 2004 05 07; 2004 08 17; 2004 08 19;  
2004 12 22;  
(33) US; US; US; US  
(71) INCYTE CORPORATION (US)  
Experimental Station, Building 336,  
Route 141 & Henry Clay Road,  
Wilmington, DE 19880 (US)  
(72) YAO, Wenqing (US);  
ZHUO, Jincong (CN);  
XU, Meizhong (CN);  
ZHANG, Colin (CN);  
METCALF, Brian (US);  
HE, Chunhong (CN);  
QIAN, Ding-Quan (CN)  
(74) Shalva Gvaramadze  
(85) 2006 12 07  
(86) PCT/US2005/015559, 2005 05 04  
(54) **AMIDO COMPOUNDS AND THEIR  
USE AS PHARMACEUTICALS**  
(57) Compound of formula (VIII)



VIII

values of which Cy, Q<sup>1</sup>, Q<sup>2</sup>, Q<sup>3</sup>, Q<sup>4</sup>, R<sup>1</sup>, R<sup>2</sup> substitutions are provided in the claims or pharmaceutically acceptable salt and composition on the basis thereof. Application of said compound or pharmaceutically acceptable salt for the treatment of such diseases as obesity, diabetes, hypertension, dementia, cognitive dysfunction,

inflammatory diseases, metabolic syndrome, etc.  
and for pharmaceutical drugs preparation.  
Claims: 10 independent  
21 dependent

(10) AP 2016 13785 A (51) Int. Cl. (2006)

C 07 D 239/26  
C 07 D 231/12  
C 07 D 233/64  
C 07 D 401/06  
C 07 D 403/04  
C 07 D 403/06  
C 07 D 237/08  
C 07 D 405/04  
C 07 D 239/26  
C 07 C 233/66  
C 07 C 233/73  
C 07 C 233/78  
C 07 D 211/26  
C 07 D 213/40  
C 07 D 213/61

(21) AP 2013 013785 (22) 2013 10 11

(31) 61/713,113

(32) 2012 10 12

(33) US

(71) H. LUNDBECK A/S (DK)

Ottliavej 9 DK-2500 Valby (DK)

(72) KILBURN, John Paul (DK);

RASMUSSEN, Lars Kyhn (DK);

JESSING, Mikkel (DK);

ELDEMENKY, Eman Mohammed (US);

CHEN, Bin (US);

JIANG, Yu (US);

HOPPER, Allen T. (US)

(74) Tamaz Shilakadze

(85) 2015 04 08

(86) PCT/EP2013/071247, 2013 10 11

(54) **BENZAMIDES**

(57) An invention relates to novel compounds of benzamides of formula (I),

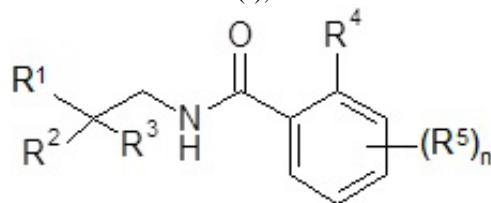

(I)

and pharmaceutical compositions containing them,  
and application thereof for the treatment of diseases  
related to P2X7 activity.

Claims: 3 independent

17 dependent

(10) AP 2016 13396 A (51) Int. Cl. (2006)

C 07 D 249/08  
C 07 D 401/12  
C 07 D 403/12

C 07 D 409/12  
A 61 K 31/497  
A 61 K 31/4439  
A 61 K 31/506  
A 61 K 31/498  
A 61 K 31/55  
A 61 K 31/5377  
A 61 P 35/00  
A 61 P 31/12  
A 61 P 29/00  
A 61 P 27/02

(21) AP 2012 013396 (22) 2012 07 26

(31) 61/654,651; 61/653,588; 61/610,178;  
61/513,432; 61/513,428

(32) 2012 06 01; 2012 05 31; 2012 03 13;  
2011 07 29; 2011 07 29

(33) US; US; US; US; US

(71) KARYOPHARM THERAPEUTICS,  
INC. (US)

2 Mercer Road Natick, MA 01760 (US)

(72) SANDANAYAKA, Vincent, P. (US);

SHACHAM, Sharon (IL);

MCCAULEY, Dilara (US);

SHECHTER, Sharon (IL)

(74) Tamaz Shilakadze

(85) 2014 02 24

(86) PCT/US2012/048319, 2012 07 26

(54) **HYDRAZIDE CONTAINING  
NUCLEAR TRANSPORT  
MODULATORS AND USAGE THEREOF**

(57) Compound of formula (I),

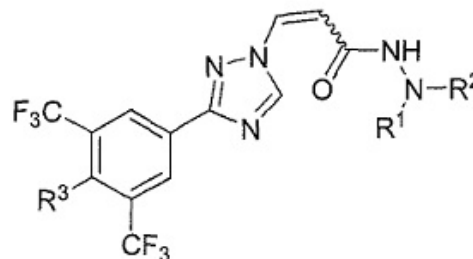

(I)

preparation method and pharmaceutical compositions  
on basis thereof and application thereof for the  
treatment of disorders and conditions associated  
with CRM1 activity.

Claims: 5 independent

16 dependent

Table: 2

Fig.: 6

(10) AP 2016 13967 A (51) Int. Cl. (2006)

C 07 D 413/12  
A 61 K 31/422  
A 61 P 33/00  
A 61 P 31/00

(21) AP 2013 013967 (22) 2013 03 13

(62) AP 2013 13660 2013 03 13 (GE)

(31) 12167640.7

(32) 2012 05 11



(33) EP  
 (71) POLICHEM SA (LU)  
 50, Val Fleuri L-1526 Luxembourg (LU)  
 (72) GAGLIARDI, Stefania (IT);  
 CONSONNI, Alessandra (IT);  
 MAILLAND, Federico (IT);  
 BULGHERONI, Anna (IT)  
 (74) Aleksandre gegechkori  
 (85) 2015 10 16  
 (86) PCT/EP2013/055078, 2013 03 13  
 (54) **SYNTHESIS OF (S)-NIFURATEL**  
 (57) Method for synthesis of (S)-nifuratel.  
 Claims: 1 independent  
 14 dependent  
 Table: 5  
 Fig.: 2

**(10) AP 2016 13675 A (51) Int. Cl. (2006)**  
**C 07 D 487/04**  
**C 07 D 519/00**

(21) AP 2013 013675 (22) 2013 06 19  
 (31) 61/820,828; 61/666,299  
 (32) 2013 05 08; 2012 06 29  
 (33) US; US  
 (71) PFIZER INC. (US)  
 235 East 42nd Street New York,  
 NY 10017 (US)  
 (72) GALATSIS, Paul (US);  
 HAYWARD, Matthew Merrill (US);  
 HENDERSON, Jaclyn (GB);  
 KORMOS, Bethany Lyn (US);  
 KURUMBAIL, Ravi G. (US);  
 STEPAN, Antonia Friederike (GB);  
 VERHOEST, Patrick Robert (US);  
 WAGER, Travis T. (US);  
 ZHANG, Lei (US)  
 (74) Shalva Gvaramadze  
 (85) 2014 12 25  
 (86) PCT/IB2013/055039, 2013 06 19  
 (54) **NOVEL 4-(SUBSTITUTED-AMINO)-**  
**7H-PYRROLO[2,3-d]PYRIMIDINES**  
**AS LRRK2 INHIBITORS**  
 (57) Compound of formula (I),

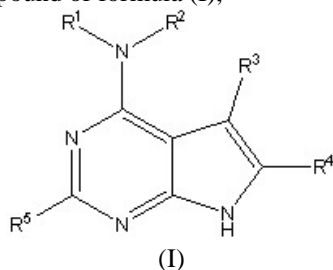

pharmaceutical compositions on basis thereof and application therefor drugs preparation intended for Parkinson disease treatment.

Claims: 9 independent  
 5 dependent  
 Table: 3

**(10) AP 2016 13859 A (51) Int. Cl. (2006)**  
**C 07 D 487/04**  
**C 07 D 519/00**  
**A 61 K 31/4985**  
**A 61 K 31/519**  
**A 61 K 31/5377**  
**A 61 K 31/501**  
**A 61 P 35/00**

(21) AP 2013 013859 (22) 2013 11 15  
 (31) 12192987.1  
 (32) 2012 11 16  
 (33) EP  
 (71) BOEHRINGER INGELHEIM  
 INTERNATIONAL GMBH (DE)  
 Binger Strasse 173 55216 Ingelheim  
 Am Rhein (DE)  
 (72) ENGELHARDT, Harald (DE);  
 SMETHURST, Christian (GB);  
 GIANNI, Davide (IT)  
 (74) Tamar Kochlamazashvili  
 (85) 2015 06 15  
 (86) PCT/EP2013/073946, 2013 11 15  
 (54) **TRIAZOLOPYRAZINE AS BRD4**  
**INHIBITORS AND USAGE THEREOF**  
**FOR CANCER TREATMENT**  
 (57) Compound of formula (I),

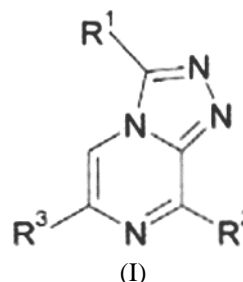

pharmaceutical compositions on basis and application therefor as drug for cancer treatment.

Claims: 5 independent  
 27 dependent

**(10) AP 2016 13828 A (51) Int. Cl. (2006)**  
**C 07 D 487/04**  
**C 07 D 519/00**  
**A 61 K 31/53**  
**A 61 P 11/00**  
**A 61 P 9/00**  
**A 61 P 25/00**  
**A 61 P 31/12**

(21) AP 2013 013828 (22) 2013 10 15  
 (31) 61/718,782; 123822399.9  
 (32) 2012 10 26; 2012 10 16  
 (33) US; US  
 (71) ALMIRALL, S.A. (ES)  
 Ronda del General Mitre 151 E-08022  
 Barcelona (ES)  
 (72) ERRA SOLA, Montserrat (ES);  
 CARRASCAL RIERA, Marta (ES);  
 TALTAVULL MOLL, Joan (ES);

CATURLA JAVALOYES, Juan  
Francisco (ES);  
BERNAL ANCHUELA, Francisco  
Javier (ES);  
PAGES SANTACANA, Lluís Miquel (ES);  
MIR CEPEDA, Marta (ES);  
COLL Gaspar Casals (ES);  
OLASAGARRE Maria Begona  
Hernandez (ES)

(74) Tamar Kochlamazashvili

(85) 2015 05 15

(86) PCT/EP2013/071551, 2013 10 15

(54) **PYRROLOTRIAZINONE**

**DERIVATIVES AS PI3K INHIBITORS**

(57) An invention relates to novel pyrrolotriazinone derivatives of formula (I),

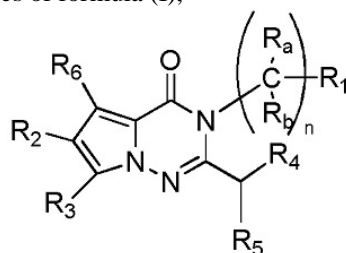

(I)

and to a method for preparation thereof, pharmaceutical compositions and application thereof the therapy as phosphoinositide 3-kinase (PI3K) inhibitors, as well.

Claims: 7 independent

19 dependent

(10) AP 2016 13667 A (51) Int. Cl. (2006)

C 07 D 495/04

A 61 K 31/519

A 61 P 35/00

A 61 P 37/00

(21) AP 2014 013667 (22) 2014 12 19

(31) 13,63500

(32) 2013 12 23

(33) FR

(71) LES LABORATOIRES SERVIER (FR)

35 rue de Verdun 92284 Suresnes Cedex (FR);

VERNALIS (R&D) LTD. (GB)

100 Berkshire Plays Warfdale Rd., Winners

Berkshire RG41 5RD (GB)

(72) KOTSCHY Andras (HU);

SZLAVIK Zoltán (HU);

CZEKEI Márton (HU);

PACZAL Attila (HU);

SZABO Zoltan (HU);

SIPOS Szabolcs (HU);

RADICS Gábor (HU);

PROSZENYAK Agnes (HU);

BALINT Balázs (HU);

BRUNO Alain (FR);

GENESTE Olivier (FR);

DAVIDSON James Edward Paul (GB);

MURRAY James Brooke (GB);

CHEN I-Jen (GB);

PERRON-SIERRA Françoise (FR)

(74) Tamaz Shilakadze

(54) **NEW THIENOPYRIMIDINE**

**DERIVATIVES, A PROCESS FOR THEIR PREPARATION AND PHARMACEUTICAL COMPOSITION CONTAINING THEM**

(57) Compound of formula I,

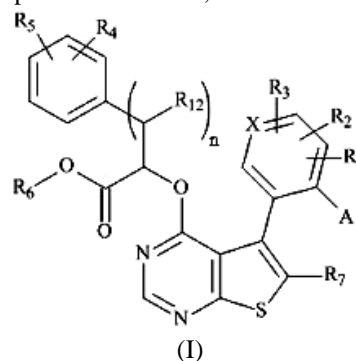

(I)

pharmaceutical compositions on basis thereof and application thereof drugs.

Claims: 11 independent

19 dependent

Table: 2

## C 08

(10) AP 2016 13326 A (51) Int. Cl. (2006)

C 08 G 73/06

C 08 L 79/06

A 61 P 41/00

C 07 D 401/04

(21) AP 2012 013326 (22) 2012 05 17

(31) RU2011119848; RU2011153043

(32) 2011 05 17; 2011 12 26

(33) RU; RU

(71) JOINT STOCK COMPANY

"PHARMASYNTEZ" (RU)

Office 3, dom 23, ul. Krasnogvardeyskaya, Irkutsk,

664007 (RU)

(72) SHURYGIN, Mikhail Gennadievich (RU);

SHURYGINA, Irina Aleksandrovn (RU)

(74) Khatuna Imnadze

(85) 2013 12 17

(86) PCT/IB2012/052483, 2012 05 17

(54) **COMPOUNDS, PHARMACEUTICAL COMPOSITIONS AND A METHOD FOR THE PROPHYLAXIS AND TREATMENT OF THE ADHESION PROCESS**

(57) Application of compounds-blockers of p38 MAP kinase as therapeutic agent for the treatment or prophylaxis of adhesion.

Claims: 5 independent

28 dependent

**C 11**

(10) AP 2016 13113 A (51) Int. Cl. (2006)  
 C 11 D 1/37  
 C 11 D 3/50  
 C 11 D 17/00  
 E 03 D 9/02  
 C 11 D 3/48

(21) AP 2011 013113 (22) 2011 11 11

(31) 10 2010 043 848.0

(32) 2010 11 12

(33) DE

(71) HENKEL AG & CO. KGAA (DE)  
 Henkelstr. 67 40589 Düsseldorf (DE)

(72) SCHIEDEL, Marc-Steffen (DE);  
 GIESEN, Brigitte (DE);  
 ERNST, Anke (DE);  
 REICHERT, Christian (DE);  
 CAPPLEMAN, Robert Stephen (DE);  
 HORN, Michael (DE)

(74) Shalva Gvaramadze

(85) 2013 06 07

(86) PCT/EP2011/069965, 2011 11 11

(54) **BALL-SHAPED TOILET BLOCKS  
 BASED ON ANIONIC SURFACTANTS**

(57) Toilet cleaning block which comprises perfume, at least one alkylbenzenesulphonate and at least one olefinsulphonate and not more than 2.5% by weight of nonionic surfactants can be spherically shaped, and is employed in a system comprising at least one device for water drain and one block for cleaning toilet.

Claims: 4 independent

12 dependent

**C 12**

(10) AP 2016 13598 A (51) Int. Cl. (2006)  
 C 12 P 13/00  
 C 12 P 13/02  
 C 12 P 41/00  
 C 07 C 227/02  
 C 07 C 229/28

(21) AP 2014 013598 (22) 2014 10 15

(31) P-13-154

(32) 2013 10 15

(33) LV

(71) JSC "OLAINFARM" (LV)  
 Rūpnīcu Iela 5, Olaine Nov. LV- 2114 (LV)

(72) LIEPINS, Vilnis (LV);  
 LIVDANE, Albine (LV);  
 REVUCA, Ekaterina (LV)

(74) Aleksandre Gegechkori

(54) **METHOD FOR SEMIPRODUCTS OF  
 PHENIBUT PRODUCTION**

(57) An invention relates to novel technologically simple production method for benzylmalonic and

cianobenzylmalonic acids diethyl ethers, which are semiproducts of phenibut production.

Claims: 2 independent

4 dependent

**C 13**

(10) AP 2016 13363 A (51) Int. Cl. (2006)  
 C 13 K 13/00  
 C 10 L 1/182  
 C 13 K 1/02  
 D 21 C 1/02

(21) AP 2012 013363 (22) 2012 07 12

(31) 61/508,407

(32) 2011 07 15

(33) US

(71) GREENFIELD SPECIALTY  
 ALCOHOLS INC. (CA)  
 20 Toronto Street, Suite 1400 Toronto, Ontario  
 M5C 2B8 (CA)

(72) DOTTORI, Frank, A. (CA);  
 BENSON, Robert, Ashley, Cooper (CA);  
 BENECH, Régis-Olivier (CA)

(74) Shalva Gvaramadze

(85) 2014 01 28

(86) PCT/CA2012/050481, 2012 07 12

(54) **CONDITIONING OF BIOMASS FOR  
 IMPROVED C5/C6 SUGAR RELEASE  
 PRIOR TO FERMENTATION**

(57) A conventional process of biomass for C5/C6 sugar improved release before fermentation including C5 and C6 sugar release from lignocellulosic biomass by fermentation to ethanol, step of pretreatment of biomass with steam at elevated temperature and pressure, collection of C5 sugars from hemicellulose breakdown, cellulose hydrolysis and collection of C6 sugars from cellulose breakdown; at that, conditioning of biomass is carried out prior to pretreatment step by heating the biomass with steam for a time period between 5 minutes to 60 minutes to achieve a steam treated biomass having a temperature of about 80 to 100°C; and adjusting a moisture content of the steam treated biomass to about 45% to 80%.

Claims: 2 independent

27 dependent

Fig.: 1

**C 22**

(10) AP 2016 13797 A (51) Int. Cl. (2006)  
 C 22 B 5/04  
 C 22 C 33/00  
 B 22 F 3/23

(21) AP 2015 013797 (22) 2015 04 15

- 
- (71) LEPL FERDINAND TAVADZE  
INSTITUTE OF METALLURGY AND  
MATERIALS SCIENCE (GE)  
Al. Kazbegis gamz. 15, 0160, Tbilisi (GE)
- (72) Garegin Zakharov (GE);  
Zurab Aslamazashvili (GE);  
Giorgi Tavadze (GE);  
Giorgi Oniashvili (GE);  
Archil Chirakadze (GE);  
Avtandil Khvadagiani (GE);  
Lali Ghurchumelia (GE);  
Zakaria Buachidze (GE);  
Giorgi Mikaberidze (GE);  
Gulnara Urushadze (GE);  
Mikhael Chikhradze (GE);  
Merab Poladashvili (GE)
- (54) **METHOD FOR FERROMANGANESE PRODUCTION**
- (57) A method includes exothermic reaction mixture preparation, production from inert gas melt in atmosphere in burning regimen at the 3-5 MPa pressure with reaction mixture powder consisting of product containing 60-80 mass% manganese oxide, which is a waste from manganese concentrates production called as enriched dirt with dispersion up to 200  $\mu\text{m}$  under thermal treatment with air at 700 -750°K within 30 minutes; and aluminium-manganese alloy is used as metal deoxidizer.  
Claims: 1 independent
-

# PATENTED INVENTIONS

## PART A

### A 21

- (11) P 2016 6562 B (51) Int. Cl. (2006)  
A 21 D 8/02  
A 21 D 13/04
- (10) AP 2016 13719 A (44) 13(449)/2016  
(21) AP 2015 013719  
(22) 2015 02 05  
(24) 2015 02 05  
(73) Maria Silagadze (GE)  
26 Maisis q. 45, 4600, Kutaisi (GE);  
Eliza Pruidze (GE)  
Rustavelis q. 137/36, 4600,  
Kutaisi (GE);  
Giorgi Pkhakadze (GE)  
26 Maisis q. 45, 4600, Kutaisi (GE);  
Nikoloz Pkhakadze (GE)  
26 Maisis q. 45, 4600, Kutaisi (GE);  
Sopio Gachechiladze (GE)  
Titsian Tabidzis q. 28/9, 4600,  
Kutaisi (GE);  
Khatia Khvadagiani (GE)  
Tabukashvilis q. 183/76, 4600,  
Kutaisi (GE)
- (72) Maria Silagadze (GE);  
Eliza Pruidze (GE);  
Giorgi Pkhakadze (GE);  
Nikoloz Pkhakadze (GE);  
Sopio Gachechiladze (GE);  
Khatia Khvadagiani (GE)
- (54) **METHOD FOR BIOLOGICAL  
APPRECIATED VALUE GLUTEN-FREE  
BREAD PREPARATION FOR SICK  
PEOPLE WITH CELIAC DISEASE**

### A 61

- (11) P 2016 6564 B (51) Int. Cl. (2006)  
A 61 B 17/32  
A 61 B 17/34  
A 61 F 2/10
- (10) AP 2016 13778 A (44) 13(449)/2016  
(21) AP 2015 013778  
(22) 2015 03 31  
(24) 2015 03 31  
(73) Tamaz Shioshvili (GE)  
Ir. Abashidzis q. 46, b. 17, 0179, Tbilisi (GE);  
Petre Badalov (GE)  
Vazha-Pshavelas gamz., kvart. IV., korp. 11,  
b. 28, 0186, Tbilisi (GE)
- (72) Tamaz Shioshvili (GE);  
Petre Badalov (GE)

### (54) **DEVICE FOR MAKING RECESS IN SKIN FOR FREE HAIR ROOTS TRANSPLANTATION**

- (11) P 2016 6559 B (51) Int. Cl. (2006)  
A 61 K 31/167  
A 61 K 31/36  
A 61 K 31/366  
A 61 K 31/381  
A 61 K 31/40  
A 61 K 31/402  
A 61 K 31/4035  
A 61 K 31/404  
A 61 K 31/4184  
A 61 K 31/42  
A 61 K 31/421  
A 61 K 31/426  
A 61 K 31/428  
A 61 K 31/429  
A 61 K 31/433  
A 61 K 31/4406  
A 61 K 31/4409  
A 61 K 31/4453  
A 61 K 31/4468  
A 61 K 31/495  
A 61 K 31/55  
A 61 P 35/00  
A 61 P 35/02  
C 07 C 233/80  
C 07 C 235/56  
C 07 C 237/40  
C 07 C 271/22  
C 07 D 207/06  
C 07 D 207/337  
C 07 D 209/08  
C 07 D 209/42  
C 07 D 209/46  
C 07 D 211/76  
C 07 D 213/04  
C 07 D 213/38  
C 07 D 213/56  
C 07 D 223/16  
C 07 D 231/14  
C 07 D 231/20  
C 07 D 231/22  
C 07 D 231/56  
C 07 D 233/61  
C 07 D 233/64  
C 07 D 239/36  
C 07 D 261/08  
C 07 D 263/32  
C 07 D 263/34  
C 07 D 277/62  
C 07 D 277/20  
C 07 D 277/28  
C 07 D 277/30

C 07 D 285/06  
 C 07 D 295/14  
 C 07 D 309/14  
 C 07 D 317/58  
 C 07 D 333/20  
 C 07 D 405/04  
 C 07 D 409/04  
 C 07 D 471/04  
 C 07 D 495/04  
 C 07 D 513/04

- (10) AP 2016 13405 A (44) 13(449)/2016  
 (21) AP 2012 013405  
 (22) 2012 08 08  
 (24) 2012 08 08  
 (31) 2011-174305  
 (32) 2011 08 09  
 (33) JP  
 (86) PCT/JP2012/070267, 2012 08 08  
 (73) TAKEDA PHARMACEUTICAL  
 COMPANY LIMITED (JP)  
 1-1, Doshomachi 4-chome, Chuo-ku,  
 Osaka-shi, Osaka 5410045 (JP)  
 (72) TOMITA, Naoki (JP);  
 KAJII, Shigeo (JP);  
 CARY, Douglas Robert (JP);  
 TOMITA, Daisuke (JP);  
 IMAMURA, Shinichi (JP);  
 TSUCHIDA, Ken (JP);  
 MATSUDA, Satoru (JP);  
 HARA, Ryujiro (JP)  
 (74) Shalva Gvaramadze  
 (54) **CYCLOPROPANEAMINE COMPOUND**

## A 62

- (11) **P 2016 6563 B** (51) **Int. Cl. (2006)**  
**A 62 C 2/06**  
**E 21 F 43/12**  
 (10) AP 2016 13724 A (44) 13(449)/2016  
 (21) AP 2015 013724  
 (22) 2015 02 05  
 (24) 2015 02 05  
 (73) Vladimer Loladze (GE)  
 Bakhtrionis q., korp. I, b. 13, 0194,  
 Tbilisi (GE);  
 Vakhtang Loladze (GE)  
 Bakhtrionis q., korp. I, b. 13, 0194,  
 Tbilisi (GE);  
 Giorgi Loladze (GE)  
 Paliashvilis q. 37/2, 0179, Tbilisi (GE);  
 Nino Loladze (GE)  
 Paliashvilis q. 37/2, 0179, Tbilisi (GE)  
 (72) Vladimer Loladze (GE);  
 Vakhtang Loladze (GE);  
 Giorgi Loladze (GE);  
 Nino Loladze (GE)  
 (54) **DEVICE FOR FIRE**  
**EXTINGUISHING AND ENERGY**

**CARRIER REJECTED FROM  
 DAMAGED HEEL OR PIPE DUCT  
 WITHDRAWAL**

## PART B

### B 61

- (11) **P 2016 6565 B** (51) **Int. Cl. (2006)**  
**B 61 B 12/00**  
**E 01 D 19/04**  
 (10) AP 2016 13827 A (44) 13(449)/2016  
 (21) AP 2015 013827  
 (22) 2015 05 15  
 (24) 2015 05 15  
 (73) LEPL GRIGOL TSULUKIDZE MINING  
 INSTITUTE (GE)  
 Mindelis q. 7, 0186, Tbilisi (GE);  
 Davit Pataraiia (GE)  
 Shartavas q. 18, b. 16, 0160, Tbilisi (GE);  
 Aleksandre Kartvelishvili (GE)  
 Vazha-Pshavelas gamz. 59, b. 15, 0186,  
 Tbilisi (GE);  
 Giorgi Nozadze (GE)  
 Temkis das., IV mkr., korp. 6, b. 37, 0178,  
 Tbilisi (GE);  
 Rusudan Maisuradze (GE)  
 Nutsunidzis Plato IV mkr., korp. 23, b. 1,  
 0183, Tbilisi (GE)  
 (72) Davit Pataraiia (GE);  
 Aleksandre Kartvelishvili (GE);  
 Giorgi Nozadze (GE);  
 Rusudan Maisuradze (GE)  
 (54) **INCLINED ABUTMENT BASE**

## PART C

### C 07

- (11) **P 2016 6560 B** (51) **Int. Cl. (2006)**  
**C 07 D 491/08**  
**C 07 D 491/18**  
**C 07 D 498/08**  
**C 07 D 498/18**  
**C 07 D 498/22**  
**C 07 D 513/18**  
**A 61 K 31/4353**  
**A 61 P 35/00**  
 (10) AP 2016 13564 A (44) 13(449)/2016  
 (21) AP 2013 013564  
 (22) 2013 02 20  
 (24) 2013 02 20

- (31) 61/607,485; 61/759,307  
(32) 2012 03 06; 2013 01 31  
(33) US; US  
(86) PCT/IB2013/051391, 2013 02 20  
(73) PFIZER INC. (US)  
235 East 42<sup>nd</sup> Street New York,  
NY 10017 (US)  
(72) BAILEY, Simon (GB);  
BURKE, Benjamin, Joseph (US);  
COLLINS, Michael, Raymond (US);  
CUI, Jingrong, Jean (US);  
DEAL, Judith, Gail (US);  
HOFFMAN, Robert, Louis (US);  
HUANG, Qinhua (CN);  
JOHNSON, Ted, William (US);  
KANIA, Robert, Steven (US);  
KATH, John, Charles (US);  
LE, Phuong, Thi, Quy (US);  
MCTIGUE, Michele, Ann (US);  
PALMER, Cynthia, Louise (US);  
RICHARDSON, Paul, Francis (GB);  
SACH, Neal, William (GB)  
(74) Shalva Gvaramadze  
(54) **MACROCYCLIC DERIVATIVES  
FOR THE TREATMENT OF  
PROLIFERATIVE DISEASES**
- 

## PART H

### H 02

- (11) P 2016 6561 B**      **(51) Int. Cl. (2006)**  
**H 02 P 9/00**  
(10) AP 2016 13658 A      (44) 13(449)/2016  
(21) AP 2014 013658  
(22) 2014 12 09  
(24) 2014 12 09  
(73) Leri Giorgadze (GE)  
Zh. Shartavas gamz. 11, b. 6, 3700,  
Rustavi (GE)  
(72) Leri Giorgadze (GE);  
Lia Giorgadze (GE)  
(54) **METHOD FOR GENERATOR  
ACTUATION AND DEVICE FOR  
REALIZATION THEREOF**
-

---

# UTILITY MODELS

## APPLICATION APPROVED FOR GRANTING PATENTS

The decision can be appealed at the Chamber of Appeal of Sakpatenti within 3 months from the publication or at the Mtskheta District Court Administrative Cases Board (Address: №17, Samkhedro str., Mtskheta), within 1 month following the publication.

### PART H

#### H 02

(10) AU 2016 14085 U (51) Int. Cl. (2006)  
H 02 K 17/00

(21) AU 2016 014085 (22) 2016 03 09

(71) Guram Makharadze (GE)

Dolidzis q. korp.15, b.9, 0171, Tbilisi (GE);

Arkad Rikrikadze (GE)

Panjikidzis q. 4, b.35, 0160, Tbilisi (GE)

(72) Guram Makharadze (GE);

Arkad Rikrikadze (GE)

(54) **DOUBLE-WINDING THREE-PHASE  
ELECTRIC MACHINE**

(57) An electric machine includes a case, a stator with magnetic conductor in which grooves the windings are disposed, and short-circuit rotor; at that, in stator grooves the single-phase main and ancillary windings are disposed. Said windings are shifted in the space on 90 electrical degrees relative to each other. One discharge end of ancillary winding is hooked-up to middle point of main winding.

Claims: 1 independent

1 dependent

Fig.: 3

---



---

# DESIGNS

## APPLICATIONS APPROVED FOR REGISTRATIONS

The decision can be appealed at the Chamber of Appeal of Sakpatenti within 3 months from the publication or at the Mtskheta District Court Administrative Cases Board (Address: №17, Samkhedro str., Mtskheta), within 1 month following the publication.

- (10) **AD 2016 916 S**      (51) **09-03**  
(21) AD 2016 000916      (22) 2016 07 04  
(28) 1  
(71) LTD "Fruit Master Group" (GE)  
    Varketili 3, 3s mkr., korp. 340, b. 5, 0163, Tbilisi (GE)  
(72) Meral Shamoianio (GE)  
(54) **BOX**  
(55)



1

---

(10) AD 2016 915 S (51) 12-99  
(21) AD 2016 000915 (22) 2016 07 04  
(28) 1  
(71) Nika Alavidze (GE)  
Kavtiskhevis q. 14, 0180, Tbilisi (GE)  
(72) Nika Alavidze (GE)  
(54) **PARKING BOOKING SYSTEM**  
(55)



1.1

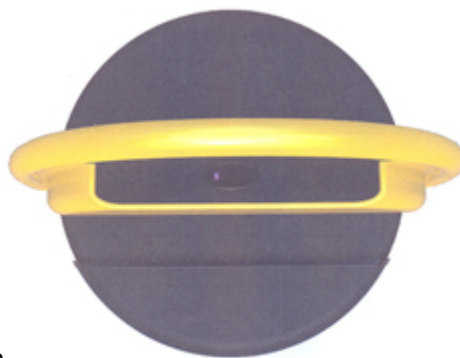

1.2



1.3



1.4



1.5



1.6

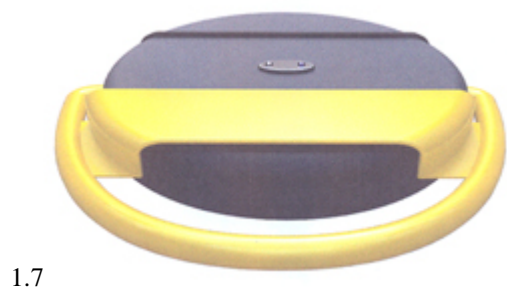

---

# TRADEMARKS

## APPLICATIONS FILED UNDER THE NATIONAL PROCEDURE APPROVED FOR REGISTRATION

The decision can be appealed at the Chamber of Appeal of Sakpatenti within 3 months from the publication or at the Mtskheta District Court Administrative Cases Board (Address: №17, Samkhedro St., Mtskheta), within 1 month following the publication.

(260) AM 2016 84259 A

(210) AM 84259

(220) 2015 10 20

(731) TRADICNI PIVOVAR V RAKOVNIKU

A.S. Havlickova 69, Rakovnik, Czech  
Republic

(740) Tamaz Shilakadze

(540)



(591) Black, white

(531) 25.01.01, 27.05.14, 02.03.11, 11.03.03

(511) 32, 33, 35, 43

---

(260) AM 2016 84260 A

(210) AM 84260

(220) 2015 10 20

(731) TRADICNI PIVOVAR V RAKOVNIKU

A.S. Havlickova 69, Rakovnik, Czech  
Republic

(740) Tamaz Shilakadze

(540)



(591) Black, white

(531) 05.07.02, 07.01.09, 18.02.01, 27.05.24,  
25.01.05

(511) 32, 33, 35, 43

---

(260) AM 2016 85065 A

(210) AM 85065

(220) 2015 12 08

(731) REVAZ VASHAKIDZE

Chavchavadzis I shes. 6, b. 48, 0179, Tbilisi,  
Georgia

(740) REVAZ VASHAKIDZE

(540)

**Helio**

(591) Red and white

(531) 27.05.03, 29.01.12

(511) 2, 16, 35

---

(260) AM 2016 85810 A

(210) AM 85810

(220) 2016 01 21

(310) 86725288

(320) 2015 08 14

(330) US

(731) AT&T Intellectual Property II, L.P.

645 East Plumb Lane, Reno, Nevada 89502,  
USA

(740) Tamaz Shilakadze

(540)



(591) Black, white

(531) 01.05.01, 26.15.01

(511) 9, 16, 35, 36, 37, 38, 41, 42, 43, 45

---

(260) AM 2016 85834 A

(210) AM 85834

(220) 2016 01 25

(731) IVYBRIDGE VENTURES LIMITED

Lampousas 1, P.C. 1095, Nicosia, Cyprus

(740) Tamar Kochlamazashvili

---

(540)



(591) Green, white  
 (531) 04.05.03, 26.11.01, 27.05.01, 27.05.24,  
 29.01.12  
 (511) 6, 8, 16, 21, 24, 35

(260) AM 2016 85891 A  
 (210) AM 85891  
 (220) 2016 01 28  
 (731) IVYBRIDGE VENTURES LIMITED  
 Lampousas 1, P.C. 1095, Nicosia, Cyprus  
 (740) Tamar Kochlamazashvili  
 (540)



(591) White, sky-blue, blue, dark blue  
 (531) 26.04.06, 27.05.11, 27.05.24, 29.01.12  
 (511) 3, 6, 8, 16, 21, 24, 35

(260) AM 2016 85902 A  
 (210) AM 85902  
 (220) 2016 02 01  
 (731) LTD "Anaklia Development Consortium"  
 Marjanishvilis q. 6, Tbilisi, Georgia  
 (740) Giorgi Tsurtsunia  
 (540)



(591) Red, black, grey, white  
 (531) 29.01.12, 26.11.13, 28.19  
 (526) The trademark is protected as a whole. "ანაკლიას" shall not be subject to independent legal protection.  
 (511) 35, 36, 37, 39

(260) AM 2016 85904 A  
 (210) AM 85904  
 (220) 2016 02 01  
 (220) 2016 02 01  
 (731) LTD "Anaklia Development Consortium"  
 Marjanishvilis q. 6, Tbilisi, Georgia

(740) Giorgi Tsurtsunia  
 (540)



(591) Grey, black, red, white  
 (531) 27.05.10, 29.01.12, 26.11.13  
 (526) The trademark is protected as a whole. "Anaklia" shall not be subject to independent legal protection.  
 (511) 35, 36, 37, 39

(260) AM 2016 86006 A  
 (210) AM 86006  
 (220) 2016 02 05  
 (731) BP P.L.C.  
 1 St James's Square, London SW1Y 4PD,  
 United Kingdom  
 (740) Shalva Gvaramadze  
 (540)

### THE ENERGY WITHIN

(511) 4, 37

(260) AM 2016 86129 A  
 (210) AM 86129  
 (220) 2016 02 11  
 (731) TROMMSDORFF GMBH & CO. KG  
 Trommsdorffstraße 2-6, 52477 Alsdorf,  
 Germany  
 (740) Tamaz Shilakadze  
 (540)

### რექტორდელტი

(511) 5

(260) AM 2016 86134 A  
 (210) AM 86134  
 (220) 2016 02 15  
 (731) G&W INTERNATIONAL CO. LTD.  
 Suite 602, East of Bld. 211, Tairan Industrial  
 Zone, Futian District, Shenzhen, 518040 China  
 (740) Liliana Darakhvelidze  
 (540)



(591) Black, white  
 (531) 18.01.08, 18.01.09, 26.11.11, 26.11.13,  
 27.05.17  
 (511) 12

(260) AM 2016 86158 A  
 (210) AM 86158  
 (220) 2016 02 15  
 (731) BIG STAR CO., LTD.  
 15 Soi. Rama 2, Soi. 100 Rama 2 Road,  
 Samaedam, Bangkhunthien, Bangkok  
 10150, Thailand  
 (740) Tamaz Shilakadze  
 (540)



(591) Black, white  
 (531) 24.15.13, 26.11.12, 27.05.01  
 (511) 25

(260) AM 2016 86159 A  
 (210) AM 86159  
 (220) 2016 02 15  
 (731) BIG STAR CO., LTD.  
 15 Soi. Rama 2, Soi. 100 Rama 2 Road,  
 Samaedam, Bangkhunthien, Bangkok  
 10150, Thailand  
 (740) Tamaz Shilakadze  
 (540)

**cania**

(591) Black, white  
 (511) 25

(260) AM 2016 86210 A  
 (210) AM 86210  
 (220) 2016 02 17  
 (731) TOYOTA JIDOSHA KABUSHIKI KAISHA  
 (also trading as Toyota Motor Corporation)  
 1, Toyota-cho, Toyota-shi, Aichi-ken, Japan  
 (740) Tamar Kochlamazashvili  
 (540)

**AYGO**

(511) 12

(260) AM 2016 86231 A  
 (210) AM 86231  
 (220) 2016 02 19  
 (731) LO.LI. PHARMA S.R.L.  
 Via dei Luxardo 33, 00156 Rome, Italy  
 (740) Tamaz Shilakadze  
 (540)

**DAV**

(511) 5

(260) AM 2016 86232 A  
 (210) AM 86232  
 (220) 2016 02 19  
 (731) LTD "GOODWINO"  
 S. Janashias q. 11a, 0179, Tbilisi,  
 Georgia  
 (740) Giorgi Taktakishvili  
 (540)

სავინო SAVINO САВИНО



(591) Black, white  
 (531) 05.07.10, 27.05.05, 28.05, 28.19  
 (511) 30, 32, 33, 35, 43

(260) AM 2016 86298 A  
 (210) AM 86298  
 (220) 2016 02 23  
 (731) TCL CORPORATION  
 No.19 Zone, Zhongkai High Technology  
 Development Zone, Huizhou, Guang Dong,  
 China  
 (740) Vakhtang Torotadze  
 (540)

**TCL**

(511) 9

(260) AM 2016 86301 A  
 (210) AM 86301  
 (220) 2016 02 23  
 (731) PORTUCEL, S.A.  
 Mitrena - Apartado 55, 2901-861 Setúbal,  
 Portugal  
 (740) Merab Kvimsadze  
 (540)

**TARGET**

(591) Black, white  
 (531) 27.05.05  
 (511) 16

(260) AM 2016 86302 A  
 (210) AM 86302  
 (220) 2016 02 23  
 (731) PORTUCEL, S.A.  
 Mitrena - Apartado 55, 2901-861 Setúbal,  
 Portugal  
 (740) Merab Kvimsadze  
 (540)

**INACOPIA**

(591) Black, white  
(531) 27.05.05  
(511) 16

(260) AM 2016 86304 A  
(210) AM 86304  
(220) 2016 02 23  
(731) PORTUCEL, S.A.  
Mitrena - Apartado 55, 2901-861 Setúbal,  
Portugal  
(740) Merab Kvimsadze  
(540)

**MULTIOFFICE**

(591) Black, white  
(531) 27.05.05  
(511) 16

(260) AM 2016 86530 A  
(210) AM 86530  
(220) 2016 03 10  
(731) AKAKI RAZMADZE  
Tigishvilis q. 19, 0101, Tbilisi, Georgia  
(740) AKAKI RAZMADZE  
(540)

**მიჯრა**  
**Mijra**

(511) 42

(260) AM 2016 86664 A  
(210) AM 86664  
(220) 2016 03 18  
(731) LTD "SHALVINO"  
Zaza Panaskertel-Tsitsishvilis q., korp. 1,  
b. 10, 0160, Tbilisi, Georgia  
(740) Shalva Gvaramadze  
(540)

**შავლებო**  
**ШАВЛЕГО**

(511) 33

(260) AM 2016 86686 A  
(210) AM 86686  
(220) 2016 03 22  
(731) DAVID BITCHIKASHVILI  
Vazha-Pshavelas gamz. 47, kvart. I, korp. 2,  
b. 121, Tbilisi, Georgia  
(740) DAVID BITCHIKASHVILI  
(540)



(591) Black, white, blue, light blue, sky-blue  
(531) 06.01.04, 27.05.05, 28.19, 26.03.04, 29.01.12  
(511) 35, 36, 42, 45

(260) AM 2016 86705 A  
(210) AM 86705  
(220) 2016 03 23  
(731) LTD "Bolero & Company"  
Kuchishvilis q. 12-14-16, b. 3, 0179, Tbilisi,  
Georgia  
(740) Mamuka Potolashvili  
(540)

**ერეკლიონი**  
**EREKLIONI**  
**ЭРЕКЛИОНИ**

(511) 33

(260) AM 2016 86849 A  
(210) AM 86849  
(220) 2016 03 31  
(731) WANDOO FINANCE SIA  
Kārļa Ulmaņa gatve 119, Mārupe, Mārupes  
nov., LV-2167, Latvia  
(740) Shalva Gvaramadze  
(540)

**WANDOO**

(511) 36

(260) AM 2016 86850 A  
(210) AM 86850  
(220) 2016 03 31  
(731) WANDOO FINANCE SIA  
Kārļa Ulmaņa gatve 119, Mārupe, Mārupes  
nov., LV-2167, Latvia  
(740) Shalva Gvaramadze  
(540)



(591) Green and white  
(531) 26.04.03, 26.04.18, 27.05.21, 29.01.12  
(511) 36

(260) AM 2016 86883 A  
(210) AM 86883  
(220) 2016 04 05  
(731) LTD "ASPHARMA GEORGIA  
PHARMACEUTICALLY COMPANY"  
Mtskhetis q. 8, 0179, Tbilisi, Georgia  
(740) Maia Samadashvili

(540)

DOREPAM  
დორეპამი  
ДОРЕПАМ

(591) Black, white

(511) 5

---

(260) AM 2016 86885 A

(210) AM 86885

(220) 2016 04 05

(731) LTD "ASPHARMA GEORGIA  
PHARMACEUTICALLY COMPANY"  
Mtskhetyis q. 8, 0179, Tbilisi, Georgia

(740) Maia Samadashvili

(540)

CONZEPA  
კონზეპა  
ΚΟΗΖΕΠΑ

(591) Black, white

(511) 5

---



## REGISTERED TRADEMARKS

(111) M 2016 27710 R  
 (151) 2016 10 18  
 (181) 2026 10 18  
 (260) AM 2016 75405 A  
 (220) 2014 01 10

(732) LTD "RICO-FOODS"  
 Guadalmina Alta, Blq Barclays Bank, la  
 planta, 29678 San Pedro de Alcantara Malaga,  
 Spain

(111) M 2016 27711 R  
 (151) 2016 10 18  
 (181) 2026 10 18  
 (260) AM 2015 79647 A  
 (220) 2014 11 25

(732) NATELA TKHELIDZE-NEBULISHVILI  
 Didi Dighomi, me-3 mkr., me-12 korp. b. 49,  
 0159, Tbilisi, Georgia

(111) M 2016 27712 R  
 (151) 2016 10 18  
 (181) 2026 10 18  
 (260) AM 2016 80026 A  
 (220) 2015 01 01

(732) LTD "INTERAGROSYSTEM"  
 Ul. Pobedy 132, Belorechensk, 352630,  
 Belorechenskij raion, Krasnodarskij kraj,  
 Russian Federation

(111) M 2016 27713 R  
 (151) 2016 10 18  
 (181) 2026 10 18  
 (260) AM 2016 80027 A  
 (220) 2015 01 01

(732) LTD "INTERAGROSYSTEM"  
 Ul. Pobedy 132, Belorechensk, 352630,  
 Belorechenskij raion, Krasnodarskij kraj,  
 Russian Federation

(111) M 2016 27714 R  
 (151) 2016 10 18  
 (181) 2026 10 18  
 (260) AM 2016 81374 A  
 (220) 2015 03 24

(732) LTD "BOLERO & COMPANY"  
 Kuchishvilis q. 12-14-16, 0179, Tbilisi, Georgia

(111) M 2016 27715 R  
 (151) 2016 10 18  
 (181) 2026 10 18  
 (260) AM 2016 81902 A

(220) 2015 05 01  
 (732) LTD "TIFLISSKI VINNI POGREB"  
 Iumashevis q. 27, 0198 Tbilisi, Georgia

(111) M 2016 27716 R  
 (151) 2016 10 18  
 (181) 2026 10 18  
 (260) AM 2016 82833 A  
 (220) 2015 07 07

(732) LTD "LOGIKMETRI"  
 Marabdis q. 29, 0160, Tbilisi, Georgia

(111) M 2016 27717 R  
 (151) 2016 10 18  
 (181) 2026 10 18  
 (260) AM 2016 82834 A  
 (220) 2015 07 07

(732) LTD "LOGIKMETRI"  
 Marabdis q. 29, 0160, Tbilisi, Georgia

(111) M 2016 27718 R  
 (151) 2016 10 18  
 (181) 2026 10 18  
 (260) AM 2016 82981 A  
 (220) 2015 07 14

(732) LTD "FASHIONTV GEORGIA-FASHIONTV  
 GEORGIA"  
 Sop. Kursebi, 497, Tkibuli, Georgia

(111) M 2016 27719 R  
 (151) 2016 10 18  
 (181) 2026 10 18  
 (260) AM 2016 83049 A  
 (220) 2015 07 20

(732) LTD "MADAVINO"  
 me-3 mas. Kaloubnis q., korp. ab., b. 24,  
 0182, Tbilisi, Georgia

(111) M 2016 27720 R  
 (151) 2016 10 18  
 (181) 2026 10 18  
 (260) AM 2016 83194 A  
 (220) 2015 07 29

(732) LTD "VAZIANI COMPANY"  
 Mshvidobis q. 42, 2200, Telavi, Georgia

(111) M 2016 27721 R  
 (151) 2016 10 18  
 (181) 2026 10 18

(260) AM 2016 83197 A  
(220) 2015 07 29  
(732) ALPARGATAS S.A.  
Avenida Doutor Cardoso de Melo, 1336,  
Vila Olímpia, 04548-004 São Paulo, SP,  
Brazil

(111) M 2016 27722 R  
(151) 2016 10 18  
(181) 2026 10 18  
(260) AM 2016 83198 A  
(220) 2015 07 29  
(732) ALPARGATAS S.A.  
Avenida Doutor Cardoso de Melo, 1336,  
Vila Olímpia, 04548-004 São Paulo, SP,  
Brazil

(111) M 2016 27723 R  
(151) 2016 10 18  
(181) 2026 10 18  
(260) AM 2016 83199 A  
(220) 2015 07 29  
(732) ALPARGATAS S.A.  
Avenida Doutor Cardoso de Melo, 1336,  
Vila Olímpia, 04548-004 São Paulo, SP,  
Brazil

(111) M 2016 27724 R  
(151) 2016 10 18  
(181) 2026 10 18  
(260) AM 2016 83254 A  
(220) 2015 07 31  
(732) LTD "GEORGIAN WINE TRADITION"  
Kostavas q. 75, b. 6, Tbilisi, Georgia

(111) M 2016 27725 R  
(151) 2016 10 18  
(181) 2026 10 18  
(260) AM 2016 83425 A  
(220) 2015 08 19  
(732) UNILEVER N.V.  
Weena 455, 3013 AL Rotterdam, Netherlands

(111) M 2016 27726 R  
(151) 2016 10 18  
(181) 2026 10 18  
(260) AM 2016 83432 A  
(220) 2015 08 19  
(732) LTD "DEALS.GE"  
Tsknetis gzat. 39, b. 69, 0178, Tbilisi,  
Georgia

(111) M 2016 27727 R  
(151) 2016 10 18  
(181) 2026 10 18

(260) AM 2016 83544 A  
(220) 2015 08 25  
(732) LTD "GEORGIAN ALLIANCE"  
Georgi Nadareishvilis q. 4 (kopili Samgoris  
chikhi), 0137, Tbilisi, Georgia

(111) M 2016 27728 R  
(151) 2016 10 18  
(181) 2026 10 18  
(260) AM 2016 83777 A  
(220) 2015 09 15  
(732) FUJITSU LIMITED  
1-1, Kamikodanaka 4-chome, Nakahara-ku,  
Kawasaki-shi, Kanagawa 211-8588, Japan

(111) M 2016 27729 R  
(151) 2016 10 18  
(181) 2026 10 18  
(260) AM 2016 83900 A  
(220) 2015 09 23  
(732) UNIVERSAL PROTEIN SUPPLEMENTS  
CORPORATION DBA UNIVERSAL  
NUTRITION  
3 Terminal Road, New Brunswick, New  
Jersey 08901, USA

(111) M 2016 27730 R  
(151) 2016 10 18  
(181) 2026 10 18  
(260) AM 2016 83973 A  
(220) 2015 09 25  
(732) UNIVERSAL PROTEIN SUPPLEMENTS  
CORPORATION DBA UNIVERSAL  
NUTRITION  
3 Terminal Road, New Brunswick, New  
Jersey 08901, USA

(111) M 2016 27731 R  
(151) 2016 10 18  
(181) 2026 10 18  
(260) AM 2016 83974 A  
(220) 2015 09 25  
(732) UNIVERSAL PROTEIN SUPPLEMENTS  
CORPORATION DBA UNIVERSAL  
NUTRITION  
3 Terminal Road, New Brunswick, New  
Jersey 08901, USA

(111) M 2016 27732 R  
(151) 2016 10 18  
(181) 2026 10 18  
(260) AM 2016 84093 A  
(220) 2015 10 07  
(732) HELLENICA COSMETIC PRODUCTS  
EXPLOITATION S.A.

---

7, Chimaras str. 151 25 Maroussi, Athens, Greece	CANCER FOUNDATION, INC. 5005 LBJ Freeway, Suite 250, Dallas, Texas 75244, USA
(111) M 2016 27733 R (151) 2016 10 18 (181) 2026 10 18 (260) AM 2016 84137 A (220) 2015 10 09 (732) MILLENNIUM & COPTHORNE INTERNATIONAL LIMITED 36 Robinson Road 04-01 City House, Singapore 068877, Singapore	(111) M 2016 27739 R (151) 2016 10 18 (181) 2026 10 18 (260) AM 2016 84222 A (220) 2015 10 16 (732) THE SUSAN G. KOMEN BREAST CANCER FOUNDATION, INC. 5005 LBJ Freeway, Suite 250, Dallas, Texas 75244, USA
(111) M 2016 27734 R (151) 2016 10 18 (181) 2026 10 18 (260) AM 2016 84148 A (220) 2015 10 09 (732) LTD "DIO" Saburtalos q. 55, 0160, Tbilisi, Georgia	(111) M 2016 27740 R (151) 2016 10 18 (181) 2026 10 18 (260) AM 2016 84287 A (220) 2015 10 22 (732) LTD "TIFLISSKI VINNI POGREB" Iumashevis q. 27, 0198, Tbilisi, Georgia
(111) M 2016 27735 R (151) 2016 10 18 (181) 2026 10 18 (260) AM 2016 84198 A (220) 2015 10 14 (732) MILLENNIUM & COPTHORNE INTERNATIONAL LIMITED 36 Robinson Road 04-01 City House, Singapore 068877, Singapore	(111) M 2016 27741 R (151) 2016 10 18 (181) 2026 10 18 (260) AM 2016 84315 A (220) 2015 10 23 (732) SOCIÉTÉ DES PRODUITS NESTLÉ S.A CH-1800 Vevey, Switzerland
(111) M 2016 27736 R (151) 2016 10 18 (181) 2026 10 18 (260) AM 2016 84205 A (220) 2015 10 15 (732) LTD "FOODLINE 2012" Gagris q. 2, 0189, Tbilisi, Georgia	(111) M 2016 27742 R (151) 2016 10 18 (181) 2026 10 18 (260) AM 2016 84375 A (220) 2015 10 28 (732) LTD "DAKO" Saburtalos q.41, b.34, 0160, Tbilisi, Georgia
(111) M 2016 27737 R (151) 2016 10 18 (181) 2026 10 18 (260) AM 2016 84209 A (220) 2015 10 15 (732) LTD "I C R TRADE" Dighmis sastsavlo satsdeli meurneoba, me-5 sart., Tbilisi, Georgia	(111) M 2016 27743 R (151) 2016 10 18 (181) 2026 10 18 (260) AM 2016 84378 A (220) 2015 10 28 (732) LTD "DAKO" Saburtalos q.41, b.34, 0160, Tbilisi, Georgia
(111) M 2016 27738 R (151) 2016 10 18 (181) 2026 10 18 (260) AM 2016 84221 A (220) 2015 10 16 (732) THE SUSAN G. KOMEN BREAST	(111) M 2016 27744 R (151) 2016 10 18 (181) 2026 10 18 (260) AM 2016 84495 A (220) 2015 11 05 (732) LTD "GEORGIAN ALLIANCE" G. Nadareishvilis q. 4 (samgoris chikhi), 0137, Tbilisi, Georgia

---

(111) M 2016 27745 R  
(151) 2016 10 18  
(181) 2026 10 18  
(260) AM 2016 84502 A  
(220) 2015 11 05  
(732) LTD "GEORGIAN ALLIANCE "  
G. Nadareishvilis q. 4 (samgoris chikhi), 0137,  
Tbilisi, Georgia

---

(111) M 2016 27746 R  
(151) 2016 10 18  
(181) 2026 10 18  
(260) AM 2016 84503 A  
(220) 2015 11 05  
(732) LTD "GEORGIAN ALLIANCE "  
G. Nadareishvilis q. 4 (samgoris chikhi), 0137,  
Tbilisi, Georgia

---

(111) M 2016 27747 R  
(151) 2016 10 18  
(181) 2026 10 18  
(260) AM 2016 84505 A  
(220) 2015 11 05  
(732) LTD "GEORGIAN ALLIANCE "  
G. Nadareishvilis q. 4 (samgoris chikhi), 0137,  
Tbilisi, Georgia

---

(111) M 2016 27748 R  
(151) 2016 10 18  
(181) 2026 10 18  
(260) AM 2016 84572 A  
(220) 2015 11 09  
(732) Closed Joint-Stock Company "SBERBANK  
CIB"  
d. 4, Romanov per, RU-125009 Moscow,  
Russian Federation

---

(111) M 2016 27749 R  
(151) 2016 10 18  
(181) 2026 10 18  
(260) AM 2016 84629 A  
(220) 2015 11 11  
(732) LTD "CBD DEVELOPMENT"  
Melikishvilis gamz. 10, 0179, Tbilisi, Georgia

---

(111) M 2016 27750 R  
(151) 2016 10 18  
(181) 2026 10 18  
(260) AM 2016 84631 A  
(220) 2015 11 11  
(732) LTD "CBD DEVELOPMENT"  
Melikishvilis gamz. 10, 0179, Tbilisi, Georgia

---

(111) M 2016 27751 R  
(151) 2016 10 18  
(181) 2026 10 18  
(260) AM 2016 84632 A  
(220) 2015 11 11  
(732) LTD "CBD DEVELOPMENT"  
Melikishvilis gamz. 10, 0179, Tbilisi, Georgia

---

(111) M 2016 27752 R  
(151) 2016 10 18  
(181) 2026 10 18  
(260) AM 2016 84634 A  
(220) 2015 11 11  
(732) LTD "CBD DEVELOPMENT"  
Melikishvilis gamz. 10, 0179, Tbilisi, Georgia

---

(111) M 2016 27753 R  
(151) 2016 10 18  
(181) 2026 10 18  
(260) AM 2016 84804 A  
(220) 2015 11 25  
(732) PHILIP MORRIS BRANDS SÀRL  
Quai Jeanrenaud 3, 2000 Neuchâtel, Switzerland

---

(111) M 2016 27754 R  
(151) 2016 10 18  
(181) 2026 10 18  
(260) AM 2016 84805 A  
(220) 2015 11 25  
(732) PHILIP MORRIS BRANDS SÀRL  
Quai Jeanrenaud 3, 2000 Neuchâtel, Switzerland

---

(111) M 2016 27755 R  
(151) 2016 10 18  
(181) 2026 10 18  
(260) AM 2016 84935 A  
(220) 2015 11 30  
(732) PHILIP MORRIS BRANDS SÀRL  
Quai Jeanrenaud 3, 2000 Neuchâtel, Switzerland

---

## TRADEMARKS REGISTERED ACCORDING TO THE ACCELERATED PROCEDURE

The decision can be appealed at the Chamber of Appeal of Sakpatenti within 3 months from the publication.

(111) M 2016 27704 R

(151) 2016 10 07

(181) 2026 10 07

(210) AM 88812

(220) 2016 10 03

(732) LTD "KAFSULO"

Delisis q. 9/7, 0177, Tbilisi, Georgia

(740) Giorgi Taktakishvili

(540)



(554) Three-dimensional

(591) Black, white

(531) 19.03.01

(511) 20, 30

(591) Green, blue, black

(531) 29.01.13, 27.05.10, 27.05.11, 27.05.22

(511) 16, 20, 21

(111) M 2016 27707 R

(151) 2016 10 12

(181) 2026 10 12

(210) AM 88813

(220) 2016 10 03

(732) LTD "PRIMARK.GE"

Temkis dasakhleba, m/r. 11, kvart. I,  
korp. 9, b. 54, 0197, Tbilisi, Georgia

(540)

PRIMARK'

(591) Sky-blue

(531) 27.05.05, 29.01.04

(511) 35

(111) M 2016 27705 R

(151) 2016 10 12

(181) 2026 10 12

(210) AM 88605

(220) 2016 09 15

(732) MAREKH ADAMASHVILI

Tskhinvalis gzat. 43, b.39, 1400, Gori, Georgia

(540)

ადამ

(511) 1, 35

(111) M 2016 27708 R

(151) 2016 10 13

(181) 2026 10 13

(210) AM 88672

(220) 2016 09 23

(732) JAPAN TOBACCO INC.

2-2-1 Toranomom, Minato-ku, Tokyo, Japan

(740) Shalva Gvaramadze

(540)

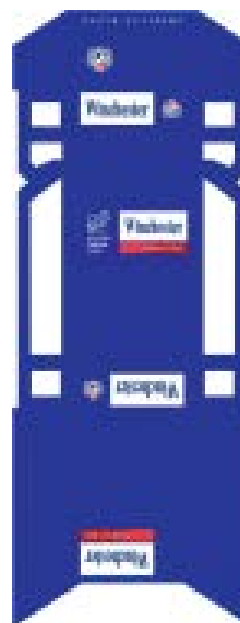

(111) M 2016 27706 R

(151) 2016 10 12

(181) 2026 10 12

(210) AM 88650

(220) 2016 09 20

(732) KAMRAN PARIZADMASHHADI

Kostavas I shesax.. 3, b. 14, 0179, Tbilisi,  
Georgia

(740) Giorgi Taktakishvili

(540)



(591) White, blue, red  
 (531) 10.01.05, 19.03.24, 24.01.03, 29.01.13  
 (511) 34

(111) M 2016 27709 R  
 (151) 2016 10 17  
 (181) 2026 10 17  
 (210) AM 88648  
 (220) 2016 09 20  
 (732) JSC "SARAJISHVILI"  
 Sarajishvilis gamz. 4, 0153, Tbilisi, Georgia  
 (740) Anano Managadze  
 (540)



(591) Black, golden  
 (531) 25.01.15, 26.01.04, 28.05, 29.01.12  
 (526) The trademark is protected as a whole. "ГРУЗИНСКИЙ" shall not be subject to independent legal protection.  
 (511) 33

(111) M 2016 27756 R  
 (151) 2016 10 18  
 (181) 2026 10 18  
 (210) AM 88843  
 (220) 2016 10 05  
 (732) ZURA CHIGOGIDZE  
 N. Ramishvilis q. 2, b. 57, 0179, Tbilisi, Georgia  
 (740) ZURA CHIGOGIDZE  
 (540)



(591) Black, red and white  
 (531) 26.04.04, 26.04.07, 26.04.22, 27.07.01, 28.19, 29.01.13  
 (511) 38

(111) M 2016 27757 R  
 (151) 2016 10 18  
 (181) 2026 10 18  
 (210) AM 88844  
 (220) 2016 10 05  
 (732) ZURA CHIGOGIDZE  
 N. Ramishvilis q. 2, b.57, 0179, Tbilisi, Georgia  
 (740) ZURA CHIGOGIDZE

(540)



(591) Blue, red and white  
 (531) 02.01.23, 04.05.03, 28.19, 29.01.13  
 (511) 38

(111) M 2016 27758 R  
 (151) 2016 10 18  
 (181) 2026 10 18  
 (210) AM 88845  
 (220) 2016 10 05  
 (732) ZURA CHIGOGIDZE  
 N. Ramishvilis q. 2, b.57, 0179, Tbilisi, Georgia  
 (740) ZURA CHIGOGIDZE  
 (540)



(591) Blue, red and white  
 (531) 01.05.23, 27.05.17, 27.07.17, 29.01.13  
 (511) 38

(111) M 2016 27759 R  
 (151) 2016 10 18  
 (181) 2026 10 18  
 (210) AM 88846  
 (220) 2016 10 05  
 (732) ZURA CHIGOGIDZE  
 N. Ramishvilis q. 2, b.57, 0179, Tbilisi, Georgia  
 (740) ZURA CHIGOGIDZE  
 (540)



(591) Black, red, white  
 (531) 02.01.01, 09.07.05, 16.01.14, 26.04.04, 27.05.24, 29.01.13  
 (511) 38

(111) M 2016 27760 R  
(151) 2016 10 18  
(181) 2026 10 18  
(210) AM 88847  
(220) 2016 10 05  
(732) ZURA CHIGOGIDZE  
N. Ramishvilis q. 2, b. 57, 0179, Tbilisi,  
Georgia  
(740) ZURA CHIGOGIDZE  
(540)



(591) Green, red and white  
(531) 26.04.04, 26.04.09, 26.04.24, 27.05.24  
(511) 38

---

(111) M 2016 27761 R  
(151) 2016 10 19  
(181) 2026 10 19  
(210) AM 88848  
(220) 2016 10 05  
(732) JSC "TELIANI VALEY"  
Tbilisis gzat. 3, 2200 Telavi, Georgia  
(540)

სოხო  
АИЧИ  
АИСИ

(511) 32

---

(111) M 2016 27762 R  
(151) 2016 10 20  
(181) 2026 10 20  
(210) AM 88849  
(220) 2016 10 05  
(732) ZBYSEK BRABEC  
Geneva, Bernex 1233, 18 ARt d'Aire la Ville,  
Switzerland  
(740) Irakli Gaprindashvili  
(540)



(591) Brown, green, grey, dark lilac, white  
(531) 05.07.10, 19.01.07, 26.01.19, 27.05.24,  
29.01.15  
(511) 38

---

## INTERNATIONAL TRADEMARKS FOR WHICH A DECISION ON GRANTING PROTECTIONS IS TAKEN

The decision can be appealed at the Chamber of Appeal of Sakpatenti within 3 months from the publication or at the Mtskheta District Court Administrative Cases Board (Address: №17, Samkhedro str., Mtskheta), within 1 month following the publication.

(260) AM 2016 79276 A\*

(800) 1129493

(891) 2014 06 05

(731) Tovarystvo z obmezhenou vidpovidalnistiu

"PHARMAGATE"

vul. Pecherskyi Uzviz, bud. 8, office 89,

m. Kyiv 01023, Ukraine

(540)

# PHARMAGATE

(591) Black, white

(511)

3 – Adhesives for cosmetic purposes; after-shave lotions; canned pressurized air for cleaning and dusting purposes; volatile alkali (ammonia) (detergent); almond milk for cosmetic purposes; almond oil; almond soap; amber (perfume); antiperspirant soap; antistatic preparations for household purposes; aromatics (essential oils); astringents for cosmetic purposes; badian essence; bath salts, not for medical purposes; cosmetic preparations for baths; beauty masks; bergamot oil; flavorings (flavourings) for beverages (essential oils); bleaching preparations (decolorants) for cosmetic purposes; bleaching preparations (laundry); bleaching salts; bleaching soda; laundry blueing; blueing for laundry; breath freshening sprays; color- colour- brightening chemicals for household purposes (laundry); cake flavourings (essential oils); cakes of toilet soap; essential oils of cedarwood; essential oils of citron; preparations for cleaning dentures; cleaning preparations; cleansing milk for toilet purposes; cloths impregnated with a detergent for cleaning; color-removing preparations; colorants for toilet purposes; cosmetic kits; cosmetics; cosmetics for animals; cotton sticks for cosmetic purposes; cotton wool for cosmetic purposes; cosmetic creams; skin whitening creams; degreasers other than for use in manufacturing processes; dental bleaching gels; dentifrices; denture polishes; deodorant soap; depilatories; detergents other than for use in manufacturing operations and for medical purposes; disinfectant soap; dry-cleaning preparations; cosmetic dyes; eau de cologne; ethereal essences; essential oils; extracts of flowers (perfumes); eyebrow cosmetics; cosmetic preparations for eyelashes; false eyelashes; fabric softeners for laundry use; false nails; floor wax; bases for flower perfumes; soap for foot perspiration; laundry glaze; greases for cosmetic purposes; hair colorants; hair lotions; hair spray; hair waving preparations; hydrogen peroxide for cosmetic purposes; potassium hypochloride; jasmine oil; petroleum jelly for cosmetic purposes;

joss sticks; lacquer-removing preparations; laundry bleach; laundry soaking preparations; lavender oil; lavender water; sachets for perfuming linen; lipsticks; tissues impregnated with cosmetic lotions; lotions for cosmetic purposes; make-up; make-up powder; make-up preparations; make-up removing preparations; mascara; medicated soap; mint essence (essential oil); mint for perfumery; moustache wax; mouth washes, not for medical purposes; musk (perfumery); nail care preparations; nail polish; oil of turpentine for degreasing; oils for cleaning purposes; oils for cosmetic purposes; oils for perfumes and scents; oils for toilet purposes; paint stripping preparations; cosmetic pencils; perfumery; shampoos for pets; polishing preparations; pomades for cosmetic purposes; potpourris (fragrances); pumice stone; rose oil; scale removing preparations for household purposes; scented water; scented wood; scouring solutions; shampoos; shaving preparations; shaving soap; shining preparations (polish); cosmetic preparations for skin care; soap; soap for brightening textile; soda lye; stain removers; sun-tanning preparations (cosmetics); talcum powder, for toilet use; terpenes (essential oils); toilet water; toiletries; decorative transfers for cosmetic purposes; washing soda, for cleaning; depilatory wax; deodorants for human beings or for animals.

5 – Dental abrasives; absorbent cotton; acaricides; acetates for pharmaceutical purposes; acids for pharmaceutical purposes; aconitine; adhesive bands for medical purposes; adhesive plaster; fly catching adhesives; adhesives for dentures; adjuvants for medical purposes; air deodorising preparations; air purifying preparations; albumin dietary supplements; albuminous foodstuffs for medical purposes; albuminous preparations for medical purposes; alcohol for pharmaceutical purposes; aldehydes for pharmaceutical purposes; algicides; alkaline iodides for pharmaceutical purposes; alkaloids for medical purposes; alloys of precious metals for dental purposes; milk of almonds for pharmaceutical purposes; aluminium acetate for pharmaceutical purposes; dental amalgams; amino acids for medical purposes; amino acids for veterinary purposes; anaesthetics; analgesics; angostura bark for medical purposes; animal washes; anthelmintics; anti-rheumatism bracelets; anti-rheumatism rings; anti-uric preparations; antibiotics; anticryptogamic preparations; antiparasitic collars for animals; antiparasitic preparations; antiseptic



cotton; antiseptics; appetite suppressants for medical purposes; aseptic cotton; asthmatic tea; bacterial poisons; bacterial preparations for medical and veterinary use; bouillons for bacteriological cultures; bacteriological preparations for medical and veterinary use; balms for medical purposes; balsamic preparations for medical purposes; hygienic bandages; menstruation bandages; bandages for dressings; barks for pharmaceutical purposes; therapeutic preparations for the bath; bath preparations, medicated; bath salts for medical purposes; oxygen baths; salts for mineral water baths; belts for sanitary napkins (towels); bicarbonate of soda for pharmaceutical purposes; biocides; biological preparations for medical purposes; biological preparations for veterinary purposes; bismuth preparations for pharmaceutical purposes; bismuth subnitrate for pharmaceutical purposes; blood for medical purposes; blood plasma; bone cement for surgical and orthopaedic purposes; bracelets for medical purposes; diabetic bread adapted for medical use; breast-nursing pads; bromine for pharmaceutical purposes; bronchodilating preparations; bunion pads; preparations for the treatment of burns; by-products of the processing of cereals for dietetic or medical purposes; cachets for pharmaceutical purposes; cachou for pharmaceutical purposes; preparations for callouses; calomel; camphor for medical purposes; camphor oil for medical purposes; candy for medical purposes; candy, medicated; powder of cantharides, capsules for medicines; carbolineum (parasiticide); castor oil for medical purposes; cattle washes; caustic pencils; caustics for pharmaceutical purposes; cedar wood for use as an insect repellent; cellulose esters for pharmaceutical purposes; cellulose ethers for pharmaceutical purposes; cement for animal hooves; charcoal for pharmaceutical purposes; chemical conductors for electrocardiograph electrodes; chemical preparations for medical purposes; chemical preparations for pharmaceutical purposes; chemical preparations for veterinary purposes; chemical reagents for medical or veterinary purposes; chemico-pharmaceutical preparations; chewing gum for medical purposes; chilblain preparations; chinoline for medical purposes; chloroform; tobacco-free cigarettes for medical purposes; cinchona for medical purposes; contact lens cleaning preparations; deodorants for clothing and textiles; cocaine; cod liver oil; collodion for pharmaceutical purposes; compresses; condurango bark for medical purposes; medicines for alleviating constipation; solutions for use with contact lenses; chemical contraceptives; corn remedies; corn rings for the feet; cotton for medical purposes; cream of tartar for pharmaceutical purposes; creosote for pharmaceutical purposes; croton bark; cultures of microorganisms for medical and veterinary use; curare; pharmaceutical preparations for treating dandruff; decoctions for pharmaceutical purposes; dental cements; dental impression materials; dental lacquer; dental mastics;

deodorants, other than for human beings or for animals; depuratives; detergents for medical purposes; chemical preparations for the diagnosis of pregnancy; diagnostic preparations for medical purposes; diastase for medical purposes; dietary supplements for animals; dietetic beverages adapted for medical purposes; dietetic foods adapted for medical purposes; dietetic substances adapted for medical use; digestives for pharmaceutical purposes; digitalin; dill oil for medical purposes; disinfectants for chemical toilets; disinfectants for hygiene purposes; dog lotions; dog washes; repellents for dogs; surgical dressings; dressings, medical; medicinal drinks; drugs for medical purposes; preparations for destroying dry rot fungus; elixirs (pharmaceutical preparations); enzyme preparations for medical purposes; enzyme preparations for veterinary purposes; enzymes for medical purposes; enzymes for veterinary purposes; ergot for pharmaceutical purposes; esters for pharmaceutical purposes; ethers for pharmaceutical purposes; eucalyptol for pharmaceutical purposes; eucalyptus for pharmaceutical purposes; evacuants; eye-washes; eyepatches for medical purposes; febrifuges; fennel for medical purposes; milk ferments for pharmaceutical purposes; ferments for pharmaceutical purposes; dietary fiber; first-aid boxes, filled; fish meal for pharmaceutical purposes; flaxseed for pharmaceutical purposes; flour for pharmaceutical purposes; flowers of sulphur for pharmaceutical purposes; fly catching paper; fly destroying preparations; food for babies; remedies for foot perspiration; formic aldehyde for pharmaceutical purposes; frostbite salve for pharmaceutical purposes; fumigating pastilles; fumigation preparations for medical purposes; fungicides; gallic acid for pharmaceutical purposes; gamboge for medical purposes; gases for medical purposes; gauze for dressings; gelatine for medical purposes; gentian for pharmaceutical purposes; germicides; glucose for medical purposes; glycerine for medical purposes; glycerophosphates; dental amalgams of gold; goulard water; greases for medical purposes; greases for veterinary purposes; guaiacol for pharmaceutical purposes; gum for medical purposes; gurjun (gurjon, gurjan) balsam for medical purposes; haematogen; haemoglobin; haemorrhoid preparations; haemostatic pencils; medicinal hair growth preparations; articles for headache; headache pencils; herbal teas for medicinal purposes; herbicides; medicinal herbs; smoking herbs for medical purposes; extracts of hops for pharmaceutical purposes; hormones for medical purposes; hydrastine; hydrastinine; hydrated chloral for pharmaceutical purposes; hydrogen peroxide for medical purposes; surgical implants (living tissues); insect repellent incense; napkins for incontinents; pants, absorbent, for incontinents; medicinal infusions; insect repellents; insecticides; semen for artificial insemination; iodides for pharmaceutical purposes; iodine for pharmaceutical

purposes; iodoform; irish moss for medical purposes; isotopes for medical purposes; jalap; petroleum jelly for medical purposes; jujube, medicated; menstruation knickers; lacteal flour for babies; lactose for pharmaceutical purposes; larvae exterminating preparations; laxatives; lecithin for medical purposes; leeches for medical purposes; preparations of lime for pharmaceutical purposes; liniments; lint for medical purposes; liquorice for pharmaceutical purposes; tissues impregnated with pharmaceutical lotions; lotions for pharmaceutical purposes; lotions for veterinary purposes; lozenges for pharmaceutical purposes; lupulin for pharmaceutical purposes; magnesia for pharmaceutical purposes; malt for pharmaceutical purposes; malted milk beverages for medical purposes; mangrove bark for pharmaceutical purposes; medicinal oils; medicinal roots; medicinal tea; medicine cases, portable, filled; medicines for dental purposes; medicines for human purposes; medicines for veterinary purposes; melissa water for pharmaceutical purposes; menstruation tampons; menthol; mercurial ointments; preparations for destroying mice; nutritive substances for microorganisms; chemical preparations to treat mildew; milking grease; mineral food supplements; mineral water salts; mineral waters for medical purposes; mint for pharmaceutical purposes; molding wax for dentists; moleskin for medical purposes; mothproofing paper; mothproofing preparations; mouthwashes for medical purposes; medicinal mud; mud for baths; mustard for pharmaceutical purposes; mustard oil for medical purposes; mustard plasters; myrobalan bark for pharmaceutical purposes; narcotics; nervines; preparations for destroying noxious animals; nutritional supplements; oil of turpentine for pharmaceutical purposes; ointments for pharmaceutical purposes; opiates; opium; opodeldoc; ophotherapy preparations; oxygen for medical purposes; panty liners (sanitary); paper for mustard plasters; parasiticides; pectin for pharmaceutical purposes; pepsins for pharmaceutical purposes; peptones for pharmaceutical purposes; pharmaceutical preparations; phenol for pharmaceutical purposes; phosphates for pharmaceutical purposes; chemical preparations for treating phylloxera; plasters for medical purposes; poisons; pomades for medical purposes; porcelain for dental prostheses; potassium salts for medical purposes; poultices; pyrethrum powder; quassia for medical purposes; quebracho for medical purposes; quinine for medical purposes; radioactive substances for medical purposes; radiological contrast substances for medical purposes; radium for medical purposes; rat poison; remedies for perspiration; rhubarb roots for pharmaceutical purposes; royal jelly dietary supplements; rubber for dental purposes; salts for medical purposes; sanitary napkins; sarsaparilla for medical purposes; scapulars for surgical purposes; sea water for medicinal bathing; sedatives; serotherapeutic medi-

cines; serums; siccatives (drying agents) for medical purposes; pharmaceutical preparations for skin care; medical preparations for slimming purposes; slug exterminating preparations; smelling salts; sodium salts for medical purposes; soil-sterilising preparations; solvents for removing adhesive plasters; soporifics; starch for dietetic or pharmaceutical purposes; sterilising preparations; steroids; stick liquorice for pharmaceutical purposes; sulphur sticks (disinfectants); strychnine; styptic preparations; sugar for medical purposes; sulphonamides (medicines); sunburn ointments; sunburn preparations for pharmaceutical purposes; suppositories; surgical cloth (tissues); syrups for pharmaceutical purposes; tartar for pharmaceutical purposes; teeth filling material; preparations to facilitate teething; thermal water; thymol for pharmaceutical purposes; tincture of iodine; tinctures for medical purposes; tobacco extracts (insecticides); tonics (medicines); preparations of trace elements for human and animal use; turpentine for pharmaceutical purposes; vaccines; vaginal washes; vermin destroying preparations; vesicants; veterinary preparations; vine disease treating chemicals; vitamin preparations; wadding for medical purposes; wart pencils; chemical preparations to treat wheat blight (smut); yeast dietary supplements; yeast for pharmaceutical purposes.

10 – Abdominal belts; abdominal corsets; abdominal pads; acupuncture needles; aerosol dispensers for medical purposes; air cushions for medical purposes; air mattresses, for medical purposes; air pillows for medical purposes; ambulance stretchers; anaesthetic apparatus; anaesthetic masks; apparatus for use in medical analysis; arch supports for footwear; armchairs for medical or dental purposes; arterial blood pressure measuring apparatus; artificial breasts; artificial eyes; artificial jaws; artificial limbs; apparatus for artificial respiration; artificial skin for surgical purposes; artificial teeth; sets of artificial teeth; babies' bottles; babies' pacifiers (teats); balling guns; knee bandages, orthopedic; supportive bandages; suspensory bandages; bandages, elastic; basins for medical purposes; bed pans; bed vibrators; hydrostatic (water) beds for medical purposes; beds, specially made for medical purposes; orthopaedic (orthopedic) belts; belts for medical purposes; belts, electric, for medical purposes; blankets, electric, for medical purposes; blood testing apparatus; appliances for washing body cavities; boots for medical purposes; bougies (surgery); breast pumps; brushes for cleaning body cavities; dental burs; cannulae; cases fitted for medical instruments; cases fitted for use by surgeons and doctors; castrating pincers; catgut; catheters; obstetric apparatus for cattle; commode chairs; childbirth mattresses; clips, surgical; clothing especially for operating rooms; thermo-electric compresses (surgery); compressors (surgical); condoms; containers especially made for medical waste; contraceptives, non-chemical; corn knives; corsets

for medical purposes; crutches; tips for crutches for invalids; cupping glasses; heating cushions, electric, for medical purposes; cushions for medical purposes; cutlery (surgical); apparatus for the treatment of deafness; defibrillators; dental apparatus; dental apparatus, electric; dentists' armchairs; diagnostic apparatus for medical purposes; dialyzers; drainage tubes for medical purposes; draw-sheets for sick beds; dropper bottles for medical purposes; droppers for medical purposes; ear picks; ear trumpets; elastic stockings for surgical purposes; electric acupuncture instruments; electrocardiographs; electrodes for medical use; enema apparatus for medical purposes; esthetic massage apparatus; feeding bottle teats; feeding bottle valves; filters for ultraviolet rays, for medical purposes; finger guards for medical purposes; supports for flat feet; fleams; orthopaedic (orthopedic) footwear; forceps; fumigation apparatus for medical purposes; furniture especially made for medical purposes; galvanic belts for medical purposes; galvanic therapeutic appliances; gastroscopes; gloves for massage; gloves for medical purposes; medical guidewires; hair prostheses; hearing aids for the deaf; hearing protectors; heart pacemakers; hematimeters; hernia bandages; hot air therapeutic apparatus; hot air vibrators for medical purposes; hypodermic syringes; ice bags for medical purposes; incontinence sheets; incubators for babies; incubators for medical purposes; inhalers; injectors for medical purposes; instrument cases for use by surgeons and doctors; insufflators; invalids' hoists; knives for surgical purposes; lamps for medical purposes; lasers for medical purposes; lenses (intraocular prostheses) for surgical implantation; masks for use by medical personnel; massage apparatus; maternity belts; medical apparatus and instruments; spoons for administering medicine; mirrors for dentists; mirrors for surgeons; needles for medical purposes; nursing appliances; obstetric apparatus; operating tables; ophthalmometers; ophthalmoscopes; orthodontic appliances; orthopaedic articles; orthopaedic soles; pads (pouches) for preventing pressure sores on patient bodies; physical exercise apparatus, for medical purposes; physiotherapy apparatus; soporific pillows for insomnia; pins for artificial teeth; plaster bandages for orthopaedic purposes (casts (Am.)); probes for medical purposes; protection devices against X-rays, for medical purposes; pumps for medical purposes; quartz lamps for medical purposes; radiological apparatus for medical purposes; radiology screens for medical purposes; radiotherapy apparatus; radium tubes for medical purposes; receptacles for applying medicines; body rehabilitation apparatus for medical purposes; respirators for artificial respiration; resuscitation apparatus; teething rings; saws for surgical purposes; scalpels; scissors for surgery; tongue scrapers; slings (supporting bandages); spirometers (medical apparatus); spittoons for medical purposes;

splints, surgical; surgical sponges; sprayers for medical purposes; sterile sheets, surgical; stethoscopes; stockings for varices; strait jackets; stretchers, wheeled; surgical apparatus and instruments; surgical drapes; surgical implants (artificial materials); suture materials; suture needles; syringes for injections; syringes for medical purposes; thermal packs for first aid purposes; thermometers for medical purposes; thread, surgical; traction apparatus for medical purposes; trocars; ultraviolet ray lamps for medical purposes; umbilical belts; urethral probes; urethral syringes; urinals (vessels); urological apparatus and instruments; uterine syringes; vaginal syringes; veterinary apparatus and instruments; vibromassage apparatus; water bags for medical purposes; X-ray apparatus for medical purposes; X-ray photographs for medical purposes; X-ray tubes for medical purposes; apparatus and installations for the production of X-rays, for medical purposes.

35 – Accounting; drawing up of statements of accounts; commercial administration of the licensing of the goods and services of others; administrative processing of purchase orders; advertising; advertising agencies; advertising by mail order; updating of advertising material; dissemination of advertising matter; rental of advertising space; commercial information and advice for consumers (consumer advice shop); cost price analysis; business appraisals; arranging subscriptions to telecommunication services for others; business management assistance; auctioneering; auditing; bill-posting; professional business consultancy; business information; business inquiries; business investigations; business management and organization consultancy; business management consultancy; business organization consultancy; business research; commercial information agencies; commercial or industrial management assistance; presentation of goods on communication media, for retail purposes; price comparison services; compilation of information into computer databases; compilation of statistics; systemization of information into computer databases; data search in computer files for others; demonstration of goods; direct mail advertising; distribution of samples; economic forecasting; efficiency experts; employment agencies; organization of exhibitions for commercial or advertising purposes; computerized file management, import-export agencies; invoicing; layout services for advertising purposes; advisory services for business management; personnel management consultancy; marketing research; marketing studies; modelling for advertising or sales promotion; news clipping services; opinion polling; organization of trade fairs for commercial or advertising purposes; outsourcing services (business assistance); personnel recruitment; word processing; procurement services for others (purchasing goods and services for other businesses); psychological testing for the selection of personnel; public relations; publication of publicity

texts; publicity columns preparation; publicity material rental; writing of publicity texts, radio advertising; rental of advertising time on communication media; sales promotion for others; secretarial services; shop window dressing; shorthand; sponsorship search; tax preparation; television advertising; transcription.

41 – Academies (education); animal training; arranging and conducting of colloquiums; arranging and conducting of conferences; arranging and conducting of congresses; arranging and conducting of seminars; arranging and conducting of symposiums; arranging and conducting of workshops (training); arranging of beauty contests; boarding schools; bookmobile services; publication of books; club services (entertainment or education); organization of sports competitions; organization of competitions (education or entertainment); correspondence courses; religious education; education information; educational examination; educational services; electronic desktop publishing; organization of exhibitions for cultural or educational purposes; vocational guidance (education or training advice); gymnastic instruction; health club services (health and fitness training); sign language interpretation; lending libraries; operating lotteries; microfilming; news reporters services; nursery schools; physical education; practical training (demonstration); videotape film production; production of radio and television programmes; providing on-line electronic publications, not downloadable; publication of electronic books and journals on-line; publication of texts, other than publicity texts; rental of videotapes; writing of texts, other than publicity texts; translation.

44 – Aerial and surface spreading of fertilizers and other agricultural chemicals; animal breeding; animal grooming; aromatherapy services; artificial insemination services; Turkish baths; public baths for hygiene purposes; beauty salons; blood bank services; chiropractics; medical clinic, services; convalescent homes; dentistry; landscape design; vermin exterminating for agriculture, horticulture and forestry; farming equipment rental; flower arranging; gardening; landscape gardening; pet grooming; hair implantation; hairdressing salons; health care; health spa services; nursing homes, horticulture; hospices; hospitals; in vitro fertilization services; lawn care; manicuring; massage; medical assistance; midwife services; nursing, medical; opticians' services; pharmacists' services to make up prescriptions; pharmacy advice; physical therapy; plant nurseries; plastic surgery; services of a psychologist; rehabilitation for substance abuse patients; rental of sanitation facilities; sanatoriums; sauna services; solarium services; tree surgery; tattooing; telemedicine services; veterinary assistance; visagists' services; weed killing; wreath making.

(260) AM 2016 79660 A\*

(800) 1188130

(891) 2014 10 03

(731) STAR MUTFAK VE MOBILYA  
AKSESUARLARI SANAYI VE TICARET  
LIMITED SİRKETİ  
Adnan Kahveci Mh, Harbiye Cd. No:34,  
BEYLİKDÜZÜ/İSTANBUL, Turkey

(540)

 The logo for STARAX features the word "STARAX" in a bold, red, sans-serif font. The letter "X" is stylized with a grey, multi-pointed starburst or asterisk shape integrated into its right side.

(591) Red and gray

(511)

6 – Non-precious metal ores; common metals and their alloys and semi-manufactured products; materials made of metal for use in constructions; metal materials and tools (including metal ladders) made for sheltering, storage, preservation, coating, wrapping, surrounding, warehousing or installment purposes; metal materials for sieving, filtering and similar purposes, metal doors and windows, rolling shutters, venetian blinds, thereof (except locks); metal cables and wires not for electrical purposes; ironmongery (hardware) articles; airing canals, holes, hole covers, pipes, chimney heads, manholes (stack) covers, grills for ventilating, heating, canalization, telephone, underground electricity and air-conditioning installations; metal materials for pointing, navigating, indicating, introduction purposes (including sign boards, panels, plates); metal pipes for liquid or gas transfer and their connection parts (including drilling pipes); metal safes; railway materials made of metal; metal crown for sea vehicles; metal moulds for casting (other than machine parts); works of art made of common metals and their alloys; metal covers, bottle caps; metal poles; metal pallets, metal ropes for lifting, loading and transportation, metal hangs, cords, columns, strips, bands and tapes for use in lifting and carrying loads.

21 – Non-electric cleaning utensils (including brushes except for painting brushes, steel chips, sponges, steel wool, cleaning wool, cleaning and wiping clothes made of textile, dish washing gloves, non-electric polishing machines, carpet brooms, mops); toothbrushes, electrical toothbrushes, dental floss, shaving brushes, hair brushes, combs; non-electric devices for household and kitchen use included in this class; ironing boards, ironing board covers, laundry drying mechanisms, cloth hangers; cages and materials for pets, plant and animal raising areas used in the household (terrariums); ornamental and decorative articles made of glass, porcelain, ceramic, clay; mousetraps, insect traps, fly catchers, fly rackets, covers for toilet holes; perfume burners (burners giving off scents when lit), perfume sprays and vaporizers (atomizers); non-electric devices for removing make-up, powder puffs, boxes for toilet articles; spraying hose heads, heads for water sprinklers, watering apparatus, garden-watering sprinklers, tips connected to faucets; unprocessed glass, semi-processed

glass, glass mosaics and glass powder for decorative purposes (except for construction), glass wool (not for insulation and textile purposes).

35 – Advertising and business services; the bringing together, for the benefit of others, of a variety of goods (excluding the transport thereof) enabling customers to conveniently view and purchase those goods; retail or wholesale services relating to non-precious metal ores; common metals and their alloys and semi-manufactured products; materials made of metal for use in constructions; metal materials and tools (including metal ladders) made for sheltering, storage, preservation, coating, wrapping, surrounding, warehousing or installment purposes; metal materials for sieving, filtering and similar purposes, metal doors and windows, rolling shutters, venetian blinds, thereof (except locks); metal cables and wires not for electrical purposes; ironmongery (hardware) articles; airing canals, holes, hole covers, pipes, chimney heads, manholes (stack) covers, grills for ventilating, heating, canalization, telephone, underground electricity and air-conditioning installations; metal materials for pointing, navigating, indicating, introduction purposes (including sign boards, panels, plates); metal pipes for liquid or gas transfer and their connection parts (including drilling pipes); metal safes; railway materials made of metal; metal crown for sea vehicles; metal moulds for casting (other than machine parts); works of art made of common metals and their alloys; metal covers, bottle caps; metal poles; metal pallets, metal ropes for lifting, loading and transportation, metal hangs, cords, columns, strips, bands and tapes for use in lifting and carrying loads; non-electric cleaning utensils (including brushes except for painting brushes, steel chips, sponges, steel wool, cleaning wool, cleaning and wiping clothes made of textile, dish washing gloves, non-electric polishing machines, carpet brooms, mops); toothbrushes, electrical toothbrushes, dental floss, shaving brushes, hair brushes, combs; non-electric devices for household and kitchen use included in this class; ironing boards, ironing board covers, laundry drying mechanisms, cloth hangers; cages and materials for pets, plant and animal raising areas used in the household (terrariums); ornamental and decorative articles made of glass, porcelain, ceramic, clay; mousetraps, insect traps, fly catchers, fly rackets, covers for toilet holes; perfume burners (burners giving off scents when lit), perfume sprays and vaporizers (atomizers); non-electric devices for removing make-up, powder puffs, boxes for toilet articles; spraying hose heads, heads for water sprinklers, watering apparatus, garden-watering sprinklers, tips connected to faucets; unprocessed glass, semi-processed glass, glass mosaics and glass powder for decorative purposes (except for construction), glass wool (not for insulation and textile purposes).

(260) AM 2016 80124 A\*

(800) 1227159

(891) 2014 09 11

(731) LKW WALTER Internationale  
Transportorganisation AG  
IZ Nö-Süd, Strasse 14, A-2355 Wiener  
Neudorf, Austria

(540)



(591) Red, blue, white

(511)

12 – Vehicles; apparatus for locomotion by land, air or water.

36 – Insurance; financial affairs; monetary affairs; real estate affairs.

39 – Transport; packaging and storage of goods; travel arrangement.

(260) AM 2016 81516 A\*

(800) 1240494

(891) 2014 12 31

(731) Joint Stock Company "YASNAYA POLYANA"  
83, Odojevskoye shosse, RU-300036 g. Tula,  
Russian Federation

(540)

крекер

**ФЕРМЕРСКИЙ**

(591) Black and White

(511)

30 – Crackers.

(260) AM 2016 84585 A

(800) 1271625

(891) 2015 08 12

(731) YULONG COMPUTER  
TELECOMMUNICATION SCIENTIFIC  
(SHENZHEN) CO., LTD.  
6/F, Building 1, Coolpad Cyber Harbor,  
Hi-Tech Industrial Park (North), Nanshan  
District, Shenzhen, China

(540)

**Coolpad**

(591) black and white

(511)

9 – Computers; laptop computers; computer peripheral devices; electronic pocket translators; computer programs [downloadable software]; notebook computers; electronic agendas; counterfeit [false] coin detectors; electronic tags for goods; facsimile machines; punched card machines for offices; weighing

apparatus and instruments; jigs [measuring instruments]; aerials; transmitters of electronic signals; intercommunication apparatus; navigational instruments; radiotelephony sets; electro-dynamic apparatus for the remote control of signals; navigation apparatus for vehicles [on-board computers]; walkie-talkies; monitoring apparatus, electric; video recorders; camcorders; cinematographic cameras; cameras [photography]; materials for electricity mains [wires, cables]; fire extinguishers; teeth protectors; alarms; spectacles [optics]; chargers for electric batteries; batteries, electric; slides [photography].

(260) AM 2016 84596 A

(800) 1272458

(891) 2015 06 30

(731) Publichne aktsionerne tovarystvo  
"KHARKIVSKA BISKVITNA FABRYKA"  
vul. Lozivska, 8, Kharkiv 61017, Ukraine

(540)

**Сеньор Батонио**

(591) Black, white

(511)

30 – Peanut confectionery; sponge cakes; cereal bars; high-protein cereal bars; farinaceous foods; pastries; buns; sandwiches; waffles; oat-based food; biscuits; cookies; cake frosting [icing]; custard; rice-based snack food; cereal-based snack food; cereal preparations; cocoa [confectionery]; caramels (candy); lozenges (confectionery); confectionery; sugar confectionery; confectionery for decorating Christmas trees; liquorice (confectionery); candy; marzipan; macaroons [pastry]; almond paste; almond confectionery; dessert mousses [confectionery]; chocolate mousses; mint for confectionery; peppermint sweets; stick liquorice [confectionery]; chips [cereal products]; pies; fondants (confectionery); pralines; gingerbread; puddings; cake powder; cakes; rice cakes; malt biscuits; petit-beurre biscuits; petits fours (cakes); cake batter/cake dough; pastry dough; crackers; tarts; fruit jellies [confectionery]; halvah; sweetmeats (candy); chocolate.

(260) AM 2016 84601 A

(800) 1271738

(891) 2015 09 29

(731) AVEO PHARMACEUTICALS, INC.  
1 Broadway, 14th Floor, Cambridge MA  
02142, USA

(540)

**FOTIVDA**

(591) black and white

(511)

5 – Pharmaceutical preparations for the treatment of cancer.

(260) AM 2016 84612 A

(800) 1087297

(891) 2015 10 16

(731) SKIN CONCEPT AG  
Industriestrasse 16, CH-8910 Affoltern am  
Albis, Switzerland

(540)

**SWISSIMAGE**

(511)

3 – Bleaching preparations and other substances for laundry use; cleaning, polishing, degreasing and abrasive preparations; soap; perfumery, essential oils, cosmetics, hair lotions; dentifrices; all the above-mentioned goods of Swiss origin.

5 – Pharmaceutical and veterinary products; sanitary products for medical purposes; dietetic substances adapted for medical use, food for babies; plasters, materials for dressings; material for dental fillings and dental impressions; disinfectants; pesticides; fungicides, herbicides; all the above-mentioned goods of Swiss origin.

(260) AM 2016 84614 A

(800) 1145970

(891) 2015 09 09

(731) LICENCIAS Y EXCLUSIVAS TEXTILES,  
S.A.  
Avenida de Balmes, 16, E-08700 Igualada,  
Spain

(540)



(591) Black, white

(511)

25 – Stockings, socks and clothing of all kinds for men, women and children; footwear and headgear.

(260) AM 2016 84745 A

(800) 1273047

(891) 2015 06 30

(731) Publichne aktsionerne tovarystvo  
"KHARKIVSKA BISKVITNA FABRYKA"  
vul. Lozivska, 8 Kharkiv 61017, Ukraine

(540)



(591) Orange, yellow and blue

(511)

30 – Peanut confectionery; sponge cakes; cereal bars; high-protein cereal bars; farinaceous foods; pastries; buns; sandwiches; waffles; oat-based food; biscuits; cookies; cake frosting [icing]; custard; rice-based snack food; cereal-based snack food; cereal preparations; cocoa [confectionery]; caramels (can-

dy); lozenges (confectionery); confectionery; sugar confectionery; confectionery for decorating Christmas trees; liquorice (confectionery); candy; marzipan; macaroons [pastry]; almond paste; almond confectionery; dessert mousses [confectionery]; chocolate mousses; mint for confectionery; peppermint sweets; stick liquorice [confectionery]; chips [cereal products]; pies; fondants (confectionery); pralines; gingerbread; puddings; cake powder; cakes; rice cakes; malt biscuits; petit-beurre biscuits; petits fours (cakes); cake batter/cake dough; pastry dough; crackers; tarts; fruit jellies [confectionery]; halvah; sweetmeats (candy); chocolate.

(260) AM 2016 85069 A

(800) 1275500

(891) 2015 09 29

(731) Rigo Trading S.A. Société Anonyme

Route de Trèves 6 EBBC, Building E, L-2633

Sennigerberg, Luxembourg

(540)

**Kracher**

(511)

30 – Confectionery.

(260) AM 2016 85146 A

(800) 1275914

(891) 2015 09 03

(731) Obshchestvo s ogranichennoy

otvetstvennostyu "TEKHNOLOGIA"

1-ya Frezernaya ul., 2/1, str. 1, RU-109202

Moscow, Russian Federation

(540)

**OLLIN**  
PROFESSIONAL

(591) black and white

(511)

3 – Bleaching preparations and other substances for laundry use; cleaning, polishing, scouring and abrasive preparations; soaps; perfumery, essential oils, cosmetics, hair lotions; dentifrices; abrasive cloth; abrasive paper; abrasives; adhesives for affixing false eyelashes; adhesives for affixing false hair; adhesives for cosmetic purposes; after-shave lotions; air fragrancing preparations; almond milk for cosmetic purposes; almond oil; almond soap; aloe vera preparations for cosmetic purposes; alum stones [astringents]; amber [perfume]; ammonia [volatile alkali] [detergent]; antiperspirant soap; antiperspirants [toiletries]; antistatic preparations for household purposes; aromatics [essential oils]; astringents for cosmetic purposes; badian essence; balms other than for medical purposes; bases for flower perfumes; bath preparations, not for medical purposes; bath salts, not for medical purposes; beard dyes;

beauty masks; bergamot oil; bleaching preparations [decolorants] for cosmetic purposes; bleaching salts; bleaching soda; breath freshening sprays; breath freshening strips; cake flavorings [essential oils]; cakes of toilet soap; canned pressurized air for cleaning and dusting purposes; carbides of metal [abrasives]; cleaning chalk; cleaning preparations; cleansing milk for toilet purposes; cloths impregnated with a detergent for cleaning; cobblers' wax; colorants for toilet purposes; color- [colour-] brightening chemicals for household purposes [laundry]; color-removing preparations; corundum [abrasive]; cosmetic creams; cosmetic dyes; cosmetic kits; cosmetic pencils; cosmetic preparations for baths; cosmetic preparations for eyelashes; cosmetic preparations for skin care; cosmetic preparations for slimming purposes; cosmetics for animals; cotton sticks for cosmetic purposes; cotton wool for cosmetic purposes; creams for leather; decorative transfers for cosmetic purposes; degreasers other than for use in manufacturing processes; dental bleaching gels; denture polishes; deodorants for human beings or for animals; deodorants for pets; deodorant soap; depilatory preparations; depilatory wax; detergents other than for use in manufacturing operations and for medical purposes; diamantine [abrasive]; disinfectant soap; douching preparations for personal sanitary or deodorant purposes [toiletries]; dry-cleaning preparations; drying agents for dishwashing machines; dry shampoos; eau de Cologne; emery; emery cloth; emery paper; essential oils of cedarwood; essential oils of citron; essential oils of lemon; ethereal essences; extracts of flowers [perfumes]; eyebrow cosmetics; eyebrow pencils; fabric softeners for laundry use; false eyelashes; false nails; flavorings [flavourings] for beverages [essential oils]; floor wax removers [scouring preparations]; fumigation preparations [perfumes]; refurbishing preparations; gaultheria oil; geraniol; glass cloth; greases for cosmetic purposes; grinding preparations; hair conditioners; hair dyes; hair spray; hair straightening preparations; hair waving preparations; heliotropine; henna [cosmetic dye]; hydrogen peroxide for cosmetic purposes; incense; ionone [perfumery]; jasmine oil; Javelle water; joss sticks; lacquer-removing preparations; laundry bleach; laundry blueing; laundry glaze; laundry preparations; laundry soaking preparations; laundry starch; laundry wax; lavender oil; lavender water; leather bleaching preparations; lip glosses; lipsticks; lotions for cosmetic purposes; make-up; make-up powder; make-up preparations; make-up removing preparations; mascara; massage gels other than for medical purposes; medicated soap; mint essence [essential oil]; mint for perfumery; mouthwashes, not for medical purposes; musk [perfumery]; mustache wax; nail art stickers; nail care preparations; nail polish; neutralizers for permanent waving; non-slipping liquids for floors; non-slipping wax for floors; oil of

turpentine for degreasing; oils for cleaning purposes; oils for cosmetic purposes; oils for perfumes and scents; oils for toilet purposes; paint stripping preparations; parquet floor wax; pastes for razor strops; perfumery; perfumes; petroleum jelly for cosmetic purposes; polish for furniture and flooring; polishing creams; polishing paper; polishing preparations; polishing rouge; polishing stones; polishing wax; pomades for cosmetic purposes; potpourris [fragrances]; preparations for cleaning dentures; preparations for unblocking drain pipes; preparations to make the leaves of plants shiny; preservatives for leather [polishes]; pumice stone; quillaia bark for washing; rose oil; rust removing preparations; sachets for perfuming linen; safrol; sandpaper; scale removing preparations for household purposes; scented water; scented wood; scouring solutions; shampoos; shampoos for pets; shaving preparations; shaving soap; shaving stones [astringents]; shining preparations [polish]; shoe cream; shoemakers' wax; shoe polish; shoe wax; silicon carbide [abrasive]; skin whitening creams; smoothing preparations [starching]; smoothing stones; soap; soap for brightening textile; soap for foot perspiration; soda lye; stain removers; starch glaze for laundry purposes; sunscreen preparations; sun-tanning preparations [cosmetics]; tailors' wax; talcum powder, for toilet use; terpenes [essential oils]; tissues impregnated with cosmetic lotions; tissues impregnated with make-up removing preparations; toiletries; toilet water; tripoli stone for polishing; turpentine, for degreasing; varnish-removing preparations; volcanic ash for cleaning; wallpaper cleaning preparations; washing soda, for cleaning; whitening; windshield cleaning liquids.

5 – Pharmaceutical and veterinary preparations; sanitary preparations for medical purposes; dietetic food and substances adapted for medical or veterinary use, food for babies; dietary supplements for humans and animals; plasters, materials for dressings; material for stopping teeth, dental wax; disinfectants; preparations for destroying vermin; fungicides, herbicides; absorbent cotton; acaricides; acetates for pharmaceutical purposes; acids for pharmaceutical purposes; aconitine; adhesive plasters; adhesives for dentures; adhesive tapes for medical purposes; adjuvants for medical purposes; air deodorising preparations; air purifying preparations; albumin dietary supplements; albuminous foodstuffs for medical purposes; albuminous preparations for medical purposes; alcohol for pharmaceutical purposes; aldehydes for pharmaceutical purposes; algicides; alginate dietary supplements; alginates for pharmaceutical purposes; alkaline iodides for pharmaceutical purposes; alkaloids for medical purposes; alloys of precious metals for dental purposes; aloe vera preparations for pharmaceutical purposes; aluminium acetate for pharmaceutical purposes; amino acids for medical purposes; amino acids for veterinary purposes; ana-

esthetics; analgesics; angostura bark for medical purposes; animal washes; antibiotics; anticryptogamic preparations; antioxidant pills; antiparasitic collars for animals; antiparasitic preparations; anti-rheumatism bracelets; anti-rheumatism rings; antiseptic cotton; antiseptics; anti-uric preparations; appetite suppressant pills; appetite suppressants for medical purposes; articles for headache; aseptic cotton; asthmatic tea; babies' diapers [napkins]; babies' napkin-pants [diaper-pants]; bacterial poisons; bacterial preparations for medical and veterinary use; bacteriological preparations for medical and veterinary use; balms for medical purposes; balsamic preparations for medical purposes; bandages for dressings; barks for pharmaceutical purposes; bath salts for medical purposes; belts for sanitary napkins [towels]; bicarbonate of soda for pharmaceutical purposes; biocides; biological preparations for medical purposes; biological preparations for veterinary purposes; biological tissue cultures for medical purposes; biological tissue cultures for veterinary purposes; bismuth preparations for pharmaceutical purposes; bismuth subnitrate for pharmaceutical purposes; blood for medical purposes; blood plasma; bone cement for surgical and orthopaedic purposes; bracelets for medical purposes; breast-nursing pads; bromine for pharmaceutical purposes; bronchodilating preparations; bunion pads; by-products of the processing of cereals for dietetic or medical purposes; cachets for pharmaceutical purposes; cachou for pharmaceutical purposes; calomel; camphor for medical purposes; camphor oil for medical purposes; candy for medical purposes; candy, medicated; capsules for medicines; carbolineum [parasiticide]; casein dietary supplements; castor oil for medical purposes; cattle washes; caustic pencils; caustics for pharmaceutical purposes; cedar wood for use as an insect repellent; cellulose esters for pharmaceutical purposes; cellulose ethers for pharmaceutical purposes; cement for animal hooves; charcoal for pharmaceutical purposes; chemical conductors for electrocardiograph electrodes; chemical contraceptives; chemical preparations for medical purposes; chemical preparations for pharmaceutical purposes; chemical preparations for the diagnosis of pregnancy; chemical preparations for treating phylloxera; chemical preparations for veterinary purposes; chemical preparations to treat mildew; chemical preparations to treat wheat blight [smut]; chemical reagents for medical or veterinary purposes; chemo-pharmaceutical preparations; chewing gum for medical purposes; chilblain preparations; chinoline for medical purposes; chloroform; cocaine; cod liver oil; collodion for pharmaceutical purposes; collyrium; compresses; condurango bark for medical purposes; contact lens cleaning preparations; cooling sprays for medical purposes; corn remedies; corn rings for the feet; cotton for medical purposes; cream of tartar for pharmaceutical purposes;



creosote for pharmaceutical purposes; croton bark; cultures of microorganisms for medical and veterinary use; curare; decoctions for pharmaceutical purposes; dental abrasives; dental amalgams; dental amalgams of gold; dental cements; dental impression materials; dental lacquer; dental mastics; deodorants for clothing and textiles; deodorants, other than for human beings or for animals; depuratives; detergents for medical purposes; diabetic bread adapted for medical use; diagnostic biomarker reagents for medical purposes; diagnostic preparations for medical purposes; diapers for incontinents; diapers for pets; diastase for medical purposes; dietary fiber; dietary supplements for animals; dietetic beverages adapted for medical purposes; dietetic foods adapted for medical purposes; dietetic substances adapted for medical use; digestives for pharmaceutical purposes; digitalin; dill oil for medical purposes; disinfectants for chemical toilets; disinfectants for hygiene purposes; dog lotions; dog washes; douching preparations for medical purposes; dressings, medical; drugs for medical purposes; elixirs [pharmaceutical preparations]; enzyme dietary supplements; enzyme preparations for medical purposes; enzyme preparations for veterinary purposes; enzymes for medical purposes; enzymes for veterinary purposes; ergot for pharmaceutical purposes; esters for pharmaceutical purposes; ethers for pharmaceutical purposes; eucalyptol for pharmaceutical purposes; eucalyptus for pharmaceutical purposes; extracts of hops for pharmaceutical purposes; eyepatches for medical purposes; eye-washes; febrifuges; fennel for medical purposes; ferments for pharmaceutical purposes; first-aid boxes, filled; fish meal for pharmaceutical purposes; flour for pharmaceutical purposes; flowers of sulfur for pharmaceutical purposes; fly catching paper; fly destroying preparations; fly glue; formic aldehyde for pharmaceutical purposes; frostbite salve for pharmaceutical purposes; fumigating sticks; fumigation preparations for medical purposes; fungicides; gallic acid for pharmaceutical purposes; gamboge for medical purposes; gases for medical purposes; gauze for dressings; gelatine for medical purposes; gentian for pharmaceutical purposes; germicides; glucose dietary supplements; glucose for medical purposes; glycerine for medical purposes; glycerophosphates; greases for medical purposes; greases for veterinary purposes; guaiacol for pharmaceutical purposes; gum for medical purposes; gurjun [gurjon, gurjan] balsam for medical purposes; headache pencils; hematogen; hemoglobin; hemorrhoid preparations; hemostatic pencils; herbal teas for medicinal purposes; herbicides; hormones for medical purposes; hydrastine; hydrastinine; hydrated chloral for pharmaceutical purposes; hydrogen peroxide for medical purposes; insecticides; insect repellent incense; insect repellents; iodides for pharmaceutical purposes;

iodine for pharmaceutical purposes; iodoform; Irish moss for medical purposes; isotopes for medical purposes; jalap; jujube, medicated; lacteal flour for babies; lactose for pharmaceutical purposes; larvae exterminating preparations; laxatives; lead water; lecithin dietary supplements; lecithin for medical purposes; leeches for medical purposes; liniments; linseed dietary supplements; linseed for pharmaceutical purposes; linseed meal for pharmaceutical purposes; linseed oil dietary supplements; lint for medical purposes; liquorice for pharmaceutical purposes; lotions for pharmaceutical purposes; lotions for veterinary purposes; lupulin for pharmaceutical purposes; magnesia for pharmaceutical purposes; malted milk beverages for medical purposes; malt for pharmaceutical purposes; mangrove bark for pharmaceutical purposes; media for bacteriological cultures; medical preparations for slimming purposes; medicated animal feed; medicinal alcohol; medicinal drinks; medicinal hair growth preparations; medicinal herbs; medicinal infusions; medicinal mud; medicinal oils; medicinal roots; medicinal tea; medicine cases, portable, filled; medicines for alleviating constipation; medicines for dental purposes; medicines for human purposes; medicines for veterinary purposes; melissa water for pharmaceutical purposes; menthol; mercurial ointments; milk ferments for pharmaceutical purposes; milking grease; milk of almonds for pharmaceutical purposes; mineral food supplements; mineral water salts; mineral waters for medical purposes; mint for pharmaceutical purposes; molding wax for dentists; moleskin for medical purposes; mothproofing paper; mothproofing preparations; mouthwashes for medical purposes; mud for baths; mustard for pharmaceutical purposes; mustard oil for medical purposes; mustard plasters; myrobalan bark for pharmaceutical purposes; narcotics; nervines; nutritional supplements; nutritive substances for microorganisms; oil of turpentine for pharmaceutical purposes; ointments for pharmaceutical purposes; opiates; opium; opodeldoc; opotherapy preparations; oxygen baths; oxygen for medical purposes; pants, absorbent, for incontinents; panty liners [sanitary]; paper for mustard plasters; parasiticides; pastilles for pharmaceutical purposes; pearl powder for medical purposes; pectin for pharmaceutical purposes; pepsins for pharmaceutical purposes; peptones for pharmaceutical purposes; personal sexual lubricants; pesticides; petroleum jelly for medical purposes; pharmaceutical preparations; pharmaceutical preparations for skin care; pharmaceutical preparations for treating dandruff; phenol for pharmaceutical purposes; phosphates for pharmaceutical purposes; poisons; pollen dietary supplements; pomades for medical purposes; porcelain for dental prostheses; potassium salts for medical purposes; poultices; powder of cantharides; preparations for callouses; preparations for destroying dry rot fungus; preparations for destroying mice; preparations for destroying no-

xious animals; preparations for reducing sexual activity; preparations for the treatment of burns; preparations of lime for pharmaceutical purposes; preparations of trace elements for human and animal use; preparations to facilitate teething; propolis dietary supplements; propolis for pharmaceutical purposes; protein dietary supplements; protein supplements for animals; purgatives; pyrethrum powder; quassia for medical purposes; quebracho for medical purposes; quinine for medical purposes; quinquina for medical purposes; radioactive substances for medical purposes; radiological contrast substances for medical purposes; radium for medical purposes; rat poison; reagent paper for medical or veterinary purposes; remedies for foot perspiration; remedies for perspiration; repellents for dogs; rhubarb roots for pharmaceutical purposes; royal jelly dietary supplements; royal jelly for pharmaceutical purposes; rubber for dental purposes; salts for medical purposes; salts for mineral water baths; sanitary pads; sanitary panties; sanitary tampons; sanitary towels; sarsaparilla for medical purposes; scapulars for surgical purposes; sea water for medicinal bathing; sedatives; semen for artificial insemination; serotherapeutic medicines; serums; siccatives [drying agents] for medical purposes; slimming pills; slug exterminating preparations; smelling salts; smoking herbs for medical purposes; sodium salts for medical purposes; soil-sterilising preparations; solutions for contact lenses; solvents for removing adhesive plasters; saporifics; starch for dietetic or pharmaceutical purposes; stem cells for medical purposes; stem cells for veterinary purposes; sterilising preparations; steroids; stick liquorice for pharmaceutical purposes; strychnine; styptic preparations; sugar for medical purposes; sulfonamides [medicines]; sulfur sticks [disinfectants]; sunburn ointments; sunburn preparations for pharmaceutical purposes; suppositories; surgical dressings; surgical implants comprised of living tissues; syrups for pharmaceutical purposes; tanning pills; tartar for pharmaceutical purposes; teeth filling material; therapeutic preparations for the bath; thermal water; thymol for pharmaceutical purposes; tincture of iodine; tinctures for medical purposes; tissues impregnated with pharmaceutical lotions; tobacco extracts [insecticides]; tobacco-free cigarettes for medical purposes; tonics [medicines]; turpentine for pharmaceutical purposes; vaccines; vaginal washes; vermifuges; vesicants; veterinary preparations; vine disease treating chemicals; vitamin preparations; vulnerary sponges; wadding for medical purposes; wart pencils; wheat germ dietary supplements; yeast dietary supplements; yeast for pharmaceutical purposes.

(260) AM 2016 85148 A  
 (800) 1276276  
 (891) 2015 08 28

(731) KUSUM PHARM LLC  
 54, Skriabina str. Sumy 40020, Ukraine  
 (540)

## ABROL

(511)  
 5 – Pharmaceutical and veterinary preparations; sanitary preparations for medical purposes; dietetic food and substances adapted for medical or veterinary use, food for babies; dietary supplements for humans and animals; plasters, materials for dressings; material for stopping teeth, dental wax; disinfectants; preparations for destroying vermin; fungicides, herbicides; absorbent cotton; acaricides; acetates for pharmaceutical purposes; acids for pharmaceutical purposes; acne treatment preparations; aconitine; adhesive plasters; adhesive tapes for medical purposes; adhesives for dentures; adjuvants for medical purposes; air purifying preparations; air deodorising preparations; albumin dietary supplements; albuminous foodstuffs for medical purposes; albuminous preparations for medical purposes; alcohol for pharmaceutical purposes; aldehydes for pharmaceutical purposes; algicides; alginate dietary supplements; alginates for pharmaceutical purposes; alkaline iodides for pharmaceutical purposes; alkaloids for medical purposes; alloys of precious metals for dental purposes; aloe vera preparations for pharmaceutical purposes; aluminium acetate for pharmaceutical purposes; amino acids for medical purposes; amino acids for veterinary purposes; anaesthetics; analgesics; angostura bark for medical purposes; animal washes; anti-rheumatism bracelets; anti-rheumatism rings; anti-uric preparations; antibiotics; anticryptogamic preparations; antioxidant pills; antiparasitic preparations; antiparasitic collars for animals; antiseptic cotton; antiseptics; appetite suppressants for medical purposes; appetite suppressant pills; articles for headache; aseptic cotton; asthmatic tea; babies' napkins [diapers]; babies' napkin-pants [diaper-pants]; bacterial poisons; bacterial preparations for medical and veterinary use; bacteriological preparations for medical and veterinary use; balms for medical purposes; balsamic preparations for medical purposes; barks for pharmaceutical purposes; bath preparations for medical purposes; bath salts for medical purposes; belts for sanitary napkins [towels]; bicarbonate of soda for pharmaceutical purposes; biocides; biological preparations for medical purposes; biological preparations for veterinary purposes; biological tissue cultures for medical purposes; biological tissue cultures for veterinary purposes; bismuth preparations for pharmaceutical purposes; bismuth subnitrate for pharmaceutical purposes; blood plasma; blood for medical purposes; bone cement for surgical and orthopaedic purposes; bracelets for medical purposes; breast-nursing pads; bromine for pharmaceutical purposes; bronchodilating prepara-

tions; bunion pads; cachets for pharmaceutical purposes; cachou for pharmaceutical purposes; preparations for callouses; calomel; camphor oil for medical purposes; camphor for medical purposes; candy, medicated; candy for medical purposes; capsules for medicines; carbolineum [parasiticide]; casein dietary supplements; castor oil for medical purposes; cattle washes; caustic pencils; caustics for pharmaceutical purposes; cedar wood for use as an insect repellent; cellulose esters for pharmaceutical purposes; cellulose ethers for pharmaceutical purposes; cement for animal hooves; charcoal for pharmaceutical purposes; chemical preparations to treat mildew; chemical preparations to treat wheat blight [smut]; chemical preparations for treating phylloxera; chemical preparations for pharmaceutical purposes; chemical preparations for medical purposes; chemical preparations for veterinary purposes; chemical reagents for medical or veterinary purposes; chemico-pharmaceutical preparations; chewing gum for medical purposes; chilblain preparations; chinoline for medical purposes; chloroform; cocaine; cod liver oil; collodion for pharmaceutical purposes; collyrium; compresses; condurango bark for medical purposes; solutions for contact lenses; contact lens cleaning preparations; cooling sprays for medical purposes; corn rings for the feet; corn remedies; cotton for medical purposes; cotton swabs for medical purposes; cream of tartar for pharmaceutical purposes; creosote for pharmaceutical purposes; croton bark; cultures of microorganisms for medical and veterinary use; curare; decoctions for pharmaceutical purposes; dental abrasives; dental amalgams; dental cements; dental impression materials; dental lacquer; dental mastics; dental amalgams of gold; deodorants, other than for human beings or for animals; deodorants for clothing and textiles; depuratives; preparations for destroying noxious animals; preparations for destroying dry rot fungus; preparations for destroying mice; detergents for medical purposes; diabetic bread adapted for medical use; diagnostic preparations for medical purposes; diagnostic biomarker reagents for medical purposes; diagnostic preparations for veterinary purposes; diapers for pets; diastase for medical purposes; dietary fibre; dietary supplements for animals; dietetic beverages adapted for medical purposes; dietetic substances adapted for medical use; digestives for pharmaceutical purposes; digitalin; dill oil for medical purposes; disinfectants for hygiene purposes; disinfectants for chemical toilets; disinfectants; dog washes; dog lotions; douching preparations for medical purposes; dressings, medical; drugs for medical purposes; elixirs [pharmaceutical preparations]; enzyme preparations for medical purposes; enzyme preparations for veterinary purposes; enzyme dietary supplements; enzymes for medical purposes; enzymes for veterinary purposes; ergot for pharmaceutical purposes; esters for pharmaceutical purposes; ethers for pharmaceutical purposes; eucalyptol for

pharmaceutical purposes; eucalyptus for pharmaceutical purposes; extracts of hops for pharmaceutical purposes; eye-washes; eyepatches for medical purposes; preparations to facilitate teething; febrifuges; fennel for medical purposes; ferments for pharmaceutical purposes; first-aid boxes, filled; fish meal for pharmaceutical purposes; flour for pharmaceutical purposes; flowers of sulfur for pharmaceutical purposes; fly catching paper; fly glue fly destroying preparations; formic aldehyde for pharmaceutical purposes; frostbite salve for pharmaceutical purposes; fumigating sticks; fumigation preparations for medical purposes; fungicides; gallic acid for pharmaceutical purposes; gamboge for medical purposes; gases for medical purposes; gauze for dressings; gelatine for medical purposes; gentian for pharmaceutical purposes; germicides; glucose for medical purposes; glucose dietary supplements; glycerine for medical purposes; glycerophosphates; greases for medical purposes; greases for veterinary purposes; guaiacol for pharmaceutical purposes; gum for medical purposes; gurjun [gurion, gurian] balsam for medical purposes; haematogen; haemoglobin; haemorrhoid preparations; haemostatic pencils; headache pencils; herbal teas for medicinal purposes; herbicides; hormones for medical purposes; hydrastine; hydrastinine; hydrated chloral for pharmaceutical purposes; hydrogen peroxide for medical purposes; insect repellents; insect repellent incense; insecticides; iodides for pharmaceutical purposes; iodine for pharmaceutical purposes; iodoform; Irish moss for medical purposes; isotopes for medical purposes; jalap; jujube, medicated; lacteal flour for babies; larvae exterminating preparations; laxatives; lead water; lecithin for medical purposes; lecithin dietary supplements; leeches for medical purposes; preparations of lime for pharmaceutical purposes; liniments; linseed for pharmaceutical purposes; linseed meal for pharmaceutical purposes; linseed dietary supplements; linseed oil dietary supplements; lint for medical purposes; liquorice for pharmaceutical purposes; lotions for pharmaceutical purposes; lotions for veterinary purposes; lupulin for pharmaceutical purposes; magnesia for pharmaceutical purposes; malt for pharmaceutical purposes; malted milk beverages for medical purposes; mangrove bark for pharmaceutical purposes; medical preparations for slimming purposes; medicated animal feed; medicinal alcohol; medicinal mud; medicinal infusions; medicinal tea; medicinal oils; medicinal herbs; medicinal roots; medicinal drinks; medicinal hair growth preparations; medicine cases, portable, filled; medicines for alleviating constipation; medicines for dental purposes; medicines for human purposes; medicines for veterinary purposes; melissa water for pharmaceutical purposes; menstruation bandages; menthol; mercurial ointments; milk ferments for pharmaceutical purposes; milk sugar for pharmaceutical purposes;

milk of almonds for pharmaceutical purposes; milking grease; mineral waters for medical purposes; mineral water salts; mineral food supplements; mint for pharmaceutical purposes; moleskin for medical purposes; mothproofing preparations; mothproofing paper; moulding wax for dentists; mouthwashes for medical purposes; mud for baths; mustard oil for medical purposes; mustard for pharmaceutical purposes; mustard plasters; myrobalan bark for pharmaceutical purposes; napkins for incontinents; narcotics; nerviness; nutritional supplements; nutritive substances for microorganisms; oil of turpentine for pharmaceutical purposes; ointments for pharmaceutical purposes; opiates; opium; opodeldoc; opotherapy preparations; oxygen baths; oxygen for medical purposes; pants, absorbent, for incontinents; panty liners [sanitary]; paper for mustard plasters; parasiticides; pastilles for pharmaceutical purposes; pearl powder for medical purposes; pectin for pharmaceutical purposes; pepsins for pharmaceutical purposes; peptones for pharmaceutical purposes; pesticides; petroleum jelly for medical purposes; pharmaceutical preparations; pharmaceutical preparations for skin care; pharmaceutical preparations for treating dandruff; phenol for pharmaceutical purposes; phosphates for pharmaceutical purposes; poisons; pollen dietary supplements; pomades for medical purposes; porcelain for dental prostheses; potassium salts for medical purposes; poultices; powder of cantharides; by-products of the processing of cereals for dietetic or medical purposes; propolis for pharmaceutical purposes; propolis dietary supplements; protein dietary supplements; protein supplements for animals; purgatives; pyrethrum powder; quassia for medical purposes; quebracho for medical purposes; quinine for medical purposes; quinquina for medical purposes; radioactive substances for medical purposes; radiological contrast substances for medical purposes; radium for medical purposes; rat poison; reagent paper for medical or veterinary purposes; preparations for reducing sexual activity; remedies for foot perspiration; remedies for perspiration; repellents for dogs; rhubarb roots for pharmaceutical purposes; royal jelly for pharmaceutical purposes; royal jelly dietary supplements; rubber for dental purposes; salts for mineral water baths; salts for medical purposes; sanitary panties; sanitary tampons; sanitary towels; sarsaparilla for medical purposes; scapulars for surgical purposes; sea water for medicinal bathing; sedatives; semen for artificial insemination; serotherapeutic medicines; serums; personal sexual lubricants; siccatives [drying agents] for medical purposes; slimming pills; slug exterminating preparations; smelling salts; smoking herbs for medical purposes; sodium salts for medical purposes; soil-sterilising preparations; solvents for removing adhesive plasters; soporifics; starch for dietetic or pharmaceutical purposes; stem cells for medical purposes; stem cells for veterinary purposes; sterilising

preparations; steroids; stick liquorice for pharmaceutical purposes; strychnine; styptic preparations; sugar for medical purposes; sulfonamides [medicines]; sulfur sticks [disinfectants]; sunburn preparations for pharmaceutical purposes; sunburn ointments; suppositories; surgical dressings; surgical implants comprised of living tissues; surgical glues; syrups for pharmaceutical purposes; tanning pills; tartar for pharmaceutical purposes; teeth filling material; therapeutic preparations for the bath; thermal water; thymol for pharmaceutical purposes; tincture of iodine; tinctures for medical purposes; tissues impregnated with pharmaceutical lotions; tobacco extracts [insecticides]; tobacco-free cigarettes for medical purposes; tonics [medicines]; preparations of trace elements for human and animal use; preparations for the treatment of burns; turpentine for pharmaceutical purposes; vaccines; vaginal washes; vermifuges; vermin destroying preparations; vesicants; veterinary preparations; vitamin preparations; vulnerary sponges; wadding for medical purposes; wart pencils; wheat germ dietary supplements; yeast for pharmaceutical purposes; yeast dietary supplements.

(260) AM 2016 85149 A

(800) 1275930

(891) 2015 07 31

(731) BOGUSLAVSKAYA KARINA IREKOVNA  
ul. Bogataya, 1, d. Matyushino, Laishevsky  
municipal district, RU-422624 Republic  
of Tatarstan, Russian Federation

(540)



(591) black and white

(511)

3 – Abrasives; amber [perfume]; scale removing preparations for household purposes; antistatic preparations for household purposes; aromatics [essential oils]; air fragrancing preparations; cake flavorings [essential oils]; flavorings [flavourings] for beverages [essential oils]; breath freshening sprays; canned pressurized air for cleaning and dusting purposes; balms other than for medical purposes; lip glosses; polishing stones; abrasive paper; emery paper; polishing paper; petroleum jelly for cosmetic purposes; shoe wax; cobblers' wax; cotton wool for cosmetic purposes; sachets for perfuming linen; drying agents for dishwashing machines; adhesives for cosmetic purposes; scented water; Javelle water; lavender water; toilet water; laundry wax; parquet floor wax; non-slipping wax for floors; depilatory wax; mustache wax; tailors' wax; polish for furniture and flooring; shoemakers' wax; polishing wax; massage

gels other than for medical purposes; heliotropine; dental bleaching gels; geraniol; make-up; deodorants for pets; scented wood; perfumes; non-slipping liquids for floors; windshield cleaning liquids; greases for cosmetic purposes; volcanic ash for cleaning; perfumery; decorative transfers for cosmetic purposes; ionone [perfumery]; shaving stones [astringents]; smoothing stones; eyebrow pencils; cosmetic pencils; silicon carbide [abrasive]; carbides of metal [abrasives]; alum stones [astringents]; tripoli stone for polishing; adhesives for affixing false eyelashes; adhesives for affixing false hair; quillaia bark for washing; corundum [abrasive]; beard dyes; colorants for toilet purposes; cosmetic dyes; laundry starch; laundry glaze; creams for leather; polishing creams; shoe polish; cosmetic creams; skin whitening creams; polishing rouge; incense; hair spray; nail polish; hair lotions; lotions for cosmetic purposes; after-shave lotions; beauty masks; oils for perfumes and scents; oils for cosmetic purposes; oils for toilet purposes; essential oils; essential oils of cedarwood; essential oils of lemon; essential oils of citron; oils for cleaning purposes; bergamot oil; gaultheria oil; jasmine oil; lavender oil; almond oil; rose oil; oil of turpentine for degreasing; whitening; cleaning chalk; almond milk for cosmetic purposes; cleansing milk for toilet purposes; musk [perfumery]; soap; disinfectant soap; deodorant soap; shaving soap; soap for brightening textile; cakes of toilet soap; medicated soap; antiperspirant soap; soap for foot perspiration; almond soap; mint for perfumery; cosmetic kits; emery; nail art stickers; false nails; eau de Cologne; bases for flower perfumes; cotton sticks for cosmetic purposes; joss sticks; pastes for razor strops; dentifrices; dentifrice powder; pumice stone; hydrogen peroxide for cosmetic purposes; breath freshening strips; abrasive cloth; glass cloth; lipsticks; pomades for cosmetic purposes; shaving preparations; cosmetic preparations for baths; toiletries; hair waving preparations; laundry soaking preparations; grinding preparations; douching preparations for personal sanitary or deodorant purposes [toiletries]; smoothing preparations [starching]; color-removing preparations; leather bleaching preparations; polishing preparations; denture polishes; mouthwashes, not for medical purposes; cosmetic preparations for slimming purposes; starch glaze for laundry purposes; refurbishing preparations; fabric softeners for laundry use; laundry bleach; dry-cleaning preparations; paint stripping preparations; lacquer-removing preparations; make-up removing preparations; floor wax removers [scouring preparations]; varnish-removing preparations; nail care preparations; cleaning preparations; preparations for cleaning dentures; wallpaper cleaning preparations; preparations for unblocking drain pipes; laundry preparations; aloe vera preparations for cosmetic purposes; sunscreen preparations; color- [colour-] brightening chemicals for household purposes [laundry]; shining preparations

[polish]; make-up powder; diamantine [abrasive]; stain removers; scouring solutions; false eyelashes; tissues impregnated with cosmetic lotions; saffrol; laundry blueing; turpentine, for degreasing; potpourris [fragrances]; bleaching soda; washing soda, for cleaning; bath salts, not for medical purposes; bleaching salts; fumigation preparations [perfumes]; preservatives for leather [polishes]; ammonia [volatile alkali] [detergent]; astringents for cosmetic purposes; eyebrow cosmetics; make-up preparations; sun-tanning preparations [cosmetics]; hair dyes; neutralizers for permanent waving; preparations to make the leaves of plants shiny; cosmetic preparations for eyelashes; depilatory and exfoliating preparations; cosmetic preparations for skin care; shoe cream; cosmetics; cosmetics for animals; mascara; detergents other than for use in manufacturing operations and for medical purposes; degreasers other than for use in manufacturing processes; bleaching preparations [decolorants] for cosmetic purposes; antiperspirants [toiletries]; talcum powder, for toilet use; terpenes [essential oils]; emery cloth; cloths impregnated with a detergent for cleaning; henna [cosmetic dye]; shampoos; shampoos for pets; dry shampoos; sandpaper; soda lye; extracts of flowers [perfumes]; ethereal essences; badian essence; mint essence [essential oil].

(260) AM 2016 85152 A

(800) 1275934

(891) 2015 08 25

(731) Zakrytoe akcionerное obshchestvo "Mediko-biologicheskij nauchno-proizvodstvennyj kompleks "Cytomed", ZAO "MBNPK "Cytomed" Muchnoj pereulok, 2, RU-191023 Saint-Petersburg, Russian Federation

(540)

## ЦИТОВИР

(511)

5 – Pharmaceutical preparations; medicinal healthcare preparations; medicines for human purposes.

(260) AM 2016 85153 A

(800) 1275949

(891) 2015 09 09

(731) ROLEX SA

3-5-7, rue François-Dussaud, CH-1211 Genève, Switzerland

(540)

## ROLEX MENTORS & PROTEGES

(511)

9 – Apparatus for capturing, recording and reproducing, handling and transmitting data, sound and images; discs, tapes and cards, all magnetic data media; discs, diskettes, CDs, audio and video tapes, exposed

films, multimedia devices and apparatus for connecting and controlling audio-video and telecommunication equipment as well as computers and printers, screens, photographic, cinematographic, optical and teaching apparatus and instruments; magnetic, magneto-optical and optical carriers for sound and/or video recording.

16 – Books, pamphlets, prospectuses, printed matter, periodicals, magazines, instruction manuals, publications, photographs, posters, cards, diaries, indexes, calendars, albums for pictures, photographs, artists' materials, goods for drawing, painting and modeling.

35 – Promotion of cultural activities; creation, production and dissemination of advertising material (prospectuses, printed matter), video demonstrations, publication of advertising texts, advertising patronage in the arts field.

36 – Financial sponsorship and patronage in the arts field; management of sponsorship funds, awarding of scholarships.

41 – Publication and editing of newspapers, periodicals, magazines, books and texts other than advertising texts; organization of competitions in the cultural, artistic and architectural field; arranging and conducting of colloquiums, conferences, congresses, prize-awarding, forums, symposiums, training courses; training in the field of music and the arts; music composition and transcription for others, education in the field of culture (music, theater, painting); organization of exhibitions for cultural and educational purposes; organization of cultural events; production of shows, films, radio programs; musical and theatrical performances, orchestra services; cultural activities, organization of shows, concerts, theatrical performances for third parties, information on cultural activities; consultancy in the field of the arts; publication of the results of cultural and artistic projects; evaluation of artistic and cultural projects (cultural activities).

(260) AM 2016 85154 A  
(800) 1276289  
(891) 2015 09 01  
(731) Public Joint Stock Company "OTCPharm"  
ul. Testovskaya, 10 RU-123317 Moscow,  
Russian Federation  
(540)



(591) azure, grey, dark-grey, green, dark-green, bordeaux.

(511)  
5 – Pharmaceutical and veterinary preparations; hygienic preparations for medical purposes; dietetic food and substances adapted for medical or veterinary use, food for babies; dietary supplements for humans and animals, including dietary supplements; plasters, materials for dressings; disinfectants, included in this class.

(260) AM 2016 85155 A  
(800) 1275966  
(891) 2015 03 13  
(731) THYSSENKRUPP BAUSERVICE GMBH  
Ottostraße 30, 41836 Hückelhoven, Germany  
(540)



(591) Red and yellow  
(511)

6 – Building materials of metal for civil underground engineering, canal construction, and building construction, also for large-surface steel sheeting, in particular sheeting and shuttering elements of metal, namely, steel installation plates, supports, braces, spindles, spreaders, sliding rails, lock planks, canal planks, supporting and tensioning frames, shuttering panels, pressure bars, posts, stabilizers, guide frames; transportable metal structures, metal boxes for trench sheeting, metallic structural elements, ironmongery and small items of metal hardware, metal pipes and rails for building purposes, metallic link chains as building materials, metallic cables and wires (not for electric purposes), metal containers, bung covers.

7 – Construction machines for canal and building construction, in particular for large-surface steel sheeting; pipe grippers as parts or accessories of said construction machines for canal and building construction.

35 – Retail services in the field of building equipment and machinery, in particular appliances for trench sheeting, namely sheeting and shuttering elements of metal, transportable metal structures, metal boxes for trench sheeting, metallic structural elements, ironmongery and small items of metal hardware, metal pipes and rails for building purposes, metallic link chains, metallic cables and wires (not for electric purposes), metal containers, metal bung covers; marketing services for the sale and distribution of the aforementioned goods.

37 – Construction, in particular civil underground engineering, canal construction, building construction, and engineering construction; leasing of construction equipment, in particular equipment for trench sheeting.

(260) AM 2016 85156 A

(800) 1275982

(891) 2015 09 14

(731) SLOVNAFT, a. s.

Vlčie Hrdlo 1, SK-824 12 Bratislava, Slovakia

(540)



(591) black and white

(511)

1 – Polyethylene in the form of granules.

(260) AM 2016 85158 A

(800) 1276012

(891) 2015 07 01

(731) AXION GMBH

Mollenbachstr. 13, 71229 Leonberg, Germany

(540)

**axion**

(511)

5 – Bracelets for medical purposes; straps for veterinary purposes; aseptic cotton; eye patches for medical purposes; eye patches for veterinary purposes; baby food; babies diapers [napkins]; bath salts for medical purposes; bath salts for veterinary purposes; medicated bath preparations; medicated bath preparations for veterinary purposes; dietary fibre; balms for medical purposes; balms for veterinary purposes; balsamic preparations for medical purposes; balsamic preparations for veterinary purposes; bandages for dressings; wadding for medical purposes; wadding for veterinary purposes; medicated candy; chemical conductors for use with electrocardiograph electrodes; chemical preparations for the diagnosis of pregnancy; disinfectants; dietetic substances adapted for medical use; dietetic substances adapted for veterinary purposes; dietetic beverages adapted for medical purposes; dietetic beverages adapted for veterinary purposes; dietetic foods adapted for medical purposes; dietetic foods adapted for veterinary purposes; albuminous preparations for medical purposes; albuminous preparations for veterinary use; eucalyptus for medical purposes; eucalyptus for veterinary purposes; fennel for medical purposes; fennel for veterinary purposes; greases for medical purposes; greases for veterinary purposes;

frostbite salve for pharmaceutical purposes; glucose preparations for medical purposes; glucose for veterinary purposes; belts for sanitary napkins [towels]; antihemorrhoidal preparations; adhesive plasters; remedies for foot perspiration; remedies for perspiration; corn remedies; corn rings for the feet; repellents for dogs; dog lotions; dog washes; pants, absorbent, for incontinents; personal sexual lubricants; tincture of iodine; preparations of lime for pharmaceutical purposes; cooling sprays for medical purposes; cooling sprays for veterinary purposes; camphor for medical purposes; camphor for veterinary purposes; camphor oil for medical purposes; camphor oil for veterinary purposes; candy for medical purposes; candy for veterinary purposes; chewing gum for medical purposes; plasters for medical purposes; plasters for veterinary purposes; adhesive bands for medical purposes; adhesive bands for veterinary purposes; compresses; headache pencils; herb teas for medicinal purposes; herb teas for veterinary purposes; stick liquorice for pharmaceutical purposes; linseed for medical purposes; linseed for veterinary purposes; solutions for use with contact lenses; solvents for removing adhesive plasters; lotions for pharmaceutical purposes; lotions for veterinary purposes; air purifying preparations; malted milk beverages for medical; malted milk beverages for veterinary purposes; medical drinks; drinks for veterinary purposes; medicinal tea; teas for veterinary purposes; medicinal preparations for stimulating hair growth; sanitary wear; menthol for pharmaceutical purposes; milk sugar for pharmaceutical purposes; mineral food supplements; acne medications; preparations for the treatment of burns; preparations for callouses; douching preparations for medical purposes; douching preparations for veterinary purposes; sanitary towels; mouthwashes for medical purposes; mouth washes for veterinary purposes; albuminous foodstuffs for medical purposes; albuminous foodstuffs for veterinary purposes; nutritional supplements; by-products of the processing of cereals for dietetic or medical purposes; byproducts of the processing of cereals for veterinary purposes; antiparasitic collars for animals; candy, medicated; mint for pharmaceutical purposes; preparations of trace elements for medical purposes; preparations of trace elements for veterinary purposes; protein supplements for animals; fumigating pastilles; contact lens cleaning preparations; ointments for pharmaceutical purposes; animal washes; glucose for medical purposes; first aid kits; medical dressings; surgical dressings and wadding for dressings; digestives for pharmaceutical purposes; veterinary preparations; vitamin preparations; cotton wool for medical purposes; cotton swabs for medical purposes; cotton swabs for veterinary purposes.

9 – Electric batteries; alarms; sound alarms; ammeters; anodes; anticathodes; display of power consum-

ption; electric loss indicator; ergometers; cables, electric; terminals [electricity]; ultrasound devices, not for medical purposes, all aforementioned goods not for use with spectrometers, x-ray analyzers, x-ray fluorescence spectrometers or testing apparatus.

10 – Body rehabilitation apparatus for medical purposes; body rehabilitation apparatus for veterinary purposes; feeding bottles; bed pans; sphygmomanometers; health trusses; ice bags for medical purposes; elastic bandages; electronic acupuncture instruments; electrodes for medical use; electrodes for veterinary purposes; walking frames for disabled persons; hearing protection devices; belts for medical purposes; belts, electric, for medical purposes; belts, electric, for veterinary purposes; mittens for medical use; mittens for veterinary purposes; invalids' hoists; blankets, electric, for medical purposes; blankets, electric, for veterinary purposes; electric warming pads for medical use; electric warming pads for veterinary purposes; inhalers; douche bags; irrigators for medical use; irrigators for veterinary use; cushions for medical purposes; cushions for veterinary purposes; pads [pouches] for preventing pressure sores on patient bodies; soporific pillows for insomnia; stockings for varices; ambulance stretchers; crutches; lamps for medical purposes; lamps for veterinary purposes; laser for medical use; laser for veterinary use; air pillows for medical purposes; air pillows for veterinary purposes; air mattresses, for medical purposes; air mattresses, for veterinary purposes; masks for use by medical personnel; massage apparatus; esthetic massage apparatus; massage mitts; physical exercise apparatus for medical purposes; ear picks; ear plugs [ear protection devices]; clothing especially for operating rooms; orthopedic articles, except artificial teeth and artificial dental prostheses; arch supports for footwear; supportive bandages; orthopaedic knee bandages; orthopedic soles; condoms; blood pressure measuring apparatus; quartz lamps for medical purposes; quartz lamps for veterinary purposes; teats; sex toys; beds, specially made for medical purposes; beds, specially made for veterinary purposes; cases fitted for medical instruments; cases fitted for veterinary instruments; furniture especially made for medical purposes; furniture, especially made for veterinary purposes; traction apparatus for medical purposes; traction apparatus for veterinary purposes; elastic stockings for surgical purposes; hot air therapeutic apparatus; thermal packs for first aid purposes; thermometers for medical purposes; thermometers for veterinary purposes; incontinence sheets; urological instruments; veterinary apparatus and instruments; oscillating massage apparatus; walking aids [for medical purposes]; water bags for medical purposes; water bags for veterinary purposes; surgical staples; vaporizers for medical purposes; vaporizers for veterinary purposes.

(260) AM 2016 85161 A

(800) 1276587

(891) 2015 09 23

(731) ORIFLAME COSMETICS AG C/O  
ORIFLAME GLOBAL MANAGEMENT AG  
Bleicheplatz 3, CH-8200 Schaffhausen,  
Switzerland

(540)

**NOVAGE ORIFLAME**

(511)

3 – Soaps; perfumery, essential oils, cosmetics, hair lotions; toothpastes.

(260) AM 2016 85166 A

(800) 1276071

(891) 2015 09 23

(731) Otkrytoe aktsionernoe obshchestvo  
"NEVSKAYA KOSMETIKA"  
prospect Oboukhovskoy oborony, 80,  
RU-192029 Sankt-Peterburg, Russian  
Federation

(540)

УШАСТЫЙ НЯНЬ

(591) black and white

(511)

5 – Food for babies; babies' diapers [napkins]; sanitary towels; napkins for incontinents; panty liners [sanitary]; sanitary tampons; pants, absorbent, for incontinents; sanitary panties; babies' napkin-pants [diaper-pants].

16 – Toilet paper; bibs of paper; towels of paper; tissues of paper for removing make-up; face towels of paper; table napkins of paper; tablemats of paper; place mats of paper; tablecloths of paper.

(260) AM 2016 85167 A

(800) 1276086

(891) 2015 10 01

(731) "MONUS" d.o.o.  
Aleksandra Dubčeka 14, 11080 Beograd-  
Zemun, Serbia

(540)





(591) Black, white and gray  
(511)  
34 – Tobacco; smokers' articles; matches; cigarettes.

(260) AM 2016 85172 A  
(800) 1276115  
(891) 2015 10 29  
(731) REEMTSMA CIGARETTENFABRIKEN  
GMBH  
Max-Born Strasse 4, 22761 Hamburg,  
Germany  
(540)

## BOLD RED

(511)  
34 – Tobacco, whether manufactured or unmanufactured; tobacco products; tobacco substitutes, none being for medicinal or curative purposes; cigarettes; cigarillos; cigars; hand-held machines for making cigarettes; cigarette tubes; cigarette filters; cigarette papers; electronic cigarettes; liquids for electronic cigarettes; matches and smokers' articles.

(260) AM 2016 85174 A  
(800) 1276147  
(891) 2015 10 05  
(731) HUAWEI TECHNOLOGIES CO., LTD.  
Administration Building, Huawei  
Technologies Co., Ltd., Bantian, Longgang  
District, Shenzhen, China  
(540)

## FusionCloud

(591) black and white  
(511)  
9 – Computer software; computer programs (downloadable software); data processing apparatus; computers; computer memories; servers (computer apparatus).

(260) AM 2016 85176 A  
(800) 1276160  
(891) 2015 09 22  
(731) ENTERTAINMENT IN FLIGHT LLC  
1209 Orange Street, c/o Corporation Trust  
Center, Wilmington DE 19801, USA  
(540)

## AIRPODS

(511)  
9 – Audio components and accessories; sound recording and reproducing apparatus; digital video recorders and players; remote control apparatus; audio speakers; earphones, headphones; microphones; voice recording and recognition apparatus; radios, radio transmitters, and receivers; handheld digital electronic devices and software related thereto; wireless

communication devices for voice, data or image transmission; electrical and electronic connectors, couplers, wires, cables, chargers, docks, docking stations, interfaces, and adapters for use with all of the aforesaid goods.

(260) AM 2016 85177 A  
(800) 1276164  
(891) 2015 07 22  
(731) The Concentrate Manufacturing Company Of  
Ireland  
Corner House, 20 Parliament Street, Hamilton,  
Bermuda  
(540)



(591) Green, white, red, dark green, yellow and gray-pink.  
(511)  
32 – Aperitifs, non-alcoholic; soda water; waters [beverages]; aerated water; mineral water [beverages]; table waters; cocktails, non-alcoholic; lemonades; non-alcoholic beverages; isotonic beverages; non-alcoholic honey-based beverages; whey beverages; non-alcoholic fruit juice beverages; fruit nectars, non-alcoholic; orgeat; powders for effervescing beverages; sarsaparilla [non-alcoholic beverage]; syrups for lemonade; syrups for beverages; smoothies; tomato juice [beverage]; cider, non-alcoholic; vegetable juices [beverages]; fruit juices; preparations for making aerated water; preparations for making beverages; pastilles for effervescing beverages; sherbets [beverages]; non-alcoholic fruit extracts; essences for making beverages.

(260) AM 2016 85179 A  
(800) 1276185  
(891) 2014 12 12  
(731) OBI International Development and Service  
GmbH  
Rheinweg 11, CH-8200 Schaffhausen,  
Switzerland  
(540)



(591) Orange and black

(511)

1 – Chemicals used in industry, photography, agriculture, horticulture and forestry; unprocessed artificial resins; unprocessed plastics; soil fertilizers; fire-extinguishing compositions; tempering and soldering preparations; chemical substances for preserving foodstuffs; adhesives for use in industry; salt for spreading on ice and snow; plant substrates, humus.

2 – Paints, varnishes, lacquers; anti-rust products; wood preservatives, preservatives against deterioration of wood; dyestuffs; mordants; raw natural resins; metals in foil and powder form for painters, decorators, printers and artists.

3 – Bleaching preparations and other substances for laundry use; cleaning, polishing, degreasing and abrasive preparations; soaps; perfumes; essential oils; cosmetics; hair lotions and dentifrices; emery paper.

4 – Industrial oils and greases; lubricants; dust absorbing, wetting and binding compositions; fuels (including motor spirit) and lighting fuel; candles and wicks for lighting.

6 – Common metals and their alloys; building materials of metal; transportable structures of metal; non-electric cables and wires of metal; ironmongery and small items of metal hardware; pipes of metal; goods of metal included in this class; garage doors of metal; tool chests of metal [empty]; statuettes of common metal; safes [strong boxes]; fences of metal; non-electric locks of metal; padlocks; chains of metal; hoppers (non-mechanical) of metal; stepladders of metal, ladders of metal; connecting pegs (pins) of metal; wall plugs of metal; fittings of metal for building; fittings of metal for windows; fittings of metal for furniture; fittings of metal for doors; door stops of metal; tensioning and lashing straps of metal; rods of metal for brazing and welding; soldering wire of metal; masts [poles] of metal; wire rope; toolboxes of metal, empty; shafts and handles of metal for tools and gardening devices; conveyor belts of metal; special containers included in this class (all aforesaid goods of metal); poles of metal for attaching marking aids, in particular marking and warning tapes; gates of metal; window screens of metal; locks; metal pegs; wall plugs of metal; thin wall bars and grids; nails and staples for hand-operated staplers (other than office requisites); legs for furniture of metal and aluminum; metal garage door rollers; wheels for sliding doors of metal; furniture casters of metal; hoops of metal.

7 – Machine tools, machine coupling and transmission components (other than for land vehicles); agricultural implements other than hand-operated; machines and parts of machines, namely mixing machines for paints, construction machines, dishwashers, washing machines and parts thereof, included in this class; mechanically operated tools

for building, gardens and do-it-yourself, power-driven agricultural and horticultural instruments; vacuum cleaners and vacuum cleaner bags; pumps (machines), pumps for heating installations, ponds, aquaria and products for aquaria; compressors (machines); spray guns for paint, compressed air guns for the extrusion of mastics, glue guns (electric), staplers (electric), guns and pumps for applying paint, mastics and other thick liquids; gas-operated soldering irons; drill chucks (parts of machines), drilling machines, die-cutting and tapping machines, electric hand drills, electric hand drill holders; planing machines; grinding machines, abrasive discs (parts of machines), cutting wheels (parts of machines), roughing wheels (parts of machines); saws (machines), electric saws; electricity generators; welding apparatus (gas driven); electric welding machines; lawnmowers, leaf blowers, scarifiers (not hand-operated); hoes (other than hand-operated); soil aerators (other than hand-operated); countersunk snowplows (not hand-operated); snow shovels (not hand-operated); snow shovels (not hand-operated); electric cleaning apparatus and installations; cleaning appliances utilizing steam; high-pressure washers; parts of engines for motor vehicles, namely spark plugs for internal combustion engines, mufflers for motors and engines (exhausts), oil and fuel filters, air filters for motors, cylinders for motors and engines, cylinder heads for engines, pistons for engines, piston rings; roller shutter drives (electric), garage door drives (electric); elevators, in particular goods lifts; electric arc welding apparatus; lathes (machine tools); lathes (electric); choppers (electric), choppers (motorized); abrasive stones (parts of machines); machines for tiling work, construction of expanded dry concrete, work in stone, screed and concreting, masonry, laying of parquet, laminate and carpet, work of coating, painting, wall-papering and welding; machines for electric installation, namely electric groove cutters; machines for sanitary installations, namely electric machines for cleaning of pipes, threading machines, pressing machines, mirror cutting machines; electric tools for construction and DIY professionals including inserts for such tools; battery screwdrivers, saws, sanding machines, polishing apparatus; hammer drills, electric planers, tile cutting machines, small electric tools, electric staplers, electric mills; power-driven garden tools including lawn mowers; hedge trimmers, chain saws and accessories for mechanically operated gardening tools, namely collecting devices and apparatus covers; spare parts for mechanically operated gardening tools, included in this class; tool drives; mobile generators for power generation; welding apparatus and welding machines (gas-operated); air powered tools; lathes (mechanical); wood-turning lathes (mechanical); pressure vaporizers (mechanical); couplings other than for land vehicles; abrasive discs, sanding inserts and spare parts for all

the aforesaid goods; rollers and wheels for machines; electric soldering irons; welding apparatus; electric soldering irons, welding machines (electric); welding electrodes; hand-operated compressed-air equipment, namely impact wrenches, pressure-operated ratchet screwdrivers, compressed air pneumatic nail guns, compressed air grinders, compressed air grease presses, sandblasting equipment, needle guns, compressed air shears; tool holders, machine tables, tool holders, tables for machines.

8 – Hand tools (hand-operated); hand-operated tools and implements for agriculture, horticulture and forestry, and for structural engineering; hand-operated sprayers; hand-operated guns for the application of paint, mastics and other viscous liquids, mastic (hand-operated guns, for extrusion); spatulas (hand tools); lasts (shoemakers' hand tools); cutlery, table cutlery of plastic or metal; silver plate (knives, forks and spoons); snow shutters (hand tools); ice scrapers; sharpening stones; staplers (hand-operated); riveters (tools); trowels; saws (tools); files (hand tools); clamps for carpenters or coopers; clips (hand tools); screwdrivers; wrenches (hand tools); hammers (tools); axes; hand-held lawn clippers; hedge trimmers (hand tools); planes; paper scissors; riveting pliers; scraping tools; hand tools for tiling work, construction of expanded dry concrete, work in stone, screed and concreting, masonry, laying of parquet, laminate and carpet, coating work, hand tools for painting, namely rollers, telescopic rods for extending paint brushes; hand tools for welding, namely hammers for embedding; hand tools including tools for cutting, punching, stamping and separation, in particular scissors, files, drills, taps, trowels, chisels, planes, socket wrenches and socket wrench inserts, vices, tool holders, hand-operated equipment for gripping and support, including stone carrying devices, namely panel lifters, clamps for transporting stone, grindstones, pliers, riveting pliers, eye-letting pliers, hand-operated tile cutting equipment, knives, in particular pocket knives, snap-off blade knives, glass cutters, carpet knives, blades, plates; scissors, including household scissors, secateurs, shears for pruning and cutting trees and hedge trimmers, hand-operated garden tools including forks, hoes, spades, shovels, rakes, sickles, scythes, trimmers and hand-operated lawnmowers; spare parts for the aforesaid goods; flat irons; oil cruets.

9 – Scientific, nautical, surveying, photographic, cinematographic, optical, weighing, measuring, signaling, checking (supervision), life-saving and teaching apparatus; scientific, nautical, surveying, photographic, cinematographic, optical, weighing, measuring, signaling, checking (supervision), life-saving and teaching instruments; apparatus and instruments for conducting, switching, transforming, accumu-

lating, regulating or controlling electricity; apparatus for recording, transmission or reproduction of sound or images; magnetic recording media, sound recording disks; extinguishers; electrical installation materials (included in this class); namely electric wires, electric cables; materials for electricity mains [wires, cables]; terminal strips; sockets, plugs and other contacts [electric connections]; covers for electric outlets; cable gutters in the form of pipes of plastic or metal for housing cables; voltmeters; welding helmets; electric drives for roller shutters, time switches (not for clocks); electronic apparatus for monitoring and measuring, electronic security systems, namely motion detectors, gas detectors, smoke and carbon monoxide detectors, radio transmitters and receivers for the control of light, anti-theft alarms (electric), bells (alarm installations), intercoms for doors, telephone apparatus; portable telephones; telephone terminals, telephone answering machines; compact disc players, car radios, antennas and their accessories (included in this class); satellite antennas and receivers, optical data media, video cassettes; bicycle computers; solar energy collectors for electricity generation; electric batteries, battery chargers; measuring apparatus; measuring tools; apparatus for controlling temperature; thermometers (not for medical use); scales; luminous signboards; protective work clothing (included in this class); protective helmets, protective helmets for sports, protective coverings for arms, knees and wrists (occupational safety); gloves for protection against accidents; electric locks; protective gloves; protective masks, protective glasses [goggles], maintenance and safety belts except for vehicle seats, included in this class; voltage detectors; intercommunication systems; marking aids, namely marking tapes, screw clamp inserts for levels, marking tapes; protective accessories for welding, welding masks.

10 – Hearing protection devices.

11 – Apparatus for lighting, heating, steam generating, cooking, refrigerating, drying, ventilating, water supply and sanitary purposes; sanitary apparatus; electric flashlights; lamps for lighting; ceiling mounted lighting apparatus; flashlights; lamp shades; toilets; toilet bowls; toilet seats; water flushing installations; portable toilets; toilet tanks; sinks; hand wash basins (parts of sanitary installations); bidets; bathtubs; whirlpool-jet apparatus; shower cubicles; shower handsets; grills (cooking apparatus); roasting spits; electric lights for Christmas trees; pipes (parts of sanitary installations); air conditioning installations; fans (air-conditioning).

12 – Vehicles; apparatus for locomotion by land, air or water; casters for trolleys and accessories for transport; wheels and casters for vehicles; hose carts; rollers and wheels for two-wheeled trolleys and wheelbarrows; luggage carriers for vehicles; luggage

nets for vehicles; trailers (vehicles); trailer hitches for vehicles.

13 – Fireworks.

16 – Paper, cardboard; moving boxes, wrapping paper; printing products (printed matter); bookbinding material; photographs; stationery; adhesives (glues) for stationery or household purposes; artists' materials; painters' brushes; typewriters and office requisites (except furniture); instructional or teaching material (except apparatus); plastic materials for packaging (included in this class); painters' rollers; do-it-yourself goods, namely handicraft templates (stationery and writing instruments), modeling paste; adhesive bands for stationery or household purposes; small bags, envelopes and pouches for packaging of paper or plastic; albums; articles for painting, namely brushes, track rollers, grills for removing paint, paint trays.

17 – Rubber, guttapercha, gum, mica; packing, stopping and insulating materials, adhesive tapes and adhesive strips (except those for medical purposes, stationery or household use); flexible pipes not of metal; insulating gloves; adhesive tapes other than stationery and not for medical or household purposes; plastic films, namely films for ponds and films for construction purposes.

18 – Leather and imitation leather; animal skins; trunks and suitcases; umbrellas, parasols and walking sticks; whips, harness and saddlery; tool bags (empty); tool chests of leather [empty]; tool chests (empty) not of metal, not of leather; beach umbrellas.

19 – Building materials, not of metal; non-metallic rigid pipes for building; asphalt, pitch and bitumen; transportable buildings not of metal; monuments not of metal; statuettes of stone, concrete or marble; parquet flooring; flooring (non-metal); furrings of wood; moldings (not of metal) for building; lumber; wood veneers; manufactured timber; semi-worked wood; wood veneers; wood paneling; mine timber; plywood; paving slabs not of metal; garage gates (not of metal); aviaries (not of metal); outdoor blinds (roller blinds) of plastic.

20 – Furniture, mirrors, picture frames; pegs [pins], not of metal; plugs [dowels], not of metal; window fittings, not of metal; furniture fittings not of metal; door fittings not of metal; ironmongery, not of metal (except electric); tables for wallpapering; racks (shelves); tool holders, not of metal; door stops not of metal; workshop equipment, included in this class, namely tool cabinets, storage boxes for small items, presentation boxes, sorting boxes, workbenches (the aforesaid goods not of metal); workshop equipment (furniture) including tool cabinets, containers for small items, presentation boxes, sorting boxes, tool stands, workbenches (the aforesaid goods of metal);

tables for wallpapering, work tables; tool boxes and chests (empty) not of metal, not of leather; shafts and handles for tools and garden implements, not of metal; chains of plastic, clamps for cables and chains, plugs, bolts, screws, nuts, washers, hooks, clips (all the aforesaid goods not of metal); shoulder poles [yokes]; special containers, not of masonry, not of metal, included in this class; ladders of wood or plastic, stepladders not of metal; pads for furniture made of felt and plastic; legs for furniture of wood and plastic; coat hangers; bed casters of metal; bed casters, not made of metal; casters [rollers] not of metal; work benches; ladders (included in this class); curtain rods; trolleys (furniture) for flower pots; flower pot stands not of metal; marking chains of plastic or wood; indoor жалюзи for windows (articles for interior design) of textile or plastic; indoor window blinds (roller blinds) of plastic; equipment for painting, namely wallpapering tables.

21 – Utensils and containers for household or kitchen use (neither of precious metal nor coated therewith); combs and sponges; brushes (except paintbrushes); articles for cleaning purposes; unworked or semi-worked glass (except building glass); glassware, porcelain and earthenware (included in this class); brooms; steel wool; steel wool for cleaning; candlesticks; buckets; soap boxes; soap dispensers; nozzles for watering cans; flower pots; grills [cooking utensils]; funnels; gloves for household purposes, gardening; drying racks for laundry; ironing boards; litter boxes [trays] for pets; buckets with or without brush hooks and/or devices for removing paint for painting work.

22 – Ropes, strings, nets, tents, marquee tents, tarpaulins, sails, sacks and bags (included in this class); raw fibrous textile materials; tensioning and lashing straps (not of metal); liber; harnesses (not of metal) for carrying loads; awnings of textile.

23 – Yarns and threads for textile use (included in this class).

24 – Fabrics and textiles, not included in other classes, bed and table covers (included in this class); household linen and table linen (not of paper), oilcloth for use as tablecloths; shower curtains of textile or plastic; blinds of textile.

25 – Clothing, footwear, headgear (including for gardening), included in this class.

26 – Lace and embroidery, ribbons and braid; buttons, hooks and eyes, pins and needles; self-adhesive tapes included in this class; artificial flowers; feathers (clothing accessories); haberdashery (except thread and yarn).

27 – Door mats, linoleum and other materials for covering existing floors (floor surfaces); wall hangings (included in this class); wall hangings not of textile; textile wallpaper.

28 – Games, toys; gymnastic and sporting articles (included in this class); ornaments for Christmas trees (except illumination articles and confectionery), Christmas tree stands; fishing rods and accessories (included in this class); scale model vehicles.

31 – Agricultural, horticultural and forestry products and grains (seeds) and other sowing materials (included in this class); live animals; fresh fruits and vegetables; live plants and natural flowers; food-stuffs for animals, malt; unprocessed timber; dried flowers for decoration; dried plants for decoration; mulch (humus cover).

(260) AM 2016 85180 A

(800) 1276664

(891) 2015 03 25

(731) TECNOVIELLE S.P.A.

Via Caduti, 2, Frazione Pieve, LUMEZZANE (BS), Italy

(540)



(591) Black, white

(511)

6 – Metal pulleys, springs and valves; manually operated metal valves; water-pipe valves of metal; metal pulleys, springs and valves [not including machine elements]; valves of metal, other than parts of machines; valves of metal, other than parts of machines, including those made from alloy steel and titanium; drain traps [valves] of metal; manually operated metal valves, other than parts of machines; goods of common metal; pipes and tubes of metal; metal ball valves; metal ball valves with built-in filters; metal plugs for ball valves; junctions of metal for pipes; compressed air pipe fittings of metal; metal pipe couplings and joints; metal couplings for fire hoses; metal couplings for pipes; elbows of metal for pipes; metal hose fittings; metal pipe fittings; metal hoses for plumbing use; metal rings; metal drain pipes; nuts of metal; bolts of metal; metal draw-off valves [other than parts of machines]; metal valves for controlling the flow of fluids in pipelines; ducts of metal for ventilating and air conditioning installations; nipples of metal for pipes; metal pipe unions; metal adapters for use with hydraulic and pneumatic systems; manifolds of metal for pipelines; metal pipe mufflers; pipework of metal; nozzles of metal; brass, unwrought or semi-wrought; grease nipples; rotating branching pipes of metal, including those made from alloy steel and titanium; metal pipe collars; clips of metal for cables and pipes; branching pipes of metal; reinforcing materials of metal for pipes; washers of metal; cotter pins of metal; flanges of metal [collars]; junctions of metal for pipes, including those made from alloy

steel and titanium; rotating junctions of metal for pipes; branching pipes of metal, including those made from alloy steel and titanium.

(260) AM 2016 85184 A

(800) 1276672

(891) 2015 04 16

(731) HERZ ARMATUREN GES.M.B.H.

Richard-Strauss-Straße 22, A-1230 Wien, Austria

(540)

(591) Black, white

(511)

6 – Fittings of metal for compressed air ducts for heating, steam generating, cooking, refrigerating, drying, ventilation apparatus, air conditioning apparatus as well as for sanitary installations; water pipes for central heating installations, solar plants and heat exchangers; building materials of metal; railway material of metal; cables and wires of metal (not for electric purposes); ironmongery and locksmithing articles; goods of metal, in particular screws, nuts, bolts, shims, iron strip, pegs of metal; valves of metal for heating bodies (not thermostatic), pipe work of metal, bypasses and pipe couplings of metal or mainly of metal; sleeves, metal pipes; penstock pipes of metal, gutter pipes of metal and branching pipes of metal, ducts of metal for ventilating and air conditioning installations, stretchers for metal bands (tension links), steel constructions, water pipes of metal, water pipe valves of metal; manhole covers of metal, trap doors of metal, valves of metal (other than parts of machines), baseboards of metal or mainly of metal; sealing caps and junction fittings of metal or mainly of metal, in particular adapting fittings of metal; parts and fittings of metal or mainly of metal for the aforesaid goods.

9 – Scientific, optical, weighing, measuring, signalling and checking (supervision) apparatus and instruments; apparatus and instruments for conducting, switching, transforming, accumulating, regulating and controlling electricity; electric apparatus for commutation, electric couplings and electric loss indicators, detectors, electronic notice boards; measuring and counting apparatus; apparatus for measuring and indicating temperature, water level measuring and indicating apparatus, pressure measuring and indicating apparatus, remote control apparatus, electric and electronic regulating apparatus and instruments, thermostats, aforesaid goods also electronically operated, plugs for valves, telerrupters, electric cables, solenoid valves, diaphragms, calibrating rings, luminous signs, pressure gauges, commutators, time switches (automatic), signal bells, sirens, variometers for the aforesaid goods; thermostat val-

ves; magnetic data carriers; dosage dispensers, remote control apparatus, operating apparatus and installations for technical building equipment; hydrometers, boiler control instruments, measuring apparatus, apparatus and instruments for physics, smoke detectors, switch boards, electric apparatus for commutation, sprinkler systems, thermometers (not for medical purposes), pressure indicator plugs for valves, heat regulating apparatus, water level indicators; electronic regulating systems; parts and components of and fittings for the aforesaid goods; computer programs (recorded); computer software; measuring, controlling and regulating apparatus for heating, steam generating, cooking, refrigerating, drying, ventilating, air conditioning and water conduit apparatus and installations, as well as for sanitary installations, remote heat and remote refrigerating installations and solar installations, floor heating installations, wall heating installations and heating boilers.

11 – Heating, steam generating, cooking, refrigerating, drying, ventilating, air conditioning and water conduit apparatus and installations as well as sanitary apparatus and installations and solar plants, in particular remote heating and refrigerating installations; heating apparatus, namely wall, ceiling and floor heating apparatus, activated through concrete core heat accumulators and heat recovery apparatus; cooling installations for surfaces; power-heat-coupling installations, thermo oil boilers; biomass heating installations; valves as well as activating and regulating fittings for the aforesaid goods, in particular for heating and refrigerating apparatus and installations therefor; regulating and safety fittings for heating, steam generating, cooking, refrigerating, drying, ventilating, air conditioning and water conduits apparatus and installations as well as for sanitary apparatus and installations as well as for remote heating and remote refrigerating installations, for radiators and residual water conduits, for central heating installations, solar plants, heat exchangers, steam, compressed air, water and gas pipes; expansion tanks for central heating installations, apparatus and installations for automatically operated pressure maintenance and replenishing; burners, pressure water tanks, showers, fittings, not of metal, for heating, steam generating, cooking, refrigerating, drying, ventilating, air conditioning and water conduit apparatus and installations, as well as for sanitary installations and for central heating installations for steam, compressed air, water and gas pipes; fittings mainly of non-metallic materials for steam, compressed air, heating, water and gas pipes as well as for heating, steam generating, drying, ventilating, air conditioning and water conduit apparatus and installations as well as for sanitary installations and for central heating installations; mixing nozzles for sanitary and bathroom installations as well as for fittings for sanitary installations; flues for heating boilers;

gas boilers, water heaters, heating boilers, heating elements and radiators, heating installations, air conditioning installations, air filtering installations; dampers (heating); regulating and safety accessories for gas installations, gas pipes, water installations as well as for water conduits; boiler pipes for heating installations, coils, taps for pipes; fans (air-conditioning), thermal solar collectors (heating), heat pumps, heat accumulators, remote heat regenerating stations, heat exchangers, water supply installations; recoil check valves (parts of heating installations), thermostatic valves (parts of heating installations), radiator thermostatic heads, fittings for drinking water installations, circuit control valves, backflow preventer valves for water supply installations, pressure reducers (parts of heating installations), outlet fittings, water filters; automatic temperature regulators [thermostatic valves] for central heating radiators, air valves for steam heating installations, brackets for gas burners, lighters, expansion tanks for central heating installations, wash-hand basins, radiator caps, thermostatic radiator valves and heating installations, radiator caps, humidifiers for central heating radiators; parts and components of and fittings for the aforesaid goods.

17 – Semi-processed plastic goods; sealing, caulking and insulating material; hoses and pipes (not of metal); junctions, mainly not of metal, for pipes; filtering material (semi-processed foams), insulating felt, pipe gaskets, pipe muffs (not of metal), gaskets, as far as not included in other classes; water-tight rings and draught excluder strips, insulators, non-conducting materials for retaining heat; studded panels for insulating purposes, reinforcing plates and pipe muffs (not of metal), in particular pipe muffs of plastics, reinforcing materials, not of metal, in particular reinforcing capsules for pipes and fittings thereof for heating, steam, generating, cooking, refrigerating, ventilating, air conditioning and for sanitary installations and remote heating and remote refrigerating technical installations; branching pipes and junctions (not of metal); pipe connectors of plastics; parts and components of and fittings for the aforesaid goods; pipes, junctions for pipes not of metal and tubes (not of metal).

19 – Building materials (not of metal), cove bases, not of metal; plaster fiberboards and plastic boards for use in construction; discharging pipes (not of metal), drain traps [valves], not of metal or plastic; building materials (mainly not of metal) as elements for building manholes; manhole covers (not of metal), penstock pipes (not of metal); parts and components of and fittings for the aforesaid goods.

(260) AM 2016 85198 A  
(800) 1276827  
(891) 2015 10 12

(731) DAFNI HAIR PRODUCTS LTD  
31 Hatlalom Raanana, Israel  
(540)

**DAFNI**

(511)  
8 – Electric hair straighteners.

(260) AM 2016 85203 A  
(800) 1250747  
(891) 2015 10 01  
(731) ETI GIDA SANAYI VE TICARET ANONIM  
SIRKETI  
Organize Sanayi Bolgesi 11, Cadde  
ESKISEHIR, Turkey

(540)



(591) Violet, purple, white, red, yellow and black  
(511)  
30 – Biscuits, chocolates, crackers, wafers, cakes, tarts, puffed corn and puffed rice and snacks made of puffed corn and puffed rice, cereals and cereal-based foodstuffs.

(260) AM 2016 85206 A  
(800) 1264965  
(891) 2015 10 05  
(731) ETI GIDA SANAYI VE TICARET ANONIM  
SIRKETI  
Organize Sanayi Bolgesi 11., Cad. Eskisehir,  
Turkey  
(540)



(591) Black, white, red and yellow  
(511)  
30 – Biscuits, chocolates, crackers, wafers, cakes, pastries and bakery products based on flour, chocolate bars, tarts, pies, breakfast cereals, bread, popcorn and rice-based snack food.

(260) AM 2016 85208 A  
(800) 1276519  
(891) 2015 10 12  
(731) KUSUM PHARM LLC  
54, Skriabina str., Sumy 40020, Ukraine  
(540)

**GAZOSPAZAM**

(511)  
5 – Pharmaceutical and veterinary preparations; sanitary preparations for medical purposes; dietetic food and substances adapted for medical or veterinary use, food for babies; dietary supplements for humans and animals; plasters, materials for dressings; material for stopping teeth, dental wax; disinfectants; preparations for destroying vermin; fungicides, herbicides; absorbent cotton; acaricides; acetates for pharmaceutical purposes; acids for pharmaceutical purposes; acne treatment preparations; aconitine; adhesive plasters; adhesive tapes for medical purposes; adhesives for dentures; adjuvants for medical purposes; air purifying preparations; air deodorising preparations; albumin dietary supplements; albuminous foodstuffs for medical purposes; albuminous preparations for medical purposes; alcohol for pharmaceutical purposes; aldehydes for pharmaceutical purposes; algicides; alginate dietary supplements; alginates for pharmaceutical purposes; alkaline iodides for pharmaceutical purposes; alkaloids for medical purposes; alloys of precious metals for dental purposes; aloe vera preparations for pharmaceutical purposes; aluminium acetate for pharmaceutical purposes; amino acids for medical purposes; amino acids for veterinary purposes; anaesthetics; analgesics; angostura bark for medical purposes; animal washes; anti-rheumatism bracelets; anti-rheumatism rings; anti-uric preparations; antibiotics; anticryptogamic preparations; antioxidant pills; antiparasitic preparations; antiparasitic collars for animals; antiseptic cotton; antiseptics; appetite suppressants for medical purposes; appetite suppressant pills; articles for headache; aseptic cotton; asthmatic tea; babies' napkins [diapers]; babies' napkin-pants [diaper-pants]; bacterial poisons; bacterial preparations for medical and veterinary use; bacteriological preparations for medical and veterinary use; balms for medical purposes; balsamic preparations for medical purposes; barks for pharmaceutical purposes; bath preparations for medical purposes; bath salts for medical purposes; belts for sanitary napkins [towels]; bicarbonate of soda for pharmaceutical purposes; biocides; biological preparations for medical purposes; biological preparations for veterinary purposes; biological tissue cultures for medical purposes; biological tissue cultures for veterinary purposes; bismuth preparations for pharmaceutical purposes; bismuth subnitrate for pharmaceutical purposes; blood plasma; blood for medical purposes; bone cement for surgical and orthopaedic purposes; bracelets for medical purposes; breast-nursing pads; bromine for

pharmaceutical purposes; bronchodilating preparations; bunion pads; cachets for pharmaceutical purposes; cachou for pharmaceutical purposes; preparations for callouses; calomel; camphor oil for medical purposes; camphor for medical purposes; candy, medicated; candy for medical purposes; capsules for medicines; carbolineum [parasiticide]; casein dietary supplements; castor oil for medical purposes; cattle washes; caustic pencils; caustics for pharmaceutical purposes; cedar wood for use as an insect repellent; cellulose esters for pharmaceutical purposes; cellulose ethers for pharmaceutical purposes; cement for animal hooves; charcoal for pharmaceutical purposes; chemical preparations to treat mildew; chemical preparations to treat wheat blight [smut]; chemical preparations for treating phylloxera; chemical preparations for pharmaceutical purposes; chemical preparations for medical purposes; chemical preparations for veterinary purposes; chemical reagents for medical or veterinary purposes; chemico-pharmaceutical preparations; chewing gum for medical purposes; chilblain preparations; chinoline for medical purposes; chloroform; cocaine; cod liver oil; collodion for pharmaceutical purposes; collyrium; compresses; condurango bark for medical purposes; solutions for contact lenses; contact lens cleaning preparations; cooling sprays for medical purposes; corn rings for the feet; corn remedies; cotton for medical purposes; cotton swabs for medical purposes; cream of tartar for pharmaceutical purposes; creosote for pharmaceutical purposes; croton bark; cultures of microorganisms for medical and veterinary use; curare; decoctions for pharmaceutical purposes; dental abrasives; dental amalgams; dental cements; dental impression materials; dental lacquer; dental mastics; dental amalgams of gold; deodorants, other than for human beings or for animals; deodorants for clothing and textiles; depuratives; preparations for destroying noxious animals; preparations for destroying dry rot fungus; preparations for destroying mice; detergents for medical purposes; diabetic bread adapted for medical use; diagnostic preparations for medical purposes; diagnostic biomarker reagents for medical purposes; diagnostic preparations for veterinary purposes; diapers for pets; diastase for medical purposes; dietary fibre; dietary supplements for animals; dietetic beverages adapted for medical purposes; dietetic substances adapted for medical use; digestives for pharmaceutical purposes; digitalin; dill oil for medical purposes; disinfectants for hygiene purposes; disinfectants for chemical toilets; disinfectants; dog washes; dog lotions; douching preparations for medical purposes; dressings, medical; drugs for medical purposes; elixirs [pharmaceutical preparations]; enzyme preparations for medical purposes; enzyme preparations for veterinary purposes; enzyme dietary supplements; enzymes for medical purposes; enzymes for veterinary purposes; ergot for

pharmaceutical purposes; esters for pharmaceutical purposes; ethers for pharmaceutical purposes; eucalyptol for pharmaceutical purposes; eucalyptus for pharmaceutical purposes; extracts of hops for pharmaceutical purposes; eye-washes; eyepatches for medical purposes; preparations to facilitate teething; febrifuges; fennel for medical purposes; ferments for pharmaceutical purposes; first-aid boxes, filled; fish meal for pharmaceutical purposes; flour for pharmaceutical purposes; flowers of sulfur for pharmaceutical purposes; fly catching paper; fly glue fly destroying preparations; formic aldehyde for pharmaceutical purposes; frostbite salve for pharmaceutical purposes; fumigating sticks; fumigation preparations for medical purposes; fungicides; gallic acid for pharmaceutical purposes; gamboge for medical purposes; gases for medical purposes; gauze for dressings; gelatine for medical purposes; gentian for pharmaceutical purposes; germicides; glucose for medical purposes; glucose dietary supplements; glycerine for medical purposes; glycerophosphates; greases for medical purposes; greases for veterinary purposes; guaiacol for pharmaceutical purposes; gum for medical purposes; gurjun [gurjon, gurjan] balsam for medical purposes; haematogen; haemoglobin; haemorrhoid preparations; haemostatic pencils; headache pencils; herbal teas for medicinal purposes; herbicides; hormones for medical purposes; hydrastine; hydrastinine; hydrated chloral for pharmaceutical purposes; hydrogen peroxide for medical purposes; insect repellents; insect repellent incense; insecticides; iodides for pharmaceutical purposes; iodine for pharmaceutical purposes; iodoform; Irish moss for medical purposes; isotopes for medical purposes; jalap; jujube, medicated; lacteal flour for babies; larvae exterminating preparations; laxatives; lead water; lecithin for medical purposes; lecithin dietary supplements; leeches for medical purposes; preparations of lime for pharmaceutical purposes; liniments; linseed for pharmaceutical purposes; linseed meal for pharmaceutical purposes; linseed dietary supplements; linseed oil dietary supplements; lint for medical purposes; liquorice for pharmaceutical purposes; lotions for pharmaceutical purposes; lotions for veterinary purposes; lupulin for pharmaceutical purposes; magnesia for pharmaceutical purposes; malt for pharmaceutical purposes; malted milk beverages for medical purposes; mangrove bark for pharmaceutical purposes; medical preparations for slimming purposes; medicated animal feed; medicinal alcohol; medicinal mud; medicinal infusions; medicinal tea; medicinal oils; medicinal herbs; medicinal roots; medicinal drinks; medicinal hair growth preparations; medicine cases, portable, filled; medicines for alleviating constipation; medicines for dental purposes; medicines for human purposes; medicines for veterinary purposes; melissa water for pharmaceutical purposes; menstruation bandages; menthol; mercurial ointments; milk ferments for



pharmaceutical purposes; milk sugar for pharmaceutical purposes; milk of almonds for pharmaceutical purposes; milking grease; mineral waters for medical purposes; mineral water salts; mineral food supplements; mint for pharmaceutical purposes; moleskin for medical purposes; mothproofing preparations; mothproofing paper; moulding wax for dentists; mouthwashes for medical purposes; mud for baths; mustard oil for medical purposes; mustard for pharmaceutical purposes; mustard plasters; myrobalan bark for pharmaceutical purposes; napkins for incontinents; narcotics; nerviness; nutritional supplements; nutritive substances for microorganisms; oil of turpentine for pharmaceutical purposes; ointments for pharmaceutical purposes; opiates; opium; opodeldoc; ophotherapy preparations; oxygen baths; oxygen for medical purposes; pants, absorbent, for incontinents; panty liners [sanitary]; paper for mustard plasters; parasiticides; pastilles for pharmaceutical purposes; pearl powder for medical purposes; pectin for pharmaceutical purposes; pepsins for pharmaceutical purposes; peptones for pharmaceutical purposes; pesticides; petroleum jelly for medical purposes; pharmaceutical preparations; pharmaceutical preparations for skin care; pharmaceutical preparations for treating dandruff; phenol for pharmaceutical purposes; phosphates for pharmaceutical purposes; poisons; pollen dietary supplements; pomades for medical purposes; porcelain for dental prostheses; potassium salts for medical purposes; poultices; powder of cantharides; by-products of the processing of cereals for dietetic or medical purposes; propolis for pharmaceutical purposes; propolis dietary supplements; protein dietary supplements; protein supplements for animals; purgatives; pyrethrum powder; quassia for medical purposes; quebracho for medical purposes; quinine for medical purposes; quinquina for medical purposes; radioactive substances for medical purposes; radiological contrast substances for medical purposes; radium for medical purposes; rat poison; reagent paper for medical or veterinary purposes; preparations for reducing sexual activity; remedies for foot perspiration; remedies for perspiration; repellents for dogs; rhubarb roots for pharmaceutical purposes; royal jelly for pharmaceutical purposes; royal jelly dietary supplements; rubber for dental purposes; salts for mineral water baths; salts for medical purposes; sanitary panties; sanitary tampons; sanitary towels; sarsaparilla for medical purposes; scapulars for surgical purposes; sea water for medicinal bathing; sedatives; semen for artificial insemination; serotherapeutic medicines; serums; personal sexual lubricants; siccatives [drying agents] for medical purposes; slimming pills; slug exterminating preparations; smelling salts; smoking herbs for medical purposes; sodium salts for medical purposes; soil-sterilising preparations; solvents for removing adhesive plasters; soporifics; starch for

dietetic or pharmaceutical purposes; stem cells for medical purposes; stem cells for veterinary purposes; sterilising preparations; steroids; stick liquorice for pharmaceutical purposes; strychnine; styptic preparations; sugar for medical purposes; sulfonamides [medicines]; sulfur sticks [disinfectants]; sunburn preparations for pharmaceutical purposes; sunburn ointments; suppositories; surgical dressings; surgical implants comprised of living tissues; surgical glues; syrups for pharmaceutical purposes; tanning pills; tartar for pharmaceutical purposes; teeth filling material; therapeutic preparations for the bath; thermal water; thymol for pharmaceutical purposes; tincture of iodine; tinctures for medical purposes; tissues impregnated with pharmaceutical lotions; tobacco extracts [insecticides]; tobacco-free cigarettes for medical purposes; tonics [medicines]; preparations of trace elements for human and animal use; preparations for the treatment of burns; turpentine for pharmaceutical purposes; vaccines; vaginal washes; vermifuges; vermin destroying preparations; vesicants; veterinary preparations; vitamin preparations; vulnerary sponges; wadding for medical purposes; wart pencils; wheat germ dietary supplements; yeast for pharmaceutical purposes; yeast dietary supplements.

(260) AM 2016 85210 A

(800) 951417

(891) 2015 11 13

(731) ALOIS DALLMAYR KAFFEE OHG

Dienerstrasse 14-15, 80331 München,  
Germany

(540)



(591) Black, white

(511)

30 – Coffee, coffee extracts, tea, tea extracts, cocoa, cocoa extracts, mixtures for coffee-containing, tea-containing, chocolate-containing and cocoa-containing beverages, alcohol-free coffee, tea, cocoa and chocolate beverages, alcohol-free ready-to-drink coffee, tea, cocoa and chocolate preparations.

43 – Services for providing food and drink for guests; restaurant, café, cafeteria, snack-bar, coffee-bar, coffee-house services as well as take-out restaurant services; the operation of restaurants, cafés,

cafeterias, snack-bars, coffee-bars, coffee-houses as well as take-out restaurants; services for providing co-workers, customers and guests in companies and government agencies with coffee, coffee beverages and other hot drinks and soft drinks as well as food and snacks.

(260) AM 2016 85212 A

(800) 978128

(891) 2015 08 18

(731) UAB "MIKROVISATA"

Savanorių pr. 125, LT-44001 Kaunas,  
Lithuania

(540)



(591) Black, white

(511)

9 – Scientific, nautical, surveying, photographic, cinematographic, optical, weighing, measuring, signalling, checking (supervision), life-saving and teaching apparatus and instruments; apparatus and instruments for conducting, switching, transforming, accumulating, regulating or controlling electricity; apparatus for recording, transmission or reproduction of sound or images; magnetic data carriers, recording discs; automatic vending machines and mechanisms for coin-operated apparatus; cash registers, calculating machines, data processing equipment and computers; fire-extinguishing apparatus.

(260) AM 2016 85214 A

(800) 1081543

(891) 2015 05 29

(731) MERZ NORTH AMERICA, INC.

6501 Six Forks Road, Raleigh NC 27615,  
USA

(540)

## AESTHETIC EXCLUSIVES

(526) The trademark is protected as a whole. "AESTHETIC" shall not be subject to independent legal protection.

(511)

35 – Consumer loyalty services for commercial, promotional and/or advertising purposes, namely, administration of a consumer loyalty program for customers receiving treatment with aesthetic products.

(260) AM 2016 85215 A

(800) 1223311

(891) 2015 08 21

(731) I.C.O.N. EUROPE, S.L.

RÚA AMOR RUIBAL, N:11 ENTLO.,  
E-36203 VIGO (PONTEVEDRA), Spain

(540)

I.C.O.N.

(591) Black, white

(511)

3 – Hair products, essential oils only for hair care and cosmetics only for hair care.

(260) AM 2016 85216 A

(800) 1276586

(891) 2015 09 18

(731) JANSSEN PHARMACEUTICA NV

Turnhoutseweg 30, B-2340 BEERSE,  
Belgium

(540)

## LOGILOR

(511)

5 – Human pharmaceutical preparations for the prevention and treatment of central nervous system diseases and pain, with the exception of dietary supplements.

(260) AM 2016 85239 A

(800) 1277001

(891) 2015 04 28

(731) LONSDALE SPORTS LIMITED

Unit A, Brook Park East Shirebrook  
NG20 8RY, United Kingdom

(540)



(591) black and white

(511)

18 – Leather and imitations of leather; animal skins, hides; leather thongs and straps; clothing, covers, collars, leashes and leads for animals; trunks and travelling bags; luggage and suitcases; luggage tags, luggage straps; haversacks, backpacks, rucksacks, knapsacks; cases of leather or imitation leather, bags, briefcase-type portfolios; wallets, purses, pouches; card holders; leather shoulder belts and straps; umbrellas, umbrella seats, parasols, walking sticks, canes; whips, harness, saddlery, horse tack; baby and child carriers; frames for handbags; straps

for skates; bandoliers; boxes made of leather or imitation leather; furniture coverings of leather; handles for suitcases and walking sticks; gym bags; training bags; parts and fittings for all the aforesaid goods.

25 – Clothing, footwear, headgear.

28 – Games and playthings; gymnastic and sporting articles, equipment and apparatus not included in other classes; exercise and fitness apparatus and equipment; supportors, protectors, guards and pads for sports, athletics and fitness; playground apparatus and equipment; decorations for Christmas trees; playing cards; skates, skateboards; bags specifically adapted for sports articles and equipment; fishing equipment; equestrian equipment; ear and eyebrow protectors for boxers; boxing masks; boxing gloves; hand tapes and wraps for boxing and MMA use; punch mitts and gloves; punch and kick boards; grappling gloves; sparring gloves; gloves for sports; gloves for use in boxing and MMA; striking bags; strike shields; target paddles; punching bags; freestanding punch bags; training dummies; striking bag platforms; dumbbells; rowing machines; chest weights; spring exercisers; grip developers; medicine balls; punching bags; skipping ropes; shoe guards; boxing and wrestling rings; gymnasium horses, parallel bars, weight benches; step machines; weightlifting gloves; trampolines; exercise equipment; weight lifting equipment; weight lifting belts; free weights; aerobic equipment; aerobic fitness belts; stationary cycles; elastic exercise bands; ankle weights; wrist weights; treadmills; exercise bikes; stationery bikes; elliptical machines; martial arts equipment; shin guards; body shields; dumb-bells; kettle bells; gym balls; gym bars; sit up benches; exercise bikes; stationary bikes; weight benches; weight towers; trampolines; parts, accessories and fittings for all the aforesaid goods.

(260) AM 2016 85244 A

(800) 1277041

(891) 2015 06 11

(731) ARIKAN SAAT ANONIM SIRKETI

AGunesli Mahmutbey Mahallesi, ISTOC

Toptancilar Carsisi, 16.da, Gonul Plaza,

Kat:2 Bagcilar Istanbul, Turkey

(540)

## Click Clock

(591) black and white

(511)

14 – Timepieces and chronometric instruments, namely chronometers, chronographs, clocks, watches, wristwatches, wall clocks, alarm clocks as well as parts and accessories for the aforesaid goods, namely hands, pallets, balance wheels, barrels, watch cases, watch straps, watch dials, clockworks, watch chains, movements for timepieces, watch springs, watch glasses, presentation cases for

timepieces, cases for timepieces, jewelry goods (including imitations), gold, jewels, precious stones and jewelry made from these, cufflinks, tie pins, tie clips, statuettes of precious metal.

35 – The bringing together, for the benefit of others, of a variety of goods, namely, optical apparatus and instruments particularly spectacles, sunglasses, magnifying glasses, cases for spectacles, magnifying glasses and sunglasses, batteries for electronic apparatus and computers, batteries for timepieces and chronometric instruments, apparatus for recording, transmission or reproduction of sound or images, magnetic and digital recording media for sound or images, timepieces and chronometric instruments, namely chronometers, chronographs, clocks, watches, wristwatches, wall clocks, alarm clocks as well as parts and accessories for the aforesaid goods, namely hands, pallets, balance wheels, barrels, watch cases, watch straps, watch dials, clockworks, watch chains, movements for timepieces, watch springs, watch glasses, presentation cases for timepieces, cases for timepieces, jewelry goods (including imitations), gold, jewels, precious stones and jewelry made from these, cufflinks, tie pins, tie clips, statuettes of precious metal enabling customers to conveniently view and purchase those goods, such services may be provided by retail stores, wholesale outlets, by means of electronic media or through mail order catalogues.

(260) AM 2016 85250 A

(800) 1277905

(891) 2015 09 22

(731) Rigo Trading S.A. Société Anonyme

Route de Trèves 6 EBBC, Building E, L-2633

Sennigerberg, Luxembourg

(540)

## Mr. Fruitman

(511)

30 – Confectionery.

(260) AM 2016 85251 A

(800) 1277119

(891) 2015 08 31

(731) Limited Liability Company SAKURA JIVA

2d Tverskaya-Yamskaya Street, bldg. 28,

RU-125047 Moscow, Russian Federation

(540)



(591) black and white

(511)

41 – Academies [education]; practical training [demonstration]; arranging and conducting of workshops [training].

44 – Manicuring; massage; hairdressing salons; beauty salons; visagists' services; solarium services; chiropractics; plastic surgery.

(260) AM 2016 85257 A

(800) 1277984

(891) 2015 10 07

(731) KOLTIV CONSULTANTS LIMITED

Gr. Xenopoulou, 17, CY-3106 Limassol,  
Cyprus

(540)

**СМАРТОПН**

(591) Black, white

(511)

29 – Alginates for culinary purposes; anchovy; peanuts, prepared; artichokes, preserved; albumen for culinary purposes; beans, preserved; bouillon; ham; fatty substances for the manufacture of edible fats; toasted laver; edible birds' nests; peas, preserved; mushrooms, preserved; game, not live; gelatine; meat jellies; jellies for food; fruit jellies; edible fats; fruit-based snack food; charcuterie; raisins; caviar; eggplant paste; vegetable marrow paste; fish roe, processed; jam; yogurt; sauerkraut; kephir [milk beverage]; milk shakes; black pudding [blood sausage]; compotes; meat, tinned [canned (Am.)]; vegetables, tinned [canned (Am.)]; fish, tinned [canned (Am.)]; fruits, tinned [canned (Am.)]; bouillon concentrates; gherkins; shrimps, not live; buttercream; croquettes; silkworm chrysalis, for human consumption; kumys [kumyss] [milk beverage]; spiny lobsters, not live; salmon, not live; onions, preserved; margarine; piccalilli; marmalade; edible oils; peanut butter; cocoa butter; butter; shellfish, not live; almonds, ground; animal marrow for food; mussels, not live; milk; condensed milk; vegetable mousses; fish mousses; fruit pulp; meat; meat, preserved; milk beverages, milk predominating; vegetables, preserved; vegetables, dried; vegetables, cooked; potato fritters; olives, preserved; lobsters, not live; nuts, prepared; tomato purée; liver pâté; pectin for culinary purposes; liver; pickles; jams; powdered eggs; milk products; foods made from fish; prostokvasha [soured milk]; poultry, not live; berry purées; fruit purées; vegetable purées; crayfish, not live; crustaceans, not live; fish, preserved; fish, not live; salted fish; ryazhenka [fermented baked milk]; vegetable salads; fruit salads; bacon; sardines, not live; pork; herrings, not live; seeds, prepared; sunflower seeds, prepared; cream [dairy products]; whipped cream; fat-containing mixtures for bread slices; smetana [sour cream]; vegetable juices for cooking; salted

meats; sausages; preparations for making bouillon; preparations for making soup; tripe; soups; vegetable soup preparations; cheese; tofu; sea-cucumbers, not live; truffles, preserved; tuna, not live; oysters, not live; milk ferments for culinary purposes; rennet; fish fillets; dates; crystallized fruits; frozen fruits; fruit, preserved; fruit preserved in alcohol; fruit, stewed; potato flakes; hummus [chickpea paste]; fruit peel; preserved garlic; lentils, preserved; potato chips; fruit chips; seaweed extracts for food; meat extracts; eggs.

30 – Aromatic preparations for food; flavorings [flavourings], other than essential oils, for cakes; flavorings [flavourings], other than essential oils, for beverages; food flavorings, other than essential oils; coffee flavorings [flavourings]; star aniseed; cereal bars; pancakes; noodle-based prepared meals; cereal-based prepared meals; buns; bread rolls; vanillin [vanilla substitute]; vanilla [flavoring] [flavouring]; vareniki [stuffed dumplings]; waffles; vermicelli [noodles]; natural sweeteners; binding agents for ice cream [edible ices]; malt biscuits; cake frosting [icing]; glucose for culinary purposes; mustard; yeast; rice-based snack food; cereal-based snack food; artificial coffee; dressings for salad; fruit jellies [confectionery]; candy decorations for cakes; confectionery for decorating Christmas trees; cakes; pastries; peanut confectionery; almond confectionery; pasta; ginger [spice]; frozen yogurt [confectionery ices]; cocoa; caramels [candy]; ketchup [sauce]; sweetmeats [candy]; liquorice [confectionery]; peppermint sweets; coffee; crackers; custard; groats for human food; corn, milled; corn, roasted; meat pies; farinaceous foods; noodles; edible ices; candy; rice cakes; mayonnaise; macaroons [pastry]; macaroni; marinades; marzipan; honey; ice cream; flour; dessert mousses [confectionery]; chocolate mousses; muesli; cocoa beverages with milk; coffee beverages with milk; coffee-based beverages; tea-based beverages; chocolate beverages with milk; chocolate-based beverages; infusions, not medicinal; chocolate-coated nuts; stick liquorice [confectionery]; soya bean paste [condiment]; pastilles [confectionery]; molasses for food; pâtés en croûte; pelmeni [dumplings stuffed with meat]; pesto [sauce]; cookies; petit-beurre biscuits; pies; pizzas; meat gravies; fondants [confectionery]; popcorn; powders for ice cream; baking powder; pralines; condiments; cereal preparations; propolis; gingerbread; spices; petits fours [cakes]; puddings; cake powder; fruit coulis [sauces]; ravioli; chewing gum; relish [condiment]; rice; wheat germ for human consumption; spring rolls; sugar; golden syrup; salt for preserving foodstuffs; cooking salt; soya sauce; tomato sauce; pasta sauce; spaghetti; tacos; tabbouleh; dough; cake dough; pastry dough; confectionery; sherbets [ices]; sauces [condiments]; seasonings; preparations for stiffening whipped cream; rusks; breadcrumbs; sushi; sandwiches; tapioca; tarts; almond paste; tor-

tillas; halvah; bread; chips [cereal products]; corn flakes; oat flakes; chicory [coffee substitute]; tea; iced tea; cheeseburgers [sandwiches]; chocolate; essences for foodstuffs, except etheric essences and essential oils.

31 – Oranges, fresh; peanuts, fresh; artichokes, fresh; draff; beans, fresh; wreaths of natural flowers; grapes, fresh; algae for human or animal consumption; fruit residue [marc]; peas, fresh; mushrooms, fresh; yeast for animal consumption; Christmas trees; grains [cereals]; fish spawn; cocoa beans, raw; potatoes, fresh; chestnuts, fresh; roots for food; maize; edible sesame, unprocessed; lemons, fresh; onions, fresh vegetables; leeks, fresh; shellfish, live; olives, fresh; almonds [fruits]; mussels, live; oats; vegetables, fresh; cucumbers, fresh; lobsters, live; nuts [fruits]; bran; peppers [plants]; citrus fruit, fresh; crayfish, live; crustaceans, live; plants; rhubarb, fresh; rice, unprocessed; rye; fish, live; lettuce, fresh; sardines, live; beet, fresh; garden herbs, fresh; truffles, fresh; tuna, live; squashes, fresh; oysters, live; fruit, fresh; hazelnuts; hops; flowers, natural; flowers, dried, for decoration; chicory, fresh; garlic, fresh; lentils, fresh; spinach, fresh; berries, fresh fruits; barley.

32 – Aperitifs, non-alcoholic; lithia water; seltzer water; soda water; aerated water; waters [beverages]; mineral water [beverages]; table waters; kvass [non-alcoholic beverage]; cocktails, non-alcoholic; beer-based cocktails; lemonades; peanut milk [non-alcoholic beverage]; milk of almonds [beverage]; non-alcoholic beverages; isotonic beverages; non-alcoholic honey-based beverages; aloe vera drinks, non-alcoholic; whey beverages; non-alcoholic fruit juice beverages; fruit nectars, non-alcoholic; orgeat; beer; ginger beer; malt beer; powders for effervescing beverages; sarsaparilla [non-alcoholic beverage]; syrups for lemonade; syrups for beverages; smoothies; tomato juice [beverage]; cider, non-alcoholic; vegetable juices [beverages]; fruit juices; preparations for making aerated water; preparations for making mineral water; preparations for making liqueurs; preparations for making beverages; must; grape must, unfermented; beer wort; malt wort; pastilles for effervescing beverages; sherbets [beverages]; non-alcoholic fruit extracts; extracts of hops for making beer; essences for making beverages.

33 – Aperitifs; arrack [arak]; baijiu [Chinese distilled alcoholic beverage]; brandy; wine; whisky; vodka; anisette [liqueur]; kirsch; gin; digesters [liqueurs and spirits]; cocktails; curacao; liqueurs; pre-mixed alcoholic beverages, other than beer-based; alcoholic beverages, except beer; alcoholic beverages containing fruit; distilled beverages; spirits [beverages]; mead [hydromel]; bitters; rum; sake; cider; rice alcohol; alcoholic extracts; alcoholic essences.

35 – Import-export agencies; commercial information agencies; advertising agencies; rental of advertising space; computerized file management; demonstration of goods; opinion polling; marketing studies; business information; commercial information and advice for consumers [consumer advice shop]; business investigations; business research; marketing research; professional business consultancy; marketing; business management of performing artists; news clipping services; organization of exhibitions for commercial or advertising purposes; organization of trade fairs for commercial or advertising purposes; shop window dressing; design of advertising materials; business appraisals; data search in computer files for others; business management assistance; commercial intermediation services; provision of an on-line marketplace for buyers and sellers of goods and services; providing business information via a web site; presentation of goods on communication media, for retail purposes; economic forecasting; auctioneering; sales promotion for others; rental of sales stands; systemization of information into computer databases; distribution of samples; dissemination of advertising matter; advertising; commercial administration of the licensing of the goods and services of others; administrative processing of purchase orders; public relations; procurement services for others [purchasing goods and services for other businesses]; business efficiency expert services.

43 – Accommodation bureaux [hotels, boarding houses]; rental of temporary accommodation; rental of meeting rooms; tourist homes; hotel reservations; boarding house bookings; temporary accommodation reservations; hotels; snack-bars; cafés; cafeterias; motels; boarding houses; boarding for animals; rental of cooking apparatus; rental of chairs, tables, table linen, glassware; rental of tents; rental of transportable buildings; rental of drinking water dispensers; restaurants; self-service restaurants; canteens; holiday camp services [lodging]; bar services; providing campground facilities; food and drink catering.

(260) AM 2016 85261 A

(800) 1278031

(891) 2015 10 31

(731) APPLE INC.

1 Infinite Loop, Cupertino CA 95014, USA

(540)

**SIRI**

(511)

14 – Horological and chronometric instruments; watches; timepieces; chronographs for use as timepieces; chronometers.

(260) AM 2016 85262 A  
 (800) 1278037  
 (891) 2015 11 05  
 (731) BEATS ELECTRONICS, LLC  
 8600 Hayden Place, Culver City CA 90232,  
 USA

(540)

## BEATS PILL

(511)  
 9 – Audio speakers; loudspeakers.

(260) AM 2016 85265 A  
 (800) 1278085  
 (891) 2015 09 22  
 (731) RIGO TRADING S.A.  
 Route de Trèves 6 EBBC, Building E,  
 L-2633 Sennigerberg, Luxembourg

(540)



(591) Green, blue, red, yellow and pink  
 (511)  
 30 – Confectionery.

(260) AM 2016 85267 A  
 (800) 1278087  
 (891) 2015 09 22  
 (731) Rigo Trading S.A. Société Anonyme  
 Route de Trèves 6 EBBC, Building E,  
 L-2633 Sennigerberg, Luxembourg

(540)



(591) Yellow, green, blue, pink and purple  
 (511)  
 30 – Confectionery.

(260) AM 2016 85268 A  
 (800) 1278091  
 (891) 2015 09 22  
 (731) Rigo Trading S.A. Société Anonyme  
 Route de Trèves 6 EBBC, Building E,  
 L-2633 Sennigerberg, Luxembourg

(540)



(591) Yellow, pink and purple  
 (511)  
 30 – Confectionery.

(260) AM 2016 85269 A  
 (800) 372243  
 (891) 2015 11 23  
 (731) BAHLESEN GMBH & CO. KG  
 Podbielskistrasse 11, 30163 Hannover,  
 Germany

(540)

## ZOO

(511)  
 29 – Walnut preparations, namely walnut pulp and  
 crunchy walnuts; dried almonds, dried, candied and  
 crystallized fruit, potato preparations for consump-  
 tion, namely potato chips, potato flakes, potato cro-  
 quettes, fried potatoes.

31 – Fresh almonds and peanuts.

(260) AM 2016 85278 A  
 (800) 1277229  
 (891) 2015 10 26  
 (731) NOVARTIS AG  
 CH-4002 Basel, Switzerland

(540)

## TAFINLAR MEK

(511)  
 5 – Pharmaceutical preparations.

(260) AM 2016 85284 A  
 (800) 1277260  
 (891) 2015 07 31  
 (731) Obschestvo s ogranichennoy otvetstvennostyu  
 "EKOPOL"  
 Suvorova Street, 35, Dzerzhinsk, RU-606010  
 Nizhny Novgorod Region, Russian Federation

(540)

## ИЗУР

(591) black and white  
 (511)  
 2 – Anti-corrosive preparations; anti-rust prepara-  
 tions for preservation; bactericidal paints; binding  
 preparations for paints; black japan; coatings  
 [paints] for concrete, cement, brick or stonework;  
 corrosion inhibitors in the nature of coatings;

enamels [varnishes]; enamels for painting; fireproof paints; hardeners for lacquer coatings; lacquers; modifying additives for paint and lacquer materials; mordants; paint and lacquer coatings; paints; preservatives against deterioration of wood; primers; protective preparations for metals, plastics; siccatives [drying agents] for paints; thinners for lacquers; thinners for paints; undercoating for vehicle chassis; undersealing for vehicle chassis; wood coatings [paints]; wood stains.

(260) AM 2016 85292 A

(800) 1277350

(891) 2015 10 12

(731) KUSUM PHARM LLC

54, Skriabina str., Sumy 40020, Ukraine

(540)

# PLATOGREL

(591) black and white

(511)

5 – Pharmaceutical and veterinary preparations; sanitary preparations for medical purposes; dietetic food and substances adapted for medical or veterinary use, food for babies; dietary supplements for humans and animals; plasters, materials for dressings; material for stopping teeth, dental wax; disinfectants; preparations for destroying vermin; fungicides, herbicides; absorbent cotton; acaricides; acetates for pharmaceutical purposes; acids for pharmaceutical purposes; acne treatment preparations; aconitine; adhesive plasters; adhesive tapes for medical purposes; adhesives for dentures; adjuvants for medical purposes; air purifying preparations; air deodorising preparations; albumin dietary supplements; albuminous foodstuffs for medical purposes; albuminous preparations for medical purposes; alcohol for pharmaceutical purposes; aldehydes for pharmaceutical purposes; algicides; alginate dietary supplements; alginates for pharmaceutical purposes; alkaline iodides for pharmaceutical purposes; alkaloids for medical purposes; alloys of precious metals for dental purposes; aloe vera preparations for pharmaceutical purposes; aluminium acetate for pharmaceutical purposes; amino acids for medical purposes; amino acids for veterinary purposes; anaesthetics; analgesics; angostura bark for medical purposes; animal washes; anti-rheumatism bracelets; anti-rheumatism rings; anti-uric preparations; antibiotics; anticryptogamic preparations; antioxidant pills; antiparasitic preparations; antiparasitic collars for animals; antiseptic cotton; antiseptics; appetite suppressants for medical purposes; appetite suppressant pills; articles for headache; aseptic cotton; asthmatic tea; babies' napkins [diapers]; babies' napkin-pants [diaper-pants]; bacterial poisons; bacterial preparations for medical and veterinary use; bacteriological preparations for medical and veterinary use; balms for me-

dical purposes; balsamic preparations for medical purposes; barks for pharmaceutical purposes; bath preparations for medical purposes; bath salts for medical purposes; belts for sanitary napkins [towels]; bicarbonate of soda for pharmaceutical purposes; biocides; biological preparations for medical purposes; biological preparations for veterinary purposes; biological tissue cultures for medical purposes; biological tissue cultures for veterinary purposes; bismuth preparations for pharmaceutical purposes; bismuth subnitrate for pharmaceutical purposes; blood plasma; blood for medical purposes; bone cement for surgical and orthopaedic purposes; bracelets for medical purposes; breast-nursing pads; bromine for pharmaceutical purposes; bronchodilating preparations; bunion pads; cachets for pharmaceutical purposes; cachou for pharmaceutical purposes; preparations for callouses; calomel; camphor oil for medical purposes; camphor for medical purposes; candy, medicated; candy for medical purposes; capsules for medicines; carbolineum [parasiticide]; casein dietary supplements; castor oil for medical purposes; cattle washes; caustic pencils; caustics for pharmaceutical purposes; cedar wood for use as an insect repellent; cellulose esters for pharmaceutical purposes; cellulose ethers for pharmaceutical purposes; cement for animal hooves; charcoal for pharmaceutical purposes; chemical preparations to treat mildew; chemical preparations to treat wheat blight [smut]; chemical preparations for treating phylloxera; chemical preparations for pharmaceutical purposes; chemical preparations for medical purposes; chemical preparations for veterinary purposes; chemical reagents for medical or veterinary purposes; chemico-pharmaceutical preparations; chewing gum for medical purposes; chilblain preparations; chinoline for medical purposes; chloroform; cocaine; cod liver oil; collodion for pharmaceutical purposes; collyrium; compresses; condurango bark for medical purposes; solutions for contact lenses; contact lens cleaning preparations; cooling sprays for medical purposes; corn rings for the feet; corn remedies; cotton for medical purposes; cotton swabs for medical purposes; cream of tartar for pharmaceutical purposes; creosote for pharmaceutical purposes; croton bark; cultures of microorganisms for medical and veterinary use; curare; decoctions for pharmaceutical purposes; dental abrasives; dental amalgams; dental cements; dental impression materials; dental lacquer; dental mastics; dental amalgams of gold; deodorants, other than for human beings or for animals; deodorants for clothing and textiles; depuratives; preparations for destroying noxious animals; preparations for destroying dry rot fungus; preparations for destroying mice; detergents for medical use; diabetic bread adapted for medical use; diagnostic preparations for medical purposes; diagnostic biomarker reagents for medical purposes; diagnostic preparations for veterinary purposes; diapers

for pets; diastase for medical purposes; dietary fibre; dietary supplements for animals; dietetic beverages adapted for medical purposes; dietetic substances adapted for medical use; digestives for pharmaceutical purposes; digitalin; dill oil for medical purposes; disinfectants for hygiene purposes; disinfectants for chemical toilets; disinfectants; dog washes; dog lotions; douching preparations for medical purposes; dressings, medical; drugs for medical purposes; elixirs [pharmaceutical preparations]; enzyme preparations for medical purposes; enzyme preparations for veterinary purposes; enzyme dietary supplements; enzymes for medical purposes; enzymes for veterinary purposes; ergot for pharmaceutical purposes; esters for pharmaceutical purposes; ethers for pharmaceutical purposes; eucalyptol for pharmaceutical purposes; eucalyptus for pharmaceutical purposes; extracts of hops for pharmaceutical purposes; eye-washes; eyepatches for medical purposes; preparations to facilitate teething; febrifuges; fennel for medical purposes; ferments for pharmaceutical purposes; first-aid boxes, filled; fish meal for pharmaceutical purposes; flour for pharmaceutical purposes; flowers of sulfur for pharmaceutical purposes; fly catching paper; fly glue fly destroying preparations; formic aldehyde for pharmaceutical purposes; frost-bite salve for pharmaceutical purposes; fumigating sticks; fumigation preparations for medical purposes; fungicides; gallic acid for pharmaceutical purposes; gamboge for medical purposes; gases for medical purposes; gauze for dressings; gelatine for medical purposes; gentian for pharmaceutical purposes; germicides; glucose for medical purposes; glucose dietary supplements; glycerine for medical purposes; glycerophosphates; greases for medical purposes; greases for veterinary purposes; guaiacol for pharmaceutical purposes; gum for medical purposes; gurjun [gurjon, gurjan] balsam for medical purposes; haematogen; haemoglobin; haemorrhoid preparations; haemostatic pencils; headache pencils; herbal teas for medicinal purposes; herbicides; hormones for medical purposes; hydrastine; hydrastinine; hydrated chloral for pharmaceutical purposes; hydrogen peroxide for medical purposes; insect repellents; insect repellent incense; insecticides; iodides for pharmaceutical purposes; iodine for pharmaceutical purposes; iodoform; Irish moss for medical purposes; isotopes for medical purposes; jalap; jujube, medicated; lacteal flour for babies; larvae exterminating preparations; laxatives; lead water; lecithin for medical purposes; lecithin dietary supplements; leeches for medical purposes; preparations of lime for pharmaceutical purposes; liniments; linseed for pharmaceutical purposes; linseed meal for pharmaceutical purposes; linseed dietary supplements; linseed oil dietary supplements; lint for medical purposes; liquorice for pharmaceutical purposes; lotions for pharmaceutical purposes; lotions for veterinary purposes; lupulin for

pharmaceutical purposes; magnesia for pharmaceutical purposes; malt for pharmaceutical purposes; malted milk beverages for medical purposes; mangrove bark for pharmaceutical purposes; medical preparations for slimming purposes; medicated animal feed; medicinal alcohol; medicinal mud; medicinal infusions; medicinal tea; medicinal oils; medicinal herbs; medicinal roots; medicinal drinks; medicinal hair growth preparations; medicine cases, portable, filled; medicines for alleviating constipation; medicines for dental purposes; medicines for human purposes; medicines for veterinary purposes; melissa water for pharmaceutical purposes; menstruation bandages; menthol; mercurial ointments; milk ferments for pharmaceutical purposes; milk sugar for pharmaceutical purposes; milk of almonds for pharmaceutical purposes; milking grease; mineral waters for medical purposes; mineral water salts; mineral food supplements; mint for pharmaceutical purposes; moleskin for medical purposes; mothproofing preparations; mothproofing paper; moulding wax for dentists; mouthwashes for medical purposes; mud for baths; mustard oil for medical purposes; mustard for pharmaceutical purposes; mustard plasters; myrobalan bark for pharmaceutical purposes; napkins for incontinents; narcotics; nerviness; nutritional supplements; nutritive substances for microorganisms; oil of turpentine for pharmaceutical purposes; ointments for pharmaceutical purposes; opiates; opium; opodeldoc; opotherapy preparations; oxygen baths; oxygen for medical purposes; pants, absorbent, for incontinents; panty liners [sanitary]; paper for mustard plasters; parasiticides; pastilles for pharmaceutical purposes; pearl powder for medical purposes; pectin for pharmaceutical purposes; pepsins for pharmaceutical purposes; peptones for pharmaceutical purposes; pesticides; petroleum jelly for medical purposes; pharmaceutical preparations; pharmaceutical preparations for skin care; pharmaceutical preparations for treating dandruff; phenol for pharmaceutical purposes; phosphates for pharmaceutical purposes; poisons; pollen dietary supplements; pomades for medical purposes; porcelain for dental prostheses; potassium salts for medical purposes; poultices; powder of cantharides; by-products of the processing of cereals for dietetic or medical purposes; propolis for pharmaceutical purposes; propolis dietary supplements; protein dietary supplements; protein supplements for animals; purgatives; pyrethrum powder; quassia for medical purposes; quebracho for medical purposes; quinine for medical purposes; quinquina for medical purposes; radioactive substances for medical purposes; radiological contrast substances for medical purposes; radium for medical purposes; rat poison; reagent paper for medical or veterinary purposes; preparations for reducing sexual activity; remedies for foot perspiration; remedies for perspiration; repellents for



dogs; rhubarb roots for pharmaceutical purposes; royal jelly for pharmaceutical purposes; royal jelly dietary supplements; rubber for dental purposes; salts for mineral water baths; salts for medical purposes; sanitary panties; sanitary tampons; sanitary towels; sarsaparilla for medical purposes; scapulars for surgical purposes; sea water for medicinal bathing; sedatives; semen for artificial insemination; serotherapeutic medicines; serums; personal sexual lubricants; siccatives [drying agents] for medical purposes; slimming pills; slug exterminating preparations; smelling salts; smoking herbs for medical purposes; sodium salts for medical purposes; soil-sterilising preparations; solvents for removing adhesive plasters; soporifics; starch for dietetic or pharmaceutical purposes; stem cells for medical purposes; stem cells for veterinary purposes; sterilising preparations; steroids; stick liquorice for pharmaceutical purposes; strychnine; styptic preparations; sugar for medical purposes; sulfonamides [medicines]; sulfur sticks [disinfectants]; sunburn preparations for pharmaceutical purposes; sunburn ointments; suppositories; surgical dressings; surgical implants comprised of living tissues; surgical glues; syrups for pharmaceutical purposes; tanning pills; tartar for pharmaceutical purposes; teeth filling material; therapeutic preparations for the bath; thermal water; thymol for pharmaceutical purposes; tincture of iodine; tinctures for medical purposes; tissues impregnated with pharmaceutical lotions; tobacco extracts [insecticides]; tobacco-free cigarettes for medical purposes; tonics [medicines]; preparations of trace elements for human and animal use; preparations for the treatment of burns; turpentine for pharmaceutical purposes; vaccines; vaginal washes; vermifuges; vermin destroying preparations; vesicants; veterinary preparations; vitamin preparations; vulnerary sponges; wadding for medical purposes; wart pencils; wheat germ dietary supplements; yeast for pharmaceutical purposes; yeast dietary supplements.

(260) AM 2016 85296 A  
 (800) 1068018  
 (891) 2015 11 13  
 (731) NORDOX AS  
 Østensjøveien 13, N-0661 Oslo, Norway  
 (540)



(591) Red, white and black  
 (511)  
 5 – Preparations for destroying vermin and insects, fungicides and herbicides.

(260) AM 2016 85297 A  
 (800) 1277379  
 (891) 2015 07 28  
 (731) MANUFACTURAS ALHAMBRA, S.L.  
 Duquesa de Almodovar, 17, E-03830 MURO  
 DE ALCOY (Alicante), Spain  
 (540)

# Alhambra

(591) black and white  
 (511)  
 15 – Musical instruments and their accessories such as electric and electronic musical instruments, cases for musical instruments, bows, pegs, strings and gut strings, pedals, bridges, bellows, mouthpieces, keyboards, keys and valves for musical instruments, music stands and music boxes.

(260) AM 2016 85323 A  
 (800) 1277716  
 (891) 2015 11 11  
 (731) HARIBO HOLDING GMBH & Co. KG  
 Hans-Riegel-Strasse 1, 53129 Bonn, Germany  
 (540)

## Haribo macht Kinder froh und Erwachsene ebenso

(511)  
 30 – Confectionery.

(260) AM 2016 85330 A  
 (800) 1277890  
 (891) 2015 11 11  
 (731) Rigo Trading S.A. Société Anonyme  
 Route de Trèves 6 EBBC, Building E, L-2633  
 Sennigerberg, Luxembourg  
 (540)

## HAPPY COLA

(511)  
 30 – Confectionery.

(260) AM 2016 85333 A  
 (800) 1277896  
 (891) 2015 11 05  
 (731) Rigo Trading S.A. Société Anonyme  
 Route de Trèves 6 EBBC, Building E, L-2633  
 Sennigerberg, Luxembourg  
 (540)

## HAPPY CHERRIES

(511)  
 30 – Confectionery.

(260) AM 2016 85337 A  
 (800) 1277900  
 (891) 2015 11 05  
 (731) Rigo Trading S.A. Société Anonyme  
 Route de Trèves 6 EBBC, Building E, L-2633  
 Sennigerberg, Luxembourg

(540)

## TANGFASTICS

(511)  
 30 – Confectionery.

(260) AM 2016 85339 A  
 (800) 1277903  
 (891) 2015 09 22  
 (731) Rigo Trading S.A. Société Anonyme  
 Route de Trèves 6 EBBC, Building E, L-2633  
 Sennigerberg, Luxembourg

(540)

## Mao

(511)  
 30 – Confectionery.

(260) AM 2016 85342 A  
 (800) 1279348  
 (891) 2015 11 06  
 (731) PHILIP MORRIS BRANDS SÀRL  
 Quai Jeanrenaud 3, CH-2000 Neuchâtel,  
 Switzerland

(540)



(591) Grey, white  
 (511)  
 34 – Tobacco, raw or manufactured; tobacco products; cigars, cigarettes, cigarillos, tobacco for roll-your-own cigarettes, pipe tobacco, chewing tobacco, snuff tobacco, kretek; snus; tobacco substitutes (not for medical purposes); electronic cigarettes; tobacco products for the purpose of being heated; electronic devices and their parts for the purpose of heating cigarettes or tobacco in order to release nicotine-containing aerosol for inhalation; smokers' articles, cigarette paper, cigarette tubes, cigarette filters, tobacco tins, cigarette cases, ashtrays, pipes, pocket apparatus for rolling cigarettes, lighters.

(260) AM 2016 85344 A  
 (800) 1279389  
 (891) 2015 07 01  
 (731) AESSE PROJECTS S.r.L.  
 Via Mercadante, 51, CATTOLICA (RN), Italy

(540)

## ANTONIO CROCE

(511)  
 3 – Perfumery, essential oils, cosmetics, soaps.

9 – Glasses; sunglasses; sports glasses; spectacle cases; lenses for glasses; frames for glasses; chains and cords for glasses; mobile phones; cases for mobile phones; tablets; cases for tablets; smartphones.

14 – Precious metals and their alloys and goods of precious metals or coated therewith included in this class; jewelry, costume jewelry; watches; time instruments.

18 – Leather and imitation of leather, goods made of leather and of imitation of leather; bags; handbags, backpacks, trunks, suitcases, wallets, purse, briefcases, umbrellas.

24 – Textiles and household textile articles, bed covers and table covers, towels, kitchen linen; bed linen; household linen.

25 – Articles of clothing, shoes, hats, belts.

30 – Pastry; confectionery; ice cream; coffee; tea; chocolates; products made of chocolate; products made of flour and cereals; spices; sauces.

35 – The bringing together, for the benefit of others, of a variety of goods, excluding the transport thereof, enabling customers to conveniently view and purchase those goods, of clothing and clothing accessories, shoes, hats, jewelry, costume jewellery, watches, handbags, suitcases, belts, perfumes, cosmetics, glasses, smartphones, tablets, linen; retail services relating to clothing and clothing accessories, shoes, hats, jewellery, costume jewellery, watches, handbags, suitcases, belts, perfumes, cosmetics, glasses; presentation of products by any means of communication for retail; advertising; distribution of advertising material; franchising, namely, services rendered by a franchisor that is transfer of business and organizational know-how.

43 – Services for providing food and drink.

(260) AM 2016 85348 A  
 (800) 1279552  
 (891) 2015 09 09  
 (731) ALLERGAN, INC.  
 2525 Dupont Drive, Irvine CA 92612-1599  
 (United States of America), USA

(540)



(591) Blue, green

(511)

3 – Soaps; perfumery; essential oils; cosmetics, namely, cosmetic preparations for skin care, cosmetic preparations for body care, cosmetic preparations for bath and shower, cosmetic creams, lotions, and ointments and gels for skin care, cosmetic skin fresheners and toners, cosmetic preparations for the hair and scalp, and hair lotions; dentifrices, namely, anti-cavity dental rinses, mouth rinses and mouth washes, cosmetic preparations for the care of mouth and teeth.

10 – Surgical, medical, dental and veterinary apparatus and instruments, namely, diagnostic test kits principally composed of medical diagnostic meters that measure conditions of the cardio-vascular and immune systems; intra-uterine non-chemical contraceptive devices; medical diagnostic instruments for the analysis of body fluids; medical devices used in connection with anti-aging, the treatment of glabellar lines, facial wrinkles, asymmetries and defects and conditions of the human skin, facial aesthetic surgery, facial aesthetic reconstruction, breast aesthetics, ophthalmic preparations.

(260) AM 2016 85349 A

(800) 1279587

(891) 2015 08 28

(731) SIM LICENSING LTD

Chrysanthou Mylona, 3, CY-3030 Limassol,  
Cyprus

(540)

ELIE SAAB

(591) Black, white

(511)

9 – Eyewear; eye glasses; sunglasses; eye glasses cases; sunglasses cases; eye glasses chains; sunglasses chains; frames for eye glasses; frames for sunglasses; contact lenses; sunglasses lenses; goggles, skiing goggles; sports helmets, bicycle helmets, helmets for motorcycles, welding helmets; spectacles, namely spectacle chains, spectacle frames, spectacle cases, spectacle lenses; spectacles (with a handle); diving glasses; optical glass; optical lamps; optical lanterns; optical lenses; optical mirrors; correcting lenses; optical magnifying glasses; optical lenses for sunglasses; optical, scientific, surveying apparatus and instruments.

(260) AM 2016 85356 A

(800) 1278138

(891) 2015 09 28

(731) Joint-Stock Company "SORMOVSKAYA  
CONFECTIONERY FACTORY"

pl. Bazarnaya, 10, RU-603003 Nizhny  
Novgorod, Russian Federation

(540)



(591) Yellow, red-brown, white, dark brown

(526) KONDITERSKAYA FABRIKA.

(511)

30 – Confectionery.

(260) AM 2016 85358 A

(800) 1278139

(891) 2015 09 21

(731) Federal State Unitary Enterprise Rossiya  
Segodnya International Information Agency  
Zubovskiy blvd., 4, str.1,2,3, RU-119021  
Moscow, Russian Federation

(540)

**SPUTNIK**

(511)

9 – Floppy disks; sound recording discs; disks, magnetic; optical discs; electronic notice boards; compact discs [audio-video]; compact discs [read-only memory]; sound recording carriers; magnetic data media; optical data media; electronic publications, downloadable.

16 – Albums; almanacs; posters; pamphlets; booklets; newsletters; signboards of paper or cardboard; newspapers; printed publications; graphic representations; calendars; books; graphic prints; periodicals; printed matter; prospectuses; graphic reproductions; photographs [printed].

35 – Advertising; business management; business administration; office functions; import-export agencies; demonstration of goods; opinion polling; marketing studies; business information; news clipping services; updating of advertising material; word processing; organization of exhibitions for commercial or advertising purposes; organization of trade fairs for commercial or advertising purposes; presentation of goods on communication media, for retail purposes; sales promotion for others; publication of publicity texts; radio advertising; distribution of samples; dissemination of advertising matter; writing of publicity texts; on-line advertising on a computer network; advertising by mail order; television advertising; compilation of statistics; compilation of information into computer databases; systemization of information into computer databases; procurement services for others [purchasing goods and services for other businesses]; photocopying.

38 – Telecommunications; news agencies; television broadcasting; cable television broadcasting; electronic bulletin board services [telecommunications services]; information about telecommunication; telecommunications routing and junction services; providing internet chatrooms; providing telecommunication channels for teleshopping services; message sending; computer aided transmission of messages and images; transmission of telegrams; electronic mail; rental of message sending apparatus; rental of telecommunication equipment; radio broadcasting; communications by fiber optic networks; communications by cellular phones; communications by computer terminals; satellite transmission; communications by telegrams; communications by telephone; facsimile transmission; teleconferencing services.

41 – Providing of training; entertainment; sporting and cultural activities; videotaping; dubbing; publication of books; education information; recreation information; entertainment information; layout services, other than for advertising purposes; microfilming; videotape editing; production of radio and television programmes; providing on-line electronic publications, not downloadable; organization of exhibitions for cultural or educational purposes; arranging and conducting of congresses; arranging and conducting of conferences; arranging and conducting of symposiums; organization of competitions [education or entertainment]; television entertainment; videotape film production; electronic desktop publishing; publication of electronic books and journals on-line; publication of texts, other than publicity texts; radio entertainment; writing of texts, other than publicity texts; news reporters services; subtitling; translation; photography; photographic reporting; production of shows.

(260) AM 2016 85362 A  
(800) 1279723  
(891) 2015 11 13

(731) GUANGZHOU BOFUXIU CLOTHING CO., LTD  
Room 401, No. 902 Xingnan Road, Nancun Town, Panyu, Guangzhou City, 510000 Guangdong, China

(540)



(591) Black, white  
(511)

25 – Hosiery; caps [headwear]; motorists' clothing; neckties; shoes; waterproof clothing; clothing; girdles; gloves [clothing]; layettes [clothing].

(260) AM 2016 85368 A

(800) 1278277

(891) 2015 08 10

(731) C & J CLARK INTERNATIONAL LIMITED  
40 High Street, Street, Somerset BA16 0EQ,  
United Kingdom

(540)



(591) black and white

(511)

3 – Preparations for preserving footwear, leather and suede; cleaning and polishing preparations for footwear; conditioners for use on footwear; preparations for use in the care of footwear; detergent compositions and pastes for cleaning shoes; compositions for providing footwear with protection from the rain; shoe creams, polishes, sprays and wax; applicators containing preparations for polishing footwear; impregnated sponges for cleaning footwear.

18 – Shoulder belts; bags; rucksacks; travelling bags; holdalls; umbrellas and parasols; sports bags; school bags; beach bags; shopping bags; backpacks; pouches; handbags; key cases; parts and fittings for all the aforesaid goods.

(260) AM 2016 85369 A

(800) 1278319

(891) 2015 08 05

(731) PUBLIC STOCK COMPANY CLOSED  
NON-DIVERSIFIED VENTURE  
CORPORATE INVESTMENT FUND  
"PRIDE"

vul. Velyka Zhytomyrska, bud. 6/11, kim.  
307 m, Kyiv 01025, Ukraine

(540)



**INTERNATIONAL MONEY TRANSFERS**

(591) black and white

(511)

36 – Issuance of credit cards; issuance of tokens of value; investment of funds; arranging finance for construction projects; online banking; electronic funds transfer; clearing-houses, financial; insurance consultancy; debt advisory services; pawnbrokerage; leasing of real estate; instalment loans; loans (financing); providing financial information via a web site; exchanging money; credit card services; lending against security; savings bank services; actuarial services; insurance information; insurance brokerage; insurance underwriting; accident insurance underwriting; fire insurance underwriting; life insurance

underwriting; health insurance underwriting; factoring; financial information; financial consultancy.

(260) AM 2016 85370 A

(800) 1278376

(891) 2015 09 08

(731) HARIBO GMBH & CO. KG

Hans-Riegel-Strasse 1, 53129 Bonn, Germany

(540)

**ЗОЛОТЫЕ МИШКИ**

(591) black and white

(511)

30 – Sugar confectionery, pastry and confectionery and non-medical chewing gum.

(260) AM 2016 85377 A

(800) 1279744

(891) 2015 11 05

(731) Obschestvo s ogranichennoy

otvetstvennostyu "KONDITIONERSKAYA

FABRIKA "POBEDA"

26 Ryabinovaya ul., 2 stroenie, RU-121471

Moscow, Russian Federation

(540)

**МАЙСКИЙ ВАЛЬС**

(591) Black, white

(511)

30 – Confectionery; sweetmeats (candy); marzipan; chocolate.

(260) AM 2016 85381 A

(800) 1279757

(891) 2015 11 02

(731) SWATCH AG (SWATCH SA)(SWATCH

LTD.)

Jakob-Stämpfli-Strasse 94, CH-2502

Biel/Bienne, Switzerland

(540)

Tick different

(591) Black, white

(511)

14 – Precious metals and their alloys and goods made of these materials or coated therewith included in this class, namely figurines, trophies; jewelry, namely rings, earrings, cufflinks, bracelets, charms, brooches, chains, necklaces, tie pins, tie clips, jewelry caskets, jewelry cases; precious stones, semi-precious stones; timepieces and chronometric instruments, namely chronometers, chronographs, clocks, watches, wristwatches, wall clocks, alarm clocks as well as parts and accessories for the aforesaid goods, namely hands, anchors, pendulums, barrels, watch cases, watch straps, watch dials, clockworks, watch

chains, movements for timepieces, watch springs, watch glasses, presentation cases for timepieces, cases for timepieces.

(260) AM 2016 85382 A

(800) 1279759

(891) 2015 11 02

(731) BAYER INTELLECTUAL PROPERTY

GMBH

Alfred-Nobel-Straße 10, 40789 Monheim am

Rhein, Germany

(540)

**QOPEAKA**

(511)

5 – Pharmaceutical preparations and substances.

(260) AM 2016 85383 A

(800) 1279761

(891) 2015 11 19

(731) SWATCH AG (SWATCH SA) (SWATCH

Ltd.)

Jakob-Stämpfli-Strasse 94, CH-2502

Biel/Bienne, Switzerland

(540)

**SKIN**

(511)

14 – Precious metals and their alloys and goods made of these materials or coated therewith included in this class, namely figurines, trophies; jewelry, namely rings, earrings, cufflinks, bracelets, charms, brooches, chains, necklaces, tie pins, tie clips, jewelry caskets, jewelry cases; precious stones, semi-precious stones; timepieces and chronometric instruments, namely chronometers, chronographs, clocks, watches, wristwatches, wall clocks, alarm clocks as well as parts and accessories for the aforesaid goods, namely hands, anchors, pendulums, barrels, watch cases, watch straps, watch dials, clockworks, watch chains, movements for timepieces, watch springs, watch glasses, presentation cases for timepieces, cases for timepieces.

(260) AM 2016 85386 A

(800) 732404

(891) 2015 08 21

(731) WALMARK, a.s.

Oldřichovice 44, CZ-739 61 Třinec, Czech Republic

(540)

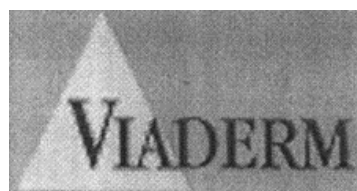

(591) Black, grey

(511)

5 – Pharmaceutical and parapharmaceutical products, vitamins and minerals and trace elements, medicated syrups, medicinal plant extracts and products containing combinations of vitamins, minerals and medicinal plant extracts, food supplements with added vitamins or minerals or trace elements, products with added vitamins, vitamins and multivitamin products, herb teas, medicinal herbs, sweetmeats or pastilles or tablets or chewing gum containing curative ingredients, dietetic products adapted for medical use, mineral water and dietetic drinks adapted for medical use, dietetic foodstuffs adapted for medical use, dietary supplements for medical purposes, protein products or foodstuffs for medical use, balms and creams for medical use, chemical products for medical use, curative oils, curative salts, dyes for medical purposes, yeast for pharmaceutical purposes.

(260) AM 2016 85387 A

(800) 734174

(891) 2015 08 21

(731) WALMARK, a.s.

Oldřichovice 44, CZ-739 61 Třinec, Czech Republic

(540)

# ArthroStop

(591) Black, white

(511)

5 – Pharmaceutical and parapharmaceutical products, vitamins and minerals and trace elements, medicated syrups, medicinal plant extracts and products containing combinations of vitamins, minerals and medicinal plant extracts, food supplements with added vitamins or minerals or trace elements, vitamin-enriched preparations, vitamins and multivitamin products, herbal teas, medicinal plants, sweet products or pastilles or tablets or chewing gum containing curative ingredients, dietetic products adapted for medical use, mineral water and dietetic beverages for medical use, dietetic foodstuffs for medical use, nutritional supplements for medical use, protein products or foodstuffs for medical use, balms and creams for medical use, chemical products for medical use, curative oils, oils for medical use, greases for medical purposes, curative salts, tinctures for medical purposes, herbal extracts or syrups, vitamin and mineral enriched foodstuffs in the form of concentrates, nutritional protein concentrates for medical use, yeast for pharmaceutical purposes.

(260) AM 2016 85388 A

(800) 741906

(891) 2015 10 08

(731) Bayerische Motoren Werke Aktiengesellschaft  
Petuelring 130, 80809 München, Germany

(540)

## X1

(511)

12 – Motor vehicles and their parts – except tires and inner tubes for tires – included in this class; apparatus for locomotion by land, air or water.

(260) AM 2016 85389 A

(800) 766457

(891) 2015 08 21

(731) WALMARK, a.s.

Oldřichovice 44, CZ-739 61 Třinec, Czech Republic

(540)

## Varixinal

(511)

5 – Pharmaceutical and parapharmaceutical products, vitamins, minerals and trace elements, nutritional and dietetic preparations and medicines, medicated syrups, medicinal plant extracts and combined preparations of minerals, trace elements and medicinal plant extracts, food supplements with added vitamins or minerals or trace elements, vitamin preparations, vitamins and multivitamin preparations, herbal teas, medicinal plants, confectioneries or pellets or tablets or capsules or chewing gums containing curative ingredients, dietetic products adapted for medical use, mineral water and dietetic beverages for medical use, dietetic foodstuffs for medical use, food supplements for medical use, protein preparations or foods for medical use, balms, creams and ointments for medical use, chemical products for medical use, herb extracts or syrups, vitamin and mineral-enriched foodstuffs in the form of concentrates, protein concentrates for medical use as nutritional food supplements, yeast for pharmaceutical purposes, medicated food supplements, nutritional or dietetic preparations for medical purposes for daily food supplement in the form of instant foods or separate mixtures, in particular consisting of powdered milk or animal or vegetable proteins, also with added vitamins or minerals or trace elements or sugar.

(260) AM 2016 85390 A

(800) 839429

(891) 2015 10 29

(731) CARTIER INTERNATIONAL AG

Hinterbergstrasse 22, Postfach 61, CH-6312 Steinhausen, Switzerland

(540)

**HYPNOSE**

(511)

14 – Cuff links, tie clips, rings, bracelets, earrings, necklaces, brooches; watches, chronometers, pendulum clocks, watchstraps, boxes of precious metal for watches and jewellery.

(260) AM 2016 85397 A

(800) 960305

(891) 2015 08 21

(731) WALMARK, a.s.

Oldřichovice 44, CZ-739 61 Třinec, Czech Republic

(540)

**Urinal**

(511)

5 – Pharmaceutical and parapharmaceutical products, vitamins and minerals and trace elements, nutritional and dietetic preparations and medicines, medicinal syrups, extract of medicinal herbs and combined preparations of vitamins, minerals, trace elements and of medicinal plant extracts, food supplements with added vitamins or minerals or trace elements, vitamin-enriched preparations, vitamins and multi-vitamin preparations, minerals and multi-mineral preparations, herb teas, medicinal herbs, confectionery or pastils or tablets or gelatine capsules or capsules or chewing gums containing curative ingredients, dietetic products adapted for medical use, dietetic mineral waters and drinks adapted for medical purposes, dietetic foodstuffs adapted for medical use, nutritional supplements for medical use, protein preparations or foodstuffs for medical use, salves and creams and ointments for medical use, chemical products for medical use, curative oils, oils for medical use, greases for medical purposes, curative salts, tinctures for medical purposes, herbal extracts or syrups, vitamin and mineral enriched foodstuffs in the form of concentrates, concentrates of protein as nutritional food supplements, yeast for pharmaceutical use, medicinal food supplements, nutritional or dietetic preparations for medical purposes used as daily food supplements in the form of instant foodstuffs or separate mixtures, composed mainly of powdered milk or animal proteins or vegetable proteins, also with supplements of vitamins or minerals or trace elements or sugar.

(260) AM 2016 85398 A

(800) 1071853

(891) 2015 10 29

(731) ASSOCIATED BRITISH FOODS PLC

Weston Centre, 10 Grosvenor Street,  
London W1K 4QY, United Kingdom

(540)

**CAOTINA**

(511)

29 – Milk and milk products; milk-based beverages.

30 – Cocoa and preparations having a base of cocoa; ready-to-drink chocolate; ready-to-drink cocoa; drinking chocolate; chocolate; chocolate products; confectionery.

32 – Non-alcoholic drinks, syrups, extracts and essences for making non-alcoholic beverages; ready-to-drink beverages; powdered beverage mixes.

(260) AM 2016 85399 A

(800) 1095631

(891) 2015 10 20

(731) Bayerische Motoren Werke Aktiengesellschaft  
Petuelring 130, 80809 München, Germany

(540)

**X2**

(511)

12 – Vehicles (except aircraft); apparatus for locomotion by land or water.

(260) AM 2016 85412 A

(800) 1278775

(891) 2015 10 20

(731) FORYOU CORPORATION

Foryou Industrial Park Area A -, Foryou  
Headquarter, No. 1 North Shangxia Road,  
Dongjiang High-tech Industry Park, Huizhou  
City, Guangdong Province, China

(540)

**ADAYO**

(591) black and white

(511)

9 – Computers; navigation apparatus for vehicles [on-board computers]; portable telephones; satellite navigational apparatus; sound recording carriers; megaphones; vehicle radios; horns for loudspeakers; automatic indicators of low pressure in vehicle tires [tyres]; projection screens.

11 – Lamps; street lamps; fluorescent lamp tube; automobile lights; light bulbs; spotlight; ceiling lights; fairy lights for festive decoration; luminous tubes for lighting; aquarium lights; luminous house numbers; light diffusers; stage lights; searchlights; lighting apparatus and installations; electric lamps; flares.

(260) AM 2016 85413 A

(800) 1227843

(891) 2015 12 01

(731) CALZEDONIA S.p.A.  
Via Portici Umberto I, 5, I-37018 Malcesine  
(Verona), Italy

(540)

**#CLZ**

(591) Black, white

(511)

25 – Clothing, footwear, headgear; underwear, dressing gowns; nightwear, namely, pajamas, nightshirts and nightgowns; knitwear, namely, knit shirts, knit skirts, knit robes; corsets; lingerie; stockings; tights; socks; sports clothing; swimwear; beachwear; slippers.

(260) AM 2016 85414 A

(800) 1261406

(891) 2015 11 26

(731) SOREMARTEC SA

Findel Business Center, Complexe B,  
Rue de Trèves, L-2632 Findel, Luxembourg

(540)

**KINDER CARDS**

(511)

30 – Pastry and confectionery, biscuits, cookies, wafers, chocolate and chocolate-based products, edible ices.

(260) AM 2016 85428 A

(800) 1278923

(891) 2015 08 26

(731) Zakrytoe aktsionernoe obshchestvo

"PHARMFIRMA "SOTEX"

d. 11, pos. Belikovo, selskoe, poselenie  
Berezhnyakovskoe, Sergievo-Posadsky,  
municipalny rayon RU-141345 Moscovskaya  
obl., Russian Federation

(540)



(591) Blue and white.

(511)

3 – Balms other than for medical purposes; massage gels other than for medical purposes; cosmetic cre-

ams; lotions for cosmetic purposes; beauty masks; oils for cosmetic purposes; cleansing milk for toilet purposes; medicated soap; cosmetic kits; tissues impregnated with cosmetic lotions; bath salts, not for medical purposes; cosmetics.

5 – Analgesics; anaesthetics; antibiotics; antiseptics; medicine cases, portable, filled; first-aid boxes, filled; balms for medical purposes; bracelets for medical purposes; anti-rheumatism bracelets; petroleum jelly for medical purposes; vaccines; dietetic substances adapted for medical use; mustard plasters; mud for baths; medicinal mud; nutritional supplements; cachets for pharmaceutical purposes; headache pencils; anti-rheumatism rings; candy, medicated; candy for medical purposes; adhesive plasters; lotions for pharmaceutical purposes; liniments; ointments for pharmaceutical purposes; medicinal oils; drugs for medical purposes; medicines for human purposes; medicinal drinks; dietetic beverages adapted for medical purposes; medicinal infusions; tinctures for medical purposes; cotton sticks for medical purposes; poultices; compresses; scapulars for surgical purposes; bunion pads; balsamic preparations for medical purposes; vitamin preparations; therapeutic preparations for the bath; preparations for callouses; sterilising preparations; pharmaceutical preparations; chemico-pharmaceutical preparations; dietetic foods adapted for medical purposes; chewing gum for medical purposes; tissues impregnated with pharmaceutical lotions; syrups for pharmaceutical purposes; greases for medical purposes; soporifics; bath salts for medical purposes; adjuvants for medical purposes; styptic preparations; disinfectants for hygiene purposes; febrifuges; depuratives; articles for headache; purgatives; tonics [medicines]; digestives for pharmaceutical purposes; nervines; serums; antioxidant pills; vulnerary sponges; enzymes for veterinary purposes; enzymes for medical purposes; ferments for pharmaceutical purposes; medicinal tea; elixirs [pharmaceutical preparations]; pharmaceutical preparations for skin care; suppositories; pastilles for pharmaceutical purposes.

10 – Physical exercise apparatus, for medical purposes; body rehabilitation apparatus for medical purposes; physiotherapy apparatus; vibromassage apparatus; acupuncture needles; needles for medical purposes; orthopedic articles; esthetic massage apparatus; massage apparatus; medical apparatus and instruments; orthopedic soles; arch supports for footwear; elastic stockings for surgical purposes; syringes for injections; syringes for medical purposes.

35 – Demonstration of goods; marketing studies; business information; business investigations; marketing research; business organization consultancy; layout services for advertising purposes; marketing; organization of exhibitions for commercial or advertising purposes; shop window dressing; retail or wholesale services for pharmaceutical, veterinary



and sanitary preparations and medical supplies; publication of publicity texts; distribution of samples; dissemination of advertising matter; direct mail advertising; advertising; advertising by mail order; television advertising; systemization of information into computer databases; telemarketing services; price comparison services; procurement services for others [purchasing goods and services for other businesses]; outsourcing services [business assistance]; auctioneering; commercial information and advice for consumers [consumer advice shop]; presentation of goods on communication media, for retail purposes; sales promotions at point of purchase or sale, for others; on-line advertising on a computer network; search engine optimization; web site traffic optimization; pay per click advertising; commercial management; business project management and administration.

(260) AM 2016 85436 A

(800) 1278950

(891) 2015 01 16

(731) APPLE INC.

1 Infinite Loop, Cupertino CA 95014,  
USA

(540)

## IPHONE

(511)

37 – Installation, maintenance, repair, servicing, and updating of consumer electronic devices, digital audio and video players, handheld computers, personal digital assistants, electronic organizers and electronic notepads (terms considered too vague by the International Bureau – rule 13.2.b) of the Common Regulations); providing technical support services regarding the usage of consumer electronic devices and accessories therefor; technical support services, namely, troubleshooting in the nature of repair of computer hardware and electronics problems; information relating to installation, maintenance, repair, servicing and updating of computers (terms considered too vague by the International Bureau – rule 13.2.b) of the Common Regulations).

(260) AM 2016 85439 A

(800) 1279099

(891) 2015 10 12

(731) SICHUAN LIJI PICKLE & FLAVOURING  
CO., LTD.

Liji Road, Songjiang Industrial Park,  
Meishan, Sichuan, China

(540)



(591) Black, white

(511)

29 – Charcuterie; meat, preserved; meat, canned; vegetables, canned; pickles; preserved vegetables; preparations for making soups; preserved truffles; preserved soya beans for food; cream [dairy products]; milk; beverages consisting principally of milk; milk products excluding ice cream, ice milk and frozen yogurt; edible fats; sesame oil; processed peanuts; sea-cucumbers, not live; fruits in preserved form; jams; vegetable salads; fruit jellies [not being confectionery]; soy-based food beverage used as a milk substitute; processed mushrooms.

30 – Wheat flour [for food]; rice; flour for food; noodles; soya flour; starch for use in manufacturing food; flavourings for foods; ketchup; chow-chow [condiment]; relish; vinegar; soy sauce [soya sauce]; coffee; tea; tea-based beverages; sugar; pastries; ice cream; cooking salt; garden herbs, preserved [seasonings].

(260) AM 2016 85441 A

(800) 1279142

(891) 2015 10 14

(731) DR. SERTUS İLAÇ SANAYİ VE TİCARET  
LİMİTED ŞİRKETİ

Evren Mah. Camiyolu Cad. No.50 K.2,  
Güneşli, Bağcılar İstanbul, Turkey

(540)

## MOLPOL МОЛПОЛ

(591) Black, white

(511)

5 – Medicines for human purposes, medicines for veterinary purposes, vitamin preparations, chemical preparations for medical purposes, dietetic substances adapted for medical use; dietetic foods adapted for medical purposes; baby foods, medicinal herbs, herbal beverages adapted for medical purposes, nutritional supplements, pollen dietary supplements, mineral food supplements, protein dietary supplements; dietary supplements for animals; fodder supplements for veterinary purposes; medicines for dental purposes, hygienic products for medical purposes including sanitary pads, breast-nursing pads and bunion pads, waddings for medical purposes, plasters for medical purposes, dressings for medical purposes, babies' napkins, preparations for destroying noxious plants, preparations for destroying noxious animals, fungicides, deodorants other than for human beings or for animals, air deodorising preparations, disinfectants for hygiene purposes, antiseptics, detergents for medical purposes.

(260) AM 2016 85442 A

(800) 1279146

(891) 2015 10 07

(731) KOLTIV CONSULTANTS LIMITED

Gr. Xenopoulou, 17, CY-3106 Limassol,  
Cyprus

(540)

**SMARTORY**

(591) Black,white

(511)

29 – Alginates for culinary purposes; anchovy; peanuts, prepared; artichokes, preserved; albumen for culinary purposes; beans, preserved; bouillon; ham; fatty substances for the manufacture of edible fats; toasted laver; edible birds' nests; peas, preserved; mushrooms, preserved; game, not live; gelatine; meat jellies; jellies for food; fruit jellies; edible fats; fruit-based snack food; charcuterie; raisins; caviar; eggplant paste; vegetable marrow paste; fish roe, processed; jam; yogurt; sauerkraut; kephir [milk beverage]; milk shakes; black pudding [blood sausage]; compotes; meat, tinned [canned (Am.)]; vegetables, tinned [canned (Am.)]; fish, tinned [canned (Am.)]; fruits, tinned [canned (Am.)]; bouillon concentrates; gherkins; shrimps, not live; buttercream; croquettes; silkworm chrysalis, for human consumption; kumys [kumyss] [milk beverage]; spiny lobsters, not live; salmon, not live; onions, preserved; margarine; piccalilli; marmalade; edible oils; peanut butter; cocoa butter; butter; shellfish, not live; almonds, ground; animal marrow for food; mussels, not live; milk; condensed milk; vegetable mousses; fish mousses; fruit pulp; meat; meat, preserved; milk beverages, milk predominating; vegetables, preserved; vegetables, dried; vegetables, cooked; potato fritters; olives, preserved; lobsters, not live; nuts, prepared; tomato purée; liver pâté; pectin for culinary purposes; liver; pickles; jams; powdered eggs; milk products; foods made from fish; prostokvasha [soured milk]; poultry, not live; berry purées; fruit purées; vegetable purées; crayfish, not live; crustaceans, not live; fish, preserved; fish, not live; salted fish; ryazhenka [fermented baked milk]; vegetable salads; fruit salads; bacon; sardines, not live; pork; herrings, not live; seeds, prepared; sunflower seeds, prepared; cream [dairy products]; whipped cream; fat-containing mixtures for bread slices; smetana [sour cream]; vegetable juices for cooking; salted meats; sausages; preparations for making bouillon; preparations for making soup; tripe; soups; vegetable soup preparations; cheese; tofu; sea-cucumbers, not live; truffles, preserved; tuna, not live; oysters, not live; milk ferments for culinary purposes; rennet; fish fillets; dates; crystallized fruits; frozen fruits; fruit, preserved; fruit preserved in alcohol; fruit, stewed; potato flakes; hummus [chickpea paste]; fruit peel; preserved garlic; lentils, preserved; potato chips; fruit chips; seaweed extracts for food; meat extracts; eggs.

30 – Aromatic preparations for food; flavorings [flavourings], other than essential oils, for cakes; flavorings [flavourings], other than essential oils, for beverages; food flavorings, other than essential oils; coffee flavorings [flavourings]; star aniseed; cereal bars; pancakes; noodle-based prepared meals; cereal-based prepared meals; buns; bread rolls; vanillin [vanilla substitute]; vanilla [flavoring] [flavouring]; vareniki [stuffed dumplings]; waffles; vermicelli [noodles]; natural sweeteners; binding agents for ice cream [edible ices]; malt biscuits; cake frosting [icing]; glucose for culinary purposes; mustard; yeast; rice-based snack food; cereal-based snack food; artificial coffee; dressings for salad; fruit jellies [confectionery]; candy decorations for cakes; confectionery for decorating Christmas trees; cakes; pastries; peanut confectionery; almond confectionery; pasta; ginger [spice]; frozen yogurt [confectionery ices]; cocoa; caramels [candy]; ketchup [sauce]; sweetmeats [candy]; liquorice [confectionery]; peppermint sweets; coffee; crackers; custard; groats for human food; corn, milled; corn, roasted; meat pies; farinaceous foods; noodles; edible ices; candy; rice cakes; mayonnaise; macaroons [pastry]; macaroni; marinades; marzipan; honey; ice cream; flour; dessert mousses [confectionery]; chocolate mousses; muesli; cocoa beverages with milk; coffee beverages with milk; coffee-based beverages; tea-based beverages; chocolate beverages with milk; chocolate-based beverages; infusions, not medicinal; chocolate-coated nuts; stick liquorice [confectionery]; soya bean paste [condiment]; pastilles [confectionery]; molasses for food; pâtés en croûte; pelmeni [dumplings stuffed with meat]; pesto [sauce]; cookies; petit-beurre biscuits; pies; pizzas; meat gravies; fondants [confectionery]; popcorn; powders for ice cream; baking powder; pralines; condiments; cereal preparations; propolis; gingerbread; spices; petits fours [cakes]; puddings; cake powder; fruit coulis [sauces]; ravioli; chewing gum; relish [condiment]; rice; wheat germ for human consumption; spring rolls; sugar; golden syrup; salt for preserving foodstuffs; cooking salt; soya sauce; tomato sauce; pasta sauce; spaghetti; tacos; tabbouleh; dough; cake dough; pastry dough; confectionery; sherbets [ices]; sauces [condiments]; seasonings; preparations for stiffening whipped cream; rusks; breadcrumbs; sushi; sandwiches; tapioca; tarts; almond paste; tortillas; halvah; bread; chips [cereal products]; corn flakes; oat flakes; chicory [coffee substitute]; tea; iced tea; cheeseburgers [sandwiches]; chocolate; essences for foodstuffs, except etheric essences and essential oils.

31 – Oranges, fresh; peanuts, fresh; artichokes, fresh; druff; beans, fresh; wreaths of natural flowers; grapes, fresh; algae for human or animal consumption; fruit residue [marc]; peas, fresh; mushrooms, fresh; yeast for animal consumption; Christmas trees; grains [cereals]; fish spawn; cocoa beans, raw;

potatoes, fresh; chestnuts, fresh; roots for food; maize; edible sesame, unprocessed; lemons, fresh; onions, fresh vegetables; leeks, fresh; shellfish, live; olives, fresh; almonds [fruits]; mussels, live; oats; vegetables, fresh; cucumbers, fresh; lobsters, live; nuts [fruits]; bran; peppers [plants]; citrus fruit, fresh; crayfish, live; crustaceans, live; plants; rhubarb, fresh; rice, unprocessed; rye; fish, live; lettuce, fresh; sardines, live; beet, fresh; garden herbs, fresh; truffles, fresh; tuna, live; squashes, fresh; oysters, live; fruit, fresh; hazelnuts; hops; flowers, natural; flowers, dried, for decoration; chicory, fresh; garlic, fresh; lentils, fresh; spinach, fresh; berries, fresh fruits; barley.

32 – Aperitifs, non-alcoholic; lithia water; seltzer water; soda water; aerated water; waters [beverages]; mineral water [beverages]; table waters; kvass [non-alcoholic beverage]; cocktails, non-alcoholic; beer-based cocktails; lemonades; peanut milk [non-alcoholic beverage]; milk of almonds [beverage]; non-alcoholic beverages; isotonic beverages; non-alcoholic honey-based beverages; aloe vera drinks, non-alcoholic; whey beverages; non-alcoholic fruit juice beverages; fruit nectars, non-alcoholic; orgeat; beer; ginger beer; malt beer; powders for effervescing beverages; sarsaparilla [non-alcoholic beverage]; syrups for lemonade; syrups for beverages; smoothies; tomato juice [beverage]; cider, non-alcoholic; vegetable juices [beverages]; fruit juices; preparations for making aerated water; preparations for making mineral water; preparations for making liqueurs; preparations for making beverages; must; grape must, unfermented; beer wort; malt wort; pastilles for effervescing beverages; sherbets [beverages]; non-alcoholic fruit extracts; extracts of hops for making beer; essences for making beverages.

33 – Aperitifs; arrack [arak]; baijiu [Chinese distilled alcoholic beverage]; brandy; wine; whisky; vodka; anisette [liqueur]; kirsch; gin; digesters [liqueurs and spirits]; cocktails; curacao; liqueurs; pre-mixed alcoholic beverages, other than beer-based; alcoholic beverages, except beer; alcoholic beverages containing fruit; distilled beverages; spirits [beverages]; mead [hydromel]; bitters; rum; sake; cider; rice alcohol; alcoholic extracts; alcoholic essences.

35 – Import-export agencies; commercial information agencies; advertising agencies; rental of advertising space; computerized file management; demonstration of goods; opinion polling; marketing studies; business information; commercial information and advice for consumers [consumer advice shop]; business investigations; business research; marketing research; professional business consultancy; marketing; business management of performing artists; news clipping services; organization of exhibitions for commercial or advertising purposes; organization of trade fairs for

commercial or advertising purposes; shop window dressing; design of advertising materials; business appraisals; data search in computer files for others; business management assistance; commercial intermediation services; provision of an on-line marketplace for buyers and sellers of goods and services; providing business information via a web site; presentation of goods on communication media, for retail purposes; economic forecasting; auctioneering; sales promotion for others; rental of sales stands; systemization of information into computer databases; distribution of samples; dissemination of advertising matter; advertising; commercial administration of the licensing of the goods and services of others; administrative processing of purchase orders; public relations; procurement services for others [purchasing goods and services for other businesses]; business efficiency expert services.

43 – Accommodation bureaux [hotels, boarding houses]; rental of temporary accommodation; rental of meeting rooms; tourist homes; hotel reservations; boarding house bookings; temporary accommodation reservations; hotels; snack-bars; cafés; cafeterias; motels; boarding houses; boarding for animals; rental of cooking apparatus; rental of chairs, tables, table linen, glassware; rental of tents; rental of transportable buildings; rental of drinking water dispensers; restaurants; self-service restaurants; canteens; holiday camp services [lodging]; bar services; providing campground facilities; food and drink catering.

(260) AM 2016 85454 A

(800) 1279235

(891) 2015 08 24

(731) CORPORACIÓN DE RADIO Y TELEVISIÓN ESPAÑOLA, S.A.  
Avda. Radio Televisión, 4, Edif. Prado del Rey E-28223 POZUELO DE ALARCÓN (MADRID), Spain

(540)



(591) Blue and white

(511)

38 – Telecommunication services: communications by radio, via satellite, via cable, via fiber-optic networks, via computer terminals; communications via global computer networks; broadcasting of radio and television programs.

41 – Education and entertainment.

(260) AM 2016 85465 A  
 (800) 1279956  
 (891) 2015 11 13  
 (731) FOSHAN SANSHUI HONGYUAN  
 CERAMICS ENTERPRISE CO., LTD.  
 Industrial Zone, Baijin Avenue, Bani  
 Town, Sanshui District, Foshan City,  
 528131 Guangdong Province, China

(540)

**Golde**

(591) black and white

(511)

19 – Earth for bricks; marble; gypsum; cement slabs;  
 glass mosaics for building; bricks; ceramic tiles; bin-  
 ding agents for making ceramic tile.

(260) AM 2016 85466 A  
 (800) 1279965  
 (891) 2015 11 12  
 (731) Bourjois SARM  
 Burgstrasse 26, CH-8750 Glarus, Switzerland

(540)

**CITY RADIANCE**

(511)

3 – Preparations for skin, scalp, hair or nail care;  
 cosmetic preparations for application on the skin,  
 scalp, hair or nails; soaps; perfumery products; es-  
 sential oils; cosmetics; toiletries for non-medical  
 use.

(260) AM 2016 85470 A  
 (800) 1280001  
 (891) 2015 11 20  
 (731) NOVARTIS AG  
 CH-4002 Basel, Switzerland

(540)

**ACTIVE SENTRY**

(511)

10 – Ophthalmic medical and surgical instruments  
 and apparatus.

(260) AM 2016 85472 A  
 (800) 1280004  
 (891) 2015 11 24  
 (731) Swedish Orphan Biovitrum AB (publ)  
 SE-112 76 Stockholm, Sweden

(540)

**ELOCTA**

(511)

5 – Pharmaceutical preparations for the treatment of  
 hemophilia.

(260) AM 2016 85474 A  
 (800) 1280045  
 (891) 2015 01 12  
 (731) DHL INTERNATIONAL GMBH  
 Charles-de-Gaulle-Str. 20, 53113 Bonn,  
 Germany

(540)

**DHL eCommerce**

(511)

9 – Apps, namely applications for smart phones,  
 tablet PCs, e-readers and other mobile or stationery  
 IT equipment [downloadable]; computer programs  
 [recorded or downloadable]; electronic publications  
 [downloadable]; DVDs, CDs and other digital recor-  
 ding carriers; downloadable sound, images and data  
 [including being data files]; apparatus for recording,  
 transmission and reproduction of sound and images;  
 magnetic recording data carriers; data processing ap-  
 paratus and computers; computer peripheral devices;  
 optical and magnetic data carriers; computer opera-  
 ting programs [recorded]; files, pictures, ring tones  
 [downloadable]; computer software platforms [soft-  
 ware]; development tools [software] for computer  
 software; web tools [software], in particular for the  
 dispatch of goods and documents [including online];  
 marketing tools [software]; product listing tools  
 [software].

16 – Paper, cardboard; printed matter; bookbinding  
 material; photographs; stationery; adhesives for sta-  
 tionery or household purposes; artists' materials;  
 paint brushes; typewriters and office requisites [ex-  
 cept furniture]; instructional and teaching material  
 [except apparatus]; plastic materials for packaging  
 [included in class 16]; bags, pouches and goods for  
 packaging, wrapping and storage made of paper,  
 cardboard or plastics; wrapping materials made of  
 paper, cardboard and plastics, not included in other  
 classes; posters.

35 – Advertising; marketing [sales research]; direct  
 marketing; business management; business adminis-  
 tration; business consultancy; office functions; up-  
 dating of advertising material; advertising agency  
 services; cost-price analysis; accounting; computeri-  
 zed file management; data management on servers;  
 invoicing services [office functions]; drawing up of  
 statistics; market research; opinion polling; publica-  
 tion and writing of publicity texts; providing com-  
 mercial and business information; business investi-  
 gations; planning and monitoring of business deve-  
 lopments with regard to organisational matters; dra-  
 wing up of business expert reports; procurement  
 services for others [purchasing of goods and services  
 for other companies]; arranging of commercial tran-  
 sactions, including within the framework of e-com-  
 merce; consultancy with regard to e-commerce; ar-  
 ranging of contracts, for others, for the buying and  
 selling of goods; arranging of contracts, for others,  
 for the providing of services; arranging of commer-

cial and business contacts, including online; distribution of product samples for advertising purposes; direct mail advertising; distribution of advertising material; demonstration of goods for advertising purposes; direct mail advertising to attract new customers and to maintain the existing customer base; layout design for advertising purposes; document reproduction services; public relations; research in computer files [for others]; business research; organisation and arranging of advertising events; organisation of exhibitions and trade fairs for commercial and advertising purposes; systematic ordering, collating, updating and maintenance of data in computer databases, in particular in the field of advertising e-mails, transport, packaging and storage of goods; professional business organisational consultancy; collecting, binding, addressing, enveloping and franking of goods, in particular letters, packages and parcels [office functions]; marketing consultancy; creating, managing, maintaining, coordinating (systematic ordering), collecting, formatting (systematic ordering), analysing, brokerage and rental of addresses and address files; planning of advertising and marketing measures; administrative processing of orders, including within the framework of e-commerce; receiving and processing of electronically transmitted orders; providing of commercial information, in particular in relation to mailshots; presentation of companies on the Internet and other media; presentation of goods on communications media, for retail purposes; publication of printed matter [including in electronic form] for advertising purposes; direct marketing consultancy; consumer consultancy; sales promotion [for others]; rental of advertising space; arranging of advertising; retail and wholesale services including by e-commerce and via the Internet as well as online or catalogue mail order services, in relation to chemicals, coatings, pharmacy articles, cosmetics and household goods, fuels and motor fuels, goods for the health sector, machines, tools and metal goods, construction articles, DIY (do-it-yourself) articles and garden articles, hobby requisites and craft supplies, electric goods and electronic goods, sound carriers and data carriers, sanitary installations, vehicles and vehicle accessories, fireworks, horological instruments and jewellery, musical instruments, printed matter, paper goods and stationery, office requisites, bag maker's goods and saddlery, furnishings and decorative articles, tents, tarpaulins, clothing, shoes and textile goods, toys, sporting goods, foodstuffs and beverages, agricultural products, horticultural products and forestry products, tobacco products and other natural stimulants; telephone answering services for unavailable subscribers; electronic commerce services, namely providing information about products via telecommunication networks for advertising and sales purposes; presentation of goods and services by providing a search-

able online advertising guide featuring the goods and services of other online vendors; consumer consultancy by providing a searchable online evaluation database for buyers and sellers; e-commerce services, namely product listing on the Internet (optimization of search engines); providing online ordering services for use by consumers to purchase goods from online merchants; listing.

36 – Insurance; transport insurance; procurement of insurances, in particular transport insurances; customs brokerage (clearance) for third parties electronic payment transactions; financial affairs; monetary affairs; real estate affairs; financial sponsorship.

38 – Telecommunications; providing access to mobile applications for use in the context of delivering and receiving parcels, addressing parcels, managing alternative delivery addresses and tracking and tracing of parcels, in particular via smart phones; computer-aided transmission of messages and images; providing access to information on the Internet; electronic mail services; web messaging; providing access to computer programs in data networks; providing access to databases; providing access to a global computer network; leasing of access time to global computer networks; electronic exchange of messages by means of chat lines, chat rooms and Internet forums; providing access to platforms and portals on the Internet, in particular for e-commerce; telecommunication services by computer terminals or fibreoptic networks; providing access to a digitalised media platform for the exchange of messages and information of all kinds; transmission of digital files; telecommunications routing and junction services; rental of telecommunications equipment; rental of message sending apparatus; rental of telecommunications apparatus; installing websites for others; electronic advertising agency services [telecommunications]; mobile telephone services; teleconferencing services; signal transmission for electronic commerce via telecommunication systems and data communication systems; providing telecommunication channels for e-commerce services; providing an online service for retailers, product manufacturers and advertisers for trademarks, namely online communication services for improving and customizing search results, placing of advertising products and monetizing of website traffic on one or several websites for e-commerce.

39 – Transport, in particular transport of goods by motor vehicle, lorry, rail, ship and aeroplane; packaging and storage of goods; tracking and tracing by means of the electronic tracking of goods as well as further logistic support services like the systematic linking of goods and information flows; transportation information; freight brokerage, unloading of freight; storage information; courier services [messages or goods]; logistics in the transport sector; col-

lection, transport and delivery of goods, in particular documents, packages, parcels, letters and pallets; rental of storage containers; management and rental of warehouses; franking of goods, in particular letters, packages, parcels, including online; freight forwarding services; transport brokerage; physical storage of electronically stored data and documents; delivery of mail-order goods; providing information relating to packaging and storage of goods; freighting of ships; freighting of aeroplanes; freighting of railways; freighting of motor vehicles; freighting of lorries; drawing up of transit documents; organization and handling of returned goods [returns management], in particular return of undeliverable items, in particular letters, packages and parcels to the sender; providing online information in the field of transport and logistics, in particular about the transport of documents, letters, packages, parcels and pallets; letter, freight and express delivery services; dispatch handling/conducting in the field of transport; providing information about logistics in the transport sector; delivery of newspapers and magazines, delivery and distribution of letters.

42 – Computer programming services; updating, design, installation, maintenance and rental of computer software; providing or rental of electronic memory space [webpace] on the Internet; computer hardware and software consultancy; security services, namely online prevention of access to computer networks by unauthorised persons; rental of computers for data processing; technical project studies; hosting the web sites of others on a computer server for a global computer network; electronic data storage; electronic data security; IT support (technical support in the field of software); design and development of computer hardware and software; consultancy in the field of computers; technical consultancy in the field of computer hardware and software; technical consultancy relating to product development; installation and maintenance of Internet access software; conversion of computer programs and data [other than physical alteration]; conversion of data or documents from physical to electronic media; server administration; technical project management in the field of electronic data processing; creating of application software; consultancy with regard to the design of homepages and Internet pages; provision of search engines for the Internet; certification agency services [trust centres], namely issuing and administration of digital codes and/or digital signatures; security services for protection against illegal network access; archiving of addresses and address files; providing an online search service for products; creating websites for others.

(260) AM 2016 85475 A  
(800) 1280054  
(891) 2015 03 19

(731) ACEITES DEL SUR-COOSUR S.A.  
Carretera de la Carolina, 29, E-23220 Vilches  
(Jaén), Spain

(540)

## HG HACIENDA GUZMAN

(511)

29 – Edible oils and fats; meat; processed fruits, mushrooms and vegetables (including nuts and vegetables); eggs and egg products; fish, seafood and shellfish; milk products and milk substitutes; potato snacks; soy-based snacks; onion rings; potato fritters; stock [soup]; stock [prepared]; bouillon; roasted chestnuts; chili con carne; chop suey; packaged food consisting primarily of seafood; prepared meals mainly consisting of game; prepared meals substantially consisting of seafood; prepared meals consisting wholly or mainly of poultry; prepared meals containing meat [primarily consisting of meat]; prepared meals containing eggs [primarily]; bouillon concentrates; soups; prepared meals containing bacon [mainly]; prepared meals mainly consisting of fish; potato flakes; pork rinds; buttercream; croquettes; stock cubes; soup cubes; dal (Indian vegetables); potato salad; chicken salad; prepared salads; stews; meat stews [food]; flavored extracts of roast beef; extracts for soups; fried kale; fish crackers; vegetable burgers; Scotch eggs; baked apples; mixes for making soups; soup powders; pollen prepared as foodstuff; refrigerated dishes made with fish; prepared meals containing chicken [primarily]; prepared meals consisting wholly or substantially of game; prepared dishes consisting primarily of meat; ready-made meals consisting wholly or substantially of meat; prepared meat dishes; cooked dishes made with meat; dish of preserved meat with chopped and lightly fried vegetables; fried fish with chips; fish in olive oil; stuffed potatoes; soy chips; potato chips; cassava chips; frozen french fries; French fries; fish cakes; meatloaf; pastes for making soup; edible birds' nests; soup mixes; processed olives; olives, prepared; canned olives; olive paste; canned processed olives; tapenades (olive paste); prepared olive purée; tomato paste; canned tomatoes; peeled tomatoes; concentrated tomato [purée]; tomato purée; tomato paste; tomato purée; tomato preserves; tomato extracts; tomatoes (preserved); tomato juice for cooking; tomato juice for cooking; soups; vegetable soup preparations; stock [soup]; canned soups; vegetable preparations (soups); prepared meals consisting primarily of meat, fish or vegetables; meat balls; Korean style noodle soup [sujebi]; Korean rice cake soup [tteokguk].

30 – Sugar, natural sweeteners, sweet topping and filling products and bee products; coffee, tea, cocoa and substitutes thereof; processed grains, starches and goods made thereof, baker's products and yeast; ice, ice cream, frozen yogurt and sherbets; bakery

products, pastry products, chocolates and desserts; salt, sauces, seasonings and condiments; savory ready-to-eat foods consisting in extruded corn; canned food containing pasta; prepared foodstuffs in the form of sauces; savory food preparations made of potato flour; corn-based snacks; wheat-based snacks; sesame snacks; snack foods consisting principally of extruded cereals; crunchy snacks made of cereals; cheese flavored cereal snacks; puffed corn snacks; cheese flavored puffed corn snacks; tortilla snacks; snack foods made from puffed corn; snack foods made from corn in the shape of rings; snack foods made of whole wheat; prepared snacks made from corn; snacks mainly consisting of bread; rice mixed with vegetables and beef [bibimbap]; filled baguettes; ready-to-eat food bars with a chocolate base; sandwiches with minced beef; fish sandwiches; sandwiches containing meat; sandwiches containing fish fillets; crumble (fruit dessert covered with a mixture of flour, butter and sugar); pizza dough crusts; ready-to-eat dry and liquid meals, mainly consisting of pasta; meals mainly consisting of pasta; meals mainly consisting of rice; prepared meals mainly containing pasta; prepared meals mainly consisting of rice prepared meals in the form of pizzas; noodle-based prepared meals; prepared pizza meals; chow mein [stir fried Chinese noodles]; tortilla chips; chimichanga; chalupas (food); canapes (sandwiches); pizza calzone; shrimp fritters; rice fritters with sweet bean paste jam (ankoro); burritos; bean jam buns; steamed buns filled with minced meat (niku-manjuh); Chinese steamed dumplings [shumai, boiled]; snacks and sandwiches; filled sandwiches; sandwiches containing salad; rice crackers for stir frying [topokki]; granular rice crackers (arare); rice crackers; fajitas; spaghetti, canned spaghetti in tomato sauce; noodle salad; macaroni salad; rice salad; enchiladas; fish and vegetable pasties; vegetable and poultry pasties; meat and vegetable pasties; Chinese filled pasties (gyoza, cooked); pies containing vegetables; pies containing fish; pies containing game; pies containing meat; pies containing poultry; vegetable pies; egg pies; pork pies; pies [savory pastries]; pies [sweet or savory]; crackers flavored with meat; crackers flavored with spices; crackers flavored with herbs; crackers flavored with cheese; crackers flavored with vegetables; rice crackers; rice crackers [senbei]; crackers made of prepared cereals; crackers filled with cheese; roasted corn kernels; hamburgers cooked and placed in a bread bun; cheeseburgers [sandwiches]; hamburgers in bread buns; chips [cereal products]; lasagna; macaroni with cheese; puff pastry with ham; pre-cooked pizza dough; fried corn; corn prepared for making popcorn; roasted corn; nachos; flavored popcorn; sugar coated popcorn; candy coated popcorn; microwave popcorn; sweet walnut candy coated popcorn; prawn bread; stuffed pasta; Korean traditional rice cakes [injeolmi]; sticky rice cakes (chapsalttock); meat

pies; meat pies [processed]; poultry or game meat pies; sweet cakes with fruits, raisins and spices; savory cakes; rice cakes; oat pastries; seaweed flavored corn chips; rice chips; corn chips flavored with vegetables; whole wheat chips; cereal chips or strips; hot dogs (prepared); pizzas; egg rolls; cheese curls [snacks]; cereal-based snack food; rice-based snack food; risotto; ravioli [processed]; quiches; quesadillas; snack food products consisting of cereal products; snack food products made from potato flour; snack food products made from corn flour; snack food products made from biscuit meal; snack food products made of cereal starch; snack food products made with soy flour; snack food products made from rice flour; snack food products made from cereal flour; prepared meals containing [principally] rice; pre-cooked meals containing pasta; pasta dishes; wraps [sandwiches]; wontons; green onion pancakes [pajeon]; snacks made from muesli; tacos; tacos (chips); tabbouleh; toasted sandwiches; sausage sandwiches; chicken sandwiches; hot dog sandwiches; toasted cheese and ham sandwich; toasted cheese sandwich; sushi; samosas; hot sausage and ketchup in an open bread bun; sausage rolls; fresh sausage rolls; dried seaweed rolls [gimbap]; spring rolls; sauces, chutney and food creams; chili oil as a condiment or dressing; marinades; food flavorings other than essential oils; flavorings and seasonings; bases for making milk shakes [flavorings]; condiments; fruit coulis [sauces]; essences for cooking; sauces; vinegar; tomato sauce; blancmanges; desserts made of artificial milk; fruit desserts.

(260) AM 2016 85476 A

(800) 1280059

(891) 2015 03 30

(731) DRAGON POLAND SPÓŁKA Z O. O.  
SPÓŁKA KOMANDYTOWA

Ul. Powstania Listopadowego 14, PL-30-298  
Kraków, Poland

(540)



(591) Orange and black

(511)

1 – Chemical products for protection and maintenance of vehicles, antifreezes, stain-preventing chemicals for use on fabrics, hydraulic fluids containing brake fluid, power steering fluids, transmission fluids, engine cooling fluids, brake fluids, chemical additives and modifiers for oils, chemicals for removing oils, chemical preparations for coloring ena-

mels and glass, concrete binders, cobblestone preservatives, concrete-aeration chemicals, concrete preservatives (except paint and oils), masonry preservatives (except paints and oils), wood-impregnating chemicals, masonry-impregnating chemicals, plasticizers for concrete and mortars, anhydrites preservatives (except paints and oils), brickwork preservatives (except paints and oils), cement preservatives (except paints and oils), roofing-tile preservatives (except paint and oils), cement-waterproofing preparations (except paints), preparations against moisture used in masonry (except paints), preparations for removing boiler scale, fire-proofing preparations, anti-boil preparations for engine coolants, ceramic materials, especially for use as filtering media, ceramic glazes, acid-proof chemical compositions, chemical reagents other than for medical or veterinary use, industrial chemicals, chemical chimney cleaners, distilled water, enamel-tarnishing chemicals, glass and carpenter's putty, oil putty, adhesives for industrial purposes, adhesives for wall tiles, adhesives for wall papers, adhesives for parquetry, adhesives for skirting, adhesives for flooring, two-component adhesives for ceramics, adhesives other than for paper or household purposes, adhesives used for connecting materials [other than for household or stationery use], preparations for bonding and/or priming, wallpaper-removing preparations, solvents for varnishes, silicones, chemical additives to fungicides, acids, unprocessed acrylic resins, unprocessed artificial resins, unprocessed epoxy resins, unprocessed synthetic resins, damp-proofing preparations for masonry, masonry preservatives (except paint and oils), stain-preventing chemicals for use on fabrics, textile-impregnating chemicals.

2 – Colorants or paints, leather dyes, dyes for industrial purposes, wood stains, stains for leather, floor stains, mordant, enamels, enamels for painting, silver emulsions, paints, enamel paints, fireproof paints, ceramic paints, water distempers or casein paints, wood coating paints, roofing coating paints, paint coatings used for coating roofs, bactericidal paints, anti-rust paints, anti-fouling paints, varnishes, parquets lacquers, varnishes for wood, varnishes for floor, black Japan, minium, white wash, anti-rust oils, oils for the preservation of wood, pigments, pigments for concrete and mordant, coatings for roofing, anti-rust preparations for metals, preparations for protecting against corrosion, preparations for protecting against water, under-coating for vehicle chassis protecting them against corrosion, aluminum powder for painters, thinners for paints and lacquers, anti-rust greases, anti-corrosive preparations, anti-corrosive bands, fixatives for paints and lacquers, binding preparations for paints, turpentine as a thinner for paints and lacquers, thickeners for paints and lacquers, raw natural resins, wood preservatives.

3 – Cleaners for: showers, joints, ceramic tiles, baths with hydromassage, ceramic toilet and bathrooms devices, household equipment and appliances such as: refrigerators and microwaves, plastics, leather, wooden furniture, fireplace glasses, windows and mirrors, grills, fireplaces, clinker, plastic panels and parquets, carpets and floor coverings, polishers, scouring preparations, wiping preparations, preparations for cleaning bathrooms and kitchens, air fragrance preparations for toilets, gels and pellets for unblocking drain pipes, preparations for cleaning drainage pipes, rust removing preparations, detergents other than for use in manufacturing operations and other than for medical purposes, paint-removing preparations, varnish-removing preparations, scale-removing preparations for household purposes, preservatives for leather (polishes), abrasive cloths, preparations to make shine the leaves of plants, washing preparations, soaps, oils for cleaning purposes, color-removing preparations, tripoli stone for polishing, abrasive paper, sand paper, preparations for cleaning waste pipes, wallpaper cleaning preparations, degreasers other than for use in manufacturing processes, chemical substances for laundry, preparations for scrubbing floors, toiletries such as: soaps, detergents, shower gels, bath salts, burnishing preparations, washing soda, bleaching soda, windscreen washer liquids for windows and mirrors, non-slipping liquids for floor, glass papers, scented water, preparations for grinding, stain removers, car upholstery stain removers, preparations for removing stains, wax for furniture, non-slipping wax for furniture, polishing wax, abrasive pastes for floor and furniture, furniture cleaning lotions, preparations for polishing tiles and stone, car shampoos, scented sachets for cars, car care preparations, preparations for removing stickers, turpentine for degreasing, parquet wax, floor wax, fabric softeners for laundry use, laundry glazes, preparations for cleaning hands, solvents for removing paints and varnishes.

4 – Petrol, wood briquettes, combustible briquettes, coal briquettes, denatured alcohol used as fuel, firewood, oils for paints, oils for the preservation of masonry, motor oils, lubricating oils, kerosene, naphtha, castor oil for technical purposes, fuel oil, combustible oils, industrial oils, moistening oils, penetrating oils, canned oils and greases in the form of aerosol used to prevent rust, removing rust and moisture and for lubrication, lubricating greases, fuel, light fuel, mineral fuels, paraffin, lubricants, car greases, candles, wax candles, illuminating wax, dust-removing preparations, dust-binding compositions for sweeping, non-chemical additives to motor fuels, firelighters, paper spills for lighting, charcoal for lighting, wood spills for lighting.

16 – Graphics, aquarelles, blotters, table linen of paper, flower-pot covers of paper, inks, filter paper, photographs, paper and cardboard and articles made of these materials, adhesives for stationery or house-



hold purposes, adhesives for paper or for household purposes, tracing needles for drawing purposes, templates for copying drawings, canvas for painting, pictures, painters' brushes, supports for the hand of the painter, painters' easels, house painters' rollers, printing blocks, modeling materials, stationery, pastels, paintbrushes, drawings, table napkins of paper, templates, adhesive tape, paper packaging, garbage bags, ink for stamps, marking chalk, stickers, labels not of textile.

17 – Non-conducting materials for retaining heat, threads of plastic, products for insulation, insulating paints, insulating varnishes, insulating felt, asbestos felt, insulating foil, flexible tubes not of metals, substances for insulating buildings against moisture, insulating materials, insulating refractory materials, sealing materials, sealing compounds, insulating sealing compounds, insulating oils, insulating tapes, insulating fabrics, fibreglass fabrics for insulation, insulating plasters, insulators, insulating metal-foils, asbestos, lute, caoutchouc, rubber, cords of rubber, mineral wool, insulating paper, pipe accessories not of metal, self-adhesive tapes other than stationery and not for medical or household purposes, weatherstripping, plastic foils other than for wrapping, seals, chemical compositions for repairing leaks, glass-wool for insulation.

19 – Alabaster, arbours structures not of metal, balustrades, swimming pool structures not of metal, beams not of metal, concrete, shuttering for concrete not of metal, concrete building elements, building glass, bituminous coatings for roofing, bituminous products for building, bituminous products for insulation, bitumen, asphalt, tars, wainscotings not of metal, gates not of metal, building timber, building materials not of metal, building panels not of metal, building stone, bricks, building cement, cement slabs, fireproof cement coatings, pipes not of metal, hips for roofing, roofing slates, roofing coatings not of metal, roof-tiles not of metal, boards, timber, doors not of metal, work of art of stone, concrete or marble, felt for building, veneers, clay, gypsum, bituminous shingles, granite, cornices not of metal, works of stonemasonry, stone, sandstone pipes, paperboard for building, clinker ballast, mantelpieces not of metal, chimney shafts not of metal, chimneys not of metal, composed cork, lattices not of metal, trellises not of metal, quartz, schist, slates, marble, mosaics for building, lintels not of metal, facings for buildings not of metal, refractory construction materials, not of metal, fencings not of metal, window frames not of metal, shutters not of metal, wood linings, windows not of metal, building paper, parquet flooring, sand for building, tiles not of metal, slabs not of metal, floors not of metal, structural shapes for building not of metal, pipes not of metal, roof gutters not of metal, stairs not of metal, plywood, ceilings not of metal, scantlings, artificial stone, wall

linings not of metal, sawn timber, terra cotta, rubble, reeds for building, limestone, lime, grouts, jalousies not of metal, gravel.

35 – Services of import-export agencies, services of advertising agencies, shop windows dressing, distribution of advertising materials, demonstration of goods, distribution of samples, advertising; sale services in department stores or supermarkets, sale services in stores and/or wholesale firms, sale services via tele-shopping system and on-line sale, mail order sale or sale by means of telecommunication such articles as: chemical products for protection and maintenance of vehicles, antifreezes, stain-preventing chemicals for use on fabrics, hydraulic fluids containing brake fluid, power steering fluids, transmission fluids, engine cooling fluids, brake fluids, chemical additives and modifiers for oils, chemicals for removing oils, chemical preparations for coloring enamels and glass, concrete binders, cobblestone preservatives, concrete-aeration chemicals, concrete preservatives (except paint and oils), masonry preservatives (except paints and oils), wood-impregnating chemicals, masonry-impregnating chemicals, plasticizers for concrete and mortars, anhydrites, brickwork preservatives (except paints and oils), cement preservatives (except paints and oils), roofing-tile preservatives (except paint and oils), cement-waterproofing preparations (except paints), preparations against moisture used in masonry (except paints), preparations for removing boiler scale, fireproofing preparations, anti-boil preparations for engine coolants, ceramic materials, especially for use as filtering media, ceramic glazes, acid-proof chemical compositions, chemical reagents other than for medical or veterinary use, industrial chemicals, chemical chimney cleaners, distilled water, enamel-tarnishing chemicals, glass and carpenter's putty, oil putty, adhesives for industrial purposes, adhesives for wall tiles, adhesives for wall papers, adhesives for parquetry, adhesives for skiltings, adhesives for flooring, two-component adhesives for ceramics, adhesives other than for paper or household purposes, montage adhesives, preparations for bonding and/or priming, wallpaper-removing preparations, self-leveling and filling the ground substances, solvents for varnishes, silicones, fungicides, acids, unprocessed acrylic resins, unprocessed artificial resins, unprocessed epoxy resins, unprocessed synthetic resins, damp-proofing preparations for masonry, masonry preservatives (except paint and oils), stain-preventing chemicals for use on fabrics, textile-impregnating chemicals, colorants or paints, leather dyes, dyes for industrial purposes, wood stains, stains for leather, floor stains, mordant, enamels, enamels for painting, silver emulsions, paints, enamel paints, fireproof paints, ceramic paints, water distempers or casein paints, wood coating paints, roofing coating paints, paint coatings used for coating roofs, bactericidal paints, anti-rust paints, anti-fouling paints,

varnishes, parquets lacquers, varnishes for wood, varnishes for floor, black Japan, minium, white wash, anti-rust oils, oils for the preservation of wood, pigments, pigments for concrete and mordant, coatings for roofing, anti-rust preparations for metals, preparations for protecting against corrosion, preparations for protecting against water, undercoating for vehicle chassis protecting them against corrosion, aluminium powder for painters, thinners for paints and lacquers, anti-rust greases, anti-corrosive preparations, anti-corrosive bands, fixatives for paints and lacquers, binding preparations for paints, turpentine as a thinner for paints and lacquers, thickeners for paints and lacquers, raw natural resins, wood preservatives, cleaners for showers, joints, ceramic tiles, baths with hydromassage, ceramic toilet and bathrooms devices, household equipment and appliances such as: refrigerators and microwaves, plastics, leather, wooden furniture, fireplace glasses, windows and mirrors, grills, fireplaces, clinker, plastic panels and parquets, carpets and floor coverings, polishers, scouring preparations, wiping preparations, preparations for cleaning bathrooms and kitchens, air fragrance preparations for toilets, gels and pellets for unblocking drain pipes, preparations for cleaning drainage pipes, rust removing preparations, detergents other than for use in manufacturing operations and other than for medical purposes, paint-removing preparations, varnish-removing preparations, dust-removing preparations, scale-removing preparations for household purposes, preservatives for leather (polishes), abrasive cloths, preparations to make shine the leaves of plants, washing preparations, soaps, oils for clearing purposes, color-removing preparations, tripoli stone for polishing, abrasive paper, sand paper, preparations for cleaning waste pipes, wallpaper cleaning preparations, degreasers other than for use in manufacturing processes, chemical substances for laundry, preparations for scrubbing floors, toiletries such as: soaps, detergents, shower gels, bath salts, means for burnishing, washing soda, bleaching soda, windscreen washer liquids for windows and mirrors, non-slipping liquids for floor, glass papers, scented water, preparations for grinding, stain removers, car upholstery stain removers, preparations for removing stains, wax for furniture, non-slipping wax for furniture, polishing wax, pasts for floor and furniture, furniture cleaning lotions, preparations for polishing tiles and stone, car shampoos, scented sachets for cars, car care kits, preparations for removing stickers, turpentine for degreasing, parquet wax, floor wax, fabric softeners for laundry use, laundry glazes, preparations for cleaning hands, solvents for removing paints and varnishes, petrol, wood briquettes, combustible briquettes, coal briquettes, denatured alcohol, firewood, oils for paints, oils for the preservation of masonry, motor oils, lubricating oils, kerosene, naphtha, castor oil for technical purposes, fuel

oil, combustible oils, industrial oils, moistening oils, penetrating oils, canned oils and greases in the form of aerosol used to prevent rust, removing rust and moisture and for lubrication, lubricating greases, fuel, light fuel, mineral fuels, paraffin, lubricants, car greases, candles, wax candles, illuminating wax, dust-removing preparations, dust-binding compositions for sweeping, non-chemical additives to motor fuels, firelighters, paper slips for lighting, charcoal for lighting, wood spills for lighting, graphics, aquarelles, blotters, table linen of paper, flower-pot covers of paper, inks, filter paper, photographs, picture frames, paper and cardboard and articles made of these materials, adhesives for stationery or household purposes, adhesives for paper or for household purposes, tracing needles for drawing purposes, templates for copying drawings, canvas for painting, pictures, painters' brushes, supports for the hand of the painter, painters' easels, house painters' rollers, printing blocks, modeling materials, stationery, pastels, paintbrushes, roller-shade of paper, drawings, table napkins of paper, templates, adhesive tape, paper packaging, garbage bags, ink for stamps, paper curtains, marking chalk, stickers, labels not of textile, non-conducting materials for retaining heat, threads of plastic, products for insulation, insulating paints, insulating varnishes, insulating felt, asbestos felt, insulating foil, flexible tubes not of metals, substances for insulating buildings against moisture, insulating materials, insulating refractory materials, sealing materials, sealing compounds, insulating sealing compounds, insulating oils, insulating tapes, insulating fabrics, fibreglass fabrics for insulation, insulating plasters, insulators, insulating metal-foils, asbestos, lute, caoutchouc, rubber, cords of rubber, mineral wool, insulating paper, pipe accessories not of metal, self-adhesive tapes other than stationery and not for medical or household purposes, weatherstripping, plastic foils other than for wrapping, seals, chemical compositions for repairing leaks, glass-wool for insulation, alabaster, arbours structures not of metal, balustrades, swimming pool structures not of metal, beams not of metal, concrete, shuttering for concrete not of metal, concrete building elements, building glass, bituminous coatings for roofing, bituminous products for building, bituminous products for insulation, bitumen, asphalt, tars, wainscotings not of metal, gates not of metal, building timber, building materials not of metal, building panels not of metal, building stone, bricks, building cement, cement slabs, fireproof cement coatings, pipes not of metal, hips for roofing, roofing slates, roofing coatings not of metal, roof-tiles not of metal, boards, timber, doors not of metal, work of art of stone, concrete or marble, felt for building, veneers, clay, gypsum, bituminous shingles, granite, cornices not of metal, works of stonemasonry, stone, sandstone pipes, paperboard for building, clinker ballast, mantelpieces not of metal, chimney shafts not of metal,

chimneys not of metal, composed cork, lattices not of metal, trellises not of metal, quartz, schist, slates, marble, mosaics for building, lintels not of metal, facings for buildings not of metal, refractory materials, fencings not of metal, window frames not of metal, shutters not of metal, wood linings, windows not of metal, building paper, parquet flooring, sand for building, tiles not of metal, slabs not of metal, floors not of metal, structural shapes for building not of metal, pipes not of metal, roof gutters not of metal, stairs not of metal, plywood, ceilings not of metal, scantlings, artificial stone, wall linings not of metal, sawn timber, terra cotta, rubble, reeds for building, limestone, lime, grouts, jalousies not of metal, gravel.

(260) AM 2016 85477 A

(800) 1280076

(891) 2015 05 25

(731) INDESIT COMPANY S.P.A.

Viale Aristide Merloni, 47, I-60044 Fabriano (AN), Italy

(540)



(591) black and white

(511)

7 – Electric household appliances in particular dish-washing machines for household purposes; electric whisks for household purposes, electric crushers for household purposes; washing machines, dishwashing machines, washing machines (laundry), washer-dryers; mixers (machines); food and drink mixers; food processing machines and electric kitchen utensils; mincers, electric apparatus and machines for shredding, grating, grinding, crushing, grinding, pressing, mashing, cutting, slicing, kneading, blending, whipping, beating, mixing or peeling foods, including electric kitchen machines; coffee grinders, electric; coffee grinders; grinders; beaters; mixers; mixing machines; centrifugal juicers for juices, fruit and vegetable extracts; electric dough makers; food processors (robots); peelers (machines); food washing machines; mixers; slicers, electrical power utensils, tin openers, knife sharpeners and machines and apparatus for preparing beverages or food, mechanical filling devices (filling apparatus); electric apparatus for making foam in milk; coffee foamers (electric); electric apparatus for waste disposal, namely waste grinders and compactors; ironing machines, rotary steam presses, portable, for fabrics; electric window cleaning equipment and electric shoe cleaning apparatus, and extractors, wet extractors, dry extractors; machines and apparatus for cleaning, electric, including vacuum cleaners; polishers; beater bar vacuum cleaners, electric steam-

cleaning apparatus; polishing discs for electric floor polishers; motors and engines, including electric, (except for land vehicles); compressors for refrigeration and air conditioning; electric pumps; condensing installations; automatic distributors; coffee vending machines; spin dryers; valves [parts of machines]; parts and fittings for the aforesaid goods included in this class.

9 – Communications apparatus; remote control apparatus for electric household appliances of all kinds; data processing apparatus and computers; computer programs, peripheral devices, computer peripheral devices; electric timers; devices for calculating time; programmable timers; thermometers; measuring glasses, measuring spoons; scales; electric controlling devices; thermostats; computer hardware; computer software; software for computers and other electronic devices; computers for controlling electric household appliances of all kinds and lighting apparatus; remote control apparatus; door closer circuits; control panels; interfaces, and input and output devices, including keyboards and screens; remote controls; telephones, mobile telephones; telephone receivers and transmitters; transmitters (telecommunication); audio and video receivers; frequency meters; central processing units; data processing apparatus and programs for controlling and using electric household appliances; printed circuits; integrated circuits; heat regulating apparatus; optical scanners, computer printers; computer monitors; video screens; data processing devices and programs for controlling and managing electric household appliances, small electric household appliances and lighting; communications devices; transmitter/receivers and/or transmitter/receiver sets; televisions; video cameras; high fidelity stereo installations; amplifiers; loudspeakers, overhead projector devices; video recorders; digital cameras; sensors; alarms; fire-extinguishing apparatus; magnetic filters; transformers; parts and fittings for all the aforesaid goods included in this class.

11 – Electric household appliances, in particular hot-plates for household purposes; electric heating apparatus; electric refrigerators for household purposes; electric roasters for household appliances; cooker hoods; ventilation hoods; hood dryers; apparatus for heating, steam generating, cooking, apparatus for cooking, baking, roasting, frying, grilling, toasting, refrigerating, freezing, defrosting and heating, immersion heaters, self-heating saucepans, electric waffle irons; cooking utensils, electric, ovens, hobs, built-in hobs, induction cooking apparatus, barbecues, electric devices for cooking, microwave ovens, stoves, toasters, grills, electric griddles, hotplates, steam apparatus (cooking); rice cookers; pasta cookers; rotisseries; convection cookers; egg boilers, heaters for feeding bottles, bread-making machines; coffee machines, coffee roasters; espresso machines,

electric coffee percolators; cappuccino machines; sandwich makers; pizza-making machines; electric frying pans, slow cookers; electric yoghurt makers; sorbet makers; ice cream makers; pancake-making apparatus; apparatus for making waffles; kettles, electric; kettles; electric machines for making hot drinks; apparatus for the preparation and distribution of soups and cold drinks and/or food, electric pressure cookers; deep fryers; refrigerators; portable refrigerators; refrigerating cabinets; freezers; refrigerating showcases; refrigerating cabinets; coolers for beverages, combined fridge/freezer apparatus, freezers; temperature controlled electric wine cellars; apparatus and machines for making ice; apparatus for drying, in particular including steam dryers, hand dryers, electrical apparatus for body, hair and beauty care, hair dryers; apparatus for ventilating, in particular ventilators, filters, fume extraction apparatus and extractor units, extractor units for kitchens; air conditioning apparatus and apparatus for improving air quality, humidifiers, dehumidifiers; air conditioners; air deodorising apparatus, scent dispensers (not for personal use); ventilators, portable electric fans, burners (ovens), heat exchangers not being parts of machines; air and water purifying apparatus and machines; filtration apparatus for refrigerator water; reverse osmosis apparatus for use in water treatment apparatus; hot, cold, boiling, sparkling and filtered water distributing apparatus; air and water conditioning apparatus and machines; water heaters, storage heaters, instantaneous water heaters; sinks; taps; kitchen sinks; heat pumps; feeding apparatus for heating boilers; thermostatic valves [parts of heating installations]; parts and fittings for the aforesaid goods included in this class.

(260) AM 2016 85478 A

(800) 1280107

(891) 2015 07 10

(731) BLUE WATER HOLDING A/S

Trafikhavnskaj 11, Postbox 515, DK-6700

Esbjerg, Denmark

(540)



(591) Blue and white

(511)

35 – Business support, management and administration relating to shipping and arrangement of transportation, including preparation of documents regarding shipping and arrangement of transportation as well as preparation of harbor and customs documents; business support, management and administration relating to operation of ships and offshore installations; budgetary control and cost analysis

services in relation to procurement services for others; import-export agencies; wholesale and retail services, including via the Internet, in relation to goods of any kind for use by ship's crews, offshore crews and passengers and for use in the operation of ships and offshore installations and their equipment and installations, including provisions, technical articles, replacement parts, equipment and supplies; procurement services for others in relation to goods of any kind for use by ship's crews, offshore crews and passengers and for use in the operation of ships and offshore installations as well as their equipment and installations, including provisions, technical articles, replacement parts, equipment and supplies; business consultancy and advice in relation to procurement services; professional business consultancy and business administration in connection with localization of freight and goods via computer.

36 – Insurance services relating to transportation of goods; customs brokerage, including preparation of export certificates; customs brokerage, including assistance with management and submission of papers, certificates and documents relating to security for goods, customs clearance, logistics and arrangement of transportation.

39 – Shipping services; freight-forwarding services; arrangement of transportation; air freight; travel arrangement; freight forwarding agency services at the ports; assistance relating to the reservation and booking of travel and transportation of goods also offered via global networks; transportation of large constructions and temperature-controlled transportation; packaging and storage of goods; storage facilities for handling and storage of cargoes; refrigerated storage services; providing cold stores and refrigerating store rooms; storage, warehousing and distribution of goods for others, including food storage services; advisory services regarding shipping services, freight-forwarding services and arrangement of transportation, including advisory services relating to storage of goods; packing and marking of freight shipments; freight forwarding and logistics, including maritime logistics; international road transport services; haulage; national transportation of freight; heavy-duty equipment transportation; transportation of foodstuffs; refrigerated transport of cold and frozen goods; transportation of fish; removal package transport; combined transport; messenger courier services; cargo handling; freight planning; rental of warehouses, store rooms, cold stores and tank storage; container rental and transportation of containers; logistics services relating to shipment and transportation and storage; stevedoring (cargo loading and unloading); shipbroking services; freighting of ships; overseas shipping; bonded storage; project management in relation to arrangement of transportation; transportation of goods of any kind

for use by ship's crews, offshore crews and passengers and for use in connection with the operation of ships and offshore installations as well as their equipment and installations, including provisions, technical articles, replacement parts, equipment and supplies.

---

(260) AM 2016 85479 A

(800) 1280136

(891) 2015 09 29

(731) ADP GAUSELMANN GMBH

Merkur-Allee 1-15, 32339 Espelkamp,  
Germany

(540)

## **Black Hole**

(511)

9 – Scientific, nautical, surveying, photographic, cinematographic, optical, weighing, measuring, signalling, checking (supervision), life-saving and teaching apparatus and instruments; apparatus and instruments for conducting, switching, transforming, accumulating, regulating or controlling electricity; apparatus for recording, transmission or reproduction of sound or images; magnetic data carriers, recording discs; compact discs, DVDs and other digital recording media; cash registers, calculating machines, data processing equipment, computers; computer software; fire-extinguishing apparatus; musical jukeboxes and parts for the aforesaid automatic machines; automatic cash dispensers, automatic money counting and money changing machines; mechanisms for coin-operated apparatus; computer and video games software; games software for use on any computer platform, including electronic entertainment and games consoles; computer games (programs for-); computer games; video games (software); computer games provided through a global computer network or supplied by means of multi-media electronic broadcast or through telecommunications or electronic transmission or via the internet; computer games, leisure and recreational software, video games and computer software, all provided in the form of storage media; programs for operating electric and electronic apparatus for games, amusement and/or entertainment purposes; automatic lottery machines; computer software for computer games on the internet; online games (software); computer software in the form of an app for mobile devices and computers; calculating apparatus in coin-operated machines and parts for the aforesaid goods; apparatus for recording, transmission, processing or reproduction of data, including sound or images, including parts for all the aforesaid goods, except radio sets, television receivers, hi-fi systems, video recorders, telephone apparatus, fax machines and telephone answering machines; computer hardware and software for casino and amusement arcade

games, for gaming machines, slot machines or video lottery gaming machines or games of chance via the internet; electric, electronic, optical or automatic apparatus, for identifying data carriers, identity cards and credit cards, bank notes and coins; electric, electronic or optical alarm and monitoring installations, including video cameras and apparatus for image transmission and image processing; data processing equipment and computers, including data processing apparatus and computers being components for data networks and parts facilitating data network communications; electric wiring harnesses; circuit boards, printed board assemblies (electronic components) and combinations thereof, being assemblies and equipment parts, included in this class.

28 – Games; toys; gymnastic and sporting articles not included in other classes; decorations for christmas trees; gaming apparatus (including coin-operated apparatus); coin-operated arcade games (machines); games for amusement arcades (included in this class); coin-operated video gaming apparatus; video games apparatus adapted for use with external screens or monitors only; casino fittings, namely roulette tables, roulette wheels; coin-operated automatic gaming machines and gaming machines, in particular for gaming arcades, with or without a prize payout; electronic or electrotechnical gaming apparatus, gaming machines, games machines and slot machines operated by coins, tokens, banknotes, tickets or by means of electronic, magnetic or biometric storage media, in particular for commercial use in casinos and amusement arcades, with or without a prize payout; automatic gaming machines and gaming machines, in particular for commercial use in casinos and gaming arcades, with or without a prize payout; coin-operated gaming machines and/or electronic money-based gaming apparatus (machines), with or without prizes; housings adapted for gaming machines, gaming apparatus and automatic gaming machines, operated by means of coins, tokens, tickets or by means of electronic, magnetic or biometric storage media, in particular for commercial use in casinos and gaming arcades, with or without a prize payout; electronic games; apparatus for electronic games and parts thereof; video output game machines; drawing apparatus for prize games and lotteries, draws or raffles; housings of metal, plastic and/or wood for coin-operated automatic machines; apparatus for games (including video games), other than adapted for use with external screens or monitors only; electropneumatic and electric slot machines with pulling handles (gaming machines); gaming tables, in particular for table football, billiards, sliding games; quoits (playthings) and darts; gaming machines, namely, electric, electronic or electromechanical apparatus for bingo games, lotteries or video lottery games and for betting offices, connected or unconnected to a computer network; LCD games consoles; automatic gaming machines; automatic

gaming machines operating in networks; apparatus and devices for accepting and storing money, being fittings for the aforesaid automatic machines, included in this class.

41 – Education; providing of training; entertainment; sporting and cultural activities; rental of automatic slot machines and entertainment machines for casinos; arranging and conducting games; gambling; operating lotteries; online game services provided via the internet, including online and being applications for smartphones; online game services provided via a computer network; provision of entertainment and/or educational content for apps for mobile devices and computers; conducting quizzes by means of smartphone applications; providing casino facilities (gambling), betting offices; operating gaming establishments, arcades and/or online internet casinos and betting platforms; gambling services via the internet.

(260) AM 2016 85480 A

(800) 1280138

(891) 2015 09 17

(731) Industria de Diseño Textil, S.A. (Inditex S.A.)  
Avenida de la Diputación, Edificio Inditex,  
E-15142 Arteixo (A Coruña), Spain

(540)

## JOIN LIFE ZARA

(511)

18 – Leather and imitation leather; animal skins; trunks and suitcases; umbrellas and parasols; walking sticks; whips, harness and saddlery; bags; travel bags; handbags; multipurpose bags, Boston bags; tote bags, envelopes [leatherware]; bags for climbers, campers and the beach; handbag frames; frames for umbrellas or parasols; alpenstocks; bags for sports; net bags for shopping; bags [envelopes, pouches] of leather, for packaging; travel cases and key cases [leatherware]; attaché cases; coin purses, not of precious metal; hat boxes of leather; sling bags for carrying infants; wheeled shopping bags; boxes of leather or leatherboard; boxes of vulcanized fiber; card cases (notecases); wallets; satchels [handbags]; school satchels; vanity cases; collars for animals; dog leashes; leather laces; umbrella covers; covers for horse-saddles; haversacks; backpacks; reins for horses; leather thread; suitcase handles; handles for walking sticks and umbrellas; whips; horse blankets; furniture coverings of leather; clothing for pets; umbrella rings; blinkers [harness]; harness for animals; harness for animals; harness fittings; walking-stick seats; bandoliers of leather; empty tool bags of leather; muzzles; bridles [harness]; halters; leather board; bands of leather; traveling trunks; shopping bags; straps for soldiers' equipment; harness straps; straps of leather [saddlery]; straps for skates; trimmings of leather for furniture; leather straps; leather butt hides; curried skins; fur coverings and covers

for animals; stirrups; parts of rubber for stirrups; bits for animals (harness); reins; attaché cases; moleskin (imitation leather); furs; animal skins; chamois leather other than for cleaning purposes; nosebags; casings, of leather, for springs; knee-pads for horses; horse riding saddles; fastenings for saddles; straps (harnesses); valves of leather.

25 – Clothing, footwear, headgear; clothing for motorists and cyclists; bibs not of paper; headbands [clothing]; bath robes; bathing suits; bathing caps and sandals; boas (mufflers); sports shoes, and beach shoes; hoods [clothing]; shawls; belts [clothing]; money belts [clothing]; wet suits for water-skiing; neckties; corsets; girdles [corsets]; fur stoles; scarves; caps [headwear]; caps; gloves [clothing]; raincoats; girdles (underwear); body linen [garments]; mantillas; stockings; socks; neckerchiefs; furs (clothing); pajamas; soles for footwear; heels; veils [clothing]; suspenders; layettes [clothing]; capes; sports jerseys; mittens; ear muffs [clothing]; inner soles; cuffs; dress shields; beachwear; dressing gowns, housecoats [overalls]; pockets for clothing; sock suspenders; stocking suspenders; petticoats; tights; leotards; aprons [clothing]; costumes; uniforms; cap peaks; wooden shoes; caps; coats; esparto for shoes or sandals; non-slip devices for footwear; bath gowns (bathrobes); bath slippers; caps (headwear); blouses; teddies [undergarments]; berets; footmuffs, not electrically heated; lace boots; boots; boot uppers; studs for football boots; half-boots; fittings of metal for footwear; toe caps for footwear; heelpieces for footwear; shirts; shirt yokes; shirt fronts; T-shirts; short-sleeved tee-shirts; bodices [lingerie]; vests; jackets; fishing vests; stuff jackets; slips [undergarments]; ready-made clothing; detachable collars and collars; clothing of leather; clothing of imitation leather; shower caps; slippers; skirts; trousers; ready-made linings [parts of clothing]; top coats; gabardines [clothing]; gymnastic shoes; jerseys [clothing]; pullovers; sweaters; liveries; muffs [clothing]; footwear uppers; pocket squares [clothing]; parkas; pelerines; pelisses; puttees and tights; knitwear [clothing]; clothing for gymnastics; underwear; sandals; saris; underpants; hats; wimples [clothing]; togas; trouser straps; suits; turbans; dresses; slippers; shoes.

(260) AM 2016 85484 A

(800) 1280213

(891) 2015 11 04

(731) HOFERO LIMITED

Archbishop Makariu III, 223, Court Avenue,  
2 floor, CY-3105 Limassol, Cyprus

(540)



(591) black and white

(511)

9 – Plates for batteries; accumulators, electric; chargers for electric batteries; battery boxes; grids for batteries; accumulators, electric, for vehicles; battery jars; batteries for lighting; batteries, electric.

(260) AM 2016 85485 A

(800) 1280217

(891) 2015 10 13

(731) KOLTIV CONSULTANTS LIMITED

Gr. Xenopoulou, 17, CY-3106 Limassol,  
Cyprus

(540)



клубмаркет

(591) black and white

(511)

29 – Ajvar [preserved peppers]; aloe vera prepared for human consumption; alginates for culinary purposes; anchovy; peanuts, prepared; artichokes, preserved; eggplant paste; vegetable marrow paste; albumen for culinary purposes; white of eggs; beans, preserved; soya beans, preserved, for food; bouillon; ginger jam; ham; fatty substances for the manufacture of edible fats; toasted laver; edible birds' nests; peas, preserved; mushrooms, preserved; game, not live; gelatine; meat jellies; jellies for food; fruit jellies; yolk of eggs; coconut fat; bone oil, edible; lard; suet for food; edible fats; fruit-based snack food; charcuterie; raisins; caviar; fish roe, processed; yogurt; sauerkraut; kephir [milk beverage]; isinglass for food; clams, not live; milk shakes; black pudding [blood sausage]; compotes; meat, tinned [canned (Am.)]; vegetables, tinned [canned (Am.)]; fish, tinned [canned (Am.)]; fruits, tinned [canned (Am.)]; bouillon concentrates; gherkins; shrimps, not live; prawns, not live; buttercream; croquettes; silkworm chrysalis, for human consumption; kumys [kumyss] [milk beverage]; spiny lobsters, not live; lecithin for culinary purposes; salmon, not live; onions, preserved; margarine; piccalilli; marmalade; edible oils; peanut butter; cocoa butter; coconut oil; coconut butter; corn oil; sesame oil; linseed oil for culinary purposes; olive oil for food; palm oil for food; palm kernel oil for food; sunflower oil for food; colza oil for food; butter; shellfish, not live; almonds, ground; animal marrow for food; mussels, not live; milk; peanut milk for culinary purposes; milk of almonds for culinary purposes; rice milk [milk substitute]; albumin milk; soya milk [milk substitute]; condensed milk; fish meal for human consumption; vegetable mousses; fish mousses; fruit pulp; meat; meat, pre-

served; milk beverages, milk predominating; vegetables, preserved; vegetables, cooked; vegetables, dried; potato fritters; olives, preserved; lobsters, not live; coconut, desiccated; nuts, prepared; liver pâté; pectin for culinary purposes; liver; pickles; jams; powdered eggs; milk products; kimchi [fermented vegetable dish]; foods made from fish; prostokvasha [soured milk]; poultry, not live; pollen prepared as foodstuff; cranberry sauce [compote]; apple purée; crayfish, not live; crustaceans, not live; fish, not live; fish, preserved; salted fish; ryazhenka [fermented baked milk]; vegetable salads; fruit salads; bacon; sardines, not live; pork; herrings, not live; seeds, prepared; sunflower seeds, prepared; whipped cream; cream [dairy products]; smetana [sour cream]; fat-containing mixtures for bread slices; tomato juice for cooking; vegetable juices for cooking; salted meats; sausages; sausages in batter; preparations for making bouillon; preparations for making soup; tripe; soups; vegetable soup preparations; whey; cheese; tahini [sesame seed paste]; tofu; sea-cucumbers, not live; truffles, preserved; tuna, not live; oysters, not live; milk ferments for culinary purposes; rennet; fish fillets; dates; crystallized fruits; frozen fruits; fruit, preserved; fruit preserved in alcohol; fruit, stewed; potato flakes; hummus [chickpea paste]; fruit peel; preserved garlic; lentils, preserved; potato chips; low-fat potato chips; fruit chips; non-alcoholic eggnog; seaweed extracts for food; meat extracts; eggs; snail eggs for consumption; tomato purée; curd.

30 – Aromatic preparations for food; flavorings [flavourings], other than essential oils, for cakes; flavorings [flavourings], other than essential oils, for beverages; food flavorings, other than essential oils; coffee flavorings [flavourings]; star aniseed; cereal bars; pancakes; noodle-based prepared meals; buns; bread rolls; vareniki [stuffed dumplings]; vanillin [vanilla substitute]; vanilla [flavoring] [flavouring]; waffles; vermicelli [noodles]; natural sweeteners; sausage binding materials; binding agents for ice cream [edible ices]; sea water for cooking; seaweed [condiment]; malt biscuits; cloves [spice]; cake frosting [icing]; glucose for culinary purposes; mustard; gluten additives for culinary purposes; yeast; thickening agents for cooking foodstuffs; leaven; rice-based snack food; cereal-based snack food; artificial coffee; vegetal preparations for use as coffee substitutes; dressings for salad; pastries; candy decorations for cakes; confectionery for decorating Christmas trees; fruit jellies [confectionery]; cakes; peanut confectionery; almond confectionery; pasta; pâtés en croûte; ginger [spice]; frozen yogurt [confectionery ices]; cocoa; capers; caramels [candy]; curry [spice]; ketchup [sauce]; quiches; gluten prepared as foodstuff; sweetmeats [candy]; liquorice [confectionery]; peppermint sweets; cinnamon [spice]; coffee; unroasted coffee; starch for food; custard; crackers; hominy grits; semolina; oatmeal; crushed barley;

groats for human food; corn, milled; corn, roasted; meat pies; turmeric; couscous [semolina]; farinaceous foods; noodles; ice for refreshment; ice, natural or artificial; edible ices; candy; rice cakes; mayonnaise; macaroons [pastry]; macaroni; maltose; hominy; marinades; marzipan; honey; royal jelly; ice cream; bean meal; nut flours; potato flour; tapioca flour; corn flour; flour; wheat flour; soya flour; barley meal; dessert mousses [confectionery]; chocolate mousses; muesli; mint for confectionery; cocoa beverages with milk; coffee beverages with milk; coffee-based beverages; chocolate beverages with milk; chocolate-based beverages; cocoa-based beverages; tea-based beverages; infusions, not medicinal; crushed oats; husked oats; nutmegs; chocolate-coated nuts; stick liquorice [confectionery]; soya bean paste [condiment]; pastilles [confectionery]; molasses for food; pepper; allspice; peppers [seasonings]; pelmeni [dumplings stuffed with meat]; pesto [sauce]; cookies; petit-beurre biscuits; pies; pizzas; meat gravies; fondants [confectionery]; popcorn; powders for ice cream; baking powder; mustard meal; pralines; condiments; meat tenderizers, for household purposes; cereal preparations; oat-based food; propolis; gingerbread; spices; petits fours [cakes]; rice pudding; puddings; cake powder; fruit coulis [sauces]; ravioli; chewing gum; relish [condiment]; rice; wheat germ for human consumption; spring rolls; sago; sugar; palm sugar; aniseed; linseed for human consumption; golden syrup; cake dough; confectionery; baking soda [bicarbonate of soda for cooking purposes]; malt for human consumption; sherbets [ices]; salt for preserving foodstuffs; cooking salt; celery salt; ham glaze; soya sauce; tomato sauce; sauces [condiments]; pasta sauce; spaghetti; seasonings; preparations for stiffening whipped cream; rusks; breadcrumbs; sushi; sandwiches; tabbouleh; tacos; tapioca; cream of tartar for culinary purposes; tarts; dough; almond paste; tortillas; garden herbs, preserved [seasonings]; chocolate decorations for cakes; vinegar; beer vinegar; ferments for pastes; halvah; bread; unleavened bread; corn flakes; oat flakes; chips [cereal products]; chicory [coffee substitute]; tea; iced tea; chutneys [condiments]; cheeseburgers [sandwiches]; minced garlic [condiment]; chowchow [condiment]; saffron [seasoning]; chocolate; malt extract for food; essences for foodstuffs, except etheric essences and essential oils; husked barley.

31 – Algarovilla for animal consumption; oranges, fresh; peanuts, fresh; artichokes, fresh; draff; beans, fresh; wreaths of natural flowers; grapes, fresh; algae for human or animal consumption; fruit residue [marc]; dog biscuits; peas, fresh; mushroom spawn for propagation; mushrooms, fresh; trees; palm trees; turf, natural; unsawn timber; undressed timber; yeast for animal consumption; Christmas trees; edible chews for animals; live animals; menagerie animals; peanut cake for animals; oil

cake; maize cake for cattle; rape cake for cattle; bagasses of cane [raw material]; cereal seeds, unprocessed; grains [cereals]; grains for animal consumption; lime for animal forage; fish spawn; cocoa beans, raw; potatoes, fresh; chestnuts, fresh; copra; raw barks; rough cork; animal foodstuffs; pet food; stall food for animals; bird food; strengthening animal forage; chicory roots; roots for food; nettles; groats for poultry; maize; edible sesame, unprocessed; shrubs; rose bushes; spiny lobsters, live; lemons, fresh; vine plants; salmon, live; onions, fresh vegetables; flower bulbs; leeks, fresh; olives, fresh; products for animal litter; bran mash for animal consumption; shellfish, live; almonds [fruits]; mussels, live; peanut meal for animals; linseed meal for animal consumption; meal for animals; flax meal [fodder]; rice meal for forage; fish meal for animal consumption; straw mulch; beverages for pets; oats; vegetables, fresh; cucumbers, fresh; lobsters, live; coconuts; nuts [fruits]; kola nuts; bran; distillery waste for animal consumption; residue in a still after distillation; palms [leaves of the palm tree]; cuttle bone for birds; peppers [plants]; aromatic sand for pets [litter]; locust beans, raw; citrus fruit, fresh; mash for fattening livestock; animal fattening preparations; preparations for egg laying poultry; fishing bait, live; by-products of the processing of cereals, for animal consumption; seed germ for botanical purposes; poultry, live; wheat; pollen [raw material]; crayfish, live; crustaceans, live; seedlings; plants; aloe vera plants; plants, dried, for decoration; rhubarb, fresh; rice, unprocessed; rye; wheat germ for animal consumption; fish, live; lettuce, fresh; sardines, live; beet, fresh; herrings, live; seeds for planting; linseed for animal consumption; hay; coconut shell; bred stock; sanded paper for pets [litter]; malt for brewing and distilling; straw [forage]; straw litter; salt for cattle; trunks of trees; wood chips for the manufacture of wood pulp; litter peat; garden herbs, fresh; sea-cucumbers, live; sugarcane; truffles, fresh; tuna, live; squashes, fresh; oysters, live; fruit, fresh; hazelnuts; fodder; hops; flowers, natural; flowers, dried, for decoration; chicory, fresh; silkworms; lentils, fresh; pine cones; hop cones; spinach, fresh; garlic, fresh; berries, fresh fruits; juniper berries; eggs for hatching, fertilised; silkworm eggs; barley.

32 – Aperitifs, non-alcoholic; lithia water; seltzer water; soda water; waters [beverages]; aerated water; mineral water [beverages]; table waters; kvass [non-alcoholic beverage]; cocktails, non-alcoholic; lemonades; peanut milk [non-alcoholic beverage]; milk of almonds [beverage]; non-alcoholic beverages; isotonic beverages; non-alcoholic honey-based beverages; soya-based beverages, other than milk substitutes; aloe vera drinks, non-alcoholic; whey beverages; non-alcoholic fruit juice beverages; fruit nectars, non-alcoholic; orgeat; beer; ginger beer; malt beer; pow-



ders for effervescent beverages; sarsaparilla [non-alcoholic beverage]; syrups for lemonade; syrups for beverages; smoothies; tomato juice [beverage]; cider, non-alcoholic; vegetable juices [beverages]; fruit juices; preparations for making aerated water; preparations for making liqueurs; preparations for making mineral water; preparations for making beverages; must; grape must, unfermented; beer wort; malt wort; pastilles for effervescent beverages; sherbets [beverages]; non-alcoholic fruit extracts; extracts of hops for making beer; essences for making beverages.

33 – Aperitifs; arrack [arak]; brandy; wine; piquette; whisky; vodka; anisette [liqueur]; kirsch; gin; digesters [liqueurs and spirits]; cocktails; curacao; anise [liqueur]; liqueurs; pre-mixed alcoholic beverages, other than beer-based; alcoholic beverages, except beer; alcoholic beverages containing fruit; spirits [beverages]; distilled beverages; mead [hydromel]; peppermint liqueurs; bitters; nira [sugarcane-based alcoholic beverage]; rum; sake; perry; cider; rice alcohol; alcoholic extracts; fruit extracts, alcoholic; alcoholic essences.

35 – Arranging subscriptions to telecommunication services for others; import-export agencies; commercial information agencies; advertising agencies; cost price analysis; rental of advertising space; business auditing; employment agencies; computerized file management; book-keeping; invoicing; business efficiency expert services; demonstration of goods; transcription of communications [office functions]; opinion polling; marketing studies; business information; commercial information and advice for consumers [consumer advice shop]; business investigations; marketing research; business research; personnel recruitment; business management and organization consultancy; business organization consultancy; business management consultancy; personnel management consultancy; professional business consultancy; layout services for advertising purposes; marketing; business management of performing artists; business management of sports people; writing of résumés for others; news clipping services; updating of advertising material; word processing; organization of exhibitions for commercial or advertising purposes; arranging newspaper subscriptions for others; organization of fashion shows for promotional purposes; organization of trade fairs for commercial or advertising purposes; shop window dressing; design of advertising material; business appraisals; payroll preparation; data search in computer files for others; sponsorship search; business management assistance; commercial or industrial management assistance; presentation of goods on communication media, for retail purposes; provision of an online marketplace for buyers and sellers of goods and services; economic forecasting; auctioneering; retail services or wholesale services for pharmaceutical,

veterinary and sanitary preparations and medical supplies; sales promotion for others; retail and wholesale store service; retail and wholesale club store service; production of advertising films; office machines and equipment rental; rental of advertising time on communication media; publicity material rental; rental of billboards [advertising boards]; rental of vending machines; rental of photocopying machines; publication of publicity texts; radio advertising; bill-posting; distribution of samples; dissemination of advertising matter; direct mail advertising; writing of publicity texts; advertising; on-line advertising on a computer network; advertising by mail order; television advertising; document reproduction; compilation of statistics; compilation of information into computer databases; business inquiries; systemization of information into computer databases; advisory services for business management; tax preparation; drawing up of statements of accounts; telemarketing services; psychological testing for the selection of personnel; business management of hotels; commercial administration of the licensing of the goods and services of others; administrative processing of purchase orders; outsourced administrative management for companies; business management of reimbursement programs for others; public relations; modelling for advertising or sales promotion; typing; relocation services for businesses; tax filing services; secretarial services; price comparison services; procurement services for others [purchasing goods and services for other businesses]; short-hand; outsourcing services [business assistance]; telephone answering for unavailable subscribers; photocopying services.

43 – Accommodation bureaux [hotels, boarding houses]; rental of temporary accommodation; rental of meeting rooms; tourist homes; hotel reservations; boarding house bookings; temporary accommodation reservations; hotels; retirement homes; snack-bars; cafés; cafeterias; motels; boarding houses; boarding for animals; rental of cooking apparatus; rental of chairs, tables, table linen, glassware; rental of tents; rental of transportable buildings; rental of drinking water dispensers; rental of lighting apparatus; restaurants; self-service restaurants; canteens; holiday camp services [lodging]; bar services; providing campground facilities; food and drink catering; day-nurseries [crèches].

---

(260) AM 2016 85507 A

(800) 1280722

(891) 2015 10 28

(731) APPLE INC.

1 Infinite Loop, Cupertino CA 95014, USA

(540)

CloudKit

(591) Black, white  
(511)  
42 – Electronic data storage services.

(260) AM 2016 85511 A  
(800) 1280820  
(891) 2015 11 16  
(731) BRIDGEWATER CHOCOLATE, LLC  
599 Federal Road, Brookfield CT 06804, USA

(540)  
**BRIDGEWATER  
CHOCOLATE**

(591) Black, white  
(511)  
30 – Candy and chocolates.

35 – Retail and online ordering and store services featuring candy and chocolates also accessible by telephone, facsimile and mail order; catalog ordering services featuring candy and chocolates.

(260) AM 2016 85512 A  
(800) 1280843  
(891) 2015 11 02  
(731) SWATCH AG (SWATCH SA)(SWATCH LTD.)  
Jakob-Stämpfli-Strasse 94, CH-2502  
Biel/Bienne, Switzerland

(540)  
Tick different

(591) Black, white  
(511)  
9 – Apparatus for recording, transmission and reproduction of sound or images; electronic payment processing apparatus, apparatus for processing cashless payment transactions; magnetic recording media, sound recording disks; compact disks, DVDs and other digital recording media; apparatus enabling the playing of compressed sound files (MP3); calculating machines and data processing equipment, software; game software for mobile telephones, for computers and for digital personal stereos; electronic game software for mobile telephones, for computers and for digital personal stereos; computers, portable computers, handheld computers, mobile computers, personal computers, wrist computers, electronic tablets and mobile and computer devices, digital personal stereos, mobile telephones and new-generation mobile telephones incorporating greater functionality (smartphones); telecommunication apparatus and instruments; apparatus for recording, transmission, reproduction of sound or images, particularly mobile telephones and new-generation mobile telephones incorporating greater functionality (smartphones); handheld electronic apparatus for accessing the Internet and

sending, receiving, recording and storing of short messages, electronic messages, telephone calls, faxes, video-conferences, images, sound, music, text and other digital data; handheld electronic apparatus for wireless receiving, storing and transmitting of data or messages; handheld electronic apparatus for monitoring and organizing personal information; handheld electronic apparatus for global positioning [GPS] and displaying maps and transport information; handheld electronic devices for detecting, monitoring, storing, surveillance and transmitting data relating to the user activity, namely position, itinerary, distance traveled, heart rate; covers for computers, portable and mobile telephones; optical apparatus and instruments, particularly spectacles, sunglasses, magnifying glasses; cases for spectacles, sunglasses and magnifying glasses; batteries for electronic apparatus and computers, batteries for timepieces and chronometric instruments.

(260) AM 2016 85513 A  
(800) 1280871  
(891) 2015 08 05  
(731) APPLE INC.  
1 Infinite Loop, Cupertino CA 95014, USA

(540)  
The logo consists of the Apple logo (a silhouette of an apple with a bite taken out) followed by the word "MUSIC" in a bold, black, sans-serif font.

(591) Black, white  
(511)  
45 – Social networking services; providing social networking services via a website.

(260) AM 2016 85515 A  
(800) 1280897  
(891) 2015 10 15  
(731) Zakrytoe aktsionernoe obshchestvo  
"MOSKOVSKAYA PIVOVARENNAYA  
KOMPANIYA"  
Vokzalnaya pl., 2, RU-141009 Mytichtchi,  
Moskovskaya oblast, Russian Federation

(540)  
The logo features a dark blue rectangular bar at the top with the text "5 OCEAN" in white. Below this is a circular emblem with a dark blue background, containing the word "BEER" at the top, "5 OCEAN" in the center, and a large red "5" below it. A small rectangular tag with the "5 OCEAN" logo is positioned at the bottom right of the circular emblem.

(591) Red, black, beige, white  
(511)  
32 – Beers; de-alcoholized beer.

(260) AM 2016 85516 A  
 (800) 779046  
 (891) 2015 11 12  
 (731) LIUGONG DRESSTA MACHINERY Sp.  
 z o.o.  
 ul. Kwiatkowskiego 1, PL-37-450 Stalowa  
 Wola, Poland

(540)



(591) Black and blue

(511)

7 – Earth movers, road making plant, mining machines, crawler dozers, wheel dozers, crawler loaders, wheel loaders, motor graders, crawler excavators, wheel excavators, landfill application dozers, boom lifting gears, crawler pipelayers, crawler conveyor-belt movers, road-mobile cranes, truck cranes.

(260) AM 2016 85517 A  
 (800) 1280292  
 (891) 2015 11 02  
 (731) Bayer Intellectual Property GmbH BIP-IPO-GTC  
 Alfred-Nobel-Straße 10, 40789 Monheim am  
 Rhein, Germany

(540)

**ALIQOPA**

(511)

5 – Pharmaceutical preparations and substances.

(260) AM 2016 85518 A  
 (800) 1280326  
 (891) 2015 07 24  
 (731) SCHNEIDER ELECTRIC SE  
 35 rue Joseph Monier, F-92500 RUEIL-  
 MALMAISON, France

(540)



(591) Black, white

(511)

6 – Common metals and their alloys; building materials of metal; transportable structures of metal; materials of metal for railway tracks; non-electric cables and wires of metal; ironmongery and small items of metal hardware; pipes of metal; safes [strong boxes]; goods of common metal not included in other classes; ores.

7 – Starters for motors and engines; regulators (machine parts); speed regulators for machines, engines; electronic speed regulators for electric motors; electric motors and combinations thereof of variable speed drives; motor reducers to operate blinds, screens, curtains, shutters, windows, garage doors, gates, and gratings; blenders (machines); pumps (parts of machines, motors or engines); valves (parts of machines); automatic distribution machines; electric propulsion with motor drives; device for electric motor speed control.

9 – Scientific, electric, electronic apparatus and instruments for transportation, distribution, processing, storage, regulation, filtering, measuring, signaling, monitoring or control of electric current, namely, electric or electronic components for such apparatus and instruments, namely, bars for collecting electricity, electric cables, transformers, current rectifiers, semiconductors, electric relays, condensers, inductors, electric condensers, fuses, starters, timers, security switches, pressure switches, switchboards, charging centers, connection boards, switches, power monitoring equipment, equipment for measuring electricity, sensors, electric vehicles controls, speed controllers, holders for cables, wireway; automation goods, namely, digital control and communication systems, automated systems, control panels, static converters, programmers, computer hardware and software in the field of power distribution, industrial control and automation, systems providing electricity to computer, inverters (electricity), batteries, accumulators, power, filtering, transformation, maintenance and storage peripherals for electrical energy, calculators, computer hardware and information processing material in the field of power distribution, lighting controls, electric curtain drives, air-conditioning control systems consisting of digital thermostats, control apparatus for air-conditioning, heating, and ventilation; thermostats; temperature sensors; electrical plugs and sockets; electric sockets; movable sockets; multi-outlet power strips; circuit breakers, electric distribution boards for circuit breakers; electrical circuit switches; electric current switches; light switches; electric switches; switches; uninterrupted electric power supplies; emergency power supply systems; voltage surge protectors; surge protectors; transient voltage surge protectors with energy packaging technology; power conditioning apparatus; home automation systems including wireless and wired controllers, touch screens, controlled devices, and software for household appliances, apparatus for lighting, heating, ventilating, and air-conditioning, home entertainment equipment, security and other applications for monitoring and controlling household power supply; remote controls for circuit breakers; electric apparatus, namely, charging stations for charging electric vehicles; motion detectors; apparatus for converting electronic radiation to electrical energy, namely, photovoltaic solar modules;

programmable controllers and actuators for optical concentration systems for maximizing collected solar energy; security systems including software and hardware for the provision of images, videos, alarm status, building plans, and other information to a remote station; electric and electronic anti-burglar alarms; electronic door alarms; safety apparatus, namely, access control systems including touch pads and security doors, security cameras and recorders; fire alarm and emergency evacuation devices, namely, control panels for fire alarms, smoke detectors, heat detectors and sound and image alert systems; timers for controlling lighting; television antennas; parabolic antennas; computer network adapters, switches, routers, and hubs; cable connectors; computer network and telephone sockets; computer networking hardware; monitors and modules for electronic surveillance to control electricity consumption and greenhouse gas emissions; audio electronic components for household purposes, namely, ambiphony systems, speakers, receivers, tuners, amplifiers, pre-amplifiers, equalizers, record players, CD players, analog-digital converters, and network digital audio players; apparatus for control, management, and electric control of buildings, namely, apparatus and instruments for analyze, protection, inspection, measuring, signaling, regulating, setting, follow-up, maintenance, supervision, design, management, control, and remote control of lighting, heating, cooling, humidification, ventilation, air-conditioning, energy consumption, fire safety, access control, and energy management systems; electric or electronic apparatus and instruments for the control and remote control of operating motors for blinds, screens, curtains, shutters, windows, doors, garage doors, gates, and gratings; electrical actuator devices containing a motor; remote control devices; detectors; sensors; communication bus, communication networks, transmitters; apparatus for communications by computer terminals; electric apparatus including a communication interface for linking to a network for wired and wireless communications, or to a communication bus; multimedia apparatus for automated systems installation in the field of construction; programmable automatons, programmable logic modules, programmable logic controllers; communication cables and wires; equipment and apparatus for telecommunications by transmission lines and distribution of electrical energy; receiving units; data processing apparatus; electronic circuits, chips (integrated circuits), microcontrollers; electronic printed circuit cards, electronic microcircuits, execution and operation software for microcircuits or electronic cards or components; microprocessors; integrated circuit cards (smart cards); electronic labels and memory cards with data or programs used for authentication and/or access control and/or for transmitting parameters to systems in buildings; compu-

ters, software, microprocessors, microcontrollers for analysis, protection, inspection, measuring, signaling, regulating, monitoring, maintenance, supervision, design, management, control, and remote control of lighting, heating, cooling, humidifying, ventilation, air-conditioning, energy consumption, automated processes monitoring; software for communication; sockets for electric lamps; cables and power supplies.

11 – LED lighting systems, namely, LED modules; parabolic mirrors to collect solar energy (heating and cooling); solar energy heating and cooling apparatus; solar energy receivers (heating and cooling); accent interior lights; ceiling lights; wall lights; solar light apparatus, namely, indoor and outdoor solar lighting apparatus; light diffusers; light bulbs; lighting apparatus; electric radiant heaters; water heaters; exhaust fans; exhaust fans for the bathroom; ceiling fans; electric heating fans; apparatus for lighting, heating, steam generating, cooling, refrigerating, drying, ventilation, and air-conditioning of buildings, water supply, and sanitary installations; lighting systems including light sensors and switches.

37 – Construction, installation, repair, and maintenance services of equipment and installations of electrical and automated systems; construction, installation, and maintenance services of installations and equipment for research and engineering in the field of electricity, home automation installations, and automated systems; construction, installation, and maintenance services of equipment for surveillance and safety and for installations in the field of electricity, home automation installations, and automated systems; installation, maintenance, and repair of apparatus and installations for lighting, heating, cooling, humidifying, ventilation, and air-conditioning for houses and buildings; information and advice related to installation, maintenance, and repair of installations and apparatus for lighting, heating, cooling, humidifying, ventilating, and air-conditioning for houses and buildings; installation and maintenance services for all protection systems for safety installations, including via a telecommunications network; installation and maintenance of intelligent systems for buildings and individual houses; installation and maintenance of home automation installations and programmable automatic units and installations for the technical management of buildings; technical installation, maintenance, and repair services of computers and computer peripheral equipment; advice and information on construction; construction consulting.

39 – Distribution and transmission of electricity, energy distribution, electricity distribution, water supply, traffic flow management of vehicles via networks and high-end communication technologies.

42 – Advisory, consultancy, and engineering services in the the field of controls networking for house-

hold, namely, wireless and wired light controls, thermostat and heating controllers, controls for roller shutters and doors, controls for apparatus, namely, oven, washing machine, drier machines, refrigerator, dishwasher, audio and video controls for household purposes; technology planning and consulting relating to solar energy; design and control of fire alarms, detection and removal systems; performance and reliability assessment of alarm systems; integration of computer systems and networks; design and development of wired and wireless computer networks; technological support allowing users to view, monitor, program, operate, and control remotely small and large apparatus, electrical systems, and security systems in homes; household connectivity services, namely, design and development of wireless and cable networks for homes; engineering services, laboratory work, engineering work (not related to construction) in the field of electric power management and building management; research and development work and study of technical projects and new products in the field of electric power management, home automation and building management for environmental protection purposes; information in the field of research and development related to energy; consulting, expert reports and material testing in the field of electric energy management and building management; control and surveillance services for electric installations and equipment, home automation, and automated systems; building control services (technical control, quality control); quality and compliance certification; programming for computers, software creation, and database design in the field of electrical energy management and building management; design, production, and management of information and computer systems, home automation installations for programming and programmable automated systems and technical management installations for buildings; monitoring energy consumption; technical studies and advice regarding the distribution of energy consumption; technical assessments and appraisals of energy consumption.

---

(260) AM 2016 85519 A

(800) 362934

(891) 2015 11 06

(731) DCI S.A.

Route de Jussy 1-3, CH-1225 Chêne-Bourg,  
Switzerland

(540)

## 5 à sec

(511)

37 – Services of cleaning of clothes, degreasing and laundering of clothes.

40 – Services of dyeing.

---

(260) AM 2016 85520 A

(800) 1280328

(891) 2015 10 08

(731) ANIMEDICA GROUP GMBH

Im Südfeld 9, 48308 Senden-Bösensell,  
Germany

(540)

## Livisto

(511)

5 – Pharmaceutical and veterinary preparations; dietetic preparations adapted for medical purposes; disinfectants; Preparations for destroying noxious animals; medicated animal feed including additives for animal feed and supplements for animal feed; additives for animal feed for non-medical purposes [animal feed supplements]; supplements for animal feed, for non-medical and for medical purposes.

31 – Animal feed; dietetic animal feed for non-medical purposes.

---

(260) AM 2016 85521 A

(800) 1280343

(891) 2015 11 13

(731) APPLE INC.

Infinite Loop, Cupertino CA 95014, USA

(540)

## APPLE NEWS FORMAT

(511)

9 – Computer software used to create, prepare, format, update, publish, deliver, manage, and promote content for viewing on mobile devices and computers.

---

(260) AM 2016 85537 A

(800) 1226018

(891) 2015 11 05

(731) Obshchestvo s ogranichennoy

otvetstvennostyu Konditerskaya fabrika  
"POBEDA"

Ryabinovaya ul., 26, 2 stroenie, RU-121471  
Moscow, Russian Federation

(540)

## FUNNY COWS

(591) Black, white

(511)

30 – Confectionery; fruit jellies (confectionery); sweetmeats (candy); marzipan; chocolate-based beverages; chocolate.

---

(260) AM 2016 85539 A

(800) 1280592

(891) 2015 11 25

(731) APPLE INC.

1 Infinite Loop, Cupertino CA 95014, USA  
(540)

## GAMEPLAYKIT

(591) Black,white

(511)

9 – Computer software used in developing other software applications; application development software.

(260) AM 2016 85540 A

(800) 1280593

(891) 2015 11 25

(731) APPLE INC.

1 Infinite Loop Cupertino CA 95014, USA

(540)

## REPLAYKIT

(591) Black,white

(511)

9 – Computer software used in developing other software applications; application development software.

(260) AM 2016 85547 A

(800) 1280623

(891) 2015 10 13

(731) SANOFI

54 rue La Boétie, F-75008 Paris, France

(540)



(591) Blue and pink.

(511)

38 – Telecommunications, communication by telephone, radio and television and by computers via Internet sites or electronic platforms in the field of health, transmission of information in the field of health care communication aimed at patients or health professionals by means of computers, the Internet, television and radio, providing online discussion forums and electronic bulletin boards for the transmission of messages among computer users in the health and pharmaceutical field, pharmaceutical and medical developments.

41 – Organization of competitions via the Internet relating to education in the field of health and nursing care.

44 – Information and services for nurses and healthcare professionals available on a platform via the Internet or via a mobile telephone application con-

cerning the sharing of information, innovations, experiences in the field of nursing care.

(260) AM 2016 85549 A

(800) 1280645

(891) 2015 05 28

(731) SJOKLAEDAGERDIN HF.

Midhrauni 11, IS-210 Gardabae, Iceland

(540)



(591) white,Blue,zed

(511)

25 – Clothing, T-shirts, shirts, tops, sweatshirts, sweatpants, pants, shorts, trousers, vests, parkas, pullovers, anoraks, coats, jackets; jacket hoods, sweaters, coveralls, jumpers, underwear, gloves, snowboarding gloves, ski gloves, neck gaiters, gaiter straps, mittens, leg gaiters and ankle gaiters, knitwear, jerseys, children's clothing, dresses; clothing for gymnastics; outerwear, one piece shell suits for adults and children, shells, ski wear, overalls, bib pants, bib overalls, snow pants, wind-resistant jackets, snow suits; rainwear, raincoats, waterproof clothing; leggings; ponchos; pajamas; skirts; uniforms; footwear; socks, stockings, tights, shoes, athletic, shoes, sneakers, hiking shoes, boots, hiking boots, ski boots, boots for snowboarding; sandals; headgear; caps, hats, headbands, scarves, bandanas, balaclavas, visors, ear muffs, skull caps; belts.

(260) AM 2016 85550 A

(800) 1280649

(891) 2015 07 24

(731) OU ZHI XIONG

No.403, Building A1, Lane Seven

Dasongfang, Jiefang Road, Lunjiao Avenue, Shunde District, Foshan Guangdong Province, China

(540)



(591) Black,white

(511)

9 – Stabilized voltage power supply; inverters [electricity]; light dimmers [regulators], electric; voltage regulators; chargers for electric batteries; measuring devices, electric; teaching apparatus; high-frequency apparatus; control panels [electricity].

(260) AM 2016 85551 A

(800) 1280653

(891) 2015 08 10

(731) GUANGZHOU ZHONGDAI DECORATIVE BUILDING MATERIALS CO., LTD  
A21003-A21008, A21018-A21023, Small Commodities Market Xinbaijia East of Jingxi Bridge, Shatai Road, Baiyun District, Guangzhou City, Guangdong Province, China

(540)



(591) Black, white

(511)

6 – Small metal hardware items, metal sheets and plates, metal pipes, metal building materials, metal staircases, metal fittings for furniture, non-electric metal locks, metal boxes, safes, metal plates, metal screws, nails, metal welding rods, metal cages for wild animals; metal panels for metal signs, neither illuminated nor mechanical.

7 – Agricultural machines, aerating pumps for aquariums, electric arc fluid, electromechanical devices for food preparation, sewing machines, electromechanical machines for food preparation, washing machines, non-manual hand-held tools, kitchen appliances, electric vacuum cleaners, packaging machines, drill bits, grinding wheels, cutting tools including mechanical knives, spray guns for paint, electric generators, curtain drawing devices, lifting devices, stone-working machines, electric machines and devices for wax-polishing, cutting machines, electric door closers, compressors, metalworking machines, locking screws for pneumatic spray guns.

8 – Hand-operated abrading instruments, hand-operated agricultural implements, hand-operated gardening tools, harpoons for fishing, electric or non-electric hair clippers for personal use, hand-operated hand tools, flat irons, glaziers' diamonds, knives, cutlery, table cutlery, forks and spoons, hand-operated riveting machines, hand-operated guns for the extrusion of mastics, devices and instruments for slaughtering butchered animals, scissors, hand-operated lifting jacks.

19 – Wood veneers, wood paneling, non-metal water pipes, non-metal building materials, non-metal greenhouse frames, building glass.

(260) AM 2016 85562 A

(800) 1281932

(891) 2015 12 04

(731) PHILIP MORRIS BRANDS SÀRL  
Quai Jeanrenaud 3, CH-2000 Neuchâtel,  
Switzerland

(540)

*ClearSeal*

(591) Black, white

(511)

34 – Tobacco, raw or manufactured; tobacco products; cigars, cigarettes, cigarillos, tobacco for roll-your-own cigarettes, pipe tobacco, chewing tobacco, snuff tobacco, kretek; snus; tobacco substitutes (not for medical purposes); electronic cigarettes; tobacco products for the purpose of being heated; electronic devices and their parts for the purpose of heating cigarettes or tobacco in order to release nicotine-containing aerosol for inhalation; smokers' articles, cigarette paper, cigarette tubes, cigarette filters, tobacco tins, cigarette cases, ashtrays, pipes, pocket apparatus for rolling cigarettes, lighters, matches.

(260) AM 2016 85566 A

(800) 1280939

(891) 2015 11 04

(731) SOCIETE DES PRODUITS SCHLATTER  
66 avenue des Champs Elysées, F-75008  
PARIS, France

(540)

**МЕТЕОСПАЗМИЛ**

(591) black and white

(511)

5 – Pharmaceutical products; pharmaceutical preparations; dietetic products for children and sick persons; medicines used for treatment of intestinal problems and functional intestinal symptoms.

(260) AM 2016 85571 A

(800) 1280983

(891) 2015 10 02

(731) BEATS ELECTRONICS, LLC  
8600 Hayden Place, Culver City CA 90232,  
USA

(540)

**BEATS 1**

(511)

41 – Arranging, organizing, conducting, and presenting concerts, live performances, entertainment special events, arts and cultural events, theatrical entertainment, competitions, contests, fairs, festivals, and exhibitions; production, distribution, and presentation of radio programs, television programs, and sound recordings; providing ongoing television, radio, audio, video, podcast, and webcast programs; providing entertainment, sports, music, informational, and news programming by means of telecommunications networks; entertainment services, namely, providing streaming, subscription, and downloadable music platform and services; provision of live entertainment and recorded entertainment, namely, musical performances; providing non-downloadable entertainment, sports, music, informational, and news programming; providing entertainment, sports, music, informational, news, and arts and culture programming via websites and non downloadable computer software applications; providing information in the field of entertainment, music, sports, news, and arts and culture via websites and non downloadable computer software applications; providing information, schedules, reviews and personalized recommendations of entertainment, arts and cultural events, concerts, live performances, competitions, fairs, festivals, and exhibitions; ticket reservation and booking services for entertainment, arts and cultural events, concerts, live performances, competitions, fairs, festivals, and exhibitions; publication and presentation of reviews, surveys, and ratings, and providing interactive websites and computer applications for the posting and sharing of reviews, survey, and ratings relating to entertainment, arts and cultural events, concerts, live performances, competitions, fairs, festivals, and exhibitions; providing non-downloadable ringtones, pre-recorded music, video, and graphics for use on mobile communications devices; providing via a website the uploading, storing, sharing, viewing and posting of images, audio, videos, online journals, blogs, podcasts, and multimedia content.

(260) AM 2016 85575 A

(800) 1280994

(891) 2015 10 13

(731) AVON PRODUCTS, INC.

World Headquarters, 777 Third Avenue New York NY 10017, USA

(540)

## **ANEW VITALE VISIBLE PERFECTION**

(591) black and white

(511)

3 – Non-medicated toilet preparations; toiletries; skin care preparations; skin moisturizers; body and

beauty care preparations; powders, cleansers, creams and lotions, all for the face, hands and body; cosmetic suntan preparations; soaps; shower and bath preparations; beauty masks; talcum powder; nail polish; nail polish remover; enamel for nails; false nails; adhesives for cosmetic purposes; cosmetics; eye cream, eye gel, eye lotion, eye makeup remover, eye shadow, eye liner, mascara, lipstick, lip liner, lip gloss; make-up foundation; blusher; tissues impregnated with cosmetic lotions; cotton sticks for cosmetic purposes; cotton wool for cosmetic purposes; preparations for cleaning the teeth; shaving and aftershave preparations; perfumes, fragrances, toilet waters, cologne; deodorants for human beings; anti-perspirants for personal use (toiletries); essential oils (cosmetic).

(260) AM 2016 85582 A

(800) 1282110

(891) 2015 11 13

(731) APPLE INC.

1 Infinite Loop, Cupertino CA 95014, USA

(540)

## **APPLE NEWS**

(511)

42 – Computer services, namely hosting a user-customized feed of news, sports, weather, commentary, and other information, content from periodicals, blogs, and websites, and other text, audio, video, and multimedia content; providing search engines for obtaining data via the internet and other electronic communications networks; providing online non-downloadable application development software, and support and consultation services for developing computer applications.

(260) AM 2016 85584 A

(800) 1282165

(891) 2015 12 01

(731) Intrum Justitia Licensing AG

Industriestrasse 13c, CH-6300 Zug, Switzerland

(540)

## **JUSTITIA INKASSO**

(591) Black, white

(511)

35 – Advertising; business management; business administration; office functions.

36 – Insurance, financial affairs; monetary affairs; real estate affairs.

41 – Education; providing of training; entertainment; sporting and cultural activities.

45 – Legal services; security services for the protection of property and individuals; personal and social



services rendered by others to meet the needs of individuals.

(260) AM 2016 85585 A

(800) 1282167

(891) 2015 12 08

(731) Rigo Trading S.A. Société Anonyme  
Route de Trèves 6 EBBC, Building E,  
L-2633 Sennigerberg, Luxembourg

(540)

**ГОЛДБЕРЕН**

(591) Black, white

(511)

29 – Preserved, frozen, dried and cooked fruits and vegetables; jellies, jams, compotes.

30 – Confectionery.

(260) AM 2016 85586 A

(800) 1282168

(891) 2015 12 08

(731) Rigo Trading S.A. Société Anonyme  
Route de Trèves 6 EBBC, Building E,  
L-2633 Sennigerberg, Luxembourg

(540)

**ХЭППИ КОЛА**

(591) Black, white

(511)

29 – Preserved, frozen, dried and cooked fruits and vegetables; jellies, jams, compotes.

30 – Confectionery.

(260) AM 2016 85588 A

(800) 1281130

(891) 2015 10 12

(731) JAPAN TOBACCO INC.  
2-2-1 Toranomom, Minato-ku, Tokyo,  
Japan

(540)



(591) black and white

(511)

34 – Tobacco, raw or manufactured; smoking tobacco, pipe tobacco, rolling tobacco, chewing tobacco, snus; cigarettes, electronic cigarettes, cigars, cigaretillos; snuff; smokers' articles included in this class; cigarette paper, cigarette tubes and matches.

(260) AM 2016 85589 A

(800) 1281132

(891) 2015 10 12

(731) JAPAN TOBACCO INC

2-2-1 Toranomom, Minato-ku, Tokyo, Japan

(540)



(591) black and white

(511)

34 – Tobacco, raw or manufactured; smoking tobacco, pipe tobacco, rolling tobacco, chewing tobacco, snus; cigarettes, electronic cigarettes, cigars, cigaretillos; snuff; smokers' articles included in this class; cigarette paper, cigarette tubes and matches.

(260) AM 2016 85590 A

(800) 1281133

(891) 2015 10 12

(731) JAPAN TOBACCO INC

2-2-1 Toranomom, Minato-ku, Tokyo, Japan

(540)



(591) black and white

(511)

34 – Tobacco, raw or manufactured; smoking tobacco, pipe tobacco, rolling tobacco, chewing tobacco, snus; cigarettes, electronic cigarettes, cigars, cigaretillos; snuff; smokers' articles included in this class; cigarette paper, cigarette tubes and matches.

(260) AM 2016 85595 A

(800) 1281229

(891) 2015 11 26

(731) Grupo Bimbo, S.A.B. de C.V.

Prolongacion Paseo De La Reforma,  
No.1000, Col. Pena Blanca Santa Fe,  
01210 Mexico City, Mexico

(540)

**PANRICO DONUTS**

(511)

30 – Bakery products.

(260) AM 2016 85596 A  
 (800) 1281239  
 (891) 2015 12 03  
 (731) THE HERCULES TIRE & RUBBER  
 COMPANY  
 16380 U.S. Route 224 East, Suite 200 Findlay,  
 OH 45840, USA

(540)

## RAPTIS

(511)  
 12 – Tires.

(260) AM 2016 85597 A  
 (800) 1282169  
 (891) 2015 12 08  
 (731) Rigo Trading S.A. Société Anonyme  
 Route de Trèves 6 EBBC, Building E,  
 L-2633 Sennigerberg, Luxembourg

(540)

## БУММИС

(591) Black, white  
 (511)  
 29 – Preserved, frozen, dried and cooked fruits and  
 vegetables; jellies, jams, compotes.  
 30 – Confectionery.

(260) AM 2016 85598 A  
 (800) 1281240  
 (891) 2015 12 03  
 (731) RXF TECHNOLOGIES, INC.  
 27332 Woodward Avenue, Suite 200, Royal  
 Oak MI 48067, USA

(540)

## OCALIVA

(511)  
 5 – Pharmaceutical preparations for human use.

(260) AM 2016 85599 A  
 (800) 1281247  
 (891) 2015 12 04  
 (731) ABBOTT PRODUCTS OPERATIONS AG  
 Hegenheimerweg 127, CH-4123  
 Allschwil, Switzerland

(540)

## ANEMIINET

(511)  
 5 – Medicines for human medicine; dietetic sub-  
 stances and foods for medical use; dietetic food sup-  
 plements.

(260) AM 2016 85601 A  
 (800) 1282170  
 (891) 2015 12 08  
 (731) Rigo Trading S.A. Société Anonyme  
 Route de Trèves 6 EBBC, Building E,  
 L-2633 Sennigerberg, Luxembourg

(540)

## ЧЕРВЯЧКИ

(591) Black, white  
 (511)  
 29 – Preserved, frozen, dried and cooked fruits and  
 vegetables; jellies, jams, compotes.  
 30 – Confectionery.

(260) AM 2016 85603 A  
 (800) 596951  
 (891) 2015 12 04  
 (731) ETA SA Manufacture Horlogère Suisse  
 Schild-Rust-Strasse 17, CH-2540 Grenchen,  
 Switzerland

(540)

## VALJOUX

(511)  
 14 – Horological items and their chronometric appa-  
 ratus and instruments, especially outlines and me-  
 chanisms of complex parts, as well as parts thereof.

(260) AM 2016 85605 A  
 (800) 1281249  
 (891) 2015 12 02  
 (731) APPLE INC.  
 1 Infinite Loop, Cupertino CA 95014, USA

(540)

## CLOCKKIT

(511)  
 9 – Computer software used in developing other  
 software applications; application development  
 software.

(260) AM 2016 85607 A  
 (800) 1281252  
 (891) 2015 12 04  
 (731) PHILIP MORRIS PRODUCTS S.A.  
 Quai Jeanrenaud 3, CH-2000 Neuchâtel,  
 Switzerland

(540)

## FLIPPACK

(511)  
 34 – Tobacco, raw or manufactured; tobacco pro-  
 ducts; cigars, cigarettes, cigarillos, tobacco for roll-  
 your-own cigarettes, pipe tobacco, chewing tobacco,  
 snuff tobacco, kretek; snus; tobacco substitutes (not  
 for medical purposes); electronic cigarettes; tobacco

products for the purpose of being heated; electronic devices and their parts for the purpose of heating cigarettes or tobacco in order to release nicotine-containing aerosol for inhalation; smokers' articles, cigarette paper, cigarette tubes, cigarette filters, tobacco tins, cigarette cases, ashtrays, pipes, pocket apparatus for rolling cigarettes, lighters, matches.

(260) AM 2016 85608 A

(800) 1281253

(891) 2015 11 25

(731) ABBOTT PRODUCTS OPERATIONS AG  
Hegenheimermattweg 127, CH-4123  
Allschwil, Switzerland

(540)

## РЕВЕРСОБАКТ

(511)

5 – Medicines for human medicine; dietetic preparations and food for medical use; dietetic food supplements.

(260) AM 2016 85609 A

(800) 1281254

(891) 2015 11 25

(731) ABBOTT PRODUCTS OPERATIONS AG  
Hegenheimermattweg 127, CH-4123  
Allschwil, Switzerland

(540)

## REVERSOBACT

(511)

5 – Medicines for human medicine; dietetic preparations and food for medical use; dietetic food supplements.

(260) AM 2016 85611 A

(800) 1281274

(891) 2015 10 16

(731) VISAN INDUSTRIAS ZOOTÉCNICAS, S.L.  
Ctra M 208 Km 0,5, E-28500 Arganda,  
Spain

(540)

## AMANOVA

(511)

31 – Animal food, animal fodder.

(260) AM 2016 85612 A

(800) 1281300

(891) 2015 04 16

(731) INDIVIDUAL ENTREPRENEUR  
KAMALIYEVA SALTANAT  
KOKENAIKYZY  
ul. Klochkova, d. 154, kv. 6, 050057 Almaty,  
Kazakstan

(540)



(591) Yellow, orange and black

(526) The trademark is protected as a whole. "TECHNODOM" shall not be subject to independent legal protection.

(511)

9 – Scientific, nautical, surveying, photographic, cinematographic, optical, weighing, measuring, signalling, checking (supervision), life-saving and teaching apparatus and instruments; apparatus and instruments for conducting, switching, transforming, accumulating, regulating or controlling electricity; apparatus for recording, transmission or reproduction of sound or images; magnetic data carriers, recording discs; compact discs, DVDs and other digital recording media; mechanisms for coin-operated apparatus; cash registers, calculating machines, data processing equipment, computers; computer software; fire-extinguishing apparatus; DVD players, answering machines, aerials, sound recording apparatus, sound transmitting apparatus, telephone apparatus, scales, camcorders, video cassettes, hands free kits for phones, dictating machines, phonograph records, disk drives for computers, computer keyboards, electronic agendas, mouse pads, compact discs [audio-video], compact discs [read-only memory], computers, laptop computers, notebook computers, mouse [computer peripheral], portable media players, microphones, modems, monitors [computer hardware], headphones, sound recording carriers, magnetic data media, optical data media, objectives [lenses] [optics], electronic pocket translators, compact disc players, cassette players, audio- and video-receivers, printers for use with computers; computer programmes, [programs], recorded; computer game software, record players, processors [central processing units], vehicle radios, scanners [data processing equipment], personal stereos, stands for photographic apparatus, television apparatus, cordless telephones, telephone receivers, amplifiers, video recorders, sound reproduction apparatus, tape recorders, battery chargers, photocopiers [photographic, electrostatic, thermic], USB flash drives, cameras [photography], cases especially made for photographic apparatus and instruments.

11 – Apparatus for lighting, heating, steam generating, cooking, refrigerating, drying, ventilating, water supply and sanitary purposes; ionization apparatus for the treatment of air or water, fruit roasters, refrigerating apparatus and machines, drying apparatus and installations, freezers, drying apparatus, bidets, boilers, other than parts of machines, spa baths [vessels], waffle irons, electric; fans [air-conditioning], electric fans for personal use, water heaters, air reheaters, extractor hoods for kitchens, grills

[cooking appliances], refrigerating chambers, pressure cooking saucepans, electric; air conditioning apparatus, coffee machines, electric; electric lamps, bread baking machines, stoves; blankets, electric, not for medical purposes; fabric steamers, bakers' ovens, kitchen ranges [ovens], microwave ovens [cooking apparatus], steam boilers, other than parts of machines; cookers, water filtering apparatus, cooking rings, steam facial apparatus [saunas], plate warmers, electric appliances for making yogurt, rotisseries, radiators, electric; lamps, toilet seats, pressure cookers [autoclaves], electric; laundry dryers, electric; hair driers [dryers], toasters, air conditioning installations, water purification installations, coffee filters, not of paper, being parts of electric coffee makers; filters for drinking water, lanterns for lighting, deep fryers, electric; bread-making machines, refrigerators, kettles, electric.

16 – Paper, cardboard and goods made from these materials, not included in other classes; printed matter; bookbinding material; photographs; stationery; adhesives for stationery or household purposes; artists' materials; paint brushes; typewriters and office requisites (except furniture); instructional and teaching material (except apparatus); plastic materials for packaging (not included in other classes); printers' type; printing blocks; posters, pamphlets, booklets, paper sheets [stationery], wrapping paper, carbon paper, newspapers, magazines [periodicals], periodicals, printed publications, catalogues, envelopes [stationery], seals [stamps], printed matter.

21 – Household or kitchen utensils and containers; combs and sponges; brushes (except paint brushes); brush-making materials; articles for cleaning purposes; steelwool; unworked or semi-worked glass (except glass used in building); glassware, porcelain and earthenware not included in other classes; dishes, saucers, mugs, vases, fruit cups, baby baths, portable; waffle irons, non-electric; ice buckets; whisks, non-electric, for household purposes; funnels, cruets, large-toothed combs for the hair, sponges for household purposes, toothpick holders, ironing boards, cutting boards for the kitchen, bread boards, strainers, kitchen containers, heat-insulated containers, heat-insulated containers for beverages, thermally insulated containers for food, frying pans, closures for pot lids, toothpicks, ceramics for household purposes, household grinders, non-electric; stew-pans, bread baskets, domestic, lunch boxes, cookie boxes, cookie jars, tea caddies, coffee percolators, non-electric; coffeepots, non-electric; coffee grinders, hand-operated; beer mugs, tankards, butter-dish covers, dish covers, cheese-dish covers, mixing spoons [kitchen utensils], basting spoons [cooking utensils], scoops [tableware], cake servers, spatulas [kitchen utensils], butter dishes, hand-operated pepper mills, mills for domestic purposes, hand-operated; confectioners' decorating bags [pastry bags],

cocktail shakers, bowls [basins], saucepan scourers of metal, cooking pot sets, cookie [biscuit] cutters, pastry cutters, chopsticks, cocktail stirrers, pepper pots, gloves for household purposes, heaters for feeding bottles, non-electric; candelabra [candlesticks], trivets [table utensils], knife rests for the table, flat-iron stands, egg cups, grill supports, abrasive pads for kitchen purposes, pottery, pots, cooking pots, painted glassware, porcelain ware, earthenware, crystal [glassware], trouser presses, cruet sets for oil and vinegar, spice sets, bottle openers, combs, electric combs, salad bowls, sugar bowls, non-electric beaters, services [dishes], coffee services [tableware], liqueur sets, tea services [tableware], sieves [household utensils], tea strainers, siphon bottles for carbonated water, domestic rolling pins, fruit presses, non-electric, for household purposes; salt cellars, drinking vessels, vessels of metal for making ices and iced drinks, refrigerating bottles, glasses [receptacles], drinking glasses, soup bowls, drying racks for laundry, table plates, graters [household utensils], vacuum bottles, kitchen utensils, non-electric cooking utensils, strainers for household purposes, coffee filters, non-electric; moulds [kitchen utensils], cake molds [moulds], ice cube molds [moulds], cookery molds [moulds], deep fryers, non-electric; bread bins, teapots, kettles, non-electric; cups, garlic presses [kitchen utensils], shaped ironing board covers, tea infusers, mops, mop wringers, corkscrews, dishwashing brushes, toothbrushes, electric toothbrushes.

35 – Advertising; business management; business administration; office functions; presentation of goods on communication media, for retail purposes; sales promotion; demonstration of goods; organization of trade fairs for commercial or advertising purposes; shop window dressing; marketing; distribution of samples; dissemination of advertising matter; advertising; television advertising; procurement services for others [purchasing goods and services for other businesses]; administrative processing of purchase orders; retail or wholesale services for goods; computerized online retail store services.

42 – Scientific and technological services and research and design relating thereto; industrial analysis and research services; design and development of computer hardware and software; creating and maintaining web sites for others; computer software design; providing search engines for the Internet; hosting computer sites [web sites]; server hosting; maintenance of computer software; computer software consultancy; information technology [IT] consultancy; computer system analysis.

(260) AM 2016 85613 A  
(800) 1281313  
(891) 2015 08 06

(731) ROBERT BOSCH TOOL CORPORATION  
1800 West Central Road, Mount Prospect IL  
60056, USA

(540)

## DREMEL

(511)

7 – Power operated hand tools [machines], namely, hand-held rotating chuck type drill driver for grinding, drilling, routing, polishing, sanding, sawing, marking, deburring, carving, sharpening, shaping, and cutting; hand-held reciprocating electric sanders, polishers; power-operated hand-held and mounted jig saws, sanders, grinders, and buffers, and power-operated hand-held scroll saws; and kits comprising combinations and/or as parts of the above-mentioned power tools and machines, namely, pads for floor polishing machines, drills, saw blades, brushes, carving cutters, routing cutters, collets, emery wheels, dressing stones, polishing wheels, cut-off wheels, buffing wheels, grinding wheels, wire wheels, engraving points, and mandrels, all sold together as a unit.

(260) AM 2016 85615 A

(800) 1281354

(891) 2015 10 14

(731) MARCEGAGLIA S.P.A.

Via Bresciani, 16, I-46040 GAZOLDO  
DEGLI IPPOLITI (MANTOVA), Italy

(540)



(591) black and white

(511)

6 – Common metals and their alloys, including steel, metal building materials, transportable buildings of metal; materials of metal for railway tracks; tubes of aluminium; building panels of metal; strips and sheets; drawn goods and flat goods of steel; roofing of metal; scaffolding of metal; fences; ores; common metals and their alloys; strips of metal; non-electric cables and wires of common metal; structures of metal; safes; metal hardware; crash barriers, of metal, for roads; tubes of steel; strips of steel; sheets; fences of metal; gates of metal; ironmongery of metal.

37 – Construction of installations and plants for metalworking and for the production of energy; varnishing.

39 – Distribution of iron and steel products; travel arrangement.

42 – Services in the field of steel and the applications thereof, in particular design, testing and start-up of plants for processing steel; services relating to environmental protection, research, analysis and consultancy in the ecological sector.

43 – Hotel services.

44 – Livestock breeding.

(260) AM 2016 85616 A

(800) 707634

(891) 2015 11 18

(731) ICER BRAKES, S.A.

Polígono Industrial de Landaben, C/E,  
E-31012 PAMPLONA (Navarra), Spain

(540)



(591) Blue and yellow

(511)

12 – Brakes and clutches for vehicles; vehicles; apparatus for locomotion by land, air or water.

(260) AM 2016 85617 A

(800) 752545

(891) 2015 11 13

(731) NORDOX AS

Østensjøveien 13, N-0661 Oslo, Norway

(540)

## NORDOX

(511)

5 – Preparations for destroying vermin; fungicides and herbicides.

(260) AM 2016 85632 A

(800) 1281643

(891) 2015 09 14

(731) WINGS FOR LIFE – SPINAL CORD

RESEARCH PRIVATSTIFTUNG

Am Brunnen 1, A-5330 Fuschl Am See,  
Austria

(540)

## WINGS FOR LIFE

(511)

9 – Scientific, nautical, surveying, photographic, cinematographic, optical, weighing, measuring, signaling, checking (supervision), life-saving and teaching apparatus and instruments; apparatus and instruments for conducting, switching, transforming, accumulating, regulating or controlling electricity; apparatus for recording, transmission or reproduction of sound or images; walkie-talkies; portable and mobile telephones and parts, spare parts and equipment, and in particular holders and sheaths; electric cables; electric plugs; electrical adaptors; batteries; accumulators; charging devices for accumulators for wireless mobile phones; subscriber identity module cards, also for use with portable and mobile phones;

cases for mobile phones; ring tones (downloadable ring tones); software for mobile phones (Apps); downloadable sound, music, image and video recordings; interactive games played on computers; photocopying apparatus and machines; magnetic data carriers; sound recording discs; compact discs; DVDs and other digital recording media; video tapes; portable music players; mechanisms for coin-operated apparatus; cash registers; calculating machines; data processing equipment; computers; computer software; fire-extinguishing apparatus; automatic cash dispensing machines; ticket dispensers; automatic photographic booths; machine readable data carriers; electronic publications (downloadable); computer programs; computer game software; mouse pads; navigation apparatus for vehicles; protective clothing [body armour]; protective spectacles; protective masks; protective helmets, in particular for sports purposes; protective shields, including ear, body and face protective shields; spectacles; spectacle frames; spectacle cases and holders; sunglasses; goggles for sports; headphones; special purpose containers (cases, sheaths, housings) for apparatus and instruments included in this class; light, marker, life-saving and signaling buoys; wind socks for indicating wind direction; electric batteries and accumulators; magnets; luminous signs; luminous advertising signs; encoded identification bracelets, magnetic; processors [central processing units]; chips [integrated circuits]; computer peripheral devices; data processing apparatus; electronic notice boards; hands free kits for phones; laptop computers; loudspeakers; magnetic data media; telephone apparatus; television apparatus; video game cartridges; wire connectors [electricity]; wires, electric; remote control apparatus; video screens; tablet computers; socks, electrically heated; personal digital assistants; global positioning system [GPS] apparatus; global positioning system (GPS) computer software; cameras [photography]; time measuring instruments (not including clocks and watches); smartphones in the shape of a watch; monitoring instruments; tracking devices; monitoring devices not for medical purposes; parts of and fittings for the aforesaid goods.

10 – Surgical medical, dental and veterinary apparatus and instruments; surgical implants, including artificial limbs, eyes and teeth; orthopedic articles; suture materials; condoms; non-chemical contraceptives; bed vibrators; vibromassage apparatus; pacifiers for babies; physical therapy equipment; hearing protection devices; feeding aids and pacifiers; sex aids; medical furniture and bedding, equipment for moving patients; medical clothing; prosthetic and artificial implants; orthopedic and mobility aids; diagnostic, examination, and monitoring equipment; heart rate monitoring apparatus; pulse rate monitors; tracking devices for medical purposes; monitoring devices for medical purposes; apparatus or instruments for medical use and being for monitoring,

tracking, recording or display purposes; parts of and fittings for the aforesaid goods.

14 – Precious metals and their alloys, not included in other classes; statues, statuettes and figurines [statuettes] of precious metal; boxes of precious metal; badges of precious metal; key rings [trinkets or fobs]; works of art of precious metal; ornaments [jewelry]; chains, earrings, rings, bracelets and necklaces of precious metal; precious stones and semi-precious stones; diamonds and agates; pearls [jewelry]; paste jewelry [costume jewelry]; cuff links; tie pins; coins; horological and chronometrical instruments; clocks; watches; chronometers; wrist watches; watch straps; clock cases; watch cases; cases for clock- and watchmaking; jewelry cases [cases]; jewellery boxes and watch boxes.

(260) AM 2016 85635 A

(800) 1281660

(891) 2015 10 12

(731) YATSUTA YEVHENIIA HEORHIIVNA  
vul. Raiduzhna, 29, kv. 68 Kyiv 02225,  
Ukraine

(540)



**radioactivefilm.**

(591) Black, white

(511)

35 – Commercial information agencies; administrative processing of purchase orders; cost price analysis; business auditing; auctioneering; book-keeping; marketing studies; opinion polling; invoicing; arranging newspaper subscriptions for others; arranging subscriptions to telecommunication services for others; payroll preparation; tax preparation; demonstration of goods; business inquiries; business management assistance; commercial or industrial management assistance; advisory services for business management; business research; economic forecasting; providing business information via a web site; compilation of information into computer databases; compilation of statistics; import-export agencies; business information; business management of performing artists; business management for freelance service providers; business management of hotels; business management of sports people; commercial information and advice for consumers [consumer advice shop]; commercial administration of the licensing of the goods and services of others; computerized file management; personnel management consultancy; business management consultancy; business organization consultancy; marketing; marketing research; typing; provision of commercial and

business contact information; rental of advertising time on communication media; writing of publicity texts; word processing; updating of advertising material; updating and maintenance of data in computer databases; web site traffic optimization; organization of exhibitions for commercial or advertising purposes; organization of fashion shows for promotional purposes; organization of trade fairs for commercial or advertising purposes; rental of advertising space; shop window dressing; business appraisals; personnel recruitment; business management and organization consultancy; business efficiency expert services; outsourcing services [business assistance]; business project management services for construction projects; commercial intermediation services; layout services for advertising purposes; news clipping services; price comparison services; procurement services for others [purchasing goods and services for other businesses]; relocation services for businesses; photocopying services; modelling for advertising or sales promotion; secretarial services; public relations; retail, or wholesale services for pharmaceutical, veterinary and sanitary preparations and medical supplies; data search in computer files for others; search engine optimization; sponsorship search; presentation of goods on communication media, for retail purposes; telephone answering for unavailable subscribers; rental of billboards [advertising boards]; office machines and equipment rental; publicity material rental; rental of vending machines; rental of sales stands; rental of photocopying machines; direct mail advertising; psychological testing for the selection of personnel; publication of publicity texts; radio advertising; advertising agencies; advertising; pay per click advertising; advertising by mail order; on-line advertising on a computer network; document reproduction; bill-posting; distribution of samples; dissemination of advertising matter; business investigations; systemization of information into computer databases; drawing up of statements of accounts; sales promotion for others; production of advertising films; shorthand; transcription of communications [office functions]; television advertising; telemarketing services; negotiation and conclusion of commercial transactions for third parties; professional business consultancy.

41 – Academies [education]; lending libraries; videotaping; arranging and conducting of congresses; arranging and conducting of colloquiums; arranging and conducting of conferences; arranging and conducting of concerts; arranging and conducting of workshops [training]; arranging and conducting of seminars; arranging and conducting of symposiums; arranging of beauty contests; sporting and cultural activities; gymnastic instruction; electronic desktop publishing; nursery schools; animal training; dubbing; educational examination; providing of training; providing on-line videos, not downloadable; providing on-line electronic publications, not downloa-

dable; providing on-line music, not downloadable; providing sports facilities; providing recreation facilities; providing golf facilities; providing casino facilities [gambling]; booking of seats for shows; correspondence courses; game services provided on-line from a computer network; recreation information; education information; entertainment information; cinema presentations; movie studios; microfilming; videotape editing; music-halls; tutoring; providing museum facilities [presentation, exhibitions]; providing karaoke services; writing of texts, other than publicity texts; night clubs; organization of balls; organization of shows [impresario services]; organization of exhibitions for cultural or educational purposes; organization of competitions [education or entertainment]; operating lotteries; organization of fashion shows for entertainment purposes; organization of sports competitions; teaching; amusement parks; sign language interpretation; party planning [entertainment]; entertainer services; disc jockey services; discotheque services; providing amusement arcade services; calligraphy services; layout services, other than for advertising purposes; zoological garden services; language interpreter services; coaching [training]; health club services [health and fitness training]; club services [entertainment or education]; modelling for artists; orchestra services; translation; mobile library services; personal trainer services [fitness training]; news reporters services; sport camp services; recording studio services; scriptwriting services; holiday camp services [entertainment]; ticket agency services [entertainment]; photographic reporting; services of schools [education]; gambling; music composition services; practical training [demonstration]; presentation of live performances; conducting fitness classes; rental of audio equipment; rental of show scenery; rental of video cameras; rental of video cassette recorders; rental of videotapes; rental of sound recordings; toy rental; games equipment rental; rental of movie projectors and accessories; rental of motion pictures; rental of skin diving equipment; rental of lighting apparatus for theatrical sets or television studios; rental of radio and television sets; rental of sports grounds; rental of sports equipment, except vehicles; rental of stage scenery; rental of tennis courts; rental of stadium facilities; vocational retraining; vocational guidance [education or training advice]; publication of electronic books and journals on-line; publication of books; publication of texts, other than publicity texts; radio entertainment; religious education; entertainment; production of shows; production of music; production of radio and television programmes; film production, other than advertising films; subtitling; theatre productions; television entertainment; physical education; photography; timing of sports events; circuses; boarding schools.

---

(260) AM 2016 85637 A

(800) 1281670

(891) 2015 10 08

(731) Public Joint Stock Company "EGORJEVSK SHOES"

Vladimirskaya ul., d. 8, Egorjevsk,  
RU-140301 Moscovskaya oblast, Russian  
Federation

(540)



(591) White, yellow, blue.

(511)

16 – Packing paper; boxes of cardboard or paper; bags [envelopes, pouches] of paper or plastics, for packaging; labels, not of textile.

25 – Ski boots; football boots; galoshes; leggings [leg warmers]; gymnastic shoes; boot uppers; heels; fittings of metal for footwear; heelpieces for footwear; footwear; tips for footwear; non-slipping devices for footwear; welts for footwear; footwear uppers; sports shoes; beach shoes; soles for footwear; lace boots; sandals; boots; inner soles; slippers; shoes; esparto shoes or sandals.

35 – Rental of advertising space; auctioneering; organization of exhibitions for commercial or advertising purposes; demonstration of goods; business investigations; opinion polling; marketing studies; import-export agencies; commercial information agencies; compilation of statistics; commercial or industrial management assistance; advisory services for business management; personnel management consultancy; compilation of information into computer databases; professional business consultancy; dissemination of advertising matter; drawing up of statements of accounts; payroll preparation; business management assistance; economic forecasting; advertising; radio advertising; television advertising; business intermediary services in the field of product sales; direct mail advertising; organization of trade fairs for commercial or advertising purposes; retail or wholesale services.

40 – Leather staining; leather working; shoe staining.

42 – Graphic arts design; industrial design; packaging design; research and development of new products for others.

(260) AM 2016 85643 A

(800) 1281752

(891) 2015 11 27

(731) Hamilton International AG (Hamilton International SA) (Hamilton International Ltd)  
Mattenstrasse 149, CH-2503 Biel/Bienne,  
Switzerland

(540)

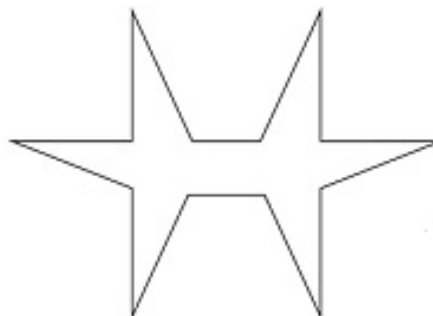

(591) Black, white

(511)

14 – Precious metals and their alloys and goods made of these materials or coated therewith included in this class, namely figurines, trophies; timepieces and chronometric instruments, namely chronometers, chronographs, clocks, watches, wristwatches, wall clocks, alarm clocks as well as parts and accessories for the aforesaid goods, namely hands, anchors, pendulums, barrels, watch cases, watch straps, watch dials, clockworks, watch chains, movements for timepieces, watch springs, watch glasses, presentation cases for timepieces, cases for timepieces.

(260) AM 2016 85647 A

(800) 1281826

(891) 2015 08 21

(731) AFLOFARM Farmacja Polska Sp. z o.o.  
ul. Partyzancka 133/151, PL-95-200  
Pabianice, Poland

(540)

## FORMOTIVA NUTRITION

(511)

5 – Pharmaceutical products, sanitary preparations for medical purposes; medical devices for medical purposes; dietetic substances adapted for medical purposes; dietary supplements; nutritional and dietary supplements for health use; food for babies; medicinal herbs, plant extracts for medicinal purpose.

29 – Meat, fish, poultry and game; meat extracts; preserved, frozen, dried and cooked fruits and vegetables; jellies, jams, compotes; eggs, milk and milk products; edible oils and fats, including nutrient for athletes and/or athletes, dietetic substances, dietetic foods, concentrates and high protein supplements, carbohydrate and high-energy fortified with vitamins, minerals and amino acids not for medical purposes included in this class.



32 – Mineral waters and aerated waters and other non-alcoholic drinks; fruit drinks and fruit juices; syrups and other preparations for the production and preparation of beverages, diet drinks, high-energy, carbohydrate, vitamins.

(260) AM 2016 85648 A

(800) 1281827

(891) 2015 08 21

(731) AFLOFARM Farmacja Polska Sp. z o.o.  
ul. Partyzancka 133/151, PL-95-200  
Pabianice, Poland

(540)

## FORMOTIVA SPORT NUTRITION

(511)

5 – Pharmaceutical products, sanitary preparations for medical purposes; medical devices for medical purposes; dietetic substances adapted for medical purposes; dietary supplements; nutritional and dietary supplements for health use; food for babies; medicinal herbs, plant extracts for medicinal purpose.

29 – Meat, fish, poultry and game; meat extracts; preserved, frozen, dried and cooked fruits and vegetables; jellies, jams, compotes; eggs, milk and milk products; edible oils and fats, including nutrient for athletes and/or athletes, dietetic substances, dietetic foods, concentrates and high protein supplements, carbohydrate and high-energy fortified with vitamins, minerals and amino acids not for medical purposes included in this class.

32 – Mineral waters and aerated waters and other non-alcoholic drinks; fruit drinks and fruit juices; syrups and other preparations for the production and preparation of beverages, diet drinks, high-energy, carbohydrate, vitamins.

(260) AM 2016 85651 A

(800) 1281830

(891) 2015 08 24

(731) Otkrytoe aktsionernoe obshchestvo  
"BOBRUYSKIY MASHINOSTROITELNY  
ZAVOD"  
ul. K. Marksya 235, g. Bobruysk, 213805  
Mogilevskaya obl., Belarus

(540)

## POWERCHROME

(591) Black, white

(511)

6 – Common metals and their alloys; materials, goods, buildings of metal, included in this class; metal building materials; transportable buildings of metal; goods of common metal not included in other classes; works of art of common metal; cast steel; cast metal; ironmongery, small items of metal hardware; pipes and tubes of metal; reinforcing mate-

rials, of metal; metal coverings included in this class.

7 – Machines, parts and accessories thereof, included in this class; machine tools, parts and accessories thereof, included in this class; apparatus, parts and accessories thereof, included in this class; pumps [machines]; pumps [parts of machines, engines or motors]; motors and engines (except for land vehicles); machine coupling and transmission components (except for land vehicles); agricultural implements, parts and accessories thereof, included in this class.

35 – Advertising; sales promotion for others; wholesale and retail trade services in respect of goods of classes 6 and 7.

(260) AM 2016 85654 A

(800) 1281902

(891) 2015 11 26

(731) Fangwen YU

(Guangdong Meibo Refrigeration Equipment Co.,Ltd.)

No.10 Keji East Road, Songxia Industrial Park, Shishan Town, Nanhai District  
528225 Foshan City, Guangdong Province,  
China

(540)

(591) black, blue.

(511)

11 – Refrigerating apparatus and machines; refrigerating containers; ice machines and apparatus; freezers; refrigerators; refrigerating appliances and installations; air cooling apparatus; air conditioning apparatus; air conditioning installations.

(260) AM 2016 85655 A

(800) 1281924

(891) 2015 11 17

(731) BOURJOIS SARL

Burgstrasse 26 CH-8750 Glarus, Switzerland

(540)

## STAMP IT LINER

(511)

3 – Preparations for skin, scalp, hair or nail care; cosmetic preparations for application on the skin, scalp, hair or nails; soaps; perfumery products; essential oils; cosmetics; toiletries for non-medical use.

(260) AM 2016 85680 A

(800) 1282520

(891) 2015 11 27

(731) GONG Hang  
No. 519, Jiangbin West Road, Choujiang  
District, Yiwu City 322000 Zhejiang, China  
(540)

## velsatis

(511)  
25 – Clothing; layettes [clothing]; bathing suits; shoes; hats; pantyhose; hosiery; gloves [clothing]; neckties; leather belts [clothing].

(260) AM 2016 85683 A  
(800) 1282979  
(891) 2015 11 09  
(731) JOSERA GMBH & Co. KG  
Industriegebiet Süd, 63924 Kleinheubach,  
Germany  
(540)

## el cheapo

(511)  
5 – Fodder supplements, not for medical purposes, in particular for pets, in particular for dogs; in particular supplements for animal foodstuffs.

31 – Foodstuffs for animals, in particular for pets, in particular dogs.

(260) AM 2016 85779 A  
(800) 1283637  
(891) 2015 11 19  
(731) Zott SE & Co. KG  
Dr.-Steichele-Strasse 4, 86690 Mertingen,  
Germany  
(540)

## Milk Tiger

(511)  
29 – Milk, dairy products, namely drinking milk, fermented milk, buttermilk; yoghurt, fruit yoghurt, yoghurt drinks, chocolate or cocoa yoghurt; non-alcoholic mixed milk drinks, kephir, cream, curd cheese, fruit and herb curd cheese; milk-based desserts; butter; cheese and cheese preparations; milk and whey powder as foodstuffs, both with or without additives; spreads (fat-containing); milk shakes; whey.

30 – Puddings, edible ice, powder for ice cream; long-life bakery goods and pastries, especially ready-to-eat cakes and waffles; cocoa-based beverages; rice pudding.

(260) AM 2016 85782 A  
(800) 1283297  
(891) 2015 10 14  
(731) PHARMACTİVE İLAÇ SANAYİ VE  
TİCARET ANONİM ŞİRKETİ

Mahmutbey Mah. Dilmenler Cad. No:19  
Aslanoba Plaza K:3, Güneşli Bağcılar,  
İstanbul, Turkey

(540)



(591) Dark blue and light blue  
(511)

5 – Pharmaceutical and veterinary preparations; sanitary preparations for medical purposes; dietetic food and substances adapted for medical or veterinary use, food for babies; dietary supplements for humans and animals; plasters, materials for dressings; material for stopping teeth, dental wax; disinfectants; preparations for destroying vermin; fungicides, herbicides.

(260) AM 2016 85785 A  
(800) 1283656  
(891) 2015 12 03  
(731) RXF TECHNOLOGIES, INC.  
27332 Woodward Avenue, Suite 200 Royal  
Oak MI 48067, USA  
(540)



(591) Black, white  
(511)

5 – Pharmaceutical preparations for human use.

(260) AM 2016 85786 A  
(800) 1283396  
(891) 2015 08 03  
(731) APPLE INC.  
1 Infinite Loop, Cupertino CA 95014, USA  
(540)

## APPLE MUSIC

(526) The trademark is protected as a whole. "MUSIC" shall not be subject to independent legal protection.

(511)

38 – Streaming of audio material featuring music on the Internet, and providing access to digital music websites on the Internet.

41 – Arranging, organizing, conducting, and presenting concerts, live performances, entertainment special events, arts and cultural events, theatrical entertainment, competitions, contests, fairs, festivals, and exhibitions; production, distribution, and presentation of radio programs, television programs, and so-

und recordings; providing ongoing television, radio, audio, video, podcast, and webcast programs; providing entertainment, sports, music, informational, and news programming by means of telecommunications networks; provision of live entertainment and recorded entertainment, namely, musical performances; providing non-downloadable entertainment, sports, music, informational, and news programming; providing information in the field of entertainment, music, sports, news, and arts and culture via websites and computer applications; providing information, schedules, reviews and personalized recommendations of entertainment, arts and cultural events, concerts, live performances, competitions, fairs, festivals, and exhibitions; ticket reservation and booking services for entertainment, arts and cultural events, concerts, live performances, competitions, fairs, festivals, and exhibitions; publication and presentation of reviews, surveys, and ratings; providing non-downloadable ringtones, pre-recorded music, video, and graphics for use on mobile communications devices; publication of books, periodicals, newspapers, newsletters, manuals, blogs, journals, and other publications; publishing of books, periodicals, newspapers, newsletters, manuals, blogs, journals, and other publications via websites and computer applications; news reporting.

(260) AM 2016 85787 A

(800) 1283405

(891) 2015 08 05

(731) APPLE INC.

1 Infinite Loop, Cupertino CA 95014, USA

(540)



(591) black and white

(526) The trademark is protected as a whole. "MUSIC" shall not be subject to independent legal protection.

(511)

38 – Streaming of audio material featuring music on the Internet, and providing access to digital music websites on the Internet.

41 – Arranging, organizing, conducting, and presenting concerts, live performances, entertainment special events, arts and cultural events, theatrical entertainment, competitions, contests, fairs, festivals, and exhibitions; production, distribution, and presentation of radio programs, television programs, and sound recordings; providing ongoing television, radio, audio, video, podcast, and webcast programs; providing entertainment, sports, music, informational, and news programming by means of telecommunications networks; provision of live entertainment and recorded entertainment, namely, musical performances; providing non-downloadable entertainment, sports,

music, informational, and news programming; providing information in the field of entertainment, music, sports, news, and arts and culture via websites and computer applications; providing information, schedules, reviews and personalized recommendations of entertainment, arts and cultural events, concerts, live performances, competitions, fairs, festivals, and exhibitions; ticket reservation and booking services for entertainment, arts and cultural events, concerts, live performances, competitions, fairs, festivals, and exhibitions; publication and presentation of reviews, surveys, and ratings; providing non-downloadable ringtones, pre-recorded music, video, and graphics for use on mobile communications devices; publication of books, periodicals, newspapers, newsletters, manuals, blogs, journals, and other publications; publishing of books, periodicals, newspapers, newsletters, manuals, blogs, journals, and other publications via websites and computer applications; news reporting.

(260) AM 2016 85788 A

(800) 1283418

(891) 2015 08 06

(731) AKSAN KOZMETİK SANAYİ VE  
TICARET LTD. STİ.

Hadimköy Mah. Derecik, Sokak No:3,  
Amavutköy, İSTANBUL, Turkey

(540)

## COMFORT LOVE

(511)

3 – Bleaching and cleaning preparations, detergents other than for use in manufacturing operations and for medical purposes, laundry bleach, fabric softeners for laundry use, stain removers, dishwasher detergents, perfumery; cosmetics; fragrances; deodorants for personal use and animals, soaps, dental care preparations; dentifrices, denture polishes, tooth whitening preparations, mouth washes, not for medical purposes, abrasive preparations; emery cloth; sandpaper; pumice stone; abrasive pastes, polishing preparations for leather, vinyl, metal and wood, polishes and creams for leather, vinyl, metal and wood, wax for polishing.

5 – Pharmaceutical and veterinary preparations for medical purposes; chemical preparations for medical and veterinary purposes, chemical reagents for pharmaceutical and veterinary purposes, dietary supplements for pharmaceutical and veterinary purposes; dietary supplements, nutritional supplements; medical preparations for slimming purposes; food for babies; herbs and herbal beverages adapted for medicinal purposes, dental preparations and articles; teeth filling material, dental impression material, dental adhesives and material for repairing teeth, sanitary preparations for medical use; hygienic pads; hygienic tampons; plasters, materials for dressings; dia-

pers, including those made of paper and textiles, preparations for destroying vermin; fungicides, herbicides, deodorants, other than for human beings or for animals; air deodorising preparations, disinfectants; antiseptics; detergents for medical purposes.

(260) AM 2016 85935 A

(800) 1285002

(891) 2015 11 22

(731) DEATH CHALLENGE INC.

Suite 397, 23371 Mulholland Drive,  
Woodland Hills CA 91364, USA

(540)



(591) Red, white, and black

(511)

38 – Broadcasting of television programmes; broadcasting of video and audio programming over the internet; broadcasting programs via a global computer network; broadcasting services and provision of telecommunication access to video and audio content provided via a video-on-demand service via the internet.

41 – Organizing, arranging, and conducting extreme athletic events; providing entertainment information in the field of extreme sports via a website.

(260) AM 2016 85941 A

(800) 1284418

(891) 2015 10 09

(731) Public Joint Stock Company Gazprom neft

Galernaya ul., 5, lit. A, RU-190000  
St-Petersburg, Russian Federation

(540)



(591) Gray, light-gray, orange, and light-orange

(511)

1 – Fertilizing preparations; tempering and soldering preparations; agar-agar; nitrogen; actinium; alka-

loids; alginates for the food industry; alginates for industrial purposes; crotonic aldehyde; ammonium aldehyde; aldehydes; americium; amyl acetate; ammonia [volatile alkali] for industrial purposes; anhydrous ammonia; ammonia; acetic anhydride; anhydrides; anti-knock substances for internal combustion engines; disincrustants; antistatic preparations, other than for household purposes; antifreeze; argon; lead arsenate; astatine; aluminium acetate; lime acetate; lead acetate; acetate of cellulose, unprocessed; acetates [chemicals]; acetylene; acetone; oenological bactericides [chemical preparations for use in wine making]; balm of gurjun [gurjon, gurjan] for making varnish; barium; barytes; albumin [animal or vegetable, raw material]; animal albumen [raw material]; iodised albumen; malt albumen; bentonite; berkelium; bicarbonate of soda for chemical purposes; potassium dioxalate; bichromate of potassium; bichromate of soda; bauxite; bromine for chemical purposes; albumenized paper; baryta paper; diazo paper; blueprint paper; test paper, chemical; litmus paper; self-toning paper [photography]; nitrate paper; sensitized paper; photometric paper; borax; agglutinants for concrete; gas purifying preparations; preservatives for pharmaceutical preparations; polish removing substances; preparations for the separation of greases; substances for preventing runs in stockings; water-softening preparations; limestone hardening substances; tanning substances; adhesives for industrial purposes; surface-active chemical agents; foundry binding substances; concrete-aeration chemicals; leather-dressing chemicals; chemicals for the manufacture of paints; chemical substances for preserving foodstuffs; starch-liquifying chemicals [ungluing agents]; flower preservatives; seed preserving substances; viscose; bismuth; bismuth subnitrate for chemical purposes; witherite; distilled water; seawater for industrial purposes; acidulated water for recharging accumulators; heavy water; hydrogen; seaweeds [fertilizers]; gadolinium; getters [chemically active substances]; protective gases for welding; solidified gases for industrial purposes; basic gallate of bismuth; gallium; gambier; helium; electrophoresis gels, other than for medical or veterinary purposes; genes of seeds for agricultural production; aluminium hydrate; hydrates; hyposulfites; ceramic glazings; glycol; expanded clay for hydroponic plant growing [substrate]; kaolin; alumina; glycerides; glycerine for industrial purposes; glucose for the food industry; glucose for industrial purposes; glucosides; gluten for the food industry; gluten for industrial purposes; holmium; hormones for hastening the ripening of fruit; peat pots for horticulture; graphite for industrial purposes; guano; humus; dextrin [size]; detergents for use in manufacturing processes; defoliants; hydrazine; diastase for industrial purposes; kieselgur; manganese dioxide; titanium dioxide for industrial purposes; zirconia; oil disper-

sants; petroleum dispersants; dispersions of plastics; dysprosium; bichloride of tin; detergent additives to gasoline [petrol]; ceramic compositions for sintering [granules and powders]; additives, chemical, to drilling muds; additives, chemical, to insecticides; chemical additives for oils; additives, chemical, to motor fuel; additives, chemical, to fungicides; dolomite for industrial purposes; tan-wood; europium; gelatine for photographic purposes; gelatine for industrial purposes; auxiliary fluids for use with abrasives; fluids for hydraulic circuits; liquids for removing sulfates from accumulators; power steering fluid; brake fluid; magnetic fluid for industrial purposes; transmission fluid; tree cavity fillers [forestry]; glaziers' putty; moderating materials for nuclear reactors; diatomaceous earth; fuller's earth for use in the textile industry; lime chloride; isotopes for industrial purposes; ion exchangers [chemicals]; ytterbium; yttrium; iodine for industrial purposes; iodine for chemical purposes; aluminium iodide; alkaline iodides for industrial purposes; casein for the food industry; casein for industrial purposes; kainite; potassium; sorrel salt; californium; gum arabic for industrial purposes; tartar other than for pharmaceutical purposes; camphor, for industrial purposes; calcium carbide; carbide; lime carbonate; magnesium carbonate; carbonates; cement [metallurgy]; lutetium [casioptium]; catalysts; biochemical catalysts; catechu; caustics for industrial purposes; alum; ammonia alum; aluminium alum; chrome alum; quebracho for industrial purposes; ketones; cinematographic films, sensitized but not exposed; oxygen; nitric acid; anthranilic acid; benzoic acid; boric acid for industrial purposes; tartaric acid; tungstic acid; gallic acid for the manufacture of ink; gallotannic acid; tannic acid; iodic acid; phenol for industrial purposes; citric acid for industrial purposes; lactic acid; formic acid; persulfuric acid; oleic acid; picric acid; pyrogallic acid; salicylic acid; sebacic acid; sulfuric acid; sulfurous acid; spirits of salt; stearic acid; carbonic acid; spirits of vinegar [dilute acetic acid]; phosphoric acid; hydrofluoric acid; cholic acid; chromic acid; oxalic acid; acids; benzene-based acids; fatty acids; mineral acids; arsenious acid; adhesives for billposting; leather glues; adhesives for wall tiles; adhesives for wallpaper; glue for industrial purposes; cement for mending broken articles; gums [adhesives], other than for stationery or household purposes; birdlime; isinglass other than for stationery, household or alimentary purposes; stem cells other than for medical or veterinary purposes; flocculants; collodion; compost; beer preserving agents; mangrove bark for industrial purposes; tan; starch for industrial purposes; silicon; creosote for chemical purposes; krypton; xenon; curium; lactose [raw material]; lactose for the food industry; lactose for industrial purposes; lanthanum; dry ice [carbon dioxide]; lecithin [raw material]; lecithin for the food industry; lecithin for industrial purposes;

lithium; magnesite; manganate; oils for tanning leather; oils for currying leather; oils for preparing leather in the course of manufacture; oils for the preservation of food; carbolineum for the protection of plants; paper pulp; wood pulp; grafting mastic for trees; mastic for leather; cement for pneumatic tires [tyres]; fillers for automobile bodies; oil cement [putty]; synthetic materials for absorbing oil; ceramic materials in particulate form, for use as filtering media; filtering materials [unprocessed plastics]; filtering materials [mineral substances]; filtering materials [vegetable substances]; filtering materials [chemical preparations]; blue vitriol; metalloids; alkaline-earth metals; alkaline metals; methane; methyl benzene; methyl benzol; flour for industrial purposes; tapioca flour for industrial purposes; potato flour for industrial purposes; soap [metallic] for industrial purposes; arsenic; emollients for industrial purposes; sodium; hypochlorite of soda; naphthalene; sal ammoniac; toxic gas neutralizers; neodymium; neon; neptunium; nitrate of uranium; nitrates; combusting preparations [chemical additives to motor fuel]; nitrous oxide; baryta; uranium oxide; oxalates; lithia [lithium oxide]; lead oxide; antimony oxide; chromium oxide; cobalt oxide for industrial purposes; mercuric oxide; gallnuts; purification preparations; wine finings; textile-brightening chemicals; beer-clarifying and preserving agents; must-finishing preparations; reducing agents for use in photography; bases [chemical preparations]; wax-bleaching chemicals; fat-bleaching chemicals; pectin for the food industry; pectin for industrial purposes; pectin [photography]; perborate of soda; humus top dressing; percarbonates; hydrogen peroxide; persulfates; perchlorates; foundry sand; plastisols; ferrotype plates [photography]; plasticizers; plastics, unprocessed; X-ray films, sensitized but not exposed; plutonium; polonium; potash; potash water; earth for growing; praseodymium; rubber preservatives; masonry preservatives, except paints and oils; brickwork preservatives, except paints and oils; cement preservatives, except paints and oils; preservatives for tiles, except paints and oils; bacteriological preparations for acetification; vulcanising preparations; renovating preparations for phonograph records; currying preparations for leather; currying preparations for skins; metal hardening preparations; fixing baths [photography]; opacifiers for glass; opacifiers for enamel; separating and unsticking [ungluing] preparations; preparations for preventing the tarnishing of lenses; preparations for preventing the tarnishing of glass; cement-waterproofing chemicals, except paints; plant growth regulating preparations; wallpaper removing preparations; anti-boil preparations for engine coolants; fulling preparations for use in the textile industry; scale removing preparations, other than for household purposes; flashlight preparations; galvanizing preparations; finishing preparations for use in the manufacture of steel; sizing pre-

parations; animal carbon preparations; corrosive preparations; cryogenic preparations; dehydrating preparations for industrial purposes; degreasing preparations for use in manufacturing processes; degumming preparations; oil-bleaching chemicals; bleaching preparations [decolorants] for industrial purposes; meat tenderizers for industrial purposes; preparations for stimulating cooking for industrial purposes; anti-incrustants; preparations of trace elements for plants; moistening [wetting] preparations for use in the textile industry; moistening [wetting] preparations for use in dyeing; moistening [wetting] preparations for use in bleaching; enzyme preparations for the food industry; enzyme preparations for industrial purposes; filtering preparations for the beverages industry; vine disease preventing chemicals; chemical preparations to prevent mildew; chemical preparations for protection against wheat blight [smut]; chemical condensation preparations; chemical preparations for smoking meat; chemical preparations for facilitating the alloying of metals; engine-decarbonising chemicals; fulling preparations; fuel-saving preparations; coal saving preparations; damp-proofing chemicals, except paints, for masonry; anti-sprouting preparations for vegetables; preparations of the distillation of wood alcohol; benzene derivatives; cellulose derivatives [chemicals]; promethium; protactinium; protein [raw material]; mordants for metals; radium for scientific purposes; radon; solvents for varnishes; anti-frothing solutions for accumulators; drilling muds; solutions for cyanotyping; galvanizing baths; silver salt solutions for silvering; toning baths [photography]; rhenium; mercury; rubidium; carbon black for industrial purposes; soot for industrial or agricultural purposes; lamp black for industrial purposes; samarium; saccharin; selenium; saltpeter; sulfur; carbon disulfide; silicates; silicones; scandium; foundry molding [moulding] preparations; acrylic resins, unprocessed; artificial resins, unprocessed; synthetic resins, unprocessed; epoxy resins, unprocessed; soda ash; calcined soda; caustic soda for industrial purposes; barium compounds; fluorspar compounds; salts [fertilisers]; salts [chemical preparations]; ammoniacal salts; ammonium salts; salts of precious metals for industrial purposes; salts for galvanic cells; salt for preserving, other than for foodstuffs; salts for coloring [colouring] metal; salts for industrial purposes; iron salts; gold salts; iodised salts; calcium salts; salt, raw; salts from rare earth metals; mercury salts; toning salts [photography]; chrome salts; chromic salts; salts of alkaline metals; fire extinguishing compositions; compositions for the manufacture of phonograph records; compositions for the manufacture of technical ceramics; compositions for repairing inner tubes of tires [tyres]; compositions for repairing tires [tyres]; acid proof chemical compositions; glutinous tree-grafting preparations; adhesive preparations for surgical bandages; fireproofing pre-

parations; compositions for threading; sauce for preparing tobacco; amyl alcohol; vinic alcohol; wood alcohol; sal ammoniac spirits; ethyl alcohol; alcohol; cement for footwear; concrete preservatives, except paints and oils; water glass [soluble glass]; strontium; substrates for soil-free growing [agriculture]; barium sulfate; sulfates; antimony sulfide; sulfides; benzoic sulfimide; sulfonic acids; sumac for use in tanning; superphosphates [fertilisers]; antimony; thallium; talc [magnesium silicate]; tannin; cream of tartar for the food industry; cream of tartar for industrial purposes; cream of tartar for chemical purposes; tellurium; terbium; tetrachlorides; carbon tetrachloride; acetylene tetrachloride; technetium; thiocarbonyl; titanite; biological tissue cultures other than for medical or veterinary purposes; sensitized cloth for photography; blueprint cloth; toluene; fuel for atomic piles; thorium; peat [fertiliser]; gum tragacanth for industrial purposes; thulium; carbonic hydrates; carbon; activated carbon; carbon for filters; animal charcoal; animal carbon; bone charcoal; blood charcoal; nitrogenous fertilisers; fertilizers; fish meal fertilizers; wood vinegar [pyrolygneous acid]; uranium; chemical intensifiers for paper; chemical intensifiers for rubber; vulcanisation accelerators; enzymes for the food industry; enzymes for industrial purposes; ferments for chemical purposes; milk ferments for the food industry; milk ferments for industrial purposes; milk ferments for chemical purposes; fermium; ferrocyanides; fixing solutions [photography]; soldering fluxes; brazing fluxes; formic aldehyde for chemical purposes; phosphatedes; phosphates [fertilisers]; phosphorus; photographic paper; photosensitive plates; sensitized photographic plates; sensitized films, unexposed; photographic developers; photographic sensitizers; chemical preparations for use in photography; photographic emulsions; francium; fluorine; chemicals for use in forestry, except fungicides, herbicides, insecticides and parasiticides; glass-frosting chemicals; leather-reno-vating chemicals; glass-staining chemicals; enamel-staining chemicals; oil-separating chemicals; water-purifying chemicals; oil-purifying chemicals; welding chemicals; condensation-preventing chemicals; stain-preventing chemicals for use on fabrics; anti-tarnishing chemicals for windows; leather-waterproofing chemicals; textile-waterproofing chemicals; chemicals, except pigments, for the manufacture of enamel; radiator flushing chemicals; leather-impregnating chemicals; textile-impregnating chemicals; horticultural chemicals, except fungicides, herbicides, insecticides and parasiticides; agricultural chemicals, except fungicides, herbicides, insecticides and parasiticides; soil conditioning preparations; chimney cleaners, chemical; industrial chemicals; color- [colour-] brightening chemicals for industrial purposes; refrigerants; coolants for vehicle engines; chlorine; chlorates; hydrochlorates; aluminium chloride; magnesium chloride; chlorides; palladium chlo-

ride; chromates; flowers of sulfur for chemical purposes; caesium; cellulose; cerium; cyanides [prussicates]; calcium cyanamide [fertilizer]; cymene; loam; slag [fertilisers]; size for finishing and priming; alkalis; caustic alkali; radioactive elements for scientific purposes; fissionable chemical elements; emulsifiers; erbium; ethane; methyl ether; sulfuric ether; ethyl ether; glycol ether; ethers; esters; cellulose ethers for industrial purposes; cellulose esters for industrial purposes; enamel and glass-staining chemicals; sodium salts [chemical compounds]; chemical substances for analyses in laboratories, other than for medical or veterinary purposes; chemical preparations for scientific purposes, other than for medical or veterinary use; preparations of microorganisms, other than for medical and veterinary use; metal annealing preparations; diagnostic preparations, other than for medical or veterinary purposes; biological preparations, other than for medical or veterinary purposes; bacteriological preparations other than for medical and veterinary use; bacterial preparations other than for medical and veterinary use; sensitized plates for offset printing; bate for dressing skins; grafting wax for trees; fissionable material for nuclear energy; artificial sweeteners [chemical preparations].

4 – Anthracite; benzene; benzol; wood briquettes; combustible briquettes; petroleum jelly for industrial purposes; wax [raw material]; ozocerite [ozokerite]; illuminating wax; industrial wax; belting wax; carnauba wax; beeswax; gas for lighting; oil-gas; fuel gas; gasoline; producer gas; solidified gases [fuel]; fuel; lubricating graphite; additives, non-chemical, to motor-fuel; firewood; paper spills for lighting; cutting fluids; fish oil, not edible; illuminating grease; grease for leather; grease for footwear; tallow; industrial grease; kerosene; coke; xylene; xylol; ligroin; wood spills for lighting; mazut; fuel oil; oils for paints; oils for releasing form work [building]; oil for the preservation of masonry; oil for the preservation of leather; textile oil; lubricating oil; Industrial oil; moistening oil; coal tar oil; coal naphtha; castor oil for industrial purposes; bone oil for industrial purposes; motor oil; sunflower oil for industrial purposes; rape oil for industrial purposes; lubricants; naphtha; petroleum, raw or refined; nightlights [candles]; oleine; paraffin; dust removing preparations; soya bean oil preparations for non-stick treatment of cooking utensils; non-slipping preparations for belts; coal dust [fuel]; firelighters; perfumed candles; Christmas tree candles; candles; grease for arms [weapons]; lubricating grease; grease for belts; vaporized fuel mixtures; dust binding compositions for sweeping; dust laying compositions; alcohol [fuel]; stearine; diesel oil; lighting fuel; mineral fuel; carburants; fuel with an alcoholic base; peat [fuel]; peat briquettes [fuel]; tinder; lignite; charcoal [fuel]; coal; coal briquettes; lamp wicks; wicks for candles; ceresine; electrical

energy; ethanol [fuel]; petroleum ether; methylated spirit; preservatives for leather [oils and greases]; lanolin; industrial oils and greases; candles and wicks for lighting.

(260) AM 2016 85942 A  
(800) 1284506  
(891) 2015 10 24  
(731) TAKEDA GmbH  
Byk-Gulden-Str. 2, 78467 Konstanz, Germany  
(540)



(591) black and white  
(511)  
5 – Pharmaceutical preparations; dietetic food adapted for medical use; dietetic substances adapted for medical use; dietary supplements.

(260) AM 2016 85943 A  
(800) 1285074  
(891) 2015 08 24  
(731) JV INVESTMENTS, SIA  
Udens iela 12-118 LV-1007 Riga, Latvia  
(540)

(591) Dark grey and olive green  
(511)  
9 – Magnetic data carriers, recording discs, compact discs, DVDs and other digital recording media; data processing equipment, computers; computer software; all computer programs and software regardless of recording media or means of dissemination, that is, software recorded on magnetic media or downloaded from a remote computer network.

35 – Advertising; business management; business administration; office functions; market research; sales promotion for others, product demonstration, software retail services.

37 – Computer, computer and communication equipment installation and repair.

42 – IT consultancy advisory and information services; scientific and technological services, research and design in these areas; the computer hardware and software design, development and improvement; professional consultation/development of computer software, computer systems design.

(260) AM 2016 85946 A  
 (800) 1284518  
 (891) 2015 11 16  
 (731) MESSE MÜNCHEN GMBH  
 Am Messesee 2, 81829 München, Germany  
 (540)



(591) black and white  
 (511)  
 16 – Printed matter.

35 – Organisation of exhibitions and trade fairs for commercial and advertising purposes; publication and issuance of advertising texts.

41 – Arranging of exhibitions for cultural and teaching purposes; organisation and arranging of congresses and meetings; publication and issuance of printed matter (except for advertising purposes).

(260) AM 2016 86013 A  
 (800) 1286185  
 (891) 2015 10 06  
 (731) PPF a.s.  
 Evropská 2690/17, CZ-160 41 Praha 6,  
 Czech Republic  
 (540)



(591) Blue, white, grey and silver  
 (511)

35 – Updating and maintenance of data in computer databases, cost price analysis, procurement services for others [purchasing goods and services for other businesses], outsourced administrative management for companies, invoicing, economic forecasting, business information, commercial administration of the licensing of the goods and services of others, marketing, marketing studies, business management and organization consultancy, business investigations, business information, business appraisals, organization of exhibitions for commercial or advertising purposes, personnel management consultancy, compilation of information into computer databases, business management consultancy, organization of trade fairs for commercial or advertising purposes, business auditing, business research, business inves-

tigations, marketing research, opinion polling, payroll preparation, advertising, publicity, advisory management services for business, secretarial services, negotiation and conclusion of commercial transactions for third parties, arranging of commercial and business contacts, public relations, outsourcing services, systemization of information into computer databases, book-keeping, accounting, publication of publicity texts, organization of exhibitions for commercial or advertising purposes, arranging subscriptions to telecommunication services for others, personnel recruitment.

36 – Financial analysis, banking, credit bureaux, fiscal valuations, mutual funds, electronic funds transfer, financial analysis and information, financial evaluation [insurance, banking, real estate]; financial consultancy, surety services/bail-bonding/guarantees, financial consultancy, financial management, financing services, financial sponsorship, mortgage banking, insurance information, capital investment, real estate agencies, insurance consultancy, hire-purchase financing, credit card services, stock brokerage services, lease-purchase financing, real estate brokerage, real estate management, fiscal assessments, financial evaluation [insurance, banking, real estate], online banking, exchanging money, provident fund services, insurance underwriting, life insurance underwriting, insurance brokerage, insurance consultancy, providing financial information via a web site, leasing of real estate, rental of offices [real estate], loans [financing], lending against security, real estate agencies, exchanging money, trusteeship, fiduciary, accident insurance underwriting, securities brokerage, issuance of credit cards, arranging finance for construction projects, financial clearing-houses, surety services/bail-bonding/guarantees.

37 – Building construction supervision, construction consultation, installation, maintenance and repair of computer hardware, construction information, construction.

38 – Electronic mail, electronic bulletin board services [telecommunications services], communications by telephone, cellular telephone communication, communications by computer terminals, message sending, providing access to databases, providing telecommunications connections to a global computer network, rental of message sending apparatus, rental of modems, rental of telephones, rental of telecommunication equipment, telecommunications routing and junction services, telephone services, information about telecommunication, broadcasting, message sending.

39 – Transport freight forwarding, message delivery, delivery of goods, carting, electricity distribution, horse rental, transportation logistics, transport and storage of trash, rental of warehouses, distribution of



energy, storage, removal services, transport brokerage.

40 – Decontamination of hazardous materials, destruction of waste and trash, recycling of waste and trash, incineration of waste and trash, printing, production of energy, waste treatment [transformation].

41 – Theatre productions, electronic desktop publishing, boarding schools, entertainment or education club services, arranging and conducting of colloquiums, music-halls, health club services [health and fitness training, coaching [training], providing of museum facilities, arranging and conducting of concerts, arranging and conducting of conferences, arranging and conducting of congresses, arranging and conducting of seminars, arranging and conducting of symposiums, organization of exhibitions for cultural or educational purposes, organization of sports competitions, arranging and conducting of workshops, operating lotteries, rental of sports ground, rental of stadium facilities, providing sports facilities, services of schools [education], instruction services, arranging and conducting of workshops, booking of seats for shows, publication of books, teaching, educational services, organization of shows [impresario services], ticket agency services [entertainment].

42 – Updating of computer software, architectural consultation, bacteriological research, biological research, electronic data storage, installation of computer software, clinical trials (clinical research), chemical analysis, chemical research, engineering, clinical trials, computer software consultancy, information technology [IT] consulting services, scientific laboratory services, recovery of computer data, computer programming, maintenance of computer software, construction drafting, technical project studies, rental of computer software, chemistry services, computer system design, computer software design, maintenance of computer software, scientific research, research and development of new products.

43 – Snack-bars, cafeterias and canteens, restaurants.

44 – Pharmacy services, nursing homes, health spa services, hospitals, medical equipment rental, health care, health counseling, medical clinic services, health centers.

45 – Intellectual property consultancy, licensing of intellectual property, monitoring intellectual property rights for legal advisory purposes, registration of domain names [legal services], licensing of computer software [legal services], intellectual property consultancy, litigation services, copyright management.

---

(260) AM 2016 86016 A  
(800) 1285265  
(891) 2015 12 18

(731) Abbott Products Operations AG  
Hegenheimermattweg 127, CH-4123  
Allschwil, Switzerland

(540)

## JELEFOLI

(511)

5 – Medicines for human medicine; dietetic substances and foods for medical use; dietetic food supplements.

---

(260) AM 2016 86017 A

(800) 1286186

(891) 2015 10 06

(731) PPF a.s.  
Evropská 2690/17, CZ-160 41 Praha 6,  
Czech Republic

(540)



(591) Blue and white

(511)

35 – Updating and maintenance of data in computer databases, cost price analysis, procurement services for others [purchasing goods and services for other businesses], outsourced administrative management for companies, invoicing, economic forecasting, business information, commercial administration of the licensing of the goods and services of others, marketing, marketing studies, business management and organization consultancy, business investigations, business information, business appraisals, organization of exhibitions for commercial or advertising purposes, personnel management consultancy, compilation of information into computer databases, business management consultancy, organization of trade fairs for commercial or advertising purposes, business auditing, business research, business investigations, marketing research, opinion polling, payroll preparation, advertising, publicity, advisory management services for business, secretarial services, negotiation and conclusion of commercial transactions for third parties, arranging of commercial and business contacts, public relations, outsourcing services, systemization of information into computer databases, book-keeping, accounting, publication of publicity texts, organization of exhibitions for commercial or advertising purposes, arranging subscriptions to telecommunication services for others, personnel recruitment.

36 – Financial analysis, banking, credit bureaux, fiscal valuations, mutual funds, electronic funds transfer, financial analysis and information, financial evaluation [insurance, banking, real estate], financial consultancy, surety services/bail-bonding/guarantees, financial consultancy, financial management, financing services, financial sponsorship, mortgage banking, insurance information, capital investment, real estate agencies, insurance consultancy, hire-purchase financing, credit card services, stock brokerage services, lease-purchase financing, real estate brokerage, real estate management, fiscal assessments, financial evaluation [insurance, banking, real estate], online banking, exchanging money, provident fund services, insurance underwriting, life insurance underwriting, insurance brokerage, insurance consultancy, providing financial information via a web site, leasing of real estate, rental of offices [real estate], loans [financing], lending against security, real estate agencies, exchanging money, trusteeship, fiduciary, accident insurance underwriting, securities brokerage, issuance of credit cards, arranging finance for construction projects, financial clearing-houses, surety services/bail-bonding/guarantees.

37 – Building construction supervision, construction consultation, installation, maintenance and repair of computer hardware, construction information, construction.

38 – Electronic mail, electronic bulletin board services [telecommunications services], communications by telephone, cellular telephone communication, communications by computer terminals, message sending, providing access to databases, providing telecommunications connections to a global computer network, rental of message sending apparatus, rental of modems, rental of telephones, rental of telecommunication equipment, telecommunications routing and junction services, telephone services, information about telecommunication, broadcasting, message sending.

39 – Transport freight forwarding, message delivery, delivery of goods, carting, electricity distribution, horse rental, transportation logistics, transport and storage of trash, rental of warehouses, distribution of energy, storage, removal services, transport brokerage.

40 – Decontamination of hazardous materials, destruction of waste and trash, recycling of waste and trash, incineration of waste and trash, printing, production of energy, waste treatment [transformation].

41 – Theatre productions, electronic desktop publishing, boarding schools, entertainment or education club services, arranging and conducting of colloquiums, music-halls, health club services [health and fitness training, coaching [training], providing of museum facilities, arranging and conducting of con-

certs, arranging and conducting of conferences, arranging and conducting of congresses, arranging and conducting of seminars, arranging and conducting of symposiums, organization of exhibitions for cultural or educational purposes, organization of sports competitions, arranging and conducting of workshops, operating lotteries, rental of sports ground, rental of stadium facilities, providing sports facilities, services of schools [education], instruction services, arranging and conducting of workshops, booking of seats for shows, publication of books, teaching, educational services, organization of shows [impresario services], ticket agency services [entertainment].

42 – Updating of computer software, architectural consultation, bacteriological research, biological research, electronic data storage, installation of computer software, clinical trials (clinical research), chemical analysis, chemical research, engineering, clinical trials, computer software consultancy, information technology [it] consulting services, scientific laboratory services, recovery of computer data, computer programming, maintenance of computer software, construction drafting, technical project studies, rental of computer software, chemistry services, computer system design, computer software design, maintenance of computer software, scientific research, research and development of new products.

43 – Snack-bars, cafeterias and canteens, restaurants.

44 – Pharmacy services, nursing homes, health spa services, hospitals, medical equipment rental, health care, health counseling, medical clinic services, health centers.

45 – Intellectual property consultancy, licensing of intellectual property, monitoring intellectual property rights for legal advisory purposes, registration of domain names (legal services), licensing of computer software [legal services], intellectual property consultancy, litigation services, copyright management.

---

(260) AM 2016 86018 A

(800) 1285267

(891) 2015 12 18

(731) Abbott Products Operations AG  
Hegenheimermattweg 127, CH-4123  
Allschwil, Switzerland

(540)

**ЖЕЛЕФОЛИ**

(591) black and white

(511)

5 – Medicines for human medicine; dietetic substances and foods for medical use; dietetic food supplements.

---

(260) AM 2016 86022 A

(800) 1285278

(891) 2015 07 15

(731) Limited liability company "GOLDEN TILE"

Mashynobudivna Str. 50, Kyiv 03067,

Ukraine

(540)



(591) black and white

(511)

6 – Common metals and their alloys; metal building materials; transportable buildings of metal; materials of metal for railway tracks; non-electric cables and wires of common metal; ironmongery, small items of metal hardware; pipes and tubes of metal; safes; goods of common metal not included in other classes; ores; advertisement columns of metal; ducts of metal for ventilating and air conditioning installations; alloys of common metal; aluminium; aluminium foil; aluminium wire; anchor plates; anchors; angle irons; metal cages for wild animals; traps for wild animals; anti-friction metal; anvils; anvils [portable]; armour plate; armour-plating; aviaries of metal [structures]; badges of metal for vehicles; balls of steel; bands of metal for tying-up purposes; barbed wire; barrel hoops of metal; barrels of metal; crash barriers of metal for roads; bars for metal railings; latch bars of metal; baskets of metal; bird baths [structures of metal]; beacons of metal, non-luminous; beak-irons [bick-irons]; bed casters of metal; fittings of metal for beds; bells; bells for animals; belt stretchers of metal; belts of metal for handling loads; beryllium [glucinium]; bicycle parking installations of metal; binding screws of metal for cables; binding thread of metal for agricultural purposes; bindings of metal; bins of metal; bird baths [structures of metal]; wind-driven bird-repelling devices made of metal; blooms [metallurgy]; mobile boarding stairs of metal for passengers; building boards of metal; bolts, flat; lock bolts; bolts of metal; bottle caps of metal; bottle closures of metal; bottle fasteners of metal; bottles [metal containers] for compressed gas or liquid air; box fasteners of metal; boxes of common metal; safety cashboxes; identification bracelets of metal for hospitals; braces of metal for handling loads; brackets of metal for building; brads; branching pipes of metal; brass, unwrought or semi-wrought; brazing alloys; rods of metal for brazing; bronze; bronzes for tombstones; bronzes [works of art]; broom handles of metal; buckles of common metal [hardware]; building boards of metal;

framework of metal for building; building materials of metal; building or furniture fittings of nickel-silver; building panels of metal; reinforcing materials of metal for building; fittings of metal for building; buildings of metal; buildings, transportable, of metal; bungs of metal; mooring buoys of metal; busts of common metal; cabanas of metal; cable joints of metal, non-electric; clips of metal for cables and pipes; cables of metal, non-electric; cadmium; metal cages for wild animals; bottle caps of metal; capsules of metal for bottles; casement windows of metal; cash-boxes of metal; casings of metal for oilwells; cask stands of metal; casks of metal; cast iron, unwrought or semi-wrought; cast steel; furniture casters of metal; cattle chains; ceilings of metal; celtium [hafnium]; ducts and pipes of metal for central heating installations; cermets; chains of metal; chests of metal; chests of metal for food; chicken-houses of metal; chill-molds [foundry]; chill-moulds [foundry]; chimney cowls of metal; chimney pots of metal; chimney shafts of metal; chimneys of metal; chrome iron; chrome ores; chromium; cladding of metal for construction and building; clips of metal for cables and pipes; closures of metal for containers; clothes hooks of metal; cobalt, raw; fittings of metal for coffins; collars of metal for fastening pipes; advertisement columns of metal; common metals, unwrought or semi-wrought; containers of metal for compressed gas or liquid air; containers of metal for liquid fuel; containers of metal for storing acids; containers of metal [storage, transport]; copper rings; copper, unwrought or semi-wrought; copper wire, not insulated; cornices of metal; cotter pins of metal; couplings of metal for chains; crampons [climbing irons]; crampons of metal [cramps]; cramps of metal [crampons]; crash barriers of metal for roads; diving boards of metal; floating docks of metal for mooring boats; door bells of metal, non-electric; door bolts of metal; door casings of metal; door closers, non-electric; door fittings of metal; door frames of metal; door handles of metal; door knockers of metal; door openers, non-electric; door panels of metal; door scrapers; door springs, non-electric; door stops of metal; doors of metal; drain pipes of metal; drain traps [valves] of metal; duckboards of metal; elbows of metal for pipes; enclosures of metal for tombs; eye bolts; collars of metal for fastening pipes; fences of metal; ferrotitanium; ferrules of metal; ferrules of metal for handles; ferrules of metal for walking sticks; figurines [statuettes] of common metal; filings of metal; firedogs [andirons]; fish plates [rails]; fittings of metal for coffins; fittings of metal for compressed air ducts; fittings of metal for furniture; fittings of metal for windows; flanges of metal [collars]; flashing of metal, for building; floating containers of metal; floating docks of metal for mooring boats; floor tiles of metal; floors of metal; foils of metal for wrapping and packaging; foot scrapers; foundry molds [moulds] of metal; frames of metal

for building; furnace fire screens; furnace fireguards of metal; furniture casters of metal; galena [ore]; gate stops of metal; gates of metal; German silver; germanium; girders of metal; gold solder; gratings of metal; gravestone slabs of metal; gravestones of metal; grease nipples; greenhouse frames of metal; greenhouses of metal, transportable; grilles of metal; guard rails of metal; gutter pipes of metal; root gutters of metal; hafnium [celtium]; handcuffs; handling pallets of metal; hardware of metal, small; harness of metal for handling loads; hinges of metal; hooks for slate [metal hardware]; hooks [metal hardware]; hooks of metal for clothes rails; hoop iron; hoop steel, barrel hoops of metal; hoppers of metal, non-mechanical; horseshoe nails; house numbers of metal, non-luminous; ice moulds of metal; ice nails [climbing irons]; identity plates of metal; indium; ingots of common metal; insect screens of metal; stretchers for iron bands [tension links]; chrome iron; molybdenum iron; iron ores; silicon iron; iron slabs; iron strip; iron, unwrought or semi-wrought; iron wire; ironmongery; beak-irons [bick-irons]; ironwork for doors; ironwork for windows; jalousies of metal; jets of metal; joists of metal; junctions of metal for pipes; keys; rings of common metal for keys; knife handles of metal; knobs of metal; door knockers of metal; ladders of metal; latch bars of metal; latches of metal; laths of metal; latticework of metal; lead seals; lead, unwrought or semi-wrought; letter boxes of metal; letters and numerals of common metal, except type; limonite; linings of metal [building]; cable linkages of metal, non-electric; lintels of metal; braces of metal for load handling; harness of metal for load handling; straps of metal for load handling; loading gauge rods, of metal, for railway waggons; loading gauge rods, of metal, for railway wagons; loading pallets, of metal; slings of metal for handling loads; locks of metal for bags; locks of metal for vehicles; locks of metal, other than electric; machine belt fasteners of metal; reinforcing materials of metal for machine belts; magnesium; manganese; manhole covers of metal; manifolds of metal for pipelines; masts of metal; materials of metal for funicular railway permanent ways; meat safes of metal; memorial plaques of metal; memorial plates of metal; metals in powder form; moldings of metal for cornices; molybdenum; boxes of metal; monuments of metal; floating docks of metal, for mooring boats; mooring bollards of metal; mooring buoys of metal; troughs of metal for mixing mortar; mouldings of metal for cornices; nails; nickel; nickel-silver; niobium; grease nipples; nozzles of metal; numberplates of metal; letters and numerals of common metal, except type; nuts of metal; casings of metal for oil-wells; ores of metal; outdoor blinds of metal; packing containers of metal; tinplate packings; padlocks; booths of metal for spraying paint; palings of metal; loading pallets of metal; transport pallets of

metal; partitions of metal; paving blocks of metal; pegs of metal; penstock pipes of metal; pilings of metal; pillars of metal for buildings; cotter pins of metal; pins [hardware]; pipe muffs of metal; manifolds of metal for pipelines; clips of metal for pipes; pipes of metal; pipes of metal, for central heating installations; penstock pipes of metal; reinforcing materials of metal for pipes; pipework of metal; pitons of metal; registration plates of metal; platforms, prefabricated, of metal; plugs of metal; wall plugs of metal; railway points; poles of metal; poles of metal for electric lines; swimming pools [metal structures]; porches of metal [building]; posts of metal; posts of metal for power lines; pot hooks of metal; preserve tins; preserving boxes of metal; props of metal; pulleys of metal, other than for machines; pyrophoric metals; railroad ties of metal; rails of metal; railway material of metal; railway sleepers of metal; railway switches; reels of metal, non-mechanical, for flexible hoses; refractory construction materials of metal; reinforcing materials of metal for building; reinforcing materials, of metal, for concrete; reinforcing materials of metal for machine belts; rings of common metal for keys; rings of metal; rivets of metal; rocket launching platforms of metal; rods of metal for brazing and welding; roller blinds of steel; roof coverings of metal; roof flashing of metal; roofing of metal; rope thimbles of metal; ropes of metal; runners of metal for sliding doors; safes [strong boxes]; safety cashboxes; safety chains of metal; sash fasteners of metal for windows; sash pulleys; scaffolding of metal; insect screens of metal; screw rings; screws of metal; scythe handles of metal; sealing caps of metal; sealing caps of metal for bottles; lead seals; sheaf binders of metal; sheet piles of metal; sheets and plates of metal; shims; shuttering of metal for concrete; shutters of metal; signalling panels, non-luminous and non-mechanical, of metal; signboards of metal; signs, non-luminous and non-mechanical, of metal; signs, non-luminous and non-mechanical, of metal, for roads; sills of metal; silos of metal; silver plated tin alloy; silver solder; skating rinks [structures of metal]; sleeves [metal hardware]; slings of metal for handling loads; soldering wire of metal; spring locks; springs [metal hardware]; spurs; stair treads [steps] of metal; staircases of metal; cask stands of metal; statues of common metal; statuettes of common metal; steel alloys; steel buildings; steel masts; steel pipes; steel sheets; steel strip; steel tubes; steel, unwrought or semi-wrought; steel wire; steps [ladders] of metal; stop collars of metal; stops of metal; strap-hinges of metal; straps of metal for handling loads; stretchers for metal bands [tension links]; belt stretchers of metal; stringers [parts of staircases] of metal; swimming pools [metal structures]; tanks of metal; tantalum [metal]; taps for casks of metal; telegraph posts of metal; telephone booths of metal; telephone boxes of metal; telpher cables; tension links; tent pegs of me-

tal; rope thimbles of metal; thread of metal for tying-up purposes; tie plates; railroad ties of metal; tile floorings of metal; tiles of metal for building; tin; tin cans; tinfoil; tinplate; tinplate packings; titanium; titanium iron; tombac; enclosures of metal for tombs; monuments of bronze for tombs; monuments of metal for tombs; tombs of metal; tombstone plaques of metal; tombstone stelae of metal; tool boxes of metal, empty; tool chests of metal, empty; tool handles of metal; towel dispensers, fixed, of metal; transport pallets of metal; traps for wild animals; tree protectors of metal; trellis of metal; troughs of metal for mixing mortar; tubing of metal; tubes of metal; tungsten; tungsten iron; turnstiles of metal; turntables [railways]; valves of metal, other than parts of machines; vanadium; weather- or wind vanes of metal; vats of metal; vaults of metal [burial]; vice claws of metal; wainscotting of metal; ferrules of metal for walking sticks; wall claddings of metal [building]; wall hooks of metal for pipes; wall linings of metal [building]; wall plugs of metal; washers of metal; water-pipe valves of metal; water-pipes of metal; weather vanes of metal; rods of metal for welding; wheel clamps [boots]; white metal; wind vanes of metal; wind-driven bird-repelling devices made of metal; window casement bolts; window fasteners of metal; window frames of metal; window pulleys; window stops of metal; windows of metal; wire cloth; wire gauze; wire of common metal; wire of common metal alloys, except fuse wire; wire rope; wire stretchers [tension links], works of art of common metal; wrapping or binding bands of metal; zinc; zirconium.

11 – Apparatus for lighting, heating, steam generating, cooking, refrigerating, drying, ventilating, water supply and sanitary purposes; air deodorising apparatus; air valves for steam heating installations; alcohol burners; anti-dazzle devices for automobiles [lamp fittings]; anti-glare devices for vehicles [lamp fittings]; anti-splash tap nozzles; aquarium filtration apparatus; aquarium lights; arc lamps; furnace ash boxes; ash conveyor installations, automatic; ash pits for furnaces; atomic piles; automobile lights; bath fittings; hot air bath fittings; bath installations; sauna bath installations; bath plumbing fixtures; bath tubs; bath tubs for sitz baths; heaters for baths; spa baths [vessels]; beverage cooling apparatus; bicycle lights; bidets, blankets, electric, not for medical purposes; boiler pipes [tubes] for heating installations; boilers, other than parts of machines; brackets for gas burners; burners; germicidal burners; incandescent burners; carbon for arc lamps; ceiling lights; clean chambers [sanitary installations]; chandeliers; chimney blowers; chimney flues; lamp chimneys; Chinese lanterns; electric lights for Christmas trees; chromatography apparatus for industrial purposes; coils [parts of distilling, heating or cooling installations]; gas condensers, other than parts of machines; installations for conditioning air; refrigerating

containers; coolers for furnaces; cooling appliances and installations; cooling installations and machines; cooling installations for liquids; cooling installations for tobacco; cooling installations for water; curling lamps; cycle lights; apparatus for dehydrating food waste; dental ovens; deodorising apparatus, not for personal use; desalination plants; desiccating apparatus; light diffusers; disinfectant dispensers for toilets; disinfectant distributors for toilets; refrigerating display cabinets [display cases]; distillation apparatus; distillation columns; diving lights; air driers; drip irrigation emitters [irrigation fittings]; fuel economizers; electric lamps; heating elements; evaporators; expansion tanks for central heating installations; fairy lights for festive decoration; faucets for pipes; heating filaments, electric; filaments for electric lamps, magnesium filaments for lighting; fittings, shaped, for furnaces; fittings, shaped, for ovens; flare stacks for use in the oil industry; flares; flashlights [torches]; chimney flues; flushing apparatus; flushing tanks; forage drying apparatus; forges, portable; fountains; ornamental fountains; framework of metal for ovens; freezers; friction lighters for igniting gas; fumigation apparatus, not for medical purposes; furnace grates; coolers for furnaces; cooling vats for furnaces; shaped fittings for furnaces; regulating and safety accessories for gas apparatus; gas boilers; gas condensers, other than parts of machines; gas lamps; gas lighters; regulation and safety accessories for gas pipes; gas scrubbers [parts of gas installations]; gas scrubbing apparatus; steam generator installations; germicidal burners; germicidal lamps for purifying air; glue-heating appliances; furnace grates; hand drying apparatus for washrooms; headlights for automobiles; hearths; heat accumulators; heat exchangers, not parts of machines; heat pumps; heat regenerators; heaters, electric, for feeding bottles; heaters for baths; heaters for heating irons; heaters for vehicles; immersion heaters; heating apparatus; heating apparatus, electric; heating apparatus for solid, liquid or gaseous fuels; heating boilers; heating elements; heating filaments, electric; heating installations; hot water heating installations; heating installations [water], heating plates; hot air bath fittings; hot air ovens; hot water bottles; luminous house numbers; humidifiers for central heating radiators; hydrants; ice boxes; ice chests; ice machines and apparatus; incinerators; ionization apparatus for the treatment of air or water; kettles, electric; kiln furniture [supports]; kilns; laboratory burners; laboratory lamps; lamp casings; lamp chimneys; lamp glasses; lamp mantles; lamp reflectors; lamp shades; lamps; lamps for directional signals of automobiles; lampshade holders; lanterns, lanterns for lighting; level controlling valves in tanks; light bulbs; light bulbs, electric; light bulbs for directional signals for vehicles; light diffusers; lighters; lighting apparatus for vehicles; diving

lights; lights for automobiles; lights for vehicles; loading apparatus for furnaces; luminous house numbers; luminous tubes for lighting; magnesium filaments for lighting; malt roasters; microwave ovens [cooking apparatus]; microwave ovens for industrial purposes; milk cooling installations; miners' lamps; mixer taps for water pipes; anti-splash tap nozzles; installations for processing nuclear fuel and nuclear moderating material; nuclear reactors; oil burners; oil lamps; oil-scrubbing apparatus; ornamental fountains; oven fittings made of fireclay; ovens, other than for laboratory use; shaped fittings for ovens; oxyhydrogen burners; pasteurisers; petrol burners; pipe line cocks [spigots]; pipes [parts of sanitary installations]; plate warmers; pocket searchlights; pocket torches, electric; pocket warmers; polymerisation installations; purification installations for sewage; radiator caps; radiators, electric; radiators [heating]; nuclear reactors; refining towers for distillation; lamp reflectors; vehicle reflectors; refrigerating apparatus and machines; refrigerating appliances and installations; refrigerating cabinets; refrigerating chambers; refrigerating containers; refrigerating display cabinets; refrigerators; regulating accessories for water or gas apparatus and pipes; regulating and safety accessories for gas apparatus; regulating and safety accessories for gas pipes; regulating and safety accessories for water apparatus; rotisseries; sanitary apparatus and installations; pressure cooking saucepans, electric; sauna bath installations; scrubbers [parts of gas installations]; searchlights; toilet seats; sinks; bath tubs for sitz-baths; sockets for electric lights; water softening apparatus and installations; solar thermal collectors [heating]; solar furnaces; spa baths [vessels]; flare stacks for use in oil refineries; steam generating installations; sterilizers; stills; stoves; stoves [heating apparatus]; street lamps; swimming pool chlorinating unit apparatus; tanning apparatus [sun beds]; taps [cocks, spigots] [faucets (Am.)] for pipes; taps [faucets]; thermostatic valves [parts of heating installations]; cooling installations for tobacco; toilet bowls; toilet seats; toilets, portable; toilets [water-closets]; torches for lighting; pocket torches, electric; discharge tubes, electric, for lighting; Turkish bath cabinets, portable; ultraviolet ray lamps, not for medical purposes; urinals [sanitary fixtures]; vehicle headlights; vehicle reflectors, ventilation [air-conditioning] installations for vehicles; ventilation hoods; ventilation hoods for laboratories; walk-in refrigerators; warming pans; washers for water taps; wash-hand basins [parts of sanitary installations], wash-hand bowls [parts of sanitary installations]; washing coppers; water closets; water conduits installations; water distribution installations; water filtering apparatus; water flushing installations; water heaters; water heaters [apparatus]; water intake apparatus; water purification installations; water purifying apparatus and machines; water

softening apparatus and installations; installations, automatic; watering machines for agricultural purposes; water-pipes for sanitary installations; whirlpool-jet apparatus.

19 – Building materials (non-metallic); non-metallic rigid pipes for building; asphalt, pitch and bitumen; non-metallic transportable buildings; monuments, not of metal; bituminous products for building; cement for blast furnaces; outdoor blinds, not of metal and not of textile; parquet floor boards; branching pipes, not of metal; bricks; earth for bricks; building cardboard [asphalted]; framework for building, not of metal; building glass; building materials, not of metal; building panels, not of metal; building paper; building stone; building timber; buildings, not of metal; buildings, transportable, not of metal; busts of stone, concrete or marble; cabanas not of metal; caissons for construction work under water; calcareous marl; calcareous stone; building cardboard; case-ment windows, not of metal; cask wood; ceilings, not of metal; cement; fireproof cement coatings; cement posts; cement slabs; raw chalk; chicken-houses, not of metal; chimney cowls, not of metal; chimney pots, not of metal; chimney shafts, not of metal; chimneys, not of metal; cladding, not of metal, for building; clay; potters' clay [raw material]; clinker ballast; clinker stone; coal tar; coatings [building materials]; advertisement columns, not of metal; concrete; concrete building elements; construction materials, not of metal; cork [compressed]; cornices, not of metal; coverings, not of metal, for building; crash barriers, not of metal, for roads; diving boards, not of metal; floating docks, not of metal, for mooring boats; door casings, not of metal; door frames, not of metal; door panels, not of metal; doors, not of metal; drain pipes, not of metal; drain traps [valves], not of metal or plastic; duckboards, not of metal; ducts, not of metal, for ventilating and air-conditioning installations; tomb or grave enclosures, not of metal; facings, not of metal, for building; fair huts; felt for building; fences, not of metal; figurines [statuettes] of stone, concrete or marble; fire burrs; fireclay; fireproof cement coatings; flashing, not of metal, for building; parquet floor boards; floor tiles, not of metal; floors, not of metal; folding doors, not of metal; foundry molds [moulds], not of metal; framework, not of metal, for building; cement for furnaces; furrings of wood; gates, not of metal; geotextiles; girders, not of metal; alabaster glass; building glass; glass granules for road marking; granite; grave or tomb enclosures, not of metal; grave slabs, not of metal; gravestones; greenhouse frames, not of metal; greenhouses, transportable, not of metal; grog [fired refractory material]; grout; gutter pipes, not of metal; gutters, not of metal; gypsum; hips for roofing; horticultural frames, not of metal; huts; insect screens not of metal; insulating glass [building]; jalousies, not of metal; joists, not of metal; laths, not of metal; latticework, not of metal;

lengthening pieces, not of metal, for chimneys; letter boxes of masonry; light cement slabs; lime; limestone; linings, not of metal, for building; lintels, not of metal; lumber; luminous paving blocks; macadam; magnesia cement; manhole covers, not of metal; mantlepieces; marble; calcareous marl; masts [poles], not of metal; memorial plaques, not of metal; moldable wood; moldings, not of metal, for building; moldings, not of metal, for cornices; monuments, not of metal; mooring bollards, not of metal; mortar for building; mosaics for building; mouldable wood; mouldings, not of metal, for building; mouldings, not of metal, for cornices; olivine for building; paint spraying booths, not of metal; palings, not of metal; palisading, not of metal; building panels not of metal; pantiles; building paper; paperboard for building; installations, not of metal, for parking bicycles; parquet floor boards; parquet flooring; partitions, not of metal; paving blocks, not of metal; paving slabs, not of metal; penstock pipes, not of metal; perches; pigsties not of metal; pilings, not of metal; gutter pipes not of metal, penstock pipes, not of metal; rigid pipes, not of metal [building]; water-pipes not of metal; pitch; planks [wood for building]; plaster; plate glass [windows], for building; platforms, prefabricated, not of metal; plywood; poles, not of metal, for power lines; swimming pools [structures, not of metal]; porches, not of metal, for building; posts, not of metal; posts, not of metal, for electric power lines; potters' clay; props, not of metal; quartz; railroad ties, not of metal; railway sleepers, not of metal; reeds, for building; refractory construction materials, not of metal; reinforcing materials, not of metal, for building; road coating materials; road marking sheets and strips of synthetic material; binding material for road repair; materials for making and coating roads; rock crystal; rocket launching platforms, not of metal; roof coverings, not of metal; roof flashing, not of metal; roofing, not of metal; roofing, not of metal, incorporating solar cells; roofing slates; rubble; safety glass; sand, except foundry sand; silver sand; sandstone for building; sandstone tubes; scaffolding, not of metal; scantlings [carpentry]; schists; sheet piles, not of metal; shingles; shuttering, not of metal, for concrete; shutters, not of metal; signalling panels, non-luminous and non-mechanical, not of metal; signs, non-luminous and non-mechanical, not of metal, for roads; non-luminous and non-mechanical signs, not of metal; silica [quartz]; sills, not of metal; silos, not of metal; skating rinks [structures, not of metal]; slabs, not of metal for building; slag [building material]; slag stone; slate; slate powder; stables not of metal; stained-glass windows; staircases, not of metal; stair-treads [steps], not of metal; statues of stone, concrete or marble; statuettes of stone, concrete or marble; stave wood; stone; works of stonemasonry; binding agents for making stones; stringers [parts of staircases], not

of metal; surfacings, not of metal, for building; tanks of masonry; tar; tarred strips, for building; telegraph posts, not of metal; telephone booths, not of metal; telephone boxes, not of metal; terra cotta; tile floorings, not of metal; tiles, not of metal; tiles, not of metal, for building; manufactured timber; sawn timber; manufactured timber; tombs, not of metal; tombstone plaques, not of metal; tombstone stelae, not of metal; tombstones; trellises, not of metal; tufa; vaults, not of metal [burial]; veneer wood; veneers; vinyl siding; wainscoting, not of metal; wall claddings, not of metal, for building; wall linings, not of metal, for building; wall tiles, not of metal, for building; water-pipe valves, not of metal or plastic; water-pipes, not of metal; window frames, not of metal; window glass, except glass for vehicle windows; window glass, for building; windows, not of metal; stained-glass windows; wood for making household utensils; wood panelling; wood paving; wood pulp board, for building; wood, semi-worked; works of art of stone, concrete or marble; xylolith.

21 – Household or kitchen utensils and containers; combs and sponges; brushes (except paint brushes); brush-making materials; articles for cleaning purposes; steelwool; unworked or semi-worked glass (except glass used in building); glassware, porcelain and earthenware not included in other classes; abrasive pads for kitchen purposes; autoclaves [pressure cookers], non-electric; aerosol dispensers, not for medical purposes; aquarium hoods; cotton waste for cleaning; basins [bowls]; beer mugs; bottles; bottle openers; butter dishes; boxes of metal, for dispensing paper towels; busts of china, terra-cotta or glass; butter-dish covers; cotton waste for cleaning; shaving brushes; shaving brush stands; eyebrow brushes; carboys; shoe horns; brushes for footwear; fitted picnic baskets, including dishes; buckets; coal scuttles; brooms; candlesticks; candle rings; cauldrons; ceramics for household purposes; chamber pots; china ornaments; closures for pot lids; coasters, not of paper and other than table linen; containers for household or kitchen use, not of precious metal; cooking pots; cooking pot sets; covers, not of paper, for flower pots; covers for dishes; crockery; crystal (glassware); cups; clothing stretchers; cloth for washing floors; buttonhooks; dishwashing brushes; feeding troughs; combs; combs for animals; electric combs; large-toothed combs for the hair; comb cases; make-up removing appliances, non-electric; sponge holders; sponges for household purposes; abrasive sponges for scrubbing the skin; smoke absorbers for household purposes; baby baths, portable; cutting boards for the kitchen; ironing boards; buckskin for cleaning; sprinkling devices; toothbrushes; toothbrushes, electric; toothpicks; isothermic bags; coffee pots, non-electric; coffee services [tableware]; coffee percolators, non-electric; coffee filters, non-electric; cruets; stew-pans; rolling pins, domestic; tar-brushes, long handled; glue-pots; cosmetic

utensils; clothing stretchers; boxes for dispensing paper towels; decanters; deodorising apparatus for personal use; dishes; dishes for soap; drinking glasses; drinking vessels; drinking troughs; nozzles for watering cans; sprinklers for watering flowers and plants; dustbins; earthenware saucepans; egg cups; enameled glass; epergnes, not of precious metal; furniture dusters; flasks, not of precious metal; flat-iron stands; flower pots; fruit cups; fused silica [semi-worked product], other than for building; glasses [receptacles]; glass bulbs [receptacles]; glass bowls; glass caps; glass flasks [containers]; glass jars [carboys]; glass for vehicle windows [semi-finished product]; glass incorporating fine electrical conductors; glass, unworked or semi-worked, except building glass; holders for flowers and plants [flower arranging]; hair for brushes; indoor terrariums [plant cultivation]; jugs; cages for household pets; birdcages; cocktail stirrers; insect traps; confectioners' decorating bags [pastry bags]; horse brushes; mangers for animals; mouse traps; fly swatters; kitchen containers, not of precious metal; kitchen mixers, non-electric; litter boxes [trays] for pets; lunch boxes; mess-tins; mosaics of glass, not for building; majolica; mills for domestic purposes, hand-operated; opal glass; cruet stands for oil and vinegar; basting spoons, for kitchen use; paper plates; mixing spoons [kitchen utensils]; pepper mills, hand-operated; pepper pots; cookie jars; vessels of metal for making ices and iced drinks; painted glassware; pie servers; plates to prevent milk boiling over; porcelain ware; pottery; pots; pot lids; refrigerating bottles; polishing apparatus and machines, for household purposes, non-electric; plate glass [raw material]; ice buckets; ice cube molds [moulds]; funnels; noodle machines, hand-operated; scoops [tableware]; pie servers; pastry cutters; vegetable dishes; salad bowls; cheese-dish covers; salt cellars; rails and rings for towels; saucepan scourers of metal; saucers; scoops [tableware]; cocktail shakers; signboards of porcelain or glass; spice sets; soap boxes; soap dispensers; spatulas [kitchen utensils]; table plates; tableware, other than knives, forks and spoons; tankards; toilet cases; toilet utensils; trivets [table utensils]; urns; utensils for household purposes; vessels of metal for making ices and iced drinks; works of art, of porcelain, terracotta ceramic, earthenware or glass; wine tasters [siphons]; water apparatus for cleaning teeth and gums; wax-polishing appliances, non-electric, for shoes; plungers for clearing blocked drains; gridiron supports; griddles [cooking utensils]; cooking skewers of metal; gardening gloves; gloves for household purposes; fiberglass other than for insulation or textile use; deep fryers, non-electric; fruit presses, non-electric, for household purposes; thermally insulated containers for food.

35 – Advertising; business management; business administration; office functions; accounting; advisory services for business management; advertising

agencies; advertising by mail order; auctioneering; administrative processing of purchase orders; arranging newspaper subscriptions for others; arranging subscriptions to telecommunication services for others; business appraisals; business information; business inquiries; business investigations; business management assistance; business management consultancy; business management and organization consultancy; business organization consultancy; business management of hotels; business research; business management of performing artists; commercial information agencies; commercial or industrial management assistance; compilation of information into computer databases; compilation of statistics; commercial information and advice for consumers [consumer advice shop]; commercial information agencies; computerized file management; data search in computer files for others; distribution of samples; document reproduction; drawing up of statements of accounts; cost price analysis; demonstration of goods; dissemination of advertising matter; drawing up of statements of accounts; economic forecasting; efficiency experts; business efficiency expert services; employment agencies; import-export agencies; invoicing; layout services for advertising purposes; marketing research; marketing studies; news clipping services; on-line advertising on a computer network; opinion polling; organization of exhibitions; organization of trade fairs for commercial or advertising purposes; office machines and equipment rental; on-line advertising on a computer network; outsourcing services [business assistance]; payroll preparation; personnel recruitment; professional business consultancy; personnel management consultancy; photocopying services; price comparison services; procurement services for others [purchasing goods and services for other businesses]; psychological testing for the selection of personnel; presentation of goods on communication media, for retail purposes; publicity material rental; public relations; radio advertising; production of radio commercials; relocation services for businesses; rental of advertising space; rental of advertising time on communication media; rental of vending machines; rental of photocopying machines; sales promotion for others; secretarial services; shop window dressing; shorthand; sponsorship search; systemization of information into computer databases; television advertising; telephone answering for unavailable subscribers; television advertising; typing; updating of advertising material; writing of publicity text; word processing.

37 – Building construction; repair; installation services; air conditioning apparatus installation and repair; airplane maintenance and repair; anti-rust treatment for vehicles; artificial snow-making services; asphaltting; boiler cleaning and repair; bricklaying; building construction supervision; building insulating; building of fair stalls and shops; building



sealing; burglar alarm installation and repair; burner maintenance and repair; car wash; chimney sweeping; cleaning of buildings [exterior surface]; cleaning of buildings [interior]; cleaning of clothing; clock and watch repair; clothing repair; construction; construction information; damp-proofing [building]; demolition of buildings; diaper cleaning; disinfecting; drilling of wells; dry cleaning; electric appliance installation and repair; elevator installation and repair; factory construction; film projector repair and maintenance; fire alarm installation and repair; freezing equipment installation and repair; fur care, cleaning and repair; furnace installation and repair; furniture maintenance; furniture restoration; harbour construction; heating equipment installation and repair; installation, maintenance and repair of computer hardware; installation of doors and windows; interference suppression in electrical apparatus; irrigation devices installation and repair; kitchen equipment installation; knife sharpening; laundering; leather care, cleaning and repair; lift installation and repair; linen ironing; machinery installation, maintenance and repair; masonry; mending clothing; mining extraction; motor vehicle maintenance and repair; motor vehicle wash; office machines and equipment installation, maintenance and repair; painting, interior and exterior; painting or repair of signs; paper hanging; parasol repair; photographic apparatus repair; pier breakwater building; pipeline construction and maintenance; plastering; plumbing; pressing of clothing; pumicing; pump repair; quarrying services; rat exterminating; rebuilding engines that have been worn or partially destroyed; rebuilding machines that have been worn or partially destroyed; refilling of toner cartridges; renovation of clothing; rental of bulldozers; rental of cleaning machines; rental of construction equipment; rental of cranes [construction equipment]; rental of excavators; rental of road sweeping machines; repair information; repair of security locks; restoration of musical instruments; restoration of works of art; re-tinning; re-reading of tires [tyres]; riveting; road paving; roofing services; rustproofing; safe maintenance and repair; sanding; scaffolding; shipbuilding; shoe repair; street cleaning; strong-room maintenance and repair; swimming-pool maintenance; telephone installation and repair; umbrella repair; underwater construction; underwater repair; upholstering; upholstery repair; varnishing; vehicle cleaning; vehicle lubrication [greasing]; vehicle maintenance; vehicle polishing; vehicle service stations [refuelling and maintenance]; vehicle wash; vermin exterminating, other than for agriculture; vulcanization of tires [tyres] [repair]; wallpapering; warehouse construction and repair; washing; washing of linen; window cleaning.

(260) AM 2016 86023 A  
 (800) 1285310  
 (891) 2015 12 17  
 (731) ACTELION PHARMACEUTICALS LTD  
 Gewerbestrasse 16, CH-4123 Allschwil,  
 Switzerland  
 (540)

## ACTELION

(511)  
 3 – Bleaching preparations and other substances for laundry use; cleaning, polishing, degreasing and abrasive preparations; soaps; perfumery, essential oils, cosmetics, hair lotions; dentifrices.

5 – Pharmaceutical and veterinary products; sanitary products for medical purposes; dietetic food and substances for medical or veterinary use, food for babies; food supplements for humans and animals; plasters, materials for dressings; material for dental fillings and dental impressions; disinfectants; products for destroying vermin; fungicides, herbicides.

9 – Scientific, nautical, surveying, photographic, cinematographic, optical, weighing, measuring, signaling, checking (supervision), life-saving and teaching apparatus and instruments; apparatus and instruments for conducting, switching, transforming, accumulating, regulating or controlling electricity; apparatus for recording, transmission or reproduction of sound or images; magnetic recording media, sound recording disks; compact disks, DVDs and other digital recording media; mechanisms for coin-operated apparatus; cash registers, calculating machines, data processing equipment, computers; software; application software; application software for mobile telephones; fire extinguishers.

10 – Surgical, medical, dental and veterinary apparatus and instruments, except CT scanners; artificial limbs, eyes and teeth; orthopedic articles; suture material.

16 – Paper, cardboard and goods made from these materials, not included in other classes; printing products (printed matter); bookbinding material; photographs; stationery; adhesives (glues) for stationery or household purposes; artists' materials; paintbrushes; typewriters and office requisites (except furniture); instructional or teaching material (except apparatus); plastic materials for packaging (not included in other classes); printing type; printing blocks.

35 – Advertising; business management; business administration; office functions.

36 – Insurance underwriting; financial affairs; monetary affairs; real estate affairs.

38 – Telecommunications; dissemination of medical and scientific information, data and content via the

Internet, via other communication networks and from a database.

41 – Education; training; entertainment; sporting and cultural activities.

42 – Scientific and technological services as well as research and design relating thereto; industrial analysis and research services; design and development of computers and software.

44 – Medical services; veterinary services; health and beauty treatments for human beings or animals; agriculture, horticulture and forestry services.

(260) AM 2016 86160 A

(800) 1287361

(891) 2015 07 10

(731) HERNO SPA

Via Opifici, 100, I-28040 LESA (NO), Italy

(540)

(591) Black, white

(511)

3 – Cosmetics in general, including perfumes, perfumes in solid form; deodorants for personal use; soaps, liquid soaps; cakes of toilet soap; bath foams; dentifrices; shampoos; essential oils; hair lotions; preparations for permanent hair waves and for setting hair; gels; hair dyes; facial creams; mascaras; eyeliners; eye shadows; make-up pencils; face powder; lipsticks; make-up foundations; body creams; nail polish; nail hardeners; sun-tanning oils and creams; detergents; bleaching products; fabric softeners; soaps; bleaching preparations and other substances for laundry use; cleaning, polishing, degreasing, scouring and abrasive preparations.

9 – Spectacles, spectacle glasses, spectacle frames, eyepieces; optical goods, particularly eyeglasses, sunglasses; fine chains for spectacles; spring glasses; cords for spectacles; protective goggles for sports; anti-glare glasses; spectacle cases; scientific apparatus and instruments; nautical, surveying and electric apparatus and instruments; photographic, cinematographic, optical, weighing, measuring and signaling apparatus; checking, inspection, emergency, life-saving and teaching apparatus; telescopes and binoculars; monoculars.

14 – Precious metals and their alloys; jewelry products, precious stones; clocks in general, and instruments for chronometers; Gold; silver; platinum; objects of precious metal and their alloys; diamonds; brilliants; precious stones; jewelry articles; jewels; cuff links and tie clips; watches; watch straps;

chronometers; jewelry articles plated with precious metals; cases and other sets for watches and jewelry.

18 – Bags; handbags; suitcases; backpacks; wallets; coin purses; school bags; satchels, attaché cases of leather; clutch bags; trunks [luggage]; fur pelts; raw-hides; curried skins; animal skins; coverings of skins (furs); animal skins and hides; furs (animal skins); raw skins; fur-skins; leather and articles made of leather; goods made of imitation leather; parasols; beach umbrellas; umbrellas; walking sticks; whips and other saddlery articles.

25 – Clothing for men, women and children in general, including dresses made from skin; shirts; blouses; skirts; tailleurs; suit jackets; trousers; shorts; undershirts; knitwear; pajamas; socks; knitwear of skin; bodices; garter belts; briefs; brassieres; slippers; hats; scarves; neckties; raincoats; overcoats; coats; bathing suits; tracksuits for sports; anoraks; ski pants; belts; furs; sashes for wear; gloves; dressing gowns, footwear in general, including slippers; footwear; footwear for sports; boots and sandals.

35 – Advertising; business management; business administration; office functions; company consultancy services relating to the establishment and operation of franchises; advisory services for business management relating to franchising; business management services relating to franchising; corporate advice relating to franchising; consulting services in connection with franchising operation.

(260) AM 2016 86163 A

(800) 1286736

(891) 2015 12 02

(731) CODAN Holding GmbH

Stig Husted-Andersen Straße 11, 23738

Lensahn, Germany

(540)



(591) White and red

(511)

10 – Medical and veterinary apparatus and instruments; protective clothing for medical purposes; parts and fittings of all the aforesaid goods, included in this class

(260) AM 2016 86165 A

(800) 1286764

(891) 2015 12 15

(731) TAKEDA PHARMACEUTICAL COMPANY LIMITED  
1-1, Doshomachi 4-chome, Chuo-ku, Osaka-shi, Osaka 540-8645, Japan

(540)

**ДЕКСИЛАНТ**

(591) blue

(511)

5 – Pharmaceutical preparations; sanitary preparations for medical purposes; dietetic food and substances adapted for medical use; dietary supplements for humans.

(260) AM 2016 86166 A

(800) 1286795

(891) 2015 12 03

(731) DACHSER SE

Thomas-Dachser-Straße 2, 87439 Kempten, Germany

(540)

**DACHSER Interlocking**

(511)

9 – Computer software particularly with regard to logistics.

35 – Professional business planning and professional business consultancy in connection with warehouses, commission stocks and transshipment centers; professional business consultancy in connection with logistics including the planning and development of the storage of goods.

39 – Transport; packaging and storage of goods; logistic services with regard to transportation; consultancy with regard to logistics.

42 – Technical planning and technical development of warehouses, commission stocks and transshipment centers as well as technical consultancy in connection with the planning and development of the storage of goods; development of computer software, in particular software for logistics; technical consultancy in the field of information technology, in particular for use in the field of logistics.

(260) AM 2016 86282 A

(800) 1288563

(891) 2015 12 22

(731) WISTA LABORATORIES LTD

25 Bukit Batok Crescent, The Elitist #06-13, Singapore 658066, Singapore

(540)

**WISTA**

(511)

5 – Pharmaceutical and medical preparations; chemical preparations for medical and pharmaceu-

tical purposes; pharmaceutical and medical preparations for use in relation to neurological diseases and disorders, neurodegenerative diseases and disorders, infectious diseases and malaria; chemical preparations for medical and pharmaceutical purposes for use in relation to neurological diseases and disorders, neurodegenerative diseases and disorders, infectious diseases and malaria; none of the aforesaid being pharmaceutical preparations and substances intended for the prevention and treatment of bone/skeletal diseases.

42 – Medical, biological, biotechnological, genetic, laboratory and pharmaceutical research, design and development services; research, development and design of drugs and medicine; drug discovery services; laboratory and medical laboratory research and development services; exploitation of scientific research and technology; preparation of reports; development and design of prognostic and diagnostic tools; consultancy and information services relating to all of the aforesaid.

(260) AM 2016 86319 A

(800) 1287946

(891) 2015 12 15

(731) "NATURA SIBERICA" Ltd

ul. Yuzhnobutovskaya, komnata 18a, dom 101, RU-117042 Moscow, Russian Federation

(540)



(591) Yellow, orange, red, pink, green, azure, blue, lilac and violet

(511)

3 – Abrasives; amber [perfume]; scale removing preparations for household purposes; antistatic preparations for household purposes; aromatics [essential oils]; air fragrancing preparations; cake flavourings [essential oils]; flavorings [flavourings] for beverages [essential oils]; breath freshening sprays; canned pressurized air for cleaning and dusting purposes; balms other than for medical purposes; lip glosses; polishing stones; abrasive paper; emery paper; polishing paper; petroleum jelly for cosmetic purposes; shoe polish; cobblers' wax; cotton wool for cosmetic purposes; sachets for perfuming linen; drying agents for dishwashing machines; adhesives for cosmetic purposes; scented water; Javelle water; lavender water; toilet water; laundry wax; floor wax; non-slip-

ping wax for floors; depilatory wax; moustache wax; tailors' wax; creams for leather; waxes for leather; polish for furniture and flooring; shoemakers' wax; polishing wax; massage gels other than for medical purposes; heliotropine; dental bleaching gels; geraniol; make-up; deodorants for pets; deodorants for human beings or for animals; depilatory preparations; scented wood; perfumes; non-slipping liquids for floors; windshield cleaning liquids; greases for cosmetic purposes; volcanic ash for cleaning; perfumery; decorative transfers for cosmetic purposes; ionone [perfumery]; shaving stones [astringents]; smoothing stones; eyebrow pencils; cosmetic pencils; silicon carbide [abrasive]; carbides of metal [abrasives]; alum stones [astringents]; tripoli stone for polishing; adhesives for affixing false eyelashes; adhesives for affixing false hair; hair conditioners; quillaia bark for washing; corundum [abrasive]; beard dyes; colorants for toilet purposes; cosmetic dyes; laundry starch; laundry glaze; shoe cream; polishing creams; cosmetic creams; skin whitening creams; polishing rouge; incense; hair spray; nail polish; hair lotions; lotions for cosmetic purposes; aftershave lotions; beauty masks; oils for perfumes and scents; oils for cosmetic purposes; oils for toilet purposes; essential oils; essential oils of cedarwood; essential oils of lemon; essential oils of citron; oils for cleaning purposes; bergamot oil; gaultheria oil; jasmine oil; lavender oil; almond oil; rose oil; oil of turpentine for degreasing; whitening; cleaning chalk; almond milk for cosmetic purposes; cleansing milk for toilet purposes; musk [perfumery]; soap; disinfectant soap; deodorant soap; shaving soap; soap for brightening textile; cakes of toilet soap; medicated soap; antiperspirant soap; soap for foot perspiration; almond soap; mint for perfumery; cosmetic kits; emery; nail art stickers; false nails; eau de Cologne; bases for flower perfumes; cotton sticks for cosmetic purposes; joss sticks; pastes for razor strops; dentifrices; pumice stone; hydrogen peroxide for cosmetic purposes; breath freshening strips; abrasive cloth; glass cloth; lipsticks; pomades for cosmetic purposes; shaving preparations; cosmetic preparations for baths; toiletries; hair straightening preparations; hair waving preparations; laundry soaking preparations; grinding preparations; douching preparations for personal sanitary or deodorant purposes [toiletries]; smoothing preparations [starching]; color-removing preparations; leather bleaching preparations; polishing preparations; denture polishes; mouthwashes, not for medical purposes; cosmetic preparations for slimming purposes; starch glaze for laundry purposes; refurbishing preparations; fabric softeners for laundry use; laundry bleach; dry-cleaning preparations; paint stripping preparations; lacquer-removing preparations; make-up removing preparations; floor wax removers [scouring preparations]; varnish-removing preparations; rust removing preparations; nail care preparations; cleaning preparations; prepa-

rations for cleaning dentures; wallpaper cleaning preparations; preparations for unblocking drain pipes; laundry preparations; aloe vera preparations for cosmetic purposes; sunscreen preparations; color-[colour-] brightening chemicals for household purposes [laundry]; shining preparations [polish]; make-up powder; diamantine [abrasive]; stain removers; scouring solutions; false eyelashes; tissues impregnated with cosmetic lotions; tissues impregnated with make-up removing preparations; saffrol; laundry blueing; turpentine, for degreasing; potpourris [fragrances]; bleaching soda; washing soda, for cleaning; bath salts, not for medical purposes; bleaching salts; fumigation preparations [perfumes]; preservatives for leather [polishes]; ammonia [volatile alkali] [detergent]; astringents for cosmetic purposes; eyebrow cosmetics; make-up preparations; sun-tanning preparations [cosmetics]; hair dyes; neutralizers for permanent waving; preparations to make the leaves of plants shiny; cosmetic preparations for eyelashes; cosmetic preparations for skin care; shoe wax; cosmetics; cosmetics for animals; mascara; detergents other than for use in manufacturing operations and for medical purposes; degreasers other than for use in manufacturing processes; bleaching preparations [decolorants] for cosmetic purposes; antiperspirants [toiletries]; talcum powder, for toilet use; terpenes [essential oils]; emery cloth; cloths impregnated with a detergent for cleaning; henna [cosmetic dye]; shampoos; shampoos for pets; dry shampoos; sandpaper; soda lye; extracts of flowers [perfumes]; ethereal essences; badian essence; mint essence [essential oil].

(260) AM 2016 86320 A

(800) 1287948

(891) 2015 12 15

(731) "NATURA SIBERICA" Ltd.

ul. Yuzhnobutovskaya, komnata 18a, dom

101, RU-117042 Moscow, Russian Federation

(540)



(591) Yellow, orange, red, pink, green, azure, blue, lilac and violet

(511)

3 – Abrasives; amber [perfume]; scale removing preparations for household purposes; antistatic preparations for household purposes; aromatics [essential oils]; air fragrancing preparations; cake flavourings [essential oils]; flavorings [flavourings] for beverages [essential oils]; breath freshening sprays; canned pressurized air for cleaning and dusting purposes; balms other than for medical purposes; lip glosses; polishing stones; abrasive paper; emery paper; polishing paper; petroleum jelly for cosmetic purposes; shoe polish; cobblers' wax; cotton wool for cosmetic purposes; sachets for perfuming linen; drying agents for dishwashing machines; adhesives for cosmetic purposes; scented water; Javelle water; lavender water; toilet water; laundry wax; floor wax; non-slip wax for floors; depilatory wax; moustache wax; tailors' wax; creams for leather; waxes for leather; polish for furniture and flooring; shoemakers' wax; polishing wax; massage gels other than for medical purposes; heliotropine; dental bleaching gels; geraniol; make-up; deodorants for pets; deodorants for human beings or for animals; depilatory preparations; scented wood; perfumes; non-slipping liquids for floors; windshield cleaning liquids; greases for cosmetic purposes; volcanic ash for cleaning; perfumery; decorative transfers for cosmetic purposes; ionone [perfumery]; shaving stones [astringents]; smoothing stones; eyebrow pencils; cosmetic pencils; silicon carbide [abrasive]; carbides of metal [abrasives]; alum stones [astringents]; tripoli stone for polishing; adhesives for affixing false eyelashes; adhesives for affixing false hair; hair conditioners; quillaia bark for washing; corundum [abrasive]; beard dyes; colorants for toilet purposes; cosmetic dyes; laundry starch; laundry glaze; shoe cream; polishing creams; cosmetic creams; skin whitening creams; polishing rouge; incense; hair spray; nail polish; hair lotions; lotions for cosmetic purposes; aftershave lotions; beauty masks; oils for perfumes and scents; oils for cosmetic purposes; oils for toilet purposes; essential oils; essential oils of cedarwood; essential oils of lemon; essential oils of citron; oils for cleaning purposes; bergamot oil; gaultheria oil; jasmine oil; lavender oil; almond oil; rose oil; oil of turpentine for degreasing; whiting; cleaning chalk; almond milk for cosmetic purposes; cleansing milk for toilet purposes; musk [perfumery]; soap; disinfectant soap; deodorant soap; shaving soap; soap for brightening textile; cakes of toilet soap; medicated soap; antiperspirant soap; soap for foot perspiration; almond soap; mint for perfumery; cosmetic kits; emery; nail art stickers; false nails; eau de Cologne; bases for flower perfumes; cotton sticks for cosmetic purposes; joss sticks; pastes for razor strops; dentifrices; pumice stone; hydrogen peroxide for cosmetic purposes; breath freshening strips; abrasive cloth;

glass cloth; lipsticks; pomades for cosmetic purposes; shaving preparations; cosmetic preparations for baths; toiletries; hair straightening preparations; hair waving preparations; laundry soaking preparations; grinding preparations; douching preparations for personal sanitary or deodorant purposes [toiletries]; smoothing preparations [starching]; color-removing preparations; leather bleaching preparations; polishing preparations; denture polishes; mouthwashes, not for medical purposes; cosmetic preparations for slimming purposes; starch glaze for laundry purposes; refurbishing preparations; fabric softeners for laundry use; laundry bleach; dry-cleaning preparations; paint stripping preparations; lacquer-removing preparations; make-up removing preparations; floor wax removers [scouring preparations]; varnish-removing preparations; rust removing preparations; nail care preparations; cleaning preparations; preparations for cleaning dentures; wallpaper cleaning preparations; preparations for unblocking drain pipes; laundry preparations; aloe vera preparations for cosmetic purposes; sunscreen preparations; color-[colour-] brightening chemicals for household purposes [laundry]; shining preparations [polish]; make-up powder; diamantine [abrasive]; stain removers; scouring solutions; false eyelashes; tissues impregnated with cosmetic lotions; tissues impregnated with make-up removing preparations; safrol; laundry blueing; turpentine, for degreasing; potpourris [fragrances]; bleaching soda; washing soda, for cleaning; bath salts, not for medical purposes; bleaching salts; fumigation preparations [perfumes]; preservatives for leather [polishes]; ammonia [volatile alkali] [detergent]; astringents for cosmetic purposes; eyebrow cosmetics; make-up preparations; sun-tanning preparations [cosmetics]; hair dyes; neutralizers for permanent waving; preparations to make the leaves of plants shiny; cosmetic preparations for eyelashes; cosmetic preparations for skin care; shoe wax; cosmetics; cosmetics for animals; mascara; detergents other than for use in manufacturing operations and for medical purposes; degreasers other than for use in manufacturing processes; bleaching preparations [decolorants] for cosmetic purposes; antiperspirants [toiletries]; talcum powder, for toilet use; terpenes [essential oils]; emery cloth; cloths impregnated with a detergent for cleaning; henna [cosmetic dye]; shampoos; shampoos for pets; dry shampoos; sandpaper; soda lye; extracts of flowers [perfumes]; ethereal essences; badian essence; mint essence [essential oil].

(260) AM 2016 86595 A

(800) 1291270

(891) 2015 10 02

(731) BEATS ELECTRONICS, LLC

8600 Hayden Place, Culver City CA 90232,  
USA

(540)

## **BEATS 1**

(511)

38 – Broadcasting and transmission of voice, data, images, music, audio, video, multimedia, television, and radio by means of telecommunications networks; broadcast and transmission of streamed music, audio, video, and multimedia content by means of telecommunications networks; matching users for the transfer of music, audio, video, and multimedia by means of telecommunications networks (terms considered too vague by the International Bureau – rule 13.2.b) of the Common Regulations); providing access to websites, databases, electronic bulletin boards, on-line forums, directories, music, and video and audio programs.

---

---

**INTERNATIONAL TRADEMARKS PROTECTED IN GEORGIA**

(260) AM 2016 80686 A  
(800) 1232831  
(151) 2014 10 02  
(181) 2024 10 02  
(891) 2014 10 02  
(511) 01, 05, 10

---

(260) AM 2016 83611 A  
(800) 1261641  
(151) 2015 06 25  
(181) 2025 06 25  
(891) 2015 06 25  
(511) 16

---

(260) AM 2015 80778 A  
(800) 1233779  
(151) 2014 08 28  
(181) 2024 08 28  
(891) 2014 08 28  
(511) 04, 07, 09, 11, 12

---

(260) AM 2016 83612 A  
(800) 1261652  
(151) 2015 05 21  
(181) 2025 05 21  
(891) 2015 05 21  
(511) 06, 07, 20

---

(260) AM 2016 83221 A  
(800) 1257061  
(151) 2015 03 23  
(181) 2025 03 23  
(891) 2015 03 23  
(511) 33

---

(260) AM 2016 83614 A  
(800) 1261716  
(151) 2015 03 25  
(181) 2025 03 25  
(891) 2015 03 25  
(511) 07, 12

---

(260) AM 2016 83384 A  
(800) 1259474  
(151) 2015 06 04  
(181) 2025 06 04  
(891) 2015 06 04  
(511) 05

---

(260) AM 2016 83623 A  
(800) 1040225  
(151) 2010 04 16  
(181) 2020 04 16  
(891) 2015 07 30  
(511) 11

---

(260) AM 2016 83538 A  
(800) 1261064  
(151) 2015 03 16  
(181) 2025 03 16  
(891) 2015 03 16  
(511) 03, 05, 16

---

(260) AM 2016 83625 A  
(800) 1164113  
(151) 2013 03 21  
(181) 2023 03 21  
(891) 2015 05 28  
(511) 03

---

(260) AM 2016 83599 A  
(800) 1261439  
(151) 2014 12 19  
(181) 2024 12 19  
(891) 2014 12 19  
(511) 09, 11, 34

---

(260) AM 2016 83675 A  
(800) 1262520  
(151) 2015 04 20  
(181) 2025 04 20  
(891) 2015 04 20  
(511) 01, 03, 04

---

(260) AM 2016 83603 A  
(800) 1261554  
(151) 2014 10 27  
(181) 2024 10 27  
(891) 2014 10 27  
(511) 43

---

(260) AM 2016 83676 A  
(800) 1262305  
(151) 2014 12 01  
(181) 2024 12 01  
(891) 2014 12 01  
(511) 30

---

(260) AM 2016 83680 A  
(800) 1262547  
(151) 2015 06 12  
(181) 2025 06 12  
(891) 2015 06 12  
(511) 04

---

(260) AM 2016 83685 A  
(800) 1262320  
(151) 2015 03 16  
(181) 2025 03 16  
(891) 2015 03 16  
(511) 05

---

(260) AM 2016 83686 A  
(800) 1262321  
(151) 2015 03 16  
(181) 2025 03 16  
(891) 2015 03 16  
(511) 05

---

(260) AM 2016 83687 A  
(800) 1262322  
(151) 2015 03 16  
(181) 2025 03 16  
(891) 2015 03 16  
(511) 05

---

(260) AM 2016 83690 A  
(800) 1262324  
(151) 2015 03 16  
(181) 2025 03 16  
(891) 2015 03 16  
(511) 05

---

(260) AM 2016 83693 A  
(800) 670314  
(151) 1997 02 06  
(181) 2017 02 06  
(891) 2015 08 06  
(511) 05

---

(260) AM 2016 83694 A  
(800) 673426  
(151) 1997 04 14  
(181) 2017 04 14  
(891) 2015 08 06  
(511) 10

---

(260) AM 2016 83696 A  
(800) 1021373  
(151) 2009 07 28

(181) 2019 07 28  
(891) 2015 06 19  
(511) 03, 10, 12, 18, 20, 24, 25, 28

---

(260) AM 2016 83745 A  
(800) 1262752  
(151) 2014 12 30  
(181) 2024 12 30  
(891) 2014 12 30  
(511) 30

---

(260) AM 2016 83747 A  
(800) 1262764  
(151) 2015 03 24  
(181) 2025 03 24  
(891) 2015 03 24  
(511) 19, 35

---

(260) AM 2016 83774 A  
(800) 1156214  
(151) 2013 02 07  
(181) 2023 02 07  
(891) 2015 05 27  
(511) 05

---

(260) AM 2016 83775 A  
(800) 1156607  
(151) 2013 02 07  
(181) 2023 02 07  
(891) 2015 05 27  
(511) 05

---

(260) AM 2016 83776 A  
(800) 1197498  
(151) 2013 11 19  
(181) 2023 11 19  
(891) 2015 08 17  
(511) 19

---

(260) AM 2016 83847 A  
(800) 1264112  
(151) 2015 07 24  
(181) 2025 07 24  
(891) 2015 07 24  
(511) 05

---

(260) AM 2016 83848 A  
(800) 1264131  
(151) 2015 07 23  
(181) 2025 07 23  
(891) 2015 07 23  
(511) 05

---



(260) AM 2016 83860 A  
(800) 1029512  
(151) 2009 12 16  
(181) 2019 12 16  
(891) 2015 06 16  
(511) 05

---

(260) AM 2016 83861 A  
(800) 1136438  
(151) 2012 07 31  
(181) 2022 07 31  
(891) 2015 06 16  
(511) 05

---

(260) AM 2016 83866 A  
(800) 1263798  
(151) 2015 06 09  
(181) 2025 06 09  
(891) 2015 06 09  
(511) 21, 33

---

(260) AM 2016 83867 A  
(800) 1264236  
(151) 2015 01 21  
(181) 2025 01 21  
(891) 2015 01 21  
(511) 11, 21, 30, 32, 43

---

(260) AM 2016 83868 A  
(800) 1264246  
(151) 2015 01 28  
(181) 2025 01 28  
(891) 2015 01 28  
(511) 05, 44

---

(260) AM 2016 83871 A  
(800) 1263837  
(151) 2015 07 10  
(181) 2025 07 10  
(891) 2015 07 10  
(511) 03, 07, 21

---

(260) AM 2016 83872 A  
(800) 1264293  
(151) 2015 04 16  
(181) 2025 04 16  
(891) 2015 04 16  
(511) 01, 03, 04, 05, 06, 07, 08, 09, 10, 11, 12, 14,  
15, 16, 18, 20, 21, 24, 25, 26, 27, 28, 29, 30,  
31, 32, 33, 34, 35, 36, 37, 38, 39, 40, 41, 42,  
43, 45

---

(260) AM 2016 83954 A  
(800) 1264704  
(151) 2015 06 25  
(181) 2025 06 25  
(891) 2015 06 25  
(511) 06, 07, 37

---

(260) AM 2016 83955 A  
(800) 1264719  
(151) 2015 05 06  
(181) 2025 05 06  
(891) 2015 05 06  
(511) 05

---

(260) AM 2016 83956 A  
(800) 1250464  
(151) 2015 03 05  
(181) 2025 03 05  
(891) 2015 08 26  
(511) 09

---

(260) AM 2016 83957 A  
(800) 1250989  
(151) 2014 09 18  
(181) 2024 09 18  
(891) 2015 07 28  
(511) 03, 09, 14, 18, 25, 35

---

(260) AM 2016 83958 A  
(800) 1264774  
(151) 2015 05 21  
(181) 2025 05 21  
(891) 2015 05 21  
(511) 29

---

(260) AM 2016 83967 A  
(800) 1264882  
(151) 2014 10 15  
(181) 2024 10 15  
(891) 2014 10 15  
(511) 01, 04, 17, 19, 20, 22, 24, 35, 39, 42

---

(260) AM 2016 83968 A  
(800) 1264883  
(151) 2015 07 07  
(181) 2025 07 07  
(891) 2015 07 07  
(511) 05

---

(260) AM 2016 83969 A  
(800) 1264898  
(151) 2015 08 06

---

(181) 2025 08 06  
(891) 2015 08 06  
(511) 03

---

(260) AM 2016 83970 A  
(800) 1264915  
(151) 2015 08 07  
(181) 2025 08 07  
(891) 2015 08 07  
(511) 10

---

(260) AM 2016 83971 A  
(800) 1264916  
(151) 2015 03 27  
(181) 2025 03 27  
(891) 2015 03 27  
(511) 25

---

(260) AM 2016 83972 A  
(800) 1264924  
(151) 2015 08 14  
(181) 2025 08 14  
(891) 2015 08 14  
(511) 14

---

(260) AM 2016 83977 A  
(800) 1264941  
(151) 2014 11 12  
(181) 2024 11 12  
(891) 2014 11 12  
(511) 05

---

(260) AM 2016 83978 A  
(800) 1264947  
(151) 2015 07 28  
(181) 2025 07 28  
(891) 2015 07 28  
(511) 05

---

(260) AM 2016 83980 A  
(800) 1264950  
(151) 2015 08 07  
(181) 2025 08 07  
(891) 2015 08 07  
(511) 03

---

(260) AM 2016 83981 A  
(800) 1264959  
(151) 2015 07 20  
(181) 2025 07 20  
(891) 2015 07 20  
(511) 13

---

(260) AM 2016 83982 A  
(800) 1264971  
(151) 2014 10 10  
(181) 2024 10 10  
(891) 2014 10 10  
(511) 09, 28, 41

---

(260) AM 2016 83983 A  
(800) 1265039  
(151) 2015 04 30  
(181) 2025 04 30  
(891) 2015 04 30  
(511) 01

---

(260) AM 2016 83986 A  
(800) 1265103  
(151) 2015 07 28  
(181) 2025 07 28  
(891) 2015 07 28  
(511) 05

---

(260) AM 2016 83988 A  
(800) 1265204  
(151) 2015 07 27  
(181) 2025 07 27  
(891) 2015 07 27  
(511) 05

---

(260) AM 2016 84102 A  
(800) 1266876  
(151) 2015 02 12  
(181) 2025 02 12  
(891) 2015 02 12  
(511) 09

---

(260) AM 2016 84105 A  
(800) 1266878  
(151) 2015 02 23  
(181) 2025 02 23  
(891) 2015 02 23  
(511) 09

---

(260) AM 2016 84106 A  
(800) 1266879  
(151) 2015 02 23  
(181) 2025 02 23  
(891) 2015 02 23  
(511) 09

---

(260) AM 2016 84123 A  
(800) 1266643  
(151) 2015 02 24

(181) 2025 02 24  
(891) 2015 02 24  
(511) 14

---

(260) AM 2016 84127 A  
(800) 1266656  
(151) 2015 02 24  
(181) 2025 02 24  
(891) 2015 02 24  
(511) 28

---

(260) AM 2016 84131 A  
(800) 1266599  
(151) 2015 05 19  
(181) 2025 05 19  
(891) 2015 05 19  
(511) 30

---

(260) AM 2016 84132 A  
(800) 1266704  
(151) 2015 06 10  
(181) 2025 06 10  
(891) 2015 06 10  
(511) 03

---

(260) AM 2016 84134 A  
(800) 1266728  
(151) 2015 06 23  
(181) 2025 06 23  
(891) 2015 06 23  
(511) 25

---

(260) AM 2016 84141 A  
(800) 826445  
(151) 2004 01 12  
(181) 2024 01 12  
(891) 2015 06 24  
(511) 01, 03, 04, 35

---

(260) AM 2016 84144 A  
(800) 1037888  
(151) 2010 04 15  
(181) 2020 04 15  
(891) 2015 09 10  
(511) 34

---

(260) AM 2016 84181 A  
(800) 1267256  
(151) 2015 06 26  
(181) 2025 06 26  
(891) 2015 06 26  
(511) 11

---

(260) AM 2016 84187 A  
(800) 1267350  
(151) 2015 06 16  
(181) 2025 06 16  
(891) 2015 06 16  
(511) 05

---

(260) AM 2016 84351 A  
(800) 1268590  
(151) 2015 05 06  
(181) 2025 05 06  
(891) 2015 05 06  
(511) 05

---

(260) AM 2016 84356 A  
(800) 1269374  
(151) 2015 08 05  
(181) 2025 08 05  
(891) 2015 08 05  
(511) 09

---

(260) AM 2016 84365 A  
(800) 1268596  
(151) 2015 06 05  
(181) 2025 06 05  
(891) 2015 06 05  
(511) 09, 36, 41, 43, 45

---

(260) AM 2016 84368 A  
(800) 1196250  
(151) 2014 02 25  
(181) 2024 02 25  
(891) 2015 09 23  
(511) 25

---

(260) AM 2016 84376 A  
(800) 1268609  
(151) 2015 05 07  
(181) 2025 05 07  
(891) 2015 05 07  
(511) 28, 30, 41

---

(260) AM 2016 84382 A  
(800) 1269089  
(151) 2015 08 05  
(181) 2025 08 05  
(891) 2015 08 05  
(511) 38

---

(260) AM 2016 84383 A  
(800) 1269156  
(151) 2015 03 19

---

(181) 2025 03 19  
(891) 2015 03 19  
(511) 09, 11, 37

---

(260) AM 2016 84386 A  
(800) 1269201  
(151) 2015 05 05  
(181) 2025 05 05  
(891) 2015 05 05  
(511) 39

---

(260) AM 2016 84514 A  
(800) 1270676  
(151) 2015 09 23  
(181) 2025 09 23  
(891) 2015 09 23  
(511) 18

---

---

# OFFICIAL NOTIFICATIONS

## INVENTIONS

### RENEWAL OF A PATENTS

**(11) P 2005 3686 B**

(73) Hartington Business S.L. (ES)

(54) **METHOD FOR OBTAINING AN ISOLATED EXTRACT OF PLANT CYCLAMEN EUROPAEUM L. AND ITS USE**

DATE OF RENEWAL: 25 10 2016

---

**(11) P 2015 6307 B**

(73) ACCURIC LTD (GB)

(54) **CURRENT REGULATOR**

DATE OF RENEWAL: 25 10 2016

---

**(11) P 2014 6174 B**

(73) Ioseb Maisuradze (GE)

(54) **METHOD TO REPAIR RAILWAY AND/OR UNDERGROUND CARRIAGE FRAME CROSS BEAM CRACK**

DATE OF RENEWAL: 25 10 2016

---

**(11) P 2015 6240 B**

(73) Besarion Partsvania (GE);

Gia Petriashvili (GE)

(54) **DEVICE FOR BIOLOGICAL TISSUE HETEROGENEITY DETERMINATION**

DATE OF RENEWAL:

25 10 2016

---

**(11) P 2012 5600 B**

(73) Zaur Tsikhelashvili (GE);

Archil Prangishvili (GE);

Nodar Chkheidze (GE);

Tamaz Batsikadze (GE);

Temur Gvelesiani (GE);

Guram Dolidze (GE)

(54) **FLOATING COAST-PROTECTING STRUCTURE**

DATE OF RENEWAL: 25 10 2016

---

**(11) P 2012 5403 B**

(73) Leri Gigineishvili (GE);

Vakhushti Kizikurashvili (GE);

Nika Karalashvili (GE);

Vazha Sharashidze (GE);

Mikheil Giorgadze (GE)

(54) **SYSTEM FOR PRODUCTION OF SUBSTRATUM WITH EARTHWORMS FOR NUFACTURE BIOHUMUS**

DATE OF RENEWAL: 25 10 2016

---

**(11) P 2013 5841 B**

(73) Ioseb Orjonikidze (GE);

Vazha Jamarashvili (GE);

Alex Mirianashvili (GE)

(54) **AIR-CONDITIONING SYSTEM WITH DEEP SEA WATER**

DATE OF RENEWAL: 25 10 2016

---

**(11) P 2016 6497 B**

(73) Endi Tumanishvili (GE);

Vazha Jamarashvili (GE)

(54) **HYDROPOWER UNIT WITH VARIABLE SCORE**

DATE OF RENEWAL: 25 10 2016

---

**(11) P 2016 6546 B**

(73) Temur Revishvili (GE);

Davit Apkhazava (GE);

Zurab Dzneladze (GE);

Merab Khomeriki (GE);

Raul Gotsiridze (GE);

Ekaterine Gobronidze (GE)

(54) **METHOD FOR NON-ALCOHOLIC TONIC CARBONATED BEVERAGE PREPARATION**

DATE OF RENEWAL: 25 10 2016

---

**(11) P 2015 6356 B**

(73) Giorgi Shamkulashvili (GE);

Levan Sharikadze (GE)

(54) **METHOD OF PROCESSING MECHANICAL RUBBER WASTE AND EQUIPMENT FOR REALIZATION THEREOF**

DATE OF RENEWAL: 25 10 2016

---

**(11) P 2014 6175 B**

(73) Iv. Javakishvili Tbilisi State University (GE)

(54) **METHOD OF SOLID-STATE SYNTHESIS  
OF OXIDE CERAMIC MATERIAL**

DATE OF RENEWAL: 25 10 2016

---

**(11) P 2007 4025 B**

(73) LG LIFE SCIENCES LTD (KR)

(54) **PROCESS FOR PREPARING ACID  
SALTS OF GEMIFLOXACIN**

DATE OF RENEWAL: 25 10 2016

---

**UTILITY MODELS**  
**RENEWAL OF A PATENTS**

**(11) U 2014 1812 Y**

(73) Meri Alania (GE);

Eter Kemertelidze (GE)

(54) **METHOD FOR OBTAINING ROBININ**

DATE OF RENEWAL: 25 10 2016

---

**(11) U 2012 1720 Y**

(73) Tinatin Kldiashvili (GE);

Ketevan Kavtaradze (GE)

(54) **METHOD OF CLOTH PRINTING**

DATE OF RENEWAL: 25 10 2016

---

**(11) U 2015 1876 Y**

(73) Nugzar Jogleidze (GE);

Konstantine Maghradze (GE)

(54) **PRODUCT OF CLINICAL NUTRITION**

DATE OF RENEWAL: 25 10 2016

---

INTERNATIONAL DESIGNS APPLICATION, WHICH WAS REGISTERED  
ON THE TERRITORY OF GEORGIA

(11) DM/087 942  
(15) 2015 10 23  
(24) 2015 10 23  
(18) 2020 10 23  
(44) 13(449) 2016 07 11  
(45) 2016/17; 2016 04 29

---

(11) DM/088 092  
(15) 2015 10 27  
(24) 2015 10 27  
(18) 2020 10 27  
(44) 13(449) 2016 07 11  
(45) 2016/17; 2016 04 29

---

(11) DM/090 227  
(15) 2016 04 05  
(24) 2016 04 05  
(18) 2021 04 05  
(44) 13(449) 2016 07 11  
(45) 2016/17; 2016 04 29

---

(11) DM/088 089  
(15) 2015 11 02  
(24) 2015 11 02  
(18) 2020 11 02  
(44) 13(449) 2016 07 11  
(45) 2016/18; 2016 05 06

---

(11) DM/088 090  
(15) 2015 11 02  
(24) 2015 11 02  
(18) 2020 11 02  
(44) 13(449) 2016 07 11  
(45) 2016/18; 2016 05 06

---

(11) DM/088 091  
(15) 2015 11 02  
(24) 2015 11 02  
(18) 2020 11 02  
(44) 13(449) 2016 07 11  
(45) 2016/18; 2016 05 06

---

(11) DM/088 093  
(15) 2015 10 30  
(24) 2015 10 30  
(18) 2020 10 30  
(44) 13(449) 2016 07 11  
(45) 2016/18; 2016 05 06

---

(11) DM/088 101  
(15) 2015 11 04  
(24) 2015 11 04  
(18) 2020 11 04  
(44) 13(449) 2016 07 11  
(45) 2016/18; 2016 05 06

---

(11) DM/088 419  
(15) 2015 11 04  
(24) 2015 11 04  
(18) 2020 11 04  
(44) 13(449) 2016 07 11  
(45) 2016/18; 2016 05 06

---

(11) DM/089 691  
(15) 2015 10 30  
(24) 2015 10 30  
(18) 2020 10 30  
(44) 13(449) 2016 07 11  
(45) 2016/18; 2016 05 06

---

(11) DM/088 150  
(15) 2015 11 10  
(24) 2015 11 10  
(18) 2020 11 10  
(44) 13(449) 2016 07 11  
(45) 2016/19; 2016 05 13

---

(11) DM/087 551  
(15) 2015 09 14  
(24) 2015 09 14  
(18) 2020 09 14  
(44) 13(449) 2016 07 11  
(45) 2016/20; 2016 05 20

---

(11) DM/087 558  
(15) 2015 09 17  
(24) 2015 09 17  
(18) 2020 09 17  
(44) 13(449) 2016 07 11  
(45) 2016/20; 2016 05 20

---

(11) DM/087 584  
(15) 2015 09 17  
(24) 2015 09 17  
(18) 2020 09 17  
(44) 13(449) 2016 07 11  
(45) 2016/20; 2016 05 20

---

(11) DM/088 589  
 (15) 2015 09 18  
 (24) 2015 09 18  
 (18) 2020 09 17  
 (44) 13(449) 2016 07 11  
 (45) 2016/20; 2016 05 20

---

(11) DM/088 592  
 (15) 2015 09 18  
 (24) 2015 09 18  
 (18) 2020 09 18  
 (44) 13(449) 2016 07 11  
 (45) 2016/20; 2016 05 20

---

(11) DM/087 593  
 (15) 2015 09 18  
 (24) 2015 09 18  
 (18) 2020 09 18  
 (44) 13(449) 2016 07 11  
 (45) 2016/20; 2016 05 20

---

(11) DM/087 597  
 (15) 2015 09 18  
 (24) 2015 09 18  
 (18) 2020 09 18  
 (44) 13(449) 2016 07 11  
 (45) 2016/20; 2016 05 20

---

(11) DM/088 236  
 (15) 2015 11 17  
 (24) 2015 11 17  
 (18) 2020 11 17  
 (44) 13(449) 2016 07 11  
 (45) 2016/20; 2016 05 20

---

(11) DM/088 280  
 (15) 2015 11 20  
 (24) 2015 11 20  
 (18) 2020 11 20  
 (44) 13(449) 2016 07 11  
 (45) 2016/20; 2016 05 20

---

(11) DM/088 464  
 (15) 2015 11 18  
 (24) 2015 11 18  
 (18) 2020 11 18  
 (44) 13(449) 2016 07 11  
 (45) 2016/20; 2016 05 20

---

(11) DM/090 456  
 (15) 2016 03 16  
 (24) 2016 03 16

(18) 2021 03 16  
 (44) 13(449) 2016 07 11  
 (45) 2016/20; 2016 05 20

---

(11)DM/090494  
 (15) 2016 03 23  
 (24) 2016 03 23  
 (18) 2021 03 23  
 (44) 13(449); 2016 07 11  
 (45) 2016/20; 2016 05 20

---

(11) DM/090 545  
 (15) 2016 03 21  
 (24) 2016 03 21  
 (18) 2021 03 21  
 (44) 13(449) 2016 07 11  
 (45) 2016/20; 2016 05 20

---

(11) DM/087 222  
 (15) 2015 05 21  
 (24) 2015 05 21  
 (18) 2020 05 21  
 (44) 13(449) 2016 07 11  
 (45) 2016/21; 2016 05 27

---

(11) DM/087 223  
 (15) 2015 05 21  
 (24) 2015 05 21  
 (18) 2020 05 21  
 (44) 13(449) 2016 07 11  
 (45) 2016/21; 2016 05 27

---

(11) DM/087 646  
 (15) 2015 09 25  
 (24) 2015 09 25  
 (18) 2020 09 25  
 (44) 13(449) 2016 07 11  
 (45) 2016/21; 2016 05 27

---

(11) DM/088 369  
 (15) 2015 11 25  
 (24) 2015 11 25  
 (18) 2020 11 25  
 (44) 13(449) 2016 07 11  
 (45) 2016/21; 2016 05 27

---

(11) DM/088 370  
 (15) 2015 11 25  
 (24) 2015 11 25  
 (18) 2020 11 25  
 (44) 13(449) 2016 07 11  
 (45) 2016/21; 2016 05 27

---



(11) DM/088 442  
(15) 2015 11 27  
(24) 2015 11 27  
(18) 2020 11 27  
(44) 13(449) 2016 07 11  
(45) 2016/21; 2016 05 27

---

(11) DM/090 601  
(15) 2016 05 11  
(24) 2016 05 11  
(18) 2021 05 11  
(44) 13(449) 2016 07 11  
(45) 2016/21; 2016 05 27

---

INTERNATIONAL REGISTRATIONS, WHOSE ACTION HAS BEEN  
 CANCELED BECAUSE OF NON PAYMENT FOR EXTENSION ON 5-YEARS

(11) DM/073 987  
 (73) NOKIA CORPORATION  
 Keilalahdentie 4, FI-02150 Espoo (FI)  
 CANCELLATION DATE: 2015 06 23  
 (58) 2016 10 11

(THE SWATCH GROUP MANAGEMENT  
 SERVICES LTD)  
 Seevorstadt 6, CH-2502 Biel/Bienne (CH)  
 CANCELLATION DATE: 2015 08 24  
 (58) 2016 10 17

(11) DM/074 022  
 (73) HANGAR GRUP AYAKKABI TEKSTİL  
 SANAYİ VE TİCARET LİMİTED ŞİRKETİ  
 Cihangir Mahallesi E-5 Karayolu Üzeri  
 Boncuk Sokak No:1, Avcılar – İstanbul (TR)  
 CANCELLATION DATE: 2015 02 10  
 (58) 2016 10 18

(11) DM/074 419  
 (73) SWATCH AG (SWATCH SA)  
 (SWATCH LTD.)  
 Jakob-Stämpfli-Strasse 94, CH-2502  
 Biel/Bienne (CH)  
 CANCELLATION DATE: 2015 09 10  
 (58) 2016 10 17

(11) DM/074 038  
 (73) RUNDPACK AG  
 Rheinstrasse 6, CH-9444 Diepoldsau (CH)  
 CANCELLATION DATE: 2015 07 23  
 (58) 2016 10 17

(11) DM/074 431  
 (73) SWATCH AG (SWATCH SA)  
 (SWATCH LTD.)  
 Jakob-Stämpfli-Strasse 94, CH-2502  
 Biel/Bienne (CH)  
 CANCELLATION DATE: 2015 09 06  
 (58) 2016 10 17

(11) DM/074 244  
 (73) "FREY WILLE" GMBH & CO KG  
 Gumpendorferstrasse 81, A-1060 Vienna (AT)  
 CANCELLATION DATE: 2015 09 01  
 (58) 2016 10 17

(11) DM/074 516  
 (73) "FREY WILLE" GMBH & CO KG  
 Gumpendorferstrasse 81, A-1060 Vienna (AT)  
 CANCELLATION DATE: 2015 10 07  
 (58) 2016 10 17

(11) DM/074 259  
 (73) "FREY WILLE" GMBH & CO KG  
 Gumpendorferstrasse 81, A-1060 Vienna (AT)  
 CANCELLATION DATE: 2015 09 08  
 (58) 2016 10 17

(11) DM/074 588  
 (73) CHECKPOINT SYSTEMS INTERNA-  
 TIONAL GMBH  
 Ersheimer Strasse 69, 69434 Hirschhorn (DE)  
 CANCELLATION DATE: 2015 08 18  
 (58) 2016 10 17

(11) DM/074 408  
 (73) THE SWATCH GROUP MANAGEMENT  
 SERVICES AG (THE SWATCH GROUP  
 MANAGEMENT SERVICES SA)  
 (THE SWATCH GROUP MANAGEMENT  
 SERVICES LTD)  
 Seevorstadt 6, CH-2502 Biel/Bienne (CH)  
 CANCELLATION DATE: 2015 08 24  
 (58) 2016 10 17

(11) DM/074 679  
 (73) NOKIA CORPORATION  
 Keilalahdentie 4, FI-02150 Espoo (FI)  
 CANCELLATION DATE: 2015 10 15  
 (58) 2016 10 17

(11) DM/074 409  
 (73) THE SWATCH GROUP MANAGEMENT  
 SERVICES AG (THE SWATCH GROUP  
 MANAGEMENT SERVICES SA)

(11) DM/074 805  
 (73) THE SWATCH GROUP MANAGEMENT  
 SERVICES AG (THE SWATCH GROUP  
 MANAGEMENT SERVICES SA)

(THE SWATCH GROUP MANAGEMENT SERVICES LTD.)  
Seevorstadt 6, CH-2501 Biel/Bienne (CH)  
CANCELLATION DATE: 2015 11 22  
(58) 2016 10 17

---

(11) DM/074 841  
(73) "FREY WILLE" GMBH & CO. KG  
Gumpendorferstrasse 81, A-1060 Vienna (AT)  
CANCELLATION DATE: 2015 11 29  
(58) 2016 10 17

---

(11) DM/074 871  
(73) ETA SA MANUFACTURE HORLOGERE SUISSE, CH-2540 GRENCHE (CH)  
CANCELLATION DATE: 2015 12 13  
(58) 2016 10 17

---

(11) DM/074 915  
(73) SANDRA HISBEQUE  
Route de l'ancienne scierie, 10, CH-1263 CRASSIER (CH)  
CANCELLATION DATE: 2015 11 04  
(58) 2016 10 18

---

(11) DM/074 974  
(73) ALFRED KÄRCHER GMBH & CO. KG  
Alfred-Kärcher-Straße 28-40, 71364 Winnenden (DE)  
CANCELLATION DATE: 2015 12 15  
(58) 2016 10 18

---

(11) DM/075 018  
(73) LUCIO TORTOLA  
Via Vittorio Emanuele, 11, I-86080 MIRANDA (IS) (IT)  
CANCELLATION DATE: 2015 11 21  
(58) 2016 10 18

---

(11) DM/075 049  
(73) MILONAS A GEORGIOS  
Kilkis Industrial Area, GR-611 00 Kilkis (GR)  
CANCELLATION DATE: 2015 08 25  
(58) 2016 10 18

---

(11) DM/075 053  
(73) "FICOSOTA SYNTEZ" OOD  
Madara Blvd. 48, BG-9701 SHUMEN (BG)  
CANCELLATION DATE: 2015 10 25  
(58) 2016 10 18

---

(11) DM/075 065  
(73) GABRIELLA ASZTALOS C/O ESCH & KRAMER  
Speditionsstrasse 17, 40221 Düsseldorf (DE)  
CANCELLATION DATE: 2015 12 13  
(58) 2016 10 18

---

(11) DM/075 113  
(73) "FREY WILLE" GMBH & CO. KG  
Gumpendorfer Strasse 81, A-1060 Wien (AT)  
CANCELLATION DATE: 2015 12 23  
(58) 2016 10 18

---

(11) DM/075 268  
(73) TIFFANY WATCH CO. LTD (MONTRES TIFFANY SA) (TIFFANY UHREN AG)  
Seevorstadt 6, CH-2502 BIEL/BIENNE (CH)  
CANCELLATION DATE: 2016 02 09  
(58) 2016 10 18

---

(11) DM/075 274  
(73) SWATCH AG (SWATCH SA) (SWATCH LTD.)  
Jakob-Stämpfli-Strasse 94, CH-2502 BIEL/BIENNE (CH)  
CANCELLATION DATE: 2016 02 11  
(58) 2016 10 18

---

(11) DM075 364  
(73) ALFRED KÄRCHER GMBH & CO. KG  
Alfred-Kärcher-Straße 28-40, 71364 Winnenden (DE)  
CANCELLATION DATE: 2016 02 16  
(58) 2016 10 18

---

(11) DM/075 382  
(73) INDRA SISTEMAS, S.A., S.A.  
Avenida Bruselas, 33-35, E-28108 Alcobendas (Madrid) (ES)  
CANCELLATION DATE: 2016 02 22  
(58) 2016 10 18

---

(11) DM/075 431  
(73) STECO METAL SANAYI TICARET LTD. STI.  
Numunebag Caddesi. NO: 38 Kat: 1, BAYRAMPASA – ISTANBUL (TR)  
CANCELLATION DATE: 2015 12 28  
(58) 2016 10 18

---

(11) DM/075 444  
(73) OMEGA SA (OMEGA AG) (OMEGA LTD.)  
    Jakob-Stämpfli-Strasse 96, CH-2502  
    Biel/Bienne (CH)  
CANCELLATION DATE: 2016 02 22  
(58) 2016 10 18

---

(11) DM/075 447  
(73) SWATCH AG (SWATCH SA)  
    (SWATCH LTD.)  
    Jakob-Stämpfli-Strasse 94, CH-2502  
    BIEL/BIENNE (CH)  
CANCELLATION DATE: 2016 02 22  
(58) 2016 10 18

---

(11) DM/075 459  
(73) SWATCH AG (SWATCH SA)  
    (SWATCH LTD.)  
    Jakob-Stämpfli-Strasse 94, CH-2502  
    Biel/Bienne (CH)  
CANCELLATION DATE: 2016 02 25  
(58) 2016 10 18

---

(11) DM/075 460  
(73) SWATCH AG (SWATCH SA)  
    (SWATCH LTD.)  
    Jakob-Stämpfli-Strasse 94, CH-2502  
    Biel/Bienne (CH)  
CANCELLATION DATE: 2016 02 25  
(58) 2016 10 18

---

---

## TRADEMARKS

### RENEWAL OF REGISTRATIONS

(111) M 1995 1232 R2  
(156) 2016 02 08  
(186) 2025 12 04  
(732) HEWLETT PACKARD ENTERPRISE  
DEVELOPMENT LP  
11445 Compaq Center Drive West, Houston,  
Texas 77070, USA

---

(111) M 1996 1403 R2  
(156) 2016 04 21  
(186) 2026 01 30  
(732) AXEL SPRINGER SE  
Axel-Springer-Strasse 65, 10969 Berlin  
/10888 Berlin, Germany

---

(111) M 1996 1585 R2  
(156) 2016 02 21  
(186) 2026 02 21  
(732) LABORATOIRES DE BIOLOGIE  
VEGETALE YVES ROCHER S.A.  
F-56201 LA GACILLY, France

---

(111) M 2005 15919 R1  
(156) 2015 10 06  
(186) 2025 04 15  
(732) LTD "GVINIS KOMPANIA SHUMI"  
Sulkhan Tsintsadzis q. 18, 0160, Tbilisi,  
Georgia

---

(111) M 1996 1594 R2  
(156) 2016 03 10  
(186) 2026 02 23  
(732) JEAN PATOU WORLDWIDE LIMITED  
Amertrans Park, Bushely Mill Lane, Watford  
herts, WD24 7JG, United Kingdom

---

(111) M 2005 16227 R1  
(156) 2016 03 17  
(186) 2025 09 28  
(732) J.T. RONNEFELDT KG  
Kurfürstenplatz 38, D-60486, Frankfurt,  
Germany

---

(111) M 2005 16293 R1  
(156) 2016 04 28  
(186) 2025 11 02  
(732) GURAM DARSANIA  
Mosashvilis q.5, b.42, 0162, Tbilisi, Georgia

---

(111) M 2005 16306 R1  
(156) 2016 01 29  
(186) 2025 11 02  
(732) HIMALAYA GLOBAL HOLDINGS LTD  
106 Elizabethen Squeare, P.O. Box 1162,  
Grand Cayman KY1-1102, Cayman Islands

---

(111) M 2005 16307 R1  
(156) 2016 01 29  
(186) 2025 11 02  
(732) HIMALAYA GLOBAL HOLDINGS LTD  
106 Elizabethen Squeare, P.O. Box 1162,  
Grand Cayman KY1-1102, Cayman Islands

---

(111) M 2005 16379 R1  
(156) 2015 12 16  
(186) 2025 12 16  
(732) PFIZER HEALTH AB  
Vetenskapsvägen 10, 191 90, Sollentuna,  
Sweden

---

(111) M 2005 16419 R1  
(156) 2016 07 04  
(186) 2025 12 28  
(732) LTD "SUKHISHVILEBI"  
Davit Agmasheneblis gamz. 123a, 0164,  
Tbilisi, Georgia

---

(111) M 2006 16443 R1  
(156) 2016 02 01  
(186) 2026 01 31  
(732) MONSOON ACCESSORIZE LIMITED  
1 Nicholas Road, London, W11 4 AN, United  
Kingdom

---

(111) M 2006 16501 R1  
(156) 2016 08 11  
(186) 2026 02 15  
(732) LTD "GURIA EQSPRESI"  
Gabriel Episkoposis q., 25/8, 3500, Ozurgeti,  
Georgia

---

(111) M 2006 16502 R1  
(156) 2016 08 11  
(186) 2026 02 15  
(732) LTD "GURIA EQSPRESI"  
Gabriel Episkoposis q., 25/8, 3500, Ozurgeti,  
Georgia

---

(111) M 2006 16503 R1  
 (156) 2016 08 11  
 (186) 2026 02 15  
 (732) LTD "GURIA EQSPRESI"  
 Gabriel Episkoposis q., 25/8, 3500, Ozurgeti,  
 Georgia

(111) M 2006 16516 R1  
 (156) 2016 05 19  
 (186) 2026 03 02  
 (732) LTD "GUDVILI"

Farnavaz Mefis gamz. No:1, 0131, Tbilisi,  
 Georgia

(111) M 2006 16549 R1  
 (156) 2016 09 20  
 (186) 2026 03 30

(732) HARRINGTON DEVELOPMENT INC.  
 Elivira Mendez Street, Valerino Bldg, 3rd  
 Floor, Panama, Panama

(111) M 2006 16678 R1

(156) 2016 06 15  
 (186) 2026 06 15

(732) RFE/RL, INC., a Delaware corporation  
 1201 Connecticut Avenue, NW, Suite 400,  
 Washington, DC 20036, USA

(111) M 2006 16682 R1

(156) 2016 07 05  
 (186) 2026 06 15

(732) SHALVA GVARAMADZE  
 Bakhtrionis q., 1 kor., b.10, 0194, Tbilisi,  
 Georgia

(111) M 2006 16687 R1

(156) 2016 07 04  
 (186) 2026 06 15

(732) LTD "AVERSI-FARMA"  
 Davit Agmasheneblis gamz., 148/2, 0112,  
 Tbilisi, Georgia

(111) M 2006 16699 R1

(156) 2016 06 26  
 (186) 2026 06 26

(732) GULF INTERNATIONAL LUBRICANTS,  
 LTD.  
 Canon's Court, 22 Victoria Street, HM12  
 Hamilton, Bermuda

(111) M 2006 16702 R1

(156) 2016 06 26  
 (186) 2026 06 26

(732) RFE/RL, INC., a Delaware corporation  
 1201 Connecticut Avenue, NW, Suite 400,  
 Washington, DC 20036, USA

(111) M 2006 16734 R1

(156) 2016 07 12  
 (186) 2026 07 12

(732) Arysta LifeScience Corporation  
 8-1, Akashi-cho, Chuo-ko, Tokyo 104 6591,  
 Japan

(111) M 2006 16786 R1

(156) 2016 10 03  
 (186) 2026 08 01

(732) LTD "VAZI -1"  
 Sof. Tserovani, 3318, Mtskhethis raioni,  
 Georgia

(111) M 2006 16865 R1

(156) 2016 10 04  
 (186) 2026 10 04

(732) INTERSUN HOLDING FZCO  
 P.O. box: 61051 Jebel Ali Free Zone, Dubai,  
 United Arab Emirates

(111) M 2006 16876 R1

(156) 2016 10 04  
 (186) 2026 10 04

(732) ASTELLAS PHARMA INC.  
 3-11, Nihonbashi-Honcho, 2-Chome, Chuo-ku,  
 Tokyo, Japan

(111) M 2006 16885 R1

(156) 2016 10 04  
 (186) 2026 10 04

(732) THE COCA-COLA COMPANY  
 a Corporate of the State of Delaware  
 One Coca-Cola Plaza, Atlanta, Georgia  
 30313, USA

(111) M 2006 16886 R1

(156) 2016 10 04  
 (186) 2026 10 04

(732) THE COCA-COLA COMPANY  
 a Corporate of the State of Delaware  
 One Coca-Cola Plaza, Atlanta, Georgia  
 30313, USA

(111) M 2006 16887 R1

(156) 2016 10 04  
 (186) 2026 10 04

(732) EMIRATES

---

Emirates Group Headquarters, PO Box 686, Dubai, United Arab Emirates	(732) OMAR KASSEM ALESAYI MARKETING CO. LTD 6 th Floor, Alesayi Plaza, Baghdadiya, Medina Road, P.O. Box 8680, Jeddah 21492, Saudi Arabia
(111) M 2006 16888 R1 (156) 2016 10 04 (186) 2026 10 04 (732) EMIRATES Emirates Group Headquarters, PO Box 686, Dubai, United Arab Emirates	(111) M 1996 1788 R2 (156) 2016 03 18 (186) 2026 03 18 (732) ARMALY SPONGE COMPANY 1900 Easy Street, Walled Lake, Michigan 48390, USA
(111) M 2006 16889 R1 (156) 2016 10 04 (186) 2026 10 04 (732) EMIRATES Emirates Group Headquarters, PO Box 686, Dubai, United Arab Emirates	(111) M 1996 1795 R2 (156) 2016 05 19 (186) 2026 03 18 (732) SAINT-GOBAIN ISOVER Les Miroirs 18, avenue d'Alsace, 92400 Courbevoie, France
(111) M 2006 16925 R1 (156) 2016 10 25 (186) 2036 10 25 (732) GRIFOLS WORLDWIDE OPERATIONS LIMITED GRANGE CASTLE BUSINESS PARK, GRANGE CASTLE, CLONDALKIN, DUBLIN 22, Ireland	(111) M 1996 1820 R2 (156) 2016 05 16 (186) 2026 03 20 (732) GENERALE BISCUIT (Société par Actions Simplifiée) 6 Av Réaumur, 92140 klamart, France
(111) M 2006 16947 R1 (156) 2016 10 26 (186) 2026 10 26 (732) SANO-BRUNOS ENTERPRISES LTD Neve Neeman, Hod Hasharon, Israel	(111) M 1996 1931 R2 (156) 2016 04 08 (186) 2026 04 08 (732) ARMAND BASI, S.L. Sant Lluc, 54-64, 08918 Badalona (Barcelona), Spain
(111) M 2006 17012 R1 (156) 2016 11 13 (186) 2026 11 13 (732) BRITISH AMERICAN TOBACCO (BRANDS) INC. (a Delaware corporation) 401 South Fourth Avenue, Suite 1800, Louisville, Kentucky 40202, USA	(111) M 1996 2320 R2 (156) 2016 06 11 (186) 2026 06 11 (732) CHAMPAGNE ALAIN THIENOT 14, Rue des Moissons 51100 Reims, France
(111) M 2006 17026 R1 (156) 2016 11 13 (186) 2026 11 13 (732) Otkritoe aktsionernoje obshchestvo "ASTON PRODUKTI PITANIA I PISHCHEVIE INGREDIENTI" ul. 1-ia lugovaia 3,b, Rostov-na-donu, 344002, Russian Federation	(111) M 1996 2354 R2 (156) 2016 06 12 (186) 2026 06 12 (732) HYUNDAI MOTOR COMPANY 140-2, Kye-Dong, Jongro-ku, Seoul, Republic of Korea
(111) M 2007 17217 R1 (156) 2017 01 16 (186) 2027 01 16	(111) M 1996 2373 R2 (156) 2016 06 15 (186) 2026 06 14 (732) PERNOD RICARD 12, Place des Etats-Unis, 75016 Paris, France

---

(111) M 1996 2440 R3  
(156) 2026 06 21  
(186) 2026 06 21  
(732) RENAULT s.a.s.  
92100 BOULOGNE-BILLANCOURT,  
France

---

(111) M 1996 2513 R2  
(156) 2016 06 27  
(186) 2026 06 27  
(732) ESSILOR INTERNATIONAL  
(COMPAGNIE GENERAL D'OPTIQUE)  
147, rue de Paris, 94220 Charenton le Pont,  
France

---

(111) M 1996 2514 R2  
(156) 2016 06 27  
(186) 2026 06 27  
(732) ESSILOR INTERNATIONAL  
(COMPAGNIE GENERAL D'OPTIQUE)  
147, rue de Paris, F-94220 Charenton le Pont,  
France

---

(111) M 1996 2515 R2  
(156) 2016 06 27  
(186) 2026 06 27  
(732) ESSILOR INTERNATIONAL  
(COMPAGNIE GENERAL D'OPTIQUE)  
147, rue de Paris, 94220 Charenton le Pont,  
France

---

(111) M 1996 2518 R2  
(156) 2016 06 27  
(186) 2026 06 27  
(732) BENELLI ARMI S.P.A.  
50, via della Stazione, I-61 029 Urbino, Italy

---

(111) M 1996 2521 R2  
(156) 2016 06 27  
(186) 2026 06 27  
(732) GFDI Gesellschaft zur Forderung der Dental-  
Industrie mbH  
Aachener Strasse 1053-1055, D-50859 Koln,  
Germany

---

(111) M 1996 2535P R2  
(156) 2016 06 28  
(186) 2026 06 28  
(732) AULBACH LIZENZ AG, a Swiss  
Corporation  
Grabenstrasse 15, 7002 Chur, Switzerland

---

(111) M 1996 2591 R2  
(156) 2016 08 19  
(186) 2026 07 08  
(732) AUDEMARS PIGUET HOLDING S.A.  
16, route de France, Le Chenit, Le Brassus,  
Switzerland

---

(111) M 1996 2650 R2  
(156) 2016 08 19  
(186) 2026 07 17  
(732) MUNDIPHARMA AG  
St. Alban-Rheinweg 74, CH-4020 Basel,  
Switzerland

---

(111) M 1996 2775 R2  
(156) 2016 08 08  
(186) 2026 07 29  
(732) AZIENDE CHIMICHE RIUNITE  
ANGELINI FRANCESCO A.C.R.A.F.  
S.p.A. Rome, Italy

---

(111) M 1996 2874 R2  
(156) 2016 09 04  
(186) 2026 09 04  
(732) ALBIS PLASTIC GmbH  
Hamburg, Germany

---

(111) M 1996 2908 R2  
(156) 2016 09 05  
(186) 2026 09 05  
(732) TWENTIETH CENTURY FOX FILM  
CORPORATION, a corporation of the State  
of Delaware  
Los Angeles, California, USA

---

(111) M 1996 2909 R2  
(156) 2016 09 05  
(186) 2026 09 05  
(732) TWENTIETH CENTURY FOX FILM  
CORPORATION, a corporation of the State  
of Delaware  
Los Angeles, California, USA

---

(111) M 1996 2910 R2  
(156) 2016 09 05  
(186) 2026 09 05  
(732) TWENTIETH CENTURY FOX FILM  
CORPORATION, a corporation of the State  
of Delaware  
Los Angeles, California, USA

---



(111) M 1996 2913 R2  
 (156) 2016 09 05  
 (186) 2026 09 05  
 (732) TWENTIETH CENTURY FOX FILM CORPORATION, a corporation of the State of Delaware  
 Los Angeles, California, USA

(111) M 1996 2925 R2  
 (156) 2016 09 05  
 (186) 2026 09 05  
 (732) ARAMIS INC.  
 767 Fifth Avenue, New York, New York, USA

(111) M 1996 3019 R2  
 (156) 2016 09 11  
 (186) 2026 09 11  
 (732) THE GB FOODS, SA  
 Plaza Europa 42, 08902 L'Hospitalet de Llobregat, Barcelona, Spain

(111) M 1996 3020 R2  
 (156) 2016 09 11  
 (186) 2026 09 11  
 (732) THE GB FOODS, SA  
 Plaza Europa 42, 08902 L'Hospitalet de Llobregat, Barcelona, Spain

(111) M 1996 3027 R2  
 (156) 2016 09 11  
 (186) 2026 09 11  
 (732) THE GB FOODS, SA;  
 Plaza Europa 42, 08902 L'Hospitalet de Llobregat, Barcelona, Spain

(111) M 1996 3138 R2  
 (156) 2016 09 16  
 (186) 2026 09 16  
 (732) Koninklijke Douwe Egberts B.V.  
 Oosterdoksstraat 80, 1011 DK Amsterdam, Netherlands

(111) M 1996 3141 R2  
 (156) 2016 09 16  
 (186) 2026 09 16  
 (732) LCS INTERNATIONAL SAS  
 19 Rue Icare, Aéroport 1-67960 Entzheim, France

(111) M 1996 3142 R2  
 (156) 2016 09 16  
 (186) 2026 09 16

(732) LCS INTERNATIONAL SAS  
 19 Rue Icare, Aéroport 1-67960 Entzheim, France

(111) M 1996 3144 R2  
 (156) 2016 09 17  
 (186) 2026 09 17  
 (732) FL EUROPE HOLDINGS, INC.  
 330 west 34-th street, New York, New York 10001, USA

(111) M 1996 3210 R2  
 (156) 2016 09 18  
 (186) 2026 09 18  
 (732) CLUETT PEABODY & Co., Inc.  
 200 Madison Avenue New York, NY 10016, USA

(111) M 1996 3214 R2  
 (156) 2016 09 19  
 (186) 2026 09 19  
 (732) YORK International Corporation  
 631 South Richland Avenue, York, Pennsylvania, USA

(111) M 1996 3238 R2  
 (156) 2016 09 19  
 (186) 2026 09 19  
 (732) CLUETT PEABODY & Co., Inc.  
 200 Madison Avenue New York, NY 10016, USA

(111) M 1996 3289 R2  
 (156) 2016 09 23  
 (186) 2026 09 23  
 (732) DAIMLER AG  
 Mercedesstrasse 137, 70327 Stuttgart, Germany

(111) M 1996 3295 R2  
 (156) 2016 09 24  
 (186) 2026 09 24  
 (732) ETABLISSEMENTS NOILLY PRAT ET CIE  
 1, rue Noilly, F-34340 Marseillan, France

(111) M 1996 3328 R2  
 (156) 2016 09 24  
 (186) 2026 09 24  
 (732) MARTELL & Co  
 Place Edouard Martell, F-16100 Cognac, France

(111) M 1996 3349 R2  
(156) 2016 09 25  
(186) 2026 09 25  
(732) G.H. MUMM & CIE, SOCIETE VINICOLE  
DE CHAMPAGNE SUCCESSEUR  
29, rue du Champ de Mars, F-51100 Reimsi,  
France

---

(111) M 1996 3454 R2  
(156) 2016 10 02  
(186) 2026 10 02  
(732) LOFTHOUSE OF FLEETWOOD LIMITED  
Maritime street, FLEETWOOD FY7 LP,  
United Kingdom

---

(111) M 1996 3455 R2  
(156) 2016 10 02  
(186) 2026 10 02  
(732) LOFTHOUSE OF FLEETWOOD LIMITED  
Maritime street, FLEETWOOD FY7 LP,  
United Kingdom

---

(111) M 1996 3474 R2  
(156) 2016 10 03  
(186) 2026 10 03  
(732) Boehringer Ingelheim Pharma GmbH & Co.  
KG  
55218 Ingelheim, Germany

---

(111) M 1996 3482 R2  
(156) 2016 10 08  
(186) 2026 10 08  
(732) SOCIETE JAS HENESSY & CO.  
rue de la Richonne, 16100 COGNAC, France

---

(111) M 1996 3506 R2  
(156) 2016 10 08  
(186) 2026 10 08  
(732) MONTRES BREGUET S.A.  
1344 L'Abbaye, Switzerland

---

(111) M 1996 3520 R2  
(156) 2016 10 08  
(186) 2026 10 08  
(732) Société des Produits Nestlé S.A.  
1800 Vevey, Switzerland

---

(111) M 1996 3521 R2  
(156) 2016 10 08  
(186) 2026 10 08  
(732) Société des Produits Nestlé S.A.  
1800 Vevey, Switzerland

---

(111) M 1996 3522 R2  
(156) 2016 10 08  
(186) 2026 10 08  
(732) SOCIETE DES PRODUITS NESTLE S.A.  
1800 Vevey, Switzerland

---

(111) M 1996 3529 R2  
(156) 2016 10 09  
(186) 2026 10 09  
(732) KAO CORPORATION  
Tokyo, Japan

---

(111) M 1996 3543 R2  
(156) 2016 10 09  
(186) 2036 10 09  
(732) INOVA PATENT GmbH  
Rickenbacherstrasse 8-10, Wolfurt, Austria

---

(111) M 1996 3563 R2  
(156) 2016 10 10  
(186) 2026 10 10  
(732) CREDIT AGRICOLE S.A.  
91/93 Boulevard Pasteur, 75015 Paris, France

---

(111) M 1996 3567 R2  
(156) 2016 10 10  
(186) 2026 10 10  
(732) SOCIETE BOLLINGER & CO  
16 rue jules lobet, 51160 AY, France

---

(111) M 1996 3571 R2  
(156) 2016 10 10  
(186) 2026 10 10  
(732) THE QUAKER OATS COMPANY;  
555, West Monroe Street, Chicago, Illinois  
60661, USA

---

(111) M 1996 3578 R2  
(156) 2016 10 10  
(186) 2026 10 10  
(732) DIAGEO BRANDS B.V.  
Molenwerf 10-12, 1014 BG Amsterdam,  
Netherlands

---

(111) M 1996 3579 R2  
(156) 2016 10 10  
(186) 2026 10 10  
(732) DIAGEO BRANDS B.V.  
Molenwerf 10-12, 1014 BG Amsterdam,  
Netherlands

---

---

(111) M 1996 3583 R2 (156) 2016 10 10 (186) 2026 10 10 (732) L' OREAL 14 Rue Royale, 75008 Paris, France	300 Park Avenue, New York, NY 10022, USA
(111) M 1996 3590 R2 (156) 2016 10 10 (186) 2026 10 10 (732) THE ROCKPORT COMPANY, LLC 1895 J. W. Foster Boulevard, Canton, Massachusetts 02021, USA	(111) M 1996 3636 R2 (156) 2016 10 16 (186) 2026 10 16 (732) COLGATE-PALMOLIVE COMPANY 300 Park Avenue, New York, NY 10022, USA
(111) M 1996 3591 R2 (156) 2016 10 10 (186) 2026 10 10 (732) MAGNA STEYR AG & Co KG Liebenauer Hauptstrasse 317, 8041 Graz, Austria	(111) M 1996 3637 R2 (156) 2016 10 16 (186) 2026 10 16 (732) COLGATE-PALMOLIVE COMPANY 300 Park Avenue, New York, NY 10022, USA
(111) M 1996 3609 R2 (156) 2016 10 11 (186) 2026 10 11 (732) MAGNA STEYR AG & Co KG Liebenauer Hauptstrasse 317, 8041 Graz, Austria	(111) M 1996 3676 R2 (156) 2016 10 23 (186) 2026 10 23 (732) NISSIN FOODS HOLDINGS CO., LTD 1-1 Nishinakajima 4-chome, Yodogawa-ku, Osaka, Japan
(111) M 1996 3624 R2 (156) 2016 10 16 (186) 2026 10 16 (732) NUTRINAT AG c/o ENGEL COPERA AG, Waldeggstrasse 37, CH-3097 Bern-Liebefeld, Switzerland	(111) M 1996 3680 R2 (156) 2016 10 24 (186) 2026 10 24 (732) SWAGELOK COMPANY 29500 Solon Road, Solon, Ohio 44139, USA
(111) M 1996 3626 R2 (156) 2016 10 16 (186) 2026 10 16 (732) FRUIT SHIPPERS LIMITED Third Floor, charlotte house, Charlotte Street, P.O. Box N-10051, Nassau, Bahamas	(111) M 1996 3693 R2 (156) 2016 10 24 (186) 2026 10 24 (732) PHILIP MORRIS BRANDS SARL Quai Jeanrenaud 3, 2000 Neuchâtel, Switzerland
(111) M 1996 3629 R2 (156) 2016 10 16 (186) 2026 10 16 (732) PROMOD Chemin du Verceau, 59700 MARCQ EN BEROEUL, France	(111) M 1996 3694 R2 (156) 2016 10 24 (186) 2026 10 24 (732) MUNDIPHARMA AG. St. Alban-Rheinweg 74, CH-4020 Basel, Switzerland
(111) M 1996 3635 R2 (156) 2016 10 16 (186) 2026 10 16 (732) COLGATE-PALMOLIVE COMPANY	(111) M 1996 3696 R2 (156) 2016 10 25 (186) 2026 10 25 (732) INTERNATIONAL BUSINESS MACHINES CORPORATION Old Orchard Road, Armonk, N.Y.10504, USA

---

(111) M 1996 3697 R2  
 (156) 2016 10 25  
 (186) 2026 10 25  
 (732) INTERNATIONAL BUSINESS  
 MACHINES CORPORATION  
 Old Orchard Road, Armonk, N.Y.10504,  
 USA

---

(111) M 1996 3698 R2  
 (156) 2016 10 25  
 (186) 2026 10 25  
 (732) INTERNATIONAL BUSINESS  
 MACHINES CORPORATION  
 Old Orchard Road, Armonk, N.Y.10504,  
 USA

---

(111) M 1996 3699 R2  
 (156) 2016 10 25  
 (186) 2026 10 25  
 (732) INTERNATIONAL BUSINESS  
 MACHINES CORPORATION  
 Old Orchard Road, Armonk, N.Y.10504,  
 USA

---

(111) M 1996 3709 R2  
 (156) 2016 10 25  
 (186) 2026 10 25  
 (732) SEPPELFRICKE ARMATUREN GMBH  
 Haldenstrasse 27, 45881 Gelsenkirchen,  
 Germany

---

(111) M 1996 3719 R2  
 (156) 2016 10 28  
 (186) 2026 10 28  
 (732) COVESTRO DEUTSCHLAND AG  
 Kaiser-Wilhelm-Alee 60, 51373 Leverkusen,  
 Germany

---

(111) M 1996 3728 R2  
 (156) 2016 10 29  
 (186) 2026 10 29  
 (732) COVESTRO DEUTSCHLAND AG  
 Kaiser-Wilhelm-Alee 60, 51373 Leverkusen,  
 Germany

---

(111) M 1996 3730 R2  
 (156) 2016 10 29  
 (186) 2026 10 29  
 (732) LANXESS DEUTSCHLAND GmbH  
 51369 Leverkusen, Germany

---

(111) M 1996 3735 R2  
 (156) 2016 10 29  
 (186) 2026 10 29

(732) COVESTRO DEUTSCHLAND AG  
 Kaiser-Wilhelm-Alee 60, 51373 Leverkusen,  
 Germany

---

(111) M 1996 3738 R2  
 (156) 2016 10 29  
 (186) 2026 10 29  
 (732) BAYER AG  
 D-51368 Leverkusen, Germany

---

(111) M 1996 3744 R2  
 (156) 2016 10 29  
 (186) 2026 10 29  
 (732) FALC S.P.A.  
 Contrada San Domenico 24, Civitanova  
 Marche (Macerata), Italy

---

(111) M 1996 3747 R2  
 (156) 2016 10 29  
 (186) 2026 10 29  
 (732) COMPAGNIE GERVAIS DANONE,  
 societe anonyme  
 17 Boulevard Haussmann, 75009 Paris,  
 France

---

(111) M 1996 3772 R2  
 (156) 2016 10 30  
 (186) 2026 10 30  
 (732) COLGATE-PALMOLIVE COMPANY  
 300 Park Avenue, New York, NY 10022,  
 USA

---

(111) M 1996 3773 R2  
 (156) 2016 10 30  
 (186) 2026 10 30  
 (732) COLGATE-PALMOLIVE COMPANY  
 300 Park Avenue, New York, NY 10022,  
 USA

---

(111) M 1996 3785 R2  
 (156) 2016 10 31  
 (186) 2026 10 31  
 (732) KIMBERLY-CLARK WORLDWIDE, INC.  
 NEENAH, WI 54956, USA

---

(111) M 1996 3786 R2  
 (156) 2016 10 31  
 (186) 2026 10 31  
 (732) KIMBERLY-CLARK WORLDWIDE, INC.  
 NEENAH, WI 54956, USA

---

(111) M 1996 3800 R2  
(156) 2016 10 31  
(186) 2026 10 31  
(732) PANASONIC CORPORATION  
1006, Oaza- Kadoma, Kadoma-shi, Osaka  
571-8501, Japan

---

(111) M 1996 3802 R2  
(156) 2016 10 31  
(186) 2026 10 31  
(732) SALVATORE FERRAGAMO S.P.A.  
Via dei Tornabuoni 2, Florence, Italy

---

(111) M 1996 3811 R2  
(156) 2016 11 01  
(186) 2026 11 01  
(732) WILLIAMSON-DICKIE  
MANUFACTURING COMPANY  
319 Lipscomb Street, Fort Worth, Texas  
76104, USA

---

(111) M 1996 3819 R2  
(156) 2016 11 04  
(186) 2026 11 04  
(732) SOCIÉTÉ DES PRODUITS NESTLÉ S.A.  
1800 Vevey, Switzerland

---

(111) M 1996 3835 R2  
(156) 2016 11 04  
(186) 2026 11 04  
(732) MOTT'S LLP  
5301 Legacy Drive, Plano, TX 75024, USA

---

(111) M 1996 3917 R2  
(156) 2016 11 11  
(186) 2026 11 11  
(732) DIAGEO NORTH AMERICA, INC.  
801 Main Avenue, Norwalk CT 06851-1127,  
USA

---

(111) M 1996 3919 R2  
(156) 2016 11 11  
(186) 2026 11 11  
(732) FOUR ROSES DISTILLERY, LLC  
1224 Bonds Mill Road, Lawrenceburg,  
kentucky 40342-9743, USA

---

(111) M 1996 3924 R2  
(156) 2016 11 11  
(186) 2026 11 11  
(732) NOVUS INTERNATIONAL, INC  
20 Research Park Drive, St. Charles, MO  
63304, USA

---

(111) M 1996 3955 R2  
(156) 2016 11 13  
(186) 2026 11 13  
(732) BASICNET S.P.A.  
Largo M., Vitale 1, Turin, Italy

---

(111) M 1996 3956 R2  
(156) 2016 11 13  
(186) 2026 11 13  
(732) BASICNET S.P.A.  
Largo M., Vitale 1, Turin, Italy

---

(111) M 1996 3957 R2  
(156) 2016 11 13  
(186) 2026 11 13  
(732) BASICNET S.P.A.  
Largo M., Vitale 1, Turin, Italy

---

(111) M 1996 3963 R2  
(156) 2016 11 14  
(186) 2026 11 14  
(732) FD MANAGEMENT, INC.,  
a Delaware corporation  
300 Delaware Avenue, Wilmington,  
Delaware 19801, USA

---

(111) M 1996 4025 R2  
(156) 2016 11 18  
(186) 2026 11 18  
(732) LANXESS DEUTSCHLAND GmbH  
51369 Leverkusen, Germany

---

(111) M 1996 4041 R2  
(156) 2016 11 19  
(186) 2026 11 19  
(732) VISA INTERNATIONAL SERVICE  
ASSOCIATION  
900 Metro Center Boulevard, Foster City,  
California 94404, USA

---

(111) M 1996 4053 R2  
(156) 2016 11 21  
(186) 2026 11 21  
(732) YOPLAIT MARQUES  
150 rue Galliéni, 92100 Boulogne-  
Billancourt, France

---

(111) M 1996 4082 R2  
(156) 2016 11 25  
(186) 2026 11 25  
(732) NOVARTIS AG  
Basel 4002, Switzerland

---

(111) M 1996 4088 R2

(156) 2016 11 26

(186) 2026 11 26

(732) LIBBY'S BRAND HOLDING LIMITED  
Vanterpool Piazza 2nd Floor, Wickhams  
Cay 1, Road Town, Tortola, British Virgin  
Islands

Quai Jeanrenaud 3, 2000 NEUCHATEL,  
Switzerland

(111) M 1996 4102 R2

(156) 2016 11 27

(186) 2026 11 27

(732) HUGO BOSS Trade Mark Management  
GmbH & Co. KG  
Dieselstrasse 12, 72555 Metzingen, Germany

(111) M 1996 4162 R2

(156) 2016 12 05

(186) 2026 12 05

(732) KELLOGG COMPANY  
One Kellog Square, P.O. Box 3599 Battle  
Creek, Michigan 49016-3599, USA

(111) M 1996 4140 R2

(156) 2016 12 04

(186) 2026 12 04

(732) CASIO KEISANKI KABUSHIKI KAISHA,  
ALSO TRADING AS CASIO COMPUTER  
CO., LTD.  
6-2, Hon-machi 1-chome, Shibuya-ku,  
Tokyo, Japan

(111) M 1996 4169 R2

(156) 2016 12 05

(186) 2026 12 05

(732) NIKON CORPORATION  
2-15-3, Konan, Minato-ku, Tokyo, Japan

(111) M 1996 4262 R2

(156) 2016 12 19

(186) 2026 12 19

(732) KELLOGG COMPANY  
One Kellog Square, P.O. Box 3599 Battle  
Creek, Michigan 49016-3599, USA

(111) M 1996 4141 R2

(156) 2016 12 04

(186) 2026 12 04

(732) CASIO KEISANKI KABUSHIKI KAISHA,  
ALSO TRADING AS CASIO COMPUTER  
CO., LTD.  
6-2, Hon-machi 1-chome, Shibuya-ku,  
Tokyo, Japan

(111) M 1996 4273 R2

(156) 2016 12 19

(186) 2026 12 19

(732) CASIO KEISANKI KABUSHIKI KAISHA,  
ALSO TRADING AS CASIO COMPUTER  
CO., LTD.  
6-2, Hon-machi 1-chome, Shibuya-ku,  
Tokyo, Japan

(111) M 1996 4142 R2

(156) 2016 12 04

(186) 2026 12 04

(732) CASIO KEISANKI KABUSHIKI KAISHA,  
ALSO TRADING AS CASIO COMPUTER  
CO., LTD.  
6-2, Hon-machi 1-chome, Shibuya-ku,  
Tokyo, Japan

(111) M 1996 4280 R2

(156) 2016 12 20

(186) 2026 12 20

(732) PHILIP MORRIS PRODUCTS S.A.  
Quai Jeanrenaud 3, 2000 NEUCHATEL,  
Switzerland

(111) M 1996 4146 R2

(156) 2016 12 04

(186) 2026 12 04

(732) KELLOGG COMPANY  
One Kellog Square, P.O. Box 3599 Battle  
Creek, Michigan 49016-3599, USA

(111) M 1996 4287 R2

(156) 2016 12 23

(186) 2026 12 23

(732) MERCK SANTE, SAS  
37, rue St. Romain, 69008 Lyon, France

(111) M 1996 4159 R2

(156) 2016 12 05

(186) 2026 12 05

(732) PHILIP MORRIS PRODUCTS S.A.

(111) M 1997 4324 R2

(156) 2017 01 08

(186) 2027 01 08

(732) U-HAUL INTERNATIONAL, INC.  
2727 North Central Avenue, Phoenix,  
Arizona 85036, USA

(111) M 1997 4647 R2  
(156) 2017 02 18  
(186) 2027 02 18  
(732) Underberg GmbH & Co. KG;  
Underbergstr.1-3, D-47495, Rheinberg,  
Germany

---

(111) M 1997 4659 R2  
(156) 2017 02 28  
(186) 2027 02 28  
(732) WINTER HOLDING GMBH & CO KG  
Heidelberger Strasse 9-11, 69226 Nussloch,  
Germany

---

(111) M 1997 4660 R2  
(156) 2017 02 28  
(186) 2027 02 28  
(732) WINTER HOLDING GMBH & CO KG  
Heidelberger Strasse 9-11, 69226 Nussloch,  
Germany

---

(111) M 1997 4661 R2  
(156) 2017 02 28  
(186) 2027 02 28  
(732) WINTER HOLDING GMBH & CO KG  
Heidelberger Strasse 9-11, 69226 Nussloch,  
Germany

---

(111) M 1997 4720 R2  
(156) 2017 03 14  
(186) 2027 03 14  
(732) CHEVRON INTELLECTUAL PROPERTY  
LLC, a State of Delaware, Limited Liability  
Company  
6001 Bollinger Canyon Road, San Ramon,  
California 94583, USA

---

(111) M 1997 4760 R2  
(156) 2017 03 19  
(186) 2027 03 19  
(732) RICHEMONT INTERNATIONAL SA  
Route des Biches 10, Villars-sur-Glane,  
Switzerland

---

(111) M 1997 7423 R2  
(156) 2017 11 10  
(186) 2027 11 10  
(732) THE SINGER COMPANY LIMITED,  
S.À.R.L.  
1, rue des Glacis, L-1628 Luxembourg,  
Luxembourg

---

## COMPLETE TRANSFER OF RIGHTS

(111) M 1996 001358 R2  
 (732) COVESTRO DEUTSCHLAND AG  
 Kaiser-Wilhelm-Alee 60, 51373 Leverkusen,  
 Germany  
 (770) BAYER AG  
 D-51368 Leverkusen, Germany  
 (580) 2016 10 11

(111) M 1996 001504 R2  
 (732) COVESTRO DEUTSCHLAND AG  
 Kaiser-Wilhelm-Alee 60, 51373 Leverkusen,  
 Germany  
 (770) BAYER AG  
 D-51368 Leverkusen, Germany  
 (580) 2016 10 11

(111) M 1996 001505 R2  
 (732) COVESTRO DEUTSCHLAND AG  
 Kaiser-Wilhelm-Alee 60, 51373 Leverkusen,  
 Germany  
 (770) BAYER AG  
 D-51368 Leverkusen, Germany  
 (580) 2016 10 11

(111) M 1996 001507 R2  
 (732) COVESTRO DEUTSCHLAND AG  
 Kaiser-Wilhelm-Alee 60, 51373 Leverkusen,  
 Germany  
 (770) BAYER AG  
 D-51368 Leverkusen, Germany  
 (580) 2016 10 11

(111) M 1996 001509 R2  
 (732) COVESTRO DEUTSCHLAND AG  
 Kaiser-Wilhelm-Alee 60, 51373 Leverkusen,  
 Germany  
 (770) BAYER AG  
 D-51368 Leverkusen, Germany  
 (580) 2016 10 11

(111) M 1996 001510 R2  
 (732) COVESTRO DEUTSCHLAND AG  
 Kaiser-Wilhelm-Alee 60, 51373 Leverkusen,  
 Germany  
 (770) BAYER AG  
 D-51368 Leverkusen, Germany  
 (580) 2016 10 11

(111) M 1996 001511 R2  
 (732) COVESTRO DEUTSCHLAND AG  
 Kaiser-Wilhelm-Alee 60, 51373 Leverkusen,  
 Germany

(770) BAYER AG  
 D-51368 Leverkusen, Germany  
 (580) 2016 10 11

(111) M 2006 016611 R1  
 (732) ACCESSORIZE LIMITED  
 1 Nicholas Road, London, W11 4 AN,  
 United Kingdom  
 (770) MONSOON ACCESSORIZE LIMITED  
 1 Nicholas Road, London, W11 4 AN,  
 United Kingdom  
 (580) 2016 10 11

(111) M 2007 017527 R  
 (732) JSC "SARAJISHVILI"  
 Sarajishvilis gamz. 4, 0153, Tbilisi, Georgia  
 (770) BUBUTEISHVILI ZURAB  
 Faliashvilis q. 62, 0179, Tbilisi, Georgia  
 (580) 2016 10 11

(111) M 2009 019079 R  
 (732) NIKOLOZ SHARDENIS DZE  
 AKHVLEDIANI  
 Delisi2 q. 4, 0177, Tbilisi, Georgia  
 (770) MAMUKA AKHVLEDIANI  
 Nutsubidzis me-5 m/raioni, korp. 2, b. 2,  
 0183, Tbilisi, Georgia  
 (580) 2016 10 11

(111) M 2009 019080 R  
 (732) AKHVLEDIANI MARIETA  
 Spiridon kedias q.9, b. 3, Tbilisi, Georgia  
 (770) MAMUKA AKHVLEDIANI  
 Nutsubidzis me-5 m/raioni, korp. 2, b. 2,  
 0183, Tbilisi, Georgia  
 (580) 2016 10 11

(111) M 2009 019620 R  
 (732) JSC "TELIANI VALEY"  
 Tbilisis gzat. 3, 2200, Telavi, Georgia  
 (770) LTD "GLAVSPIRTPROM" ,  
 Paliashvilis q. 26, 0179, Tbilisi, Georgia  
 (580) 2016 10 03

(111) M 2010 020505 R  
 (732) LTD "GLOBAL CBS"  
 Stanislavskis q. 5, 0119, Tbilisi, Georgia  
 (770) LTD "CBS PHARMACEUTICALL"



Jansug Kakhidzis q. 8, 0102, Tbilisi, Georgia  
(580) 2016 10 11

---

(111) M 1996 002369 R2  
(732) COVESTRO DEUTSCHLAND AG  
Kaiser-Wilhelm-Alee 60, 51373 Leverkusen,  
Germany  
(770) BAYER AG  
D-51368 Leverkusen, Germany  
(580) 2016 10 11

---

(111) M 2013 024061 R  
(732) JSC "SARAJISHVILI"  
Sarajishvilis gamz. 4, 0153, Tbilisi, Georgia  
(770) BUBUTEISHVILI ZURAB  
Paliashvilis q. 62, 0179, Tbilisi, Georgia  
(580) 2016 10 11

---

(111) M 2015 025681 R  
(732) JSC "SARAJISHVILI"  
Sarajishvilis gamz. 4, 0153, Tbilisi, Georgia  
(770) BUBUTEISHVILI ZURAB  
Paliashvilis q. 62, 0179, Tbilisi, Georgia  
(580) 2016 10 11

---

(111) M 1996 003082 R1  
(732) BODEGAS FUNDADOR S.L.  
Avenida Del Prezidente Carmona No:10,  
28020 Madrid, Spain  
(770) BEAM SUNTORY UK LIMITED  
2 Longwalk Road, Stockley Park, Uxbridge,  
Middlesex, England UB11 1BA, United  
Kingdom  
(580) 2016 10 11

---

(111) M 1996 003144 R2  
(732) FL EUROPE HOLDINGS, INC.  
330 west 34-th street, New York, New  
York 10001, USA  
(770) FL EUROPE HOLDINGS, INC.  
112 west 34-th street, City of New York,  
State of New York, 10120, USA  
(580) 2016 10 07

---

(111) M 1996 003474 R2  
(732) BOEHRINGER INGELHAIM PHARMA  
GMBH & Co. KG  
55218 Ingelheim, Germany  
(580) 2016 10 11

---

(111) M 1996 003719 R2  
(732) COVESTRO DEUTSCHLAND AG  
Kaiser-Wilhelm-Alee 60, 51373 Leverkusen,  
Germany  
(770) BAYER AG  
D-51368 Leverkusen, Germany  
(580) 2016 10 11

---

(111) M 1996 003728 R2  
(732) COVESTRO DEUTSCHLAND AG  
Kaiser-Wilhelm-Alee 60, 51373 Leverkusen,  
Germany  
(770) BAYER AG  
D-51368 Leverkusen, Germany  
(580) 2016 10 11

---

(111) M 1996 003735 R2  
(732) COVESTRO DEUTSCHLAND AG  
Kaiser-Wilhelm-Alee 60, 51373 Leverkusen,  
Germany  
(770) BAYER AG  
D-51368 Leverkusen, Germany  
(580) 2016 10 11

---

(111) M 1996 004186 R1  
(732) COVESTRO DEUTSCHLAND AG  
Kaiser-Wilhelm-Alee 60, 51373 Leverkusen,  
Germany  
(770) BAYER AG  
D-51368 Leverkusen, Germany  
(580) 2016 10 11

---

(111) M 1997 006274 R1  
(732) THE PROCTER & GAMBLE COMPANY  
One Procter & Gamble Plaza, Cincinnati  
Ohio 45202, USA  
(770) PROCTER & GAMBLE  
MANUFACTURING COLOGNE GMBH  
Wilhelm-Mauser-Straße 40, 50827 Köln,  
Germany  
(580) 2016 10 07

---

(111) M 1995 000744 R2  
(732) COVESTRO DEUTSCHLAND AG  
Kaiser-Wilhelm-Alee 60, 51373 Leverkusen,  
Germany  
(770) BAYER AG  
D-51368 Leverkusen, Germany  
(580) 2016 10 11

---

---

**CHANGES IN NAMES AND/OR ADDRESSES OF OWNERS**

(111) M 2005 015985 R1  
 (732) INTERVET INC.  
 1095 Morris Avenue, Union, State of New Jersey 07083, USA  
 (770) SCHERING-PLOUGH ANIMAL HEALTH CORPORATION a Delaware corporation  
 1095 Morris Avenue, Union, State of New Jersey 07083, USA  
 (580) 2016 10 10

---

(111) M 2005 015985 R1  
 (732) INTERVET INC.  
 2 Giralda Farms, Madison, New Jersey 07940, USA  
 (770) INTERVET INC.  
 1095 Morris Avenue, Union, State of New Jersey 07083, USA  
 (580) 2016 10 10

---

(111) M 2006 016663 R1  
 (732) WYETH LLC  
 235 East 42 nd Street, New York, NY 10017, USA  
 (770) WYETH LLC  
 Five Giralda Farms, Madison, New Jersey, 07940, USA  
 (580) 2016 10 12

---

(111) M 2006 016960 R1  
 (732) HIMALAYA GLOBAL HOLDINGS LTD  
 Dubai International Financial Centre, Gate Village 4, Level 5, P.O. Box 506807, Dubai, United Arab Emirates  
 (770) HIMALAYA GLOBAL HOLDINGS LTD  
 Dubai International Financial Centre, The Gate, Level 12, Suite 27, P.O. Box 506807, Dubai, United Arab Emirates  
 (580) 2016 10 10

---

(111) M 2006 016960 R1  
 (732) HIMALAYA GLOBAL HOLDINGS LTD.  
 106 Elizabeten Square, P.O. Box 1162, Grand Cayman KY1-1102, Cayman Islands  
 (770) HIMALAYA GLOBAL HOLDINGS LTD  
 Dubai International Financial Centre, Gate Village 4, Level 5, P.O. Box 506807, Dubai, United Arab Emirates  
 (580) 2016 10 10

---

(111) M 2011 021713 R  
 (732) HIMALAYA GLOBAL HOLDINGS LTD  
 Dubai International Financial Centre, Gate Village 4, Level 5, P.O. Box 506807, Dubai, United Arab Emirates  
 (770) HIMALAYA GLOBAL HOLDINGS LTD  
 Dubai International Financial Centre, The Gate, Level 12, Suite 27, P.O. Box 506807, Dubai, United Arab Emirates  
 (580) 2016 10 10

---

(111) M 2011 021713 R  
 (732) HIMALAYA GLOBAL HOLDINGS LTD  
 106 Elizabeten Square, P.O. Box 1162, Grand Cayman KY1-1102, Cayman Islands  
 (770) HIMALAYA GLOBAL HOLDINGS LTD  
 Dubai International Financial Centre, Gate Village 4, Level 5, P.O. Box 506807, Dubai, United Arab Emirates  
 (580) 2016 10 10

---

(111) M 1996 003019 R2  
 (732) THE GB FOODS, SA  
 Plaza Europa 42, 08902 L'Hospitalet de Llobregat, Barcelona, Spain  
 (770) PREPARADOS ALIMENTICIOS, S.A.  
 Josep Tarradellas, 38, E-08029 Barcelona, Spain  
 (580) 2016 10 10

---

(111) M 1996 003020 R2  
 (732) THE GB FOODS, SA  
 Plaza Europa 42, 08902 L'Hospitalet de Llobregat, Barcelona, Spain  
 (770) PREPARADOS ALIMENTICIOS, S.A.  
 Josep Tarradellas, 38, E-08029 Barcelona, Spain  
 (580) 2016 10 10

---

(111) M 1996 003027 R2  
 (732) THE GB FOODS, SA  
 Plaza Europa 42, 08902 L'Hospitalet de Llobregat, Barcelona, Spain  
 (770) PREPARADOS ALIMENTICIOS, S.A.  
 Josep Tarradellas, 38, E-08029 Barcelona, Spain  
 (580) 2016 10 10

---

(111) M 1996 003144 R2  
(732) FL EUROPE HOLDINGS, INC.  
112 west 34-th street, City of New York,  
State of New York,10120, USA  
(770) FOOT LOCKER RETAIL, INC.  
233 BROADWAY, NEW YORK, USA  
(580) 2016 10 07

---

(111) M 1996 003314 R1  
(732) NTN-SNR ROULEMENTS  
1, rue des Usines, 74000 Annecy, France  
(770) SNR ROULEMENTS  
1, rue des Usines, 74000 Annecy, France  
(580) 2016 10 10

---

(111) M 1996 003474 R2  
(732) C.H. BOEHRINGER SOHN AG & Co. KG  
55218 Ingelheim, Germany  
(770) C.H. BOEHRINGER SOHN  
Binger Strasse 148, 6507 Ingelheim,  
Germany  
(580) 2016 10 11

---

(111) M 1996 003835 R2  
(732) MOTT'S LLP  
5301 Legacy Drive, Plano, TX 75024, USA  
(770) MOTT'S LLP  
Corporation Trust Center, 1209 Orange  
Street, Wilmington, New Castle County,  
Delaware 19801, USA  
(580) 2016 10 07

---

(111) M 1997 005749 R1  
(732) NTN-SNR ROULEMENTS  
1, rue des Usines, 74000 Annecy, France  
(770) SNR ROULEMENTS  
1, rue des Usines, 74000 Annecy, France  
(580) 2016 10 10

---

(111) M 1997 007305 R1  
(732) EASTMAN CHEMICAL FINANCE B.V.  
Fascinatio Boulevard 602, 2909 VACapelle  
ann den IJssel, Netherlands  
(770) FLEXSYS HOLDING, B.V.  
51010 Zutphenseweg, NL-7418 Deventer,  
The Netherlands, Netherlands  
(580) 2016 10 11

---

(111) M 1995 000805 R2  
(732) FL EUROPE HOLDINGS, INC.  
330 west 34-th street, New York, New  
York 10001, USA

(770) FL EUROPE HOLDINGS, INC.  
112 west 34-th street, City of New York,  
State of New York,10120, USA  
(580) 2016 10 07

---

(111) M 1995 000806 R2  
(732) FL EUROPE HOLDINGS, INC.  
330 west 34-th street, New York, New York  
10001, USA  
(770) FL EUROPE HOLDINGS, INC.  
112 west 34-th street, City of New York,  
State of New York,10120, USA  
(580) 2016 10 07

---

---

**INVALIDATION OF TRADEMARKS REGISTRATION**

(111) M 1996 1541 R1  
 (141) 2006 02 14, Not payment for prolongation of registration on the following of 10 years  
 (732) FUCHS PETROLUB AG  
 Friesenheimer Strasse 17, 68169 Mannheim, Germany

---

(111) M 2006 16511 R  
 (141) 2016 09 02, Not payment for prolongation of registration on the following of 10 years  
 (732) JSC "DELIDORI"  
 sop. Navazari (sakonservo qarkhana), 3308, Mtskhethis raioni, Georgia

---

(111) M 2006 16513 R  
 (141) 2016 09 02, Not payment for prolongation of registration on the following of 10 years  
 (732) LTD "A-B-C Pharmaceuticals"  
 Lisis Tba 1, 0171, Tbilisi, Georgia

---

(111) M 2006 16514 R  
 (141) 2016 09 02, Not payment for prolongation of registration on the following of 10 years  
 (732) GIORGI TEVZADZE  
 Gogebashvilis me-2 shesakhvevi, korp. 4, bina 20, 0179, Tbilisi, Georgia

---

(111) M 2006 16515 R  
 (141) 2016 09 02, Not payment for prolongation of registration on the following of 10 years  
 (732) LTD "SANTE GMT PRODUCTS"  
 Kakheti Highway, 10-th km, 0182, Tbilisi, Georgia

---

(111) M 2006 16519 R  
 (141) 2016 09 02, Not payment for prolongation of registration on the following of 10 years  
 (732) BANGKOK INTERFURN CO., LTD  
 43/13 Moo 7 Soi Rama 2 Soi 50, Rama 2 Road, Samaedam, Bangkhunthien, Bangkok 10150, Thailand

---

(111) M 2006 16522 R  
 (141) 2016 09 02, Not payment for prolongation of registration on the following of 10 years  
 (732) GRIFOLS THERAPEUTICS INC.  
 4101 RESEARCH COMMONS, 79 TW ALEXANDER DRIVE, RESEARCH TRIANGLE PARK, NORTH CAROLINA 27709, USA

---

(111) M 2006 16523 R  
 (141) 2016 09 02, Not payment for prolongation of registration on the following of 10 years  
 (732) CHICHIKO GOLETIANI  
 Davit Agmasheneblis gamz., 71, 0102, Tbilisi, Georgia

---

(111) M 2006 16524 R  
 (141) 2016 09 02, Not payment for prolongation of registration on the following of 10 years  
 (732) GENERAL MOTORS CORPORATION  
 300 Renaissance Center, City of Detroit, State of Michigan 48265-3000, USA

---

(111) M 2006 16533 R  
 (141) 2016 09 15, Not payment for prolongation of registration on the following of 10 years  
 (732) ARLA FOODS AMBA  
 Sonderhoj 14, DK-8260 Viby J, Denmark

---

(111) M 2006 16534 R  
 (141) 2016 09 15, Not payment for prolongation of registration on the following of 10 years  
 (732) ARLA FOODS AMBA  
 Sonderhoj 14, DK-8260 Viby J, Denmark

---

(111) M 2006 16537 R  
 (141) 2016 09 15, Not payment for prolongation of registration on the following of 10 years  
 (732) HAYAT KIMYA SANAYI A.Ş.  
 Mahir Iz Caddesi No:25 Altunizade üsküdar, Istanbul, Turkey

---

(111) M 1996 1654 R1  
 (141) 2006 02 28, Not payment for prolongation of registration on the following of 10 years  
 (732) ESTEE LAUDER COSMETICS LTD  
 161 Commander boulevard, Agincourt, Ontario, Canada

---

(111) M 2006 16540 R  
 (141) 2016 09 15, Not payment for prolongation of registration on the following of 10 years  
 (732) LTD "VAINMEN SH.P.S"  
 Gudiashvilis q. 11, 0105, Tbilisi, Georgia

---

(111) M 2006 16542 R  
 (141) 2016 09 15, Not payment for prolongation of registration on the following of 10 years

---

(732) HAYAT KIMYA SANAYI A.Ş.  
Mahir Iz Caddesi No:25 Altunizade üsküdar,  
Istanbul, Turkey

(111) M 1996 1671 R1  
(141) 2006 03 06, Not payment for prolongation of  
registration on the following of 10 years  
(732) JAPAN TOBACCO INC.  
2-2-1 Toranomon Minato-ku, Tokyo, Japan

(111) M 1996 1672 R1  
(141) 2006 03 06, Not payment for prolongation of  
registration on the following of 10 years  
(732) STENDHAL SAS  
76, 78 Avenue des Champs Elysées, 75008  
PARIS, France

(111) M 1996 1681 R1  
(141) 2006 09 06, Not payment for prolongation of  
registration on the following of 10 years  
(732) JSC Goris Sakonservo Gaertianeba  
"GORKONI"  
Shindisis gzatk. 17, 383503, Gori, Georgia

(111) M 1996 1684 R1  
(141) 2006 09 06, Not payment for prolongation of  
registration on the following of 10 years  
(732) HERAEUS KULZER GMBH & CO., KG  
Grüner Weg 11, 63450 Hanau, Germany

(111) M 1996 1686 R1  
(141) 2006 09 06, Not payment for prolongation of  
registration on the following of 10 years  
(732) BEYER INTELLECTUAL PROPERTY  
GMBH  
Alfred-Nobel-Strasse 10, 40789 Monheim  
am Rhein, Germany

(111) M 1996 1695 R1  
(141) 2006 09 07, Not payment for prolongation of  
registration on the following of 10 years  
(732) BEYER INTELLECTUAL PROPERTY  
GMBH  
Alfred-Nobel-Strasse 10, 40789 Monheim  
am Rhein, Germany

(111) M 1996 1702 R1  
(141) 2006 09 07, Not payment for prolongation of  
registration on the following of 10 years  
(732) BAYER AG  
D-51368 Leverkusen, Germany

(111) M 1996 1703 R1  
(141) 2006 09 07, Not payment for prolongation of  
registration on the following of 10 years  
(732) TEVA GMBH  
Graf-Arco-Straße 3, 89079 Ulm, Germany

(111) M 1996 1707 R1  
(141) 2006 03 07, Not payment for prolongation of  
registration on the following of 10 years  
(732) BAYER INTELLECTUAL PROPERTY  
GMBH  
Alfred-Nobel-Strasse 10, 40789 Monheim am  
Rhein, Germany

(111) M 1996 1708 R1  
(141) 2006 09 08, Not payment for prolongation of  
registration on the following of 10 years  
(732) PHILIP MORRIS BRANDS SARL  
Quai Jeanrenaud 3, 2000 Neuchâtel,  
Switzerland

(111) M 1996 1709 R1  
(141) 2006 09 08, Not payment for prolongation of  
registration on the following of 10 years  
(732) PHILIP MORRIS BRANDS SARL  
Quai Jeanrenaud 3, 2000 Neuchâtel,  
Switzerland

(111) M 1996 1710 R1  
(141) 2006 09 08, Not payment for prolongation of  
registration on the following of 10 years  
(732) PHILIP MORRIS BRANDS SARL  
Quai Jeanrenaud 3, 2000 Neuchâtel,  
Switzerland

(111) M 1996 1714 R1  
(141) 2006 09 08, Not payment for prolongation of  
registration on the following of 10 years  
(732) YVES SAINT LAURENT PARFUMS S.A.  
28/34 Boulevard du Parc, 92521 Neuilly,  
Cedex, France

(111) M 1996 1715 R1  
(141) 2006 09 08, Not payment for prolongation of  
registration on the following of 10 years  
(732) YVES SAINT LAURENT PARFUMS S.A.  
28/34 Boulevard du Parc, 92521 Neuilly,  
Cedex, France

(111) M 1996 1716 R1  
(141) 2006 09 08, Not payment for prolongation of  
registration on the following of 10 years

(732) YVES SAINT LAURENT PARFUMS S.A.  
28/34 Boulevard du Parc, 92521 Neuilly,  
Cedex, France

---

(111) M 1996 1718 R1  
(141) 2006 09 08, Not payment for prolongation of  
registration on the following of 10 years  
(732) YVES SAINT LAURENT PARFUMS S.A.  
28/34 Boulevard du Parc, 92521 Neuilly,  
Cedex, France

---

(111) M 1996 1732 R1  
(141) 2006 09 12, Not payment for prolongation of  
registration on the following of 10 years  
(732) E.R. SQUIBB & SONS. L.L.C.  
The Corporation Trust Company, 1209  
Orange Street, Wilmington, New Castle  
Country, 19801 Delaware, USA

---

(111) M 1996 1801 R1  
(141) 2006 09 19, Not payment for prolongation of  
registration on the following of 10 years  
(732) FOOT LOCKER, INC.  
112 west 34-th street, City of New York,  
State of New York 10120, USA

---

(111) M 1996 1805 R1  
(141) 2006 09 19, Not payment for prolongation of  
registration on the following of 10 years  
(732) JAPAN TOBACCO INC.  
2-2-1, Toranomom, Minato-ku, Tokyo, Japan

---

(111) M 1996 1808 R1  
(141) 2006 09 19, Not payment for prolongation of  
registration on the following of 10 years  
(732) JAPAN TOBACCO INC.  
2-2-1, Toranomom, Minato-ku, Tokyo, Japan

---

(111) M 1996 1809 R1  
(141) 2006 09 19, Not payment for prolongation of  
registration on the following of 10 years  
(732) GALLAHER LIMITED  
Members Hill, Brooklands Road, Weybridge,  
Surrey, KT13 0QU United Kingdom

---

(111) M 1996 1816 R1  
(141) 2006 03 21, Not payment for prolongation of  
registration on the following of 10 years  
(732) THE DIAL CORP., a Delaware corporation  
15501 North Dial Boulevard, Scottsdale,  
Arizona 85260-1619, USA

---

(111) M 1996 1817 R1  
(141) 2006 09 20, Not payment for prolongation of  
registration on the following of 10 years  
(732) ESTEE LAUDER COSMETICS LTD  
161 Commander boulevard, Agincourt,  
Ontario, Canada

---

(111) M 1996 1818 R1  
(141) 2006 09 20, Not payment for prolongation of  
registration on the following of 10 years  
(732) ESTEE LAUDER COSMETICS LTD  
161 Commander boulevard, Agincourt,  
Ontario, Canada

---

(111) M 1996 1823 R1  
(141) 2006 09 20, Not payment for prolongation of  
registration on the following of 10 years  
(732) ESTEE LAUDER COSMETICS LTD  
161 Commander boulevard, Agincourt,  
Ontario, Canada

---

(111) M 1996 1824 R1  
(141) 2006 09 20, Not payment for prolongation of  
registration on the following of 10 years  
(732) ESTEE LAUDER COSMETICS LTD  
161 Commander boulevard, Agincourt,  
Ontario, Canada

---

(111) M 1996 1829 R1  
(141) 2006 09 21, Not payment for prolongation of  
registration on the following of 10 years  
(732) KABUSHIKI KAISHA KANEBO  
KESHOHIN (KANEBO COSMETICS INC)  
11-2, Toranomom 5-chome, Minato-ku,  
Tokyo, Japan

---

(111) M 1996 1837 R1  
(141) 2006 09 22, Not payment for prolongation of  
registration on the following of 10 years  
(732) SYNGENTA LIMITED  
European Regional Centre, Priestley Road,  
Surrey Research Park, Guildford, Surrey  
GU2 7YH, United Kingdom

---

(111) M 1996 1839 R1  
(141) 2006 09 22, Not payment for prolongation of  
registration on the following of 10 years

(732) SYNGENTA LIMITED  
European Regional Centre, Priestley Road,  
Surrey Research Park, Guildford, Surrey  
GU2 7YH, United Kingdom

---

(111) M 1996 1841 R1  
(141) 2006 03 27, Not payment for prolongation of registration on the following of 10 years  
(732) KABUSHIKI KAISHA KANEBO  
KESHOHIN (KANEBO COSMETICS INC)  
11-2, Toranomom 5-chome, Minato-ku,  
Tokyo, Japan

---

(111) M 1996 1849 R1  
(141) 2006 09 26, Not payment for prolongation of registration on the following of 10 years  
(732) MEAD JOHNSON & COMPANY  
2400 West Lloyd Expressway, Evansville,  
Indiana 47721, USA

---

(111) M 1996 1851 R1  
(141) 2006 09 26, Not payment for prolongation of registration on the following of 10 years  
(732) E.R. SQUIBB & SONS, L.L.C.  
Lawrenceville-Princeton Road, Princeton,  
New Jersey 08540, USA

---

(111) M 1996 1852 R1  
(141) 2006 09 26, Not payment for prolongation of registration on the following of 10 years  
(732) SONY MUSIC ENTERTAINMENT  
550 Madison Avenue, New York, New York,  
USA

---

(111) M 1996 1853 R1  
(141) 2006 09 26, Not payment for prolongation of registration on the following of 10 years  
(732) SONY MUSIC ENTERTAINMENT  
550 Madison Avenue, New York, New York,  
USA

---

# CLASSIFICATION INDEXES

## INVENTIONS

### CONCORDANCE TABLE OF INTERNATIONAL CLASSIFICATION INDEX AND PUBLICATION NUMBERS

INTERNATIONAL CLASSIFICATION INDEXES (51)	NUMBER OF PUBLISHED APPLICATION (10)
B 01 D 1/00; A 23 L 1/06; A 23 L 2/00	AP 2016 13943 A
C 07 D 221/00, 223/02, 223/04, 231/04	AP 2016 9736 A
C 07 D 239/26; C 07 D 231/12; C 07 D 233/64; C 07 D 401/06; C 07 D 403/04; C 07 D 403/06; C 07 D 237/08; C 07 D 405/04; C 07 D 239/26; C 07 C 233/66; C 07 C 233/73; C 07 C 233/78; C 07 D 211/26; C 07 D 213/40; C 07 D 213/61	AP 2016 13785 A
C 07 D 249/08; C 07 D 401/12; C 07 D 403/12; C 07 D 409/12; A 61 K 31/497; A 61 K 31/4439; A 61 K 31/506; A 61 K 31/498; A 61 K 31/55; A 61 K 31/5377; A 61 P 35/00; A 61 P 31/12; A 61 P 29/00; A 61 P 27/02	AP 2016 13396 A
C 07 D 413/12; A 61 K 31/422; A 61 P 33/00; A 61 P 31/00	AP 2016 13967 A
C 07 D 487/04; C 07 D 519/00	AP 2016 13675 A
C 07 D 487/04; C 07 D 519/00; A 61 K 31/4985; A 61 K 31/519; A 61 K 31/5377; A 61 K 31/501; A 61 P 35/00	AP 2016 13859 A
C 07 D 487/04; C 07 D 519/00; A 61 K 31/53; A 61 P 11/00; A 61 P 9/00; A 61 P 25/00; A 61 P 31/12	AP 2016 13828 A
C 07 D 495/04; A 61 K 31/519; A 61 P 35/00; A 61 P 37/00	AP 2016 13667 A
C 08 G 73/06; C 08 L 79/06; A 61 P 41/00; C 07 D 401/04	AP 2016 13326 A
C 11 D 1/37; C 11 D 3/50; C 11 D 17/00; E 03 D 9/02; C 11 D 3/48	AP 2016 13113 A
C 12 P 13/00, 13/02, 41/00; C 07 C 227/02, 229/28	AP 2016 13598 A
C 13 K 13/00; C 10 L 1/182; C 13 K 1/02; D 21 C 1/02	AP 2016 13363 A
C 22 B 5/04; C 22 C 33/00; B 22 F 3/23	AP 2016 13797 A

### CONCORDANCE TABLE OF PUBLICATION NUMBERS AND INTERNATIONAL CLASSIFICATION INDEX

NUMBER OF PUBLISHED APPLICATION (10)	INTERNATIONAL CLASSIFICATION INDEXES (51)
AP 2016 9736 A	C 07 D 221/00, 223/02, 223/04, 231/04
AP 2016 13113 A	C 11 D 1/37; C 11 D 3/50; C 11 D 17/00; E 03 D 9/02; C 11 D 3/48
AP 2016 13326 A	C 08 G 73/06; C 08 L 79/06; A 61 P 41/00; C 07 D 401/04
AP 2016 13363 A	C 13 K 13/00; C 10 L 1/182; C 13 K 1/02; D 21 C 1/02
AP 2016 13396 A	C 07 D 249/08; C 07 D 401/12; C 07 D 403/12; C 07 D 409/12; A 61 K 31/497; A 61 K 31/4439; A 61 K 31/506; A 61 K 31/498; A 61 K 31/55; A 61 K 31/5377; A 61 P 35/00; A 61 P 31/12; A 61 P 29/00; A 61 P 27/02
AP 2016 13598 A	C 12 P 13/00, 13/02, 41/00; C 07 C 227/02, 229/28
AP 2016 13667 A	C 07 D 495/04; A 61 K 31/519; A 61 P 35/00; A 61 P 37/00
AP 2016 13675 A	C 07 D 487/04; C 07 D 519/00
AP 2016 13785 A	C 07 D 239/26; C 07 D 231/12; C 07 D 233/64; C 07 D 401/06; C 07 D 403/04; C 07 D 403/06; C 07 D 237/08; C 07 D 405/04; C 07 D 239/26; C 07 C 233/66; C 07 C 233/73; C 07 C 233/78; C 07 D 211/26; C 07 D 213/40; C 07 D 213/61



1	2
AP 2016 13797 A	C 22 B 5/04; C 22 C 33/00; B 22 F 3/23
AP 2016 13828 A	C 07 D 487/04; C 07 D 519/00; A 61 K 31/53; A 61 P 11/00; A 61 P 9/00; A 61 P 25/00; A 61 P 31/12
AP 2016 13859 A	C 07 D 487/04; C 07 D 519/00; A 61 K 31/4985; A 61 K 31/519; A 61 K 31/5377; A 61 K 31/501; A 61 P 35/00
AP 2016 13943 A	B 01 D 1/00; A 23 L 1/06; A 23 L 2/00
AP 2016 13967 A	C 07 D 413/12; A 61 K 31/422; A 61 P 33/00; A 61 P 31/00

**CONCORDANCE TABLE OF INTERNATIONAL CLASSIFICATION INDEX,  
PATENT NUMBERS AND PUBLICATION NUMBERS**

INTERNATIONAL CLASSIFICATION INDEX (51)	NUMBER OF PATENT (11)	NUMBER OF PUBLISHED APPLICATION (10)
A 21 D 8/02; A 21 D 13/04	P 2016 6562 B	AP 2016 13719 A
A 61 B 17/32; A 61 B 17/34; A 61 F 2/10	P 2016 6564 B	AP 2016 13778 A
A 61 K 31/167; A 61 K 31/36; A 61 K 31/366; A 61 K 31/381; A 61 K 31/40; A 61 K 31/402; A 61 K 31/4035; A 61 K 31/404; A 61 K 31/4184; A 61 K 31/42; A 61 K 31/421; A 61 K 31/426; A 61 K 31/428; A 61 K 31/429; A 61 K 31/433; A 61 K 31/4406; A 61 K 31/4409; A 61 K 31/4453; A 61 K 31/4468; A 61 K 31/495; A 61 K 31/55; A 61 P 35/00; A 61 P 35/02; C 07 C 233/80; C 07 C 235/56; C 07 C 237/40; C 07 C 271/22; C 07 D 207/06; C 07 D 207/337; C 07 D 209/08; C 07 D 209/42; C 07 D 209/46; C 07 D 211/76; C 07 D 213/04; C 07 D 213/38; C 07 D 213/56; C 07 D 223/16; C 07 D 231/14; C 07 D 231/20; C 07 D 231/22; C 07 D 231/56; C 07 D 233/61; C 07 D 233/64; C 07 D 239/36; C 07 D 261/08; C 07 D 263/32; C 07 D 263/34; C 07 D 277/62; C 07 D 277/20; C 07 D 277/28; C 07 D 277/30; C 07 D 285/06; C 07 D 295/14; C 07 D 309/14; C 07 D 317/58; C 07 D 333/20; C 07 D 405/04; C 07 D 409/04; C 07 D 471/04; C 07 D 495/04; C 07 D 513/04	P 2016 6559 B	AP 2016 13405 A
A 62 C 2/06; E 21 F 43/12	P 2016 6563 B	AP 2016 13724 A
B 61 B 12/00; E 01 D 19/04	P 2016 6565 B	AP 2016 13827 A
C 07 D 491/08; C 07 D 491/18; C 07 D 498/08; C 07 D 498/18; C 07 D 498/22; C 07 D 513/18; A 61 K 31/4353; A 61 P 35/00	P 2016 6560 B	AP 2016 13564 A
H 02 P 9/00	P 2016 6561 B	AP 2016 13658 A

**CONCORDANCE TABLE OF PATENT NUMBERS,  
PUBLICATION NUMBERS AND INTERNATIONAL CLASSIFICATION INDEX**

NUMBER OF PATENT (11)	NUMBER OF PUBLISHED APPLICATION (10)	INTERNATIONAL CLASSIFICATION INDEX (51)
P 2016 6559 B	AP 2016 13405 A	A 61 K 31/167; A 61 K 31/36; A 61 K 31/366; A 61 K 31/381; A 61 K 31/40; A 61 K 31/402; A 61 K 31/4035; A 61 K 31/404; A 61 K 31/4184; A 61 K 31/42; A 61 K 31/421; A 61 K 31/426; A 61 K 31/428; A 61 K 31/429; A 61 K 31/433; A 61 K 31/4406; A 61 K 31/4409; A 61 K 31/4453; A 61 K 31/4468; A 61 K 31/495; A 61 K 31/55; A 61 P 35/00; A 61 P 35/02; C 07 C 233/80; C 07 C 235/56; C 07 C 237/40; C 07 C 271/22; C 07 D 207/06; C 07 D 207/337; C 07 D 209/08; C 07 D 209/42; C 07 D 209/46; C 07 D 211/76; C 07 D 213/04; C 07 D 213/38; C 07 D 213/56; C 07 D 223/16; C 07 D 231/14; C 07 D 231/20; C 07 D 231/22; C 07 D 231/56; C 07 D 233/61; C 07 D 233/64; C 07 D 239/36; C 07 D 261/08; C 07 D 263/32; C 07 D 263/34; C 07 D 277/62; C 07 D 277/20; C 07 D 277/28; C 07 D 277/30; C 07 D 285/06; C 07 D 295/14; C 07 D 309/14; C 07 D 317/58; C 07 D 333/20; C 07 D 405/04; C 07 D 409/04; C 07 D 471/04; C 07 D 495/04; C 07 D 513/04
P 2016 6560 B	AP 2016 13564 A	C 07 D 491/08; C 07 D 491/18; C 07 D 498/08; C 07 D 498/18; C 07 D 498/22; C 07 D 513/18; A 61 K 31/4353; A 61 P 35/00
P 2016 6561 B	AP 2016 13658 A	H 02 P 9/00
P 2016 6562 B	AP 2016 13719 A	A 21 D 8/02; A 21 D 13/04
P 2016 6563 B	AP 2016 13724 A	A 62 C 2/06; E 21 F 43/12
P 2016 6564 B	AP 2016 13778 A	A 61 B 17/32; A 61 B 17/34; A 61 F 2/10
P 2016 6565 B	AP 2016 13827 A	B 61 B 12/00; E 01 D 19/04

**CONCORDANCE TABLE OF APPLICATION NUMBERS, PUBLICATION NUMBERS AND PATENTS**

NUMBER OF APPLICATION (21)	NUMBER OF PUBLISHED APPLICATION (10)	NUMBER OF PATENT (11)
AP 2012 013405	AP 2016 13405 A	P 2016 6559 B
AP 2013 013564	AP 2016 13564 A	P 2016 6560 B
AP 2014 013658	AP 2016 13658 A	P 2016 6561 B
AP 2015 013719	AP 2016 13719 A	P 2016 6562 B
AP 2015 013724	AP 2016 13724 A	P 2016 6563 B
AP 2015 013778	AP 2016 13778 A	P 2016 6564 B
AP 2015 013827	AP 2016 13827 A	P 2016 6565 B

## UTILITY MODELS

### CONCORDANCE TABLE OF INTERNATIONAL CLASSIFICATION INDEX AND PUBLICATION NUMBERS

INTERNATIONAL CLASSIFICATION INDEXES (51)	NUMBER OF PUBLISHED APPLICATION (10)
H 02 K 17/00	AU 2016 14085 U

### CONCORDANCE TABLE OF PUBLICATION NUMBERS AND INTERNATIONAL CLASSIFICATION INDEX

NUMBER OF PUBLISHED APPLICATION (10)	INTERNATIONAL CLASSIFICATION INDEXES (51)
AU 2016 14085 U	H 02 K 17/00

## DESIGNS

### CONCORDANCE TABLE OF INTERNATIONAL CLASSIFICATION INDEX AND PUBLICATION NUMBERS

INTERNATIONAL CLASSIFICATION INDEXES (51)	NUMBER OF PUBLISHED APPLICATION (10)
09-03	AD 2016 916 S
12-99	AD 2016 915 S

### CONCORDANCE TABLE OF PUBLICATION NUMBERS AND INTERNATIONAL CLASSIFICATION INDEX

NUMBER OF PUBLISHED APPLICATION (10)	INTERNATIONAL CLASSIFICATION INDEXES (51)
AD 2016 915 S	12-99
AD 2016 916 S	09-03

## TRADEMARKS

### CONCORDANCE TABLE OF REGISTRATION NUMBERS, APPLICATION NUMBERS, PUBLICATION NUMBERS AND BULLETIN NUMBERS

NUMBER OF REGISTRATION (111)	NUMBER OF APPLICATIONS (210)	NUMBER OF PUBLISHED APPLICATIONS (260)	NUMBER OF BULLETIN
M 2016 27704 R	AM 88812	-	20(456)2016
M 2016 27705 R	AM 88605	-	20(456)2016
M 2016 27706 R	AM 88650	-	20(456)2016
M 2016 27707 R	AM 88813	-	20(456)2016
M 2016 27708 R	AM 88672	-	20(456)2016
M 2016 27709 R	AM 88648	-	20(456)2016
M 2016 27710 R	AM 75405	AM 2016 75405 A	9(445)2016
M 2016 27711 R	AM 79647	AM 2015 79647 A	22(434)2015
M 2016 27712 R	AM 80026	AM 2016 80026 A	9(445)2016
M 2016 27713 R	AM 80027	AM 2016 80027 A	9 (445)2016
M 2016 27714 R	AM 81374	AM 2016 81374 A	12(448)2016
M 2016 27715 R	AM 81902	AM 2016 81902 A	11(447)2016
M 2016 27716 R	AM 82833	AM 2016 82833 A	5(441)2016
M 2016 27717 R	AM 82834	AM 2016 82834 A	5(441)2016
M 2016 27718 R	AM 82981	AM 2016 82981 A	10(446)2016
M 2016 27719 R	AM 83049	AM 2016 83049 A	7(443)2016
M 2016 27720 R	AM 83194	AM 2016 83194 A	5(441)2016
M 2016 27721 R	AM 83197	AM 2016 83197 A	8(444)2016
M 2016 27722 R	AM 83198	AM 2016 83198 A	8(444)2016
M 2016 27723 R	AM 83199	AM 2016 83199 A	8(444)2016
M 2016 27724 R	AM 83254	AM 2016 83254 A	6(442)2016
M 2016 27725 R	AM 83425	AM 2016 83425 A	11(447)2016
M 2016 27726 R	AM 83432	AM 2016 83432 A	11(447)2016
M 2016 27727 R	AM 83544	AM 2016 83544 A	7(443)2016
M 2016 27728 R	AM 83777	AM 2016 83777 A	9(445)2016
M 2016 27729 R	AM 83900	AM 2016 83900 A	11(447)2016
M 2016 27730 R	AM 83973	AM 2016 83973 A	10(446)2016
M 2016 27731 R	AM 83974	AM 2016 83974 A	10(446)2016
M 2016 27732 R	AM 84093	AM 2016 84093 A	10(446)2016
M 2016 27733 R	AM 84137	AM 2016 84137 A	10(446)2016
M 2016 27734 R	AM 84148	AM 2016 84148 A	11(447)2016
M 2016 27735 R	AM 84198	AM 2016 84198 A	10(446)2016
M 2016 27736 R	AM 84205	AM 2016 84205 A	11(447)2016
M 2016 27737 R	AM 84209	AM 2016 84209 A	11(447)2016
M 2016 27738 R	AM 84221	AM 2016 84221 A	11(447)2016
M 2016 27739 R	AM 84222	AM 2016 84222 A	11(447)2016
M 2016 27740 R	AM 84287	AM 2016 84287 A	11(447)2016
M 2016 27741 R	AM 84315	AM 2016 84315 A	11(447)2016
M 2016 27742 R	AM 84375	AM 2016 84375 A	11(447)2016
M 2016 27743 R	AM 84378	AM 2016 84378 A	11(447)2016
M 2016 27744 R	AM 84495	AM 2016 84495 A	11(447)2016
M 2016 27745 R	AM 84502	AM 2016 84502 A	11(447)2016
M 2016 27746 R	AM 84503	AM 2016 84503 A	11(447)2016
M 2016 27747 R	AM 84505	AM 2016 84505 A	11(447)2016
M 2016 27748 R	AM 84572	AM 2016 84572 A	11(447)2016
M 2016 27749 R	AM 84629	AM 2016 84629 A	11(447)2016
M 2016 27750 R	AM 84631	AM 2016 84631 A	11(447)2016

1	2	3	4
M 2016 27751 R	AM 84632	AM 2016 84632 A	11(447)2016
M 2016 27752 R	AM 84634	AM 2016 84634 A	11(447)2016
M 2016 27753 R	AM 84804	AM 2016 84804 A	11(447)2016
M 2016 27754 R	AM 84805	AM 2016 84805 A	11(447)2016
M 2016 27755 R	AM 84935	AM 2016 84935 A	11(447)2016
M 2016 27756 R	AM 88843	-	20(456)2016
M 2016 27757 R	AM 88844	-	20(456)2016
M 2016 27758 R	AM 88845	-	20(456)2016
M 2016 27759 R	AM 88846	-	20(456)2016
M 2016 27760 R	AM 88847	-	20(456)2016
M 2016 27761 R	AM 88848	-	20(456)2016
M 2016 27762 R	AM 88849	-	20(456)2016

CONCORDANCE TABLE OF PUBLICATION NUMBERS  
AND APPLICATION NUMBERS

NUMBER OF PUBLISHED APPLICATION (260)	NUMBER OF APPLICATION (210)	1	2
1	2		
AM 2016 84259 A	AM 84259 A	AM 2016 86159 A	AM 86159 A
AM 2016 84260 A	AM 84260 A	AM 2016 86210 A	AM 86210 A
AM 2016 85065 A	AM 85065 A	AM 2016 86231 A	AM 86231 A
AM 2016 85810 A	AM 85810 A	AM 2016 86232 A	AM 86232 A
AM 2016 85834 A	AM 85834 A	AM 2016 86298 A	AM 86298 A
AM 2016 85891 A	AM 85891 A	AM 2016 86301 A	AM 86301 A
AM 2016 85902 A	AM 85902 A	AM 2016 86302 A	AM 86302 A
AM 2016 85904 A	AM 85904 A	AM 2016 86304 A	AM 86304 A
AM 2016 86006 A	AM 86006 A	AM 2016 86530 A	AM 86530 A
AM 2016 86129 A	AM 86129 A	AM 2016 86664 A	AM 86664 A
AM 2016 86134 A	AM 86134 A	AM 2016 86686 A	AM 86686 A
AM 2016 86158 A	AM 86158 A	AM 2016 86705 A	AM 86705 A
		AM 2016 86849 A	AM 86849 A
		AM 2016 86850 A	AM 86850 A
		AM 2016 86883 A	AM 86883 A
		AM 2016 86885 A	AM 86885 A

CONCORDANCE TABLE OF INDEX OF GOODS AND/OR SERVICES  
AND APPLICATION NUMBERS

INDEX OF GOODS AND/OR SERVICES (511)	NUMBER OF PUBLISHED APPLICATIONS (26)	1	2
1	2		
2	AM 2016 85065 A	6	AM 2016 85891 A
3	AM 2016 85891 A	8	AM 2016 85834 A
4	AM 2016 86006 A	8	AM 2016 85891 A
5	AM 2016 86129 A	9	AM 2016 85810 A
5	AM 2016 86231 A	9	AM 2016 86298 A
5	AM 2016 86883 A	12	AM 2016 86134 A
5	AM 2016 86885 A	12	AM 2016 86210 A
6	AM 2016 85834 A	16	AM 2016 85065 A
		16	AM 2016 85810 A
		16	AM 2016 85834 A
		16	AM 2016 85891 A
		16	AM 2016 86301 A
		16	AM 2016 86302 A

1	2	1	2
16	AM 2016 86304 A	35	AM 2016 86686 A
21	AM 2016 85834 A	36	AM 2016 85810 A
21	AM 2016 85891 A	36	AM 2016 85902 A
24	AM 2016 85834 A	36	AM 2016 85904 A
24	AM 2016 85891 A	36	AM 2016 86686 A
25	AM 2016 86158 A	36	AM 2016 86849 A
25	AM 2016 86159 A	36	AM 2016 86850 A
30	AM 2016 86232 A	37	AM 2016 85810 A
32	AM 2016 86232 A	37	AM 2016 85902 A
32	AM 2016 84259 A	37	AM 2016 85904 A
32	AM 2016 84260 A	37	AM 2016 86006 A
33	AM 2016 84259 A	38	AM 2016 85810 A
33	AM 2016 84260 A	39	AM 2016 85902 A
33	AM 2016 86232 A	39	AM 2016 85904 A
33	AM 2016 86664 A	41	AM 2016 85810 A
33	AM 2016 86705 A	42	AM 2016 85810 A
35	AM 2016 84259 A	42	AM 2016 86530 A
35	AM 2016 84260 A	42	AM 2016 86686 A
35	AM 2016 85065 A	43	AM 2016 84259 A
35	AM 2016 85810 A	43	AM 2016 84260 A
35	AM 2016 85834 A	43	AM 2016 85810 A
35	AM 2016 85891 A	43	AM 2016 86232 A
35	AM 2016 85902 A	45	AM 2016 85810 A
35	AM 2016 85904 A	45	AM 2016 86686 A
35	AM 2016 86232 A		

**CONCORDANCE TABLE OF INDEX OF GOODS AND/OR SERVICES  
AND NUMBERS OF TRADEMARKS REGISTERED ACCORDING  
TO THE ACCELERATED PROCEDURE**

INDEX OF GOODS AND/OR SERVICES (511)	NUMBERS OF REGISTERED ACCORDING TO THE ACCELERATED PROCEDURE (111)
1	M 20165 27705 R
16	M 20165 27706 R
20	M 20165 27706 R
20	M 20165 27704 R
21	M 20165 27706 R
30	M 20165 27704 R
32	M 20165 27761 R
33	M 20165 27709 R
34	M 20165 27708 R
35	M 20165 27705 R
35	M 20165 27707 R
38	M 20165 27756 R
38	M 20165 27757 R
38	M 20165 27758 R
38	M 20165 27759 R
38	M 20165 27760 R
38	M 20165 27762 R

# OFFICIAL BULLETIN OF THE INDUSTRIAL PROPERTY

## 20(456)

EDITOR-IN-CHIEF: N. Bebrishvili

EDITORS-TRANSLATORS: E. Gabunia

PROOFREADER: A. Shikhashvili

COMPUTER LAYOUT: M. Ordenidze  
K. Svanidze

[www.sakpatenti.org.ge](http://www.sakpatenti.org.ge)

E-mail: [info@sakpatenti.org.ge](mailto:info@sakpatenti.org.ge)