



**NATIONAL INTELLECTUAL PROPERTY CENTER OF GEORGIA
SAKPATENTI**

**OFFICIAL BULLETIN
OF THE INDUSTRIAL PROPERTY**

21(457)

**2016
TBILISI**

INID CODES FOR IDENTIFICATION OF BIBLIOGRAPHIC DATA

INVENTIONS, UTILITY MODELS

- (10) Number of publication for application, which has been examined
- (11) Number of patent and kind of document
- (21) Serial number of application
- (22) Date of filing of the application
- (23) Date of exhibition or the date of the earlier filing and the number of application, if any
- (24) Date from which patent may have effect
- (31) Number of priority application
- (32) Date of filing of priority application
- (33) Code of the country or regional organization allotting priority application number
- (44) Date of publication of application not granted, but examined and number of bulletin
- (45) Date of publication of registered document
- (51) International Patent Classification Index
- (54) Title of the invention
- (57) Abstract
- (60) Number of examined patent document granted by foreign patent office, date from which patent has effect and country code
- (62) Number of the earlier application and in case of divided application, date of filing an application
- (71) Name, surname and address of applicant (country code)
- (72) Name, surname of inventor (country code)
- (73) Name, surname and address of patent owner (country code)
- (74) Name, surname of representative or patent attorney
- (85) Date of commencement of the national phase of International Application
- (86) Number and date of filing of international application
- (87) Number and date of publication of international application

DESIGNS

- (10) Number of publication for application
- (11) Number of patent and kind of document or number of registration
- (15) Date of registration/Date of patent renewal
- (18) Expected expiration date of patent or registration
- (21) Serial number of application
- (22) Date of filing of the application
- (23) Date of exhibition or the date of the earlier filing and the number of application, if any
- (24) Date from which patent may have effect
- (28) Number of designs included in the application
- (30) Data relating to priority (number of application, date of filing of application, two-letter code identifying the authority with whom the priority application was made)
- (31) Number of priority application
- (32) Date of filing of priority application
- (33) Code of the country or regional organization allotting priority application number
- (34) Two-letter code according to WIPO St.3 identifying the authority with which the priority application was made
- (44) Date of publication of design and number of bulletin (the first publication)
- (45) Date of publication of design registered by WIPO and number of bulletin
- (51) International Classification for designs (class and subclass of the Locarno Classification)
- (54) Title of the invention
- (55) Reproduction of the design
- (57) Description of characteristic features of the design including indication of colors
- (58) Date of recording of any kind of amendment in the Register
- (62) Number of the earlier application, registration and document number and if available the date of filing an application in case of divided application
- (71) Name, surname and address of applicant (country code)
- (72) Name, surname of creator (country code)
- (73) Name, surname and address of patent owner (country code)
- (74) Name, surname of representative or patent attorney
- (81) Contracting states concerned
 - II designated contracting states according to the 1960 Act
 - III designated contracting states according to the 1999 Act
- (85) Owner's permanent address
- (86) Owner's nationality
- (87) Owner's residence
- (88) State in which the owner has a real and effective industrial or commercial establishment

TRADEMARKS

- (111) – Number of registration
- (151) – Date of registration
- (156) – Date of the renewal
- (181) – Expected expiration date of registration
- (186) – Renewal expiration date of registration
- (141) – Date of cancel of duration of the mark
- (210) – Serial number of application
- (220) – Date of filing of the application
- (230) – Date concerning exhibition
- (260) – Number of application, for which favorable decision of examination about registration has been taken (publication number)
- (310) – Number of the first application
- (320) – Date of filing of the first application
- (330) – Code, identifying national or regional Office where the first application was made
- (511) – International Classification of Goods and Services for the purposes of registration of trade marks and/or list of goods and/or services classified according thereto
- (531) – Description of figurative elements of Trade Marks according to the International Classification of the Figurative Elements of Marks
- (540) – Reproduction of Trade Mark
- (550) – Nature and kind of Trade Mark
- (580) – Date of recording of any kind changes in respect of applications or registrations
- (591) – Information concerning colors claimed
- (731) – Name and address of the applicant
- (732) – Name and address of the holder of the registration
- (740) – Name and address of the representative
- (750) – Address for correspondence
- (770) – Name and address of the previous applicant or holder in case of change in ownership
- (771) – Previous name and address of the applicant or holder in case of change in ownership
- (791) – Name and address of the licensee
- (793) – Indication of conditions and/or restrictions under the license (Type of license, number of license agreement, data of license, data of validity of license)
- (800) – Certain data relating to the international registration of Trade Marks under the Protocol Relating to Madrid Agreement (International registration number)

CODES FOR PUBLICATION IN BULLETIN

- (21) AP 0000 000000 – serial number of application for invention
- (10) AP 0000 0000 A – number of published application for invention (first publication)
- (11) P 0000 0000 B – number of patent for invention (second publication)
- (21) API 0000 000000 – number of application for imported patent
- (11) PI 0000 0000 A – number of imported patent (first publication)
- (21) AU 0000 000000 – serial number of application for utility model
- (10) AU 0000 000 U – number of published application for utility model (first publication)
- (11) U 0000 000 Y – number of patent for utility model (second publication)
- (21) AD 0000 000000 – serial number of application for design
- (10) AD 0000 000 S – number of published application for design (first publication)
- (11) D 0000 000 S – number of patent for design (second publication)

INTERNATIONAL PATENT CLASSIFICATION FOR INVENTIONS AND UTILITY MODELS

- SECTION A – HUMAN NECESSITIES
- SECTION B – PERFORMING OPERATIONS; TRANSPORTING
- SECTION C – CHEMISTRY; METALLURGY
- SECTION D – TEXTILES; PAPER
- SECTION E – FIXED CONSTRUCTIONS
- SECTION F – MECHANICAL ENGINEERING; LIGHTING; HEATING; WEAPONS; BLASTING
- SECTION G – PHYSICS
- SECTION H – ELECTRICITY

-
- M – Trade Mark
 - (210) AM 0000 000000 – Serial number of application;
 - (260) AAM 0000 00000 A – Publication number of application;
 - (111) M 0000 00000 R – Number of registration;
 - (111) MMM0000 00000 Rn – Number of renewals, in which n=1,2,3;
 - (111) M 0000 00000 R(P) – Number of registration under partial assignment of rights
-

LIST OF CODES, IN ALPHABETIC SEQUENCE, AND THE CORRESPONDING (SHORT) NAMES OF STATES, OTHER ENTITIES AND INTERGOVERNMENTAL ORGANIZATIONS
(WIPO STANDARD ST.3)

AD	Andorra				
AE	United Arab Emirates				
AF	Afghanistan				
AG	Antigua and Barbuda				
AI	Anguilla				
AL	Albania				
AM	Armenia				
AN	Netherlands Antilles				
AO	Angola				
AP	African Regional Intellectual Property Organization (ARIPO)				
AR	Argentina				
AT	Austria				
AU	Australia				
AW	Aruba				
AZ	Azerbaijan				
BA	Bosnia and Herzegovina				
BB	Barbados				
BD	Bangladesh				
BE	Belgium				
BF	Burkina Faso				
BG	Bulgaria				
BH	Bahrain				
BI	Burundi				
BJ	Benin				
BM	Bermuda				
BN	Brunei Darussalam				
BO	Bolivia				
BR	Brazil				
BS	Bahamas				
BT	Bhutan				
BV	Bouvet Island				
BW	Botswana				
BX	Benelux Office for Intellectual Property (BOIP)				
BY	Belarus				
BZ	Belize				
CA	Canada				
CD	Democratic Republic of the Congo				
CF	Central African Republic				
CG	Congo				
CH	Switzerland				
CI	Cote d'Ivoire				
CK	Cook Islands				
CL	Chile				
CM	Cameroon				
CN	China				
CO	Colombia				
CR	Costa Rica				
CU	Cuba				
CV	Cape Verde				
CY	Cyprus				
CZ	Czech Republic				
DE	Germany				
DJ	Djibouti				
DM	Dominica				
DO	Dominican Republic				
DZ	Algeria				
EA	Eurasian Patent Organization (EAPO)				
EC	Ecuador				
EE	Estonia				
EG	Egypt				
EH	Western Sahara				
EM	Office for Harmonization in the Internal Market (Trademarks and Designs)(OHIM)				
EP	European Patent Office (EPO)				
ER	Eritrea				
ES	Spain				
ET	Ethiopia				
FI	Finland				
FJ	Fiji				
FK	Falkland Islands (Malvinas)				
FO	Faroe Islands				
FR	France				
GA	Gabon				
GB	United Kingdom				
GC	Patent Office of the Cooperation Council for the Arab States of the Gulf (GCC)				
GD	Grenada				
GG	Guernsey				
GH	Ghana				
GI	Gibraltar				
GT	Guatemala				
GW	Guinea- Bissau				
GY	Guyana				
HK	The Hong Kong Special Administrative Region of the People's Republic of China				
HN	Honduras				
HR	Croatia				
HT	Haiti				
HU	Hungary				
IB	International Bureau of the World Intellectual Property Organization (WIPO)				
ID	Indonesia				
IE	Ireland				
IL	Israel				
IM	Isle of Man				
IN	India				
IQ	Iraq				
ID	Indonesia				
IE	Ireland				
IL	Israel				
IM	Isle of Man				
IN	India				
IQ	Iraq				
IR	Iran (Islamic Republic of)				
IS	Iceland				
IT	Italy				
JE	Jersey				
JM	Jamaica				
JO	Jordan				
JP	Japan				
KE	Kenya				
KG	Kyrgyzstan				
KH	Cambodia				
KI	Kiribati				
KM	Saint Kitts and Nevis				
KP	Democratic People's Republic of Korea				
KR	Republic of Korea				
KW	Kuwait				
KY	Cayman Islands				
KZ	Kazakhstan				
LA	Lao People's Democratic Republic				
LB	Lebanon				
LC	Saint Lucia				
LI	Liechtenstein				
LK	Sri Lanka				
LR	Liberia				
LS	Lesotho				
LT	Lithuania				
LU	Luxembourg				
LV	Latvia				
LY	Libyan Arab Jamahiriya				
MA	Morocco				
MC	Monaco				
MD	Republic of Moldova				
ME	Montenegro				
MG	Madagascar				
MK	The former Yugoslav Republic of Macedonia				
ML	Mali				
MM	Myanmar				
MN	Mongolia				
MO	Macao				
MP	Northern Mariana Islands				
MR	Mauritania				
MS	Montserrat				
MT	Malta				
MU	Mauritius				
MV	Maldives				
MW	Malawi				
MX	Mexico				
MY	Malaysia				
MZ	Mozambique				
NA	Namibia				
NE	Niger				
NG	Nigeria				
NI	Nicaragua				
NL	Netherlands				
NO	Norway				
NP	Nepal				
NR	Nauru				
NZ	New Zealand				
OA	African Intellectual Property Organization (OAPI)				
OM	Oman				
PA	Panama				
PE	Peru				
PG	Papua New Guinea				
PH	Philippines				
PK	Pakistan				
PL	Poland				
PT	Portugal				
PW	Palau				
PY	Paraguay				
QA	Qatar				
QZ	Community Plant Variety Office (European Community) (CPVO)				
RO	Romania				
RS	Serbia				
RU	Russian Federation				
RW	Rwanda				
SA	Saudi Arabia				
SB	Solomon Islands				
SC	Seychelles				
SD	Sudan				
SG	Singapore				
SH	Saint Helena				
SI	Slovenia				
SK	Slovakia				
SL	Sierra Leone				
SM	San Marino				
SN	Senegal				
SO	Somalia				
SR	Suriname				
ST	Sao Tome and Principe				
SV	El Salvador				
SY	Syrian Arab Republic				
SZ	Swaziland				
TC	Turks and Caicos Islands				
TD	Chad				
TG	Togo				
TH	Thailand				
TJ	Tajikistan				
TL	Timor-Leste				
TM	Turkmenistan				
TN	Tunisia				
TO	Tonga				
TR	Turkey				
SE	Sweden				
TT	Trinidad and Tobago				
TV	Tuvalu				
TW	Taiwan, Province of China				
TZ	United Republic of Tanzania				
UA	Ukraine				
UG	Uganda				
US	United States of America				
UY	Uruguay				
UZ	Uzbekistan				
VA	Holy See				
VC	Saint Vincent and the Grenadines				
VE	Venezuela				
VG	Virgin Islands (British)				
VN	Viet Nam				
VU	Vanuatu				
WO	World Intellectual Property Organization (WIPO)				
WS	Samoa				
XN	Nordic Patent Institute (NPI)				
YE	Yemen				
ZA	South Africa				
ZM	Zambia				
ZW	Zimbabwe				

**NATIONAL INTELLECTUAL PROPERTY CENTER OF GEORGIA
SAKPATENTI**

**OFFICIAL BULLETIN
OF THE INDUSTRIAL PROPERTY**

21(457)

**INVENTIONS
UTILITY MODELS
DESIGNS
TRADEMARKS**

DATE OF PUBLICATION
2016 11 10

CONTENTS

PUBLISHED TITLES OF PROTECTION	3
INVENTIONS	
▪ APPLICATIONS APPROVED FOR GRANTING PATENTS	4
▪ PATENTED INVENTIONS	7
UTILITY MODELS	
▪ APPLICATIONS APPROVED FOR GRANTING PATENTS	10
▪ PATENTED UTILITY MODELS	11
DESIGNS	
▪ APPLICATION APPROVED FOR REGISTRATION	12
▪ DESIGNS REGISTERED WITH THE INTERNATIONAL BUREAU CLAIMING PRIORITY ON THE TERRITORY OF GEORGIA	13
TRADEMARKS	
▪ APPLICATIONS FILED UNDER THE NATIONAL PROCEDURE APPROVED FOR REGISTRATION	65
▪ TRADEMARKS REGISTERED ACCORDING TO THE ACCELERATED PROCEDURE	69
▪ INTERNATIONAL TRADEMARKS FOR WHICH A DECISION ON GRANTING PROTECTION IS TAKEN	72
▪ INTERNATIONAL TRADEMARKS PROTECTED IN GEORGIA	108
OFFICIAL NOTIFICATIONS	
INVENTIONS	
▪ RENEWAL OF A PATENTS	120
UTILITY MODELS	
▪ RENEWAL OF A PATENTS	121
TRADEMARKS	
▪ RENEWAL OF REGISTRATIONS	122
▪ COMPLETE TRANSFER OF RIGHTS	130
▪ CHANGES IN NAMES AND/OR ADDRESSES OF OWNERS	131
▪ CANCELLING OF TRADEMARK REGISTRATION	133
CLASSIFICATION INDEXES	
INVENTIONS	134
UTILITY MODELS	136
DESIGNS	137
TRADEMARKS	138

PUBLISHED TITLES OF PROTECTION

INVENTIONS

- **APPLICATIONS APPROVED FOR GRANTING PATENTS:**
13747; 13889; 13355; 12547; 13783; 12838; 13809
- **PATENTED INVENTIONS:**
6566-6574

UTILITY MODELS

- **APPLICATIONS APPROVED FOR GRANTING PATENTS:**
13910; 14069
- **PATENTED UTILITY MODELS:**
1910-1911

DESIGNS

- **APPLICATION APPROVED FOR REGISTRATION:**
913
- **DESIGNS REGISTERED WITH THE INTERNATIONAL BUREAU CLAIMING PRIORITY ON THE TERRITORY OF GEORGIA:**
89515; 89795; 87393; 89576; 89630-89634; 89748; 92167; 89695, 89696; 89704; 89749; 89796; 89847; 89992; 90746; 92345-92347; 89951; 90170; 92419

TRADEMARKS

- **APPLICATIONS FILED UNDER THE NATIONAL PROCEDURE APPROVED FOR REGISTRATION:**
84226, 84227; 85421; 85879; 85913; 86005; 86333; 86367; 86439; 86504; 86506; 86509; 86558; 86561; 86626; 86673; 86679; 86696; 86699; 86832; 86834; 86884; 86887, 86888; 86905
- **TRADEMARKS REGISTERED ACCORDING TO THE ACCELERATED PROCEDURE:**
27763-27777
- **INTERNATIONAL TRADEMARKS FOR WHICH A DECISION ON GRANTING PROTECTIONS IS TAKEN:**
85656; 85664; 85684-85688; 85690, 85691; 85714-85716; 85733; 85735; 85747; 85760; 85762; 85767; 85778; 85784; 85789-85791; 85793, 85794; 85866; 85869; 85871; 85910; 85914, 85915; 85917, 85918; 85921-85924; 85926; 85939, 85940; 85948, 85949; 85951-85955; 85957-85959; 86093
- **INTERNATIONAL TRADEMARKS PROTECTED IN GEORGIA:**
74427; 83032; 83160; 83483; 83500; 83655; 83683; 83689; 83691; 83698; 83754; 83756-83767; 83769; 83784; 83786; 83788; 83795; 83797; 83802; 83804, 83805; 83810, 83811; 83813-83815; 83820-83824; 83827; 83829; 83831; 83834-83836; 83840; 83843; 83846; 83849, 83850; 83862-83864; 83869, 83870; 83873, 83874; 83876; 83879; 83886, 83887; 83896-83898; 83902-83904; 83908-83910; 83914-83918; 83921, 83922; 83924-83933; 83936; 83938-83944; 83946-83953; 83962, 83963; 83989-83991; 84003-84012; 84014; 84016-84018; 84020-84024; 84103; 84136; 84140; 84143; 84145; 84147; 84170-84173; 84175; 84190-84192; 84194, 84195; 84214; 84293; 84319; 84362-84364; 84366; 84370, 84371; 84379; 84381; 84388; 84580; 84920, 84921; 84926, 84927; 84929; 85131; 85135, 85136; 85139

INVENTIONS

APPLICATIONS APPROVED FOR GRANTING PATENTS

The decision can be appealed at the Chamber of Appeal of Sakpatenti within 3 months from the publication or at the Mtskheta District Court Administrative Cases Board (Address: №17, Samkhedro str., Mtskheta), within 1 month following the publication.

PART A

A 61

(10) AP 2016 13747 A (51) Int. Cl. (2006)
A 61 K 9/00
A 61 K 47/32
A 61 K 31/415

(21) AP 2013 013747 (22) 2013 07 31
(31) 13/562,686
(32) 2012 07 31
(33) US
(71) EGIS GYÓGYSZERGYÁR ZRT. (HU)
Keresztúri út 30-38. H-1106 Budapest (HU)
(72) MIKULÁSIK, Endre (HU);
SPAITS, Tamás (HU);
SZAKÁLYNÉ SINKA, Ágota (HU)
(74) Liliana Darakhvelidze
(85) 2015 02 27
(86) PCT/HU2013/000080, 2013 07 31
(54) **TRANSDERMAL FORMULATION
CONTAINING COX INHIBITORS**
(57) Compositions as a gel contain COX-2 inhibitor, solubilizer, polyethylene glycol, gel-forming agent, precipitating agent, volatile siloxane agent, menthol and solvent.
Claims: 3 independent
36 dependent

(10) AP 2016 13889 A (51) Int. Cl. (2006)
A 61 K 31/427
A 61 K 38/05
A 61 P 17/06

(21) AP 2012 013889 (22) 2012 12 19
(71) POLICHEM S.A. (LU)
50, Val Fleuri L-1526 Luxembourg (LU)
(72) CASERINI, Maurizio (IT);
MAILLAND, Federico (CH)
(74) Aleksandre Gegechkori
(85) 2015 07 17
(86) PCT/EP2012/076088, 2012 12 19
(54) **USE OF PIDOTIMOD TO TREAT
PSORIASIS**
(57) Pidotimod is applied at psoriasis treatment.
Claims: 1 independent
15 dependent

(10) AP 2016 13355 A (51) Int. Cl. (2006)
A 61 K 38/26
A 61 K 38/17
A 61 K 38/16
A 61 P 3/10
A 61 P 3/04
A 61 P 3/00

(21) AP 2012 013355 (22) 2012 06 12
(31) 61/500,027; 61/547,360
(32) 2011 06 22; 2011 10 14
(33) US; US
(71) INDIANA UNIVERSITY RESEARCH
AND TECHNOLOGY CORPORATION (US)
351 West 10th Street Indianapolis,
IN 46202 (US)
(72) DIMARCHI, Richard, D. (US);
SMILEY, David, L. (US)
(74) Tamaz Shilakadze
(85) 2014 01 21
(86) PCT/US2012/042084, 2012 06 12
(54) **GLUCAGON/GLP-1 RECEPTOR
CO-AGONISTS**
(57) An invention relates to natural glucagon variant peptide with aminoacid sequence SEQ ID NO:17, conjugate thereof characterized with human receptor GLP-1 binding extreme increased activity, and medical usage thereas pharmaceutical composition.
Claims: 5 independent
3 dependent
Fig.: 4

PART B

B 01

(10) AP 2016 12547 A (51) Int. Cl. (2006)
B 01 D 53/14
B 01 D 47/02
B 01 D 47/06
B 01 D 53/18
B 01 D 53/48
B 01 D 53/54
B 01 D 53/62

(21) AP 2010 012547 (22) 2010 06 25

- (31) 61/220,352
- (32) 2010 06 25
- (33) US
- (71) ENVIRORESOLUTIONS INC. (CA)
101-4338 Main Street Vancouver,
BC V5V 3P9 (CA)
- (72) McCLELLAND, Kenneth, James (CA)
- (74) Pavle Meipariani
- (85) 2012 01 25
- (86) PCT/CA2010/000988, 2010 06 25
- (54) **IMPROVED GAS SCRUBBER
APPARATUS AND METHOD**

(57) Gas-cleaning system (scrubber) and method for removing contaminant from gas stream comprises a tank, a submerged head extending horizontally, wherein the submerged head comprises a plate having slots extending throughout, four solid joined vertical walls inset from the walls of the tank below the plate to form an open ended box under the plate, and openings along each edge of the plate between the walls of the tank and the vertical walls of the submerged head; a first baffle above the submerged head and means for spraying scrubbing fluid. The scrubber may comprise a flooded head extending horizontally above the first baffle and head having narrow slots extending throughout; and a second baffle extending horizontally between the four walls of the tank.

Claims: 2 independent
13 dependent

Fig.: 10

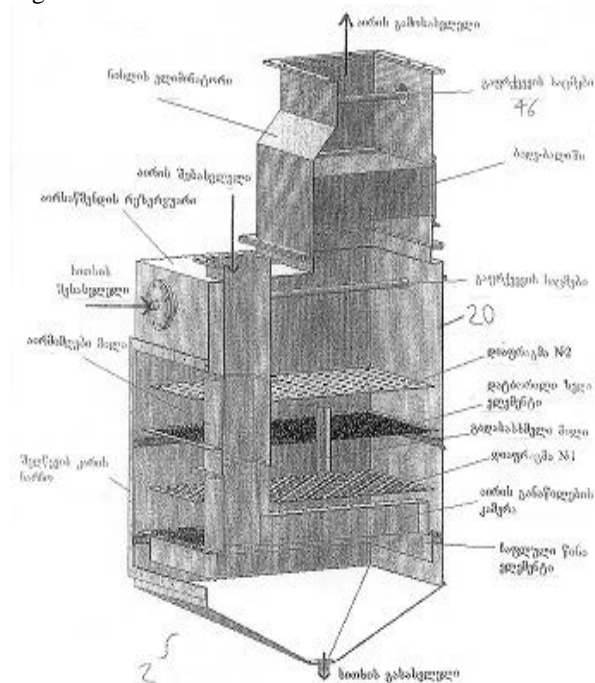

Fig. 8

PART C

C 07

- (10) AP 2016 13783 A (51) Int. Cl. (2006)
C 07 D 401/14
A 61 K 31/4439
A 61 P 9/00
A 61 P 13/00
A 61 P 25/00
A 61 P 3/00

- (21) AP 2013 013783 (22) 2013 09 03
- (31) 61/697,899
- (32) 2012 09 07
- (33) US

- (71) BOEHRINGER INGELHEIM
INTERNATIONAL GMBH (DE)
Binger Str. 173, 55216 Ingelheim
Am Rhein (DE)
- (72) BRENNEMAN, Jehrod Burnett (US);
GINN, John David (US);
LOWE, Michael D. (US);
SARKO Christopher Ronald (US);
TASBER Edward S. (US);
ZHANG, Zhonghua (CN)

- (74) Tamar Kochlamazashvili
- (85) 2015 04 06
- (86) PCT/US2013/057826, 2013 09 03
- (54) **ALKOXY PYRAZOLES AS SOLUBLE
GUANYLATE CYCLASE ACTIVATORS**
- (57) Present invention relates to alkoxy pyrazoles derivatives of formula (I)

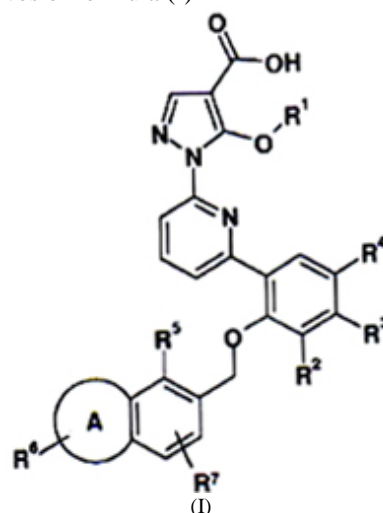

and pharmaceutical acceptable salts thereof; pharmaceutical compositions containing them applicable at the diseases and disorders caused with guanylate cyclase activation and potentiation.

Claims: 3 independent
24 dependent

(10) AP 2016 12838 A (51) Int. Cl. (2006)**C 07 H 21/02****C 12 P 21/06**

(21) AP 2011 012838 (22) 2011 01 24

(31) 61/336,457

(32) 2010 01 22

(33) US

(71) DOW AGROSCIENCES LLC (US)

9330 Zionsville Road Indianapolis, Indiana

46268-1054 (US);

SANGAMO BIOSCIENCES, INC. (US)

Point Richmond Tech Center 501 Canal Blvd.,

Suite A100 Richmond, California 94804 (US)

(72) AINLEY, William M. (US);

MURRAY, Michael G. (US);

URNOV, Fyodor (US);

ZEITLER, Bryan (US)

(74) Tamaz Shilakadze

(85) 2012 08 20

(86) PCT/US2011/000125, 2011 01 24

(54) TARGETED GENOMIC ALTERATION

(57) An invention relates to exogenic nucleic acid integration process in eukaryotic cell isolated genome by usage of zinc finger-like nuclease ZFN for polypeptide one or more expression.

Claims: 3 independent

7 dependent

Fig.: 15

filled with shock wave suppression agent, wherein switched to an inducer by means of wire the electromagnetic signals wireless receiver and pyrotechnical chemical substance are installed. The detectors are allocated on saving building walls or ceiling, and the atomizer is disposed on building floor, wall or ceiling, on certain distance from the detector, the initiator and pyrotechnical chemical substance are placed in waterproof, elastic casing disposed on tank lid inner surface.

Claims: 1 independent

3 dependent

Fig.: 6

PART E**E 21****(10) AP 2016 13809 A (51) Int. Cl. (2006)****E 21 F 5/14**

(21) AP 2015 013809 (22) 2015 04 24

(71) LEPL Grigol Tsulukidze Minining

Institute (GE)

Mindelis q. 7, 0186, Tbilisi (GE);

Edgar Mataradze (GE)

Dgesbuadzis q. 1, b. 102, 0186, Tbilisi (GE);

Nikoloz Chikhradze (GE)

I. Petritsis gamz. 9a, b. 9, 0131, Tbilisi (GE);

Theodor Krauthammer (US)

365 Vail Holl; Box 116580, Gainesville,

FL 32611-6580, USA (US)

(72) Edgar Mataradze (GE);

Nikoloz Chikhradze (GE);

Theodor Krauthammer (US)

(54) SYSTEM SAFING FROM EXPLOSION

(57) A system includes explosion detector and shock wave suppression agent atomizer. The detector consists of extra pressure and memory sensors, identification module and electromagnetic signals wireless transmitter. The atomizer includes a tank

PATENTED INVENTIONS

PART A

A 61

(11) P 2016 6568 B **(51) Int. Cl. (2006)**
A 61 K 31/015
A 61 K 31/201
A 61 K 31/202
A 61 K 31/203
A 61 K 31/355
A 61 K 9/08
A 61 P 25/16
A 61 P 25/28
A 61 P 43/00

(10) AP 2016 13272 A (44) 14(450)/2016
 (21) AP 2012 013272
 (22) 2012 03 28
 (24) 2012 03 28
 (31) 61/469,081
 (32) 2011 03 29
 (33) US

(86) PCT/IB2012/000824, 2012 03 28

(73) PALUPA MEDICAL LTD. (CY)
 66 Metochiou Avenue 2407 Engomi
 Nicosia (CY)

(72) MARIOS, Pantzaris (CY);
 IOANNIS, Patrikios (CY);
 GEORGIOS, Loukaidis (CY)

(74) Tamaz Shilakadze

**(54) COMPOSITIONS FOR THE
 TREATMENT OF NEUROLOGIC
 DISORDERS**

(11) P 2016 6571 B **(51) Int. Cl. (2006)**
A 61 K 31/137
A 61 K 47/32
A 61 K 47/34
A 61 K 47/26
A 61 K 9/20
A 61 K 9/48
A 61 J 3/07
A 61 J 3/10
A 61 P 37/06
A 61 P 31/18
A 61 P 25/28

(10) AP 2016 13729 A (44) 14(450)/2016
 (21) AP 2013 013729
 (22) 2013 07 05
 (24) 2013 07 05
 (31) 2012129101
 (32) 2012 07 11
 (33) RU
 (86) PCT/RU2013/000572, 2013 07 05

(73) IVACHTCHENKO, Alexandre
 Vasilievich (RU)
 Moscow Rd. 3, Dolgoprudny, Moscow
 Region 141700 (RU);
 ALLA CHEM, LLC (US)
 318 N. Carson Street, Suite 208 NV, Carson
 City, 89701 (US)

(72) IVACHTCHENKO, Alexandre
 Vasilievich (RU);
 DEMIN, Alexandre Viktorovich (RU)

(74) Shalva Gvaramadze

**(54) PHARMACEUTICAL COMPO-
 SITION HAVING IMPROVED
 FLOWABILITY, MEDICINAL AGENT,
 AND METHOD FOR PRODUCING AND
 USING SAME**

PART B

B 01

(11) P 2016 6574 B **(51) Int. Cl. (2006)**
B 01 D 39/06
B 01 D 39/18
B 01 D 39/20

(10) AP 2016 13862 A (44) 14(450)/2016

(21) AP 2015 013862

(22) 2015 06 17

(24) 2015 06 17

(73) Jemal Shengelia (GE)
 Nutsubidzis q. 2, b. 9, 0177, Tbilisi (GE);
 Irakli Suladze (GE)

Al. Kazbegis gamz. 49a, b. 15, 0177,
 Tbilisi (GE);

Gigla Tsurtsumia (GE)

Didi Dighomi, Ioane Petritsis q. 8a, b. 2,
 0131, Tbilisi (GE);

Tamar Tkeshelashvili (GE)

Baghdati, sop. Persati, XV k. II chikhi 4 (GE);

Vakhtang Tediashvili (GE)

Vazha-Pshavelas III kv., 24 korp., b. 1,
 Tbilisi (GE)

(72) Jemal Shengelia (GE);

Irakli Suladze (GE);

Gigla Tsurtsumia (GE);

Tamar Tkeshelashvili (GE);

Vakhtang Tediashvili (GE)

**(54) METHOD FOR ANTIBACTERIAL
 FILTER MATERIAL PREPARATION**

B 65

- (11) P 2016 6573 B** (51) **Int. Cl. (2006)**
B 65 D 43/08
B 65 D 53/02
- (10) AP 2016 13815 A (44) 14(450)/2016
(21) AP 2015 013815
(22) 2015 04 30
(24) 2015 04 30
(73) Zhora Gabrichidze (GE)
Gldanis mas., I mkr., korp. 4, b. 44, 0167,
Tbilisi (GE)
(72) Zhora Gabrichidze (GE)
(54) **SET FOR COVERING "QVEVRI"**
(WINE JAR)

B 66

- (11) P 2016 6572 B** (51) **Int. Cl. (2006)**
B 66 D 5/26
- (10) AP 2016 13775 A (44) 14(450)/2016
(21) AP 2015 013775
(22) 2015 03 30
(24) 2015 03 30
(73) Simon Bitsadze (GE)
Pekinis q. 31g, b. 29, 0160, Tbilisi (GE)
(72) Simon Bitsadze (GE)
(54) **MAGNETIC HYDRAULIC PUSHER**

PART C**C 07**

- (11) P 2016 6567 B** (51) **Int. Cl. (2006)**
C 07 C 233/18
C 07 C 231/24
A 61 K 31/165
A 61 P 25/20
A 61 P 25/22
A 61 P 25/00
A 61 P 9/00
A 61 P 1/00
A 61 P 25/24
- (10) AP 2016 13264 A (44) 14(450)/2016
(21) AP 2012 013264
(22) 2012 03 22
(24) 2012 03 22
(31) 201110070634.0
(32) 2011 03 23
(33) CN
(86) PCT/CN2012/072818, 2012 03 22
(73) LES LABORATOIRES SERVIER (FR)
35, Rue de Verdun F-92884 Suresnes
Cédex (FR);

SHANGHAI INSTITUTE OF
PHARMACEUTICAL INDUSTRY (CN)
No.1320 West Beijing Road Jing'an District,
Shanghai 200040 (CN)

- (72) HUANG, Yu (CN);
LONG, Qing (CN);
ZHU, Xueyan (CN);
SHAN, Hanbin (CN);
YUAN, Zhedong (CN);
YU, Xiong (CN)
(74) Tamaz Shilakadze
(54) **MIXED CRYSTAL AGOMELATINE**
(FORM-VIII), PREPARATION METHOD
AND USE THEREOF AND PHARMA-
CEUTICAL COMPOSITION
CONTAINING SAME

- (11) P 2016 6569 B** (51) **Int. Cl. (2006)**
C 07 C 273/16
C 07 C 273/02
B 01 J 2/22
- (10) AP 2016 13361 A (44) 14(450)/2016
(21) AP 2012 013361
(22) 2012 10 12
(24) 2012 10 12
(31) 11185307.3
(32) 2011 10 14
(33) EP
(86) PCT/NL2012/050715, 2012 10 12
(73) STAMICARBON B.V. (NL)
Mercator 3 NL-6135 KW Sittard (NL)
(72) MENNEN, Johannes Henricus (NL)
(74) Tamar Kochlamazashvili
(54) **UREA FINISHING METHOD**

- (11) P 2016 6566 B** (51) **Int. Cl. (2006)**
C 07 J 71/00
A 61 K 31/58
A 61 P 5/44
A 61 P 11/06
A 61 P 37/08
- (10) AP 2016 13223 A (44) 14(450)/2016
(21) AP 2012 013223
(22) 2012 03 14
(24) 2012 03 14
(31) 11158230.0
(32) 2011 03 15
(33) EP
(86) PCT/EP2012/054439, 2012 03 14
(73) CHIESI FARMACEUTICI S.p.A. (IT)
Via Palermo, 26/A I-43100 Parma (IT)
(72) GHIDINI, Eleonora (IT);
RIZZI, Andrea (IT)
(74) Tamaz Shilakadze
(54) **ISOXAZOLIDINE DERIVATIVES**

PART H

H 04

- (11) P 2016 6570 B (51) Int. Cl. (2006)
H 04 B 11/00
- (10) AP 2016 13610 A (44) 14(450)/2016
- (21) AP 2013 013610
- (22) 2013 03 21
- (24) 2013 03 21
- (31) 61/686,023
- (32) 2012 03 29
- (33) US
- (86) PCT/US2013/033317, 2013 03 21
- (73) RENSSELAER POLYTECHNICAL
INSTITUTE (US)
110 8th St., The J-Bldg., Troy,
NY 12180-3590 (US)
- (72) LORY, Trystan J. (US);
SAULNIER, Harry J. (US);
WILT, Kail R. (US);
ASHDOWN, Jonathan D. (US);
SCARTON, Henry A. (US);
HAVENS, Andrew (US)
- (74) Giorgi Meipariani
- (54) **DUPLEX ULTRASOUND SYSTEM
FOR COMMUNICATION AND ENERGY
TRANSMISSION THROUGH WALL
WITH FREQUENCY TRACKING**
-

UTILITY MODELS

APPLICATIONS APPROVED FOR GRANTING PATENTS

The decision can be appealed at the Chamber of Appeal of Sakpatenti within 3 months from the publication or at the Mtskheta District Court Administrative Cases Board (Address: №17, Samkhedro str., Mtskheta), within 1 month following the publication.

PART B

B 65

(10) AU 2016 13910 U (51) Int. Cl. (2006)
B 65 D 5/40

(21) AU 2015 013910 (22) 2015 08 12

(71) Nugzar Robitashvili (GE)

Panaskertelis q. 20a, b. 26, 0194, Tbilisi (GE)

(72) Nugzar Robitashvili (GE)

(54) **CARDBOARD FAT-AND WATERPROOF
CONTAINER FOR FOODSTUFF**

(57) A container is executed with sheet procurement having longitudinal 1, transversal 2 and diagonal 3 fold lines, which in its nest folding creates a bottom 4, side walls 5 and a lid 6. At that, fold diagonal lines are disposed in procurement corners and are connecting longitudinal and transversal lines crosspoints to procurement corners tops. A barrier insuperable for liquid is created in container corners on its whole length at its forming.

Claims: 1 independent

Fig.: 4

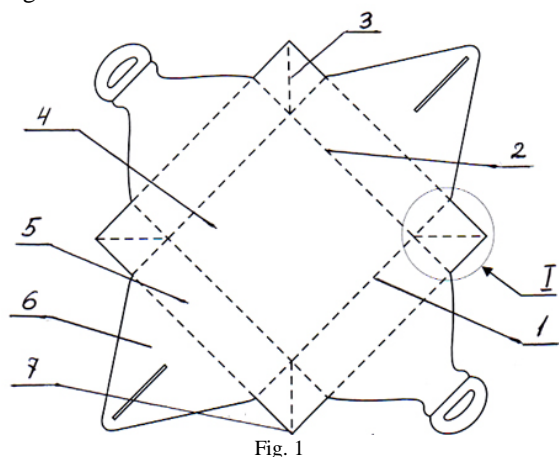

PART F

F 41

(10) AU 2016 14069 U (51) Int. Cl. (2006)
F 41 G 1/00

G 02 B 5/32

(21) AU 2016 014069 (22) 2016 02 25

(71) LEPL INSTITUTE "OPTIC" (GE)

M. Aleksidzis q. 1, 0160, Tbilisi (GE)

(72) Nikoloz Keratishvili (GE);

Gocha Abramishvili (GE);

Irakli Avaliani (GE);

Davit Zardiashvili (GE);

Davit Shalamberidze (GE);

Irakli Kordzakhia (GE)

(54) **HOLOGRAPHIC COLLIMATOR
TARGET**

(57) There is represented compact holographic target comprising target mark image hologram and light source – laser diode for lightening hologram. Target mark structure is configured capable to form collimator beams with falling down light.

Claims: 1 independent

2 dependent

Fig.: 4

PATENTED UTILITY MODELS
PART C**C 22**

- (11) U 2016 1910 Y (51) Int. Cl. (2006)
C 22 C 29/00
C 22 C 29/10
C 22 C 1/05
- (10) AU 2016 13726 U (44) 14(450)/2016
(21) AU 2015 013726
(22) 2015 02 06
(24) 2015 02 06
(73) Nikoloz Jalabadze (GE)
Nutsubidzis perd., V mkr., korp. 1, b. 68,
0183, Tbilisi (GE);
Givi Sharashenidze (GE)
Didi Dighomi, I. Petrits'is q. 6, b. 155,
0131, Tbilisi (GE);
Otar Tserodze (GE)
I. Abashidzis q. 24a, b. 11, 0162, Tbilisi (GE);
Levan Lortkipanidze (GE)
Tashkentis shes. 9, b. 9, 0160, Tbilisi (GE)
- (72) Nikoloz Jalabadze (GE);
Givi Sharashenidze (GE);
Otar Tserodze (GE);
Levan Lortkipanidze (GE)
- (54) **STEEP ALLOY RECEIVED BY
SINTERING ON TITANIUM DIBORIDE
AND TITANIUM CARBIDE BASE**
-

PART E**E 02**

- (11) U 2016 1911 Y (51) Int. Cl. (2006)
E 02 D 17/20
- (10) AU 2016 13961 U (44) 14(450)/2016
(21) AU 2015 013961
(22) 2015 10 13
(24) 2015 10 13
(31) 13896/01; 13921/02
(32) 2015 07 27; 2015 08 25
(33) GE; GE
(73) Vladimer Loladze (GE)
Bakhtrionis q. korp. I, b. 13, 0194,
Tbilisi (GE);
Merab Lortkipanidze (GE)
Ir. Abashidzis q. 40, b. 33, 0179, Tbilisi (GE);
Shakhi Bakanidze (GE)
D. Zhordanias q. 12, 0108, Tbilisi (GE);
Irakli Zubitashvili (GE)
Nino Ramishvilis q. 35b, b. 50, 0179,
Tbilisi (GE);
Vakhtang Loladze (GE)
Bakhtrionis q. korp. I, b. 13, 0194,
Tbilisi (GE);
Giorgi Loladze (GE)
Paliashvilis q. 37/2, 0179, Tbilisi (GE)
- (72) Vladimer Loladze (GE);
Merab Lortkipanidze (GE);
Shakhi Bakanidze (GE);
Irakli Zubitashvili (GE);
Vakhtang Loladze (GE);
Giorgi Loladze (GE)
- (54) **METHOD FOR STRENGTHENING
LANDSLIDE SLOPES**
-

DESIGNS

APPLICATIONS APPROVED FOR REGISTRATIONS

The decision can be appealed at the Chamber of Appeal of Sakpatenti within 3 months from the publication or at the Mtskheta District Court Administrative Cases Board (Address: №17, Samkhedro str., Mtskheta), within 1 month following the publication.

- (10) **AD 2016 913 S** (51) **32-00**
- (21) AD 2016 000913
- (22) 2016 06 08
- (28) 2
- (71) LTD "IDEA DESIGN GROUP" (GE)
Shindisis q. 4/2, 0105, Tbilisi (GE)
- (72) Aleksii Kavtaradze (GE)
- (54) **GRAPHICAL IMAGE**
- (55)

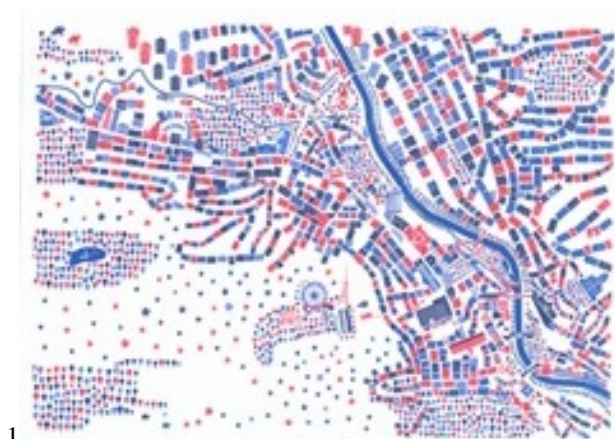

**DESIGNS, WHICH HAVE BEEN REGISTERED WITH THE INTERNATIONAL
BUREAU CLAIMING PRIORITY ON THE TERRITORY OF GEORGIA**

The decision can be appealed at the Chamber of Appeal of Sakpatenti within 3 months from the publication or at the Mtskheta District Court Administrative Cases Board (Address: №17, Samkhedro Str., Mtskheta), within 1 month following the publication.

(11) DM/089515

(15) 2016 02 23

(22) 2016 02 23

(28) 1

(73) HARRY WINSTON SA

Chemin du Tourbillon 8, CH-1228 Plan-les-Ouates (CH)

(85) CH

(86) CH

(87) CH

(88) CH

(89) CH

(81) II. BZ, MA III. AL, AM, AZ, BA, CH, EM, GE, KG, KR, LI, MC, MD, ME, MK, MN, NO, OM, SG, TN, TR, UA

(72) Rie YATSUGI-KANG

272 Highland St., NJ 07626 Cresskill, États-Unis d'Amérique

(54) Finger ring

(55)

(51) 11-01

(45) 2016/34 (2016 08 26)

1.1**1.2****1.3****1.4**

1.5



1.6



1.7



1.8



(11) DM/089795

(51) 10-07

(15) 2016 02 24

(45) 2016/34 (2016 08 26)

(22) 2016 02 24

(28) 1

(73) RADO UHREN AG (RADO WATCH CO. LTD) (MONTRES RADO SA)

45, Bielstrasse, CH-2543 Lengnau (CH)

(85) CH

(86) CH

(87) CH

(88) CH

(89) CH

(81) II. BZ, MA III. AL, AM, AZ, BA, CH, EM, GE, KG, KR, LI, MC, MD, ME, MK, MN, NO, OM, SG, TN, TR, UA

(72) Fabrice DUPORT

Avenue de la Gare 4, 2000 Neuchâtel, Suisse

(54) 1. Watch dial with related hands

(55)

1.1

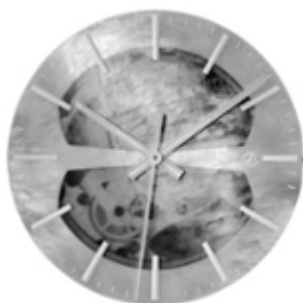

1.2



1.3



1.4



1.5



1.6



1.7



(11) DM/087393

(51) 10-02

(15) 2015 08 26

(45) 2016/35 (2016 09 02)

(22) 2015 08 26

(28) 3

(73) SWATCH AG (SWATCH SA) (SWATCH LTD.)

Jakob-Stämpfli-Strasse 94, CH-2502 Biel/Bienne (CH)

(85) CH

(86) CH

(87) CH

(88) CH

(89) CH

(81) II. BZ, MA III. AL, AM, AZ, BA, CH, EM, GE, KG, KR, LI, MD, ME, MK, MN, OM, TN, TR

(72) 1: Pedro RAMOS BRINCA

Rue Edmond-de-Reynier 2, 2000 Neuchâtel, Suisse;

2: Martin NORRLIND

Ackersteinstrasse 167, 8049 Zürich, Suisse;

1: Patrizio VITA

Via Congiunte Dx 30, 04010 Latina (LT), Italie;

2: Sivert BAKKENG

C/O THANK YOU

Enghavevej 40, 1674 Copenhagen, Danemark;

3: Sigrid CALON

Ringbaan Oost 196, 5018 Ha Tilburg, Pays-Bas

(54) 1.-3. Wristwatches

(55)

1.1

1.2



2



1.3



3.1



3.2



(11) DM/089576

(51) 11-01

(15) 2016 02 29

(45) 2016/35 (2016 09 02)

(22) 2016 02 29

(28) 2

(73) MONTRES BREGUET S.A.

Place de la Tour 23, CH-1344 L'ABBAYE (CH)

(85) CH

(86) CH

(87) CH

(88) CH

(89) CH

(81) II. BZ, MA III. AL, AM, AZ, BA, CH, EM, GE, KG, KR, LI, MC, MD, ME, MK, MN, NO, OM, SG, TN, TR, UA

(72) Christelle IFF

Route de Saint-Aubin 31, 1565 Missy, Suisse

(54) 1. Finger ring; 2. Earrings

(55)



2.1



2.2



2.3



2.4



2.5



2.6



2.7



(11) DM/089630

(51) 10-07

(15) 2016 03 02

(45) 2016/35 (2016 09 02)

(22) 2016 03 02

(28) 1

(73) SWATCH AG (SWATCH SA) (SWATCH LTD.)

Jakob-Stämpfli-Strasse 94, CH-2502 Biel/Bienne (CH)

(85) CH

(86) CH

(87) CH

(88) CH

(89) CH

(81) II. BZ, MA III. AL, AM, AZ, BA, CH, EM, GE, KG, KR, LI, MC, MD, ME, MK, MN, NO, OM, SG, TN, TR, UA

(72) Raphaël WAECKER

Rue des Brues 9, 2615 Sonvilier, Suisse;

Damien GOYET

Rue Principale 45, 68480 Winkel, France;

Vincent MEYER

Rue des Cygnes 25, 2503 Bienne, Suisse;

Martin JUFER, Blenggen, 4917 Melchnau, Suisse

(54) 1. Watch case

(55)

1.1

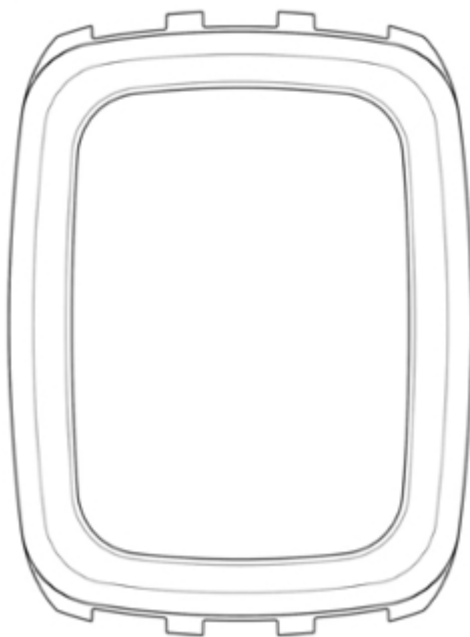

1.2

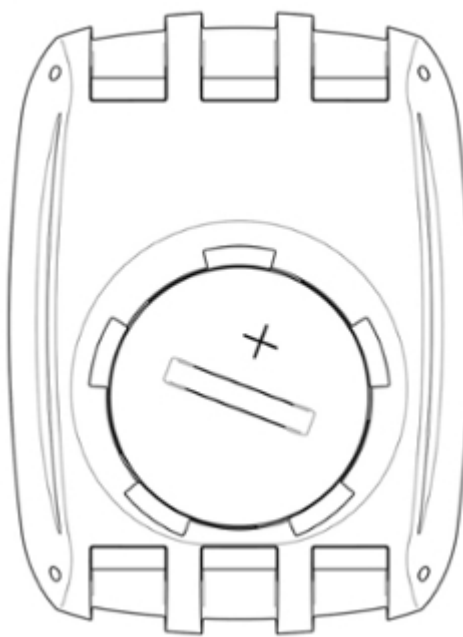

1.3



1.4



1.5



1.7

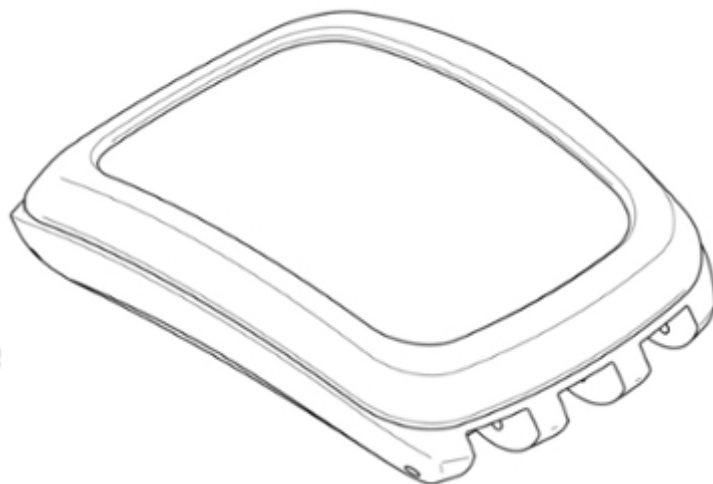

1.6



1.8

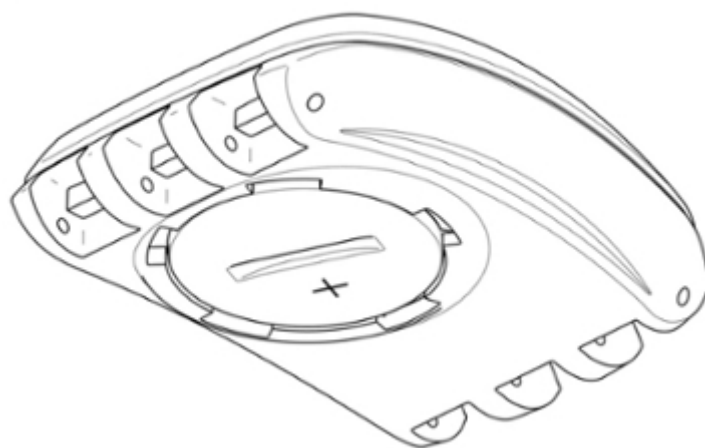

(11) DM/089631

(51) 02-07

(15) 2016 03 02

(45) 2016/35 (2016 09 02)

(22) 2016 03 02

(28) 1

(73) OMEGA SA (OMEGA AG) (OMEGA LTD.)

Jakob-Stämpfli-Strasse 96, CH-2502 Biel/Bienne (CH)

(85) CH

(86) CH

(87) CH

(88) CH

(89) CH

(81) II. BZ, MA III. AL, AM, AZ, BA, CH, EM, GE, KG, LI, MC, MD, ME, MK, MN, NO, OM, SG, TN, TR, UA

(72) Jean-Claude Monachon

Rue Alice-de-Chambrier 1, 2022 Bevaix, Suisse

(54) 1. Cuff links

(55)

1.1



1.2



(11) DM/089632

(15) 2016 03 02

(22) 2016 03 02

(28) 4

(73) SWATCH AG (SWATCH SA) (SWATCH LTD.)

Jakob-Stämpfli-Strasse 94, CH-2502 Biel/Bienne (CH)

(85) CH

(86) CH

(87) CH

(88) CH

(89) CH

(81) II. BZ, MA III. AL, AM, AZ, BA, CH, EM, GE, KG, KR, LI, MC, MD, ME, MK, MN, NO, OM, SG, TN, TR, UA

(72) Severin ZAUGG

Ernastrasse 20, 8004 Zurich, Suisse

(54) 1.-4. Icons

(55)



(11) DM/089633

(15) 2016 03 02

(22) 2016 03 02

(28) 6

(73) OMEGA SA (OMEGA AG) (OMEGA LTD.)

Jakob-Stämpfli-Strasse 96, CH-2502 Biel/Bienne (CH)

(85) CH

(86) CH

(87) CH

(88) CH

(89) CH

(81) II. BZ, MA III. AL, AM, AZ, BA, CH, EM, GE, KG, LI, MC, MD, ME, MK, MN, NO, OM, SG, TN, TR, UA

(72) Jean-Claude Monachon

Rue Alice-de-Chambrier 1, 2022 Bevaix, Suisse

(54) 1. Bracelet; 2.-3. Jewelry parts; 4. Bracelet; 5. Finger ring; 6. Earrings

(55)

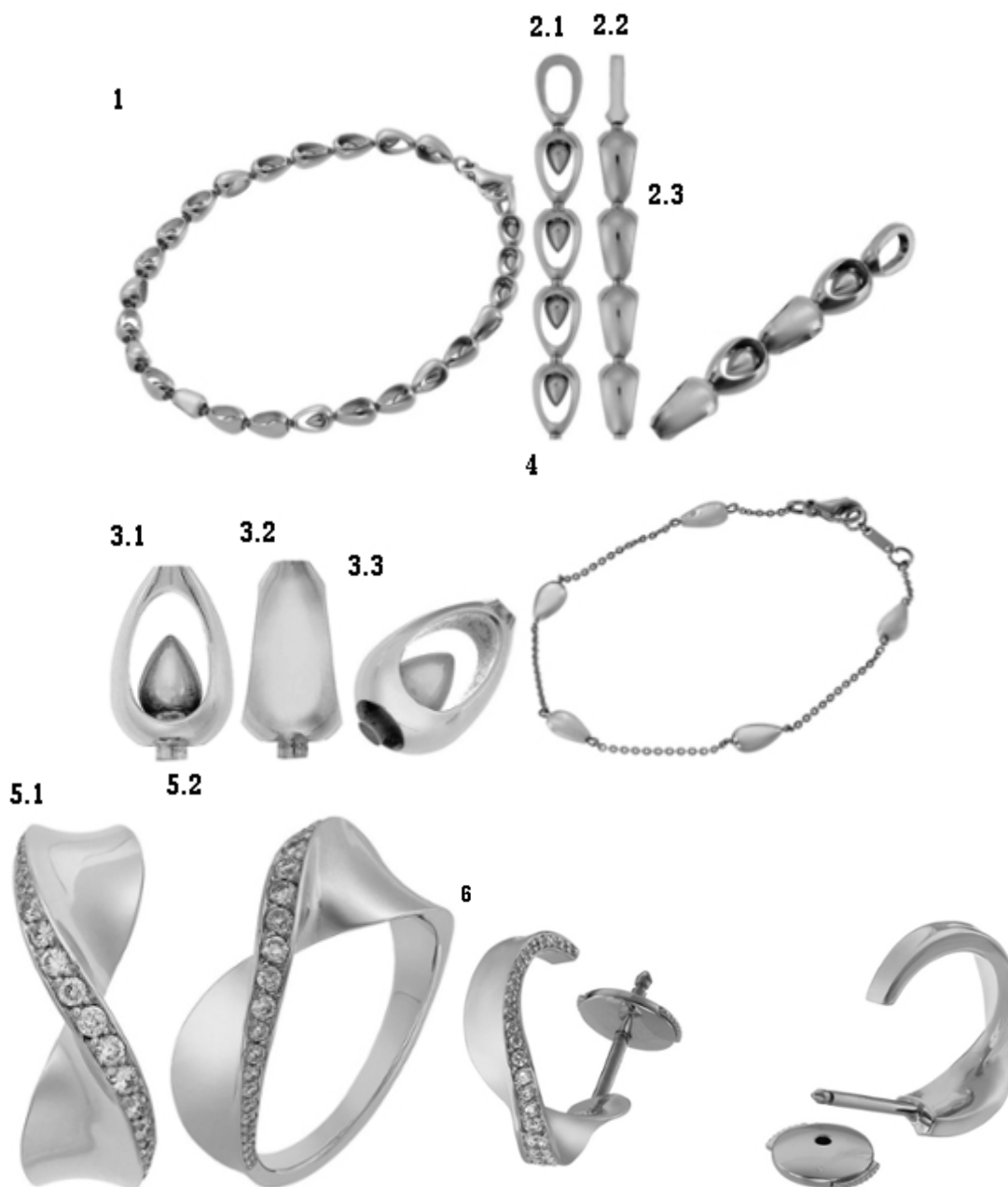

(11) DM/089634

(51) 10-07

(15) 2016 03 01

(45) 2016/35 (2016 09 02)

(22) 2016 03 01

(28) 4

(73) OMEGA SA (OMEGA AG) (OMEGA LTD.)

Jakob-Stämpfli-Strasse 96, CH-2502 Biel/Bienne (CH)

(85) CH

(86) CH

(87) CH

(88) CH

(89) CH

(81) II. BZ, MA III. AL, AM, AZ, BA, CH, EM, GE, KG, KR, LI, MC, MD, ME, MK, MN, NO, OM, SG, TN, TR, UA

(72) Jean-Claude Monachon

Rue Alice-de-Chambrier 1, 2022 Bevaix, Suisse

(54) 1.-2. Watch rims; 3. Watch case; 4. Dial with hands

(55)

1.1

1.2

1.3

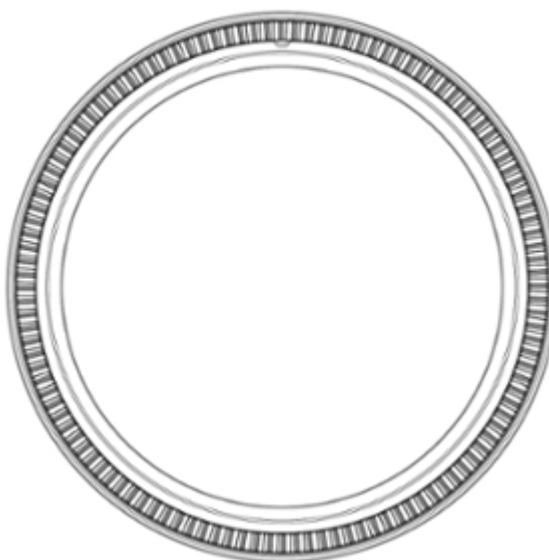
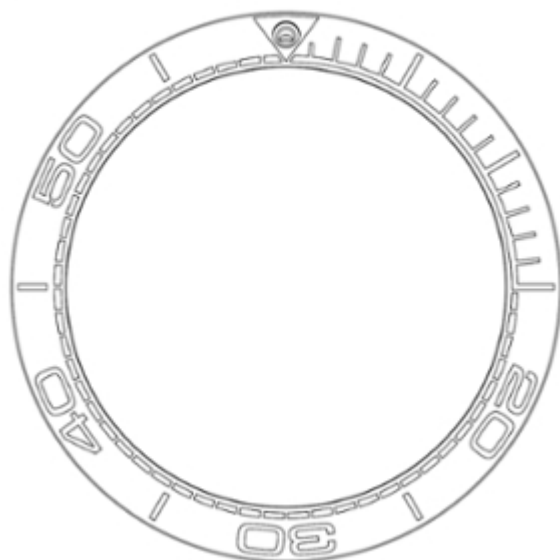

1.4



1.5



1.6



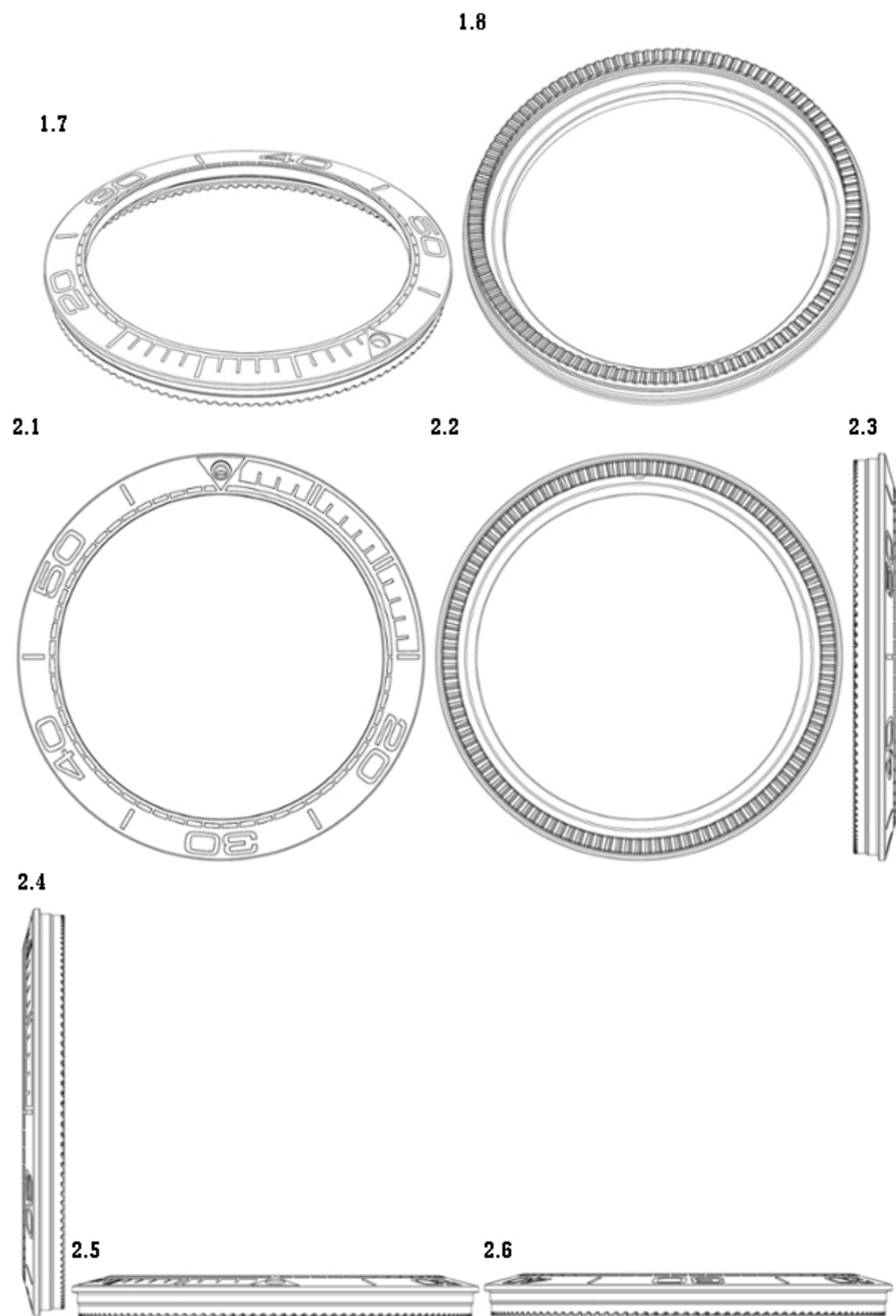

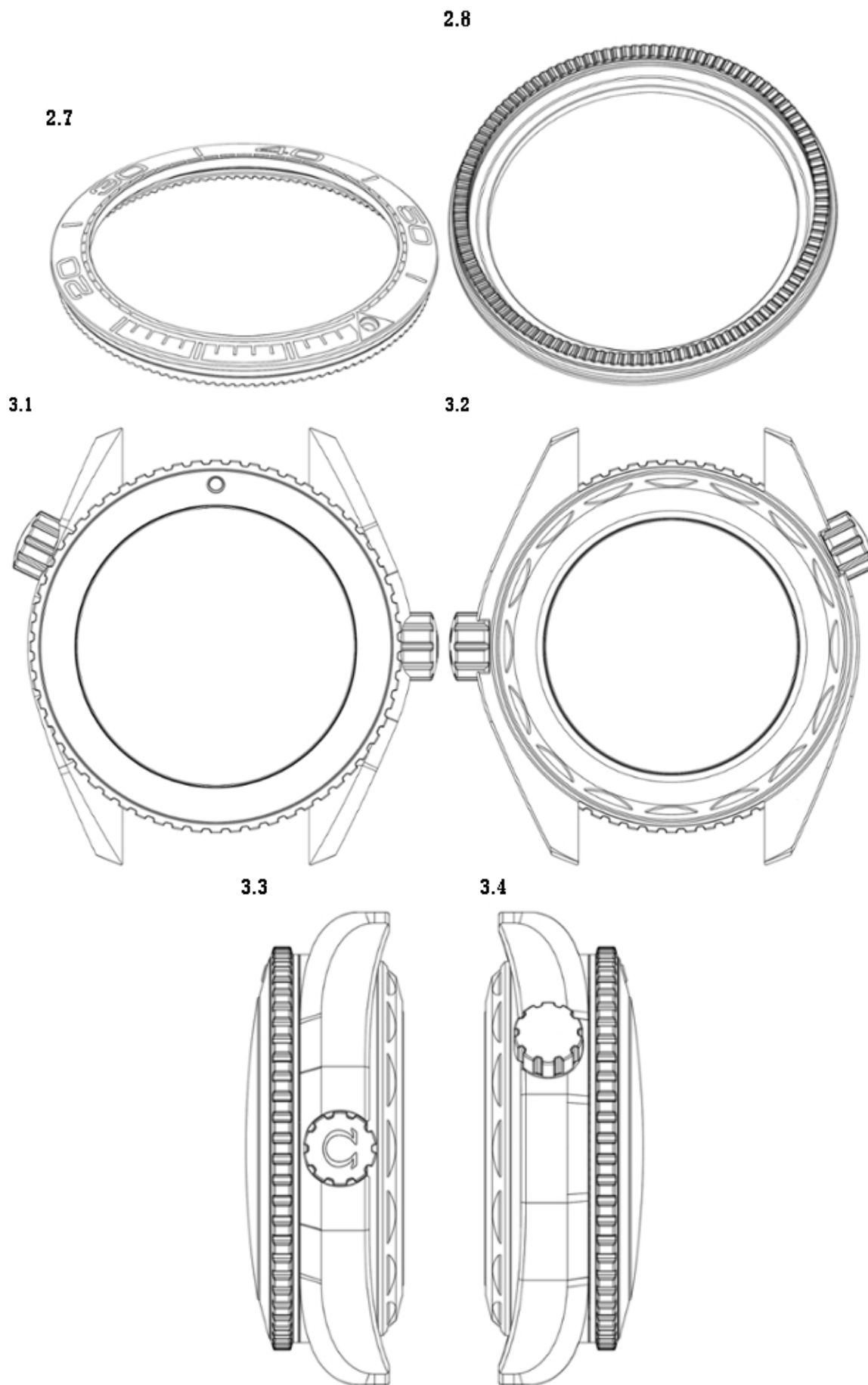

3.5

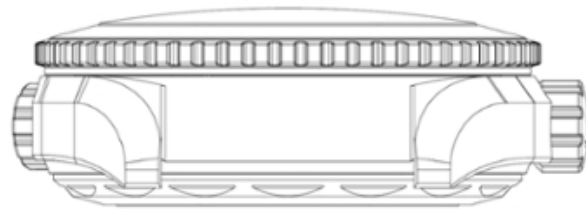

3.6

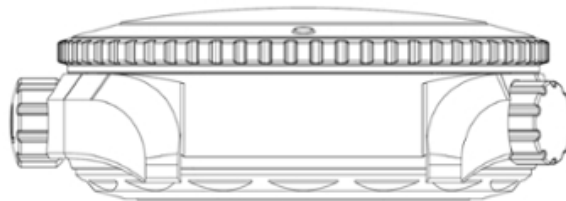

3.7

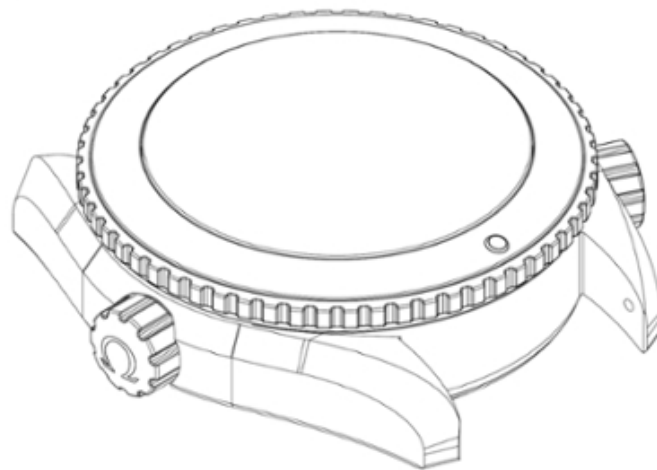

3.8

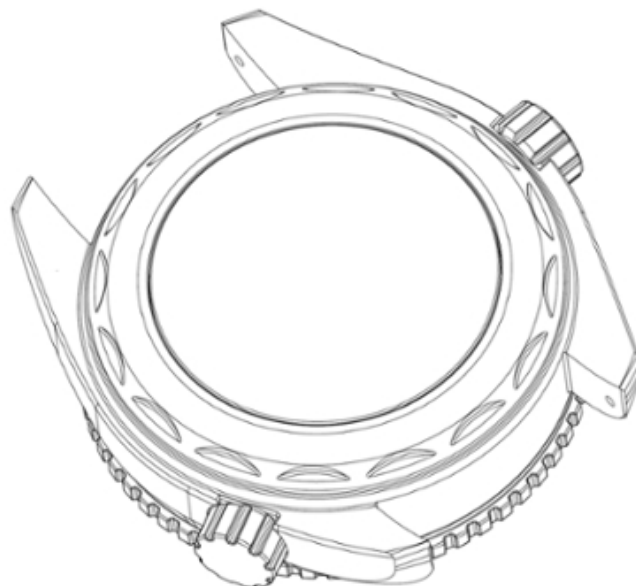

4.1



4.2

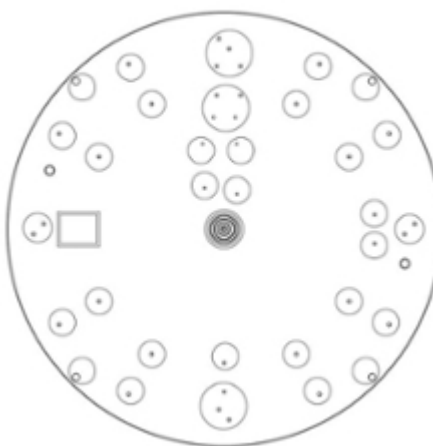

4.3



4.4



4.5



4.6



4.7



4.8

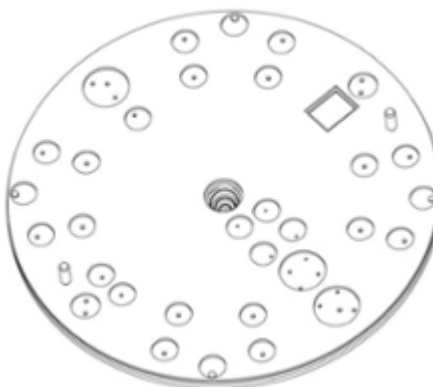

(11) DM/089748

(51) 10-02

(15) 2016 02 29

(45) 2016/35 (2016 09 02)

(22) 2016 02 29

(28) 1

(73) MONTRES BREGUET S.A

Place de la Tour 23, CH-1344 L'ABBAYE (CH)

(85) CH

(86) CH

(87) CH

(88) CH

(89) CH

(81) II. BZ, MA III. AL, AM, AZ, BA, CH, EM, GE, KG, KR, LI, MC, MD, ME, MK, MN, NO, OM, SG, TN, TR, UA

(72) Christelle IFF

Route de Saint-Aubin 31, 1565 Missy, Suisse;

Vincent LAUCELLA

Route de France 38, 1348 Le Brassus, Suisse

(54) 1. Wristwatch

(55)



(11) DM/092167**(51) 24-01**

(15) 2016 08 05

(45) 2016/35 (2016 09 02)

(22) 2016 08 05

(28) 2

(73) CHEN NACHUM

101 Weissman st, 4342135 Raanana (IL)

(85) --

(86) FR, EM

(87) --

(88) --

(89) FR

(81) II. MA, SR III. AL, AM, AZ, BA, CH, EG, EM, GE, IS, JP, KG, KR, MD, NA, NO, OA, RS, SG, ST, TJ, TM,

TN, TR, UA, US

(72) Chen Nachum

101 Weissman st, 4342135 Raanana, Israel

(54) 1. Appliance for electrical nerve stimulation; 2. Medical electrodes

(55)

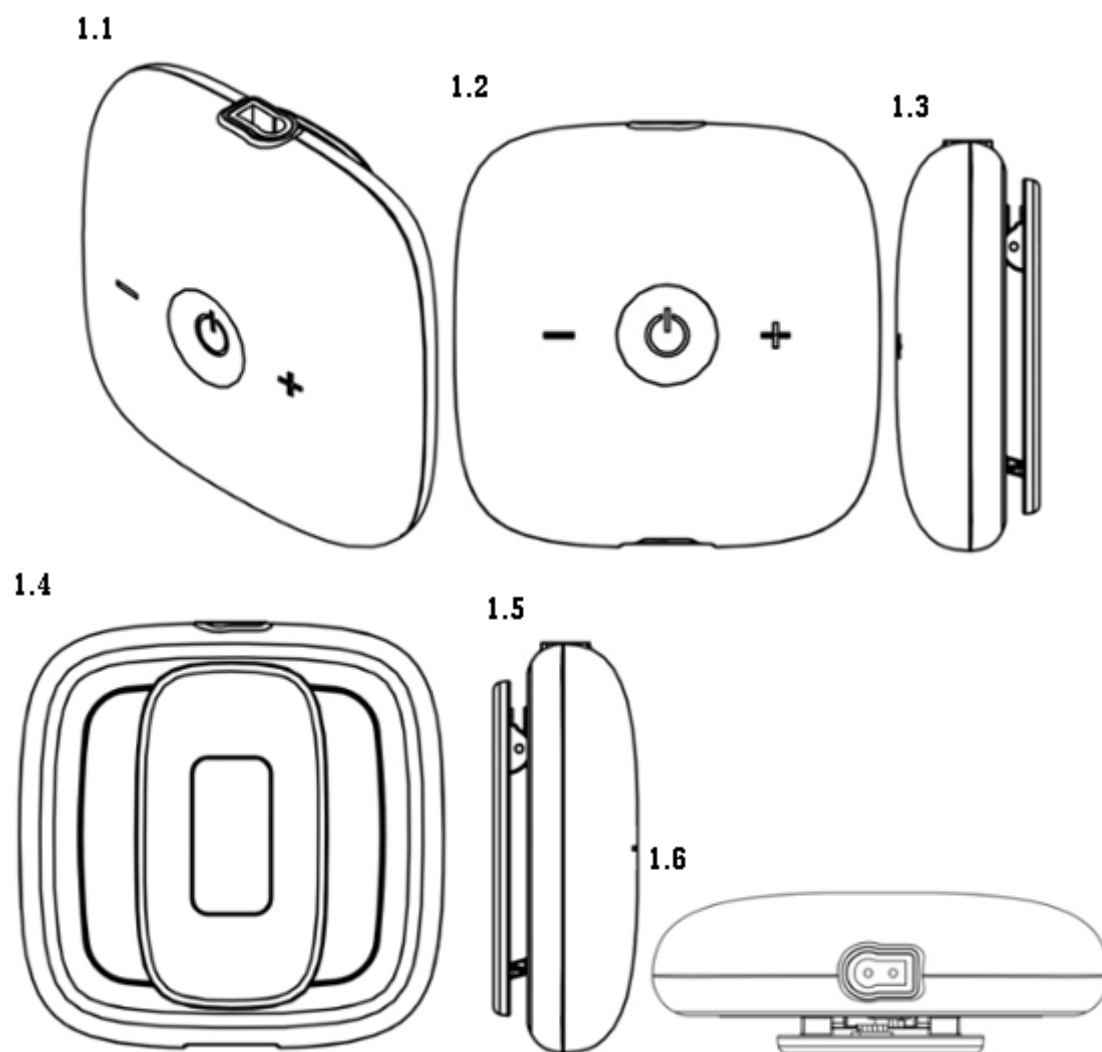

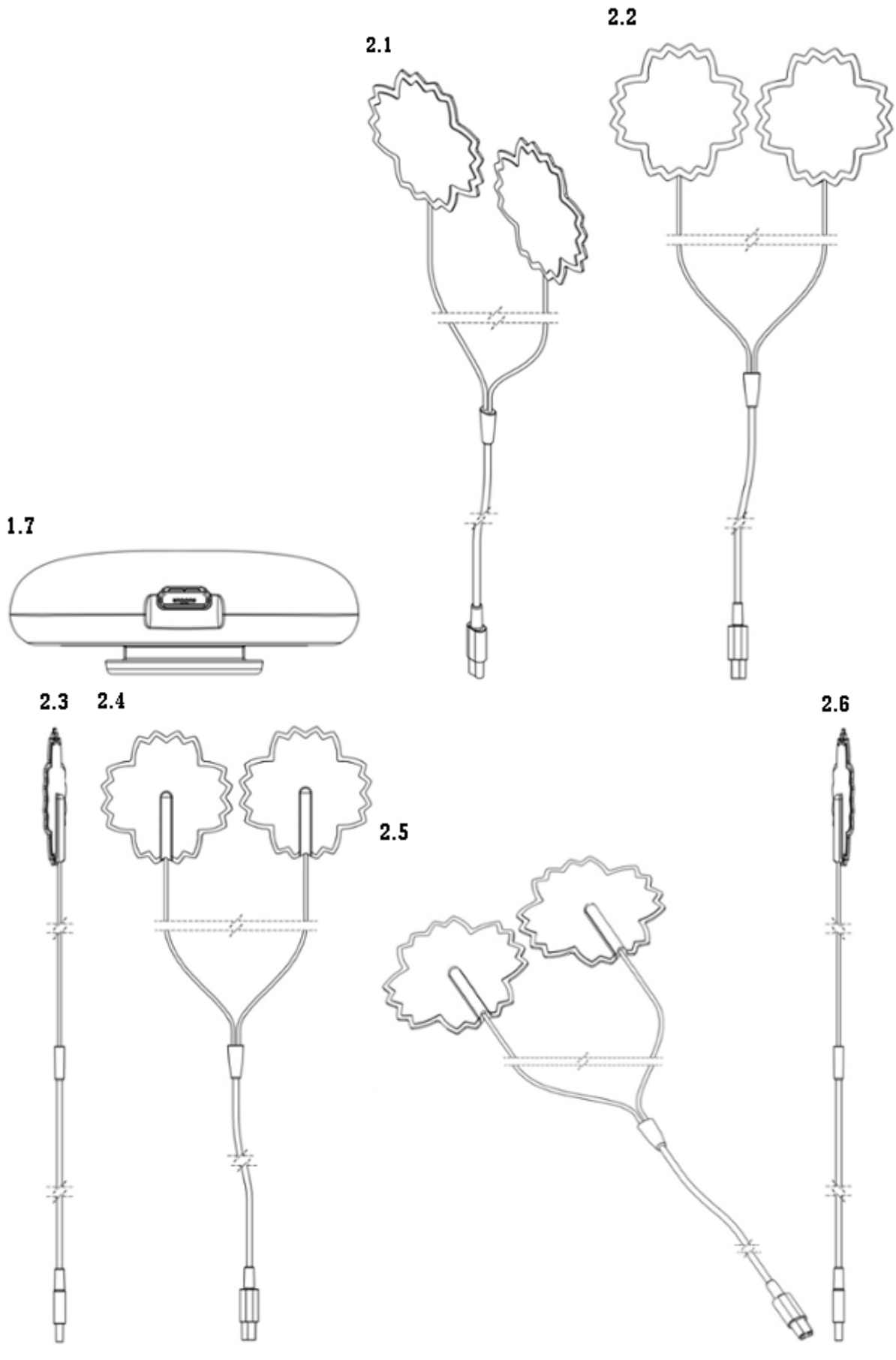

(11) DM/089695**(51) 10-07**

(15) 2016 03 04

(45) 2016/36 (2016 09 09)

(22) 2016 03 04

(28) 2

(73) MONTRES JAQUET DROZ SA (MONTRES JAQUET DROZ AG) (MONTRES JAQUET DROZ LTD.)
Allée du Tourbillon 2, CH-2300 La Chaux-de-Fonds (CH)

(85) CH

(86) CH

(87) CH

(88) CH

(89) CH

(81) II. BZ, MA III. AL, AM, AZ, BA, CH, EM, GE, KG, LI, MC, MD, ME, MK, MN, NO, OM, SG, TN, TR, UA

(72) Yann Leiggener

Avenue Léopold-Robert 11, 2300 La Chaux-de-Fonds, Suisse;

Christian Lattmann

Chemin de Château-Neuf 17, 1125 Monnaz, Suisse

(54) 1.-2. Dials

(55)

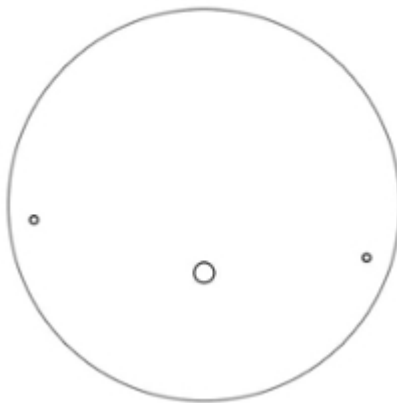
1.1**1.2****1.3 1.4****1.5****1.6****2.1****1.7**

2.2



2.3



2.4



2.5



2.6



2.7



(11) DM/089696

(51) 10-02

(15) 2016 03 04

(45) 2016/36 (2016 09 09)

(22) 2016 03 04

(28) 2

(73) HARRY WINSTON SA

Chemin du Tourbillon 8, CH-1228 Plan-les-Ouates (CH)

(85) CH

(86) CH

(87) CH

(88) CH

(89) CH

(81) IL, BZ, MA III, AL, AM, AZ, BA, CH, EM, GE, KG, KR, LI, MC, MD, ME, MK, MN, NO, OM, SG, TN, TR, UA

(72) Emmanuelle DOMINGUEZ

285 Rue de la Luchette, 74580 Viry, France

(54) 1.-2. Brooch watches

(55)

1.1



1.2

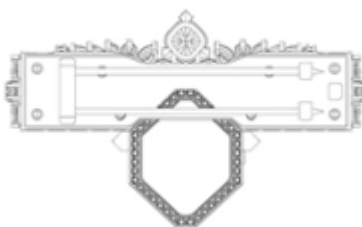

1.3



1.4



1.5



1.6



1.7

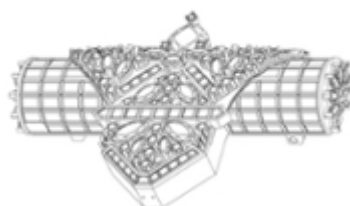

1.8

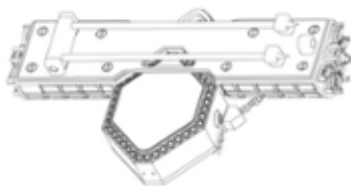

2.1

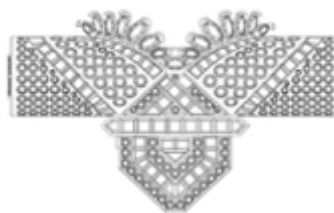

2.2

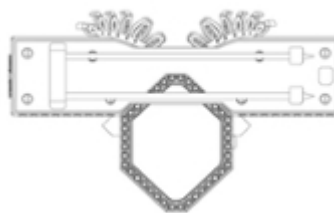

2.3



2.4



2.5



2.6



2.7

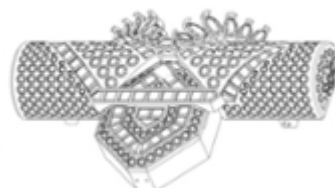

2.8

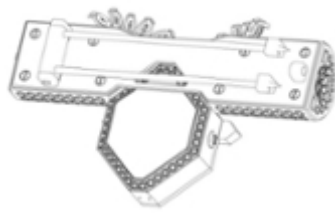

(11) DM/089704

(51) 10-07

(15) 2016 03 07

(45) 2016/36 (2016 09 09)

(22) 2016 03 07

(28) 6

(73) HARRY WINSTON SA

Chemin du Tourbillon 8, CH-1228 Plan-les-Ouates (CH)

(85) CH

(86) CH

(87) CH

(88) CH

(89) CH

(81) IL, BZ, MA III, AL, AM, AZ, BA, CH, EM, GE, KG, KR, LI, MC, MD, ME, MK, MN, NO, OM, SG, TN, TR, UA

(72) Emmanuelle DOMINGUEZ

Rue de la Luchette 285, 74580 VIRY, France

(54) 1.-2. Dials; 3.-4. Watch cases; 5. Watch holder for bracelet; 6. Watch holder for pendant

(55)

1.1

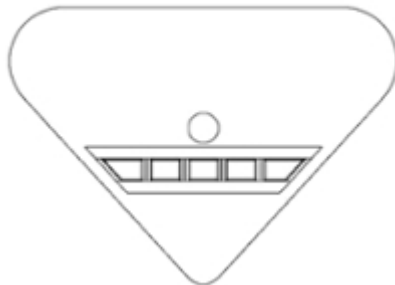

1.2

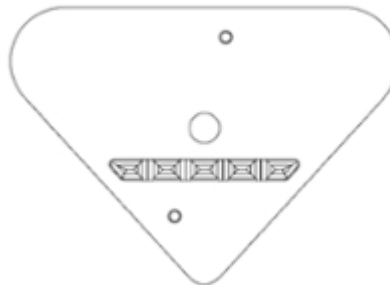

1.3 1.4



1.7

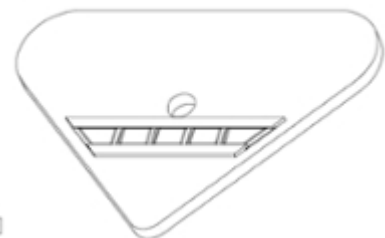

1.5



1.6



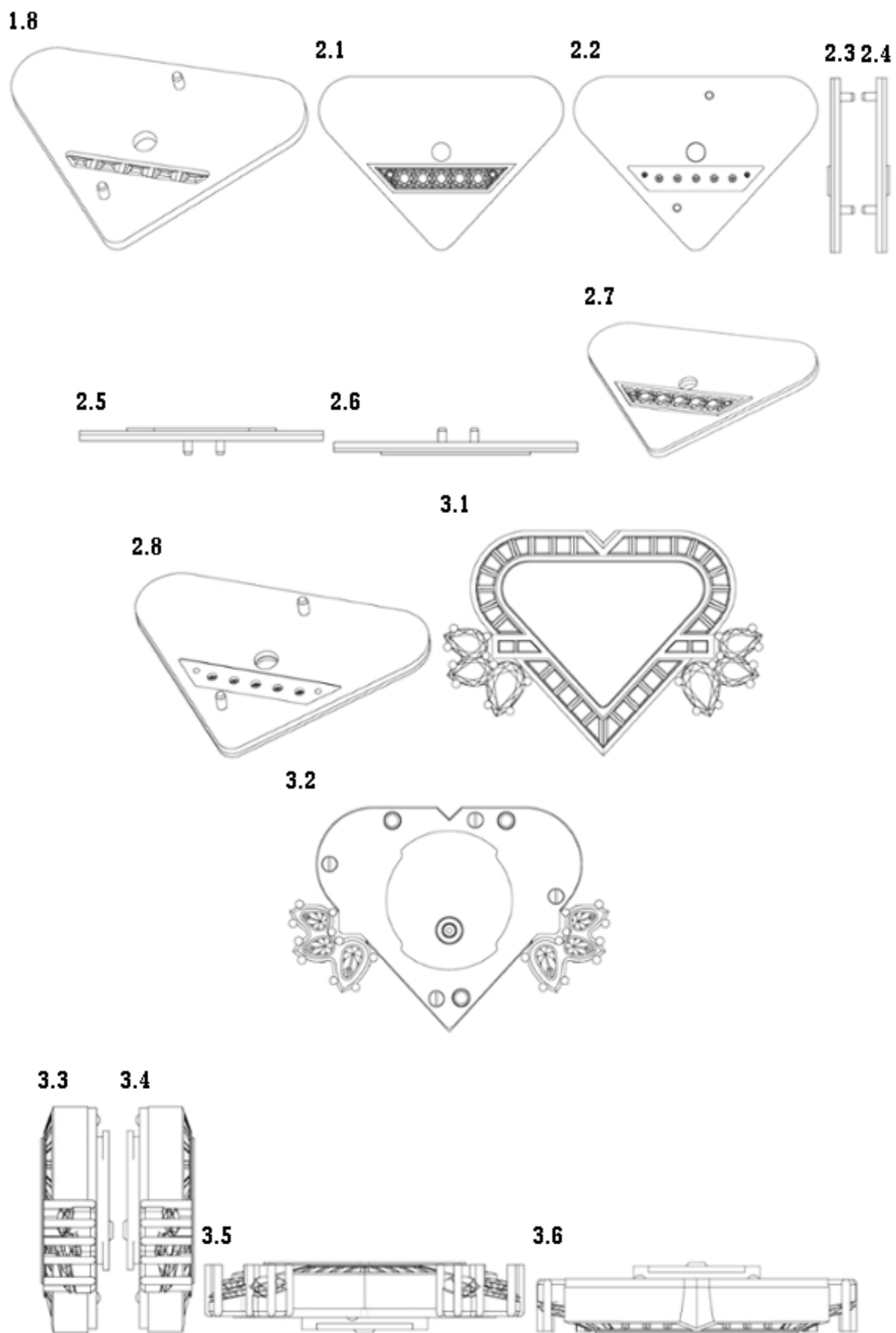

3.7



3.8

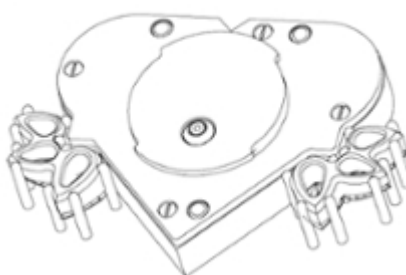

4.1



4.2

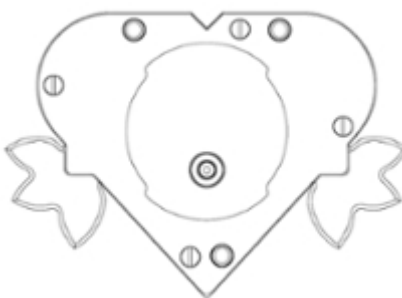

4.3



4.4



4.5



4.6



4.7



4.8

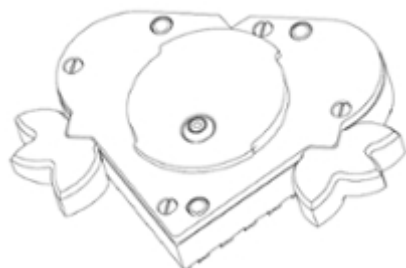

5.1

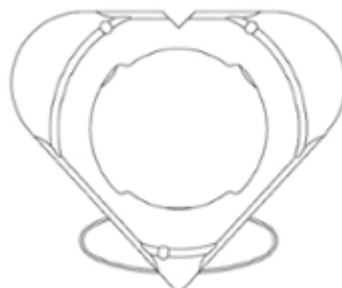

5.2



5.3 5.4



5.5



5.6



6.1

6.2

5.7



5.8

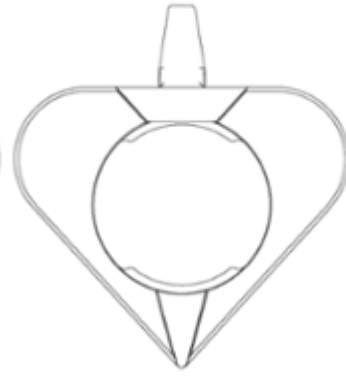

6.3

6.4

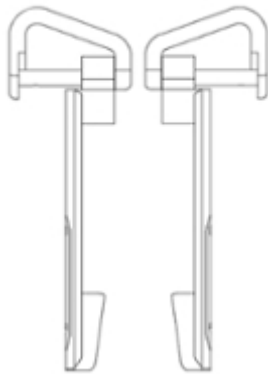

6.5



6.6



6.7



6.8



(11) DM/089749

(51) 10-07

(15) 2016 03 07

(45) 2016/36 (2016 09 09)

(22) 2016 03 07

(28) 6

(73) HARRY WINSTON SA

Chemin du Tourbillon 8, CH-1228 Plan-les-Ouates (CH)

(85) CH

(86) CH

(87) CH

(88) CH

(89) CH

(81) II. BZ, MA III. AL, AM, AZ, BA, CH, EM, GE, KG, KR, LI, MC, MD, ME, MK, MN, NO, OM, SG, TN, TR, UA

(72) 1-4: Sophie VALZAN

Atelier La Fabrique à Ressorts, Rue Sambre et Meuse 25, 75010 Paris, France;

5-6: Emmanuelle DOMINGUEZ

Rue de la Luchette 285, 74580 Viry, France

(54) 1.-5. Dials; 6. Watch bracelet

(55)

1.1

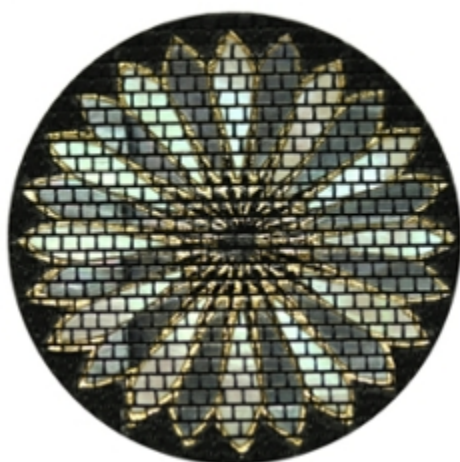

1.2

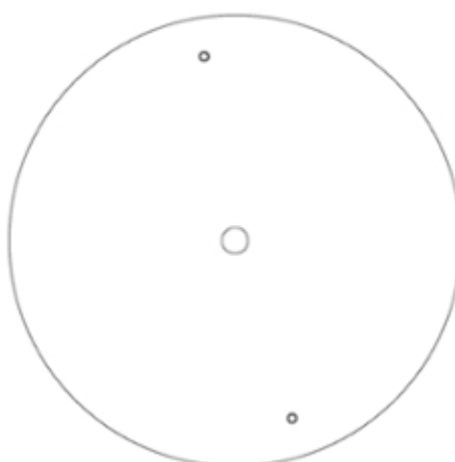

1.3 1.4



1.5



1.6



2.1

1.7

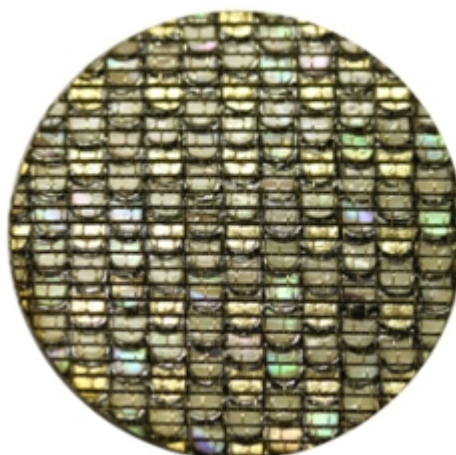

2.2

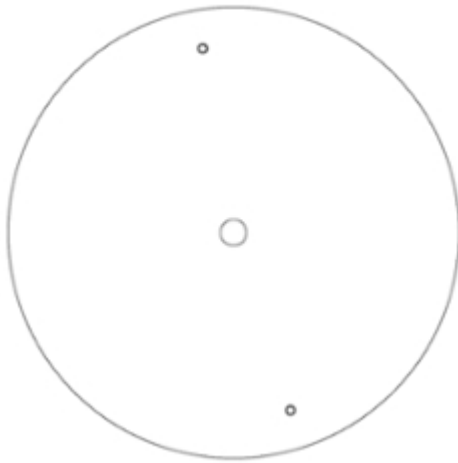

2.3 2.4



2.5



2.7

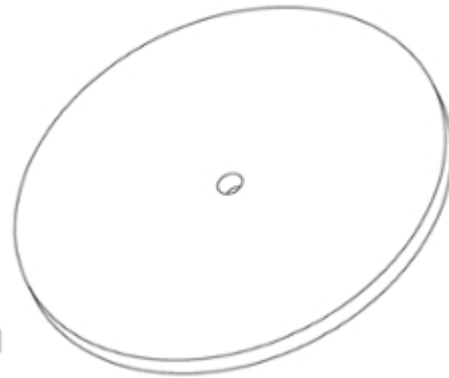

2.6



3.1

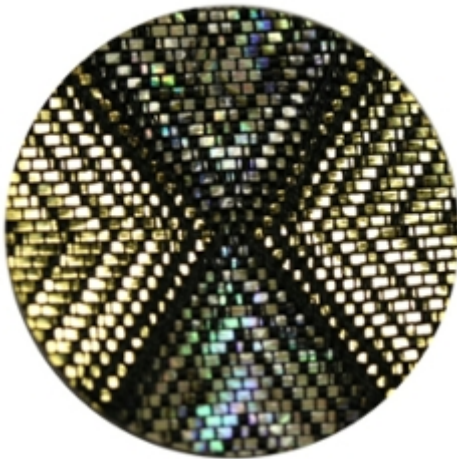

3.2

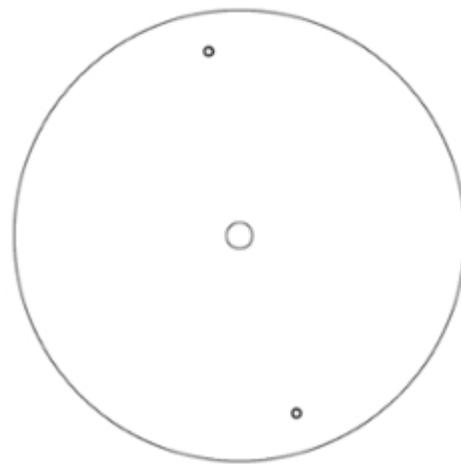

3.3 3.4



3.5



3.6



3.7

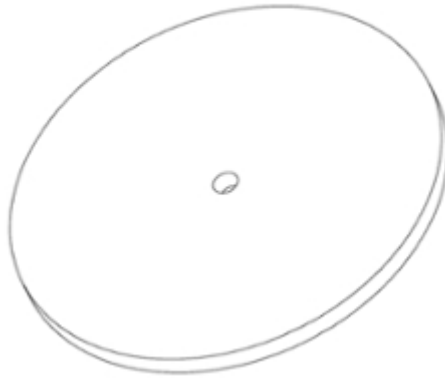

4.1

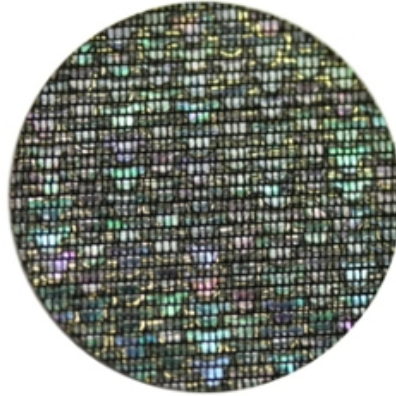

4.2

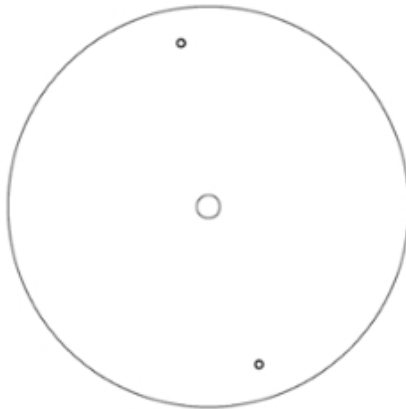

4.3 4.4



4.5



4.7

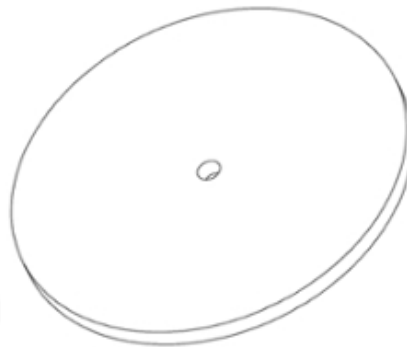

4.6



5.1

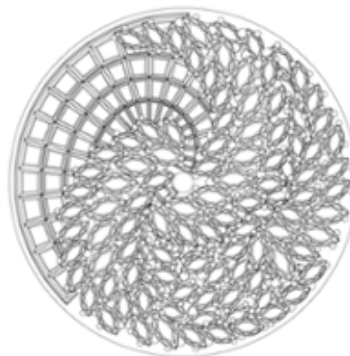

5.2

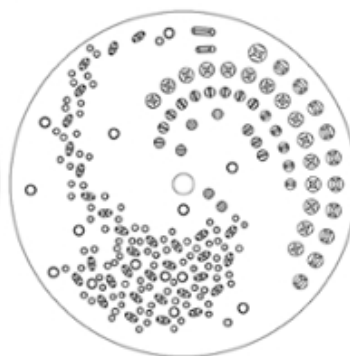

5.3 5.4



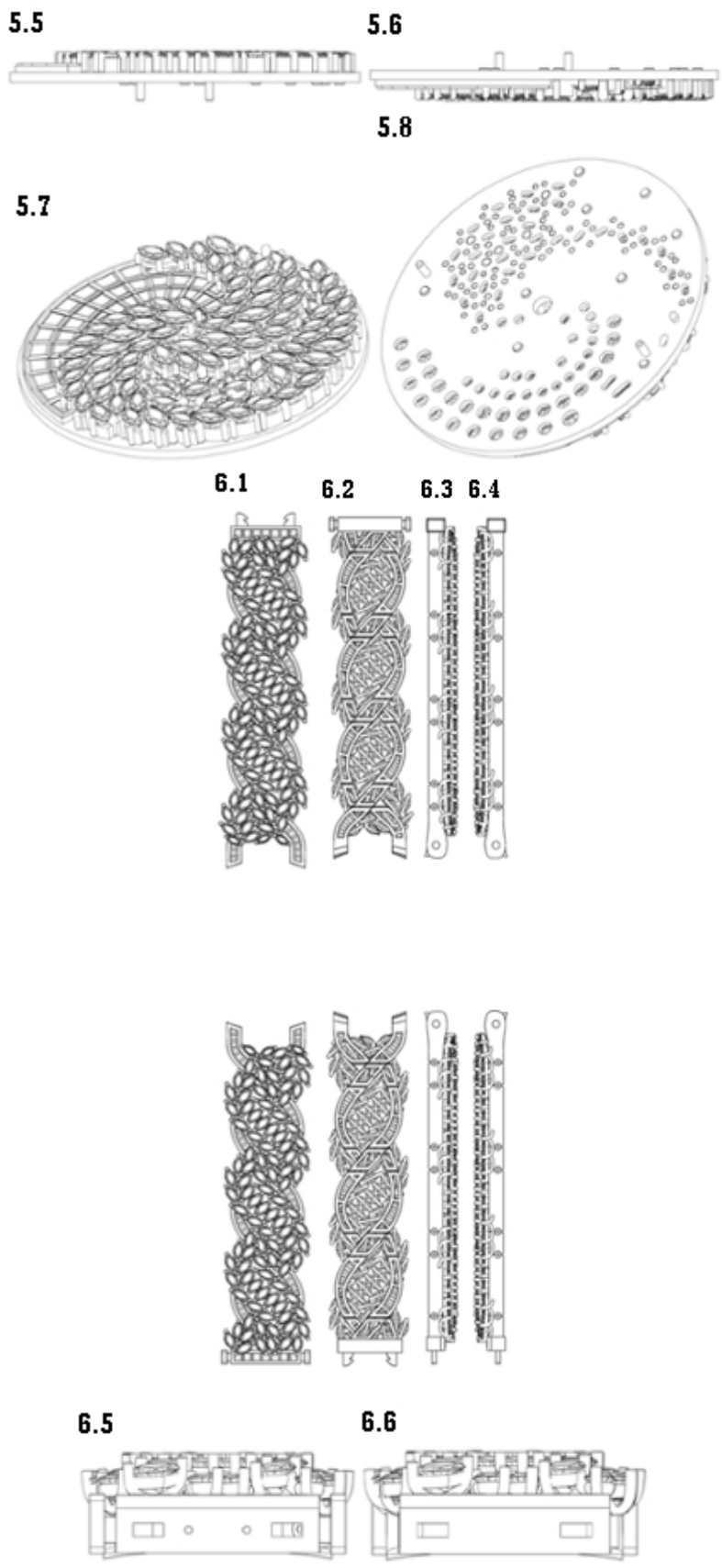

6.7



6.8



(11) DM/089796**(51) 03-01**

(15) 2016 03 08

(45) 2016/36 (2016 09 09)

(22) 2016 03 08

(28) 1

(73) HARRY WINSTON SA

Chemin du Tourbillon 8, CH-1228 Plan-les-Ouates (CH)

(85) CH

(86) CH

(87) CH

(88) CH

(89) CH

(81) II. BZ, MA III. AL, AM, AZ, BA, CH, EM, GE, KG, KR, LI, MC, MD, ME, MK, MN, NO, OM, SG, TN, TR, UA

(72) Emmanuelle DOMINGUEZ

Rue de la Luchette 285, 74580 VIRY, France

(54) 1. Clutch bag

(55)

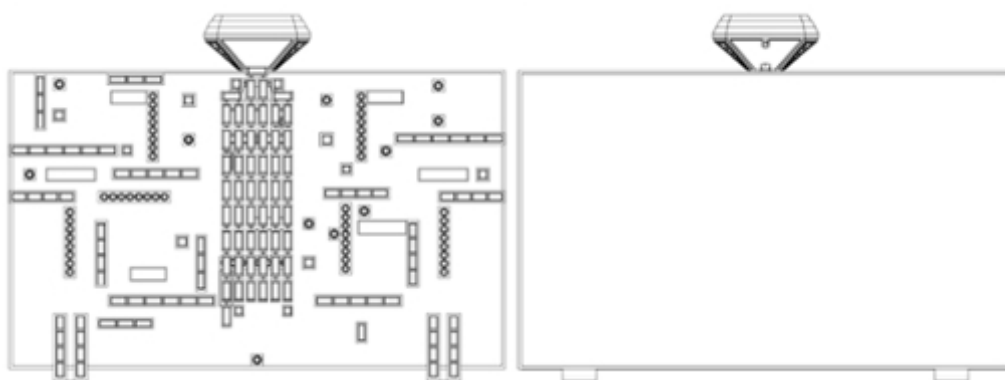
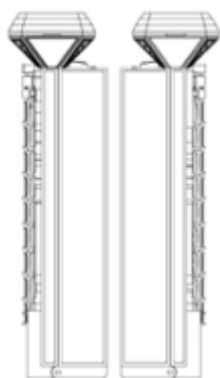
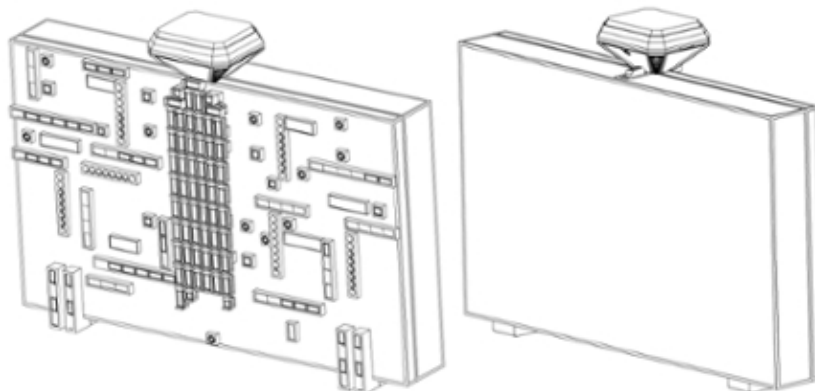
1.1**1.2****1.3****1.4****1.5****1.6****1.7****1.8**

1.9

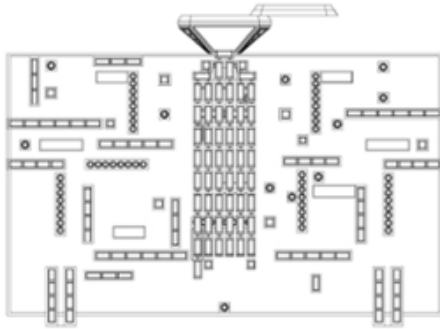

1.10



1.11

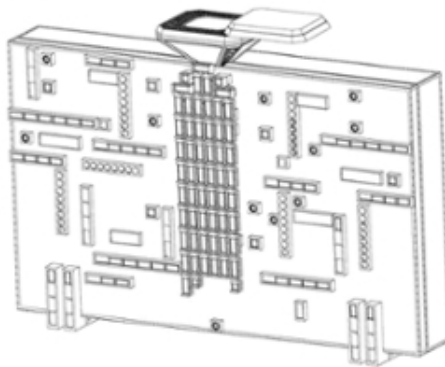

1.12

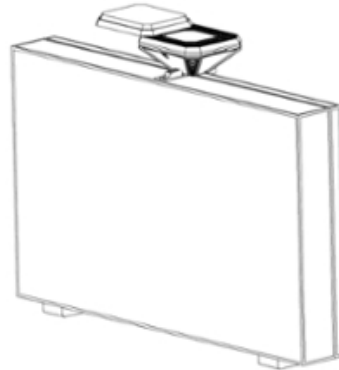

1.13



1.14



1.15

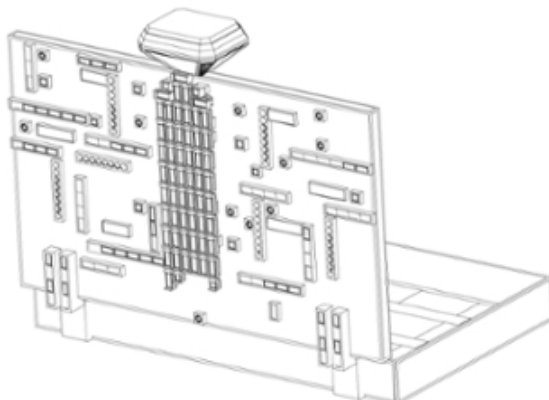

1.16

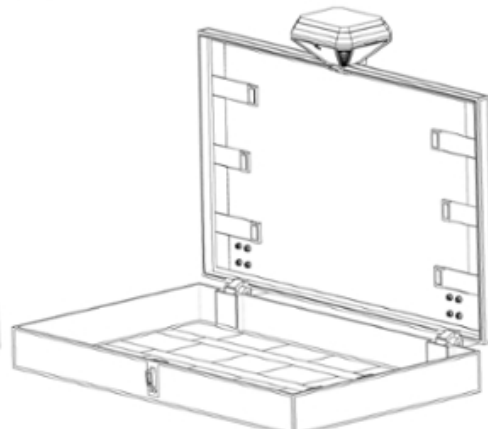

(11) DM/089847**(51) 16-06**

(15) 2016 03 10

(45) 2016/37 (2016 09 16)

(22) 2016 03 10

(28) 1

(73) OMEGA SA (OMEGA AG) (OMEGA LTD.)

Jakob-Stämpfli-Strasse 96, CH-2502 Biel/Bienne (CH)

(85) CH

(86) CH

(87) CH

(88) CH

(89) CH

(81) II. BZ, MA III. AL, AM, AZ, BA, CH, EM, GE, KG, KR, LI, MC, MD, ME, MK, MN, NO, OM, SG, TN, TR, UA

(72) Jean-Claude Monachon

Rue Alice-de-Chambrier 1, 2022 Bevaix, Suisse;

Alessandro Da Forno

Via Villanova, 32044 Pieve di Cadore, Italie

(54) 1. Frame for spectacles

(55)

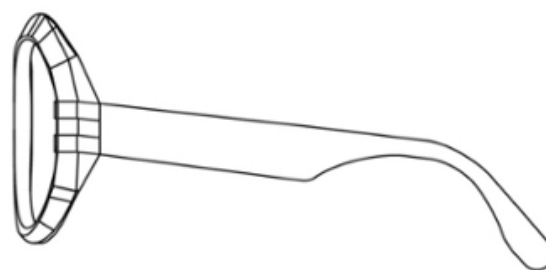
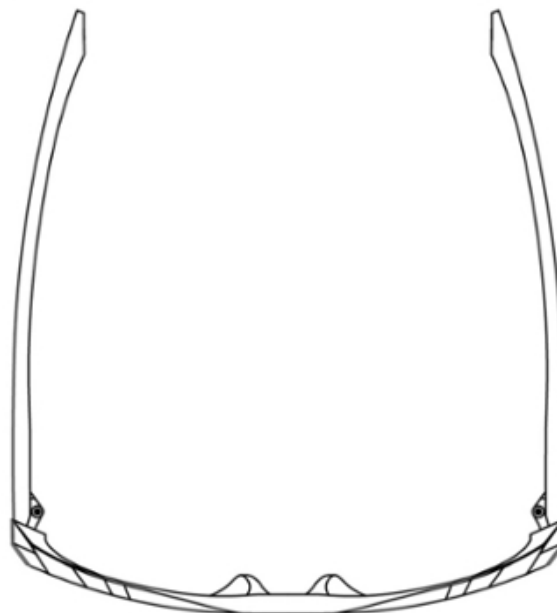
1.1**1.2****1.3**

(11) DM/089992

(51) 10-07

(15) 2016 03 11

(45) 2016/37 (2016 09 16)

(22) 2016 03 11

(28) 4

(73) GLASHÜTTER UHRENBETRIEB GMBH

Altenberger Straße 1, 01768 Glashütte (DE, EM)

(85) DE, EM

(86) DE, EM

(87) DE, EM

(88) DE, EM

(89) DE

(81) II. BZ, MA III. AL, AM, AZ, BA, CH, EM, GE, KG, LI, MC, MD, ME, MK, MN, NO, OM, SG, TN, TR, UA

(72) Julia Schröder

Tauernstraße 40, 01279 Dresden, Germany

(54) 1.-4. Dials

(55)

1.1

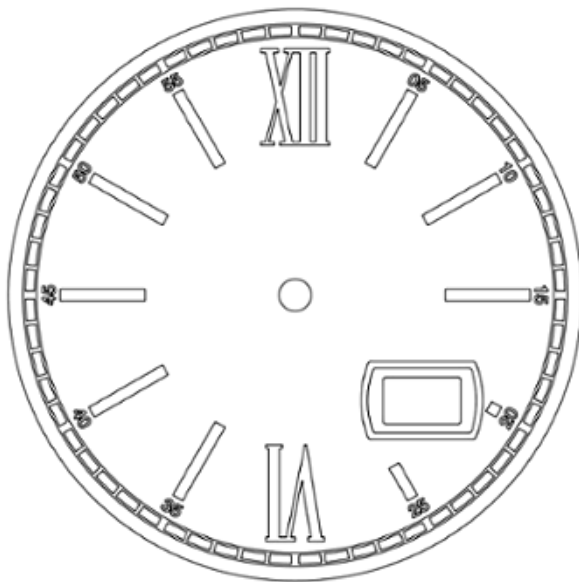

1.2

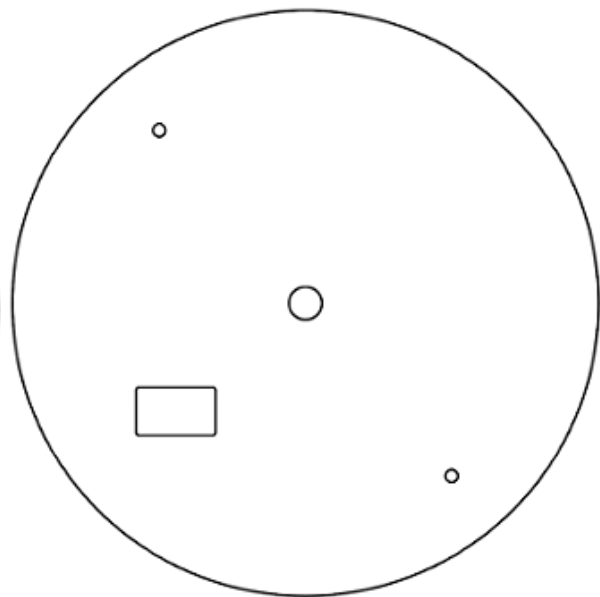

1.3



1.4



1.5



1.6



1.7

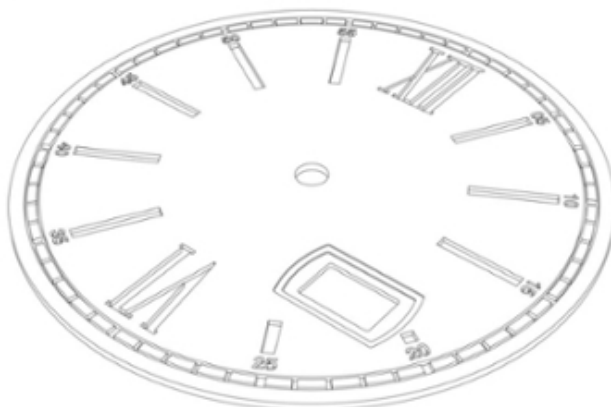

2.1



2.2

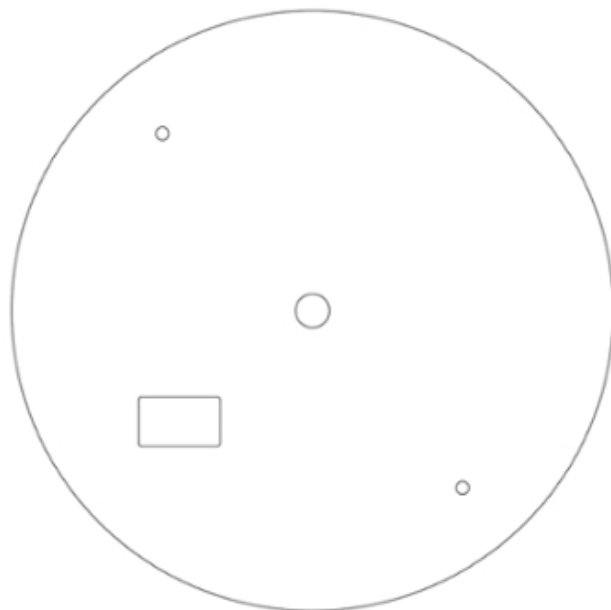

2.3



2.4



2.5



2.6



3.1

2.7

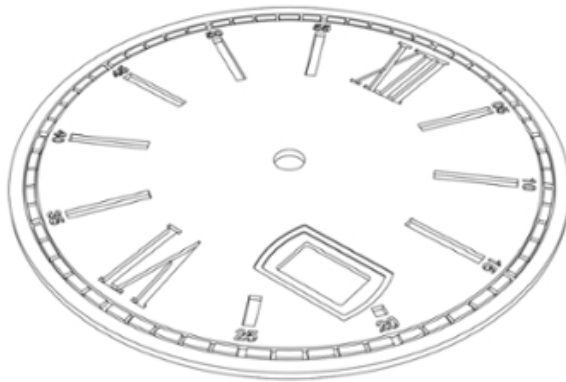

3.2

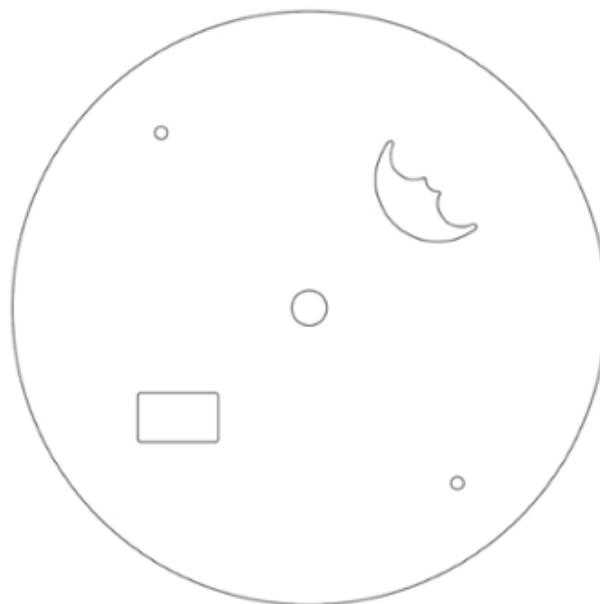

3.3



3.4



3.5



3.6



3.7

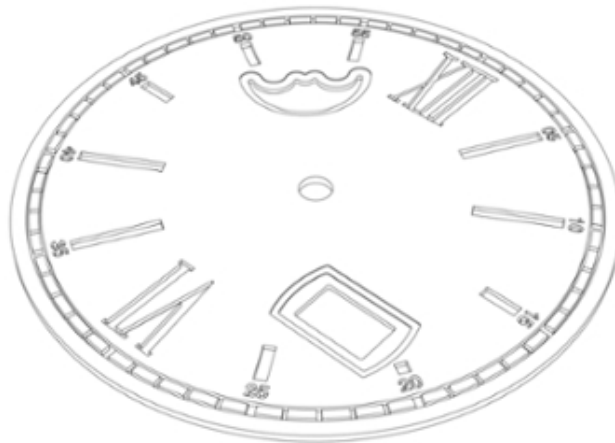

4.1



4.2

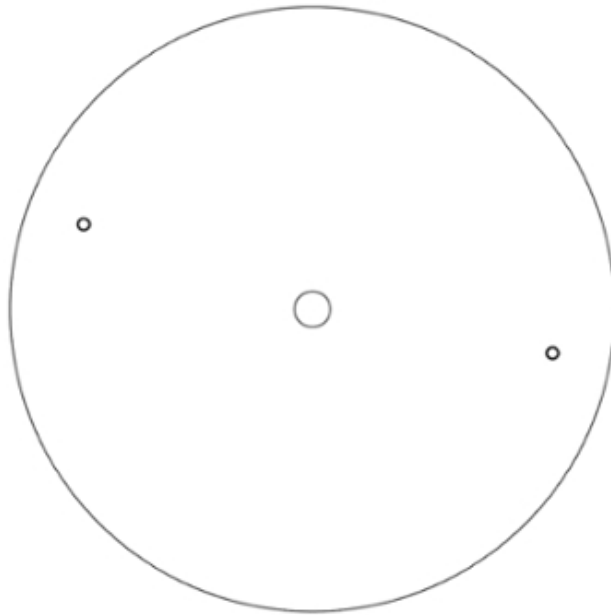

4.3



4.4



4.5



4.6



4.7



- (11) DM/090746 (51) 25-02
(15) 2016 03 10 (45) 2016/37 (2016 09 16)
(22) 2016 03 10
(28) 5
(30) No. 1: 10.09.2015; 2015503251; RU; No. 2: 10.09.2015; 2015503252; RU; No. 3: 10.09.2015; 2015503253; RU; No. 4: 10.09.2015; 2015503254; RU; No. 5: 10.09.2015; 2015503255; RU
(73) VADYM POPLAVSKYI
D. Galitskogo 1-8, Rivne 33000 (UA)
(85) --
(86) UA
(87) --
(88) --
(89) UA
(81) III. AZ, GE, MD, MN, UA
(72) Vadym Poplavskyi
D. Galitskogo 1-8, 33000 Rivne, Ukraine
(54) 1.-5. Construction insulating elements for pipelines
(55)

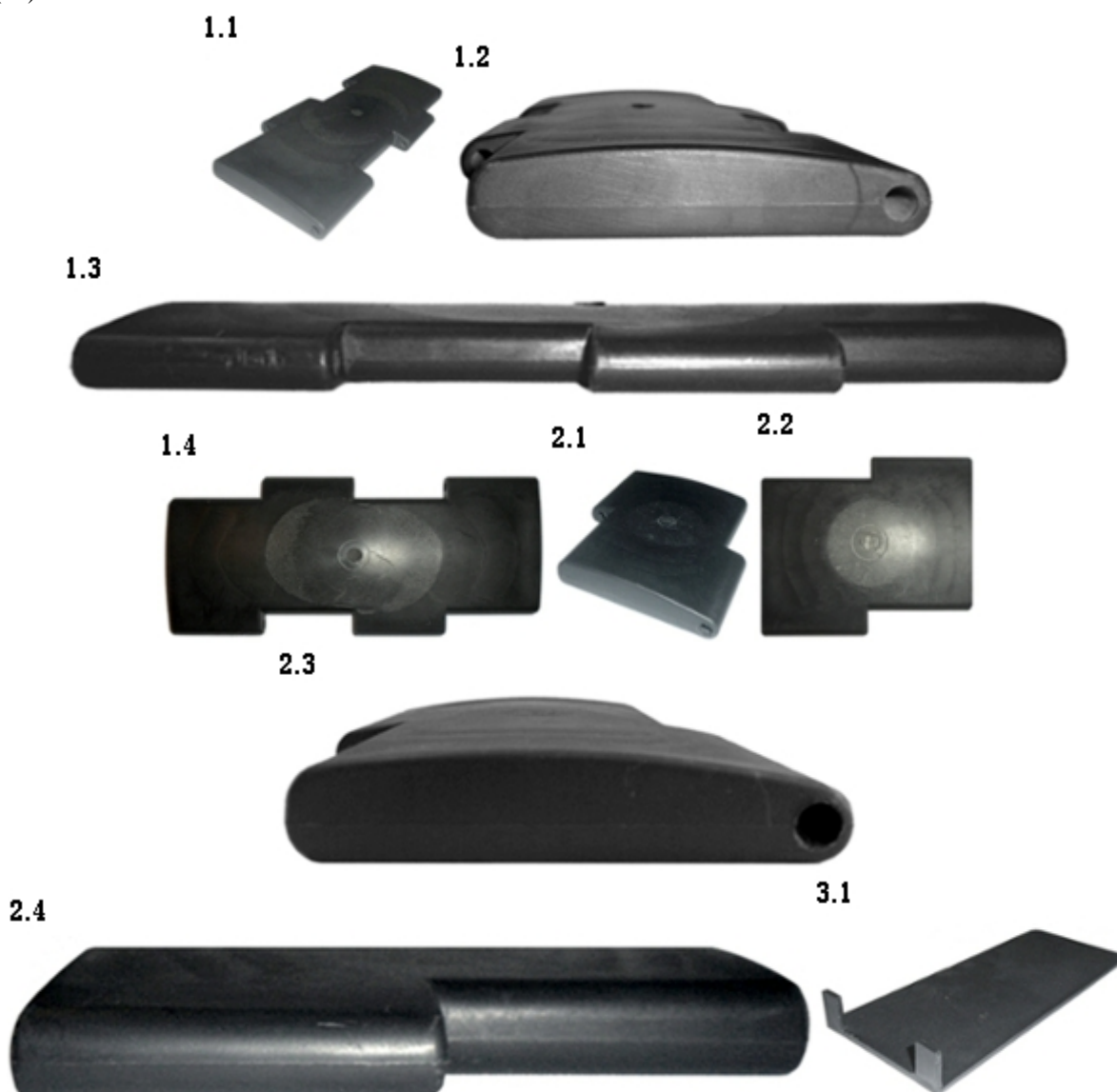

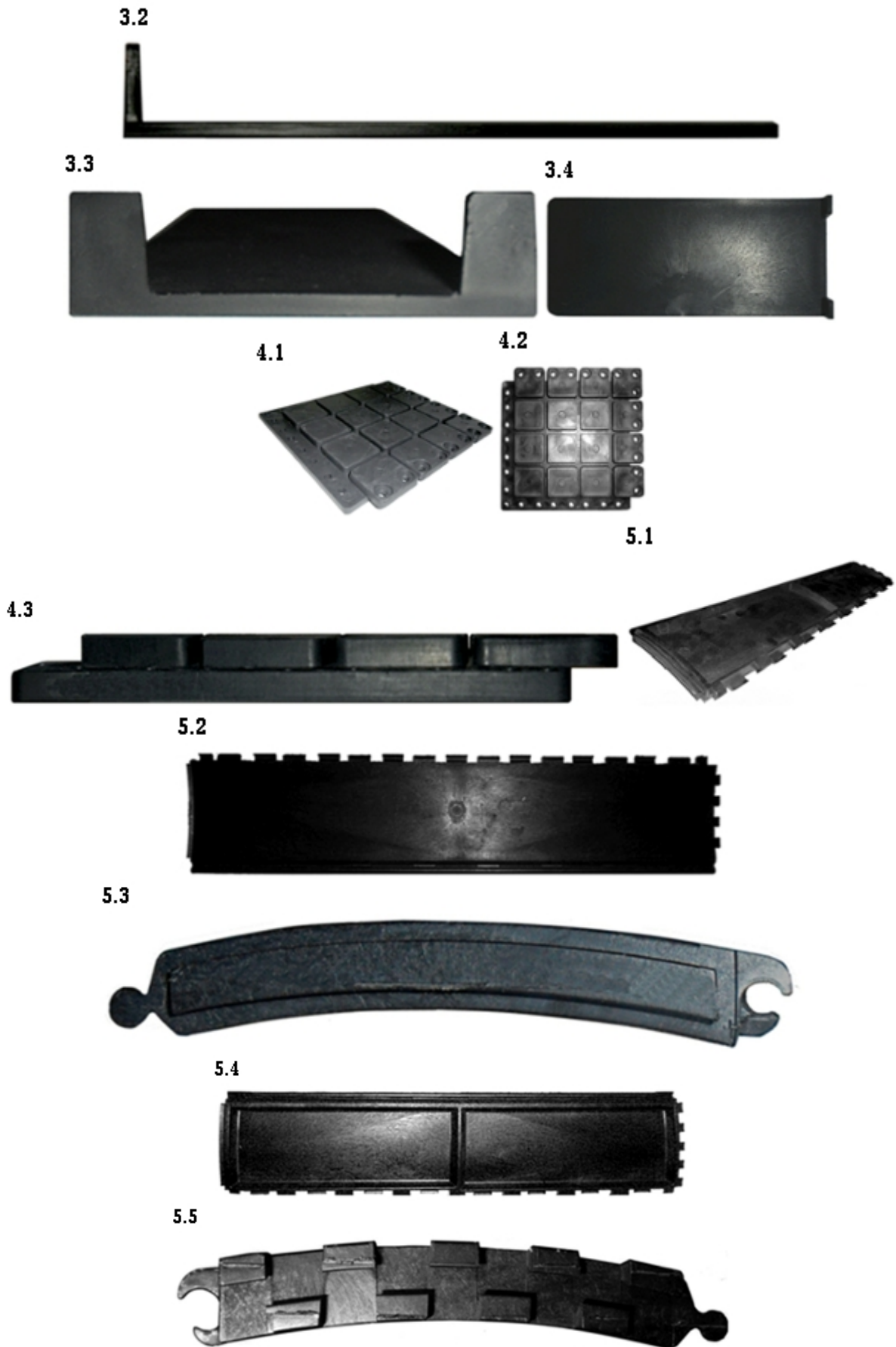

(11) DM/092345

(51) 09-01

(15) 2016 08 26

(45) 2016/37 (2016 09 16)

(22) 2016 08 26

(28) 1

(73) YUDUM GIDA SANAYI VE TICARET ANONIM SIRKETI

Metem Plaza, Icerenkoy Mah. Bahcelerarasi Sok. K:23 No:43 Atasehir, ISTANBUL (TR)

(85) --

(86) TR

(87) TR

(88) TR

(89) TR

(81) III. AL, AM, AZ, BA, BG, BN, BW, CH, DE, DK, EE, EG, EM, ES, FI, FR, GE, GH, HR, HU, IS, JP, KG, KR, LI, LT, LV, MC, MD, ME, MK, MN, NA, NO, OA, OM, PL, RO, RS, RW, SG, SI, ST, SY, TJ, TM, TN, UA, US

(72) ZELIHA BURCU YAMAN

Metem Plaza, Icerenkoy Mah. Bahcelerarasi Sok. K:23 No:43 Atasehir, ISTANBUL, Turkey

(54) 1. Oil bottle

(55)

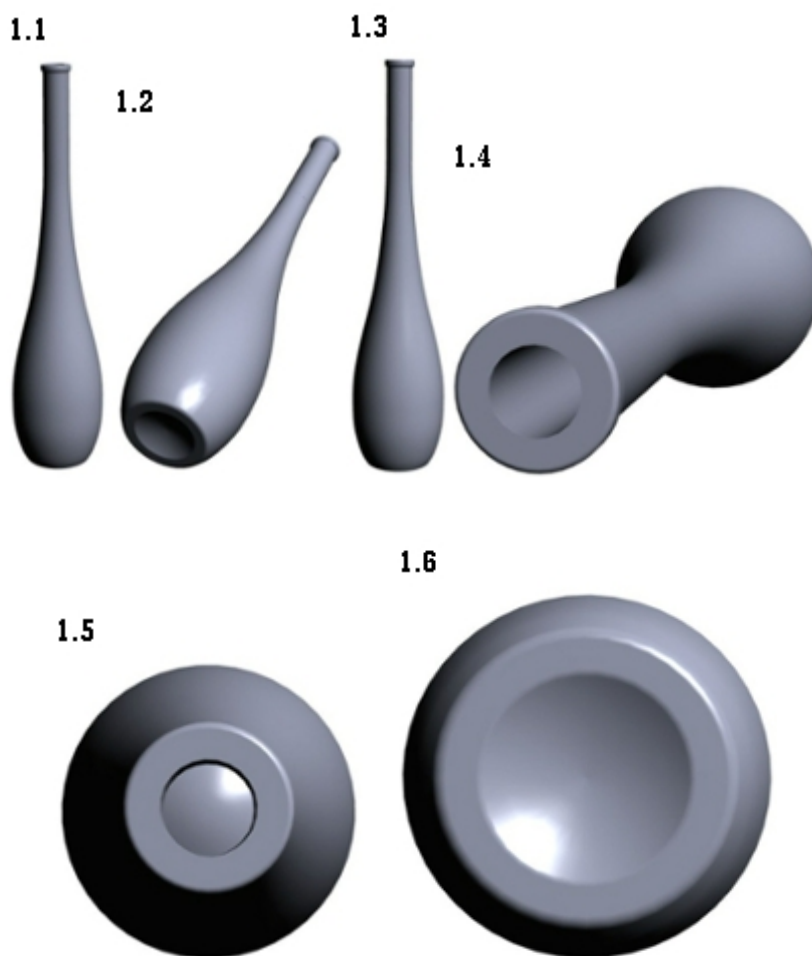

(11) DM/092346

(51) 09-01

(15) 2016 08 26

(45) 2016/37 (2016 09 16)

(22) 2016 08 26

(28) 1

(73) YUDUM GIDA SANAYI VE TICARET ANONIM SIRKETI

Metem Plaza, Icerenkoy Mah. Bahcelerarasi Sok. K:23 No:43 Atasehir, ISTANBUL (TR)

(85) --

(86) TR

(87) --

(88) TR

(89) TR

(81) III. AL, AM, AZ, BA, BG, BN, BW, CH, DE, DK, EE, EG, EM, ES, FI, FR, GE, GH, HR, HU, IS, JP, KG, KR, LI, LT, LV, MC, MD, ME, MK, MN, NA, NO, OA, OM, PL, RO, RS, RW, SG, SI, ST, SY, TJ, TM, TN, TR, UA, US

(72) ZELIHA BURCU YAMAN

Metem Plaza, Icerenkoy Mah. Bahcelerarasi Sok. K:23 No:43 Atasehir, ISTANBUL, Turkey

(54) 1. Oil bottle

(55)

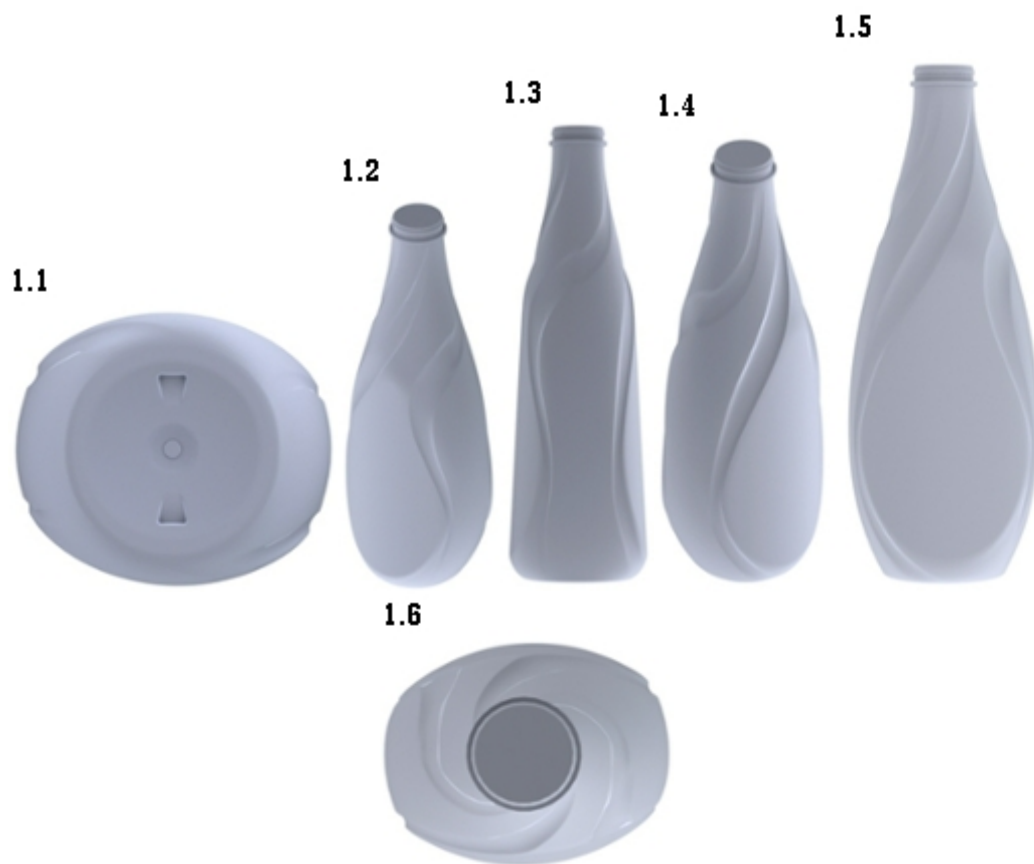

(11) DM/092347

(51) 09-01

(15) 2016 08 26

(45) 2016/37 (2016 09 16)

(22) 2016 08 26

(28) 1

(73) YUDUM GIDA SANAYI VE TICARET ANONIM SIRKETI

Mete Plaza, Icerenkoy Mah. Bahcelerarasi Sok. K:23 No:43 Atasehir, ISTANBUL (TR)

(85) --

(86) TR

(87) --

(88) TR

(89) TR

(81) III. AL, AM, AZ, BA, BG, BN, BW, CH, DE, DK, EE, EG, EM, ES, FI, FR, GE, GH, HR, HU, IS, JP, KG, KR, LI, LT, LV, MC, MD, ME, MK, MN, NA, NO, OA, OM, PL, RO, RS, RW, SG, SI, ST, SY, TJ, TM, TN, TR, UA, US

(72) ZELIHA BURCU YAMAN

Mete Plaza, Icerenkoy Mah. Bahcelerarasi Sok. K:23 No:43 Atasehir, ISTANBUL, Turkey

(54) 1. Oil bottle

(55)

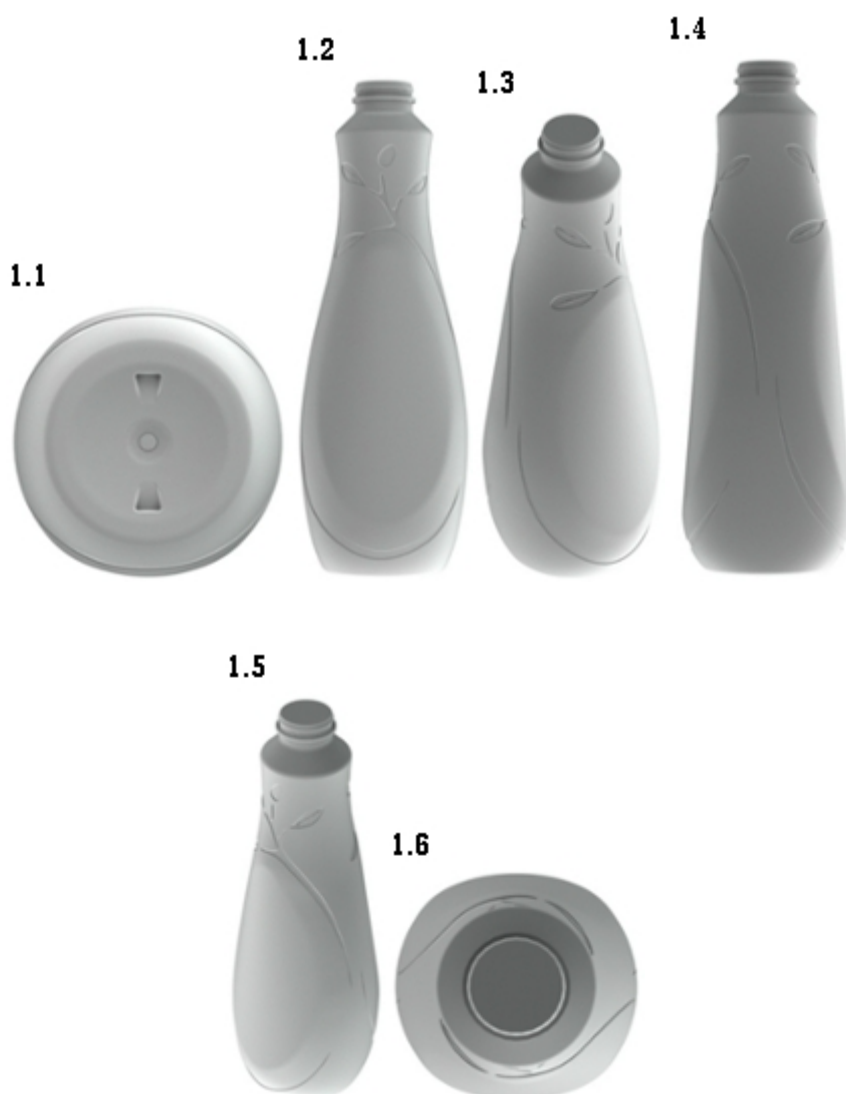

(11) DM/089951

(51) 11-01

(15) 2016 03 21

(45) 2016/38 (2016 09 23)

(22) 2016 03 21

(28) 1

(73) HARRY WINSTON SA

Chemin du Tourbillon 8, CH-1228 Plan-les-Ouates (CH)

(85) CH

(86) CH

(87) CH

(88) CH

(89) CH

(81) II. BZ, MA III. AL, AM, AZ, BA, CH, EM, GE, KG, KR, LI, MC, MD, ME, MK, MN, NO, OM, SG, TN, TR, UA

(72) Rie YATSUGI-KANG

272 Highland St., NJ 07626 Cresskill, États-Unis d'Amérique

(54) 1. Finger ring

(55)

1.1



1.2



1.3



1.4



1.5



1.6



1.7



1.8



(11) DM/090170

(15) 2016 03 22

(22) 2016 03 22

(28) 1

(73) RILANA PLS 2D

Peyo K. Yavorov Str., BG-2700 Blagoevgrad (BG)

(85) BG, EM

(86) BG, EM

(87) BG, EM

(88) BG, EM

(89) BG

(81) II. BJ, BZ, CI, GA, KP, MA, ML, NE, SN, SR III. AL, AM, AZ, BA, BN, BW, CH, EG, EM, GE, JP, KG, KR,

LI, MC, MD, ME, MK, MN, NA, NO, OA, OM, RS, RW, SG, ST, SY, TJ, TN, TR, UA, US

(72) Dimitar Sotirov Stoykov

11, Han Asparuh street, 2700 Blagoevgrad, Bulgaria

(54) 1. Bottle

(55)

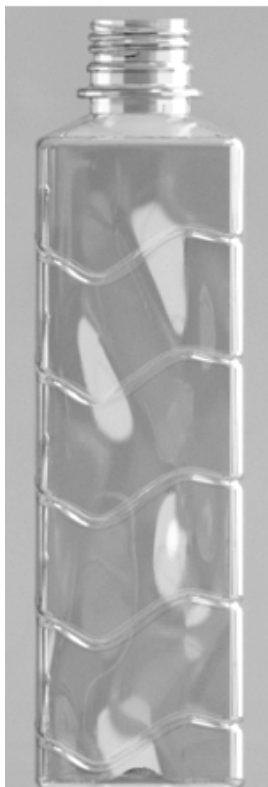
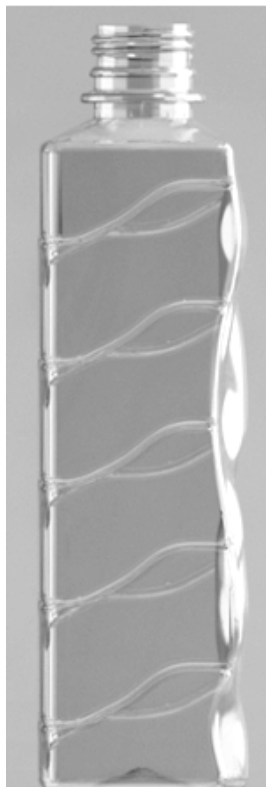
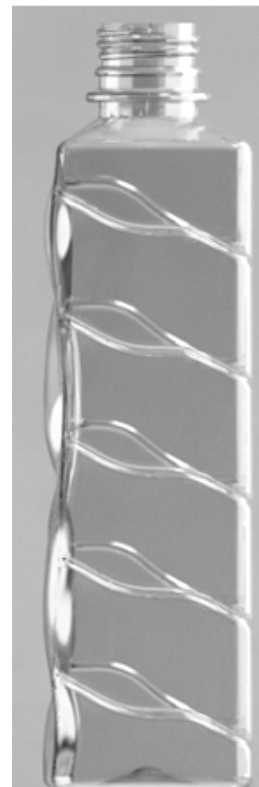
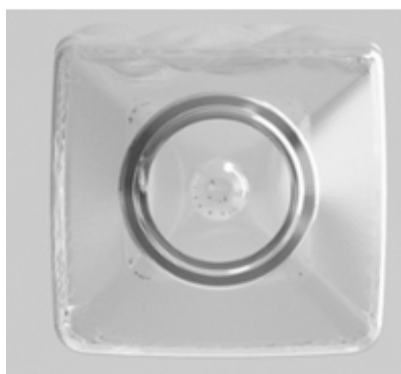
1.1**1.2****1.3****1.4****1.5****1.6**

1.7

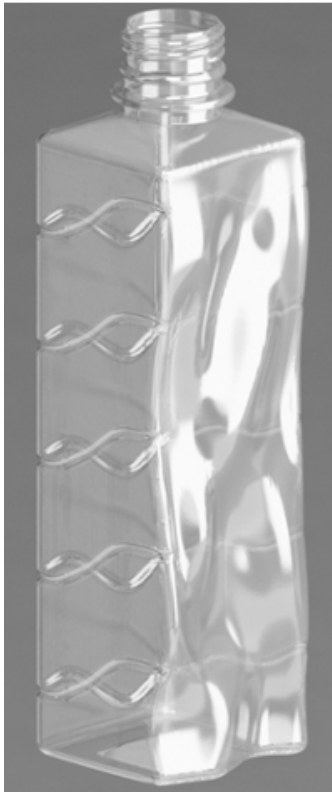

1.8



1.9

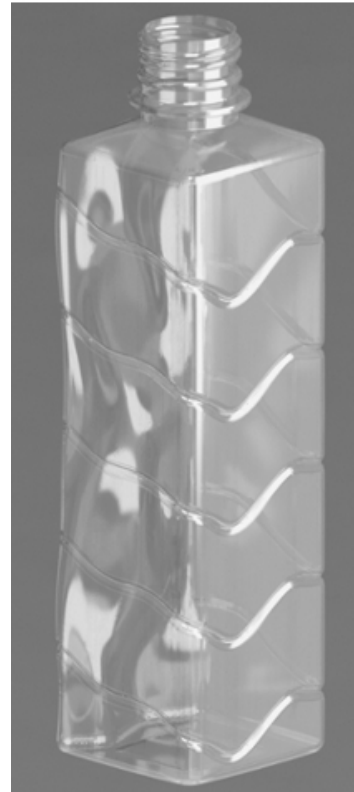

1.10



1.11

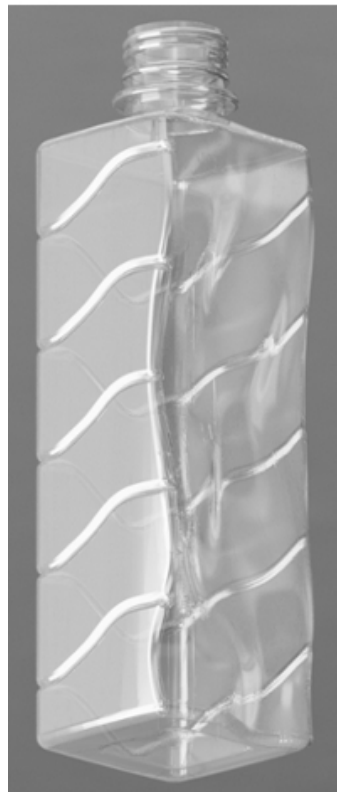

1.12

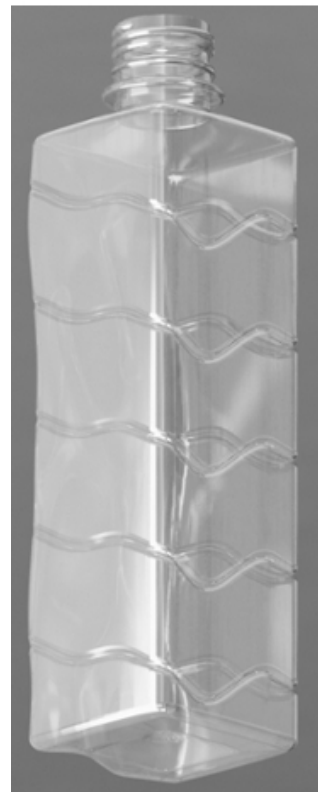

(11) DM/092419

(51) 24-04

(15) 2015 11 19

(45) 2016/38 (2016 09 23)

(22) 2015 11 19

(28) 1

(73) JAMES RICKMAN

249 Cardinal Lane, Paducah, KY 42001 (US)

(85) US

(86) US

(87) US

(88) US

(89) US

(81) III. AL, AM, AZ, BA, BG, BN, BW, CH, EG, EM, GE, GH, IS, JP, KG, KR, LI, MC, MD, ME, MK, MN, NA,

NO, OA, OM, RS, RW, SG, ST, SY, TJ, TN, TR, UA, US

(72) James Rickman

249 Cardinal Lane, Paducah, KY 42001, United States of America

(54) 1. Incontinence aid

(55)

1.1

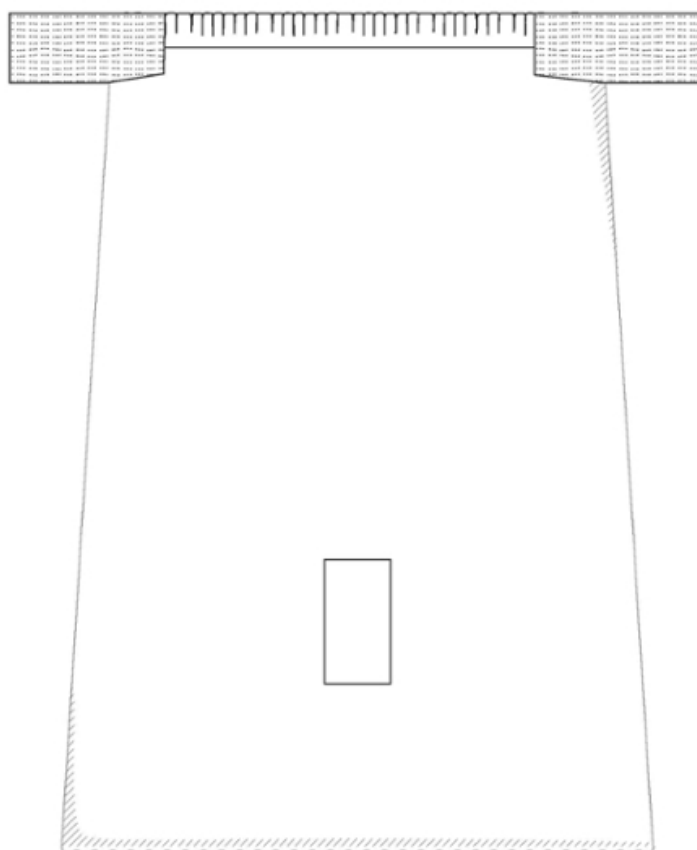

1.2

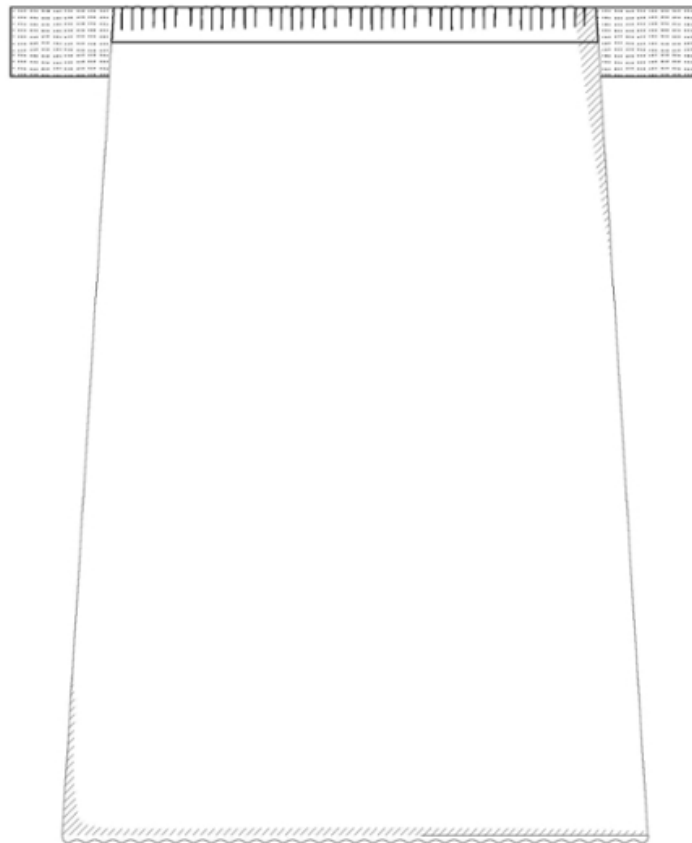

1.3

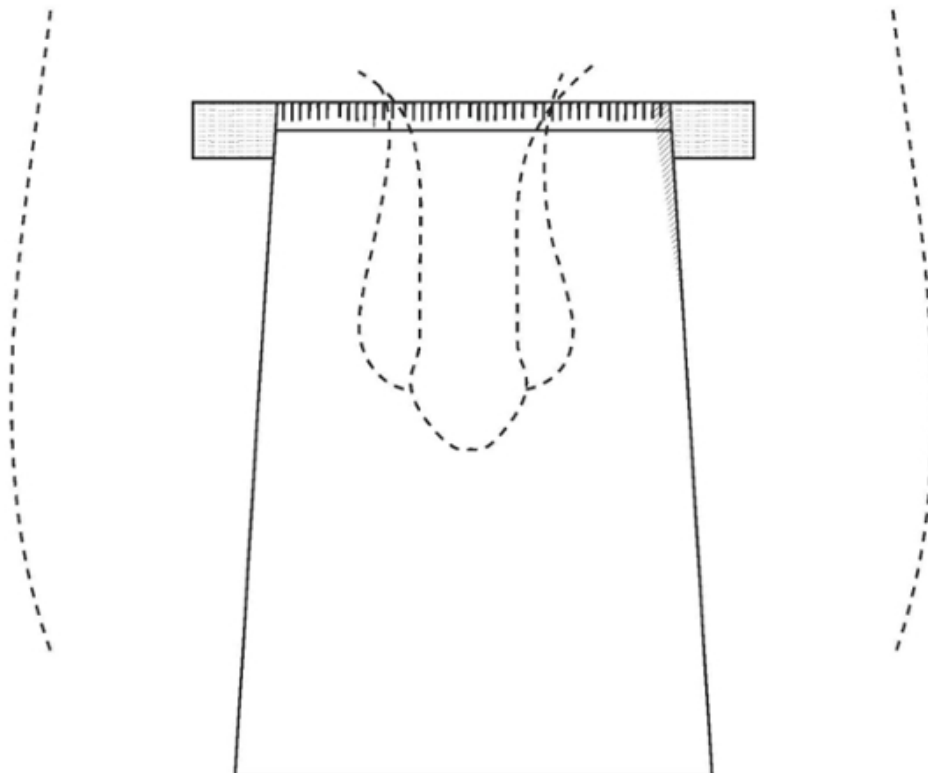

1.4

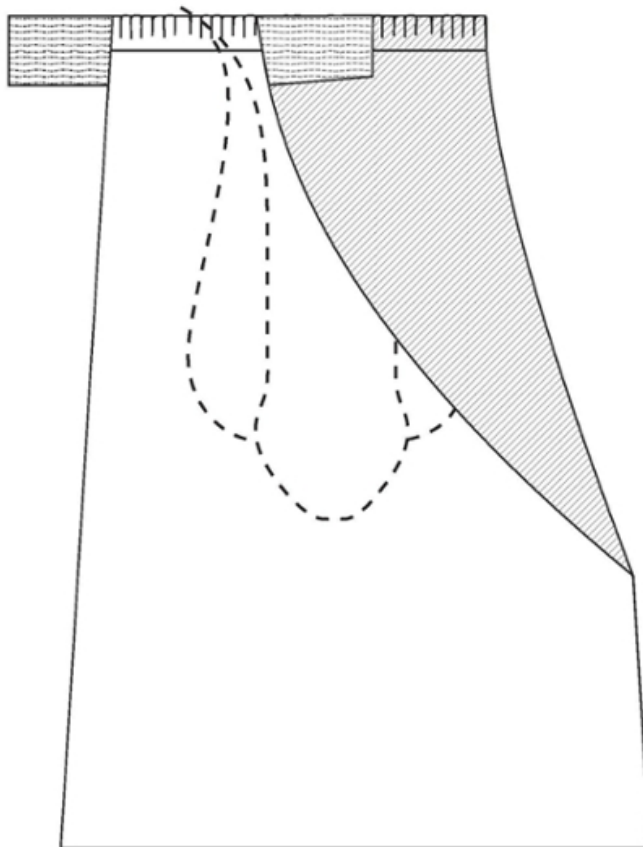

1.5

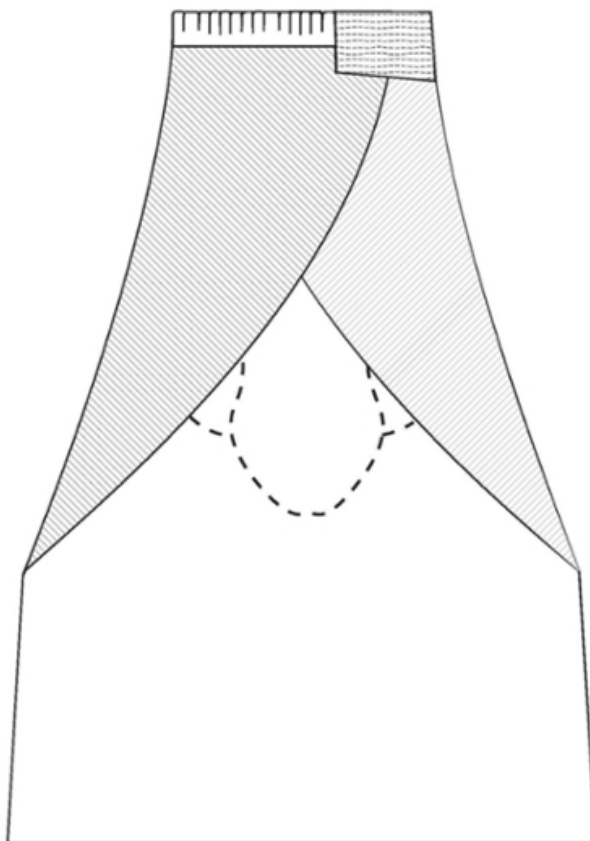

1.6

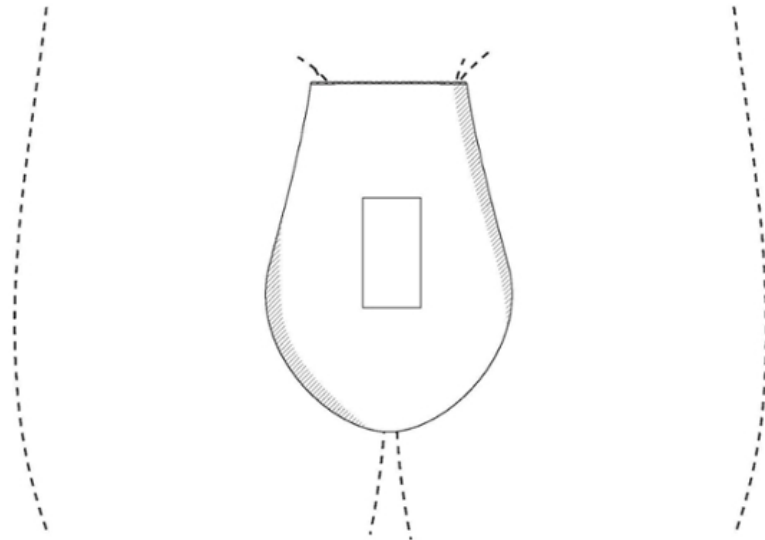

1.7



1.8



1.9



1.10



1.11

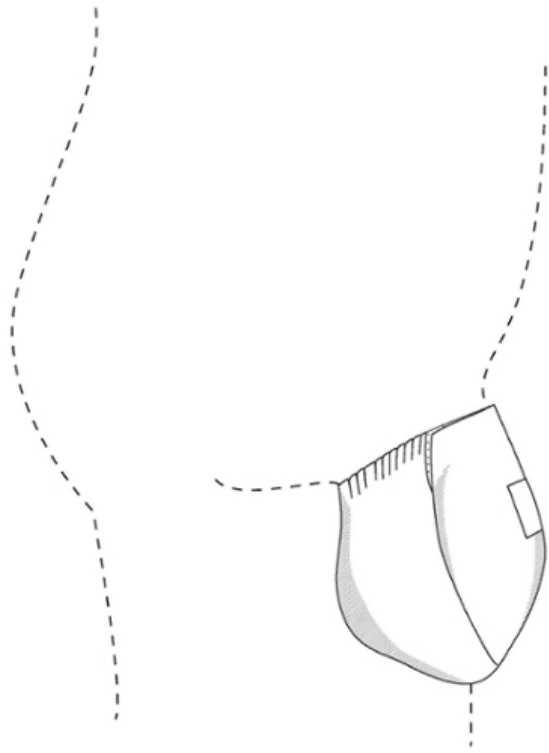

TRADEMARKS

APPLICATIONS FILED UNDER THE NATIONAL PROCEDURE APPROVED FOR REGISTRATION

The decision can be appealed at the Chamber of Appeal of Sakpatenti within 3 months from the publication or at the Mtskheta District Court Administrative Cases Board (Address: №17, Samkhedro St., Mtskheta), within 1 month following the publication.

(260) AM 2016 84226 A
(210) AM 84226
(220) 2015 10 16
(731) GROWTHWAY INVESTMENTS LIMITED
Simou Menardou 8, RIA COURT 8, 1st floor,
Flat/Office 101, 6015 Larnaca, Cyprus
(740) Tamaz Shilakadze
(540)



(591) Black, white
(531) 02.07.02, 05.13.08, 06.01.02, 25.01.19,
26.01.18, 27.05.11
(511) 32, 33, 35, 43

(260) AM 2016 84227 A
(210) AM 84227
(220) 2015 10 16
(731) GROWTHWAY INVESTMENTS LIMITED
Simou Menardou 8, RIA COURT 8, 1st floor,
Flat/Office 101, 6015 Larnaca, Cyprus
(740) Tamaz Shilakadze
(540)



(591) Black, white
(531) 05.11.15, 24.01.03, 24.01.09, 25.01.19,
27.05.17
(511) 32, 33, 35, 43

(260) AM 2016 85421 A
(210) AM 85421
(220) 2015 12 24
(731) DAVID KASHIA
Ingorokvas q. 6, 0105, Tbilisi, Georgia
(740) Natela Dograshvili
(540)



(591) White, red, sky-blue, brown, yellow
(531) 01.15.17, 02.05.22, 05.05.20, 25.01.01,
28.19, 29.01.15, 08.01.18
(511) 35

(260) AM 2016 85879 A
(210) AM 85879
(220) 2016 01 27
(731) LEPL GEORGIAN NATIONAL MUSEUM
Rustavelis gamz. 3, 0105, Tbilisi, Georgia
(540)



(591) Black, golden
(531) 03.11.11, 17.02.25, 26.01.16, 26.01.21,
29.01.12

(526) The trademark is protected as a whole. "საქართველოს", "ეროვნული", "მუზეუმი", "GEORGIAN", "NATIONAL", "MUSEUM" shall not be subject to independent legal protection.
(511) 35, 41, 43

(260) AM 2016 85913 A
(210) AM 85913
(220) 2016 02 01
(731) ALFRED SCHELLENBERG GMBH
An den Weiden 31, 57078 Siegen, Germany
(740) Merab Kvimsadze
(540)



(591) Black, white
(531) 26.01.05, 26.11.12, 27.05.10
(511) 6, 9

(260) AM 2016 86005 A
(210) AM 86005
(220) 2016 02 05
(731) CELINE
16 rue Vivienne, 75002 Paris, France
(740) Shalva Gvaramadze
(540)



(591) Black, white
(531) 27.05.01
(511) 9, 18, 25

(260) AM 2016 86333 A
(210) AM 86333
(220) 2016 02 25
(731) THONET Gesellschaft mit beschränkter Haftung
Michael-Thonet-Strasse 1, 35066 Frankenberg, Germany
(740) Shalva Gvaramadze
(540)



(511) 20

(260) AM 2016 86367 A
(210) AM 86367
(220) 2016 02 29
(310) 86/899,148
(320) 2016 02 05
(330) US

(731) LTD "AROMAPRODUKT"
Guramishvilis gamz. 17, 0192, Tbilisi, Georgia
(740) Tamaz Shilakadze
(540)



(526) The trademark is protected as a whole. "GEORGIA'S" and "NATURAL" shall not be subject to independent legal protection.
(511) 29, 30, 32

(260) AM 2016 86439 A
(210) AM 86439
(220) 2016 03 03
(731) DURATA THERAPEUTICS HOLDING C.V.
190 Elgin Avenue, George Town, Grand Cayman KY1-9005, Cayman Islands
(740) Liliana Darakhvelidze
(540)



(511) 5

(260) AM 2016 86504 A
(210) AM 86504
(220) 2016 03 09
(731) FERROSAN A/S
Sydmarken 5, DK-2860 Søborg, Denmark
(740) Shalva Gvaramadze
(540)



(511) 5

(260) AM 2016 86506 A
(210) AM 86506
(220) 2016 03 09
(731) FERROSAN A/S
Sydmarken 5, DK-2860 Søborg, Denmark
(740) Shalva Gvaramadze
(540)



(511) 5

(260) AM 2016 86509 A
(210) AM 86509
(220) 2016 03 09
(731) FERROSAN A/S
Sydmarken 5, DK-2860 Søborg, Denmark
(740) Shalva Gvaramadze
(540)



(511) 5

(260) AM 2016 86558 A
 (210) AM 86558
 (220) 2016 03 14
 (731) JOHNSON & JOHNSON
 ONE JOHNSON & JOHNSON PLAZA,
 NEW BRUNSWICK, NEW JERSEY
 08933, USA

(740) Giorgi Taktakishvili

(540)

**ONETOUCH SELECT PLUS
 SIMPLE**

(511) 10

(260) AM 2016 86561 A
 (210) AM 86561
 (220) 2016 03 14
 (731) LTD "G-M-P"
 Sop. Ponichala 65 , 0165, Tbilisi, Georgia

(740) Nugzar Ksovreli

(540)

**ბენზილორი
 БЕНЗИЛОР
 BENZILOR**

(511) 5

(260) AM 2016 86626 A
 (210) AM 86626
 (220) 2016 03 16
 (731) NISSAN JIDOSHA KABUSHIKI KAISHA
 (also trading as Nissan Motor Co., Ltd.)
 No.2, Takara-cho, Kanagawa-ku, Yokohama-shi,
 Kanagawa-ken, Japan

(740) Shalva Gvaramadze

(540)

I N F I N I T I

(591) Black, white

(531) 27.05.17

(511) 12

(260) AM 2016 86673 A
 (210) AM 86673
 (220) 2016 03 18
 (731) LTD "STUDIA MAESTRO"
 Sop. Dighomi, Didgoris q. 68/22, 3305,
 Tbilisi, Georgia

(740) Dimitri Dzamukashvili

(540)

თეკუნას კულინარიუმი

(511) 38, 41

(260) AM 2016 86679 A
 (210) AM 86679
 (220) 2016 03 18
 (731) LTD "STUDIA MAESTRO"
 Sop. Dighomi, Didgoris q. 68/22, 3305,
 Tbilisi, Georgia

(740) Dimitri Dzamukashvili

(540)

**სტუდია „მონიტორის“
 ჟურნალისტური
 გამოცემა**

(511) 38, 41

(260) AM 2016 86696 A
 (210) AM 86696
 (220) 2016 03 23
 (731) LTD "GURJI"
 Il. Cchavchavadzis gamz. 54a, b. 13, 0179,
 Tbilisi, Georgia

(740) Giorgi Taktakishvili

(540)

**ხოშიანი
 Хошиани
 Hoshiani**

(511) 33

(260) AM 2016 86699 A
 (210) AM 86699
 (220) 2016 03 23
 (731) BENTLEY MOTORS LIMITED
 Pymys Lane, Crewe, CW1 3PL, United
 Kingdom

(740) Shalva Gvaramadze

(540)

BENTLEY

(511) 12

(260) AM 2016 86832 A
 (210) AM 86832
 (220) 2016 03 30
 (310) 86/823,299
 (320) 2015 11 17
 (330) US
 (731) ZUFFA, LLC
 2960 West Sahara Avenue, Las Vegas,
 Nevada 89102, USA

(740) Tamaz Shilakadze

(540)

UFC GYM

(591) Black, white
(531) 26.11.08, 27.05.01, 27.05.11, 27.05.17
(511) 41

(260) AM 2016 86834 A
(210) AM 86834
(220) 2016 03 30
(731) ZUFFA, LLC
2960 West Sahara Avenue, Las Vegas,
Nevada 89102, USA
(740) Tamaz Shilakadze
(540)

UFC GYM

(511) 41

(260) AM 2016 86884 A
(210) AM 86884
(220) 2016 04 05
(731) LTD "ASPHARMA GEORGIA
PARMACEUTICAL COMPANY"
Mtskhethis q. 8, 0179, Tbilisi, Georgia
(740) Maia Samadashvili
(540)

EVALEP
ევალეპი
ЭВАЛЕП

(591) Black, white
(511) 5

(260) AM 2016 86887 A
(210) AM 86887
(220) 2016 04 05
(731) GILEAD SCIENCES IRELAND UC
Ida Business and Technology Park,
Carrigtohill, Co. Cork, Ireland
(740) Shalva Gvaramadze
(540)

РИМЦИФИК

(511) 5

(260) AM 2016 86888 A
(210) AM 86888
(220) 2016 04 05
(731) GILEAD SCIENCES IRELAND UC
Ida Business and Technology Park,
Carrigtohill, Co. Cork, Ireland
(740) Shalva Gvaramadze
(540)

ВЕМЛИДИ

(511) 5

(260) AM 2016 86905 A
(210) AM 86905
(220) 2016 04 07
(330) GE
(731) LTD "ASKANELI GROUP"
Kakhetis gzat., 110a, (nakv. 01/016), 0190,
Tbilisi, Georgia
(740) Giorgi Taktakishvili
(540)

ასკანელი
Askaneli
Асканели

(511) 35

TRADEMARKS REGISTERED ACCORDING TO THE ACCELERATED PROCEDURE

The decision can be appealed at the Chamber of Appeal of Sakpatenti within 3 months from the publication.

(111) M 2016 27763 R

(151) 2016 10 21

(181) 2026 10 21

(210) AM 88928

(220) 2016 10 11

(732) ZBYSEK BRABEK

Geneva, Bernex 1233, A Rt d'Aire la Ville,
Switzerland

(740) Irakli Gaprindashvili

(540)

საფერავო TV
Саперави TV
Saperavi TV

(511) 38

(111) M 2016 27764 R

(151) 2016 10 21

(181) 2026 10 21

(210) AM 88894

(220) 2016 10 07

(732) LTD "ROYAL BUSINESS"

Sop. Shashiani, 1500, Gurjaanis raioni,
Georgia

(740) Rahim Abach

(540)



(591) Black and green

(531) 02.01.01, 27.05.19, 29.01.12

(511) 29, 30

(111) M 2016 27765 R

(151) 2016 10 21

(181) 2026 10 21

(210) AM 88892

(220) 2016 10 07

(732) LTD "MAKNATUNA"

Gugunavas q. 3, 4600, Kutaisi, Georgia

(740) Mamuka Kurdadze

(540)

გააზიარე სიყვარული

(511) 29, 30

(111) M 2016 27766 R

(151) 2016 10 21

(181) 2026 10 21

(210) AM 88706

(220) 2016 09 28

(732) SONATA TRADING INTERNATIONAL FZC

PoBox 53010, Free Industrial zone of
HAMRIA, Sharzha, United Arab Emirates

(740) Irakli Gvilia

(540)



(591) Blue, green, white

(531) 05.05.20, 26.11.12, 27.05.07, 27.05.08,
29.01.13

(511) 3

(111) M 2016 27767 R

(151) 2016 10 21

(181) 2026 10 21

(210) AM 88720

(220) 2016 09 28

(732) SONATA TRADING INTERNATIONAL FZC

PoBox 53010, Free Industrial zone of
HAMRIA, Sharzha, United Arab Emirates

(740) Irakli Gvilia

(540)



(591) Pink, sky-blue, blue, orange, green, lilac,
brown, black, white

(531) 02.05.01, 02.05.02, 02.05.03, 27.05.08,
29.01.15

(511) 3

(111) M 2016 27768 R
 (151) 2016 10 21
 (181) 2026 10 21
 (210) AM 88726
 (220) 2016 09 28
 (732) SONATA TRADING INTERNATIONAL FZC
 PoBox 53010, Free Industrial zone of
 HAMRIA, Sharzha, United Arab Emirates
 (740) Irakli Gvilia
 (540)

BriteX

(591) Red and white
 (531) 01.01.12, 01.15.07, 27.05.08, 27.05.17,
 29.01.12
 (511) 3

(111) M 2016 27769 R
 (151) 2016 10 24
 (181) 2026 10 24
 (210) AM 88927
 (220) 2016 10 11
 (732) IRMA NIORADZE
 Z. Paliashvilis q. 90-92, b. 21, 0162, Tbilisi,
 Georgia
 (740) Giorgi Taktakishvili
 (540)

MAYA

(511) 41

(111) M 2016 27770 R
 (151) 2016 10 24
 (181) 2026 10 24
 (210) AM 88715
 (220) 2016 09 28
 (732) SONATA TRADING INTERNATIONAL FZC
 PoBox 53010, Free Industrial zone of
 HAMRIA, Sharzha, United Arab Emirates
 (740) Irakli Gvilia
 (540)

Bentol

(591) Different tone blue and sky-blue, white
 (531) 27.05.03, 29.01.04
 (511) 3

(111) M 2016 27771 R
 (151) 2016 10 24
 (181) 2026 10 24
 (210) AM 88579
 (220) 2016 09 14
 (732) VALIO LTD
 Meijertie 6, 00370 Helsinki, Finland

(740) Giorgi Taktakishvili
 (540)



(591) Blue, green, yellow, white
 (531) 08.03.05, 08.03.06, 19.03.24, 26.13.25,
 26.15.13, 29.01.14
 (511) 29

(111) M 2016 27772 R
 (151) 2016 11 01
 (181) 2026 11 01
 (210) AM 89053
 (220) 2016 10 18
 (732) NOVA PLASTIK SANAYI VE TICARET
 ANONIM ŞİRKETİ
 Muratpaşa Mah., Uluyol Cad. No:19 Kat 10
 D.48, İstanbul Tower, Bayrampaşa
 İSTANBUL, Turkey
 (740) Vakhtang Torotadze
 (540)

NOVA

(591) Sky-blue, blue
 (531) 27.05.17, 29.01.04
 (511) 35

(111) M 2016 27773 R
 (151) 2016 11 02
 (181) 2026 11 02
 (210) AM 89186
 (220) 2016 10 27
 (732) LTD "GEORGIAN BUILDING
 CONSORTIUM"
 A. Razmadzis q. 57, 0179, Tbilisi, Georgia
 (740) Nino Papiashvili
 (540)



(591) Blue and grey
 (531) 25.07.04, 26.11.07, 26.11.08, 27.05.23,

29.01.12
(511) 37

(111) M 2016 27774 R
(151) 2016 11 03
(181) 2026 11 03
(210) AM 89093
(220) 2016 10 21
(732) LTD "WEST INVEST"
Kairos q. 13a, (nakveti 2/64), 0137, Tbilisi,
Georgia
(740) Paata Arjevanidze
(540)



(591) Golden, yellow, black, green, red
(531) 05.13.10, 25.01.01, 27.05.01, 29.01.15
(526) The trademark is protected as a whole. "Olio"
shall not be subject to independent legal protection.
(511) 29

(111) M 2016 27775 R
(151) 2016 11 07
(181) 2026 11 07
(210) AM 88768
(220) 2016 09 29
(732) LASHA NORAKIDZE
Suvorovis q. 11, Ochamchire, Abkhazia
(refugee adress: Gldanis I m/r., korp. 16,
b. 176, 0167, Tbilisi, Georgia)
(740) LASHA NORAKIDZE
(540)

მარგალი

(511) 5

(111) M 2016 27776 R
(151) 2016 11 07
(181) 2026 11 07
(210) AM 89113
(220) 2016 10 25
(732) INGA GRIGOLIA
Veris me-2 shesak., b. 38, 0170, Tbilisi,
Georgia
(740) Giorgi Meipariani
(540)

რეაქცია

(511) 38, 41

(111) M 2016 27777 R

(151) 2016 11 07
(181) 2026 11 07
(210) AM 89183
(220) 2016 10 27
(732) LTD "GULF ARABIAN"
Mukhianis I m/r, korp.7, b.22, 0172, Tbilisi,
Georgia
(540)



(591) Green, white and red
(531) 05.03.15, 01.17.11, 29.01.13
(511) 30

INTERNATIONAL TRADEMARKS FOR WHICH A DECISION ON GRANTING PROTECTIONS IS TAKEN

The decision can be appealed at the Chamber of Appeal of Sakpatenti within 3 months from the publication or at the Mtskheta District Court Administrative Cases Board (Address: №17, Samkhedro str., Mtskheta), within 1 month following the publication.

(260) AM 2016 85656 A

(800) 1282175

(891) 2015 10 22

(731) ZİYLAN MAĞAZACILIK VE
PAZARLAMA ANONİM ŞİRKETİ
Merkez Mah. Taşocağı Cad. No.24 K.3,
Mahmutbey İstanbul, Turkey

(540)

ERICA PABLO

(591) black and white

(511)

25 – Inner and outer clothing made from all kinds of material, except clothing for protective purposes, namely, socks, scarfs, mufflers, shawls, bandanas, belts as clothing accessories, headgear, namely, hats, caps, bonnets; footwear, namely, shoes, slippers, sandals.

(260) AM 2016 85664 A

(800) 1282932

(891) 2015 09 23

(731) Association limited "Medical center "M.T.K."
10, Mykola Amosov Str. 680, Kyiv 03680,
Ukraine

(540)

ПАСКОНАТ

(591) Black, white

(511)

5 – Pharmaceutical preparations; amino acids for medical purposes; aminosalicic acid for medical purposes; antibiotics; antibacterial preparations for medical purposes; multi-component medical preparations; germicides; bacterial preparations for medical use; bacteriological preparations for medical use; biological preparations for medical purposes; vaccines; homeopathic preparations; elixirs (pharmaceutical preparations); medical preparations against mycobacteria; adjuvants for medical purposes; immunobiological preparations for medical use; antituberculous preparations; depuratives; medicines for human purposes; medicinal drinks; medicinal infusions; medical preparations for the prevention and treatment of various diseases; pastilles for pharmaceutical purposes; medical preparations for the prevention and treatment of various infectious diseases; medical preparations for the prevention and treatment of pulmonary diseases; medical and pharmaceutical preparations for the prevention and treat-

ment of tuberculosis; pharmaceutical preparations for treatment of mycobacterial infections, including tuberculosis; antifungal preparations; anti-inflammatory preparations; antimicrobial medical preparations for systematic use; injectable pharmaceuticals; syrups for pharmaceutical purposes; substances for use in pharmaceutical preparations; chemico-pharmaceutical preparations; chemical preparations for medical purposes.

(260) AM 2016 85684 A

(800) 1282989

(891) 2015 10 22

(731) THYSSENKRUPP BILSTEIN GMBH
August-Bilstein-Str. 4, 58256 Ennepetal;
THYSSENKRUPP AG
ThyssenKrupp Allee 1 45143 Essen, Germany

(540)



(591) Blue, yellow

(511)

7 – Shock absorber plungers; shock absorbers for machines.

12 – Parts for motor vehicles, included in this class; hydraulic units for motor vehicles in the form of shock-absorbing and/or stabilising elements for chassis and chassis superstructures of motor vehicles; vibration dampers for wheel suspensions of motor vehicles, and individual parts and attachments therefor, included in this class; suspension struts, included in this class; suspension struts for vehicles, in particular air suspension struts; combined spring/damper modules for vehicles; MacPherson suspension struts for land vehicles; suspension struts with steel springs or air springs for wheel suspensions of motor vehicles, and individual parts and attachments therefor, included in this class; gas-filled shock absorbers, in particular hydropneumatic shock absorbers for motor vehicles and for use as machine parts, included in this class; support bearings for motor vehicle vibration dampers; springs for wheel suspensions of motor vehicles, in particular helical compression springs, air springs, single air springs.

17 – Buffers of rubber, in particular in the form of individual parts and attachments for vibration dampers and suspension struts for wheel suspensions of motor vehicles.

(260) AM 2016 85685 A
 (800) 1282554
 (891) 2015 12 02
 (731) MAR-KO FLEISCHWAREN GMBH & CO.
 KG
 Waldecker Straße 15, 99444 Blankenhain,
 Germany

(540)

SALAMINI KIXX

(511)
 29 – Meats products and charcuterie; uncooked charcuterie; snacks made from the aforesaid products.

(260) AM 2016 85686 A
 (800) 1282993
 (891) 2015 11 18
 (731) APPLE INC.
 1 Infinite Loop, Cupertino CA 95014, USA

(540)



(591) Black, beige, blue, orange, green and pink
 (511)

9 – Computer software for organizing, storing, providing access to, redeeming, scanning, sharing, and providing information about goods, services, discounts, tickets, boarding passes, coupons, consumer loyalty programs, and gift cards concerning a wide range of consumer products, services, and cultural, sporting and entertainment events; computer software for promoting the goods, services and providing information of others over a global communications network in any format, namely, handheld digital mobile communications devices; computer software for downloading and storing vouchers and tickets for admission to sporting, cultural and entertainment events; computer software for capturing, managing, and storing credit card and debit card information; computer software to facilitate electronic payments.

(260) AM 2016 85687 A
 (800) 1282201
 (891) 2015 07 09
 (731) WORLD MEDICINE İLAÇ SANAYİ VE
 TİCARET ANONİM ŞİRKETİ

Evren Mah. Camiyolu Cad. No:50 K:1 B,
 Zemin 4-5-6, Güneşli Bağcılar, İstanbul,
 Turkey

(540)

GOCHAMIN
ГОЧАМИН

(591) black and white

(511)

5 – Medicines for human purposes, medicines for veterinary purposes, vitamin preparations, chemical preparations for medical purposes, dietetic substances adapted for medical use; dietetic foods adapted for medical, purposes; baby foods, medicinal herbs, herbal beverages adapted for medical purposes, nutritional supplements, pollen dietary supplements, mineral food supplements, protein dietary supplements; dietary supplements for animals; fodder supplements for veterinary purposes; medicines for dental purposes, hygienic products for medical purposes including sanitary pads, breast-nursing pads and bunion pads, waddings for medical purposes, plasters for medical purposes, dressings for medical purposes, babies' napkins, preparations for destroying noxious plants, preparations for destroying noxious animals, fungicides, deodorants other than for human beings or for animals, air deodorising preparations, disinfectants for hygiene purposes, antiseptics, detergents for medical purposes.

(260) AM 2016 85688 A
 (800) 1282222
 (891) 2015 09 18
 (731) PRODECO PHARMA srl Unipersonale
 Via G. Toniolo, 25/1, I-31033 Castelfranco
 Veneto (TV), Italy

(540)



(591) black and white

(511)

3 – Bleaching preparations and other substances for laundry use; cleaning, polishing, scouring and abrasive preparations; soaps; perfumery, essential oils, cosmetics, hair lotions; toothpastes.

5 – Pharmaceutical, veterinary and sanitary preparations, dietetic substances for medical use, food for babies, plasters, materials for dressings, material for stopping teeth, dental wax, disinfectants, preparations for destroying vermin, fungicides, herbicides.

(260) AM 2016 85690 A
 (800) 1282556
 (891) 2015 12 11
 (731) ARALEZ PHARMACEUTICALS TRADING
 DESIGNATED ACTIVITY COMPANY
 56 Fitzwilliam Square, Dublin 2, Ireland
 (540)

ARALEZ

(511)
 5 – Pharmaceutical preparations and substances.
 42 – Research and development of new products; re-
 search and development of pharmaceutical prepara-
 tions and medicines.

(260) AM 2016 85691 A
 (800) 1282229
 (891) 2015 09 30
 (731) TOVARYSTVO Z OBMEZHENOIU
 VIDPOVIDALNISTIU "NATSIONALNA
 HORILCHANA KOMPANIIA"
 Smilianske shose, 8-i kilometr, bud. 2,
 s. Stepanyk, Cherkaskyi raion, Cherkaska
 oblast 19632, Ukraine

(540)



(591) black and white
 (554) Three - Dimensional
 (511)
 33 – Anisette (liqueur); kirsch; vodka; gin, sake.

(260) AM 2016 85714 A
 (800) 1282629
 (891) 2015 04 17
 (731) ÖZKANLAR ELEKTRONİK İLETİŞİM
 İNŞAAT VE GIDA TİCARET LİMİTED
 ŞİRKETİ
 Tahtakale Mah. Tahtakale Cad. Dekalo Han
 No:16 D:101, Eminönü Fatih İstanbul, Turkey

(540)

SYROX

(591) Black,white
 (511)
 7 – Machines, machine tools and industrial robots
 for processing and shaping wood, metals, glass, plas-
 tics and minerals, 3D printers; construction machi-

nes and robotic mechanisms (machines) for use in
 construction: bulldozers, diggers (machines), exca-
 vators, road construction and road paving machines,
 drilling machines, rock drilling machines, road swee-
 ping machines; lifting, loading and transmission
 machines and robotic mechanisms (machines) for
 lifting, loading and transmission purposes: elevators,
 escalators and cranes; machines and robotic mecha-
 nisms (machines) for use in agriculture and animal
 breeding, machines and robotic mechanisms (machines)
 for processing cereals, fruits, vegetables and
 food; engines and motors, other than for land vehi-
 cles, parts and fittings therefor: hydraulic and pneu-
 matic controls for engines and motors, brakes other
 than for vehicles, brake linings for engines, cranks-
 hafts, gearboxes, other than for land vehicles, gear-
 boxes, cylinders for engines, pistons for engines, tur-
 bines, not for land vehicles, filters for engines and
 motors, oil, air and fuel filters for land vehicle en-
 gines, exhausts for land vehicle engines, exhaust ma-
 nifolds for land vehicle engines, engine cylinders for
 land vehicles, engine cylinder heads for land vehi-
 cles, pistons for land vehicle engines, carburetors for
 land vehicles, fuel conversion apparatus for land ve-
 hicle engines, injectors for land vehicle engines, fuel
 economisers for land vehicle engines, pumps for
 land vehicle engines, valves for land vehicle engi-
 nes, starter motors for land vehicles, dynamos for
 land vehicle engines, sparking plugs for land vehicle
 engines; bearings (parts of machines), roller or ball
 bearings; machines for mounting and detaching tires;
 alternators, current generators, electric generators,
 current generators operated with solar energy; pain-
 ting machines, automatic spray guns for paint, el-
 ectric, hydraulic and pneumatic punching machines
 and guns, electric adhesive tape dispensers (machi-
 nes), electric guns for compressed gas or liquid spra-
 ying machines, electric hand drills, electric hand
 saws, electric jigsaw machines, spiral machines, co-
 mpressed air machines, compressors (machines), ve-
 hicle washing installations, robotic mechanisms (ma-
 chines) with the abovementioned functions; electric
 and gas-operated welding apparatus, electric arc
 welding apparatus, electric soldering apparatus, elec-
 tric arc cutting apparatus, electrodes for welding
 machines, industrial robots (machines) with the above-
 mentioned functions; printing machines; packaging
 machines, filling, plugging and sealing machines, la-
 bellers (machines), sorting machines, industrial ro-
 bots (machines) with the abovementioned functions,
 electric packing machines for plugging and sealing
 of plastics; machines for textile processing, sewing
 machines, industrial robots (machines) with the abo-
 vementioned functions; fuel dispensing pumps for
 service stations, self-regulating fuel pumps; electric
 kitchen machines for chopping, grinding, crushing,
 mixing and mincing foodstuff, washing machines,
 laundry washing machines, dishwashers, spin driers
 (not heated), electric cleaning machines for cleaning

floors, carpets or floorings, vacuum cleaners and parts thereof; automatic vending machines; galvanizing and electroplating machines; electric door openers and closers; joints (parts of engines).

9 – Measurement apparatus and equipment including those for scientific, nautical, topographic, meteorologic, industrial and laboratory purposes, thermometers, not for medical purposes, barometers, ammeters, voltmeters, hygrometers, testing apparatus not for medical purposes, telescopes, periscopes, directional compasses, speed indicators, laboratory apparatus, microscopes, magnifying glasses, stills, ovens and furnaces for laboratory experiments; apparatus for recording, transmission or reproduction of sound or images, cameras, photographic cameras, television apparatus, video recorders, CD and DVD players and recorders, MP3 players, computers, desktop computers, tablet computers, microphones, loudspeakers, earphones, telecommunications apparatus, apparatus for the reproduction of sound or images, computer peripheral devices, cell phones, covers for cell phones, telephone apparatus, computer printers, scanners [data processing equipment], photocopiers; magnetic and optic data carriers and computer software and programmes recorded thereto, downloadable and recordable electronic publications, encoded magnetic and optic cards; antennas, satellite antennas, amplifiers for antennas, parts of the aforementioned goods; ticket dispensers, automatic teller machines (ATM); electronic components used in the electronic parts of machines and apparatus, semi-conductors, electronic circuits, integrated circuits, chips (integrated circuits), diodes, transistors (electronic), magnetic heads for electronic apparatus, electronic locks, photocells, remote control apparatus for opening and closing doors, optical sensors; counters and quantity indicators for measuring the quantity of consumption, automatic time switches; clothing for protection against accidents, irradiation and fire, safety vests and life-saving apparatus and equipment; eyeglasses, sunglasses, optical lenses and cases, containers, parts and components thereof; apparatus and instruments for conducting, transforming, accumulating or controlling electricity, electric plugs, junction boxes (electricity), electric switches, circuit breakers, fuses, lighting ballasts, battery starter cables, electrical circuit boards, electric resistances, electric sockets, transformers (electricity), electrical adapters, battery chargers, electric door bells, electric and electronic cables, batteries, electric accumulators; alarms and anti-theft alarms, other than for vehicles, electric bells; signalling apparatus and instruments, luminous or mechanical signs for traffic use; fire extinguishing apparatus, fire engines, fire hose and fire hose nozzles; radar apparatus, sonars, night vision apparatus and instruments; decorative magnets; metronomes.

28 – Games and toys; arcade video game machines; game apparatus and machines for use with an external display screen and monitor, including those coin-operated; toys for animals; toys for outdoor pla-

ygrounds, parks and game parks; gymnastic and sporting articles not included in other classes; fishing tackle, artificial fishing bait, decoys for hunting and fishing; Christmas trees of artificial material, ornaments for Christmas trees, artificial snow for Christmas trees, rattles (playthings), novelties for parties, dances (party favors), paper party hats.

(260) AM 2016 85715 A

(800) 1283073

(891) 2015 11 26

(731) WENZHOU AKADA FOREIGN TRADE CO., LTD.

North of 4/F, Room 203, Guoda Plaza,
Economic and Technical Development
Zone, Wenzhou Zhejiang, China

(540)

AKADA

(591) Black, white

(511)

6 – Door handles of metal; knobs of metal; chains of metal; door bolts of metal; hinges of metal; fittings of metal for furniture; ironmongery; locks of metal, other than electric; padlocks; keys.

(260) AM 2016 85716 A

(800) 1282639

(891) 2015 04 17

(731) WERIT-Kunststoffwerke W. Schneider GmbH & Co. KG

Kölner Straße, 57610 Altenkirchen, Germany

(540)



(591) Black, white

(511)

6 – Common metals and their alloys; metal building materials; transportable metal constructions; railway material of metal; cables and wires of metal (not for electrical purposes); metal hardware and ironmongery; metallic pipes and tubes; vessels, especially container tanks, barrels, containers and intermediate bulk containers (IBC), especially for transportation and storage, made primarily of metal, especially tin plate or tin sheets, including rain water tanks for installation in cellar and soil, storage and transport containers for every object and/or liquid, industry tanks, heating oil tanks and pallet boxes; protection

cages, made primarily of metal, for containers of all types, especially for intermediate bulk containers (IBC); frameworks, made primarily of metal, for buildings and/or containers; transport, storage and support pallets (made primarily of metal); container seals (made primarily of metal); packaging containers made of metal; taps for barrels (made primarily of metal); storage racks for barrels (made primarily of metal); metal reinforcement materials for building purposes; semi-processed building elements made of metal for the production of sanitary facilities, especially for frame and/or pre wall installations, as well as their parts; protection cages and pallets made of metal for containers of all types; frameworks made of metal; masonry claddings made of metal, metal frames for building purposes; claddings made of metal for building purposes; wall claddings made of metal; roof tiles made of metal; holders for antennas, not adapted.

11 – Water supply installations as well as sanitary apparatuses and systems; sinks, kitchen sinks; bath apparatuses; bathtubs; bath installations; bidets; showers; shower cubicles (complete); shower heads; taps; handles for showers; tubs for sitz baths; toilets (WC); toilet bowls (WC); toilet seats (WC); toilet flushing apparatuses; toilet tanks (WC), especially for wall mounting or surface installation; drain and filler valves (WC); panels (WC) made of plastic or metal; partition walls for bathtubs or showers; urinals (sanitary facilities); wash-hand basins (parts of sanitary installations); toilet modules, wash basin modules, urinal modules, bidet modules, bath filler modules and combinations thereof; water filtration devices; toilet cisterns; whirlpool jet apparatuses; ionization devices for the treatment of water; sea-water desalination installations and water purification installations and apparatuses, especially portable ones; water softening apparatuses and installations; water purification installations and machines; water sterilization apparatuses, water supply and distribution installations; water dispensing systems and apparatuses; heat accumulators.

20 – Architectural fittings, not of metal, namely, window fittings, furniture fittings, coffin fittings, door fittings and bed fittings; fastening materials of plastic; vessel, including tanks, barrels, canisters, containers and IBCs, especially for storage and transportation, made of plastic, including rainwater tanks for installation in cellars and soil, storage and transport containers for every object, industrial tanks; heating oil tanks and pallet boxes; transport, loading and conveyor pallets (non-metal); injection-moulded parts made of plastic, including drain taps, screw caps and valves and parts thereof; cans, boxes and cases made of plastic; handle sets, not of metal; dowels (connecting dowels, pins), not of metal; dowels (wall plugs), not of metal; screws, nuts, protection caps, washers and other connecting and fixing

parts made of plastic; container seals (not of metal); packaging containers made of plastic; staves; taps for barrels (not of metal); barrel stands (not of metal); floating containers (non-metal); clips made of plastic for cables and pipes; stands for flowerpots; furniture; magazine and newspaper racks; vats, rain barrels, all of the aforementioned products not of metal.

(260) AM 2016 85733 A

(800) 1282794

(891) 2015 08 26

(731) WORLD MEDICINE İLAÇ SANAYİ VE
TİCARET ANONİM ŞİRKETİ
Evren Mah. Camiyolu Cad. No.50 Kat 1 B,
Zemin 4-5-6 Güneşli, Bağcılar İstanbul,
Turkey

(540)

ASPOCARDİN

АСПОКАРДИН

(591) Black,white

(511)

5 – Medicines for human purposes, medicines for veterinary purposes, vitamin preparations, chemical preparations for medical purposes, dietetic substances adapted for medical use; dietetic foods adapted for medical purposes; baby foods, medicinal herbs, herbal beverages adapted for medical purposes, nutritional supplements, pollen dietary supplements, mineral food supplements, protein dietary supplements; dietary supplements for animals; fodder supplements for veterinary purposes; medicines for dental purposes, hygienic products for medical purposes including sanitary pads, breast-nursing pads and bunion pads, waddings for medical purposes, plasters for medical purposes, dressings for medical purposes, babies' napkins, preparations for destroying noxious plants, preparations for destroying noxious animals, fungicides, deodorants other than for human beings or for animals, air deodorising preparations, disinfectants for hygiene purposes, antiseptics, detergents for medical purposes.

(260) AM 2016 85735 A

(800) 1282795

(891) 2015 08 26

(731) WORLD MEDICINE İLAÇ SANAYİ VE
TİCARET ANONİM ŞİRKETİ
Evren Mah. Camiyolu Cad. No.50 Kat 1 B, Zemin 4-5-6 Güneşli, Bağcılar, İstanbul, Turkey

(540)

SIKORA

СИКОРА

(591) Black, white

(511)

5 – Medicines for human purposes, medicines for veterinary purposes, vitamin preparations, chemical preparations for medical purposes, dietetic substances adapted for medical use; dietetic foods adapted for medical purposes; baby foods, medicinal herbs, herbal beverages adapted for medical purposes, nutritional supplements, pollen dietary supplements, mineral food supplements, protein dietary supplements; dietary supplements for animals; fodder supplements for veterinary purposes; medicines for dental purposes, hygienic products for medical purposes including sanitary pads, breast-nursing pads and bunion pads, waddings for medical purposes, plasters for medical purposes, dressings for medical purposes, babies' napkins, preparations for destroying noxious plants, preparations for destroying noxious animals, fungicides, deodorants other than for human beings or for animals, air deodorising preparations, disinfectants for hygiene purposes, antiseptics, detergents for medical purposes.

(260) AM 2016 85747 A

(800) 1283074

(891) 2015 11 26

(731) SHANDONG LINGLONG TYRE CO., LTD.

No.777 Jinlong Road, Zhaoyuan City,

265400 Shangdong Province, China

(540)



(591) Black, white

(511)

12 – Automobile tires; inner tubes for pneumatic tires; casings for pneumatic tires; treads for retreading tires; tires for airplanes; pneumatic tires, solid, for vehicle wheels; vehicle wheel tires; pneumatic tires; bicycle tires; tires for vehicle wheels.

(260) AM 2016 85760 A

(800) 1141156

(891) 2015 12 21

(731) CUETARA, S.L.

Avda. Hermanos Gómez Cuétara Núm. 1

E-28590 VILLAREJO DE SALVANES,

Madrid, Spain

(540)



(591) Red, white and gray

(511)

30 – Coffee, tea, cocoa, chocolate, sugar, rice, tapioca, sago, artificial coffee; flour and preparations made from cereals, bread, pastry and confectionery, edible ices; honey, treacle; yeast, baking powder; salt, mustard; vinegar, sauces (condiments); spices; ice; biscuits.

(260) AM 2016 85762 A

(800) 1182416

(891) 2015 11 25

(731) AIR HOUSE PTY LTD

57 Audley Street, Petersham NSW 2049,

Australia

(540)



(591) Black, white, yellow, red

(511)

41 – Children's entertainment services; providing facilities for entertainment; provision of entertainment facilities.

(260) AM 2016 85767 A

(800) 1244734

(891) 2015 11 10

(731) BIRKENSTOCK SALES GMBH

Rheinstraße 10, 53560 Vettelschoß, Germany

(540)

BIRKENSTOCK

(511)

18 – Leather and imitation leather goods made thereof, namely bags, hand bags, gym bags, purse, coin purses, key bags, key bags, briefcases, rucksacks, business card holders, travel garment covers, toiletry bags, toiletry cases (sold empty); animal skins, hides; trunks and travelling bags; umbrellas and parasols; walking sticks; whips, harness and saddlery; parts and accessories for all the aforesaid goods, included in this class.

25 – Clothing, footwear, headgear; parts and fittings for footwear, namely shoe uppers, heels, outsoles, inner soles, insoles, parts for shoe bottoms, foot supports, arch supports and shoe inserts; inner soles; soles for footwear.

35 – Advertising; business management; business administration; office functions; wholesaling and retailing in relation to paints, varnishes, lacquers, preservatives against rusts and against deterioration of wood, colorants, mordants, raw natural resins, metals in foil and powder form for painters, decorators, printers and artists, printing ink, food dyes, colorants for beverages, shoe dyes, mordants for leather, ink for leather, protective preparations for metals, thinners for paints and lacquers, undercoating

for vehicle chassis, silvering powders, gildings, dusters, bleaching preparations and other substances for laundry use, cleaning, polishing, scouring and abrasive preparations, soaps, perfumery, essential oils, cosmetics, hair lotions, dentifrices, air fragrancing preparations, breath freshening sprays, sachets for perfuming linen, tissues impregnated with cosmetic lotions, tissues impregnated with cleaning preparations, perfumed tissues, preparations for cleaning and polishing leather and shoes, creams for leather, preservatives for leather, leather polish, cleaning preparations for shoes, shoe cream, shoe polish, shoe spray, shoe wax, pharmaceutical and veterinary preparations, sanitary preparations for medical purposes, dietetic food and substances adapted for medical or veterinary use, food for babies, dietary supplements for humans and animals, plasters, materials for dressings, material for stopping teeth, dental wax, disinfectants, preparations for destroying vermin, fungicides, herbicides, dietetic substances adapted for medical use, tissues impregnated with pharmaceutical lotions, air deodorising preparations, first-aid boxes and first-aid cushions, filled, first-aid kits, filled, foot impression materials and foot impression foams, hand tools and implements (hand-operated), cutlery, side arms, razors, hair clippers for personal use (hand instruments) and nail clippers, files, electric or non-electric fingernail polishers, manicure sets and pedicure sets, shaving cases, non-electric hand implements for hair curling, electric and non-electric depilation appliances, cuticle nippers, pincers, razor blades, scientific, nautical, surveying, photographic, cinematographic, optical, weighing, measuring, signalling, checking (supervision), lifesaving and teaching apparatus and instruments, apparatus and instruments for conducting, switching, transforming, accumulating, regulating or controlling electricity, apparatus for recording, transmission or reproduction of sound or images, magnetic data carriers, recording discs, compact discs, DVDs and other digital data carriers, mechanisms for coin-operated apparatus, cash registers, calculating machines, data processing equipment, computers, computer software, fireextinguishing apparatus, spectacles, sunglasses, spectacle frames, spectacle cases, contact lenses, containers for contact lenses, headphones, bathroom scales, fat measuring scales, digital photo frames, light dimmers (regulators), electronic publications (downloadable), electronic agendas, ergometers, time switches, laptop bags, bags for tablet computers and for mobile telephones, parts and fittings for all the aforesaid goods, surgical, medical, dental and veterinary apparatus and instruments, artificial limbs, eyes and teeth, orthopaedic articles, suture materials, massage apparatus, pulse meters, electric footwarmers for medical purposes, electric blankets and heating cushions for medical purposes, inner soles for corrective treatment for foot conditions, orthopaedic shoe inserts and inserts for orthopaedic

footwear, including orthopaedic inner soles incorporating arch supports, orthopaedic supports for feet and shoes, foot bandages (supportive), orthopaedic foot pads, arch cushions (orthopaedic), supports for flat feet, elasticised supports for the ankle, foot supports, soles for shoes (orthopaedic), orthotic inserts for footwear, orthopaedic footwear and the like for rehabilitation, foot gymnastics and therapy, and for other medical purposes, parts and fittings for all the aforesaid goods, in particular fitting components, wedges, pads, insoles, foam padding, foam pads and moulded shoe soles, including in the form of orthopaedic fully plastic inserts, elastic stockings for medical purposes, parts and fittings for all of the aforesaid goods, apparatus for lighting, heating, steam generating, cooking, refrigerating, drying, ventilating, water supply and sanitary purposes, water filters, air deodorising apparatus, air humidifiers, electric blankets and heating cushions, other than for medical purposes, massage bath installations, barbecues, tanning apparatus (sun beds), ornamental fountains, domestic fireplaces, whirlpools, sauna bath installations, parts and fittings for all the aforesaid goods, precious metals and their alloys, jewellery, precious stones, horological and chronometric instruments, watch cases and jewellery cases, paper, cardboard, printed matter, bookbinding material, photographs, stationery, adhesives for stationery or household purposes, artists' materials, paintbrushes, typewriters and office requisites (except furniture), instructional and teaching material (except apparatus), plastic materials for packaging (not included in other classes), printers' type, printing blocks, stationery, tissues of paper for removing makeup, disposable articles of paper, filtering materials of paper, paper materials for packaging, works of art and figurines of paper or cardboard and architectural models, bags, pouches and goods for packaging, wrapping and storage purposes of paper, cardboard or plastic, posters, leather and imitations of leather, and goods made of these materials, namely bags, handbags, sports bags, purses, wallets, key cases, key holders, attaché cases, backpacks, business card holders, garment bags, toiletry bags, toiletry cases, animal skins, hides, trunks and travelling bags, umbrellas and parasols, walking sticks, whips, harness and saddlery, parts and fittings for all the aforesaid goods, building materials (non-metallic), nonmetallic rigid pipes for building, asphalt, pitch and bitumen, non-metallic transportable buildings, monuments, not of metal, clay, rock crystal, letter boxes of masonry, building glass, safety glass, paint spraying booths, not of metal, insect screens, not of metal, geotextiles, granite, cork (compressed), marble, mosaics for building, schists, bird baths (not of metal), wall and ceiling panels of wood, plastic and foamed material, covering and cladding panels, not of metal, strips, not of metal, included in class 19, wall and facade plasters, floor coverings of wood or stone,

windows and doors, wall and ceiling panelling of wood, parquet, laminate, tiles, not of metal, wood, porches, not of metal, for building, jalousies, not of metal, transportable buildings (non-metallic) in the form of summerhouses and gazebos, garden pavilions, greenhouses, conservatories, transportable tool sheds, not of metal, building materials of wood, plastic, clay or glass for use in gardening and landscaping, works of art and figurines (statuettes) of stone, concrete, marble, swimming pools (structures, not of metal), furniture, mirrors, picture frames, furnishings, display boards, bamboo curtains, statues, figurines, works of art and ornaments and decorations, included in this class, containers and closures and holders therefor, dowels, not of metal, nonelectric fans for personal use, coathooks, not of metal, nonluminous house numbers, not of metal, fixed towel dispensers, not of metal, baskets, not of metal, garment covers (storage), mattresses, massage tables, sleeping bags for camping, slatted bed frames, inflatable publicity objects, air mattresses, not for medical purposes, air cushions, not for medical purposes, tent pegs, not of metal, parts and fittings for all the aforesaid goods, roller blinds of textile or of plastic, household or kitchen utensils and containers, combs and sponges, brushes (except paint brushes), brush-making materials, articles for cleaning purposes, steelwool, unworked or semiworked glass (except glass used in building), glassware, porcelain and earthenware not included in other classes, cosmetic utensils, fitted picnic baskets, comb cases, shaving brush stands, perfume burners, shoe horns, non-electric waxpolishing appliances for shoes, shoe trees, boot trees, fitted vanity cases, non-electric portable coldboxes, toothbrushes, parts and fittings for the aforesaid goods, textiles and textile goods, not included in other classes, bed covers, table covers, household textiles, shower curtains of textile, sanitary flannel, wall hangings of textile, clothing, footwear, headgear, parts and fittings for footwear, namely shoe uppers, heels, outsoles, inner soles, insoles, parts for shoe bottoms, foot supports, arch supports and shoe inserts, lace and embroidery, ribbons and braid, buttons, hooks and eyes, pins and needles, artificial flowers, fruits and plants, badges for wear, not of precious metal, ornamental novelty badges (buttons), sew-on badges, brooches (clothing accessories), haberdashery, except thread, hair ornaments, hair curlers, other than hand implements, false hair, shoe ornaments, not of precious metal, numerals or letters for marking linen, carpets, rugs, mats and matting, linoleum and other materials for covering existing floors, wall hangings (non-textile), games and playthings, gymnastic and sporting articles not included in other classes, decorations for christmas trees, mobiles, video game machines, game consoles, controllers for game consoles, parts and fittings for gymnastic and sporting articles, meat, fish, poultry and game, meat extracts, preserved, frozen, dried and co-

oked fruits and vegetables, jellies, jams, compotes, eggs, milk and milk products, edible oils and fats, milk beverages, milk predominating, prepared meals, consisting predominantly of meat, fish, poultry, game, vegetables, eggs, milk or milk products, coffee, tea, cocoa and artificial coffee, rice, tapioca and sago, flour and preparations made from cereals, bread, pastry and confectionery, ices, sugar, honey, treacle, yeast, baking powder, salt, mustard, vinegar, sauces (condiments), spices, ice, prepared meals, consisting predominantly of pasta, rice, pizza, grains and agricultural, horticultural and forestry products not included in other classes, live animals, fresh fruits and vegetables, seeds, natural plants and flowers, foodstuffs for animals, malt, beers, mineral and aerated waters and other non-alcoholic beverages, fruit beverages and fruit juices, syrups and other preparations for making beverages; business consulting services; business consultancy services relating to marketing.

(260) AM 2016 85778 A

(800) 1283628

(891) 2015 11 25

(731) PHILIP MORRIS BRANDS SÀRL

Quai Jeanrenaud 3 CH-2000 Neuchâtel,
Switzerland

(540)

MLB

(511)

9 – Batteries for electronic cigarettes; batteries for electronic devices that are used for heating tobacco, battery chargers for electronic devices that are used for heating tobacco; USB chargers for electronic devices that are used for heating tobacco; car chargers for electronic cigarettes; car chargers for devices that are used for heating tobacco.

34 – Tobacco, raw or manufactured; tobacco products; cigars, cigarettes, cigarillos, tobacco for roll-your-own cigarettes, pipe tobacco, chewing tobacco, snuff tobacco, kretek; snus; tobacco substitutes (not for medical purposes); electronic cigarettes; tobacco products for the purpose of being heated; electronic devices and their parts for the purpose of heating cigarettes or tobacco in order to release nicotine-containing aerosol for inhalation; smokers' articles, cigarette paper, cigarette tubes, cigarette filters, tobacco tins, cigarette cases, ashtrays, pipes, pocket apparatus for rolling cigarettes, lighters, matches; electronic devices for inhalation containing essential oils (smokers' articles); liquid nicotine solutions, namely, liquid nicotine for use in electronic cigarettes; aromatic preparations, namely, liquid preparation used to refill cartridges of electronic cigarettes; wired vaporizer for electronic cigarettes and electronic smoking devices.

35 – Wholesale or retail services in the field of tobacco products, electronic cigarettes and products for use with electronic cigarettes.

(260) AM 2016 85784 A

(800) 1283352

(891) 2015 08 19

(731) APPLE INC.

1 Infinite Loop, Cupertino CA 95014, USA

(540)



(591) Pink, red, white, grey, dark green and light green

(554) Three - Dimensional

(511)

42 – Computer programming; design and development of computer hardware and software; computer hardware and software consulting services; support and consultation services for developing computer systems, databases and applications; providing computer hardware or software information online; providing online non-downloadable software; information, advisory and consultancy services relating to all the aforesaid.

(260) AM 2016 85789 A

(800) 1283435

(891) 2015 07 13

(731) RETAL INDUSTRIES LIMITED

Chrysanthou Mylona, 10, MAGNUM HOUSE, CY-3030 Limassol, Cyprus

(540)

RETAL

(591) black and white

(511)

1 – Plastics, unprocessed, including polyethylene terephthalate.

16 – Plastic film for wrapping.

17 – Semi-processed plastic substances, including preforms (blanks) for manufacturing containers for food and non-food products, including bottles, cans; plastic film, not for wrapping.

20 – Goods of plastics, not included in other classes, including handles for carrying bottles, screw tops, not of metal, for containers, including bottles.

21 – Reusable plastic water bottles, empty; household containers for food and non-food products, including cans.

40 – Processing of polyethylene terephthalate; processing of polyethylene.

42 – Research and development of new products for others; consultancy in the fields of development and design of plastic packaging equipment; packaging design services.

(260) AM 2016 85790 A

(800) 1283437

(891) 2015 07 13

(731) OBI GmbH & Co. Deutschland KG

Albert-Einstein-Str. 7-9, 42929

Wermelskirchen, Germany

(540)

OBI

(591) Orange and black

(511)

1 – Chemicals used in industry, and photography, as well as in agriculture, horticulture and forestry; unprocessed plastics; manures; fire extinguishing compositions; tempering and soldering preparations; chemical substances for preserving foodstuffs; adhesives used in industry; gritting salt for ice and snow; plant substrates, loam; filtering media of chemical and non-chemical substances included in this class; chemical preparations and materials for film, photography and printing; detergents for use in manufacture and industry; salts for industrial purposes; synthetic resins, unprocessed; starches for use in manufacturing and industry; putties, and fillers and pastes for use in industry.

2 – Paints, varnishes, lacquers; preservatives against rust; preservatives against deterioration of wood; mordants; raw natural resins; metals in foil and powder form for painters, decorators, printers and artists; dyes, colorants, pigments; thinners and thickeners for coatings, dyes and inks; coatings; additives in connection with the aforesaid goods, included in this class.

3 – Bleaching preparations and other substances for laundry use; cleaning, polishing, scouring and abrasive preparations; soaps; perfumery; essential oils; cosmetics; hair lotions, dentifrices; emery paper; polishing creams.

4 – Industrial oils and greases; lubricants; dust absorbing, wetting and binding compositions; fuels (including motor spirit) and illuminants; candles and wicks for lighting.

5 – Pharmaceutical and veterinary preparations; sanitary preparations for medical purposes; dietetic su-

stances adapted for medical use, food for babies; plasters, materials for dressings; disinfectants; filled first-aid boxes; preparations for destroying vermin; fungicides, herbicides, insecticides.

6 – Building and construction materials and elements of metal; structures and transportable buildings of metal; non-electric cables and wires of common metal; ironmongery, small items of metal hardware; pipes and tubes of metal; garage doors of metal; tool chests of metal [empty]; statuettes and works of art of common metal; safes; fences of metal; bird houses of metal; non-electric locks of metal; padlocks; chains of metal; hoppers (non-mechanical) of metal; ladders of metal, stepladders of metal; unprocessed and semi-processed materials of metal, not specified for use; metal hardware; doors, gates, windows and outdoor blinds of metal; containers of metal for the storage and transportation of goods; parts and accessories for all the aforesaid goods, included in this class; tanks of metal; tent pegs of metal; window sills of metal; lintels of metal; fittings of metal for windows; shutters of metal; window openers (non-electric); metallic insect screens for windows; window casement bolts; shutters of metal; iron work for windows; window closers, non-electric; window stops of metal; window fasteners of metal; metal rolling window shutters; window hinges of metal; window seals of metal; metal trellis; swimming pools (prefabricated metal structures); roofing of metal; construction kits of metal; prefabricated houses of metal; non-electric window openers.

7 – Machines and machine tools for treatment of materials and for manufacturing; machines, namely paint mixing machines, construction machines, rinsing machines, washing machines and parts therefor, included in this class; machine tools, mechanical tools for construction, horticultural and craft purposes, mechanical horticultural and agricultural tools; vacuum cleaners and vacuum cleaner bags; pumps for heating installations, ponds, aquariums and aquarium systems; compressors (machines); spray guns for paint, compressed air guns for the extrusion of mastics, glue guns (electric), tackers (electric), pistols and pumps for applying paints, mastics and other viscous products; gas-powered soldering irons; drill chucks (parts of machines), drilling machines, electric hand drills, die-cutting and tapping machines, drill stands for electric hand drills; planing machines; trueing machines, abrasive discs (parts of machines), cutting discs (parts of machines), saws (machines), power saws; generators of electricity; gas-powered welding apparatus; lawnmowers, leaf blowers, scarifiers (other than hand-operated); snow blowers (other than hand-operated); electric cleaning machines and apparatus; cleaning appliances utilizing steam; high pressure washers; parts for motors and engines, namely spark plugs for internal com-

bustion engines, mufflers for motors and engines (exhausts), petrol and oil filters, filters for cleaning cooling air for motors and engines, cylinders for motors and engines, cylinder heads for motors and engines, pistons for motors and engines, piston rings; roller blind drives (electric), garage door drives (electric); elevators [lifts]; agricultural, earthmoving, construction, oil and gas extraction and mining equipment; pumps, compressors and fans; robots; moving and handling equipment; generators of electricity; engines, powertrains, and generic parts for machines; dispensing machines; sweeping, cleaning, washing and laundering machines; parts and accessories for the aforesaid goods, included in this class; engines for boats; window openers, electric; hydraulic window openers, pneumatic window openers; machines and apparatus for polishing (electric); electric soldering irons, welding apparatus (electric).

8 – Hand tools (hand operated); hand-operated implements for agricultural, horticultural and forestry purposes, and for structural engineering; hand-operated vaporisers; hand-operated guns for applying paints, mastics and other thick fluid products, guns, hand-operated, for the extrusion of mastics; lasts (shoemakers' hand tools); cutlery, cutlery of plastic or metal; silver plate (cutlery); snow shovels (hand tools); frost scrapers; sharpening stones; tackers (hand-operated); riveters [hand tools]; trowels; saws (hand tools); files [hand tools]; clamps for carpenters or coopers; tongs [hand tools]; screwdrivers; wrenches (hand tools); hammers [hand tools]; axes; lawn clippers (hand-operated); hedge trimmers (hand-operated); planes; paper shears; hygienic and beauty implements for humans and animals; edged and blunt weapons; food preparation implements, kitchen knives and cutlery; hand-operated tools and implements for treatment of materials, and for construction, repair and maintenance; lifting tools; parts and accessories for the aforesaid goods, included in this class; flat irons.

9 – Scientific, nautical, surveying, photographic, cinematographic, optical, weighing, measuring, signalling, checking (supervision), life saving and teaching apparatus and instruments; apparatus and instruments for conducting, switching, transforming, accumulating, regulating or controlling electricity; apparatus for recording, transmission or reproduction of sound or images; magnetic data carriers, recording discs; fire-extinguishing apparatus; electric installation material (included in this class), namely electric cables, electric leads, lustre terminals; voltmeters; electronic controls for roller blinds, time switches (not for clockworks); electronic monitoring and measuring apparatus, namely motion detectors, gas, smoke and carbon monoxide alarms, radio transmitters and receivers for controlling light, burglar alarm installations (electric), bells (alarm installations), door phones, telephone terminals, answering

machines; car radios, compact disc players (cdp), aerials and aerial accessories (included in this class); satellite receivers and satellite receiver aerials, optical data carriers relating to construction and gardening articles, and craftsmen services; video cassettes relating to construction and gardening articles, and craftsmen services; computers for bicycles; solar energy collectors for power generation; electric batteries, battery charging equipment; measuring instruments; measuring tools; temperature controlling apparatus; thermometers (not for medical purposes); balancing apparatus; signs, luminous; protective work clothing (included in this class); protective helmets, protective sports helmets, arm, knee and wrist guards (work safety); gloves for protection against accidents; recorded data relating to construction and gardening articles, and craftsmen services; information technology and audiovisual apparatus; magnets, magnetizers and demagnetizers; devices for medical treatment using electricity; apparatus, instruments and cables for electricity; optical devices, enhancers and correctors; security, safety, protective and signalling apparatus and equipment; diving equipment; navigation, guidance, tracking, targeting and map making devices; measuring, detecting and monitoring instruments, indicators and controllers; scientific research and laboratory apparatus, educational apparatus and simulators; parts and accessories for all the aforesaid goods, included in this class; starter cables for motors; ergometers; video telephones; hands-free kits for telephones; downloadable ring tones for mobile phones; cell phones; cell phone straps; telephone receivers; telephone transmitters; usb flash drives; cases adapted for mobile phones; covers for mobile telephones; headphones; communications head sets; wireless headsets for smartphones; telephone headsets; microphones for telephones; cell phone chargers; batteries for use in mobile telephones; batteries for cellular phones; usb cables for mobile telephones; data transmission cables; electrical power adaptors; adapters for mobile phones; adapter plugs for mobile telephones; electric adapter cables; electrical power adaptors; flash memory card; optical cards; memory cards; sim cards for mobile telephones; display screen protectors in the nature of films for mobile phones; holders adapted for mobile phones; styluses for operating mobile telephones; downloadable graphics for mobile phones; downloadable ring tones for mobile phones; carriers adapted for mobile phones; smart watches; fitness trackers; read only memory [rom] cards; balancing apparatus; telephones incorporating intercommunication systems; intercommunication apparatus; guided wave intercoms.

11 – Apparatus for lighting, heating, steam generating, cooking, refrigerating, drying, ventilating, water supply and sanitary purposes; electric lamps; lamps; ceiling lights; pocket torches, electric; lamp shades; water closets; toilet bowls; toilet seats; flush-

ing apparatus; toilets, portable; toilet tanks; sinks; wash basins (parts of sanitary installations); bidets; baths; whirlpool-jet apparatus; shower cubicles and enclosures; shower handsets; grills (cooking appliances); roasting spits; electric lights for christmas trees; water-pipes for sanitary installations; air conditioning installations; fans (air-conditioning); flues and installations for conveying exhaust gases; sun tanning appliances; sanitary installations, water supply and sanitation equipment; burners, boilers and heaters; lighting and lighting reflectors; food and beverage cooking, heating, cooling and treatment equipment; fireplaces; filters for industrial and household use; industrial treatment installations, namely gas filters and purifiers, industrial ovens and furnaces (not for food or beverages), chemical processing equipment, industrial installations for filtering liquids, installations for the collection of gases, installations for the collection of liquids, installations for cutting impurities from molten metals, bioreactors for clarifying industrial waste water, apparatus for draining food waste; personal heating and drying implements; drying installations; refrigerating and freezing equipment; regulating and safety accessories for water and gas installations; nuclear installations; apparatus and installations for ventilating, air conditioning and air purification; igniters; parts and accessories for all the aforesaid goods, included in this class; turkish bath cabinets, portable; fountains; ornamental fountains; sauna bath installations.

12 – Vehicles; apparatus for locomotion by land, air or water; luggage carriers for vehicles; luggage nets for vehicles; trailers (vehicles); trailer hitches for vehicles; tyres for motor vehicles; anti-skid chains; hub caps; rims for vehicle wheels; bicycles, including motorised bicycles.

13 – Fireworks.

14 – Precious metal and their alloys; jewellery, precious stones; horological and chronometric instruments.

16 – Paper, cardboard; printed matter relating to construction and gardening articles, and craftsmen services; bookbinding material; stationery; adhesives for stationery or household purposes; paintbrushes; typewriters and office requisites (except furniture); instructional and teaching material (except apparatus); plastic materials for packaging, included in this class; paint rollers; craft requisites, namely craft stencils (stationery), paste for modelling; adhesive tapes for stationery or household purposes; bags, envelopes and pouches of paper or plastics for packaging; scrapbooks; architects' models; decoration and art materials and media; filtering materials of paper; bags and articles for packaging, wrapping and storage of paper, cardboard or plastics; stationery and educational supplies; adhesives for stationery or household purposes; money holders; disposable paper

products; parts and accessories for all the aforesaid goods, included in this class; modelling paste; paint-brushes.

17 – Rubber, gutta-percha, gum, asbestos, mica; packing, stopping and insulating materials, adhesive tapes and adhesive strips (other than for medical purposes, for stationery or for household purposes); flexible pipes, not of metal; insulating gloves; non-metallic flexible pipes, tubes, hoses, and fittings therefor, including rubber valves; seals, sealants and fillers; insulating materials and articles; unprocessed and semi-processed materials, not adapted for a specific use, included in this class, namely polyester, mineral fibers, elastomers, cellulose, fibres impregnated with artificial resins; finished or semi-finished products, designed for a specific purpose, included in this class, namely shock-absorbing materials and materials for packaging, vibration dampers, seals, sealing foils and semi-processed synthetic filter materials, adhesive tapes, strips and films; finished or semi-finished products, designed for a specific purpose, included in this class, namely clutch linings and brake linings, materials for restoring and repairing tyres, anti-corrosion tapes, foam supports for flower arranging, fixing foils, glass tapes and strips, marking tapes, rubber pouches, protective rubber articles, protective asbestos screens, elastic bands, handles and supports of rubber, threads of plastic for soldering, plugs of plastic; parts and accessories for all the aforesaid goods, included in this class; fiberglass for insulation; mineral wool for insulation.

18 – Leather and imitation leather; animal skins, hides; trunks and travelling bags; umbrellas, big umbrellas and walking sticks; whips, harness and saddlery; tool bags sold empty; tool bags of leather (empty); parasols; rucksacks.

19 – Building materials and building elements (non-metallic); non-metallic rigid pipes for building; asphalt, pitch and bitumen; buildings and portable buildings (non-metallic); monuments, not of metal; statuettes of stone, concrete or marble; parquet flooring; floors (non-metal); furrings of wood; mouldings, not of metal, for building; construction materials of wood; wood veneers; manufactured timber; semi-worked wood; wood veneers; wood panelling; mine timber; plywood; tiles, not of metal; garage doors (non metallic); aviaries (not of metal); doors, gates, windows and window coverings, not of metal; unprocessed and semi-processed materials not adapted for any specific use, included in this class, namely pitch, tar, asphalt and asphalt, stone, rock, clay and minerals, wood and artificial wood; statues and works of art, included in this class; parts and accessories for all the aforesaid goods, included in this class; lintels, not of metal; non-metallic window sills; non-metallic frames for glazed windows; wooden shutters; shutters, not of metal; latticework, not of metal; swimming pools, prefabricated (structures

not of metal); roofing tiles, not of metal; construction kits for prefabricated houses; prefabricated houses, not of metal.

20 – Furniture, mirrors, picture frames; work benches; ladders (included in this class); pasting tables; poles for curtains; flower-pot pedestals (furniture); mounts, not of metal, for flower pots; barrier chains of plastic or wood; clothes hangers and clothes hooks; indoor blinds for windows (furnishings) of textile or plastic; goods, not of metal, namely mooring buoys, locks and keys, door, gate and window fittings, valves, fasteners, spindles, clamps, connectors and connections, fans, clack valves, handles and rails, joints, hooks and mounts, identification bracelets, moulds and shapers, pennant holders; goods, not of metal, namely dowels, protectors and support equipment, spools, stiffening materials, rings, poles, saw benches, mats for sinks, spacer rings, intermediate layers for bathtubs, staircase fittings, spiral springs, stackable adapters, staves, posts and masts, suction cups, overhead rail systems, trailers, tension rollers, tent parts, paper towel holders, trays; statues, figurines, works of art and ornaments and decorations, included in this class; animal housing and beds; yellow amber, stuffed animals, meerscham; containers not of metal; closures, not of metal, for containers; ladders and movable steps, non-metallic; display stands; parts and accessories for all the aforesaid goods, included in this class; tent pegs, not of metal; sleeping bags for camping; reservoirs, not of metal nor of masonry; coatstands; indoor blinds of textile or plastic.

21 – Household or kitchen utensils and containers (not of precious metal or coated therewith); combs and sponges; unworked or semi-worked glass (except glass used in building); glassware, porcelain and earthenware included in this class; steel wool for cleaning; candlesticks; buckets; soap boxes; soap dispensers; watering can sprinklers; flower pots; griddles (cooking utensils); funnels; gloves for household purposes, gardening gloves; drying racks for laundry; drying racks for laundry; ironing boards; statues, figurines, signs and works of art, included in this class; unworked and semi-worked glass, except building glass; brushes, brooms and brush-making articles; tableware, cookware and containers; articles for cleaning purposes; cosmetic and toilet utensils, and bathroom articles; articles for animals, namely aquariums and vivariums, devices for pest and vermin control, bird baths, cages, feed and drinking articles, fish bowls, grooming articles, nesting articles, tags, waste disposal articles; household articles for clothing and footwear, namely boot jacks and shoehorns, button hooks, stretchers for clothing, trouser presses, tie presses and mangles for clothing, wax-polishing appliances non-electric for shoes, shoe trees (stretchers) and shapers; parts and accessories for all the aforesaid goods, included in this

class; glass wool other than for insulation; polishing leather.

22 – Ropes, string, nets, tarpaulins, sails, sacks and bags (included in this class); bast fibres; harness (not of metal) for handling loads; awnings of plastic or textile; car towing ropes.

24 – Bed linen and table linen (included in this class); linens, table and bed linen, not of paper, oilcloth (for use as tablecloth); shower curtains of textile or plastic.

25 – Work clothing; footwear; headgear (including for gardening purposes), all the aforesaid goods included in this class.

26 – Artificial flowers.

27 – Carpets, door mats, mats, linoleum and other materials for covering existing floors; wall hangings, included in this class; wall hangings (non-textile); textile wallpapers.

28 – Games and playthings; gymnastic and sporting articles (included in this class); decorations for christmas trees (except illumination articles and confectionery), christmas tree stands; fishing tackle and accessories (included in this class); scale-model vehicles; swimming pools [play articles].

31 – Agricultural, horticultural and forestry products and grains (seeds), and other propagation material (included in this class); live animals; fresh fruits and vegetables; live plants and natural flowers; foodstuffs for animals, malt; raw timber; flowers, dried, for decoration; plants, dried, for decoration; litter for pets; straw mulch.

35 – Wholesaling and retailing relating to construction, diy and gardening articles, tools, metal hardware, paints, wood, floor coverings, kitchens, plants, installation material, building materials, telephone networks, animal foodstuffs and zoo requisites, including via the internet; professional business consultancy for franchising concepts; advertising; arranging of contracts for the providing of craft services; photocopying; operating a bonus system for purchases in hardware stores, namely processing discount transactions and issuing encoded cards for processing discount transactions; telemarketing services.

36 – Financing and funding services; financial services relating to the provision of vouchers for the purchase of goods; monetary affairs; issuing, exchanging and redeeming vouchers; clearing and discounting services; cash card services; issuing stored value cards; issuing of cash vouchers.

37 – Building construction; repair work, namely repair of buildings; repair and maintenance of machines and mechanical tools and implements, repair of hand tools (hand-operated); painting, interior and exterior; selvedge gumming; repair of shoes; heating

equipment installation and repair; installation and repair of telephones, installation and repair of telephone installations; rental of construction machines, construction tools and construction equipment, included in this class; building, construction and demolition; rental of tools, plant and equipment for construction and demolition; mining, and oil and gas extraction; pest control and extermination (other than for agricultural, horticultural or forestry purposes), and disinfection; leasing and rental in relation to the aforesaid services, included in this class; consultancy and information in relation to the aforesaid services, included in this class; construction consultation; assembly of prefabricated houses; construction works for prefabricated houses; sharpening and grinding of knives, lawnmower blades and saws; rental of hand-operated tools.

38 – Telecommunications; internet telephony services, internet based telecommunication services; provision of on-line forums; provision of internet access services; computer communication and internet access; internet access services; telecommunication service for internet access; provision of internet access services; electrical data transmission over a global remote data processing network, including the internet; provision of telecommunication access and links to computer databases and to the internet; internet service provider services.

39 – Transport; packaging and storage of goods; rental of passenger vehicle trailers; delivery of goods; delivery of goods by mail order; rental and hire of vehicles; packing and packaging services; transport (removal) and storage of waste and recycling materials.

40 – Key cutting; engraving; cutting-to-size of wood, plates, frames and tissues; sewing of curtains; paint mixing services; cutting of screw threads; food and beverage treatment; energy production; printing, and photographic and cinematographic development; duplication of audio and video recordings; air and water conditioning and purification; slaughtering; rental of generators; rental of air conditioning apparatus; rental of space heating apparatus; recycling of waste and trash.

41 – Education; providing of training.

42 – Architectural services; design of interior decor; architectural consultancy; planning and design of kitchens and bathroom; consultancy in the field of energy-saving.

44 – Services in the field of agriculture, horticulture and forestry, pond and aquarium maintenance (included in this class), lawn maintenance, animal grooming; landscape design; landscape gardening.

45 – Security services for the protection of property and individuals; issuing licences for franchising con-

cepts; licensing of industrial property rights and copyright; opening of security locks.

(260) AM 2016 85791 A

(800) 1283444

(891) 2015 07 09

(731) WORLD MEDICINE İLAÇ SANAYİ VE
TİCARET ANONİM ŞİRKETİ
Evren Mah. Camiyolu Cad. No:50 K:1 B,
Zemin 4-5-6, Güneşli Bağcılar, İstanbul,
Turkey

(540)

TUFANOL
ТУФАНОЛ

(591) black and white

(511)

5 – Medicines for human purposes, medicines for veterinary purposes, vitamin preparations, chemical preparations for medical purposes, dietetic substances adapted for medical use; dietetic foods adapted for medical purposes; baby foods, medicinal herbs, herbal beverages adapted for medical purposes, nutritional supplements, pollen dietary supplements, mineral food supplements, protein dietary supplements; dietary supplements for animals; fodder supplements for veterinary purposes; medicines for dental purposes, hygienic products for medical purposes including sanitary pads; breast-nursing pads and bunion pads, waddings for medical purposes, piasters for medical purposes, dressings for medical purposes, babies' napkins, preparations for destroying noxious plants, preparations for destroying noxious animals, fungicides, deodorants other than for human beings or for animals, air deodorising preparations, disinfectants for hygiene purposes, antiseptics, detergents for medical purposes.

(260) AM 2016 85793 A

(800) 1283674

(891) 2015 12 08

(731) AMERICAN AIR FILTER COMPANY, INC.
Suite 2200, 9920 Corporate Campus Drive,
Louisville KY 40223, USA

(540)

PULSEPAK

(591) Black, white

(511)

11 – Air filter machines for industrial and commercial installations.

(260) AM 2016 85794 A

(800) 1283679

(891) 2015 11 17

(731) ROLEX SA

3-5-7 rue François-Dussaud, CH-1211 Genève
26, Switzerland

(540)



(591) Green and gold

(511)

14 – Timepieces, namely watches, wristwatches, component parts of timepieces and accessories for timepieces not included in other classes, clocks and other chronometric instruments, chronometers, chronographs (timepieces), apparatus for timing sports events, time measuring and marking apparatus and instruments not included in other classes; watch bands, dials (clock and watchmaking), cases and presentation cases for timepieces and jewelry, watch movements and their parts; jewelry; precious stones and semi-precious stones; precious metals and their alloys.

42 – Scientific and technological services, namely calibration services, scientific, technical and mechanical research services; classification and certification services in the field of timepieces; monitoring and testing services in the field of timepieces for certification purposes; issuance of classification and certification documents in the field of timepieces.

(260) AM 2016 85866 A

(800) 1283949

(891) 2015 10 15

(731) European League Against Rheumatism,
EULAR
Seestrasse 240, CH-8802 Kilchberg,
Switzerland

(540)

EULAR

(511)

9 – Digital recording media; online publications (downloadable) provided from databases or the Internet.

16 – Printing products (printed matter); books, brochures; printed reports; instructional, educational or training assistance.

35 – Data compilation and systematization in a computer database; compilation of commercial directories.

36 – Provision of funds for research institutions and organizations; financial sponsorship in the field of

science, education, research and development; provision of financial assistance for conferences and courses.

38 – Provision of email and instant messaging services.

41 – Training, education and teaching; organizing and conducting classes, seminars, conferences, symposiums, meetings, training workshops, exhibitions and special events including media events; issue and publication of research results; medical training held as information sessions; all the aforementioned services in the field of rheumatology.

42 – Consulting Services in the field of scientific and industrial research, scientific, technological and research services, consultancy services in the field of research and development in the field of therapy; all the aforementioned services in the field of rheumatology; provision of information and data relating to scientific and technological research and development.

43 – Provision of conference facilities, housing service agencies (hotels, boarding accomodation).

45 – Granting licenses for research and development (legal services) in the field of rheumatology.

(260) AM 2016 85869 A

(800) 1201439

(891) 2015 09 04

(731) ROSNEFT OIL COMPANY

Sofiyskaya nab., 26/1, RU-115035 Moscow,
Russian Federation

(540)



(591) Black, golden

(511)

4 – Anthracite; benzol; wood briquettes; combustible briquettes; petroleum jelly for industrial purposes; wax [raw material]; ozocerite [ozokerite]; illuminating wax; industrial wax; belting wax; carnauba wax; beeswax; gas for lighting; producer gas; solidified gases [fuel]; lubricating graphite; additives, non-chemical, to motor-fuel; firewood; paper spills for lighting; fish oil, not edible; lanolin; illuminating grease; grease for leather; grease for shoes; tallow; industrial grease; coke; xylene; xylol; ligroin; wood spills for lighting; oils for paints; oils for releasing form work

[building]; oil for the preservation of masonry; oil for the preservation of leather; textile oil; moistening oil; coal tar oil; coal naphtha; castor oil for technical purposes; bone oil for industrial purposes; sunflower oil for industrial purposes; rape oil for industrial purposes; nightlights [candles]; oleine; paraffin; dust removing preparations; soya bean oil preparations for non-stick treatment of cooking utensils; non-sliping preparations for belts; coal dust [fuel]; fire-lighters; perfumed candles; Christmas tree candles; lubricating grease; dust binding compositions for sweeping; dust laying compositions; alcohol [fuel]; methylated spirit; preservatives for leather [oils and greases]; stearine; mineral fuel; motor fuel; fuel with an alcoholic base; peat [fuel]; peat briquettes [fuel]; tinder; lignite; charcoal [fuel]; coal; coal briquettes; lamp wicks; wicks for candles; ceresine; electrical energy; ethanol [fuel]; petroleum ether.

19 – Building materials (non-metallic); non-metallic rigid pipes for building; asphalt, pitch and bitumen; non-metallic transportable buildings; monuments, not of metal; aquaria [structures]; alabaster; window frames, not of metal; asbestos cement; asphalt; beams, not of metal; balustrading; huts; swimming pools [structures, not of metal]; silos, not of metal; harbours [structures not of metal]; concrete; bitumen; joists, not of metal; telephone booths, not of metal; beacons, not of metal, non-luminous; building paper; busts of stone, concrete or marble; bird baths [structures, not of metal]; binding agents for making briquettes; binding material for road repair; stained-glass windows; felt for building; aviaries, not of metal [structures]; gates, not of metal; diving boards, not of metal; geotextiles; gypsum; plaster; potters' clay; potters' clay [raw material]; earth for bricks; clay; gravel; aquarium gravel; granite; doors, not of metal; folding doors, not of metal; coal tar; chimney pots, not of metal; prefabricated houses [kits], not of metal; parquet floor boards; memorial plaques, not of metal; roofing shingles; wood for making household utensils; veneer wood; moldable wood; chimney shafts, not of metal; jalousies, not of metal; roof gutters, not of metal; street gutters, not of metal; agglomerated bagasses of cane [building material]; signs, non-luminous and non-mechanical, not of metal, for roads; non-luminous and non-mechanical signs, not of metal; calcareous stone; lime; fences, not of metal; works of stonemasonry; works of art of stone, concrete or marble; cabanas, not of metal; stone; rubble; artificial stone; building stone; paint spraying booths, not of metal; gravestones; reeds, for building; greenhouse frames, not of metal; framework, not of metal, for building; cornices, not of metal; building cardboard [asphalted]; wood pulp board, for building; building cardboard; skating rinks [structures, not of metal]; quartz; caissons for construction work under water; bricks; fire burrs; water-pipe valves, not of metal or plastic; drain traps [valves], not of metal or plastic; cask wood; mooring

bollards, not of metal; cement posts; chimney cowl, not of metal; buildings, not of metal; buildings, transportable, not of metal; door casings, not of metal; stringers [parts of staircases], not of metal; silica [quartz]; roofing, not of metal; manhole covers, not of metal; xylolith; chicken-houses, not of metal; building timber; manufactured timber; sawn timber; wood, semi-worked; staircases, not of metal; road marking sheets and strips of synthetic material; reinforcing materials, not of metal, for building; bituminous products for building; tar; road coating materials; materials for making and coating roads; fireclay; pitch; building materials, not of metal; refractory construction materials, not of metal; masts [poles], not of metal; raw chalk; calcareous marl; mosaics for building; marble; slate powder; porches, not of metal, for building; tombs, not of metal; flashing, not of metal, for building; roof flashing, not of metal; perches; duckboards, not of metal; wall claddings, not of metal, for building; moldings, not of metal, for cornices; moldings, not of metal, for building; coatings [building materials]; tomb or grave enclosures, not of metal; laths, not of metal; wood panelling; wall linings, not of metal, for building; palings, not of metal; crash barriers, not of metal, for roads; latticework, not of metal; olivine for building; shuttering, not of metal, for concrete; poles, not of metal, for electric power lines; props, not of metal; branching pipes, not of metal; fair huts; tombs [monuments], not of metal; wainscoting, not of metal; signalling panels, non-luminous and non-mechanical, not of metal; building panels, not of metal; parquet flooring; partitions, not of metal; lintels, not of metal; casement windows, not of metal; aquarium sand; silver sand; sand, except foundry sand; sandstone for building; planks [wood for building]; tarred strips, for building; rocket launching platforms, not of metal; platforms, prefabricated, not of metal; floor tiles, not of metal; tiles, not of metal, for building; paving slabs, not of metal; cement slabs; grave slabs, not of metal; scaffolding, not of metal; asphalt paving; wood paving; paving blocks, not of metal; lighting slabs; macadam; fireproof cement coatings; bituminous coatings for roofing; roof coverings, not of metal; roofing, not of metal, incorporating solar cells; wooden floor boards; cladding, not of metal, for building; mantlepieces; door panels, not of metal; floors, not of metal; sills, not of metal; porphyry [stone]; ceilings, not of metal; floating docks, not of metal, for mooring boats; cork [compressed]; grout; asbestos mortar; tanks of masonry; scantlings [carpentry]; furrings of wood; vinyl siding; pilings, not of metal; pigsties, not of metal; insect screens not of metal; vaults, not of metal [burial]; schists; blinds [outdoor], not of metal and not of textile; shutters, not of metal; statues of stone, concrete or marble; figurines [statuettes] of stone, concrete or marble; alabaster glass; safety glass; glass granules for road marking; insulating glass [building]; window glass,

for building; window glass, except glass for vehicle windows; building glass; plate glass [windows], for building; tombstone stelae, not of metal; stables, not of metal; advertisement columns, not of metal; posts, not of metal; telegraph posts, not of metal; hips for roofing; stair-treads [steps], not of metal; tombstone plaques, not of metal; greenhouses, transportable, not of metal; terra cotta; penstock pipes, not of metal; water-pipes, not of metal; gutter pipes, not of metal; ducts, not of metal, for ventilating and air conditioning installations; drain pipes, not of metal; chimneys, not of metal; rigid pipes, not of metal [building]; turnstiles, not of metal; tufa; angle irons, not of metal; lengthening pieces, not of metal, for chimneys; bicycle parking installations, not of metal; plywood; foundry molds [moulds], not of metal; cement for blast furnaces; cement for furnaces; magnesia cement; cement; pantiles; slate; roofing slates; slag [building material]; clinker stone; railroad ties, not of metal; veneers; clinker ballast; concrete building elements; letter boxes of masonry.

35 – Arranging subscriptions to telecommunication services for others; import-export agencies; commercial information agencies; cost price analysis; rental of advertising space; business auditing; employment agencies; accounting; invoicing; business efficiency expert services; demonstration of goods; transcription; marketing studies; commercial information and advice for consumers [consumer advice shop]; business research; marketing research; personnel recruitment; business management and organization consultancy; business organization consultancy; business management consultancy; personnel management consultancy; professional business consultancy; layout services for advertising purposes; marketing; business management of performing artists; business management of sports people; organization of fashion shows for promotional purposes; organization of trade fairs for commercial or advertising purposes; shop window dressing; business appraisals; payroll preparation; sponsorship search; business management assistance; commercial or industrial management assistance; presentation of goods on communication media, for retail purposes; economic forecasting; auctioneering; sales promotion for others; production of advertising films; office machines and equipment rental; rental of advertising time on communication media; publicity material rental; rental of vending machines; rental of photocopying machines; bill-posting, outdoor advertising; distribution of samples; direct mail advertising; writing of publicity texts; business inquiries; systemization of information into computer databases; advisory services for business management; tax preparation; drawing up of statements of accounts; telemarketing services; psychological testing for the selection of personnel; business management of hotels; commercial administration of the licensing of the goods and services of others; administrative proces-

sing of purchase orders; public relations; modelling for advertising or sales promotion; relocation services for businesses; price comparison services; secretarial services; procurement services for others [purchasing goods and services for other businesses]; shorthand; outsourcing services [business assistance]; telephone answering for unavailable subscribers; photocopying services.

39 – Air transport; motor coach rental; boat rental; garage rental; rental of vehicle roof racks; aircraft rental; parking place rental; rental of warehouses; booking of seats for travel; travel reservation; transport reservation; towing; bottling services; water distribution; delivery of newspapers; message delivery; parcel delivery; delivery of goods; delivery of goods by mail order; flower delivery; launching of satellites for others; traffic information; transportation information; storage information; transportation logistics; rescue operations [transport]; arranging of cruises; arranging of travel tours; carting; transport and storage of trash; transporting furniture; lighterage services; removal services; transport of travellers; guarded transport of valuables; barge transport; marine transport; passenger transport; river transport; portage; refloating of ships; vehicle breakdown assistance [towing]; shipbrokerage; transport brokerage; freight brokerage; car rental; railway truck rental; rental of diving bells; rental of diving suits; rental of motor racing cars; railway coach rental; rental of wheelchairs; rental of storage containers; horse rental; rental of freezers; refrigerator rental; vehicle rental; electricity distribution; distribution of energy; packaging of goods; ice-breaking; piloting; water supplying; escorting of travellers; ambulance transport; streetcar transport; wrapping of goods; operating canal locks; car parking; chauffeur services; pleasure boat transport; courier services [messages or merchandise]; salvaging; salvage of ships; underwater salvage; taxi transport; franking of mail; freighting; physical storage of electronically-stored data or documents; boat storage; storage of goods; warehousing; sightseeing [tourism]; freight forwarding.

(260) AM 2016 85871 A
(800) 1283985
(891) 2015 08 13
(731) BAYER OY
P.O. Box 415, FI-20101 Turku, Finland
(540)



(591) red and white

(511)
5 – Pharmaceutical preparations.
10 – Medical devices and apparatus.

(260) AM 2016 85910 A
(800) 1284858
(891) 2015 10 12
(731) SCHRACK SECONET AG
Eibesbrunnnergasse 18, A-1120 Wien, Austria
(540)

SECOLOG IP

(511)
9 – Security, safety, protection and signalling apparatus and equipment, in particular alarm and warning equipment, and access and access control apparatus; information technology and audiovisual apparatus, in particular communications equipment, signal cables for IT, audiovisuals and telecommunications, data processing apparatus and equipment as well as (electrical and mechanical) accessories, and audio, visual and photographic apparatus; electronic control systems; measuring, detecting and monitoring instruments, devices and regulators, including time recording instruments and apparatus (not including clocks and watches), other than clocks and watches; recorded content, in particular software; interfaces, namely interface apparatus or programs for security, safety, protection and signalling installations and communications systems; parts and fittings of all the aforesaid goods, included in this class.

37 – Installation, maintenance and repair of electronic control systems.

42 – IT services and engineering in connection with consultancy, planning and programming of electronic control systems for security, safety, protection and signalling installations and communications systems.

(260) AM 2016 85914 A
(800) 1284881
(891) 2015 11 16
(731) PRYVATNE AKTSIONERNE
TOVARYSTVO "ROSAVA"
vul. Levanevskogo, 91, m. Bila Tserkva,
Kyevska oblast 09108, Ukraine
(540)

ROSAVA-AgroS

(591) Black, white
(511)
12 – Automobile tires; casings for pneumatic tires; inner tubes for pneumatic tires; vehicle wheels; tires for vehicle wheels.

(260) AM 2016 85915 A

(800) 1284882

(891) 2015 10 22

(731) ZIYLAN MAĞAZACILIK VE
PAZARLAMA ANONİM ŞİRKETİ
Merkez Mahallesi Taşocağı, Caddesi No.24
K.3, Mahmutbey İstanbul, Turkey

(540)



(591) Blue, white, red

(511)

25 – Inner and outer clothing made from all kinds of material, except clothing for protective purposes, namely, socks, scarfs, mufflers, shawls, bandanas, belts as clothing accessories, headgear, namely, hats, caps, bonnets; footwear, namely, shoes, slippers, sandals.

(260) AM 2016 85917 A

(800) 1284290

(891) 2015 12 15

(731) JAPAN TOBACCO INC.
2-2-1 Toranomom, Minato-ku Tokyo,
Japan

(540)



(591) black and white

(511)

34 – Tobacco, raw or manufactured; smoking tobacco, pipe tobacco, rolling tobacco, chewing tobacco, snus; cigarettes, electronic cigarettes, cigars, cigaretillos; snuff; smokers' articles included in this class; cigarette paper, cigarette tubes and matches.

(260) AM 2016 85918 A

(800) 1284314

(891) 2015 07 08

(731) GUANGDONG DONGTAI METAL GOODS
CO., LTD.
2, He An Industry Rd. 1, DongFeng, LeLiu,
Shunde, Foshan, Guangdong, China

(540)

DTC

(591) black and white

(511)

6 – Branching pipes of metal; latches of metal; pegs of metal; chains of metal; fittings of metal for furniture; door handles of metal; ironmongery; locks (other than electric) of metal; pulleys of metal, other than for machines; metal displays (terms considered too vague by the International Bureau – rule 13.2.b) of the Common Regulations).

(260) AM 2016 85921 A

(800) 1284976

(891) 2015 10 09

(731) Public Joint Stock Company Gazprom neft
Galernaya
ul., 5, lit. A, RU-190000 St-Petersburg,
Russian Federation

(540)



(591) Gray, light-gray, orange, yellow, brown, black, and light-blue

(511)

1 – Chemical products for use in oil and gas industry; fertilizing preparations; tempering and soldering preparations; brake fluid; fluids for hydraulic circuits; power steering fluid; transmission fluid; anti-boil preparations for engine coolants; fluids for car locks; defrosting fluids for car locks; deicing fluids for vehicles; agar-agar; nitrogen; actinium; alkaloids; alginates for the food industry; alginates for industrial purposes; crotonic aldehyde; ammonium aldehyde; aldehydes; americium; amyl acetate; ammonia [volatile alkali] for industrial purposes; anhydrous ammonia; ammonia; acetic anhydride; anhydrides; anti-knock substances for internal combustion engines; disincrustants; antistatic preparations, other than for household purposes; antifreeze; argon; lead arsenate; astatine; aluminium acetate; lime acetate; lead acetate; acetate of cellulose, unprocessed; acetates [chemicals]; acetylene; acetone; oenological bactericides [chemical preparations for use in wine making]; balm of gurrjun [gurrjun, gurjan] for making varnish; barium; barytes; albumin [animal or vegetable, raw material]; animal albumen [raw material];

iodised albumen; malt albumen; bentonite; berkelium; bicarbonate of soda for chemical purposes; potassium dioxalate; bichromate of potassium; bichromate of soda; bauxite; bromine for chemical purposes; albumenized paper; baryta paper; diazo paper; blueprint paper; test paper, chemical; litmus paper; self-toning paper [photography]; nitrate paper; sensitized paper; photometric paper; borax; agglutinants for concrete; gas purifying preparations; preservatives for pharmaceutical preparations; polish removing substances; preparations for the separation of greases; substances for preventing runs in stockings; water-softening preparations; limestone hardening substances; tanning substances; adhesives for industrial purposes; surface-active chemical agents; foundry binding substances; concrete-aeration chemicals; leather-dressing chemicals; chemicals for the manufacture of paints; chemical substances for preserving foodstuffs; starch-liquifying chemicals [ungluing agents]; flower preservatives; seed preserving substances; viscose; bismuth; bismuth subnitrate for chemical purposes; witherite; distilled water; seawater for industrial purposes; acidulated water for recharging accumulators; heavy water; hydrogen; seaweeds [fertilizers]; gadolinium; getters [chemically active substances]; protective gases for welding; solidified gases for industrial purposes; basic gallate of bismuth; gallium; gambier; helium; electrophoresis gels, other than for medical or veterinary purposes; genes of seeds for agricultural production; aluminium hydrate; hydrates; hyposulfites; ceramic glazings; glycol; expanded clay for hydroponic plant growing [substrate]; kaolin; alumina; glycerides; glycerine for industrial purposes; glucose for the food industry; glucose for industrial purposes; glucosides; gluten for the food industry; gluten for industrial purposes; holmium; hormones for hastening the ripening of fruit; peat pots for horticulture; graphite for industrial purposes; guano; humus; dextrin [size]; detergents for use in manufacturing processes; defoliant; diastase for industrial purposes; manganese dioxide; titanium dioxide for industrial purposes; zirconia; oil dispersants; petroleum dispersants; dispersions of plastics; dysprosium; detergent additives to gasoline [petrol]; ceramic compositions for sintering [granules and powders]; additives, chemical, to drilling muds; additives, chemical, to insecticides; chemical additives for oils; additives, chemical, to motor fuel; additives, chemical, to fungicides; dolomite for industrial purposes; tan-wood; europium; gelatine for photographic purposes; gelatine for industrial purposes; auxiliary fluids for use with abrasives; magnetic fluid for industrial purposes; tree cavity fillers [forestry]; glaziers' putty; moderating materials for nuclear reactors; rare earths; diatomaceous earth; fuller's earth for use in the textile industry; lime chloride; isotopes for industrial purposes; ion exchangers [chemicals]; ytterbium; yttrium; iodine for industrial purposes; iodine for chemical purposes; aluminium

iodide; alkaline iodides for industrial purposes; casein for the food industry; casein for industrial purposes; kainite; potassium; sorrel salt; californium; gum arabic for industrial purposes; tartar other than for pharmaceutical purposes; camphor, for industrial purposes; calcium carbide; carbide; lime carbonate; magnesium carbonate; carbonates; cement [metallurgy]; lutetium [cassiopium]; catalysts; biochemical catalysts; catechu; caustics for industrial purposes; alum; ammonia alum; aluminium alum; chrome alum; quebracho for industrial purposes; ketones; cinematographic films, sensitized but not exposed; oxygen; nitric acid; anthranilic acid; benzoic acid; boric acid for industrial purposes; tartaric acid; tungstic acid; gallic acid for the manufacture of ink; gallotannic acid; tannic acid; iodic acid; phenol for industrial purposes; citric acid for industrial purposes; lactic acid; formic acid; persulfuric acid; oleic acid; picric acid; pyrogallic acid; salicylic acid; sebacic acid; sulfuric acid; sulfurous acid; spirits of salt; stearic acid; carbonic acid; spirits of vinegar [dilute acetic acid]; phosphoric acid; hydrofluoric acid; cholic acid; chromic acid; oxalic acid; acids; benzene-based acids; fatty acids; mineral acids; arsenious acid; adhesives for billposting; leather glues; adhesives for wall tiles; adhesives for wallpaper; glue for industrial purposes; cement for mending broken articles; gums [adhesives], other than for stationery or household purposes; birdlime; isinglass other than for stationery, household or alimentary purposes; gluten [glue], other than for stationery or household purposes; stem cells other than for medical or veterinary purposes; flocculants; collodion; compost; beer preserving agents; mangrove bark for industrial purposes; tan; starch for industrial purposes; silicon; krypton; xenon; curium; lactose [raw material]; lactose for the food industry; lactose for industrial purposes; lanthanum; dry ice [carbon dioxide]; lecithin [raw material]; lecithin for the food industry; lecithin for industrial purposes; lithium; magnesite; manganate; oils for tanning leather; oils for currying leather; oils for preparing leather in the course of manufacture; oils for the preservation of food; carbolineum for the protection of plants; paper pulp; wood pulp; grafting mastic for trees; mastic for leather; cement for pneumatic tires [tyres]; fillers for automobile bodies; oil cement [putty]; synthetic materials for absorbing oil; ceramic materials in particulate form, for use as filtering media; filtering materials [unprocessed plastics]; filtering materials [mineral substances]; filtering materials [vegetable substances]; filtering materials [chemical preparations]; blue vitriol; metalloids; alkaline-earth metals; alkaline metals; methane; methyl benzene; methyl benzol; flour for industrial purposes; tapioca flour for industrial purposes; potato flour for industrial purposes; soap [metallic] for industrial purposes; arsenic; bate for dressing skins; emollients for industrial purposes; sodium; hypochlorite of soda; naphth-

halene; sal ammoniac; toxic gas neutralizers; neodymium; neon; neptunium; nitrate of uranium; nitrates; combusting preparations [chemical additives to motor fuel]; nitrous oxide; baryta; uranium oxide; oxalates; lithia [lithium oxide]; lead oxide; antimony oxide; chromium oxide; cobalt oxide for industrial purposes; mercuric oxide; gallnuts; purification preparations; wine finings; textile-brightening chemicals; beer-clarifying and preserving agents; must-fining preparations; reducing agents for use in photography; bases [chemical preparations]; wax-bleaching chemicals; fat-bleaching chemicals; pectin for the food industry; pectin for industrial purposes; pectin [photography]; perborate of soda; humus top dressing; percarbonates; hydrogen peroxide; persulfates; perchlorates; foundry sand; plastisols; sensitized plates for offset printing; ferrotype plates [photography]; plasticizers; plastics, unprocessed; X-ray films, sensitized but not exposed; plutonium; polonium; potash; potash water; earth for growing; praseodymium; rubber preservatives; masonry preservatives, except paints and oils; brickwork preservatives, except paints and oils; cement preservatives, except paints and oils; preservatives for tiles, except paints and oils; bacterial preparations other than for medical and veterinary use; bacteriological preparations for acetification; bacteriological preparations other than for medical and veterinary use; biological preparations, other than for medical or veterinary purposes; vulcanising preparations; diagnostic preparations, other than for medical or veterinary purposes; renovating preparations for phonograph records; cement-waterproofing chemicals, except paints; currying preparations for leather; currying preparations for skins; metal hardening preparations; fixing baths [photography]; opacifiers for glass; opacifiers for enamel; separating and unsticking [ungluing] preparations; preparations for preventing the tarnishing of lenses; preparations for preventing the tarnishing of glass; plant growth regulating preparations; wallpaper removing preparations; fulling preparations for use in the textile industry; scale removing preparations, other than for household purposes; flashlight preparations; galvanizing preparations; finishing preparations for use in the manufacture of steel; sizing preparations; animal carbon preparations; meat tenderizers for industrial purposes; corrosive preparations; cryogenic preparations; dehydrating preparations for industrial purposes; degreasing preparations for use in manufacturing processes; degumming preparations; oil-bleaching chemicals; bleaching preparations [decolorants] for industrial purposes; preparations for stimulating cooking for industrial purposes; anti-incrustants; preparations of trace elements for plants; moistening [wetting] preparations for use in the textile industry; moistening [wetting] preparations for use in dyeing; moistening [wetting] preparations for use in bleaching; enzyme preparations for the food industry; enzyme prepara-

tions for industrial purposes; filtering preparations for the beverages industry; vine disease preventing chemicals; chemical preparations to prevent mildew; chemical preparations for protection against wheat blight [smut]; chemical condensation preparations; chemical preparations for smoking meat; chemical substances for analyses in laboratories, other than for medical or veterinary purposes; chemical preparations for scientific purposes, other than for medical or veterinary use; chemical preparations for facilitating the alloying of metals; engine-decarbonising chemicals; fulling preparations; fuel-saving preparations; coal saving preparations; damp-proofing chemicals, except paints, for masonry; anti-sprouting preparations for vegetables; preparations of the distillation of wood alcohol; by-products of the processing of cereals for industrial purposes; benzene derivatives; cellulose derivatives [chemicals]; promethium; protactinium; protein [raw material]; mordants for metals; radium for scientific purposes; radon; solvents for varnishes; anti-frothing solutions for accumulators; drilling muds; solutions for cyanotyping; galvanizing baths; silver salt solutions for silvering; toning baths [photography]; chemical reagents, other than for medical or veterinary purposes; rhenium; mercury; rubidium; carbon black for industrial purposes; soot for industrial or agricultural purposes; lamp black for industrial purposes; samarium; saccharin; selenium; saltpeter; sulfur; silver nitrate; carbon disulfide; silicates; aluminium silicate; silicenes; scandium; foundry molding [moulding] preparations; acrylic resins, unprocessed; artificial resins, unprocessed; synthetic resins, unprocessed; epoxy resins, unprocessed; soda ash; calcined soda; caustic soda for industrial purposes; barium compounds; fluorspar compounds; salts [fertilisers]; salts [chemical preparations]; ammoniacal salts; ammonium salts; salts of precious metals for industrial purposes; salts for galvanic cells; salt for preserving, other than for foodstuffs; salts for coloring [colouring] metal; salts for industrial purposes; iron salts; gold salts; iodised salts; calcium salts; salt, raw; salts from rare earth metals; mercury salts; toning salts [photography]; chrome salts; chromic salts; salts of alkaline metals; rock salt; mold-release preparations; fire extinguishing compositions; compositions for the manufacture of phonograph records; compositions for the manufacture of technical ceramics; compositions for repairing inner tubes of tires [tyres]; compositions for repairing tires [tyres]; acid proof chemical compositions; glutinous tree-grafting preparations; adhesive preparations for surgical bandages; fireproofing preparations; compositions for threading; sauce for preparing tobacco; amyl alcohol; vinic alcohol; wood alcohol; sal ammoniac spirits; ethyl alcohol; alcohol; cement for footwear; concrete preservatives, except paints and oils; water glass [soluble glass]; strontium; substrates for soil-free growing [agriculture]; barium sulfate; sulfates;

antimony sulfide; sulfides; benzoic sulfimide; sulfonic acids; sumac for use in tanning; superphosphates [fertilisers]; antimony; thallium; talc [magnesium silicate]; tannin; cream of tartar for the food industry; cream of tartar for industrial purposes; cream of tartar for chemical purposes; tellurium; terbium; tetrachlorides; carbon tetrachloride; acetylene tetrachloride; technetium; thiocarbanilide; titanite; biological tissue cultures other than for medical or veterinary purposes; sensitized cloth for photography; blueprint cloth; toluene; fuel for atomic piles; thorium; peat [fertiliser]; carbonic hydrates; carbon; activated carbon; carbon for filters; animal charcoal; animal carbon; bone charcoal; blood charcoal; nitrogenous fertilisers; fertilizers; fish meal fertilizers; wood vinegar [pyrolygneous acid]; uranium; chemical intensifiers for paper; chemical intensifiers for rubber; vulcanisation accelerators; enzymes for the food industry; enzymes for industrial purposes; ferments for chemical purposes; milk ferments for the food industry; milk ferments for industrial purposes; milk ferments for chemical purposes; fermium; ferrocyanides; fixing solutions [photography]; soldering fluxes; brazing fluxes; formic aldehyde for chemical purposes; phosphatides; phosphates [fertilisers]; phosphorus; photographic paper; photosensitive plates; sensitized photographic plates; sensitized films, unexposed; photographic developers; photographic sensitizers; chemical preparations for use in photography; photographic emulsions; francium; fluorine; chemicals for use in forestry, except fungicides, herbicides, insecticides and parasiticides; glass-staining chemicals; leather-renovating chemicals; glass-staining chemicals; enamel-staining chemicals; oil-separating chemicals; water-purifying chemicals; oil-purifying chemicals; welding chemicals; condensation-preventing chemicals; stain-preventing chemicals for use on fabrics; anti-tarnishing chemicals for windows; leather-waterproofing chemicals; textile-waterproofing chemicals; chemicals, except pigments, for the manufacture of enamel; radiator flushing chemicals; leather-impregnating chemicals; textile-impregnating chemicals; horticultural chemicals, except fungicides, herbicides, insecticides and parasiticides; agricultural chemicals, except fungicides, herbicides, insecticides and parasiticides; soil conditioning preparations; chimney cleaners, chemical; color- [colour-] brightening chemicals for industrial purposes; refrigerants; coolants for vehicle engines; chlorine; chlorates; hydrochlorates; aluminium chloride; magnesium chloride; chlorides; palladium chloride; chromates; flowers of sulfur for chemical purposes; caesium; cellulose; cerium; cyanides [prussiates]; calcium cyanamide [fertilizer]; cymene; loam; slag [fertilisers]; size for finishing and priming; alkalis; caustic alkali; radioactive elements for scientific purposes; fissionable chemical elements; emulsifiers; erbium; ethane; methyl ether; sulfuric ether; ethyl ether; glycol ether; ethers; esters; cellulose ethers

for industrial purposes; cellulose esters for industrial purposes; size for use in the textile industry; artificial sweeteners [chemical preparations]; fissionable material for nuclear energy; liquids for removing sulfates from accumulators; grafting wax for trees; preparations of microorganisms, other than for medical and veterinary use; sodium salts [chemical compounds]; enamel and glass-staining chemicals; transmission oils.

4 – Anthracite; benzine; benzene; benzol; wood briquettes; combustible briquettes; petroleum jelly for industrial purposes; wax [raw material]; ozocerite [ozokerite]; illuminating wax; industrial wax; belting wax; carnauba wax; beeswax; gas for lighting; oil-gas; fuel gas; gasoline; producer gas; solidified gases [fuel]; fuel; lubricating graphite; additives, non-chemical, to motor-fuel; firewood; paper spills for lighting; cutting fluids; fish oil, not edible; illuminating grease; grease for leather; grease for footwear; tallow; industrial grease; kerosene; coke; xylene; xylol; ligroin; wood spills for lighting; mazut; fuel oil; oils for paints; oils for releasing form work [building]; oil for the preservation of masonry; oil for the preservation of leather; textile oil; lubricating oil; industrial oil; moistening oil; coal tar oil; coal naphtha; castor oil for industrial purposes; bone oil for industrial purposes; motor oil; sunflower oil for industrial purposes; rape oil for industrial purposes; lubricants; naphtha; petroleum, raw or refined; nightlights [candles]; oleine; paraffin; dust removing preparations; soya bean oil preparations for non-stick treatment of cooking utensils; non-slipping preparations for belts; coal dust [fuel]; firelighters; perfumed candles; Christmas tree candles; candles; grease for arms [weapons]; lubricating grease; grease for belts; vaporized fuel mixtures; dust binding compositions for sweeping; dust laying compositions; alcohol [fuel]; stearine; lighting fuel; mineral fuel; carburants; fuel with an alcoholic base; peat [fuel]; peat briquettes [fuel]; tinder; lignite; charcoal [fuel]; coal; coal briquettes; lamp wicks; wicks for candles; ceresine; electrical energy; ethanol [fuel]; petroleum ether; aviation fuel; crude oil; automotive greases; preservatives for leather [oils and greases]; methylated spirit; candles and wicks for lighting; dust binding compositions; dust absorbing compositions; dust wetting compositions; industrial oils and greases; automotive lubricants; coal used as fuel; diesel oil; biodiesel oil; biodiesel fuel; fuel for motor vehicles; aircraft fuel; aircraft motor gasoline; jet fuel; jet biofuel; base oil for industrial purposes; crude oil for industrial purposes; refined oil; unrefined oil; synthetic oil; non-synthetic oil; mineral oil; oil used in the manufacture of waxes, rubber, caoutchouc and plastics; heating oil; heavy oil; heavy fuel; liquefied gaseous fuels; light oil; light oil products; residual heavy fuels and oils [mazut]; residual light fuels and oils [mazut].

(260) AM 2016 85922 A
 (800) 1284372
 (891) 2015 10 30
 (731) HYUNDAI MOTOR COMPANY
 12 Heolleung-ro, Seocho-Gu, Seoul 137-938,
 Republic of Korea

(540)

G70

(591) black and white

(511)

12 – Automobiles; sports cars; coach vans; parts and accessories for automobiles; suspension shock absorbers for vehicles; braking devices for vehicles; trucks; passenger cars; passenger cars for more than seven passengers; power transmissions and gearings for land vehicles; transmissions for land vehicles; automobile engines.

(260) AM 2016 85923 A
 (800) 1284373
 (891) 2015 12 03
 (731) INTERCEPT PHARMACEUTICALS, INC.
 450 W. 15th Street, Suite 505, New York
 NY 10011, USA

(540)



(591) Gray, black and white

(511)

5 – Pharmaceutical preparations for human use.

(260) AM 2016 85924 A
 (800) 1284979
 (891) 2015 08 21
 (731) DR. IHDE DENTAL AG
 Dorfplatz 11, CH-8737 Gommiswald,
 Switzerland

(540)

PREPCAP

(511)

10 – Dental implants and their accessories.

(260) AM 2016 85926 A
 (800) 1284984
 (891) 2015 07 03
 (731) VANTURIAN INVESTMENTS LTD.
 Kimonos, 40, CY-3095 Limassol,
 Cyprus

(540)

OSHIHARI

(591) Black, white

(511)

29 – Albumen for culinary purposes; alginates for culinary purposes; almonds, ground; anchovy; animal marrow for food; apple purée; bacon; beans, preserved; black pudding (blood sausage); black pudding; blood sausage; bone oil, edible; bouillon concentrates; bouillon; broth concentrates; broth; butter; buttercream; caviar; charcuterie; cheese; chocolate nut butter; clams, not live; cocoa butter; coconut butter; coconut fat; coconut oil; coconut, desiccated; colza oil for food; corn oil; cranberry sauce (compote); crayfish, not live; cream (dairy products); croquettes; crustaceans, not live; crystallized fruits; curd; dates; edible birds' nests; edible fats; edible oils; eggs; fat-containing mixtures for bread slices; fatty substances for the manufacture of edible fats; fish fillets; fish meal for human consumption; fish, not live; fish, preserved; fish, tinned (canned (Am.))); foods made from fish; frosted fruits; frozen fruits; fruit chips; fruit jellies; fruit peel; fruit preserved in alcohol; fruit pulp; fruit salads; fruit, preserved; fruit, stewed; fruit-based snack food; fruits, tinned (canned (Am.)); game, not live; gelatine; gherkins; ginger jam; ham; herrings; hummus (chickpea paste); isinglass for food; jams; jellies for food; kefir (milk beverage); kephir (milk beverage); kimchi (fermented vegetable dish); koumiss (kumiss) (milk beverage); kumys (kumyss) (milk beverage); lard; lentils, preserved; liver pastes; liver pate; liver; lobsters, not live; maize oil; margarine; marmalade; meat extracts; meat jellies; meat, preserved; meat, tinned (canned (Am.)); meat; milk; milk beverages, milk predominating; milk products; mushrooms, preserved; mussels, not live; nuts, prepared; olive oil for food; olives, preserved; onions, preserved; oysters, not live; palm kernel oil for food; palm oil for food; peanut butter; peanuts, prepared; peas, preserved; pectin for culinary purposes; piccalilli; pickles; pollen prepared as foodstuff; pork; potato chips; potato crisps; potato flakes; potato fritters; poultry, not live; powdered eggs; prawns, not live; preparations for making bouillon; preparations for making soup; raisins; rape oil for food; rennet; salmon; salted fish; salted meats; sardines; sauerkraut; sausages in batter, sausages; sea-cucumbers, not live; seaweed extracts for food; sesame oil; shellfish, not live; shrimps, not live; silkworm chrysalis, for human consumption; snail eggs for consumption; soups; soya beans, preserved, for food; soya milk (milk substitute); spiny lobsters, not live; suet for food; sunflower oil for food; tahini (sesame seed paste); toasted laver, tofu; tomato juice for cooking; tomato paste; tripe; truffles, preserved; tuna fish; vegetables, cooked; vegetables, dried; vegetable juices for cooking; vegetable salads; vegetable soup preparations; vegetables, preserved; vegetables, tinned (canned (Am.)); whey;

whipped cream; white of eggs; yoghurt; yogurt; yolk of eggs.

30 – Allspice; almond confectionery; almond paste; aniseed; aromatic preparations for food; artificial coffee; baking powder; baking soda (bicarbonate of soda for cooking purposes); barley meal; bean meal; bee glue; beer vinegar, bicarbonate of soda for cooking purposes (baking soda); binding agents for edible ices; binding agents for ice cream; biscuits; bread; bread rolls; breadcrumbs; buns; cake batter; cake dough; cake powder, cakes; candy; capers; caramels (candy); celery salt; cereal preparations; cereal-based snack food; chewing gum; chicory (coffee substitute); chocolate; chocolate beverages with milk; chocolate-based beverages; chow-chow (condiment); chutneys (condiments); cinnamon (spice); cloves (spice); cocoa; cocoa beverages with milk; cocoa-based beverages; coffee; coffee beverages with milk; coffee flavorings (flavourings); coffee-based beverages; condiments; confectionery; confectionery for decorating Christmas trees; cookies; cooking salt; corn flakes; corn flour, corn meal; corn, milled; corn, roasted; couscous (semolina); crackers; crushed barley; crushed oats; curry (spice); custard; dressings for salad; edible decorations for cakes; edible ices; essences for foodstuffs, except etheric essences and essential oils; farinaceous food pastes; farinaceous foods; ferments for pastes; flavorings (flavourings), other than essential oils, for beverages; flavorings (flavourings), other than essential oils, for cakes; flavorings, other than essential oils, for beverages; flavorings, other than essential oils, for cakes; flavourings, other than essential oils; flavourings, other than essential oils, for beverages; flavourings, other than essential oils, for cakes; flour; fondants (confectionery); frozen yoghurt (confectionery ices); frozen yogurt (confectionery ices); fruit jellies (confectionery); garden herbs, preserved (seasonings); ginger (spice); gingerbread; glucose for culinary purposes; gluten prepared as foodstuff, golden syrup; groats for human food; gruel, with a milk base, for food; halvah; hominy; hominy grits; honey; husked barley; husked oats; ice cream; ice for refreshment; ice, natural or artificial; iced tea; infusions, not medicinal; ketchup (sauce); leaven; liquorice (confectionery); lozenges (confectionery); macaroni; macaroons (pastry); maize flakes; maize flour, maize meal; maize, milled; maize, roasted; malt biscuits; malt extract for food; malt for human consumption; maltose; marzipan; mayonnaise; meal; meat gravies; meat pies; meat tenderizers, for household purposes; mint for confectionery; molasses for food; muesli; mustard; mustard meal; natural sweeteners; noodles; nutmegs; oat flakes; oat-based food; oatmeal; pancakes; pasta; pastilles (confectionery); pastries; peanut confectionery; pepper, peppermint sweets; peppers (seasonings); petit-beurre biscuits; petits fours (cakes); pies; pizzas; popcorn; potato flour; powder for edible

ices; powders for ice cream; pralines; preparations for stiffening whipped cream; propolis; puddings; quiches; ravioli; relish (condiment); ribbon vermicelli; rice; rice cakes; rice-based snack food; royal jelly; saffron (seasoning); sago; salt for preserving foodstuffs; sandwiches; sauces (condiments); sausage binding materials; sea water for cooking; seasonings; seaweed (condiment); semolina; sherbets (ices); sorbets (ices); soya bean paste (condiment); soya flour; soya sauce; spaghetti; spices; spring rolls; star aniseed; starch for food; stick liquorice (confectionery); sugar; sugar confectionery; sushi; sweetmeats (candy); tabbouleh; tacos; tapioca; tapioca flour; tarts; tea; tea-based beverages; thickening agents for cooking foodstuffs; tomato sauce; tortillas; turmeric; unleavened bread; unroasted coffee; vanilla (flavoring) (flavouring); vanillin (vanilla substitute); vegetal preparations for use as coffee substitutes; vermicelli (noodles); vinegar; waffles; yeast.

35 – Accounting; administrative processing of purchase orders; advertising; advertising agencies; advertising by mail order; advisory services for business management; arranging newspaper subscriptions for others; arranging subscriptions to telecommunication services for others; auctioneering; billposting; book-keeping; business appraisals; business auditing; business efficiency expert services; business information; business inquiries; business investigations; business management and organization consultancy; business management assistance; business management consultancy; business management of hotels; business management of performing artists; business organization consultancy; business research; commercial administration of the licensing of the goods and services of others; commercial information agencies; commercial information and advice for consumers (consumer advice shop); commercial or industrial management assistance; compilation of information into computer databases; compilation of statistics; computerized file management; cost price analysis; data search in computer files for others; demonstration of goods; direct mail advertising; dissemination of advertising matter; distribution of samples; document reproduction; drawing up of statements of accounts; economic forecasting; employment agencies; import-export agencies; invoicing; marketing research; marketing studies; modelling for advertising or sales promotion; news clipping services; office machines and equipment rental; on-line advertising on a computer network; opinion polling; organization of exhibitions for commercial or advertising purposes; outdoor advertising; outsourcing services (business assistance); payroll preparation; personnel management consultancy; personnel recruitment; photocopying services; presentation of goods on communication media, for retail purposes; price comparison services; procurement services for others (purchasing goods and services for other businesses); professional business consultancy; psyc-

hological testing for the selection of personnel; public relations; publication of publicity texts; publicity; publicity agencies; preparation of publicity material; publicity material rental; radio advertising; production of radio commercials; rental of advertising space; rental of advertising time on communication media; rental of photocopying machines; rental of vending machines; sales promotion for others; secretarial services; shop window dressing; shorthand; sponsorship search; systemization of information into computer databases; tax preparation; telephone answering for unavailable subscribers; television advertising; production of television commercials; transcription of communications (office functions); typing; updating of advertising material; word processing; writing of publicity texts.

(260) AM 2016 85939 A

(800) 1284500

(891) 2015 10 21

(731) ADP GAUSELMANN GMBH

Merkur-Allee 1-15, 32339 Espelkamp,
Germany

(540)

Mystical Pride

(511)

9 – Scientific, nautical, surveying, photographic, cinematographic, optical, weighing, measuring, signalling, checking (supervision), life-saving and teaching apparatus and instruments; apparatus and instruments for conducting, switching, transforming, accumulating, regulating or controlling electricity; apparatus for recording, transmission or reproduction of sound or images; magnetic data carriers, recording discs; compact discs, DVDs and other digital recording media; cash registers, calculating machines, data processing equipment, computers; computer software; fire-extinguishing apparatus; musical jukeboxes and parts for the aforesaid automatic machines; automatic cash dispensers, automatic money counting and money changing machines; coin-operated mechanisms; computer and video games software; games software for use on any computer platform, including electronic entertainment and games consoles; computer game programs; computer games programs; video games (software); computer games provided through a global computer network or supplied by means of multi-media electronic broadcast or through telecommunications or electronic transmission or via the internet; computer games, leisure and recreational software, video games and computer software, all being provided in the form of storage media; programs for operating electric and electronic apparatus for games, amusement and/or entertainment purposes; automatic lottery machines; computer software for computer games on the internet; online games (software), in particular for online betting games, online prize games, online gambling

games, online games of skill and online casino games; computer software in the form of an app for mobile devices and computers; calculating apparatus in coin-operated machines and parts for the aforesaid goods; apparatus for recording, transmission, processing or reproduction of data, including sound or images, including parts for all the aforesaid goods, except radio sets, television receivers, hi-fi systems, video recorders, telephone apparatus, fax machines and telephone answering machines; computer hardware and software for casino and amusement arcade games, for gaming machines, slot machines or video lottery gaming machines or games of chance via the internet; electric, electronic, optical or automatic apparatus, for identifying data carriers, identity cards and credit cards, bank notes and coins; electric, electronic or optical alarm and monitoring installations, including video cameras and apparatus for image transmission and image processing; data processing apparatus and computers, including data processing apparatus and computers being components for data networks and parts facilitating data network communications; electric wiring harnesses; circuit boards, printed circuit boards (electronic components) and combinations thereof, being assemblies and parts for apparatus, included in this class.

28 – Toys; toys; gymnastic and sporting articles not included in other classes; decorations for christmas trees; gaming apparatus (including coin-operated apparatus); coin-operated arcade games (machines); games for amusement arcades (included in this class); coin-operated video gaming apparatus; video games apparatus adapted for use with external screens or monitors only; casino fittings, namely roulette tables, roulette wheels; coin-operated automatic gaming machines and gaming machines, in particular for gaming arcades, with or without a prize payout; electronic or electrotechnical gaming apparatus, automatic gaming machines, gaming machines, slot machines operated by coins, tokens, banknotes, tickets or by means of electronic, magnetic or biometric storage media, in particular for commercial use in casinos and amusement arcades, with or without a prize payout; automatic gaming machines and gaming machines, in particular for commercial use in casinos and gaming arcades, with or without a prize payout; coin-operated gaming machines and/or electronic money-based gaming apparatus (machines), with or without prizes; housings adapted for gaming machines, gaming apparatus and automatic gaming machines, operated by means of coins, tokens, tickets or by means of electronic, magnetic or biometric storage media, in particular for commercial use in casinos and gaming arcades, with or without a prize payout; electronic games; electronic game entertainment apparatus and accessories; video output game machines; drawing apparatus for prize games and lotteries, draws or raffles; housings of metal, plastic and/or wood for coin-operated automatic machines;

apparatus for games (including video games), other than adapted for use with external screens or monitors only; electropneumatic and electric slot machines with pulling handles (gaming machines); gaming tables, in particular for table football, billiards, sliding games; arrows and flying discs (toys); gaming machines, namely, electric, electronic or electromechanical apparatus for bingo games, lotteries or video lottery games and for betting offices, networked or unnetworked; LCD games consoles; automatic gaming machines; all the aforesaid automatic gaming machines, gaming machines and apparatus operating in networks; apparatus and devices for accepting and storing money, being fittings for the aforesaid automatic machines, included in this class.

41 – Education; providing of training; entertainment; sporting and cultural activities; rental of automatic slot machines and entertainment machines for casinos; arranging and conducting games; gambling; operating of lotteries; operating games on the internet, including online and being applications for smartphones; on-line game services provided via the internet; provision of entertainment and/or educational content for apps for mobile devices and computers; conducting quizzes by means of smartphone applications; providing casino facilities (gambling), betting offices; operating gaming establishments, arcades and/or online internet casinos and betting platforms; gambling services via the internet.

(260) AM 2016 85940 A
(800) 1285026
(891) 2015 03 13
(731) TUI AG

Karl-Wiechert-Allee 4, 30625 Hannover,
Germany

(540)



Toscana Resort Castelfalfi

Hotels · Villas · Golf

(591) Black, white
(511)

43 – Providing temporary accommodation; providing of food and drinks for guests; accommodation bureau services; providing and rental of holiday homes, holiday flats and apartments; providing room reservation and hotel reservation services; providing hotel and motel services; catering; services of boarding houses; rental of meeting rooms; bar services; providing of food and drinks for guests in restaurants; providing food and drinks in Internet cafés; consultation provided by telephone call centres and hotlines in the field of accommodation services, providing and rental of holiday homes, room reservation services and hotel reservation as well as accommodation and catering for guests.

(260) AM 2016 85948 A
(800) 1284556
(891) 2015 12 22
(731) JANSSEN PHARMACEUTICA NV
Turnhoutseweg 30, B-2340 BEERSE,
Belgium
(540)

RECEPTIV

(511)
5 – Diagnostic preparations and reagents for medical purposes.

10 – Medical devices for measuring levels of anti-psychotic pharmaceutical preparations in a patient's blood.

(260) AM 2016 85949 A
(800) 1284559
(891) 2015 12 16
(731) JANSSEN PHARMACEUTICA NV
Turnhoutseweg 30, B-2340 BEERSE,
Belgium
(540)

CLINICADE

(511)
5 – Diagnostic preparations and reagents for medical purposes.

10 – Medical devices for measuring levels of anti-psychotic pharmaceutical preparations in a patient's blood.

(260) AM 2016 85951 A
(800) 1284561
(891) 2015 12 16
(731) JANSSEN PHARMACEUTICA NV
Turnhoutseweg 30, B-2340 BEERSE,
Belgium
(540)

INTRAVIEW

(511)
5 – Diagnostic preparations and reagents for medical purposes.

10 – Medical devices for measuring levels of anti-psychotic pharmaceutical preparations in a patient's blood.

(260) AM 2016 85952 A
(800) 1284576
(891) 2015 10 09
(731) Public Joint Stock Company Gazprom neft
Galernaya
ul., 5, lit. A, RU-190000 St-Petersburg,
Russian Federation

(540)



(591) Gray, light-gray, orange, yellow, brown, black, and light-blue

(511)

1 – Chemical products for use in oil and gas industry; fertilizing preparations; tempering and soldering preparations; brake fluid; fluids for hydraulic circuits; power steering fluid; transmission fluid; anti-boil preparations for engine coolants; fluids for car locks; defrosting fluids for car locks; deicing fluids for vehicles; agar-agar; nitrogen; actinium; alkaloids; alginates for the food industry; alginates for industrial purposes; crotonic aldehyde; ammonium aldehyde; aldehydes; americium; amyl acetate; ammonia [volatile alkali] for industrial purposes; anhydrous ammonia; ammonia; acetic anhydride; anhydrides; anti-knock substances for internal combustion engines; disincrustants; antistatic preparations, other than for household purposes; antifreeze; argon; lead arsenate; astatine; aluminium acetate; lime acetate; lead acetate; acetate of cellulose, unprocessed; acetates [chemicals]; acetylene; acetone; oenological bactericides [chemical preparations for use in wine making]; balm of gurjun [gurjon, gurjan] for making varnish; barium; barytes; albumin [animal or vegetable, raw material]; animal albumen [raw material]; iodised albumen; malt albumen; bentonite; berkelium; bicarbonate of soda for chemical purposes; potassium dioxalate; bichromate of potassium; bichromate of soda; bauxite; bromine for chemical purposes; albumenized paper; baryta paper; diazo paper; blueprint paper; test paper, chemical; litmus paper; self-toning paper [photography]; nitrate paper; sensitized paper; photometric paper; borax; agglutinants for concrete; gas purifying preparations; preservatives for pharmaceutical preparations; polish removing substances; preparations for the separation of greases; substances for preventing runs in stockings; water-softening preparations; limestone hardening substances; tanning substances; adhesives for industrial purposes; surface-active chemical agents; foundry binding substances; concrete-aeration chemicals; leather-dressing chemicals; chemicals for the manufacture of paints; chemical substances for preserving foodstuffs; starch-liquifying chemicals [ungluing agents]; flower preservatives; seed preserving substances; viscose; bismuth; bismuth subnitrate for chemical purposes; witherite; distilled water; seawater for industrial purposes; acidulated water for recharging accumulators; heavy water; hydrogen; seawe-

eds [fertilizers]; gadolinium; getters [chemically active substances]; protective gases for welding; solidified gases for industrial purposes; basic gallate of bismuth; gallium; gambier; helium; electrophoresis gels, other than for medical or veterinary purposes; genes of seeds for agricultural production; aluminium hydrate; hydrates; hyposulfites; ceramic glazings; glycol; expanded clay for hydroponic plant growing [substrate]; kaolin; alumina; glycerides; glycerine for industrial purposes; glucose for the food industry; glucose for industrial purposes; glucosides; gluten for the food industry; gluten for industrial purposes; holmium; hormones for hastening the ripening of fruit; peat pots for horticulture; graphite for industrial purposes; guano; humus; dextrin [size]; detergents for use in manufacturing processes; defoliants; diastase for industrial purposes; manganese dioxide; titanium dioxide for industrial purposes; zirconia; oil dispersants; petroleum dispersants; dispersions of plastics; dysprosium; detergent additives to gasoline [petrol]; ceramic compositions for sintering [granules and powders]; additives, chemical, to drilling muds; additives, chemical, to insecticides; chemical additives for oils; additives, chemical, to motor fuel; additives, chemical, to fungicides; dolomite for industrial purposes; tan-wood; europium; gelatine for photographic purposes; gelatine for industrial purposes; auxiliary fluids for use with abrasives; magnetic fluid for industrial purposes; tree cavity fillers [forestry]; glaziers' putty; moderating materials for nuclear reactors; rare earths; diatomaceous earth; fuller's earth for use in the textile industry; lime chloride; isotopes for industrial purposes; ion exchangers [chemicals]; ytterbium; yttrium; iodine for industrial purposes; iodine for chemical purposes; aluminium iodide; alkaline iodides for industrial purposes; casein for the food industry; casein for industrial purposes; kainite; potassium; sorrel salt; californium; gum arabic for industrial purposes; tartar other than for pharmaceutical purposes; camphor, for industrial purposes; calcium carbide; carbide; lime carbonate; magnesium carbonate; carbonates; cement [metallurgy]; lutetium [cassiopium]; catalysts; biochemical catalysts; catechu; caustics for industrial purposes; alum; ammonia alum; aluminium alum; chrome alum; quebracho for industrial purposes; ketones; cinematographic films, sensitized but not exposed; oxygen; nitric acid; anthranilic acid; benzoic acid; boric acid for industrial purposes; tartaric acid; tungstic acid; gallic acid for the manufacture of ink; gallotannic acid; tannic acid; iodic acid; phenol for industrial purposes; citric acid for industrial purposes; lactic acid; formic acid; persulfuric acid; oleic acid; picric acid; pyrogallol acid; salicylic acid; sebacic acid; sulfuric acid; sulfurous acid; spirits of salt; stearic acid; carbonic acid; spirits of vinegar [dilute acetic acid]; phosphoric acid; hydrofluoric acid; cholic acid; chromic acid; oxalic acid; acids; benzene-based acids; fatty acids; mineral

acids; arsenious acid; adhesives for billposting; leather glues; adhesives for wall tiles; adhesives for wallpaper; glue for industrial purposes; cement for mending broken articles; gums [adhesives], other than for stationery or household purposes; birdlime; isinglass other than for stationery, household or alimentary purposes; gluten [glue], other than for stationery or household purposes; stem cells other than for medical or veterinary purposes; flocculants; collodion; compost; beer preserving agents; mangrove bark for industrial purposes; tan; starch for industrial purposes; silicon; krypton; xenon; curium; lactose [raw material]; lactose for the food industry; lactose for industrial purposes; lanthanum; dry ice [carbon dioxide]; lecithin [raw material]; lecithin for the food industry; lecithin for industrial purposes; lithium; magnesite; manganate; oils for tanning leather; oils for currying leather; oils for preparing leather in the course of manufacture; oils for the preservation of food; carbolineum for the protection of plants; paper pulp; wood pulp; grafting mastic for trees; mastic for leather; cement for pneumatic tires [tyres]; fillers for automobile bodies; oil cement [putty]; synthetic materials for absorbing oil; ceramic materials in particulate form, for use as filtering media; filtering materials [unprocessed plastics]; filtering materials [mineral substances]; filtering materials [vegetable substances]; filtering materials [chemical preparations]; blue vitriol; metalloids; alkaline-earth metals; alkaline metals; methane; methyl benzene; methyl benzol; flour for industrial purposes; tapioca flour for industrial purposes; potato flour for industrial purposes; soap [metallic] for industrial purposes; arsenic; bate for dressing skins; emollients for industrial purposes; sodium; hypochlorite of soda; naphthalene; sal ammoniac; toxic gas neutralizers; neodymium; neon; neptunium; nitrate of uranium; nitrates; combusting preparations [chemical additives to motor fuel]; nitrous oxide; baryta; uranium oxide; oxalates; lithia [lithium oxide]; lead oxide; antimony oxide; chromium oxide; cobalt oxide for industrial purposes; mercuric oxide; gallnuts; purification preparations; wine finings; textile-brightening chemicals; beer-clarifying and preserving agents; must-finishing preparations; reducing agents for use in photography; bases [chemical preparations]; wax-bleaching chemicals; fat-bleaching chemicals; pectin for the food industry; pectin for industrial purposes; pectin [photography]; perborate of soda; humus top dressing; percarbonates; hydrogen peroxide; persulfates; perchlorates; foundry sand; plastisols; sensitized plates for offset printing; ferrotype plates [photography]; plasticizers; plastics, unprocessed; X-ray films, sensitized but not exposed; plutonium; polonium; potash; potash water; earth for growing; praseodymium; rubber preservatives; masonry preservatives, except paints and oils; brickwork preservatives, except paints and oils; cement preservatives, except paints and oils; preservatives

for tiles, except paints and oils; bacterial preparations other than for medical and veterinary use; bacteriological preparations for acetification; bacteriological preparations other than for medical and veterinary use; biological preparations, other than for medical or veterinary purposes; vulcanising preparations; diagnostic preparations, other than for medical or veterinary purposes; renovating preparations for phonograph records; cement-waterproofing chemicals, except paints; currying preparations for leather; currying preparations for skins; metal hardening preparations; fixing baths [photography]; opacifiers for glass; opacifiers for enamel; separating and unstickening [ungluing] preparations; preparations for preventing the tarnishing of lenses; preparations for preventing the tarnishing of glass; plant growth regulating preparations; wallpaper removing preparations; fulling preparations for use in the textile industry; scale removing preparations, other than for household purposes; flashlight preparations; galvanizing preparations; finishing preparations for use in the manufacture of steel; sizing preparations; animal carbon preparations; meat tenderizers for industrial purposes; corrosive preparations; cryogenic preparations; dehydrating preparations for industrial purposes; degreasing preparations for use in manufacturing processes; degumming preparations; oil-bleaching chemicals; bleaching preparations [decolorants] for industrial purposes; preparations for stimulating cooking for industrial purposes; anti-incrustants; preparations of trace elements for plants; moistening [wetting] preparations for use in the textile industry; moistening [wetting] preparations for use in dyeing; moistening [wetting] preparations for use in bleaching; enzyme preparations for the food industry; enzyme preparations for industrial purposes; filtering preparations for the beverages industry; vine disease preventing chemicals; chemical preparations to prevent mildew; chemical preparations for protection against wheat blight [smut]; chemical condensation preparations; chemical preparations for smoking meat; chemical substances for analyses in laboratories, other than for medical or veterinary purposes; chemical preparations for scientific purposes, other than for medical or veterinary use; chemical preparations for facilitating the alloying of metals; engine-decarbonising chemicals; fulling preparations; fuel-saving preparations; coal saving preparations; damp-proofing chemicals, except paints, for masonry; anti-sprouting preparations for vegetables; preparations of the distillation of wood alcohol; by-products of the processing of cereals for industrial purposes; benzene derivatives; cellulose derivatives [chemicals]; promethium; protactinium; protein [raw material]; mordants for metals; radium for scientific purposes; radon; solvents for varnishes; anti-frothing solutions for accumulators; drilling muds; solutions for cyanotyping; galvanizing baths; silver salt solutions for silvering; toning baths [photography]; che-

mical reagents, other than for medical or veterinary purposes; rhenium; mercury; rubidium; carbon black for industrial purposes; soot for industrial or agricultural purposes; lamp black for industrial purposes; samarium; saccharin; selenium; saltpeter; sulfur; silver nitrate; carbon disulfide; silicates; aluminium silicate; silicones; scandium; foundry molding [moulding] preparations; acrylic resins, unprocessed; artificial resins, unprocessed; synthetic resins, unprocessed; epoxy resins, unprocessed; soda ash; calcined soda; caustic soda for industrial purposes; barium compounds; fluorspar compounds; salts [fertilisers]; salts [chemical preparations]; ammoniacal salts; ammonium salts; salts of precious metals for industrial purposes; salts for galvanic cells; salt for preserving, other than for foodstuffs; salts for coloring [colouring] metal; salts for industrial purposes; iron salts; gold salts; iodised salts; calcium salts; salt, raw; salts from rare earth metals; mercury salts; toning salts [photography]; chrome salts; chromic salts; salts of alkaline metals; rock salt; mold-release preparations; fire extinguishing compositions; compositions for the manufacture of phonograph records; compositions for the manufacture of technical ceramics; compositions for repairing inner tubes of tires [tyres]; compositions for repairing tires [tyres]; acid proof chemical compositions; glutinous tree-grafting preparations; adhesive preparations for surgical bandages; fireproofing preparations; compositions for threading; sauce for preparing tobacco; amyl alcohol; vinic alcohol; wood alcohol; sal ammoniac spirits; ethyl alcohol; alcohol; cement for footwear; concrete preservatives, except paints and oils; water glass [soluble glass]; strontium; substrates for soil-free growing [agriculture]; barium sulfate; sulfates; antimony sulfide; sulfides; benzoic sulfimide; sulfonic acids; sumac for use in tanning; superphosphates [fertilisers]; antimony; thallium; talc [magnesium silicate]; tannin; cream of tartar for the food industry; cream of tartar for industrial purposes; cream of tartar for chemical purposes; tellurium; terbium; tetrachlorides; carbon tetrachloride; acetylene tetrachloride; technetium; thiocarbanilide; titanite; biological tissue cultures other than for medical or veterinary purposes; sensitized cloth for photography; blueprint cloth; toluene; fuel for atomic piles; thorium; peat [fertiliser]; carbonic hydrates; carbon; activated carbon; carbon for filters; animal charcoal; animal carbon; bone charcoal; blood charcoal; nitrogenous fertilisers; fertilizers; fish meal fertilizers; wood vinegar [pyroligneous acid]; uranium; chemical intensifiers for paper; chemical intensifiers for rubber; vulcanisation accelerators; enzymes for the food industry; enzymes for industrial purposes; ferments for chemical purposes; milk ferments for the food industry; milk ferments for industrial purposes; milk ferments for chemical purposes; fermium; ferrocyanides; fixing solutions [photography]; soldering fluxes; brazing fluxes; formic aldehyde for chemical

purposes; phosphatides; phosphates [fertilisers]; phosphorus; photographic paper; photosensitive plates; sensitized photographic plates; sensitized films, unexposed; photographic developers; photographic sensitizers; chemical preparations for use in photography; photographic emulsions; francium; fluorine; chemicals for use in forestry, except fungicides, herbicides, insecticides and parasiticides; glass-frosting chemicals; leather-renovating chemicals; glass-staining chemicals; enamel-staining chemicals; oil-separating chemicals; water-purifying chemicals; oil-purifying chemicals; welding chemicals; condensation-preventing chemicals; stain-preventing chemicals for use on fabrics; anti-tarnishing chemicals for windows; leather-waterproofing chemicals; textile-waterproofing chemicals; chemicals, except pigments, for the manufacture of enamel; radiator flushing chemicals; leather-impregnating chemicals; textile-impregnating chemicals; horticultural chemicals, except fungicides, herbicides, insecticides and parasiticides; agricultural chemicals, except fungicides, herbicides, insecticides and parasiticides; soil conditioning preparations; chimney cleaners, chemical; color- [colour-] brightening chemicals for industrial purposes; refrigerants; coolants for vehicle engines; chlorine; chlorates; hydrochlorates; aluminium chloride; magnesium chloride; chlorides; palladium chloride; chromates; flowers of sulfur for chemical purposes; caesium; cellulose; cerium; cyanides [prussiates]; calcium cyanamide [fertilizer]; cymene; loam; slag [fertilisers]; size for finishing and priming; alkalis; caustic alkali; radioactive elements for scientific purposes; fissionable chemical elements; emulsifiers; erbium; ethane; methyl ether; sulfuric ether; ethyl ether; glycol ether; ethers; esters; cellulose ethers for industrial purposes; cellulose esters for industrial purposes; size for use in the textile industry; artificial sweeteners [chemical preparations]; fissionable material for nuclear energy; liquids for removing sulfates from accumulators; grafting wax for trees; preparations of microorganisms, other than for medical and veterinary use; sodium salts [chemical compounds]; enamel and glass-staining chemicals; transmission oils.

4 – Anthracite; benzine; benzene; benzol; wood briquettes; combustible briquettes; petroleum jelly for industrial purposes; wax [raw material]; ozokerite [ozokerite]; illuminating wax; industrial wax; belting wax; carnauba wax; beeswax; gas for lighting; oil-gas; fuel gas; gasoline; producer gas; solidified gases [fuel]; fuel; lubricating graphite; additives, non-chemical, to motor-fuel; firewood; paper spills for lighting; cutting fluids; fish oil, not edible; illuminating grease; grease for leather; grease for footwear; tallow; industrial grease; kerosene; coke; xylene; xylol; ligroin; wood spills for lighting; mazut; fuel oil; oils for paints; oils for releasing form work [building]; oil for the preservation of masonry; oil for the preservation of leather; textile oil; lubricating oil; indus-

trial oil; moistening oil; coal tar oil; coal naphtha; castor oil for industrial purposes; bone oil for industrial purposes; motor oil; sunflower oil for industrial purposes; rape oil for industrial purposes; lubricants; naphtha; petroleum, raw or refined; nightlights [candles]; oleine; paraffin; dust removing preparations; soya bean oil preparations for non-stick treatment of cooking utensils; non-slipping preparations for belts; coal dust [fuel]; firelighters; perfumed candles; Christmas tree candles; candles; grease for arms [weapons]; lubricating grease; grease for belts; vaporized fuel mixtures; dust binding compositions for sweeping; dust laying compositions; alcohol [fuel]; stearine; lighting fuel; mineral fuel; carburants; fuel with an alcoholic base; peat [fuel]; peat briquettes [fuel]; tinder; lignite; charcoal [fuel]; coal; coal briquettes; lamp wicks; wicks for candles; ceresine; electrical energy; ethanol [fuel]; petroleum ether; aviation fuel; crude oil; automotive greases; preservatives for leather [oils and greases]; methylated spirit; candles and wicks for lighting; dust binding compositions; dust absorbing compositions; dust wetting compositions; industrial oils and greases; automotive lubricants; coal used as fuel; diesel oil; biodiesel oil; biodiesel fuel; fuel for motor vehicles; aircraft fuel; aircraft motor gasoline; jet fuel; jet biofuel; base oil for industrial purposes; crude oil for industrial purposes; refined oil; unrefined oil; synthetic oil; non-synthetic oil; mineral oil; oil used in the manufacture of waxes, rubber, caoutchouc and plastics; heating oil; heavy oil; heavy fuel; liquefied gaseous fuels; light oil; light oil products; residual heavy fuels and oils [mazut]; residual light fuels and oils [mazut].

(260) AM 2016 85953 A
 (800) 1285080
 (891) 2015 08 21
 (731) AFLOFARM Farmacja Polska Sp. z o.o.
 ul. Partyzancka 133/151, PL-95-200
 Pabianice, Poland
 (540)

4MOTIVA

(511)
 5 – Pharmaceutical products, sanitary preparations for medical purposes; medical devices for medical purposes; dietetic substances adapted for medical purposes; dietary supplements; nutritional and dietary supplements for health use; food for babies; medicinal herbs, plant extracts for medicinal purpose.

29 – Meat, fish, poultry and game; meat extracts; preserved, frozen, dried and cooked fruits and vegetables; jellies, jams, compotes; eggs, milk and milk products; edible oils and fats, including nutrient for athletes, dietetic substances, dietetic foods, concentrates and high protein supplements, carbohydrate and high-energy fortified with vitamins, minerals

and amino acids not for medical purposes included in this class.

32 – Mineral waters and aerated waters and other non-alcoholic drinks; fruit drinks and fruit juices; syrups and other preparations for the production and preparation of beverages, diet drinks, high-energy, carbohydrate, vitamins.

(260) AM 2016 85954 A
 (800) 1284577
 (891) 2015 10 09
 (731) Public Joint Stock Company Gazprom neft
 Galernaya
 ul., 5, lit. A, RU-190000 St-Petersburg,
 Russian Federation

(540)

 The logo for G-Box features the word "G-Box" in a bold, sans-serif font. The letter "G" is stylized with a red-to-orange gradient and a white outline, while "Box" is in a dark gray color.

(591) Gray, light-gray, orange, and light-orange
 (511)

1 – Chemical products for use in oil and gas industry; fertilizing preparations; tempering and soldering preparations; brake fluid; fluids for hydraulic circuits; power steering fluid; transmission fluid; anti-boil preparations for engine coolants; fluids for car locks; defrosting fluids for car locks; deicing fluids for vehicles; agar-agar; nitrogen; actinium; alkaloids; alginates for the food industry; alginates for industrial purposes; crotonic aldehyde; ammonium aldehyde; aldehydes; americium; amyl acetate; ammonia [volatile alkali] for industrial purposes; anhydrous ammonia; ammonia; acetic anhydride; anhydrides; anti-knock substances for internal combustion engines; disincrustants; antistatic preparations, other than for household purposes; antifreeze; argon; lead arsenate; astatine; aluminium acetate; lime acetate; lead acetate; acetate of cellulose, unprocessed; acetates [chemicals]; acetylene; acetone; oenological bactericides [chemical preparations for use in wine making]; balm of gurjun [gurjon, gurjan] for making varnish; barium; barytes; albumin [animal or vegetable, raw material]; animal albumen [raw material]; iodised albumen; malt albumen; bentonite; berkelium; bicarbonate of soda for chemical purposes; potassium dioxalate; bichromate of potassium; bichromate of soda; bauxite; bromine for chemical purposes; albumenized paper; baryta paper; diazo paper; blueprint paper; test paper, chemical; litmus paper; self-toning paper [photography]; nitrate paper; sensitized paper; photometric paper; borax; agglutinants for concrete; gas purifying preparations; preservatives for pharmaceutical preparations; polish removing substances; preparations for the separation of greases; substances for preventing runs in stockings; water-softening preparations; limestone hardening substances; tanning substances; adhesives for indus-

trial purposes; surface-active chemical agents; foundry binding substances; concrete-aeration chemicals; leather-dressing chemicals; chemicals for the manufacture of paints; chemical substances for preserving foodstuffs; starch-liquifying chemicals [ungluing agents]; flower preservatives; seed preserving substances; viscose; bismuth; bismuth subnitrate for chemical purposes; witherite; distilled water; seawater for industrial purposes; acidulated water for recharging accumulators; heavy water; hydrogen; seaweeds [fertilizers]; gadolinium; getters [chemically active substances]; protective gases for welding; solidified gases for industrial purposes; basic gallate of bismuth; gallium; gambier; helium; electrophoresis gels, other than for medical or veterinary purposes; genes of seeds for agricultural production; aluminium hydrate; hydrates; hyposulfites; ceramic glazings; glycol; expanded clay for hydroponic plant growing [substrate]; kaolin; alumina; glycerides; glycerine for industrial purposes; glucose for the food industry; glucose for industrial purposes; glucosides; gluten for the food industry; gluten for industrial purposes; holmium; hormones for hastening the ripening of fruit; peat pots for horticulture; graphite for industrial purposes; guano; humus; dextrin [size]; detergents for use in manufacturing processes; defoliants; diastase for industrial purposes; manganese dioxide; titanium dioxide for industrial purposes; zirconia; oil dispersants; petroleum dispersants; dispersions of plastics; dysprosium; detergent additives to gasoline [petrol]; ceramic compositions for sintering [granules and powders]; additives, chemical, to drilling muds; additives, chemical, to insecticides; chemical additives for oils; additives, chemical, to motor fuel; additives, chemical, to fungicides; dolomite for industrial purposes; tan-wood; europium; gelatine for photographic purposes; gelatine for industrial purposes; auxiliary fluids for use with abrasives; magnetic fluid for industrial purposes; tree cavity fillers [forestry]; glaziers' putty; moderating materials for nuclear reactors; rare earths; diatomaceous earth; fuller's earth for use in the textile industry; lime chloride; isotopes for industrial purposes; ion exchangers [chemicals]; ytterbium; yttrium; iodine for industrial purposes; iodine for chemical purposes; aluminium iodide; alkaline iodides for industrial purposes; casein for the food industry; casein for industrial purposes; kainite; potassium; sorrel salt; californium; gum arabic for industrial purposes; tartar other than for pharmaceutical purposes; camphor, for industrial purposes; calcium carbide; carbide; lime carbonate; magnesium carbonate; carbonates; cement [metallurgy]; lutetium [cassiopium]; catalysts; biochemical catalysts; catechu; caustics for industrial purposes; alum; ammonia alum; aluminium alum; chrome alum; quebracho for industrial purposes; ketones; cinematographic films, sensitized but not exposed; oxygen; nitric acid; anthranilic acid; benzoic acid; boric acid for industrial purposes;

tartaric acid; tungstic acid; gallic acid for the manufacture of ink; gallotannic acid; tannic acid; iodic acid; phenol for industrial purposes; citric acid for industrial purposes; lactic acid; formic acid; persulfuric acid; oleic acid; picric acid; pyrogallic acid; salicylic acid; sebacic acid; sulfuric acid; sulfurous acid; spirits of salt; stearic acid; carbonic acid; spirits of vinegar [dilute acetic acid]; phosphoric acid; hydrofluoric acid; cholic acid; chromic acid; oxalic acid; acids; benzene-based acids; fatty acids; mineral acids; arsenious acid; adhesives for billposting; leather glues; adhesives for wall tiles; adhesives for wallpaper; glue for industrial purposes; cement for mending broken articles; gums [adhesives], other than for stationery or household purposes; birdlime; isinglass other than for stationery, household or alimentary purposes; gluten [glue], other than for stationery or household purposes; stem cells other than for medical or veterinary purposes; flocculants; collodion; compost; beer preserving agents; mangrove bark for industrial purposes; tan; starch for industrial purposes; silicon; krypton; xenon; curium; lactose [raw material]; lactose for the food industry; lactose for industrial purposes; lanthanum; dry ice [carbon dioxide]; lecithin [raw material]; lecithin for the food industry; lecithin for industrial purposes; lithium; magnesite; manganate; oils for tanning leather; oils for currying leather; oils for preparing leather in the course of manufacture; oils for the preservation of food; carbolineum for the protection of plants; paper pulp; wood pulp; grafting mastic for trees; mastic for leather; cement for pneumatic tires [tyres]; fillers for automobile bodies; oil cement [putty]; synthetic materials for absorbing oil; ceramic materials in particulate form, for use as filtering media; filtering materials [unprocessed plastics]; filtering materials [mineral substances]; filtering materials [vegetable substances]; filtering materials [chemical preparations]; blue vitriol; metalloids; alkaline-earth metals; alkaline metals; methane; methyl benzene; methyl benzol; flour for industrial purposes; tapioca flour for industrial purposes; potato flour for industrial purposes; soap [metallic] for industrial purposes; arsenic; bate for dressing skins; emollients for industrial purposes; sodium; hypochlorite of soda; naphthalene; sal ammoniac; toxic gas neutralizers; neodymium; neon; neptunium; nitrate of uranium; nitrates; combusting preparations [chemical additives to motor fuel]; nitrous oxide; baryta; uranium oxide; oxalates; lithia [lithium oxide]; lead oxide; antimony oxide; chromium oxide; cobalt oxide for industrial purposes; mercuric oxide; gallnuts; purification preparations; wine finings; textile-brightening chemicals; beer-clarifying and preserving agents; must-finishing preparations; reducing agents for use in photography; bases [chemical preparations]; wax-bleaching chemicals; fat-bleaching chemicals; pectin for the food industry; pectin for industrial purposes; pectin [photography]; perborate of soda; humus top

dressings; percarbonates; hydrogen peroxide; persulfates; perchlorates; foundry sand; plastisols; sensitized plates for offset printing; ferrotype plates [photography]; plasticizers; plastics, unprocessed; X-ray films, sensitized but not exposed; plutonium; polonium; potash; potash water; earth for growing; praseodymium; rubber preservatives; masonry preservatives, except paints and oils; brickwork preservatives, except paints and oils; cement preservatives, except paints and oils; preservatives for tiles, except paints and oils; bacterial preparations other than for medical and veterinary use; bacteriological preparations for acetification; bacteriological preparations other than for medical and veterinary use; biological preparations, other than for medical or veterinary purposes; vulcanising preparations; diagnostic preparations, other than for medical or veterinary purposes; renovating preparations for phonograph records; cement-waterproofing chemicals, except paints; currying preparations for leather; currying preparations for skins; metal hardening preparations; fixing baths [photography]; opacifiers for glass; opacifiers for enamel; separating and unsticking [ungluing] preparations; preparations for preventing the tarnishing of lenses; preparations for preventing the tarnishing of glass; plant growth regulating preparations; wallpaper removing preparations; fulling preparations for use in the textile industry; scale removing preparations, other than for household purposes; flashlight preparations; galvanizing preparations; finishing preparations for use in the manufacture of steel; sizing preparations; animal carbon preparations; meat tenderizers for industrial purposes; corrosive preparations; cryogenic preparations; dehydrating preparations for industrial purposes; degreasing preparations for use in manufacturing processes; degumming preparations; oil-bleaching chemicals; bleaching preparations [decolorants] for industrial purposes; preparations for stimulating cooking for industrial purposes; anti-incrustants; preparations of trace elements for plants; moistening [wetting] preparations for use in the textile industry; moistening [wetting] preparations for use in dyeing; moistening [wetting] preparations for use in bleaching; enzyme preparations for the food industry; enzyme preparations for industrial purposes; filtering preparations for the beverages industry; vine disease preventing chemicals; chemical preparations to prevent mildew; chemical preparations for protection against wheat blight [smut]; chemical condensation preparations; chemical preparations for smoking meat; chemical substances for analyses in laboratories, other than for medical or veterinary purposes; chemical preparations for scientific purposes, other than for medical or veterinary use; chemical preparations for facilitating the alloying of metals; engine-decarbonising chemicals; fulling preparations; fuel-saving preparations; coal saving preparations; damp-proofing chemicals, except paints, for masonry; anti-

sprouting preparations for vegetables; preparations of the distillation of wood alcohol; by-products of the processing of cereals for industrial purposes; benzene derivatives; cellulose derivatives [chemicals]; promethium; protactinium; protein [raw material]; mordants for metals; radium for scientific purposes; radon; solvents for varnishes; anti-frothing solutions for accumulators; drilling muds; solutions for cyanotyping; galvanizing baths; silver salt solutions for silvering; toning baths [photography]; chemical reagents, other than for medical or veterinary purposes; rhenium; mercury; rubidium; carbon black for industrial purposes; soot for industrial or agricultural purposes; lamp black for industrial purposes; samarium; saccharin; selenium; saltpeter; sulfur; silver nitrate; carbon disulfide; silicates; aluminium silicate; silicones; scandium; foundry molding [moulding] preparations; acrylic resins, unprocessed; artificial resins, unprocessed; synthetic resins, unprocessed; epoxy resins, unprocessed; soda ash; calcined soda; caustic soda for industrial purposes; barium compounds; fluorspar compounds; salts [fertilisers]; salts [chemical preparations]; ammoniacal salts; ammonium salts; salts of precious metals for industrial purposes; salts for galvanic cells; salt for preserving, other than for foodstuffs; salts for coloring [colouring] metal; salts for industrial purposes; iron salts; gold salts; iodised salts; calcium salts; salt, raw; salts from rare earth metals; mercury salts; toning salts [photography]; chrome salts; chromic salts; salts of alkaline metals; rock salt; mold-release preparations; fire extinguishing compositions; compositions for the manufacture of phonograph records; compositions for the manufacture of technical ceramics; compositions for repairing inner tubes of tires [tyres]; compositions for repairing tires [tyres]; acid proof chemical compositions; glutinous tree-grafting preparations; adhesive preparations for surgical bandages; fireproofing preparations; compositions for threading; sauce for preparing tobacco; amyl alcohol; vinic alcohol; wood alcohol; sal ammoniac spirits; ethyl alcohol; alcohol; cement for footwear; concrete preservatives, except paints and oils; water glass [soluble glass]; strontium; substrates for soil-free growing [agriculture]; barium sulfate; sulfates; antimony sulfide; sulfides; benzoic sulfimide; sulfonic acids; sumac for use in tanning; superphosphates [fertilisers]; antimony; thallium; talc [magnesium silicate]; tannin; cream of tartar for the food industry; cream of tartar for industrial purposes; cream of tartar for chemical purposes; tellurium; terbium; tetrachlorides; carbon tetrachloride; acetylene tetrachloride; technetium; thiocarbanilide; titanite; biological tissue cultures other than for medical or veterinary purposes; sensitized cloth for photography; blueprint cloth; toluene; fuel for atomic piles; thorium; peat [fertiliser]; carbonic hydrates; carbon; activated carbon; carbon for filters; animal charcoal; animal carbon; bone charcoal; blood char-

coal; nitrogenous fertilisers; fertilizers; fish meal fertilizers; wood vinegar [pyroligneous acid]; uranium; chemical intensifiers for paper; chemical intensifiers for rubber; vulcanisation accelerators; enzymes for the food industry; enzymes for industrial purposes; ferments for chemical purposes; milk ferments for the food industry; milk ferments for industrial purposes; milk ferments for chemical purposes; fermium; ferrocyanides; fixing solutions [photography]; soldering fluxes; brazing fluxes; formic aldehyde for chemical purposes; phosphatides; phosphates [fertilisers]; phosphorus; photographic paper; photosensitive plates; sensitized photographic plates; sensitized films, unexposed; photographic developers; photographic sensitizers; chemical preparations for use in photography; photographic emulsions; francium; fluorine; chemicals for use in forestry, except fungicides, herbicides, insecticides and parasiticides; glass-frosting chemicals; leather-renovating chemicals; glass-staining chemicals; enamel-staining chemicals; oil-separating chemicals; water-purifying chemicals; oil-purifying chemicals; welding chemicals; condensation-preventing chemicals; stain-preventing chemicals for use on fabrics; anti-tarnishing chemicals for windows; leather-waterproofing chemicals; textile-waterproofing chemicals; chemicals, except pigments, for the manufacture of enamel; radiator flushing chemicals; leather-impregnating chemicals; textile-impregnating chemicals; horticultural chemicals, except fungicides, herbicides, insecticides and parasiticides; agricultural chemicals, except fungicides, herbicides, insecticides and parasiticides; soil conditioning preparations; chimney cleaners, chemical; color- [colour-] brightening chemicals for industrial purposes; refrigerants; coolants for vehicle engines; chlorine; chlorates; hydrochlorates; aluminium chloride; magnesium chloride; chlorides; palladium chloride; chromates; flowers of sulfur for chemical purposes; caesium; cellulose; cerium; cyanides [prussiates]; calcium cyanamide [fertilizer]; cymene; loam; slag [fertilisers]; size for finishing and priming; alkalis; caustic alkali; radioactive elements for scientific purposes; fissionable chemical elements; emulsifiers; erbium; ethane; methyl ether; sulfuric ether; ethyl ether; glycol ether; ethers; esters; cellulose ethers for industrial purposes; cellulose esters for industrial purposes; size for use in the textile industry; artificial sweeteners [chemical preparations]; fissionable material for nuclear energy; liquids for removing sulfates from accumulators; grafting wax for trees; preparations of microorganisms, other than for medical and veterinary use; sodium salts [chemical compounds]; enamel and glass-staining chemicals; transmission oils.

4 – Anthracite; benzene; benzol; wood briquettes; combustible briquettes; petroleum jelly for industrial purposes; wax [raw material]; ozocerite [ozokerite]; illuminating wax; industrial wax; belting wax; carnauba wax; beeswax; gas for lighting; oil-

gas; fuel gas; gasoline; producer gas; solidified gases [fuel]; fuel; lubricating graphite; additives, non-chemical, to motor-fuel; firewood; paper spills for lighting; cutting fluids; fish oil, not edible; illuminating grease; grease for leather; grease for footwear; tal-low; industrial grease; kerosene; coke; xylene; xylol; ligroin; wood spills for lighting; mazut; fuel oil; oils for paints; oils for releasing form work [building]; oil for the preservation of masonry; oil for the preservation of leather; textile oil; lubricating oil; industrial oil; moistening oil; coal tar oil; coal naphtha; castor oil for industrial purposes; bone oil for industrial purposes; motor oil; sunflower oil for industrial purposes; rape oil for industrial purposes; lubricants; naphtha; petroleum, raw or refined; nightlights [candles]; oleine; paraffin; dust removing preparations; soya bean oil preparations for non-stick treatment of cooking utensils; non-slipping preparations for belts; coal dust [fuel]; firelighters; perfumed candles; Christmas tree candles; candles; grease for arms [weapons]; lubricating grease; grease for belts; vaporized fuel mixtures; dust binding compositions for sweeping; dust laying compositions; alcohol [fuel]; stearine; lighting fuel; mineral fuel; carburants; fuel with an alcoholic base; peat [fuel]; peat briquettes [fuel]; tinder; lignite; charcoal [fuel]; coal; coal briquettes; lamp wicks; wicks for candles; ceresine; electrical energy; ethanol [fuel]; petroleum ether; aviation fuel; crude oil; automotive greases; preservatives for leather [oils and greases]; methylated spirit; candles and wicks for lighting; dust binding compositions; dust absorbing compositions; dust wetting compositions; industrial oils and greases; automotive lubricants; coal used as fuel; diesel oil; biodiesel oil; biodiesel fuel; fuel for motor vehicles; aircraft fuel; aircraft motor gasoline; jet fuel; jet biofuel; base oil for industrial purposes; crude oil for industrial purposes; refined oil; unrefined oil; synthetic oil; non-synthetic oil; mineral oil; oil used in the manufacture of waxes, rubber, caoutchouc and plastics; heating oil; heavy oil; heavy fuel; liquefied gaseous fuels; light oil; light oil products; residual heavy fuels and oils [mazut]; residual light fuels and oils [mazut].

(260) AM 2016 85955 A

(800) 1284597

(891) 2015 11 25

(731) MÄURER & Wirtz GmbH & Co. KG
Zweifaller Strasse 120, 52224 Stolberg,
Germany

(540)

Pure Pastel Lemon

(511)

3 – Soaps; cosmetics except such with coloring characteristics or effects; perfumery, essential oils, hair lotions; dentifrices.

(260) AM 2016 85957 A

(800) 1285105

(891) 2015 10 20

(731) ILTF, Inc.

2100 E. Valencia Drive, Suite B-3, Fullerton
CA 92831, USA

(540)



(591) Black, white

(511)

35 – Retail or wholesale services for frozen yogurt and frozen yogurt-based desserts.

43 – Restaurant services; restaurants; take-out restaurant services; cafe-restaurants; fast-food restaurants; carry-out restaurant services and express restaurant services featuring frozen yogurt and frozen yogurt-based desserts.

(260) AM 2016 85958 A

(800) 1285122

(891) 2015 09 23

(731) HARMENGTON LIMITED

Poseidonos 1, Ledra Business Centre, Egkomi
CY-2406 Nicosia, Cyprus

(540)



(591) Red and green

(511)

16 – Absorbent sheets of paper or plastic for foodstuff packaging; address stamps; address plates for addressing machines; addressing machines; adhesive tape dispensers [office requisites]; adhesive tapes for stationery or household purposes; adhesive bands for stationery or household purposes; adhesives [glues] for stationery or household purposes; advertisement boards of paper or cardboard; albums/scrapbooks; almanacs; announcement cards [stationery]; aquarelles/watercolours [paintings]; architects' models; arithmetical tables/calculating tables; artists' watercolour [watercolour] saucers; atlases; bags [envelopes, pouches] of paper or plastics, for packaging; bags for microwave cooking; balls for ball-point pens; bibs of paper; binding strips [bookbinding]; biological samples for use in microscopy [teaching mate-

rials]; blackboards; blotters; blueprints/plans; book-binding material; bookbinding apparatus and machines [office equipment]; book bindings, bookends, booklets, bookmarkers; books; bottle wrappers of cardboard or paper; boxes of cardboard or paper; cabinets for stationery [office requisites]; calendars; canvas for painting; carbon paper; cardboard; cards/charts; easels for stamps [seals]; catalogues; chalk for lithography; chalk holders; charcoal pencils; chart pointers, non-electric; chromolithographs [chromos]/chromos; cigar bands; clipboards; clips for offices; cloth for bookbinding; coasters of paper; comic books; compasses for drawing; composing frames [printing]; composing sticks; conical paper bags; copying paper [stationery]; cords for bookbinding; correcting fluids [office requisites]; correcting ink [heliography]; covers [stationery]/wrappers [stationery]; cream containers of paper; credit card imprinters, non-electric; desk mats; diagrams; document files [stationery]; document laminators for office use; document holders [stationery]; drawer liners of paper, perfumed or not; drawing pads; drawing pins/thumbtacks; drawing boards; drawing materials; drawing instruments; drawing sets; drawing pens; drawing rulers; drawing squares; drawing t-squares; duplicators; elastic bands for offices; electrocardiograph paper; electrotypes; embroidery designs [patterns]; engraving plates; engravings; envelope sealing machines, for offices; envelopes [stationery]; erasing products; etching needles; etchings; fabrics for bookbinding; face towels of paper; figurines [statuettes] of papier mâché; files [office requisites]; filler paper; filtering materials [paper]; finger-stalls [office requisites]; flags of paper; flower-pot covers of paper; flyers; folders for paper/jackets for papers; folders [stationery]; forms, printed; pens; franking machines for office use; french curves; garbage bags of paper or of plastics; geographical maps; glue for stationery or household purposes; graining combs; graphic prints; graphic reproductions; graphic representations; greeting cards; gums [adhesives] for stationery or household purposes; hand labelling appliances; hand-rests for painters; handkerchiefs of paper; handwriting specimens for copying; hat boxes of cardboard; hectographs; histological sections for teaching purposes; holders for stamps [seals]; holders for check books [cheque books]; house painters' rollers; humidity control sheets of paper or plastic for foodstuff packaging; index cards [stationery]; indexes; indian inks; ink; ink sticks; ink stones [ink reservoirs]; inking pads; inking ribbons; inking sheets for duplicators; inking sheets for document reproducing machines; isinglass for stationery or household purposes; labels, not of textile; loose-leaf binders; ledgers [books]; letter trays; lithographic works of art; lithographic stones; lithographs; magazines [periodicals]; manifolds [stationery]; manuals [handbooks]/handbooks [manuals]; marking chalk; marking pens [stationery]; mats for beer glasses; mime-

ograph apparatus and machines; modelling clay; modelling wax, not for dental purposes; modelling materials; modelling paste; moisteners [office requisites]; moisteners for gummed surfaces [office requisites]; money clips; moulds for modelling clays [artists' materials]; apparatus for mounting photographs; musical greeting cards; newsletters; newspapers; nibs; note books; numbering apparatus; numbers [type]; obliterating stamps; office perforators; office requisites, except furniture; oleographs; packaging material made of starches; packing [cushioning, stuffing] materials of paper or cardboard; pads [stationery]; paint boxes [articles for use in school]; paint trays; paintbrushes; painters' easels; painting [pictures], framed or unframed; palettes for painters; pamphlets; pantographs [drawing instruments]; paper; paper for recording machines; paper sheets [stationery]; paper clasps; paper tapes and cards for the records of computer programmes; paper ribbons; paper shredders for office use; paper coffee fillers; paper bows; paper-clips; paperweights; papier mâché; parchment paper; passport holders; pastels [crayons]; pen clips; pen wipers; pencil sharpening machines, electric or non-electric; pencil leads; pencil holders; pencil lead holders; pencils; penholders; perforated cards for jacquard looms; photo-engravings; photograph stands; photographs [printed]; placards of paper or cardboard; place mats of paper; plastic film for wrapping; plastic bubble packs for wrapping or packaging; plastic cling film extensible for palletization, plastics for modelling; polymer modelling clay; portraits; postage stamps; postcards; posters; printed timetables; printed matter; printed publications; printers' blankets, not of textile; printers' galleys; printing blocks; printing type; printing sets portable [office requisites]; prints [engravings]; prospectuses; punches [office requisites]; rollers for typewriters; rosaries/chaplets; rubber erasers; school supplies [stationery]; scrapers [erasers] for offices; sealing stamps; sealing wax; sealing compounds for stationery purposes; sealing wafers; seals [stamps]; self-adhesive tapes for stationery or household purposes; sewing patterns; sheets of reclaimed cellulose for wrapping; shields [paper seals]; signboards of paper or cardboard; silver paper; slate pencils; song books; spools for inking ribbons; square rulers; stamp pads; stamp stands; stands for pens and pencils; stapling presses [office requisites]; starch paste [adhesive] for stationery or household purposes; stationery; steatite [tailor's chalk]; steel letters; steel pens; stencil cases; stencil plates; stencils [stationery]; stencils; stickers [stationery]; stuffing of paper or cardboard; table linen of paper; table napkins of paper; tablecloths of paper; tablemats of paper; tags for index cards; tailors' chalk; teaching materials [except apparatus]; terrestrial globes; tickets; tissues of paper for removing make-up; toilet paper/hygienic paper; towels of paper; tracing patterns; tracing paper; tracing cloth; tracing needles for

drawing purposes; trading cards other than for games; transfers [decalcomanias]; transparencies [stationery]; trays for sorting and counting money; type [numerals and letters]/letters [type]; typewriter ribbons; typewriter keys; typewriters electric or non-electric; vignetting apparatus, viscose sheets for wrapping; waxed paper; wood pulp board [stationery]; wood pulp paper; wrapping paper; wristbands for the retention of writing instruments; writing slates; writing or drawing books; writing chalk; writing materials; writing paper; writing cases [stationery]; writing cases [sets]; writing brushes; writing instruments; writing board erasers; xuan paper for chinese painting and calligraphy.

21 – Holders for flowers and plants [flower arranging]; horse brushes; hot pots, non-electrically heated; ice cube molds [moulds]; ice buckets/coolers [ice pails]; indoor terrariums [plant cultivation]; indoor aquaria/tanks [indoor aquaria]; indoor terrariums [vivariums]; insect traps; insulating flasks/vacuum bottles; ironing board covers, shaped; ironing boards; isothermic bags; jugs/pitchers; kettles, non-electric; kitchen grinders, non-electric; kitchen containers; kitchen utensils; knife rests for the table; lamp-glass brushes; large-toothed combs for the hair; lazy susans; liqueur sets; litter boxes [trays] for pets/litter trays for pets; lunch, boxes; majolica; mangers for animals; menu card holders; mess-tins; mills for domestic purposes, hand operated; mixing spoons [kitchen utensils]; mop wringers; mops; mosaics of glass, not for building; moulds [kitchen utensils] mouse traps; mugs; nozzles for watering hose; nozzles for watering cans/rosettes for watering cans; opal glass; opaline glass; oven mitts/barbecue mitts/kitchen mitts; painted glassware; paper plates; pastry cutters; pepper mills, hand-operated; pepper pots; perfume burners; perfume vaporizers/perfume sprayers; fitted picnic baskets, including dishes; pie servers/tart scoops; pig bristles; piggy banks; pipettes [wine-tasters]/wine tasters [siphons]; plate glass [raw material]; plates to prevent milk boiling over; plungers for clearing blocked drains; polishing leather; polishing materials for making shiny, except preparations, paper and stone; polishing gloves; porcelain ware; pot lids; potholders; pots; pottery; powder puffs; powder compacts; powdered glass for decoration; rags [cloth] for cleaning/cloths for cleaning/rags for cleaning; rat traps; refrigerating bottles; make-up removing appliances; rings for birds; rolling pins, domestic; salad bowls; salt cellars/salt shakers; saucepan scourers of metal; saucers; scoops [tableware] scouring pads/pads for cleaning; scrubbing brushes; services [dishes]; shaving brushes; shaving brush stands/stands for shaving brushes; shoe trees [stretchers]; shoe horns; sieves [household utensils]; sifters [household utensils]; signboards of porcelain or glass; siphon bottles for carbonated water; soap boxes; soap dispensers; soap holders/dishes for soap; soup bowls; spatulas [kitchen utensils]; spi-

ce sets; sponge holders; sponges for household purposes; make-up sponges; spouts; sprinklers; statues of porcelain, ceramic, earthenware or glass; steel wool for cleaning; stew-pans; strainers for household purposes; strainers; straws for drinking/drinking straws; sugar bowls; syringes for watering flowers and plants/sprinklers for watering flowers and plants; table plates; tableware, other than knives, forks and spoons; tankards; tar-brushes, long handled; tea caddies; tea services [tableware]; tea infusers/tea balls; tea strainers; tea cosies; teapots; thermally insulated containers for food; toilet brushes; toilet cases/fitted vanity cases; toilet paper dispensers; toilet sponges; toilet utensils; toilet paper holders; toothbrushes; toothbrushes, electric; toothpick holders; toothpicks; towel rails and rings/rails and rings for towels; trays for domestic purposes, of paper; trays for domestic purposes; trivets [table utensils]; trouser presses; urns; vases; vegetable dishes; vessels of metal for making ices and iced drinks; washing boards; washtubs; waste paper baskets; water apparatus for cleaning teeth and gums; watering devices/sprinkling devices; watering cans; apparatus for wax-polishing, non-electric; wax-polishing appliances, non-electric, for shoes; whisks, non-electric, for household purposes; window-boxes; wool waste for cleaning; abrasive pads for kitchen purposes; abrasive sponges for scrubbing the skin; aerosol dispensers not for medical purposes; animal bristles [brushware]; aquarium hoods; electric devices for attracting and killing insects; autoclaves [pressure cookers], non-electric/pressure cookers [autoclaves], non-electric; baby baths, portable; baking mats; basins [receptacles]; baskets for domestic use; basting spoons [cooking utensils]; basting brushes; beaters non-electric; beer mugs; bird baths; birdcages; blenders non-electric for household purposes; bootjacks; boot trees [stretchers]; bottle openers, electric and non-electric; bottles; bowls [basins]; boxes for dispensing paper towels; boxes of glass; bread baskets, domestic; bread boards; brooms; brush goods; material for brush-making; brushes; brushes for footwear; electric brushes, except parts of machines; brushes for cleaning tanks and containers; buckets/pails; bulb basters; busts of porcelain, ceramic, earthenware or glass; butter dishes; butter-dish covers; buttonhooks; cabarets [trays]; cages for household pets; cake molds [moulds]; candelabra [candlesticks]/candlesticks; candle rings; candle extinguishers; candle jars [holders]; candy boxes/boxes for sweetmeats; car washing mitts; carpet beaters [hand instruments]; carpet sweepers; cauldrons; ceramics for household purposes; chamber pots; chamois leather for cleaning; cheese-dish covers; china ornaments; chopsticks; cinder sifters [household utensils]; cleaning instruments, hand-operated; cleaning tow; closures for pot lids; cloth for washing floors; clothes-pegs; clothing stretchers; coasters not of paper and other than table linen; cocktail shakers; cocktail stirrers;

coffee grinders, hand-operated; coffee services [tableware]; coffee filters, non-electric; coffeepots, non-electric; comb cases; combs; confectioners' decorating bags [pastry bags]; containers for household or kitchen use; cookery molds [moulds]; cookie [biscuit] cutters; cookie jars; cooking pot sets; cooking skewers of metal/cooking pins of metal; cooking pots; cooking utensils, non-electric; cosmetic utensils; cosmetic spatulas; cotton waste for cleaning; cruet sets for oil and vinegar; cruets; crushers for kitchen use, non-electric; crystal [glassware]; cups; currycombs; cutting boards for the kitchen; decanters; deep fryers, non-electric; deodorising apparatus for personal use; dish covers; dishes; dishwashing brushes; drinking troughs; drinking vessels; drinking horns; drinking glasses; dripping pans; drying racks for laundry; dustbins/garbage cans/refuse bins/trash cans; dusting apparatus, non-electric; dusting cloths [rags]; earthenware/crockery; earthenware saucepans; egg cups; enamelled glass; epergnes; eyebrow brushes; feather-dusters; feeding troughs; flasks; flat-iron stands; floss for dental purposes; flower pots; flower-pot covers, not of paper/covers, not of paper, for flower pots; fly swatters; food steamers, non-electric; fruit cups; fruit presses, non-electric, for household purposes; frying pans; funnels; furniture dusters; gardening gloves; garlic presses [kitchen utensils]; glass bulbs [receptacles]/glass vials [receptacles]; glass flasks [containers]; glass jars [carboys]; glass bowls; glass, unworked or semi-worked, except building glass; glass wool other than for insulation; glass incorporating fine electrical conductors; glasses receptacles; glove stretchers; gloves for household purposes; glue-pots; graters for kitchen use; grill supports/gridiron supports; grills [cooking utensils]/griddles [cooking utensils]; hair for brushes; heat-insulated containers for beverages; heat-insulated containers; heaters for feeding bottles, non-electric; hip flasks; works of art of porcelain, ceramic, earthenware or glass.

(260) AM 2016 85959 A

(800) 1285130

(891) 2015 09 17

(731) HELIOS DOMŽALE, d.o.o.

Količevo 2, SI-1230 DOMŽALE, Slovenia

(540)

**GRAVI
HEL**

(591) Black, white

(511)

1 – Chemical products used in industry, especially chemicals used in manufacturing of paints, industrial

chemicals, aldehydes, anti-static preparations (except for household purposes), bacteriologic preparations (except for medical and veterinary purposes); chemical reactant (except for medical and veterinary purposes); concrete preservatives, except paints and oils; condensation-preventing chemicals; degreasing preparations for use in manufacturing processes; decolorants for industrial processes; emulsifiers; fireproofing preparations; preservatives used in masonry, except paints and oils; enamel staining chemicals; salts for coloring metal; artificial resins, unprocessed; plastics, unprocessed; tanning substances; adhesives for industrial purposes, solvents for varnishes.

2 – Paints, including wood colorings, bactericidal paints, fireproof paints, paints for ceramics; aluminium paints, printing ink and printing paints; painting coatings i.e. coatings, whitening substances, dyes, and binding substances for paints; varnishes for painting; lacquers, including lacquers on the basis of varnish and painting lacquers; anti-rust preparations, especially preservatives against rust; preservatives for metal, minium, red lead, white lead, undercoatings and coatings for chassis of vehicles; mastic, primers; thinners for paints and lacquers; thickeners for paints and lacquers; agglutinants for paints; mordants; enamels; fixatives for watercolors; mordants for leather; wood preservatives, including wood coatings and wood mordants; metals in foil and powder form for painters, decorators, printers and artists, colorants.

17 – Artificial resins (semi-processed), acrylic resins (semi-processed); rubber (raw other semi-processed); seals and rings of rubber; semi-processed plastics; plastic fibres, not for use in textile; adhesive bands and tapes (other than stationery and not for medical purposes; insulating fabrics, insulating oil, insulating paints, insulating varnish, insulating tape and band, substances for insulating buildings against moisture; filtering materials (semi-processed foams or films of plastics); flexible tubes, not of metal.

(260) AM 2016 86093 A

(800) 1264896

(891) 2015 11 24

(731) NOVINTUM MEDICAL TECHNOLOGY
GMBH

Herrenacker 15 CH-8200 Schaffhausen,
Switzerland

(540)

VEINPLICITY

(511)

10 – Surgical, medical, dental and veterinary apparatus and instruments.

INTERNATIONAL TRADEMARKS PROTECTED IN GEORGIA

(260) AM 2015 74427 A
(800) 733058
(151) 2000 03 24
(891) 2013 07 23
(181) 2020 03 24
(511)

3 – Perfumes, toilet soaps, ethereal oils, cosmetics, deodorants for personal use; creams, lotions and oils for the face and body; skin cleansing milks, creams and oils; make-up creams; beauty masks; make-up removers; eye shadows; lipsticks; mascara, rouge; crayons for the eyes and lips; face and body powders; suntanning and after sun exposure creams, oils and lotions; pre and after shave lotions; talcum powders, bath salts, bath foam, bath oil; products for the care and conditioning of hair, hair shampoo, hair lotions; depilatory preparations; nail enamels and polishes; excluding goods for infants and children up to 11 years old.

(260) AM 2016 83032 A
(800) 1254611
(151) 2015 04 30
(181) 2025 04 30
(891) 2015 04 30
(511) 30

(260) AM 2016 83160 A
(800) 1256402
(151) 2015 02 17
(181) 2025 02 17
(891) 2015 02 17
(511) 01, 05, 10

(260) AM 2016 83483 A
(800) 1260228
(151) 2015 03 16
(181) 2025 03 16
(891) 2015 03 16
(511) 16

(260) AM 2016 83500 A
(800) 1260678
(151) 2015 06 05
(181) 2025 06 05
(891) 2015 06 05
(511) 33

(260) AM 2016 83655 A
(800) 1262375
(151) 2015 03 04
(181) 2025 03 04
(891) 2015 03 04
(511) 19, 21

(260) AM 2016 83683 A
(800) 1262577
(151) 2015 05 20
(181) 2025 05 20
(891) 2015 05 20
(511) 09, 14, 18, 25

(260) AM 2016 83689 A
(800) 1262323
(151) 2015 03 24
(181) 2025 03 24
(891) 2015 03 24
(511) 03, 04, 06, 09, 11, 12, 14, 16, 18, 20, 21, 24, 25, 28, 29, 30, 32, 35, 36, 38, 41, 43

(260) AM 2016 83691 A
(800) 1262346
(151) 2015 06 16
(181) 2025 06 16
(891) 2015 06 16
(511) 05

(260) AM 2016 83698 A
(800) 1102301
(151) 2011 11 09
(181) 2021 11 09
(891) 2015 06 12
(511) 16

(260) AM 2016 83754 A
(800) 1262890
(151) 2014 11 13
(181) 2024 11 13
(891) 2014 11 13
(511) 06, 09, 11, 12, 19, 36, 37, 38, 39

(260) AM 2016 83756 A
(800) 1262891
(151) 2014 11 13
(181) 2024 11 13

(891) 2014 11 13
(511) 06, 09, 11, 12, 19, 36, 37, 38, 39

(260) AM 2016 83757 A
(800) 1262915
(151) 2015 06 04
(181) 2025 06 04
(891) 2015 06 04
(511) 06, 09

(260) AM 2016 83758 A
(800) 1262916
(151) 2015 06 04
(181) 2025 06 04
(891) 2015 06 04
(511) 06, 09

(260) AM 2016 83759 A
(800) 1262955
(151) 2015 07 02
(181) 2025 07 02
(891) 2015 07 02
(511) 30

(260) AM 2016 83760 A
(800) 1262977
(151) 2015 01 15
(181) 2025 01 15
(891) 2015 01 15
(511) 05

(260) AM 2016 83761 A
(800) 1262987
(151) 2015 07 01
(181) 2025 07 01
(891) 2015 07 01
(511) 32, 33

(260) AM 2016 83762 A
(800) 1262988
(151) 2014 12 29
(181) 2024 12 29
(891) 2014 12 29
(511) 29, 30

(260) AM 2016 83763 A
(800) 1263056
(151) 2014 10 17
(181) 2024 10 17
(891) 2014 10 17
(511) 25, 35

(260) AM 2016 83764 A
(800) 1263058
(151) 2014 11 28
(181) 2024 11 28
(891) 2014 11 28
(511) 03, 05, 29, 30, 32

(260) AM 2016 83765 A
(800) 1263067
(151) 2014 11 21
(181) 2024 11 21
(891) 2014 11 21
(511) 09, 42

(260) AM 2016 83766 A
(800) 1263068
(151) 2014 12 04
(181) 2024 12 04
(891) 2014 12 04
(511) 06, 07, 09, 11, 12, 16, 17, 25, 35, 37

(260) AM 2016 83767 A
(800) 1263069
(151) 2014 12 29
(181) 2024 12 29
(891) 2014 12 29
(511) 17, 19, 35

(260) AM 2016 83769 A
(800) 810462
(151) 2003 06 04
(181) 2023 06 04
(891) 2015 07 08
(511) 16

(260) AM 2016 83784 A
(800) 1263201
(151) 2015 06 24
(181) 2025 06 24
(891) 2015 06 24
(511) 29

(260) AM 2016 83786 A
(800) 1263262
(151) 2015 06 24
(181) 2025 06 24
(891) 2015 06 24
(511) 29

(260) AM 2016 83788 A
(800) 1263278
(151) 2015 05 05

(181) 2025 05 05
(891) 2015 05 05
(511) 14, 18, 25

(260) AM 2016 83795 A
(800) 1263318
(151) 2015 01 23
(181) 2025 01 23
(891) 2015 01 23
(511) 09

(260) AM 2016 83797 A
(800) 1263388
(151) 2015 03 20
(181) 2025 03 20
(891) 2015 03 20
(511) 16, 35

(260) AM 2016 83802 A
(800) 1263505
(151) 2015 07 23
(181) 2025 07 23
(891) 2015 07 23
(511) 05

(260) AM 2016 83804 A
(800) 1263511
(151) 2015 02 17
(181) 2025 02 17
(891) 2015 02 17
(511) 03, 09, 14, 18, 24, 25, 35

(260) AM 2016 83805 A
(800) 1263513
(151) 2015 01 15
(181) 2025 01 15
(891) 2015 01 15
(511) 05

(260) AM 2016 83810 A
(800) 1263514
(151) 2015 01 23
(181) 2025 01 23
(891) 2015 01 23
(511) 05

(260) AM 2016 83811 A
(800) 1263519
(151) 2015 06 03
(181) 2025 06 03
(891) 2015 06 03
(511) 09

(260) AM 2016 83813 A
(800) 1263521
(151) 2015 06 01
(181) 2025 06 01
(891) 2015 06 01
(511) 03

(260) AM 2016 83814 A
(800) 1263528
(151) 2015 05 25
(181) 2025 05 25
(891) 2015 05 25
(511) 16, 21

(260) AM 2016 83815 A
(800) 1263545
(151) 2015 02 18
(181) 2025 02 18
(891) 2015 02 18
(511) 03, 05, 42, 44

(260) AM 2016 83820 A
(800) 1263620
(151) 2015 03 04
(181) 2025 03 04
(891) 2015 03 04
(511) 09, 35

(260) AM 2016 83821 A
(800) 1263634
(151) 2015 03 23
(181) 2025 03 23
(891) 2015 03 23
(511) 09

(260) AM 2016 83822 A
(800) 1263663
(151) 2015 07 01
(181) 2025 07 01
(891) 2015 07 01
(511) 14

(260) AM 2016 83823 A
(800) 1263707
(151) 2015 03 04
(181) 2025 03 04
(891) 2015 03 04
(511) 35, 42

(260) AM 2016 83824 A
(800) 1263717
(151) 2015 03 19

(181) 2025 03 19
(891) 2015 03 19
(511) 07

(260) AM 2016 83827 A
(800) 1263767
(151) 2015 06 11
(181) 2025 06 11
(891) 2015 06 11
(511) 03

(260) AM 2016 83829 A
(800) 1263768
(151) 2015 06 11
(181) 2025 06 11
(891) 2015 06 11
(511) 03

(260) AM 2016 83831 A
(800) 1263779
(151) 2015 05 27
(181) 2025 05 27
(891) 2015 05 27
(511) 05, 09, 10, 11, 42

(260) AM 2016 83834 A
(800) 1264329
(151) 2015 06 11
(181) 2025 06 11
(891) 2015 06 11
(511) 28

(260) AM 2016 83835 A
(800) 1264330
(151) 2015 05 08
(181) 2025 05 08
(891) 2015 05 08
(511) 05

(260) AM 2016 83836 A
(800) 1264351
(151) 2015 06 18
(181) 2025 06 18
(891) 2015 06 18
(511) 06, 07, 09, 19

(260) AM 2016 83840 A
(800) 1264398
(151) 2015 06 08
(181) 2025 06 08
(891) 2015 06 08
(511) 09, 18, 25

(260) AM 2016 83843 A
(800) 1263925
(151) 2015 06 05
(181) 2025 06 05
(891) 2015 06 05
(511) 01, 30

(260) AM 2016 83846 A
(800) 766533
(151) 2001 08 03
(181) 2021 08 03
(891) 2015 07 09
(511) 25

(260) AM 2016 83849 A
(800) 1264178
(151) 2015 03 19
(181) 2025 03 19
(891) 2015 03 19
(511) 02

(260) AM 2016 83850 A
(800) 928002
(151) 2007 01 10
(181) 2017 01 10
(891) 2007 01 10
(511) 09

(260) AM 2016 83862 A
(800) 1136875
(151) 2012 08 20
(181) 2022 08 20
(891) 2015 06 06
(511) 18

(260) AM 2016 83863 A
(800) 1183777
(151) 2013 10 22
(181) 2023 10 22
(891) 2015 08 13
(511) 18, 25, 35

(260) AM 2016 83864 A
(800) 1256092
(151) 2015 06 03
(181) 2025 06 03
(891) 2015 08 04
(511) 20

(260) AM 2016 83869 A
(800) 1264270
(151) 2015 03 18

(181) 2025 03 18
(891) 2015 03 18
(511) 09, 42

(260) AM 2016 83870 A
(800) 1263814
(151) 2015 07 01
(181) 2025 07 01
(891) 2015 07 01
(511) 03

(260) AM 2016 83873 A
(800) 1264315
(151) 2015 05 26
(181) 2025 05 26
(891) 2015 05 26
(511) 09, 28, 35, 38, 41, 42, 45

(260) AM 2016 83874 A
(800) 1264322
(151) 2015 06 02
(181) 2025 06 02
(891) 2015 06 02
(511) 06, 09

(260) AM 2016 83876 A
(800) 1264323
(151) 2015 06 02
(181) 2025 06 02
(891) 2015 06 02
(511) 06, 09

(260) AM 2016 83879 A
(800) 1263923
(151) 2015 05 26
(181) 2025 05 26
(891) 2015 05 26
(511) 09, 28, 35, 38, 41, 42, 45

(260) AM 2016 83886 A
(800) 1264430
(151) 2014 11 13
(181) 2024 11 13
(891) 2014 11 13
(511) 06, 09, 11, 12, 19, 36, 37, 38, 39

(260) AM 2016 83887 A
(800) 1264431
(151) 2014 11 13
(181) 2024 11 13
(891) 2014 11 13
(511) 06, 09, 11, 12, 19, 36, 37, 38, 39

(260) AM 2016 83896 A
(800) 1264448
(151) 2014 12 15
(181) 2024 12 15
(891) 2014 12 15
(511) 05

(260) AM 2016 83897 A
(800) 1264475
(151) 2015 04 22
(181) 2025 04 22
(891) 2015 04 22
(511) 11, 14, 18, 24, 25, 35

(260) AM 2016 83898 A
(800) 1264481
(151) 2015 04 15
(181) 2025 04 15
(891) 2015 04 15
(511) 05

(260) AM 2016 83902 A
(800) 1265324
(151) 2015 05 18
(181) 2025 05 18
(891) 2015 05 18
(511) 09

(260) AM 2016 83903 A
(800) 1264483
(151) 2015 04 15
(181) 2025 04 15
(891) 2015 04 15
(511) 05

(260) AM 2016 83904 A
(800) 1264484
(151) 2015 05 07
(181) 2025 05 07
(891) 2015 05 07
(511) 09, 28, 41

(260) AM 2016 83908 A
(800) 1265354
(151) 2015 07 20
(181) 2025 07 20
(891) 2015 07 20
(511) 30

(260) AM 2016 83909 A
(800) 1265383
(151) 2015 08 03

(181) 2025 08 03
(891) 2015 08 03
(511) 05

(260) AM 2016 83910 A
(800) 1265397
(151) 2015 08 04
(181) 2025 08 04
(891) 2015 08 04
(511) 20

(260) AM 2016 83914 A
(800) 1264510
(151) 2015 06 02
(181) 2025 06 02
(891) 2015 06 02
(511) 06, 09

(260) AM 2016 83915 A
(800) 1264528
(151) 2015 05 26
(181) 2025 05 26
(891) 2015 05 26
(511) 03

(260) AM 2016 83916 A
(800) 1265414
(151) 2015 08 05
(181) 2025 08 05
(891) 2015 08 05
(511) 09

(260) AM 2016 83917 A
(800) 1264529
(151) 2015 05 26
(181) 2025 05 26
(891) 2015 05 26
(511) 03

(260) AM 2016 83918 A
(800) 1264550
(151) 2015 06 19
(181) 2025 06 19
(891) 2015 06 19
(511) 03

(260) AM 2016 83921 A
(800) 1265495
(151) 2015 08 11
(181) 2025 08 11
(891) 2015 08 11
(511) 42

(260) AM 2016 83922 A
(800) 1265496
(151) 2015 07 31
(181) 2025 07 31
(891) 2015 07 31
(511) 03

(260) AM 2016 83924 A
(800) 1265498
(151) 2015 08 10
(181) 2025 08 10
(891) 2015 08 10
(511) 05

(260) AM 2016 83925 A
(800) 1265499
(151) 2015 08 10
(181) 2025 08 10
(891) 2015 08 10
(511) 05

(260) AM 2016 83926 A
(800) 1265526
(151) 2015 08 21
(181) 2025 08 21
(891) 2015 08 21
(511) 03

(260) AM 2016 83927 A
(800) 186298
(151) 1955 07 18
(181) 2025 07 18
(891) 2015 07 18
(511) 05, 31

(260) AM 2016 83928 A
(800) 451556
(151) 1980 03 27
(181) 2020 03 27
(891) 2015 08 25
(511) 01

(260) AM 2016 83929 A
(800) 546029
(151) 1989 08 19
(181) 2019 08 19
(891) 2015 08 12
(511) 36, 39

(260) AM 2016 83930 A
(800) 576603
(151) 1991 10 28

(181) 2021 10 28
(891) 2015 06 16
(511) 11

(260) AM 2016 83931 A
(800) 584785
(151) 1992 04 13
(181) 2022 04 13
(891) 2015 06 26
(511) 25

(260) AM 2016 83932 A
(800) 757947
(151) 2001 03 16
(181) 2021 03 16
(891) 2015 06 24
(511) 05, 29, 30

(260) AM 2016 83933 A
(800) 777710
(151) 2002 02 13
(181) 2022 02 13
(891) 2015 06 15
(511) 14, 18, 25

(260) AM 2016 83936 A
(800) 797933
(151) 2002 10 09
(181) 2022 10 09
(891) 2015 06 15
(511) 09, 16, 35

(260) AM 2016 83938 A
(800) 1264559
(151) 2014 10 15
(181) 2024 10 15
(891) 2014 10 15
(511) 01, 04, 17, 19, 20, 22, 24, 35, 39, 42

(260) AM 2016 83939 A
(800) 1264581
(151) 2015 03 24
(181) 2025 03 24
(891) 2015 03 24
(511) 18, 25, 28, 32, 33, 35, 38, 41, 43

(260) AM 2016 83940 A
(800) 1264625
(151) 2014 12 01
(181) 2024 12 01
(891) 2014 12 01
(511) 30

(260) AM 2016 83941 A
(800) 943474
(151) 2007 09 11
(181) 2017 09 11
(891) 2015 08 25
(511) 05, 10

(260) AM 2016 83942 A
(800) 1264643
(151) 2015 01 30
(181) 2025 01 30
(891) 2015 01 30
(511) 04

(260) AM 2016 83943 A
(800) 1021976
(151) 2009 07 30
(181) 2019 07 30
(891) 2015 06 23
(511) 16, 20, 21

(260) AM 2016 83944 A
(800) 1028964
(151) 2009 09 24
(181) 2019 09 24
(891) 2015 06 22
(511) 29

(260) AM 2016 83946 A
(800) 1100710
(151) 2011 05 20
(181) 2021 05 20
(891) 2015 08 21
(511) 43

(260) AM 2016 83947 A
(800) 1141002
(151) 2012 09 28
(181) 2022 09 28
(891) 2015 05 29
(511) 18, 25

(260) AM 2016 83948 A
(800) 1264644
(151) 2015 02 10
(181) 2025 02 10
(891) 2015 02 10
(511) 03, 35

(260) AM 2016 83949 A
(800) 1264669
(151) 2015 04 16

(181) 2025 04 16
(891) 2015 04 16
(511) 03, 05, 21

(260) AM 2016 83950 A
(800) 1200602
(151) 2014 02 07
(181) 2024 02 07
(891) 2015 07 07
(511) 03, 05, 35

(260) AM 2016 83951 A
(800) 1211984
(151) 2014 03 04
(181) 2024 03 04
(891) 2015 08 27
(511) 30

(260) AM 2016 83952 A
(800) 1264682
(151) 2015 05 29
(181) 2025 05 29
(891) 2015 05 29
(511) 21

(260) AM 2016 83953 A
(800) 1242118
(151) 2015 01 16
(181) 2025 01 16
(891) 2015 07 06
(511) 30

(260) AM 2016 83962 A
(800) 1264806
(151) 2015 01 21
(181) 2025 01 21
(891) 2015 01 21
(511) 12

(260) AM 2016 83963 A
(800) 1264823
(151) 2015 04 01
(181) 2025 04 01
(891) 2015 04 01
(511) 10, 11

(260) AM 2016 83989 A
(800) 1265219
(151) 2015 06 25
(181) 2025 06 25
(891) 2015 06 25
(511) 05

(260) AM 2016 83990 A
(800) 1265261
(151) 2015 08 04
(181) 2025 08 04
(891) 2015 08 04
(511) 09, 10

(260) AM 2016 83991 A
(800) 1265277
(151) 2014 10 10
(181) 2024 10 10
(891) 2014 10 10
(511) 09, 28, 41

(260) AM 2016 84003 A
(800) 1265557
(151) 2015 01 23
(181) 2025 01 23
(891) 2015 01 23
(511) 05

(260) AM 2016 84004 A
(800) 1266043
(151) 2015 04 21
(181) 2025 04 21
(891) 2015 04 21
(511) 05

(260) AM 2016 84005 A
(800) 1266048
(151) 2015 06 02
(181) 2025 06 02
(891) 2015 06 02
(511) 05, 29, 30, 31, 32, 35, 38, 41, 42, 43

(260) AM 2016 84006 A
(800) 1266071
(151) 2015 07 08
(181) 2025 07 08
(891) 2015 07 08
(511) 30

(260) AM 2016 84007 A
(800) 1265564
(151) 2015 05 18
(181) 2025 05 18
(891) 2015 05 18
(511) 09, 35, 36, 38

(260) AM 2016 84008 A
(800) 1265578
(151) 2015 07 27

(181) 2025 07 27
(891) 2015 07 27
(511) 05

(260) AM 2016 84009 A
(800) 1265581
(151) 2015 08 12
(181) 2025 08 12
(891) 2015 08 12
(511) 09

(260) AM 2016 84010 A
(800) 1265621
(151) 2015 04 17
(181) 2025 04 17
(891) 2015 04 17
(511) 01

(260) AM 2016 84011 A
(800) 1265632
(151) 2015 05 18
(181) 2025 05 18
(891) 2015 05 18
(511) 09

(260) AM 2016 84012 A
(800) 1265684
(151) 2015 06 29
(181) 2025 06 29
(891) 2015 06 29
(511) 03, 05, 35

(260) AM 2016 84014 A
(800) 1265738
(151) 2015 08 20
(181) 2025 08 20
(891) 2015 08 20
(511) 14

(260) AM 2016 84016 A
(800) 1265744
(151) 2014 11 26
(181) 2024 11 26
(891) 2014 11 26
(511) 32, 33

(260) AM 2016 84017 A
(800) 1266118
(151) 2015 06 02
(181) 2025 06 02
(891) 2015 06 02
(511) 05, 29, 30, 31, 32, 35, 38, 41, 42, 43

(260) AM 2016 84018 A
(800) 736069
(151) 2000 05 16
(181) 2020 05 16
(891) 2015 08 31
(511) 14, 18, 25

(260) AM 2016 84020 A
(800) 804754
(151) 2003 06 03
(181) 2023 06 03
(891) 2015 07 31
(511) 05

(260) AM 2016 84021 A
(800) 1265794
(151) 2014 12 17
(181) 2024 12 17
(891) 2014 12 17
(511) 09, 16, 25, 41

(260) AM 2016 84022 A
(800) 855900
(151) 2005 06 30
(181) 2025 06 30
(891) 2015 08 14
(511) 21

(260) AM 2016 84023 A
(800) 1066105
(151) 2011 01 07
(181) 2021 01 07
(891) 2015 07 27
(511) 05

(260) AM 2016 84024 A
(800) 1265814
(151) 2015 05 12
(181) 2025 05 12
(891) 2015 05 12
(511) 06, 07, 08

(260) AM 2016 84103 A
(800) 1266818
(151) 2015 08 28
(181) 2025 08 28
(891) 2015 08 28
(511) 35

(260) AM 2016 84136 A
(800) 1266743
(151) 2015 07 17

(181) 2025 07 17
(891) 2015 07 17
(511) 09

(260) AM 2016 84140 A
(800) 614748
(151) 1994 03 07
(181) 2024 03 07
(891) 2015 07 10
(511) 03

(260) AM 2016 84143 A
(800) 965445
(151) 2008 04 10
(181) 2018 04 10
(891) 2015 07 13
(511) 05, 10

(260) AM 2016 84145 A
(800) 1063208
(151) 2010 11 11
(181) 2020 11 11
(891) 2015 02 26
(511) 34

(260) AM 2016 84147 A
(800) 1135408
(151) 2012 09 04
(181) 2022 09 04
(891) 2015 09 03
(511) 09, 16, 41

(260) AM 2016 84170 A
(800) 1204205
(151) 2014 03 26
(181) 2024 03 26
(891) 2015 08 03
(511) 30

(260) AM 2016 84171 A
(800) 1209194
(151) 2014 04 23
(181) 2024 04 23
(891) 2015 07 30
(511) 37

(260) AM 2016 84172 A
(800) 1163160
(151) 2013 04 26
(181) 2023 04 26
(891) 2015 07 10
(511) 01, 02, 04

(260) AM 2016 84173 A
(800) 1231884
(151) 2014 08 06
(181) 2024 08 06
(891) 2015 05 07
(511) 07

(260) AM 2016 84175 A
(800) 1250817
(151) 2015 05 05
(181) 2025 05 05
(891) 2015 09 15
(511) 34

(260) AM 2016 84190 A
(800) 1267376
(151) 2015 07 06
(181) 2025 07 06
(891) 2015 07 06
(511) 03

(260) AM 2016 84191 A
(800) 1267380
(151) 2015 07 13
(181) 2025 07 13
(891) 2015 07 13
(511) 20

(260) AM 2016 84192 A
(800) 1267411
(151) 2015 08 06
(181) 2025 08 06
(891) 2015 08 06
(511) 09

(260) AM 2016 84194 A
(800) 1267467
(151) 2015 05 07
(181) 2025 05 07
(891) 2015 05 07
(511) 09, 16, 35, 39

(260) AM 2016 84195 A
(800) 1267483
(151) 2015 07 07
(181) 2025 07 07
(891) 2015 07 07
(511) 05

(260) AM 2016 84214 A
(800) 1267594
(151) 2015 09 09

(181) 2025 09 09
(891) 2015 09 09
(511) 09

(260) AM 2016 84293 A
(800) 1268872
(151) 2015 08 18
(181) 2025 08 18
(891) 2015 08 18
(511) 05

(260) AM 2016 84319 A
(800) 1268288
(151) 2015 07 27
(181) 2025 07 27
(891) 2015 07 27
(511) 05

(260) AM 2016 84362 A
(800) 1269263
(151) 2015 06 25
(181) 2025 06 25
(891) 2015 06 25
(511) 12

(260) AM 2016 84363 A
(800) 1269283
(151) 2015 06 15
(181) 2025 06 15
(891) 2015 06 15
(511) 03, 05, 10

(260) AM 2016 84364 A
(800) 1269307
(151) 2015 07 22
(181) 2025 07 22
(891) 2015 07 22
(511) 07, 12

(260) AM 2016 84366 A
(800) 1021183
(151) 2009 10 14
(181) 2019 10 14
(891) 2009 09 25
(511) 10

(260) AM 2016 84370 A
(800) 1214203
(151) 2014 03 12
(181) 2024 03 12
(891) 2015 07 22
(511) 09, 16, 35, 39, 42

(260) AM 2016 84371 A
(800) 1253923
(151) 2015 04 30
(181) 2025 04 30
(891) 2015 09 29
(511) 30

(260) AM 2016 84379 A
(800) 1269069
(151) 2015 03 27
(181) 2025 03 27
(891) 2015 03 27
(511) 11

(260) AM 2016 84381 A
(800) 1269080
(151) 2015 05 01
(181) 2025 05 01
(891) 2015 05 01
(511) 03

(260) AM 2016 84388 A
(800) 1269246
(151) 2015 06 23
(181) 2025 06 23
(891) 2015 06 23
(511) 05

(260) AM 2016 84580 A
(800) 1271615
(151) 2015 08 04
(181) 2025 08 04
(891) 2015 08 04
(511) 42

(260) AM 2016 84920 A
(800) 1274096
(151) 2015 06 08
(181) 2025 06 08
(891) 2015 06 08
(511) 03, 09, 14, 18, 25, 28, 35, 41

(260) AM 2016 84921 A
(800) 1274112
(151) 2015 07 08
(181) 2025 07 08
(891) 2015 07 08
(511) 12

(260) AM 2016 84926 A
(800) 1274146
(151) 2015 07 21

(181) 2025 07 21
(891) 2015 07 21
(511) 29, 30

(260) AM 2016 84927 A
(800) 1274189
(151) 2015 09 02
(181) 2025 09 02
(891) 2015 09 02
(511) 03

(260) AM 2016 84929 A
(800) 1274285
(151) 2015 09 15
(181) 2025 09 15
(891) 2015 09 15
(511) 09

(260) AM 2016 85131 A
(800) 1048943
(151) 2010 08 17
(181) 2020 08 17
(891) 2015 11 09
(511) 05

(260) AM 2016 85135 A
(800) 1217187
(151) 2014 03 27
(181) 2024 03 27
(891) 2015 10 19
(511) 41, 43, 45

(260) AM 2016 85136 A
(800) 1224342
(151) 2014 09 17
(181) 2024 09 17
(891) 2015 11 09
(511) 05

(260) AM 2016 85139 A
(800) 1263313A
(151) 2015 05 07
(181) 2025 05 07
(891) 2015 11 10
(511) 12, 27, 28

OFFICIAL NOTIFICATIONS

INVENTIONS

RENEWAL OF A PATENTS

(11) P 2014 6185 B

(73) MINER ENTERPRISES, INC. (US)

(54) **RAILROAD FREIGHT CAR DRAFT GEAR**

DATE OF RENEWAL: 10 11 2016

(11) P 2014 6160 B

(73) MINER ENTERPRISES, INC. (US)

(54) **FRICITION/ELASTOMERIC DRAFT GEAR**

DATE OF RENEWAL: 10 11 2016

(11) P 2012 5561 B

(73) Steigerwald Arzneimittelwerk GmbH (DE)

(54) **METHOD FOR THE PRODUCTION OF A PLANT-BASED MEDICAMENT**

DATE OF RENEWAL: 10 11 2016

(11) P 2014 6023 B

(73) Merab Rukhadze (GE)

(54) **ELECTROMAGNETIC ACTUATOR**

DATE OF RENEWAL: 10 11 2016

(11) P 2009 4825 B

(73) Zviad Kheladze (GE);

Zurab Kheladze (GE);

Sergo Jaiani (GE);

Badri Tsutskiridze (GE)

(54) **USE OF PLASMA EMITTER BY THE NEW PURPOSE**

DATE OF RENEWAL: 10 11 2016

(11) P 2009 4858 B

(73) Zviad Kheladze (GE);

Zurab Kheladze (GE)

(54) **USE OF NITROGLYCERIN BY THE NEW PURPOSE**

DATE OF RENEWAL: 10 11 2016

UTILITY MODELS

RENEWAL OF A PATENTS

(11) U 2014 1815 Y

(73) Archil Ghaghanidze (GE);

Shalva Kandelaki (GE);

Dimitri Lominadze (GE)

**(54) METHOD OF QUICKLY IGNITING AND SMOOTHLY BURNING COAL BRIQUETTE
PRODUCTION**

DATE OF RENEWAL: 10 11 2016

(11) U 2015 1849 Y

(73) Kristo Kakhniashvili (GE);

Kakhaber Khutsishvili (GE)

(54) METHOD OF OBTAINING ORGANOMINERAL FERTILIZER

DATE OF RENEWAL: 10 11 2016

(11) U 2012 1725 Y

(73) Aleksandre Akhobadze (GE);

Levan Akhobadze (GE);

Nino Tsikarishvili (GE)

(54) METHOD OF BIOLOGICALLY ACTIVE WHITE BREAD PRODUCTION

DATE OF RENEWAL: 10 11 2016

TRADEMARKS

RENEWAL OF REGISTRATIONS

(111) M 2006 16731 R1
(156) 2016 07 12
(186) 2026 07 12
(732) OTIS ELEVATOR COMPANY
One Carrier Place, Farmington, Connecticut
06032, USA

(111) M 2006 16890 R1
(156) 2016 10 04
(186) 2026 10 04
(732) DNATA
Dnata Travel Centre, P.O. Box 1515, Dubai,
United Arab Emirates

(111) M 2006 16891 R1
(156) 2016 10 04
(186) 2026 10 04
(732) VLAKTOR TRADING LIMITED
Zinonos Kitieos, 8, Kato Lakatamia, P.C.
2322 Nicosia, Cyprus

(111) M 2006 16895 R1
(156) 2016 10 04
(186) 2026 10 04
(732) DSQUARED2 TM S.A.
18, rue de l'Eau L-1449 Luxembourg,
Luxembourg

(111) M 2006 16896 R1
(156) 2016 10 04
(186) 2026 10 04
(732) SSANGYONG MOTOR COMPANY
150-3, Chilkoi-dong, Pyungtaek-si, Kyungki-
do, Republic of Korea

(111) M 2006 16897 R1
(156) 2016 10 04
(186) 2026 10 04
(732) NOVARTIS AG
4002 Basel, Switzerland

(111) M 2006 16898 R1
(156) 2016 10 04
(186) 2026 10 04
(732) Fidia Farmaceutici S.p.A.
Via Ponte della Fabbrica 3 A, I-35031 Abano
Terme, Italy

(111) M 2006 16900 R1
(156) 2016 10 04
(186) 2026 10 04
(732) GRENDENE S.A.
Av. Pimentel Gomes, 214, Bairro:
Expectativa, 62040-050 SOBRAL-CE, Brazil

(111) M 2006 16901 R1
(156) 2016 10 04
(186) 2026 10 04
(732) GRENDENE S.A.
Av. Pimentel Gomes, 214, Bairro:
Expectativa, 62040-050 SOBRAL-CE, Brazil

(111) M 2006 16902 R1
(156) 2016 10 04
(186) 2026 10 04
(732) LTD "AVERSI-PHARMA"
Davit Agmasheneblis gamz. 148/2, 0112,
Tbilisi, Georgia

(111) M 2006 16903 R1
(156) 2016 10 04
(186) 2026 10 04
(732) LTD "AVERSI-PHARMA"
Davit Agmasheneblis gamz. 148/2, 0112,
Tbilisi, Georgia

(111) M 2006 16904 R1
(156) 2016 10 04
(186) 2026 10 04
(732) LTD "AVERSI-PHARMA"
Davit Agmasheneblis gamz. 148/2, 0112,
Tbilisi, Georgia

(111) M 2006 16907 R1
(156) 2016 10 04
(186) 2026 10 04
(732) LTD "AVERSI-PHARMA"
Davit Agmasheneblis gamz. 148/2, 0112,
Tbilisi, Georgia

(111) M 2006 16908 R1
(156) 2016 10 04
(186) 2026 10 04
(732) LTD "AVERSI-PHARMA"
Davit Agmasheneblis gamz. 148/2, 0112,
Tbilisi, Georgia

(111) M 2006 16909 R1
(156) 2016 10 04
(186) 2026 10 04
(732) LTD "AVERSI-PHARMA"
Davit Agmasheneblis gamz. 148/2, 0112,
Tbilisi, Georgia

(111) M 2006 16910 R1
(156) 2016 10 04
(186) 2026 10 04
(732) LTD "AVERSI-PHARMA"
Davit Agmasheneblis gamz. 148/2, 0112,
Tbilisi, Georgia

(111) M 2006 16911 R1
(156) 2016 10 04
(186) 2026 10 04
(732) LTD "AVERSI-PHARMA"
Davit Agmasheneblis gamz. 148/2, 0112,
Tbilisi, Georgia

(111) M 2006 16913 R1
(156) 2016 10 04
(186) 2026 10 04
(732) LTD "AVERSI-PHARMA"
Davit Agmasheneblis gamz. 148/2, 0112,
Tbilisi, Georgia

(111) M 2006 16914 R1
(156) 2016 10 04
(186) 2026 10 04
(732) LTD "AVERSI-PHARMA"
Davit Agmasheneblis gamz. 148/2, 0112,
Tbilisi, Georgia

(111) M 2006 16915 R1
(156) 2016 10 04
(186) 2026 10 04
(732) LTD "AVERSI-PHARMA"
Davit Agmasheneblis gamz. 148/2, 0112,
Tbilisi, Georgia

(111) M 2006 16916 R1
(156) 2016 10 04
(186) 2026 10 04
(732) LTD "AVERSI-PHARMA"
Davit Agmasheneblis gamz. 148/2, 0112,
Tbilisi, Georgia

(111) M 2006 16917 R1
(156) 2016 10 04
(186) 2026 10 04

(732) LTD "AVERSI-PHARMA"
Davit Agmasheneblis gamz. 148/2, 0112,
Tbilisi, Georgia

(111) M 2006 16960 R1
(156) 2016 10 26
(186) 2026 10 26
(732) HIMALAYA GLOBAL HOLDINGS LTD.
106 Elizabeten Squeare, P.O. Box 1162,
Grand Cayman KY1-1102, Cayman Islands

(111) M 2006 16983 R1
(156) 2016 10 26
(186) 2026 10 26
(732) JSC "NOBEL ILAC SANAYII VE
TICARET ANONIM SIRKETI"-is tsarm.
saqartveloshi
Tavisuflebis moedani N4,, 0105, Tbilisi, Georgia

(111) M 2006 16987 R1
(156) 2016 10 26
(186) 2026 10 26
(732) NOVARTIS AG
Basel 4002, Switzerland

(111) M 2006 16988 R1
(156) 2016 10 26
(186) 2026 10 26
(732) NOVARTIS AG
Basel 4002, Switzerland

(111) M 2006 16989 R1
(156) 2016 10 26
(186) 2026 10 26
(732) SMITHKLINE BEECHAM (CORK)
LIMITED
Currabinny, Carrigaline, County Cork, Ireland

(111) M 2006 17041 R1
(156) 2016 11 13
(186) 2026 11 13
(732) Bristol-Myers Squibb & Gilead Sciences,
LLC (Delaware Limited Liability company)
333 Lakeside Drive, Foster City, California
94404, USA

(111) M 2006 17062 R1
(156) 2016 11 13
(186) 2026 11 13
(732) NOVARTIS AG
Basel 4002, Switzerland

(111) M 2006 17063 R1
 (156) 2016 11 13
 (186) 2026 11 13
 (732) NOVARTIS AG
 Basel 4002, Switzerland

(111) M 2006 17093 R1
 (156) 2016 11 13
 (186) 2026 11 13
 (732) YILDIZ HOLDING A.S.
 Kisikli mah. Ferah Cad. Kisikli Cesme Sk.
 No:2/4 B. Camlica, Uskudar, ISTANBUL,
 Turkey

(111) M 2006 17099 R1
 (156) 2016 11 13
 (186) 2026 11 13
 (732) GRENDENE S.A.
 Av. Pimentel Gomes, 214, Bairro:
 Expectativa, 62040-050 SOBRAL-CE, Brazil

(111) M 2006 17117 R1
 (156) 2016 11 28
 (186) 2026 11 28
 (732) TOTO LTD
 1-1, Nakashima 2-chome, Kokurakita-ku,
 Kitakyushu-shi, Fukuoka-Ken, Japan

(111) M 2006 17118 R1
 (156) 2016 11 28
 (186) 2026 11 28
 (732) ISUZU JIDOSHA KABUSHIKI KAISHA
 (also trading as Isuzu Motors Limited)
 26-1, Minami-Oi 6-Chome, Shinagawa-Ku,
 Tokyo, Japan

(111) M 2006 17119 R1
 (156) 2016 11 28
 (186) 2026 11 28
 (732) INTEL CORPORATION
 2200 Mission College Boulevard, Santa
 Clara, California 95052-8119, USA

(111) M 2006 17124 R1
 (156) 2016 11 28
 (186) 2026 11 28
 (732) INTEL CORPORATION
 2200 Mission College Boulevard, Santa
 Clara, California 95052-8119, USA

(111) M 2006 17128 R1
 (156) 2016 11 28
 (186) 2026 11 28

(732) DIAGEO IRELAND
 St. James's Gate, Dublin 8, Ireland

(111) M 2006 17159 R1
 (156) 2016 12 14
 (186) 2026 12 14
 (732) INTEL CORPORATION
 2200 Mission College Boulevard, Santa
 Clara, California 95052-8119, USA

(111) M 2006 17160 R1
 (156) 2016 12 14
 (186) 2026 12 14
 (732) INTEL CORPORATION
 2200 Mission College Boulevard, Santa
 Clara, California 95052-8119, USA

(111) M 2006 17198 R1
 (156) 2016 12 15
 (186) 2026 12 15
 (732) GOOGLE INC.
 1600 Amphitheatre Parkway, Mountain
 View, CA 94043, USA

(111) M 2006 17199 R1
 (156) 2016 12 15
 (186) 2026 12 15
 (732) GOOGLE INC.
 1600 Amphitheatre Parkway, Mountain
 View, CA 94043, USA

(111) M 2006 17200 R1
 (156) 2016 12 15
 (186) 2026 12 15
 (732) GOOGLE INC.
 1600 Amphitheatre Parkway, Mountain
 View, CA 94043, USA

(111) M 2006 17202 R1
 (156) 2016 12 15
 (186) 2026 12 15
 (732) INTEL CORPORATION
 2200 Mission College Boulevard, Santa
 Clara, California 95052-8119, USA

(111) M 2006 17213 R1
 (156) 2016 12 27
 (186) 2026 12 27
 (732) JSC "GRINDEKS"
 Krustpils street 53, Riga 1057, Latvia

(111) M 2007 17335 R1
(156) 2017 02 27
(186) 2027 02 27
(732) DAIICHI SANKYO COMPANY, LIMITED
3-5-1, Nihonbashi Honcho, Chuo-ku, Tokyo,
Japan

(111) M 1996 2876 R2
(156) 2016 09 04
(186) 2026 09 04
(732) JOHNSON & JOHNSON
One Johnson & Johnson Plaza, New
Brunswick, New Jersey 08933, USA

(111) M 1996 2901 R2
(156) 2016 09 05
(186) 2026 09 05
(732) MEDTRONIC, INC.
Minneapolis, Minnesota, USA

(111) M 1996 2902 R2
(156) 2016 09 05
(186) 2026 09 05
(732) JOHNSON & JOHNSON
One Johnson & Johnson Plaza, New
Brunswick, New Jersey 08933, USA

(111) M 1996 2916 R2
(156) 2016 09 05
(186) 2026 09 05
(732) MEDTRONIC, INC.
Minneapolis, Minnesota, USA

(111) M 1996 2953 R2
(156) 2016 09 06
(186) 2026 09 06
(732) TAKEDA GmbH
Bik-Gulden Strasse 2, 78467 Konstanz,
Germany

(111) M 1996 2977 R2
(156) 2016 09 10
(186) 2026 09 10
(732) ALLIED DOMECQ SPIRITS & WINE
LIMITED
Chivas House, 72 Chancellors Road, London
W6 9RS, United Kingdom

(111) M 1996 2978 R2
(156) 2016 09 10
(186) 2026 09 10

(732) ALLIED DOMECQ SPIRITS & WINE
LIMITED
Chivas House, 72 Chancellors Road, London
W6 9RS, United Kingdom

(111) M 1996 3017 R2
(156) 2016 09 11
(186) 2026 09 11
(732) Boehringer Ingelheim Pharma GmbH & Co.
KG
55218 Ingelheim, Germany

(111) M 1996 3081 R2
(156) 2016 09 13
(186) 2026 09 13
(732) Bodegas Fundador S.L.
Avenida Del Prezidente Carmona No.10,
28020 Madrid, Spain

(111) M 1996 3082 R2
(156) 2016 09 13
(186) 2026 09 13
(732) Bodegas Fundador S.L.
Avenida Del Prezidente Carmona No10,
28020 Madrid, Spain

(111) M 1996 3084 R2
(156) 2016 09 13
(186) 2026 09 13
(732) ALLIED DOMECQ SPIRITS & WINE
LIMITED
Chivas House, 72 Chancellors Road, London
W6 9RS, United Kingdom

(111) M 1996 3090 R2
(156) 2016 09 13
(186) 2026 09 13
(732) JOHNSON & JOHNSON
One Johnson & Johnson Plaza, New
Brunswick, New Jersey 08933, USA

(111) M 1996 3094 R2
(156) 2016 09 13
(186) 2026 09 13
(732) JOHNSON & JOHNSON
One Johnson & Johnson Plaza, New
Brunswick, New Jersey 08933-7001, USA

(111) M 1996 3095 R2
(156) 2016 09 13
(186) 2026 09 13
(732) JOHNSON & JOHNSON

One Johnson & Johnson Plaza, New
Brunswick, New Jersey 08933-7001, USA

4560 Horton Street, Emeryville, California
94608-2916, USA

(111) M 1996 3097 R2

(156) 2016 09 13

(186) 2026 09 13

(732) JOHNSON & JOHNSON

One Johnson & Johnson Plaza, New
Brunswick, New Jersey 08933-7001, USA

(111) M 1996 3287 R2

(156) 2016 09 23

(186) 2026 09 23

(732) SYBASE INC.

One Sybase Drive, Dublin, California 94568,
USA

(111) M 1996 3113 R2

(156) 2016 09 16

(186) 2026 09 16

(732) Kraft Foods Belgium Intellectual Property
BVBA (Sprl)

Brusselsesteenweg 450, 1500 Halle, Belgium

(111) M 1996 3294 R2

(156) 2016 09 24

(186) 2026 09 24

(732) FCA ITALY S.P.A. IN EXTENDED FORM
FIAT CHRYSLER AUTOMOBILES ITALY
S.P.A. AND IN BRIEF FIAT GROUP
AUTOMOBILES S.P.A. AND FIAT AUTO
S.P.A.

Corso Giovanni Agnelli 200, 10135 Torino,
Italy

(111) M 1996 3114 R2

(156) 2016 09 16

(186) 2026 09 16

(732) Kraft Foods Belgium Intellectual Property
BVBA (Sprl)

Brusselsesteenweg 450, 1500 Halle, Belgium

(111) M 1996 3300 R2

(156) 2016 09 24

(186) 2026 09 24

(732) MARTELL & Co

Place Edouard Martell, F-16100 Cognac,
France

(111) M 1996 3130 R2

(156) 2016 09 16

(186) 2026 09 16

(732) WARNACO U.S., INC., a Delaware
Corporation

470 Wheelers Farms Road, Milford,
Connecticut 06460, USA

(111) M 1996 3305 R2

(156) 2016 09 24

(186) 2026 09 24

(732) SOREMARTEC S.A.

Findel Business Center, Complexe B, Rue de
Treves, L-2632 Findel, Luxembourg

(111) M 1996 3174 R2

(156) 2016 09 17

(186) 2026 09 17

(732) KOCHER-PLASTIK MASCHINENBAU
GmbH

22-30, Talstrasse, D-74429 Sulzbach-Laufen,
Germany

(111) M 1996 3314 R2

(156) 2016 09 24

(186) 2026 09 24

(732) NTN-SNR ROULEMENTS

1, rue des Usines, 74000 Annecy, France

(111) M 1996 3246 R2

(156) 2016 09 20

(186) 2026 09 20

(732) JOHNSON & JOHNSON

One Johnson & Johnson Plaza, New
Brunswick, New Jersey 08933, USA

(111) M 1996 3336 R2

(156) 2016 09 25

(186) 2026 09 25

(732) KARELIA TOBACCO COMPANY, INC

PO BOX 22, GR-24100 Kalamata, Greece

(111) M 1996 3260 R2

(156) 2016 09 20

(186) 2026 09 20

(732) NOVARTIS VACCINES AND
DIAGNOSTICS INC.

(111) M 1996 3348 R2

(156) 2016 09 25

(186) 2026 09 25

(732) G.H. MUMM & CIE, SOCIETE VINICOLE
DE CHAMPAGNE SUCCESSEUR

29, rue du Champ de Mars, F-51100 Reimsi,
France

(111) M 1996 3362 R2

(156) 2016 09 26

(186) 2026 09 26

(732) FERRERO S.P.A.

Piazzale Pietro Ferrero 1, 12051 Alba,
Cuneo, Italy

(111) M 1996 3364 R2

(156) 2016 09 26

(186) 2026 09 26

(732) FERRERO S.P.A.

Piazzale Pietro Ferrero 1, 12051 Alba,
Cuneo, Italy

(111) M 1996 3365 R2

(156) 2016 09 26

(186) 2026 09 26

(732) FERRERO S.P.A.

Piazzale Pietro Ferrero 1, 12051 Alba,
Cuneo, Italy

(111) M 1996 3366 R2

(156) 2016 09 26

(186) 2026 09 26

(732) FERRERO S.P.A.

Piazzale Pietro Ferrero 1, 12051 Alba,
Cuneo, Italy

(111) M 1996 3367 R2

(156) 2016 09 26

(186) 2026 09 26

(732) FERRERO S.P.A.

Piazzale Pietro Ferrero 1, 12051 Alba,
Cuneo, Italy

(111) M 1996 3368 R2

(156) 2016 09 26

(186) 2026 09 26

(732) FERRERO S.P.A.

Piazzale Pietro Ferrero 1, 12051 Alba,
Cuneo, Italy

(111) M 1996 3373 R2

(156) 2016 09 27

(186) 2026 09 27

(732) CADBURY UK LIMITED

P.O. Box 12, Bournville Lane, Bournville,
Birmingham B30 2LU, United Kingdom

(111) M 1996 3414 R2

(156) 2016 09 30

(186) 2026 09 30

(732) FERRERO S.P.A.

Piazzale Pietro Ferrero 1, 12051 Alba,
Cuneo, Italy

(111) M 1996 3415 R2

(156) 2016 09 30

(186) 2026 09 30

(732) FERRERO S.P.A.

Piazzale Pietro Ferrero 1, 12051 Alba,
Cuneo, Italy

(111) M 1996 3419 R2

(156) 2016 09 30

(186) 2026 09 30

(732) TAITTINGER COMPAGNIE

COMMERCIALE ET VITICOLE

CHAMPENOISE

9 Place Saint Nicaise, 51100 Reims, France

(111) M 1996 3428 R2

(156) 2016 09 30

(186) 2026 09 30

(732) FISCHER

BETEILIGUNGSVERWALTUNGS GMBH

Fischerstrasse 8, 4910 Ried im Innkreis,

Austria

(111) M 1996 3440 R2

(156) 2016 09 30

(186) 2026 09 30

(732) INTERCONTINENTAL GREAT BRANDS

LLC.

100 Deforest Ave, East Hanover, NJ, 07936,

USA

(111) M 1996 3441 R2

(156) 2016 09 30

(186) 2026 09 30

(732) INTERCONTINENTAL GREAT BRANDS

LLC.

100 Deforest Ave, East Hanover, NJ, 07936,

USA

(111) M 1996 3445 R2

(156) 2016 09 30

(186) 2026 09 30

(732) PABIANICKIE ZAKLADY FARMA-

CEUTYCZNE "POLFA" Spółka Akcyjna

ul. Marszałka J. Piłsudskiego 5, Pabianice,

95-200, Poland

(111) M 1996 3456 R2
(156) 2016 10 02
(186) 2026 10 02
(732) FERRERO S.P.A.
Piazzale Pietro Ferrero 1, 12051 Alba,
CUNEO, Italy

(111) M 1996 3473 R2
(156) 2016 10 03
(186) 2026 10 03
(732) BOEHRINGER INGELHEIM PHARMA
GMBH & CO. KG
55218 Ingelheim, (DE), Germany

(111) M 1996 3477 R2
(156) 2016 10 03
(186) 2026 10 03
(732) BOEHRINGER INGELHEIM PHARMA
GMBH & CO. KG
55218 Ingelheim, (DE) , Germany

(111) M 1996 3503 R2
(156) 2016 10 08
(186) 2026 10 08
(732) INTERCONTINENTAL GREAT BRANDS
LLC.
100 Deforest Ave, East Hanover, NJ, 07936,
USA

(111) M 1996 3532 R2
(156) 2016 10 09
(186) 2026 10 09
(732) BULL S.A.S.
Les Clayes Sous Bois, 78340-B.P.68, Rue
Jean Jaures, France

(111) M 1996 3537 R2
(156) 2016 10 09
(186) 2026 10 09
(732) FERRERO S.P.A. ;
Piazzale Pietro Ferrero 1, 12051 Alba,
Cuneo, Italy

(111) M 1996 3548 R2
(156) 2016 10 09
(186) 2026 10 09
(732) AMERICAN EXPRESS MARKETING &
DEVELOPMENT CORP.
200 Vesey St., 49-12, New York, N.Y.
10285, USA

(111) M 1996 3549 R2
(156) 2016 10 09
(186) 2026 10 09

(732) AMERICAN EXPRESS MARKETING &
DEVELOPMENT CORP.
200 Vesey St., 49-12, New York, N.Y.
10285, USA

(111) M 1996 3550 R2
(156) 2016 10 09
(186) 2026 10 09
(732) FERRERO S.P.A.
Piazzale Pietro Ferrero 1, 12051 Alba,
CUNEO, Italy

(111) M 1996 3551 R2
(156) 2016 10 09
(186) 2026 10 09
(732) FERRERO S.P.A.
Piazzale Pietro Ferrero 1, 12051 Alba,
CUNEO, Italy

(111) M 1996 3552 R2
(156) 2016 10 09
(186) 2026 10 09
(732) FERRERO S.P.A.
Piazzale Pietro Ferrero 1, 12051 Alba,
CUNEO, Italy

(111) M 1996 3553 R2
(156) 2016 10 09
(186) 2026 10 09
(732) FERRERO S.P.A.
Piazzale Pietro Ferrero 1, 12051 Alba,
CUNEO, Italy

(111) M 1996 3554 R2
(156) 2016 10 09
(186) 2026 10 09
(732) FERRERO S.P.A.
Piazzale Pietro Ferrero 1, 12051 Alba,
CUNEO, Italy

(111) M 1996 3589 R2
(156) 2016 10 10
(186) 2026 10 10
(732) AESCULAP AG
Am Aesculap-Platz, 78532 Tuttlingen,
Germany

(111) M 1996 3733 R2
(156) 2016 10 29
(186) 2026 10 29
(732) BAYER INTELLECTUAL PROPERTY
GMBH

Alfred-Nobel-Strasse 10, 40789 Monheim
am Rhein, Germany

(111) M 1996 3816 R2
(156) 2016 11 01
(186) 2026 11 01
(732) COMPAGNIE GERVAIS DANONE,
societe anonyme
17 Boulevard Haussmann, 75009 Paris,
France

(111) M 1996 3952 R2
(156) 2016 11 13
(186) 2026 11 13
(732) THE DIAL CORPORATION
7201 E. Henkel Way, Scottsdale, Arizona
85255, USA

(111) M 1996 4188P R2
(156) 2016 12 12
(186) 2026 12 12
(732) MARLEY PLASTICS LTD
Dickley Lane, Lenham, Maidstone, Kent
ME17 2DE, United Kingdom

(111) M 1997 4913 R2
(156) 2017 04 02
(186) 2017 04 02
(732) RELIGIOUS TECHNOLOGY CENTER
1710 Ivar Avenue, Los Angeles, California,
USA

(111) M 1997 4914 R2
(156) 2017 04 02
(186) 2017 04 02
(732) RELIGIOUS TECHNOLOGY CENTER
1710 Ivar Avenue, Los Angeles, California,
USA

(111) M 1997 4915 R2
(156) 2017 04 02
(186) 2017 04 02
(732) RELIGIOUS TECHNOLOGY CENTER
1710 Ivar Avenue, Los Angeles, California,
USA

(111) M 1997 4916 R2
(156) 2017 04 02
(186) 2017 04 02
(732) RELIGIOUS TECHNOLOGY CENTER
1710 Ivar Avenue, Los Angeles, California,
USA

(111) M 1997 4917 R2
(156) 2017 04 03
(186) 2017 04 03
(732) RELIGIOUS TECHNOLOGY CENTER
1710 Ivar Avenue, Los Angeles, California,
USA

(111) M 1997 4918 R2
(156) 2017 04 03
(186) 2017 04 03
(732) RELIGIOUS TECHNOLOGY CENTER
1710 Ivar Avenue, Los Angeles, California,
USA

COMPLETE TRANSFER OF RIGHTS

(111) M 2011 021648 R
(732) FRONTERAS HOLDINGS LTD
60 Market Square, P.O. Box 364, Belize city,
Belize
(770) I.P. CREATIONS ENTERPRISES LIMITED
Arch. Makariou III, 146 ALPHA TOWER,
4 th Floor, P.C. 3021 Limassol, Cyprus
(580) 2016 10 26

(111) M 2013 024018 R
(732) DOSU MAYA MAYACILIK ANONIM
ŞİRKETİ
Barberos Mah., Al Zambak Sok. No:2 D:32,
Atasehir, Istanbul, Turkey
(770) ÖZMAYA SANAYİ A. Ş.
Eski Adana Yolu Üzeri P.K.50, 01960
Ceyhan/ADANA, Turkey
(580) 2016 05 11

(111) M 2014 025085 R
(732) BIOGAIA AB
P.O. Box 3242, SE-103 64, Stockholm,
Sweden
(770) LTD "UNIMED GRUP KORP"
Giorgi Saakadzis dagmarti 6, sart. 3,
komertsiuli farti 11, 0177, Tbilisi, Georgia
(580) 2016 10 25

(111) M 1996 003017 R2
(732) BOEHRINGER INGELHAIM PHARMA
GMBH & CO. KG
55218 Ingelheim, Germany
(770) DR. KARL THOMAE GmbH
Birkendorfen Strasse 65, D-88397 Biberach
an der Riss, Germany
(580) 2016 10 28

(111) M 1996 003081 R2
(732) BODEGAS FUNDADOR S.L.
Avenida Del Prezidente Carmona No.10,
28020 Madrid, Spain
(770) BEAM SUNTORY UK LIMITED
2 Longwalk Road, Stockley Park, Uxbridge,
Middlesex, England UB11 1BA, United
Kingdom (580) 2016 10 26

CHANGES IN NAMES AND/OR ADDRESSES OF OWNERS

(111) M 1999 012500 R1
 (732) PROCTER AND GAMBLE
 INTERNATIONAL OPERATIONS S.A.
 47, Route de Saint-Georges, 1213 Petit-
 Lancy, Switzerland
 (770) PROCTER AND GAMBLE
 INTERNATIONAL OPERATIONS
 47, Route de Saint-Georges, 1213 Petit-
 Lancy, Switzerland
 (580) 2016 10 25

(111) M 2006 016731 R1
 (732) OTIS ELEVATOR COMPANY
 One Carrier Place, Farmington, Connecticut
 06032, USA
 (770) OTIS ELEVATOR COMPANY
 10 Farm Springs, Farmington, Connecticut
 06032, New Jersey, USA
 (580) 2016 10 25

(111) M 2013 024018 R
 (732) LESAFFRE TURQUIE MAYACILIK
 ÜRETİM VE TİCARET ANONİM ŞİRKETİ
 SAHRAYICEDİD MAH. ATATÜRK CAD.
 CEBESÖY SK.
 NO.8, KADOKÖY, İSTANBUL, Turkey
 (770) DOSU MAYA MAYACILIK ANONİM
 ŞİRKETİ
 Barberos Mah., Al Zambak Sok. No:2 D:32,
 Atasehir, Istanbul, Turkey
 (580) 2016 10 25

(111) M 1996 003050 R1
 (732) TRANSAMERICA CORPORATION
 4333 Edgewood Road NE, Cedar Rapids,
 Iowa 52499, USA
 (770) TRANSAMERICA CORPORATION
 1150 S. Olive Street, Suite T-2100, Los
 Angeles, CA 90015-2211, USA
 (580) 2016 10 25

(111) M 1996 003769 R1
 (732) TRANSAMERICA CORPORATION
 4333 Edgewood Road NE, Cedar Rapids,
 Iowa 52499, USA
 (770) TRANSAMERICA CORPORATION
 1150 S. Olive Street, Suite T-2100, Los
 Angeles, CA 90015-2211, USA
 (580) 2016 10 25

(111) M 1996 003952 R2
 (732) THE DIAL CORPORATION
 19001 North Scottsdale Road, Arizona
 85255, USA
 (770) THE DIAL CORPORATION
 15501 North Dial Boulevard, Scottsdale,
 Arizona 85260-1619, USA
 (580) 2016 10 28

(111) M 1996 003952 R2
 (732) THE DIAL CORPORATION
 7201 E. Henkel Way, Scottsdale, Arizona
 85255, USA
 (770) THE DIAL CORPORATION
 19001 North Scottsdale Road, Arizona
 85255, USA
 (580) 2016 10 28

(111) M 1997 004913 R2
 (732) RELIGIOUS TECHNOLOG CENTER
 1710 Ivar Avenue, Los Angeles, California,
 USA
 (770) RELIGIOUS TECHNOLOG CENTER
 California, Los Angeles, USA
 (580) 2016 10 25

(111) M 1997 004914 R2
 (732) RELIGIOUS TECHNOLOG CENTER
 1710 Ivar Avenue, Los Angeles, California,
 USA
 (770) RELIGIOUS TECHNOLOG CENTER
 California, Los Angeles, USA
 (580) 2016 10 25

(111) M 1997 004915 R2
 (732) RELIGIOUS TECHNOLOG CENTER
 1710 Ivar Avenue, Los Angeles, California,
 USA
 (770) RELIGIOUS TECHNOLOG CENTER
 California, Los Angeles, USA
 (580) 2016 10 25

(111) M 1997 004916 R2
 (732) RELIGIOUS TECHNOLOG CENTER
 1710 Ivar Avenue, Los Angeles, California,
 USA
 (770) RELIGIOUS TECHNOLOG CENTER,
 California, Los Angeles, USA
 (580) 2016 10 25

(111) M 1997 004917 R2
(732) RELIGIOUS TECHNOLOG CENTER
1710 Ivar Avenue, Los Angeles, California,
USA
(770) RELIGIOUS TECHNOLOG CENTER
California, Los Angeles, USA
(580) 2016 10 25

(111) M 1997 004918 R2
(732) RELIGIOUS TECHNOLOG CENTER
1710 Ivar Avenue, Los Angeles, California,
USA
(770) RELIGIOUS TECHNOLOG CENTER
California, Los Angeles, USA
(580) 2016 10 25

(111) M 1997 006273 R1
(732) PROCTER AND GAMBLE
INTERNATIONAL OPERATIONS S.A.
47, Route de Saint-Georges, 1213 Petit-
Lancy, Switzerland
(770) PROCTER AND GAMBLE
INTERNATIONAL OPERATIONS
47, Route de Saint-Georges, 1213 Petit-
Lancy, Switzerland
(580) 2016 10 25

(111) M 1997 007370 R1
(732) COÖPERATIE AVEBE U.A.
Prins Hendrikplein 20, 9641 GK Veendam,
Netherlands
(770) COÖPERATIE "AVEBE" U.A.
AVEBE-Weg 1, 9607 PT Foxhol,
Netherlands
(580) 2016 10 25

CANCELLING OF TRADEMARK REGISTRATION

(111) M 2012 22502 R

(151) 2012 04 20

(732) LTD "VIPLINE GEORGIA COMPANY"

Kostavas q. 69, 0171, Tbilisi, Georgia

(540)



(141) 2016 11 08

GROUNDS: Order №62 of Sakpatenti Chairman of 2016 10 21 for enforcement of the decision of 5 August 2014 Tbilisi City Court Civil Cases Board (Case №2/15299-13).

CLASSIFICATION INDEXES

INVENTIONS

CONCORDANCE TABLE OF INTERNATIONAL CLASSIFICATION INDEX AND PUBLICATION NUMBERS

INTERNATIONAL CLASSIFICATION INDEXES (51)	NUMBER OF PUBLISHED APPLICATION (10)
A 61 K 9/00; A 61 K 47/32; A 61 K 31/415	AP 2016 13747 A
A 61 K 31/427; A 61 K 38/05; A 61 P 17/06	AP 2016 13889 A
A 61 K 38/26; A 61 K 38/17; A 61 K 38/16; A 61 P 3/10; A 61 P 3/04; A 61 P 3/00	AP 2016 13355 A
B 01 D 53/14; B 01 D 47/02; B 01 D 47/06; B 01 D 53/18; B 01 D 53/48; B 01 D 53/54; B 01 D 53/62	AP 2016 12547 A
C 07 D 401/14; A 61 K 31/4439; A 61 P 9/00; A 61 P 13/00; A 61 P 25/00; A 61 P 3/00	AP 2016 13783 A
C 07 H 21/02; C 12 P 21/06	AP 2016 12838 A
E 21 F 5/14	AP 2016 13809 A

CONCORDANCE TABLE OF PUBLICATION NUMBERS AND INTERNATIONAL CLASSIFICATION INDEX

NUMBER OF PUBLISHED APPLICATION (10)	INTERNATIONAL CLASSIFICATION INDEXES (51)
AP 2016 12547 A	B 01 D 53/14; B 01 D 47/02; B 01 D 47/06; B 01 D 53/18; B 01 D 53/48; B 01 D 53/54; B 01 D 53/62
AP 2016 12838 A	C 07 H 21/02; C 12 P 21/06
AP 2016 13355 A	A 61 K 38/26; A 61 K 38/17; A 61 K 38/16; A 61 P 3/10; A 61 P 3/04; A 61 P 3/00
AP 2016 13747 A	A 61 K 9/00; A 61 K 47/32; A 61 K 31/415
AP 2016 13783 A	C 07 D 401/14; A 61 K 31/4439; A 61 P 9/00; A 61 P 13/00; A 61 P 25/00; A 61 P 3/00
AP 2016 13809 A	E 21 F 5/14
AP 2016 13889 A	A 61 K 31/427; A 61 K 38/05; A 61 P 17/06

CONCORDANCE TABLE OF INTERNATIONAL CLASSIFICATION INDEX, PATENT NUMBERS AND PUBLICATION NUMBERS

INTERNATIONAL CLASSIFICATION INDEX (51)	NUMBER OF PATENT (11)	NUMBER OF PUBLISHED APPLICATION (10)
A 61 K 31/015; A 61 K 31/201; A 61 K 31/202; A 61 K 31/203; A 61 K 31/355; A 61 K 9/08; A 61 P 25/16; A 61 P 25/28; A 61 P 43/00	P 2016 6568 B	AP 2016 13272 A
A 61 K 31/137; A 61 K 47/32; A 61 K 47/34; A 61 K 47/26; A 61 K 9/20; A 61 K 9/48; A 61 J 3/07; A 61 J 3/10; A 61 P 37/06; A 61 P 31/18; A 61 P 25/28	P 2016 6571 B	AP 2016 13729 A
B 01 D 39/06, 39/18, 39/20	P 2016 6574 B	AP 2016 13862 A

1	2	3
B 65 D 43/08, 53/02	P 2016 6573 B	AP 2016 13815 A
B 66 D 5/26	P 2016 6572 B	AP 2016 13775 A
C 07 C 233/18; C 07 C 231/24; A 61 K 31/165; A 61 P 25/20; A 61 P 25/22; A 61 P 25/00; A 61 P 9/00; A 61 P 1/00; A 61 P 25/24	P 2016 6567 B	AP 2016 13264 A
C 07 C 273/16; C 07 C 273/02; B 01 J 2/22	P 2016 6569 B	AP 2016 13361 A
C 07 J 71/00; A 61 K 31/58; A 61 P 5/44; A 61 P 11/06; A 61 P 37/08	P 2016 6566 B	AP 2016 13223 A
H 04 B 11/00	P 2016 6570 B	AP 2016 13610 A

**CONCORDANCE TABLE OF PATENT NUMBERS,
PUBLICATION NUMBERS AND INTERNATIONAL CLASSIFICATION INDEX**

NUMBER OF PATENT (11)	NUMBER OF PUBLISHED APPLICATION (10)	INTERNATIONAL CLASSIFICATION INDEX (51)
P 2016 6566 B	AP 2016 13223 A	C 07 J 71/00; A 61 K 31/58; A 61 P 5/44; A 61 P 11/06; A 61 P 37/08
P 2016 6567 B	AP 2016 13264 A	C 07 C 233/18; C 07 C 231/24; A 61 K 31/165; A 61 P 25/20; A 61 P 25/22; A 61 P 25/00; A 61 P 9/00; A 61 P 1/00; A 61 P 25/24
P 2016 6568 B	AP 2016 13272 A	A 61 K 31/015; A 61 K 31/201; A 61 K 31/202; A 61 K 31/203; A 61 K 31/355; A 61 K 9/08; A 61 P 25/16; A 61 P 25/28; A 61 P 43/00
P 2016 6569 B	AP 2016 13361 A	C 07 C 273/16; C 07 C 273/02; B 01 J 2/22
P 2016 6570 B	AP 2016 13610 A	H 04 B 11/00
P 2016 6571 B	AP 2016 13729 A	A 61 K 31/137; A 61 K 47/32; A 61 K 47/34; A 61 K 47/26; A 61 K 9/20; A 61 K 9/48; A 61 J 3/07; A 61 J 3/10; A 61 P 37/06; A 61 P 31/18; A 61 P 25/28
P 2016 6572 B	AP 2016 13775 A	B 66 D 5/26
P 2016 6573 B	AP 2016 13815 A	B 65 D 43/08, 53/02
P 2016 6574 B	AP 2016 13862 A	B 01 D 39/06, 39/18, 39/20

**CONCORDANCE TABLE OF APPLICATION NUMBERS, PUBLICATION NUMBERS
AND PATENTS**

NUMBER OF APPLICATION (21)	NUMBER OF PUBLISHED APPLICATION (10)	NUMBER OF PATENT (11)
AP 2012 013223	AP 2016 13223 A	P 2016 6566 B
AP 2012 013264	AP 2016 13264 A	P 2016 6567 B
AP 2012 013272	AP 2016 13272 A	P 2016 6568 B
AP 2012 013361	AP 2016 13361 A	P 2016 6569 B
AP 2013 013610	AP 2016 13610 A	P 2016 6570 B
AP 2013 013729	AP 2016 13729 A	P 2016 6571 B
AP 2015 013775	AP 2016 13775 A	P 2016 6572 B
AP 2015 013815	AP 2016 13815 A	P 2016 6573 B
AP 2015 013862	AP 2016 13862 A	P 2016 6574 B

UTILITY MODELS

CONCORDANCE TABLE OF INTERNATIONAL CLASSIFICATION INDEX AND PUBLICATION NUMBERS

INTERNATIONAL CLASSIFICATION INDEXES (51)	NUMBER OF PUBLISHED APPLICATION (10)
B 65 D 5/40	AU 2016 13910 U
F 41 G 1/00; G 02 B 5/32	AU 2016 14069 U

CONCORDANCE TABLE OF PUBLICATION NUMBERS AND INTERNATIONAL CLASSIFICATION INDEX

NUMBER OF PUBLISHED APPLICATION (10)	INTERNATIONAL CLASSIFICATION INDEXES (51)
AU 2016 13910 U	B 65 D 5/40
AU 2016 14069 U	F 41 G 1/00; G 02 B 5/32

CONCORDANCE TABLE OF INTERNATIONAL CLASSIFICATION INDEX, PATENT NUMBERS AND PUBLICATION NUMBERS

INTERNATIONAL CLASSIFICATION INDEX (51)	NUMBER OF PATENT (11)	NUMBER OF PUBLISHED APPLICATION (10)
C 22 C 29/00, 29/10; C 22 C 1/05	U 2016 1910 Y	AU 2016 13726 U
E 02 D 17/20	U 2016 1911 Y	AU 2016 13961 U

CONCORDANCE TABLE OF PATENT NUMBERS, PUBLICATION NUMBERS AND INTERNATIONAL CLASSIFICATION INDEX

NUMBER OF PATENT (11)	NUMBER OF PUBLISHED APPLICATION (10)	INTERNATIONAL CLASSIFICATION INDEX (51)
U 2016 1910 Y	AU 2016 13726 U	C 22 C 29/00, 29/10; C 22 C 1/05
U 2016 1911 Y	AU 2016 13961 U	E 02 D 17/20

CONCORDANCE TABLE OF APPLICATION NUMBERS, PUBLICATION NUMBERS AND PATENTS

NUMBER OF APPLICATION (21)	NUMBER OF PUBLISHED APPLICATION (10)	NUMBER OF PATENT (11)
AU 2015 013726	AU 2016 13726 U	U 2016 1910 Y
AU 2015 013961	AU 2016 13961 U	U 2016 1911 Y

DESIGNS**REGISTERED DESIGNS**CONCORDANCE TABLE OF INTERNATIONAL CLASSIFICATION INDEX
AND PUBLICATION NUMBERS

INTERNATIONAL CLASSIFICATION INDEXES (51)	NUMBER OF PUBLISHED APPLICATION (10)
32-00	AD 2016 913 S

CONCORDANCE TABLE OF PUBLICATION NUMBERS
AND INTERNATIONAL CLASSIFICATION INDEX

NUMBER OF PUBLISHED APPLICATION (10)	INTERNATIONAL CLASSIFICATION INDEXES (51)
AD 2016 913 S	32-00

TRADEMARKS

CONCORDANCE TABLE OF REGISTRATION NUMBERS, APPLICATION NUMBERS, PUBLICATION NUMBERS AND BULLETIN NUMBERS

NUMBER OF REGISTRATION (111)	NUMBER OF APPLICATIONS (210)	NUMBER OF PUBLISHED APPLICATIONS (260)	NUMBER OF BULLETIN
M 2016 27763 R	AM 88928	-	21(457)2016
M 2016 27764 R	AM 88894	-	21(457)2016
M 2016 27765 R	AM 88892	-	21(457)2016
M 2016 27766 R	AM 88706	-	21(457)2016
M 2016 27767 R	AM 88720	-	21(457)2016
M 2016 27768 R	AM 88726	-	21(457)2016
M 2016 27769 R	AM 88927	-	21(457)2016
M 2016 27770 R	AM 88715	-	21(457)2016
M 2016 27771 R	AM 88579	-	21(457)2016
M 2016 27772 R	AM 89053	-	21(457)2016
M 2016 27773 R	AM 89186	-	21(457)2016
M 2016 27774 R	AM 89093	-	21(457)2016
M 2016 27775 R	AM 88768	-	21(457)2016
M 2016 27776 R	AM 89113	-	21(457)2016
M 2016 27777 R	AM 89183	-	21(457)2016

CONCORDANCE TABLE OF PUBLICATION NUMBERS AND APPLICATION NUMBERS

NUMBER OF PUBLISHED APPLICATION (260)	NUMBER OF APPLICATION (210)	1	2
1	2		
AM 2016 84226 A	AM 84226 A	AM 2016 86506 A	AM 86506 A
AM 2016 84227 A	AM 84227 A	AM 2016 86509 A	AM 86509 A
AM 2016 85421 A	AM 85421 A	AM 2016 86558 A	AM 86558 A
AM 2016 85879 A	AM 85879 A	AM 2016 86561 A	AM 86561 A
AM 2016 85913 A	AM 85913 A	AM 2016 86626 A	AM 86626 A
AM 2016 86005 A	AM 86005 A	AM 2016 86673 A	AM 86673 A
AM 2016 86333 A	AM 86333 A	AM 2016 86679 A	AM 86679 A
AM 2016 86367 A	AM 86367 A	AM 2016 86696 A	AM 86696 A
AM 2016 86439 A	AM 86439 A	AM 2016 86699 A	AM 86699 A
AM 2016 86504 A	AM 86504 A	AM 2016 86832 A	AM 86832 A
		AM 2016 86834 A	AM 86834 A
		AM 2016 86884 A	AM 86884 A
		AM 2016 86887 A	AM 86887 A
		AM 2016 86888 A	AM 86888 A
		AM 2016 86905 A	AM 86905 A

**CONCORDANCE TABLE OF INDEX OF GOODS AND/OR SERVICES
AND APPLICATION NUMBERS**

INDEX OF GOODS AND/OR SERVICES (511)	NUMBER OF PUBLISHED APPLICATIONS (26)	1	2
1	2	30	AM 2016 86367 A
5	AM 2016 86439 A	32	AM 2016 84226 A
5	AM 2016 86504 A	32	AM 2016 84227 A
5	AM 2016 86506 A	32	AM 2016 86367 A
5	AM 2016 86509 A	33	AM 2016 84226 A
5	AM 2016 86561 A	33	AM 2016 84227 A
5	AM 2016 86884 A	33	AM 2016 86696 A
5	AM 2016 86887 A	35	AM 2016 84226 A
5	AM 2016 86888 A	35	AM 2016 84227 A
5	AM 2016 86888 A	35	AM 2016 85421 A
6	AM 2016 85913 A	35	AM 2016 85879 A
9	AM 2016 85913 A	35	AM 2016 86905 A
9	AM 2016 86005 A	38	AM 2016 86673 A
10	AM 2016 86558 A	38	AM 2016 86679 A
12	AM 2016 86626 A	41	AM 2016 85879 A
12	AM 2016 86699 A	41	AM 2016 86673 A
18	AM 2016 86005 A	41	AM 2016 86679 A
20	AM 2016 86333 A	41	AM 2016 86832 A
25	AM 2016 86005 A	41	AM 2016 86834 A
29	AM 2016 86367 A	43	AM 2016 84226 A
		43	AM 2016 84227 A
		43	AM 2016 85879 A

**CONCORDANCE TABLE OF INDEX OF GOODS AND/OR SERVICES
AND NUMBERS OF TRADEMARKS REGISTERED ACCORDING
TO THE ACCELERATED PROCEDURE**

INDEX OF GOODS AND/OR SERVICES (511)	NUMBERS OF REGISTERED ACCORDING TO THE ACCELERATED PROCEDURE (111)
3	M 2016 27766 R
3	M 2016 27767 R
3	M 2016 27768 R
3	M 2016 27770 R
5	M 2016 27775 R
29	M 2016 27764 R
29	M 2016 27765 R
29	M 2016 27771 R
29	M 2016 27774 R
30	M 2016 27764 R
30	M 2016 27765 R
30	M 2016 27777 R
35	M 2016 27772 R
37	M 2016 27773 R
38	M 2016 27763 R
38	M 2016 27776 R
41	M 2016 27769 R
41	M 2016 27776 R

OFFICIAL BULLETIN OF THE INDUSTRIAL PROPERTY

21(457)

EDITOR-IN-CHIEF: N. Bebrishvili

EDITORS-TRANSLATORS: E. Gabunia

PROOFREADER: A. Shikhashvili

COMPUTER LAYOUT: M. Ordenidze
K. Svanidze

www.sakpatenti.org.ge

E-mail: info@sakpatenti.org.ge