

სამრეწველო საკუთრების ოფიციალური ბიულეტენი

გამოგონებები

სასარგებლო მოდელები

დიზაინები

სასაქონლო ნიშნები

საქონლის ადგილწარმოშობის დასახელებები



საქართველოს ინტელექტუალური
საკუთრების ეროვნული ცენტრი

საკპატიენტი

SAKPATENTI

NATIONAL INTELLECTUAL PROPERTY
CENTER OF GEORGIA

www.sakpatenti.gov.ge

გამოქვეყნების თარიღი – 2020 11 10

21(553)

საერთაშორისო კოდეზი გიზლიობრაფიული მონაცემების იდენტიფიკაციისათვის

გამოგონებადი, სასარგებლო მოდელები

- (10) - ექსპერტიზაგაელოლი განაცხადის გამოქვეყნების ნომერი
- (11) - პატენტის ნომერი და სახეობის კოდი
- (21) - განაცხადის სარეგისტრაციო ნომერი
- (22) - განაცხადის შეტანის თარიღი
- (23) - საგამოფენო პრიორიტეტის თარიღი ან აღრიხდელი პრიორიტეტის მქონე განაცხადის შეტანის თარიღი და, თუ შესაძლებელია, განაცხადის ომერი
- (24) - თარიღი, რომლიდანაც იწყება პატენტის მოქმედება
- (31) - საპრიორიტეტო განაცხადის ნომერი
- (32) - საპრიორიტეტო განაცხადის შეტანის თარიღი
- (33) - კოდი ქვეყნისა ან რეგიონული ორგანიზაციისა, რომლის უწყებამაც მიანიჭა ნომერი საპრიორიტეტო განაცხადს
- (44) - დამცავი საბუთის ჯერ ამქონე, მაგრამ ექსპერტიზაგაელოლი განაცხადის გამოქვეყნების თარიღი და ბიულეტენის ნომერი
- (45) - რეგისტრაცია გაელოლი საპატენტო საბუთის გამოქვეყნების თარიღი
- (51) - საერთაშორისო საპატენტო კლასიფიკაციის ინდექსი
- (54) - გამოგონების დასახელება

- (57) - რეფერატის ტექსტი
- (60) - სრულ ექსპერტიზაგაელოლი გამოგონებაზე უცხოური საპატენტო უწყების მიერ გაცემული დამცავი საბუთის ნომერი, თარიღი, რომლიდანაც იწყება ამ დამცავი საბუთის მოქმედება, და კოდი ქვეყნისა ან რეგიონული ორგანიზაციისა, რომლის უწყებამაც გასცა ეს დამცავი საბუთი
- (62) - უფრო აღრიხდელი განაცხადის ნომერი და, თუ შესაძლებელია, ნარდგენის თარიღი გამოცემული განაცხადის შემთხვევაში
- (71) - განმცხადებლის სახელი, გვარი (ქვეყნის კოდი)
- (72) - გამომგონებლის სახელი, გვარი (ქვეყნის კოდი)
- (73) - პატენტმფლობელის სახელი, გვარი (ქვეყნის კოდი), მისამართი
- (74) - ნარმომადგენლის ან პატენტრწმუნებულის სახელი, გვარი
- (85) - საერთაშორისო განაცხადის ეროვნული ფაზის დანეების თარიღი
- (86) - საერთაშორისო განაცხადის ნომერი და შეტანის თარიღი
- (87) - საერთაშორისო განაცხადის გამოქვეყნების ნომერი და თარიღი
- (94) - დაცვის დამატებითი მონობით გაგრძელებული პატენტის მოქმედების ვადის ამონურვის თარიღი

ღიზინები

- (10) - განაცხადის გამოქვეყნების ნომერი
- (11) - პატენტის ნომერი და სახეობის კოდი ან რეგისტრაციის ნომერი
- (15) - რეგისტრაციის თარიღი/პატენტის გაგრძელების თარიღი
- (18) - პატენტის ან რეგისტრაციის მოქმედების ვადის გასვლის სავარაუდო თარიღი
- (21) - განაცხადის ნომერი
- (22) - განაცხადის შეტანის თარიღი
- (23) - საგამოფენო პრიორიტეტის თარიღი ან აღრიხდელი პრიორიტეტის მქონე განაცხადის შეტანის თარიღი და, თუ შესაძლებელია, განაცხადის ნომერი
- (24) - თარიღი, რომლიდანაც იწყება პატენტის მოქმედება
- (28) - ღიზინების რაოდენობა განაცხადში
- (30) - საპრიორიტეტო მონაცემები (განაცხადის ნომერი, განაცხადის შეტანის თარიღი და ორასოიანი კოდი იმ ორგანიზაციის იდენტიფიკაციისათვის, სადაც იყო ნარდგენილი საპრიორიტეტო განაცხადი)
- (31) - საპრიორიტეტო განაცხადის ნომერი
- (32) - საპრიორიტეტო განაცხადის შეტანის თარიღი
- (33) - კოდი ქვეყნისა ან რეგიონული ორგანიზაციისა, რომლის უწყებამაც მიანიჭა ნომერი საპრიორიტეტო განაცხადს
- (34) - ისმო-ს სტანდარტის (შთ.3) შესაბამის ორასოიანი კოდი იმ ორგანიზაციის იდენტიფიკაციისათვის, სადაც იყო ნარდგენილი საპრიორიტეტო განაცხადი
- (44) - ღიზინის გამოქვეყნების თარიღი და ბიულეტენის ნომერი (პირველი პუბლიკაცია)

- (45) - საერთაშორისო ბიუროს მიერ დარეგისტრირებული ღიზინის გამოქვეყნების თარიღი და ბიულეტენის ნომერი
- (51) - ღიზინების საერთაშორისო კლასიფიკაცია (ლოკარნოს კლასიფიკაციის კლასი და ქვეკლასი)
- (54) - ღიზინის დასახელება
- (55) - ღიზინის გამოსახულება
- (57) - ღიზინის არსებითი ნიშნების აღწერა, ფერის ჩათვლით
- (58) - ყველა სახის ცვლილების შესახებ რეგისტრში ჩანანერის შეტანის თარიღი
- (62) - აღრიხდელი განაცხადის, რეგისტრაციის ან საბუთის ნომერი და, თუ შესაძლებელია, ნარდგენის თარიღი, გამოცემული განაცხადის შემთხვევაში
- (71) - განმცხადებლის სახელი, გვარი (ქვეყნის კოდი), მისამართი
- (72) - ავტორის სახელი, გვარი ან დასახელება (ქვეყნის კოდი)
- (73) - პატენტმფლობელის სახელი, გვარი (ქვეყნის კოდი), მისამართი
- (74) - ნარმომადგენლის სახელი, გვარი და მისამართი
- (81) - შესაბამისი მონაწილე მხარეები:
 - II. მონაწილე მხარეები, აღნიშნული 1960 წლის აქტის თანახმად
 - III. მონაწილე მხარეები, აღნიშნული 1999 წლის აქტის თანახმად
- (85) - მფლობელის მუდმივი საცხოვრებელი ადგილი
- (86) - მფლობელის მოქალაქეობა
- (87) - მფლობელის საცხოვრებელი ადგილი
- (88) - ქვეყანა, სადაც მფლობელს აქვს ნამდვილი და მოქმედი სამრეწველო ან საეკონომიკური სანარმო

სასაქონლო ნიშნები

- (111) - რეგისტრაციის ნომერი
- (151) - რეგისტრაციის თარიღი
- (156) - რეგისტრაციის ვადის გაგრძელების თარიღი
- (181) - რეგისტრაციის ვადის გასვლის სავარაუდო თარიღი
- (186) - ვადის გაგრძელების ვადის სავარაუდო თარიღი
- (141) - რეგისტრაციის მოქმედების ვადის გაუქმების თარიღი
- (210) - განაცხადის ნომერი
- (220) - განაცხადის შეტანის თარიღი
- (230) - საგამოფენო მონაცემები
- (260) - ნომერი განაცხადისა, რომელზედაც გამოტანილია ექსპერტიზის დადებითი გადაწყვეტილება რეგისტრაციის შესახებ (გამოქვეყნების ნომერი)
- (310) - პირველი განაცხადის ნომერი
- (320) - პირველი განაცხადის შეტანის თარიღი
- (330) - პირველი განაცხადის მიმღები ეროვნული ან რეგიონული უწყების ან ორგანიზაციის საიდენტიფიკაციო კოდი
- (511) - საქონლისა და მომსახურების საერთაშორისო კლასიფიკაცია სასაქონლო ნიშნის რეგისტრაციისათვის და/ან კლასიფიკირებული საქონლისა და/ან მომსახურების ჩამონათვალი
- (526) - დისკლამაცია
- (531) - სასაქონლო ნიშნის გამოსახულებითი ელემენტების აღწერა სასაქონლო ნიშნების გამოსახულებითი ელემენტების საერთაშორისო კლასიფიკაციის (ვენის კლასიფიკაცია) მიხედვით
- (540) - ნიშნის გამოსახულება

- (550) - სასაქონლო ნიშნის ტიპი ან სახეობა
- (551) - მითითება, რომ ნიშანი არის კოლექტიური, სასერტიფიკაციო ან საგარანტიო
- (554) - სამგანზომილებიანი (მოცულობითი) ნიშანი
- (580) - განაცხადსა და ნიშნის რეგისტრაციისათვის დაკავშირებული ყველა სახის ცვლილებაზე ჩანანერის შეტანის თარიღი
- (591) - ინფორმაცია განცხადებულ ფერებზე
- (731) - განმცხადებლის სახელი და მისამართი
- (732) - მფლობელის სახელი და მისამართი
- (740) - ნარმომადგენლის სახელი და მისამართი
- (750) - მიმონერის მისამართი
- (770) - ცვლილებამდე განმცხადებლის ან მფლობელის სახელი და მისამართი უფლების გადაცემის შემთხვევაში
- (771) - ცვლილებამდე განმცხადებლის ან მფლობელის სახელი და მისამართი უფლების გადაცემის გარეშე
- (791) - ლიცენზიატის სახელი და მისამართი
- (793) - ლიცენზიის პირობები და/ან შეზღუდვაზე მინიშნება (ლიცენზიის სახე, სალიცენზიო ხელშეკრულების ნომერი, სალიცენზიო ხელშეკრულების თარიღი, სალიცენზიო ხელშეკრულების მოქმედების ვადა)
- (800) - სასაქონლო ნიშნის რეგისტრაციის მონაცემები ნიშნების საერთაშორისო რეგისტრაციის მადრიდის ხელშეკრულებასთან დაკავშირებული პროტოკოლის მიხედვით (საერთაშორისო რეგისტრაციის ნომერი)
- (852) - ნაწილობრივ გაუქმებული საქონლის/მომსახურების ჩამონათვალი
- (891) - შემდგომი გარეცემების თარიღი

- (21) AP 0000 000000 - გამოგონებაზე განაცხადის ნომერი
- (10) AP 0000 0000 A - გამოგონებაზე განაცხადის გამოქვეყნების ნომერი (პირველი პუბლიკაცია)
- (11) P 0000 0000 B - გამოგონების პატენტის ნომერი (მეორე პუბლიკაცია)
- (21) API 0000 000000 - შემოტანილი პატენტზე განაცხადის ნომერი
- (11) PI 0000 0000 A - შემოტანილი პატენტის ნომერი (პირველი პუბლიკაცია)
- (21) AU 0000 000000 - სასარგებლო მოდელზე განაცხადის ნომერი
- (10) AU 0000 000 U - სასარგებლო მოდელზე განაცხადის გამოქვეყნების ნომერი (პირველი პუბლიკაცია)
- (11) U 0000 000 Y - სასარგებლო მოდელის პატენტის ნომერი (მეორე პუბლიკაცია)
- (21) AD 0000 000000 - ღიზინზე განაცხადის ნომერი
- (10) AD 0000 000 S - ღიზინზე განაცხადის გამოქვეყნების ნომერი (პირველი პუბლიკაცია)
- (11) D 0000 000 S - რეგისტრირებული ღიზინი
- M - სასაქონლო ნიშანი
- (210) AM 0000 000000 - განაცხადის ნომერი
- (260) AAM 0000 00000 A - განაცხადის გამოქვეყნების ნომერი
- (111) M 0000 0000 R - რეგისტრაციის ნომერი
- MMM0000 0000 Rn - მომდენო ვადით რეგისტრაციის ნომერი, სადაც n=1, 2, 3...
- M 0000 0000 R(P) - რეგისტრაციის ნომერი ნიშანზე უფლების ნაწილობრივ გადაცემისას
- * - საქპატენტის სააპელაციო პალატის გადაწყვეტილების შემდეგ გამოქვეყნებული განაცხადის ნომერი
- ** - სასამართლოს გადაწყვეტილების შემდეგ გამოქვეყნებული განაცხადის ნომერი

გამოგონებადისა და სასარგებლო მოდელების საერთაშორისო კლასიფიკაციის ინდექსები

- განყოფილება A - ადამიანის პირველადი მოთხოვნილების საგნები
- განყოფილება B - ტექნოლოგიური პროცესები; ტრანსპორტირება
- განყოფილება C - ქიმიკა; მეტალურგია
- განყოფილება D - საფეიქრო ნაწარმი; ქაღალდი
- განყოფილება E - მშენებლობა; სამთო საქმე; სტაციონარული ნაგებობები
- განყოფილება F - მექანიკა; განათება; გათბობა; იარაღი; ასაფეთქებელი საშუალებები
- განყოფილება G - ფიზიკა
- განყოფილება H - ელექტრობა

სამრეწველო საკუთრების ოფიციალური ბიულეტენი

გამოგონებები

სასარგებლო მოდელები

დიზაინები

სასაქონლო ნიშნები

საქონლის ადგილწარმოშობის დასახელებები

შ ი ნ ა ა რ ს ი

გამოქვეყნებული ობიექტები	3
გამოგონებები	
• განაცხადები, რომლებზეც გამოტანილია გადაწყვეტილება პატენტის გაცემის შესახებ	4
• გამოგონების პატენტები	7
სასარგებლო მოდელები	
• განაცხადი, რომელზეც გამოტანილია გადაწყვეტილება პატენტის გაცემის შესახებ	9
• სასარგებლო მოდელების პატენტები	10
დიზაინები	
• განაცხადები, რომლებზეც გამოტანილია გადაწყვეტილება რეგისტრაციის შესახებ	11
• დაჩქარებული პროცედურებით რეგისტრირებული დიზაინები	22
• დიზაინები, რომლებიც რეგისტრირებულია საერთაშორისო ბიუროში საქართველოს ტერიტორიაზე უფლებათა გავრცელების მოთხოვნით	25
სასაქონლო ნიშნები	
• ეროვნული პროცედურით შემოტანილი განაცხადები, რომლებზეც გამოტანილია გადაწყვეტილება პატენტის გაცემის შესახებ	44
• რეგისტრირებული სასაქონლო ნიშნები	64
• დაჩქარებული პროცედურებით რეგისტრირებული სასაქონლო ნიშნები	68
• საერთაშორისო სასაქონლო ნიშნები, რომლებზეც გამოტანილია გადაწყვეტილება დაცვის მინიჭების შესახებ	71
• საერთაშორისო სასაქონლო ნიშნები, რომლებსაც მიენიჭათ დაცვა საქართველოში	210
საქონლის ავტილწარმოების დასახელება	
ავტილწარმოების დასახელების ღვინის „მაღაანის ქისი“ წარმოების სპეციფიკაცია	
• მაღაანის ქისი	218
ოფიციალური შეტყობინებები	
გამოგონებები	
• პატენტების მოქმედების აღდგენა	226
• პატენტების გაუქმება აღდგენის უფლებით	227
• პატენტების მოქმედების აღდგენის ვადის ამოწურვა	228
სასარგებლო მოდელები	
• პატენტების მოქმედების აღდგენა	230
• პატენტების გაუქმება აღდგენის უფლებით	231
• პატენტის მოქმედების აღდგენის ვადის ამოწურვა	231
დიზაინები	
• დიზაინის რეგისტრაციის მოქმედების ვადის გაგრძელება	232
• სალიცენზიო ხელშეკრულების გაუქმება	232
• საერთაშორისო დიზაინების რეგისტრაციის მოქმედების ვადის გაგრძელება	233
სასაქონლო ნიშნები	
• რეგისტრაციის მოქმედების ვადის გაგრძელება	237
• უფლებების სრული გადაცემა	239
• მფლობელის სახელის და/ან მისამართის ცვლილება	243
• სასაქონლო ნიშნების რეგისტრაციის შეწყვეტა	244
• სალიცენზიო ხელშეკრულების რეგისტრაცია	246
• საერთაშორისო სალიცენზიო ხელშეკრულებები	248
• სალიცენზიო ხელშეკრულების გაუქმება	249
სისტემური საპიეზლები	
გამოგონებები	250
სასარგებლო მოდელები	251
დიზაინები	253
სასაქონლო ნიშნები	254

გამოქვეყნებული ობიექტები

გამობრუნებები

- განაცხადები, რომლებზეც გამოტანილია გადაწყვეტილება პატენტის გაცემის შესახებ: 15132; 15046; 14875; 15295; 14510
- პატენტები: 7173-7179

სასარგებლო მოდელები

- განაცხადები, რომლებზეც გამოტანილია გადაწყვეტილება პატენტის გაცემის შესახებ: 14497
- პატენტები: 2056, 2057

ღიზანებები

- განაცხადები, რომლებზეც გამოტანილია გადაწყვეტილება რეგისტრაციის შესახებ: 1156; 1155; 1153; 1154
- დაჩქარებული პროცედურებით რეგისტრირებული ღიზანებები: 871, 870
- ღიზანები, რომლებიც რეგისტრირებულია საერთაშორისო ბიუროში საქართველოს ტერიტორიაზე უფლებათა გავრცელების მოთხოვნით 209554; 203513; 207017; 209998; 210101; 210093; 210125, 210126; 21009

სასაქონლო ნიშნები

- ეროვნული პროცედურით შემოტანილი განაცხადები, რომლებზეც გამოტანილია გადაწყვეტილება რეგისტრაციის შესახებ: 100030*; 105671, 105672; 106777; 107148; 107151; 107263; 107478; 107645, 107646; 107649, 107650; 107652; 107656; 107659-107661; 107667, 107668; 107678-107684; 107807; 107815; 107818-107822; 107832, 107833; 107887; 107892-107911; 107913, 107914; 107916-107922; 107930; 108059
- რეგისტრირებული სასაქონლო ნიშნები: 33255-33291
- დაჩქარებული პროცედურით რეგისტრირებული სასაქონლო ნიშნები: 33250-33254; 33292-33295
- საერთაშორისო სასაქონლო ნიშნები, რომლებზეც გამოტანილია გადაწყვეტილება დაცვის მიზნების შესახებ: 94618; 99145; 102849*; 102867*; 102982; 105389; 106488-106490; 106533, 106534; 106547, 106548; 106559; 106561; 106563; 106569-106576; 106579; 106619-106621; 106623-106626; 106637; 106685-106695; 106697-106701; 106705-106710; 106712; 106738-106740; 106744, 106745; 106835- 106847; 106849; 106860-106869; 106872; 106888, 106889; 106906; 106986; 106999; 107006, 107007; 107026-107028; 107069-107075; 107089, 107090; 107146; 107186; 107188-107191; 107193-107195; 107324, 107325; 107327; 107419; 107421; 107423; 107427-107429; 107431; 107542-107547; 107592; 107603; 107635; 107640; 107642; 107735-107738; 107740-107742; 107744
- საერთაშორისო სასაქონლო ნიშნები, რომლებსაც მიენიჭათ დაცვა საქართველოში: 103937; 104051; 104167, 104168; 104225; 104696; 104719; 104735, 104836; 104840; 104871; 104945; 104984; 104987; 105046; 105066; 105069; 105077, 105078; 105084; 105093; 105099; 105168-105172; 105174, 105175; 105177; 105180, 105181; 105186; 105189, 105190; 105194; 105203, 105204; 105206; 105261-105263; 105265; 105275; 105277-105280; 105282; 105292-105294; 105305; 105307, 105308; 105310, 105311; 105313-105321; 105332; 105486; 105490-105499; 105681; 105688, 105689; 105848; 105959; 105995-105997; 106000; 106016; 106020, 106021; 106287; 106359; 106429

საქონლის აღბილწაროშობის დასახელება

3496/6

გამობონებები

ბანაცხადები, რომლებზეც გამოტანილია გადაწყვეტილება პატენტის გაცემის შესახებ

გადაწყვეტილების გასაჩივრება შესაძლებელია საქპატენტის სააპელაციო პალატაში გამოქვეყნებულ ბიდან 3 თვის ვადაში ან მცხეთის რაიონული სასამართლოს ადმინისტრაციულ საქმეთა კოლეგიაში 1 თვის ვადაში (მის.: ქ. მცხეთა, სამხედროს ქ. №17).

ბანყოფილება A

A 61

(10) AP 2020 15132 A (51) Int. Cl. (2006)
A 61 K 31/4168
A 61 P 3/04
A 61 P 9/00
A 61 P 3/10
C 07 D 233/91

(21) AP 2018 15132 (22) 2018 01 05

(31) 62/443,244; 62/581,355; 62/585,326

(32) 2017 01 06; 2017 11 03; 2017 11 13

(33) US; US; US

(71) რიუეს ფარმასეუტიკალს ინკ. (US)
7066 ფორესტ სტრიტ, შარლოტსვილ,
ვირჯინია 22903, აშშ (US)

(72) შაჰარიარ მ. ხან (US)

(74) შალვა გვარამაძე

(85) 2019 07 05

(86) PCT/US2018/012491, 2018 01 05

(54) შინილის ახალი წარმოებულები

(57) 5-[(2,4-დინიტროფენოქსი)მეთილ]-1-მეთილ-2-ნიტრო-1H-იმიდაზოლი ან მისი ფარმაცევტულად მისადები მარილი და მათი გამოყენება მიტოქონდრიული დარღვევების სამკურნალოდ.

მუხლები: 6 დამოუკიდებელი

7 დამოკიდებული

ფიგურა: 33

(10) AP 2020 15046 A (51) Int. Cl. (2006)
A 61 K 31/7076
A 61 P 31/18

(21) AP 2017 15046 (22) 2017 02 10

(62) AP 2017 14873 2017 02 10

(31) 62/294,576; 62/297,657

(32) 2016 02 12; 2016 02 19

(33) US; US

(71) მერკ შარპ & დოუმ კორპ. (US)
126 ისტ ლინკოლნ ავენიუ, რავეი,
ნიუ-ჯერსი 07065-0907, აშშ (US)

(72) ჯეი, ა. გრობლერი (US);
დებორა, ენ ნიკოლ-გრიფიტი (CA);
მაიკლ, დ. მილერი (US);
დარია ჰაზუდა (US)

(74) შალვა გვარამაძე

(85) 2019 04 12

(86) PCT/US2017/017283, 2017 02 10

(54) აივ-ის და შიფის მკურნალობის და პროფილაქტიკის ხმრხები

(57) ნაერთის, ფორმულით (I),

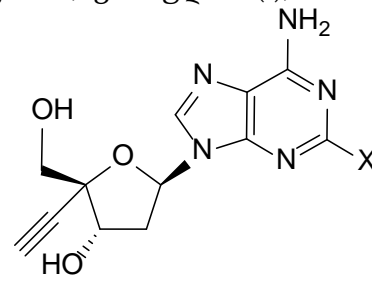

გამოყენება კომპოზიციის სახით, სუბიექტში HIV უკუტრანსკრიპტაზას ინჰიბირებისთვის, HIV ინფექციის მკურნალობისთვის და, ასევე, AIDS ან ARC მკურნალობისთვის.

მუხლები: 1 დამოუკიდებელი

4 დამოკიდებული

ფიგურა: 3

(10) AP 2020 14875 A (51) Int. Cl. (2006)
A 61 P 35/00
C 07 K 16/00

(21) AP 2017 14875 (22) 2017 03 14

(31) 62/307,686

(32) 2016 03 14

(33) US

(71) უნივერსიტეტეტ ი ოსლო (NO)
პო ბოქს 1072, ბლინდერნი, ოსლო, 0316,
ნორვეგია (NO)

(72) სტიან ფოსი (NO);

ინგერ სანდლიე (NO);
 იან ტერიე ანდერსენი (NO)
 (74) ხათუნა იმნაძე
 (85) 2018 09 13
 (86) PCT/IB2017/000327, 2017 03 14
 (54) კონსტრუირებული იმუნოგლობული
 ლინის, FcRn-ის შეკავშირებული
 შიდაპირები

(57) მოცემული გამოგონება ეხება კომპოზიცი-
 ებს და ხერხებს ანტისხეულებით განპირობებუ-
 ლი თერაპიისთვის. კერძოდ, მოცემულ გამოგო-
 ნებაში უზრუნველყოფილია კომპოზიცია, რო-
 მელიც შეიცავს: თერაპიულ, კონსტრუირებულ
 იმუნოგლობულინს, ნახევარსიცოცხლის შეცვ-
 ლილი პერიოდით, FcRn-თან შეკავშირების
 შეცვლილი აფინურობით, სადაც იმუნოგლო-
 ბულინის Fc უბანში იმუნოგლობულინი შეი-
 ცავს, სულ მცირე, ერთ მუტაციას.
 მუხლები: 8 დამოუკიდებელი
 9 დამოკიდებული
 ფიგურა: 8

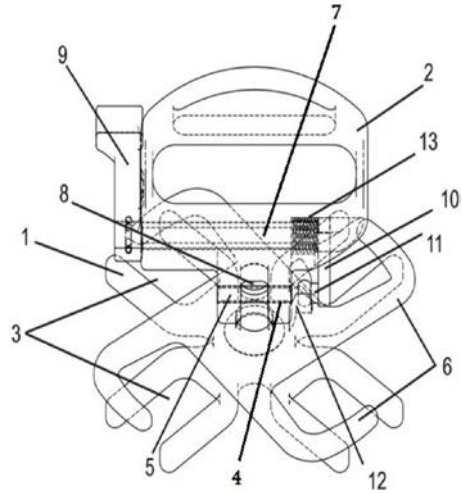

ფიგ. 1

ბანყოფილება B

B 65

(10) AP 2020 15295 A (51) Int. Cl. (2006)
 B 65 D 71/00
 (21) AP 2020 15295 (22) 2020 03 02
 (71) ზურაბ ვაშალომიძე (GE)
 ქინძმარაულის შესახვევი, კორპ. 11, ბ. 62,
 0137, თბილისი, საქართველო (GE)
 (72) ზურაბ ვაშალომიძე (GE)
 (54) ბოთლების ნაკრების დამჭერი
 (57) დამჭერი შეიცავს კორპუსს 1 სახელოდ 2
 და ბოთლების დამჭერ კვანძს, რომელიც შეს-
 რულებულია კორპუსზე შესრულებული რადი-
 ალური ჭრილებისა 3 და კორპუსის მიმართ შე-
 მობრუნების შესაძლებლობით დასმული კავე-
 ბიანი ფირფიტის 6 სახით. გარდა ამისა, დამჭე-
 რი აღჭურვილია კორპუსის მიმართ კავებიანი
 ფირფიტის საფიქსაციო კვანძით 7, რომელსაც
 გააჩნია სახელოდ შესრულებული დილაკი-
 დან 9 მართვის შესაძლებლობა.
 მუხლები: 1 დამოუკიდებელი
 ფიგურა: 7

ბანყოფილება C

C 22

(10) AP 2020 14510 A (51) Int. Cl. (2006)
 C 22 C 38/50
 (21) AP 2017 14510 (22) 2017 06 05
 (71) დავით კოპალეიშვილი (GE)
 აბაშიძის ქ. 68, ბ. 47, 0162, თბილისი,
 საქართველო (GE);
 ოთარ ბარბაქაძე (GE)
 მოსკოვის გამზ., V კვარტ., კორპ. 7, ბ. 26,
 0145, თბილისი, საქართველო (GE);
 ვასილ კოპალეიშვილი (GE)
 აბაშიძის ქ. 68, ბ. 47, 0162, თბილისი,
 საქართველო (GE);
 მზია თაბაგარი (GE)
 ქ. შარტავას ქ. 35/37, ბ. 34, 0160, თბილისი,
 საქართველო (GE);
 ირაკლი ქაშაკაშვილი (GE)
 ი. ჭავჭავაძის გამზ. 19, ბ. 11, 0179,
 თბილისი, საქართველო (GE)
 (72) დავით კოპალეიშვილი (GE);
 ოთარ ბარბაქაძე (GE);
 ვასილ კოპალეიშვილი (GE);
 მზია თაბაგარი (GE);
 ირაკლი ქაშაკაშვილი (GE)
 (54) ბამჭოლი ღბანის სამართლებების
 საწარმოების ფოლადი
 (57) გამჭოლი ღბანის სამართლებების საწარმო-
 ელად განკუთვნილი ფოლადი, რომელიც შეი-
 ცავს ნახშირბადს, სილიციუმს, მანგანუმს, ნი-
 კელს, მოლიბდენს, ქრომს, ვანადიუმს, ტიტანს,
 ალუმინს, კალციუმს, სპილენძს და რკინას, კომ-

პონენტების %-ში:	შემდეგი	შემცველობით	მასურ
ნახშირბადი	0,04-0,12;		
სილიციუმი	0,5-1,2;		
მანგანუმი	0,60-0,80;		
ნიკელი	4,0-6,0;		
სპილენძი	0,8-1,2;		
მოლიბდენი	0,5-0,7;		
ქრომი	0,7-1,0;		
ვანადიუმი	0,12-0,20;		
ტიტანი	0,01-0,02;		
ალუმინი	0,03-0,045;		
კალციუმი	0,05-0,1		
რკინა	–	დანარჩენი.	

მუხლები: 1 დამოუკიდებელი
ცხრილი: 2

ბამოგონების პატენტები

ბანყოფილება A

A 61

- (11) P 2020 7176 B (51) Int. Cl. (2006)
A 61 K 9/08
A 61 K 9/14
- (10) AP 2020 14833 A (44) 12(544)/2020
- (21) AP 2016 14833
- (22) 2016 01 30
- (24) 2016 01 30
- (31) 6951/CHE/2015
- (32) 2015 12 18
- (33) IN
- (86) PCT/IN2016/050035, 2016 01 30
- (73) ნატკო ფარმა ლიმიტედ (IN)
ნატკო ჰაუს, როუდ №2 ბანჯარა ჰილს,
ჰაიდარაბადი, 500034 (IN)
- (72) ვენკატა სატიანარაიანა აპადვედულა (IN);
ვენკაიახ ჩოვდარი ნანნაპანენი (IN);
დურგა მახესვარი პარვატანენი (IN);
მიტრაბხანუ მოხანტი (IN);
კალი სატია ბხუჯანგა რაო ადიბხატლა (IN)
- (74) თამარ კოჭლამაზაშვილი
- (54) შპნილამინოპირიმიდონ ჟარმოე-
ბულის შემცველი ფარმაცევტული
კომპოზიციები

- (11) P 2020 7178 B (51) Int. Cl. (2006)
A 61 K 31/00
A 61 K 9/14
A 61 K 47/26
A 61 K 9/00
A 61 K 47/12

- (10) AP 2020 14782 A (44) 8(540)/2020
- (21) AP 2016 14782
- (22) 2016 11 14
- (24) 2016 11 14
- (31) 15194660,5
- (32) 2015 11 16
- (33) EP
- (86) PCT/EP2016/077558, 2016 11 14
- (73) კიეზი ფარმაჩეუტიჩი ს.პ.ა. (IT)
ვია პალერმო 26/1, I- 43100 პარმა (IT)
- (72) ლეონარდო ორტენზი (IT);
ფრანჩესკა სკარეტი (IT);
კლაუდიო კაფიერო (IT)

- (74) თამაზ შილაკაძე
- (54) ანტიჰოლინერგების, კორტიკოსტე-
როიდების და ბეტა-აღრენერგების
შემცველი მშრალი ფხვნილის
ფორმულაციის მიღების ხერხი

- (11) P 2020 7177 B (51) Int. Cl. (2006)
A 61 K 31/44
A 61 P 29/00
C 07 D 401/12
C 07 D 213/75

- (10) AP 2020 14909 A (44) 13(545)/2020
- (21) AP 2014 14909
- (22) 2014 01 29
- (24) 2014 01 29
- (62) AP 2014 13922 2014 01 29
- (31) 61/759,059
- (32) 2013 01 31
- (33) US
- (86) PCT/US2014/013652, 2014 01 29
- (73) ვერტექს ფარმასიუტიკალზ
ინკორპორეიტედ (US)
50 ნოზერნ ავენიუ, ბოსტონი, მასაჩუსეტსი
02210, აშშ (US)
- (72) ანდრეას, პ. ტერმინი (US);
ბრაიან, რიჩარდ ბეარი (US);
ჯეიმს, ფილიპ ჯონსონი (CA);
ვიჯაიალაკსმი არუმეუგამი (US);
კორი ანდერსონი (US);
იულიანა, ლუსი ასგიანი (US);
სარა, საბინა სადიდა-რუა (US)
- (74) შალვა გვარამაძე
- (54) პირიფონ ამიღები როგორც ნატრიუმის
არხების მოღვაწეობები

- (11) P 2020 7174 B (51) Int. Cl. (2006)
A 61 K 39/395
C 07 K 16/18
C 07 K 16/28

- (10) AP 2020 14811 A (44) 13(545)/2020
- (21) AP 2016 14811
- (22) 2016 11 17
- (24) 2016 11 17
- (31) 62/257,001
- (32) 2015 11 18
- (33) US
- (86) PCT/US2016/062393, 2016 11 17

- (73) მერკ შარპ & დოუმ კორპ. (US)
126 ისტ ლინკოლნ ავენიუ, რავეი,
ნიუ-ჯერსი 07065-0907, აშშ (US)
- (72) ბიერნ ვიქტორი (BE);
იუჰა პუნონენი (US);
მარიბელ ბიუმონტი (US);
კარლო ბუტონი (BE);
ბრუნო დომბრეხტი (BE);
რობერტ ა. კასტელინი (US);
მარი-ანჟ ბიუიზი (BE)
- (74) შალვა გვარამაძე
- (54) CTLA4 შემავსებელი მოლეკულები

- (31) 61/939,198
- (32) 2014 02 12
- (33) US
- (86) PCT/IB2015/001410, 2015 02 12
- (73) ჯეოტეკ ტექნოლოჯის ლტდ (IL)
4 კაუფმან სტ შარბატ ჰაუს 12თ,
ფლ. 8213502 ტელ-ავივი (IL)
- (72) იცჰარ ჰალაჰმი (IL);
ოდედ ერეზი (IL)
- (74) შალვა გვარამაძე
- (54) გეომეტრიული მასალა შეჭიდული-
ბისა და დეფორმაციისადმი ბაშმეო-
ბუნებრივი სიმტკიცით

- (11) P 2020 7179 B (51) Int. Cl. (2006)
A 61 K 47/24
A 61 K 47/14
A 61 K 31/355
A 61 P 31/10
A 61 P 31/04

- (10) AP 2020 15201 A (44) 14(546)/2020
- (21) AP 2018 15201
- (22) 2018 05 28
- (24) 2018 05 28
- (31) 102017000058311
- (32) 2017 05 29
- (33) IT
- (86) PCT/EP2018/063926, 2018 05 28
- (73) ბიო.ლო. გა. ს.რ.ლ. (IT)
ვია ჯუზეპე ლაზარინი, 66, კონელიანო,
ტრევიზო, 31015 (IT)
- (72) ჯორჯო პანინი (IT)
- (74) ნუგზარ ქსოვრელი
- (54) ბაქტერიული ან სოკოვანი ბიომრის
სამკურნალო შემადგენლობა
პიტამინ E-ს ან მისი რთული
ეიქსტის საფუძველზე

ბანყოფილება H

H 01

- (11) P 2020 7175 B (51) Int. Cl. (2006)
H 01 L 31/00
- (10) AP 2020 15077 A (44) 13(545)/2020
- (21) AP 2019 15077
- (22) 2019 05 13
- (24) 2019 05 13
- (73) სსიპ მიკრო და ნანოელექტრონიკის
ინსტიტუტი (GE)
ი. ჭავჭავაძის გამზ. 13, 0179, თბილისი,
საქართველო (GE)
- (72) ამირან ბიბილაშვილი (GE);
ნინა ხუჭუა (GE);
ნუგზარ დოლიძე (GE);
ზურაბ ჯიბუტი (GE);
ნოდარ გაფიშვილი (GE);
რევაზ მელქაძე (GE);
მარინა ტიგიშვილი (GE)
- (74) ამირან ბიბილაშვილი
- (54) ინტეგრირებული ორდიაკონიანი
ულტრაიისფერი და ინფრაწითელი
ფოტოდეტექტორის შემწვის
მეთოდი

ბანყოფილება E

E 02

- (11) P 2020 7173 B (51) Int. Cl. (2006)
E 02 D 31/00
E 01 C 3/00
E 01 C 3/04
E 01 B 2/00
- (10) AP 2020 14264 A (44) 13(545)/2020
- (21) AP 2015 14264
- (22) 2015 02 12
- (24) 2015 02 12

სასარბებლო მოდელები

ბანაცხადი, რომელზეც გამოტანილია გადაწყვეტილება პატენტის გაცემის შესახებ

გადაწყვეტილების გასაჩივრება შესაძლებელია საქპატენტის სააპელაციო პალატაში გამოქვეყნებიდან 3 თვის ვადაში ან მცხეთის რაიონული სასამართლოს ადმინისტრაციულ საქმეთა კოლეგიაში 1 თვის ვადაში (მის.: ქ. მცხეთა, სამხედროს ქ. №17).

ბანყოფილება C

C 10

(10) AU 2020 14497 U (51) Int. Cl. (2006)

C 10 L 1/19

C 11 C 39/10

(21) AU 2017 14497 (22) 2017 05 19

(71) ანზორ ყუფარაძე (GE)

ა. ჩეხოვის ქ. 23, 4600, ქუთაისი,

საქართველო (GE)

(72) ანზორ ყუფარაძე (GE)

(74) არჩილ გეგუჩაძე

(54) ბიოლიზიმის მიღების ხერხი

(57) ბიოლიზიმის მიღების ხერხი, რომელიც ითვალისწინებს ტრიგლიცერიდების ერთ-ატომიანი სპირტებით პერეეთერიფიკაციას მაღალ ტემპერატურაზე, ფუძოვანი კატალიზატორების მეშვეობით, როგორებიცაა კალიუმის (KOH) ან ნატრიუმის (NaOH) ჰიდროქსიდები, მიღებული ნარევის ნჯღრევას, დაყოვნებას, რეცხვას და შრობას, ამასთან, პერეეთერიფიკაციამდე ხდება ცალკე ტრიგლიცერიდების გაცხელება $50\pm 90^{\circ}\text{C}$ ტემპერატურის დიაპაზონში 2 ± 20 წთ განმავლობაში, ხოლო ცალკე – ერთატომიანი სპირტ(ებ)ისა და ფუძოვანი (ჰიდროქსიდული) კატალიზატორ(ებ)ის შერევა, ხოლო შერეული ნივთიერებების ნჯღრევა ხდება 5 ± 10 წთ განმავლობაში, დაყოვნებისას კი ხდება მიღებულ კოლოიდურ ხსნარში მაღალი ძაბვის ელექტროდებით 1 ± 25 კვ სტატიკური ძაბვის მიწოდება 2 ± 7 სთ განმავლობაში, ამასთან, ერთ-ერთ კატალიზატორად შესაძლოა დამატებით კალციუმის ჰიდროქსიდის ($\text{Ca}(\text{OH})_2$) გამოყენება საწყის ინგრედიენტთა შემდეგი თანაფარდობით (მას. %): ცხიმი $83\pm 89,8$; მეთილის ან ეთილის სპირტი $9,2\pm 16,1$; ნატრიუმის ჰიდროქსიდი $0\pm 0,9$ და/ან კალიუმის ჰიდროქსიდი $0\pm 0,5$ და/ან კალციუმის ჰიდროქსიდი $0\pm 0,5$.

მუხლები: 1 დამოუკიდებელი

სასარბებლო მოდელის პატენტები

ბანყოფილება A

A 01

- (11) U 2020 2057 Y (51) Int. Cl. (2006)
A 01 G 9/14
(10) AU 2020 15204 U (44) 13(545)/2020
(21) AU 2019 15204
(22) 2019 10 25
(24) 2019 10 25
(73) ავთანდილ ბიწაძე (GE)
გლდანი, ალექო გობრომიძის ჩიხი 11,
0167, თბილისი, საქართველო (GE)
(72) ავთანდილ ბიწაძე (GE)
(54) სათბურის ცივი რეპრონებისთვის
-

ბანყოფილება B

B 65

- (11) U 2020 2056 Y (51) Int. Cl. (2006)
B 65 D 81/03
(10) AU 2020 15238 U (44) 13(545)/2020
(21) AU 2018 15238
(22) 2018 07 24
(24) 2018 07 24
(31) 2017126900
(32) 2017 07 26
(33) RU
(86) PCT/RU2018/000493, 2018 07 24
(73) ობშესტვო ს ოგრანიჩენოი
ოტკვეტსტვენოსტიუ „ჯეტლაბ“ (RU)
ულიცა ნობელია, დ. 7, პომეშენიე 142,
ტერიტორია სკოლკოვო ინოვაციონოვო
ცენტრა, მოსკოვი, 121205, რუსეთის
ფედერაცია (RU)
(72) ვალერია ოლეგოვნა იუშინა (RU)
(74) შალვა გვარამაძე
(54) საფუთავი ბოთლის ტრანსპორტი-
რებისთვის
-

ღიზინები

ბანაცხადები, რომლებზეც გამოტანილია გადაწყვეტილება რეგისტრაციის შესახებ

გადაწყვეტილების გასაჩივრება შესაძლებელია საქპატენტის სააპელაციო პალატაში გამოქვეყნებულ ბიდან 3 თვის ვადაში ან მცხეთის რაიონული სასამართლოს ადმინისტრაციულ საქმეთა კოლეგიაში 1 თვის ვადაში (მის.: ქ. მცხეთა, სამხედროს ქ. №17).

- (10) AD 2020 1156 S (51) 09-03
- (21) AD 2020 1156 (22) 2020 05 08
- (28) 4
- (71) გოდივა ბელჯიუმ ბ.ვ.ბ.ა./ს.პ.რ.ლ. (BE)
ვეარსენსტრატი 42 D, 1070, ანდერლეჰტი, ბელგია (BE)
- (72) ალი ულკერი (BE)
- (74) თამაზ შილაკაძე (GE)
- (54) შოკოლადის კოლოფი
- (55)



1.1



1.2



1.3



1.4



1.5

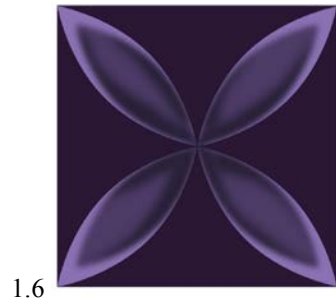

1.6



1.7



2.1



2.2



2.3

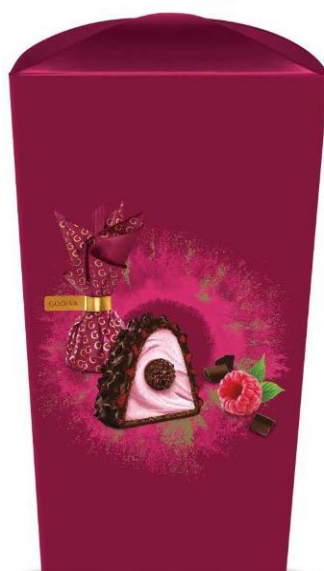

2.4



2.5

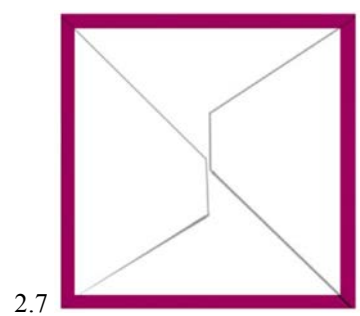
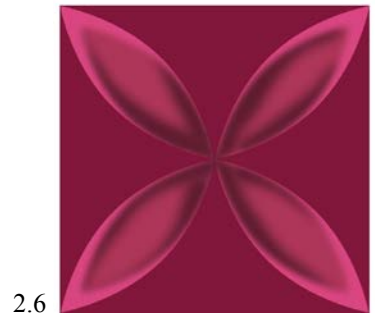

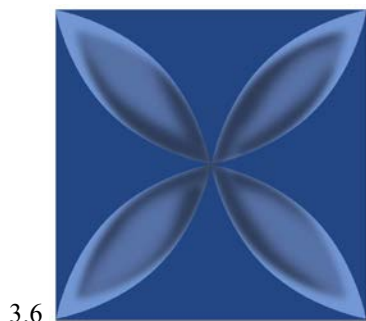

3.6



3.7



4.1



4.2



4.3



4.4



4.5

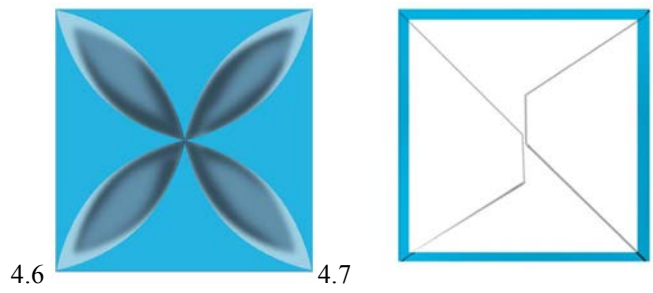

- (10) AD 2020 1155 S (51) 09-05
- (21) AD 2020 1155 (22) 2020 05 08
- (28) 4
- (71) გოდივა ბელჯიუმ ბ.ვ.ბ.ა./ს.პ.რ.ლ. (BE)
 ვეარსენსტრატი 42 D, 1070, ანდერლეჰტი, ბელგია (BE)
- (72) ალი ულკერი (BE)
- (74) თამაზ შილაკაძე (GE)
- (54) შოკოლადის საფუთავი
- (55)





2.1



2.2



2.3



2.4



2.5



2.6



3.1



3.2



3.3



3.4



3.5



3.6



4.1



4.2



4.3



4.4



4.5



4.6

- (10) AD 2020 1153 S (51) 19-08
- (21) AD 2020 1153 (22) 2020 05 06
- (28) 5
- (31) 2019504994; 2019504994; 2019504994; 2019504994; 2019504994
- (32) 2019 11 08; 2019 11 08; 2019 11 08; 2019 11 08; 2019 11 08
- (33) RU; RU; RU; RU; RU
- (71) შპს „ერმაწ“ (RU)

- რამენსკის რაიონი, დასახლ. რაოს, 15, მოსკოვის ოლქი, 140126, რუსეთის ფედერაცია (RU)
- (72) მაქსიმ სერგეევჩი პონომარიოვი (RU)
- (74) ალექსანდრე გეგეჭკორი (GE)
- (54) ეტიკეტი
- (55)

1.1

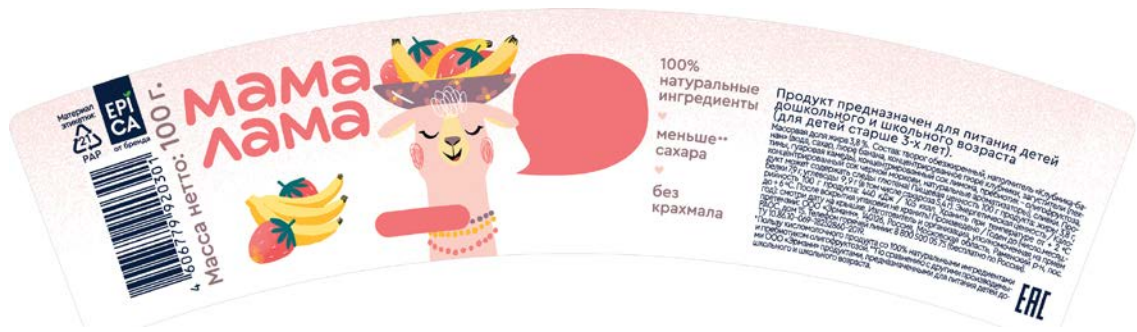

2.1

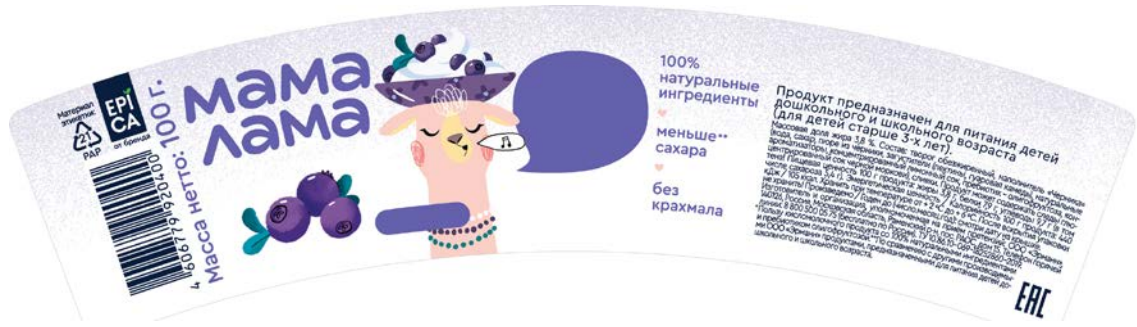

3.1

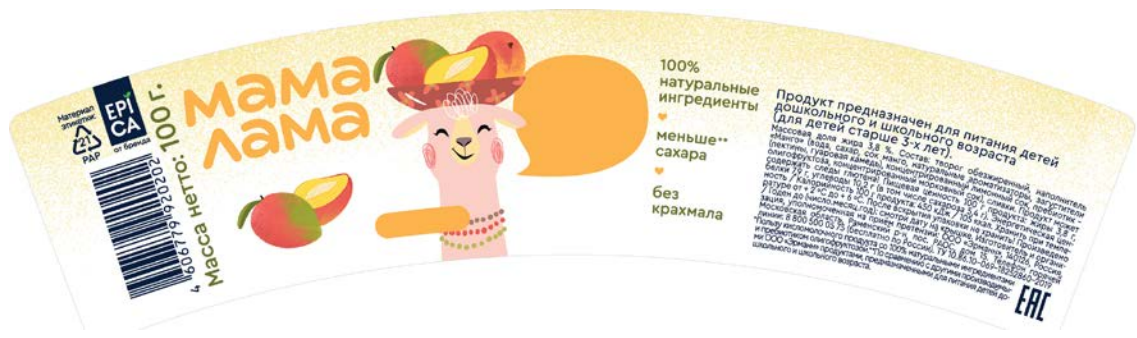

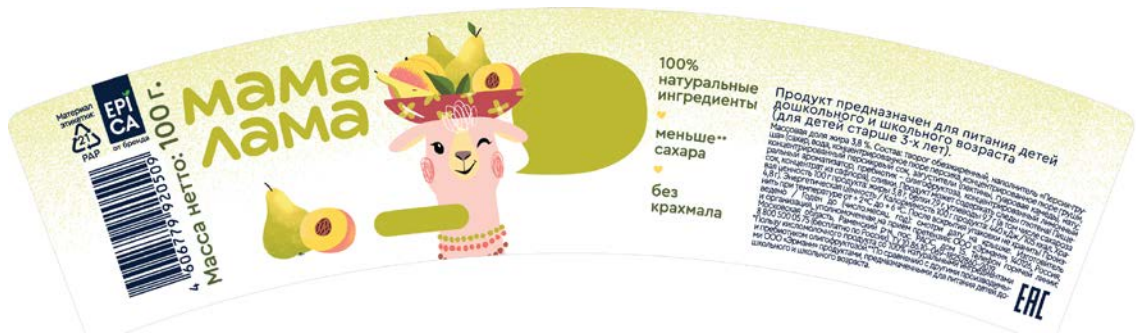

4.1

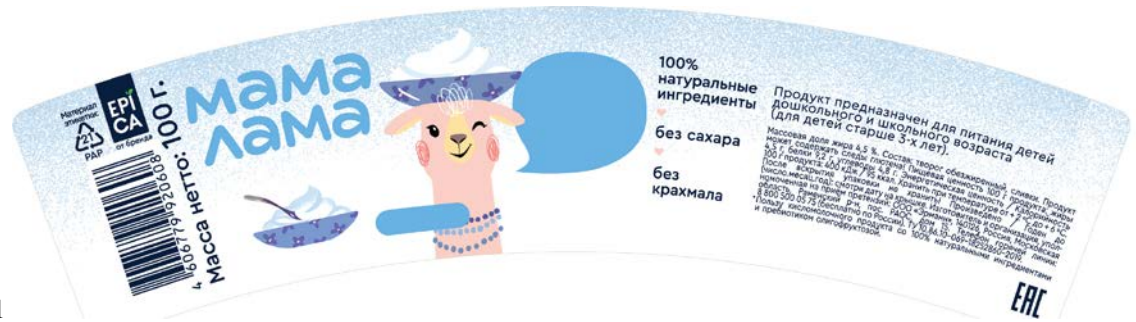

5.1

- (10) AD 2020 1154 S (51) 19-08
- (21) AD 2020 1154 (22) 2020 05 06
- (28) 7
- (31) 2019504993; 2019504993; 2019504993; 2019504993; 2019504993; 2019504993; 2019504993
- (32) 2019 11 08; 2019 11 08; 2019 11 08; 2019 11 08; 2019 11 08; 2019 11 08; 2019 11 08
- (33) RU; RU; RU; RU; RU; RU; RU
- (71) შპს „ერმან“ (RU)
- რამენსკის რაიონი, დასახლ. რაოს, 15, მოსკოვის ოლქი, 140126, რუსეთის ფედერაცია (RU)
- (72) მაქსიმ სერგეევიჩ პონომაროვი (RU)
- (74) ალექსანდრე გეგეჭკორი (GE)
- (54) ქტიკეპი
- (55)



1.1

2.1



3.1



4.1



დაჩქარებული პროცედურით რეგისტრირებული ლიზინები

რეგისტრაციის გაუქმების მოთხოვნით საჩივრის შეტანა შესაძლებელია საკაბინტის სააპელაციო პალატაში გამოქვეყნებიდან 3 თვის ვადაში.

(11) D 2020 871 S (51) 12-07

(21) AD 2020 1184 (22) 2020 10 07

(24) 2020 10 07

(28) 1

(18) 2025 10 07

(73) ივანე მასია (GE)

ერეკლე ტატიშვილის ქ. 17, ბ. 7, 0179, თბილისი, საქართველო (GE)

(72) ივანე მასია (GE)

(54) კიბრიდული უპილოტო საფრენი აპარატი

(55)

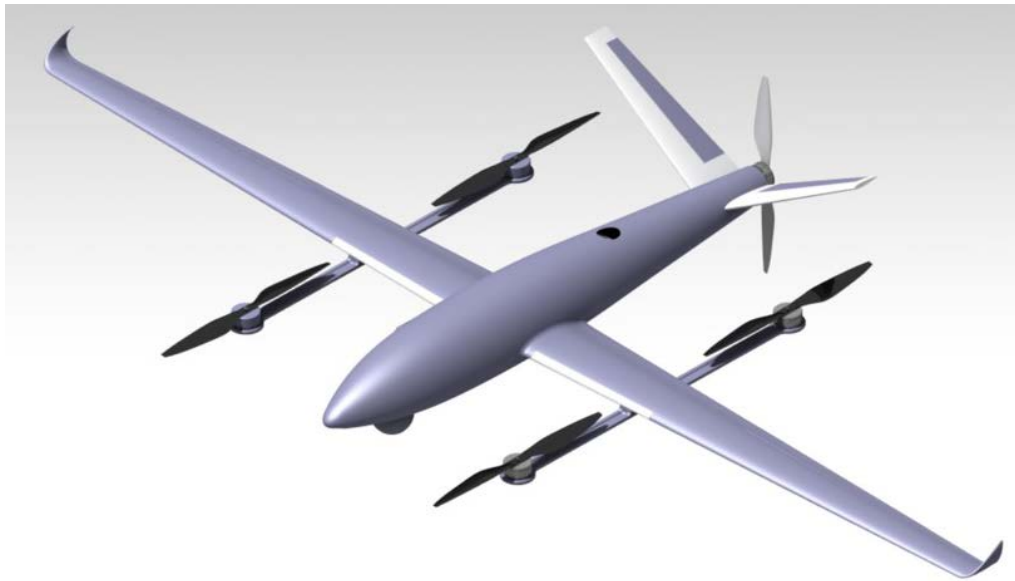

1.1

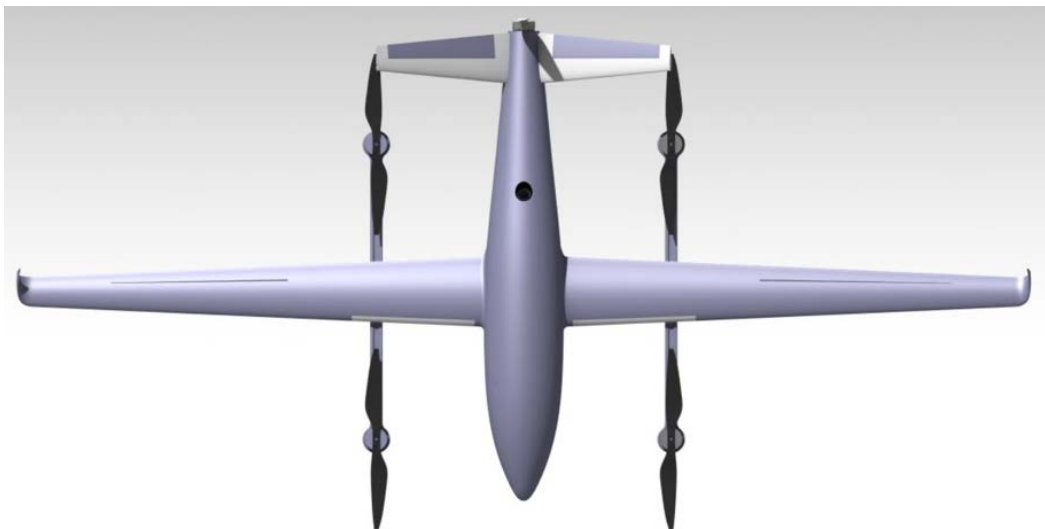

1.2

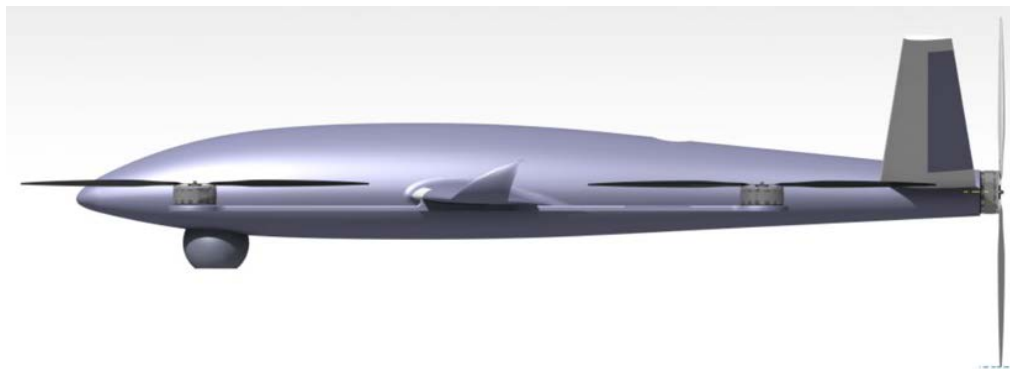

1.3

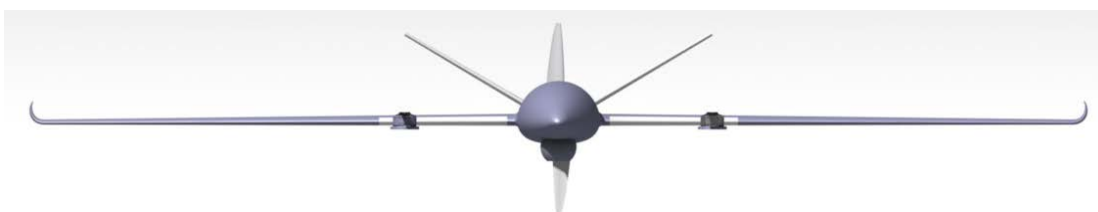

1.4

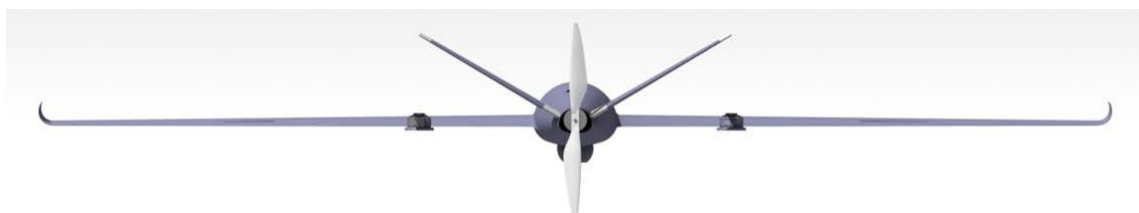

1.5

- (11) D 2020 870 S (51) 32-00
(21) AD 2020 1187 (22) 2020 10 08
(24) 2020 10 08
(28) 1
(18) 2025 10 08
(73) შპს „ფრივეი ინდასტრიზ“ (UA)
კავალერიისკა ქ. 19, კროპივნიცკი, კიროვოგრადაის ოლქი, 25002, უკრაინა (UA)
(72) ეკატერინა მიტროშკინა (UA)
(74) დავით მამუკაშვილი (GE)
(54) ბრაზიკული სიმბ(ო)ლი
(55)



1.1

ლიზენცია, რომელიც რეგისტრირებულია საქართველოს ბიუროში საქართველოს ტერიტორიაზე უფლებათა გავრცელების მოთხოვნით

გადაწყვეტილების გასაჩივრება შესაძლებელია საქპატენტის სააპელაციო პალატაში გამოქვეყნებულიდან 3 თვის ვადაში ან მცხეთის რაიონული სასამართლოს ადმინისტრაციულ საქმეთა კოლეგიაში 1 თვის ვადაში (მის.: ქ. მცხეთა, სამხედროს ქ. №17).

- (11) DM/209 554 (51) 13-03
- (15) 2019 10 11 (44) 33/2020 (2020 08 14)
- (22) 2019 10 11
- (28) 2
- (73) Any Pte. Ltd.
30 Cecil Street, №19-08 Prudential Tower, 049712 Singapore (SG)
- (85) –
- (86) SG
- (87) –
- (88) –
- (89) SG
- (81) III. ES, HU, IS, MN, PL, GB, LT, KR, JP, BN, FR, AL, HR, LV, TM, BZ, MC, SG, NA, DE, BA, US, MK, LI, KG, FI, RU, EG, AM, MD, TJ, BW, GH, ST, TR, KH, TN, KP, CH, UA, AZ, ME, BX, SI, OA, RS, NO, EE, OM, CA, GE, RO, SM, EM, DK, SY, RW, BG
- (72) Olav Beruto
Millennium Residence 112/048 19 C2 Floor Tower B, Sukhumvit Soi 20, Klongtoei, 10110, Bangkok (TH)
- (74) Aedificare Law Corporation
20 Collyer Quay №23-01, 049319 Singapore (SG)
- (54) 1.-2. Control panel [electricity]
- (55)

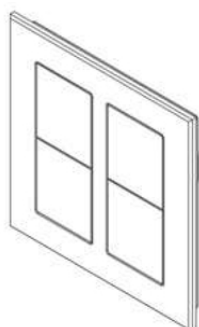

1.1

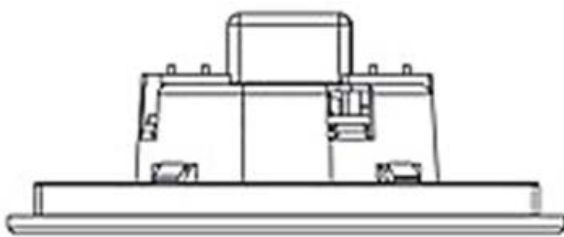

1.2

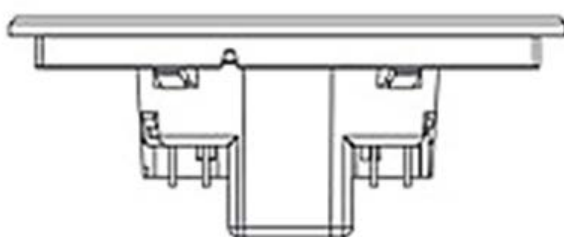

1.3

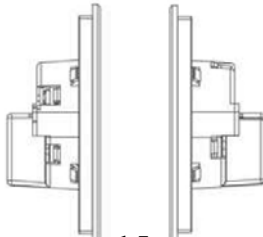

1.4

1.5

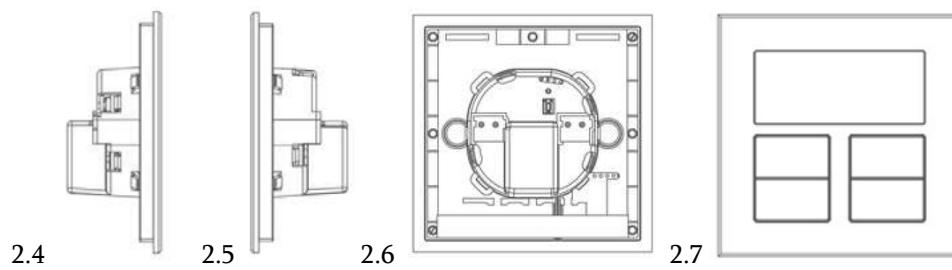
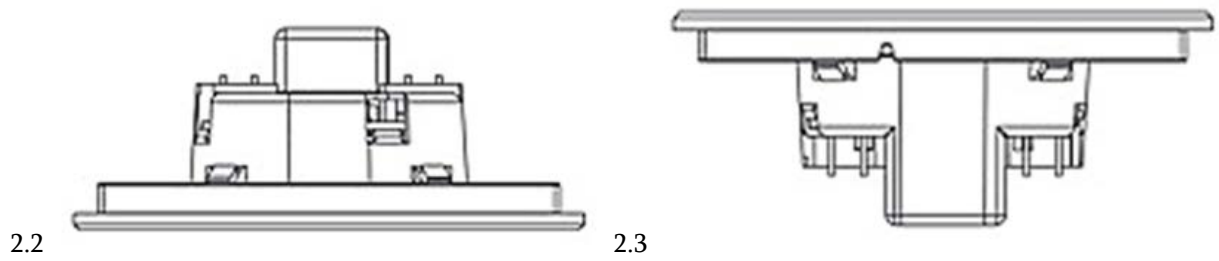
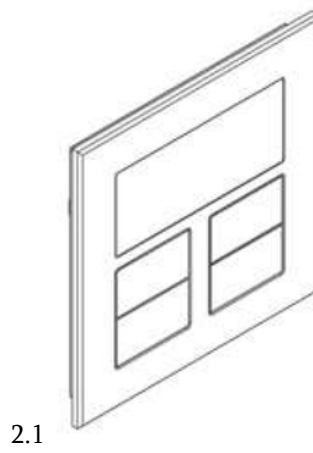
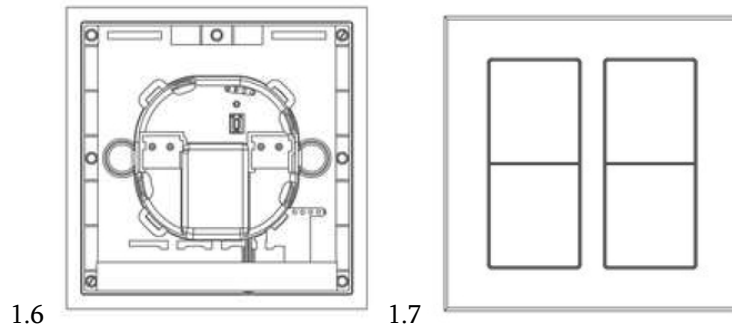

- (11) DM/203 513
- (15) 2019 08 30
- (22) 2019 08 30
- (28) 2
- (73) TISSOT SA (TISSOT AG) (TISSOT LTD)
17, Chemin Des Tourelles, 2400 Le Locle (CH)
- (85) CH
- (86) CH
- (87) CH
- (88) CH
- (89) CH
- (81) II. MA III. AM, AL, ME, MD, SG, BA, MK, GE, TR, GB, TN, EM, CH
- (72) Lorenzo VALLONE
Place De L'Eglise 19, 1255, Veyrier (CH);
Gilles HABEGGER
C/o TISSOT SA, Chemin Des Tourelles 17, 2400, Le Locle (CH)
- (74) The Swatch Group AG (The Swatch Group SA) (The Swatch Group Ltd)
6, Faubourg Du Lac, 2501 Biel/Bienne (CH)
- (46) 2020-09-04
- (54) 1. Watch, 2. Watch bracelet
- (55)



1.1



1.2



1.3



1.4



1.5



1.6



1.7



2.1



2.2

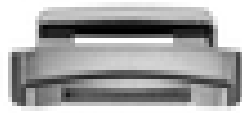

2.3



2.4



2.5

2.6



2.7

- (11) DM/207 017 (51) 11-01
- (15) 2020 03 03 (44) 36/2020 (2020 09 04)
- (22) 2020 03 03
- (28) 4
- (73) HARRY WINSTON SA
 Chemin Du Tourbillon 8, 1228 Plan-les-Ouates (CH)
- (85) CH
- (86) CH
- (87) CH
- (88) CH
- (89) CH
- (81) II. MA III. AM, UA, AL, AZ, BZ, ME, MD, MC, SG, MN, NO, BA, OM, CA, MK, TR, GE, LI, KG, GB,
 TN, EM, CH
- (72) 1;4 Rie YATSUGI-KANG
 C/o Harry Winston Inc., 718 Fifth Avenue, 10019, New York, N.Y. (US);
 2-3 Delphine ABDOURAHIM
 C/o Harry Winston Inc. 718 Fifth Avenue, 10019, New York, N.Y. (US)
- (74) The Swatch Group AG (The Swatch Group SA) (The Swatch Group Ltd.)
 Faubourg Du Lac 6, 2501 Biel/Bienne (CH)
- (54) 1. Finger ring, 2.-4. Necklace
- (55)

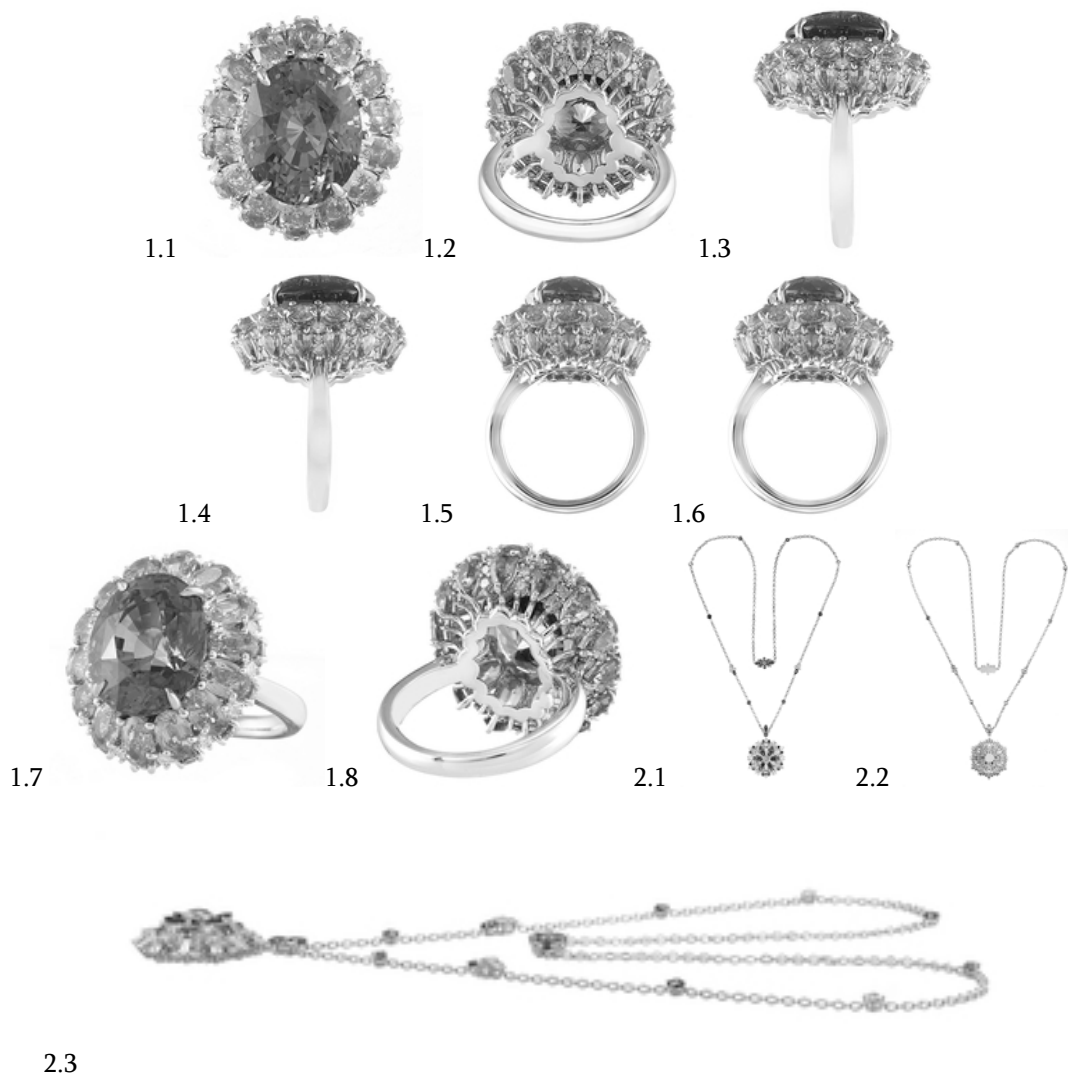



2.4



2.5



2.6



2.7



2.8



3.1



3.2



3.3



3.4



3.5



3.6



3.7



3.8



4.1



4.2



4.3



4.4



4.5



4.6



4.7



4.8

- (11) DM/209 998 (51) 14-04
- (15) 2019 10 09 (44) 36/2020 (2020 09 04)
- (22) 2019 10 09
- (28) 1
- (30) No1: 12.04.2019; 29/687,424; US; DAS: 7372; US
- (73) Jiveworld, SPC
100 Shoreline Hwy., Bldg. B, Suite 100, 94941 Mill Valley (US)
- (85) US
- (86) US
- (87) US
- (88) US
- (89) US
- (81) III. ES, HU, IS, MN, PL, GB, LT, KR, JP, FR, BN, AL, HR, LV, TM, BZ, MC, SG, NA, DE, BA, MK, LI, KG, RU, FI, EG, AM, MD, TJ, BW, GH, ST, TR, KH, TN, CH, KP, UA, AZ, ME, SI, BX, OA, RS, NO, EE, CA, GE, OM, RO, SM, EM, DK, SY, RW, BG
- (72) Frank William Harrison
7 Green Street, OX41YB, Oxford (GB)
- (74) SPRINKLE IP LAW GROUP
1301 W. 25th Street, Suite 408, 78705 Austin (US)
- (54) 1. Graphical user interface for display screen or portion thereof
- (55)

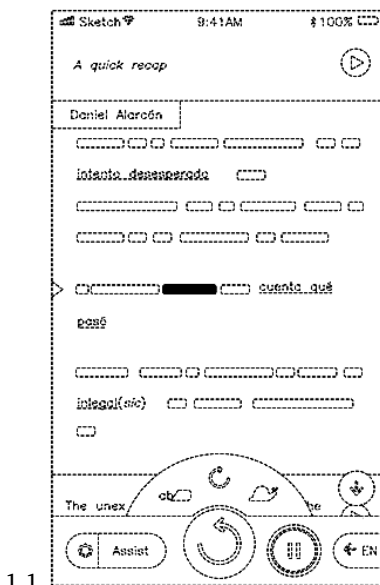

- (11) DM/210 101 (51) 02-04
 (15) 2020 08 28 (44) 37/2020 (2020 09 11)
 (22) 2020 08 28
 (28) 1
 (73) Valentino S.p.A
 Via Turati 16/18, I-20121 Milano (EM)
 (85) –
 (86) EM, IT
 (87) EM, IT
 (88) EM, IT
 (89) EM
 (81) III. TR, US, GE, UA, KG, AZ, EM, KR, JP, TJ, RU
 (72) Jacopo Venturini
 C/o Valentino S.p.A. Via Turati 16/18, I-20121, Milano (IT)
 (74) Matteo Mozzi
 C/o Jacobacci & Partners Via Senato, 8, I-20121 Milano (IT)
 (54) 1. Shoe
 (55)



1.1

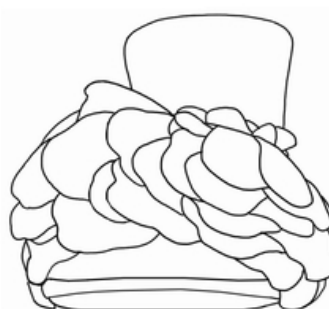

1.2

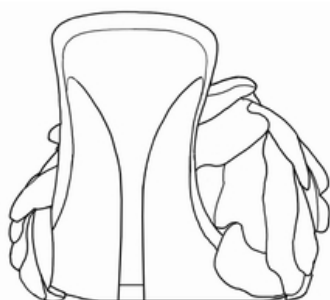

1.3

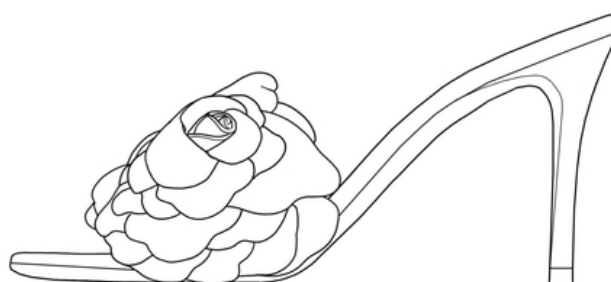

1.4

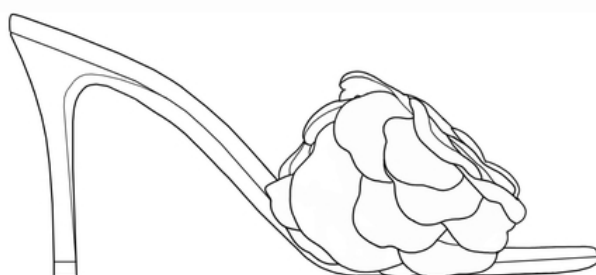

1.5



1.6



1.7

- (11) DM/210 093
- (15) 2020 08 28
- (22) 2020 08 28
- (28) 2
- (73) Valentino S.p.A
Via Turati 16/18, I-20121 Milano (EM)
- (85) –
- (86) EM, IT
- (87) EM, IT
- (88) EM, IT
- (89) EM
- (81) III. GE, TR, UA, KG, AZ, EM, KR, JP, TJ, RU
- (72) Jacopo Venturini
C/o Valentino S.p.A. Via Turati 16/18, I-20121, Milano (IT)
- (74) Matteo Mozzi
C/o Jacobacci & Partners Via Senato, 8, I-20121 Milano (IT)
- (54) 1. Bag, 2. Bag
- (55)

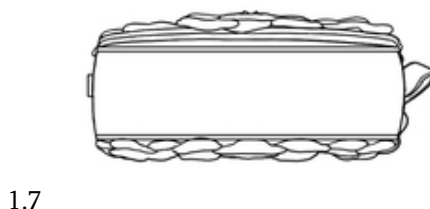
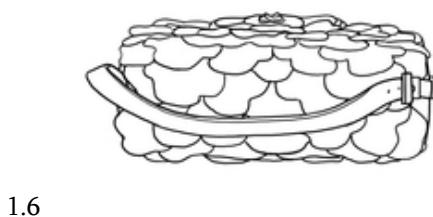
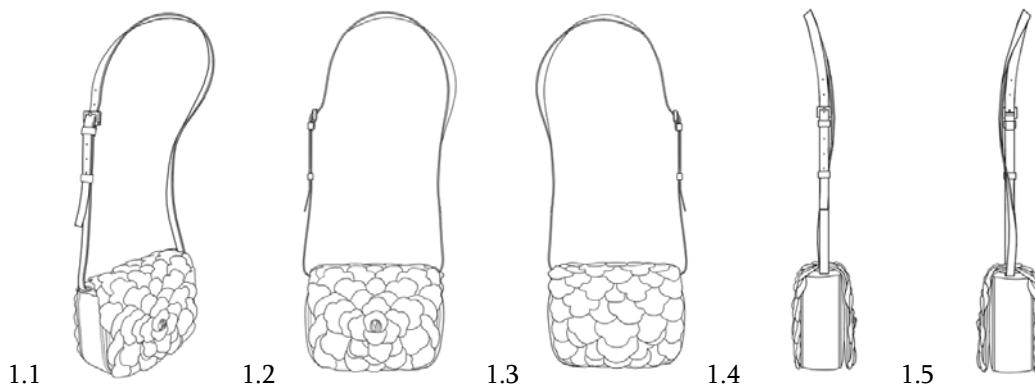

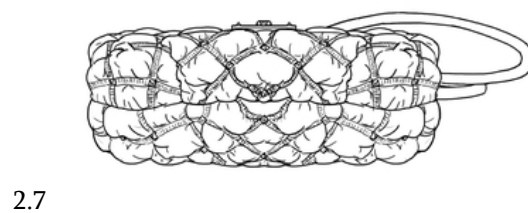
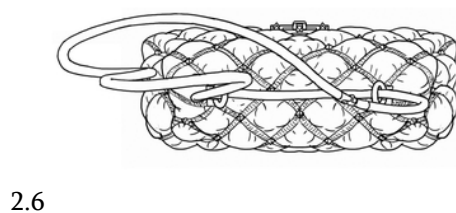
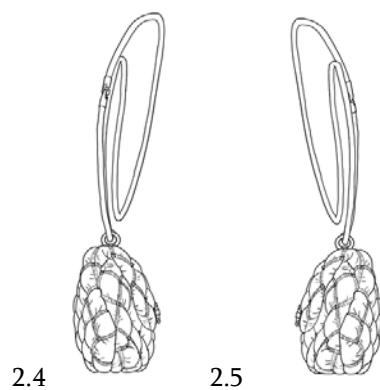

- (11) DM/210 125 (51) 21-01
 (15) 2019 08 08 (44) 37/2020 (2020 09 11)
 (22) 2019 08 08
 (28) 1
 (73) ALEXANDER SAVOYSKY
 Ul. A.Gubina, Build. 28, Ap. 42, 357736 Kislovodsk (RU);
 ERIK MAKKILL
 Djankoisky Pr., Build. 5, Ap. 3, Room 3, 117623 Moscow (RU)
 (85) RU; RU
 (86) RU; RU
 (87) RU; RU
 (88) RU; RU
 (89) RU; RU
 (81) III. ES, HU, IS, MN, PL, GB, LT, KR, JP, BN, FR, AL, LV, HR, TM, BZ, MC, SG, NA, DE, BA, US, MK, LI, KG, FI, RU, EG, AM, MD, TJ, BW, GH, ST, TR, KH, TN, CH, KP, UA, AZ, ME, SI, BX, OA, NO, RS, EE, OM, CA, GE, RO, SM, EM, DK, SY, BG, RW
 (72) ERIK MAKKILL
 Djankoisky Pr., Build. 5, Ap. 3, Room 3, 117623 Moscow (RU);
 ALEXANDER SAVOYSKY
 Ul. A.Gubina, Build. 28, Ap. 42, 357736 Kislovodsk (RU)
 (74) Patent Agency "Ermakova, Stoliarova And Partners"
 Shmitovsky Pr. 2/2, 123100 Moscow (RU)
 (54) 1. Gameboard
 (55)



1.1



1.2



1.3



1.4



1.5



1.6



1.7

- (11) DM/210 126
- (15) 2020 06 23
- (22) 2020 06 23
- (28) 1
- (73) Adp Gauselmann GmbH
Merkur-Allee 1-15, 32339 Espelkamp (DE)
- (85) DE, EM
- (86) DE
- (87) DE
- (88) --
- (89) DE
- (81) III. BA, US, GE, MK, RO, LI, MX, GB, SM, LT, CH, RU
- (72) Jens Uwe Themann
Geistwall 37, 32312, Lübbecke (DE)
- (54) 1. Gaming machine
- (55)



1.1

1.2

1.3

- (11) DM/210 209 (51) 27-01
 (15) 2020 08 31 (44) 38/2020 (2020 09 18)
 (22) 2020 08 31
 (28) 25
 (30) No1: 20.03.2020; 7764295; EM; No2: 20.03.2020; 7764295; EM; No3: 20.03.2020; 7764295; EM;
 No4: 20.03.2020; 7764295; EM; No5: 20.03.2020; 7764295; EM; No6: 20.03.2020; 7764295; EM;
 No7: 20.03.2020; 7764295; EM; No8: 20.03.2020; 7764295; EM; No9: 20.03.2020; 7764295; EM;
 No10: 20.03.2020; 7764295; EM; No11: 20.03.2020; 7764295; EM; No12: 20.03.2020; 7764295; EM;
 No13: 20.03.2020; 7764295; EM; No14: 20.03.2020; 7764295; EM; No15: 20.03.2020; 7764295; EM;
 No16: 20.03.2020; 7764295; EM; No17: 20.03.2020; 7764295; EM; No18: 20.03.2020; 7764295; EM;
 No19: 20.03.2020; 7764295; EM; No20: 20.03.2020; 7764295; EM; No21: 20.03.2020; 7764295; EM;
 No22: 20.03.2020; 7764295; EM; No23: 20.03.2020; 7764295; EM; No24: 20.03.2020; 7764295; EM;
 No25: 20.03.2020; 7764295; EM
 (73) JAPAN TOBACCO INC
 2-2-1 Toranomom, Minato-ku Tokyo (JP)
 (85) –
 (86) JP
 (87) JP
 (88) CH
 (89) CH
 (81) II. MA III. UA, AM, AZ, VN, MD, TJ, SG, OA, MN, RS, GE, OM, KH, KG, KR, JP, CH, RU
 (72) 1-11; 24-25 Fabio Molinaro
 Robilant Associati, Via Vigevano, 41, 20144, Milan (IT);
 12-23 Kheireddine Sidhoum
 Dragon Rouge, 32 Rue Pagès, 92150, Suresnes (FR)
 (74) BAYLOS
 Calle José Lázaro Galdiano 6, 28036 Madrid (ES)
 (54) 1.-25. Cigarette filter
 (55)

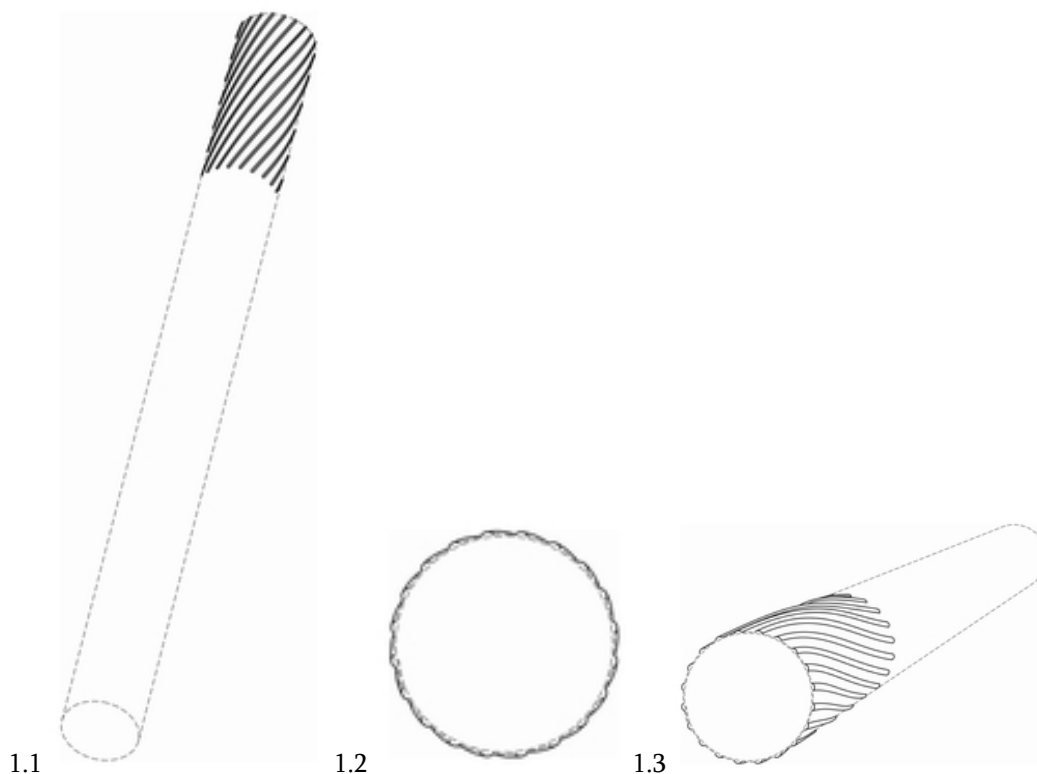

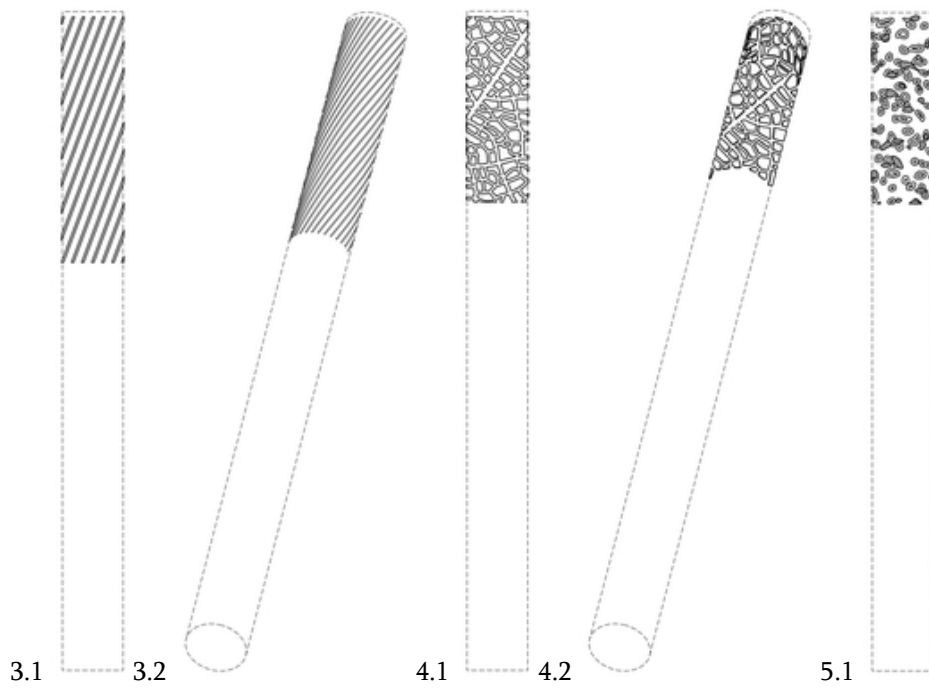
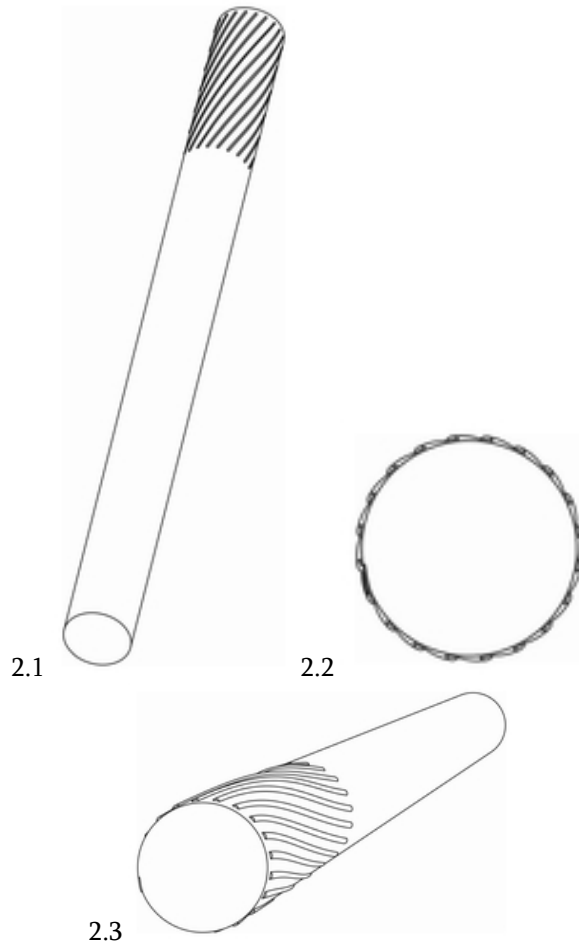

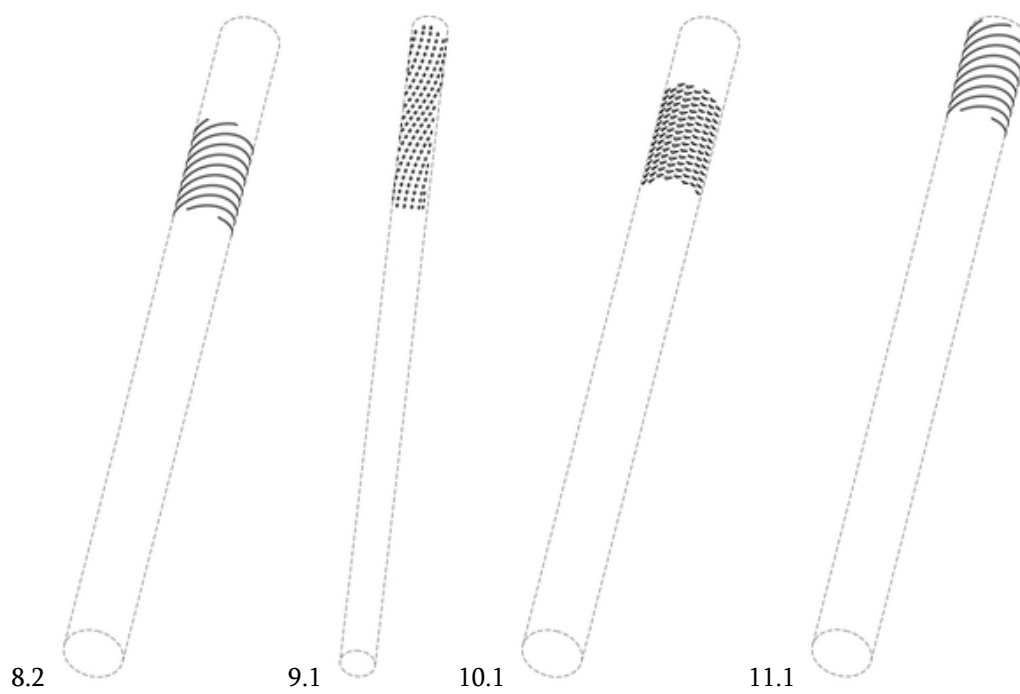
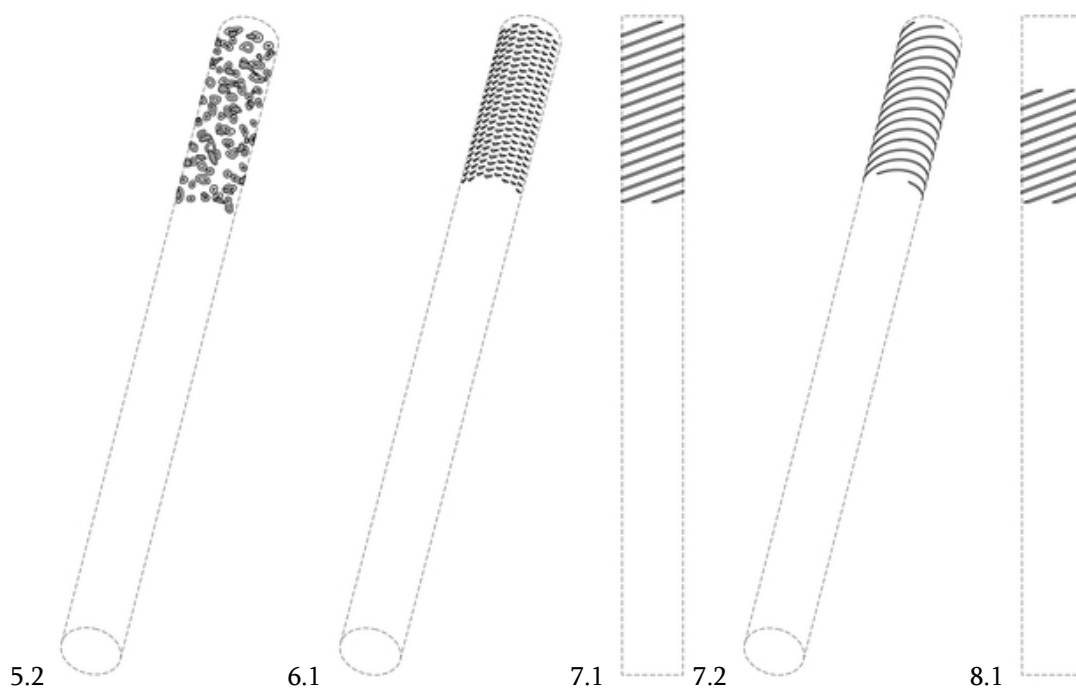

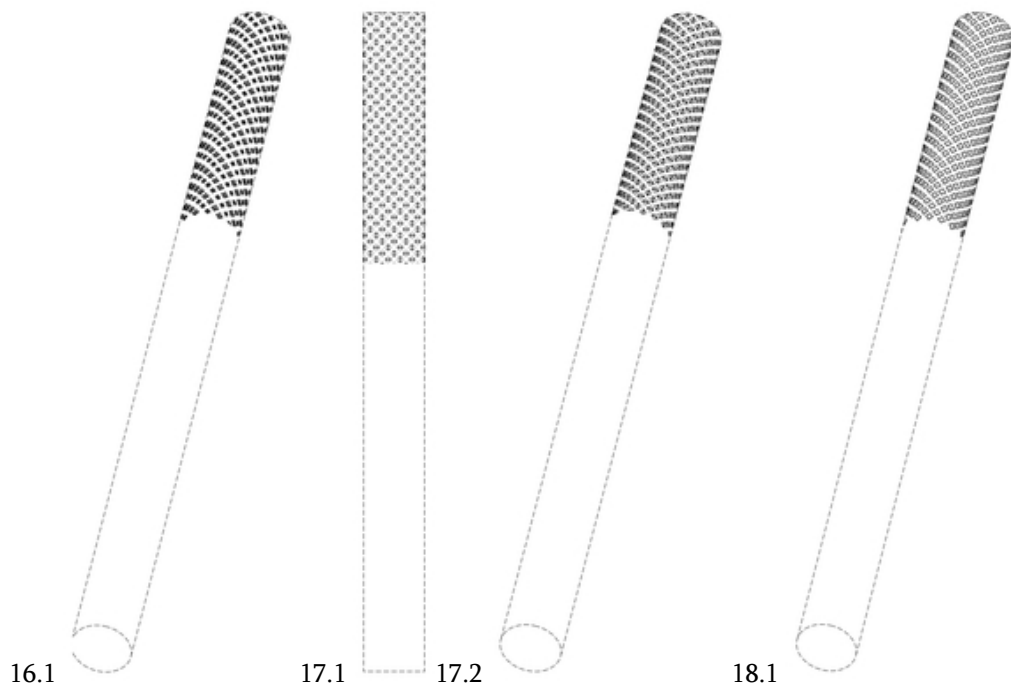
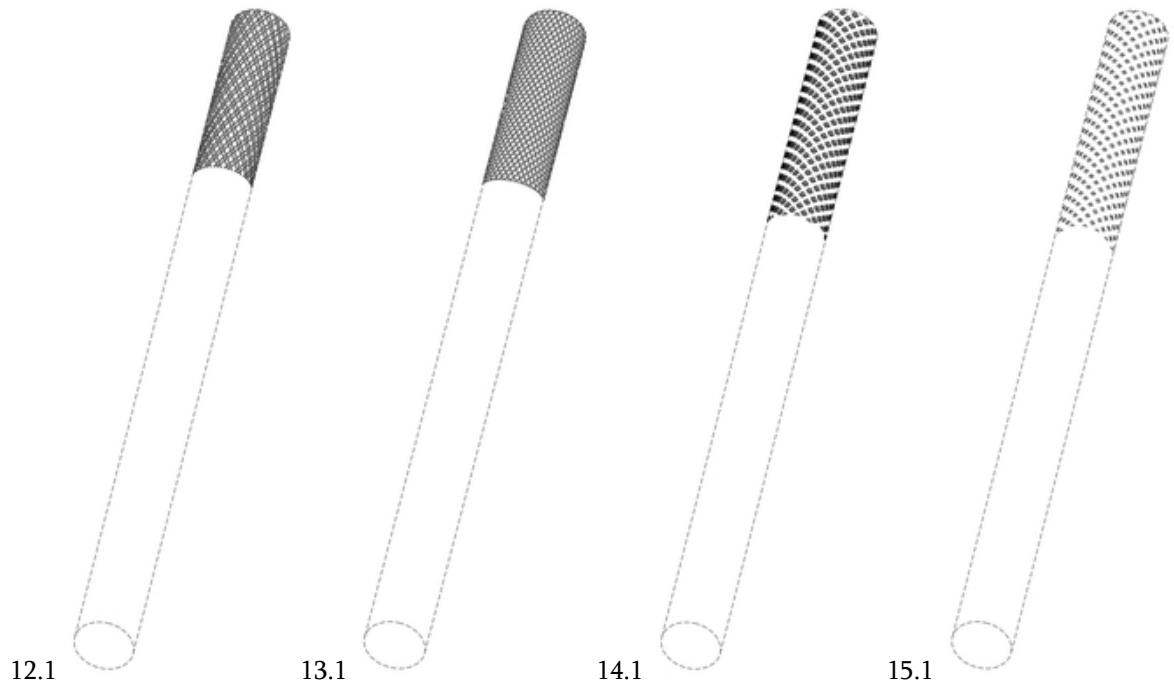

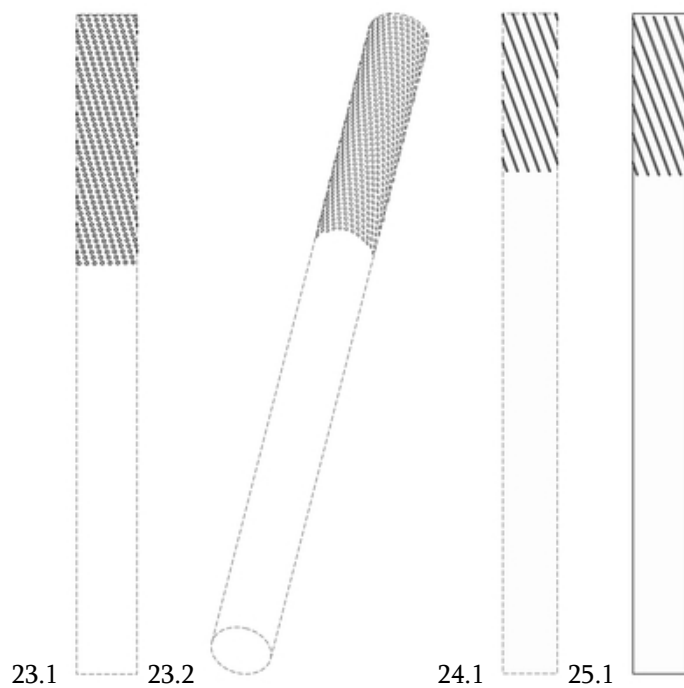
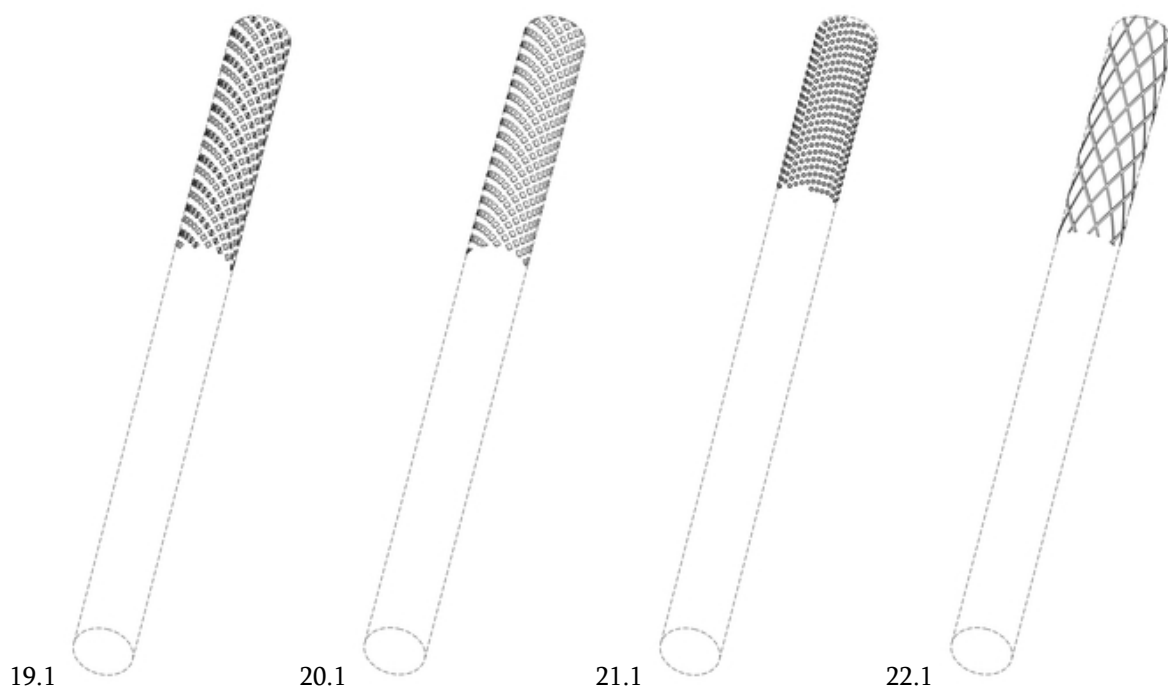

სასაქონლო ნიშნები

ეროვნული პროცედურით შემოტანილი ბანაცხავები, რომლებზეც გამოტანილია გადაწყვეტილება კატენის ბაცემის შესახებ

გადაწყვეტილების გასაჩივრება შესაძლებელია საქპატენტის სააპელაციო პალატაში გამოქვეყნებიდან 3 თვის ვადაში ან მცხეთის რაიონული სასამართლოს ადმინისტრაციულ საქმეთა კოლეგიაში 1 თვის ვადაში (მის.: ქ. მცხეთა, სამხედროს ქ. №17).

(260) AM 2020 100030 A*

(210) AM 100030

(220) 2018 10 24

(731) ინმიუზიკ ბრენდს ინკ.

200 სენიკ ვიუ დრაივი, 02864,

კამბერლენდი, როდ აილენდ, აშშ

(740) გიორგი ბათლიძე

(540)



(591) შავ-თეთრი

(531) 26.03.01; 26.03.24; 27.05.23

(511)

9 – მიკროფონები; მიმღებები (აუდიო - ვიდეო); აუდიო გადამცემები; რადიოგადამცემები; ბგერის გამამლიერებლები; ხმამაღლამოლაპარაკე კავშირის სისტემები; რადიომიმღებები; რადიო ტიუნერები; ეკვალიზერები; ბგერის ჩამწერი მოწყობილობები; დინამიკები; ხმამაღლამოლაპარაკეები; ბგერის ჩამწერი პროცესორები; ბგერითი მიქშერები; ელექტრული კაბელები; კვების წყაროები, მათი ნაწილები და აქსესუარები; ხმამაღლამოლაპარაკეების კონტროლირების პროგრამული უზრუნველყოფა.

(260) AM 2020 105671 A

(210) AM 105671

(220) 2019 11 07

(731) გაბა ინტერნაციონალ ჰოლდინგ გმბჰ

გრაბეტსმათვეგ, თერვილი, 4106,

შვეიცარია

(740) ნათელა ოთარიძე

(540)

MERIDOL

(591) შავ-თეთრი

(511)

21 – კბილის ჯაგრისები, კბილის გასაწმენდი ძაფები, კბილებს შორის სივრცის გასაწმენდი მოწყობილობები.

(260) AM 2020 105672 A

(210) AM 105672

(220) 2019 11 07

(731) გაბა ინტერნაციონალ ჰოლდინგ გმბჰ

გრაბეტსმათვეგ, თერვილი, 4106,

შვეიცარია

(740) ნათელა ოთარიძე

(540)

ELMEX

(591) შავ-თეთრი

(511)

3 – პირის ღრუს მოსავლელი საშუალებები, მათ შორის, კბილის პასტები, პირის ღრუს სავლებები, კბილების მათეთრებელი პრეპარატები.

5 – პირის ღრუს მოსავლელი სამკურნალო საშუალებები, სამკურნალო კბილის პასტები, სამკურნალო პირის ღრუს სავლებები; პირის და სტომატოლოგიური მოვლის ფარმაცევტული პრეპარატები.

21 – კბილის ჯაგრისები, კბილის გასაწმენდი ძაფები, კბილებს შორის სივრცის გასაწმენდი მოწყობილობები.

(260) AM 2020 106777 A

(210) AM 106777

(220) 2020 01 29

(731) შპს „ჯიველი“

სულხან ცინცაძის ქ. 59, ბ. 41, 0160,

თბილისი, საქართველო

(740) ავთანდილ ჭარბაძე

(540)



(591) შავი, წითელი, ოქროსფერი
 (531) 05.03.04; 05.03.19; 05.07.10; 24.13.09;
 25.01.19; 26.04.24; 27.05.24; 28.19; 29.01.13
 (526) GOMBORI, გომბორი, GEORGIA,
 KAKHETI, საქართველოს დროშის
 ელემენტები
 (511)
 3 – ღვინო.

(260) AM 2020 107148 A
 (210) AM 107148
 (220) 2020 02 14
 (731) შპს „ლოპოტა“
 სოფ. ნაფარეული, 2211, თელავის რაიონი,
 საქართველო
 (740) ირაკლი სულაძე
 (540)

თბილისის რაიონი



ლოპოტა

LAKE RESORT & SPA

(591) შავ-თეთრი
 (531) 03.09.24; 27.05.01; 27.05.10; 28.19
 (511)
 43 – ადგილების დაჯავშნა სასტუმროში; ბარების მომსახურება; დროებითი საცხოვრებელი უზრუნველყოფის მომსახურება (სასტუმროები, პანსიონები); დროებითი საცხოვრებლის დაჯავშნა; თვითმომსახურების რესტორნებით მომსახურება; კაფეებით მომსახურება; კაფეტერიებით მომსახურება; რესტორნებით მომსახურება; სასადილოებით მომსახურება; სასტუმროებით მომსახურება; სასაუზმეებით მომსახურება; შეხვედრების ჩასატარებელი ოთახების გაქირავება; შეფ-მზარეულის მომსახურება; ჩილიმ ბარების მომსახურება.

(260) AM 2020 107151 A
 (210) AM 107151
 (220) 2020 02 14
 (731) შპს „ლოპოტა“
 სოფ. ნაფარეული, 2211, თელავი,
 საქართველო
 (740) ირაკლი სულაძე

(540)
Lopota Resort
ლოპოტა რეზორტ
Лопота Резорт

(591) შავ-თეთრი
 (511)
 43 – ადგილების დაჯავშნა სასტუმროში; ბარების მომსახურება; დროებითი საცხოვრებელი უზრუნველყოფის მომსახურება (სასტუმროები, პანსიონები); დროებითი საცხოვრებლის დაჯავშნა; დროებითი საცხოვრებელი უზრუნველყოფა (ჩამოსვლის და გამგზავრების მართვა); თვითმომსახურების რესტორნებით მომსახურება; კაფეებით მომსახურება; რესტორნებით მომსახურება; სასადილოებით მომსახურება; სასტუმროებით მომსახურება; სასაუზმეებით მომსახურება; შეხვედრების ჩასატარებელი ოთახების გაქირავება; შეფ-მზარეულის მომსახურება; ჩილიმ ბარების მომსახურება.

(260) AM 2020 107263 A
 (210) AM 107263
 (220) 2020 02 21
 (731) შპს „ბასიანი“
 ი. მოსაშვილის ქ. 7/7, თბილისი,
 საქართველო
 (740) გელა ფერაძე
 (540)

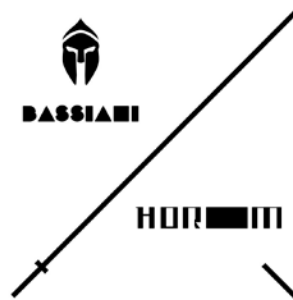

(591) შავ-თეთრი
 (531) 04.05.21; 09.07.01; 09.07.25; 23.01.01
 (526) BASSIANI
 (511)
 41 – განათლება; სასწავლო პროცესის უზრუნველყოფა; გართობა; სპორტული და კულტურული აქტივობები (ღონისძიებები).
 43 – საკვებით და სასმელით უზრუნველყოფა; დროებითი საცხოვრებელი უზრუნველყოფა.

(260) AM 2020 107478 A
(210) AM 107478
(220) 2020 03 09
(731) სულხან სახვაძე
სოფ. უბისა, ხარაგაულის რაიონი,
საქართველო
(540)

MYPROTEIN

(591) ლურჯი, თეთრი
(531) 27.05.17; 29.01.04
(511)
35 – რეკლამა; ბიზნესის მართვა; ბიზნესის
ადმინისტრირება; საოფისე მომსახურება.

(260) AM 2020 107645 A
(210) AM 107645
(220) 2020 03 20
(731) ბიგ სტარ კო., ლტდ
15 სოი. რამა 2, სოი. 100 რამა 2 როუდი,
სამაედამი, ბანგხუნთიენი, ბანგკოკი
10150, ტაილანდი
(740) თამაზ შილაკაძე
(540)



(591) შავ-თეთრი
(531) 26.04.04; 26.04.12; 26.04.18; 27.05.01;
27.05.21
(511)
25 – ფეხსაცმელი; სპორტული ფეხსაცმელი; რე-
ზინის ძირიანი ფეხსაცმელი; სანდლები; სატყა-
პუნო ქოშები; ფოსტლები, საშინაო ფეხსაცმე-
ლი; ყოველდღიური ფეხსაცმელი; პლაჟის ფეხ-
საცმელი; წინდები.

(260) AM 2020 107646 A
(210) AM 107646
(220) 2020 03 23
(731) სს „თბილღვინო“
სარაჯიშვილის გამზ. 2, 0153, თბილისი,
საქართველო

(740) გიორგი თავთაქიშვილი
(540)

Georgian Story

ქართული ამბავი

(591) შავ-თეთრი
(531) 28.19
(511)
33 – ღვინოები, მათ შორის, სუფრის ღვინო,
ცქრიალა ღვინო, შემაგრებული ღვინო, დესერ-
ტის ღვინო, ლიქიორი, ბრენდი, არაყი.

(260) AM 2020 107649 A
(210) AM 107649
(220) 2020 03 23
(731) მარიამ ბრეგაძე
ეგ. ნინოშვილის ქ. 19, 4300, ტყიბული,
საქართველო
(540)



(591) თეთრი, ნარინჯისფერი
(531) 03.01.06; 03.01.08; 03.01.16; 26.04.15;
26.04.22; 26.04.24; 28.19; 29.01.12

(511)
5 – ფარმაცევტული, სამედიცინო და ვეტერინა-
ლური პრეპარატები; სამედიცინო დანიშნულე-
ბის ჰიგიენური პრეპარატები; სამედიცინო ან
ვეტერინარული გამოყენებისთვის ვარგისი
დიეტური საკვები და ნივთიერებები, საკვები
ჩვილებსთვის; დიეტური დანამატები ადამიან-
ებისა და ცხოველებისთვის; ლეიკოპლასტიკი,
სახვევი მასალა; კბილების დასამაგრებელი
მასალა, სტომატოლოგიური ცვილი; სადეზინ-
ფექციო საშუალებები; მავნე მწერების გასანად-
გურებელი პრეპარატები, ფუნგიციდები, ჰერბი-
ციდები.

(260) AM 2020 107650 A
(210) AM 107650
(220) 2020 03 23
(731) ბერლინ-ხემი აგ
გლინიკერ ვეგ 125, ბერლინი, 12489,
გერმანია
(740) გიორგი ღვინჯილია

(540)

ATTEHTO

(591) შავ-თეთრი

(511)

5 – ფარმაცევტული პრეპარატები, მედიკამენტები, სამედიცინო მიზნებისათვის განკუთვნილი დიეტური ნივთიერებები.

(260) AM 2020 107652 A

(210) AM 107652

(220) 2020 03 25

(731) თელიანი ველი პოლსკა ს.ა.

კობიერზიცკა 9A/14, 52-315 ვროსლავი, პოლონეთი

(740) შალვა გვარამაძე

(540)



(591) შავი, რუხი, კრემისფერი, სხვადასხვა ტონის ყავისფერი, ოქროსფერი

(531) 03.06.01; 03.06.06; 05.03.04; 05.03.09; 06.19.07; 07.01.03; 24.09.09; 25.01.18; 25.01.19; 26.01.01; 26.01.05; 26.01.15; 27.05.01; 29.01.14

(526) GRUZIA

(511)

3 – ღვინო და ალკოჰოლური სასმელები.

(260) AM 2020 107656 A

(210) AM 107656

(220) 2020 03 25

(731) ბასე აგრიკალჩერალ სოლუმენს

სიდ უს ლლკ

100 პარკ ავენიუ, ფლორამ პარკი, ნიუ-ჯერზი, აშშ

(740) გიორგი თაქთაქიშვილი

(540)

INSUN

(591) შავ-თეთრი

(511)

1 – სოფლის მეურნეობაში, მეტყვევობასა და მეზღვეობაში გამოსაყენებელი ქიმიური ნივთიერებები, კერძოდ, მცენარეების გასაძლიერებელი პრეპარატები, მცენარეებში სტრესის მართვის ქიმიური ან ბიოლოგიური პრეპარატები, მცენარეების ზრდის მარეგულირებელი პრეპარატები, თესლეულის დასამუშავებელი ქიმიური პრეპარატები, თესლეულის გენები სოფლის მეურნეობაში წარმოებისათვის.

31 – სოფლის მეურნეობის, მეზღვეობისა და მეტყვევობის ნაწარმი, კერძოდ, პესტიციდებით ან ქიმიური ან ბიოლოგიური ნაწარმით დამუშავებული თესლეული, მარცვლეული და მცენარის ვეგეტატიური ნაწილები; სხვა კლასებში შეტანილის გარდა.

(260) AM 2020 107659 A

(210) AM 107659

(220) 2020 03 26

(731) შპს „ევროგეო ქიმია“

პეტრე იბერის ქ. 24, სართ. 1, 0159, თბილისი, საქართველო

(540)

DONEMIX[®]

(591) შავი, წითელი, თეთრი

(531) 27.05.17; 29.01.12

(511)

3 – სარეცხისათვის ბზინვარების მიმნიჭებელი პრეპარატები; საპნები; მათეთრებელი პრეპარატები (სარეცხი საშუალება); ავეჯისა და იატაკის გასაპრიალებელი საშუალებები; იატაკის ცვილი; ლაქების ამოსაყვანი საშუალებები; სარეცხი საშუალებები (დეტერგენტები), სამრეწველო და სამედიცინო დანიშნულების გარდა; მინადულის, ხაშურის მოსაცილებელი პრეპარატები, საყოფაცხოვრებო დანიშნულების; სადეზინფექციო საშუალებები (პარფიუმერია); მათეთრებელი პრეპარატები (სარეცხი საშუალება); საქარე მინების გასაწმენდი სითხეები; შამპუნები; ნაჭერი საპონი; ჟანგის მოსაცილებელი პრეპარატები; დამარბილებლები რეცხვისათვის (ქსოვილის).

(260) AM 2020 107660 A

(210) AM 107660

(220) 2020 03 26

(731) სს „გომის სპირტის და არყის კომპანია“

სოფ. გომი, ხაშურის რაიონი, საქართველო

(740) დიმიტრი ძამუკაშვილი
(540)



საფთა საყარო
CLEAN WORLD

(591) ლურჯი, ცისფერი, თეთრი
(531) 02.01.23; 02.03.23; 02.09.15; 28.19; 29.01.04
(511)

5 – ფარმაცევტული და ვეტერინარული პრეპარატები; სამედიცინო დანიშნულების ჰიგიენური პრეპარატები; სამედიცინო ან ვეტერინარული დანიშნულების დიეტური საკვები და ნივთიერებები, ბავშვთა საკვები; დიეტური დანამატები ადამიანებისა და ცხოველებისათვის; სალბუნები, სახვევი მასალა; კბილის დასაბუნე და კბილის ცვილი; მადეზინფიცირებელი საშუალებები; მავნე ცხოველების გასანადგურებელი პრეპარატები; ფუნგიციდები, ჰერბიციდები.

(260) AM 2020 107661 A
(210) AM 107661
(220) 2020 03 26
(731) შპს „PARK GIDA“
მე-5 უბანი, ქ. 46ა, სოფ. ხუცუბანი,
ქობულეთი, საქართველო
(740) დათო ჯაიანი
(540)

black jack
ბლექ ჯექ

(591) შავ-თეთრი
(511)
33 – ალკოჰოლური სასმელები, ლუდის გარდა; ალკოჰოლური შედგენილობები სასმელების დასამზადებლად.

(260) AM 2020 107667 A
(210) AM 107667
(220) 2020 03 30
(731) გლანზია ნუტრიშენალს (ირლანდია)
ლიმიტედ
გლანზია ჰაუს, კილკენი, ირლანდია

(740) გიორგი ბათლიძე
(540)

ISOPURE

(591) შავ-თეთრი
(511)
5 – ვიტამინები, მინერალები, საკვები დანამატები სასმელის დასამზადებელი ფხვნილის სახით და ფილის ფორმით და სპორტულ-გამაჯანსაღებელი სასმელები, კერძოდ, მაღალი რაოდენობით ცილებისა და მაღალი რაოდენობით პროტეინის შემცველი სასმელები ქილასა და ბოთლებში.

(260) AM 2020 107668 A
(210) AM 107668
(220) 2020 03 30
(731) გლანზია ნუტრიშენალს (ირლანდია)
ლიმიტედ
გლანზია ჰაუს, კილკენი, ირლანდია
(740) გიორგი ბათლიძე
(540)

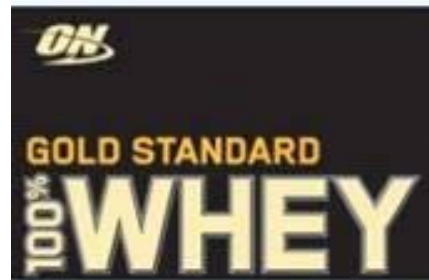

(591) ყვითელი ოქროსფერი, კრემისფერი, შავი
(531) 24.15.13; 26.04.02; 26.04.05; 26.04.22;
26.04.24;
26.11.12; 27.05.01; 27.05.09; 27.05.10;
27.05.23; 27.05.24; 29.01.13

(511)
5 – დიეტური და საკვები დანამატები; დიეტური და საკვები დანამატები სასმელის ნარევის დანამატების სახით; დიეტური საკვების დანამატები თხევადი სასმელის სახით; საკვები დანამატები ენერჯის მომატებისათვის; ფხვნილოვანი საკვები და დიეტური დანამატების სასმელის ნარევი; ფხვნილოვანი საკვები დანამატების სასმელის ნარევი და სხვადასხვა ფხვნილოვანი საკვები ინგრედიენტები და დასალევი მზა ნარევი; დიეტური სასმელები; დიეტური სასმელები, რომელიც ამასთან ენერჯის მომყვანია; დიეტური მიზნებისათვის განკუთვნილი სპორტული სასმელები; დიეტური სასმელები სპორტული მომზადების მიზნებისათვის; ნუტრიციულად გამდიდრებული

სასმელები დიეტური მიზნებისათვის; დიეტური მიზნებისათვის განკუთვნილი სასმელის მოსამზადებელი ფხვნილები;

(260) AM 2020 107678 A
(210) AM 107678
(220) 2020 04 01
(731) ქეი თი & ჯი კორპორეიშნ
71, ბეოტკკოტ-გილ, დაედოკ-გუ,
ტეჯონი, კორეის რესპუბლიკა
(740) პავლე მეიფარიანი
(540)

BOHEM CIGAR MINI AROMA

(591) შავ-თეთრი
(511)
34 – თამბაქო; სიგარეტები; პაპიროსები; სიგარები; ბურნუთი; პაპიროსის, სიგარეტის ქაღალდი; ჩიბუხები; სიგარეტის ფილტრები; პორტსიგარები (მვირფასი ლითონებისგან დამზადებული გარდა); თამბაქოს ქისები; სანთებლები (მვირფასი ლითონებისგან დამზადებული გარდა); ასანთი; ჩიბუხის გასაწმენდი მოწყობილობები; საფერფლეები (მვირფასი ლითონებისგან დამზადებული გარდა); სიგარის ბოლოების საჭრელი სამარჯვეები.

(260) AM 2020 107679 A
(210) AM 107679
(220) 2020 04 01
(731) ქეი თი & ჯი კორპორეიშნ
71, ბეოტკკოტ-გილ, დაედოკ-გუ,
ტეჯონი, კორეის რესპუბლიკა
(740) პავლე მეიფარიანი
(540)

BOHEM CIGAR MINI ORIGINAL BLEND

(591) შავ-თეთრი
(511)
34 – თამბაქო; სიგარეტები; პაპიროსები; სიგარები; ბურნუთი; პაპიროსის, სიგარეტის ქაღალდი; ჩიბუხები; სიგარეტის ფილტრები; პორტსიგარები (მვირფასი ლითონებისგან დამზადებული გარდა); თამბაქოს ქისები; სანთებლები (მვირფასი ლითონებისგან დამზადებული გარდა); ასანთი; ჩიბუხის გასაწმენდი მოწყობილობები; საფერფლეები (მვირფასი ლითონებისგან დამზადებული გარდა); სიგარის ბოლოების საჭრელი სამარჯვეები.

ბისგან დამზადებული გარდა); სიგარის ბოლოების საჭრელი სამარჯვეები.

(260) AM 2020 107680 A
(210) AM 107680
(220) 2020 04 01
(731) ქეი თი & ჯი კორპორეიშნ
71, ბეოტკკოტ-გილ, დაედოკ-გუ,
ტეჯონი, კორეის რესპუბლიკა
(740) პავლე მეიფარიანი
(540)

ESSE EXCHANGE CLUB

(591) შავ-თეთრი
(511)
34 – თამბაქო; სიგარეტები; პაპიროსები; სიგარები; ბურნუთი; პაპიროსის, სიგარეტის ქაღალდი; ჩიბუხები; სიგარეტის ფილტრები; პორტსიგარები (მვირფასი ლითონებისგან დამზადებული გარდა); თამბაქოს ქისები; სანთებლები (მვირფასი ლითონებისგან დამზადებული გარდა); ასანთი; ჩიბუხის გასაწმენდი მოწყობილობები; საფერფლეები (მვირფასი ლითონებისგან დამზადებული გარდა); სიგარის ბოლოების საჭრელი სამარჯვეები.

(260) AM 2020 107681 A
(210) AM 107681
(220) 2020 04 01
(731) ქეი თი & ჯი კორპორეიშნ
71, ბეოტკკოტ-გილ, დაედოკ-გუ,
ტეჯონი, კორეის რესპუბლიკა
(740) პავლე მეიფარიანი
(540)

ESSE EXCHANGE M

(591) შავ-თეთრი
(511)
34 – თამბაქო; სიგარეტები; პაპიროსები; სიგარები; ბურნუთი; პაპიროსის, სიგარეტის ქაღალდი; ჩიბუხები; სიგარეტის ფილტრები; პორტსიგარები (მვირფასი ლითონებისგან დამზადებული გარდა); თამბაქოს ქისები; სანთებლები (მვირფასი ლითონებისგან დამზადებული გარდა); ასანთი; ჩიბუხის გასაწმენდი მოწყობილობები; საფერფლეები (მვირფასი ლითონებისგან დამზადებული გარდა); სიგარის ბოლოების საჭრელი სამარჯვეები.

(260) AM 2020 107682 A
 (210) AM 107682
 (220) 2020 04 01
 (731) ქეი თი & ჯი კორპორეიშნ
 71, ბეოტკკოტ-გილ, დაედოკ-გუ,
 ტეჯონი, კორეის რესპუბლიკა
 (740) პავლე მეიფარიანი
 (540)

ESSE EXCHANGE S

(591) შავ-თეთრი
 (511)
 34 – თამბაქო; სიგარეტები; პაპიროსები; სიგარე-
 ბი; ზურნუთი; პაპიროსის, სიგარეტის ქაღალ-
 დი; ჩიბუხები; სიგარეტის ფილტრები; პორტსი-
 გარები (მვირფასი ლითონებისგან დამზადე-
 ბულის გარდა); თამბაქოს ქისები; სანთებლები
 (მვირფასი ლითონებისგან დამზადებული
 გარდა); ასანთი; ჩიბუხის გასაწმენდი მოწყობი-
 ლობები; საფერფლეები (მვირფასი ლითონე-
 ბისგან დამზადებული გარდა); სიგარის ბო-
 ლოების საჭრელი სამარჯვეები.

(260) AM 2020 107683 A
 (210) AM 107683
 (220) 2020 04 01
 (731) ქეი თი & ჯი კორპორეიშნ
 71, ბეოტკკოტ-გილ, დაედოკ-გუ,
 ტეჯონი, კორეის რესპუბლიკა
 (740) პავლე მეიფარიანი
 (540)

ESSE SPECIAL CRYSTAL

(591) შავ-თეთრი
 (511)
 34 – თამბაქო; სიგარეტები; პაპიროსები; სიგარე-
 ბი; ზურნუთი; პაპიროსის, სიგარეტის ქაღალ-
 დი; ჩიბუხები; სიგარეტის ფილტრები; პორტსი-
 გარები (მვირფასი ლითონებისგან დამზადე-
 ბულის გარდა); თამბაქოს ქისები; სანთებლები
 (მვირფასი ლითონებისგან დამზადებული
 გარდა); ასანთი; ჩიბუხის გასაწმენდი მოწყობი-
 ლობები; საფერფლეები (მვირფასი ლითონე-
 ბისგან დამზადებული გარდა); სიგარის ბო-
 ლოების საჭრელი სამარჯვეები.

(260) AM 2020 107684 A
 (210) AM 107684
 (220) 2020 04 02
 (731) შპს „ინი გრუპი“
 კოსტავას ქ. 76, ბ. 9ა, 0171, თბილისი,
 საქართველო

(540)
აჰ ტურფავ ტურფავ
ah turfav turfav

(591) შავ-თეთრი
 (511)
 43 – საკვებით და სასმელებით უზრუნველ-
 ყოფა; დროებითი საცხოვრებელი უზრუნველ-
 ყოფა.

(260) AM 2020 107807 A
 (210) AM 107807
 (220) 2020 04 07
 (310) 2019 01760
 (320) 2019 10 10
 (330) AZ
 (731) რემეტსმა სიგარეტენფაბრიკენ გმზჰ
 მაქს-ბორნ-შტრასე 4, ჰამბურგი, 22761,
 გერმანია
 (740) გიორგი ღვინჯილია
 (540)

FOCUS

(591) შავ-თეთრი
 (511)
 34 – თამბაქო დამუშავებული და დაუმუშავებე-
 ლი; თამბაქოს პროდუქტები; არასამედიცინო
 და არასამკურნალო დანიშნულების თამბაქოს
 შემცველები; სიგარეტები; სიგარილოები;
 სიგარები; ხელით სიგარეტის დასამზადებელი
 მანქანები; მილები სიგარეტებისათვის; სიგარე-
 ტების ფილტრები; სიგარეტის ქაღალდი; ელექ-
 ტრო სიგარეტები; სითხეები ელექტრო სიგარე-
 ტებისათვის; ასანთი და მწვევლთა საკუთნო.

(260) AM 2020 107815 A
 (210) AM 107815
 (220) 2020 04 08
 (731) შპს „მრკტ.კომ“
 გიორგი ათონელის ქ. 31, მთაწმინდის
 რაიონი, 0108, თბილისი, საქართველო
 (540)

MRKT
მრკტ

(591) შავ-თეთრი
 (511)
 9 – სამეცნიერო, კვლევითი, სანავიგაციო, ფო-
 ტოგრაფიული, კინემატოგრაფიული, აუდიო-
 ვიზუალური, ოპტიკური, ამწონი, გამზომი,

სასიგნალო, აღმომჩენი, საკონტროლო, დასაკვირვებელი, სამაშველო და სასწავლო ხელსაწყოები და ინსტრუმენტები; დენის გადაცემის, განაწილების, გარდაქმნის, დაგროვების, რეგულირების ან მართვის ხელსაწყოები და ინსტრუმენტები; ხმის ან გამოსახულების ჩამწერი, გადამცემი და აღმწარმოებელი აპარატურა; ჩაწერილი და ჩამოსატვირთი მედია, კომპიუტერული პროგრამები, ციფრული ბეჭდვის ან მსგავსი ჩასაწერი და შესანახი მედია; მექანიზმები მონეტებზე მომუშავე აპარატებისთვის; სალაროს აპარატები, საანგარიშო მანქანები, კომპიუტერები და კომპიუტერის პერიფერიული მოწყობილობები; მყვინთავის სამოსი, მყვინთავის ნიღბები, მყვინთავის ყურსაცობები, ცხვირის სამაგრები მყვინთავებისა და მოცურავეებისთვის, მყვინთავის ხელთათმანები, სასუნთქი აპარატურა წყალქვეშა ცურვისთვის; ცეცხლმქრობი აპარატები.

35 – რეკლამა; ბიზნეს მენეჯმენტი; ბიზნესის ადმინისტრირება; საოფისე სამსახური.

39 – ტრანსპორტირება; საქონლის შეფუთვა და შენახვა; მოგზაურობის ორგანიზება.

42 – სამეცნიერო და ტექნოლოგიური მომსახურება და მათ მიკუთვნებული სამეცნიერო კვლევები და ნაშრომები; სამრეწველო ანალიზისა და სამეცნიერო კვლევასთან დაკავშირებული მომსახურება; კომპიუტერების ტექნიკური და პროგრამული უზრუნველყოფის დამუშავება და განვითარება.

(260) AM 2020 107818 A
 (210) AM 107818
 (220) 2020 04 08
 (731) შპს „ბარაქა“
 პეტრე ქავთარაძის ქ., III შესახ. 4, ბ. 43,
 ვაკის რაიონი, თბილისი, საქართველო
 (740) თამარ ხარაზიშვილი
 (540)

მაჩეტე Machete

(591) შავ-თეთრი
 (511)
 5 – ფარმაცევტული და ვეტერინარული პრეპარატები; სამედიცინო დანიშნულების ჰიგიენური პრეპარატები; სამედიცინო ან ვეტერინარული დანიშნულების დიეტური საკვები და ნივთიერებები, ბავშვთა საკვები; დიეტური

დანამატები ადამიანებისა და ცხოველებისათვის; სალბუნები, სახვევი მასალა; კბილის დასაბუნენი და კბილის ცვილი; მადეზინფიცირებელი საშუალებები; მავნე ცხოველების გასანადგურებელი პრეპარატები; ფუნგიციდები, ჰერბიციდები, მათ შორის, და არა მხოლოდ; ბაქტერიული შხამები; ბაქტერიციდები; ბიოლოგიური პრეპარატები ვეტერინარული მიზნებისათვის; ბიოციდები; ვირთავების საწამლავი; ვეტერინარული პრეპარატები; თავგების გასანადგურებელი პრეპარატები; ინსექტიციდები; მავნე მცენარეების გასანადგურებელი პრეპარატები; მწერების გასაღვნი შესახრჩოლებლები; ნიადაგის სტერილიზაციის პრეპარატები; პარაზიტების გასანადგურებელი პრეპარატები; პესტიციდები; სპოროფანების საწინააღმდეგო პრეპარატები.

(260) AM 2020 107819 A
 (210) AM 107819
 (220) 2020 04 08
 (731) შპს „ბარაქა“
 პეტრე ქავთარაძის ქ., III შესახ. 4, ბ. 43,
 ვაკის რაიონი, თბილისი, საქართველო
 (740) თამარ ხარაზიშვილი
 (540)

რედ ჰალკი Red Hulk

(591) შავ-თეთრი
 (511)
 5 – ფარმაცევტული და ვეტერინარული პრეპარატები; სამედიცინო დანიშნულების ჰიგიენური პრეპარატები; სამედიცინო ან ვეტერინარული დანიშნულების დიეტური საკვები და ნივთიერებები, ბავშვთა საკვები; დიეტური დანამატები ადამიანებისა და ცხოველებისათვის; სალბუნები, სახვევი მასალა; კბილის დასაბუნენი და კბილის ცვილი; მადეზინფიცირებელი საშუალებები; მავნე ცხოველების გასანადგურებელი პრეპარატები; ფუნგიციდები, ჰერბიციდები, მათ შორის და არა მხოლოდ; ბაქტერიული შხამები; ბაქტერიციდები; ბიოლოგიური პრეპარატები ვეტერინარული მიზნებისათვის; ბიოციდები; ვირთავების საწამლავი; ვეტერინარული პრეპარატები; თავგების გასანადგურებელი პრეპარატები; ინსექტიციდები; მავნე მცენარეების გასანადგურებელი პრეპარატები; მწერების გასაღვნი შესახრჩოლებლები; ნიადაგის სტერილიზაციის პრეპარა-

რებელი საშუალებები; მავნე ცხოველების გასანადგურებელი პრეპარატები; ფუნგიციდები, ჰერბიციდები, მათ შორის, და არამხოლოდ; ბაქტერიული შხამები; ბაქტერიციდები; ბიოლოგიური პრეპარატები ვეტერინარული მიზნებისათვის; ბიოციდები; ვირთაგვების საწამლავი; ვეტერინარული პრეპარატები; თაგვების გასანადგურებელი პრეპარატები; ინსექტიციდები; მავნე მცენარეების გასანადგურებელი პრეპარატები; მწერების გასადევნი შესახრჩოლებლები; ნიადაგის სტერილიზაციის პრეპარატები; პარაზიტების გასანადგურებელი პრეპარატები; პესტიციდები; სპოროვანების საწინააღმდეგო პრეპარატები.

(260) AM 2020 107832 A
 (210) AM 107832
 (220) 2020 04 09
 (731) შპს „ბარაქა“
 პეტრე ქავთარაძის ქ., III შესახ. 4, ბ. 43,
 ვაკის რაიონი, თბილისი,
 საქართველო
 (740) თამარ ხარაზიშვილი
 (540)

დრიბლინგი Dribbling

(591) შავ-თეთრი
 (511)
 5 – ფარმაცევტული და ვეტერინარული პრეპარატები; სამედიცინო დანიშნულების ჰიგიენური პრეპარატები; სამედიცინო ან ვეტერინარული დანიშნულების დიეტური საკვები და ნივთიერებები, ბავშვთა საკვები; დიეტური დანამატები ადამიანებისა და ცხოველებისათვის; სალბუნები, სახვევი მასალა; კბილის დასაბჟენი და კბილის ცვილი; მადეზინფიცირებელი საშუალებები; მავნე ცხოველების გასანადგურებელი პრეპარატები; ფუნგიციდები, ჰერბიციდები, მათ შორის, და არამხოლოდ; ბაქტერიული შხამები; ბაქტერიციდები; ბიოლოგიური პრეპარატები ვეტერინარული მიზნებისათვის; ბიოციდები; ვირთაგვების საწამლავი; ვეტერინარული პრეპარატები; თაგვების გასანადგურებელი პრეპარატები; ინსექტიციდები; მავნე მცენარეების გასანადგურებელი პრეპარატები; მწერების გასადევნი შესახრჩოლებლები; ნიადაგის სტერილიზაციის პრეპარატები; პარაზიტების გასანადგურებელი პრეპარატები; პესტიციდები; სპოროვანების საწინააღმდეგო პრეპარატები.

რატები; პესტიციდები; სპოროვანების საწინააღმდეგო პრეპარატები.

(260) AM 2020 107833 A
 (210) AM 107833
 (220) 2020 04 09
 (731) შპს „ბარაქა“
 პეტრე ქავთარაძის ქ., III შესახ. 4, ბ. 43,
 ვაკის რაიონი, თბილისი, საქართველო
 (740) თამარ ხარაზიშვილი
 (540)

ბარონი Baron

(591) შავ-თეთრი
 (511)
 5 – ფარმაცევტული და ვეტერინარული პრეპარატები; სამედიცინო დანიშნულების ჰიგიენური პრეპარატები; სამედიცინო ან ვეტერინარული დანიშნულების დიეტური საკვები და ნივთიერებები, ბავშვთა საკვები; დიეტური დანამატები ადამიანებისა და ცხოველებისათვის; სალბუნები, სახვევი მასალა; კბილის დასაბჟენი და კბილის ცვილი; მადეზინფიცირებელი საშუალებები; მავნე ცხოველების გასანადგურებელი პრეპარატები; ფუნგიციდები, ჰერბიციდები, მათ შორის, და არამხოლოდ; ბაქტერიული შხამები; ბაქტერიციდები; ბიოლოგიური პრეპარატები ვეტერინარული მიზნებისათვის; ბიოციდები; ვირთაგვების საწამლავი; ვეტერინარული პრეპარატები; თაგვების გასანადგურებელი პრეპარატები; ინსექტიციდები; მავნე მცენარეების გასანადგურებელი პრეპარატები; მწერების გასადევნი შესახრჩოლებლები; ნიადაგის სტერილიზაციის პრეპარატები; პარაზიტების გასანადგურებელი პრეპარატები; პესტიციდები; სპოროვანების საწინააღმდეგო პრეპარატები.

(260) AM 2020 107887 A
 (210) AM 107887
 (220) 2020 04 10
 (731) ტოიოტა ჯიდოშა კაბუშიკი კაიშა
 (მოვაჭრე, როგორც ტოიოტა მოტორ
 კორპორეიშენ)
 1, ტოიოტა-ჩო, ტოიოტა-ში, აიჩი-კენ,
 იაპონია
 (740) თამარ კოჭლამაზაშვილი

(540)

NX350

(591) შავ-თეთრი

(511)

12 – ავტომობილები და მათი ნაწილები, კონსტრუქციის ელემენტები, მათთვის განკუთვნილი მზიდი ნაწილები.

(260) AM 2020 107892 A

(210) AM 107892

(220) 2020 04 12

(731) შპს „ბარაქა“

პეტრე ქავთარაძის ქ., III შესახ. 4, ბ. 43, ვაკის რაიონი, თბილისი, საქართველო

(740) თამარ ხარაზიშვილი

(540)

გორილა Gorilla

(591) შავ-თეთრი

(511)

5 – ფარმაცევტული და ვეტერინარული პრეპარატები; სამედიცინო დანიშნულების ჰიგიენური პრეპარატები; სამედიცინო ან ვეტერინარული დანიშნულების დიეტური საკვები და ნივთიერებები, ბავშვთა საკვები; დიეტური დანამატები ადამიანებისა და ცხოველებისათვის; სალბუნები, სახვევი მასალა; კბილის დასაბუნენი და კბილის ცვილი; მადეზინფიცირებელი საშუალებები; მავნე ცხოველების გასანადგურებელი პრეპარატები; ფუნგიციდები, ჰერბიციდები, მათ შორის, და არამხოლოდ; ბაქტერიული შხამები; ბაქტერიციდები; ბიოლოგიური პრეპარატები ვეტერინარული მიზნებისათვის; ბიოციდები; ვირთაგვების საწამლავი; ვეტერინარული პრეპარატები; თაგვების გასანადგურებელი პრეპარატები; ინსექტიციდები; მავნე მცენარეების გასანადგურებელი პრეპარატები; მწერების გასადევნი შესახრჩოლებლები; ნიადაგის სტერილიზაციის პრეპარატები; პარაზიტების გასანადგურებელი პრეპარატები; პესტიციდები; სპოროვანების საწინააღმდეგო პრეპარატები.

(260) AM 2020 107893 A

(210) AM 107893

(220) 2020 04 12

(731) შპს „ბარაქა“

პეტრე ქავთარაძის ქ., III შესახ. 4, ბ. 43, ვაკის რაიონი, თბილისი, საქართველო

(740) თამარ ხარაზიშვილი

(540)

პირატი Pyrate

(591) შავ-თეთრი

(511)

5 – ფარმაცევტული და ვეტერინარული პრეპარატები; სამედიცინო დანიშნულების ჰიგიენური პრეპარატები; სამედიცინო ან ვეტერინარული დანიშნულების დიეტური საკვები და ნივთიერებები, ბავშვთა საკვები; დიეტური დანამატები ადამიანებისა და ცხოველებისათვის; სალბუნები, სახვევი მასალა; კბილის დასაბუნენი და კბილის ცვილი; მადეზინფიცირებელი საშუალებები; მავნე ცხოველების გასანადგურებელი პრეპარატები; ფუნგიციდები, ჰერბიციდები, მათ შორის, და არამხოლოდ; ბაქტერიული შხამები; ბაქტერიციდები; ბიოლოგიური პრეპარატები ვეტერინარული მიზნებისათვის; ბიოციდები; ვირთაგვების საწამლავი; ვეტერინარული პრეპარატები; თაგვების გასანადგურებელი პრეპარატები; ინსექტიციდები; მავნე მცენარეების გასანადგურებელი პრეპარატები; მწერების გასადევნი შესახრჩოლებლები; ნიადაგის სტერილიზაციის პრეპარატები; პარაზიტების გასანადგურებელი პრეპარატები; პესტიციდები; სპოროვანების საწინააღმდეგო პრეპარატები.

(260) AM 2020 107894 A

(210) AM 107894

(220) 2020 04 12

(731) შპს „ბარაქა“

პეტრე ქავთარაძის ქ., III შესახ. 4, ბ. 43, ვაკის რაიონი, თბილისი, საქართველო

(740) თამარ ხარაზიშვილი

(540)

თორი Thor

(591) შავ-თეთრი

(511)

5 – ფარმაცევტული და ვეტერინარული პრეპარატები; სამედიცინო დანიშნულების ჰიგიენური პრეპარატები; სამედიცინო ან ვეტერინარული დანიშნულების დიეტური საკვები და

ნივთიერებები, ბავშვთა საკვები; დიეტური დანამატები ადამიანებისა და ცხოველებისათვის; სალბუნები, სახვევი მასალა; კბილის დასაბუნები და კბილის ცვილი; მადეზინფიცირებელი საშუალებები; მავნე ცხოველების გასანადგურებელი პრეპარატები; ფუნგიციდები, ჰერბიციდები, მათ შორის, და არამხოლოდ; ბაქტერიული შხამები; ბაქტერიციდები; ბიოლოგიური პრეპარატები ვეტერინარული მიზნებისათვის; ბიოციდები; ვირთაგვების საწამლავი; ვეტერინარული პრეპარატები; თავგების გასანადგურებელი პრეპარატები; ინსექტიციდები; მავნე მცენარეების გასანადგურებელი პრეპარატები; მწერების გასადევნი შესახროლებლები; ნიადაგის სტერილიზაციის პრეპარატები; პარაზიტების გასანადგურებელი პრეპარატები; პესტიციდები; სპოროვანების საწინააღმდეგო პრეპარატები.

(260) AM 2020 107895 A

(210) AM 107895

(220) 2020 04 12

(731) შპს „ბარაქა“

პეტრე ქავთარაძის III შესახ. 4, ბ. 43, ვაკის რაიონი, თბილისი, საქართველო

(740) თამარ ხარაზიშვილი

(540)

სეკრეტი Secret

(591) შავ-თეთრი

(511)

5 – ფარმაცევტული და ვეტერინარული პრეპარატები; სამედიცინო დანიშნულების ჰიგიენური პრეპარატები; სამედიცინო ან ვეტერინარული დანიშნულების დიეტური საკვები და ნივთიერებები, ბავშვთა საკვები; დიეტური დანამატები ადამიანებისა და ცხოველებისათვის; სალბუნები, სახვევი მასალა; კბილის დასაბუნები და კბილის ცვილი; მადეზინფიცირებელი საშუალებები; მავნე ცხოველების გასანადგურებელი პრეპარატები; ფუნგიციდები, ჰერბიციდები, მათ შორის, და არამხოლოდ; ბაქტერიული შხამები; ბაქტერიციდები; ბიოლოგიური პრეპარატები ვეტერინარული მიზნებისათვის; ბიოციდები; ვირთაგვების საწამლავი; ვეტერინარული პრეპარატები; თავგების გასანადგურებელი პრეპარატები; ინსექტიციდები; მავნე მცენარეების გასანადგურებელი პრეპარატები; მწერების გასადევნი შესახროლებლები; ნიადაგის სტერილიზაციის პრეპარატები;

ტები; პარაზიტების გასანადგურებელი პრეპარატები; პესტიციდები; სპოროვანების საწინააღმდეგო პრეპარატები.

260) AM 2020 107896 A

(210) AM 107896

(220) 2020 04 12

(731) შპს „ბარაქა“

პეტრე ქავთარაძის ქ., III შესახ. 4, ბ. 43, ვაკის რაიონი, თბილისი, საქართველო

(740) თამარ ხარაზიშვილი

(540)

ამინოზი Aminoz

(591) შავ-თეთრი

(511)

5 – ბაქტერიული შხამები; ბაქტერიციდები; ბიოციდები; ვირთაგვების საწამლავი; თავგების გასანადგურებელი პრეპარატები; ინსექტიციდები; მავნე მცენარეების გასანადგურებელი პრეპარატები; მწერების გასადევნი შესახროლებლები; ნიადაგის სტერილიზაციის პრეპარატები; პარაზიტების გასანადგურებელი პრეპარატები; პესტიციდები;

(260) AM 2020 107897 A

(210) AM 107897

(220) 2020 04 12

(731) შპს „ბარაქა“

პეტრე ქავთარაძის ქ., III შესახ. 4, ბ. 43, ვაკის რაიონი, თბილისი, საქართველო

(740) თამარ ხარაზიშვილი

(540)

კუპრექსი

(591) შავ-თეთრი

(511)

5 – ფარმაცევტული და ვეტერინარული პრეპარატები; სამედიცინო დანიშნულების ჰიგიენური პრეპარატები; სამედიცინო ან ვეტერინარული დანიშნულების დიეტური საკვები და ნივთიერებები, ბავშვთა საკვები; დიეტური დანამატები ადამიანებისა და ცხოველებისათვის; სალბუნები, სახვევი მასალა; კბილის დასაბუნები და კბილის ცვილი; მადეზინფიცირებელი საშუალებები; მავნე ცხოველების გასანადგურებელი პრეპარატები; ფუნგიციდები, ჰერბიციდები, მათ შორის, და არამხოლოდ; ბაქტერიული შხამები; ბაქტერიციდები; ბიო-

ლოგიური პრეპარატები ვეტერინარული მიზნებისათვის; ბიოციდები; ვირთაგვების საწამლავი; ვეტერინარული პრეპარატები; თავგების გასანადგურებელი პრეპარატები; ინსექტიციდები; მავნე მცენარეების გასანადგურებელი პრეპარატები; მწერების გასადევნი შესახროლებლები; ნიადაგის სტერილიზაციის პრეპარატები; პარაზიტების გასანადგურებელი პრეპარატები; პესტიციდები; სპოროვანების საწინააღმდეგო პრეპარატები.

(260) AM 2020 107898 A
(210) AM 107898
(220) 2020 04 12
(731) შპს „ბარაქა“
პეტრე ქავთარაძის ქ., III შესახ. 4, ბ. 43,
ვაკის რაიონი, თბილისი, საქართველო
(740) თამარ ხარაზიშვილი
(540)

ბომბა Bomb

(591) შავ-თეთრი
(511)
5 – ფარმაცევტული და ვეტერინარული პრეპარატები; სამედიცინო დანიშნულების ჰიგიენური პრეპარატები; სამედიცინო ან ვეტერინარული დანიშნულების დიეტური საკვები და ნივთიერებები, ბავშვთა საკვები; დიეტური დანამატები ადამიანებისა და ცხოველებისათვის; სალბუნები, სახვევი მასალა; კბილის დასაბჟენი და კბილის ცვილი; მადეზინფიცირებელი საშუალებები; მავნე ცხოველების გასანადგურებელი პრეპარატები; ფუნგიციდები, ჰერბიციდები, მათ შორის, და არამხოლოდ; ბაქტერიული შხამები; ბაქტერიციდები; ბიოლოგიური პრეპარატები ვეტერინარული მიზნებისათვის; ბიოციდები; ვირთაგვების საწამლავი; ვეტერინარული პრეპარატები; თავგების გასანადგურებელი პრეპარატები; ინსექტიციდები; მავნე მცენარეების გასანადგურებელი პრეპარატები; მწერების გასადევნი შესახროლებლები; ნიადაგის სტერილიზაციის პრეპარატები; პარაზიტების გასანადგურებელი პრეპარატები; პესტიციდები; სპოროვანების საწინააღმდეგო პრეპარატები.

(260) AM 2020 107899 A
(210) AM 107899
(220) 2020 04 12
(731) შპს „ბარაქა“
პეტრე ქავთარაძის ქ., III შესახ. 4, ბ. 43,
ვაკის რაიონი, თბილისი, საქართველო
(740) თამარ ხარაზიშვილი
(540)

პანდორა Pandora

(591) შავ-თეთრი
(511)
5 – ფარმაცევტული და ვეტერინარული პრეპარატები; სამედიცინო დანიშნულების ჰიგიენური პრეპარატები; სამედიცინო ან ვეტერინარული დანიშნულების დიეტური საკვები და ნივთიერებები, ბავშვთა საკვები; დიეტური დანამატები ადამიანებისა და ცხოველებისათვის; სალბუნები, სახვევი მასალა; კბილის დასაბჟენი და კბილის ცვილი; მადეზინფიცირებელი საშუალებები; მავნე ცხოველების გასანადგურებელი პრეპარატები; ფუნგიციდები, ჰერბიციდები, მათ შორის, და არამხოლოდ; ბაქტერიული შხამები; ბაქტერიციდები; ბიოლოგიური პრეპარატები ვეტერინარული მიზნებისათვის; ბიოციდები; ვირთაგვების საწამლავი; ვეტერინარული პრეპარატები; თავგების გასანადგურებელი პრეპარატები; ინსექტიციდები; მავნე მცენარეების გასანადგურებელი პრეპარატები; მწერების გასადევნი შესახროლებლები; ნიადაგის სტერილიზაციის პრეპარატები; პარაზიტების გასანადგურებელი პრეპარატები; პესტიციდები; სპოროვანების საწინააღმდეგო პრეპარატები.

(260) AM 2020 107900 A
(210) AM 107900
(220) 2020 04 12
(731) შპს „ბარაქა“
პეტრე ქავთარაძის ქ., III შესახ. 4, ბ. 43,
ვაკის რაიონი, თბილისი, საქართველო
(740) თამარ ხარაზიშვილი
(540)

ვუპერი Wooper

(591) შავ-თეთრი

(511)

5 – ფარმაცევტული და ვეტერინარული პრეპარატები; სამედიცინო დანიშნულების ჰიგიენური პრეპარატები; სამედიცინო ან ვეტერინარული დანიშნულების დიეტური საკვები და ნივთიერებები, ბავშვთა საკვები; დიეტური დანამატები ადამიანებისა და ცხოველებისათვის; სალბუნები, სახვევი მასალა; კბილის დასაბუნები და კბილის ცვილი; მადეზინფიცირებელი საშუალებები; მავნე ცხოველების გასანადგურებელი პრეპარატები; ფუნგიციდები, ჰერბიციდები, მათ შორის, და არამხოლოდ; ბაქტერიული შხამები; ბაქტერიციდები; ბიოლოგიური პრეპარატები ვეტერინარული მიზნებისათვის; ბიოციდები; ვირთაგვების საწამლავი; ვეტერინარული პრეპარატები; თავგების გასანადგურებელი პრეპარატები; ინსექტიციდები; მავნე მცენარეების გასანადგურებელი პრეპარატები; მწერების გასაღვნი შესახრჩოლებლები; ნიადაგის სტერილიზაციის პრეპარატები; პარაზიტების გასანადგურებელი პრეპარატები; პესტიციდები; სპოროვანების საწინააღმდეგო პრეპარატები.

(260) AM 2020 107901 A

(210) AM 107901

(220) 2020 04 12

(731) შპს „ბარაქა“

პეტრე ქავთარაძის ქ., III შესახ. 4, ბ. 43, ვაკის რაიონი, თბილისი, საქართველო

(740) თამარ ხარაზიშვილი

(540)

პიროელექტრა Pyroelectra

(591) შავ-თეთრი

(511)

5 – ფარმაცევტული და ვეტერინარული პრეპარატები; სამედიცინო დანიშნულების ჰიგიენური პრეპარატები; სამედიცინო ან ვეტერინარული დანიშნულების დიეტური საკვები და ნივთიერებები, ბავშვთა საკვები; დიეტური დანამატები ადამიანებისა და ცხოველებისათვის; სალბუნები, სახვევი მასალა; კბილის დასაბუნები და კბილის ცვილი; მადეზინფიცირებელი საშუალებები; მავნე ცხოველების გასანადგურებელი პრეპარატები; ფუნგიციდები, ჰერბიციდები, მათ შორის, და არამხოლოდ; ბაქტერიული შხამები; ბაქტერიციდები; ბიოლოგიური პრეპარატები ვეტერინარული მიზნებისათვის; ბიოციდები; ვირთაგვების საწამ-

ლავი; ვეტერინარული პრეპარატები; თავგების გასანადგურებელი პრეპარატები; ინსექტიციდები; მავნე მცენარეების გასანადგურებელი პრეპარატები; მწერების გასაღვნი შესახრჩოლებლები; ნიადაგის სტერილიზაციის პრეპარატები; პარაზიტების გასანადგურებელი პრეპარატები; პესტიციდები; სპოროვანების საწინააღმდეგო პრეპარატები.

(260) AM 2020 107902 A**

(210) AM 107902

(220) 2020 04 12

(731) შპს „ბარაქა“

პეტრე ქავთარაძის ქ., III შესახ. 4, ბ. 43, ვაკის რაიონი, თბილისი, საქართველო

(740) თამარ ხარაზიშვილი

(540)

ბარნელაცილი Barnelaceli

(591) შავ-თეთრი

(511)

5 – ფარმაცევტული და ვეტერინარული პრეპარატები; სამედიცინო ან ვეტერინარული დანიშნულების დიეტური საკვები და ნივთიერებები, ბავშვთა საკვები; დიეტური დანამატები ადამიანებისა და ცხოველებისათვის; სალბუნები, სახვევი მასალა; კბილის დასაბუნები და კბილის ცვილი; მადეზინფიცირებელი საშუალებები; მავნე ცხოველების გასანადგურებელი პრეპარატები; ფუნგიციდები, ჰერბიციდები, მათ შორის, და არამხოლოდ; ბაქტერიული შხამები; ბაქტერიციდები; ბიოლოგიური პრეპარატები ვეტერინარული მიზნებისათვის; ბიოციდები; ვირთაგვების საწამლავი; ვეტერინარული პრეპარატები; თავგების გასანადგურებელი პრეპარატები; ინსექტიციდები; მავნე მცენარეების გასანადგურებელი პრეპარატები; მწერების გასაღვნი შესახრჩოლებლები; ნიადაგის სტერილიზაციის პრეპარატები; პარაზიტების გასანადგურებელი პრეპარატები; პესტიციდები; სპოროვანების საწინააღმდეგო პრეპარატები.

(260) AM 2020 107903 A

(210) AM 107903

(220) 2020 04 12

(731) შპს „ბარაქა“

პეტრე ქავთარაძის ქ., III შესახ. 4, ბ. 43, ვაკის რაიონი, თბილისი, საქართველო

(260) AM 2020 107906 A
 (210) AM 107906
 (220) 2020 04 12
 (731) შპს „ბარაქა“
 პეტრე ქავთარაძის ქ., III შესახ. 4, ბ. 43,
 ვაკის რაიონი, თბილისი, საქართველო
 (740) თამარ ხარაზიშვილი
 (540)

ციპრინი
Ciprin

(591) შავ-თეთრი
 (511)
 5 – მავნე ცხოველების გასანადგურებელი პრეპარატები; ჰერბიციდები, მათ შორის და არამხოლოდ: ბაქტერიული შხამები; ბაქტერიციდები; ბიოციდები; ვირთაგვების საწამლავე; თაგვების გასანადგურებელი პრეპარატები; ინსექტიციდები; მავნე მცენარეების გასანადგურებელი პრეპარატები; მწერების გასადევნი შესახრჩოლებლები; ნიადაგის სტერილიზაციის პრეპარატები; პარაზიტების გასანადგურებელი პრეპარატები; პესტიციდები.

(260) AM 2020 107907 A
 (210) AM 107907
 (220) 2020 04 12
 (731) შპს „ბარაქა“
 პეტრე ქავთარაძის ქ., III შესახ. 4, ბ. 43,
 ვაკის რაიონი, თბილისი, საქართველო
 (740) თამარ ხარაზიშვილი
 (540)

კუპერ 88

(591) შავ-თეთრი
 (511)
 5 – მავნე ცხოველების გასანადგურებელი პრეპარატები; ჰერბიციდები, მათ შორის და არამხოლოდ: ბაქტერიული შხამები; ბაქტერიციდები; ბიოციდები; ვირთაგვების საწამლავე; თაგვების გასანადგურებელი პრეპარატები; ინსექტიციდები; მავნე მცენარეების გასანადგურებელი პრეპარატები; მწერების გასადევნი შესახრჩოლებლები; ნიადაგის სტერილიზაციის პრეპარატები; პარაზიტების გასანადგურებელი პრეპარატები; პესტიციდები.

(260) AM 2020 107908 A
 (210) AM 107908
 (220) 2020 04 12

(731) შპს „ბარაქა“
 პეტრე ქავთარაძის ქ., III შესახ. 4, ბ. 43,
 ვაკის რაიონი, თბილისი, საქართველო
 (740) თამარ ხარაზიშვილი
 (540)

კუპრაბლო

(591) შავ-თეთრი
 (511)
 5 – ფარმაცევტული და ვეტერინარული პრეპარატები; სამედიცინო დანიშნულების ჰიგიენური პრეპარატები; სამედიცინო ან ვეტერინარული დანიშნულების დიეტური საკვები და ნივთიერებები, ბავშვთა საკვები; დიეტური დანამატები ადამიანებისა და ცხოველებისათვის; სალბუნები, სახვევი მასალა; კბილის დასაბუნენი და კბილის ცვილი; მადეზინფიცირებელი საშუალებები; მავნე ცხოველების გასანადგურებელი პრეპარატები; ფუნგიციდები, ჰერბიციდები, მათ შორის, და არამხოლოდ; ბაქტერიული შხამები; ბაქტერიციდები; ბიოლოგიური პრეპარატები ვეტერინარული მიზნებისათვის; ბიოციდები; ვირთაგვების საწამლავე; ვეტერინარული პრეპარატები; თაგვების გასანადგურებელი პრეპარატები; ინსექტიციდები; მავნე მცენარეების გასანადგურებელი პრეპარატები; მწერების გასადევნი შესახრჩოლებლები; ნიადაგის სტერილიზაციის პრეპარატები; პარაზიტების გასანადგურებელი პრეპარატები; პესტიციდები; სპოროგანების საწინააღმდეგო პრეპარატები.

(260) AM 2020 107909 A
 (210) AM 107909
 (220) 2020 04 12
 (731) შპს „ბარაქა“
 პეტრე ქავთარაძის ქ., III შესახ. 4, ბ. 43,
 ვაკის რაიონი, თბილისი, საქართველო
 (740) თამარ ხარაზიშვილი
 (540)

ნიქსონი
Nixon

(591) შავ-თეთრი
 (511)
 5 – ფარმაცევტული და ვეტერინარული პრეპარატები; სამედიცინო დანიშნულების ჰიგიენური პრეპარატები; სამედიცინო ან ვეტერინარული დანიშნულების დიეტური საკვები და ნივთიერებები, ბავშვთა საკვები; დიეტური

დანამატები ადამიანებისა და ცხოველებისათვის; სალბუნები, სახვევი მასალა; კბილის და საბჟენი და კბილის ცვილი; მადეზინფიცირებელი საშუალებები; მავნე ცხოველების გასანადგურებელი პრეპარატები; ფუნგიციდები, ჰერბიციდები, მათ შორის, და არამხოლოდ; ბაქტერიული შხამები; ბაქტერიციდები; ბიოლოგიური პრეპარატები ვეტერინარული მიზნებისათვის; ბიოციდები; ვირთაგვების საწამლავი; ვეტერინარული პრეპარატები; თავგების გასანადგურებელი პრეპარატები; ინსექტიციდები; მავნე მცენარეების გასანადგურებელი პრეპარატები; მწერების გასადევნი შესახროლებლები; ნიადაგის სტერილიზაციის პრეპარატები; პარაზიტების გასანადგურებელი პრეპარატები; პესტიციდები; სპოროგანების საწინააღმდეგო პრეპარატები.

(260) AM 2020 107910 A
(210) AM 107910
(220) 2020 04 12
(731) შპს „ბარაქა“
პეტრე ქავთარაძის ქ., III შესახ. 4, ბ. 43,
ვაკის რაიონი, თბილისი, საქართველო
(740) თამარ ხარაზიშვილი
(540)

ფელიქსი Felix

(591) შავ-თეთრი
(511)
5 – ფარმაცევტული და ვეტერინარული პრეპარატები; სამედიცინო დანიშნულების ჰიგიენური პრეპარატები; სამედიცინო ან ვეტერინარული დანიშნულების დიეტური საკვები და ნივთიერებები, ბავშვთა საკვები; დიეტური დანამატები ადამიანებისა და ცხოველებისათვის; სალბუნები, სახვევი მასალა; კბილის და საბჟენი და კბილის ცვილი; მადეზინფიცირებელი საშუალებები; მავნე ცხოველების გასანადგურებელი პრეპარატები; ფუნგიციდები, ჰერბიციდები, მათ შორის, და არამხოლოდ; ბაქტერიული შხამები; ბაქტერიციდები; ბიოლოგიური პრეპარატები ვეტერინარული მიზნებისათვის; ბიოციდები; ვირთაგვების საწამლავი; ვეტერინარული პრეპარატები; თავგების გასანადგურებელი პრეპარატები; ინსექტიციდები; მავნე მცენარეების გასანადგურებელი პრეპარატები; მწერების გასადევნი შესახროლებლები; ნიადაგის სტერილიზაციის პრეპარატები; პარაზიტების გასანადგურებელი პრეპარატები;

რატები; პესტიციდები; სპოროგანების საწინააღმდეგო პრეპარატები.

(260) AM 2020 107911 A
(210) AM 107911
(220) 2020 04 12
(731) შპს „ბარაქა“
პეტრე ქავთარაძის ქ., III შესახ. 4, ბ. 43,
ვაკის რაიონი, თბილისი, საქართველო
(740) თამარ ხარაზიშვილი
(540)

ბოლტრერი Boltrer

(591) შავ-თეთრი
(511)
5 – ფარმაცევტული და ვეტერინარული პრეპარატები; სამედიცინო დანიშნულების ჰიგიენური პრეპარატები; სამედიცინო ან ვეტერინარული დანიშნულების დიეტური საკვები და ნივთიერებები, ბავშვთა საკვები; დიეტური დანამატები ადამიანებისა და ცხოველებისათვის; სალბუნები, სახვევი მასალა; კბილის და საბჟენი და კბილის ცვილი; მადეზინფიცირებელი საშუალებები; მავნე ცხოველების გასანადგურებელი პრეპარატები; ფუნგიციდები, ჰერბიციდები, მათ შორის, და არამხოლოდ; ბაქტერიული შხამები; ბაქტერიციდები; ბიოლოგიური პრეპარატები ვეტერინარული მიზნებისათვის; ბიოციდები; ვირთაგვების საწამლავი; ვეტერინარული პრეპარატები; თავგების გასანადგურებელი პრეპარატები; ინსექტიციდები; მავნე მცენარეების გასანადგურებელი პრეპარატები; მწერების გასადევნი შესახროლებლები; ნიადაგის სტერილიზაციის პრეპარატები; პარაზიტების გასანადგურებელი პრეპარატები; პესტიციდები; სპოროგანების საწინააღმდეგო პრეპარატები.

(260) AM 2020 107913 A
(210) AM 107913
(220) 2020 04 13
(731) ბრანდტ კონსოლიდეტიდ, ინკ.
(დელავერის კორპორაცია)
2935 ს. კუკ მილ როუდ, სპრინგფილდი,
შტატი ილინოისი 62711, აშშ
(740) შალვა გვარამაძე
(540)

TRITEK

(591) შავ-თეთრი
(511)
1 – ადუვანტები (დანამატები) პესტიციდთან ერთად გამოსაყენებლად.

(260) AM 2020 107914 A
(210) AM 107914
(220) 2020 04 13
(731) ბრანდტ კონსოლიდები ინკ.
(დელავერის კორპორაცია)
2935 ს. კუკ მილ როუდ, სპრინგფილდი,
შტატი ილინოისი 62711, აშშ
(740) შალვა გვარამაძე
(540)

UMBRELLA

(591) შავ-თეთრი
(511)
1 – ადუვანტები (დანამატები) პესტიციდთან ერთად გამოსაყენებლად.

(260) AM 2020 107916 A
(210) AM 107916
(220) 2020 04 14
(731) სს „თბილღვინო“
სარაჯიშვილის გამზ. 2, 0153, თბილისი,
საქართველო
(740) გიორგი თაქთაქიშვილი
(540)

ნანათი NANATI

(591) შავ-თეთრი
(531) 27.05.01
(511)
33 – ღვინოები, მათ შორის, სუფრის ღვინო, ცქრიალა ღვინო, შემაგრებული ღვინო, დესერტის ღვინო, ლიქიორი, ბრენდი, არაყი.

(260) AM 2020 107917 A
(210) AM 107917
(220) 2020 04 14
(731) ტოიოტა ჯიდოშა კაბუშიკი კაიშა
(მოვაჭრე, როგორც ტოიოტა მოტორ
კორპორეიშენ)
1, ტოიოტა-ჩო, ტოიოტა-ში, აიჩი-კენ,
იაპონია
(740) თამარ კოჭლამაზაშვილი
(540)

NX350h

(591) შავ-თეთრი
(511)
12 – ავტომობილები და მათი ნაწილები, კონსტრუქციის ელემენტები, მათთვის განკუთვნილი მზიდი ნაწილები.

(260) AM 2020 107918 A
(210) AM 107918
(220) 2020 04 14
(731) საქართველოში INPHA LLP-ის
წარმომადგენლობითი ოფისი
ბესიკის ქ. 4-ის მიმდებარედ, ნაკვეთი
46/10, 0108, თბილისი, საქართველო
(540)

Регермин რეგერმინ Regermin

(591) შავ-თეთრი
(511)
5 – ფარმაცევტული, სამედიცინო და ვეტერინალური პრეპარატები; სამედიცინო დანიშნულების ჰიგიენური პრეპარატები; სამედიცინო ან ვეტერინალური გამოყენებისთვის ვარგისი დიეტური საკვები და ნივთიერებები, საკვები ჩვილებისთვის; დიეტური დანამატები ადამიანებისა და ცხოველებისთვის; ლეიკოპლასტიკი, სახვევი მასალა; კბილების დასამაგრებელი მასალა, სტომატოლოგიური ცვილი; სადენონფექციო საშუალებები; მავნე მწერების გასაწადგურებელი პრეპარატები, ფუნგიციდები, ჰერბიციდები.

(260) AM 2020 107919 A
(210) AM 107919
(220) 2020 04 14
(731) საქართველოში INPHA LLP-ის
წარმომადგენლობითი ოფისი
ბესიკის ქ. 4-ის მიმდებარედ, ნაკვეთი
46/10, 0108, თბილისი, საქართველო
(540)

Мелакид მელაკიდი Melakid

(591) შავ-თეთრი
(511)
5 – ფარმაცევტული, სამედიცინო და ვეტერინალური პრეპარატები; სამედიცინო დანიშნულები

ბის ჰიგიენური პრეპარატები; სამედიცინო ან ვეტერინალური გამოყენებისთვის ვარგისი დიეტური საკვები და ნივთიერებები, საკვები ჩვილებისთვის; დიეტური დანამატები ადამიანებისა და ცხოველებისთვის; ლეიკოპლასტირი, სახვევი მასალა; კბილების დასამაგრებელი მასალა, სტომატოლოგიური ცვილი; სადეზინფექციო საშუალებები; მავნე მწერების გასანადგურებელი პრეპარატები, ფუნგიციდები, ჰერბიციდები.

(260) AM 2020 107920 A

(210) AM 107920

(220) 2020 04 14

(731) საქართველოში INPHA LLP-ის

წარმომადგენლობითი ოფისი

ბესიკის ქ. 4-ის მიმდებარედ, ნაკვეთი

46/10, 0108, თბილისი, საქართველო

(540)

Визофлур
ვიზოფლური
Vizoflur

(591) შავ-თეთრი

(511)

5 – ფარმაცევტული, სამედიცინო და ვეტერინალური პრეპარატები; სამედიცინო დანიშნულების ჰიგიენური პრეპარატები; სამედიცინო ან ვეტერინალური გამოყენებისთვის ვარგისი დიეტური საკვები და ნივთიერებები, საკვები ჩვილებისთვის; დიეტური დანამატები ადამიანებისა და ცხოველებისთვის; ლეიკოპლასტირი, სახვევი მასალა; კბილების დასამაგრებელი მასალა, სტომატოლოგიური ცვილი; სადეზინფექციო საშუალებები; მავნე მწერების გასანადგურებელი პრეპარატები, ფუნგიციდები, ჰერბიციდები.

(260) AM 2020 107921 A

(210) AM 107921

(220) 2020 04 14

(731) საქართველოში INPHA LLP-ის

წარმომადგენლობითი ოფისი

ბესიკის ქ. 4-ის მიმდებარედ, ნაკვეთი

46/10, 0108, თბილისი, საქართველო

(540)

Трибиотик
ტრიბიოტიკი
Tribiotik

(591) შავ-თეთრი

(511)

5 – ფარმაცევტული, სამედიცინო და ვეტერინალური პრეპარატები; სამედიცინო დანიშნულების ჰიგიენური პრეპარატები; სამედიცინო ან ვეტერინალური გამოყენებისთვის ვარგისი დიეტური საკვები და ნივთიერებები, საკვები ჩვილებისთვის; დიეტური დანამატები ადამიანებისა და ცხოველებისთვის; ლეიკოპლასტირი, სახვევი მასალა; კბილების დასამაგრებელი მასალა, სტომატოლოგიური ცვილი; სადეზინფექციო საშუალებები; მავნე მწერების გასანადგურებელი პრეპარატები, ფუნგიციდები, ჰერბიციდები.

(260) AM 2020 107922 A

(210) AM 107922

(220) 2020 04 14

(731) საქართველოში INPHA LLP-ის

წარმომადგენლობითი ოფისი

ბესიკის ქ. 4-ის მიმდებარედ, ნაკვეთი

46/10, 0108, თბილისი, საქართველო

(540)

Флузикол
ფლუზიკოლი
Fluzicol

(591) შავ-თეთრი

(511)

5 – ფარმაცევტული, სამედიცინო და ვეტერინალური პრეპარატები; სამედიცინო დანიშნულების ჰიგიენური პრეპარატები; სამედიცინო ან ვეტერინალური გამოყენებისთვის ვარგისი დიეტური საკვები და ნივთიერებები, საკვები ჩვილებისთვის; დიეტური დანამატები ადამიანებისა და ცხოველებისთვის; ლეიკოპლასტირი, სახვევი მასალა; კბილების დასამაგრებელი მასალა, სტომატოლოგიური ცვილი; სადეზინფექციო საშუალებები; მავნე მწერების გასანადგურებელი პრეპარატები, ფუნგიციდები, ჰერბიციდები.

(260) AM 2020 107930 A

(210) AM 107930

(220) 2020 04 16

(731) გეტე ფარმა ინტერნეშნლ ფზ ელელსი

ოფისი No. 1307, 13 ფლორ, ალ-ტურაია

ტაურ 1, დუბაი მედია სიტი, დუბაი,

არაბთა გაერთიანებული საამიროები

(740) მერაბ კვიციანი

(540)

SILDOSIN

(591) შავ-თეთრი

(531) 27.05.01

(511)

5 – ფარმაცევტული პრეპარატები.

(260) AM 2020 108059 A

(210) AM 108059

(220) 2020 04 24

(731) სს „გეფა“

აკაკი ბელიაშვილის ქ. 142, 0159,
თბილისი, საქართველო

(740) სალომე ჯელაძე

(540)

ელექტროლიტი ბენე**Electrolyte Bene****Электролит Бене**

(591) შავ-თეთრი

(511)

5 – ფარმაცევტული, სამედიცინო და ვეტერინალური პრეპარატები; სამედიცინო დანიშნულების ჰიგიენური პრეპარატები; სამედიცინო ან ვეტერინალური გამოყენებისთვის ვარგისი დიეტური საკვები და ნივთიერებები, საკვები ჩვილებისთვის; დიეტური დანამატები ადამიანებისა და ცხოველებისთვის; ლეიკოპლასტიკი, სახვევი მასალა; კბილების დასამაგრებელი მასალა, სტომატოლოგიური ცვილი; სადეზინფექციო საშუალებები; მავნე მწერების გასანადგურებელი პრეპარატები, ფუნგიციდები, ჰერბიციდები.

რეგისტრირებული სასაქონლო ნიშნები

(111) M 2020 33255 R (151) 2020 10 27 (181) 2030 10 27 (260) AM 2019 102028 A (220) 2019 03 03 (732) სპორტ & ფეშენ მენეჯმენტ პტე. ლტდ. 6 შენტონ ვეი, ოუე დაუნტაუნ 2, N18-11, სინგაპური, 068809, სინგაპური	(111) M 2020 33260 R (151) 2020 10 27 (181) 2030 10 27 (260) AM 2019 104768 A (220) 2019 09 05 (732) შპს „ტეტრადა ჯორჯია“ სტანისლავსკის ქ. 5, 0119, თბილისი, საქართველო
(111) M 2020 33256 R (151) 2020 10 27 (181) 2030 10 27 (260) AM 2019 104091 A (220) 2019 07 16 (732) სვის ფარმა ინტერნეიშენალ აგ ლინდენშტრასე 22, 8008 ციურიხი, შვეიცარია	(111) M 2020 33261 R (151) 2020 10 27 (181) 2030 10 27 (260) AM 2019 104897 A (220) 2019 09 13 (732) ოტკრიტოე აკციონერნოე ობშჩესტვო „კობრინსკი მასლოდელნი- სიროდელნი ზავოდ“ ულ. სოვეტსკაია, 128, 225304, კობრინ, ბრესტსკაია ობლ., ბელარუსი
(111) M 2020 33257 R (151) 2020 10 27 (181) 2030 10 27 (260) AM 2019 104549 A (220) 2019 08 16 (732) შპს „ბერიკა“ ჭავჭავაძის გამზ, შესახ. 1, 6, ბ. 80, 0128, თბილისი, საქართველო	(111) M 2020 33262 R (151) 2020 10 27 (181) 2030 10 27 (260) AM 2019 104940 A (220) 2019 09 19 (732) შპს „ბრიტანულ ქართული აკადემია“ ლეო კვაჭაძის ქ. 17, საბურთალოს რაიონი, თბილისი, საქართველო
(111) M 2020 33258 R (151) 2020 10 27 (181) 2030 10 27 (260) AM 2019 104551 A (220) 2019 08 16 (732) შპს „ბერიკა“ ჭავჭავაძის გამზ, შესახ. 1, 6, ბ. 80, 0128, თბილისი, საქართველო	(111) M 2020 33263 R (151) 2020 10 27 (181) 2030 10 27 (260) AM 2019 105013 A (220) 2019 09 21 (732) ბიოსიდუს ს.ა. კონსტიტუსიონ 4234, ბუენოს-აირესი, არგენტინა
(111) M 2020 33259 R (151) 2020 10 27 (181) 2030 10 27 (260) AM 2019 104767 A (220) 2019 09 05 (732) შპს „ტეტრადა ჯორჯია“ სტანისლავსკის ქ. 5, 0119, თბილისი, საქართველო	(111) M 2020 33264 R (151) 2020 10 27 (181) 2030 10 27 (260) AM 2019 105026 A (220) 2019 09 24 (732) სს „გეფა“

აკაკი ბელიაშვილის ქ. 142, 0159, თბილისი, საქართველო	(111) M 2020 33270 R (151) 2020 10 27 (181) 2030 10 27 (260) AM 2019 105257 A (220) 2019 10 11 (732) ეკატერინე ცხადაძე გურამიშვილის გამზ. 1, ბ. 10, თბილისი, საქართველო; გიორგი ხეჩუაშვილი ზადრი შოშიტაიშვილის ჩიხი 6, ბ. 9, თბილისი, საქართველო
(111) M 2020 33265 R (151) 2020 10 27 (181) 2030 10 27 (260) AM 2019 105033 A (220) 2019 09 25 (732) ქალაქ თბილისის მერია შარტავას ქ. 7, 0160, თბილისი, საქართველო	(111) M 2020 33271 R (151) 2020 10 27 (181) 2030 10 27 (260) AM 2019 105644 A (220) 2019 11 05 (732) შპს „აჭარა ჯგუფი“ კოსტავას ქ. 14, თბილისი, მთაწმინდის რაიონი, საქართველო
(111) M 2020 33266 R (151) 2020 10 27 (181) 2030 10 27 (260) AM 2019 105246 A (220) 2019 10 09 (732) შპს „ალაზანი ვაინერი“ დ. თავდადებულის ქ. 3, 4800, ყვარელი, საქართველო	(111) M 2020 33272 R (151) 2020 10 27 (181) 2030 10 27 (260) AM 2019 105665 A (220) 2019 11 06 (732) შპს „ნექს დეიტა სისტემს“ ზახტრიონის ქ. 41, თბილისი, საქართველო
(111) M 2020 33267 R (151) 2020 10 27 (181) 2030 10 27 (260) AM 2019 105247 A (220) 2019 10 09 (732) შპს „ალაზანი ვაინერი“ დ. თავდადებულის ქ. 3, 4800, ყვარელი, საქართველო	(111) M 2020 33273 R (151) 2020 10 27 (181) 2030 10 27 (260) AM 2019 105740 A (220) 2019 11 08 (732) მგა ენტერტეინმენტ, ინკ. 9220 უინნეტკა ავენიუ, ჩატსუორტ, კალიფორნია, 91311, აშშ
(111) M 2020 33268 R (151) 2020 10 27 (181) 2030 10 27 (260) AM 2019 105248 A (220) 2019 10 09 (732) შპს „ალაზანი ვაინერი“ დ. თავდადებულის ქ. 3, 4800, ყვარელი, საქართველო	(111) M 2020 33274 R (151) 2020 10 27 (181) 2030 10 27 (260) AM 2019 105742 A (220) 2019 11 08 (732) მგა ენტერტეინმენტ, ინკ. 9220 უინნეტკა ავენიუ, ჩატსუორტ, კალიფორნია, 91311, აშშ
(111) M 2020 33269 R (151) 2020 10 27 (181) 2030 10 27 (260) AM 2019 105254 A (220) 2019 10 11 (732) ინტერნეტმენელ ფუდსტაფს კო ლ.ლ.კ საფოსტო ყუთი 4115 შარჯა, არაბთა გაერთიანებული საამიროები	

(111) M 2020 33275 R
 (151) 2020 10 27
 (181) 2030 10 27
 (260) AM 2019 105749 A
 (220) 2019 11 11
 (732) აკციონერნოე ობშჩესტვო „მეჟდუნაროდ-ნი ცენტრ რეპროდუქტივნი მედიცინი“ პროსპექტ კომენდანტსკი, დომ 53, კორპუს 1, ლიტ. ა, პომ. №19 H, გოროდ სანკტ-პეტერბურგი, 197350, რუსეთის ფედერაცია

(111) M 2020 33276 R
 (151) 2020 10 27
 (181) 2030 10 27
 (260) AM 2019 105768 A
 (220) 2019 11 15
 (732) ჰუგო ბოს ტრეიდ მარკ მენეჯმენტ გმბჰ & კო. კზ დიზელშტრასე 12 მეცინგენი 72555, გერმანია

(111) M 2020 33277 R
 (151) 2020 10 27
 (181) 2030 10 27
 (260) AM 2019 105795 A
 (220) 2019 11 18
 (732) აკორ 82 რუ ჰენრი ფარმან, 92130 ისი-ლე-მულინო, საფრანგეთი

(111) M 2020 33278 R
 (151) 2020 10 27
 (181) 2030 10 27
 (260) AM 2019 105807 A
 (220) 2019 11 19
 (732) სსიპ ღვინის ეროვნული სააგენტო მ. გელოვანის გამზ. 6, 0159, თბილისი, საქართველო

(111) M 2020 33279 R
 (151) 2020 10 27
 (181) 2030 10 27
 (260) AM 2019 105811 A
 (220) 2019 11 19
 (732) ლელა გეჯაძე ჟიული შარტავას გამზ. 14, ბ. 72, რუსთავი, საქართველო

(111) M 2020 33280 R
 (151) 2020 10 27
 (181) 2030 10 27
 (260) AM 2019 105819 A
 (220) 2019 11 21
 (732) შპს „კარდენახის ვენახები“ ქუთაისის ქ. 27, ბ. 9, ბათუმი, საქართველო

(111) M 2020 33281 R
 (151) 2020 10 27
 (181) 2030 10 27
 (260) AM 2019 105877 A
 (220) 2019 11 25
 (732) შვედონ ინტელექტუალ პროპერტი ლლკ 6001 ბოლინგერ კანიონ როუდი, სან-რამონი, კალიფორნიის შტატი 94583, აშშ

(111) M 2020 33282 R
 (151) 2020 10 27
 (181) 2030 10 27
 (260) AM 2019 105885 A
 (220) 2019 11 27
 (732) ვესტერნ დიჯიტალ ტექნოლოჯის, ინკ 5601 გრეიტ ოაქს პარკვი სან ხოსე, კალიფორნია, 95119, აშშ

(111) M 2020 33283 R
 (151) 2020 10 27
 (181) 2030 10 27
 (260) AM 2019 105967 A
 (220) 2019 12 02
 (732) სს „ქართული ლუდის კომპანია“ სოფ. საგურამო, 3311, მცხეთის რაიონი, საქართველო

(111) M 2020 33284 R
 (151) 2020 10 27
 (181) 2030 10 27
 (260) AM 2019 105974 A
 (220) 2019 12 03
 (732) შპს „კარიბჭე“ პეტრე ქავთარაძის ქ. 14ბ, ბ. 29, თბილისი, საქართველო

- (111) M 2020 33285 R
 (151) 2020 10 27
 (181) 2030 10 27
 (260) AM 2019 105991 A
 (220) 2019 12 05
 (732) ფილიპ მორის ბრენდზ სარლ
 კე ჟანრენო 3, 2000 ნევმატელი,
 შვეიცარია
-
- (111) M 2020 33286 R
 (151) 2020 10 27
 (181) 2030 10 27
 (260) AM 2019 106043 A
 (220) 2019 12 06
 (732) იუნაიტედ სტეიტს პოლო ესოსიეიშენ
 1400 ცენტრპარკ ბლვდ., სუიტ 200, 33401
 უესტ პალმ ბიჩი, ფლორიდა, აშშ
-
- (111) M 2020 33287 R
 (151) 2020 10 27
 (181) 2030 10 27
 (260) AM 2019 106044 A
 (220) 2019 12 06
 (732) იუნაიტედ სტეიტს პოლო ესოსიეიშენ
 1400 ცენტრპარკ ბლვდ., სუიტ 200, 33401
 უესტ პალმ ბიჩი, ფლორიდა, აშშ
-
- (111) M 2020 33288 R
 (151) 2020 10 27
 (181) 2030 10 27
 (260) AM 2019 106167 A
 (220) 2019 12 16
 (732) ფილიპ მორის პროდაქტს ს. ა.
 კე ჟანრენო 3, 2000 ნევმატელი,
 შვეიცარია
-
- (111) M 2020 33289 R
 (151) 2020 10 27
 (181) 2030 10 27
 (260) AM 2019 106183 A
 (220) 2019 12 18
 (732) სთეით ატომიკ ენერჯი კორპორეიშენ
 „როსატომი“
 119017, მოსკოვი, ბოლშაია ორდინკა
 სთრით 24, რუსეთის ფედერაცია
-
- (111) M 2020 33290 R
 (151) 2020 10 27
 (181) 2030 10 27
 (260) AM 2019 106184 A
 (220) 2019 12 18
 (732) სთეით ატომიკ ენერჯი კორპორეიშენ
 „როსატომი“
 119017, მოსკოვი, ბოლშაია ორდინკა
 სთრით 24, რუსეთის ფედერაცია
-
- (111) M 2020 33291 R
 (151) 2020 10 27
 (181) 2030 10 27
 (260) AM 2019 106320 A
 (220) 2019 12 25
 (732) შპს „სვი“
 კოსტავას ქ. 75, ბ. 31, 0171, თბილისი,
 საქართველო
-

დაჩქარებული პროცედურით რეგისტრირებული სასაქონლო ნიშნები

რეგისტრაციის გაუქმების მოთხოვნით საჩივრის შეტანა შესაძლებელია საქპატენტის სააპელაციო პალატაში გამოქვეყნებიდან 3 თვის ვადაში.

(111) M 2020 33250 R

(151) 2020 10 20

(181) 2030 10 20

(210) AM 110046

(220) 2020 10 08

(732) შპს „პრავდაქარ“

უზნაძის ქ. 111, ბ. 11, შენობა 2, თბილისი, საქართველო

(540)

pravdacar

(591) შავ-თეთრი

(511)

35 – რეკლამა; ბიზნესის მართვა; ბიზნესის ადმინისტრირება; საოფისე მომსახურება.

(111) M 2020 33251 R

(151) 2020 10 21

(181) 2030 10 21

(210) AM 110136

(220) 2020 10 15

(732) შპს „ჯიქეი ვაინერი“

სოფ. ნუკრიანი, სიღნაღის მუნიციპალიტეტი, საქართველო

(740) მარიამ ელიზბარაშვილი

(540)

დერგი dergi

(591) შავ-თეთრი

(511)

33 – ალკოჰოლური სასმელები, ლუდის გარდა; ალკოჰოლური შედგენილობები სასმელების დასამზადებლად.

43 – საკვებით და სასმელით უზრუნველყოფა; დროებითი საცხოვრებელი უზრუნველყოფა.

(111) M 2020 33252 R

(151) 2020 10 21

(181) 2030 10 21

(210) AM 110140

(220) 2020 10 15

(732) ხათუნა კორაშვილი

იპოლიტე ხვიჩიას ქ. 7, თბილისი, საქართველო

(740) თამაზ შილაკაძე

(540)

Golden Hands მჭრის ბეჭედი

(591) ოქროსფერი, ყავისფერი

(531) 26.04.02; 26.04.22; 26.04.24; 27.05.01; 28.19; 29.01.12

(511)

43 – საკვებით და სასმელებით უზრუნველყოფა; დროებითი საცხოვრებელი უზრუნველყოფა.

(111) M 2020 33253 R

(151) 2020 10 21

(181) 2030 10 21

(210) AM 110141

(220) 2020 10 15

(732) შპს „ქართული ვაზისა და ღვინის კომპანია“

დავით აღმაშენებლის გამზ. 179ა, ბ. 25, 0112, თბილისი, საქართველო;

ნიკა ფერაძე

დ. ყიფიანის ქ. 4, თბილისი, საქართველო

(540)

Kirke

კირკე

(591) შავ-თეთრი

(511)

33 – ალკოჰოლური სასმელები, ლუდის გარდა; ალკოჰოლური შედგენილობები სასმელების დასამზადებლად.

(111) M 2020 33254 R

(151) 2020 10 26

(181) 2030 10 26

(210) AM 110022
 (220) 2020 10 05
 (732) შპს „მატო მუკუზანი“
 ველისციხე, გურჯაანი, საქართველო
 (540)



(591) ოქროსფერი, შავი
 (531) 07.01.08; 07.01.09; 07.01.12; 07.01.24;
 19.09.02; 27.05.01; 27.05.10; 27.05.24
 (526) Mukuzani
 (511)
 33 – ღვინო.

(111) M 2020 33292 R
 (151) 2020 10 29
 (181) 2030 10 29
 (210) AM 109656
 (220) 2020 09 04
 (732) კამიკი დრინკს ლლზ
 11 ჩარჩ როუდ, გრეიტ ბუკემი, სარი
 KT23 3PB, გაერთიანებული სამეფო
 (740) შალვა გვარამაძე
 (540)



(591) შავი, ნაცრისფერი, სახვადასხვა ტონის
 წითელი
 (531) 23.01.01; 24.03.01; 24.03.07; 24.03.18; 28.03;
 29.01.13
 (511)
 33 – ვისკი, ჯინი, არაყი, ლიქიორები.

(111) M 2020 33293 R
 (151) 2020 10 29
 (181) 2030 10 29
 (210) AM 110291
 (220) 2020 10 27
 (732) უის-მოტორ
 ზავარიანის ქ. 12, ერევანი, სომხეთი
 (740) ალექსანდრე არაქელოვი
 (540)



(591) წითელი, შავი
 (531) 26.11.03; 26.11.05; 26.11.08; 27.05.06;
 27.05.08; 27.05.11; 29.01.12
 (511)
 12 – სატრანსპორტო საშუალებები; ხმელეთზე,
 ჰაერში და წყალზე გადასაადგილებელი აპარა-
 ტები.

(111) M 2020 33294 R
 (151) 2020 10 30
 (181) 2030 10 30
 (210) AM 110202
 (220) 2020 10 19
 (732) კურბან მუსაევი
 იაღლუჯას ქ. 22, 032, რუსთავი,
 საქართველო
 (540)



(591) შავ-თეთრი
 (531) 03.01.01; 03.01.16; 05.13.08; 24.09.02;
 24.09.12; 25.01.05; 26.01.15; 26.01.21;
 27.05.01; 27.05.09; 27.05.10
 (511)
 7 – მანქანები და ჩარხები; მოტორები და ძრ-
 ვები (მიწისზედა სატრანსპორტო საშუალებები-
 სათვის განკუთვნილის გარდა); მანქანათა გა-
 დაბმისა და გადამცემის ელემენტები (მიწის-
 ზედა სატრანსპორტო საშუალებებისათვის
 განკუთვნილის გარდა); სასოფლო-სამეურნეო
 იარაღები, განსხვავებული ხელის იარაღებისა-
 გან; ინკუბატორები; ავტომატური სავაჭრო აპა-
 რატები.

8 – ხელის იარაღები და ინსტრუმენტები (ხელით სამართავი); მჭრელი ინსტრუმენტები; ცივი იარაღი, ცეცხლსასროლის გარდა; სამართებლები.

9 – სამეცნიერო, კვლევითი, სანავიგაციო, ფოტოგრაფიული, კინემატოგრაფიული, აუდიოვიზუალური, ოპტიკური, ამწონი, გამზომი, სასიგნალო, აღმომჩენი, საკონტროლო, დასაკვირვებელი, სამაშველო და სასწავლო ხელსაწყოები და ინსტრუმენტები; დენის გადაცემის, განაწილების, გარდაქმნის, დაგროვების, რეგულირების ან მართვის ხელსაწყოები და ინსტრუმენტები; ხმის ან გამოსახულების ჩამწერი, გადაცემი და აღმწარმოებელი აპარატურა; ჩაწერილი და ჩამოსატვირთი მედია, კომპიუტერული პროგრამები, ციფრული ბეჭდვის ან მსგავსი ჩასაწერი და შესანახი მედია; მექანიზმები მონეტებზე მომუშავე აპარატებისთვის; სალაროს აპარატები, საანგარიშო მანქანები, კომპიუტერები და კომპიუტერის პერიფერიული მოწყობილობები; მყვინთავის სამოსი, მყვინთავის ნიღბები, მყვინთავის ყურსაცობები, ცხვირის სამაგრები მყვინთავებისა და მოცურავეებისთვის, მყვინთავის ხელთათმანები, სასუნთქი აპარატურა წყალქვეშა ცურვისთვის; ცეცხლმქრობი აპარატები.

11 – განათების, გათბობის, ორთქლწარმოქმნის, საკვები პროდუქტის თბური დამუშავების, გასაცივებელი, საშრობი, ვენტილაციის, წყალგამანაწილებელი და სანიტარულ-ტექნიკური მოწყობილობები.

(111) M 2020 33295 R

(151) 2020 11 03

(181) 2030 11 03

(210) AM 110195

(220) 2020 10 16

(732) შპს „ელიტ ფუდი“

ილო მოსაშვილის ქ. 1, ბ. 79, თბილისი,

საქართველო

(540)



(591) ოქროსფერი, შინდისფერი

(531) 03.04.01; 03.04.04; 25.01.05; 27.01.12; 28.19; 29.01.13

(511)

29 – ხორცი, თევზი, ფრინველი და ნანადირევი; ხორცის ექსტრაქტები; დაკონსერვებული, გაყინული, გამხმარი და მოხარშული ან შემწვარი ხილი და ბოსტნეული; ჟელეები, ხილფაფები, კომპოტები; კვერცხი; საკვები ზეთები და ცხიმები.

საერთაშორისო სასარტო ნოშნეპი, რომლებზეც ბამოტანილია ბაღაწყვეტილება ღაცვის მინიჭების შუსახეპ

ბაღაწყვეტილების ბასარტოშნეპა შუსადლებელია სარტოტენტის საბებლაციო პალატაში ბამო-
ქვეყნებიდან 3 თვის ვადაში ან მცხეთის რაიონული სასამართლოს ადმინისტრაციულ საქმეთა
კოლეგიაში 1 თვის ვადაში (მის.: ქალაქი მცხეთა, სამხედროს ქ. №17).

(260) AM 2020 94618 A

(800) 1369852

(151) 2017 08 08

(891) 2017 08 08

(731) Shenzhen Mark Technologies Co., LTD
607, 608, 609 Room (facilities), 6th Floor,
Building A, Dongfangyayuan, Chentian
Community, Xixiang, Baomin 2nd Road,
Bao'an District, Shenzhen, China

(540)



(591) Black, white

(531) 27.05.01; 27.05.07; 27.05.08

(511)

9 – Computer peripheral devices; mouse [compu-
ter peripheral]; notebook computers; mouse pads;
cabinets for loudspeakers; telephone transmitters;
microphones; connectors [electricity]; DVD pla-
yers.

(260) AM 2020 99145 A

(800) 976476

(151) 2008 08 26

(891) 2018 06 22

(731) HAIMA INVESTMENT GROUP CO., LTD
No. 2 Jinniu Road, Jinpan Industrial
Development Area, Haikou, China

(540)



(591) Black, white

(531) 27.05.01; 27.05.17

(511)

12 – Luggage carriers for vehicles; cycles cars; au-
tomobiles; vehicle chassis; wheels (vehicle); vehi-
cles for locomotion by land, air, water or rail; en-
gines for land vehicles; automobile bodies; tires for
vehicle wheels; upholstery for vehicles.

(260) AM 2020 102849 A*

(800) 1462437

(151) 2018 08 20

(891) 2018 08 20

(731) Xiaomi Inc.

Floor 13, Rainbow City Shopping Mall II,
of China Resources, NO. 68, Qinghe Middle
Street, Haidian District, Beijing, China

(540)



(591) Black, white

(531) 27.05.01

(511)

11 – Lamps; lights for vehicles; germicidal lamps
for purifying air; curling lamps; acetylene flares;
cooking apparatus and installations; lava rocks for
use in barbecue grills; refrigerators; air purifying
apparatus and machines; hair driers [dryers]; water
heaters; stage fog machine; heating installations;
watering installations, automatic; solar heaters for
baths; filters for drinking water; radiators, electric;
lighters; polymerisation installations; air cleaner;
household air cleaner; portable electric fans; fans
[air-conditioning]; household electric fans; LED
lamps; air conditioners; air filters for air condi-
tioning; portable headlight; household electric wa-
ter purifier; water filtering apparatus; reading
lamps; desk lamps; electric cooker; coffee percola-
tors, electric; kettles, electric; household faucet fil-
ters; water purifying apparatus; household humi-
difier; coffee machines, electric; multicookers; cei-
ling lights; bathroom warmers; household electric
kettle; bread toasters; microwave ovens [cooking
apparatus].

(260) AM 2020 102867 A*
 (800) 1462814
 (151) 2019 02 27
 (891) 2019 02 27
 (731) Open-Type Joint Stock Company "ROT FRONT"
 2-oy Novokuznetskiy pereulok, d. 13/15,
 RU-115184 Moscow, Russian Federation

(540)



(591) Dark brown, light brown, red, orange, yellow and white
 (531) 24.17.02; 25.01.15; 26.03.02; 26.03.03; 26.03.04; 26.03.06; 26.03.07; 26.11.03; 26.13.25; 28.05; 29.01.15
 (526) ®
 (511)
 30 – Aromatic preparations for food; flavorings, other than essential oils, for cakes; flavorings, other than essential oils, for beverages; coffee flavorings; food flavorings, other than essential oils; star aniseed; high-protein cereal bars; pancakes; noodle-based prepared meals; buns; bread rolls; vanillin [vanilla substitute]; waffles; vermicelli [noodles]; natural sweeteners; sausage binding materials; binding agents for ice cream; sea water for cooking; seaweed [condiment]; malt biscuits; cloves [spice]; cake frosting [icing]; mustard; gluten additives for culinary purposes; yeast; thickening agents for cooking foodstuffs; rice-based snack food; cereal-based snack food; artificial coffee; vegetal preparations for use as coffee substitutes; dressings for salad; fruit jellies [confectionery]; confectionery for decorating Christmas trees; cakes; pastries; peanut confectionery; almond confectionery; pasta; ginger [spice]; frozen yogurt [confectionery ices]; cocoa; capers; caramels [candy]; curry [spice]; ketchup [sauce]; quiches; gluten prepared as foodstuff; sweetmeats [candy]; liquorice [confectionery]; peppermint sweets; cinnamon [spice]; coffee; unroasted coffee; starch for food; crackers; custard; groats for human food; hominy grits; semolina; oatmeal; crushed barley; corn, mil

led; corn, roasted; meat pies; turmeric; couscous [semolina]; noodles; ice for refreshment; ice, natural or artificial; edible ices; rice cakes; mayonnaise; macaroons [pastry]; macaroni; maltose; hominy; marinades; marzipan; honey; royal jelly; ice cream; flour; bean meal; tapioca flour; potato flour; corn flour; wheat flour; soya flour; barley meal; dessert mousses [confectionery]; chocolate mousses; museli; mint for confectionery; cocoa beverages with milk; coffee beverages with milk; coffee-based beverages; tea-based beverages; chocolate beverages with milk; chocolate-based beverages; cocoa-based beverages; infusions, not medicinal; crushed oats; husked oats; nutmegs; stick liquorice [confectionery]; soya bean paste [condiment]; pastilles [confectionery]; molasses for food; pepper; allspice; peppers [seasonings]; pesto [sauce]; cookies; petit-beurre biscuits; pies; pizzas; meat gravies; fondants [confectionery]; popcorn; powders for making ice cream; baking powder; mustard meal; pralines; condiments; meat tenderizers for household purposes; cereal preparations; oat-based food; propolis; gingerbread; spices; petits fours [cakes]; puddings; cake powder; fruit coulis [sauces]; ravioli; chewing gum; relish [condiment]; rice; wheat germ for human consumption; spring rolls; sago; sugar; aniseed; golden syrup; confectionery; baking soda [bicarbonate of soda for cooking purposes]; malt for human consumption; salt for preserving foodstuffs; cooking salt; celery salt; sherbets [ices]; ham glaze; soya sauce; tomato sauce; s-uces [condiments]; spaghetti; seasonings; preparations for stiffening whipped cream; rusks; breadcrumbs; sushi; sandwiches; tabbouleh; tacos; tapioca; cream of tartar for culinary purposes; tarts; almond paste; tortillas; garden herbs, preserved [seasonings]; beer vinegar; vinegar; ferments for pastes; halvah; bread; unleavened bread; corn flakes; oat flakes; chicory [coffee substitute]; tea; iced tea; chutneys [condiments]; cheeseburgers [sandwiches]; chow-chow [condiment]; saffron [seasoning]; malt extract for food; essences for foodstuffs, except etheric essences and essential oils; husked barley.

(260) AM 2020 102982 A
 (800) 1464765
 (151) 2018 11 02
 (891) 2018 11 02
 (731) AKSA JENERATÖR SANAYİ ANONİM ŞİRKETİ

Rüzgarlıbahçe Mahallesi, Selvi Çıkmazı,
No:10, Kavacık, Beykoz, İstanbul, Turkey
(540)



(591) Green, blue, black and white
(531) 25.05.01; 26.04.07; 26.04.09; 26.04.18;
26.04.24; 27.05.24; 29.01.14
(511)

7 – Machines, machine tools and industrial robots for processing and shaping wood, metals, glass, plastics and minerals, 3D printers; construction machines and robotic mechanisms for use in construction, bulldozers, diggers, excavators, road construction and road paving machines, drilling machines, rock drilling machines, road sweeping machines; lifting, loading and transmission machines and robotic mechanisms for lifting, loading and transmission purposes: elevators, escalators and cranes; machines and robotic mechanisms for use in agriculture and animal breeding, machines and robotic mechanisms for processing cereals, fruits, vegetables and food; beverage preparation machines, electromechanical; beverage processing machines; engines and motors, other than for land vehicles, parts and fittings therefor, hydraulic and pneumatic controls for engines and motors, brakes other than for vehicles, brake linings for engines, crankshafts, transmission gears for machines, cylinders for engines, pistons for engines, turbines, not for land vehicles, filters for engines and motors, oil, air and fuel filters for land vehicle engines, exhausts for land vehicle engines, exhaust manifolds for land vehicle engines, engine cylinders for land vehicles, engine cylinder heads for land vehicles, pistons for land vehicle engines, carburetors for land vehicles, fuel conversion apparatus for land vehicle engines, injectors for land vehicle engines, fuel economizers for land vehicle engines, pumps for land vehicle engines, valves for land vehicle engines, starters for motors and engines, dynamos for land vehicle engines, sparking plugs for land vehicle engines; bearings (parts of machines), roller or ball bearings; machines for mounting and detaching tires; alternators, current generators, electric generators, current generators operated with solar energy; painting machines, automatic spray guns for paint, electric, hydraulic and pneumatic

punching machines and guns, electric adhesive tape dispensers, electric guns for compressed gas or liquid spraying machines, electric hand drills, electric hand saws, electric jigsaw machines, spiral machines, compressed air machines, compressors, vehicle washing installations, robotic mechanisms with the abovementioned functions; printing machines; packaging machines, filling, plugging and scaling machines, labelers, sorting machines, industrial robots with the abovementioned functions, electric packing machines for plugging and scaling of plastics; machines for textile processing, sewing machines, industrial robots with the abovementioned functions; pumps [machines], self-regulating fuel pumps; electric kitchen machines for chopping, grinding, crushing, mixing and mincing foodstuff, washing machines, laundry washing machines, dishwashers, spin driers (not heated), electric cleaning machines for cleaning floors, carpets or floorings, vacuum cleaners and parts thereof; automatic vending machines; galvanizing and electroplating machines; electric door openers and closers; joints (parts of engines).

(260) AM 2020 105389 A
(800) 1492806
(151) 2019 08 02
(891) 2019 08 02
(731) SAN MARCO GROUP S.P.A.
Via Alta, 10, I-30020 Marcon (VE),
Italy
(540)



(591) White, red PANTONE 485C, gray and cool gray 11C
(531) 04.03.01; 20.07.02; 26.04.07; 26.04.16;
26.04.18; 26.04.24; 27.05.09; 27.05.10;
27.05.24; 29.01.13
(511)
2 – Coloring substances; varnishes; lacquers; enamels; paints.
17 – Insulating paints; insulating varnishes.

(260) AM 2020 106488 A
(800) 1507648
(151) 2019 05 21
(891) 2019 05 21
(731) Bausch & Lomb Incorporated
1400 North Goodman Street, Rochester,
New York 14609, USA
(540)

BAUSCH HEALTH COMPANIES

(591) Black, white
(511)

3 – Cosmetics; non-medicated skin care preparations, namely, cleansers; exfoliants; moisturizers; sunblocks; cosmetic creams for skin care; skin lotion; cosmetic creams and lotions, skin lightening preparations, anti-aging preparations, namely, anti-aging cream, anti-wrinkle creams and anti-aging lotion, body powder, hair shampoo, dandruff hair shampoo, body wash, nail care preparations, nail varnishes and polishes, cuticle conditioners, impregnated cleaning, dusting or polishing cloths.

5 – Pharmaceutical products; pharmaceutical preparations and substances; antifungal preparations; topical anti-itch preparations; contact lens solutions; contact lens disinfectants; contact lens wetting solutions; ophthalmic solutions and preparations for the eye; disinfecting and saline solution for contact lenses; solutions for use with contact lenses; rewetting drops for use with contact lenses; eye drops; ophthalmic preparations, namely impregnated strips for applying preparations to the eye; pharmaceutical preparation for injection into the eye; eye drops, solutions, gels and ointments used for the treatment of eye conditions such as dry eyes, allergies, inflammation and redness; pharmaceutical preparations and substances for the treatment of ophthalmological and ocular diseases and disorders; pharmaceutical preparations for use with and/or in the care of contact lenses and kits containing said preparations, pharmaceutical preparations for ocular or intraocular surgery; ophthalmic pharmaceutical preparations and substances; viscoelastic eye lubricant, pharmaceutical preparations and substances for the treatment of eye diseases, disorders and conditions, ophthalmic pharmaceuticals, namely, solutions and ointments for the treatment of dry eye symptoms, hypertonic ophthalmic solution for medical pur-

poses; ophthalmic pharmaceutical preparation, namely used in ophthalmic surgical procedures; pharmaceuticals, namely, ophthalmic solutions for the treatment of glaucoma and ocular hypertension; pharmaceutical preparations and substances for use in dermatology and skin disorders, skin conditions, acne, fungal infections and skin care, acne medications and acne treatment preparations; pharmaceutical preparations and substances for the prevention and treatment of skin care disorders, conditions, injuries, illnesses and ailments; pharmaceutical preparations and substances for the prevention and treatment of dermatological disorders and diseases and dermatitis; dermatological and skin care pharmaceutical preparations and substances, pharmaceutical preparations and substances for the treatment of ophthalmological, ocular and eye diseases and disorders; soporifics; vitamin and mineral supplements; antibiotics; medicated skin creams; medicated skin care preparations; food supplements, vitamin and mineral supplements and herbal supplements in tablet, capsule, liquid or powder form; pharmaceutical preparations for the treatment, prevention and/or alleviation of disorders of the gastrointestinal tract; pharmaceutical preparations for the treatment of chorea; pharmaceutical preparations for the treatment of hyperkinetic movement disorders; pharmaceutical preparations for the treatment of neurological disorders and movement disorders; pharmaceutical preparations, namely, pharmaceutical preparations and substances for the treatment of skin disorders, diseases, conditions and ailments; pharmaceutical preparations and substances for the treatment of eye disorders, diseases, conditions and ailments; pharmaceutical preparations and products for ophthalmological use; pharmaceutical preparations and substances for the prevention, treatment and alleviation of pain; anti-depressants; pharmaceutical preparations and substances for the prevention, treatment and alleviation of anxiety, depression, depressive disorders and mental illness; pharmaceutical preparations and substances for the prevention, treatment and alleviation of disorders, diseases, conditions and ailments of the cardiovascular system; pharmaceutical preparations and substances for the treatment of viral, metabolic, endocrine, musculoskeletal, cardiovascular, cardiopulmonary, hepatological, ophthalmic, respiratory, neurological, gastrointestinal, hormonal, dermatological, psyc-

hiatric and immune system related diseases and disorders; pharmaceutical preparations for treating allergic rhinitis and asthma; pharmaceutical preparations, namely, immunomodulators; pharmaceutical gel for the treatment of vaginal disorders; intravenous preparations for the treatment of hyperammonemia of all origins; nitroglycerin plasters for medical use; anticonvulsants; pharmaceutical preparations for treating inflammatory disorders such as psoriasis; pharmaceutical preparations and substances for the prevention, treatment and alleviation of stress; pharmaceutical preparations and substances for the prevention, treatment and alleviation of diabetes; pharmaceutical preparations and substances for controlling insulin levels; pharmaceutical preparations and substances for the prevention, treatment and alleviation of hypertension; pharmaceutical preparations and substances for the cessation of smoking; pharmaceutical preparations and substances for the prevention and treatment of sexually transmitted diseases; pharmaceutical preparations and substances for the prevention and treatment of herpes; pharmaceutical preparations and substances for the prevention, treatment and alleviation of sleep disorders; pharmaceutical preparations and substances for the prevention, treatment and alleviation of acute myocardial infarctions; pharmaceutical preparations and substances for the prevention, treatment and alleviation of symptomatic congestive heart failure; pharmaceutical preparations and substances for the prevention, treatment and alleviation of asymptomatic left ventricular dysfunction; fibrinolytic or thrombolytic agents; pharmaceutical preparations and substances for the prevention, treatment and alleviation of pain and inflammation, namely, anti-inflammatories and pain relief medication; pharmaceutical preparations and substances for the prevention, treatment and alleviation of migraines; pharmaceutical preparations and substances for the treatment of fungal infections, onychomycosis, tinea infections, and similar diseases of the skin and nails; pharmaceutical preparations and substances for use in dermatological use; topical anti-itch preparations for use on humans for the treatment of skin disorders and skin rashes; medicated skin care preparations; medicated skin lotions; medicated body lotions; nutritionally fortified soft chews for use as nutritional supplements, probiotic compositions for use as nutritional supplements; multivitamin preparations;

food supplements; nutritional supplements; vitamins; natural herbal supplements; mineral supplements; protein supplements; pharmaceutical preparations and substances for the treatment of epilepsy, seizures and neurological and psychological diseases and disorders; viscoelastic solutions for intraocular use; medicines and medicinal preparations for human purposes, namely, to support treatment of hemorrhoids, chronic venous insufficiency and lymphedema; sanitary preparations for medical purposes; pharmaceutical preparations to support treatment of hemorrhoids, chronic venous insufficiency and lymphedema; homeopathic pharmaceuticals for use in support treatment of hemorrhoids, chronic venous insufficiency and lymphedema and vitamin preparations, all in the form of tablets or powder or soft gelatin capsules or hard gelatin capsules; homeopathic preparations, namely homeopathic supplements for weight loss purposes; preparations containing herbs for medical purposes; medicinal teas; dietetic food preparations adapted for medical purposes; food supplements for medical purposes, namely, food supplements for enhancing the immune system's resistance and improving bodily health; pharmaceutical preparations, namely, a topical cream for the treatment of pre-cancerous skin lesions; pharmaceutical preparations and substances for the prevention and treatment of disorders, diseases, conditions and ailments of the cardio-vascular system; pharmaceutical preparations and substances for the prevention and treatment of hypertension; pharmaceutical preparations for the treatment of nausea, emesis; analgesics; medicated skin care preparations for use in treating scars and damaged skin; topical gel for medical and therapeutic use in the treatment of scars and damaged skin; antiviral agents; antiobesity agent; dermotherapeutic preparation; pharmaceutical products namely lipid and triglyceride reducing agents; diuretics; anti-itch creams; pharmaceutical preparations for the treatment of oral mucositis and xerostomia; pharmaceutical preparations and substances for the treatment of eye disorders, diseases, conditions and ailments; pharmaceutical preparations and products for ophthalmological use; pharmaceutical preparations and substances for the prevention, treatment and alleviation of pain; anti-depressants; pharmaceutical preparations and substances for the prevention, treatment and alleviation of disorders, diseases, conditions and ailments of the car-

diovascular system; pharmaceutical preparations and substances for the prevention, treatment and alleviation of parkinson's disease; pharmaceutical preparations and substances for the prevention, treatment and alleviation of huntington's disease; pharmaceutical preparations and substances for the prevention, treatment and alleviation of amyotrophic lateral sclerosis; pharmaceutical preparations and substances for the prevention, treatment and alleviation of alzheimer's disease; pharmaceutical preparations and substances for the prevention, treatment and alleviation of tourette syndrome; pharmaceutical preparations and substances for the prevention, treatment and alleviation of epilepsy; pharmaceutical preparations and substances for the prevention, treatment and alleviation of multiple sclerosis; pharmaceutical preparations and substances for the prevention, treatment and alleviation of cardiopulmonary disorders, diseases, conditions, and ailments; pharmaceutical preparations and substances for the prevention, treatment and alleviation of disorders, diseases, conditions, and ailments of the circulatory system; pharmaceutical preparations and substances for the prevention, treatment and alleviation of hypertension, high blood pressure, heart failure and ventricular dysfunction; pharmaceutical preparations and substances for the prevention, treatment and alleviation of viral and infectious diseases; pharmaceutical preparations and substances for the prevention, treatment and alleviation of central nervous system disorders, diseases, conditions and ailments, namely, central nervous system movement disorders, ocular motility disorders, spinal cord diseases, encephalitis, cerebral palsy, insomnia, mood disorders, bipolar disorder, seizure disorders; pharmaceutical preparations and substances for the prevention, treatment and alleviation of disorders, diseases, conditions and ailments of the respiratory system; pharmaceutical preparations and substances for the prevention, treatment and alleviation of disorders, diseases, conditions and ailments of the endocrine system; pharmaceutical preparations for the treatment of immunologic diseases, namely, auto immune motility diseases, immunologic deficiency syndromes, auto immune diseases, acquired immune deficiency syndrome (aids), hypersensitivity, allergies, tumors of the immunological organs; pharmaceutical preparations and substances for the prevention, treatment and alleviation of disorders, diseases, condi-

tions and ailments of the musculoskeletal system, namely, bone diseases and bone degenerative conditions; pharmaceutical preparations and substances for the prevention, treatment and alleviation of migraines; pharmaceutical preparations and substances for use in oncology; pharmaceutical preparations and substances for the treatment of polycystic ovary syndrome; pharmaceutical preparations and substances for the treatment of infertility; veterinary products, namely, veterinary preparations for dogs, cats and horses for use during ophthalmic surgery and recovery therefrom; eye drops for veterinary use; pharmaceutical preparations for the treatment of cancer, neurological and dermatological disorders; pharmaceutical preparations for the treatment of myasthenia gravis, depression, mood/anxiety conditions, solar keratoses and cancer; anti-depressants; tranquilizers; nasal spray preparations; pharmaceutical preparations for the treatment of neuromuscular conditions; pharmaceutical preparations for the treatment of skin related diseases, cancer and precancerous conditions, and disorders related to the modulation of apoptosis; vitamin supplement distributed by prescription only; pharmaceutical preparations, namely, an oral glucose gel for the treatment of low blood sugar; pharmaceutical preparation for the treatment of headaches; skin lotion for the relief of itch caused by insect bites, eczema, sunburn and poison ivy; dressings for wounds; preparations and substances for the relief of anorectal discomfort, inflammation, and irritation; hemorrhoidal suppositories; pharmaceutical preparations for the treatment of irritable bowel syndrome; drugs to treat opioid-induced constipation; psychotropic preparations; cough treatment medicine; eye wash; eyedrops containing antihistamines and decongestants; pharmaceutical preparations, namely, an ophthalmic preparation for use in eye examinations; pharmaceuticals preparation that operates physiologically to control skin pigmentation; pharmaceutical preparations for wounds; pharmaceutical steroid preparations for topical use; pharmaceutical preparations, namely, antiemetics; preparations for use in cleaning contact lenses and kits containing said preparations; impregnated cellulose fiber strips for use in ophthalmic diagnosis.

9 – Contact lenses, software for use in ophthalmic medical and surgical procedures, namely, for swept source optical coherence tomography; ma-

gnifying glasses [optics]; software used in ophthalmological and optometric instruments, namely, corneal topographer, aberrometer and lasers, all sold as a unit and used for the diagnosis of eye conditions and vision correction; cases and containers for contact lenses; eyeglass chains; eyeglass cords; contact lens cases; plastic blanks for contact lenses; computer network consisting of a network server and network operating software allowing for the calculation, transfer and storage of data between components of ophthalmic, eye and vision correction systems and the customer support service provider; software, namely the algorithm feature for measuring and tuning the amount of radio frequency energy delivered to a patient treatment area sold as an integral component of equipment for cosmetic skin procedures.

10 – Cosmetic apparatus, namely, light based devices providing mainly pulsed light for performing non-ablative aesthetic skin treatment procedures; surgical, medical, and veterinary apparatus and instruments, namely, medical device intended to be used as intraocular lens in order to replace the natural crystalline lens of the eye during cataract surgery; artificial limbs, and teeth; surgical instruments, namely, endoscopes; disposable surgical instruments, other than for the dental sector; veterinary implants consisting primarily of artificial materials; artificial corneal lenses for veterinary use; veterinary lens extractors; veterinary instruments, namely, slit lamps, ophthalmoscopes, tonometers, veterinary ultrasound apparatus, microsurgical instruments, tension ring injectors, and surgical sewing material, namely, needles and sutures; surgical instruments, namely, an ultrasonic surgical system consisting of an ultrasonic surgical instrument to separate, fragment, and coagulate tissue, surgical irrigators and aspirators for medical use and related equipment, namely, a precision fluid delivery system comprised of a pump, controller and surgical tubing, fluid canisters, ultrasonic medical handpieces, probes and cannulas sold as a unit; medical devices, namely, finger-attached ultrasonic probes for diagnostic medical imaging; kit containing one or more surgical instruments, namely, cannulae or ultrasonic probes, and a sterilization tray that holds the instruments; respiratory apparatus for medical use; drug delivery device; intraocular lenses; phacoemulsification apparatus and instruments for use in ophthalmic surgical procedures; ophthalmic medical and sur-

gical apparatus, equipment and instruments, namely, intraocular lenses, haptics for mounting intraocular lenses, and parts, components and fittings for the aforementioned goods; ophthalmic medical and surgical apparatus, equipment and instruments, namely, intraocular lenses, folding intraocular lenses, and parts, components and fittings for the aforementioned goods; lasers for medical use; lasers for ophthalmic medical and surgical procedures; ophthalmic surgical device used to inject intraocular lenses, and intraocular lenses; single-use ocular syringe preloaded with a capsular tension ring for use in cataract surgery; surgical instrument, namely, a vitreous cutter; ophthalmic surgical instruments and devices used in performing ophthalmic surgical procedures, and component parts thereof; ophthalmic medical devices, namely, intraocular lenses; medical device, namely, intraocular implant; surgical blades for use in ophthalmic surgery; lasers for the medical and cosmetic treatment of the face and skin; medical devices for non-surgical cosmetic skin treatments; medical devices for contracting skin, body sculpting, and soft tissue reconstruction in a non-invasive manner; medical devices, namely, medical instruments for the non-invasive removal of human body fat utilizing an external energy source; surgical fat-collection canister kit consisting of a canister and a canister base assembly, a canister lid assembly, one or more ports, and one or more syringe caps; surgical instruments for fragmentation, cutting, coagulation, aspiration and irrigation; medical aesthetic devices that administer a combination of pneumatic energy and broadband light or pneumatic energy or broadband light alone for skin treatment and hair removal; medical devices, namely, lasers, radio frequency, ultrasound and thermal devices for use in connection with non-surgical cosmetic skin treatment systems; medical devices, namely, phototherapeutic apparatus for medical purposes, namely, devices for use in the treatment of dermatological conditions including acne microsurgical instruments used in ophthalmic procedures to remove cataracts; medical and surgical instruments and apparatus, namely, a vacuum and fluid control system consisting of pumps, tubing, sensors, valves, needles, sleeves, fluid collection containers, and recipient connections; secure tubing connection device used with and in ophthalmic, ocular, cataract and eye-related surgical procedures; surgical instru-

ments, namely, surgical needles for ophthalmic surgery; surgical, medical apparatus and instruments used in performing ophthalmic, ocular and eye-related surgery, namely, knives and cutters; single-use injector and capsular tension ring; keratome blades; ophthalmic and optometric instruments for making both measurements of surfaces of the eye & for performing diagnosis of the eye; intravitreal implants containing a pharmaceutical for the treatment of eye and vision conditions.

16 – Publications in the nature of newsletters, pamphlets and bulletins in the field of health issues; printed matter describing contact lens care and contact lens care products.

35 – Providing customer incentive award programs via a website through issuance and processing of loyalty points for purchase of a company's goods and services to promote medical and pharmaceutical compliance through gamification, behavioral economics and consumer marketing concepts to engage and motivate patients to follow instructions and directions for pharmaceutical preparations and substances, namely, pharmaceutical preparations and substances for the treatment of skin disorders, diseases, conditions and ailments; providing customer incentive award programs through issuance and processing of loyalty points for purchase of a company's goods and services to promote medical and pharmaceutical compliance through gamification, behavioral economics and consumer marketing concepts to engage and motivate patients to follow instructions and directions for pharmaceutical preparations and substances, namely, pharmaceutical preparations and substances for the treatment of skin disorders, diseases, conditions and ailments; advertising services to promote public awareness of issues relating to good vision and eye health, protecting the eyes and sight, and the benefits of ocular vitamin and mineral supplements; inventory management services in the eye health care field; inventory management services in the field of contact lenses; mail order retail services featuring vitamin and mineral supplements and nutritional supplements; promoting skin treatment services by means of incentive reward programs; administration of a consumer loyalty program to promote skin treatment services; customer loyalty services and customer membership club services, for commercial, promotional and/or advertising purposes; retail

store services via global computer network featuring medical instruments and devices; processing prescription orders for pharmaceutical preparations; distribution of promotional material and publications relating to treating chronic immune disorders, joint inflammation disorders and chronic inflammatory disorders; administration of a program where prescriptions and information submitted by health care professionals enable patients to acquire pharmaceuticals covered by medical and dental benefits [sales promotion].

41 – Providing on-line publications in the nature of newsletters, pamphlets and bulletins in the field of health issues; providing training in the fields of eye care, health of the eye and ophthalmics, for the purposes of educating and assisting eye care professionals, and distribution of course materials in connection therewith; educational services, namely, providing classes, seminars, and workshops in the field of medical procedures, namely, ultrasonic assisted lipoplasty and body sculpting, and distribution of course materials in connection therewith; educational services, namely, providing training for the purposes of educating and assisting eye care professionals in the fields of eye care, health of the eye and ophthalmics, production of course materials and training materials to be distributed at seminars.

42 – Development services in the field of pharmaceuticals except clinical research services; custom design of ophthalmic surgical instruments; providing scientific research and providing information in the field of scientific industry research for the purposes of informing eye care professionals in the fields of eye care, health of the eye and ophthalmics; hosting a website for use by healthcare professionals in the field of ophthalmology; hosting a website offering educational information in the field of ophthalmology.

44 – Cosmetic treatment services, namely, the non-invasive removal of human body fat utilizing an external energy source; cosmetic treatment services, namely, skin care, body care and face care services; medical information in the field of pharmaceutical preparations and substances for the treatment of skin disorders, diseases, conditions and ailments to engage and motivate patients to follow instructions and directions for medical and pharmaceutical compliance through gamification, behavioral economics and consumer marke-

ting concepts provided via a web-site; providing medical information in the field of pharmaceutical preparations and substances for the treatment of skin disorders, diseases, conditions and ailments to engage and motivate patients to follow instructions and directions for medical and pharmaceutical compliance through gamification, behavioral economics and consumer marketing concepts; providing medical information related to chronic pain due to irritable bowel syndrome with diarrhea, opioid-induced constipation, and ulcerative colitis; medical and surgical services, namely, ophthalmic, ocular and eye care medical and surgical services; providing medical information and advice in the field of health issues provided via a website; information in the field of medical services relating to procedures in the nature of body contouring provided via a website; providing medical information and medical services in the field of eye care, health of the eye and ophthalmics; dermatology services; skin massage therapy; medical spa services; non-invasive cosmetic medical services; liposuction and surgical body shaping services; medical services for skin treatment; skin health restoration procedures; cosmetic therapies; cosmetic body care services in the nature of non-surgical body contouring; medical services, namely, skin subcutaneous tissue treatment services; aesthetic and therapeutic skin and body treatment services; providing dermatological treatment services using lasers and radio frequency devices; providing health information; medical services, namely, orthokeratology procedures; cosmetic and plastic surgery and dermatological treatment services; medical services in the nature of performing ultrasonic surgical procedures; medical procedures, namely, ultrasonic body shaping treatments; pharmacists' services to make up prescriptions; preparation and dispensing of medications.

(260) AM 2020 106489 A
 (800) 1507662
 (151) 2019 11 15
 (891) 2019 11 15
 (731) Apple Inc.
 One Apple Park Way, Cupertino
 CA 95014, USA
 (540)

FIND MY

(591) Black, white

(511)
 9 – Downloadable computer software for use in finding, tracking, displaying, and sharing the geographic location of individuals and consumer electronics goods, sending notifications on the geographic location of individuals, locating lost or missing consumer electronics goods, and preventing unauthorized access to consumer electronics goods.

(260) AM 2020 106490 A
 (800) 1507716
 (151) 2019 11 01
 (891) 2019 11 01
 (731) PT. SOFTEX INDONESIA
 Jalan Raya Serang Km. 7 Komp., Industri
 Gajah Tunggal, Pasir Jaya, Jatiuwung,
 Tangerang, Banten 15135, Indonesia
 (540)



(591) White and blue
 (531) 02.09.01; 27.03.02; 27.05.02; 27.05.08;
 29.01.12
 (511)
 5 – Disposable baby diaper made from paper and cellulose; disposable baby diaper pants.

(260) AM 2020 106533 A
 (800) 1507739
 (151) 2019 07 31
 (891) 2019 07 31
 (731) ALIFAX S.R.L.
 Via Petrarca, 2/1, I-35020 POLVERARA
 (PD), Italy
 (540)



(591) Black, white
 (531) 26.04.01; 26.04.05; 26.04.22; 27.01.03

(511)

9 – Test tubes; holders for test tubes; holders for collecting and transport of scientific specimen being laboratory equipment; apparatus and instruments for scientific research in laboratories; computer software, recorded.

10 – Medical specimen cups; medical specimen cup holders; collection and transport holders for medical specimen; medical diagnostic apparatus; diagnostic apparatus and instruments for medical purposes; analyzers for medical use; apparatus for the analysis of biological fluids; apparatus for analyzing bacteria in biological samples for medical use; automated analyzers for body fluids for medical use; material analysis apparatus for foreign matter in bodily fluids for medical purposes.

44 – Animal healthcare services; pharmacy advice; health counseling; medical advice for individuals with disabilities; medical equipment rental; rental of sanitation facilities; health centre services; blood bank services; human tissue bank services; nursing home services; rest home services; convalescent home services; medical clinic services; palliative care; in vitro fertilization services; artificial insemination services; hospice services; medical services; hospital services; health care services; therapy services.

(260) AM 2020 106534 A

(800) 1507754

(151) 2019 10 28

(891) 2019 10 28

(731) HUAWEI TECHNOLOGIES CO., LTD.

Administration Building, Huawei Technologies Co., Ltd., Bantian, Longgang District, Shenzhen, China

(540)

HUAWEI Maleoon

(591) Black, white

(531) 27.05.10

(511)

9 – Smartglasses; smartwatches; smartphones; wearable activity trackers; digital photo frames; microphones; computer hardware; computer memories; cabinets for loudspeakers; network communication apparatus; personal digital assistants (PDAs); thin client computers; hand-held electronic dictionaries; wearable computers; telecommunication apparatus in the form of jewellery; selfie

sticks for mobile phones; wearable video display monitors; selfie lenses; downloadable mobile phone software applications; television apparatus; computer operating programs, recorded; electronic game programs, downloadable; computer game programs, recorded; computer game programs downloaded via a web site; liquid crystal displays (LCD) with large screens; electronic diaries; video image printers; wrist-mounted smartphones; television apparatus for vehicles; computer programs, downloadable; computer software, recorded; downloadable computer game software via a global computer network and wireless devices; modems; sleeves for laptops; electric batteries; tablet computers; covers for tablet computers; flat panel displays; flexible flat panel displays for computers; laptop computers; notebook computers; headphones; earphones; virtual reality headsets; digital video recorder for vehicles; set-top boxes; loudspeakers; portable media players; sound transmitting apparatus; camcorders; cameras (photography); video monitors; computer programs, recorded; computer software applications, downloadable; optical lenses; humanoid robots with artificial intelligence; smart rings; human face recognition devices; thermal imaging cameras.

42 – Computer software design; providing information on computer technology and programming via a web site; software as a service [SaaS]; cloud computing; platform as a service [PaaS]; updating and maintenance of computer software; design and development of multimedia products; research and development of computer software; mobilephone software design; software design and development; design and development of mobilephone software applications; design and development of instant messaging software; development and creation of computer programs for data processing; electronic data storage; developing of driver and operating system software; quality system certification; providing user authentication services using single sign-on technology for online software applications; providing user authentication services using biometric hardware and software technology for e-commerce transactions.

(260) AM 2020 106547 A

(800) 1508051

(151) 2019 11 06

(891) 2019 11 06

(731) ÇAĞATAY EVCİL HAYVAN MAMALARI
VE YEM ÜRÜNLERİ SANAYİ VE
TİCARET ANONİM ŞİRKETİ
Ümit Mahallesi, 7406/1 Sokak, No: 9,
Bornova – İzmir, Turkey

(540)



(591) Black, white

(531) 26.04.22; 27.05.01

(526) Köpek maması

(511)

31 – Food for animals; dog food.

(260) AM 2020 106548 A

(800) 1508099

(151) 2019 10 07

(891) 2019 10 07

(731) Zahorii Hlib Volodymyrovych
10, Prorizna street, apt. 19, Kyiv 01001,
Ukraine;
PRIVATE JOINT STOCK COMPANY
"PHARMACEUTICAL FIRM "DARNITSA"
13 Boryspilska Street, Kyiv 02093, Ukraine

(540)

DARNITSA GROUP

(591) Black, white

(511)

5 – Antiseptics; vaccines; veterinary preparations; vitamin preparations; disinfectants; diagnostic preparations for veterinary purposes; diagnostic preparations for medical purposes; dietetic beverages adapted for medical purposes; dietetic substances adapted for medical use; dietetic foods adapted for medical purposes; plant extracts for pharmaceutical purposes; herbal extracts for medical purposes; capsules for medicines; medicines for human purposes; drugs for medical purposes; medicinal drinks; medicinal oils; medicated toiletry preparations; medicated shampoos; ointments for pharmaceutical purposes; teeth filling material; medicinal alcohol; food supplements; dressings, medical; nutritional supplements; pre-filled syringes for medi-

cal purposes; air purifying preparations; food for babies; protein dietary supplements; tissues impregnated with pharmaceutical lotions; alcohol for pharmaceutical purposes; stem cells for medical purposes; transplants [living tissues]; pharmaceutical preparations; pharmaceuticals; ferments for pharmaceutical purposes; phytotherapy preparations for medical purposes; chemico-pharmaceutical preparations; chemical preparations for medical purposes; chemical preparations for pharmaceutical purposes; chemical reagents for medical or veterinary purposes; surgical glues; surgical dressings; candy, medicated; candy for medical purposes; sanitary preparations for medical purposes; plasters for medical purposes.

(260) AM 2020 106559 A

(800) 1508393

(151) 2019 08 12

(891) 2019 08 12

(731) Obshchestvo s ogranichennoy
otvetstvennostyu "Upravlyayushchaya
kompania Miksit"
p. Moskovskiy, 22-y km Kievskogo sh.,
domovl. 4, str. 5, office 713-E, RU-125362
Moscow, Russian Federation

(540)



(591) Black, yellow, purple, dark pink, blue and white

(531) 25.05.25; 26.03.04; 27.05.01; 29.01.15

(511)

8 – Hand tools and implements, hand-operated; cutlery; side arms, other than firearms; razors; glaziers' diamonds [parts of hand tools]; apparatus for tattooing; laser hair removal apparatus, other than for medical purposes; razors, electric or non-electric; sharpening steels; scythe stones; gimlets [hand tools]; borers; augers [hand tools]; carpenters' augers; hand drills, hand-operated; pickhammers; levers; table forks; weeding forks [hand tools]; agricultural forks [hand tools]; lawn clippers [hand instruments]; harpoons; harpoons for fishing; nail pullers, hand-operated; rakes [hand tools]; sand trap rakes; cutter bars [hand tools]; whetstone holders; priming irons [hand tools]; sculptors' chisels; lifting jacks, hand-operated; truncheons; clamps for carpenters or cooper; spa-

des [hand tools]; rabbeting planes; chisels; engraving needles; tattoo needles; edge tools [hand tools]; garden tools, hand-operated; abrading instruments [hand instruments]; numbering punches; goffering irons; implements for decanting liquids [hand tools]; depilation appliances, electric and non-electric; sharpening instruments; blade sharpening instruments; livestock marking tools; nail clippers, electric or non-electric; oyster openers; polishing irons [glazing tools]; ear-piercing apparatus; tube cutting instruments; wire strippers [hand tools]; riveters [hand tools]; expanders [hand tools]; cutting tools [hand tools]; ski edge sharpening tools, hand-operated; hand tools, hand-operated; sterile body piercing instruments; stamping-out tools [hand tools]; picks [hand tools]; sharpening stones; punch rings [knuckle dusters]; trowels; centre punches [hand tools]; daggers; pickaxes; mallets [hand instruments]; pliers; punch pliers [hand tools]; blades [weapons]; annular screw plates; wrenches [hand tools]; tap wrenches; ladles [hand tools]; foundry ladles [hand tools]; meat claws; breast drills; lasts [shoemakers' hand tools]; scythe rings; instruments for punching tickets; diggers [hand tools]; rams [hand tools]; scythes; hainault scythes; fire irons; emery grinding wheels; grindstones [hand tools]; sledgehammers; thistle extractors [hand tools]; nail nippers; tree pruners; nail drawers [hand tools]; ice picks; blades [hand tools]; razor blades; blades for planes; plane irons; jig-saws; table knives, forks and spoons for babies; table knives, forks and spoons of plastic; crow bars; trowels [gardening]; shovels [hand tools]; palette knives; machetes; beard clippers; hair clippers for personal use, electric and non-electric; hair clippers for animals [hand instruments]; taps [hand tools]; fireplace bellows [hand tools]; swords; hammers [hand tools]; emergency hammers; fullers [hand tools]; stone hammers; masons' hammers; riveting hammers [hand tools]; mattocks; ditchers [hand tools]; mincing knives [hand tools]; manicure sets; manicure sets, electric; pedicure sets; needle files; bits [hand tools]; files [tools]; emery files; air pumps, hand-operated; hand pumps; shaving cases; cheese slicers, non-electric; fruit segmenters; egg slicers, non-electric; pizza cutters, non-electric; scaling knives; hobby knives [scalpels]; fruit corers; molding irons; ceramic knives; can openers, non-electric; tin openers, non-electric; farriers' knives; budding

knives; hunting knives; penknives; grafting tools [hand tools]; braiders [hand tools]; box cutters; bill-hooks; paring knives; knives; cleavers; wick trimmers [scissors]; shears; cattle shearers; border shears; pruning shears; shearers [hand instruments]; scissors; sword scabbards; vegetable slicers; kitchen mandolines; vegetable spiralizers, hand-operated; vegetable peelers [hand tools]; agricultural implements, hand-operated; stopping instruments; screwdrivers, non-electric; sabres; stirring sticks for mixing paint; reamer sockets; drill holders [hand tools]; perforating tools [hand tools]; pestles for pounding [hand tools]; emery boards; nail files; nail files, electric; saws [hand tools]; bow saws; tweezers; hair-removing tweezers; guns [hand tools]; non-electric caulking guns; guns, hand-operated, for the extrusion of mastics; dies [hand tools]; fruit pickers [hand tools]; saw blades [parts of hand tools]; shear blades; tool belts [holders]; hair braiders, electric; table cutlery [knives, forks and spoons]; crimping irons; hand implements for hair curling; vegetable choppers; money scoops; instruments and tools for skinning animals; fingernail polishers, electric or non-electric; nail buffers, electric or non-electric; hackles [hand tools]; pin punches; nail punches; fish tapes [hand tools]; punches [hand tools]; insecticide sprayers [hand tools]; syringes for spraying insecticides; reamers; frames for handsaws; saw holders; rasps [hand tools]; cutters; paring irons [hand tools]; graving tools [hand tools]; milling cutters [hand tools]; razor strops; leather strops; planes; scythe handles; knife handles; handles for hand-operated hand tools; marline spikes; bits [parts of hand tools]; hollowing bits [parts of hand tools]; secateurs; silver plate [knives, forks and spoons]; pruning knives; sickles; drawing knives; scrapers [hand tools]; scrapers for skis; mortise chisels; caulking irons; gouges [hand tools]; mortars for pounding [hand tools]; mitre boxes [hand tools]; branding irons; hatchets; adzes [tools]; vices; bench vices [hand implements]; hoop cutters [hand tools]; axes; holing axes; fulling tools [hand tools]; earth rammers [hand tools]; tube cutters [hand tools]; squares [hand tools]; extension pieces for braces for screw taps; embossers [hand tools]; apparatus for destroying plant parasites, hand-operated; metal wire stretchers [hand tools]; metal band stretchers [hand tools]; flat irons; irons [non-electric hand tools]; razor cases; ratchets [hand tools]; scraping tools [hand tools]; awls; choppers

[knives]; spatulas [hand tools]; spatulas for use by artists; wine bottle foil cutters, hand-operated; bayonets; curling tongs; cuticle tweezers; eyelash curlers.

9 – navigation, surveying, optical, signalling, detecting, testing, inspecting, life-saving; apparatus and instruments for conducting, switching, transforming, accumulating; mechanisms for coin-operated apparatus; cash registers, calculating devices; diving suits, divers' masks, ear plugs for divers, nose clips for divers and swimmers, gloves for divers, breathing apparatus for underwater swimming; fire extinguishing apparatus; 3D spectacles; fire engines; answering machines; electrical adapters; batteries for electronic cigarettes; accumulators, electric; accumulators, electric, for vehicles; anodes; antennas; anticathodes; high-frequency apparatus; testing apparatus not for medical purposes; monitoring apparatus, other than for medical purposes; distillation apparatus for scientific purposes; diffraction apparatus [microscopy]; apparatus to check franking; apparatus for fermentation [laboratory apparatus]; breathing apparatus for underwater swimming; breathing apparatus, except for artificial respiration; apparatus and installations for the production of X-rays, not for medical purposes; electric apparatus for commutation; magnetic resonance imaging [MRI] apparatus, not for medical purposes; intercommunication apparatus; stills for laboratory experiments; radiological apparatus for industrial purposes; X-ray apparatus not for medical purposes; blueprint apparatus; flashing lights [luminous signals]; stereoscopic apparatus; facsimile machines; igniting apparatus, electric, for igniting at a distance; beacons, luminous; battery jars; anode batteries; galvanic batteries; batteries for lighting; solar batteries; solar panels for the production of electricity; batteries, electric; betatrons; binoculars; electronic tags for goods; lens hoods; fire hose nozzles; encoded identification bracelets, magnetic; safety tarpaulins; bullet-proof clothing; signalling buoys; life buoys; marking buoys; directional compasses; electrolyzers; camcorders; circuit closers; mechanical signs; signs, luminous; switchboxes [electricity]; current rectifiers; hands-free kits for telephones; heliographic apparatus; peepholes [magnifying lenses] for doors; hairdressing training heads [teaching apparatus]; holograms; plotters; plumb bobs; piezoelectric sensors; smoke detectors; counterfeit coin detectors; transparencies [photography]; slide projectors; dia-

phragms [photography]; dictating machines; light-emitting diodes [LED]; quantum dot light-emitting diodes [QLED]; organic light-emitting diodes [OLED]; DNA chips; bullet-proof waistcoats; life jackets; reflective safety vests; identification threads for electric wires; nose clips for divers and swimmers; locks, electric; bells [warning devices]; alarm bells, electric; electric door bells; signal bells; audio interfaces; acoustic conduits; mirrors for inspecting work; road signs, luminous or mechanical; marine depth finders; probes for scientific purposes; buzzers; eyewear; reflective articles for wear, for the prevention of accidents; inverters [electricity]; incubators for bacteria culture; instruments containing eyepieces; ionization apparatus not for the treatment of air or water; coaxial cables; fiber optic cables; cables, electric; decompression chambers; rearview cameras for vehicles; cinematographic cameras; thermal imaging cameras; mouth guards for sports; life-saving capsules for natural disasters; electronic pens [visual display units]; holders for electric coils; identity cards, magnetic; riding helmets; protective helmets; carriers for dark plates [photography]; cathodes; spools [photography]; choking coils [impedance]; coils, electric; electromagnetic coils; cinematographic film, exposed; solenoid valves [electromagnetic switches]; wire connectors [electricity]; encoded key cards; push buttons for bells; mouse pads; magnetic encoders; visors for helmets; collectors, electric; calibrating rings; smart rings; ring sizers; protective suits for aviators; commutators; comparators; marine compasses; condensers [capacitors]; contacts, electric; wind socks for indicating wind direction; traffic cones; branch boxes [electricity]; distribution boxes [electricity]; junction boxes [electricity]; connectors [electricity]; battery boxes; cabinets for loudspeakers; diving suits; galena crystals [detectors]; covers for electric outlets; lasers, not for medical purposes; darkroom lamps [photography]; thermionic tubes; amplifying tubes; flashlights [photography]; fire escapes; contact lenses; correcting lenses [optics]; close-up lenses; optical lenses; optical condensers; sounding lines; electricity conduits; magnifying glasses [optics]; thread counters; magnets; decorative magnets; crash test dummies; resuscitation mannequins [teaching apparatus]; security tokens [encryption devices]; divers' masks; solderers' helmets; protective masks; respiratory masks, other than for artificial respiration; materials for electricity mains [wires, cables];

furniture especially made for laboratories; megaphones; diaphragms [acoustics]; diaphragms for scientific apparatus; metal detectors for industrial or military purposes; metronomes; mechanisms for counter-operated apparatus; coin-operated mechanisms for television sets; shutter releases [photography]; microscopes; microtomes; microphones; modems; lightning rods; selfie sticks [hand-held monopods]; terminals [electricity]; junction sleeves for electric cables; teeth protectors; knee-pads for workers; sheaths for electric cables; identification sheaths for electric wires; life saving apparatus and equipment; shoes for protection against accidents, irradiation and fire; objectives [lenses] [optics]; lenses for astrophotography; selfie lenses; egg-candlers; fire extinguishers; rescue laser signalling flares; electrified fences; limiters [electricity]; clothing for protection against accidents, irradiation and fire; clothing for protection against fire; asbestos clothing for protection against fire; clothing especially made for laboratories; survival blankets; ozonisers [ozonators]; eyepieces; wrist rests for use with computers; eyeglass frames; oscillographs; plumb lines; mirrors [optics]; eyeglasses; sunglasses; goggles for sports; electronic collars to train animals; signalling panels, luminous or mechanical; wah-wah pedals; pince-nez; switches, electric; periscopes; data gloves; gloves for divers; gloves for protection against accidents; gloves for protection against X-rays for industrial purposes; asbestos gloves for protection against accidents; furnaces for laboratory use; plates for batteries; wafers for integrated circuits; printed circuit boards; compact disc players; cassette players; protective films adapted for computer screens; protective films adapted for smartphones; sound recording strips; X-ray films, exposed; films, exposed; life-saving rafts; laboratory trays; digital signs; stands adapted for laptops; semi-conductors; personal digital assistants [PDAs]; fire pumps; life belts; fuses; circuit breakers; converters, electric; telerupters; food analysis apparatus; naval signalling apparatus; prisms [optics]; hemline markers; retorts' stands; apparatus for changing record player needles; drainers for use in photography; cleaning apparatus for sound recording discs; fire beaters; telescopic sights for firearms; telescopic sights for artillery; test tubes; magnetic wires; telegraph wires; telephone wires; wires, electric; conductors, electric; copper wire, insulated; fuse wire; rods for water diviners; distribution consoles [electricity];

masts for wireless aerials; transmitting sets [telecommunication]; radios; vehicle radios; sprinkler systems for fire protection; frames for photographic transparencies; screens for photoengraving; flowmeters; walkie-talkies; voltage surge protectors; cell switches [electricity]; washing trays [photography]; marking gauges [joinery]; time switches, automatic; relays, electric; safety restraints, other than for vehicle seats and sports equipment; X-ray photographs, other than for medical purposes; rheostats; respirators for filtering air; retorts; refractometers; refractors; grids for batteries; electric sockets; speaking tubes; horns for loudspeakers; subwoofers; optical fibers [light conducting filaments]; traffic-light apparatus [signalling devices]; dog whistles; signalling whistles; sports whistles; inductors [electricity]; safety nets; nets for protection against accidents; fire alarms; signals, luminous or mechanical; rescue flares, non-explosive and non-pyrotechnic; sirens; connections for electric lines; couplings, electric; sonars; sound locating instruments; lighting ballasts; resistances, electric; spectrograph apparatus; spectroscopes; satellites for scientific purposes; protection devices for personal use against accidents; charging stations for electric vehicles; radiotelegraphy sets; radiotelephony sets; spectacle lenses; anti-glare glasses; optical glass; personal stereos; stereoscopes; stands for photographic apparatus; stroboscopes; fire boats; sulfimeters; bags adapted for laptops; drying racks [photography]; spherometers; integrated circuits; printed circuits; counters; parking meters; ear plugs for divers; television apparatus; telegraphs [apparatus]; telescopes; teleprompters; crucibles [laboratory]; tone arms for record players; transistors [electronic]; transponders; transformers [electricity]; step-up transformers; resuscitation training simulators; vehicle breakdown warning triangles; triodes; starter cables for motors; discharge tubes, electric, other than for lighting; capillary tubes; neon signs; X-ray tubes not for medical purposes; telephone receivers; headgear being protective helmets; light-emitting electronic pointers; amplifiers; particle accelerators; steering apparatus, automatic, for vehicles; balancing apparatus; invoicing machines; tape recorders; protection devices against X-rays, not for medical purposes; railway traffic safety appliances; oxygen transvasing apparatus; theft prevention installations, electric; film cutting apparatus; drying apparatus for photographic prints; optical cha-

racter readers; centering apparatus for photographic transparencies; battery chargers; chargers for electric batteries; chargers for electronic cigarettes; acoustic alarms; apparatus for editing cinematographic film; cathodic anti-corrosion apparatus; couplers [data processing equipment]; anti-theft warning apparatus; anti-interference devices [electricity]; demagnetizing apparatus for magnetic tapes; acoustic couplers; alarms; fog signals, non-explosive; whistle alarms; adding machines; photocopiers [photographic, electrostatic, thermic]; electric and electronic effects units for musical instruments; filters for respiratory masks; filters for ultraviolet rays, for photography; filters for use in photography; magic lanterns; optical lamps; signal lanterns; cameras [photography]; glazing apparatus for photographic prints; shutters [photography]; darkrooms [photography]; photometers; flashbulbs [photography]; digital photo frames; enlarging apparatus [photography]; photovoltaic cells; containers for contact lenses; eyeglass cases; containers for microscope slides; cases for smartphones; cases especially made for photographic apparatus and instruments; laboratory centrifuges; eyeglass chains; cyclotrons; Petri dishes; sleeves for laptops; covers for personal digital assistants [PDAs]; covers for tablet computers; covers for smartphones; fire blankets; chips [integrated circuits]; electrified rails for mounting spot lights; asbestos screens for firemen; fire hose; virtual reality headsets; protective helmets for sports; head guards for sports; lifeboats; snorkels; cell phone straps; eyeglass cords; tripods for cameras; switchboards; distribution boards [electricity]; screens [photography]; workmen's protective face-shields; projection screens; radiology screens for industrial purposes; fluorescent screens; ducts [electricity]; galvanic cells; epidiascopes; armatures [electricity].

10 – Surgical, medical, dental and veterinary apparatus and instruments; artificial limbs, eyes and teeth; orthopedic articles; suture materials; therapeutic and assistive devices adapted for the disabled; massage apparatus; apparatus, devices and articles for nursing infants; sexual activity apparatus, devices and articles; analyzers for bacterial identification for medical purposes; cholesterol meters; blood testing apparatus; testing apparatus for medical purposes; apparatus for use in medical analysis; anaesthetic apparatus; galvanic therapeutic appliances; apparatus for artificial respiration; apparatus for the treatment of deafness; physical ex-

ercise apparatus for medical purposes; body rehabilitation apparatus for medical purposes; dental apparatus and instruments; surgical apparatus and instruments; resuscitation apparatus; dental apparatus, electric; physiotherapy apparatus; bed vibrators; hot air therapeutic apparatus; diagnostic apparatus for medical purposes; traction apparatus for medical purposes; radiotherapy apparatus; microdermabrasion apparatus; fumigation apparatus for medical purposes; apparatus for the regeneration of stem cells for medical purposes; apparatus for DNA and RNA testing for medical purposes; apparatus and installations for the production of X-rays, for medical purposes; magnetic resonance imaging [MRI] apparatus for medical purposes; orthodontic appliances; radiological apparatus for medical purposes; X-ray apparatus for medical purposes; hearing aids; nasal aspirators; trusses; maternity belts; bandages, elastic; cupping glasses; biomagnetic rings for therapeutic or medical purposes; dental burs; acupressure bands; bracelets for medical purposes; anti-nausea wristbands; anti-rheumatism bracelets; feeding bottles; air cushions for medical purposes; vaporizers for medical purposes; hot air vibrators for medical purposes; vibromassage apparatus; gastroscopes; haemocytometers; glucose meters; lice combs; surgical sponges; defibrillators; dialyzers; containers especially made for medical waste; clips, surgical; mirrors for dentists; mirrors for surgeons; probes for medical purposes; urethral probes; artificial teeth; acupuncture needles; suture needles; needles for medical purposes; pill crushers; biodegradable bone fixation implants; surgical implants comprised of artificial materials; inhalers; hydrogen inhalers; injectors for medical purposes; incubators for medical purposes; incubators for babies; obstetric apparatus; obstetric apparatus for cattle; electric acupuncture instruments; surgical cutlery; insufflators; endoscopy cameras for medical purposes; cannulae; droppers for medical purposes; dropper bottles for medical purposes; heart monitors; heart pacemakers; catheters; catgut; draw-sheets for sick beds; enema apparatus for medical purposes; clips for dummies; artificial skin for surgical purposes; menstrual cups; teething rings; anti-rheumatism rings; compressors [surgical]; thermo-electric compresses [surgery]; abdominal corsets; corsets for medical purposes; crutches; dentists' armchairs; armchairs for medical or dental purposes; waterbeds for medical purposes; air beds for medical purpo-

ses; beds specially made for medical purposes; feeding bottle valves; love dolls [sex dolls]; lasers for medical purposes; lamps for medical purposes; curing lamps for medical purposes; quartz lamps for medical purposes; ultraviolet ray lamps for medical purposes; lancets; lenses [intraocular prostheses] for surgical implantation; spoons for administering medicine; masks for use by medical personnel; respiratory masks for artificial respiration; anaesthetic masks; therapeutic facial masks; gum massagers for babies; childbirth mattresses; air mattresses for medical purposes; furniture especially made for medical purposes; water bags for medical purposes; douche bags; breast pumps; body fat monitors; body composition monitors; urinals being vessels; portable hand-held urinals; teeth protectors for dental purposes; temperature indicator labels for medical purposes; knee bandages, orthopaedic; tips for crutches; finger guards for medical purposes; medical guidewires; pumps for medical purposes; thread, surgical; knives for surgical purposes; scissors for surgery; ambulance stretchers; stretchers, wheeled; boots for medical purposes; orthopaedic footwear; clothing especially for operating rooms; compression garments; blankets, electric, for medical purposes; supports for flat feet; ophthalmometers; ophthalmoscopes; cooling pads for first aid purposes; slings [supporting bandages]; gloves for massage; gloves for medical purposes; pessaries; saws for surgical purposes; ear picks; cooling patches for medical purposes; spittoons for medical purposes; plaster bandages for orthopaedic purposes; supportive bandages; suspensory bandages; abdominal pads; cushions for medical purposes; pads for preventing pressure sores on patient bodies; air pillows for medical purposes; soporific pillows for insomnia; heating cushions, electric, for medical purposes; abdominal belts; galvanic belts for medical purposes; hypogastric belts; belts for medical purposes; orthopaedic belts; umbilical belts; belts, electric, for medical purposes; condoms; aerosol dispensers for medical purposes; sphygmomanometers; pulse meters; esthetic massage apparatus; veterinary apparatus and instruments; medical apparatus and instruments; urological apparatus and instruments; brushes for cleaning body cavities; invalids' hoists; appliances for washing body cavities; corn knives; incontinence sheets; sterile sheets, surgical; surgical drapes; hair prostheses; artificial breasts; artificial jaws; ice bags for medical purposes; toe separators for orthopae-

dic purposes; surgical bougies; orthodontic rubber bands; X-ray photographs for medical purposes; respirators for artificial respiration; surgical robots; ear trumpets; strait jackets; sex toys; scalpels; tongue scrapers; dummies for babies; feeding bottle teats; baby feeding dummies; receptacles for applying medicines; spirometers [medical apparatus]; vaginal syringes; implantable subcutaneous drug delivery devices; hearing protectors; contraceptives, non-chemical; orthopaedic soles; stents; stethoscopes; operating tables; commode chairs; basins for medical purposes; bed pans; instrument cases for use by doctors; arch supports for footwear; ear plugs [ear protection devices]; thermal packs for first aid purposes; thermometers for medical purposes; tomographs for medical purposes; trocars; walking sticks for medical purposes; quad canes for medical purposes; drainage tubes for medical purposes; X-ray tubes for medical purposes; radium tubes for medical purposes; balling guns; protection devices against X-rays, for medical purposes; apparatus for acne treatment; filters for ultraviolet rays, for medical purposes; patient examination gowns; wheeled walkers to aid mobility; walking frames for disabled persons; cases fitted for medical instruments; elastic stockings for surgical purposes; stockings for varices; splints, surgical; tongue depressors for medical purposes; syringes for injections; syringes for medical purposes; hypodermic syringes; uterine syringes; urethral syringes; pins for artificial teeth; castrating pincers; forceps; robotic exoskeleton suits for medical purposes; radiology screens for medical purposes; electrodes for medical use; electrocardiographs; brain pacemakers.

11 – Apparatus and installations for lighting, heating, cooling, steam generating, cooking, drying, ventilating, water supply and sanitary purposes; lamp shades; steam accumulators; heat accumulators; defrosters for vehicles; disinfectant apparatus for medical purposes; distillation apparatus; desiccating apparatus; hydromassage bath apparatus; disinfectant apparatus; air deodorizing apparatus; tanning apparatus [sun beds]; ionization apparatus for the treatment of air or water; coffee roasters; beverage cooling apparatus; hand drying apparatus for washrooms; fruit roasters; water purifying apparatus and machines; refrigerating apparatus and machines; drying apparatus and installations; freezers; heating and cooling apparatus for dispensing hot and cold beverages; drying apparatus; coolers

for furnaces; expansion tanks for central heating installations; flushing tanks; refining towers for distillation; bidets; boilers, other than parts of machines; bath tubs; spa baths [vessels]; bath tubs for sitz baths; waffle irons, electric; fans [air-conditioning]; fans [parts of air-conditioning installations]; electric fans for personal use; roasting spits; refrigerating display cabinets; heated display cabinets; water heaters; water heaters [apparatus]; water flushing installations; air reheaters; extractor hoods for kitchens; gas condensers, other than parts of machines; acetylene generators; microbubble generators for baths; hydrants; string lights for festive decoration; burners; acetylene burners; gas burners; burners for lamps; germicidal burners; incandescent burners; oxyhydrogen burners; laboratory burners; oil burners; alcohol burners; hot water bottles; footwarmers, electric or non-electric; bed warmers; USB-powered hand warmers; pocket warmers; warming pans; grills [cooking appliances]; food dehydrators, electric; lampshade holders; stills; showers; refrigerating containers; gas lighters; lighters; friction lighters for igniting gas; chimney blowers; coils [parts of distilling, heating or cooling installations]; furnace ash boxes; evaporators; electric appliances for making yoghurt; shower enclosures; Turkish bath cabinets, portable; heating apparatus; cool boxes, electric; refrigerating chambers; fireplaces, domestic; chimney flues; structural framework for ovens; air valves for steam heating installations; level controlling valves in tanks; thermostatic valves [parts of heating installations]; electrically heated carpets; light bulbs; light bulbs, electric; solar thermal collectors [heating]; distillation columns; furnace grates; ventilation hoods; ventilation hoods for laboratories; lamp globes; air-conditioning apparatus; air conditioners for vehicles; gas boilers; laundry room boilers; heating boilers; coffee machines, electric; faucets for pipes and pipelines; taps; mixer faucets for water pipes; forges, portable; lava rocks for use in barbecue grills; couscous cookers, electric; electric lights for Christmas trees; acetylene flares; safety lamps; gas lamps; curling lamps; nail lamps; curing lamps, not for medical purposes; germicidal lamps for purifying air; light bulbs for directional signals for vehicles; arc lamps; laboratory lamps; oil lamps; ultraviolet ray lamps, not for medical purposes; miners' lamps; electric lamps; chandeliers; barbecues; bread baking machines; watering machines for agricultural purposes; ice-cream making

machines; pounded rice cake making machines, electric, for household purposes; multicookers; footmuffs, electrically heated; heaters for baths; heaters for heating irons; immersion heaters; brackets for gas burners; anti-splash tap nozzles; heat pumps; filaments for electric lamps; magnesium filaments for lighting; heating filaments, electric; luminous house numbers; socks, electrically heated; heating apparatus for defrosting vehicle windows; hot air bath fittings; bath fittings; loading apparatus for furnaces; kiln furniture [supports]; sauna bath installations; refrigerating appliances and installations; directional lights for bicycles; electrically heated clothing; blankets, electric, not for medical purposes; fabric steamers; lamp reflectors; vehicle reflectors; hearths; electric cooktops; food steamers, electric; steam boilers, other than parts of machines; pasteurisers; lamp mantles; sockets for electric lights; coffee percolators, electric; stoves [heating apparatus]; bakers' ovens; hot air ovens; kitchen ranges [ovens]; microwave ovens [cooking apparatus]; microwave ovens for industrial purposes; incinerators; kilns; solar furnaces; dental ovens; furnaces, other than for laboratory use; urinals being sanitary fixtures; feeding apparatus for heating boilers; heating plates; cookers; hot plates; wine cellars, electric; heaters, electric, for feeding bottles; aquarium heaters; USB-powered cup heaters; aquarium lights; heating cushions, electric, not for medical purposes; clean chambers [sanitary installations]; tortilla presses, electric; water intake apparatus; deodorizing apparatus, not for personal use; apparatus for dehydrating food waste; fumigation apparatus, not for medical purposes; gas scrubbing apparatus; oil-scrubbing apparatus; glue-heating appliances; forage drying apparatus; water filtering apparatus; air purifying apparatus and machines; ice machines and apparatus; cooling appliances and installations; cooking apparatus and installations; lighting apparatus and installations; sanitary apparatus and installations; cooking rings; lighting apparatus for vehicles; light-emitting diodes [LED] lighting apparatus; heating apparatus for solid, liquid or gaseous fuels; heating apparatus, electric; hot air apparatus; steam facial apparatus [saunas]; safety accessories for water or gas apparatus and pipes; regulating and safety accessories for gas apparatus; regulating accessories for water or gas apparatus and pipes; regulating and safety accessories for water apparatus; regulating and safety accessories for gas pipes; an-

ti-glare devices for vehicles [lamp fittings]; roasting jacks; plate warmers; rotisseries; radiator caps; searchlights; diving lights; washers for water faucets; heat guns; radiators [heating]; central heating radiators; radiators, electric; sinks; disinfectant dispensers for toilets; drip irrigation emitters [irrigation fittings]; light diffusers; nuclear reactors; heat regenerators; pressure water tanks; roasters; lamps; standard lamps; floor lamps; ceiling lights; toilet seats; hydroponic growing systems; lighting installations for air vehicles; sous-vide cookers, electric; pressure cookers, electric; gas scrubbers [parts of gas installations]; lamp glasses; sterilizers; water sterilizers; air sterilizers; air dryers; laundry dryers, electric; hair dryers; malt roasters; tobacco roasters; tajines, electric; heat exchangers, other than parts of machines; thermopots, electric; bread toasters; discharge tubes, electric, for lighting; lamp chimneys; luminous tubes for lighting; pipes [parts of sanitary installations]; flues for heating boilers; boiler pipes [tubes] for heating installations; toilets [water-closets]; toilets, portable; humidifiers for central heating radiators; wash-hand basins [parts of sanitary installations]; toilet bowls; water conduits installations; bath plumbing fixtures; air-conditioning installations; desalination plants; installations for processing nuclear fuel and nuclear moderating material; watering installations, automatic; cooling installations for water; cooling installations for liquids; milk cooling installations; cooling installations for tobacco; water purification installations; purification installations for sewage; steam generating installations; water distribution installations; air filtering installations; swimming pool chlorinating apparatus; ventilation [air-conditioning] installations and apparatus; ventilation [air-conditioning] installations for vehicles; water softening apparatus and installations; cooling installations and machines; heating installations; heaters for vehicles; hot water heating installations; polymerisation installations; water supply installations; flare stacks for use in the oil industry; ash conveyor installations, automatic; whirlpool-jet apparatus; air cooling apparatus; aquarium filtration apparatus; cooking utensils, electric; flaming torches; headlights for automobiles; vehicle headlights; filters for air conditioning; filters for drinking water; wicks adapted for oil stoves; lights for automobiles; bicycle lights; motorcycle lights; lights for vehicles; electric torches; head torches; lanterns for lighting; candle

lanterns; street lamps; Chinese lanterns; fountains; ornamental fountains; chocolate fountains, electric; air fryers; deep fryers, electric; fittings, shaped, for ovens; oven fittings made of fireclay; bread-making machines; refrigerators; refrigerators, cooling apparatus and freezers for medical storage purposes; chromatography apparatus for industrial purposes; kettles, electric; dampers [heating]; book sterilization apparatus; refrigerating cabinets; carbon for arc lamps; heating elements.

14 – Precious metals and their alloys; jewellery, precious and semi-precious stones; horological and chronometric instruments; agates; diamonds; amulets [jewelry]; anchors [clock- and watchmaking]; barrels [clock- and watchmaking]; bracelets [jewelry]; bracelets made of embroidered textile [jewellery]; watch bands; charms for key rings; jewellery charms; brooches [jewelry]; alarm clocks; pins [jewelry]; ornamental pins; tie pins; jewellery hat pins; beads for making jewelry; pearls made of ambroid [pressed amber]; busts of precious metal; jewelry rolls; jet, unwrought or semi-wrought; jewelry findings; key rings [split rings with trinket or decorative fob]; retractable key rings; pearls [jewelry]; copper tokens; tie clips; cufflinks; clasps for jewelry; badges of precious metal; gold, unwrought or beaten; cloisonné jewelry; works of art of precious metal; ivory jewelry; jewelry of yellow amber; iridium; cabochons; spun silver [silver wire]; necklaces [jewelry]; split rings of precious metal for keys; rings [jewelry]; boxes of precious metal; presentation boxes for jewelry; watch cases [parts of watches]; clock cases; pendulums [clock- and watchmaking]; medals; locket [jewelry]; precious metals, unwrought or semi-wrought; movements for clocks and watches; clockworks; misbaha [prayer beads]; coins; gold thread [jewelry]; threads of precious metal [jewelry]; silver thread [jewelry]; olivine [gems]; osmium; palladium; platinum [metal]; watch springs; crucifixes of precious metal, other than jewelry; crucifixes as jewelry; rhodium; ruthenium; stopwatches; silver, unwrought or beaten; earrings; ingots of precious metals; statues of precious metal; figurines of precious metal; watch glasses; paste jewelry [costume jewelry]; watch hands; clock hands; ornaments of jet; shoe jewelry; hat jewelry; presentation boxes for watches; chronographs [watches]; chronometers; chronoscopes; chains [jewelry]; watch chains; dials [clock- and watchmaking]; atomic clocks; watches; sundials; clocks and watches, electric;

control clocks [master clocks]; clocks; wristwatches; rosaries; jewelry boxes; spinel [precious stones].

18 – Leather and imitations of leather; animal skins; luggage and carrying bags; umbrellas and parasols; walking sticks; whips, harness and saddlery; collars, leashes and clothing for animals; mountaineering sticks; slings for carrying infants; luggage tags; pocket wallets; saddlecloths for horses; business card cases; reins; reins for guiding children; sling bags for carrying infants; harness fittings; credit card cases [wallets]; parts of rubber for stirrups; chamois leather, other than for cleaning purposes; umbrellas; parasols; saddlery; frames for umbrellas or parasols; handbag frames; card cases [notecases]; cases of leather or leatherboard; valves of leather; imitation leather; leather, unworked or semi-worked; leatherboard; casings, of leather, for springs; umbrella rings; hat boxes of leather; boxes of leather or leatherboard; boxes of vulcanized fiber; purses; chain mesh purses; fastenings for saddles; butts [parts of hides]; saddle trees; bags [envelopes, pouches] of leather, for packing; moleskin [imitation of leather]; travelling sets [leatherware]; knee-pads for horses; muzzles; halters; vanity cases, not fitted; furniture coverings of leather; clothing for pets; covers for animals; trimmings of leather for furniture; hiking sticks; conference folders; music cases; goldbeaters' skin; cat o' nine tails; leather leashes; pads for horse saddles; horseshoes; girths of leather; leathercloth; horse blankets; garment bags for travel; shoulder belts [straps] of leather; briefcases; traces [harness]; fur; randsels [Japanese school satchels]; haversacks; leather straps; straps for soldiers' equipment; harness straps; straps for skates; straps of leather [saddlery]; chin straps, of leather; stirrup leathers; umbrella handles; walking stick handles; suitcase handles; grips for holding shopping bags; rucksacks; travelling bags; riding saddles; net bags for shopping; umbrella or parasol ribs; stirrups; bags for climbers; tool bags, empty; handbags; beach bags; saddlebags; compression cubes adapted for luggage; bags for sports; bags for campers; shopping bags; wheeled shopping bags; school satchels; bags; pouch baby carriers; travelling trunks; trunks [luggage]; nose bags [feed bags]; bridoons; umbrella sticks; walking stick seats; tefillin [phylacteries]; bits for animals [harness]; bridles [harness]; harness for animals; key cases; horse collars; suitcases; motorized suitcases; suitcases with wheels;

valises; attaché cases; covers for horse saddles; umbrella covers; kid; curried skins; cattle skins; leather cord; blinkers [harness]; labels of leather; game bags [hunting accessories].

24 – Textiles and substitutes for textiles; frieze [cloth]; banners of textile or plastic; velvet; household linen; diapered linen; bath linen, except clothing; bed linen; table linen, not of paper; cot bumpers [bed linen]; buckram; fustian; sleeping bag liners; felt; bunting of textile or plastic; gauze [cloth]; damask; jersey [fabric]; table runners, not of paper; drugget; shower curtains of textile or plastic; curtains of textile or plastic; net curtains; zephyr [cloth]; canvas for tapestry or embroidery; bolting cloth; baby buntings; crepe [fabric]; crepon; marabouts [cloth]; furniture coverings of textile; fabrics for textile use; filtering materials of textile; wall hangings of textile; non-woven textile fabrics; plastic material [substitute for fabrics]; textile material; tablemats of textile; bivouac sacks being covers for sleeping bags; sleeping bags; sleeping bags for babies; moleskin [fabric]; muslin fabric; pillowcases; mattress covers; bed blankets; blankets for household pets; brocades; diaper changing cloths for babies; handkerchiefs of textile; picnic blankets; travelling rugs [lap robes]; coasters of textile; bed valances; linings [textile]; hat linings, of textile, in the piece; curtain holders of textile material; bed covers; bed covers of paper; furniture coverings of plastic; towels of textile; hemp cloth; gummed cloth, other than for stationery purposes; printers' blankets of textile; cloth; door curtains; sheets [textile]; eiderdowns [down coverlets]; bath mitts; shrouds; glass cloths [towels]; cloths for removing make-up; face towels of textile; place mats of textile; table napkins of textile; mosquito nets; calico; oilcloth for use as tablecloths; tablecloths, not of paper; billiard cloth; taffeta [cloth]; ticks [mattress covers]; tick [linen]; lingerie fabric; fabric, impervious to gases, for aeronautical balloons; jute fabric; fabric for footwear; ramie fabric; esparto fabric; rayon fabric; fiberglass fabrics for textile use; adhesive fabric for application by heat; linen cloth; upholstery fabrics; hemp fabric; lining fabric for footwear; traced cloth for embroidery; chenille fabric; printed calico cloth; knitted fabric; cotton fabrics; silk fabrics for printing patterns; woollen cloth; elastic woven material; fabric; fabric of imitation animal skins; haircloth [sackcloth]; cheese cloth; tulle; flags of textile or plastic; flannel [fabric]; trellis [cloth]; co-

vers for cushions; fitted toilet lid covers of fabric; covers [loose] for furniture; pillow shams; chevions [cloth]; silk [cloth]; labels of textile.

25 – Clothing, footwear, headgear; wimples; bandanas [neckerchiefs]; underwear; sweat-absorbent underwear; berets; overalls; boas [necklets]; teddies [underclothing]; boxer shorts; ankle boots; ski boots; boots for sports; breeches for wear; trousers; football boots; brassieres; valenki [felted boots]; mittens; collars [clothing]; detachable collars; shirt yokes; veils [clothing]; gabardines [clothing]; galoshes; neckties; ascots; leggings [leg warmers]; gaiters; boot uppers; corselets; jerseys [clothing]; vests; sports jerseys; hosiery; heels; hoods [clothing]; hat frames [skeletons]; pockets for clothing; neck scarfs [mufflers]; caps being headwear; kimonos; cap peaks; visors being headwear; tights; slips [underclothing]; combinations [clothing]; wet suits for water-skiing; bodices [lingerie]; corsets [underclothing]; suits; bathing suits; masquerade costumes; beach clothes; leotards; jackets [clothing]; stuff jackets [clothing]; fishing vests; leggings [trousers]; liveries; camisoles; sports singlets; cuffs; short-sleeve shirts; mantillas; coats; sleep masks; furs [clothing]; hand warmers [fingerless gloves]; fingerless gloves; miters [hats]; muffs [clothing]; footmuffs, not electrically heated; bibs, not of paper; bibs, sleeved, not of paper; fur stoles; hairdressing capes; heel protectors for shoes; ear muffs [clothing]; socks; sweat-absorbent socks; beach shoes; sports shoes; paper clothing; outer-clothing; embroidered clothing; ready-made clothing; motorists' clothing; cyclists' clothing; clothing for gymnastics; clothing of imitations of leather; clothing of leather; waterproof clothing; uniforms; clothing containing slimming substances; fittings of metal for footwear; maniples; overcoats; panties; parkas; pelerines; gloves [clothing]; ski gloves; pajamas; bathing trunks; shirt fronts; scarfs; pocket squares; dresses; headbands [clothing]; garters; sock suspenders; stocking suspenders; ready-made linings [parts of clothing]; dress shields; soles for footwear; heelpieces for footwear; braces for clothing [suspenders]; half-boots; lace boots; ponchos; girdles; belts [clothing]; money belts [clothing]; layettes [clothing]; non-slipping devices for footwear; sweaters; heelpieces for stockings; welts for footwear; chasubles; shirts; wooden shoes; sandals; bath sandals; boots; jumper dresses; saris; sarongs; footwear uppers; inner soles; albs; bath slippers; togas; knitwear [clothing];

underpants; gymnastic shoes; slippers; shoes; skull caps; turbans; aprons [clothing]; judo uniforms; karate uniforms; tee-shirts; dressing gowns; bath robes; top hats; tips for footwear; stockings; sweat-absorbent stockings; shawls; paper hats [clothing]; shower caps; bathing caps; sashes for wear; studs for football boots; hats; babies' pants [underwear]; trouser straps; pelisses; esparto shoes or sandals; skirts; petticoats; skorts.

26 – Lace, braid and embroidery, and haberdashery ribbons and bows; buttons, hooks and eyes, pins and needles; artificial flowers; hair decorations; false hair; appliqués [haberdashery]; haberdashery bows; fringes; mica spangles; shoe eyelets; false beards; charms, other than for jewellery, key rings or key chains; brooches [clothing accessories]; hat pins, other than jewellery; entomological pins; pins, other than jewelry; beads, other than for making jewelry; wreaths of artificial flowers; artificial Christmas wreaths; artificial Christmas wreaths incorporating lights; human hair; lace for edgings; artificial garlands; artificial Christmas garlands; artificial Christmas garlands incorporating lights; darning lasts; expanding bands for holding sleeves; frills [lacework]; trouser clips for cyclists; bobby pins; hair barrettes; heat adhesive patches for repairing textile articles; blouse fasteners; shoe fasteners; fastenings for clothing; fastenings for suspenders; belt clasps; hook and pile fastening tapes; zippers; zippers for bags; badges for wear, not of precious metal; competitors' numbers; embroidery needles; needles for wool combing machines; binding needles; saddlers' needles; shoemakers' needles; sewing needles; darning needles; boxes for needles; lace trimmings; haberdashery [dressmakers' articles], except thread; decorative articles for the hair; heat adhesive patches for decoration of textile articles [haberdashery]; edgings for clothing; braids; gold embroidery; silver embroidery; bobbins for retaining embroidery floss or wool [not parts of machines]; tassels [haberdashery]; snap fasteners; sewing boxes; tresses of hair; false hems; hooks [haberdashery]; crochet needles; rug hooks; hooks for corsets; shoe hooks; haberdashery ribbons; ribbons for the hair; ribbons and bows, not of paper, for gift wrapping; prize ribbons; hatbands; elastic ribbons; letters for marking linen; numerals for marking linen; numerals or letters for marking linen; sewing kits; toupees; sewing thimbles; needle-threaders; skirt flounces; bows for the hair; spangles for clothing; hair curling

papers; wigs; feathers [clothing accessories]; birds' feathers [clothing accessories]; ostrich feathers [clothing accessories]; eyelets for clothing; picot [lace]; whalebones for corsets; hair bands; brassards; tapes for curtain headings; shoulder pads for clothing; pin cushions; needle cushions; top-knots [pompoms]; hair curlers, electric and non-electric, other than hand implements; buckles [clothing accessories]; shoe buckles; ornamental novelty badges [buttons]; artificial plants, other than Christmas trees; rosettes [haberdashery]; frills for clothing; hair nets; chenille [passementerie]; knitting needles; cords for trimming; shoe trimmings; trimmings for clothing; hat trimmings; false moustaches; festoons [embroidery]; artificial fruit; needle cases; shuttles for making fishing nets; hair coloring caps; bodkins; hair extensions; shoe laces; cords for clothing; woollen laces; hair pins; hair curling pins; collar supports.

(260) AM 2020 106561 A
 (800) 1508409
 (151) 2019 10 09
 (891) 2019 10 09
 (731) WORLD ETHNO "NOMADIADA" LTD
 64, Omirou Street, Imperium Tower,
 CY-3096 Limassol, Cyprus
 (540)



(591) Pantone 605, Pantone Purple C,
 Pantone/PMS 2421 C, Pantone/PMS 1655,
 Pantone/PMS 1585, Pantone/PMS 7480,
 Pantone/PMS 311 CP, Pantone/PMS
 18-1664 TCX, Plascon Eyes of Iris B7-A1-3,
 Pantone/PMS 2582 C.
 (531) 03.07.17; 27.03.01; 27.05.01; 29.01.15
 (511)
 38 – Telecommunication; provision and rental of telecommunications facilities and equipment; telecommunication network services.

(260) AM 2020 106563 A
 (800) 1508481
 (151) 2019 08 26
 (891) 2019 08 26
 (731) "SOUTHERN JUICE COMPANY" Limited
 Pobedy st., 132, Belorechensk, RU-352630
 Krasnodar region, Russian Federation
 (540)

Better than milk

(591) Black, white
 (511)
 29 – Preserved, frozen, dried and cooked fruits and vegetables; jellies, jams, compotes; jellies for food; fruit jellies; fruit-based snack food; arrangements of processed fruit; compotes; fruits, tinned; buttercream; marmalade; pressed fruit paste; jams; fruit salads; crystallized fruits; frozen fruits; fruit, preserved; fruit preserved in alcohol; fruit, stewed; fruit peel; fruit chips.

30 – Bread, pastries and confectionery; ice cream; flavorings, other than essential oils, for beverages; food flavorings, other than essential oils; cereal bars; high-protein cereal bars; pancakes; buns; bread rolls; vareniki [stuffed dumplings]; waffles; zephyr [confectionery]; fruit jellies [confectionery]; cakes; pastries; frozen yogurt [confectionery ices]; caramels [candy]; quiches; sweetmeats [candy]; dulce de leche; custard; candy; macaroons [pastry]; pastila [confectionery]; pastilles [confectionery]; cookies; petit-beurre biscuits; pies; fondants [confectionery]; pralines; gingerbread; petits fours [cakes]; puddings; fruit coulis [sauces]; confectionery; sherbets [ices]; chocolate-based spreads; chocolate spreads containing nuts; tarts; tea; iced tea; confectionery based on custard mix; custard mix; custard-based fillings for cakes and pastries, including oat-based fillings; cream cakes and pastries, including oat-based; custard pastry desserts, including oat-based.

32 – Mineral and aerated waters; fruit beverages and fruit juices; lithia water; seltzer water; soda water; aerated water; mineral water [beverages]; waters [beverages]; table waters; cocktails, non-alcoholic; lemonades; soft drinks; non-alcoholic fruit juice beverages; fruit nectars, non-alcoholic; fruit juices; sherbets [beverages]; non-alcoholic fruit extracts.

35 – Advertising; business management; business administration; organization of trade fairs and

exhibitions for commercial or advertising purposes; presentation of goods on communication media, for retail purposes; sales promotion for others; retail and wholesale store services including online services; market studies; public relations.

(260) AM 2020 106569 A

(800) 1508565

(151) 2019 06 21

(891) 2019 06 21

(731) TOBB UND LOJİSTİK YATIRIM ANONİM

ŞİRKETİ

Eskişehir Yol.Kat-Dumlupınar Blv., No.252

Tobb İkiz Kuleler C Kule K.27, Çankaya

Ankara, Turkey

(540)



(591) Orange, grey

(531) 27.05.09; 27.05.17; 29.01.12

(511)

9 – Computer programs and software for land, water, rail and intermodal transportation systems.

35 – Collecting, compiling and management of computerized databases consisting of transit notifications and reports, clerical services for document verification/validation related to customs legislation, administration and management services of customer information and/or business information related to customs legislation with the aid of computer data.

36 – Customs brokerage services, electronic transfer of custom transit declaration services to custom offices, services of providing assurance for customs tariff and similar customs credits that will originate before customs offices domestically and abroad related to the international transportation activities, particularly the international transportations to be performed in accordance with the common transit provisions of common transit convention and customs regulation.

38 – Radio and television broadcasting services, telecommunication services; providing access to Internet, news agencies.

39 – Services for renting land, water and air transportation vehicles and services for land, water and air transportation.

42 – Software development services for analysis and verification of the appropriateness of custom transit declarations according to the national/international/supranational regulations of customs procedures for goods and services; software development services for customer and business information system services related to customs transit declarations.

(260) AM 2020 106570 A

(800) 1508581

(151) 2019 10 18

(891) 2019 10 18

(731) Obshestvo s ogranichennoy

otvetstvennostyu "J-UNITED GROUP"

OOO "J-UNITED GROUP", 83, Beruniy

street, Olmazarskiy district, Tashkent city

100020, Uzbekistan

(540)



(591) Red, black and white

(531) 26.04.01; 26.04.05; 26.04.12; 26.04.18;
26.04.24; 27.05.09; 27.05.17; 29.01.13

(511)

35 – Advertising; business management; business administration; office functions.

(260) AM 2020 106571 A

(800) 1508598

(151) 2019 07 08

(891) 2019 07 08

(731) Open Joint Stock Company "Molochny

kombinat Voronegsky"

45 Strelkovoy Divizi, 259, RU-394016

Voroneg, Russian Federation

(540)



(591) Green, light green, blue, light blue, orange and white

(531) 01.15.15; 26.01.02; 26.01.16; 26.01.24; 28.05;
29.01.14

(511)

29 – Meat, fish, poultry and game; meat extracts; preserved, frozen, dried and cooked fruits and vegetables; jellies, jams, compotes; eggs, milk and milk products; oils and fats for food; alginates for culinary purposes; anchovy, not live; peanuts, prepared; albumen for culinary purposes; white of eggs; beans, preserved; soya beans, preserved, for food; bouillon; ginger jam; fatty substances for the manufacture of edible fats; edible birds' nests; peas, preserved; mushrooms, preserved; gelatine; meat jellies; jellies for food; fruit jellies; yolk of eggs; coconut fat; bone oil for food; lard; suet for food; fruit-based snack food; charcuterie; raisins; caviar; yogurt; sauerkraut; kephir [milk beverage]; isinglass for food; black pudding; meat, tinned; vegetables, tinned; fish, tinned; fruits, tinned; bouillon concentrates; gherkins; shrimps, not live; buttercream; croquettes; silkworm chrysalis for human consumption; kumys [milk beverage]; kelp, processed; spiny lobsters, not live; salmon, not live; onions, preserved; margarine; marmalade; vegetable oils for food; peanut butter; cocoa butter for food; coconut oil; butter; shellfish, not live; almonds, ground; animal marrow for food; mussels, not live; soya milk being milk substitute; fish meal for human consumption; fruit pulp; meat, preserved; milk beverages, milk predominating; potato fritters; olives, preserved; lobsters, not live; coconut, desiccated; nuts, prepared; tomato purée; liver pâté; pectin for culinary purposes; liver; pickles; jams; powdered eggs; ham; kimchi [fermented vegetable dish]; fish-based foodstuffs; curd; poultry, not live; pollen prepared as foodstuff; cranberry compote; apple purée; crustaceans, not live; fish, not live; fish, preserved; salted fish; vegetable salads; fruit salads; bacon; wieners; sardines, not live; pork; herrings, not live; cream [dairy products]; whipped cream; fat-containing mixtures for bread slices; sour cream; tomato juice for cooking; vegetable juices for cooking; salted meats; sausages; sausages in batter; preparations for making bouillon; preparations for making soup; tripe; soups; vegetable soup preparations; cheese; whey; cheese curds; cheese spreads; tahini [sesame seed paste]; strained cheese; tofu; sea-cucumbers, not live; truffles, preserved; tuna fish; oysters, not live; rennet; fish fillets; dates; crystallized fruits; frozen fruits; fruit preserved in alcohol; potato flakes; hummus [chickpea paste]; fruit peel; lentils, preserved; potato chips; fruit chips; seaweed extracts for

food; snail eggs for consumption; peanut milk-based beverages; almond milk-based beverages.

30 – Piccalilli.

32 – Beer; mineral and aerated waters; fruit beverages and fruit juices; syrups and other preparations for making beverages; aperitifs, non-alcoholic; waters [beverages]; kvass [non-alcoholic beverage]; cocktails, non-alcoholic; lemonades; fruit drinks; isotonic beverages; non-alcoholic honey-based beverages; whey beverages; fruit nectars, non-alcoholic; orgeat; powders for effervescing beverages; sarsaparilla [non-alcoholic beverage]; syrups for lemonade; syrups for beverages; tomato juice [beverage]; apple juice; vegetable juices [beverages]; preparations for making aerated water; must; grape must, unfermented; beer wort; malt wort; pastilles for effervescing beverages; sherbets [beverages]; non-alcoholic fruit extracts; extracts of hops for making beer; essences for making beverages.

35 – Advertising; business management; business administration; office functions; arranging subscriptions to telecommunication services for others; import-export agency services; commercial information agency services; advertising agency services; cost price analysis; rental of advertising space; account auditing; employment agency services; computerized file management; book-keeping; invoicing; demonstration of goods; transcription of communications [office functions]; opinion polling; market studies; business information; commercial information and advice for consumers in the choice of products and services; provision of business statistical information; business investigations; marketing research; personnel recruitment; personnel management consultancy; business organization consultancy; business management consultancy; professional business consultancy; layout services for advertising purposes; business management of performing artists; news clipping services; updating of advertising material; word processing; secretarial services; shorthand; organization of exhibitions for commercial or advertising purposes; arranging newspaper subscriptions for others; organization of trade fairs for advertising purposes; shop window dressing; business appraisals; payroll preparation; data search in computer files for others; sponsorship search; business management assistance; commercial or industrial management assistance; presentation of goods on

communication media, for retail purposes; economic forecasting; auctioneering; sales promotion for others; office machines and equipment rental; rental of advertising time on communication media; publicity material rental; rental of vending machines; rental of photocopying machines; publication of publicity texts; typing; radio advertising; bill-posting; distribution of samples; dissemination of advertising matter; writing of publicity texts; on-line advertising on a computer network; advertising by mail order; television advertising; document reproduction; compilation of statistics; compilation of information into computer databases; business inquiries; systemization of information into computer databases; tax preparation; drawing up of statements of accounts; copywriting; psychological testing for the selection of personnel; business management of hotels; commercial administration of the licensing of the goods and services of others; administrative processing of purchase orders; public relations; modelling for advertising or sales promotion; relocation services for businesses; price comparison services; procurement services for others [purchasing goods and services for other businesses]; outsourcing services [business assistance]; telephone answering for unavailable subscribers; photocopying services; business efficiency expert services.

39 – Packaging and storage of goods; organization of tours; air transport; boat rental; parking place rental; booking of seats for travel; travel reservation; transport reservation; towing; vehicle breakdown towing services; water distribution; delivery of newspapers; message delivery; parcel delivery; delivery of goods; delivery of goods by mail order; flower delivery; launching of satellites for others; traffic information; transportation information; storage information; arranging of cruises; hauling; carting; transport and storage of trash; transporting furniture; barge transport; ferry-boat transport; transport of travellers; freight [shipping of goods]; guarded transport of valuables; bus transport; car transport; boat transport; railway transport; marine transport; passenger transport; river transport; portage; refloating of ships; shipbrokerage; transport brokerage; freight brokerage [forwarding (Am.)]; operating canal locks; car rental; railway truck rental; rental of diving bells; rental of diving suits; rental of motor racing cars; rental of wheelchairs; rental of storage containers; horse rental; refrigerator rental; vehicle rental;

stevedoring; unloading cargo; electricity distribution; distribution of energy; packaging of goods; ambulance transport; garage rental; rental of vehicle roof racks; rental of warehouses; ice-breaking; piloting; water supplying; escorting of travellers; underwater salvage; salvage of ships; taxi transport; streetcar transport; transport by pipeline; car parking; chauffeur services; pleasure boat transport; courier services [messages or merchandise]; transport; franking of mail; freighting; physical storage of electronically stored data or documents; boat storage; storage; transport services for sightseeing tours; freight forwarding; salvaging.

43 – Services for providing food and drink; providing temporary housing accommodation; accommodation bureau services [hotels, boarding houses]; rental of temporary accommodation; rental of meeting rooms; tourist home services; hotel reservations; boarding house bookings; temporary accommodation reservations; hotel services; retirement home services; snack-bar services; café services; cafeteria services; motel services; boarding house services; boarding for animals; rental of chairs, tables, table linen, glassware; rental of tents; rental of transportable buildings; restaurant services; self-service restaurant services; canteen services; holiday camp services [lodging]; bar services; providing campground facilities; food and drink catering; day-nursery [crèche] services.

(260) AM 2020 106572 A

(800) 1508632

(151) 2019 07 25

(891) 2019 07 25

(731) Obshchestvo s ogranichennoy otvetstvennostyu "Upravlyayushchaya, kompania Miksit"
p. Moskovskiy, 22-y km Kievskogo sh., domovl. 4, str. 5, office 713-E,
RU-125362 Moscow, Russian Federation

(540)

MIXIT

(591) Black, white

(511)

3 – Non-medicated cosmetics and toiletry preparations; non-medicated dentifrices; perfumery, essential oils; bleaching preparations and other substances for laundry use; cleaning, polishing, scou-

ring and abrasive preparations; abrasives; amber [perfume]; descaling preparations for household purposes; antistatic preparations for household purposes; aromatics [essential oils]; air fragrancing preparations; cake flavorings [essential oils]; flavorings for beverages [essential oils]; food flavorings [essential oils]; breath freshening sprays; canned pressurized air for cleaning and dusting purposes; balms, other than for medical purposes; basma [cosmetic dye]; lip glosses; nail glitter; polishing stones; abrasive paper; emery paper; polishing paper; petroleum jelly for cosmetic purposes; shoe polish; cobblers' wax; cotton wool for cosmetic purposes; sachets for perfuming linen; drying agents for dishwashing machines; adhesives for cosmetic purposes; scented water; Javelle water; lavender water; toilet water; wax for parquet floors; floor wax; non-slipping wax for floors; depilatory wax; mustache wax; tailors' wax; creams for leather; polish for furniture and flooring; shoemakers' wax; polishing wax; massage gels, other than for medical purposes; heliotropine; dental bleaching gels; geraniol; make-up; deodorants for pets; deodorants for human beings or for animals; depilatory preparations; air fragrance reed diffusers; scented wood; perfumes; non-slipping liquids for floors; windshield cleaning liquids; greases for cosmetic purposes; volcanic ash for cleaning; perfumery; decorative transfers for cosmetic purposes; ionone [perfumery]; shaving stones [astringents]; smoothing stones; eyebrow pencils; cosmetic pencils; silicon carbide [abrasive]; carbides of metal [abrasives]; alum stones [astringents]; tripoli stone for polishing; adhesives for affixing false eyelashes; adhesives for affixing false hair; hair conditioners; quillaia bark for washing; corundum [abrasive]; beard dyes; colorants for toilet purposes; cosmetic dyes; laundry starch; laundry glaze; shoe cream; polishing creams; cosmetic creams; skin whitening creams; polishing rouge; incense; hair spray; nail polish; hair lotions; lotions for cosmetic purposes; after-shave lotions; beauty masks; oils for perfumes and scents; oils for cosmetic purposes; oils for toilet purposes; essential oils of cedarwood; essential oils of lemon; essential oils of citron; oils for cleaning purposes; bergamot oil; gaultheria oil; jasmine oil; lavender oil; almond oil; rose oil; oil of turpentine for degreasing; whitening; cleaning chalk; almond milk for cosmetic purposes; cleansing milk for toilet purposes; musk [perfumery]; deodorant soap; shaving soap; soap for brightening textile;

cakes of toilet soap; antiperspirant soap; soap for foot perspiration; soap; almond soap; mint for perfumery; cosmetic kits; emery; gel eye patches for cosmetic purposes; nail art stickers; false nails; eau de Cologne; bases for flower perfumes; joss sticks; pastes for razor strops; dentifrices; pumice stone; lipstick cases; hydrogen peroxide for cosmetic purposes; breath freshening strips; teeth whitening strips; abrasive cloth; glass cloth [abrasive cloth]; lipsticks; pomades for cosmetic purposes; shaving preparations; cosmetic preparations for baths; bath preparations, not for medical purposes; hair straightening preparations; hair waving preparations; laundry soaking preparations; grinding preparations; smoothing preparations [starching]; color-removing preparations; leather bleaching preparations; denture polishes; mouthwashes, not for medical purposes; cosmetic preparations for slimming purposes; starch glaze for laundry purposes; preparations to make the leaves of plants shiny; refurbishing preparations; eye-washes, not for medical purposes; fabric softeners for laundry use; laundry bleach; dry-cleaning preparations; paint stripping preparations; lacquer-removing preparations; make-up removing preparations; floor wax removers [scouring preparations]; varnish-removing preparations; rust removing preparations; nail care preparations; preparations for cleaning dentures; wallpaper cleaning preparations; preparations for unblocking drain pipes; chemical cleaning preparations for household purposes; collagen preparations for cosmetic purposes; bleaching preparations [decolorants] for household purposes; laundry preparations; aloe vera preparations for cosmetic purposes; sunscreen preparations; color-brightening chemicals for household purposes [laundry]; breath freshening preparations for personal hygiene; shining preparations [polish]; make-up powder; diamantine [abrasive]; stain removers; nail varnish removers; vaginal washes for personal sanitary or deodorant purposes; scouring solutions; false eyelashes; baby wipes impregnated with cleaning preparations; tissues impregnated with cosmetic lotions; tissues impregnated with make-up removing preparations; saffrol; massage candles for cosmetic purposes; laundry blueing; turpentine for degreasing; potpourris [fragrances]; bleaching soda; washing soda, for cleaning; bath salts, not for medical purposes; bleaching salts; fumigation preparations [perfumes]; preservatives for leather [polishes]; ammonia [volatile alkali] [detergent]; as-

tringents for cosmetic purposes; eyebrow cosmetics; make-up preparations; sun-tanning preparations [cosmetics]; hair dyes; neutralizers for permanent waving; cosmetic preparations for eyelashes; cosmetic preparations for skin care; shoe wax; cosmetics; cosmetics for children; cosmetics for animals; mascara; cleansers for intimate personal hygiene purposes, non medicated; douching preparations for personal sanitary or deodorant purposes [toiletries]; detergents, other than for use in manufacturing operations and for medical purposes; degreasers, other than for use in manufacturing processes; bleaching preparations [decolorants] for cosmetic purposes; antiperspirants [toiletries]; toiletry preparations; phytocosmetic preparations; talcum powder, for toilet use; cotton sticks for cosmetic purposes; terpenes [essential oils]; emery cloth; cloths impregnated with a detergent for cleaning; henna [cosmetic dye]; shampoos for animals [non-medicated grooming preparations]; shampoos for pets [non-medicated grooming preparations]; dry shampoos; shampoos; sandpaper; soda lye; herbal extracts for cosmetic purposes; extracts of flowers [perfumes]; ethereal essences; badian essence; mint essence [essential oil].

5 – Pharmaceuticals, medical and veterinary preparations; sanitary preparations for medical purposes; dietetic food and substances adapted for medical or veterinary use, food for babies; dietary supplements for human beings and animals; plasters, materials for dressings; material for dental fillings and dental impressions; disinfectants; preparations for destroying noxious animals; fungicides, herbicides; acaricides; aconitine; alkaloids for medical purposes; alginates for pharmaceutical purposes; algicides; aldehydes for pharmaceutical purposes; dental amalgams of gold; dental amalgams; amino acids for veterinary purposes; amino acids for medical purposes; analgesics; anaesthetics; antibiotics; antiseptics; medicine cases, portable, filled; first-aid boxes, filled; aluminium acetate for pharmaceutical purposes; acetates for pharmaceutical purposes; germicides; balms for medical purposes; bandages for dressings; diagnostic biomarker reagents for medical purposes; biocides; bracelets impregnated with insect repellent; bromine for pharmaceutical purposes; paper for mustard plasters; fly catching paper; reagent paper for veterinary purposes; reagent paper for medical purposes; mothproofing paper; petroleum jelly for medical purposes; vaccines; oxygen baths; antiseptic

cotton; aseptic cotton; absorbent cotton; wadding for medical purposes; cotton for medical purposes; dietetic substances adapted for medical use; radiological contrast substances for medical purposes; nutritive substances for microorganisms; radioactive substances for medical purposes; bismuth subnitrate for pharmaceutical purposes; melissa water for pharmaceutical purposes; sea water for medicinal bathing; mineral waters for medical purposes; thermal water; dietary fiber; molding wax for dentists; gases for medical purposes; guaia-col for pharmaceutical purposes; sexual stimulant gels; hematogen; hemoglobin; hydrastine; hydrastinine; glycerine for medical purposes; glycerophosphates; glucose for medical purposes; gentian for pharmaceutical purposes; hormones for medical purposes; mustard for pharmaceutical purposes; mustard plasters; mud for baths; medicinal mud; gamboge for medical purposes; gurjun balsam for medical purposes; air deodorising preparations; deodorants, other than for human beings or for animals; deodorants for clothing and textiles; diastase for medical purposes; digitalin; vitamin supplement patches; mineral food supplements; nutritional supplements; albumin dietary supplements; yeast dietary supplements; alginate dietary supplements; glucose dietary supplements; casein dietary supplements; lecithin dietary supplements; linseed oil dietary supplements; propolis dietary supplements; protein dietary supplements; protein supplements for animals; royal jelly dietary supplements; pollen dietary supplements; wheat germ dietary supplements; linseed dietary supplements; acai powder dietary supplements; dietary supplements with a cosmetic effect; enzyme dietary supplements; yeast for pharmaceutical purposes; gelatine for medical purposes; cod liver oil; isotopes for medical purposes; immunostimulants; insecticides; iodine for pharmaceutical purposes; iodides for pharmaceutical purposes; alkaline iodides for pharmaceutical purposes; iodoform; calomel [fungicide]; cream of tartar for pharmaceutical purposes; tartar for pharmaceutical purposes; camphor for medical purposes; capsules for medicines; cachets for pharmaceutical purposes; capsules made of dendrimer-based polymers, for pharmaceuticals; hemostatic pencils; wart pencils; caustic pencils; carbolineum [parasiticide]; caustics for pharmaceutical purposes; cachou for pharmaceutical purposes; quassia for medical purposes; quebracho for medical purposes; oxygen for medical purposes;

gallic acid for pharmaceutical purposes; acids for pharmaceutical purposes; adhesives for dentures; surgical glues; stem cells for veterinary purposes; stem cells for medical purposes; cocaine; collagen for medical purposes; collodion for pharmaceutical purposes; corn rings for the feet; candy, medicated; angostura bark for medical purposes; barks for pharmaceutical purposes; cedar wood for use as an insect repellent; condurango bark for medical purposes; croton bark; mangrove bark for pharmaceutical purposes; myrobalan bark for pharmaceutical purposes; quinquina for medical purposes; medicated animal feed; medicinal roots; rhubarb roots for pharmaceutical purposes; lint for medical purposes; starch for dietetic or pharmaceutical purposes; creosote for pharmaceutical purposes; blood for medical purposes; cultures of microorganisms for medical or veterinary use; curare; dental lacquer; liquorice for pharmaceutical purposes; lactose for pharmaceutical purposes; candy for medical purposes; adhesive plasters; medicines for alleviating constipation; adhesive bands for medical purposes; lecithin for medical purposes; lotions for veterinary purposes; medicated hair lotions; lotions for pharmaceutical purposes; medicated after-shave lotions; personal sexual lubricants; lupulin for pharmaceutical purposes; magnesia for pharmaceutical purposes; liniments; ointments for pharmaceutical purposes; sunburn ointments; mercurial ointments; frostbite salve for pharmaceutical purposes; gauze for dressings; medicinal oils; mustard oil for medical purposes; camphor oil for medical purposes; castor oil for medical purposes; oil of turpentine for pharmaceutical purposes; dill oil for medical purposes; dental mastics; dental abrasives; dental impression materials; dressings, medical; surgical dressings; drugs for medical purposes; medicines for veterinary purposes; serotherapeutic medicines; medicines for human purposes; medicines for dental purposes; menthol; medicinal drinks; moleskin for medical purposes; almond milk for pharmaceutical purposes; powdered milk for babies; royal jelly for pharmaceutical purposes; milk ferments for pharmaceutical purposes; Irish moss for medical purposes; flour for pharmaceutical purposes; linseed meal for pharmaceutical purposes; fish meal for pharmaceutical purposes; fly glue; antibacterial soap; disinfectant soap; medicated soap; freeze-dried meat adapted for medical purposes; mint for pharmaceutical purposes; dietetic beverages adapted for medical

purposes; malted milk beverages for medical purposes; injectable dermal fillers; narcotics; medicinal infusions; tincture of iodine; eucalyptol for pharmaceutical purposes; tinctures for medical purposes; opium; opodeldoc; decoctions for pharmaceutical purposes; antiparasitic collars for animals; cotton swabs for medical purposes; cotton sticks for medical purposes; stick liquorice for pharmaceutical purposes; sulfur sticks [disinfectants]; pastilles for pharmaceutical purposes; medicated dentifrices; pectin for pharmaceutical purposes; pepsins for pharmaceutical purposes; peptones for pharmaceutical purposes; hydrogen peroxide for medical purposes; pesticides; leeches for medical purposes; blood plasma; nicotine patches for use as aids to stop smoking; eyepatches for medical purposes; poultices; compresses; scapulars for surgical purposes; babies' diaper-pants; babies' nappin-pants; diapers for pets; diapers for incontinence; bunion pads; breast-nursing pads; pomades for medical purposes; powder of cantharides; pyrethrum powder; anti-uric preparations; bacterial preparations for medical and veterinary use; bacteriological preparations for medical and veterinary use; balsamic preparations for medical purposes; albuminous preparations for medical purposes; biological preparations for veterinary purposes; biological preparations for medical purposes; bismuth preparations for pharmaceutical purposes; vitamin preparations; diagnostic preparations for veterinary purposes; diagnostic preparations for medical purposes; douching preparations for medical purposes; bath preparations for medical purposes; therapeutic preparations for the bath; hemorrhoid preparations; preparations for callouses; lice treatment preparations [pediculicides]; acne treatment preparations; preparations to facilitate teething; preparations for the treatment of burns; fumigation preparations for medical purposes; opotherapy preparations; air purifying preparations; bronchodilating preparations; preparations for reducing sexual activity; sterilising preparations; soil-sterilising preparations; corn remedies; pharmaceutical preparations for treating dandruff; herbicides; preparations for destroying dry rot fungus; larvae exterminating preparations; fly destroying preparations; preparations for destroying mice; slug exterminating preparations; vermin destroying preparations; pharmaceutical preparations for skin care; contact lens cleaning preparations; preparations of microorganisms for medical or veteri-

nary use; lime-based pharmaceutical preparations; styptic preparations; medicated eye-washes; medicinal hair growth preparations; nutraceutical preparations for therapeutic or medical purposes; opiates; anticryptogamic preparations; aloe vera preparations for pharmaceutical purposes; preparations of trace elements for human and animal use; sulfonamides [medicines]; pharmaceutical preparations; pharmaceutical preparations for treating sunburn; enzyme preparations for veterinary purposes; enzyme preparations for medical purposes; phytotherapy preparations for medical purposes; chemico-pharmaceutical preparations; chemical preparations for veterinary purposes; chemical preparations for the diagnosis of pregnancy; chemical preparations for medical purposes; chemical preparations for treating diseases affecting cereal plants; chemical preparations for treating wheat blight; chemical preparations for treating diseases affecting vine plants; chemical preparations for treating mildew; chemical preparations for treating phylloxera; chemical preparations for pharmaceutical purposes; chilblain preparations; moth-proofing preparations; collyrium; lead water; chemical conductors for electrocardiograph electrodes; albuminous foodstuffs for medical purposes; dietetic foods adapted for medical purposes; by-products of the processing of cereals for dietetic or medical purposes; homogenized food adapted for medical purposes; freeze-dried food adapted for medical purposes; pharmaceuticals; sanitary towels; panty liners [sanitary]; propolis for pharmaceutical purposes; pearl powder for medical purposes; radium for medical purposes; hydrated chloral for pharmaceutical purposes; solvents for removing adhesive plasters; vaginal washes for medical purposes; solutions for contact lenses; chemical reagents for medical or veterinary purposes; gum for medical purposes; rubber for dental purposes; chewing gum for medical purposes; nicotine gum for use as an aid to stop smoking; insect repellents; insect repellent incense; repellents for dogs; tissues impregnated with pharmaceutical lotions; sarsaparilla for medical purposes; sugar for medical purposes; asthmatic tea; fumigating sticks; massage candles for therapeutic purposes; suppositories; linseed for pharmaceutical purposes; tobacco-free cigarettes for medical purposes; siccatives [drying agents] for medical purposes; syrups for pharmaceutical purposes; turpentine for pharmaceutical purposes; milking grease; greases for veterinary

purposes; greases for medical purposes; lacteal flour for babies; infant formula; soporifics; bicarbonate of soda for pharmaceutical purposes; bath salts for medical purposes; salts for mineral water baths; salts for medical purposes; potassium salts for medical purposes; sodium salts for medical purposes; smelling salts; mineral water salts; malt for pharmaceutical purposes; semen for artificial insemination; alcohol for pharmaceutical purposes; medicinal alcohol; alloys of precious metals for dental purposes; ergot for pharmaceutical purposes; cooling sprays for medical purposes; antibacterial handwashes; adjuvants for medical purposes; astringents for medical purposes; vermifuges; disinfectants for hygiene purposes; disinfectants for chemical toilets; appetite suppressants for medical purposes; medical preparations for slimming purposes; parasiticides; mouthwashes for medical purposes; febrifuges; depuratives; animal washes [insecticides]; detergents for medical purposes; cattle washes [insecticides]; dog washes [insecticides]; insecticidal veterinary washes; vesicants; purgatives; remedies for perspiration; remedies for foot perspiration; chemical contraceptives; antiparasitic preparations; sedatives; laxatives; tonics [medicines]; medicated toiletry preparations; digestives for pharmaceutical purposes; nervines; media for bacteriological cultures; steroids; strychnine; serums; tanning pills; appetite suppressant pills; slimming pills; jujube, medicated; antioxidant pills; sanitary tampons; vulnerary sponges; thymol for pharmaceutical purposes; biological tissue cultures for veterinary purposes; biological tissue cultures for medical purposes; smoking herbs for medical purposes; medicinal herbs; transplants [living tissues]; surgical implants comprised of living tissues; pants, absorbent, for incontinence; sanitary panties; charcoal for pharmaceutical purposes; fennel for medical purposes; porcelain for dental prostheses; phenol for pharmaceutical purposes; enzymes for veterinary purposes; enzymes for medical purposes; ferments for pharmaceutical purposes; formic aldehyde for pharmaceutical purposes; phosphates for pharmaceutical purposes; quinine for medical purposes; chinoline for medical purposes; diabetic bread adapted for medical use; chloroform; flowers of sulfur for pharmaceutical purposes; cement for animal hooves; bone cement for surgical and orthopaedic purposes; dental cements; medicinal tea; herbal teas for medicinal purposes; insecticidal animal shampoos; medicated

shampoos; medicated shampoos for pets; pediculicidal shampoos; medicated dry shampoos; pre-filled syringes for medical purposes; eucalyptus for pharmaceutical purposes; herbal extracts for medical purposes; plant extracts for pharmaceutical purposes; tobacco extracts [insecticides]; extracts of hops for pharmaceutical purposes; elixirs [pharmaceutical preparations]; ethers for pharmaceutical purposes; esters for pharmaceutical purposes; cellulose esters for pharmaceutical purposes; cellulose ethers for pharmaceutical purposes; rat poison; poisons; bacterial poisons; jalap.

8 – Hand tools and implements, hand-operated; cutlery; side arms, other than firearms; razors; glaziers' diamonds [parts of hand tools]; apparatus for tattooing; laser hair removal apparatus, other than for medical purposes; razors, electric or non-electric; sharpening steels; scythe stones; gimlets [hand tools]; borers; augers [hand tools]; carpenters' augers; hand drills, hand-operated; pickhammers; levers; table forks; weeding forks [hand tools]; agricultural forks [hand tools]; lawn clippers [hand instruments]; harpoons; harpoons for fishing; nail pullers, hand-operated; rakes [hand tools]; sand trap rakes; cutter bars [hand tools]; whetstone holders; priming irons [hand tools]; sculptors' chisels; lifting jacks, hand-operated; truncheons; clamps for carpenters or coopers; spades [hand tools]; rabbeting planes; chisels; engraving needles; tattoo needles; edge tools [hand tools]; garden tools, hand-operated; abrading instruments [hand instruments]; numbering punches; goffering irons; implements for decanting liquids [hand tools]; depilation appliances, electric and non-electric; sharpening instruments; blade sharpening instruments; livestock marking tools; nail clippers, electric or non-electric; oyster openers; polishing irons [glazing tools]; ear-piercing apparatus; tube cutting instruments; wire strippers [hand tools]; riveters [hand tools]; expanders [hand tools]; cutting tools [hand tools]; ski edge sharpening tools, hand-operated; hand tools, hand-operated; sterile body piercing instruments; stamping-out tools [hand tools]; picks [hand tools]; sharpening stones; punch rings [knuckle dusters]; trowels; centre punches [hand tools]; daggers; pickaxes; mallets [hand instruments]; pliers; punch pliers [hand tools]; blades [weapons]; annular screw plates; wrenches [hand tools]; tap wrenches; ladles [hand tools]; foundry ladles [hand tools]; meat claws; breast drills; lasts [shoemakers' hand

tools]; scythe rings; instruments for punching tickets; diggers [hand tools]; rams [hand tools]; scythes; hainault scythes; fire irons; emery grinding wheels; grindstones [hand tools]; sledgehammers; thistle extractors [hand tools]; nail nippers; tree pruners; nail drawers [hand tools]; ice picks; blades [hand tools]; razor blades; blades for planes; plane irons; jig-saws; table knives, forks and spoons for babies; table knives, forks and spoons of plastic; crow bars; trowels [gardening]; shovels [hand tools]; palette knives; machetes; beard clippers; hair clippers for personal use, electric and non-electric; hair clippers for animals [hand instruments]; taps [hand tools]; fireplace bellows [hand tools]; swords; hammers [hand tools]; emergency hammers; fullers [hand tools]; stone hammers; masons' hammers; riveting hammers [hand tools]; mattocks; ditchers [hand tools]; mincing knives [hand tools]; manicure sets; manicure sets, electric; pedicure sets; needle files; bits [hand tools]; files [tools]; emery files; air pumps, hand-operated; hand pumps; shaving cases; cheese slicers, non-electric; fruit segmenters; egg slicers, non-electric; pizza cutters, non-electric; scaling knives; hobby knives [scalpels]; fruit corers; molding irons; ceramic knives; can openers, non-electric; tin openers, non-electric; farriers' knives; budding knives; hunting knives; penknives; grafting tools [hand tools]; braiders [hand tools]; box cutters; bill-hooks; paring knives; knives; cleavers; wick trimmers [scissors]; shears; cattle shearers; border shears; pruning shears; shearers [hand instruments]; scissors; sword scabbards; vegetable slicers; kitchen mandolines; vegetable spiralizers, hand-operated; vegetable peelers [hand tools]; agricultural implements, hand-operated; stropping instruments; screwdrivers, non-electric; sabres; stirring sticks for mixing paint; reamer sockets; drill holders [hand tools]; perforating tools [hand tools]; pestles for pounding [hand tools]; emery boards; nail files; nail files, electric; saws [hand tools]; bow saws; tweezers; hair-removing tweezers; guns [hand tools]; non-electric caulking guns; guns, hand-operated, for the extrusion of mastics; dies [hand tools]; fruit pickers [hand tools]; saw blades [parts of hand tools]; shear blades; tool belts [holders]; hair braiders, electric; table cutlery [knives, forks and spoons]; crimping irons; hand implements for hair curling; vegetable choppers; money scoops; instruments and tools for skinning animals; fingernail polishers, electric or non-el-

electric; nail buffers, electric or non-electric; hackles [hand tools]; pin punches; nail punches; fish tapes [hand tools]; punches [hand tools]; insecticide sprayers [hand tools]; syringes for spraying insecticides; reamers; frames for handsaws; saw holders; rasps [hand tools]; cutters; paring irons [hand tools]; graving tools [hand tools]; milling cutters [hand tools]; razor strops; leather strops; planes; scythe handles; knife handles; handles for hand-operated hand tools; marline spikes; bits [parts of hand tools]; hollowing bits [parts of hand tools]; secateurs; silver plate [knives, forks and spoons]; pruning knives; sickles; drawing knives; scrapers [hand tools]; scrapers for skis; mortise chisels; caulking irons; gouges [hand tools]; mortars for pounding [hand tools]; mitre boxes [hand tools]; branding irons; hatchets; adzes [tools]; vices; bench vices [hand implements]; hoop cutters [hand tools]; axes; holing axes; fulling tools [hand tools]; earth rammers [hand tools]; tube cutters [hand tools]; squares [hand tools]; extension pieces for braces for screw taps; embossers [hand tools]; apparatus for destroying plant parasites, hand-operated; metal wire stretchers [hand tools]; metal band stretchers [hand tools]; flat irons; irons [non-electric hand tools]; razor cases; ratchets [hand tools]; scraping tools [hand tools]; awls; choppers [knives]; spatulas [hand tools]; spatulas for use by artists; wine bottle foil cutters, hand-operated; bayonets; curling tongs; cuticle tweezers; eyelash curlers.

9 – Navigation, surveying, optical, signalling, detecting, testing, inspecting, life-saving and apparatus and instruments; apparatus and instruments for conducting, switching, transforming, accumulating, mechanisms for coin-operated apparatus; cash registers, calculating devices; diving suits, divers' masks, ear plugs for divers, nose clips for divers and swimmers, gloves for divers, breathing apparatus for underwater swimming; fire extinguishing apparatus; 3D spectacles; fire engines; answering machines; electrical adapters; batteries for electronic cigarettes; accumulators, electric; accumulators, electric, for vehicles; anodes; antennas; anticathodes; high-frequency apparatus; testing apparatus not for medical purposes; monitoring apparatus, other than for medical purposes; distillation apparatus for scientific purposes; diffraction apparatus [microscopy]; apparatus to check franking; apparatus for fermentation [laboratory apparatus]; breathing apparatus for underwater

swimming; breathing apparatus, except for artificial respiration; apparatus and installations for the production of X-rays, not for medical purposes; electric apparatus for commutation; magnetic resonance imaging [MRI] apparatus, not for medical purposes; intercommunication apparatus; stills for laboratory experiments; radiological apparatus for industrial purposes; X-ray apparatus not for medical purposes; blueprint apparatus; flashing lights [luminous signals]; stereoscopic apparatus; facsimile machines; igniting apparatus, electric, for igniting at a distance; beacons, luminous; battery jars; anode batteries; galvanic batteries; batteries for lighting; solar batteries; solar panels for the production of electricity; batteries, electric; betatrons; binoculars; electronic tags for goods; lens hoods; fire hose nozzles; encoded identification bracelets, magnetic; safety tarpaulins; bullet-proof clothing; signalling buoys; life buoys; marking buoys; directional compasses; electrolyzers; camcorders; circuit closers; mechanical signs; signs, luminous; switchboxes [electricity]; current rectifiers; hands-free kits for telephones; heliographic apparatus; peepholes [magnifying lenses] for doors; hairdressing training heads [teaching apparatus]; holograms; plotters; plumb bobs; piezoelectric sensors; smoke detectors; counterfeit coin detectors; transparencies [photography]; slide projectors; diaphragms [photography]; dictating machines; light-emitting diodes [LED]; quantum dot light-emitting diodes [QLED]; organic light-emitting diodes [OLED]; DNA chips; bullet-proof waistcoats; life jackets; reflective safety vests; identification threads for electric wires; nose clips for divers and swimmers; locks, electric; bells [warning devices]; alarm bells, electric; electric door bells; signal bells; audio interfaces; acoustic conduits; mirrors for inspecting work; road signs, luminous or mechanical; marine depth finders; probes for scientific purposes; buzzers; eyewear; reflective articles for wear, for the prevention of accidents; inverters [electricity]; incubators for bacteria culture; instruments containing eyepieces; ionization apparatus not for the treatment of air or water; coaxial cables; fiber optic cables; cables, electric; decompression chambers; rearview cameras for vehicles; cinematographic cameras; thermal imaging cameras; mouth guards for sports; life-saving capsules for natural disasters; electronic pens [visual display units]; holders for electric coils; identity cards, magnetic; riding helmets; protective helmets; carriers for

dark plates [photography]; cathodes; spools [photography]; choking coils [impedance]; coils, electric; electromagnetic coils; cinematographic film, exposed; solenoid valves [electromagnetic switches]; wire connectors [electricity]; encoded key cards; push buttons for bells; mouse pads; magnetic encoders; visors for helmets; collectors, electric; calibrating rings; smart rings; ring sizers; protective suits for aviators; commutators; comparators; marine compasses; condensers [capacitors]; contacts, electric; wind socks for indicating wind direction; traffic cones; branch boxes [electricity]; distribution boxes [electricity]; junction boxes [electricity]; connectors [electricity]; battery boxes; cabinets for loudspeakers; diving suits; galena crystals [detectors]; covers for electric outlets; lasers, not for medical purposes; darkroom lamps [photography]; thermionic tubes; amplifying tubes; flashlights [photography]; fire escapes; contact lenses; correcting lenses [optics]; close-up lenses; optical lenses; optical condensers; sounding lines; electricity conduits; magnifying glasses [optics]; thread counters; magnets; decorative magnets; crash test dummies; resuscitation mannequins [teaching apparatus]; security tokens [encryption devices]; divers' masks; solderers' helmets; protective masks; respiratory masks, other than for artificial respiration; materials for electricity mains [wires, cables]; furniture especially made for laboratories; megaphones; diaphragms [acoustics]; diaphragms for scientific apparatus; metal detectors for industrial or military purposes; metronomes; mechanisms for counter-operated apparatus; coin-operated mechanisms for television sets; shutter releases [photography]; microscopes; microtomes; microphones; modems; lightning rods; selfie sticks [hand-held monopods]; terminals [electricity]; junction sleeves for electric cables; teeth protectors; kneepads for workers; sheaths for electric cables; identification sheaths for electric wires; life saving apparatus and equipment; shoes for protection against accidents, irradiation and fire; objectives [lenses] [optics]; lenses for astrophotography; selfie lenses; egg-candlers; fire extinguishers; rescue laser signalling flares; electrified fences; limiters [electricity]; clothing for protection against accidents, irradiation and fire; clothing for protection against fire; asbestos clothing for protection against fire; clothing especially made for laboratories; survival blankets; ozonisers [ozonators]; eyepieces;

wrist rests for use with computers; eyeglass frames; oscillographs; plumb lines; mirrors [optics]; eyeglasses; sunglasses; goggles for sports; electronic collars to train animals; signalling panels, luminous or mechanical; wah-wah pedals; pince-nez; switches, electric; periscopes; data gloves; gloves for divers; gloves for protection against accidents; gloves for protection against X-rays for industrial purposes; asbestos gloves for protection against accidents; furnaces for laboratory use; plates for batteries; wafers for integrated circuits; printed circuit boards; compact disc players; cassette players; protective films adapted for computer screens; protective films adapted for smartphones; sound recording strips; X-ray films, exposed; films, exposed; life-saving rafts; laboratory trays; digital signs; stands adapted for laptops; semi-conductors; personal digital assistants [PDAs]; fire pumps; life belts; fuses; circuit breakers; converters, electric; telerupters; food analysis apparatus; naval signalling apparatus; prisms [optics]; hemline markers; retorts' stands; apparatus for changing record player needles; drainers for use in photography; cleaning apparatus for sound recording discs; fire beaters; telescopic sights for firearms; telescopic sights for artillery; test tubes; magnetic wires; telegraph wires; telephone wires; wires, electric; conductors, electric; copper wire, insulated; fuse wire; rods for water diviners; distribution consoles [electricity]; masts for wireless aerials; transmitting sets [telecommunication]; radios; vehicle radios; sprinkler systems for fire protection; frames for photographic transparencies; screens for photoengraving; flowmeters; walkie-talkies; voltage surge protectors; cell switches [electricity]; washing trays [photography]; marking gauges [joinery]; time switches, automatic; relays, electric; safety restraints, other than for vehicle seats and sports equipment; X-ray photographs, other than for medical purposes; rheostats; respirators for filtering air; retorts; refractometers; refractors; grids for batteries; electric sockets; speaking tubes; horns for loudspeakers; subwoofers; optical fibers [light conducting filaments]; traffic-light apparatus [signalling devices]; dog whistles; signalling whistles; sports whistles; inductors [electricity]; safety nets; nets for protection against accidents; fire alarms; signals, luminous or mechanical; rescue flares, non-explosive and non-pyrotechnic; sirens; connections for electric lines; couplings, electric; sonars; sound locating instruments; lighting ballasts; resis-

tances, electric; spectrograph apparatus; spectros-
copes; satellites for scientific purposes; protection
devices for personal use against accidents; char-
ging stations for electric vehicles; radiotelegraphy
sets; radiotelephony sets; spectacle lenses; anti-gla-
re glasses; optical glass; personal stereos; stereos-
copes; stands for photographic apparatus; strobos-
copes; fire boats; sulfimeters; bags adapted for
laptops; drying racks [photography]; spherometers;
integrated circuits; printed circuits; counters; par-
king meters; ear plugs for divers; television appar-
atus; telegraphs [apparatus]; telescopes; telepromp-
ters; crucibles [laboratory]; tone arms for record
players; transistors [electronic]; transponders; tran-
sformers [electricity]; step-up transformers; re-
suscitation training simulators; vehicle breakdown
warning triangles; triodes; starter cables for mo-
tors; discharge tubes, electric, other than for light-
ing; capillary tubes; neon signs; X-ray tubes not
for medical purposes; telephone receivers; head-
gear being protective helmets; light-emitting elec-
tronic pointers; amplifiers; particle accelerators;
steering apparatus, automatic, for vehicles; balan-
cing apparatus; invoicing machines; tape recor-
ders; protection devices against X-rays, not for
medical purposes; railway traffic safety appliances;
oxygen transvasing apparatus; theft prevention
installations, electric; film cutting apparatus; dry-
ing apparatus for photographic prints; optical cha-
racter readers; centering apparatus for photograp-
hic transparencies; battery chargers; chargers for
electric batteries; chargers for electronic cigare-
ttes; acoustic alarms; apparatus for editing cinema-
tographic film; cathodic anti-corrosion apparatus;
couplers [data processing equipment]; anti-theft
warning apparatus; anti-interference devices [elec-
tricity]; demagnetizing apparatus for magnetic ta-
pes; acoustic couplers; alarms; fog signals, non-ex-
plosive; whistle alarms; adding machines; photoco-
piers [photographic, electrostatic, thermic]; elec-
tric and electronic effects units for musical instru-
ments; filters for respiratory masks; filters for ul-
traviolet rays, for photography; filters for use in
photography; magic lanterns; optical lamps; signal
lanterns; cameras [photography]; glazing apparatus
for photographic prints; shutters [photography];
darkrooms [photography]; photometers; flash-
bulbs [photography]; digital photo frames; enlar-
ging apparatus [photography]; photovoltaic cells;
containers for contact lenses; eyeglass cases; con-
tainers for microscope slides; cases for smartpho-

nes; cases especially made for photographic appa-
ratus and instruments; laboratory centrifuges; eye-
glass chains; cyclotrons; Petri dishes; sleeves for
laptops; covers for personal digital assistants
[PDAs]; covers for tablet computers; covers for
smartphones; fire blankets; chips [integrated cir-
cuits]; electrified rails for mounting spot lights;
asbestos screens for firemen; fire hose; virtual rea-
lity headsets; protective helmets for sports; head
guards for sports; lifeboats; snorkels; cell phone
straps; eyeglass cords; tripods for cameras; switch-
boards; distribution boards [electricity]; screens
[photography]; workmen's protective face-shields;
projection screens; radiology screens for industrial
purposes; fluorescent screens; ducts [electricity];
galvanic cells; epidiascopes; armatures [electricity].

10 – Surgical, medical, dental and veterinary appa-
ratus and instruments; artificial limbs, eyes and
teeth; orthopedic articles; suture materials; thera-
peutic and assistive devices adapted for the disab-
led; massage apparatus; apparatus, devices and arti-
cles for nursing infants; sexual activity apparatus,
devices and articles; analyzers for bacterial identi-
fication for medical purposes; cholesterol meters;
blood testing apparatus; testing apparatus for me-
dical purposes; apparatus for use in medical analy-
sis; anaesthetic appara-tus; galvanic therapeutic
appliances; apparatus for artificial respiration; ap-
paratus for the treatment of deafness; physical ex-
ercise apparatus for medical purposes; body reha-
bilitation apparatus for medical purposes; dental
apparatus and instruments; surgical apparatus and
instruments; resuscitation apparatus; dental appa-
ratus, electric; physiotherapy apparatus; bed vibra-
tors; hot air therapeutic apparatus; diagnostic ap-
paratus for medical purposes; traction apparatus
for medical purposes; radiotherapy apparatus; mic-
rodermabrasion apparatus; fumigation apparatus
for medical purposes; apparatus for the regenera-
tion of stem cells for medical purposes; apparatus
for DNA and RNA testing for medical purposes;
apparatus and installations for the production of
X-rays, for medical purposes; magnetic resonance
imaging [MRI] apparatus for medical purposes;
orthodontic appliances; radiological apparatus for
medical purposes; X-ray apparatus for medical
purposes; hearing aids; nasal aspirators; trusses;
maternity belts; bandages, elastic; cupping glasses;
biomagnetic rings for therapeutic or medical pur-
poses; dental burs; acupressure bands; bracelets for
medical purposes; anti-nausea wristbands; anti-

rheumatism bracelets; feeding bottles; air cushions for medical purposes; vaporizers for medical purposes; hot air vibrators for medical purposes; vibromassage apparatus; gastroscopes; haemocytometers; glucose meters; lice combs; surgical sponges; defibrillators; dialyzers; containers especially made for medical waste; clips, surgical; mirrors for dentists; mirrors for surgeons; probes for medical purposes; urethral probes; artificial teeth; acupuncture needles; suture needles; needles for medical purposes; pill crushers; biodegradable bone fixation implants; surgical implants comprised of artificial materials; inhalers; hydrogen inhalers; injectors for medical purposes; incubators for medical purposes; incubators for babies; obstetric apparatus; obstetric apparatus for cattle; electric acupuncture instruments; surgical cutlery; insufflators; endoscopy cameras for medical purposes; cannulae; droppers for medical purposes; dropper bottles for medical purposes; heart monitors; heart pacemakers; catheters; catgut; draw-sheets for sick beds; enema apparatus for medical purposes; clips for dummies; artificial skin for surgical purposes; menstrual cups; teething rings; anti-rheumatism rings; compressors [surgical]; thermo-electric compresses [surgery]; abdominal corsets; corsets for medical purposes; crutches; dentists' armchairs; armchairs for medical or dental purposes; waterbeds for medical purposes; air beds for medical purposes; beds specially made for medical purposes; feeding bottle valves; love dolls [sex dolls]; lasers for medical purposes; lamps for medical purposes; curing lamps for medical purposes; quartz lamps for medical purposes; ultraviolet ray lamps for medical purposes; lancets; lenses [intraocular prostheses] for surgical implantation; spoons for administering medicine; masks for use by medical personnel; respiratory masks for artificial respiration; anaesthetic masks; therapeutic facial masks; gum massagers for babies; childbirth mattresses; air mattresses for medical purposes; furniture especially made for medical purposes; water bags for medical purposes; douche bags; breast pumps; body fat monitors; body composition monitors; urinals being vessels; portable hand-held urinals; teeth protectors for dental purposes; temperature indicator labels for medical purposes; knee bandages, orthopaedic; tips for crutches; finger guards for medical purposes; medical guidewires; pumps for medical purposes; thread, surgical; knives for surgical purposes; scissors for surgery; ambulance stretchers;

stretchers, wheeled; boots for medical purposes; orthopaedic footwear; clothing especially for operating rooms; compression garments; blankets, electric, for medical purposes; supports for flat feet; ophthalmometers; ophthalmoscopes; cooling pads for first aid purposes; slings [supporting bandages]; gloves for massage; gloves for medical purposes; pessaries; saws for surgical purposes; ear picks; cooling patches for medical purposes; spittoons for medical purposes; plaster bandages for orthopaedic purposes; supportive bandages; suspensory bandages; abdominal pads; cushions for medical purposes; pads for preventing pressure sores on patient bodies; air pillows for medical purposes; soporific pillows for insomnia; heating cushions, electric, for medical purposes; abdominal belts; galvanic belts for medical purposes; hypogastric belts; belts for medical purposes; orthopaedic belts; umbilical belts; belts, electric, for medical purposes; condoms; aerosol dispensers for medical purposes; sphygmomanometers; pulse meters; esthetic massage apparatus; veterinary apparatus and instruments; medical apparatus and instruments; urological apparatus and instruments; brushes for cleaning body cavities; invalids' hoists; appliances for washing body cavities; corn knives; incontinence sheets; sterile sheets, surgical; surgical drapes; hair prostheses; artificial breasts; artificial jaws; ice bags for medical purposes; toe separators for orthopaedic purposes; surgical bougies; orthodontic rubber bands; X-ray photographs for medical purposes; respirators for artificial respiration; surgical robots; ear trumpets; strait jackets; sex toys; scalpels; tongue scrapers; dummies for babies; feeding bottle teats; baby feeding dummies; receptacles for applying medicines; spirometers [medical apparatus]; vaginal syringes; implantable subcutaneous drug delivery devices; hearing protectors; contraceptives, non-chemical; orthopaedic soles; stents; stethoscopes; operating tables; commode chairs; basins for medical purposes; bed pans; instrument cases for use by doctors; arch supports for footwear; ear plugs [ear protection devices]; thermal packs for first aid purposes; thermometers for medical purposes; tomographs for medical purposes; trocars; walking sticks for medical purposes; quad canes for medical purposes; drainage tubes for medical purposes; X-ray tubes for medical purposes; radium tubes for medical purposes; balling guns; protection devices against X-rays, for medical purposes; apparatus for acne treatment; filters for ultra-

violet rays, for medical purposes; patient examination gowns; wheeled walkers to aid mobility; walking frames for disabled persons; cases fitted for medical instruments; elastic stockings for surgical purposes; stockings for varices; splints, surgical; tongue depressors for medical purposes; syringes for injections; syringes for medical purposes; hypodermic syringes; uterine syringes; urethral syringes; pins for artificial teeth; castrating pincers; forceps; robotic exoskeleton suits for medical purposes; radiology screens for medical purposes; electrodes for medical use; electrocardiographs; brain pacemakers.

11 – Apparatus and installations for lighting, heating, cooling, steam generating, cooking, drying, ventilating, water supply and sanitary purposes; lamp shades; steam accumulators; heat accumulators; defrosters for vehicles; disinfectant apparatus for medical purposes; distillation apparatus; desiccating apparatus; hydromassage bath apparatus; disinfectant apparatus; air deodorizing apparatus; tanning apparatus [sun beds]; ionization apparatus for the treatment of air or water; coffee roasters; beverage cooling apparatus; hand drying apparatus for washrooms; fruit roasters; water purifying apparatus and machines; refrigerating apparatus and machines; drying apparatus and installations; freezers; heating and cooling apparatus for dispensing hot and cold beverages; drying apparatus; coolers for furnaces; expansion tanks for central heating installations; flushing tanks; refining towers for distillation; bidets; boilers, other than parts of machines; bath tubs; spa baths [vessels]; bath tubs for sitz baths; waffle irons, electric; fans [air-conditioning]; fans [parts of air-conditioning installations]; electric fans for personal use; roasting spits; refrigerating display cabinets; heated display cabinets; water heaters; water heaters [apparatus]; water flushing installations; air reheaters; extractor hoods for kitchens; gas condensers, other than parts of machines; acetylene generators; microbubble generators for baths; hydrants; string lights for festive decoration; burners; acetylene burners; gas burners; burners for lamps; germicidal burners; incandescent burners; oxyhydrogen burners; laboratory burners; oil burners; alcohol burners; hot water bottles; footwarmers, electric or non-electric; bed warmers; USB-powered hand warmers; pocket warmers; warming pans; grills [cooking appliances]; food dehydrators, electric; lampshade holders; stills; showers; refrigerating containers; gas

lighters; lighters; friction lighters for igniting gas; chimney blowers; coils [parts of distilling, heating or cooling installations]; furnace ash boxes; evaporators; electric appliances for making yoghurt; shower enclosures; Turkish bath cabinets, portable; heating apparatus; cool boxes, electric; refrigerating chambers; fireplaces, domestic; chimney flues; structural framework for ovens; air valves for steam heating installations; level controlling valves in tanks; thermostatic valves [parts of heating installations]; electrically heated carpets; light bulbs; light bulbs, electric; solar thermal collectors [heating]; distillation columns; furnace grates; ventilation hoods; ventilation hoods for laboratories; lamp globes; air-conditioning apparatus; air conditioners for vehicles; gas boilers; laundry room boilers; heating boilers; coffee machines, electric; faucets for pipes and pipelines; taps; mixer faucets for water pipes; forges, portable; lava rocks for use in barbecue grills; couscous cookers, electric; electric lights for Christmas trees; acetylene flares; safety lamps; gas lamps; curling lamps; nail lamps; curing lamps, not for medical purposes; germicidal lamps for purifying air; light bulbs for directional signals for vehicles; arc lamps; laboratory lamps; oil lamps; ultraviolet ray lamps, not for medical purposes; miners' lamps; electric lamps; chandeliers; barbecues; bread baking machines; watering machines for agricultural purposes; ice-cream making machines; pounded rice cake making machines, electric, for household purposes; multicookers; footmuffs, electrically heated; heaters for baths; heaters for heating irons; immersion heaters; brackets for gas burners; anti-splash tap nozzles; heat pumps; filaments for electric lamps; magnesium filaments for lighting; heating filaments, electric; luminous house numbers; socks, electrically heated; heating apparatus for defrosting vehicle windows; hot air bath fittings; bath fittings; loading apparatus for furnaces; kiln furniture [supports]; sauna bath installations; refrigerating appliances and installations; directional lights for bicycles; electrically heated clothing; blankets, electric, not for medical purposes; fabric steamers; lamp reflectors; vehicle reflectors; hearths; electric cooktops; food steamers, electric; steam boilers, other than parts of machines; pasteurisers; lamp mantles; sockets for electric lights; coffee percolators, electric; stoves [heating apparatus]; bakers' ovens; hot air ovens; kitchen ranges [ovens]; microwave ovens [cooking apparatus]; microwave

ovens for industrial purposes; incinerators; kilns; solar furnaces; dental ovens; furnaces, other than for laboratory use; urinals being sanitary fixtures; feeding apparatus for heating boilers; heating plates; cookers; hot plates; wine cellars, electric; heaters, electric, for feeding bottles; aquarium heaters; USB-powered cup heaters; aquarium lights; heating cushions, electric, not for medical purposes; clean chambers [sanitary installations]; tortilla presses, electric; water intake apparatus; deodorizing apparatus, not for personal use; apparatus for dehydrating food waste; fumigation apparatus, not for medical purposes; gas scrubbing apparatus; oil-scrubbing apparatus; glue-heating appliances; forage drying apparatus; water filtering apparatus; air purifying apparatus and machines; ice machines and apparatus; cooling appliances and installations; cooking apparatus and installations; lighting apparatus and installations; sanitary apparatus and installations; cooking rings; lighting apparatus for vehicles; light-emitting diodes [LED] lighting apparatus; heating apparatus for solid, liquid or gaseous fuels; heating apparatus, electric; hot air apparatus; steam facial apparatus [saunas]; safety accessories for water or gas apparatus and pipes; regulating and safety accessories for gas apparatus; regulating accessories for water or gas apparatus and pipes; regulating and safety accessories for water apparatus; regulating and safety accessories for gas pipes; anti-glare devices for vehicles [lamp fittings]; roasting jacks; plate warmers; rotisseries; radiator caps; searchlights; diving lights; washers for water faucets; heat guns; radiators [heating]; central heating radiators; radiators, electric; sinks; disinfectant dispensers for toilets; drip irrigation emitters [irrigation fittings]; light diffusers; nuclear reactors; heat regenerators; pressure water tanks; roasters; lamps; standard lamps; floor lamps; ceiling lights; toilet seats; hydroponic growing systems; lighting installations for air vehicles; sous-vide cookers, electric; pressure cookers, electric; gas scrubbers [parts of gas installations]; lamp glasses; sterilizers; water sterilizers; air sterilizers; air dryers; laundry dryers, electric; hair dryers; malt roasters; tobacco roasters; tajines, electric; heat exchangers, other than parts of machines; thermo-pots, electric; bread toasters; discharge tubes, electric, for lighting; lamp chimneys; luminous tubes for lighting; pipes [parts of sanitary installations]; flues for heating boilers; boiler pipes [tubes] for heating installations; toilets [water-clo-

sets]; toilets, portable; humidifiers for central heating radiators; wash-hand basins [parts of sanitary installations]; toilet bowls; water conduits installations; bath plumbing fixtures; air-conditioning installations; desalination plants; installations for processing nuclear fuel and nuclear moderating material; watering installations, automatic; cooling installations for water; cooling installations for liquids; milk cooling installations; cooling installations for tobacco; water purification installations; purification installations for sewage; steam generating installations; water distribution installations; air filtering installations; swimming pool chlorinating apparatus; ventilation [air-conditioning] installations and apparatus; ventilation [air-conditioning] installations for vehicles; water softening apparatus and installations; cooling installations and machines; heating installations; heaters for vehicles; hot water heating installations; polymerisation installations; water supply installations; flare stacks for use in the oil industry; ash conveyor installations, automatic; whirlpool-jet apparatus; air cooling apparatus; aquarium filtration apparatus; cooking utensils, electric; flaming torches; headlights for automobiles; vehicle headlights; filters for air conditioning; filters for drinking water; wicks adapted for oil stoves; lights for automobiles; bicycle lights; motorcycle lights; lights for vehicles; electric torches; head torches; lanterns for lighting; candle lanterns; street lamps; Chinese lanterns; fountains; ornamental fountains; chocolate fountains, electric; air fryers; deep fryers, electric; fittings, shaped, for ovens; oven fittings made of fireclay; bread-making machines; refrigerators; refrigerators, cooling apparatus and freezers for medical storage purposes; chromatography apparatus for industrial purposes; kettles, electric; dampers [heating]; book sterilization apparatus; refrigerating cabinets; carbon for arc lamps; heating elements.

14 – Precious metals and their alloys; jewellery, precious and semi-precious stones; horological and chronometric instruments; agates; diamonds; amulets [jewelry]; anchors [clock- and watchmaking]; barrels [clock- and watchmaking]; bracelets [jewelry]; bracelets made of embroidered textile [jewellery]; watch bands; charms for key rings; jewellery charms; brooches [jewelry]; alarm clocks; pins [jewelry]; ornamental pins; tie pins; jewellery hat pins; beads for making jewelry; pearls made of ambroid [pressed amber]; busts of precious metal;

jewelry rolls; jet, unwrought or semi-wrought; jewelry findings; key rings [split rings with trinket or decorative fob]; retractable key rings; pearls [jewelry]; copper tokens; tie clips; cuff links; clasps for jewelry; badges of precious metal; gold, unwrought or beaten; cloisonné jewelry; works of art of precious metal; ivory jewelry; jewelry of yellow amber; iridium; cabochons; spun silver [silver wire]; necklaces [jewelry]; split rings of precious metal for keys; rings [jewelry]; boxes of precious metal; presentation boxes for jewelry; watch cases [parts of watches]; clock cases; pendulums [clock- and watchmaking]; medals; lockets [jewelry]; precious metals, unwrought or semi-wrought; movements for clocks and watches; clockworks; misbaha [prayer beads]; coins; gold thread [jewelry]; threads of precious metal [jewelry]; silver thread [jewelry]; olivine [gems]; osmium; palladium; platinum [metal]; watch springs; crucifixes of precious metal, other than jewelry; crucifixes as jewelry; rhodium; ruthenium; stopwatches; silver, unwrought or beaten; earrings; ingots of precious metals; statues of precious metal; figurines of precious metal; watch glasses; paste jewelry [costume jewelry]; watch hands; clock hands; ornaments of jet; shoe jewelry; hat jewelry; presentation boxes for watches; chronographs [watches]; chronometers; chronoscopes; chains [jewelry]; watch chains; dials [clock- and watchmaking]; atomic clocks; watches; sundials; clocks and watches, electric; control clocks [master clocks]; clocks; wristwatches; rosaries; jewelry boxes; spinel [precious stones].

16 – Paper and cardboard; printed matter; book-binding material; photographs [printed]; stationery and office requisites, except furniture; adhesives for stationery or household purposes; artists' and drawing materials; paintbrushes; instructional and teaching materials; plastic sheets, films and bags for wrapping and packaging; printers' type, printing blocks; fountain pens; watercolours [paintings]; albums; almanacs; document laminators for office use; mimeograph apparatus and machines; atlases; posters; banknotes; banners of paper; paper bows, other than haberdashery or hair decorations; name badges [office requisites]; table linen of paper; tickets; baggage claim check tags of paper; forms, printed; announcement cards [stationery]; glitter for stationery purposes; note books; pads [stationery]; drawing pads; wristbands for the retention of writing instruments; pamphlets; booklets; paper sheets [stationery]; waxed paper; paper

for medical examination tables; paper for recording machines; paper for radiograms; papers for painting and calligraphy; electrocardiograph paper; drawer liners of paper, perfumed or not; wood pulp paper; carbon paper; copying paper [stationery]; parchment paper; writing paper; rice paper; luminous paper; toilet paper; wrapping paper; filter paper; washi; blotters; newsletters; rollers for typewriters; house painters' rollers; composing sticks; modelling wax, not for dental purposes; signboards of paper or cardboard; sewing patterns; bunting of paper; newspapers; electrotypes; hectographs; modelling clay; polymer modelling clay; terrestrial globes; drawing sets; engravings; slate pencils; pencil leads; document holders [stationery]; pencil holders; chalk holders; holders for cheque books; holders for stamps [seals]; page holders; name badge holders [office requisites]; diagrams; table runners of paper; engraving plates; writing slates; blackboards; galley racks [printing]; drawing boards; advertisement boards of paper or cardboard; duplicators; punches [office requisites]; cream containers of paper; magazines [periodicals]; money clips; clips for name badge holders [office requisites]; tags for index cards; pen clips; book-markers; etching needles; tracing needles for drawing purposes; periodicals; printed publications; paper shredders for office use; graphic representations; credit card imprinters, non-electric; graining combs; drawing instruments; calendars; tracing paper; tracing cloth; tracing patterns; gums [adhesives] for stationery or household purposes; lithographic stones; ink stones [ink reservoirs]; pencils; pencil lead holders; charcoal pencils; pictures; transfers [decalcomanias]; paintings [pictures], framed or unframed; wood pulp board [stationery]; hat boxes of cardboard; cards; index cards [stationery]; geographical maps; paper tapes and cards for the recordal of computer programmes; trading cards, other than for games; perforated cards for Jacquard looms; catalogues; spools for inking ribbons; covers of paper for flower pots; painters' brushes; writing brushes; typewriter keys; glue for stationery or household purposes; isinglass for stationery or household purposes; gluten [glue] for stationery or household purposes; starch paste [adhesive] for stationery or household purposes; books; manifolds [stationery]; comic books; drawing pins; cigar bands; envelopes [stationery]; boxes of paper or cardboard; cases for stamps [seals]; paint boxes for use in schools; correcting

fluids [office requisites]; printed coupons; stencils [stationery]; French curves; paper ribbons, other than haberdashery or hair decorations; typewriter ribbons; barcode ribbons; gummed tape [stationery]; adhesive bands for stationery or household purposes; correcting tapes [office requisites]; inking ribbons; adhesive tapes for stationery or household purposes; self-adhesive tapes for stationery or household purposes; square rulers for drawing; drawing rulers; flyers; absorbent sheets of paper or plastic for foodstuff packaging; humidity control sheets of paper or plastic for foodstuff packaging; viscose sheets for wrapping; sheets of reclaimed cellulose for wrapping; plastic bubble packs for wrapping or packaging; steel letters; type [numerals and letters]; lithographs; letter trays; paint trays; architects' models; postage stamps; plastics for modelling; graphic prints; modelling materials; teaching materials [except apparatus]; sealing compounds for stationery purposes; adhesives [glues] for stationery or household purposes; stuffing of paper or cardboard; packing [cushioning, stuffing] materials of paper or cardboard; packaging material made of starches; filtering materials of paper; tablemats of paper; addressing machines; pencil sharpening machines, electric or non-electric; bookbinding apparatus and machines [office equipment]; typewriters, electric or non-electric; paper creasers [office requisites]; franking machines for office use; chalk for lithography; writing chalk; tailors' chalk; marking chalk; spray chalk; bags [envelopes, pouches] of paper or plastics, for packaging; garbage bags of paper or of plastics; plastic bags for pet waste disposal; painters' easels; hand-rests for painters; printing sets, portable [office requisites]; bibs of paper; bibs, sleeved, of paper; stickers [stationery]; finger-stalls [office requisites]; writing cases [stationery]; cords for bookbinding; paper knives [letter openers]; printed sheet music; numbering apparatus; bottle envelopes of paper or cardboard; sealing wafers; covers [stationery]; passport holders; plastic cling film, extensible, for palletization; embroidery designs [patterns]; handwriting specimens for copying; oleographs; musical greeting cards; greeting cards; postcards; etchings; conical paper bags; paper bags for use in the sterilization of medical instruments; bags for microwave cooking; palettes for painters; ink sticks; pantographs [drawing instruments]; loose-leaf binders; files [office requisites]; jackets for papers; papier mâché; pastels [crayons]; model-

ling paste; pen cases; pen wipers; office perforators; pens [office requisites]; nibs of gold; nibs; steel pens; drawing pens; song books; seals [stamps]; sealing stamps; clipboards; address plates for addressing machines; handkerchiefs of paper; plastic film for wrapping; desk mats; trays for sorting and counting money; coasters of paper; bookends; stamp stands; mats for beer glasses; stands for pens and pencils; photograph stands; obliterating stamps; inking pads; stamp pads; binding strips [bookbinding]; towels of paper; inking sheets for document reproducing machines; inking sheets for duplicators; bookbinding cloth; gummed cloth for stationery purposes; printers' blankets, not of textile; portraits; paperweights; writing cases [sets]; inkstands; office requisites, except furniture; writing materials; writing instruments; drawing materials; school supplies [stationery]; adhesive tape dispensers [office requisites]; hand labelling appliances; lithographic works of art; prospectuses; printed timetables; ledgers [books]; printers' galleys; indexes; paper cutters [office requisites]; rubber erasers; elastic bands for offices; T-squares for drawing; graphic reproductions; retractable reels for name badge holders [office requisites]; penholders; marking pens [stationery]; tissues of paper for removing make-up; paper wipes for cleaning; dental tray covers of paper; face towels of paper; place mats of paper; tablecloths of paper; paper clasps; document files [stationery]; scrapers [erasers] for offices; paper-clips; staples for offices; erasing products; biological samples for use in microscopy [teaching materials]; histological sections for teaching purposes; figurines of papier mâché; steatite [tailor's chalk]; writing board erasers; composing frames [printing]; sealing wax; arithmetical tables; placards of paper or cardboard; writing or drawing books; fabrics for bookbinding; pencil sharpeners, electric or non-electric; transparencies [stationery]; stencil plates; stencils for decorating food and beverages; cardboard tubes; Indian inks; moisteners [office requisites]; moisteners for gummed surfaces [office requisites]; squares for drawing; chart pointers, non-electronic; bottle wrappers of paper or cardboard; envelope sealing machines for offices; sealing machines for offices; vignetting apparatus; apparatus for mounting photographs; stapling presses [office requisites]; manuals [handbooks]; paper coffee filters; flags of paper; silver paper; molds for modelling clays [artists' materials]; photo-engravings; stencil cases; canvas for

painting; chromolithographs [chromos]; animation cels; compasses for drawing; numbers [type]; artists' watercolor saucers; correcting ink [heliography]; ink; inkwells; blueprints; stencils; erasing shields; balls for ball-point pens; cabinets for stationery [office requisites]; address stamps; stamps [seals]; shields [paper seals]; prints [engravings]; labels of paper or cardboard.

18 – Leather and imitations of leather; animal skins; luggage and carrying bags; umbrellas and parasols; walking sticks; whips, harness and saddlery; collars, leashes and clothing for animals; mountaineering sticks; slings for carrying infants; luggage tags; pocket wallets; saddlecloths for horses; business card cases; reins; reins for guiding children; sling bags for carrying infants; harness fittings; credit card cases [wallets]; parts of rubber for stirrups; chamois leather, other than for cleaning purposes; umbrellas; parasols; saddlery; frames for umbrellas or parasols; handbag frames; card cases [notecases]; cases of leather or leatherboard; valves of leather; imitation leather; leather, unworked or semi-worked; leatherboard; casings, of leather, for springs; umbrella rings; hat boxes of leather; boxes of leather or leatherboard; boxes of vulcanized fiber; purses; chain mesh purses; fastenings for saddles; butts [parts of hides]; saddle trees; bags [envelopes, pouches] of leather, for packaging; moleskin [imitation of leather]; travelling sets [leatherware]; knee-pads for horses; muzzles; halters; vanity cases, not fitted; furniture coverings of leather; clothing for pets; covers for animals; trimmings of leather for furniture; hiking sticks; conference folders; music cases; goldbeaters' skin; cat o' nine tails; leather leashes; pads for horse saddles; horseshoes; girths of leather; leathercloth; horse blankets; garment bags for travel; shoulder belts [straps] of leather; briefcases; traces [harness]; fur; randsels [Japanese school satchels]; haversacks; leather straps; straps for soldiers' equipment; harness straps; straps for skates; straps of leather [saddlery]; chin straps, of leather; stirrup leathers; umbrella handles; walking stick handles; suitcase handles; grips for holding shopping bags; rucksacks; travelling bags; riding saddles; net bags for shopping; umbrella or parasol ribs; stirrups; bags for climbers; tool bags, empty; handbags; beach bags; saddlebags; compression cubes adapted for luggage; bags for sports; bags for campers; shopping bags; wheeled shopping bags; school satchels; bags; pouch baby carriers; travelling trunks;

trunks [luggage]; nose bags [feed bags]; bridoons; umbrella sticks; walking stick seats; tefillin [phylacteries]; bits for animals [harness]; bridles [harness]; harness for animals; key cases; horse collars; suitcases; motorized suitcases; suitcases with wheels; valises; attaché cases; covers for horse saddles; umbrella covers; kid; curried skins; cattle skins; leather cord; blinkers [harness]; labels of leather; game bags [hunting accessories].

20 – Furniture, mirrors, picture frames; containers, not of metal, for storage or transport; unworked or semi-worked bone, horn, whalebone or mother-of-pearl; shells; meerschaum; yellow amber; picture frame brackets; bumper guards for cots, other than bed linen; reels, not of metal, non-mechanical, for flexible hoses; pulleys of plastics for blinds; bolts, not of metal; casks of wood for decanting wine; mooring buoys, not of metal; casks, not of metal; barrels, not of metal; identification bracelets, not of metal; sideboards; busts of wood, wax, plaster or plastic; costume stands; bolsters; fans for personal use, non-electric; work benches; vice benches [furniture]; valet stands; coatstands; coat hangers; shoulder poles [yokes]; screws, not of metal; display stands; showcases [furniture]; newspaper display stands; jewelry organizer displays; collars, not of metal, for fastening pipes; comb foundations for beehives; signboards of wood or plastics; loading gauge rods, not of metal, for railway wagons; nuts, not of metal; covers for clothing [wardrobe]; shoe pegs, not of metal; nesting boxes; coffins; doors for furniture; curtain holders, not of textile material; pegs [pins], not of metal; divans; door closers, not of metal, non-electric; kennels for household pets; birdhouses; keyboards for hanging keys; display boards; plugs [dowels], not of metal; containers, not of metal, for liquid fuel; troughs, not of metal, for mixing mortar; oil drainage containers, not of metal; packaging containers of plastic; indoor window blinds [furniture]; indoor window blinds of paper; indoor window blinds of woven wood; indoor window blinds of textile; flower-stands [furniture]; curtain tie-backs; clips, not of metal, for cables and pipes; binding screws, not of metal, for cables; clips of plastic for sealing bags; rivets, not of metal; imitation tortoiseshell; locks, not of metal, for vehicles; locks, other than electric, not of metal; bead curtains for decoration; door bolts, not of metal; bottle closures, not of metal; closures, not of metal, for containers; latches, not of metal; hand-held

mirrors [toilet mirrors]; bamboo; scratching posts for cats; animal claws; animal hooves; coral; whalebone, unworked or semi-worked; stag antlers; tortoiseshell; horn, unworked or semi-worked; animal horns; rattan; corozo; plaited straw, except matting; wickerwork; hampers [baskets] for the transport of items; works of art of wood, wax, plaster or plastic; cabinet work; reeds [plaiting materials]; settees; jerrycans, not of metal; curtain rods; index cabinets [furniture]; reels of wood for yarn, silk, cord; drain traps [valves] of plastic; water-pipe valves of plastic; valves, not of metal, other than parts of machines; staves of wood; plastic keys; plastic key cards, not encoded and not magnetic; mats for infant playpens; sleeping mats; saw horses; bed casters, not of metal; furniture casters, not of metal; brush mountings; chopping blocks [tables]; wind chimes [decoration]; door bells, not of metal, non-electric; bottle caps, not of metal; cradles; tent pegs, not of metal; curtain rings; split rings, not of metal, for keys; chests of drawers; console tables; containers, not of metal [storage, transport]; floating containers, not of metal; lecterns; dog kennels; bakers' bread baskets; baskets, not of metal; Moses baskets; bottle casings of wood; tool boxes, not of metal, empty; faucets, not of metal, for casks; armchairs; hairdressers' chairs; deck chairs; hospital beds; waterbeds, not for medical purposes; bedsteads of wood; air beds, not for medical purposes; beds; cots for babies; edgings of plastic for furniture; brackets, not of metal, for furniture; screw tops, not of metal, for bottles; table tops; sash fasteners, not of metal, for windows; hooks, not of metal, for clothes rails; curtain hooks; clothes hooks, not of metal; bag hangers, not of metal; beds for household pets; nesting boxes for household pets; ladders of wood or plastics; playpens for babies; mannequins; air mattresses, not for medical purposes; camping mattresses; mattresses; furniture of metal; inflatable furniture; office furniture; school furniture; mobiles [decoration]; door knockers, not of metal; shoe dowels, not of metal; curtain rails; runners, not of metal, for sliding doors; legs for furniture; feet for furniture; house numbers, not of metal, non-luminous; barrel hoops, not of metal; door stops, not of metal or rubber; window stops, not of metal or rubber; moldings for picture frames; bed bases; furniture partitions of wood; freestanding partitions [furniture]; mother-of-pearl, unworked or semi-worked; mirror tiles; ambroid plates; registrati-

on plates, not of metal; identity plates, not of metal; loading pallets, not of metal; handling pallets, not of metal; transport pallets, not of metal; head-rests [furniture]; trays, not of metal; stakes, not of metal, for plants or trees; trestles [furniture]; magazine racks; book rests [furniture]; stands for calculating machines; flower-pot pedestals; plastic ramps for use with vehicles; baby changing mats; pet cushions; pillows; cushions; head support cushions for babies; anti-roll cushions for babies; air cushions, not for medical purposes; air pillows, not for medical purposes; head positioning pillows for babies; removable mats or covers for sinks; racks [furniture]; library shelves; shelves for file cabinets; furniture shelves; shelves for storage; wood ribbon; straw edgings; towel stands [furniture]; hat stands; bathtub grab bars, not of metal; cask stands, not of metal; inflatable publicity objects; counters [tables]; bedding, except linen; corks for bottles; corks; stoppers, not of glass, metal or rubber; sealing caps, not of metal; stair rods; standing desks; embroidery frames; dispensers for dog waste bags, fixed, not of metal; towel dispensers, fixed, not of metal; picture frames; sections of wood for beehives; crucifixes of wood, wax, plaster or plastic, other than jewelry; tanks, not of metal nor of masonry; fodder racks; curtain rollers; door handles, not of metal; knobs, not of metal; fishing baskets; writing desks; bath seats for babies; seats of metal; benches [furniture]; vats, not of metal; honeycombs; sofas; bungs, not of metal; statues of wood, wax, plaster or plastic; figurines of wood, wax, plaster or plastic; oyster shells; silvered glass [mirrors]; shelving units; ambroid bars; umbrella stands; gun racks; carts for computers [furniture]; lap desks; dressing tables; washstands [furniture]; typing desks; drafting tables; massage tables; tables of metal; wall-mounted baby changing platforms; saw benches [furniture]; desks; portable desks; tea carts; dinner wagons [furniture]; tables; steps [ladders], not of metal; step stools, not of metal; chairs [seats]; high chairs for babies; shower chairs; chests, not of metal; placards of wood or plastics; stools; footstools; crates; trolleys [furniture]; straw plaits; mobile boarding stairs, not of metal, for passengers; straw mattresses; decorations of plastic for foodstuffs; beehives; door fasteners, not of metal; window fasteners, not of metal; funerary urns; winding spools, not of metal, non-mechanical, for flexible hoses; hand-held flagpoles, not of metal; door fittings, not of

metal; coffin fittings, not of metal; bed fittings, not of metal; furniture fittings, not of metal; window fittings, not of metal; infant walkers; garment covers [storage]; stuffed animals; stuffed birds; hinges, not of metal; chaise longues; poles, not of metal; screens [furniture]; filing cabinets; medicine cabinets; plate racks; meat safes; bookcases; wardrobes; cupboards; bamboo curtains; slatted indoor blinds; screens for fireplaces [furniture]; labels of plastic; lockers; chests for toys; tool chests, not of metal, empty; boxes of wood or plastic; letter boxes, not of metal or masonry; bottle racks.

21 – Household or kitchen utensils and containers; cookware and tableware, except forks, knives and spoons; combs and sponges; brushes, except paintbrushes; material for brush-making; articles for cleaning purposes; unworked or semi-worked glass, except building glass; glassware, porcelain and earthenware; pressure cookers, non-electric; indoor aquaria; wine aerators; buckets; cookie jars; candle jars [holders]; china ornaments; dishes; paper plates; vegetable dishes; saucers; mugs; candy boxes; bottles; demijohns; busts of porcelain, ceramic, earthenware, terra-cotta or glass; vases; epergnes; fruit cups; inflatable bath tubs for babies; bird baths; baby baths, portable; plungers for clearing blocked drains; waffle irons, non-electric; coolers [ice pails]; mop wringer buckets; buckets made of woven fabrics; whisks, non-electric, for household purposes; cooking skewers of metal; towel rails and rings; clothing stretchers; hair for brushes; horsehair for brush-making; birdcages; funnels; carpet beaters [hand instruments]; signboards of porcelain or glass; candle extinguishers; heads for electric toothbrushes; flower pots; chamber pots; glue-pots; cruets; decanters; large-toothed combs for the hair; combs for animals; tea cosies; abrasive sponges for scrubbing the skin; make-up sponges; sponges for household purposes; toilet sponges; sponge holders; stands for portable baby baths; toothpick holders; soap holders; table napkin holders; holders for flowers and plants [flower arranging]; tea bag rests; shaving brush stands; toilet paper holders; soap dispensers; toilet paper dispensers; plug-in diffusers for mosquito repellents; aromatic oil diffusers, other than reed diffusers; ironing boards; cutting boards for the kitchen; bread boards; washing boards; crushers for kitchen use, non-electric; strainers for household purposes; smoke absorbers for household purposes; containers for household or kitchen use; kitchen

containers; glass jars [carboys]; heat-insulated containers; heat-insulated containers for beverages; thermally insulated containers for food; glass flasks [containers]; closures for pot lids; chamois leather for cleaning; toothpicks; ceramics for household purposes; majolica; works of art of porcelain, ceramic, earthenware, terra-cotta or glass; kitchen grinders, non-electric; cleaning instruments, hand-operated; cabarets [trays]; stew-pans; couscous cooking pots, non-electric; covers, not of paper, for flower pots; shaving brushes; make-up brushes; basting brushes; cages for household pets; baking mats; ladles for serving wine; polishing leather; hot pots, not electrically heated; glass bulbs [receptacles]; shoe trees; napkin rings; poultry rings; rings for birds; coin banks; piggy banks; bread baskets for household purposes; baskets for household purposes; waste paper baskets; feeding troughs; mangers for animals; lunch boxes; tea caddies; washtubs; earthenware saucepans; mess-tins; cauldrons; coffee percolators, non-electric; coffeepots, non-electric; coffee grinders, hand-operated; fused silica [semi-worked product], other than for building; beer mugs; tankards; rat traps; pot lids; aquarium hoods; butter-dish covers; dish covers; cheese-dish covers; reusable silicone food covers; buttonhooks; reusable ice cubes; pitchers; perfume burners; watering cans; fly traps; insect traps; ice cream scoops; mixing spoons [kitchen utensils]; basting spoons [cooking utensils]; pie servers; cosmetic spatulas; spatulas for kitchen use; litter boxes for pets; butter dishes; polishing materials for making shiny, except preparations, paper and stone; tablemats, not of paper or textile; noodle machines, hand-operated; lint removers, electric or non-electric; pasta makers, hand-operated; polishing apparatus and machines, for household purposes, non-electric; pepper mills, hand-operated; mills for household purposes, hand-operated; feather-dusters; brooms; isothermic bags; confectioners' decorating bags [pastry bags]; bowls [basins]; mosaics of glass, not for building; saucepan scourers of metal; soap boxes; mouse traps; cooking pot sets; nozzles for watering cans; pouring spouts; cake decorating tips and tubes; nozzles for watering hose; fitted picnic baskets, including dishes; toilet cases; floss for dental purposes; fiberglass thread, other than for textile use; cookie [biscuit] cutters; pastry cutters; sprinklers; syringes for watering flowers and plants; egg yolk separators; cotton waste for cleaning; wool waste for cleaning;

cleaning tow; cold packs for chilling food and beverages; chopsticks; cocktail stirrers; food steamers, non-electric; pepper pots; oven mitts; animal grooming gloves; gloves for household purposes; car washing mitts; polishing gloves; gardening gloves; pestles for kitchen use; droppers for household purposes; wine-tasting pipettes; droppers for cosmetic purposes; plates for diffusing aromatic oil; plates to prevent milk boiling over; dripping pans; trays for household purposes; trays of paper, for household purposes; lazy susans; heaters for feeding bottles, non-electric; candelabra [candlesticks]; trivets [table utensils]; coasters, not of paper or textile; grill supports; menu card holders; knife rests for the table; flat-iron stands; egg cups; abrasive pads for kitchen purposes; scouring pads; drinking troughs; serving ladles; powdered glass for decoration; pottery; pots; cooking pots; painted glassware; tableware, other than knives, forks and spoons; porcelain ware; earthenware; crystal [glassware]; cosmetic utensils; toilet utensils; trouser presses; tortilla presses, non-electric [kitchen utensils]; deodorizing apparatus for personal use; cruet sets for oil and vinegar; make-up removing appliances; spice sets; apparatus for wax-polishing, non-electric; bottle openers, electric and non-electric; glove stretchers; boot jacks; crumb trays; tie presses; potholders; clothes-pegs; glass stoppers; powder compacts; perfume vaporizers; powder puffs; dusting apparatus, non-electric; foam toe separators for use in pedicures; electric combs; grills [cooking utensils]; sifters [household utensils]; drinking horns; shoe horns; candle drip rings; broom handles; salad bowls; place mats, not of paper or textile; sugar bowls; beaters, non-electric; egg separators, non-electric, for household purposes; services [dishes]; coffee services [tableware]; liqueur sets; tea services [tableware]; cooking mesh bags, other than for microwaves; sieves [household utensils]; cinder sifters [household utensils]; tea strainers; siphon bottles for carbonated water; rolling pins, domestic; frying pans; squeegees [cleaning instruments]; steel wool for cleaning; curry-combs; blenders, non-electric, for household purposes; scoops for household purposes; fruit presses, non-electric, for household purposes; drinking straws; salt cellars; drinking vessels; vessels of metal for making ices and iced drinks; refrigerating bottles; bulb basters; cups of paper or plastic; glasses [receptacles]; drinking glasses; statues of porcelain, ceramic, earthenware, terra-cotta or glass;

figurines of porcelain, ceramic, earthenware, terra-cotta or glass; glass for vehicle windows [semi-finished product]; plate glass [raw material]; opal glass; opaline glass; glass incorporating fine electrical conductors; enamelled glass, not for building; glass wool, other than for insulation; vitreous silica fibers, other than for textile use; fiberglass, other than for insulation or textile use; mortars for kitchen use; portable cool boxes, non-electric; soup bowls; drying racks for laundry; rotary washing lines; tajines, non-electric; basins [receptacles]; table plates; disposable table plates; graters for kitchen use; insulating flasks; indoor terrariums [plant cultivation]; indoor terrariums [vivariums]; cloth for washing floors; polishing cloths; cloths for cleaning; dusting cloths [rags]; furniture dusters; urns; aerosol dispensers, not for medical purposes; wax-polishing appliances, non-electric, for shoes; water apparatus for cleaning teeth and gums; electric devices for attracting and killing insects; watering devices; utensils for household purposes; kitchen utensils; cooking utensils, non-electric; coffee filters, non-electric; flasks; hip flasks; drinking bottles for sports; boot trees; molds [kitchen utensils]; egg poachers; cake moulds; ice cube moulds; cookery moulds; deep fryers, non-electric; comb cases; bread bins; fly swatters; teapots; kettles, non-electric; cups; garlic presses [kitchen utensils]; ironing board covers, shaped; tea infusers; glass bowls; mop wringers; mops; cocktail shakers; corkscrews, electric and non-electric; animal bristles [brushware]; pig bristles for brush-making; dishwashing brushes; ski wax brushes; brushes for cleaning tanks and containers; lamp-glass brushes; horse brushes; scrubbing brushes; toothbrushes; toothbrushes, electric; carpet sweepers; brushes for footwear; tar-brushes, long handled; toilet brushes; electric brushes, except parts of machines; brushes; eyebrow brushes; nail brushes; eyelash brushes; nutcrackers; ice tongs; salad tongs; sugar tongs; decanter tags; nest eggs, artificial; boxes for dispensing paper towels; dustbins; window-boxes; boxes of glass.

24 – Textiles and substitutes for textiles; frieze [cloth]; banners of textile or plastic; velvet; household linen; diapered linen; bath linen, except clothing; bed linen; table linen, not of paper; cot bumpers [bed linen]; buckram; fustian; sleeping bag liners; felt; bunting of textile or plastic; gauze [cloth]; damask; jersey [fabric]; table runners, not of paper; drugget; shower curtains of textile or

plastic; curtains of textile or plastic; net curtains; zephyr [cloth]; canvas for tapestry or embroidery; bolting cloth; baby buntings; crepe [fabric]; crepon; marabouts [cloth]; furniture coverings of textile; fabrics for textile use; filtering materials of textile; wall hangings of textile; non-woven textile fabrics; plastic material [substitute for fabrics]; textile material; tablemats of textile; bivouac sacks being covers for sleeping bags; sleeping bags; sleeping bags for babies; moleskin [fabric]; muslin fabric; pillowcases; mattress covers; bed blankets; blankets for household pets; brocades; diaper changing cloths for babies; handkerchiefs of textile; picnic blankets; travelling rugs [lap robes]; coasters of textile; bed valances; linings [textile]; hat linings, of textile, in the piece; curtain holders of textile material; bed covers; bed covers of paper; furniture coverings of plastic; towels of textile; hemp cloth; gummed cloth, other than for stationery purposes; printers' blankets of textile; cloth; door curtains; sheets [textile]; eiderdowns [down coverlets]; bath mitts; shrouds; glass cloths [towels]; cloths for removing make-up; face towels of textile; place mats of textile; table napkins of textile; mosquito nets; calico; oilcloth for use as tablecloths; tablecloths, not of paper; billiard cloth; taffeta [cloth]; ticks [mattress covers]; tick [linen]; lingerie fabric; fabric, impervious to gases, for aeronautical balloons; jute fabric; fabric for footwear; ramie fabric; esparto fabric; rayon fabric; fiberglass fabrics for textile use; adhesive fabric for application by heat; linen cloth; upholstery fabrics; hemp fabric; lining fabric for footwear; traced cloth for embroidery; chenille fabric; printed calico cloth; knitted fabric; cotton fabrics; silk fabrics for printing patterns; woollen cloth; elastic woven material; fabric; fabric of imitation animal skins; haircloth [sackcloth]; cheese cloth; tulle; flags of textile or plastic; flannel [fabric]; trellis [cloth]; covers for cushions; fitted toilet lid covers of fabric; covers [loose] for furniture; pillow shams; cheviots [cloth]; silk [cloth]; labels of textile.

25 – Clothing, footwear, headgear; wimples; bandanas [neckerchiefs]; underwear; sweat-absorbent underwear; berets; overalls; boas [necklets]; teddies [underclothing]; boxer shorts; ankle boots; ski boots; boots for sports; breeches for wear; trousers; football boots; brassieres; valenki [felted boots]; mittens; collars [clothing]; detachable collars; shirt yokes; veils [clothing]; gabardines [clothing]; galoshes; neckties; ascots; leggings [leg warmers];

gaiters; boot uppers; corselets; jerseys [clothing]; vests; sports jerseys; hosiery; heels; hoods [clothing]; hat frames [skeletons]; pockets for clothing; neck scarfs [mufflers]; caps being headwear; kimonos; cap peaks; visors being headwear; tights; slips [underclothing]; combinations [clothing]; wet suits for water-skiing; bodices [lingerie]; corsets [underclothing]; suits; bathing suits; masquerade costumes; beach clothes; leotards; jackets [clothing]; stuff jackets [clothing]; fishing vests; leggings [trousers]; liveries; camisoles; sports singlets; cuffs; short-sleeve shirts; mantillas; coats; sleep masks; furs [clothing]; hand warmers [fingerless gloves]; fingerless gloves; miters [hats]; muffs [clothing]; footmuffs, not electrically heated; bibs, not of paper; bibs, sleeved, not of paper; fur stoles; hairdressing capes; heel protectors for shoes; ear muffs [clothing]; socks; sweat-absorbent socks; beach shoes; sports shoes; paper clothing; outer clothing; embroidered clothing; ready-made clothing; motorists' clothing; cyclists' clothing; clothing for gymnastics; clothing of imitations of leather; clothing of leather; waterproof clothing; uniforms; clothing containing slimming substances; fittings of metal for footwear; maniples; overcoats; panties; parkas; pelerines; gloves [clothing]; ski gloves; pajamas; bathing trunks; shirt fronts; scarfs; pocket squares; dresses; headbands [clothing]; garters; sock suspenders; stocking suspenders; ready-made linings [parts of clothing]; dress shields; soles for footwear; heelpieces for footwear; braces for clothing [suspenders]; half-boots; lace boots; ponchos; girdles; belts [clothing]; money belts [clothing]; layettes [clothing]; non-slipping devices for footwear; sweaters; heelpieces for stockings; welts for footwear; chasubles; shirts; wooden shoes; sandals; bath sandals; boots; jumper dresses; saris; sarongs; footwear uppers; inner soles; albs; bath slippers; togas; knitwear [clothing]; underpants; gymnastic shoes; slippers; shoes; skull caps; turbans; aprons [clothing]; judo uniforms; karate uniforms; tee-shirts; dressing gowns; bath robes; top hats; tips for footwear; stockings; sweat-absorbent stockings; shawls; paper hats [clothing]; shower caps; bathing caps; sashes for wear; studs for football boots; hats; babies' pants [underwear]; trouser straps; pelisses; esparto shoes or sandals; skirts; petticoats; skorts.

26 – Lace, braid and embroidery, and haberdashery ribbons and bows; buttons, hooks and eyes, pins and needles; artificial flowers; hair decorations; false hair; appliqués [haberdashery]; haberdashery

bows; fringes; mica spangles; shoe eyelets; false beards; charms, other than for jewellery, key rings or key chains; brooches [clothing accessories]; hat pins, other than jewellery; entomological pins; pins, other than jewelry; beads, other than for making jewelry; wreaths of artificial flowers; artificial Christmas wreaths; artificial Christmas wreaths incorporating lights; human hair; lace for edgings; artificial garlands; artificial Christmas garlands; artificial Christmas garlands incorporating lights; darning lasts; expanding bands for holding sleeves; frills [lacework]; trouser clips for cyclists; bobby pins; hair barrettes; heat adhesive patches for repairing textile articles; blouse fasteners; shoe fasteners; fastenings for clothing; fastenings for suspenders; belt clasps; hook and pile fastening tapes; zippers; zippers for bags; badges for wear, not of precious metal; competitors' numbers; embroidery needles; needles for wool combing machines; binding needles; saddlers' needles; shoemakers' needles; sewing needles; darning needles; boxes for needles; lace trimmings; haberdashery [dressmakers' articles], except thread; decorative articles for the hair; heat adhesive patches for decoration of textile articles [haberdashery]; edgings for clothing; braids; gold embroidery; silver embroidery; bobbins for retaining embroidery floss or wool [not parts of machines]; tassels [haberdashery]; snap fasteners; sewing boxes; tresses of hair; false hems; hooks [haberdashery]; crochet needles; rug hooks; hooks for corsets; shoe hooks; haberdashery ribbons; ribbons for the hair; ribbons and bows, not of paper, for gift wrapping; prize ribbons; hatbands; elastic ribbons; letters for marking linen; numerals for marking linen; numerals or letters for marking linen; sewing kits; toupees; sewing thimbles; needle-threaders; skirt flounces; bows for the hair; spangles for clothing; hair curling papers; wigs; feathers [clothing accessories]; birds' feathers [clothing accessories]; ostrich feathers [clothing accessories]; eyelets for clothing; picot [lace]; whalebones for corsets; hair bands; brassards; tapes for curtain headings; shoulder pads for clothing; pin cushions; needle cushions; top-knots [pompoms]; hair curlers, electric and non-electric, other than hand implements; buckles [clothing accessories]; shoe buckles; ornamental novelty badges [buttons]; artificial plants, other than Christmas trees; rosettes [haberdashery]; frills for clothing; hair nets; chenille [passementerie]; knitting needles; cords for trimming; shoe trimmings; tri-

mmings for clothing; hat trimmings; false moustaches; festoons [embroidery]; artificial fruit; needle cases; shuttles for making fishing nets; hair coloring caps; bodkins; hair extensions; shoe laces; cords for clothing; woollen laces; hair pins; hair curling pins; collar supports.

35 – Advertising; business management; business administration; office functions; arranging subscriptions to telecommunication services for others; import-export agency services; commercial information agency services; advertising agency services; cost price analysis; rental of office equipment in coworking facilities; rental of advertising space; business auditing; financial auditing; business intermediary services relating to the matching of potential private investors with entrepreneurs needing funding; employment agency services; computerized file management; book-keeping; invoicing; demonstration of goods; transcription of communications [office functions]; opinion polling; market studies; business information; commercial information and advice for consumers in the choice of products and services; business investigations; business research; marketing research; personnel recruitment; business management and organization consultancy; business organization consultancy; business management consultancy; personnel management consultancy; professional business consultancy; consultancy regarding public relations communication strategies; consultancy regarding advertising communication strategies; layout services for advertising purposes; marketing; marketing in the framework of software publishing; targeted marketing; business management of performing artists; business management of sports people; writing of résumés for others; scriptwriting for advertising purposes; news clipping services; updating and maintenance of information in registries; updating and maintenance of data in computer databases; updating of advertising material; word processing; online retail services for downloadable and pre-recorded music and movies; online retail services for downloadable ring tones; online retail services for downloadable digital music; organization of exhibitions for commercial or advertising purposes; arranging newspaper subscriptions for others; organization of fashion shows for promotional purposes; organization of trade fairs for commercial or advertising purposes; shop window dressing; design of advertising materials; business appraisals; payroll preparation;

data search in computer files for others; sponsorship search; administrative assistance in responding to calls for tenders; business management assistance; commercial or industrial management assistance; commercial intermediation services; providing business information via a web site; provision of commercial and business contact information; provision of an online marketplace for buyers and sellers of goods and services; web indexing for commercial or advertising purposes; presentation of goods on communication media, for retail purposes; media relations services; economic forecasting; auctioneering; wholesale services for pharmaceutical, veterinary and sanitary preparations and medical supplies; retail services for works of art provided by art galleries; retail services for pharmaceutical, veterinary and sanitary preparations and medical supplies; sales promotion for others; promotion of goods and services through sponsorship of sports events; production of teleshopping programmes; production of advertising films; office machines and equipment rental; rental of advertising time on communication media; publicity material rental; rental of billboards [advertising boards]; rental of vending machines; rental of sales stands; rental of photocopying machines; publication of publicity texts; radio advertising; bill-posting; distribution of samples; dissemination of advertising matter; direct mail advertising; registration of written communications and data; writing of publicity texts; online advertising on a computer network; advertising by mail order; television advertising; document reproduction; compilation of statistics; compilation of information into computer databases; business inquiries; systemization of information into computer databases; advisory services for business management; corporate communications services; negotiation of business contracts for others; negotiation and conclusion of commercial transactions for third parties; compiling indexes of information for commercial or advertising purposes; tax preparation; drawing up of statements of accounts; telemarketing services; psychological testing for the selection of personnel; interim business management; outsourced administrative management for companies; business management of hotels; business management for freelance service providers; business project management services for construction projects; commercial administration of the licensing of the goods and services of others; business

management of reimbursement programs for others; administration of consumer loyalty programs; administration of frequent flyer programs; administrative processing of purchase orders; public relations; commercial lobbying services; competitive intelligence services; modelling for advertising or sales promotion; typing; market intelligence services; appointment reminder services [office functions]; web site traffic optimization; relocation services for businesses; tax filing services; search engine optimization for sales promotion; appointment scheduling services [office functions]; gift registry services; price comparison services; pay per click advertising; secretarial services; procurement services for others [purchasing goods and services for other businesses]; shorthand; outsourcing services [business assistance]; telephone answering for unavailable subscribers; photocopying services; business efficiency expert services; retail and wholesale services.

39 – Transport; packaging and storage of goods; organization of tours; air transport; motor coach rental; boat rental; garage rental; rental of vehicle roof racks; aircraft rental; parking place rental; rental of electric wine cellars; rental of warehouses; rental of tractors; booking of seats for travel; travel reservation; transport reservation; towing; vehicle breakdown towing services; bottling services; water distribution; delivery of newspapers; message delivery; parcel delivery; delivery of goods; delivery of goods by mail order; flower delivery; replenishment of vending machines; launching of satellites for others; traffic information; transportation information; storage information; transportation logistics; rescue operations [transport]; arranging of cruises; arranging of passenger transportation services for others via an online application; arranging of transportation for travel tours; armored-car transport; hauling; carting; transport and storage of trash; transporting furniture; lighterage services; ferry-boat transport; removal services; transport of travellers; guarded transport of valuables; bus transport; car transport; barge transport; boat transport; railway transport; marine transport; passenger transport; river transport; ambulance transport; streetcar transport; portorage; refloating of ships; cash replenishment of automated teller machines; shipbrokerage; transport brokerage; freight brokerage [forwarding (Am.)]; providing driving directions for travel purposes; car rental; railway truck rental; rental of di-

ving bells; rental of diving suits; rental of motor racing cars; rental of aircraft engines; railway coach rental; rental of wheelchairs; rental of storage containers; horse rental; rental of freezers; rental of navigational systems; refrigerator rental; vehicle rental; stevedoring; unloading cargo; electricity distribution; distribution of energy; packing of goods; collection of recyclable goods [transport]; ice-breaking; piloting; water supplying; escorting of travellers; transport by pipeline; operating canal locks; car parking; chauffeur services; pleasure boat transport; car sharing services; courier services [messages or merchandise]; salvaging; salvage of ships; gift wrapping; underwater salvage; taxi transport; transport services for sightseeing tours; luggage storage; franking of mail; freight [shipping of goods]; freighting; physical storage of electronically stored data or documents; boat storage; storage; freight forwarding.

40 – Treatment of materials; paper finishing; applying finishes to textiles; beer brewing for others; upcycling [waste recycling]; vulcanization [material treatment]; skin dressing; fruit crushing; embroidering; galvanization; electroplating; engraving; decontamination of hazardous materials; air deodorizing; stripping finishes; tanning; metal tempering; freezing of foods; gilding; gold plating; material treatment information; cadmium plating; permanent-press treatment of fabrics; food and drink preservation; food smoking; leather staining; fur dyeing; shoe staining; textile dyeing; cloth dyeing; laminating; lithographic printing; metal casting; fur glossing; tin plating; boilermaking; taxidermy; magnetization; nickel plating; abrasion; paper treating; water treating; woodworking; processing of cinematographic films; leather working; cloth edging; metal treating; fur conditioning; fur mothproofing; waste treatment [transformation]; textile mothproofing; fabric waterproofing; crease-resistant treatment for clothing; cloth fireproofing; textile treating; wool treating; framing of works of art; window tinting treatment, being surface coating; air freshening; fabric bleaching; air purification; soldering; clothing alteration; recycling of waste and trash; processing of oil; pattern printing; photographic printing; offset printing; metal plating; printing; burnishing by abrasion; flour milling; dressmaking; custom manufacturing of bread; rental of boilers; knitting machine rental; rental of generators; rental of air-conditioning apparatus; rental of space heating apparatus; photograp-

hic film development; pottery firing; blacksmithing; custom assembling of materials for others; bookbinding; welding services; glass-blowing; saddlery working; grinding; cloth cutting; sawing of materials; refining services; timber felling and processing; fur satining; silver plating; incineration of waste and trash; laser scribing; warping [looms]; sorting of waste and recyclable material [transformation]; photocomposing services; quilting; planing of materials; fulling of cloth; tinting of car windows; slaughtering of animals; destruction of waste and trash; cloth pre-shrinking; custom 3D printing for others; services of a dental technician; cryopreservation services; key cutting; dyeing services; sandblasting services; production of energy; custom tailoring; custom fashioning of fur; photogravure; millworking; chromium plating; colour separation services; silkscreen printing; optical glass grinding.

42 – Scientific and technological services and research and design relating thereto; industrial analysis and industrial research services; design and development of computer hardware and software; water analysis; computer system analysis; handwriting analysis [graphology]; chemical analysis; energy auditing; recovery of computer data; business card design; graphic design of promotional materials; interior design; industrial design; graphic arts design; computer virus protection services; oil-field surveys; geological surveys; engineering; installation of computer software; meteorological information; clinical trials; material testing; textile testing; bacteriological research; biological research; geological research; research in the field of environmental protection; cosmetic research; mechanical research; research in the field of welding; research in the field of building construction; research in the field of telecommunications technology; research in the field of physics; chemical research; research and development of new products for others; medical research; scientific and technological research relating to patent mapping; scientific and technological research in the field of natural disasters; scientific research; analysis for oil-field exploitation; underwater exploration; technological research; calibration [measuring]; web site design consultancy; computer security consultancy; information technology [IT] consultancy; consultancy in the design and development of computer hardware; architectural consultancy; internet security consultancy; computer software

consultancy; data security consultancy; technological consultancy; oil-well testing; quality control; vehicle roadworthiness testing; land surveying; dress designing; updating of computer software; monitoring of computer systems to detect breakdowns; monitoring of computer systems for detecting unauthorized access or data breach; monitoring of computer systems by remote access; software as a service [SaaS]; maintenance of computer software; authenticating works of art; design of interior decor; quality evaluation of standing timber; quality evaluation of wool; digitization of documents [scanning]; conversion of data or documents from physical to electronic media; urban planning; providing information on computer technology and programming via a web site; provision of scientific information, advice and consultancy in relation to carbon offsetting; providing search engines for the internet; platform as a service [PaaS]; conversion of computer programs and data, other than physical conversion; conducting technical project studies; computer system design; rental of web servers; computer rental; rental of computer software; unlocking of mobile phones; geological prospecting; oil prospecting; hosting computer sites [web sites]; server hosting; development of computer platforms; construction drafting; software development in the framework of software publishing; cloud seeding; consultancy in the field of energy-saving; creating and designing website-based indexes of information for others [information technology services]; creating and maintaining web sites for others; computer programming; technical writing; copying of computer programs; cloud computing; architectural services; chemistry services; outsource service providers in the field of information technology; packaging design; off-site data backup; computer technology consultancy; telecommunications technology consultancy; scientific laboratory services; weather forecasting; styling [industrial design]; cartography services; exploration services in the field of the oil, gas and mining industries; data encryption services; electronic data storage; surveying; electronic monitoring of credit card activity to detect fraud via the internet; electronic monitoring of personally identifying information to detect identity theft via the internet.

44 – Medical services; veterinary services; hygienic and beauty care for human beings or animals; agriculture, horticulture and forestry services; ren-

tal of animals for gardening purposes; rental of beehives; public bath services for hygiene purposes; Turkish bath services; hospital services; depilatory waxing; reforestation services; rehabilitation for substance abuse patients; landscape design; health center services; nursing home services; wreath making; hair implantation; medical advice for individuals with disabilities; pharmacy advice; aromatherapy services; animal-assisted therapy; speech therapy; manicuring; chiropractic; massage; medical testing; medical screening; horticulture; orthodontic services; artificial insemination services; palliative care; hairdressing; body piercing; midwife services; veterinary assistance; dentistry services; medical assistance; tree planting for carbon offsetting purposes; preparation of prescriptions by pharmacists; medical equipment rental; rental of sanitary installations; farming equipment rental; aerial and surface spreading of fertilizers and other agricultural chemicals; animal breeding; gardening; landscape gardening; beauty salon services; sanatorium services; blood bank services; health care; health counselling; flower arranging; tattooing; vermin exterminating for agriculture, aquaculture, horticulture and forestry; weed killing; health spa services; human tissue bank services; aquaculture services; visagists' services; convalescent home services; rest home services; medical clinic services; medical analysis services for diagnostic and treatment purposes provided by medical laboratories; alternative medicine services; opticians' services; plant nursery services; pest control services for agriculture, aquaculture, horticulture and forestry; in vitro fertilization services; services of a psychologist; sauna services; solarium services; telemedicine services; therapy services; nursing, medical; lawn care; animal grooming; pet grooming; physical therapy; plastic surgery; tree surgery; hospice services.

(260) AM 2020 106573 A

(800) 1508651

(151) 2019 10 25

(891) 2019 10 25

(731) HUAWEI TECHNOLOGIES CO., LTD.

Administration Building, Huawei

Technologies Co., Ltd., Bantian, Longgang

District, Shenzhen, China

(540)

HUAWEI GeminiDB

(591) Black, white
(531) 27.05.10
(511)

9 – Computer software for computer access control; computers; data processing apparatus; computer memories; central processing units (processors); integrated circuit cards (smart cards); laptop computers; computer hardware; humanoid robots with artificial intelligence; thin client computers; hand-held electronic dictionaries; wearable computers; smartglasses; smartwatches; smart rings; scales; scales with body mass analyzers; human face recognition devices; digital signs; video telephones; global positioning system [GPS] apparatus; wearable activity trackers; telecommunication apparatus in the form of jewellery; navigation apparatus for vehicles (on-board computers); cell phones; loudspeakers; camcorders; television apparatus; earphones; virtual reality headsets; wearable video display monitors; teaching machines; headphones; set-top boxes; digital video recorder for vehicles; television cameras; electronic book readers; digital photo frames; cameras (photography); smartphones; computer programs for editing images, sounds and videos; graphics accelerators; computer programs for document management; operating system programs; computer operating programs; computer operating software; computer central processing units; computer programs for searching content in the computers and computer networks by remote access; computer software for operating and controlling audio and video apparatus; compiler software; computer chatbot software for simulating conversation; computer software for controlling self-service terminal; computer software of maintaining and running computer system; computer programs applications (programs for executing computer maintenance); computer operating programs, recorded; computer software, recorded; computer software applications, downloadable; tablet computers; computer software platforms, recorded or downloadable; notebook computers; computer software for wireless content transmission; computer software for network management.

42 – Reconstruction of databases; development of computer platforms; data migration services; electronic data back-up services; software as a service [SaaS]; cloud computing; platform as a service [PaaS]; updating and maintenance of computer software; design and development of multimedia

products; research and development of computer software; mobilephone software design; software design and development; design and development of mobilephone software applications; design and development of instant messaging software; development and creation of computer programs for data processing; electronic data storage; developing of driver and operating system software; database development services; database design and development; design of computer databases; computer software design; providing information on computer technology and programming via a web site.

(260) AM 2020 106574 A

(800) 1508678

(151) 2019 08 13

(891) 2019 08 13

(731) Guangzhou Cheerwin Holdings Limited
X1301-I6051, No. 106, Fengze East Road,
Nansha District Guangzhou, China

(540)

CHEERWIN

(591) Black, white

(531) 26.04.09; 27.05.17

(511)

3 – Laundry detergent; soap; cleaning preparations for household purposes; toilet bowl detergents; spot removers; cleaning preparations; washing-up detergents; dishwashing detergents; polishing preparations; cosmetics; perfumes; dentifrices; incense; cosmetics for animals; air fragrancing preparations.

5 – Dietetic substances adapted for medical use; depuratives; repellents for dogs; animal washes [insecticides]; fly destroying preparations; mosquito-repellent incense; disinfectants; pesticides; mothballs; ant repellent paper; fly catching paper; babies' napkin-pants; sanitary towels; insect repellents; sanitizing wipes; adhesive tapes for medical purposes; diapers for pets; dental lacquer.

10 – Medical apparatus and instruments; apparatus, devices and articles for nursing infants; dental apparatus and instruments; galvanic therapeutic appliances; beds, specially made for medical purposes; babies' bottles; condoms; artificial limbs; crutches; suture materials.

11 – Lamps; automobile lights; light bulbs, electric; cooking utensils, electric; refrigerators; electric fans for personal use; hot air apparatus; mixer taps for water pipes; bath fittings; disinfectant apparatus; radiators, electric; lighters.

16 – Posters; bookbinding material; folders for papers; writing instruments; drawing instruments; duplicators; teaching materials [except apparatus]; modelling materials; printed publications; stationery.

21 – Toothpicks; ultrasonic pest repellent devices; electric devices for attracting and killing insects; plug-in diffusers for mosquito repellents; containers for household or kitchen use; washtubs; brushes; toothbrushes; cosmetic utensils; heat-insulated containers; cleaning instruments, hand-operated; killing mosquito apparatus; fly swatters.

24 – Cloth; corduroy fabrics; wall hangings of textile; felt; towels of textile; quilts; loose covers for furniture; curtains of textile; bunting of textile or plastic; shrouds; household linen.

25 – Clothing; layettes [clothing]; bathing trunks; swimsuits; footwear; caps [headwear]; hosiery; gloves [clothing]; neckties; scarfs; girdles; shower caps; sleep masks.

37 – Construction information; construction; upholstery; maintenance and repair of heating apparatus; electric appliance installation and repair; vehicle washing; clock and watch repair; varnishing; dry cleaning; elevator installation and repair; maintenance and repair of vehicles.

(260) AM 2020 106575 A

(800) 1508679

(151) 2019 11 04

(891) 2019 11 04

(731) ERSAŞ ALÜMİNYUM ANONİM ŞİRKETİ
Topçular Mah. İncirlik Cad., Ersaş İş
Merkezi No:18, Eyüp, TR-34055 İSTANBUL,
Turkey

(540)

Pal SYSTEM

(591) Black, white

(531) 27.05.01

(511)

6 – Ores of non-precious metal; common metals and their alloys and semi-finished products made

of these materials, irons for construction, mats and stirrups of common metals for buildings, common metals in the form of plate, billet, stick, profile, sheet and sheeting; goods and materials of common metal used for storage, wrapping, packaging and sheltering purposes, containers of metal (storage, transport), buildings of metal, frames of metal for building, poles of metal for building, metal boxes, packaging containers of metal, aluminium foil, fences made of metal, guard barriers of metal, metal tubes, storage containers of metal, metal containers for the transportation of goods, ladders of metal; building materials of metal; furniture casters of metal; scaffolding of metal, metal scaffolding towers; doors, windows, shutters, jalousies and their cases and fittings of metal; non-electric cables and wires of metal; ironmongery, small hardware of metal, screws of metal, nails, bolts of metal, nuts of metal, pegs of metal, flakes of metal, pitons of metal, metal chains, furniture casters of metal, fittings of metal for furniture, door handles of metal, window handles of metal, hinges of metal, metal latches, metal locks, metal keys for locks, metal rings, metal pulleys; ventilation ducts, vents, vent covers, pipes, chimney caps, manhole covers, grilles of metal for ventilation, heating, sewage, telephone, underground electricity and air conditioning installations; metal panels or boards (non-luminous and non-mechanical) used for signalling, route showing, publicity purposes, signboards of metal, advertisement columns of metal, signaling panels of metal, non-luminous and non-mechanical traffic signs of metal; pipes of metal for transportation of liquids and gas, drilling pipes of metal and their metal fittings, valves of metal, couplings of metal for pipes, elbows of metal for pipes, clips of metal for pipes, connectors of metal for pipes; safes (strong boxes) of metal; metal railway materials, metal rails, metal railway ties, railway switches; bollards of metal, floating docks of metal, mooring buoys of metal, anchors; metal moulds for casting, other than machine parts; works of art made of common metals or their alloys, trophies of common metal; metal closures, bottle caps of metal; metal poles, metal pillars, metal stakes; metal pallets and metal ropes for lifting, loading and transportation purposes, metal hangers, ties, straps, tapes and bands used for load-lifting and load-carrying; wheel chocks made primarily of metal; metal profile laths for vehicles for the purposes of decoration.

7 – Machines, machine tools and industrial robots for processing and shaping wood, metals, glass, plastics and minerals, 3D printers; construction machines and robotic mechanisms (machines) for use in construction; bulldozers, diggers (machines), excavators, road construction and road paving machines, drilling machines, rock drilling machines, road sweeping machines; lifting, loading and transmission machines and robotic mechanisms (machines) for lifting, loading and transmission purposes; elevators, escalators and cranes; machines and robotic mechanisms (machines) for use in agriculture and animal breeding, machines and robotic mechanisms (machines) for processing cereals, fruits, vegetables and food, machines for preparing and processing beverages; engines and motors, other than for land vehicles, parts and fittings therefor; hydraulic and pneumatic controls for engines and motors, brakes other than for vehicles, brake linings for engines, crankshafts, gearboxes, other than for land vehicles, cylinders for engines, pistons for engines, turbines, not for land vehicles, filters for engines and motors, oil, air and fuel filters for land vehicle engines, exhausts for land vehicle engines, exhaust manifolds for land vehicle engines, engine cylinders for land vehicles, engine cylinder heads for land vehicles, pistons for land vehicle engines, carburetors for land vehicles, fuel conversion apparatus for land vehicle engines, injectors for land vehicle engines, fuel economisers for land vehicle engines, pumps for land vehicle engines, valves for land vehicle engines, starter motors for land vehicles, dynamos for land vehicle engines, sparking plugs for land vehicle engines; bearings (parts of machines), roller or ball bearings; machines for mounting and detaching tires; alternators, current generators, electric generators, current generators operated with solar energy; painting machines, automatic spray guns for paint, electric, hydraulic and pneumatic punching machines and guns, electric adhesive tape dispensers (machines), electric guns for compressed gas or liquid spraying machines, electric hand drills, electric hand saws, electric jigsaw machines, spiral machines, compressed air machines, compressors (machines), vehicle washing installations, robotic mechanisms (machines) with the abovementioned functions; electric and gas-operated welding apparatus, electric arc welding apparatus, electric soldering apparatus, electric arc cutting apparatus, electrodes for welding machi-

nes, industrial robots (machines) with the abovementioned functions; printing machines; packaging machines, filling, plugging and sealing machines, labellers (machines), sorting machines, industrial robots (machines) with the abovementioned functions, electroplating machines; sealing machines for industrial purposes; machines for textile processing, sewing machines, industrial robots (machines) with the abovementioned functions; hydrogen dispensing pumps for service stations; pumps for counter-current swimming; aerating pumps for aquaria; compressed air pumps; air pumps [garage installations], fuel dispensing pumps for service stations, self-regulating fuel pumps; electric kitchen machines for chopping, grinding, crushing, mixing and mincing foodstuff, washing machines, laundry washing machines, dishwashers, spin driers (not heated), electric cleaning machines for cleaning floors, carpets or floorings, vacuum cleaners and parts thereof; automatic vending machines; galvanizing and electroplating machines; electric door openers and closers; gaskets for engines and motors.

19 – Sand, gravel, crushed stone, asphalt, bitumen, cement, gypsum, plaster, concrete, marble blocks for construction, included in this class; building materials (as finished products) made of concrete, gypsum, clay, potters' clay, stone, marble, wood, plastics and synthetic materials for building, construction, road construction purposes, included in this class; non-metallic buildings, non-metallic building materials, poles not of metal for power lines, barriers not of metal, natural and synthetic coatings in the form of panels and sheets, being building materials, bitumen cardboard coatings for roofing, bitumen coating for roofing, doors and windows of wood and synthetic materials; traffic signs not of metal, non-luminous and non-mechanical, for roads; monuments and statuettes of stone, concrete and marble; building glass; prefabricated swimming pools not of metal (structures); aquarium sand.

(260) AM 2020 106576 A

(800) 1508696

(151) 2019 12 03

(891) 2019 12 03

(731) Apple Inc.

One Apple Park Way, Cupertino CA 95014, USA

(540)



(591) The color(s) light gray, medium gray and yellow is/are claimed as a feature of the mark

(531) 26.15.09; 29.01.12

(511)

9 – Computer software; computer software used in developing other software applications; application development software.

(260) AM 2020 106579 A

(800) 1284608

(151) 2015 11 18

(891) 2019 12 20

(731) ROWE MINERALÖLWERK GMBH
Langgewann 101, 67547 Worms, Germany

(540)

I.G.A.T.

(591) Black, white

(511)

2 – Anti-corrosive preparations; anti-rust greases; anti-rust oils.

3 – Cleaning agents and preparations; cleaning agents for motor vehicles; cleaning preparations for automobiles; natural oils for cleaning purposes; oils for cleaning purposes.

4 – Artificial petroleum; automotive engine oils; automotive greases; automotive lubricants for car engines; gear oils; grease for machines; greases for technical purposes; industrial greases; industrial lubricants; industrial oils; industrial oils being quenching oils; lubricants; lubricants being gear oils; lubricants for industrial apparatus; lubricating greases; lubricating oil for motor vehicle engines; lubricating oils; lubricating oils for automotive apparatus; lubrication grease for vehicles; mineral lubricating oils; mineral oils; mineral oils and greases for industrial purposes [not for fuel]; motor oils; motor oils for vehicles; motor vehicle lubricants; non-chemical additives for engine oils; non-

chemical additives for gear oils; non-chemical additives for greases; non-chemical additives for lubricants; non-chemical additives for machine oils; non-chemical additives for motor oils; non-chemical additives for oils; oil based lubricants; oils containing rust preventing additives; oils for automobiles; oils for cooling; oils for tempering metals; penetrating greases; penetrating oils; synthetic lubricants; synthetic oils; white oils.

(260) AM 2020 106619 A

(800) 1508923

(151) 2019 07 19

(891) 2019 07 19

(731) "Avesto Group" Limited Liability Company
13 Istaravshan str., Dushanbe city,
Shohmansur district, Tajikistan

(540)



(591) Turquoise, white

(531) 05.05.20; 05.05.21; 26.01.03; 26.01.15;
26.04.01; 26.04.07; 26.04.10; 27.05.01;
29.01.03

(511)

35 – Advertising; business management; business administration; office functions; subscription to telecommunications services for third parties; import-export agencies; commercial information agencies; advertising agencies; cost analysis; rental of advertising space; commercial auditing; business brokerage in the selection of potential private investors and entrepreneurs who need funding; employment agency services; maintenance of computerized databases; accounting services; invoicing; demonstration of goods; recording of messages [office functions]; public opinion studies; market research; business information; commercial information and advice for consumers [consumer advice shop]; business research; business and marketing studies; marketing research; staff recruitment; advice on the organization and management of business; advice on business organization; public relations consulting as part of a communication strategy; business management advice; advice on personnel management; professional advice in the

field of business; advertising counseling as part of a communication strategy; advertising design; marketing; creative business management; business management of sports people; writing a resume for third parties; writing of advertising texts; arranging subscriptions to reviews for others; updating and maintaining information in registers; updating and maintaining information in electronic databases; updating of advertising materials; word processing; organization of exhibitions for commercial or advertising purposes; organization of subscriptions to newspapers for third parties; organization of fashion shows for promotional purposes; organization of trade fairs for commercial or advertising purposes; window dressing; design of promotional materials; business evaluation of commercial activities; preparation of payment documents; search for information in computer files for third parties; sponsorship search; assistance in business management; assistance in the management of commercial or industrial enterprises; commercial intermediation services; providing business information through websites; provision of information in the field of business and commercial contacts; provision of an on-line marketplace for buyers and sellers of goods and services; providing a list of websites for commercial or advertising purposes; presentation of goods on all media for retail sale; economic forecasting; auction sale; retail or wholesale services relating to medicines, veterinary and hygiene products and medical supplies; sales promotion for third parties; production of television commercials; production of advertising films; rental of office equipment and devices; rental of advertising space on the internet; rental of promotional materials; rental of billboards; rental of vending machines; rental of sales stands; rental of photocopying machines; publication of advertising texts; radio advertising; publication of advertising material / outdoor advertising; sample distribution; distribution of promotional materials; distribution of promotional materials; registration of data and written communications; editing of advertising texts; advertising; interactive advertising in a computer network; advertising by mail; television advertising; reproduction of documents; collection and provision of statistical data; collection of information in computer databases; information about business transactions; systematization of information in computer databases; business management advisory services; negotiating busi-

ness contracts for third parties; coordination and conclusion of commercial transactions for third parties; compilation of information indexes for commercial or advertising purposes; drawing up tax returns; compiling accounts reports; telemarketing; psychological testing in the selection of personnel; external administrative management for companies; business management of hotels for others; freelance management; business management of commercial projects for construction projects; business management of commercial licenses for goods and services for third parties; business management of commercial reimbursement programs for third parties; management of customer loyalty schemes; business administration of frequent travel programs; administrative processing of orders; public relations services; services of models for advertising or product promotion; typing services; meeting reminder services [office functions]; website traffic optimization services; enterprise relocation services; tax filing services; search engine optimization for sales promotion; meeting programming services (office functions); cost price analysis; pay per click advertising; secretarial services; procurement services for third parties [procurement and provision of entrepreneurs with goods]; services of stenographers; arranging of contracts for the buying and selling of goods; telephone answering service; photocopying services; business expertise.

36 – Credit agencies; debt collection agencies; real estate agencies; financial analysis; rental of apartments; renting co-working offices / office rentals for collaboration of various specialists; real estate rental; office rental [real estate]; rental of farms and lease-purchase of agricultural equipment; financial leasing; savings banks; rental of offices [real estate]; rent collection; issuance of traveler's checks; credit card issue; stock investments; insurance information; financial information; clearing; insurance advice; financial advice; debt counseling; issuance of tradable securities; secured loans; liquidation of commercial and industrial activities [financial services]; brokerage in the field of stocks; money exchange; remote banking service; debit card service; credit card service; financial brokerage services; factoring agency services; collection of payments; organization of financing construction projects; evaluation of antiques; valuation of jewels; financial evaluation of standing timber; mark assessment; real estate valua-

tion; evaluation of numismatic items; evaluation of works of art; financial evaluation of wool; financial assessments [insurance, banking, real estate]; estimates of financial repair costs; transfer of funds in the electronic payment system; bail bonding; exchange intermediation; intermediation in real estate transactions; mediation in the implementation of carbon credits; insurance intermediation; issuance of customer loyalty discount cards; providing loans [financing]; provision of loans; providing financial information through websites; check authentication; placement of funds; fundraising; intermediary deals with stocks and bonds; financial sponsorship; mortgage loans; installment loans; insurance; life insurance; health insurance; accident insurance; marine accident insurance underwriting; fire insurance; housing management; property management; management of financial compensation payments for third parties; real estate broker services; banking services; brokerage services; pension services; loan guarantees; trustee services; reserve funds services / savings fund services; financial customs brokerage services; establishment of mutual funds; financing; safe deposit services; safe deposit services for valuables; financial advice relating to tax.

(260) AM 2020 106620 A

(800) 1508953

(151) 2019 07 10

(891) 2019 07 10

(731) "OLIS LTD" LIMITED LIABILITY COMPANY

vul. Karpenka-Karoho, 47, m. Zaporizhzhia, Zaporizhka obl. 69014, Ukraine

(540)

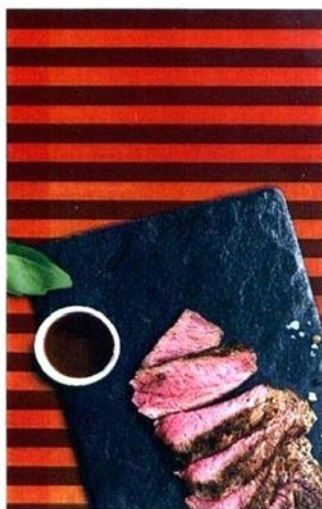

(591) Gray, red, pink, burgundy, green, white, black and brown

(531) 05.03.14; 08.05.01; 08.05.04; 11.01.17;

11.01.25; 25.07.01; 29.01.14

(511)

29 – Beans, preserved; bouillon; peas, preserved; mushrooms, preserved; fruit-based snack food; raisins; caviar; aubergine paste; vegetable marrow paste; fish roe, prepared; compotes; meat, tinned; vegetables, tinned; fish, tinned; fruits, tinned; bouillon concentrates; gherkins; sweet corn, processed; onions, preserved; corn oil for food; sesame oil for food; linseed oil for food; extra virgin olive oil for food; olive oil for food; condensed milk; vegetables, preserved; vegetables, dried; vegetables, cooked; olives, preserved; candied nuts; nuts, prepared; tomato paste; liver pastes; fruits and berries cooked in sugar syrup; cranberry purée; tomato purée; apple puree; fish, preserved; sardines, not live; sunflower seeds, prepared; fat-containing mixtures for bread slices; tomato juice for cooking; vegetable juices for cooking; preparations for making bouillon; preparations for making soup; truffles, preserved; fruit, preserved; fruit preserved in alcohol; fruit, stewed; hazelnuts, prepared; preserved garlic; berries, preserved.

30 – Cereal bars; vanillin [vanilla substitute]; vermicelli [noodles]; mustard; dressings for salad; pasta; capers; curry [spice], ketchup [sauce]; crackers; corn flour; semolina; oatmeal; crushed barley; groats for human food; corn, milled; corn, roasted; turmeric; couscous [semolina]; noodles; mayonnaise; macaroni; piccalilli; marinades; bean meal; potato flour; maize flour; nut flours; groats for human food; wheat flour; soya flour; barley meal; tea beverages; nutmegs; pepper; allspice; peppers [seasonings]; pesto [sauce]; condiments; spices; cake powder; fruit coulis [sauces]; relish [condiment]; rice; instant rice; sugar; sesame seeds [seasonings]; processed seeds for use as a seasoning; aniseed; cooking salt; soya sauce; tomato sauce; sauces [condiments]; pasta sauce; spaghetti; flavourings; rusks; garden herbs, preserved [seasonings]; vinegar; chips [cereal products]; oat flakes; minced garlic [condiment]; chow-chow [condiment]; saffron [seasoning].

(260) AM 2020 106621 A

(800) 1508985

(151) 2019 12 03

(891) 2019 12 03

(731) Apple Inc.

One Apple Park Way, Cupertino CA 95014, USA

(540)



(591) The color(s) white, yellow, medium gray and dark gray is/are claimed as a feature of the mark

(531) 21.03.01; 26.04.04; 26.15.01; 26.15.03; 26.15.05; 29.01.14

(511)

9 – Computer software; computer software used in developing other software applications; application development software.

(260) AM 2020 106623 A

(800) 1509078

(151) 2019 08 02

(891) 2019 08 02

(731) DRiV IP LLC

1209 Orange Street, Wilmington DE 19801, USA

(540)



(591) Black, white

(531) 17.05.01; 17.05.07; 26.01.01; 26.01.03; 26.01.17; 26.01.18; 26.11.12; 27.05.08

(511)

12 – Parts for land vehicles, namely, shock absorbers, suspension struts, brakes, brake drums, brake rotors, brake shoes, brake master cylinders, brake pads, brake discs, windshield wiper blades and windshield wiper pumps, transmission oil seals,

clutches, clutch bearings, clutch linings, clutch seals, driveline roller bearings for vehicle drivelines, wheel bearings, power steering hoses, electric steering gears, hydraulic disc brakes and hydraulic clutch mechanisms, suspension center links, suspension drag links, suspension bushings, alignment shims; steering and suspension systems and parts for steering and suspension systems for land vehicles, namely, ball joints, bushing kits, tie rod ends, sleeves, stabilizer kits and sockets, coil springs, control arms, idler arms and pitman arms, king bolts, rack and pinion bellows, rubber shackles, steering couplers, steering stabilizers, suspension sway bar links, drag links, center links, track bars, hub assemblies, universal joints.

(260) AM 2020 106624 A

(800) 1509107

(151) 2019 11 22

(891) 2019 11 22

(731) Avon Products, Inc.

601 Midland Avenue, Rye, NY 10580, USA

(540)

AVON The Company For Women

(591) Black, white

(511)

35 – Distributorship services; retail mail order and catalogue services, namely advertising services, organization, advice, selection and coordination of the marketing promotion, management and sale of products by retail and order mail, the aforementioned services provided via a global computer network and through consultants; all the above services in the fields of beauty care, fashion, and related goods.

42 – Technological consultation services by means of global computer information networks; the above services in the fields of beauty care, fashion, and related goods.

(260) AM 2020 106625 A

(800) 1509142

(151) 2019 12 05

(891) 2019 12 05

(731) Guess? IP Holder L.P.

1444 South Alameda Street, Los Angeles CA 90021, USA

(540)

GUESS ECO

(591) Black, white

(511)

25 – Men's, women's, boys', girls', and infants' apparel, namely, underwear, footwear, swimwear, caps, headwear, pajamas, hosiery, gloves, belts, socks, shorts, t-shirts, sweatpants, sweatshirts, knit tops, skirts, pants, trousers, sweaters, jeans, dungarees, vests, coats, jackets, dresses, scarves, blouses, cardigans, gowns, golf shirts, jogging suits, turtlenecks, polo shirts; women's panties, bras, lingerie, tank tops, crop tops, bustiers, camisoles, tap pants, rompers and teddies; infants' coveralls.

(260) AM 2020 106626 A

(800) 1509165

(151) 2019 08 14

(891) 2019 08 14

(731) GN Audio A/S

Lautrupbjerg 7, DK-2750 Ballerup,
Denmark

(540)



(591) Yellow and black

(531) 26.11.22; 27.05.10; 27.05.11; 29.01.12

(511)

9 – Headsets, headphones and earphones; speakers; microphones; telephones; telephone adapters; telephone cables; battery chargers; speakerphones; wire and wireless communication apparatus; interface units and communication software; busy indicator lights for use with wire and wireless communication apparatus; software; measuring apparatus and instruments; noise level indicators; apparatus for recording, transmission and reproduction of sound.

10 – Hearing aids; hearing protection devices; medical apparatus and instruments for use in relation to hearing.

14 – Jewellery; imitation jewellery; clocks and watches; cufflinks, tie pins and tie clips; key rings, key chains and charms therefor; jewellery charms, jewellery boxes, as well as parts and accessories for the aforementioned goods.

17 – Unprocessed and semi-processed rubber, gutta-percha (latex [rubber]) gum, asbestos, mica; plastics and resins in extruded form for use in manufacture, packing and insulating of materials; flexible pipes, tubes and hoses, not of metal; electrical, thermal and acoustic insulating materials.

18 – Leather goods; leather and imitations of leather; animal skins and hides; luggage and carrying bags, including suitcases, trunks, travelling bags, handbags, school bags; luggage tags and baggage tags; business card cases and pocket wallets; boxes and cases of leather or imitations of leather; umbrellas and parasols; walking sticks; collars, leashes and clothing for animals.

25 – Clothing, footwear and headwear for human beings.

35 – Marketing and advertising; business management; business administration; office functions; retail services.

41 – Audio equipment rental services; education, coaching and training of persons; entertainment; sporting and cultural activities.

(260) AM 2020 106637 A

(800) 1509394

(151) 2019 10 17

(891) 2019 10 17

(731) Yiwu Shenrui Cosmetics Firm

No. H3-27329, International Trade Market,
China Commodities City, Yiwu, Zhejiang,
China

(540)



(591) Black, white

(531) 25.05.25; 27.05.17; 27.05.24

(511)

10 – Nursing equipment; dental apparatus and instruments; thermal packs for first aid purposes; facial masks for sanitary purposes; feeding bottle teats; condoms; hair prostheses; orthopaedic articles; suture materials; slings (supporting bandages).

(260) AM 2020 106685 A
 (800) 1509473
 (151) 2019 11 26
 (891) 2019 11 26
 (731) Richter Gedeon Nyrt.
 Gyömrői út 19-21, H-1103 Budapest,
 Hungary
 (540)

UTERNA

(591) Black, white
 (511)
 5 – Pharmaceutical preparations.

(260) AM 2020 106686 A
 (800) 1509475
 (151) 2019 11 26
 (891) 2019 11 26
 (731) Richter Gedeon Nyrt.
 Gyömrői út 19-21, H-1103 Budapest,
 Hungary
 (540)

BUBUXIN

(591) Black, white
 (511)
 5 – Pharmaceutical preparations.

(260) AM 2020 106687 A
 (800) 1509481
 (151) 2019 12 03
 (891) 2019 12 03
 (731) APPLE INC.
 One Apple Park Way, Cupertino CA 95014,
 USA
 (540)

SWIFTUI

(591) Black, white
 (511)
 9 – Downloadable computer software for building user interfaces in software applications; Downloadable computer software for application development; Downloadable computer software used in developing other software applications; none of the foregoing relating to financial communications or the facilitation of financial transactions.

(260) AM 2020 106688 A
 (800) 1509499
 (151) 2019 11 20
 (891) 2019 11 20
 (731) aktsionernoe obshchestvo "KROKUS
 INTERNESHNL"
 ul. Mezhdunarodnaya, d. 18, g. Krasnogorsk,
 RU-143401 Krasnogorsky raion,
 Moskovskaya obl., Russian Federation
 (540)



(591) Black, white
 (531) 28.05
 (511)
 30 – Coffee; artificial coffee; chicory [coffee substitute]; coffee beverages with milk; cocoa-based beverages; coffee-based beverages; cocoa beverages with milk; chamomile-based beverages; tea-based beverages; tea; iced tea.
 32 – Aperitifs, non-alcoholic; seltzer water; soda water; waters [beverages]; aerated water; mineral water [beverages]; table waters; kvass [non-alcoholic beverage]; cocktails, non-alcoholic; lemonades; non-alcoholic beverages; isotonic beverages; non-alcoholic honey-based beverages; rice-based beverages, other than milk substitutes; soya-based beverages, other than milk substitutes; aloe vera drinks, non-alcoholic; whey beverages; protein-enriched sports beverages; soft drinks; non-alcoholic beverages flavored with coffee; non-alcoholic beverages flavored with tea; non-alcoholic fruit juice beverages; fruit nectars, non-alcoholic; powders for effervescing beverages; sarsaparilla [non-alcoholic beverage]; syrups for lemonade; syrups for beverages; smoothies; tomato juice [beverage]; cider, non-alcoholic; vegetable juices [beverages]; fruit juices; preparations for making aerated water; non-alcoholic preparations for making beverages; pastilles for effervescing beverages; sherbets [beverages]; non-alcoholic fruit extracts; essences for making beverages.

(260) AM 2020 106689 A
(800) 1509522
(151) 2019 07 16
(891) 2019 07 16
(731) SHENZHEN YALE ELECTRONICS CO.,
LTD.
4 Floor, Building 2, Yujingtai Industrial
District, Huarong Road, Langkou
Community, Dalang Street, Longhua
District, Shenzhen, 518000 Guangdong,
China
(540)



(591) Black, white
(531) 26.04.18; 26.04.24; 27.05.24
(511)
9 – Computer peripheral devices; data processing
apparatus; calculating machines; scanners [data
processing equipment]; computer keyboards; mou-
se [computer peripheral]; computer memory devi-
ces; satellite navigational apparatus; cases for tele-
phones; microphones; cabinets for loudspeakers;
headsets; camcorders; headphones; cameras [pho-
tography]; theft prevention installations, electric;
chargers for electric batteries; batteries; learning
machine; portable telephones; voltage stabilizing
power supply.

(260) AM 2020 106690 A
(800) 1509527
(151) 2019 11 26
(891) 2019 11 26
(731) Richter Gedeon Nyrt.
Gyömrői út 19-21, H-1103 Budapest,
Hungary
(540)

BIBYRAX

(591) Black, white
(511)
5 – Pharmaceutical preparations.

(260) AM 2020 106691 A
(800) 1509530
(151) 2019 09 24
(891) 2019 09 24

(731) Hyundai Motor Company
12, Heolleung-ro, Seocho-gu, Seoul 06797,
Republic of Korea
(540)

eGV80

(591) Black, white
(531) 27.05.01; 27.07.01
(511)
12 – Automobiles; passenger cars; vans; sports cars;
electric cars; hybrid cars; sport utility vehicles;
light trucks; hydrogen fuel cell electric cars.

(260) AM 2020 106692 A
(800) 1509545
(151) 2019 11 26
(891) 2019 11 26
(731) Richter Gedeon Nyrt.
Gyömrői út 19-21, H-1103 Budapest,
Hungary
(540)

ROSABEL

(591) Black, white
(511)
5 – Pharmaceutical preparations.

(260) AM 2020 106693 A
(800) 1509551
(151) 2019 09 24
(891) 2019 09 24
(731) Hyundai Motor Company
12, Heolleung-ro, Seocho-gu, Seoul 06797,
Republic of Korea
(540)

eGV90

(591) Black, white
(531) 27.05.01; 27.05.10; 27.07.01
(511)
12 – Automobiles; passenger cars; vans; sports cars;
electric cars; hybrid cars; sport utility vehicles;
light trucks; hydrogen fuel cell electric cars.

(260) AM 2020 106694 A
(800) 1509605
(151) 2019 07 17
(891) 2019 07 17
(731) OWNR WALLET OÚ

Punane tn 6-219, Lisnamae Linaosa, Harju maakond, EE-13619 Tallin, Estonia

(540)

owner.

(591) Blue

(531) 24.17.02; 27.05.01; 29.01.04

(511)

9 – 3D spectacles; answering machines; electronic parking lot ticket dispensers; circuit breakers; automated teller machines [ATM]; steering apparatus, automatic, for vehicles, namely, simulators for the steering and control of vehicles; batteries for electronic cigarettes; accumulators, electric; acoustic couplers; data processing apparatus; Global Positioning System [GPS] apparatus; audio- and video-receivers; audio interfaces; batteries, electric, for vehicles; cordless telephones; biochips for research or scientific purposes; computer memory devices; black boxes being electronic data recorders; encoded identification bracelets, magnetic being measuring instruments; video screens; camcorders; blank video cassettes; video baby monitors; video telephones; hands-free kits for telephones; virtual reality headsets; floppy disk drives; disks, blank magnetic; disk drives for computers; juke boxes for computers; downloadable electronic publications in the nature of books, magazines, manuals in the field of eLearning courses; electronic interactive whiteboards; electronic pocket translators; protective films adapted for computer screens; protective films adapted for smartphones; optical readers being data processing equipment; compact discs, audio-video featuring eLearning courses in the field of general human interests; computers; computer hardware; computer game software; computer software, recorded for the administration, documentation, tracking, reporting and delivery of training in the form of eLearning; joysticks for use with computers, other than for video games; computer keyboards; computer peripheral devices; computer programs, downloadable software for the administration, documentation, tracking, reporting and delivery of training in the form of eLearning; computer programs, recorded for the administration, documentation, tracking, reporting and delivery of training in the form of eLearning; computer operating programs, recorded; commutators; electric apparatus for commutation being communicators; computer mice being computer peripheral; mobile telephones; mo-

dem; monitors being computer hardware; computer monitors for computer programs; navigation apparatus for vehicles being on-board computers; headphones; notebook computers; optical fibers being light conducting filaments; blank optical discs; optical character readers; optical data media, namely, blank optical data carriers; transmitters of electronic signals; computer software applications, downloadable for the administration, documentation, tracking, reporting and delivery of training in the form of eLearning; central processing units being processors; smartwatches; smart rings; smartglasses; smartphones; solar batteries; solar panels for production of electricity; blank usb flash drives.

36 – Actuarial services; financial analysis; banking; stock brokerage services; stocks and bonds brokerage; brokerage of carbon credits; real estate brokerage; insurance brokerage; securities brokerage; repair costs evaluation [financial appraisal]; issuance of travellers' cheques; issuance of credit cards; issuance of tokens of value; investment of funds; arranging finance for construction projects; online banking; trusteeship; debt advisory services; electronic funds transfer; providing financial information via a web site; safe deposit services; deposits of valuables; charitable fund raising; rent collection; capital investment; mortgage banking; apartment house management; real estate management; clearing-houses, financial; insurance consultancy; stock exchange quotations; pawnbrokerage; marine insurance underwriting; providing rebates at participating establishments of others through use of a membership card; loans [financing]; installment loans; bail-bonding; exchanging money; processing of debit card payments; processing of credit card payments; organization of monetary collections; rental of apartments; rental of real estate; rental of offices [real estate]; rental of offices for co-working; rental of farms; antique appraisal; stamp appraisal; real estate appraisal; numismatic appraisal; art appraisal; fiscal valuation; jewellery appraisal; cheque verification; lending against security; accommodation bureau services (apartments); real estate agency services; credit bureau services; mutual funds; surety services; financing services; debt collection agency services; savings bank services; provident fund services; insurance information; insurance underwriting; accident insurance underwriting; fire insurance underwriting; life insurance underwriting; health insurance

underwriting; factoring; financial information; financial management; financial management of reimbursement payments for others; financial consultancy; financial evaluation of development costs relating to the oil, gas and mining industries; financial appraisals in responding to calls for tenders; financial sponsorship; financial research; financial customs brokerage services; hire-purchase financing; business liquidation services, financial; retirement payment services.

42 – Computer system analysis; outsource service providers in the field of information technology; recovery of computer data; off-site data backup; duplication of computer programs; electronic data storage; electronic monitoring of personally identifying information to detect identity theft via the internet; electronic monitoring of credit card activity to detect fraud via the internet; providing information on computer technology and programming via a web site; providing search engines for the internet; installation of computer software; computer programming; conversion of data or documents from physical to electronic media; conversion of computer programs and data, other than physical conversion; computer technology consultancy; internet security consultancy; data security consultancy; information technology [IT] consultancy; computer software consultancy; computer security consultancy; consultancy in the design and development of computer hardware; web site design consultancy; monitoring of computer systems for detecting unauthorized access or data breach; monitoring of computer systems to detect breakdowns; monitoring of computer systems by remote access to ensure proper functioning; maintenance of computer software; updating of computer software; computer virus protection services; software as a service (SaaS) services, namely, hosting software for use by others for the administration, documentation, tracking, reporting and delivery of training in the form of eLearning; computer software design; rental of web servers; computer rental; rental of computer software; hosting computer sites being web sites; computer system design; creating and designing website-based indexes of information for others being information technology services; cloud computing featuring software for the administration, documentation, tracking, reporting and delivery of training in the form of eLearning; server hosting.

(260) AM 2020 106695 A
 (800) 1509627
 (151) 2019 11 15
 (891) 2019 11 15
 (731) SOREMARTEC S.A.
 16 Route de Trèves, L-2633 Senningerberg,
 Luxembourg
 (540)



(591) Purple, white, gold, yellow, brown and pink
 (531) 02.03.01; 02.03.15; 02.03.23; 08.01.04;
 08.01.07; 08.01.15; 25.01.06; 29.01.14
 (511)
 30 – Biscuits.

(260) AM 2020 106697 A
 (800) 1509659
 (151) 2019 10 04
 (891) 2019 10 04
 (731) D.SOLUTIONS LIMITED LIABILITY
 COMPANY
 57 Lva Tolstoho str., Kyiv 01032, Ukraine
 (540)



(591) Dark-blue and yellow
 (531) 26.13.25; 27.05.09; 29.01.12
 (511)
 7 – Alternators; current generators; dynamos; hydraulic turbines; generators of electricity; wind turbines.
 9 – Accumulators, electric; batteries, electric; accumulators, electric, for vehicles; gasometers [measuring instruments]; current rectifiers; electric installations for the remote control of industrial operations; voltage surge protectors; battery chargers; chargers for electric batteries; charging stations for electric vehicles; couplings, electric; cables, electric; counters; measures; measuring devi-

ces, electric; materials for electricity mains [wires, cables]; switchboxes [electricity]; switchboards; switches, electric; wires, electric; ducts [electricity]; electric sockets; distribution boxes [electricity]; distribution consoles [electricity]; distribution boards [electricity]; solar batteries; solar panels for the production of electricity; transformers [electricity]; heat regulating apparatus.

35 – Advertising; invoicing; commercial intermediation services; sales promotion for others.

36 – Business liquidation services, financial; clearing, financial; financial consultancy; insurance underwriting; insurance consultancy; hire-purchase financing.

37 – Drilling of wells; electric appliance installation and repair; mining extraction; vehicle battery charging; services of electricians; installation of utilities in construction sites; laying of cable; repair of power lines; pipeline construction and maintenance; construction; interference suppression in electrical apparatus.

39 – Electricity distribution; water supplying.

40 – Incineration of waste and trash; production of energy; recycling of waste and trash; rental of generators; sorting of waste and recyclable material [transformation].

42 – Construction drafting; consultancy in the field of energy-saving; energy auditing; exploration services in the field of the oil, gas and mining industries; industrial design; research in the field of environmental protection.

(260) AM 2020 106698 A

(800) 1509741

(151) 2019 06 25

(891) 2019 06 25

(731) Krion Solid Surface, S.A.

Carretera Villarreal-Puebla De Arenoso,
Km-1, (CV-20), E-12540 Villarreal
(Castellón), Spain

(540)

KRION
Unlimited Surfaces

(591) Black, white

(531) 27.05.09; 27.05.10

(511)

11 – Apparatus and installations for lighting, heating, cooling, steam generating, cooking, drying, ventilating and water distribution, as well as sanitary installations; bathtubs, toilets, bidets, washbasins, sinks; bath heaters, bath installations, toilet lids, toilet bowls; faucets; shower columns; shower trays.

19 – Non-metallic building materials; non-metallic rigid pipes for building; asphalt, pitch, tar and bitumen; transportable buildings, not of metal; monuments, not of metal; glass doors and windows, glass panels; swimming pools (structures not of metal); non-metallic floors; ceilings, not of metal.

20 – Furniture, mirrors, picture frames; containers not of metal for storage or transport; bone, horn, whalebone or mother-of-pearl, unwrought or semi-wrought; shells; meerschaum; yellow amber; counters (tables); dressers; worktops; bathroom accessories in the form of furniture; locks and keys, not of metal; non-metallic accessories for doors, gates and windows; attachments, not of metal; indoor blinds and accessories for curtains and indoor blinds; clothes hangers; clothes stands; clothes hooks of non-metallic materials; containers, fasteners and accessories relating thereto, non-metallic; ladders and mobile ladders, not of metal; show cases, display stands and boards, non-metallic; street furniture, not of metal; counter tops of stainless steel.

(260) AM 2020 106699 A

(800) 1509757

(151) 2019 05 14

(891) 2019 05 14

(731) Obshchestvo s ogranichennoy

otvetstvennostyu "Nalchiksky molochny
kombinat"

ul. Kirova, d. 294 A, g. Nalchik, RU-360000
Kabardino-Balkarskaya Respublika, Russian
Federation

(540)

НОВАЯ ДЕРЕВНЯ

(591) Black, white

(531) 28.05

(511)

29 – Fatty substances for the manufacture of edible fats; edible fats; suet for food; yogurt; kephir [milk beverage]; buttercream; margarine; butter; milk; soya milk being milk substitute; milk products;

curd; ryazhenka [fermented baked milk]; whipped cream; fat-containing mixtures for bread slices; cheese; strained cheese; tofu; fermented milk pastes.

30 – Frozen yogurt [confectionery ices]; gruel, with a milk base, for food; chocolate beverages with milk; puddings; preparations for stiffening whipped cream; milk chocolate.

- (260) AM 2020 106700 A
 (800) 1509761
 (151) 2019 10 23
 (891) 2019 10 23
 (731) BROUWERIJ HET NEST
 Beyntel 17, B-2360 Oud-Turnhout, Belgium
 (540)



- (591) Black, white, yellow, red, blue, golden and grey
 (531) 11.03.02; 11.03.03; 21.01.01; 21.01.05;
 21.01.07; 24.03.07; 24.03.16; 24.03.18;
 24.07.01; 24.07.23; 28.05; 29.01.15

(511)
 32 – Beer and beer-based beverages; non-alcoholic beverages; preparations for making beverages.

- (260) AM 2020 106701 A
 (800) 1509762
 (151) 2019 10 23
 (891) 2019 10 23
 (731) BROUWERIJ HET NEST
 Beyntel 17, B-2360 Oud-Turnhout, Belgium
 (540)



- (591) Black, white, yellow, red, blue, golden and grey
 (531) 11.03.02; 11.03.03; 21.01.01; 21.01.05;
 21.01.07; 24.03.07; 24.03.16; 24.03.18;
 24.07.01; 24.07.23; 28.05; 29.01.15

(511)
 32 – Beer and beer-based beverages; non-alcoholic beverages; preparations for making beverages.

- (260) AM 2020 106705 A
 (800) 1509807
 (151) 2019 11 26
 (891) 2019 11 26
 (731) Richter Gedeon Nyrt.
 Gyömrői út 19-21, H-1103 Budapest,
 Hungary
 (540)

FUTAGIN

- (591) Black, white
 (511)
 5 – Pharmaceutical preparations.

- (260) AM 2020 106706 A
 (800) 1509835
 (151) 2019 11 15
 (891) 2019 11 15
 (731) SOREMARTEC S.A.
 16 Route de Trèves, L-2633 Senningerberg,
 Luxembourg
 (540)

KEEBLER

- (591) Black, white
 (511)
 30 – Biscuits.

- (260) AM 2020 106707 A
 (800) 1509851
 (151) 2019 11 19
 (891) 2019 11 19
 (731) KIA MOTORS CORPORATION
 12, Heolleung-ro, Seocho-gu, Seoul,
 Republic of Korea
 (540)

KIA K8

- (591) Black, white

(511)
12 – Automobiles; sports cars; vans [vehicles]; trucks; motor buses; electric vehicles.

(260) AM 2020 106708 A
(800) 1509853
(151) 2019 11 27
(891) 2019 11 27
(731) "Unipharm-Ukraine", LLC
Moskovskiy prospect 9-V, Kyiv 04073,
Ukraine

(540)

ELANCE

(591) Black, white

(511)
10 – Surgical, medical, dental and veterinary apparatus and instruments; artificial limbs, eyes and teeth; orthopaedic articles; suture materials; therapeutic and assistive devices adapted for the disabled; apparatus, devices and articles for nursing infants; sexual activity apparatus, devices and articles.

31 – Raw and unprocessed agricultural, aquacultural, horticultural and forestry products; raw and unprocessed grains and seeds; fresh fruits and vegetables, fresh herbs; natural plants and flowers; bulbs, seedlings and seeds for planting; live animals; foodstuffs and beverages for animals; malt.

32 – Beers; non-alcoholic beverages; mineral and aerated waters; fruit beverages and fruit juices; syrups and other non-alcoholic preparations for making beverages.

(260) AM 2020 106709 A
(800) 1509860
(151) 2019 11 26
(891) 2019 11 26
(731) Richter Gedeon Nyrt.
Gyömrői út 19-21, H-1103 Budapest,
Hungary

(540)

ALBARIN

(591) Black, white

(511)

5 – Pharmaceutical preparations.

(260) AM 2020 106710 A
(800) 1509868
(151) 2019 09 17
(891) 2019 09 17
(731) SHENZHEN SOUNDSOUL INFORMATION TECHNOLOGY CO., LTD.
20L, Building 5, Mingjin Plaza, No.1 Yuheng Road, Yunong Community, Futian Street, Futian District, Shenzhen City, 518000 Guangdong Province, China

(540)

SOUNDPEATS

(591) Black, white

(511)

9 – Loudspeakers; microphones; horns for loudspeakers; audio interfaces; headphones; subwoofers; virtual reality headsets; earphones; headsets for cellular phones; diaphragms [acoustics].

(260) AM 2020 106712 A
(800) 1509880
(151) 2019 11 26
(891) 2019 11 26
(731) "Unipharm-Ukraine", LLC
Moskovskiy prospect 9-V, Kyiv 04073,
Ukraine

(540)

ELANIUM

(591) Black, white

(511)

3 – Non-medicated cosmetics and toiletry preparations; non-medicated dentifrices; perfumery, essential oils; bleaching preparations and other substances for laundry use; cleaning, polishing, scouring and abrasive preparations.

5 – Preparations for destroying vermin; herbicides.

10 – Surgical, medical, dental and veterinary apparatus and instruments; artificial limbs, eyes and teeth; orthopaedic articles; suture materials; therapeutic and assistive devices adapted for the disabled; massage apparatus; apparatus, devices and articles for nursing infants; sexual activity apparatus, devices and articles.

31 – Raw and unprocessed agricultural, aquacultural, horticultural and forestry products; raw and unprocessed grains and seeds; fresh fruits and vegetables, fresh herbs; natural plants and flowers; bulbs, seedlings and seeds for planting; live animals; foodstuffs and beverages for animals; malt.

32 – Beers; non-alcoholic beverages; mineral and aerated waters; fruit beverages and fruit juices; syrups and other non-alcoholic preparations for making beverages.

(260) AM 2020 106738 A
 (800) 1510358
 (151) 2019 08 09
 (891) 2019 08 09
 (731) Venture Products, Inc.
 500 Venture Drive, Orrville OH 44667, USA

(540)

VENTRAC

(591) Black, white

(511)

7 – Tractor-drawn and tractor-powered implements, namely, blades, blowers, brooms, snow blowers, snow plows, turbine style blowers, V-blades, landscape rakes, power buckets, power rakes, tillers, trenchers, loaders, lawn edgers, sod cutters, stump grinders, aerators, mowers, vacuum collectors, spreaders, drop spreaders, finger weeders, tine weeders, harrows, plows, cultivators, plastic winders, and plastic lifters; self-propelled, powered implements for attachment to universal utility vehicle namely, blades, blowers, brooms, snow blowers, snow plows, turbine style blowers, V-blades, landscape rakes, power buckets, power rakes, tillers, trenchers, loaders, lawn edgers, sod cutters, stump grinders, aerators, mowers, vacuum collection systems, spreaders, drop spreaders, finger weeders, tine weeders, harrows, plows, cultivators, plastic winders, and plastic lifters; walk-behind power units for agricultural and estate care in the nature of tillers, cultivators, mowers, seeders and snow removers.

12 – Agricultural and estate care tractors; two-wheel tractors; ride on utility vehicles for weeding, gardening, and snow removal; self-propelled utility vehicles for weeding, gardening, and snow removal.

(260) AM 2020 106739 A
 (800) 1510363
 (151) 2019 11 20
 (891) 2019 11 20
 (731) FRANCESCO SMALTO INTERNATIONAL
 2 rue de Bassano, F-75116 PARIS, France

(540)



(591) Blue, brown
 (531) 05.05.05; 05.05.19; 05.05.21; 24.01.03;
 24.01.10; 24.01.15; 29.01.13

(511)

18 – Leather and imitations of leather; unworked or semi-worked leather; imitation leather; imitation leather; furs [animal skins]; fur-skins; traveling bags, traveling sets (leather goods), trunks, traveling trunks and suitcases, garment bags for travel purposes, boxes intended for toiletry articles known as "vanity cases", leather or leather board boxes; bags, rucksacks, shoulder bags, handbags, sports bags, carrying cases, attaché cases, document cases and business cases of leather; luggage tags for luggage, whips, leashes, saddlery; walking sticks; clutch bags, wallets, business card cases; credit card holders [wallets]; purses, key cases, card cases; umbrellas; parasols; beach umbrellas.

25 – Clothing; footwear excluding orthopedic footwear; headwear.

(260) AM 2020 106740 A
 (800) 227292
 (151) 1959 12 31
 (891) 2020 01 07
 (731) DENTINOX GESELLSCHAFT FÜR
 PHARMAZEUTISCHE PRÄPARATE LENK
 & SCHUPPAN
 Nunsdorfer Ring 19, 12277 Berlin, Germany

(540)

Babynos

(591) Black, white

(531) 27.05.01; 27.05.17

(511)

5 – Chemical-pharmaceutical products for medical and sanitary use, particularly dental cleaning and

care products and prophylactic and analgesic products for localized disorders caused by teething rash, disinfectants.

(260) AM 2020 106744 A
 (800) 1301842
 (151) 2016 01 20
 (891) 2019 12 13
 (731) H&M Hennes & Mauritz AB
 SE-106 38 Stockholm, Sweden
 (540)

ARKET

(591) Black, white
 (511)
 3 – Hand soaps; body soaps; body lotions; hand creams; body scrubs; washing detergent; washing up liquid; shoe cream; leather balm; saddle soap.
 4 – Scented candles.
 8 – Scissors; manicure sets; mortars and pestles; salad tongs; salad forks; non-electric can openers.
 14 – Jewelry; watches.
 16 – Table mats (paper); table cloths (paper); paper napkins; notebooks; pencils; pens; crayons; paper clips; erasers; wash tapes; tape (for office use); books; magazines.
 18 – Bags; wallets; umbrellas; parasols.
 21 – Bowls; ceramics; porcelain; glass ware; trays; chopping boards; cork screws; spatulas; sugar sifter; powder sifter; salt and pepper set; whisks; grater; brushes; bottle and wine openers; salad bowls; tea strainer; candle holders; coasters; porcelain for tooth brushes; shoe trees; shoe brushes; shoe horns; dish brushes and cloths; shoe brushes.
 24 – Kitchen towels; hand towels; table mats (textile); table cloths (textile).
 25 – Clothing; underwear; swimwear; shoes; headgear; apron.
 29 – Edible oils; jams.
 32 – Non-alcoholic drinks.
 34 – Matches.
 35 – Retail services in relation to hand soaps, body soaps, body lotions, hand creams, body scrubs, washing detergent, washing up liquid, shoe cream/leather balm/saddle soap, scented candles, scissors,

manicure sets, sunglasses, headphones, mobile phone cases, jewelry, watches, table mats (paper), table cloths (paper), paper napkins, notebooks, pencils, pens, crayons, paper clips, erasers, wash tapes, tape (for office use), books, magazines; retail services in relation to bags, wallets, belts, umbrellas, parasols, bowls, ceramics, porcelain, glass ware, trays, chopping boards, cork screws, spatulas, sugar sifter, powder sifter, salt and pepper set, whisks, grater, brushes, openers, mortars, pestles, salad set, tea strainer, candle holders, coasters, porcelain for tooth brush, shoe trees, shoe brushes; retail services in relation to shoe horns, dish brush and cloths, measuring cups, shoe brushes, kitchen towels, hand towels, table mats (textile), table cloths (textile), clothing, underwear, swimwear, shoes, headgear, apron, oil, jam, chocolate, salt, spices, honey, vinegar, ketchup, mayonnaise, mustard, tea, coffee, granola, condiments, non-alcoholic drinks, matches.

43 – Services for providing food and drinks.

(260) AM 2020 106745 A
 (800) 1312512
 (151) 2016 06 06
 (891) 2019 10 21
 (731) Limited Liability Company
 "ECOTECHNOLOGIYA"
 Bukharetskaya street, 124/56, lit. A, 3N,
 RU-192288 Saint-Petersburg, Russian
 Federation

(540)



The logo for 'MAXIMUS' features the word in a bold, serif font. The letter 'X' is stylized with a red and white checkered pattern, and the letter 'I' has a red dot above it.

(591) Black, white, red and gold
 (531) 27.05.02; 29.01.13
 (511)
 28 – Creels [fishing traps]; bite sensors [fishing tackle]; reels for fishing; fish hooks; lines for fishing; gut for fishing; hunting game calls; artificial fishing bait; floats for fishing; decoys for hunting or fishing; scent lures for hunting or fishing; bite indicators [fishing tackle]; fishing tackle; rods for fishing.

(260) AM 2020 106835 A
 (800) 1510371
 (151) 2019 08 14
 (891) 2019 08 14

(731) Alfred Kärcher SE & Co. KG
 Alfred-Kärcher-Strasse 28-40, 71364
 Winnenden, Germany

(540)



(591) Black, white

(531) 26.03.03; 26.03.04; 26.03.24; 26.04.02

(511)

3 – Cleaning preparations; cleaning agents and care products for carpets and wall-to-wall carpets; chemical preparations for cleaning, protecting and preserving vehicle surfaces; blasting abrasives for mechanical surface treatment, in particular mineral blasting abrasives and sandblasting abrasives; shining preparations [polish]; laundry preparations; soaps.

7 – Mechanical spraying, rinsing and cleaning apparatus, and installations consisting thereof, in particular high-pressure cleaning apparatus, steam cleaning and steam jet apparatus, particle jet apparatus, spray extraction apparatus, brushing machines, vacuum cleaners, floor cleaning machines; vacuuming and wiping robots; floor polishing apparatus; carpet brushing vacuum cleaners; cleaning machines for hard surfaces; cleaning machines for hard floors; cleaning machines for textile covers; motorized sweepers; electric apparatus for cleaning the interior of containers; cleaning machines for glass surfaces; mechanical window cleaning apparatus; automatic window cleaning apparatus (electric); mechanically operated apparatus for cleaning motor vehicles; motor-powered tools for scraping off ice; cleaning machines for parts made of metal, plastic and/or glass; degreasers [machines]; robots for cleaning; electric suction apparatus for industrial purposes; vehicle washing installations; mechanical apparatus for removing preservatives from vehicles; washing apparatus; dishwashers; hydraulic controls for machines; mechanical apparatus for extracting gas from tanks; mechanical apparatus for producing dry-ice granulate; parts of the aforesaid goods, in particular brushes, hoses, hand-operated spray guns as parts of high-

pressure cleaning apparatus, suction heads, spray nozzles, jet tubes, vacuum cleaner hoses, vacuum cleaner bags, vacuum cleaner filters; reels, mechanical, for flexible hoses; motor-powered gardening implements; motor-powered forestry implements and machines; motor-powered agricultural implements and machines; weeding machines; motor-powered mowing implements and mowing machines; harvesting machines; power saws; chains for power saws; brush cutters (machines); scythes (machines); hedge trimmers (machines); lawnmowers (machines); automatic lawnmowers (electric); mowing robots; scarifiers (machines); horticultural machines; machines for cleaning streets; earth moving machines; buckets for earth moving machines; motor-powered spreading implements and spreading machines; accessories for motor-powered spreading implements and spreading machines (included in this class); snow blowers; snow ploughs; snow removal machines; shovels as parts of snow ploughs; front-end loaders; buckets for front-end loaders; broaching machines; scraping blades [parts of machines]; motor-powered soil cultivation implements and soil cultivation machines; machine equipment mountable on vehicles for horticulture, agriculture, forestry and municipal purposes; machine equipment drawn by vehicles for horticulture, agriculture, forestry and municipal purposes; pumps (included in this class), in particular water pumps, pumps for ponds, submersible pumps, garden pumps, domestic water pumps, high-pressure pumps, metering pumps; leaf vacuums; leaf blowers; mechanical high-pressure water jet apparatus for cleaning, removing and treating surfaces and for cutting, drilling and deburring; high-pressure water tools, in particular high-pressure lances and high-pressure spray guns; water jet nozzles (parts of machines); nozzle supports (parts of machines); valves (parts of machines); injectors (parts of machines); filter apparatus (machines); pneumatically, hydraulically or electrically driven handling machines, automatic [manipulators], positioning devices, feeding mechanisms and robots for guiding high-pressure water tools; generators for power generation.

9 – Apparatus and instruments for conducting, switching, transforming, accumulating, regulating and controlling electricity; wireless transmitters and receivers; data storage media; mobile data communications apparatus; electric controls, including coin-operated; electric controllers; radio re-

mote controls; time switches; electric connection cables; extension cords; batteries (electric); rechargeable electric batteries; chargers for electric batteries; electric irrigation control apparatus; readers for the contactless reading of markings, in particular bar code readers and RFID (Radio Frequency Identification) readers; measuring apparatus; dosimeters; data processing equipment and computers; computer software, recorded; computer software (downloadable); application software; protective clothing for protecting from fire, radioactive radiation, biological contamination and chemical contamination; protective and safety equipment; protective helmets; safety goggles; protective masks; protective boots; respiratory masks; filters for respiratory masks; protective work clothing.

11 – Drying apparatus, in particular for motor vehicles; apparatus for cleaning the body, namely body showers; garden showers; cooling apparatus; heating apparatus; heating installations; steam generating apparatus; hot air generating apparatus; water heaters (apparatus); sprinkler systems for irrigation; water intake apparatus; dispensers for dispensing mineral waters, carbonated waters, table waters, fruit beverages, fruit juices and/or lemonades [except vending machines]; water distribution installations; drop nozzles for irrigation installations; water filters; filters for drinking water; air filters; blowers for ventilation purposes; air purifiers; air dryers; air humidifiers; thermal oil heaters; electric cooking appliances and cooking installations; mobile field kitchens, namely transportable electric, fuel-powered or gas-powered cooking appliances; field laundries, namely transportable electric, fuel-powered or gas-powered laundry dryers; drinking water and waste water treatment apparatus and installations consisting thereof.

35 – Wholesale and retail services, including wholesale and retail services via the internet and/or mail order, for the following goods: cleaning agents, detergents, soaps, household goods, electric goods, electronic goods, data carriers, domestic technology products, communications technology products, cleaning technology products, washing installations, material treatment and surface treatment technology products, horticultural, agricultural, forestry and municipal apparatus, mechanical and hand-operated gardening implements, wa-

ter treatment technology products, cooling, heating and cooking technology products; organizational and business management consultancy for companies, in particular with regard to optimizing processes; compiling data in computer databases; statistical evaluation of data; systematization of data in computer databases; recording and updating of data in computer databases for business purposes and for organizing and optimizing the use of cleaning machines and cleaning apparatus for building, path and street cleaning; economic evaluation of data.

37 – Building construction; domestic maintenance, repair and cleaning services (caretaker services); assembling of machine plant (installation work); maintenance, upkeep and servicing of buildings; street cleaning; car park cleaning; cleaning of articles made of metal, plastic and glass; interior and exterior cleaning of buildings; window cleaning; carpet and upholstery cleaning; facade cleaning; maintenance and repair of cleaning, water treatment, cooling, heating and cooking apparatus and installations and of mechanical high-pressure water jet apparatus, high-pressure water tools, handling machines, automatic [manipulators], positioning devices, feed mechanisms and robots for guiding high-pressure water tools; maintenance and repair of horticultural, agricultural, forestry and municipal apparatus; cleaning, servicing and maintenance of motor vehicles; servicing and cleaning of motor vehicles by provision of motor vehicle cleaning installations and motor vehicle servicing installations; servicing and cleaning of motor vehicles by making available self-service vehicle washing installations in return for payment; rental of machines and mechanical apparatus for cleaning purposes, in particular high-pressure cleaning apparatus, steam cleaning and steam jet apparatus, particle jet apparatus, spray extraction apparatus, brushing machines, vacuum cleaners, floor cleaning machines, vacuuming and wiping robots, floor polishing apparatus, carpet brushing vacuum cleaners, cleaning machines for hard surfaces, cleaning machines for hard floors, cleaning machines for textile covers, sweepers, apparatus for cleaning the interior of containers, cleaning machines for glass surfaces, mechanical window cleaning apparatus, automatic window cleaning apparatus (electric), mechanically operated apparatus for cleaning motor vehicles, motor-powered tools for scraping off ice, cleaning machines for parts made of metal,

plastic and/or glass, degreasers [machines], cleaning robots, air purifiers; rental of electric suction apparatus for use in industrial cleaning processes; rental of vehicle washing installations; rental of laundry dryers; rental of steam generating apparatus and hot air generating apparatus for cleaning and washing purposes; rental of drying machines, namely air blowers and air dryers for use in cleaning processes; rental of washing apparatus, dishwashers and laundry dryers; rental of earth moving machines, motor-powered spreading implements and spreading machines, snow blowers and snow ploughs, snow removal machines; rental of pumps for drainage purposes and for irrigation purposes, in particular water pumps, submersible pumps, domestic water pumps, high-pressure pumps; rental of mechanical high-pressure water jet apparatus for cleaning surfaces; rental of high-pressure water tools for cleaning and/or washing purposes, in particular high-pressure lances and high-pressure spray guns; consultancy services relating to cleaning, in particular building, path and street cleaning, and relating to organizing and optimizing the use of cleaning machines and cleaning apparatus for building, path and street cleaning.

39 – Rental of pumps for supplying service water and drinking water.

(260) AM 2020 106836 A

(800) 1510382

(151) 2019 12 05

(891) 2019 12 05

(731) Guess? IP Holder L.P.

1444 South Alameda Street, Los Angeles
CA 90021, USA

(540)



(591) Green, black and white.

(531) 24.15.01; 24.17.04; 26.03.05; 29.01.12

(526) U.S.A. WASHED JEANS.

(511)

25 – Men's, women's, boys', girls', and infants' apparel, namely, underwear, footwear, swimwear, caps, headwear, pajamas, hosiery, gloves, belts, socks, shorts, t-shirts, sweatpants, sweatshirts, knit tops, skirts, pants, trousers, sweaters, jeans, dungarees, vests, coats, jackets, dresses, scarves, blouses, cardigans, gowns, golf shirts, jogging suits, turtlenecks, polo shirts; women's panties, bras, lingerie, tank tops, crop tops, bustiers, camisoles, tap pants, rompers and teddies; infants' coveralls.

(260) AM 2020 106837 A

(800) 1510386

(151) 2019 11 19

(891) 2019 11 19

(731) DOLCE & GABBANA TRADEMARKS

S.r.l.

Via Goldoni 10, I-20129 Milano,

Italy

(540)

DOLCE & GABBANA L'IMPERATRICE

(591) Black, white

(511)

3 – Cosmetics; perfumes; perfumes in solid form; antiperspirants [toiletries]; soap; liquid soap; cakes of toilet soap; bath foam; dentifrices; shampoos; essential oils; hair lotions; permanent waving and curling preparations; cosmetics in the form of gels; tints for the hair; face creams for cosmetic purposes; mascara; eyeliner; eyeshadow; make-up pencils; sun bronzers; lipsticks; foundation; cosmetic body creams; nail polish; preparations for reinforcing the nails; nail varnish removers; cosmetic oils; suntan creams.

(260) AM 2020 106838 A

(800) 1510390

(151) 2019 12 06

(891) 2019 12 06

(731) OBNHCHESTVO S OGRANICHENNOY OTVETSTVENNOSTYU "NPO Petrovaks Farm"

ul. Sosnovaya, d. 1, g. Podolsk, s. Pokrov,

RU-142143 Moscow region, Russian

Federation

(540)



(591) Black, white

(531) 01.01.01; 01.01.02; 01.01.09; 01.07.06;
26.13.25

(511)

3 – Abrasives; amber [perfume]; descaling preparations for household purposes; antistatic preparations for household purposes; aromatics [essential oils]; air fragrancing preparations; cake flavorings [essential oils]; flavorings for beverages [essential oils]; food flavorings [essential oils]; breath freshening sprays; canned pressurized air for cleaning and dusting purposes; balms, other than for medical purposes; basma [cosmetic dye]; lip glosses; polishing stones; abrasive paper; emery paper; polishing paper; petroleum jelly for cosmetic purposes; shoe polish; cobblers' wax; cotton wool for cosmetic purposes; sachets for perfuming linen; drying agents for dishwashing machines; adhesives for cosmetic purposes; scented water; Javelle water; lavender water; toilet water; wax for parquet floors; floor wax; non-slipping wax for floors; depilatory wax; mustache wax; tailors' wax; creams for leather; polish for furniture and flooring; shoemakers' wax; polishing wax; massage gels, other than for medical purposes; heliotropine; dental bleaching gels; geraniol; make-up; deodorants for pets; depilatory preparations; air fragrance reed diffusers; scented wood; perfumes; non-slipping liquids for floors; windshield cleaning liquids; greases for cosmetic purposes; volcanic ash for cleaning; perfumery; decorative transfers for cosmetic purposes; ionone [perfumery]; shaving stones [astringents]; smoothing stones; eyebrow pencils; cosmetic pencils; silicon carbide [abrasive]; carbides of metal [abrasives]; alum stones [astringents]; tripoli stone for polishing; adhesives for affixing false eyelashes; adhesives for affixing false hair; hair conditioners; quillaia bark for washing; corundum [abrasive]; beard dyes; colorants for toilet purposes; cosmetic dyes; laundry starch; laundry glaze; shoe cream; polishing creams; cosmetic creams; skin whitening creams; polishing rouge; in-

cense; hair spray; nail plish; hair lotions; lotions for cosmetic purposes; after-shave lotions; beauty masks; oils for perfumes and scents; oils for cosmetic purposes; oils for toilet purposes; essential oils; essential oils of cedarwood; essential oils of lemon; essential oils of citron; oils for cleaning purposes; bergamot oil; gaultheria oil; jasmine oil; lavender oil; almond oil; rose oil; oil of turpentine for degreasing; whitening; cleaning chalk; almond milk for cosmetic purposes; cleansing milk for toilet purposes; musk [perfumery]; soap; deodorant soap; shaving soap; soap for brightening textile; cakes of toilet soap; antiperspirant soap; soap for foot perspiration; almond soap; mint for perfumery; cosmetic kits; emery; nail art stickers; false nails; eau de Cologne; bases for flower perfumes; joss sticks; pastes for razor strops; dentifrices; pumice stone; lipstick cases; hydrogen peroxide for cosmetic purposes; breath freshening strips; teeth whitening strips; abrasive cloth; glass cloth [abrasive cloth]; lipsticks; pomades for cosmetic purposes; shaving preparations; cosmetic preparations for baths; bath preparations, not for medical purposes; hair straightening preparations; hair waving preparations; laundry soaking preparations; grinding preparations; smoothing preparations [starching]; color-removing preparations; leather bleaching preparations; polishing preparations; denture polishes; mouthwashes, not for medical purposes; cosmetic preparations for slimming purposes; starch glaze for laundry purposes; preparations to make the leaves of plants shiny; refurbishing preparations; eye-washes, not for medical purposes; fabric softeners for laundry use; laundry bleach; dry-cleaning preparations; paint stripping preparations; lacquer-removing preparations; make-up removing preparations; floor wax removers [scouring preparations]; varnish-removing preparations; rust removing preparations; nail care preparations; cleaning preparations; preparations for cleaning dentures; wallpaper cleaning preparations; preparations for unblocking drain pipes; chemical cleaning preparations for household purposes; collagen preparations for cosmetic purposes; bleaching preparations [decolorants] for household purposes; laundry preparations; aloe vera preparations for cosmetic purposes; sunscreen preparations; color-brightening chemicals for household purposes [laundry]; breath freshening preparations for personal hygiene; shining preparations [polish]; make-up powder; diamantine [abrasive]; stain removers; na-

il varnish removers; vaginal washes for personal sanitary or deodorant purposes; scouring solutions; false eyelashes; baby wipes impregnated with cleaning preparations; tissues impregnated with cosmetic lotions; tissues impregnated with make-up removing preparations; safrol; massage candles for cosmetic purposes; laundry blueing; turpentine for degreasing; potpourris [fragrances]; bleaching soda; bath salts, not for medical purposes; bleaching salts; fumigation preparations [perfumes]; preservatives for leather [polishes]; ammonia [volatile alkali] [detergent]; astringents for cosmetic purposes; eyebrow cosmetics; make-up preparations; sun-tanning preparations [cosmetics]; hair dyes; neutralizers for permanent waving; cosmetic preparations for eyelashes; cosmetic preparations for skin care; shoe wax; cosmetics; cosmetics for children; cosmetics for animals; mascara; cleansers for intimate personal hygiene purposes, non medicated; douching preparations for personal sanitary or deodorant purposes [toiletries]; detergents, other than for use in manufacturing operations and for medical purposes; degreasers, other than for use in manufacturing processes; bleaching preparations [decolorants] for cosmetic purposes; toiletry preparations; antiperspirants [toiletries]; phytocosmetic preparations; talcum powder, for toilet use; cotton sticks for cosmetic purposes; terpenes [essential oils]; emery cloth; cloths impregnated with a detergent for cleaning; henna [cosmetic dye]; shampoos; shampoos for animals [non-medicated grooming preparations]; shampoos for pets [non-medicated grooming preparations]; dry shampoos; sandpaper; soda lye; herbal extracts for cosmetic purposes; extracts of flowers [perfumes]; ethereal essences; badian essence; mint essence [essential oil]; nail glitter; deodorants for human beings or for animals; gel eye patches for cosmetic purposes; washing soda, for cleaning.

5 – Acaricides; aconitine; alkaloids for medical purposes; alginates for pharmaceutical purposes; algicides; aldehydes for pharmaceutical purposes; dental amalgams of gold; dental amalgams; amino acids for veterinary purposes; amino acids for medical purposes; analgesics; anaesthetics; antibiotics; antiseptics; medicine cases, portable, filled; first-aid boxes, filled; aluminium acetate for pharmaceutical purposes; acetates for pharmaceutical purposes; germicides; balms for medical purposes; bandages for dressings; diagnostic biomarker reagents for medical purposes; biocides; bracelets im-

pregnated with insect repellent; bromine for pharmaceutical purposes; paper for mustard plasters; fly catching paper; reagent paper for veterinary purposes; reagent paper for medical purposes; mothproofing paper; petroleum jelly for medical purposes; vaccines; oxygen baths; antiseptic cotton; aseptic cotton; absorbent cotton; wadding for medical purposes; cotton for medical purposes; dietetic substances adapted for medical use; radiological contrast substances for medical purposes; nutritive substances for microorganisms; radioactive substances for medical purposes; melissa water for pharmaceutical purposes; sea water for medicinal bathing; mineral waters for medical purposes; thermal water; dietary fiber; molding wax for dentists; gases for medical purposes; guaiacol for pharmaceutical purposes; sexual stimulant gels; hematogen; hemoglobin; hydrastine; hydrastinine; glycerine for medical purposes; glycerophosphates; glucose for medical purposes; gentian for pharmaceutical purposes; hormones for medical purposes; mustard for pharmaceutical purposes; mustard plasters; mud for baths; medicinal mud; gamboge for medical purposes; gurjun balsam for medical purposes; air deodorising preparations; deodorants, other than for human beings or for animals; deodorants for clothing and textiles; diastase for medical purposes; digitalin; vitamin supplement patches; mineral food supplements; nutritional supplements; albumin dietary supplements; dietary supplements for animals; yeast dietary supplements; alginate dietary supplements; glucose dietary supplements; casein dietary supplements; lecithin dietary supplements; linseed oil dietary supplements; propolis dietary supplements; protein dietary supplements; protein supplements for animals; royal jelly dietary supplements; pollen dietary supplements; wheat germ dietary supplements; linseed dietary supplements; acai powder dietary supplements; dietary supplements with a cosmetic effect; enzyme dietary supplements; yeast for pharmaceutical purposes; gelatine for medical purposes; cod liver oil; isotopes for medical purposes; immunostimulants; insecticides; iodine for pharmaceutical purposes; iodides for pharmaceutical purposes; alkaline iodides for pharmaceutical purposes; iodoform; calomel [fungicide]; tartar for pharmaceutical purposes; camphor for medical purposes; capsules for medicines; cachets for pharmaceutical purposes; capsules made of dendrimer-based polymers, for pharmaceuticals; hemostatic pencils;

wart pencils; caustic pencils; carbolineum [parasiticide]; caustics for pharmaceutical purposes; cachou for pharmaceutical purposes; quassia for medical purposes; quebracho for medical purposes; oxygen for medical purposes; gallic acid for pharmaceutical purposes; acids for pharmaceutical purposes; adhesives for dentures; surgical glues; stem cells for veterinary purposes; stem cells for medical purposes; cocaine; collagen for medical purposes; collodion for pharmaceutical purposes; corn rings for the feet; candy, medicated; barks for pharmaceutical purposes; cedar wood for use as an insect repellent; croton bark; mangrove bark for pharmaceutical purposes; myrobalan bark for pharmaceutical purposes; quinquina for medical purposes; medicated animal feed; medicinal roots; rhubarb roots for pharmaceutical purposes; lint for medical purposes; starch for dietetic or pharmaceutical purposes; creosote for pharmaceutical purposes; blood for medical purposes; cultures of microorganisms for medical or veterinary use; curare; dental lacquer; liquorice for pharmaceutical purposes; lactose for pharmaceutical purposes; candy for medical purposes; adhesive plasters; medicines for alleviating constipation; lecithin for medical purposes; lotions for veterinary purposes; medicated hair lotions; lotions for pharmaceutical purposes; medicated after-shave lotions; personal sexual lubricants; lupulin for pharmaceutical purposes; magnesia for pharmaceutical purposes; liniments; ointments for pharmaceutical purposes; sunburn ointments; mercurial ointments; frostbite salve for pharmaceutical purposes; gauze for dressings; medicinal oils; mustard oil for medical purposes; camphor oil for medical purposes; castor oil for medical purposes; oil of turpentine for pharmaceutical purposes; dill oil for medical purposes; dental mastics; dental abrasives; dental impression materials; teeth filling material; dressings, medical; surgical dressings; drugs for medical purposes; medicines for veterinary purposes; serotherapeutic medicines; medicines for human purposes; medicines for dental purposes; menthol; medicinal drinks; mole-skin for medical purposes; almond milk for pharmaceutical purposes; powdered milk for babies; royal jelly for pharmaceutical purposes; milk ferments for pharmaceutical purposes; Irish moss for medical purposes; flour for pharmaceutical purposes; linseed meal for pharmaceutical purposes; fish meal for pharmaceutical purposes; fly glue; antibacterial soap; disinfectant soap; medicated soap;

freeze-dried meat adapted for medical purposes; mint for pharmaceutical purposes; dietetic beverages adapted for medical purposes; malted milk beverages for medical purposes; narcotics; medicinal infusions; tincture of iodine; eucalyptol for pharmaceutical purposes; tinctures for medical purposes; opium; opodeldoc; decoctions for pharmaceutical purposes; antiparasitic collars for animals; stick liquorice for pharmaceutical purposes; sulfur sticks [disinfectants]; pastilles for pharmaceutical purposes; medicated dentifrices; pectin for pharmaceutical purposes; pepsins for pharmaceutical purposes; peptones for pharmaceutical purposes; hydrogen peroxide for medical purposes; pesticides; food for babies; leeches for medical purposes; blood plasma; nicotine patches for use as aids to stop smoking; eyepatches for medical purposes; poultices; compresses; scapulars for surgical purposes; diapers for pets; diapers for incontinence; bunion pads; breast-nursing pads; pomades for medical purposes; powder of cantharides; pyrethrum powder; anti-uric preparations; bacterial preparations for medical and veterinary use; bacteriological preparations for medical and veterinary use; balsamic preparations for medical purposes; albuminous preparations for medical purposes; biological preparations for veterinary purposes; biological preparations for medical purposes; veterinary preparations; bismuth preparations for pharmaceutical purposes; vitamin preparations; diagnostic preparations for medical purposes; bath preparations for medical purposes; therapeutic preparations for the bath; hemorrhoid preparations; preparations for callouses; lice treatment preparations [pediculicides]; acne treatment preparations; preparations to facilitate teething; preparations for the treatment of burns; fumigation preparations for medical purposes; opotherapy preparations; air purifying preparations; bronchodilating preparations; preparations for reducing sexual activity; sterilising preparations; soil-sterilising preparations; corn remedies; pharmaceutical preparations for treating dandruff; preparations for destroying noxious animals; herbicides; preparations for destroying dry rot fungus; larvae exterminating preparations; fly destroying preparations; preparations for destroying mice; slug exterminating preparations; vermin destroying preparations; pharmaceutical preparations for skin care; contact lens cleaning preparations; preparations of microorganisms for medical or veterinary use; lime-based pharma-

ceutical preparations; haemostatic preparations; medicated eye-washes; medicinal hair growth preparations; nutraceutical preparations for therapeutic or medical purposes; opiates; anticryptogamic preparations; aloe vera preparations for pharmaceutical purposes; preparations of trace elements for human and animal use; sulfonamides [medicines]; pharmaceutical preparations; pharmaceutical preparations for treating sunburn; enzyme preparations for veterinary purposes; enzyme preparations for medical purposes; phytotherapy preparations for medical purposes; chemico-pharmaceutical preparations; chemical preparations for veterinary purposes; chemical preparations for the diagnosis of pregnancy; chemical preparations for medical purposes; chemical preparations for treating diseases affecting cereal plants; chemical preparations for treating wheat blight; chemical preparations for treating diseases affecting vine plants; chemical preparations for treating mildew; chemical preparations for treating phylloxera; chemical preparations for pharmaceutical purposes; chilblain preparations; mothproofing preparations; collyrium; lead water; chemical conductors for electrocardiograph electrodes; albuminous food-stuffs for medical purposes; dietetic foods adapted for medical purposes; by-products of the processing of cereals for dietetic or medical purposes; homogenized food adapted for medical purposes; freeze-dried food adapted for medical purposes; pharmaceuticals; sanitary towels; panty liners [sanitary]; propolis for pharmaceutical purposes; pearl powder for medical purposes; radium for medical purposes; hydrated chloral for pharmaceutical purposes; solvents for removing adhesive plasters; vaginal washes for medical purposes; solutions for contact lenses; chemical reagents for medical or veterinary purposes; gum for medical purposes; rubber for dental purposes; chewing gum for medical purposes; nicotine gum for use as an aid to stop smoking; insect repellents; insect repellent incense; repellents for dogs; tissues impregnated with pharmaceutical lotions; sarsaparilla for medical purposes; sugar for medical purposes; asthmatic tea; fumigating sticks; massage candles for therapeutic purposes; suppositories; linseed for pharmaceutical purposes; tobacco-free cigarettes for medical purposes; siccatives [drying agents] for medical purposes; syrups for pharmaceutical purposes; turpentine for pharmaceutical purposes; greases for veterinary purposes; greases for medi-

cal purposes; lacteal flour for babies; infant formula; soporifics; bicarbonate of soda for pharmaceutical purposes; bath salts for medical purposes; salts for mineral water baths; salts for medical purposes; potassium salts for medical purposes; sodium salts for medical purposes; smelling salts; mineral water salts; malt for pharmaceutical purposes; semen for artificial insemination; alcohol for pharmaceutical purposes; medicinal alcohol; alloys of precious metals for dental purposes; ergot for pharmaceutical purposes; cooling sprays for medical purposes; antibacterial handwashes; adjuvants for medical purposes; astringents for medical purposes; vermifuges; disinfectants; disinfectants for hygiene purposes; disinfectants for chemical toilets; appetite suppressants for medical purposes; medical preparations for slimming purposes; parasiticides; mouthwashes for medical purposes; febrifuges; depuratives; animal washes [insecticides]; detergents for medical purposes; cattle washes [insecticides]; dog washes [insecticides]; insecticidal veterinary washes; vesicants; purgatives; remedies for perspiration; remedies for foot perspiration; chemical contraceptives; antiparasitic preparations; sedatives; laxatives; tonics [medicines]; medicated toiletry preparations; digestives for pharmaceutical purposes; nervines; media for bacteriological cultures; steroids; strychnine; serums; tanning pills; appetite suppressant pills; slimming pills; jujube, medicated; antioxidant pills; sanitary tampons; vulnery sponges; thymol for pharmaceutical purposes; biological tissue cultures for veterinary purposes; biological tissue cultures for medical purposes; smoking herbs for medical purposes; medicinal herbs; surgical implants comprised of living tissues; pants, absorbent, for incontinence; sanitary panties; charcoal for pharmaceutical purposes; porcelain for dental prostheses; phenol for pharmaceutical purposes; enzymes for veterinary purposes; enzymes for medical purposes; ferments for pharmaceutical purposes; formic aldehyde for pharmaceutical purposes; phosphates for pharmaceutical purposes; fungicides; quinine for medical purposes; chinoline for medical purposes; diabetic bread adapted for medical use; chloroform; flowers of sulfur for pharmaceutical purposes; cement for animal hooves; bone cement for surgical and orthopaedic purposes; dental cements; medicinal tea; herbal teas for medicinal purposes; insecticidal animal shampoos; medicated shampoos; medicated shampoos for pets; pediculicidal shampoos; medi-

cated dry shampoos; pre-filled syringes for medical purposes; eucalyptus for pharmaceutical purposes; herbal extracts for medical purposes; plant extracts for pharmaceutical purposes; tobacco extracts [insecticides]; extracts of hops for pharmaceutical purposes; elixirs [pharmaceutical preparations]; ethers for pharmaceutical purposes; esters for pharmaceutical purposes; cellulose esters for pharmaceutical purposes; rat poison; poisons; bacterial poisons; jalap; bismuth subnitrate for pharmaceutical purposes; cream of tartar for pharmaceutical purposes; angostura bark for medical purposes; condurango bark for medical purposes; adhesive tapes for medical purposes; injectable dermal fillers; cotton sticks for medical purposes; babies' diapers; diagnostic preparations for veterinary purposes; douching preparations for medical purposes; milking grease; transplants [living tissues]; babies' diaper-pants; fennel for medical purposes; cellulose ethers for pharmaceutical purposes.

35 – Arranging subscriptions to telecommunication services for others; import-export agency services; commercial information agency services; advertising agency services; cost price analysis; rental of office equipment in co-working facilities; rental of advertising space; business auditing; financial auditing; business intermediary services relating to the matching of potential private investors with entrepreneurs needing funding; employment agency services; computerized file management; book-keeping; invoicing; demonstration of goods; transcription of communications [office functions]; opinion polling; market studies; business information; commercial information and advice for consumers in the choice of products and services; business investigations; business research; marketing research; personnel recruitment; business management and organization consultancy; business organization consultancy; business management consultancy; personnel management consultancy; professional business consultancy; consultancy regarding advertising communication strategies; consultancy regarding public relations communication strategies; layout services for advertising purposes; marketing; marketing in the framework of software publishing; targeted marketing; business management of performing artists; business management of sports people; writing of résumés for others; scriptwriting for advertising purposes; news clipping services; updating and maintenance of information in registries; updating

and maintenance of data in computer databases; updating of advertising material; word processing; online retail services for downloadable and pre-recorded music and movies; online retail services for downloadable ring tones; online retail services for downloadable digital music; organization of exhibitions for commercial or advertising purposes; arranging newspaper subscriptions for others; organization of fashion shows for promotional purposes; organization of trade fairs for commercial or advertising purposes; shop window dressing; design of advertising materials; business appraisals; payroll preparation; data search in computer files for others; sponsorship search; administrative assistance in responding to calls for tenders; business management assistance; commercial or industrial management assistance; commercial intermediation services; providing business information via a web site; provision of commercial and business contact information; web indexing for commercial or advertising purposes; economic forecasting; auctioneering; retail services for works of art provided by art galleries; sales promotion for others; promotion of goods and services through sponsorship of sports events; production of tele-shopping programmes; production of advertising films; office machines and equipment rental; rental of advertising time on communication media; publicity material rental; rental of billboards [advertising boards]; rental of vending machines; rental of sales stands; rental of photocopying machines; publication of publicity texts; radio advertising; bill-posting; distribution of samples; dissemination of advertising matter; direct mail advertising; registration of written communications and data; writing of publicity texts; advertising; online advertising on a computer network; advertising by mail order; television advertising; document reproduction; compilation of statistics; compilation of information into computer databases; business inquiries; systemization of information into computer databases; advisory services for business management; corporate communications services; negotiation of business contracts for others; negotiation and conclusion of commercial transactions for third parties; compiling indexes of information for commercial or advertising purposes; tax preparation; drawing up of statements of accounts; telemarketing services; psychological testing for the selection of personnel; interim business management; business management of hotels; business

management for freelance service providers; business project management services for construction projects; commercial administration of the licensing of the goods and services of others; business management of reimbursement programs for others; administration of consumer loyalty programs; administration of frequent flyer programs; administrative processing of purchase orders; public relations; commercial lobbying services; competitive intelligence services; modelling for advertising or sales promotion; typing; market intelligence services; appointment reminder services [office functions]; web site traffic optimization; relocation services for businesses; tax filing services; search engine optimization for sales promotion; appointment scheduling services [office functions]; gift registry services; price comparison services; pay per click advertising; secretarial services; procurement services for others [purchasing goods and services for other businesses]; shorthand; outsourcing services [business assistance]; telephone answering for unavailable subscribers; photocopying services; business efficiency expert services; provision of an online marketplace for buyers and sellers of goods and services; presentation of goods on communication media, for retail purposes; media relations services; wholesale services for pharmaceutical, veterinary and sanitary preparations and medical supplies; retail services for pharmaceutical, veterinary and sanitary preparations and medical supplies; outsourced administrative management for companies.

44 – Rental of animals for gardening purposes; rental of beehives; public bath services for hygiene purposes; Turkish bath services; hospital services; depilatory waxing; reforestation services; landscape design; health center services; nursing home services; wreath making; hair implantation; medical advice for individuals with disabilities; pharmacy advice; aromatherapy services; animal-assisted therapy; manicuring; chiropractic; massage; medical testing; horticulture; artificial insemination services; palliative care; hairdressing; body piercing; midwife services; veterinary assistance; dentistry services; medical assistance; tree planting for carbon offsetting purposes; preparation of prescriptions by pharmacists; medical equipment rental; rental of sanitary installations; farming equipment rental; aerial and surface spreading of fertilizers and other agricultural chemicals; animal breeding; rehabilitation for substance abuse pati-

ents; gardening; landscape gardening; beauty salon services; sanatorium services; blood bank services; health care; health counselling; flower arranging; tattooing; weed killing; health spa services; human tissue bank services; aquaculture services; visagists' services; convalescent home services; rest home services; medical clinic services; medical analysis services for diagnostic and treatment purposes provided by medical laboratories; alternative medicine services; opticians' services; orthodontic services; plant nursery services; pest control services for agriculture, aquaculture, horticulture and forestry; speech therapy; in vitro fertilization services; services of a psychologist; sauna services; solarium services; telemedicine services; therapy services; nursing, medical; lawn care; animal grooming; pet grooming; physical therapy; plastic surgery; tree surgery; hospice services; medical screening; vermin exterminating for agriculture, aquaculture, horticulture and forestry.

(260) AM 2020 106839 A
 (800) 1510401
 (151) 2019 11 26
 (891) 2019 11 26
 (731) Richter Gedeon Nyrt.
 Gyömrői út 19-21, H-1103 Budapest,
 Hungary
 (540)

VITUDIN

(591) Black, white
 (511)
 5 – Pharmaceutical preparations.

(260) AM 2020 106840 A
 (800) 1510402
 (151) 2019 11 26
 (891) 2019 11 26
 (731) Richter Gedeon Nyrt.
 Gyömrői út 19-21, H-1103 Budapest,
 Hungary
 (540)

MEDILIN

(591) Black, white
 (511)
 5 – Pharmaceutical preparations.

(260) AM 2020 106841 A
 (800) 1510403
 (151) 2019 11 26
 (891) 2019 11 26
 (731) Richter Gedeon Nyrt.
 Gyömrői út 19-21, H-1103 Budapest,
 Hungary
 (540)

AMINETTE

(591) Black, white
 (511)
 5 – Pharmaceutical preparations.

(260) AM 2020 106842 A
 (800) 1510404
 (151) 2019 11 26
 (891) 2019 11 26
 (731) Richter Gedeon Nyrt.
 Gyömrői út 19-21, H-1103 Budapest,
 Hungary
 (540)

CARISSILA

(591) Black, white
 (511)
 5 – Pharmaceutical preparations.

(260) AM 2020 106843 A
 (800) 1510405
 (151) 2019 11 26
 (891) 2019 11 26
 (731) Richter Gedeon Nyrt.
 Gyömrői út 19-21, H-1103 Budapest,
 Hungary
 (540)

CUPARYL

(591) Black, white
 (511)
 5 – Pharmaceutical preparations.

(260) AM 2020 106844 A
 (800) 1510412
 (151) 2019 11 20
 (891) 2019 11 20
 (731) Skolkovotech Limited Liability Company
 Kashtanovaya street, house 12, building 1,
 room 3, v. Zarechye, Odintsovskii district,

RU-143085 Moscow region, Russian
 Federation
 (540)



(591) Black, white
 (531) 01.15.03; 27.01.01; 27.05.10
 (526) Smart voltage control.
 (511)
 7 – 3D printers; vending machines; welding machines, electric; welding apparatus, gas-operated; vulcanization apparatus; acetylene cleaning apparatus; high pressure washers; apparatus for drawing up beer under pressure; apparatus for aerating water; apparatus for aerating beverages; electrical apparatus for sealing plastics [packaging]; electric arc cutting apparatus; electric arc welding apparatus; electric welding apparatus; inking apparatus for printing machines; soldering apparatus, electric; fittings for engine boilers; expansion tanks [parts of machines]; drums [parts of machines]; reels, mechanical, for flexible hoses; brake shoes, other than for vehicles; concrete mixers [machines]; reels [parts of machines]; bobbins for weaving looms; harrows; journal boxes [parts of machines]; bulldozers; hoppers [mechanical discharging]; mine borers; railway wagon lifts; rolling mill cylinders; crank shafts; printing rollers for machines; camshafts for vehicle engines; transmission shafts, other than for land vehicles; valves [parts of machines]; fans for motors and engines; saw benches [parts of machines]; winnowers; vibrators [machines] for industrial use; bearings [parts of machines]; water heaters [parts of machines]; bellows [parts of machines]; agitators; exhausts for motors and engines; drilling rigs, floating or non-floating; lawnmowers [machines]; card clothing [parts of carding machines]; nail pullers, electric; emergency power generators; alternators; dynamos; bicycle dynamos; current generators; generators of electricity; hydraulic controls for machines, motors and engines; mufflers for motors and engines; drilling heads [parts of machines]; drilling bits [parts of machines]; cylinder heads for engines; soldering blow pipes, gas-operated; gas-operated blow torches; raking machines; stalk separators [machines]; sieves [machines or parts of machines]; mud catchers and collectors [machines]; tar-

ring machines; rubber tracks being parts of crawlers on mining machines; rubber tracks being parts of crawlers on snow ploughs; rubber tracks being parts of crawlers on loading-unloading machines and apparatus; rubber tracks being parts of crawlers on agricultural machines; rubber tracks being parts of crawlers on construction machines; hydraulic engines and motors; aeronautical engines; aeroplane engines; engines for air cushion vehicles; compressed air engines; jet engines, other than for land vehicles; engines for boats; driving motors, other than for land vehicles; motors, other than for land vehicles; propulsion mechanisms, other than for land vehicles; disintegrators; tympan [parts of printing presses]; holding devices for machine tools; turf removing ploughs; pump diaphragms; chisels for machines; jacks [machines]; rack and pinion jacks; moving walkways; electric hand drills; crushers for kitchen use, electric; flues for engine boilers; reapers; reapers and binders; millstones; rakes for raking machines; shredders [machines] for industrial use; kitchen grinders, electric; injectors for engines; incubators for eggs; ski edge sharpening tools, electric; tools [parts of machines]; hand-held tools, other than hand-operated; agricultural implements, other than hand-operated; air condensers; control cables for machines, engines or motors; capstans; calenders; rotary steam presses, portable, for fabrics; ditchers [ploughs]; carburettors; carriages for knitting machines; crankcases for machines, motors and engines; steamrollers; pressure valves [parts of machines]; clack valves [parts of machines]; pressure reducers [parts of machines]; cowlings [parts of machines]; machine wheels; freewheels, other than for land vehicles; scale collectors for machine boilers; lasts for shoes [parts of machines]; brake pads, other than for vehicles; piston segments; grease rings [parts of machines]; reapers and threshers; coal-cutting machines; compressors [machines]; air pumps [garage installations]; compressors for refrigerators; conveyors [machines]; belt conveyors; converters for steelworks; steam condensers [parts of machines]; aerocondensers; diggers [machines]; rams [machines]; thermic lances [machines]; mechanized livestock feeders; boxes for matrices [printing]; gear boxes, other than for land vehicles; grease boxes [parts of machines]; housings [parts of machines]; harvesting machines; steam engine boilers; coffee grinders, other than hand-operated; taps [parts of machines, engines or motors]; cranes

[lifting and hoisting apparatus]; roller bridges; mobile cranes; water separators; spray guns for paint; cranks [parts of machines]; potters' wheels; grindstones [parts of machines]; cultivators [machines]; soldering lamps; winches; ploughshares; belts for conveyors; lubricators [parts of machines]; igniting magnetos; handling machines, automatic [manipulators]; churns; matrices for use in printing; machine fly-wheels; hair clipping machines for animals; paper machines; blowing machines; knitting machines; galvanizing machines; bending machines; ironing machines; mineworking machines; net hauling machines [fishing]; electroplating machines; bottle sealing machines; sealing machines for industrial purposes; embossing machines; engraving machines; finishing machines; crushing machines; waste disposal units; blade sharpening [stropping] machines; earth moving machines; cord making machines; lace making machines; butter machines; cigarette machines for industrial purposes; sausage making machines; stereotype machines; hosiery looms; grinding machines; dyeing machines; bottle washing machines; dishwashers; bottle filling machines; racket stringing machines; leather-working machines; dairy machines; glass-working machines; tobacco processing machines; grain husking machines; painting machines; oil refining machines; peeling machines; machines for processing plastics; ore treating machines; printing machines for use on sheet metal; brewing machines; whitewashing machines; road sweeping machines, self-propelled; leather paring machines; bitumen making machines; papermaking machines; pasta making machines, electric; machines for the production of sugar; weeding machines; sifting machines; cinder sifters [machines]; puddling machines; notchers [machine tools]; bread cutting machines; road making machines; railroad constructing machines; machines for the textile industry; rammers [machines]; rail-laying machines; bottle capping machines; bottle stoppering machines; packaging machines; waste compacting machines; die-stamping machines; stamping machines; darning machines; milking machines; drainage machines; wrapping machines; grain separators; bookbinding apparatus and machines for industrial purposes; machines and apparatus for cleaning, electric; machines and apparatus for carpet shampooing, electric; machines and apparatus for polishing [electric]; sizing machines; punching machines; riveting machines; kitchen machi-

nes, electric; foundry machines; smoothing presses; fleshing machines; rinsing machines; flour mill machines; type-setting machines [printing]; hemming machines; grating machines for vegetables; braiding machines; wringing machines for laundry; cutting machines; steam engines; printing machines; rotary printing presses; industrial inkjet printing machines; compressed air machines; tilling machines for agricultural purposes; trimming machines; spinning machines; filling machines; friezing machines; cutters [machines]; satinizing machines; agricultural machines; mixing machines; sorting machines for industry; stitching machines; washing machines [laundry]; coin-operated washing machines; clippers [machines]; spinning frames; spin driers [not heated]; looms; kneading machines; typographic machines; type-setting machines [photocomposition]; beating machines; beaters, electric; packing machines; filtering machines; molding machines; carding machines; sewing machines; typecasting machines; electromechanical machines for chemical industry; labellers [machines]; mills [machines]; mills for household purposes, other than hand-operated; pepper mills, other than hand-operated; centrifugal mills; machine wheelwork; feeders [parts of machines]; forge blowers; mixers [machines]; blenders, electric, for household purposes; vacuum cleaner bags; threshing machines; pneumatic hammers; hammers [parts of machines]; tilt hammers; power hammers; reeling apparatus, mechanical; motorized cultivators; motors for boats; clutches, other than for land vehicles; meat choppers [machines]; superchargers; brake linings, other than for vehicles; guides for machines; suction nozzles for vacuum cleaners; vacuum cleaner attachments for disseminating perfumes and disinfectants; pumps [machines]; pumps [parts of machines, engines or motors]; aerating pumps for aquaria; vacuum pumps [machines]; compressed air pumps; pumps for heating installations; beer pumps; pumps for counter-current swimming; lubricating pumps; self-regulating fuel pumps; fuel dispensing pumps for service stations; centrifugal pumps; hydrogen dispensing pumps for service stations; blades [parts of machines]; knives for mowing machines; chaff cutter blades; knives, electric; shears, electric; scissors, electric; vegetable spiralizers, electric; engine mounts, other than for land vehicles; bearing brackets for machines; pulverisers [machines]; axles for machines; steam traps; chucks [parts of machines];

drill chucks [parts of machines]; exhaust manifold for engines; soldering irons, gas-operated; soldering irons, electric; superheaters; gears, other than for land vehicles; reduction gears, other than for land vehicles; drilling machines; saws [machines]; chain saws; guns [tools using explosives]; glue guns, electric; compressed air guns for the extrusion of mastics; carburetter feeders; feeding apparatus for engine boilers; loading ramps; ploughs; pneumatic transporters; pneumatic controls for machines, motors and engines; hangers [parts of machines]; anti-friction bearings for machines; roller bearings; self-oiling bearings; bearings for transmission shafts; ball-bearings; elevators [lifts]; hoists; lifts, other than ski-lifts; pulleys; saw blades [parts of machines]; pistons [parts of machines or engines]; shock absorber plungers [parts of machines]; pistons for engines; pistons for cylinders; catalytic converters; torque converters, other than for land vehicles; fuel conversion apparatus for internal combustion engines; presses [machines for industrial purposes]; wine presses; basket presses; fodder presses; printing presses; typographic presses; swaging machines; pedal drives for sewing machines; cleaning appliances utilizing steam; food processors, electric; springs [parts of machines]; spinning wheels; punches for punching machines; vacuum cleaners; radiators [cooling] for motors and engines; sewage pulverizers; air brushes for applying colour; regulators [parts of machines]; pressure regulators [parts of machines]; speed governors for machines, engines and motors; knives [parts of machines]; cutting blow pipes, gas-operated; blade holders [parts of machines]; loom shafts; gears for weaving looms; belts for machines; elevator belts; fan belts for motors and engines; dynamo belts; belts for motors and engines; adhesive bands for pulleys; industrial robots; 3D printing pens; kick starters for motorcycles; joysticks being parts of machines, other than for game machines; stuffing boxes [parts of machines]; paper feeders [printing]; whisks, electric, for household purposes; sparking plugs for internal combustion engines; glow plugs for Diesel engines; brake segments, other than for vehicles; bedding machines; steam/oil separators; cream/milk separators; ball rings for bearings; sowers [machines]; pigs for cleaning pipes; snow ploughs; sheaf-binding machines; shaft couplings [machines]; juice extractors, electric; chaff cutters; suction cups for milking machines; stands for machines; machine to-

ols; die-cutting and tapping machines; woodworking machines; sharpening machines; bicycle assembling machines; mortising machines; stoneworking machines; metalworking machines; threading machines; planing machines; lathes [machine tools]; milling machines; trueing machines; metal drawing machines; rolling mills; starters for motors and engines; stators [parts of machines]; glaziers' diamonds [parts of machines]; tables for machines; derricks; slide rests [parts of machines]; couplings, other than for land vehicles; heat exchangers [parts of machines]; transmissions for machines; transmissions, other than for land vehicles; boiler tubes [parts of machines]; wind turbines; hydraulic turbines; turbines, other than for land vehicles; turbocompressors; connecting rods for machines, motors and engines; joints [parts of engines]; central vacuum cleaning installations; suction machines for industrial purposes; machines for the mineralization of drinking water; washing installations for vehicles; degreasers [machines]; dust exhausting installations for cleaning purposes; sifting installations; pneumatic tube conveyors; dust removing installations for cleaning purposes; condensing installations; pneumatic waste oil drainers; lifting apparatus; air suction machines; dividing machines; igniting devices for internal combustion engines; window closers, hydraulic; window closers, electric; window closers, pneumatic; washing apparatus; binding apparatus for hay; extractors for mines; door openers, hydraulic; door openers, pneumatic; door openers, electric; window openers, hydraulic; window openers, pneumatic; window openers, electric; curtain drawing devices, electrically operated; adhesive tape dispensers [machines]; anti-pollution devices for motors and engines; beverage preparation machines, electromechanical; food preparation machines, electromechanical; elevator operating apparatus; control mechanisms for machines, engines or motors; shoe polishers, electric; machines and apparatus for wax-polishing, electric; air cushion devices for moving loads; handling apparatus for loading and unloading; elevating apparatus; aprons [parts of machines]; filter presses; filters for cleaning cooling air, for engines; filters being parts of machines or engines; molds [parts of machines]; printing plates; journals [parts of machines]; centrifugal machines; elevator chains [parts of machines]; driving chains, other than for land vehicles; transmission chains, other than for land vehicles;

cylinders for motors and engines; cylinders for machines; printing cylinders; pneumatic jacks; shuttles [parts of machines]; universal joints [Cardan joints]; steam mops; pulleys [parts of machines]; vacuum cleaner hoses; screwdrivers, electric; brushes [parts of machines]; dynamo brushes; brushes, electrically operated [parts of machines]; carbon brushes [electricity]; ejectors; robotic exoskeleton suits, other than for medical purposes; fuel economisers for motors and engines; excavators; shovels, mechanical; agricultural elevators; motors, electric, other than for land vehicles; electrodes for welding machines; electric hammers; parquet wax-polishers, electric; cartridges for filtering machines; moving staircases [escalators]; automatic grapnels for marine purposes; electric fruit squeezers; de-aerators for feedwater.

9 – DVD players; ticket dispensers; coin-operated musical automata [juke boxes]; fire engines; answering machines; electrical adapters; batteries for electronic cigarettes; accumulators, electric; accumulators, electric, for vehicles; accelerometers; actinometers; alidades; altimeters; ammeters; nanoparticle size analysers; anemometers; anodes; antennas; anticathodes; apertometers [optics]; high-frequency apparatus; testing apparatus not for medical purposes; remote control apparatus; electrodynamic apparatus for the remote control of railway points; electro-dynamic apparatus for the remote control of signals; monitoring apparatus, other than for medical purposes; sound recording apparatus; Global Positioning System [GPS] apparatus; distillation apparatus for scientific purposes; diffraction apparatus [microscopy]; air analysis apparatus; apparatus to check franking; sound transmitting apparatus; apparatus for fermentation [laboratory apparatus]; breathing apparatus for underwater swimming; breathing apparatus, except for artificial respiration; apparatus and installations for the production of X-rays, not for medical purposes; cash registers; electric apparatus for commutation; magnetic resonance imaging [MRI] apparatus, not for medical purposes; intercommunication apparatus; stills for laboratory experiments; projection apparatus; fire extinguishing apparatus; radiological apparatus for industrial purposes; X-ray apparatus not for medical purposes; blueprint apparatus; flashing lights [luminous signals]; stereoscopic apparatus; telephone apparatus; facsimile machines; phototelegraphy apparatus; igniting apparatus, electric, for igniting at a distance;

acid hydrometers; salinometers; acidimeters for batteries; aerometers; beacons, luminous; battery jars; automated teller machines [ATM]; barometers; anode batteries; galvanic batteries; batteries for lighting; solar batteries; solar panels for the production of electricity; batteries, electric; balances [steelyards]; betatrons; binoculars; biochips; electronic tags for goods; lens hoods; magnetic tape units for computers; computer memory devices; fire hose nozzles; encoded identification bracelets, magnetic; connected bracelets [measuring instruments]; safety tarpaulins; electronic key fobs being remote control apparatus; bullet-proof clothing; signalling buoys; life buoys; marking buoys; directional compasses; vacuum gauges; electrolyzers; variometers; verniers; scales; baby scales; bathroom scales; letter scales; weighbridges; precision balances; scales with body mass analysers; levelling staffs [surveying instruments]; camcorders; video baby monitors; video cassettes; video telephones; video screens; viewfinders, photographic; electric plugs; micrometer screws for optical instruments; viscosimeters; circuit closers; wavemeters; voltmeters; mechanical signs; signs, luminous; switchboxes [electricity]; current rectifiers; gas testing instruments; gasometers [measuring instruments]; galvanometers; hands-free kits for telephones; heliographic apparatus; hygrometers; hydrometers; weights; peepholes [magnifying lenses] for doors; hairdressing training heads [teaching apparatus]; holograms; plotters; sounding leads; plumb bobs; range finders; piezoelectric sensors; densimeters; densitometers; detectors; smoke detectors; infrared detectors; counterfeit coin detectors; joysticks for use with computers, other than for video games; transparencies [photography]; slide projectors; diaphragms [photography]; dictating machines; dynamometers; light-emitting diodes [LED]; quantum dot light-emitting diodes [QLED]; organic light-emitting diodes [OLED]; floppy disks; sound recording discs; disks, magnetic; optical discs; circular slide rules; disk drives for computers; juke boxes for computers; wearable video display monitors; electronic numeric displays; DNA chips; electronic interactive whiteboards; electronic notice boards; electric wire harnesses for automobiles; bullet-proof waistcoats; life jackets; reflective safety vests; identification threads for electric wires; nose clips for divers and swimmers; locks, electric; bells [warning devices]; alarm bells, electric; electric door bells; signal bells; audio interfaces; acous-

tic conduits; mirrors for inspecting work; road signs, luminous or mechanical; marine depth finders; probes for scientific purposes; buzzers; needles for surveying compasses; needles for record players; eyewear; reflective articles for wear, for the prevention of accidents; measures; pressure measuring apparatus; simulators for the steering and control of vehicles; inverters [electricity]; pressure indicators; automatic indicators of low pressure in vehicle tires; temperature indicators; incubators for bacteria culture; measuring instruments; cosmographic instruments; mathematical instruments; levelling instruments; instruments containing eyepieces; surveying instruments; azimuth instruments; interfaces for computers; ionization apparatus not for the treatment of air or water; satellite finder meters; spark-guards; coaxial cables; fiber optic cables; cables, electric; calipers; slide calipers; screw-tapping gauges; calorimeters; calculating machines; pocket calculators; decompression chambers; rearview cameras for vehicles; cinematographic cameras; thermal imaging cameras; mouth guards for sports; life-saving capsules for natural disasters; electronic pens [visual display units]; holders for electric coils; identity cards, magnetic; video game cartridges; ink cartridges, unfilled, for printers and photocopiers; memory cards for video game machines; encoded magnetic cards; riding helmets; protective helmets; carriers for dark plates [photography]; cathodes; spools [photography]; choking coils [impedance]; coils, electric; electromagnetic coils; cinematographic film, exposed; computer keyboards; solenoid valves [electromagnetic switches]; wire connectors [electricity]; thin client computers; encoded key cards; electronic book readers; electronic agendas; push buttons for bells; magnetic encoders; visors for helmets; collectors, electric; calibrating rings; smart rings; ring sizers; protective suits for aviators; commutators; compact discs [audio-video]; comparators; marine compasses; computers; laptop computers; tablet computers; notebook computers; wearable computers; condensers [capacitors]; contacts, electric; wind socks for indicating wind direction; traffic cones; branch boxes [electricity]; distribution boxes [electricity]; junction boxes [electricity]; battery boxes; cabinets for loudspeakers; diving suits; galena crystals [detectors]; covers for electric outlets; logs [measuring instruments]; lasers, not for medical purposes; lactodensimeters; lactometers; vacuum tubes [radio]; darkroom

lamps [photography]; thermionic tubes; amplifying tubes; flashlights [photography]; head cleaning tapes [recording]; magnetic tapes; videotapes; surveying chains; fire escapes; rulers [measuring instruments]; square rulers for measuring; slide-rules; contact lenses; correcting lenses [optics]; optical lenses; optical condensers; sounding lines; electricity conduits; measuring spoons; magnifying glasses [optics]; thread counters; magnets; decorative magnets; close-up lenses; crash test dummies; resuscitation mannequins [teaching apparatus]; pressure gauges; security tokens [encryption devices]; divers' masks; solderers' helmets; protective masks; respiratory masks, other than for artificial respiration; materials for electricity mains [wires, cables]; voting machines; money counting and sorting machines; material testing instruments and machines; furniture especially made for laboratories; megaphones; portable media players; diaphragms [acoustics]; diaphragms for scientific apparatus; metal detectors for industrial or military purposes; digital weather stations; metronomes; rules [measuring instruments]; carpenters' rules; dressmakers' measures; mechanisms for coin-operated apparatus; mechanisms for counter-operated apparatus; coin-operated mechanisms for television sets; shutter releases [photography]; micrometers; microprocessors; microscopes; microtomes; microphones; audio mixers; modems; lightning rods; monitors [computer hardware]; monitors [computer programs]; selfie sticks [hand-held monopods]; terminals [electricity]; junction sleeves for electric cables; teeth protectors; temperature indicator labels, not for medical purposes; knee-pads for workers; headphones; surveyors' levels; sound recording carriers; magnetic data media; optical data media; electronic sheet music, downloadable; computer software, recorded; sheaths for electric cables; identification sheaths for electric wires; weighing machines; computer hardware; punched card machines for offices; objectives [lenses] [optics]; lenses for astrophotography; selfie lenses; egg-candlers; fire extinguishers; rescue laser signalling flares; electrified fences; limiters [electricity]; clothing for protection against accidents, irradiation and fire; clothing for protection against fire; asbestos clothing for protection against fire; clothing especially made for laboratories; survival blankets; ozonisers [ozonators]; octants; eyepieces; ohmmeters; wrist rests for use with computers; eyeglass frames; oscillographs; plumb lines; mirrors [optics]; eyeglasses;

sunglasses; goggles for sports; electronic collars to train animals; finger sizers; signalling panels, luminous or mechanical; wah-wah pedals; radio pagers; pince-nez; electronic pocket translators; transmitters [telecommunication]; telephone transmitters; transmitters of electronic signals; switches, electric; periscopes; data gloves; gloves for divers; gloves for protection against accidents; gloves for protection against X-rays for industrial purposes; asbestos gloves for protection against accidents; furnaces for laboratory use; droppers for measuring, other than for medical or household purposes; laboratory pipettes; pyrometers; planimeters; plane tables [surveying instruments]; plates for batteries; computer software platforms, recorded or downloadable; wafers for integrated circuits; printed circuit boards; compact disc players; cassette players; protective films adapted for computer screens; protective films adapted for smartphones; sound recording strips; X-ray films, exposed; films, exposed; life-saving rafts; laboratory trays; digital signs; stands adapted for laptops; semi-conductors; polarimeters; personal digital assistants [PDAs]; fire pumps; measuring glassware; life belts; fuses; circuit breakers; converters, electric; telerupters; food analysis apparatus; diagnostic apparatus, not for medical purposes; distance recording apparatus; distance measuring apparatus; speed measuring apparatus [photography]; appliances for measuring the thickness of leather; apparatus for measuring the thickness of skins; speed checking apparatus for vehicles; teaching apparatus; time recording apparatus; apparatus and instruments for astronomy; surveying apparatus and instruments; weighing apparatus and instruments; nautical apparatus and instruments; navigational instruments; optical apparatus and instruments; apparatus and instruments for physics; chemistry apparatus and instruments; measuring apparatus; measuring devices, electric; boiler control instruments; meteorological instruments; naval signalling apparatus; observation instruments; navigation apparatus for vehicles [on-board computers]; satellite navigational apparatus; regulating apparatus, electric; telecommunication apparatus in the form of jewellery; precision measuring apparatus; audio- and video-receivers; prisms [optics]; computer software applications, downloadable; printers for use with computers; retorts' stands; apparatus for changing record player needles; drainers for use in photography; cleaning apparatus for sound recording

discs; fire beaters; telescopic sights for firearms; telescopic sights for artillery; test tubes; pressure indicator plugs for valves; magnetic wires; telegraph wires; telephone wires; wires, electric; conductors, electric; copper wire, insulated; fuse wire; computer programs, recorded; computer game software, downloadable; computer game software, recorded; computer programs, downloadable; computer operating programs, recorded; computer screen saver software, recorded or downloadable; record players; processors [central processing units]; rods for water diviners; electronic publications, downloadable; distribution consoles [electricity]; control panels [electricity]; radar apparatus; masts for wireless aerials; transmitting sets [telecommunication]; radios; vehicle radios; sprinkler systems for fire protection; frames for photographic transparencies; screens for photoengraving; flowmeters; walkie-talkies; voltage surge protectors; voltage regulators for vehicles; stage lighting regulators; light dimmers [regulators], electric; speed regulators for record players; cell switches [electricity]; washing trays [photography]; marking gauges [joinery]; T-squares for measuring; time switches, automatic; relays, electric; X-ray photographs, other than for medical purposes; rheostats; respirators for filtering air; retorts; refractometers; refractors; grids for batteries; security surveillance robots; laboratory robots; teaching robots; telepresence robots; humanoid robots with artificial intelligence; electric sockets; height measuring instruments; speaking tubes; horns for loudspeakers; subwoofers; saccharometers; optical fibers [light conducting filaments]; traffic-light apparatus [signalling devices]; dog whistles; signalling whistles; sports whistles; sextants; inductors [electricity]; safety nets; nets for protection against accidents; fire alarms; signals, luminous or mechanical; rescue flares, non-explosive and non-pyrotechnic; sirens; electronic access control systems for interlocking doors; hand-held electronic dictionaries; integrated circuit cards [smart cards]; smartglasses; smartphones; smartwatches; connections for electric lines; couplings, electric; sonars; sound locating instruments; lighting ballasts; resistances, electric; spectrograph apparatus; spectroscopes; speed indicators; alcoholmeters; satellites for scientific purposes; protection devices for personal use against accidents; audiovisual teaching apparatus; charging stations for electric vehicles; radiotelegraphy sets; radiotelephony sets; spectacle lenses;

anti-glare glasses; optical glass; personal stereos; stereoscopes; stands for photographic apparatus; stroboscopes; fire boats; sulfimeters; bags adapted for laptops; drying racks [photography]; spherometers; integrated circuits; printed circuits; counters; parking meters; kilometer recorders for vehicles; revolution counters; abacuses; egg timers [sandglasses]; taximeters; ear plugs for divers; tachometers; television apparatus; telegraphs [apparatus]; telescopes; teleprompters; teleprinters; cordless telephones; cellular phones; theodolites; interactive touch screen terminals; thermo-hygrometers; thermometers, not for medical purposes; thermostats; thermostats for vehicles; climate control digital thermostats; crucibles [laboratory]; tone arms for record players; totalizers; transistors [electronic]; transponders; protractors [measuring instruments]; transformers [electricity]; step-up transformers; resuscitation training simulators; vehicle breakdown warning triangles; triodes; starter cables for motors; discharge tubes, electric, other than for lighting; capillary tubes; neon signs; Pitot tubes; X-ray tubes not for medical purposes; telephone receivers; headgear being protective helmets; squares for measuring; gauges; quantity indicators; gasoline gauges; water level indicators; electric loss indicators; light-emitting electronic pointers; slope indicators; levels [instruments for determining the horizontal]; mercury levels; spirit levels; urinometers; amplifiers; particle accelerators; electric installations for the remote control of industrial operations; baby monitors; steering apparatus, automatic, for vehicles; balancing apparatus; video recorders; sound reproduction apparatus; invoicing machines; tape recorders; protection devices against X-rays, not for medical purposes; railway traffic safety appliances; data processing apparatus; oxygen transvasing apparatus; theft prevention installations, electric; devices for the projection of virtual keyboards; film cutting apparatus; drying apparatus for photographic prints; optical character readers; centering apparatus for photographic transparencies; dosage dispensers; battery chargers; chargers for electric batteries; chargers for electronic cigarettes; acoustic alarms; sounding apparatus and machines; apparatus for editing cinematographic film; cathodic anti-corrosion apparatus; couplers [data processing equipment]; anti-theft warning apparatus; computer peripheral devices; anti-interference devices [electricity]; demagnetizing apparatus for magnetic tapes;

acoustic couplers; alarms; fog signals, non-explosive; whistle alarms; adding machines; heat regulating apparatus; photocopiers [photographic, electrostatic, thermic]; electric and electronic effects units for musical instruments; bar code readers; downloadable image files; downloadable music files; animated cartoons; filters for respiratory masks; filters for ultraviolet rays, for photography; filters for use in photography; USB flash drives; magic lanterns; optical lamps; signal lanterns; cameras [photography]; glazing apparatus for photographic prints; shutters [photography]; darkrooms [photography]; photometers; flash-bulbs [photography]; digital photo frames; enlarging apparatus [photography]; photovoltaic cells; containers for contact lenses; eyeglass cases; containers for microscope slides; cases for smartphones; cases especially made for photographic apparatus and instruments; chromatography apparatus for laboratory use; chronographs [time recording apparatus]; laboratory centrifuges; eyeglass chains; cyclotrons; compasses for measuring; frequency meters; time clocks [time recording devices]; Petri dishes; sleeves for laptops; covers for personal digital assistants [PDAs]; covers for tablet computers; covers for smartphones; fire blankets; chips [integrated circuits]; jigs [measuring instruments]; pedometers; meteorological balloons; electrified rails for mounting spot lights; asbestos screens for firemen; fire hose; virtual reality headsets; protective helmets for sports; head guards for sports; lifeboats; snorkels; cell phone straps; eyeglass cords; tripods for cameras; switchboards; distribution boards [electricity]; equalizers [audio apparatus]; workmen's protective face-shields; projection screens; radiology screens for industrial purposes; fluorescent screens; exposure meters [light meters]; ducts [electricity]; galvanic cells; downloadable graphics for mobile phones; epidiascopes; ergometers; armatures [electricity]; black boxes [data recorders]; downloadable emoticons for mobile phones; screens [photography]; downloadable ring tones for mobile phones; readers [data processing equipment]; wearable activity trackers; trackballs [computer peripherals]; scanners [data processing equipment]; safety restraints, other than for vehicle seats and sports equipment; hemline markers; shoes for protection against accidents, irradiation and fire; life saving apparatus and equipment; ear pads for headphones; mouse [computer peripheral]; co-

mpact discs; mouse pads; toner cartridges, unfilled, for printers and photocopiers; 3D spectacles.

11 – Lamp shades; steam accumulators; heat accumulators; defrosters for vehicles; disinfectant apparatus for medical purposes; distillation apparatus; desiccating apparatus; hydromassage bath apparatus; disinfectant apparatus; air deodorizing apparatus; tanning apparatus [sun beds]; ionization apparatus for the treatment of air or water; coffee roasters; beverage cooling apparatus; hand drying apparatus for washrooms; fruit roasters; water purifying apparatus and machines; refrigerating apparatus and machines; drying apparatus and installations; freezers; heating and cooling apparatus for dispensing hot and cold beverages; drying apparatus; coolers for furnaces; expansion tanks for central heating installations; flushing tanks; refining towers for distillation; bidets; boilers, other than parts of machines; bath tubs; spa baths [vessels]; bath tubs for sitz baths; waffle irons, electric; fans [air-conditioning]; fans [parts of air-conditioning installations]; electric fans for personal use; roasting spits; refrigerating display cabinets; heated display cabinets; water heaters; water heaters [apparatus]; water flushing installations; air reheaters; extractor hoods for kitchens; gas condensers, other than parts of machines; acetylene generators; microbubble generators for baths; hydrants; burners; acetylene burners; gas burners; burners for lamps; germicidal burners; incandescent burners; oxyhydrogen burners; laboratory burners; oil burners; alcohol burners; hot water bottles; footwarmers, electric or non-electric; bed warmers; USB-powered hand warmers; pocket warmers; warming pans; grills [cooking appliances]; food dehydrators, electric; lampshade holders; stills; showers; refrigerating containers; lighters; gas lighters; friction lighters for igniting gas; chimney blowers; coils [parts of distilling, heating or cooling installations]; furnace ash boxes; evaporators; shower enclosures; Turkish bath cabinets, portable; heating apparatus; cool boxes, electric; refrigerating chambers; fireplaces, domestic; chimney flues; structural framework for ovens; air valves for steam heating installations; level controlling valves in tanks; thermostatic valves [parts of heating installations]; electrically heated carpets; light bulbs; light bulbs, electric; solar thermal collectors [heating]; distillation columns; furnace grates; ventilation hoods; ventilation hoods for laboratories; lamp globes; air-conditioning apparatus; air conditioners for ve-

hicles; gas boilers; laundry room boilers; heating boilers; coffee machines, electric; taps; faucets for pipes and pipelines; mixer faucets for water pipes; forges, portable; lava rocks for use in barbecue grills; couscous cookers, electric; electric lights for Christmas trees; acetylene flares; safety lamps; gas lamps; curling lamps; nail lamps; curing lamps, not for medical purposes; germicidal lamps for purifying air; light bulbs for directional signals for vehicles; arc lamps; laboratory lamps; oil lamps; ultraviolet ray lamps, not for medical purposes; miners' lamps; electric lamps; chandeliers; barbecues; watering machines for agricultural purposes; ice-cream making machines; pounded rice cake making machines, electric, for household purposes; multicookers; footmuffs, electrically heated; heaters for baths; heaters for heating irons; immersion heaters; brackets for gas burners; anti-splash tap nozzles; heat pumps; filaments for electric lamps; magnesium filaments for lighting; heating filaments, electric; luminous house numbers; socks, electrically heated; heating apparatus for defrosting vehicle windows; hot air bath fittings; bath fittings; loading apparatus for furnaces; kiln furniture [supports]; sauna bath installations; refrigerating appliances and installations; directional lights for bicycles; electrically heated clothing; blankets, electric, not for medical purposes; fabric steamers; lamp reflectors; vehicle reflectors; hearths; electric cooktops; food steamers, electric; steam boilers, other than parts of machines; pasteurisers; lamp mantles; sockets for electric lights; coffee percolators, electric; stoves [heating apparatus]; bakers' ovens; hot air ovens; kitchen ranges [ovens]; microwave ovens [cooking apparatus]; microwave ovens for industrial purposes; incinerators; kilns; solar furnaces; dental ovens; furnaces, other than for laboratory use; urinals being sanitary fixtures; feeding apparatus for heating boilers; heating plates; cookers; hot plates; wine cellars, electric; heaters, electric, for feeding bottles; aquarium heaters; USB-powered cup heaters; aquarium lights; heating cushions, electric, not for medical purposes; clean chambers [sanitary installations]; tortilla presses, electric; water intake apparatus; deodorizing apparatus, not for personal use; apparatus for dehydrating food waste; fumigation apparatus, not for medical purposes; gas scrubbing apparatus; oil-scrubbing apparatus; glue-heating appliances; forage drying apparatus; water filtering apparatus; air purifying apparatus and machines; ice machines

and apparatus; cooling appliances and installations; cooking apparatus and installations; lighting apparatus and installations; sanitary apparatus and installations; cooking rings; lighting apparatus for vehicles; light-emitting diodes [LED] lighting apparatus; heating apparatus for solid, liquid or gaseous fuels; heating apparatus, electric; hot air apparatus; steam facial apparatus [saunas]; safety accessories for water or gas apparatus and pipes; regulating and safety accessories for gas apparatus; regulating accessories for water or gas apparatus and pipes; regulating and safety accessories for water apparatus; regulating and safety accessories for gas pipes; roasting jacks; plate warmers; anti-glare devices for vehicles [lamp fittings]; rotisseries; radiator caps; searchlights; diving lights; washers for water faucets; heat guns; radiators [heating]; central heating radiators; radiators, electric; sinks; disinfectant dispensers for toilets; drip irrigation emitters [irrigation fittings]; light diffusers; nuclear reactors; heat regenerators; pressure water tanks; roasters; lamps; ceiling lights; toilet seats; hydroponic growing systems; lighting installations for air vehicles; sous-vide cookers, electric; pressure cookers, electric; gas scrubbers [parts of gas installations]; lamp glasses; sterilizers; water sterilizers; air sterilizers; air dryers; laundry dryers, electric; hair dryers; malt roasters; tobacco roasters; tajines, electric; heat exchangers, other than parts of machines; bread toasters; discharge tubes, electric, for lighting; lamp chimneys; luminous tubes for lighting; pipes [parts of sanitary installations]; flues for heating boilers; boiler pipes [tubes] for heating installations; toilets [water-closets]; toilets, portable; humidifiers for central heating radiators; wash-hand basins [parts of sanitary installations]; toilet bowls; water conduits installations; air-conditioning installations; desalination plants; installations for processing nuclear fuel and nuclear moderating material; watering installations, automatic; cooling installations for water; cooling installations for liquids; milk cooling installations; cooling installations for tobacco; water purification installations; purification installations for sewage; steam generating installations; water distribution installations; air filtering installations; swimming pool chlorinating apparatus; ventilation [air-conditioning] installations and apparatus; ventilation [air-conditioning] installations for vehicles; water softening apparatus and installations; cooling installations and machines; heating insta-

llations; heaters for vehicles; hot water heating installations; polymerisation installations; water supply installations; flare stacks for use in the oil industry; ash conveyor installations, automatic; whirlpool-jet apparatus; air cooling apparatus; aquarium filtration apparatus; cooking utensils, electric; flaming torches; headlights for automobiles; vehicle headlights; filters for air conditioning; filters for drinking water; wicks adapted for oil stoves; lights for automobiles; bicycle lights; motorcycle lights; lights for vehicles; electric torches; head torches; lanterns for lighting; candle lanterns; street lamps; Chinese lanterns; fountains; ornamental fountains; chocolate fountains, electric; air fryers; deep fryers, electric; fittings, shaped, for ovens; oven fittings made of fireclay; bread-making machines; refrigerators; refrigerators, cooling apparatus and freezers for medical storage purposes; chromatography apparatus for industrial purposes; kettles, electric; dampers [heating]; book sterilization apparatus; refrigerating cabinets; carbon for arc lamps; heating elements; bath installations; standard lamps; thermo-pots, electric; electric appliances for making yogurt; bread baking machines; fairy lights for festive decoration.

12 – Motor buses; motor coaches; motor homes; driverless cars [autonomous cars]; motor racing cars; cars; robotic cars; sports cars; concrete mixing vehicles; refrigerated vehicles; caravans; shock absorbers for automobiles; suspension shock absorbers for vehicles; space vehicles; aircraft; aeronautical apparatus, machines and appliances; air cushion vehicles; hot air balloons; ski carriers for cars; luggage carriers for vehicles; bumpers for automobiles; vehicle bumpers; tires for vehicle wheels; barges; brake shoes for vehicles; tailboard lifts [parts of land vehicles]; armored vehicles; buffers for railway rolling stock; mine cars; tilt trucks; railway carriages; sleeping cars; dining cars; refrigerated railway wagons; transmission shafts for land vehicles; bicycles; electric bicycles; valves for vehicle tires; helicopters; helicams; automobile hoods; stroller hoods; hoods for vehicles; oars; paddles for canoes; sculls; screws [propellers] for ships; lug nuts for vehicle wheels; hydroplanes; seaplanes; flanges for railway wheel tires; trucks; trucks with a crane feature incorporated; horns for vehicles; treads for vehicles [tractor type]; doors for vehicles; bicycle motors; motorcycle engines; engines for land vehicles; jet engines for land vehicles; driving motors for land vehicles; screw-

propellers; screw-propellers for boats; airships; rake discs for vehicles; telpher railways [cable cars]; dredgers [boats]; trolleys; military drones; civilian drones; delivery drones; camera drones; clips adapted for fastening automobile parts to automobile bodies; vehicle bonnet pins; adhesive rubber patches for repairing inner tubes; bicycle bells; rearview mirrors; portholes; cars for cable transport installations; inner tubes for pneumatic tires; inner tubes for bicycle tires; canoes; hoods for vehicle engines; crankcases for land vehicle components, other than for engines; boats; caissons [vehicles]; bicycle wheels; vehicle wheels; mine cart wheels; casters for trolleys [vehicles]; brake pads for automobiles; hub caps; strollers; pet strollers; side cars; prams; brake linings for vehicles; ships; baskets adapted for bicycles; gear boxes for land vehicles; ship hulls; panniers adapted for bicycles; panniers adapted for motorcycles; fenders for ships; bands for wheel hubs; ejector seats for aircraft; wheelchairs; caps for vehicle fuel tanks; boat hooks; automobile bodies; tipping bodies for trucks; bodies for vehicles; treads for retreading tires; locomotives; masts for boats; golf carts [vehicles]; sprinkling trucks; propulsion mechanisms for land vehicles; mopeds; motor scooters; motorcycles; rubbish trucks; tyre mousse inserts; fitted footmuffs for pushchairs; fitted footmuffs for prams; freewheels for land vehicles; clutches for land vehicles; repair outfits for inner tubes; pumps for bicycle tires; upholstery for vehicles; rims for bicycle wheels; rims for vehicle wheels; windows for vehicles; omnibuses; engine mounts for land vehicles; axles for vehicles; headlight wipers; parachutes; ferry boats; bicycle pedals; ashtrays for automobiles; gearing for land vehicles; carts; headrests for vehicle seats; bicycle kickstands; vehicle running boards; air bags [safety devices for automobiles]; ski lifts; chairlifts; casings for pneumatic tyres; sleeping berths for vehicles; pontoons; torque converters for land vehicles; cigar lighters for automobiles; non-skid devices for vehicle tires; anti-glare devices for vehicles; anti-theft devices for vehicles; sun-blinds adapted for automobiles; trailers for transporting bicycles; bicycle trailers; balance weights for vehicle wheels; shock absorbing springs for vehicles; bicycle frames; motorcycle frames; spars for ships; reduction gears for land vehicles; safety belts for vehicle seats; security harness for vehicle seats; vehicle suspension springs; rudders; bicycle handlebars; motorcycle

handlebars; vehicle joysticks; bicycle cranks; aeroplanes; amphibious airplanes; sleighs [vehicles]; rescue sleds; kick sledges; brake segments for vehicles; bicycle saddles; luggage nets for vehicles; dress guards for bicycles; fitted stroller mosquito nets; anti-theft alarms for vehicles; reversing alarms for vehicles; safety seats for children, for vehicles; vehicle seats; bellows for articulated buses; hydraulic circuits for vehicles; push scooters [vehicles]; mobility scooters; snowmobiles; rolling stock for railways; rolling stock for funicular railways; spokes for bicycle wheels; vehicle wheel spokes; spoilers for vehicles; air vehicles; vehicles for locomotion by land, air, water or rail; ambulances; autonomous underwater vehicles for seabed inspections; water vehicles; remotely operated vehicles for underwater inspections; remote control vehicles, other than toys; electric vehicles; tricycles; delivery tricycles; inclined ways for boats; windscreens; windshield wipers; hubs for bicycle wheels; hubs for vehicle wheels; bags adapted for pushchairs; saddlebags adapted for bicycles; railway couplings; trailer hitches for vehicles; couplings for land vehicles; wheelbarrows; handling carts; two-wheeled trolleys; shopping trolleys; fishing trolleys; hose carts; bogies for railway cars; casting carriages; tilting-carts; roll cage trolleys; forklift trucks; cleaning trolleys; bicycle brakes; brakes for vehicles; torsion bars for vehicles; tractors; tramcars; transmissions for land vehicles; military vehicles for transport; aerial conveyors; trailers [vehicles]; funnels for ships; funnels for locomotives; cleats [nautical]; turbines for land vehicles; signal arms for vehicles; rowlocks; disengaging gear for boats; steering gears for ships; cable transport apparatus and installations; spoke clips for wheels; tipping apparatus [parts of railway wagons]; funiculars; vans [vehicles]; automobile chains; bicycle chains; motorcycle chains; driving chains for land vehicles; anti-skid chains; transmission chains for land vehicles; undercarriages for vehicles; stroller covers; spare wheel covers; covers for vehicle steering wheels; saddle covers for bicycles; saddle covers for motorcycles; seat covers for vehicles; vehicle covers [shaped]; automobile chassis; vehicle chassis; connecting rods for land vehicles, other than parts of motors and engines; axle journals; gears for bicycles; tubeless tires for bicycles; bicycle tyres; automobile tires; pneumatic tires; solid tires for vehicle wheels; spikes for tires; davits for boats; launches; timbers

[frames] for ships; mudguards; bicycle mudguards; tow trucks; motors, electric, for land vehicles; yachts; self-balancing electric unicycles; self-balancing scooters; air pumps [vehicle accessories]; steering wheels for vehicles; side view mirrors for vehicles; self-balancing boards; gyrocopters.

28 – Arcade video game machines; video game machines; gaming machines for gambling; amusement machines, automatic and coin-operated; toy vehicles; swimming pools [play articles]; trampolines; novelty toys for parties; scratch cards for playing lottery games; starting blocks for sports; bodyboards; skating boots with skates attached; boomerangs; dolls' feeding bottles; tricycles for infants [toys]; stationary exercise bicycles; creels [fishing traps]; shuttlecocks; spinning tops [toys]; dumb-bells; gyroscopes and flight stabilizers for model aircraft; jigsaw puzzles; clay pigeons [targets]; punching bags; bite sensors [fishing tackle]; hang gliders; joysticks for video games; flying discs [toys]; discuses for sports; dolls' houses; dominoes; swimming kickboards; paddleboards; surfboards; spring boards [sports articles]; skateboards; sailboards; chessboards; checkerboards; drones [toys]; darts; Christmas trees of synthetic material; cups for dice; swimming jackets; ascenders [mountaineering equipment]; kites; needles for pumps for inflating balls for games; toys; toys for pets; stuffed toys; inflatable games for swimming pools; plush toys; novelty toys for playing jokes; games; portable games and toys incorporating telecommunication functions; parlor games; board games; ring games; building games; toy imitation cosmetics; swimming pool air floats; kaleidoscopes; bladders of balls for games; rosin used by athletes; edges of skis; trading cards for games; bingo cards; playing cards; fairground ride apparatus; reels for fishing; rocking horses; swings; yoga swings; skittles; skittles [games]; billiard cues; golf clubs; hockey sticks; baby gyms; seal skins [coverings for skis]; bells for Christmas trees; dolls' rooms; controllers for toys; confetti; ice skates; roller skates; in-line roller skates; dice; paintball guns [sports apparatus]; ski bindings; dolls' beds; roulette wheels; fish hooks; building blocks [toys]; dolls; flippers for swimming; rhythmic gymnastics ribbons; fishing lines; gut for fishing; bows for archery; skis; waterskis; roller skis; mah-jong; hunting game calls; puppets; masks [playthings]; carnival masks; theatrical masks; fencing masks; toy putty; matryoshka dolls; masts for sailboards; ball pitching machines;

teddy bears; chalk for billiard cues; targets; electronic targets; toy models; scale model kits [toys]; scale model vehicles; kite reels; balls for games; artificial fishing bait; billiard table cushions; knee guards [sports articles]; billiard cue tips; elbow guards [sports articles]; backgammon games; pumps specially adapted for use with balls for games; dolls' clothes; fencing weapons; play tents; ski sticks for roller skis; ski sticks; twirling batons; paragliders; pachinkos; baseball gloves; boxing gloves; golf gloves; gloves for games; batting gloves [accessories for games]; fencing gauntlets; pinatas; toy pistols; toy air pistols; percussion caps [toys]; caps for pistols [toys]; toy dough; protective films adapted for screens for portable games; rattles [playthings]; horseshoe games; candle holders for Christmas trees; Christmas tree stands; sole coverings for skis; water wings; floats for fishing; portable games with liquid crystal displays; swimming belts; waist trimmer exercise belts; decoys for hunting or fishing; scent lures for hunting or fishing; archery implements; soap bubbles [toys]; divot repair tools [golf accessories]; billiard markers; video game consoles; hand-held consoles for playing video games; protective paddings [parts of sports suits]; rackets; surfboard leashes; harness for sailboards; weight lifting belts [sports articles]; toy robots; sling shots [sports articles]; rollers for stationary exercise bicycles; harpoon guns [sports articles]; plush toys with attached comfort blanket; scooters [toys]; sleds [sports articles]; bob-sleighs; butterfly nets; landing nets for anglers; nets for sports; tennis nets; bite indicators [fishing tackle]; slot machines [gaming machines]; appliances for gymnastics; quoits; bar-bells; climbers' harness; fishing tackle; artificial snow for Christmas trees; snowshoes; snowboards; remote-controlled toy vehicles; clay pigeon traps; billiard tables; coin-operated billiard tables; tables for table tennis; strings for rackets; gut for rackets; golf bags, with or without wheels; cricket bags; golf bag carts; slides [playthings]; body-building apparatus; machines for physical exercises; men's athletic supporters [sports articles]; rods for fishing; ornaments for Christmas trees, except illumination articles and confectionery; tennis ball throwing apparatus; conjuring apparatus; apparatus for games; bowling apparatus and machinery; toy figures; counters [discs] for games; chips for gambling; foosball tables; party poppers [party novelties]; Christmas crackers [party novelties]; bags especially designed

for skis and surfboards; marbles for games; billiard balls; playing balls; play balloons; paintballs [ammunition for paintball guns] [sports apparatus]; snow globes; chess games; checkers [games]; poles for pole vaulting; paper party hats; shin guards [sports articles]; camouflage screens [sports articles]; chest expanders [exercisers]; controllers for game consoles; toy mobiles.

42 – Water analysis; computer system analysis; handwriting analysis [graphology]; chemical analysis; energy auditing; recovery of computer data; business card design; graphic design of promotional materials; industrial design; graphic arts design; computer virus protection services; oil-field surveys; geological surveys; engineering; installation of computer software; meteorological information; clinical trials; material testing; textile testing; bacteriological research; biological research; geological research; research in the field of environmental protection; cosmetic research; mechanical research; research in the field of welding; research in the field of building construction; research in the field of telecommunications technology; research in the field of physics; research and development of new products for others; medical research; scientific and technological research relating to patent mapping; scientific and technological research in the field of natural disasters; scientific research; analysis for oil-field exploitation; underwater exploration; technological research; calibration [measuring]; web site design consultancy; computer security consultancy; information technology [IT] consultancy; consultancy in the design and development of computer hardware; architectural consultancy; internet security consultancy; computer software consultancy; data security consultancy; technological consultancy; oil-well testing; quality control; vehicle roadworthiness testing; land surveying; dress designing; updating of computer software; monitoring of computer systems to detect breakdowns; monitoring of computer systems for detecting unauthorized access or data breach; monitoring of computer systems by remote access; software as a service [SaaS]; maintenance of computer software; authenticating works of art; design of interior decor; quality evaluation of standing timber; quality evaluation of wool; digitization of documents [scanning]; conversion of data or documents from physical to electronic media; urban planning; providing search engines for the internet; conversion of computer

programs and data, other than physical conversion; conducting technical project studies; computer system design; rental of web servers; computer rental; rental of computer software; unlocking of mobile phones; geological prospecting; oil prospecting; hosting computer sites [web sites]; development of computer platforms; construction drafting; computer software design; software development in the framework of software publishing; chemical research; cloud seeding; server hosting; consultancy in the field of energy-saving; creating and designing website-based indexes of information for others [information technology services]; creating and maintaining web sites for others; computer programming; technical writing; copying of computer programs; cloud computing; architectural services; chemistry services; outsource service providers in the field of information technology; packaging design; off-site data backup; computer technology consultancy; telecommunications technology consultancy; scientific laboratory services; weather forecasting; styling [industrial design]; cartography services; exploration services in the field of the oil, gas and mining industries; data encryption services; electronic data storage; surveying; electronic monitoring of credit card activity to detect fraud via the internet; electronic monitoring of personally identifying information to detect identity theft via the internet; platform as a service [PaaS]; provision of scientific information, advice and consultancy in relation to carbon offsetting; providing information on computer technology and programming via a web site.

(260) AM 2020 106845 A

(800) 1510414

(151) 2019 11 11

(891) 2019 11 11

(731) Obshchestvo s ogranichennoy
otvetstvennostyu "MONOPAK"
Altuf'yevskoye shosse, d. 89, kv. 14,
RU-127576 Moscow, Russian Federation

(540)



(591) White, blue, red, green

(531) 26.04.03; 26.04.09; 26.15.09; 27.05.02;
29.01.14

(511)

3 – Descaling preparations for household purposes;
antistatic preparations for household purposes; ca-

nned pressurized air for cleaning and dusting purposes; sachets for perfuming linen; drying agents for dishwashing machines; wax for parquet floors; floor wax; non-slipping wax for floors; tailors' wax; polish for furniture and flooring; polishing wax; non-slipping liquids for floors; windshield cleaning liquids; laundry glaze; shoe cream; polishing creams; bath preparations, not for medical purposes; preparations for soaking laundry; grinding preparations; smoothing preparations [starching]; color-removing preparations; polishing preparations; starch glaze for laundry purposes; preparations to make the leaves of plants shiny; furnishing preparations; fabric softeners for laundry use; laundry bleaching preparations; dry-cleaning preparations; paint stripping preparations; lacquer-removing preparations; floor wax removers [scouring preparations]; varnish-removing preparations; rust removing preparations; cleaning preparations; wallpaper cleaning preparations; preparations for unblocking drain pipes; chemical cleaning preparations for household purposes; bleaching preparations [decolorants] for household purposes; laundry preparations; color-brightening chemicals for household purposes [laundry]; shining preparations [polish]; stain removers; scouring solutions; laundry blueing; turpentine for degreasing; bleaching soda; washing soda, for cleaning; bath salts, not for medical purposes; bleaching salts; preservatives for leather [polishes]; ammonia [volatile alkali] [detergent]; shoe wax; detergents, other than for use in manufacturing operations and for medical purposes; degreasers, other than for use in manufacturing processes; cloths impregnated with a detergent for cleaning; soda lye.

8 – Table knives, forks and spoons of plastic.

10 – Draw-sheets for sick beds; masks for use by medical personnel; therapeutic facial masks; boots for medical purposes; clothing especially for operating rooms; gloves for massage; gloves for medical purposes; condoms.

16 – Table linen of paper; parchment paper; packing paper; filter paper; boxes of paper or cardboard; paper ribbons, other than haberdashery or hair decorations; gummed tape [stationery]; adhesive bands for stationery or household purposes; adhesive tapes for stationery or household purposes; self-adhesive tapes for stationery or household purposes; absorbent sheets of paper or plastic for foodstuff packaging; humidity control sheets of

paper or plastic for foodstuff packaging; viscose sheets for wrapping; sheets of reclaimed cellulose for wrapping; plastic bubble packs for wrapping or packaging; packing [cushioning, stuffing] materials of paper or cardboard; packaging material made of starches; filtering materials of paper; tablemats of paper; bags [envelopes, pouches] of paper or plastics, for packaging; garbage bags of paper or of plastics; bibs of paper; bibs, sleeved, of paper; bottle envelopes of paper or cardboard; conical paper bags; paper bags for use in the sterilization of medical instruments; bags for microwave cooking; plastic film for wrapping; desk mats; coasters of paper; mats for beer glasses; towels of paper; paper wipes for cleaning; place mats of paper; table napkins of paper; tablecloths of paper; bottle wrappers of paper or cardboard; paper coffee filters; silver paper.

17 – Duct tapes; insulating tapes; adhesive bands, other than stationery and not for medical or household purposes; self-adhesive tapes, other than stationery and not for medical or household purposes; viscose sheets, other than for wrapping; sheets of regenerated cellulose, other than for wrapping; insulating materials; padding materials of rubber or plastics; packing [cushioning, stuffing] materials of rubber or plastics; filtering materials of semi-processed films of plastic; bags [envelopes, pouches] of rubber, for packaging; insulating gloves; plastic sheeting for agricultural purposes; plastic film, other than for wrapping; foils of metal for insulating.

20 – Packaging containers of plastic; bamboo; hampers [baskets] for the transport of items; settees; containers, not of metal [storage, transport]; bungs, not of metal; decorations of plastic for foodstuffs.

21 – Paper plates; sponges for household purposes; containers for household or kitchen use; kitchen containers; toothpicks; baking mats; pie servers; spatulas for kitchen use; polishing materials for making shiny, except preparations, paper and stone; tablemats, not of paper or textile; isothermic bags; confectioners' decorating bags [pastry bags]; wool waste for cleaning; cleaning tow; cold packs for chilling food and beverages; chopsticks; cocktail stirrers; kitchen mitts; animal grooming gloves; gloves for household purposes; car washing mitts; polishing gloves; gardening gloves; trays of paper, for household purposes; tableware, other

than knives, forks and spoons; place mats, not of paper or textile; cups of paper or plastic; glasses [receptacles]; drinking glasses; disposable table plates; drinking straws; cloth for washing floors; polishing cloths; cloths for cleaning; dusting cloths [rags]; furniture dusters; utensils for household purposes; kitchen utensils; cake molds; cookery molds.

22 – Padding materials, not of rubber, plastics, paper or cardboard; packing [cushioning, stuffing] materials, not of rubber, plastics, paper or cardboard; bags [envelopes, pouches] of textile, for packaging; sacks for the transport and storage of materials in bulk.

25 – Paper clothing; waterproof clothing; uniforms; headwear; paper hats [clothing].

(260) AM 2020 106846 A
 (800) 1510417
 (151) 2019 09 16
 (891) 2019 09 16
 (731) FICOSOTA OOD
 Madara Blvd. 48, BG-9701 Shumen,
 Bulgaria

(540)



(591) Light red-orange (identified by the Pantone code)

(531) 02.09.01; 19.07.01; 19.07.12; 19.07.16;
 24.13.01; 24.17.07; 29.01.15

(554) მოცულობითი

(511)

3 – Powder laundry detergents; liquid laundry detergent and capsules, containing laundry detergent; laundry fabric conditioner; hair shampoo; bath and shower gel; wipes, impregnated with a cleaning preparation; non-medicated diaper rash

cream; bar soap; liquid soap; body lotion; talcum powder (non-medicated -) for babies; non-medicated bath preparations; baby oils; baby bath mousse; sunscreen creams; sun-tanning oils.

(260) AM 2020 106847 A

(800) 1510421

(151) 2019 11 05

(891) 2019 11 05

(731) OWNR WALLET OÜ

Punane tn 6-219, Lisnamae Linaosa,

EE-13619 Tallinn, Harju maakond, Estonia

(540)

OWNR Wallet

(591) Black, white

(531) 27.05.01; 27.05.10

(511)

9 – 3D spectacles; answering machines; electronic parking lot ticket dispensers; circuit breakers; automated teller machines [ATM]; steering apparatus, automatic, for vehicles, namely, simulators for the steering and control of vehicles; batteries for electronic cigarettes; accumulators, electric; acoustic couplers; data processing apparatus; Global Positioning System [GPS] apparatus; audio- and video-receivers; audio interfaces; batteries, electric, for vehicles; cordless telephones; biochips for research or scientific purposes; computer memory devices; black boxes being electronic data recorders; encoded identification bracelets, magnetic being measuring instruments; video screens; camcorders; blank video cassettes; video baby monitors; video telephones; hands-free kits for telephones; virtual reality headsets; floppy disk drives; disks, blank magnetic; disk drives for computers; juke boxes for computers; downloadable electronic publications in the nature of books, magazines, manuals in the field of eLearning courses; electronic interactive whiteboards; electronic pocket translators; protective films adapted for computer screens; protective films adapted for smartphones; optical readers being data processing equipment; compact discs, audio-video featuring eLearning courses in the field of general human interests; computers; computer hardware; computer game software; computer software, recorded for the administration, documentation, tracking, reporting and delivery of training in the form of eLearning; joysticks for use with computers, other than for

video games; computer keyboards; computer peripheral devices; computer programs, downloadable software for the administration, documentation, tracking, reporting and delivery of training in the form of eLearning; computer programs, recorded for the administration, documentation, tracking, reporting and delivery of training in the form of eLearning; computer operating programs, recorded; commutators; electric apparatus for commutation being communicators; computer mice being computer peripheral; mobile telephones; modems; monitors being computer hardware; computer monitors for computer programs; navigation apparatus for vehicles being on-board computers; headphones; notebook computers; optical fibers being light conducting filaments; blank optical discs; optical character readers; optical data media, namely, blank optical data carriers; transmitters of electronic signals; computer software applications, downloadable for the administration, documentation, tracking, reporting and delivery of training in the form of eLearning; central processing units being processors; smartwatches; smart rings; smartglasses; smartphones; solar batteries; solar panels for production of electricity; blank usb flash drives.

36 – Actuarial services; financial analysis; banking; stock brokerage services; stocks and bonds brokerage; brokerage of carbon credits; real estate brokerage; insurance brokerage; securities brokerage; repair costs evaluation [financial appraisal]; issuance of travellers' cheques; issuance of credit cards; issuance of tokens of value; investment of funds; arranging finance for construction projects; online banking; trusteeship; debt advisory services; electronic funds transfer; providing financial information via a web site; safe deposit services; deposits of valuables; charitable fund raising; rent collection; capital investment; mortgage banking; apartment house management; real estate management; clearing-houses, financial; insurance consultancy; stock exchange quotations; pawnbrokerage; marine insurance underwriting; providing rebates at participating establishments of others through use of a membership card; loans [financing]; installment loans; bail-bonding; exchanging money; processing of debit card payments; processing of credit card payments; organization of monetary collections; rental of apartments; rental of real estate; rental of offices [real estate]; rental of offices for co-working; rental of farms; antique appraisal;

stamp appraisal; real estate appraisal; numismatic appraisal; art appraisal; fiscal valuation; jewellery appraisal; cheque verification; lending against security; accommodation bureau services (apartments); real estate agency services; credit bureau services; mutual funds; surety services; financing services; debt collection agency services; savings bank services; provident fund services; insurance information; insurance underwriting; accident insurance underwriting; fire insurance underwriting; life insurance underwriting; health insurance underwriting; factoring; financial information; financial management; financial management of reimbursement payments for others; financial consultancy; financial evaluation of development costs relating to the oil, gas and mining industries; financial appraisals in responding to calls for tenders; financial sponsorship; financial research; financial customs brokerage services; hire-purchase financing business liquidation services, financial; retirement payment services.

42 – Computer system analysis; outsource service providers in the field of information technology; recovery of computer data; off-site data backup; duplication of computer programs; electronic data storage; electronic monitoring of personally identifying information to detect identity theft via the Internet; electronic monitoring of credit card activity to detect fraud via the Internet; providing information on computer technology and programming via a web site; providing search engines for the Internet; installation of computer software; computer programming; conversion of data or documents from physical to electronic media; conversion of computer programs and data, other than physical conversion; computer technology consultancy; Internet security consultancy; data security consultancy; information technology [IT] consultancy; computer software consultancy; computer security consultancy; consultancy in the design and development of computer hardware; web site design consultancy; monitoring of computer systems for detecting unauthorized access or data breach; monitoring of computer systems to detect breakdowns; monitoring of computer systems by remote access to ensure proper functioning; maintenance of computer software; updating of computer software; computer virus protection services; software as a service (SaaS), namely, hosting software for use by others for the administration, documentation, tracking, reporting and delivery of

training in the form of eLearning; computer software design; rental of web servers; computer rental; rental of computer software; hosting computer sites being web sites; computer system design; creating and designing website-based indexes of information for others being information technology services; cloud computing featuring software for the administration, documentation, tracking, reporting and delivery of training in the form of eLearning; server hosting.

(260) AM 2020 106849 A

(800) 1510484

(151) 2019 10 02

(891) 2019 10 02

(731) Alvotech hf.

Saemundargotu 15-19, IS-101 Reykjavik,
Iceland

(540)

ALVOTECH

(591) Black, white

(511)

10 – Surgical apparatus and instruments; medical apparatus and instruments; injectors for medical purposes.

35 – Retail and wholesale of pharmaceuticals, surgical apparatus, surgical instruments, medical apparatus and medical instruments; the bringing together, for the benefit of others, pharmaceuticals, surgical apparatus, surgical instruments, medical apparatus and medical instruments, excluding the transport thereof, enabling customers to conveniently view and purchase those goods; marketing of pharmaceuticals, surgical apparatus, surgical instruments, medical apparatus and medical instruments; importing and exporting of pharmaceuticals, surgical apparatus, surgical instruments, medical apparatus and medical instruments.

44 – Medical services; hygienic and beauty care for human beings; advisory services relating to pharmaceuticals; medical, medicinal and pharmaceutical consultancy; provision of pharmaceutical information; consultancy relating to pharmaceutical and medical products.

(260) AM 2020 106860 A

(800) 1510789

(151) 2019 12 16

(891) 2019 12 16

(731) TAIZHOU QIANTAO PUMPS CO., LTD.

Dayang Cheng Industrial Area, Daxi Town,
Wenling City, 317525 Zhejiang Province,
China

(540)

CHIMP

(591) Black, white

(531) 27.05.01; 27.05.04; 27.05.09; 27.05.17

(511)

7 – Blowing machines for the compression, ex-
haustion and transport of gases; starters for motors
and engines; driving motors, other than for land
vehicles; centrifugal pumps; pumps [parts of ma-
chines, engines, or motors]; vacuum pumps [ma-
chines]; compressed air machines; compressors
[machines]; blowing machines.

(260) AM 2020 106861 A

(800) 1510827

(151) 2019 12 16

(891) 2019 12 16

(731) SANLIUYIDU (FUJIAN) SPORTS GOODS
CO., LTD.

Jiangtou Industrial Zone, Chendai Town,
Jinjiang City, 362211 Fujian, China

(540)



(591) Black, white

(531) 26.13.25; 27.07.01; 27.07.17

(511)

18 – Leather, unworked or semi-worked; furniture
coverings of leather; leather straps; backpacks;
handbags; pocket wallets; bags for sports; umbre-
llas; walking sticks; harness fittings.

25 – Footwear; sports shoes; hosiery; gloves [clo-
thing]; waterproof clothing; clothing; shoes; hats;
scarves; girdles.

35 – Presentation of goods on communication me-
dia, for retail purposes; organization of exhibitions
for commercial or advertising purposes; commer-

cial administration of the licensing of the goods
and services of others; import-export agency ser-
vices; sales promotion for others; marketing; busi-
ness management of sports people; systemization
of information into computer databases; business
auditing; rental of sales stands.

(260) AM 2020 106862 A

(800) 1510833

(151) 2019 12 05

(891) 2019 12 05

(731) Santen Pharmaceutical Co., Ltd.

9-19 Shimoshinjo 3-chome,
Higashiyodogawa-ku, Osaka-shi, Osaka-fu
533-8651, Japan

(540)

DUCRESSA

(591) Black, white

(511)

5 – Ophthalmic preparations.

(260) AM 2020 106863 A

(800) 1510846

(151) 2019 12 16

(891) 2019 12 16

(731) SHENZHEN LONGBO WATCHES
INDUSTRY CO., LTD.

Fifth floor, Building B, Chenglong Qiukou
Industrial Park, Xixiang 107 National Road
West, Baoan District, Shenzhen, Guangdong,
China

(540)

MEIBIN

美宾

(591) Black, white

(531) 28.03

(511)

14 – Watches; watch bands; alloys of precious me-
tal; charms for jewellery; works of art of precious
metal; clocks; movements for clocks and watches;
presentation boxes for watches; jewellery; jewe-
lly charms.

(260) AM 2020 106864 A
(800) 1510853
(151) 2019 10 23
(891) 2019 10 23
(731) Yiwu Chuangyi kitchenware Co., Ltd.
No. 60494, 60502, market, zone 5, Yiwu
International Trade City, Zhejiang Province,
China

(540)



(591) Black, white
(531) 24.17.25; 27.05.01
(511)

8 – Abrading instruments [hand instruments]; garden tools, hand-operated; beard clippers; nail clippers, electric or non-electric; flat irons; graving tools [hand tools]; scissors; side arms, other than firearms; spoons; table cutlery [knives, forks and spoons].

21 – Utensils for household purposes; containers for household or kitchen use; tableware, other than knives, forks and spoons; kitchen utensils; cooking utensils, non-electric; drinking vessels; sieves [household utensils]; cleaning instruments, hand-operated.

(260) AM 2020 106865 A
(800) 1510891
(151) 2019 12 20
(891) 2019 12 20
(731) SHENZHEN IVPS TECHNOLOGY CO.,
LTD.
101, Building 69, Liantang Industrial Zone,
Tangwei Community, Fenghuang Street,
Guangming District, Shenzhen, 518107
Guangdong, China

(540)



(591) Black, white
(531) 27.05.01; 27.05.17
(511)

34 – Oral vaporizers for smokers; flavorings, other than essential oils, for use in electronic cigarettes; electronic cigarettes; liquid solutions for use in el-

ectronic cigarettes; tobacco pipes; electronic cigarettes for use as an alternative to traditional cigarettes; cigarette cases; electronic cigars; liquid nicotine solutions for use in electronic cigarettes; tips of yellow amber for cigar and cigarette holders.

(260) AM 2020 106866 A
(800) 1510892
(151) 2019 12 16
(891) 2019 12 16
(731) SHENZHEN LONGBO WATCHES
INDUSTRY CO., LTD.
fifth floor, Building B, Chenglong Qjukou
Industrial Park, Xixiang 107 National Road
West, Baoan District, Shenzhen, Guangdong,
China

(540)



(591) Black, white
(531) 27.05.01
(511)

14 – Platinum [metal]; boxes of precious metal; bracelets [jewelry]; clocks; wristwatches; watch chains; clock cases; watches; watch cases [parts of watches].

(260) AM 2020 106867 A
(800) 1510902
(151) 2019 12 25
(891) 2019 12 25
(731) Obshchestvo s ogranichennoi
otvetstvennost'yu "AURUM"
ul. Inzhenernaya, 4a, RU-630090
Novosibirsk, Russian Federation

(540)



(591) Black, white
(511)

35 – Administration of frequent flyer programs; administrative processing of purchase orders; business management for freelance service providers; commercial information and advice for consumers [consumer advice shop]; provision of an online marketplace for buyers and sellers of goods and services.

(260) AM 2020 106868 A
 (800) 1510903
 (151) 2019 12 11
 (891) 2019 12 11
 (731) Acino Pharma AG
 Birsweg 2, CH-4253 Liesberg, Switzerland
 (540)

Vyrsolis

(591) Black, white
 (511)
 5 – Pharmaceutical products.

(260) AM 2020 106869 A
 (800) 1510937
 (151) 2019 08 15
 (891) 2019 08 15
 (731) Tovarystvo z obmezhenoiu vidpovidalnistiu
 "Tuplex-Ukraine"
 vul. Bohdana Khmelnytskoho, 44, m. Kyiv
 01030, Ukraine
 (540)

TUPLEX

(591) Black, white
 (531) 27.05.01; 27.05.17
 (511)
 35 – Administrative assistance in responding to requests for proposals [RFPs]; administrative processing of purchase orders; administration of consumer loyalty programs; administration of frequent flyer programs; cost price analysis; business auditing; financial auditing; auctioneering; outsourced administrative management for companies, accounting; web indexing for commercial or advertising purposes; negotiation of business contracts for others; market studies; opinion polling; invoicing.

37 – Installation, maintenance and repair of computer hardware; machinery installation, maintenance and repair; office machines and equipment installation, maintenance and repair; building sealing; building insulating; repair information; construction information; construction consultancy; varnishing; painting, interior and exterior; building construction supervision; roofing services; factory construction; warehouse construction and repair; painting or repair of signs; cleaning of buildings [interior]; cleaning of buildings [exterior surface].

41 – Arranging and conducting of congresses; arranging and conducting of colloquiums; arranging

and conducting of conferences; arranging and conducting of in-person educational forums; arranging and conducting of workshops [training]; arranging and conducting of seminars; arranging and conducting of symposiums; electronic desktop publishing; training services provided via simulators; tutoring; organization of exhibitions for cultural or educational purposes; organization of competitions [education or entertainment]; organization of sports competitions; layout services, other than for advertising purposes; coaching [training]; vocational retraining; vocational guidance [education or training advice]; publication of texts, other than publicity texts; entertainment services.

42 – Computer system analysis; architectural consultancy; architectural services; outsource service providers in the field of information technology; construction drafting; material testing; graphic arts design; graphic design of promotional materials; packaging design; technological research; research and development of new products for others; mechanical research; research in the field of building construction; electronic data storage; engineering; computer programming; computer software consultancy; quality control; scientific research; surveying; maintenance of computer software; urban planning; industrial design; hosting computer sites [web sites]; software development in the framework of software publishing; technical writing; technological consultancy; styling [industrial design].

(260) AM 2020 106872 A
 (800) 1510990
 (151) 2019 11 15
 (891) 2019 11 15
 (731) BETA GIDA SANAYİ VE TİCARET
 ANONİM ŞİRKETİ
 Hacı Sabancı Organize Sanayi Bölgesi Osb,
 Fuzuli Caddesi No:1, Sarıçam, Adana,
 Turkey
 (540)



(591) Black, white

(531) 05.07.02; 06.19.15; 25.01.10; 26.13.25;
27.05.01; 27.05.02; 27.05.24; 29.01.15

(511)

30 – Coffee, cocoa; coffee or cocoa based beverages, chocolate based beverages; pasta, stuffed dumplings, noodles; pastries and bakery products based on flour; desserts based on flour and chocolate; bread, simit [Turkish ring-shaped bagel covered with sesame seeds], poğaç [Turkish bagel], pita, sandwiches, katmer [Turkish pastry], pies, cakes, baklava [Turkish dessert based on dough coated with syrup], kadayif [Turkish dessert based on dough]; desserts based on dough coated with syrup; puddings, custard, kazandibi [Turkish pudding], rice pudding, keşkül [Turkish pudding]; honey, bee glue for human consumption, propolis for food purposes; condiments for foodstuff, vanilla (flavoring), spices, sauces (condiments), tomato sauce; yeast, baking powder; flour, semolina, starch for food; sugar, cube sugar, powdered sugar; tea, ice tea; confectionery, chocolate, biscuits, crackers, wafers; chewing gums; ice-cream, edible ices; salt; cereal-based snack food, popcorn, crushed oats, corn chips, breakfast cereals, processed wheat for human consumption, crushed barley for human consumption, processed oats for human consumption, processed rye for human consumption, rice; molasses for food.

(260) AM 2020 106888 A

(800) 1511279

(151) 2019 12 17

(891) 2019 12 17

(731) Apple Inc.

One Apple Park Way, Cupertino CA 95014,
USA

(540)

MAC CATALYST

(591) Black, white

(511)

9 – Downloadable computer software used in developing other software applications; downloadable application development software.

(260) AM 2020 106889 A

(800) 1511328

(151) 2019 12 05

(891) 2019 12 05

(731) Santen Pharmaceutical Co., Ltd.

9-19 Shimoshinjo 3-chome,
Higashiyodogawa-ku, Osaka-shi, Osaka-fu
533-8651, Japan

(540)

ДУКРЕССА

(591) Black, white

(531) 28.05

(511)

5 – Ophthalmic preparations.

(260) AM 2020 106906 A

(800) 1511698

(151) 2019 11 26

(891) 2019 11 26

(731) Del Mare 1911 S.p.A.

Via Mecenate 75, I-20138 Milano MI, Italy

(540)

Silver Highplot

(591) Black, white

(531) 27.05.01

(511)

25 – Clothing, footwear, headgear.

(260) AM 2020 106986 A

(800) 1512466

(151) 2019 11 01

(891) 2019 11 01

(731) Limited Liability Company "DomBytChim"

Lenina Str., 39A, Yablonovskiy urban-type
settlement, Takhtamukayskiy region,
RU-385140 Adygeya republic, Russian
Federation

(540)



(591) White, black, blue, red

(531) 25.03.01; 27.01.01; 27.05.17; 29.01.13

(511)

1 – Antistatic preparations, other than for household purposes.

3 – Abrasives; antistatic preparations for household purposes; windshield cleaning liquids; oils for cleaning purposes; dry-cleaning preparations; paint stripping preparations; lacquer-removing pre-

parations; rust removing preparations; cleaning preparations; scouring solutions; washing soda, for cleaning; abrasive pastes; polishing preparations; canned pressurized air for cleaning and dusting purposes; detergents, other than for use in manufacturing operations and for medical purposes; degreasers, other than for use in manufacturing processes; stain removing preparations.

(260) AM 2020 106999 A

(800) 1512871

(151) 2019 07 05

(891) 2019 07 05

(731) Gazer Limited

Las Suite, 5 Percy Street, London W1T 1DG,
United Kingdom

(540)



(591) Black, white

(531) 26.01.03; 26.01.18; 26.01.24; 27.05.09;
27.05.10; 27.05.11

(511)

9 – Anti-theft warning apparatus for vehicles; audio- and videoreceivers for vehicles; automatic indicators of low pressure in vehicle tyres; batteries, electric; batteries, electric, for vehicles; cameras only for vehicles use, specifically: dash cameras and backup cameras; backup cameras for vehicles; backup cameras for vehicles; chargers for electric accumulators; chargers for electronic cigarettes; computer programs, recorded for vehicles; computer software applications, downloadable for vehicles; computer software, recorded for vehicles; control panels [electricity] for vehicle; electric wire harnesses for automobiles; electronic access control systems for interlocking doors for vehicles; electronic key fobs being remote control apparatus; electronic numeric displays for vehicles; electronic pens [visual display units]; Global Positioning System [GPS] apparatus for vehicles; hands-free kits for telephones; igniting apparatus, electric, for igniting at a distance; interactive touch screen terminals for vehicles; intercommunication apparatus for vehicle; interfaces for computers for vehicles; joysticks for use with computers, other than for video games; mileage recorders for vehi-

les; mirrors for vehicles; monitoring apparatus for vehicles; monitors [computer programs] for vehicles; navigation apparatus for vehicles [on-board computers]; navigational instruments for vehicles; parking sensors for vehicles; projection screens; remote control apparatus for vehicles; satellite navigational apparatus; simulators for the steering and control of vehicles; sirens for vehicles; speed checking apparatus for vehicles; speed indicators for vehicles; television apparatus; thermostats for vehicles; transmitters of electronic signals for vehicles; vehicle breakdown warning triangles; vehicle radios.

(260) AM 2020 107006 A

(800) 1513101

(151) 2019 06 20

(891) 2019 06 20

(731) Aebi Schmidt Holding AG

Schulstrasse 4, CH-8500 Frauenfeld, Switzerland

(540)



(591) Red

(531) 26.03.23; 26.11.09; 29.01.01

(511)

7 – Suction machines for industrial use; sweeping machines, sprayers, spreaders or clearing machines as attached, carried or interchangeable equipment for vehicles; Hydraulic and pneumatic drives for machines, motors and engines; agricultural implements mounted on trailers (other than hand-operated); sprayers or spreaders or cleaning or clearing machines mountable on vehicles or trailers; road sweeping machines mounted on vehicles; automatic cleaning machines; construction machines (road building); floor scrubbing machines; brushes [parts of machines]; brush sweeping machines; electric vacuum cleaning apparatus [for industrial use]; electric brushes; electric floor sweeping machines; electric floor cleaning apparatus; electric machines for floor care by cleaning, polishing, scouring, vacuuming; electric cleaning machines; electric vacuum cleaning machines; electric vacuum cleaners; dust removing installations for cleaning purposes; mobile machines, in particular motor-driven agricultural mowers, road swe-

eping machines, sowers, road construction machines, snowblowers, snow plows and multi-use machines, fertilizer spreaders, sprayers, sand turbines, sand blowers, sand blower turbines, in so far as included in the class; transmissions, other than for land vehicles; belts for conveyors; transport devices for dry and wet salt, de-icing preparations; road sweeping machines, sowers, road construction machines, snowblowers, snow plows and multi-purpose machines, fertilizer spreaders, sprayers, sand turbines, sand blowers, sand blower turbines, in so far as included in the class; elevating apparatus; lifting apparatus; sweeping machines; power transmission mechanisms for machines; power transmission devices for machines; couplings; harvesting machines; mechanical spreaders; feeders [parts of machines]; mixing machines; mixers [machines]; lawnmowers; clearers; cleaning apparatus [machines] with brushes; cleaning machines; cleaning machines for industrial purposes; cleaning machines and apparatus [electric]; air suction machines; suction machines for industrial use; agricultural implements other than hand-operated, suction and combined machines and hay distributors, hay aeration installations; snow blowing accessories for vehicles; snow throwers; vehicled snow throwers; snow removal apparatus; snow throwers; sprayers, sprayers for liquid media, in particular for use against black ice (other than hand-operated); control apparatus for machines, motors or engines; road sweeping machines, sowers; road sweepers [machines]; road sweeping machines [self-propelled]; sweeping machines [self-propelled]; spreaders/spreading machines; transmissions for vehicles, other than for land vehicles; shredders [machines] for industrial use; sweeping vehicles; snow plow vehicles; spreader vehicles; rammers; sprayers [machines].

9 – Dosage dispensers; electronic control systems for dosage and distribution spreading product; electronic control for unmanned vehicles; navigation apparatus; positioning apparatus; marking apparatus; computer software for data warehousing automation; black boxes (data recorders); data recorders; sensors for detecting data of machines, machine installations and vehicles; electric control, testing and monitoring devices; software.

12 – Trailers [vehicles]; trailer vehicles; drive gears [parts for land vehicles]; electric motors for land vehicles; attached or carried equipment adapted to

vehicles; attached or carried equipment adapted to utility vehicles; vehicle chassis; electric vehicles; undercarriages for vehicles; vehicles; transport vehicles for industrial use; vehicles, namely, vehicles for agricultural, forestry and municipal transport; vehicles equipped with bucket loaders; vehicles equipped with loading apparatus; vehicles equipped with lifting apparatus; vehicles equipped with prehensile apparatus; vehicles for emptying loads; bodies for vehicles; gear boxes for land vehicles; hydraulic circuits for vehicles; bodies for land vehicles; boxes, tilting-carts; dumping trucks; automobiles; housings for parts of land vehicles, except for motors and engines; land vehicles for industrial use; tipping bodies for trucks; multi-purpose trolleys; multi-use work vehicles, in particular apparatus mounts; garbage collection vehicles; utility vehicles; sprinkling trucks [street cleaning]; street cleaning vehicles; treads for vehicles [tractor type]; driving chains for land vehicles; tractors; cars; undercarriages for vehicles; railway freight cars; attached equipment for railway vehicles; attached equipment for railway freight cars; self-driving cars.

35 – Window display decoration services for advertising purposes; commercial business conduct advice; providing information and consulting services relating to e-commerce; procurement services for others [purchasing goods and services for other businesses]; operation of an import-export agency; wholesale and retail commerce, also via the global computer network, in particular for vehicles, utility vehicles, tractors, vehicle parts, trailers, attached parts, carried parts, accessories, spare parts, devices, apparatus machines (whether hand-operated or otherwise); services in the field of electronic commerce, namely, the contract mediation for purchase and sale of goods online; services in the field of electronic commerce, namely, advertising via computer networks in the nature of data, texts, images, sound or any combination thereof for sale of goods and services of all types; services in the field of electronic commerce, namely, provision of information on goods via telecommunication networks for advertising and sales purposes; online provision of information concerning the selection of goods via the global computer network; presentation and preparation of various offers of goods and services via global electronic computer networks (the Internet), enabling consumers to conveniently view, compare and pur-

chase aforesaid goods and services; development and implementation of marketing strategies for others; analysis, research and information for business, preparing feasibility studies, development, management of projects on special vehicles and special railway vehicles.

36 – Financial services; financial advice; providing of know-how with respect to finance (financial advice); building management; real estate management; lease-purchase financing.

37 – Servicing, maintenance and repair of vehicles and vehicle parts; rental of construction machines, in particular road sweeping machines, self-propelled sweeping machines, road construction machines, snow blowers, snow plows; rental of sprayers for maintenance and servicing of roads, roadways and aircraft take-off and landing runways; advice in the field of cleaning, servicing and maintenance of machines and vehicles; consultancy services in the field of cleaning, servicing and maintenance of roads, roadways and aircraft take-off and landing runways; providing equipment for retrofitting and renovation of machines and vehicles; customized renovation of vehicles and components thereof; advice with respect to installation, maintenance, repair of hydraulic apparatus; installation, maintenance and repair of lighting systems; installation, maintenance and repair of control systems.

42 – Design and development of central database optimized for analysis; technical product development; technological consultancy services; technical design and management of special vehicles and special railway vehicles; technical design and management of hydraulic installations; technical design and management of lighting systems; technical design and management of control systems; technical design and management of de-icing systems; development of computer programs; development of web data mining applications; creation of programs for electronic data processing; analysis of computer systems; technological consultancy services in relation to the use of equipment and vehicles, in particular in the field of agriculture, horticulture and forestry and in the municipal field for sweeping, spraying, spreading or clearing.

45 – Management and licensing of intellectual property.

(260) AM 2020 107007 A

(800) 1513108

(151) 2019 12 17

(891) 2019 12 17

(731) Aktsionernoe obshchestvo "Essen production AG"

Avtozavodsky district, New Passage 3, of. 95, RU-445037 Tolyatti, Samara Region, Russian Federation

(540)



(591) Red, white, beige, green, dark green, yellow

(531) 05.03.13; 05.07.09; 25.01.09; 28.05; 29.01.15

(526) The word "Jam", the naturalistic image of berries, element ®

(511)

29 – Jams.

(260) AM 2020 107026 A

(800) 1438256

(151) 2018 05 21

(891) 2019 12 26

(731) Obschestvo s ogranichennoi
otvetstvennostyu

"NAUCHNO-PROIZVODSTVENNAYA
FIRMA "MATERIA MEDICA HOLDING"
Trety Samotchny pereulok, 9, RU-127473
Moscow, Russian Federation

(540)

РИНИВИР

(591) Black, white

(531) 28.05

(511)

5 – Pharmaceuticals, medical and veterinary preparations; sanitary preparations for medical purposes; dietetic food and substances adapted for medical or veterinary use, food for babies; dietary supplements for humans and animals; disinfectants; preparations for the prevention and treatment of inflammation and inflammatory diseases, respira-

tory and infectious diseases, immunological, bacterial, viral and fungal infections, herpes infections; preparations based on antibodies; preparations based on antibodies, including preparations for the prevention and treatment of inflammation and inflammatory diseases, respiratory and infectious diseases, immunological, bacterial, viral and fungal infections, herpes infections; drugs for the treatment of influenza; preparations based on antibodies for the treatment of influenza; immunomodulators; antimutagenic drugs; disinfectants for hygienic purposes, including for the control of microorganisms that cause human infectious diseases; plasters, materials for dressings; material for stopping teeth, dental wax; preparations for destroying vermin; fungicides, herbicides; acaricides; aconitine; alkaloids for medical purposes; alginates for pharmaceutical purposes; algicides; aldehydes for pharmaceutical purposes; dental amalgams of gold; dental amalgams; amino acids for veterinary purposes; amino acids for medical purposes; analgesics; anaesthetics; antibiotics; antiseptics; medicine cases, portable, filled; first-aid boxes, filled; aluminium acetate for pharmaceutical purposes; acetates for pharmaceutical purposes; germicides; balms for medical purposes; bandages for dressings; diagnostic biomarker reagents for medical purposes; biocides; bromine for pharmaceutical purposes; paper for mustard plasters; fly catching paper; reagent paper for veterinary purposes; reagent paper for medical purposes; moth-proofing paper; petroleum jelly for medical purposes; vaccines; oxygen baths; antiseptic cotton; aseptic cotton; absorbent cotton; wadding for medical purposes; cotton for medical purposes; dietetic substances adapted for medical use; radiological contrast substances for medical purposes; nutritive substances for microorganisms; radioactive substances for medical purposes; bismuth subnitrate for pharmaceutical purposes; melissa water for pharmaceutical purposes; sea water for medicinal bathing; mineral waters for medical purposes; thermal water; dietary fiber; molding wax for dentists; gases for medical purposes; guaiacol for pharmaceutical purposes; sexual stimulant gels; hematogen; hemoglobin; hydrastine; hydrastinine; glycerine for medical purposes; glycerophosphates; glucose for medical purposes; gentian for pharmaceutical purposes; hormones for medical purposes; mustard for pharmaceutical purposes; mustard plasters; mud for baths; medicinal mud; gamboge

for medical purposes; gurjun balsam for medical purposes; air deodorising preparations; deodorants, other than for human beings or for animals; deodorants for clothing and textiles; diastase for medical purposes; digitalin; mineral food supplements; nutritional supplements; albumin dietary supplements; dietary supplements for animals; yeast dietary supplements; alginate dietary supplements; glucose dietary supplements; casein dietary supplements; lecithin dietary supplements; linseed oil dietary supplements; propolis dietary supplements; protein supplements for animals; protein dietary supplements; royal jelly dietary supplements; pollen dietary supplements; wheat germ dietary supplements; linseed dietary supplements; enzyme dietary supplements; yeast for pharmaceutical purposes; gelatine for medical purposes; cod liver oil; isotopes for medical purposes; immunostimulants; insecticides; iodine for pharmaceutical purposes; iodides for pharmaceutical purposes; alkaline iodides for pharmaceutical purposes; iodoform; calomel [fungicide]; cream of tartar for pharmaceutical purposes; tartar for pharmaceutical purposes; camphor for medical purposes; cachets for pharmaceutical purposes; hemostatic pencils; capsules for medicines; wart pencils; caustic pencils; carbolineum [parasiticide]; caustics for pharmaceutical purposes; cachou for pharmaceutical purposes; quassia for medical purposes; quebracho for medical purposes; oxygen for medical purposes; gallic acid for pharmaceutical purposes; acids for pharmaceutical purposes; adhesives for dentures; surgical glues; stem cells for veterinary purposes; stem cells for medical purposes; cocaine; collagen for medical purposes; collodion for pharmaceutical purposes; corn rings for the feet; candy, medicated; angostura bark for medical purposes; barks for pharmaceutical purposes; cedar wood for use as an insect repellent; condurango bark for medical purposes; croton bark; mangrove bark for pharmaceutical purposes; myrobalan bark for pharmaceutical purposes; quinquina for medical purposes; medicated animal feed; medicinal roots; rhubarb roots for pharmaceutical purposes; lint for medical purposes; starch for dietetic or pharmaceutical purposes; creosote for pharmaceutical purposes; blood for medical purposes; cultures of microorganisms for medical or veterinary use; dental lacquer; liquorice for pharmaceutical purposes; lactose for pharmaceutical purposes; candy for medical purposes; adhesive plasters; medicines for alleviating constipa-

tion; adhesive tapes for medical purposes; lecithin for medical purposes; lotions for veterinary purposes; medicated hair lotions; lotions for pharmaceutical purposes; magnesia for pharmaceutical purposes; liniments; ointments for pharmaceutical purposes; sunburn ointments; mercurial ointments; frostbite salve for pharmaceutical purposes; gauze for dressings; medicinal oils; mustard oil for medical purposes; camphor oil for medical purposes; castor oil for medical purposes; oil of turpentine for pharmaceutical purposes; dill oil for medical purposes; dental mastics; dental abrasives; dental impression materials; teeth filling material; dressings, medical; surgical dressings; drugs for medical purposes; medicines for veterinary purposes; serotherapeutic medicines; medicines for human purposes; medicines for dental purposes; menthol; medicinal drinks; moleskin for medical purposes; almond milk for pharmaceutical purposes; powdered milk for babies; royal jelly for pharmaceutical purposes; milk ferments for pharmaceutical purposes; Irish moss for medical purposes; flour for pharmaceutical purposes; linseed meal for pharmaceutical purposes; fish meal for pharmaceutical purposes; fly glue; antibacterial soap; disinfectant soap; medicated soap; freeze-dried meat adapted for medical purposes; mint for pharmaceutical purposes; dietetic beverages adapted for medical purposes; malted milk beverages for medical purposes; medicinal infusions; tincture of iodine; eucalyptol for pharmaceutical purposes; tinctures for medical purposes; opium; opodeldoc; decoctions for pharmaceutical purposes; antiparasitic collars for animals; cotton sticks for medical purposes; stick liquorice for pharmaceutical purposes; sulfur sticks [disinfectants]; pastilles for pharmaceutical purposes; medicated dentifrices; pectin for pharmaceutical purposes; pepsins for pharmaceutical purposes; peptones for pharmaceutical purposes; hydrogen peroxide for medical purposes; pesticides; leeches for medical purposes; blood plasma; eyepatches for medical purposes; poultices; compresses; scapulars for surgical purposes; babies' diapers; diapers for pets; diapers for incontinent; bunion pads; breast-nursing pads; pomades for medical purposes; powder of cantharides; pyrethrum powder; anti-uric preparations; bacterial preparations for medical and veterinary use; bacteriological preparations for medical and veterinary use; balsamic preparations for medical purposes; albuminous preparations for medical purposes;

biological preparations for veterinary purposes; veterinary preparations; bismuth preparations for pharmaceutical purposes; vitamin preparations; diagnostic preparations for medical purposes; bath preparations for medical purposes; therapeutic preparations for the bath; hemorrhoid preparations; preparations for callouses; lice treatment preparations [pediculicides]; acne treatment preparations; preparations to facilitate teething; preparations for the treatment of burns; fumigation preparations for medical purposes; opotherapy preparations; air purifying preparations; bronchodilating preparations; preparations for reducing sexual activity; soil-sterilising preparations; sterilising preparations; corn remedies; pharmaceutical preparations for treating dandruff; preparations for destroying noxious animals; herbicides; preparations for destroying dry rot fungus; larvae exterminating preparations; fly destroying preparations; preparations for destroying mice; slug exterminating preparations; vermin destroying preparations; pharmaceutical preparations for skin care; contact lens cleaning preparations; preparations of microorganisms for medical or veterinary use; lime-based pharmaceutical preparations; medicated eye-washes; medicinal hair growth preparations; nutraceutical preparations for therapeutic or medical purposes; opiates; anticryptogamic preparations; aloe vera preparations for pharmaceutical purposes; preparations of trace elements for human and animal use; sulfonamides [medicines]; pharmaceutical preparations; pharmaceutical preparations for treating sunburn; enzyme preparations for veterinary purposes; enzyme preparations for medical purposes; phytotherapy preparations for medical purposes; chemico-pharmaceutical preparations; chemical preparations for veterinary purposes; chemical preparations for the diagnosis of pregnancy; chemical preparations for medical purposes; chemical preparations to treat wheat blight; vine disease treating chemicals; chemical preparations to treat mildew; chemical preparations for treating phylloxera; chemical preparations for pharmaceutical purposes; chilblain preparations; mothproofing preparations; collyrium; lead water; chemical conductors for electrocardiograph electrodes; albuminous foodstuffs for medical purposes; dietetic foods adapted for medical purposes; by-products of the processing of cereals for dietetic or medical purposes; homogenized food adapted for medical purposes; freeze-dried food ada-

pted for medical purposes; pharmaceuticals; sanitary towels; panty liners [sanitary]; propolis for pharmaceutical purposes; pearl powder for medical purposes; radium for medical purposes; hydrated chloral for pharmaceutical purposes; solvents for removing adhesive plasters; vaginal washes for medical purposes; solutions for contact lenses; chemical reagents for medical or veterinary purposes; gum for medical purposes; rubber for dental purposes; chewing gum for medical purposes; insect repellents; insect repellent incense; repellents for dogs; tissues impregnated with pharmaceutical lotions; sarsaparilla for medical purposes; sugar for medical purposes; asthmatic tea; fumigating sticks; suppositories; linseed for pharmaceutical purposes; tobacco-free cigarettes for medical purposes; siccatives [drying agents] for medical purposes; syrups for pharmaceutical purposes; turpentine for pharmaceutical purposes; milking grease; greases for veterinary purposes; greases for medical purposes; lacteal flour for babies; infant formula; soporifics; bicarbonate of soda for pharmaceutical purposes; bath salts for medical purposes; salts for mineral water baths; salts for medical purposes; potassium salts for medical purposes; sodium salts for medical purposes; smelling salts; mineral water salts; malt for pharmaceutical purposes; semen for artificial insemination; alcohol for pharmaceutical purposes; medicinal alcohol; alloys of precious metals for dental purposes; ergot for pharmaceutical purposes; cooling sprays for medical purposes; antibacterial handwashes; adjuvants for medical purposes; vermifuges; astringents for medical purposes; disinfectants for hygiene purposes; disinfectants for chemical toilets; douching preparations for medical purposes; appetite suppressants for medical purposes; medical preparations for slimming purposes; parasiticides; mouthwashes for medical purposes; febrifuges; depuratives; animal washes [insecticides]; detergents for medical purposes; cattle washes [insecticides]; dog washes [insecticides]; insecticidal veterinary washes; vesicants; purgatives; remedies for perspiration; remedies for foot perspiration; chemical contraceptives; antiparasitic preparations; sedatives; laxatives; tonics [medicines]; medicated toiletry preparations; digestives for pharmaceutical purposes; nervines; media for bacteriological cultures; steroids; strychnine; serums; tanning pills; appetite suppressant pills; slimming pills; antioxidant pills; jujube, medicated; sanitary tampons; vulnerary sponges; thy-

mol for pharmaceutical purposes; biological tissue cultures for veterinary purposes; biological tissue cultures for medical purposes; smoking herbs for medical purposes; medicinal herbs; transplants [living tissues]; surgical implants comprised of living tissues; pants, absorbent, for incontinents; sanitary panties; babies' diaper-pants; charcoal for pharmaceutical purposes; fennel for medical purposes; porcelain for dental prostheses; phenol for pharmaceutical purposes; enzymes for veterinary purposes; enzymes for medical purposes; ferments for pharmaceutical purposes; formic aldehyde for pharmaceutical purposes; phosphates for pharmaceutical purposes; quinine for medical purposes; chinoline for medical purposes; diabetic bread adapted for medical use; chloroform; flowers of sulfur for pharmaceutical purposes; cement for animal hooves; bone cement for surgical and orthopaedic purposes; dental cements; medicinal tea; herbal teas for medicinal purposes; insecticidal animal shampoo; medicated shampoos; medicated shampoos for pets; pediculicidal shampoos; medicated dry shampoos; pre-filled syringes for medical purposes; eucalyptus for pharmaceutical purposes; herbal extracts for medical purposes; plant extracts for pharmaceutical purposes; tobacco extracts [insecticides]; extracts of hops for pharmaceutical purposes; elixirs [pharmaceutical preparations]; ethers for pharmaceutical purposes; esters for pharmaceutical purposes; cellulose esters for pharmaceutical purposes; cellulose ethers for pharmaceutical purposes; rat poison; poisons; bacterial poisons; jalap.

(260) AM 2020 107027 A
 (800) 1446953
 (151) 2018 11 14
 (891) 2019 12 28
 (731) Puzenko Kyrylo Dmytrovych

prospekt Myru, 114, kv. 28, m. Mariupol,
 Donetsk obl. 87548, Ukraine

(540)



(591) Black, white

(531) 26.04.03; 26.04.16; 26.04.22; 27.05.01
(511)

43 – Food and drink catering; canteen services; café services; cafeteria services; restaurant services; self-service restaurant services; snack-bar services; rental of cooking apparatus; rental of transportable buildings; rental of chairs, tables, table linen, glassware; food sculpting; mobile restaurant services; take-away food services.

(260) AM 2020 107028 A

(800) 1510727

(151) 2019 11 07

(891) 2020 01 23

(731) BEL

2 allée de Longchamp, F-92150 SURESNES,
France

(540)



(591) Green – Pantone 360 C; Green – Pantone 561 C.

(531) 01.15.15; 04.05.05; 05.03.13; 05.03.14;
26.01.03; 26.01.15; 26.01.22; 26.01.24;
27.05.09; 29.01.12

(511)

29 – Eggs, milk (in all its forms), butter, cream, cheese and specialty cheese products, yogurts, lactic proteins and whey and other dairy products; milk-based beverages; preserved, dried, cooked, frozen and prepared fruits and vegetables; jellies, jams; compotes; fruit purée; marmalades; crystallized fruits; candied fruits; dried fruits; glazed fruits; fruit-based snack food; desiccated coconut; raisins; fruit peel; fruit salads, fruits in syrup; fruit pulp; fruit slices; fruit preserved in alcohol; fruit spreads; yogurts; drinking yogurts; fruit yogurts and flavored yogurts; stirred yogurts.

30 – Coffee; tea; cocoa; sugar; rice; tapioca; sago; coffee substitutes; flours; cereal preparations; bread; pastry; confectionery; edible ices; honey; golden syrup; salt; mustard; spices; ice for refreshment; gruel, with a milk base, for food; frozen yogurt [confectionery ices]; baking powder; yeast; vinegars; sauces [condiments].

35 – Sale of foodstuffs; retailing or wholesaling of eggs, milk [in all its forms], butter, cream, cheese and cheese specialties, yogurt, milk and whey proteins and other dairy products, milk-based beverages, preserved, dried, cooked, frozen and prepared fruit and vegetables, jellies, jams, compotes, fruit purees, marmalades, crystallized fruit, candied fruit, dried fruit, iced fruit, fruit-based snacks, dried coconut, raisins, fruit zests, fruit salads, fruit in syrup, fruit pulp, fruit slices, fruit preserved in alcohol, fruit spreads, yogurts, drinking yogurts, fruit yogurts and flavored yogurts, stirred yogurts, coffee, tea, cocoa, sugar, rice, tapioca, sago, coffee substitutes, flours, cereal-based preparations, bread, pastry, confectionery, edible ices, honey, golden syrup, salt, mustard, spices, ice for refreshment, milk-based porridge, frozen yogurt [ice cream], baking powder, yeast, vinegars, sauces [condiments]; advertising; advertising by mail order; radio and television advertising; advertising sponsorship; search for patrons (sponsors); commercial business management; promotional, marketing and advertising material dissemination (leaflets, printed matter, prospectuses, samples); distribution of goods for advertising and promotional purposes; sales promotion and commercial promotion; presentation of goods on all communication media, for retail sale; marketing; communication campaign organization and management (marketing); editing and publishing of commercial and/or advertising images, data and texts; business inquiries or information; public relations; business management assistance; management assistance for businesses or commercial functions in an industrial or commercial company; personnel management consultancy; market studies; opinion polling; online advertising on a computer network; rental of advertising time on all communication media; editing and publication of advertising texts; personnel recruitment; dissemination of advertisements; bill-posting; sponsoring (advertising).

(260) AM 2020 107069 A

(800) 1513400

(151) 2019 09 30

(891) 2019 09 30

(731) adp Gauselmann GmbH

Merkur-Allee 1-15, 32339 Espelkamp,
Germany

(540)

TRIMEXX

(591) Black, white

(511)

9 – Computer software; coin-operated mechanisms; computer and video game software; games software, in particular for use with computer platform, including electronic entertainment and games consoles; computer games programs; video games (software); computer games provided through a global computer network or supplied by means of multi-media electronic broadcast or through telecommunications or electronic transmission or via the internet; computer games, leisure and recreational software, video games and computer software, all being provided in the form of storage media; programs for operating electric and electronic apparatus for games, amusement and/or entertainment purposes; computer software for computer games on the internet; online games (software), in particular for online betting games, online prize games, online gambling games, online games of skill and online casino games; computer software in the form of an app for mobile devices and computers; calculating apparatus in coin-operated machines and parts for the aforesaid goods; electric, electronic, optical or automatic apparatus, for identifying data carriers, identity cards and credit cards, bank notes and coins; software in particular for casino and/or amusement arcades games, for gaming machines and/or slot machines each one with or without prize payouts; gaming software that generates or displays wager outcomes of gaming machines; operational computer games software; computer software for managing of games (games compilation); computer programs for video games; computer video game software.

28 – Games; toys; gaming apparatus (including coin-operated apparatus); coin-operated arcade games (machines); games for amusement arcades (included in this class); coin-operated video gaming apparatus; video games apparatus adapted for use with external screens or monitors only; casino fittings, namely roulette tables, roulette wheels; coin-operated automatic gaming machines and gaming machines, in particular for gaming arcades, with or without a prize payout; electronic or electrotechnical gaming apparatus, automatic gaming machines, gaming machines, slot machines opera-

ted by coins, tokens, banknotes, tickets or by means of electronic, magnetic or biometric storage media, in particular for commercial use in casinos and amusement arcades, with or without a prize payout; automatic gaming machines and gaming machines, in particular for commercial use in casinos and gaming arcades, with or without a prize payout; coin-operated gaming machines and/or electronic money-based gaming apparatus (machines), with or without prizes; housings adapted for gaming machines, gaming apparatus and automatic gaming machines, operated by means of coins, tokens, tickets or by means of electronic, magnetic or biometric storage media, in particular for commercial use in casinos and gaming arcades, with or without a prize payout; electronic games; electronic game entertainment apparatus and part thereof; video output game machines; drawing apparatus for prize games and lotteries, draws or raffles; housings of metal, plastic and/or wood adapted for coin-operated automatic amusement machines; apparatus for games (including video games), other than adapted for use with external screens or monitors only; electropneumatic and electric slot machines with pulling handles (games machines); gaming tables, in particular for table football, billiards, sliding games; flying discs (toys) and darts; gaming machines, namely electric, electronic or electromechanical apparatus for bingo games, lotteries or video lottery games and for betting offices, connected or unconnected to a computer network; LCD games consoles; automated gaming machines; all the aforesaid automatic machines operating in networks; apparatus and devices for accepting and storing money, being fittings for the aforesaid automatic machines, included in this class; automatic lottery machines.

(260) AM 2020 107070 A

(800) 1513421

(151) 2019 12 30

(891) 2019 12 30

(731) Onu Technology, Inc.

7280 Blue Hill Drive, Suite 10, San Jose
CA 95129, USA

(540)

CORONAI

(591) Black, white

(511)

9 – Computer software platforms for providing access to the internet; Downloadable cloud-computing software for providing computational resources to remote users; Downloadable cloud-computing software for requesting computational resources from remote users.

36 – Currency exchange services; Electronic financial trading services; Financial services, namely, providing a virtual currency for use by members of an on-line community via a global computer network; Financial services, namely, providing electronic transfer of a virtual currency for use by members of an on-line community via a global computer network; On-line real-time currency trading.

(260) AM 2020 107071 A

(800) 1513441

(151) 2019 10 09

(891) 2019 10 09

(731) Stastnik Gesellschaft m.b.H.

Erlaaerstraße 187, A-1230 Wien,

Austria

(540)



(591) Red, white

(531) 26.04.22; 27.05.24; 29.01.12

(511)

29 – Salami; meats; sausage meat; preserved sausages; sausages; pepperoni; kielbasa; smoked sausages; botifarra sausages; cured sausages; uncooked sausages; air-dried sausages; sausages; hot dog sausages; charcuterie; salted meats; salted meats; frozen meat products.

30 – Mustard; mustard powder for food; mustard powder [spice]; mustard preparations for food; sauces [condiments]; hot sauce; savory sauces, chutneys and pastes; seasonings.

43 – Hospitality services [food and drink]; services for providing food and drink.

(260) AM 2020 107072 A

(800) 1513469

(151) 2019 12 19

(891) 2019 12 19

(731) ALUCOIL, S.A.U.

Calle Ircio, s/n, Polígono Industrial, E-09200

Bayas Miranda de Ebro (Burgos), Spain

(540)



(591) Blue, red, yellow and white

(531) 26.04.03; 26.04.09; 27.05.09; 27.05.10;

27.05.17; 29.01.14

(511)

6 – Facades, roofs, panels and enclosures of metal.

(260) AM 2020 107073 A

(800) 1513506

(151) 2018 12 19

(891) 2018 12 19

(731) adp Gauselmann GmbH

Merkur-Allee 1-15, 32339 Espelkamp,

Germany

(540)

Wicked Temptations

(591) Black, white

(511)

9 – Computer software; coin-operated mechanisms; computer and video games software; games software in particular for use on any computer platform, including electronic entertainment and games consoles; computer game programs; video games (software); computer games provided through a global computer network or supplied by means of multi-media electronic broadcast or through telecommunications or electronic transmission or via the internet; computer games, leisure and recreational software, video games and computer software, all being provided in the form of storage media; programs for operating electric and electronic apparatus for games, amusement and/or entertainment purposes; computer software for computer games on the internet; online games (software), in particular for online betting games, online prize games, online gambling games, online games of skill and online casino games; computer

software in the form of an app for mobile devices and computers; calculating apparatus in coin-operated machines and parts for the aforesaid goods; electric, electronic, optical or automatic apparatus, for identifying data carriers, identity cards and credit cards, bank notes and coins; software in particular for casino and/or amusement arcade games, for gaming machines and/or slot machines each one with or without prize payouts; gaming software that generates or displays wager outcomes of gaming machines; operational computer games software; computer software for managing of games (game collection); collection of video games (terms considered too vague by the International Bureau – rule 13.2.b) of the Common Regulations); video game collections (terms considered too vague by the International Bureau – rule 13.2.b) of the Common Regulations).

28 – Games; toys; gaming apparatus (including coin-operated apparatus); coin-operated arcade games (machines); games for amusement arcades (included in this class); coin-operated video gaming apparatus; video games apparatus adapted for use with external screens or monitors only; casino fittings, namely roulette tables, roulette wheels; coin-operated automatic gaming machines and gaming machines, in particular for gaming arcades, with or without a prize payout; electronic or electrotechnical gaming apparatus, automatic gaming machines, gaming machines, slot machines operated by coins, tokens, banknotes, tickets or by means of electronic, magnetic or biometric storage media, in particular for commercial use in casinos and amusement arcades, with or without a prize payout; automatic gaming machines and gaming machines, in particular for commercial use in casinos and gaming arcades, with or without a prize payout; coin-operated gaming machines and/or electronic money-based gaming apparatus (machines), with or without prizes; housings adapted for gaming machines, gaming apparatus and automatic gaming machines, operated by means of coins, tokens, tickets or by means of electronic, magnetic or biometric storage media, in particular for commercial use in casinos and gaming arcades, with or without a prize payout; electronic games; electronic game entertainment apparatus and parts thereof; video output game machines; drawing apparatus for prize games and lotteries, draws or raffles; housings of metal, plastic and/or wood for coin-operated automatic machines; apparatus for

games (including video games), other than adapted for use with external screens or monitors only; electropneumatic and electric slot machines with pulling handles (gaming machines); gaming tables, in particular for table football, billiards, sliding games; flying discs (toys) and darts; gaming machines, namely electric, electronic or electromechanical apparatus for bingo games, lotteries or video lottery games and for betting offices, connected or unconnected to a computer network; LCD games consoles; automatic gaming machines; all the aforesaid automatic machines operating in networks; apparatus and devices for accepting and storing money, being fittings for the aforesaid automatic machines, included in this class; automatic lottery machines.

(260) AM 2020 107074 A

(800) 1513512

(151) 2019 10 02

(891) 2019 10 02

(731) Individual entrepreneur DAVYDOV
DMITRIY VIKTOROVICH

Orbita-2 microdistrict, 5, Bostandyk district,
050043 Almaty city, Kazakhstan

(540)



(591) Blue, white, gold, black and blue

(531) 26.04.05; 26.04.12; 26.04.18; 26.04.24;
26.11.01; 26.11.12; 29.01.13

(511)

41 – Entertainment services; sporting and cultural activities namely gambling services; providing entertainment services; online gambling services; providing casino facilities [gambling], betting and gambling services in connection with or relating to sports; game services provided by means of communications by computer terminals or cellular phone.

(260) AM 2020 107075 A
 (800) 1513523
 (151) 2019 11 20
 (891) 2019 11 20
 (731) DEVA HOLDING AŞ
 HALKALI MERKEZ MAH., BASIN
 EKSPRES CADDESİ., NO.1 KAT.5,
 KÜÇÜKÇEKMECE, TR-34303 İSTANBUL,
 Turkey
 (540)



(591) Black, white
 (531) 26.04.18
 (511)
 5 – Pharmaceuticals, medical and veterinary preparations; sanitary preparations for medical purposes; dietetic food and substances adapted for medical or veterinary use, food for babies; dietary supplements for human beings and animals; plasters, materials for dressings; material for stopping teeth, dental wax; disinfectants; preparations for destroying vermin; fungicides; herbicides.

(260) AM 2020 107089 A
 (800) 1514040
 (151) 2019 12 18
 (891) 2019 12 18
 (731) Open-Type Joint Stock Company
 "ROT FRONT"
 2-oy Novokuznetskiy pereulok, d. 13/15,
 RU-115184 g. Moscow, Russian Federation
 (540)

РОМАШКИ - ЛЮТИКИ

(591) Black, white
 (531) 28.05
 (511)
 30 – Confectionery; boiled sweets; sweetmeats [candy]; pralines; fondants [confectionery]; chocolate; pastries.

(260) AM 2020 107090 A
 (800) 1514043
 (151) 2019 11 27
 (891) 2019 11 27
 (731) Motorherz GmbH
 Immermannstraße 13, 40210 Düsseldorf,
 Germany
 (540)

KRAUF

(591) Black, white
 (511)
 7 – Pumps [machines]; pumps [parts of machines or engines]; vacuum pumps [machines]; self-regulating fuel pumps; starters for motors; power generators; electric generators.

35 – Procurement services for others [purchasing goods and services for other businesses]; sales promotion for others.

(260) AM 2020 107146 A
 (800) 1501333
 (151) 2019 10 17
 (891) 2020 01 17
 (731) "Fresh and Snack Company" Limited liability
 Company
 Lipitsy, 13, Serpuhovskiy district,
 RU-142261 Moscow region, Russian
 Federation
 (540)



(591) Black, white, beige and yellow
 (531) 03.04.04; 03.04.13; 03.04.24; 27.05.01;
 27.05.02; 27.05.03; 29.01.14
 (511)
 29 – Ajvar [preserved peppers]; aloe vera prepared for human consumption; alginates for culinary purposes; anchovy, not live; peanuts, prepared; artichokes, preserved; albumen for culinary purposes; white of eggs; beans, preserved; soya beans, preserved, for food; bouillon; ginger jam; ham; fatty substances for the manufacture of edible fats; laver, preserved; edible birds' nests; peas, preserved; mushrooms, preserved; guacamole [mashed avocado]; game, not live; gelatine; meat jellies; jellies for food; fruit jellies; yolk of eggs; coconut

fat; bone oil for food; lard; suet for food; edible fats; fruit-based snack food; milk substitutes; charcuterie; raisins; caviar; eggplant paste; vegetable marrow paste; fish roe, processed; yogurt; galbi [grilled meat dish]; sauerkraut; kephir [milk beverage]; kimchi [fermented vegetable dish]; isinglass for food; clams, not live; potato-based dumplings; klipfish [salted and dried cod]; milk shakes; black pudding; onion rings; arrangements of processed fruit; compotes; meat, tinned; vegetables, tinned; fish, tinned; fruits, tinned; bouillon concentrates; corn dogs; gherkins; shrimps, not live; prawns, not live; buttercream; croquettes; silkworm chrysalis for human consumption; sweet corn, processed; kumys [milk beverage]; spiny lobsters, not live; le-cithin for culinary purposes; salmon, not live; onions, preserved; margarine; marmalade; oils for food; peanut butter; cocoa butter for food; coconut oil for food; coconut butter; corn oil for food; sesame oil for food; linseed oil for food; extra virgin olive oil for food; olive oil for food; palm oil for food; palm kernel oil for food; sunflower oil for food; colza oil for food; butter; soya bean oil for food; shellfish, not live; almonds, ground; animal marrow for food; mussels, not live; milk; peanut milk; peanut milk for culinary purposes; coconut milk; coconut milk for culinary purposes; almond milk; almond milk for culinary purposes; oat milk; rice milk; rice milk for culinary purposes; albumin milk; condensed milk; soya milk; powdered milk; fish meal for human consumption; vegetable mousses; fish mousses; fruit pulp; meat; meat, preserved; freeze-dried meat; milk beverages, milk predominating; peanut milk-based beverages; coconut milk-based beverages; almond milk-based beverages; edible insects, not live; sausage casings, natural or artificial; vegetables, preserved; freeze-dried vegetables; vegetables, dried; vegetables, cooked; potato fritters; olives, preserved; lobsters, not live; flavored nuts; candied nuts; coconut, desiccated; nuts, prepared; tomato purée; pressed fruit paste; liver pâté; pectin for culinary purposes; liver; pickles; jams; powdered eggs; milk products; fish-based foodstuffs; prostokvasha [soured milk]; poultry, not live; bulgogi [Korean beef dish]; pollen prepared as foodstuff; cranberry compote; apple purée; crayfish, not live; crustaceans, not live; fish, preserved; fish, not live; salted fish; ryazhenka [fermented baked milk]; vegetable salads; fruit salads; bacon; sardines, not live; pork; herrings, not live; seeds, prepared; sunflower seeds, prepared;

cream [dairy products]; whipped cream; vegetable-based cream; fat-containing mixtures for bread slices; smetana [sour cream]; lemon juice for culinary purposes; tomato juice for cooking; vegetable juices for cooking; salted meats; sausages; sausages in batter; hot dog sausages; preparations for making bouillon; preparations for making soup; nut-based spreads; tripe; soups; vegetable soup preparations; whey; cheese; tajine [prepared meat, fish or vegetable dish]; tahini [sesame seed paste]; tofu; sea-cucumbers, not live; truffles, preserved; tuna, not live; oysters, not live; falafel; milk ferments for culinary purposes; rennet; dates; crystallized fruits; frozen fruits; fruit, preserved; fruit preserved in alcohol; fruit, stewed; hazelnuts, prepared; potato flakes; hummus [chickpea paste]; fruit peel; preserved garlic; lentils, preserved; potato chips; low-fat potato chips; fruit chips; vegetable chips; non-alcoholic eggnog; seaweed extracts for food; meat extracts; escamoles [edible ant larvae, prepared]; yuba [tofu skin]; berries, preserved; eggs; snail eggs for consumption; yakitori; soya patties; tofu patties; potato sticks.

30 – Vanilla flavorings for culinary purposes; flavorings, other than essential oils, for cakes; flavorings, other than essential oils, for beverages; coffee flavorings; food flavorings, other than essential oils; star aniseed; baozi [stuffed buns]; cereal bars; high-protein cereal bars; pancakes; noodle-based prepared meals; freeze-dried dishes with the main ingredient being pasta; freeze-dried dishes with the main ingredient being rice; buns; bulgur; bread rolls; edible rice paper; edible paper; vanillin [vanilla substitute]; vareniki [stuffed dumplings]; waffles; vermicelli [noodles]; natural sweeteners; sausage binding materials; binding agents for ice cream; sea water for cooking; seaweed [condiment]; malt biscuits; cloves [spice]; mirror icing [mirror glaze]; cake frosting [icing]; glucose for culinary purposes; mustard; croûtons; buckwheat, processed; gluten additives for culinary purposes; yeast; thickening agents for cooking foodstuffs; leaven; rice-based snack food; cereal-based snack food; artificial coffee; vegetal preparations for use as coffee substitutes; dressings for salad; zephyr [confectionery]; fruit jellies [confectionery]; candy decorations for cakes; confectionery for decorating Christmas trees; cakes; pastries; peanut confectionery; almond confectionery; pasta; ginger [spice]; frozen yogurt [confectionery ices]; cocoa; cream of tartar for culinary purposes; capers; caramels [can-

dy]; curry [spice]; ketchup [sauce]; gimbap [Korean rice dish]; kimchi jeon [fermented vegetable pancakes]; quinoa, processed; quiches; gluten prepared as foodstuff; flour-based dumplings; sweetmeats [candy]; liquorice [confectionery]; peppermint sweets; mints for breath freshening; dulce de leche; cinnamon [spice]; coffee; unroasted coffee; starch for food; crackers; custard; hominy grits; semolina; oatmeal; crushed barley; groats for human food; ice cubes; corn, milled; corn, roasted; meat pies; turmeric; couscous [semolina]; noodles; soba noodles; udon noodles; ice for refreshment; ice, natural or artificial; edible ices; candy; rice cakes; lomper [potato-based flatbread]; mayonnaise; macaroons [pastry]; macaroni; maltose; hominy; piccalilli; marinades; marzipan; honey; royal jelly; ice cream; bean meal; buckwheat flour; tapioca flour; potato flour; corn flour; nut flours; flour; wheat flour; soya flour; barley meal; dessert mousses [confectionery]; chocolate mousses; muesli; mint for confectionery; cocoa beverages with milk; coffee beverages with milk; coffee-based beverages; cocoa-based beverages; chamomile-based beverages; tea-based beverages; chocolate beverages with milk; chocolate-based beverages; infusions, not medicinal; crushed oats; husked oats; okonomiyaki [Japanese savory pancakes]; onigiri [rice balls]; nutmegs; chocolate-coated nuts; stick liquorice [confectionery]; soya bean paste [condiment]; pastila [confectionery]; pastilles [confectionery]; molasses for food; pâtés en croûte; pelmeni [dumplings stuffed with meat]; pepper; allspice; peppers [seasonings]; pesto [sauce]; cookies; petit-beurre biscuits; bibimbap [rice mixed with vegetables and beef]; pies; pizzas; meat gravies; fondants [confectionery]; popcorn; powders for making ice cream; baking powder; mustard meal; pralines; condiments; meat tenderizers for household purposes; cereal preparations; oat-based food; propolis; gingerbread; spices; petits fours [cakes]; rice pudding; puddings; cake powder; fruit coulis [sauces]; ravioli; ramen [Japanese noodle-based dish]; chewing gum; chewing gum for breath freshening; relish [condiment]; rice; instant rice; wheat germ for human consumption; spring rolls; sago; sugar; palm sugar; sesame seeds [seasonings]; linseed for culinary purposes [seasoning]; processed seeds for use as a seasoning; aniseed; agave syrup [natural sweetener]; golden syrup; confectionery; batter mixes for okonomiyaki [Japanese savory pancakes]; baking soda [bicarbonate of soda for cooking

purposes]; malt for human consumption; salt for preserving foodstuffs; cooking salt; celery salt; sherbets [ices]; ham glaze; cranberry sauce [condiment]; soya sauce; tomato sauce; apple sauce [condiment]; sauces [condiments]; pasta sauce; spaghetti; seasonings; chocolate-based spreads; chocolate spreads containing nuts; preparations for stiffening whipped cream; shaved ice with sweetened red beans; rusks; breadcrumbs; sushi; senbei [rice crackers]; sandwiches; tabbouleh; tacos; tapioca; tarts; dough; pastry dough; almond paste; rice pulp for culinary purposes; cake dough; garden herbs, preserved [seasonings]; chocolate decorations for cakes; vinegar; beer vinegar; ferments for pastes; halvah; bread; unleavened bread; chips [cereal products]; corn flakes; oat flakes; hot dog sandwiches; jiaozi [stuffed dumplings]; chicory [coffee substitute]; tea; iced tea; chutneys [condiments]; minced garlic [condiment]; cheeseburgers [sandwiches]; chow-chow [condiment]; saffron [seasoning]; chocolate; malt extract for food; essences for foodstuffs, except etheric essences and essential oils; husked barley; flowers or leaves for use as tea substitutes.

(260) AM 2020 107186 A

(800) 1514818

(151) 2019 11 21

(891) 2019 11 21

(731) DENK PHARMA GmbH & Co. KG

Prinzregentenstraße 79, 81675 München,
Germany

(540)

AXABAN-DENK

(591) Black, white

(511)

5 – Pharmaceutical and chemical products for medical purposes; preparations for medical purposes; dietetic substances adapted for medical use based on vitamins, minerals, trace elements, proteins and carbohydrates; food supplements for medical and non-medical purposes; dietetic products for non-medical purposes based on carbohydrates with added proteins, vitamins, minerals and trace elements.

35 – Wholesale and retail services in relation to pharmaceutical and chemical products for industrial, scientific, agricultural, horticultural and forestry purposes, in particular for the food, nutriti-

onal supplement, pharmaceutical and cosmetics industries; wholesale and retail services in relation to artificial sweeteners, dyes and colourants, plant extracts and plant oils for cosmetic purposes, chemical products for pharmaceutical and medical purposes, animal and plant oils and plant extracts for pharmaceutical and medical purposes, proteins for pharmaceutical and medical purposes, nutritional supplements for pharmaceutical and medical purposes, minerals and vitamins.

(260) AM 2020 107188 A
 (800) 1514820
 (151) 2019 12 16
 (891) 2019 12 16
 (731) Public Joint-Stock Company "RUSSKY PRODUCT"
 Moskovskaya str., 77, Detchino vlg.,
 Maloyaroslavetskiy region, RU-249080
 Kaluzhskaya area, Russian Federation

(540)

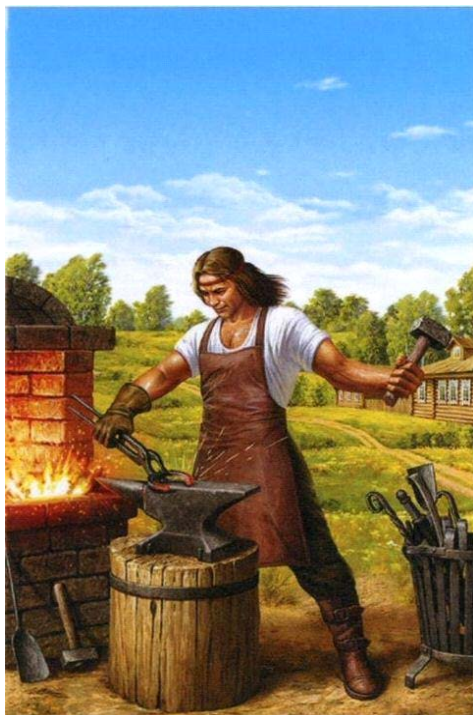

(591) Red, yellow, blue, white, light-green, green, orange, beige, brown, gray and black.
 (531) 02.01.15; 02.01.30; 06.19.16; 13.03.01; 13.03.02; 14.07.01; 14.07.04; 14.07.04; 14.07.07; 29.01.15
 (511)
 30 – Oatmeal; crushed barley; groats for human food; cereal preparations; oat-based food; chips [cereal products]; oat flakes.

(260) AM 2020 107189 A
 (800) 1514821
 (151) 2019 12 16
 (891) 2019 12 16
 (731) Public Joint-Stock Company "RUSSKY PRODUCT"
 Moskovskaya str., 77, Detchino vlg.,
 Maloyaroslavetskiy region, RU-249080
 Kaluzhskaya area, Russian Federation

(540)



(591) Red, yellow, dark-blue, blue, white, light-green, green, beige and brown
 (531) 02.03.12; 05.07.02; 05.07.05; 06.07.25; 06.19.11; 06.19.16; 29.01.15
 (511)
 30 – Oatmeal; crushed barley; groats for human food; cereal preparations; oat-based food; chips [cereal products]; oat flakes.

(260) AM 2020 107190 A
 (800) 1514822
 (151) 2019 12 16
 (891) 2019 12 16
 (731) Public Joint-Stock Company "RUSSKY PRODUCT"
 Moskovskaya str., 77, Detchino vlg.,
 Maloyaroslavetskiy region, RU-249080
 Kaluzhskaya area, Russian Federation

(540)



(591) Red, dark-blue, blue, white, light-green, green, orange, beige, brown, gray and black
 (531) 02.01.03; 02.05.03; 06.07.11; 07.01.03; 29.01.15
 (511)
 30 – Oatmeal; crushed barley; groats for human food; cereal preparations; oat-based food; chips [cereal products]; oat flakes.

(260) AM 2020 107191 A
 (800) 1514823
 (151) 2019 12 10
 (891) 2019 12 10
 (731) PLISSE' S.P.A.
 Via Ghebo 1, PIOMBINO DESE (PD), Italy

(540)



(591) Black, white
 (531) 26.11.02; 26.11.09; 27.05.21
 (511)
 18 – Leather and imitations of leather; animal skins and hides; luggage and carrying bags; umbrellas and parasols; walking sticks; whips, harness and saddlery; collars, leashes and clothing for animals; handbags; handbags for ladies; suitcases; pocket wallets; clutch bags; shoulder bags.
 25 – Clothing, footwear, headwear; sandals; hats; stockings; mittens; berets; sashes for wear; under-

wear; hosiery; skirts; trousers; coats; pelisses; jackets [clothing]; shirts; bathing suits; dresses; suits; overcoats; waistbands [parts of clothing]; shoulder wraps [clothing]; casual wear; neckerchiefs; Bermuda shorts; blousons.

(260) AM 2020 107193 A
 (800) 1514924
 (151) 2019 12 16
 (891) 2019 12 16
 (731) Public Joint-Stock Company "RUSSKY PRODUCT"
 Moskovskaya Str., 77, Detchino vlg., Maloyaroslavetskiy region, RU-249080 Kaluzhskaya area, Russian Federation

(540)



(591) Red, yellow, blue, dark-blue, lilac, white, light-green, green, orange, beige, brown and gray
 (531) 02.07.02; 02.07.04; 02.07.14; 06.19.09; 06.19.16; 14.09.07; 14.09.10; 19.01.12; 29.01.15
 (511)
 30 – Oatmeal; crushed barley; groats for human food; cereal preparations; oat-based food; chips [cereal products]; oat flakes.

(260) AM 2020 107194 A
 (800) 1514947
 (151) 2019 12 16
 (891) 2019 12 16
 (731) Public Joint-Stock Company "RUSSKY PRODUCT"

Moskovskaya Str, 77, Detchino vlg.,
Maloyaroslavetskiy region, RU-249080
Kaluzhskaya area, Russian Federation

(540)



(591) Red, dark-blue, blue, white, light-green,
green, orange, beige, brown, gray and black

(531) 02.03.17; 02.03.30; 02.05.03; 02.07.10;
03.07.24; 06.19.10; 06.19.16; 29.01.15

(511)

30 – Oatmeal; crushed barley; groats for human
food; cereal preparations; oat-based food; chips
[cereal products]; oat flakes.

(260) AM 2020 107195 A

(800) 1514981

(151) 2020 01 13

(891) 2020 01 13

(731) UNILUMIN GROUP CO., LTD

112 Yongfu Rd., Qiaotou Village, Fuyong
Town, Baoan District, 518000 Shenzhen,
Guangdong, China

(540)

Unilumin

(591) Black, white

(531) 27.05.01

(511)

9 – Neon signs; light dimmers [regulators], elec-
tric; electronic notice boards; control panels [elec-
tricity]; flashing lights (luminous signals); electro-
nic bulletin boards; phototube; traffic-light appa-
ratus [signalling devices]; fluorescent screens;
signs, luminous; LED display screens; signal lan-

terns; electronic indicator boards; semi-conductor
devices.

11 – Miners' lamps; spotlight; lamps; light diffu-
sers; lighting apparatus for vehicles; apparatus for
lighting; standard lamps; lighting apparatus and
installations; aquarium lights; diving lights; lights
for vehicles; light bulbs; luminous tubes for ligh-
ting; street lamps; apparatus for stage lighting; el-
ectric torches; fluorescent tube.

(260) AM 2020 107324 A

(800) 1516527

(151) 2019 12 18

(891) 2019 12 18

(731) URSA Salgótarján Glass Wool Close Co., Ltd.
Szépvölgyi út 41, 2/2, H-1037 BUDAPEST,
Hungary

(540)



(591) Blue, red, white

(531) 03.01.14; 03.01.24; 26.04.05; 26.04.15;
26.04.18; 27.05.01; 29.01.13

(511)

17 – Insulating, soundproofing and stopping mate-
rials; fabrics, felts, webs, plates, panels and sheets
for use as insulation material; rubber or plastics for
padding and stuffing; mineral wool, glass wool,
stone wool, rock wool, slag wool and fiber glass for
thermal or acoustic insulation; glass fibers for in-
sulation; slag wool, glass wool blankets and panels
for insulation; wood fiber, plastic insulation mate-
rials, especially foamed plastic materials; insulati-
on boards, made from polystyrene, especially ma-
de from extruded polystyrene; XPS (extruded po-
lystyrene) material for packing and stuffing; XPS
(extruded polystyrene) panels for insulation; plas-
tic film, other than for packaging purposes; subs-
tances for insulating buildings against moisture;
sealant compounds for joints; insulating paper, in-
sulating tape and band, rubber, gutta-percha, gum,
asbestos, mica; plastics in extruded form for use in
manufacture; packing materials, joint packaging
for flexible pipes; membranes and other materials

for air tightness and vapor barriers (membrane for moisture protection); vapor barriers; insulating adhesives for sealing and/or attaching or linking membranes of air tightness and/or vapor barriers (for moisture protection) to anything that has to pass through like carpentry, timber studs, tubes, chimney, parts used for ventilation, ducts; insulating adhesives, especially in the form of tapes to be used in combination with insulating material, like mineral wool and XPS (extruded polystyrene); adhesive tapes for industrial purposes; insulating material for buildings and/or to glass; mineral wool for insulation purposes together with respective fixing for fastening the insulation material and/or mineral wool to the construction of a building, namely warm frame construction, cold frame construction, wall/floor junction timber floor, cavity batts made of mineral fibers, pitched roof insulation, roof junctions for separating wall / attic space, roof junctions for separating wall / room in the roof.

19 – Building materials (non-metallic), including panels and sheets of mineral fibers (especially fiber glass) for buildings; ducts for air conditioning, self-bearing duct designs made from mineral wool especially glass fiber panels used for HVAC (heating, ventilation and air conditioning); mineral wool panels with woven or non-woven facings or coverings; non-metallic rigid pipes for building; asphalt, pitch and bitumen; non-metallic transportable buildings; monuments, not of metal, waterproofing claddings.

- (260) AM 2020 107325 A
- (800) 1516534
- (151) 2019 12 18
- (891) 2019 12 18
- (731) URSA Salgótarján Glass Wool Close Co., Ltd.
Szépvölgyi út 41, 2/2, H-1037 BUDAPEST,
Hungary
- (540)



- (591) Black, red, orange
- (531) 03.01.14; 03.01.24; 26.04.05; 26.04.18;
26.05.15; 27.05.01; 29.01.13

(511)
17 – Insulating, soundproofing and stopping materials; fabrics, felts, webs, plates, panels and sheets for use as insulation material; rubber or plastics for padding and stuffing; mineral wool, glass wool, stone wool, rock wool, slag wool and fiber glass for thermal or acoustic insulation; glass fibers for insulation; slag wool, glass wool blankets and panels for insulation; wood fiber, plastic insulation materials, especially foamed plastic materials; insulation boards, made from polystyrene, especially made from extruded polystyrene; XPS (extruded polystyrene) material for packing and stuffing; XPS (extruded polystyrene) panels for insulation; plastic film, other than for packaging purposes; substances for insulating buildings against moisture; sealant compounds for joints; insulating paper, insulating tape and band, rubber, gutta-percha, gum, asbestos, mica; plastics in extruded form for use in manufacture; packing materials, joint packaging for flexible pipes; membranes and other materials for air tightness and vapor barriers (membrane for moisture protection); vapor barriers; insulating adhesives for sealing and/or attaching or linking membranes of air tightness and/or vapor barriers (for moisture protection) to anything that has to pass through like carpentry, timber studs, tubes, chimney, parts used for ventilation, ducts; insulating adhesives, especially in the form of tapes to be used in combination with insulating material, like mineral wool and XPS (extruded polystyrene); adhesive tapes for industrial purposes; insulating material for buildings and/or to glass; mineral wool for insulation purposes together with respective fixing for fastening the insulation material and/or mineral wool to the construction of a building, namely warm frame construction, cold frame construction, wall/floor junction timber floor, cavity batts made of mineral fibers, pitched roof insulation, roof junctions for separating wall / attic space, roof junctions for separating wall / room in the roof.

19 – Building materials (non-metallic), including panels and sheets of mineral fibers (especially fiber glass) for buildings; ducts for air conditioning, self-bearing duct designs made from mineral wool especially glass fiber panels used for HVAC (heating, ventilation and air conditioning); mineral wool

panels with woven or non-woven facings or coverings; non-metallic rigid pipes for building; asphalt, pitch and bitumen; non-metallic transportable buildings; monuments, not of metal, waterproofing claddings.

(260) AM 2020 107327 A

(800) 1516539

(151) 2019 10 01

(891) 2019 10 01

(731) BIOMA SA

Via Luserte Sud 8, CH-6572 Quartino,
Switzerland

(540)

Bioma

(591) Black, white

(531) 27.03.01; 27.05.17

(511)

1 – Chemical or biological products for industry, agriculture, horticulture, forestry; compost; fertilizers; biological preparations intended for industry and science; food preserving agents; preserving agents for foodstuffs of animal origin; chemical additives for manufacture of foodstuffs for animals.

5 – Food supplements for domestic animals or for human consumption; food supplements; food supplements for animal husbandry.

31 – Food for animals.

44 – Services provided by consultants and provision of advice relating to agriculture, horticulture and forestry; advisory and consultancy services relating to weed, pest and vermin control in agriculture, horticulture and forestry.

(260) AM 2020 107419 A

(800) 1517896

(151) 2019 10 29

(891) 2019 10 29

(731) "HOLDING OF EMOTIONS "IFEST"

Limited

14 Rynok sq., Lviv 79008, Ukraine

(540)



(591) Red, green, beige, black, brown and pink

(531) 05.07.16; 25.01.01; 25.01.06; 28.05; 29.01.15

(511)

30 – Peanut confectionery; flavourings, other than essential oils, for beverages; food flavourings, other than essential oils; aromatic preparations for food; baozi [stuffed buns]; cereal bars; high-protein cereal bars; royal jelly; bibimbap [rice mixed with vegetables and beef]; bean meal; nut flours; buckwheat flour; tapioca flour; flour; bulgur; bread rolls; buns; burritos; vareniki [stuffed dumplings]; waffles; vermicelli [noodles]; flour-based dumplings; oatmeal; oat flakes; cookies; cake frosting [icing]; chocolate-coated nuts; dulce de leche; essences for foodstuffs, except etheric essences and essential oils; chewing gum for breath freshening; chewing gum; cranberry sauce [condiment]; custard; thickening agents for cooking foodstuffs; artificial coffee; frozen yoghurt [confectionery ices]; coffee; unroasted coffee; coffee flavourings; coffee beverages with milk; cocoa; caramels [candy]; potato flour; confectionery; confectionery for decorating Christmas trees; sugar confectionery; cinnamon [spice]; crackers; corn, milled; corn, roasted; corn flakes; noodles; mints for breath freshening; macaroni; pasta; macaroons [pastry]; honey; marzipan; honey; almond paste; almond confectionery; ice cream; dessert mousses [confectionery]; nutmegs; muesli; coffee-based beverages; cocoa-based beverages; chamomile-based beverages; tea-based beverages; chocolate-based beverages; infusions, not medicinal; processed seeds for use as a seasoning; crushed oats; husked oats; pastila [confectionery]; lozenges [confectionery]; pelmeni [dumplings stuffed with meat]; pies; pizzas; popcorn; powders for making ice cream; pralines; candy decorations for cakes; propolis; gingerbread; spices; puddings; cake powder; ravioli; malt for human consumption; sweetmeats [candy]; sherbets [ices]; spaghetti; chocolate-based spreads; chocolate spreads containing nuts; cakes; dough; cake batter; cake dough; pastry dough; tortillas; fruit jellies [confectionery]; halvah; edible ices; bread; pastries; candy; chocolate; chocolate beverages with milk; barley meal; crushed barley.

33 – Alcoholic beverages, except beer; alcoholic beverages containing fruit; anisette [liqueur]; anise [liqueur]; aperitifs; arrack [arak]; baijiu [Chinese distilled alcoholic beverage]; brandy; wine; whiskey; vodka; kirsch; perry; gin; digesters [liqueurs]

and spirits]; cocktails; curacao; liqueurs; hydromel [mead]; peppermint liqueurs; pre-mixed alcoholic beverages, other than beer-based; bitters; nira [sugarcane-based alcoholic beverage]; distilled beverages; piquette; rice alcohol; rum; sake; cider; spirits [beverages]; alcoholic extracts; alcoholic essences; fruit extracts, alcoholic.

35 – Administrative processing of purchase orders; administration of consumer loyalty programs; administration of frequent flyer programs; cost price analysis; business auditing; financial auditing; auctioneering; outsourced administrative management for companies; accounting; web indexing for commercial or advertising purposes; negotiation of business contracts for others; market studies; opinion polling; invoicing; arranging subscriptions to telecommunication services for others; payroll preparation; tax preparation; demonstration of goods; business inquiries; business management assistance; commercial or industrial management assistance; advisory services for business management; business research; economic forecasting; providing business information via a web site; compilation of information into computer databases; compilation of statistics; business information; business management of performing artists; business management for freelance service providers; business management of hotels; business management of reimbursement programs for others; interim business management; commercial information and advice for consumers in the choice of products and services; commercial administration of the licensing of the goods and services of others; computerized file management; personnel management consultancy; business management consultancy; consultancy regarding advertising communication strategies; consultancy regarding public relations communication strategies; business organization consultancy; marketing; marketing in the framework of software publishing; targeted marketing; marketing research; typing; provision of commercial and business contact information; provision of an online marketplace for buyers and sellers of goods and services; writing of curriculum vitae for others; writing of publicity texts; scriptwriting for advertising purposes; word processing; updating of advertising material; updating and maintenance of data in computer databases; updating and maintenance of information in registries; web site traffic optimization; organization of exhibitions for commercial or advertising purposes; orga-

nization of trade fairs for commercial or advertising purposes; rental of advertising space; shop window dressing; business appraisals; personnel recruitment; business management and organization consultancy; business intermediary services relating to the matching of potential private investors with entrepreneurs needing funding; commercial information agency services; employment agency services; business efficiency expert services; outsourcing services [business assistance]; business project management services for construction projects; competitive intelligence services; corporate communications services; layout services for advertising purposes; appointment reminder services [office functions]; price comparison services; relocation services for businesses; market intelligence services; procurement services for others [purchasing goods and services for other businesses]; media relations services; gift registry services; import-export agency services; modelling for advertising or sales promotion; advertising agency services; public relations; commercial lobbying services; commercial intermediation services; online retail services for downloadable digital music; data search in computer files for others; sponsorship search; search engine optimization for sales promotion; presentation of goods on communication media, for retail purposes; telephone answering for unavailable subscribers; rental of billboards [advertising boards]; office machines and equipment rental; rental of office equipment in co-working facilities; publicity material rental; rental of advertising time on communication media; rental of vending machines; rental of sales stands; direct mail advertising; publication of publicity texts; radio advertising; registration of written communications and data; advertising; pay per click advertising; outdoor advertising; advertising by mail order; online advertising on a computer network; document reproduction; bill-posting; distribution of samples; dissemination of advertising matter; design of advertising materials; business investigations; systemization of information into computer databases; drawing up of statements of accounts; compiling indexes of information for commercial or advertising purposes; sales promotion for others; promotion of goods and services through sponsorship of sports events; production of advertising films; production of teleshopping programs; transcription of communications [office functions]; television advertising; telemarketing

services; negotiation and conclusion of commercial transactions for third parties; professional business consultancy.

43 – Providing campground facilities; boarding house bookings; food and drink catering; information and advice in relation to the preparation of meals; rental of meeting rooms; rental of temporary accommodation; accommodation bureau services [hotels, boarding houses]; bar services; retirement home services; hotel services; day-nursery [crèche] services; canteen services; cafe services; cafeteria services; motel services; boarding house services; personal chef services; restaurant services; self-service restaurant services; washoku restaurant services; udon and soba restaurant services; snack-bar services; holiday camp services [lodging]; tourist home services; cake decorating; decorating of food; rental of tents; rental of cooking apparatus; rental of lighting apparatus; rental of transportable buildings; rental of chairs, tables, table linen, glassware; hotel reservations; temporary accommodation reservations; reception services for temporary accommodation [management of arrivals and departures]; food sculpting.

(260) AM 2020 107421 A

(800) 1518006

(151) 2019 09 30

(891) 2019 09 30

(731) SERHAT ALAN İTHALAT İHRACAT
TİCARET LİMİTED ŞİRKETİ
Turgut Özal Mah. 654.Sok., No:6 İnegöl,
Bursa, Turkey;
INEGOL ALAN MOBİLYA İNSAAT
SANAYİ VE TİCARET LİMİTED ŞİRKETİ
Mahmudiye Mah. Yeni San., 12.Sokak B3
Blok No:111 Inegöl, Bursa, Turkey

(540)



(591) Gold, black

(531) 27.05.09; 27.05.17; 29.01.12

(511)

20 – Furniture, made of any kind of material; mattresses; pillows; air mattresses and cushions, not

for medical purposes, water beds; mirrors; beehives, artificial honeycombs and sections of wood for honeycombs; bouncing chairs for babies, playpens for babies, cradles, infant walkers; display boards, frames for pictures and paintings, identification plates, identification tags, nameplates, identification labels made of wood or synthetic materials; packaging containers of wood or plastics, casks for use in transportation or storage, barrels, storage drums, tanks, boxes, storage containers, transportation containers, chests, loading pallets and closures for the aforementioned goods, of wood or plastics; small hardware goods of wood or synthetic materials included in this class, furniture fittings, of wood or synthetic materials, opening and closing mechanisms of wood or synthetic materials; ornaments and decorative goods of wood, cork, reed, cane, wicker, horn, bone, ivory, whalebone, shell, amber, mother-of-pearl, meerschaum, beeswax, plastic or plaster namely figurines, holiday ornaments for walls, sculptures, trophies; non-metal baskets, fishing baskets; kennels, nesting boxes and beds for household pets; portable ladders and mobile boarding stairs of wood or synthetic materials; bamboo curtains, roller indoor blinds [for interiors], slatted indoor blinds, strip curtains, bead curtains for decoration, curtain hooks, curtain rings, curtain tie-backs, curtain rods; non-metal wheel chocks.

(260) AM 2020 107423 A

(800) 1518079

(151) 2019 11 01

(891) 2019 11 01

(731) PT SOFTEX INDONESIA
Jl. Raya Serang Km. 7 Komp Industri Gajah,
Pasir Jaya, Kec. Jatiuwung, Kab Tangerang,
Banten, Indonesia

(540)



(591) Blue, white and pink

(531) 03.13.01; 27.05.01; 29.01.13

(511)

5 – Menstruation pads; menstruation tampons; sanitary napkins; sanitary pads; panty liners (sanitary).

(260) AM 2020 107427 A

(800) 1518163

(151) 2019 10 10

(891) 2019 10 10

(731) Plasson Ltd.

Maagan Michael, 37805 M.P. Menashe,

Israel

(540)



(591) Black, white

(531) 26.03.04; 26.04.11; 26.13.25; 27.05.01;

27.05.17

(511)

11 – Sanitary apparatus, faucets, draining lines, sinks, toilet bowls and seats, flushing cisterns, apparatus and parts for water supply and distribution and sanitary purposes, flushing apparatus, showerheads, apparatus for heating, apparatus for ventilating, lighting apparatus and installations, electric lighting fittings, indoor light fittings, environmental control apparatus for lighting purposes, environmental control apparatus for ventilation and heating purposes.

17 – Fittings, not of metal, for pipes; pipe fittings comprised primarily of plastic; couplings, connectors, connections, seals and muffs, not of metal, for pipes.

20 – Plastic valves for fluid piping systems.

21 – Water and feed accumulation bins for livestock, semi-automatic livestock drinking systems, semi-automatic livestock feeders, nipple drinking systems, automatic laying nest and cage systems.

(260) AM 2020 107428 A

(800) 1518178

(151) 2019 09 18

(891) 2019 09 18

(731) Krion Solid Surface, S.A.

Carretera Villarreal -, Puebla de Arenoso

(Cv-20), Km-1, E-12540 Villarreal,

Castellón, Spain

(540)



(591) Black, white

(531) 27.05.01

(511)

19 – Non-metallic building materials; non-metallic rigid pipes for building, asphalt, pitch, tar and bitumen; transportable buildings, not of metal; monuments, not of metal; glass doors and windows, glass panels; swimming pools (structures, not of metal); non-metallic floors; ceilings, not of metal.

20 – Furniture, mirrors, picture frames; containers not of metal for storage or transport; bone, horn, whalebone or mother-of-pearl, unwrought or semi-wrought; shells; meerschaum; yellow amber; counters (tables); dressers; Worktops; bathroom accessories in the form of furniture; locks and keys, not of metal; non-metallic accessories for doors, gates and windows; indoor blinds and accessories for curtains and indoor blinds; clothes stands; clothes hooks of non-metallic materials; containers, fasteners and accessories relating thereto, non-metallic; ladders and mobile ladders, not of metal; show cases, display stands and boards, non-metallic; street furniture, not of metal.

(260) AM 2020 107429 A

(800) 1518203

(151) 2019 10 04

(891) 2019 10 04

(731) KAR PORSELEN SANAYİ VE TİCARET

LİMİTED ŞİRKETİ

Akse Mah. 538 Sok. No:1, Çayırova /

KOCAELİ, Turkey

(540)



(591) Black, white

(531) 05.03.13; 26.01.03; 26.01.18; 26.04.05;

26.11.13; 27.05.07; 27.05.09; 27.05.10;

29.01.13

(511)

21 – Non-electric household or kitchen utensils, included in this class, [other than forks, knives, spoons], services [dishes], pots and pans, bottle openers, flower pots, drinking straws, non-electric cooking utensils; ornaments and decorative goods of glass, porcelain, earthenware or clay namely statues, figurines, vases, and trophies.

(260) AM 2020 107431 A
 (800) 1518267
 (151) 2020 02 01
 (891) 2020 02 01
 (731) Apple Inc.
 One Apple Park Way, Cupertino CA 95014,
 USA
 (540)

CRYPTOKIT

(591) Black, white
 (511)
 9 – Downloadable computer software used in de-
 veloping other software; downloadable application
 development software.

(260) AM 2020 107542 A
 (800) 1356943
 (151) 2016 11 15
 (891) 2020 01 21
 (731) DREAM FACTORY INC.
 Umeda Square Bldg. 16F, 1-12-17, Umeda,
 Kita-Ku, OSAKA-CITY, OSAKA 530-0001,
 Japan
 (540)



(591) Black, white
 (531) 26.02.05; 26.04.18; 26.11.01; 26.11.12;
 27.05.01
 (511)
 10 – Esthetic massage apparatus for commercial
 use; acupressure apparatus for industrial purposes;
 massage apparatus [for medical purposes]; acupre-
 ssure apparatus; medical apparatus and instru-
 ments [other than walking aids, crutches]; esthetic
 massage apparatus for household purposes; electric
 massage apparatus for household purposes; vibro-
 massage apparatus; back massage apparatus; body
 massagers; foot massage apparatus; neck massage
 apparatus.
 11 – Electric hot air hand dryers for household
 purpose; hair dryers; hair dryers for household
 purposes; facial saunas using ultrasonic waves for
 household purposes; facial saunas using ultrasonic
 waves for industrial purposes; electric facial saunas
 for household purposes; electric facial saunas for
 industrial purposes; electric pore suction facial

saunas for industrial purposes; facial steamers; fa-
 cial cleansing apparatus using ultrasonic waves for
 industrial purposes; electric apparatus for hair
 removal for use in beauty salons; portable electric
 foot baths; electric hair steamers for use in beauty
 salons; hair drying machines for beauty salon use;
 towel steamers for hair salons.

21 – Electric scalp cleansing brushes.

27 – Gymnastic mats.

28 – Training implements; sports equipment [ot-
 her than for climbing, surfing, water-skiing and
 scuba diving].

(260) AM 2020 107543 A
 (800) 1362620
 (151) 2017 05 05
 (891) 2020 01 30
 (731) Obshchestvo s ogranichennoy
 otvetstvennostyu "Black Star Foods"
 ulitsa Novyy Arbat, d.21, et. Cherdachnaya
 nadstroyka, pom. 1, kom. 38A, RU-119019
 Moscow, Russian Federation
 (540)



(591) Black, white
 (531) 08.01.04; 08.07.25; 27.05.24
 (511)
 43 – Services for providing food and drink, and
 temporary accommodation; accommodation bu-
 reau services [hotels, boarding houses]; rental of
 temporary accommodation; rental of meeting ro-
 oms; tourist home services; hotel reservations; bo-
 arding house bookings; temporary accommodation
 reservations; hotel services; retirement home ser-
 vices; snack-bar services; cafe services; cafeteria
 services; motel services; boarding house services;
 boarding for animals; rental of cooking apparatus;
 rental of chairs, tables, table linen, glassware; ren-
 tal of lighting apparatus; rental of tents; rental of
 transportable buildings; rental of drinking water

dispensers; restaurant services; self-service restaurant services; reception services for temporary accommodation [management of arrivals and departures]; food sculpting; canteen services; holiday camp services [lodging]; bar services; providing campground facilities; food and drink catering; washoku restaurant services; day-nursery [crèche] services.

(260) AM 2020 107544 A

(800) 1380445

(151) 2017 09 25

(891) 2020 01 30

(731) Obshchestvo s ogranichennoy otvetstvennostyu "Black Star Foods" ulitsa Novyy Arbat, d.21, et. cherdachnaya nadstroyka, pom. 1, kom. 38A, RU-119019 Moscow, Russian Federation

(540)

Black Star Burger Блэк Стар Бургер

(591) Black, white

(531) 28.05

(511)

43 – Accommodation bureau services [hotels, boarding houses]; rental of temporary accommodation; rental of meeting rooms; tourist home services; hotel reservations; boarding house bookings; temporary accommodation reservations; hotel services; retirement home services; snack-bar services; cafe services; cafeteria services; motel services; boarding house services; boarding for animals; rental of cooking apparatus; rental of chairs, tables, table linen, glassware; rental of lighting apparatus; rental of tents; rental of transportable buildings; rental of drinking water dispensers; restaurant services; self-service restaurant services; food sculpting; canteen services; holiday camp services [lodging]; bar services; providing campground facilities; food and drink catering; day-nursery [crèche] services; fast food restaurant services.

(260) AM 2020 107545 A

(800) 1401020

(151) 2017 11 07

(891) 2020 01 31

(731) Supercell Oy

Itämerenkatu 11, FI-00180 Helsinki, Finland

(540)

BRAWL STARS

(591) Black, white

(511)

9 – Computer software and computer game software; downloadable computer software and computer game software; data storage media; game software adapted for use with television receivers; pre-recorded motion picture, television, and animation films; bags, cases and sleeves for storing and carrying telephones, computers, headphones and cameras; covers for mobile phones, portable computers and tablets; headphones; downloadable publications; decorative magnets; memory sticks; straps for cameras; straps for telephones; straps specially adapted for headphones; straps for computer bags; electric power units.

16 – Paper and cardboard; comic books; newspapers, photographs, magazines, books, printed periodicals, newsletters, notebooks, and brochures; computer game instruction manuals; writing paper and envelopes; calendars; bookmarks; notebook and calendar covers; packing paper, wrapping paper and packaging materials; cardboard boxes; party decorations made of paper; pens, erasers; posters, paper banners; figures made of paper; paper bags; sticker albums, stickers; cards, post cards, collectable cards, trading cards; paper signs.

25 – Clothing, footwear, headgear; T-shirts, sweat shirts, shirts, blouses, vests; jeans, pants, shorts; underwear, sportswear; socks; coats, jackets, suits; skirts; scarves; gloves, mittens; bathing suits, pajamas, negligee robes, bathrobes; caps and hats.

28 – Electronic games; hand-held units for playing electronic games; action skill games; action figures as toys; toys, games and playthings; board games; game cards; play sets for action figures; game cards and playing cards; soft dolls; plush toys; stuffed toys, water toys, wooden toys, toys made of plastics; children's multiple activity toys; puzzles; balloons; bags, cases and sleeves for storing and carrying apparatus for games.

41 – Electronic game services provided by means of a global communication network; providing on-line computer games; on-line gaming services; providing on-line computer games, multi-player matching services, and on-line entertainment in the nature of tournaments, cyber or virtual sports

leagues and games shows; providing information on-line relating to computer games; provision of games by means of a computer based systems; providing interactive social games in a virtual environment; providing entertainment information relating to computer games via information network; entertainment services; sporting and cultural activities; providing on-line publications; presentation of movies, films, animations, and television programs; entertainment services in the nature of creation, development, and production of movies, films, animations, and television programs; organising events and conferences for entertainment purposes; organising of competitions; providing a web site featuring entertainment information relating to computer games; providing computer games and gaming services through an internet website portal; organising and conducting video and computer game matches and tournaments; organising of electronic sports events.

(260) AM 2020 107546 A

(800) 1465399

(151) 2019 01 14

(891) 2020 01 27

(731) KURRUK GROUP AYAKKABICILIK SAN. İÇ VE DIŞ TİC.LTD.ŞTİ
Sanayi Mahallesi, Cadde No:10/1,
Şehitkamil, TR-60278 Gaziantep, Turkey

(540)



(591) Blue

(531) 24.07.01; 24.07.23; 26.13.25; 27.05.01;

27.05.02; 27.05.03; 27.05.08; 29.01.13

(511)

25 – Clothing, including underwear and outerclothing, other than special purpose protective clothing; socks, mufflers (clothing), shawls, bandanas, scarves, belts (clothing), footwear, shoes, slippers, sandals, headgear, hats, caps with visors, berets, caps (headwear), skull caps.

35 – The bringing together, for the benefit of others, of a variety of goods, namely, clothing, including underwear and outerclothing, other than

special purpose protective clothing, socks, mufflers (clothing), shawls, bandanas, scarves, belts (clothing), footwear, shoes, slippers, sandals, headgear, hats, caps with visors, berets, caps (headwear), skull caps, enabling customers to conveniently view and purchase those goods, such services may be provided by retail stores, wholesale outlets, by means of electronic media or through mail order catalogues.

(260) AM 2020 107547 A

(800) 1517728

(151) 2020 02 03

(891) 2020 02 21

(731) Kerten Unlimited Company

13-18 City Quay, Dublin 2, Ireland

(540)

FOOD SOUK

(591) Black, white

(511)

43 – Provision of food and drink; temporary accommodation; café services; cafeteria services; restaurant services.

(260) AM 2020 107592 A

(800) 1520096

(151) 2020 02 17

(891) 2020 02 17

(731) CIMC ENRIC Investment Holdings

(Shenzhen) Company Limited

CIMC R&D Center 306, No.2 Gangwan

Avenue, Shekou Industrial Zone,

Shenzhen, 518000 GuangDong,

(540)

Enric 安瑞科

(591) Black, white

(531) 27.05.17; 28.03

(511)

12 – Vehicles for locomotion by land, air, water or rail; boats; motorcycles; trailers [vehicles]; motor cars; telpher railways [cable cars]; trolleys; anti-theft devices for vehicles; carts; automobile tyres.

(260) AM 2020 107603 A
 (800) 1520444
 (151) 2019 10 26
 (891) 2019 10 26
 (731) Kalaye Khane Paya Pars Co.
 78, 4th Str., Shahrak sanati J, Isfahan,
 Islamic Republic of Iran
 (540)

Ahmad



(591) Black, white
 (531) 27.05.01; 27.05.17; 28.01
 (511)
 21 – Flasks.

35 – Advertising; export agency services relating to flasks; retail and wholesale services relating to flasks.

(260 AM 2020 107635 A
 (800) 1521286
 (151) 2020 02 07
 (891) 2020 02 07
 (731) José Eisenberg
 24, avenue Princesse Grace, MC-98000
 Monte-Carlo, Monaco
 (540)

YOUTH A STATE OF MIND

(591) Black, white
 (511)
 3 – Non-medicated cosmetics; non-medicated soaps; soaps for cosmetic use; non-medicated body soaps; cosmetic preparations for baths; hair shampoos; non-medicated shampoos; perfumery preparations; perfumes; scented waters for cosmetic personal use; deodorants for cosmetic personal use; cosmetic skin care preparations; lotions for cosmetic use; beauty masks; skin whitening creams; cosmetic preparations for cleansing and removing make-up from the skin; oils for cosmetic use; cosmetic preparations for slimming; cosmetic skin-tanning preparations; make-up; lipsticks; lip glosses; pencils for cosmetic use; make-up; mascara for eyelashes; nail polish; make-up powders; facial foundation; non-medicated hair lotions; hair sprays.

(260) AM 2020 107640 A
 (800) 959852
 (151) 2008 02 20
 (891) 2019 10 29
 (731) PRIMÁTOR a.s.
 Dobrošovská 130, CZ-547 40 Náchod,
 Czech Republic
 (540)



(591) Black, red and white
 (531) 26.04.04; 26.04.07; 26.04.18; 27.05.03;
 27.05.10; 27.05.24; 29.01.13
 (511)
 32 – Beers.

(260) AM 2020 107642 A
 (800) 1126123
 (151) 2012 04 12
 (891) 2020 02 06
 (731) "Delta Medical Promotions AG"
 Oetenbachgasse 26, CH-8001 Zurich,
 Switzerland
 (540)

DermaPRO

(591) Black, white
 (531) 27.05.01; 27.05.10
 (511)
 5 – Dental abrasives; absorbent cotton; acaricides; acetates for pharmaceutical purposes; acids for pharmaceutical purposes; aconitine; adhesive bands for medical purposes; adhesive plaster; fly catching adhesives; adhesives for dentures; adjuvants for medical purposes; air deodorising preparations; air purifying preparations; albumin dietary supplements; albuminous foodstuffs for medical purposes; albuminous preparations for medical purposes; alcohol for pharmaceutical purposes; aldehydes for pharmaceutical purposes; algicides; alkaline iodides for pharmaceutical purposes; alkaloids for medical purposes; alloys of precious metals for dental purposes; milk of almonds for pharmaceutical purposes; aluminium acetate for pharmaceutical purposes; dental amalgams; amino acids for medical purposes; amino acids for veterinary purposes; anaesthetics; analgesics; angostura

bark for medical purposes; animal washes; anthelmintics; anti-rheumatism bracelets; anti-rheumatism rings; anti-uric preparations; antibiotics; anticryptogamic preparations; antiparasitic collars for animals; antiparasitic preparations; antiseptic cotton; antiseptics; appetite suppressants for medical purposes; aseptic cotton; asthmatic tea; bacterial poisons; bacterial preparations for medical and veterinary use; bouillons for bacteriological cultures; bacteriological preparations for medical and veterinary use; balms for medical purposes; balsamic preparations for medical purposes; hygienic bandages; menstruation bandages; bandages for dressings; barks for pharmaceutical purposes; therapeutic preparations for the bath; bath preparations, medicated; bath salts for medical purposes; oxygen baths; salts for mineral water baths; belts for sanitary napkins (towels); bicarbonate of soda for pharmaceutical purposes; biocides; biological preparations for medical purposes; biological preparations for veterinary purposes; bismuth preparations for pharmaceutical purposes; bismuth subnitrate for pharmaceutical purposes; blood for medical purposes; blood plasma; bone cement for surgical and orthopaedic purposes; bracelets for medical purposes; diabetic bread adapted for medical use; breast-nursing pads; bromine for pharmaceutical purposes; bronchodilating preparations; bunion pads; preparations for the treatment of burns; by-products of the processing of cereals for dietetic or medical purposes; cachets for pharmaceutical purposes; cachou for pharmaceutical purposes; preparations for callouses; calomel; camphor for medical purposes; camphor oil for medical purposes; candy for medical purposes; candy, medicated; powder of cantharides; capsules for medicines; carbolineum (parasiticide); castor oil for medical purposes; cattle washes; caustic pencils; caustics for pharmaceutical purposes; cedar wood for use as an insect repellent; cellulose esters for pharmaceutical purposes; cellulose ethers for pharmaceutical purposes; cement for animal hooves; charcoal for pharmaceutical purposes; chemical conductors for electrocardiograph electrodes; chemical preparations for medical purposes; chemical preparations for pharmaceutical purposes; chemical preparations for veterinary purposes; chemical reagents for medical or veterinary purposes; chemico-pharmaceutical preparations; chewing gum for medical purposes; chilblain preparations; chinoline for medical purposes; chloroform; tobacco-free cigarettes

for medical purposes; cinchona for medical purposes; contact lens cleaning preparations; deodorants for clothing and textiles; cocaine; cod liver oil; collodion for pharmaceutical purposes; compresses; condurango bark for medical purposes; medicines for alleviating constipation; solutions for use with contact lenses; chemical contraceptives; corn remedies; corn rings for the feet; cotton for medical purposes; cream of tartar for pharmaceutical purposes; creosote for pharmaceutical purposes; croton bark; cultures of microorganisms for medical and veterinary use; curare; pharmaceutical preparations for treating dandruff; decoctions for pharmaceutical purposes; dental cements; dental impression materials; dental lacquer; dental mastics; deodorants, other than for human beings or for animals; depuratives; detergents for medical purposes; chemical preparations for the diagnosis of pregnancy; diagnostic preparations for medical purposes; diastase for medical purposes; dietary supplements for animals; dietetic beverages adapted for medical purposes; dietetic foods adapted for medical purposes; dietetic substances adapted for medical use; digestives for pharmaceutical purposes; digitalin; dill oil for medical purposes; disinfectants for chemical toilets; disinfectants for hygiene purposes; dog lotions; dog washes; repellents for dogs; surgical dressings; dressings, medical; medicinal drinks; drugs for medical purposes; preparations for destroying dry rot fungus; elixirs (pharmaceutical preparations); enzyme preparations for medical purposes; enzyme preparations for veterinary purposes; enzymes for medical purposes; enzymes for veterinary purposes; ergot for pharmaceutical purposes; esters for pharmaceutical purposes; ethers for pharmaceutical purposes; eucalyptol for pharmaceutical purposes; eucalyptus for pharmaceutical purposes; evacuants; eye-washes; eye-patches for medical purposes; febrifuges; fennel for medical purposes; milk ferments for pharmaceutical purposes; ferments for pharmaceutical purposes; dietary fiber; first-aid boxes, filled; fish meal for pharmaceutical purposes; flaxseed for pharmaceutical purposes; flour for pharmaceutical purposes; flowers of sulphur for pharmaceutical purposes; fly catching paper; fly destroying preparations; food for babies; remedies for foot perspiration; formic aldehyde for pharmaceutical purposes; frost-bite salve for pharmaceutical purposes; fumigating pastilles; fumigation preparations for medical purposes; fungicides; gallic acid for pharmaceutical

purposes; gamboge for medical purposes; gases for medical purposes; gauze for dressings; gelatine for medical purposes; gentian for pharmaceutical purposes; germicides; glucose for medical purposes; glycerine for medical purposes; glycerophosphates; dental amalgams of gold; goulard water; greases for medical purposes; greases for veterinary purposes; guaiacol for pharmaceutical purposes; gum for medical purposes; gurjun (gurjon, gurjan) balsam for medical purposes; haematogen; haemoglobin; haemorrhoid preparations; haemostatic pencils; medicinal hair growth preparations; articles for headache; headache pencils; herbal teas for medicinal purposes; herbicides; medicinal herbs; smoking herbs for medical purposes; extracts of hops for pharmaceutical purposes; hormones for medical purposes; hydrastine; hydrastinine; hydrated chloral for pharmaceutical purposes; hydrogen peroxide for medical purposes; surgical implants (living tissues); insect repellent incense; napkins for incontinents; pants, absorbent, for incontinents; medicinal infusions; insect repellents; insecticides; semen for artificial insemination; iodides for pharmaceutical purposes; iodine for pharmaceutical purposes; iodoform; Irish moss for medical purposes; isotopes for medical purposes; jalap; petroleum jelly for medical purposes; jujube, medicated; menstruation knickers; lacteal flour for babies; lactose for pharmaceutical purposes; larvae exterminating preparations; laxatives; lecithin for medical purposes; leeches for medical purposes; preparations of lime for pharmaceutical purposes; liniments; lint for medical purposes; liquorice for pharmaceutical purposes; tissues impregnated with pharmaceutical lotions; lotions for pharmaceutical purposes; lotions for veterinary purposes; lozenges for pharmaceutical purposes; lupulin for pharmaceutical purposes; magnesia for pharmaceutical purposes; malt for pharmaceutical purposes; malted milk beverages for medical purposes; mangrove bark for pharmaceutical purposes; medicinal oils; medicinal roots; medicinal tea; medicine cases, portable, filled; medicines for dental purposes; medicines for human purposes; medicines for veterinary purposes; melissa water for pharmaceutical purposes; menstruation tampons; menthol; mercurial ointments; preparations for destroying mice; nutritive substances for microorganisms; chemical preparations to treat mildew; milking grease; mineral food supplements; mineral water salts; mineral waters for medical purposes; mint

for pharmaceutical purposes; molding wax for dentists; moleskin for medical purposes; mothproofing paper; mothproofing preparations; mouthwashes for medical purposes; medicinal mud; mud for baths; mustard for pharmaceutical purposes; mustard oil for medical purposes; mustard plasters; myrobalan bark for pharmaceutical purposes; narcotics; nervines; preparations for destroying noxious animals; nutritional supplements; oil of turpentine for pharmaceutical purposes; ointments for pharmaceutical purposes; opiates; opium; opodeldoc; opotherapy preparations; oxygen for medical purposes; panty liners (sanitary); paper for mustard plasters; parasiticides; pectin for pharmaceutical purposes; pepsins for pharmaceutical purposes; peptones for pharmaceutical purposes; pharmaceutical preparations; phenol for pharmaceutical purposes; phosphates for pharmaceutical purposes; chemical preparations for treating phylloxera; plasters for medical purposes; poisons; pomades for medical purposes; porcelain for dental prostheses; potassium salts for medical purposes; poultices; pyrethrum powder; quassia for medical purposes; quebracho for medical purposes; quinine for medical purposes; radioactive substances for medical purposes; radiological contrast substances for medical purposes; radium for medical purposes; rat poison; remedies for perspiration; rhubarb roots for pharmaceutical purposes; royal jelly dietary supplements; rubber for dental purposes; salts for medical purposes; sanitary napkins; sarsaparilla for medical purposes; scapulars for surgical purposes; sea water for medicinal bathing; sedatives; serotherapeutic medicines; serums; siccatives (drying agents) for medical purposes; pharmaceutical preparations for skin care; medical preparations for slimming purposes; slug exterminating preparations; smelling salts; sodium salts for medical purposes; soil-sterilising preparations; solvents for removing adhesive plasters; soporifics; starch for dietetic or pharmaceutical purposes; sterilising preparations; steroids; stick liquorice for pharmaceutical purposes; sulphur sticks (disinfectants); strychnine; styptic preparations; sugar for medical purposes; sulphonamides (medicines); sunburn ointments; sunburn preparations for pharmaceutical purposes; suppositories; surgical cloth (tissues); syrups for pharmaceutical purposes; tartar for pharmaceutical purposes; teeth filling material; preparations to facilitate teething; thermal water; thymol for pharmaceutical purposes; tincture of

iodine; tinctures for medical purposes; tobacco extracts (insecticides); tonics (medicines); preparations of trace elements for human and animal use; turpentine for pharmaceutical purposes; vaccines; vaginal washes; vermin destroying preparations; vesicants; veterinary preparations; vine disease treating chemicals; vitamin preparations; wadding for medical purposes; wart pencils; chemical preparations to treat wheat blight (smut); yeast dietary supplements; yeast for pharmaceutical purposes.

(260) AM 2020 107735 A

(800) 1522566

(151) 2020 01 08

(891) 2020 01 08

(731) EXENA SRL

Via Breda 7/A, I-62012 Civitanova Marche,
Italy

(540)



(591) Dark blue, grey, orange and white

(531) 26.04.02; 26.04.05; 26.04.22; 26.04.24;
27.05.09; 27.05.10; 29.01.14

(511)

9 – Protective helmets; fire alarms; gloves for protection against x-rays for industrial purposes; gloves for protection against accidents; safety restraints (other than for vehicle seats and sports equipment); bulletproof waistcoats; footwear for protection against accidents, radiation and fire; clothing for protection against fire; protective masks; spectacle cases; nets for protection against accidents; spectacles (optics); filters for respiratory masks; protective helmets; workmens protective face-shields; workmens protective face shields; visors; projection screens; smoke detectors; workmens protective face-shields; anti-dazzle shades; cathodic anti-corrosion devices; clothing for protection against accidents, irradiation and fire; respiratory masks (other than for artificial respiration); protective masks; protective devices for personal use against accidents; fire-extinguishing apparatus; safety clothing for protection against accident or injury; safety gloves for protection against

accident or injury; safety helmets; safety glasses for protecting the eyes.

25 – Clothing, footwear, headgear; socks; heelpieces for stockings; leather clothing; footwear; stockings; uniforms; sports shoes; overalls; gloves [clothing]; visors [headwear]; combinations [clothing]; wearing apparel; clothing of imitation leather; sandals; sweat-absorbent stockings; t-shirts; slippers; fittings of metal for footwear; heelpieces for footwear; ski boots; trousers; shoes; wooden shoes; footwear uppers; football shoes; soles for footwear; clothing; singlets; hosiery; uppers for footwear; sweat-absorbent underclothing (underwear); headgear; shirts; non-slip devices for footwear.

(260) AM 2020 107736 A

(800) 1522570

(151) 2019 10 28

(891) 2019 10 28

(731) SHANDONG CREATEK TECHNOLOGY
CO., LTD.

Room 508, No.7617 Airport Road, Hi-Tech
District, Ji'Nan, 250014 Shandong Province,
China

(540)

REZEME

(591) Black, white

(531) 27.05.17

(511)

7 – Clutches, other than for land vehicles; automobile oil pump; pistons for engines; engines, other than for land vehicles; triangle belts for conveyors of rubber; automobile motor piston; pumps [parts of machines, engines or motors]; engine bearings for vehicles; valves [parts of machines]; filters being parts of machines or engines.

12 – Engines for land vehicles; clutches for land vehicles; upholstery for vehicles; automobiles; bodies for vehicles; vehicle chassis; automobile tires; transmissions, for land vehicles; vehicles for locomotion by land, air, water or rail; electric vehicles.

(260) AM 2020 107737 A

(800) 1522584

(151) 2019 09 17

(891) 2019 09 17

(731) Obshchestvo s ogranichennoy
otvetstvennostyu "Upravlyayushchaya
kompaniya Miksit"
22-y km Kievskogo sh., p. Moskovskiy,
domovl. 4, str. 5, office 713-E, RU-125362
Moscow, Russian Federation

(540)

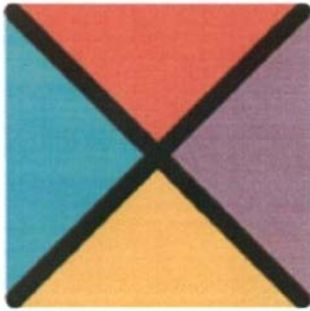

(591) Black, red, yellow, lilac and blue

(531) 25.05.03; 25.05.05; 25.05.06; 25.05.25;
26.03.04; 26.04.11; 29.01.15

(511)

3 – Abrasives; self-tanning preparations [cosmetic]; ambergris [perfume]; amber [perfume]; antiperspirants for personal use; air fragrancing preparations; cake flavorings [essential oils]; flavorings for beverages [essential oils]; flavorings and fragrances, except perfumes for personal use; scented pine cones; aromatics [essential oils]; breath freshening sprays; shaving balms; non-medicated lip balms; non-medicated cosmetic hair styling and care balms; balms, other than for medical purposes; after-shave balms; incense and incense cones; lip glosses; glitter for cosmetic purposes; face glitter; nail glitter; body glitter; abrasive paper; pre-moistened cosmetic tissues; emery paper; polishing paper; petroleum jelly for cosmetic purposes; hair care oil masks; body care oil masks; cotton wool for cosmetic purposes; all-purpose cotton sticks for personal use; food flavorings prepared from essential oils; fragrances for personal use; perfumes for industrial purposes; cleaners for cosmetic brushes; adhesives for cosmetic purposes; coloring preparations for cosmetic purposes; scented water; Javelle water; lavender water; scented linen water; eau de parfum; toilet water; bay leaves oil-based toilet water; toilet water containing snake oil; depilatory wax; mustache wax; hair wax; creams for leather; polishing wax; non-medicated anti-aging gels; shaving gel; bath and shower gels, not for medical purposes; hair gel; shower gel; sun tan gel; skin

gels for accelerating, enhancing or extending tan; gels for cosmetic use; massage gels, other than for medical purposes; sculpting gel; eye contour gels; make-up removing gels; non-medicated body soaks; hair styling gel; hair care gels; beauty gels; heliotropine; after-shave gel; after-sun gels [cosmetics]; moisturizing gels [cosmetic]; bath gel; dental bleaching gels; geraniol; cosmetic clay; polishes for leather; make-up; non-medicated lip protectors; scented body sprays; body deodorants [perfumery]; deodorants for personal use [perfumery]; deodorants for human beings; foot deodorant sprays; feminine deodorant sprays; non-medicated antiperspirants; body deodorants in pill form; depilatory preparations; cosmetic pads; cosmetic pre-moistened cleaning pads; scented wood; perfumes; fragrances for personal use; fragrance sachets for eye pillows; perfuming sachets; bath pearls for cosmetic use; nail polish removers; liquid perfumes; greases for cosmetic purposes; nail polish top coat; non-medicated dentifrices; cosmetics; perfumery; perfumes in solid form; decorative transfers for cosmetic purposes; ionone [perfumery]; shaving stones [astringents]; foot smoothing stones; smoothing stones; eyebrow pencils; eye pencils; lip liners; make-up pencils; eyeliner pencils; cosmetic pencils; lip pencils; decalcomanias for fingernails; alum stones [astringents]; scented ceramic stones; blush pencils; adhesives for affixing false eyelashes; adhesives for affixing false hair; adhesives for affixing false nails or eyelashes; hair piece bonding glue; cold creams, i.e. face and body winter care creams; eye compresses for cosmetic purposes; hair conditioners; hair conditioners for babies; skin conditioners; nail conditioners; under-eye enhancers; concealers for spots and blemishes; decorative cosmetics; theatrical make-up; children's play cosmetics; cosmetics for use on the skin; facial make-up; cosmetics for personal use; body and beauty care cosmetics; skin bronzer; cosmetics and toiletries; beard dyes; colorants for toilet purposes; cosmetic dyes; eyebrow colors in the form of pencils and powders; hair dyes; eyelash and eyebrow dyes; body mask creams; cream soap; body cream soap; foundation; creamy face powder; creamy rouge; anti-aging creams [for cosmetic use]; anti-cellulite creams; fragranced creams; aromatherapy creams for cosmetic use; shaving creams; hair creams; lip creams; shower creams; suntan creams; self-tanning creams; skin creams in liquid and solid; eye contour creams; non-medicated skin

creams; bath creams; skin bronzing creams; face creams for cosmetic purposes; non-medicated foot creams; nail creams; polishing creams; hand creams; hand skin softeners; skin cleansing creams; make-up removing creams; body creams for cosmetic use; depilatory creams; anti-pigmentation creams; hair care creams [for cosmetic use]; day creams; pre-shave creams; skin conditioning creams for cosmetic purposes; cosmetic creams; vanishing creams; cosmetic creams for the skin; cosmetic hand creams; cosmetic body creams; cosmetic creams for skin care; beauty creams for body care; skin whitening creams; retinol cream for cosmetic purposes; concealers; facial concealer; cosmetic creams for fair skin types; non-medicated scalp treatment creams; night creams; foundation creams; skin lightening creams; cuticle creams; anti-wrinkle creams [for cosmetic use]; exfoliant creams; cleansing creams [cosmetic]; cosmetic creams for firming skin around eyes; after-shave creams; after-sun creams; non-medicated protective creams; [non-medicated] sun blocking creams; age spot reducing creams; sunscreens; waterproof sunscreen; water-resistant sunscreen; topical herbal creams for firming and enhancing breasts; mizuoshiroi [liquid foundation]; moisturizing skin creams [cosmetics]; incense; spirit gum for cosmetic use; hair spray; nail polish; nail varnish for cosmetic purposes; abrasive bands; anti-age lotions; fragranced lotions; aromatherapy lotions for cosmetic use; self-tanning lotions [cosmetic]; shaving lotions; bath lotions; hair lotions; eye lotions; baby lotions [toiletries]; hair waving lotions; cosmetic suntan lotions; lotions for cosmetic purposes; sun care lotions [for cosmetic use]; lotions for the face; [non-medicated] massage lotions; permanent waving lotions; body lotions; styling lotions; hair strengthening treatment lotions; lotions for strengthening the nails; lotions for cellulite reduction; hair care lotions [for cosmetic use]; hand care lotions; beauty lotions; cosmetic hair lotions; cosmetic skin lotions; cosmetic facial lotions; cosmetic skin care lotions; cosmetic lotions for reducing the appearance of age spots and freckles; non-medicated hair restoration lotions; non-medicated foot lotions; sunscreen lotions; skin cleansing lotions; after-shave lotions; after-sun lotions [for cosmetic use]; non-medicated stimulating lotions for the skin; toning lotions for the face, body and hands for cosmetic purposes; moisturizing skin lotions; moisturizing body lotions; moisturizing lotions

[cosmetic]; body make-up; gel eye masks; skin masks; body masks; beauty masks; cosmetic facial moisturizers; facial beauty masks; body mask lotions; body mask powders; skin moisturizer masks; scented oils; perfume oils for the manufacture of cosmetic preparations; aromatic oils; essential oils for personal use; aromatic essential oils; baby oils [toiletries]; aromatherapy oils; non-medicated bath oils; hair oils; bintsuke-abura [Japanese hair fixing oil]; shower oils; sun-tanning oils for cosmetic purposes; oils for perfumes and scents; oils for hair conditioning; scented oils used to produce aromas when heated; oils for cleaning purposes; oils for cosmetic purposes; cosmetic oils for the skin; massage oils; perfume oils; after-sun oils [cosmetics]; sun protection oils [cosmetics]; cosmetic moisturizing oils; oils for toilet purposes; essential oils; essential oils as fragrances for laundry purposes; essential oils for use in aromatherapy; essential oils for household use; essential oils for use as food flavorings; essential oils for use in the manufacture of scented products; essential oils for cosmetic purposes; essential oils for use in manufacturing processes; essential oils for industrial use; essential oils of cedarwood; essential oils of lemon; essential oils of citron; natural essential oils; bergamot oil; gaultheria oil; body oil [for cosmetic use]; body butter for cosmetic use; jasmine oil; cocoa butter for cosmetic purposes; lavender oil; lavender oil for cosmetic use; almond oil; peppermint oil [perfumery]; rose oil; rose oil for cosmetic purposes; chalk for make-up; chalk for cosmetic use; almond milk for cosmetic purposes; bath milk; bronzing milk; cosmetic face milk; make-up removing milk; cosmetic body milk; beauty milk; cleansing milk; facial cleansing milk; after-sun milk [cosmetics]; cleansing milk for toilet purposes; moisturizing milk; synthetic musk; natural musk; musk [perfumery]; hair mousse; styling mousse; styling paste for hair; grooming mousses; skin care mousse; aftershave mousses; soap; waterless soap; liquid soaps; granulated soap; deodorant soap; shaving soap; soaps for household use; bath soap; skin soap; facial soaps; soaps for personal use; hand soap; body soaps; cakes of soap for body washing; soaps for body care; perfumed soap; liquid soap; liquid bath soaps; liquid soap for washing dishes; liquid face soaps; liquid hand soaps; liquid soap for body washing; liquid soap used in foot baths; loofah soaps; cosmetic soap; cakes of toilet soap; antiperspirant soap; soap for foot perspiration; hand-made soaps;

toilet soap; almond soap; saddle soap; mint for perfumery; cosmetic kits; emery; cosmetic patches containing sunscreen and sun block for use on the skin; nail art stickers; false nails; artificial fingernails of precious metal; eaux de Cologne; aftershave cologne; hair rinses [shampoo-conditioners]; anti-cavity mouth rinses, not for medical purposes; non-medicated mouth rinses; room fragrancing preparations; breath fresheners, not for medical purposes; breath fresheners; breath fresheners in the form of chew sticks made from birchwood extracts; hair lighteners; bases for flower perfumes; nail polish base coat; make-up bases in the form of pastes; hand cleansers; potpourri sachets for incorporating in aromatherapy pillows; lip gloss palettes; incense sticks; cotton sticks for cosmetic purposes; joss sticks; perfumery, essential oils, cosmetics, hair lotions; abrasive pastes; flavored toothpastes; tooth polish; dentifrices; dentifrices in the form of chewing gum; toothpaste in soft cake form; dentifrice gels; cosmetic paste for application to the face to counteract glare; pumice stone; pumice stones for personal use; artificial pumice stones; bath foam; lipstick cases; shower and bath foam; cosmetic foams containing sunscreens; foam cleaning preparations; skin cleansing foams; foam cleansers for personal use; shaving foam; bath fizzies; aftershave foams; hydrogen peroxide for cosmetic purposes; hydrogen peroxide for use on the hair; sanding gloves; eyeliner; abrasive strips; wax strips for removing body hair; breath freshening strips; abrasive cloth; abrasive cloth and paper; glass cloth [abrasive cloth]; lipsticks; lip pomades; hair pomades; pomades for cosmetic purposes; hair-washing powder; tooth powder [for cosmetic use]; moistened tooth powder; solid powder for compacts [cosmetics]; shaving preparations; cosmetic preparations for baths; bath preparations, not for medical purposes; non-medicated bubble bath preparations; toiletry preparations; hair waving preparations; douching preparations for personal sanitary or deodorant purposes [toiletries]; color-removing preparations; hair bleaching preparations; leather bleaching preparations; preparations for perming and setting the hair; polishing preparations; denture polishes; gargles, not for medical purposes; mouthwashes, not for medical purposes; cosmetic preparations for slimming purposes; starch glaze for laundry purposes; preparations for removing gel nails; wax stripping preparations; lacquer-removing preparations; make-up remo-

ving preparations; hair treatment preparations; hair care preparations, not for medical purposes; preparations for the care of the scalp and hair; nail care preparations; preparations for cleaning dentures; cleaning, polishing, scouring and abrasive preparations; depilatory preparations and substances; cosmetics and cosmetic preparations; cosmetic preparations for skin renewal; cosmetic hair regrowth inhibiting preparations; menthol bath preparations, not for medical purposes; non-medicated skin care preparations; non-medicated preparations for the care of skin, hair and scalp; bubble bath preparations [for cosmetic use]; cosmetic nail and skin care preparations; aloe vera preparations for cosmetic purposes; sunscreen preparations; baby powder [toiletries]; shining preparations [polish]; cosmetic products in the form of aerosols for skin care; perfumed powder [for cosmetic use]; bath powder [cosmetics]; face powder [for cosmetic use]; make-up powder; body powder; make-up for compacts; pressed face powder; perfumed talcum powder; loose face powder; face powder in the form of powder-coated paper; cosmetic face powder; carpet cleaners with deodorizer; scouring solutions; cold waving solutions; eyeglass lens cleaning solutions; teeth cleaning lotions; false eyelashes; blusher; liquid rouge; pre-moistened baby wipes; impregnated cloths for dusting; impregnated cleaning, dusting or polishing cloths; pre-moistened cosmetic wipes; disposable wipes impregnated with cleaning chemicals or compounds for industrial and commercial use; disposable wipes impregnated with cleansing chemicals or compounds for personal hygiene; disposable wipes impregnated with cleansing compounds for use on the face; cloths or tissues impregnated with a skin cleanser [for cosmetic use]; pre-moistened towelettes impregnated with dishwashing detergent; wipes impregnated with a skin cleanser; cloths impregnated with cleaning preparations; tissues impregnated with essential oils, for cosmetic use; feminine hygiene cleansing towelettes; tissues impregnated with cosmetics; cleaning pads impregnated with cosmetics; cleaning pads impregnated with toilet preparations; tissues impregnated with cosmetic lotions; pre-moistened towelettes impregnated with a detergent for cleaning; exfoliants; skin exfoliants; cosmetic face scrubs; cosmetic body scrubs; potpourris [fragrances]; bath salts for cosmetic use; bath salts, not for medical purposes; non-medicated bath salts; cosmetic bath salts; bo-

dy washes; fumigation preparations [perfumes]; preservatives for leather [polishes]; brilliantine; adhesive removers; glue removers [other than for industrial purposes]; paint removing compositions; facial washes [cosmetic]; adhesives for false eyelashes, hair and nails; buffing compounds; scented room sprays; topical skin sprays for cosmetic purposes; body sprays; body sprays used as personal deodorants and fragrances; hair styling spray; grooming sprays; cosmetic skin fresheners; scented fabric refresher sprays; scented linen sprays; non-medicated bactericide detergents; nail repair preparations; astringents for cosmetic purposes; sanitary preparations being toiletries; aromatherapy preparations; lotions for beards; eyebrow cosmetics; bath and shower preparations; non-medicated bath preparations; hair nourishers; hair straightening preparations; make-up preparations; shower preparations; sun-tanning preparations [cosmetics]; cosmetic intertrigo treatment products; beauty care preparations; cosmetic body treatment products; eye make-up; face makeup products; body makeup products; hair styling preparations; customized detergents; hair wash preparations; hair bleach; skin whitening preparations; neutralizers for permanent waving; nail buffing preparations; non-medicated nappy rash cream; cuticle softeners; hair relaxing preparations; cosmetic preparations for eyelashes; make-up removing lotions; eye make-up removers; hair setting preparations; hair toning products; depilatory and exfoliating preparations; cuticle removing preparations; color-removing preparations for hair; nail hardeners; hair grooming preparations; non-medicated grooming preparations, other than animal washes; non-medicated lip care preparations; cosmetic preparations for the hair and scalp; cosmetic preparations for skin care; preparations for body and beauty care; hair fixing products; pre-shave and after-shave preparations; cosmetics in the form of lotions; washing-up liquids; anti-aging skin care preparations; hand-made customized cosmetic products from the custom selected components; cosmetic facial preparations; mascara; cosmetic preparations for dry skin during pregnancy; cosmetic facial masks; cosmetic hair dressing preparations; cosmetic preparations for skin care and skin treatment; cosmetic nail care preparations; cosmetic preparations for the care of mouth and teeth; cosmetic preparations for body care; cosmetic breast firming preparations; cosmetic facial care prepara-

tions; cosmetic preparations to protect against sunburn; hand-made cosmetic products; hair frosting preparations [highlighting preparations]; detergents other than for use in manufacturing operations and for medical purposes; non-medicated hair treatment preparations for cosmetic purposes; non-medicated massage preparations; non-medicated preparations for the alleviation of sunburn; non-medicated foot care preparations; non-medicated hair care preparations; non-medicated skin cleansing preparations; degreasing preparations; degreasing preparations for household purposes; degreasers, other than for use in manufacturing processes; degreasing preparations with a solvent base; bleaching preparations [decolorants] for cosmetic purposes; hair colorants; skin cleansers; facial cleansers; cleansing preparations for personal use; hand cleaning preparations; facial cleansing grains; cosmetic preparations; after-shave preparations; aftersun products; hair care preparations; hair care preparations consisting of organic coconut virgin oil and coconut virgin oil; lip care preparations; skin care preparations; facial peel preparations for cosmetic purposes; non-medicated body care preparations; wrinkle removing skin care preparations; wrinkle-minimizing cosmetic preparations for topical facial use; cosmetic hair softening products; cosmetic skin softening products; preparations for protecting the hair from the sun; sun protectors for lips [cosmetics]; sunscreens [for cosmetic use]; cosmetic sun-protecting preparations; antiperspirants [toiletries]; moisturizers; hair moisturizers; skin moisturizers; moisturizing preparations [cosmetic]; anti-aging moisturizers; cosmetics and personal care preparations; non-medicated skin serums; talcum powder [for cosmetic use]; non-medicated foot powder; non-medicated bath powders; talcum powder, for toilet use; non-medicated foot soaks; temporary tattoos for cosmetic purposes; skin texturizers; eyeshadow; terpenes [essential oils]; nail tips; emery cloth; toners for cosmetic use; hair tonics; skin toners; cosmetic facial toners; bath herbs, not for medical purposes; non-medicated preparations for the bath; non-medicated toiletries; color hair mascaras; eyelash mascaras; fingernail sculpturing overlays [cosmetics]; hair fixers [hair styling preparations]; bath flakes; henna for cosmetic purposes; henna [cosmetic dye]; shampoos; hair shampoos; shampoos for babies; shampoos for human hair; shampoo-conditioners; color rinses for the hair; dandruff

shampoos; dry shampoos; pomanders [aromatic substances]; cotton balls for cosmetic purposes; bath bombs; sandpaper for sharpening drawing pencils; extracts of flowers [perfumes]; liquid; mouth wash elixirs; facial emulsions; body emulsions; after-shave emulsions; skin care emulsions; ethereal essences; badian essence; mint essence [essential oil].

5 – Drug delivery agents; aconitine; alkaloids for medical purposes; alginates for pharmaceutical purposes; aldehydes for pharmaceutical purposes; amino acids for medical purposes; analgesics; anesthetics; antibacterial liquid hand soap; antibacterial substances for medical purposes; antibacterial gels; antibiotics; anticoagulants; antimicrobials for dermatological use; anti-microbial hand wash; antioxidants [dietary supplements]; antiseptics; cotton swabs for medical purposes; corn pads; deodorizing room sprays; aluminium acetate for pharmaceutical purposes; acetates for pharmaceutical purposes; bacteriostats for medical use; germicides; pain relief preparations; medicated lip balms; medicated lip salves; balms for medical purposes; multi-purpose medicated mentholated salves; anesthetic balms in the form of medicinal preparations; anti-inflammatory balms in the form of medicinal preparations; bandages for skin wounds; bandages for dressings; antiseptic sprays; surgical bandages; biocides; biological preparations for medical purposes; petroleum jelly for medical purposes; oxygen baths; medicated bath preparations for therapeutic use; antiseptic cotton; aseptic cotton; absorbent cotton; wadding for medical purposes; medicated shampoos; cotton for medical purposes; disinfectants for medical purposes; dietetic substances adapted for medical use; vitamins and minerals as dietary supplements; nutritionally fortified water for medical use; melissa water for pharmaceutical purposes; sea water for medicinal bathing; vitamin enriched water for medical purposes; mineral waters for medical purposes; thermal water; dietary fiber; dental waxes; gases for medical purposes; witch hazel [astringent]; guaiacol for pharmaceutical purposes; medicated oral care gels; gels, creams and solutions for dermatological use; lubricant gels for personal use; medicated brush-on oral care gels; topical gels for medical and therapeutic purposes; anti-adhesion gels for use with wound drainage devices; anti-inflammatory gels; alcohol-based antibacterial skin sanitizer gels; hydrastinine; hydrocortisone creams; antimicrobial

clay; hydrastine; glycerin for medical use; glycerophosphates; glucose for medical purposes; gentian for pharmaceutical purposes; mustard for pharmaceutical purposes; mud for baths; medicinal mud; contraceptive sponges; gamboge for medical purposes; gurjun balsam for medical purposes; all-purpose disinfectants; household deodorizers; air deodorising preparations; deodorants for clothing and textiles; digitalin; sterile cotton pads; biologically active mineral supplements; vitamin supplements; dietary supplements for controlling cholesterol; dietetic substances consisting of vitamins, minerals, amino acids and trace elements; calcium supplements; dietary supplements; dietary and nutritional supplements; dietary supplement drinks; dietetic food supplements; dietary supplements for humans; wheat dietary supplements; soy protein dietary supplements; zinc dietary supplements; herbal supplements; dietary supplements consisting of amino acids; dietary supplements consisting of amino acids, minerals and trace elements; dietary supplements consisting of vitamins; dietary supplements consisting of trace elements; dietary supplements consisting of minerals; mineral food supplements; nutritional supplements; albumin dietary supplements; vitamin and mineral dietary supplements; dietary supplements for animals; yeast dietary supplements; alginate dietary supplements; glucose dietary supplements; casein dietary supplements; lecithin dietary supplements; linseed oil dietary supplements; propolis dietary supplements; protein dietary supplements; royal jelly dietary supplements; pollen dietary supplements; wheat germ dietary supplements; linseed dietary supplements; powdered fruit-flavored dietary supplement drink mixes; nutritional supplements made of starch adapted for medical purposes; enzyme dietary supplements; yeast for pharmaceutical purposes; gelatine for medical purposes; ginseng for medical use; cod liver oil; meal replacement and dietary supplement drink mixes for medical purposes; pharmaceutical preparations for use in dermatology; calomel; cream of tartar for pharmaceutical purposes; camphor for medical use; cachets for pharmaceutical purposes; hemostatic pencils; wart pencils; caustic pencils; headache pencils; caustics for pharmaceutical purposes; cachou for pharmaceutical purposes; quassia for medical purposes; quebracho for medical purposes; gallic acid for pharmaceutical purposes; acids for pharmaceutical purposes; adhesive tapes for medical purpo-

ses; ground flaxseed fiber for use as a dietary supplement; meal replacement shakes for medical purposes; collodion for pharmaceutical purposes; corn rings for the feet; room deodorizing compositions; medicinal compresses; candy, medicated; angostura bark for medical purposes; barks for pharmaceutical purposes; cedar wood for use as an insect repellent; condurango bark for medical purposes; croton bark; mangrove bark for pharmaceutical purposes; myrobalan bark for pharmaceutical purposes; quinquina for medical purposes; medicinal roots; rhubarb roots for pharmaceutical purposes; medicinal radix glycyrrhizae; lint for medical purposes; hydrocortisone; cosmeceuticals for therapeutic purposes; starch for dietetic or pharmaceutical purposes; starch for dietetic purposes; starch for pharmaceutical purposes; starch and starch products for pharmaceutical purposes; medicated lip creams; creams for dermatological use; medicinal creams; multi-purpose medicated antibiotic creams; medicated skin creams; medicinal creams for skin care; corn and callus creams; anti-itch creams [antipruritics]; antifungal creams for medical purposes; antibiotic creams; herbal creams for medical purposes; liquorice for pharmaceutical purposes; lactose for pharmaceutical purposes; vitamin drops; candy for medical purposes; adhesive plasters; sticking plasters for medical purposes; non-prescription medicines; dissolvable strips to stop bleeding from minor cuts and grazes; lecithin for medical purposes; antibacterial hand lotions; lotions for treating athlete's foot; medicated face lotions; medicated body lotions; lotions for pharmaceutical purposes; barrier lotions for protection from toxic oils of poisonous plants; medicated lotions; medicated skin lotions; medicated muscle soaks; medicated lotions and creams for the body, skin, face, and hands; medicated diaper rash lotions; calamine lotions; medicated lotions for sunburn; pharmaceutical lotions for the skin; hygienic lubricants; water-based personal lubricants; silicone-based personal lubricants; lupulin for pharmaceutical purposes; liniments; ointments for pharmaceutical purposes; rubbing compounds for medical or therapeutic purposes; medicated diaper rash ointments; sunburn ointments; frostbite salve for pharmaceutical purposes; ointments for treating diaper rash; anti-itch ointments [antipruritics]; anti-inflammatory ointments; herbal ointments for sensitive skin; gauze for medical purposes; gauze for dressings; herbal mud packs for the-

rapeutic purposes; medicated baby oils; medicinal oils; mustard oil for medical purposes; camphor oil for medical purposes; castor oil for medical purposes; almond oil for pharmaceutical purposes; oil of turpentine for pharmaceutical purposes; dill oil for medical purposes; materials for oral prophylaxis; medical adhesives for binding wounds; dressings, medical; bactericide skin soaps; bactericide soaps; disinfectant soap; drugs for medical purposes; serotherapeutic medicines; medicines for human purposes; medicines for dental purposes; menthol; medicinal drinks; moleskin for use as a medical bandage; almond milk for pharmaceutical purposes; royal jelly for medical use; royal jelly for pharmaceutical purposes; milk ferments for pharmaceutical purposes; Irish moss for medical purposes; flour for pharmaceutical purposes; linseed meal for pharmaceutical purposes; multivitamin preparations; mint for pharmaceutical purposes; nutritionally fortified beverages for medical purposes; dietary drink mixes for use as meal replacements for medical purposes; dietetic beverages adapted for medical purposes; meal replacement drinks for medical purposes; malted milk beverages for medical purposes; medicated beverages; diabetic fruit juice beverages adapted for medical purposes; vitamin fortified beverages for medical purposes; beverages adapted for medical purposes; medicinal infusions; medicinal herbal infusions; eucalyptol for pharmaceutical purposes; tinctures for medical purposes; diabetic fruit nectars adapted for medical purposes; nematocides; nutraceuticals for use as dietary supplements; nutraceuticals for therapeutic purposes; pain relief medication; opodeldoc; anti-cavity mouth rinses for medical purposes; medicinal oral rinses; deodorizers for garbage disposals; decoctions for pharmaceutical purposes; stick liquorice for pharmaceutical purposes; sulfur sticks [disinfectants]; pastilles for pharmaceutical purposes; zinc supplement lozenges; pectin for pharmaceutical purposes; pepsins for pharmaceutical purposes; synthetic peptides for pharmaceutical purposes; peptones for pharmaceutical purposes; nanoparticle-based pharmaceuticals; hydrogen peroxide for medical purposes; pills for pharmaceutical purposes; meal replacement bars for medical purposes; vitamin and mineral bars for medical purposes; plasters, materials for dressings; medical and surgical plasters; corn plasters; anti-inflammatory analgesic plasters; compresses; adhesive bandages; cooling dressing for medical purposes; self-adhesi-

ve dressings; ear bandages; eye pads for medical purposes; bunion pads; pomades for medical purposes; powder of cantharides; pyrethrum powder; antiseptic preparations; bacterial preparations for medical purposes; bacteriological preparations for medical purposes; balsamic preparations for medical purposes; albuminous preparations for medical purposes; biological preparations for medical purposes; biotechnological preparations for medical purposes; biochemical preparations for medical purposes; vitamin preparations; hygienic preparations for medical purposes; diagnostic preparations for medical purposes; dietetic preparations adapted for medical purposes; dietetic food preparations adapted for medical purposes; bath preparations for medical purposes; therapeutic preparations for the bath; fumigation preparations for medical purposes; ophotherapy preparations; air purifying preparations; preparations for making dietetic beverages adapted for medical purposes; preparations for making medicated beverages; eye-washes; medicated wart removing preparations; corn remedies; pharmaceutical preparations for treating dandruff; pharmaceutical preparations for skin care; pharmaceutical preparations and substances for the treatment of damaged skin and tissue; pharmaceutical antiallergic preparations and substances; pharmaceutical preparations and substances with analgesic properties; pharmaceutical preparations and substances with anti-inflammatory properties; preparations of lime for pharmaceutical purposes; chilblain preparations; medicinal preparations and substances; pharmaceutical preparations and substances; potassium preparations for pharmaceutical purposes; caffeine preparations for stimulative use; herbal medicines; medicinal preparations; medicated shaving preparations; medicinal hair growth preparations; medicated hair care preparations; antibacterial scented soaps; nanoparticle-based medical preparations; coca alkaloid preparations for medical purposes; amino acid preparations for medical purposes; pain relief preparations; ophthalmic preparations; anti-inflammatory preparations; antifungal preparations; anticryptogamic preparations; crude medicines; aloe vera preparations for pharmaceutical purposes; vitamin and mineral preparations for medical purposes; human micronutrient preparations; methionine preparations; caffeine preparations for medical purposes; lysine preparations; tetracycline preparations; thiolutin preparations; threonine preparations; tryptophane

preparations; trichomycin preparations; lipotropic factor preparations; chondroitin preparations; odor neutralizing preparations for clothing and textiles; pharmaceuticals for skin care; pharmaceutical preparations; pharmaceutical preparations for activating cellular function; pharmaceutical preparations for wounds; pharmaceutical preparations for treating skin disorders; pharmaceutical preparations for treating and preventing skin and nail diseases; pharmaceutical preparations for treating sports injuries; pharmaceuticals for dry skin treatment; pharmaceutical preparations for the relief of insect bites; pharmaceuticals for prevention of skin blemishes; pharmaceutical preparations for the prevention of stretch marks; pharmaceutical preparations for hydrating the skin during pregnancy; pharmaceutical preparations for human use; pharmaceutical preparations for treating sunburn; enzyme preparations for medical purposes; chemico-pharmaceutical preparations; chemical preparations for medical purposes; chemical preparations for pharmaceutical purposes; collyrium; lead water; medicated baby powder; albuminous foodstuffs for medical purposes; dietetic foods adapted for medical purposes; food for enteral feeding; by-products of the processing of cereals for dietetic or medical purposes; gluten-free foods adapted for medical purposes; dietary and nutritionally fortified food products adapted for medical purposes; food for infants; food adapted for diabetics; dietetic food and substances adapted for medical or veterinary use, food for babies; propolis for medicinal or therapeutic purposes; propolis for pharmaceutical purposes; pearl powder for medical purposes; processed bee pollen for medicinal or therapeutic purposes; solvents for removing adhesive plasters; hydrated chloral for pharmaceutical purposes; disinfecting hand wash; gargles for medical purposes; rodenticides; gum for medical purposes; rubber for dental purposes; chewing gum for medical purposes; mint-flavored chewing gum for medical purposes; muscle relaxants; mosquito-repellent incense; insect repellents; insect repellent in candle form; insect repellent incense; pre-moistened medicated tissues; sanitizing wipes; tissues and wipes impregnated with pharmaceutical lotions and creams; tissues impregnated with antibacterial preparations; tissues impregnated with pharmaceutical lotions; tissues impregnated with insect repellents; sarsaparilla for medical purposes; dietetic sugar for medical purposes; sugar for me-

dical purposes; sugar substitutes for medicinal or therapeutic purposes; fumigating sticks; suppositories; linseed for pharmaceutical purposes; siccatives [drying agents] for medical purposes; turpentine for pharmaceutical purposes; greases for medical purposes; meal replacement snacks for medical purposes; mineral water salts; bath salts for medical purposes; salts for mineral water baths; bath salts and bath preparations for medical purposes; medicated bath salts; salts for medical purposes; potassium salts for medical purposes; Epsom salts for medical purposes; sodium salts for medical purposes; smelling salts; malt for pharmaceutical purposes; alcohol for topical use; alcohol for pharmaceutical purposes; isopropyl alcohol for medical purposes; medicinal alcohol; ergot for pharmaceutical purposes; antibacterial sprays; medicinal sprays for the mouth; medicinal sprays; medicated nasal spray preparations; medicated throat sprays; medicated soap; medicated toothpastes; nasal sprays for medical purposes; nasal and oral spray preparations for use as central nervous system stimulants; decongestant nasal sprays; cooling sprays for medical purposes; anti-inflammatory sprays; herbal sprays for medical purposes; medicated douches; anesthetics for non-surgical use; bactericides; antihistamines; analgesic preparations; adjuvants for medical purposes; styptic preparations; sanitary preparations for medical purposes; hypolipidemic agents; homeopathic medicines; disinfectants; disinfectants for hygiene purposes; mouth cavity cleansers for medical purposes; dermatological preparations; nail sanitizing preparations; hand-sanitizing preparations; nail fungus treatment preparations; acne treatment preparations; burn relief medication; medicated hand wash; antibiotic hand wash; preparations for cleansing the skin for medical purposes; appetite suppressants for medical purposes; medical preparations for slimming purposes; mouthwashes for medical purposes; preparations of trace elements for human use; therapeutic drugs and agents; medicated preparations for skin treatment; medicinal health care preparations; medicated grooming preparations; medicated mouth care and treatment preparations; medicated skin care preparations; allergy relief medication; medicated lip care preparations; menthol bath preparations for medical purposes; menthol vapor bath preparations for babies; topical anesthetics; detergents for medical purposes; articles for headache; skin care preparations for medical purposes; foot

care preparations for medical purposes; nail care preparations for medical purposes; anti-inflammatories; antifungal medication; liquid antipruritics; microbicides; decongestants; remedies for perspiration; herbal remedies; sanitary preparations for personal hygiene, other than toiletries; hypnotic sedatives; digestives for pharmaceutical purposes; tonics for medical purposes; tonics [medicines]; herbal preparations for medical purposes; nervines; anhidrotics; all-purpose disinfecting and deodorizing preparations; pharmaceutical preparations for health care; pharmaceuticals for ophthalmic use; pharmaceutical drugs; chemical preparations for sanitary purposes; media for bacteriological cultures; steroids; hair growth stimulants for medical purposes; antioxidant pills; tanning pills; appetite suppressant pills; slimming pills; powders for treating athlete's foot; medicated foot powders; tampons for medical purposes; cotton sticks for medical purposes; medicated swabs; thymol for pharmaceutical purposes; thiomersal; fabric deodorizers; smoking herbs for medical purposes; medicinal herbs; medicinal herbs in dried or preserved form; trypsins for medical purposes; charcoal for pharmaceutical purposes; fennel for medical purposes; enzymes for medical purposes; ferments for pharmaceutical purposes; phosphates for pharmaceutical purposes; quinine for medical purposes; chinoline for medical purposes; vitamin enriched bread for therapeutic purposes; diabetic bread adapted for medical use; flowers of sulfur for pharmaceutical purposes; medicinal tea; herbal teas for medicinal purposes; slimming tea for medical purposes; eucalyptus for pharmaceutical purposes; medicinal herbal extracts for medical purposes; herbal extracts for medical use; extracts of hops for pharmaceutical purposes; electrolytes for medical purposes; elixirs [pharmaceutical preparations]; ethers for pharmaceutical purposes; esters for pharmaceutical purposes; cellulose esters for pharmaceutical purposes; cellulose ethers for pharmaceutical purposes; esters for pharmaceutical purposes; cellulose esters for pharmaceutical purposes; cellulose ethers for pharmaceutical purposes.

16 – Fountain pens; albums; almanacs; paint applicators in the nature of sponges; atlases; posters; banners of paper; paper bows; decorative paper bows for wrapping; paper bows for gift wrapping; paper badges; cardboard hangtags; paper hangtags; forms, printed; paperboard blanks; order forms; adhesive

notepads; score pads; art pads; writing paper pads; note books; illustrated notepads; loose-leaf binders; blank paper notebooks; pamphlets; cosmetic brochures; advertising pamphlets; booklets; paper; waterproof paper; waxed paper; fluting paper [corrugating medium]; notebook paper; business card paper [semi-finished]; découpage paper (paper for decorating surfaces using découpage technique by gluing paper cut images); paper for wrapping and packaging; adhesive notepaper; paper for making bags and sacks; paper stationery; directory paper; envelope paper; postcard paper; gift wrapping paper; cosmetic packaging paper; label paper; drawer liners of paper, perfumed or not; proofing paper; tengujosi [paper made from paper mulberry]; wood pulp paper; imitation leather paper; calender-finished paper; paper and cardboard; acid-resistant paper; carbon paper; plastic-coated copying paper; kraft paper; crêpe paper; crêpe paper for domestic use; laminated paper; metallic gift wrapping paper; wrapping paper for food and sterile products; parchment paper; recycled paper; recycled bond paper; rice paper; napkin paper; luminous paper; synthetic paper; gummed paper; paper containing mica; honeycomb paper; xuan paper for Chinese painting and calligraphy; heat transfer paper; heat sensitive paper; paper embossers [office requisites]; wrapping paper; environmentally-friendly packaging paper and containers of paper; synthetic bond paper; mildewproof paper; cellophane paper; greaseproof paper; party ornaments of paper; paper name badges; newsletters; printed vouchers; scented drawer liners of paper; printed questionnaires; signboards of paper or cardboard; pennants made of paper; printed news releases; newspapers; ivory paper; corrugated cardboard; engravings; art etchings; art pictures; digests in the field of cosmetology, medical cosmetics and health products; pencil holders; advertisement boards of paper or cardboard; day planners; in-flight magazines; magazines [periodicals]; medical journals; professional journals for cosmetologists and aesthetic medicine professionals; clips for offices; badges of cardboard; identification tags of paper; periodicals; periodical literature on innovations in the field of cosmetics, medical cosmetics, cosmetology and hygiene care; house organs; printed publications; printed publications related to education in the field of cosmetics and cosmetic treatment; calligraphic works; cardboard articles; works of art of paper; graphic representations; printed visuals; illustrations; prin-

ted instructions for creating designed and customized cosmetic products; calendars; pocket calendars; wall calendars; desk calendars; tear-off calendars; printed calendars; tracing paper; tracing cloth; tracing patterns; gums [adhesives] for stationery or household purposes; pencils; crayons; pictures; transfers [decalcomanias]; three-dimensional decalcomanias for use on any surface; paintings [pictures], framed or unframed; cardboard; white paperboard; bristol boards; corrugated paper; mat boards; poster board; illustration boards; wood pulp board [stationery]; pasteboard; millboard; packing cardboard; colorboard [colored paperboard]; cards; business cards; note cards; blank note cards; printed informational cards; catalogues; cosmetics catalogs; paintbrushes; books; memorandum books; birthday books; gift books; books on making "designed", "customized" cosmetics; picture books; collages; envelopes of paper for packaging; envelopes [stationery]; storage containers made of paper; industrial packaging containers of paper; cardboard, corrugated cardboard containers; paper cartons for delivering goods; paper or cardboard boxes for storing cosmetics; paper or cardboard collapsible boxes; cardboard counter display boxes for cosmetics; paper or cardboard boxes; paperboard boxes for industrial packaging; cardboard packaging boxes in made-up form; boxes of paper or cardboard; gift boxes of cardboard or paper; paint boxes and brushes; paper closures for containers; printed coupons; printed courses of lectures and workshops on "designing" and proper selection of cosmetics; sealing tape for paper cartons; ribbons of paper for gift wrapping; ribbons for hand-held label printers [office requisites]; adhesive bands for stationery or household purposes; gummed tape [stationery]; adhesive tapes for stationery or household purposes; self-adhesive tapes for stationery or household purposes; score sheets; flyers; informational leaflet on cosmetic or medicinal and cosmetic products or its components; leaflets; pharmaceutical information leaflets; leaflets with information on cosmetics, including hand-made cosmetics, "customized" cosmetics; humidity control sheets of paper or plastic for foodstuff packaging; viscose sheets for wrapping; sheets of reclaimed cellulose for wrapping; informational sheets; transparent celluloid sheets used for hand-drawn animation; plastic bubble packs for wrapping or packaging; graphic prints; graphic art prints; teaching materials [except apparatus]; sea-

ling compounds for stationery purposes; printed material in the nature of color samples; printed correspondence course materials; printing materials on cosmetology and biochemistry for cosmetic purposes; printed teaching materials; printed instructional, educational, and teaching materials; plastic materials for packaging; plastic transparencies; packaging materials made of recycled paper; packaging material made of starches; teaching materials of paper; instructional and teaching materials; printed training materials; filtering materials [paper]; printed assortment sheets; paper bags; shopping bags of paper; bags of paper for packaging; party goodie bags of paper or plastic; Halloween goodie bags of paper or plastic; gift bags of paper; bags [envelopes, pouches] of paper or plastics, for packaging; bags of plastic for packaging; plastic bags for securing valuables; plastic bags for household purposes; bumper stickers; blank plastic stickers; shipping labels of paper; stickers [stationery]; sealing wafers; linerboard for corrugated cardboard; treated paper for wrapping flowers and floral displays; oleographs; questionnaires printed for collection of feedback and suggestions from consumers of "designed", "customized" cosmetics; letter openers of precious metal; musical greeting cards; printed greeting cards with electronic information stored therein; greeting cards; pop-up greeting cards; postcards; blank or partially printed postcards; holiday cards; Christmas cards; occasion cards; picture postcards; cards bearing universal greetings; prints in the nature of photographs; pictorial prints; photographic prints; printed reports; printed consumer reports; printed research reports; etchings; conical paper bags; paper gift bags for cosmetics and health products; shopping bags of plastic; plastic bags for packing; bags [envelopes, pouches] of paper or plastics, for merchandise packaging; gift bags of paper or plastic; grocery bags of paper or plastic; printed informational folders; presentation folders; papier mâché; passe-partouts of paper; picture framing mat boards; pastels [crayons]; artists' pastels; oil pastels; partwork (highly technical periodicals of informative, entertaining, collectible nature, accompanied by disks, separate elements of models, or whole models that are collected during the period of publication); pens [office requisites]; nibs of gold; nibs; steel pens; colored art and craft sand; prints in the nature of pictures; lithographic prints; informational letters; unmounted posters; mounted

posters; plastic adhesives for household or domestic use; handkerchiefs of paper; adhesive plastic film used for mounting images; polypropylene foil for wrapping; plastic flexible packaging film sold in bulk to industrial and commercial manufacturers; plastic films for gift basket wrapping; plastic film for wrapping; letter trays; stands for pens and pencils; photograph stands; photographic or art mounts of paper or cardboard; coasters of cardboard; desktop document racks; towels of paper; hygienic hand towels of paper; portraits; instructional manuals for teaching purposes; study guides; posters made of paper; decorative paper centerpieces; paperweights; writing cases [sets]; printed invitations; magazine supplements to newspapers; artists' materials; office stationery; writing materials; souvenir programs; event programs; printed curricula; printed matter; lithographic works of art; cat box liners in the form of plastic bags; gummed tape for stationery or household purposes; prospectuses; photographic or art mounts; graphic reproductions; recipes printed and sold as a component of packaging for cosmetics sets and its components; printed guides; India ink pens; penholders; pens for writing and highlighting; tissue paper; tissues of paper for cosmetic use; facial tissues of paper; tissues of paper for removing makeup; coarse tissue for cosmetic purposes; découpage napkins; cellulose wipes; face towels of paper; doilies of paper; book series on cosmetics and cosmetic treatment; printed award certificates; printed certificates; decorative adhesive scotch tapes (decorative tapes for stationery or household purposes); scrapbooks; social note cards; commemorative books; reference books on cosmetics and cosmetology; directories [printed matter]; paper bags for household purposes; pouches of paper for packaging; carrying cases made of paper; placards of paper or cardboard; iron-on transfers of paper; stationery; sharpeners for cosmetic pencils; pencil sharpeners; transparencies [stationery]; three-dimensional models for educational purposes; party decorations of paper; metallic paper party decorations; dangling ornaments of paper; cardboard packaging; plastic wrap; plastic gift wrap; cardboard or paper packaging for bottles, vials, jars; textbooks; figures made of paper; figurines [statuettes] of papier mâché; flags of paper; flags and pennants of paper; felt-tip pens; flash cards [teaching materials]; silver paper; photograph albums; photoengravings; photographs [printed]; murals; pen

and pencil cases; stationery cases; chromolithographs [chromos]; price tags; cardboard or paper name plates; desktop stationery cabinets; printing fonts; printed advertising boards of paper or cardboard; book plates; paper emblems; shields [paper seals]; printed emblems; health and beauty encyclopedias; sketches; prints [engravings]; labels of paper; hand-painted paper labels for bottles, vials, jars; blank or partially printed paper labels; labels, not of textile; reinforced stationery tabs; printed paper labels; adhesive labels of paper; adhesive labels to be printed with an individual's medical and personal information [not of textile]; adhesive labels, not of textile; barcode paper labels; printed paper labels for cosmetics of unusual design; marking tabs; gift tags of paper; cardboard boxes; name badge holders [office requisites].

20 – Non-metal cylinders for compressed gas or liquids, sold empty; nameplates of plastic; storage drums of plastic; casks, not of metal; barrels, not of metal; busts of wood, wax, plaster or plastic; busts of bone or ivory; fans for personal use, non-electric; display stands; display cases for merchandise; floor units of cardboard for displaying merchandise; fitted plastic inserts for use as container liners; upright signboards of wood or plastics; signboards of wood or plastics; low cabinets with a large number of sections (credenza); point-of-purchase displays [furniture]; directory boards; industrial containers for cosmetic, hygienic and medicinal and cosmetic compositions and components; packaging containers of plastic; flower-stands [furniture]; non-metal clips; closures of plastic for containers; imitation tortoiseshell; bead curtains for decoration; bottle closures, not of metal; closures, not of metal, for containers; closures for containers, not of metal, nor of paper; latches, not of metal; mirrors [looking glasses]; shaving mirrors; bathroom mirrors; locker mirrors; personal compact mirrors; hand-held mirrors [toilet mirrors]; mirrors enhanced by electric lights; animal teeth; bamboo; animal claws; animal hooves; coral; meerschau; whalebone, unworked or semi-worked; stag antlers; tortoiseshell; shells; horn, unworked or semi-worked; animal horns; rattan; ivory, unworked or semi-worked; corozo; plaited straw, except matting; wickerwork; hampers [baskets]; wood carvings; works of art made of wax; works of art made of plaster; works of art made of wood; works of art of wood, wax, plaster or plastic; cabinet work; valves, not of metal, for containers; val-

ves of plastic, other than parts of machines; plastic clips for sealing bags; caps of plastic; bottle caps, not of metal; chests of drawers; plastic containers for drugs and medicinal and cosmetic products for commercial use; general purpose storage containers, not of metal; storage containers of plastic for commercial or industrial use; coral, unworked or semi-worked; organizer baskets for cosmetics; baskets, not of metal; boxes of wood; bottle casings of wood; tool boxes, not of metal [furniture]; lockboxes, not of metal; boxes of plastic; shipping and storage boxes of plastic; box springs; bathroom vanities [furniture]; screw tops, not of metal, for bottles; plastic drawer lining material; mobiles [decoration]; plastic handcuff strips; desktop statuary made of bone, ivory, plaster, plastic, wax or wood; tortoiseshell, unworked or semi-worked; meerschau, unworked or semi-worked; raw mother-of-pearl; mother-of-pearl, unworked or semi-worked; plaques of bone, ivory, plastic, wax or wood; mirror tiles; ambroid plates; registration plates, not of metal; trays, not of metal; pillows; neck support cushions; bath pillows; inflatable pillows; air cushions, not for medical purposes; inflatable neck support cushions; air pillows, not for medical purposes; neck-supporting pillows; showshelves; shelves for filing-cabinets [furniture]; freestanding towel racks [furniture]; shelves for storage; racks [furniture]; wall shelves for cosmetics; folding shelves; wood ribbon; straw edgings; towel stands [furniture]; inflatable publicity objects; presentation boards; counters [tables]; corks for bottles; cork or cork substitute stoppers; corks; sealing caps, not of metal; shims, not of metal; towel dispensers, fixed, not of metal; drawer dividers; sea shells; photograph frames; picture frames; mirror frames; tanks, not of metal nor of masonry; water tanks of plastic; water tanks of plastic for household purposes; water tanks of plastic for industrial purposes; bone carvings; fodder racks; artificial horns; antlers; rattan, unworked or semi-worked; sculptures of bone, ivory, plaster, plastic, wax or wood; sculptures of plastic; vats, not of metal; bungs, not of metal; statues of wax; statues of plaster; statues of wood; statues of wood, wax, plaster or plastic; statues of bone; statues of bone, ivory, plaster, plastic, wax or wood; statues of plastic; statues of ivory; figurines of wood, wax, plaster or plastic; statuettes of resin; oyster shells; glass for use in framing art; silvered glass [mirrors]; metal shelving; paper racks [furniture]; non-metallic

stands; dressing tables; three-mirror dressing tables; washstands [furniture]; tables; display tables; placards of wood or plastics; crates of wood; crates; crates of plastic; straw plaits; articles made of wood, cork, reed, thatch, willow, horn, bone, ivory, whalebone, tortoiseshell, shells, amber, mother-of-pearl, meerschaum, of substitutes of such materials or plastics, included in this class; plastic squeeze tubes, empty; gift package decorations made of plastic; plastic decorations for cosmetic bottles; figures of bone, ivory, plaster, plastic, wax or wood; cold cast resin figurines; figurines [statuettes] of bone or ivory; figures made of rattan; plastic molds for making soap; plastic molds for making soap for commercial production purposes; lounge chairs for cosmetic treatments; plastic shields (small plates used to mark products whereon technical, decorative or advertising information is applied); caskets; cabinets for storing cosmetics; mirrored cabinets; display cabinets; cases of wood or plastic; storage boxes for cosmetics, not of metal; plant stand room dividers.

21 – Atomizers for household purposes; cotton ball jars; storage jars of glass; potpourri dishes; bottles; squeeze bottles; spray bottles; spray bottles, empty; cleaning cotton; buckets made of woven fabrics; feather brooms; hair for brushes; cattle hair for brushes; funnels; large-toothed combs for the hair; hair combs, electric; sponges; abrasive sponges for scrubbing the skin; facial sponges for applying make-up; sponges for applying body powder; bath sponges; facial cleansing sponges; microdermabrasion sponges for cosmetic use; mesh sponges for scrubbing the body; mesh sponges made of nylon for cleaning the body; toilet sponges; soap dispensers; glass dispensers for cosmetics, unfilled; household or kitchen utensils and containers; household containers; shaving bowls; lotion containers, empty, for household purposes; glass jars [carboys]; glass flasks [containers]; chamois leather for cleaning; ceramics for household purposes; majolica; glassware, porcelain and earthenware not included in other classes; works of art of porcelain, ceramic, earthenware, terra-cotta or glass; droppers, empty, for cosmetic purposes; brushes for use in hair tinting; shaving brushes; shaving brushes of badger hair; lip brushes; make-up brushes; polishing leather; glass bulbs [receptacles]; fitted vanity cases; fused silica [semi-worked product], other than for building; lids for containers for cosmetics; shaving pots; soap boxes; wall-mounted soap dis-

hes; canister sets; dental care kits comprising toothbrushes and floss; toilet cases; sprinklers; shower caddies; applicator sticks for applying make-up; gloves for hairstyling (dyeing, permanent); exfoliating gloves; exfoliating pads; foot exfoliating pads; shelves for cosmetics; painted glassware; cosmetic utensils; toilet utensils; deodorizing apparatus for personal use; make-up removing appliances; appliances for removing make-up, non-electric; appliances for removing make-up, electric; glass stoppers; powder compacts; powder compacts sold empty; sprayers for cleaning gums and teeth; vials, bottles and containers, included in this class; perfume vaporizers; powder puffs; grass sprinklers; dispensers for liquid soap; dispensers for facial tissues; dispensers for cellulose wipes, for household purposes; foam toe separators for use in pedicures; eyelash separators; combs; hairbrushes; combs for back-combing hair; combs and sponges; electric combs; plastic bath racks [caddies]; beaters, non-electric; glasses [receptacles]; statues of porcelain, ceramic, earthenware, terra-cotta or glass; figurines [statuettes] of porcelain, ceramic, earthenware or glass; exfoliating slippers; aerosol dispensers, not for medical purposes; water apparatus for cleaning teeth and gums; watering devices; hot air hair brushes; flasks; bottles for applying hair color; empty vials for cosmetic formulations; perfume atomizers, empty; comb cases; bowls for use in hair tinting; mixing bowls; back scratchers; neoprene zippered bottle holders; cosmetic spatulas; cosmetic spatulas for use with depilatory preparations; animal bristles [brushware]; pig bristles for brush-making; brushes; electric rotating hair brushes; electrically heated hair brushes; bath brushes; bottle brushes; scrubbing brushes; brushes, except paintbrushes; toothbrushes; toothbrushes, non-electric; toothbrushes, electric; toilet brushes; eyebrow brushes; nail brushes; boxes for dispensing paper towels; boxes of metal, for dispensing paper towels; household containers fitted for storage of bleaching preparations and other household detergents; household containers fitted for storage of perfumes, cosmetic products, hair lotions, shampoos, toothpastes and powders; household containers fitted for storage of cosmetic and hygienic products; household containers fitted for storage of pharmaceutical, hygienic and veterinary preparations; household containers for general storage of dietary substances; household containers for general storage of disinfectants, fungicides, herbici-

des, insecticides and preparations for the destruction of harmful animals; cleaning swabs.

35 – Arranging subscriptions to telecommunication services for others; modeling agencies; import-export agency services; commercial information agency services; advertising agency services; business administration; administrative processing of orders; business management analysis; analysis of market research data and statistics; market analysis and research; analysis of business data; marketing analysis; analysis of advertising response; analysis of response to advertising; cost price analysis; cost-benefit analysis; leasing of advertising space on the Internet; rental of advertising space; business auditing; business consultancy; strategic business planning; business advice relating to advertising; computerized file management; preparation of publicity materials; book-keeping; vending machine services; invoicing; business management and administration; demonstration of goods; demonstration of goods for advertising purposes; arranging of contracts, for others, for the purchase and sale of goods and services; arranging of advertising contracts for others; arranging commercial transactions, for others, via on-line shops; purchasing of goods and services for other businesses; opinion polling; market studies; Internet advertising services; business information; commercial information and advice for consumers [consumer advice shop]; market research in the field of advertising; business investigations; business research; marketing research; personnel recruitment; computerized accounting; business management and organization consultancy; advertising and marketing consultancy; business management advice and assistance; market research consultancy; business management consultancy in the field of transport and delivery services; advice on commercial management in the field of services for the production of cosmetic, hygienic and medicinal and cosmetic products; corporate management consultancy; business organization consultancy; business management consultancy; professional business consultancy; procurement of contracts for others; layout services for advertising purposes; marketing; marketing and promotional activities relating to business administration and management; marketing and promotional services; product marketing; business project management and administration; commercial management; business management; merchandising services; news clipping services;

updating and maintenance of data in computer databases; updating of advertising material; compilation of market conjuncture data via computer databases; word processing; arranging and concluding commercial transactions for others; arranging and conducting of advertising events; personnel management assistance; arranging of auctions; organization of exhibitions for commercial or advertising purposes; organization of exhibitions and events for commercial or advertising purposes; organization of exhibitions and trade fairs for commercial or advertising purposes; arranging and conducting of auctions; arranging and conducting of auctions and reverse auctions via computer and telecommunication networks; arranging and conducting of commercial exhibitions and shows; arranging and conducting of trade shows; arranging and conducting of promotional and marketing events; arranging and conducting of trade fairs for commercial or advertising purposes; organizing and conducting trade fairs, events and exhibitions for commercial or advertising purposes; organization and management of customer loyalty programs; organization of events, exhibitions, fairs and shows for commercial, promotional and advertising purposes; organization, operation and supervision of sales and promotional incentive schemes; organization, operation and supervision of loyalty and incentive schemes; arranging newspaper subscriptions for others; arranging subscriptions to online publications for others; organization of fashion shows for promotional purposes; organization of fashion shows for commercial purposes; organization, operation and supervision of customer loyalty schemes; organization of advertising events; organization of trade fairs for commercial or advertising purposes; shop window dressing; preparation and compilation of business and commercial reports and information; provision of marketing reports; marketing assistance; provision and rental of advertising space and outdoor advertising space; provision and rental of advertising space and publicity material; providing information and advice to consumers regarding the selection of products and items to be purchased; provision of space on web sites for advertising goods and services; presentation of companies on the Internet and other media; presentation of companies and their goods and services on the Internet; presentation of goods on communication media, for retail purposes; conducting of trade fairs; auctioneering;

retail sale or wholesale of medicines, hygiene products and medical supplies; on-line promotion of computer networks and web sites; promotion, advertising and marketing of on-line web sites; sales promotions at point of purchase or sale, for others; sales promotion for others; promoting the goods and services of others through advertisements on Internet web sites; promoting the goods and services of others on the Internet; rental of advertising time on communication media; publicity material rental; direct marketing; publication of printed matter for advertising purposes; publication of printed matter for advertising purposes in electronic form; publication of publicity materials on-line; publication of publicity materials; publication of publicity materials and texts; publication of publicity texts; radio advertising; development and implementation of marketing strategies for others; marketing strategy planning; bill-posting; distribution of samples for advertising purposes; distribution of flyers, brochures, printed matter and samples for advertising purposes; distribution of samples; distribution of advertising matter; dissemination of advertising matter; dissemination of advertisements; dissemination of advertising for others via the Internet; dissemination of advertising for others via an on-line electronic communications network; distribution of products for advertising purposes; direct mail advertising; writing of publicity texts; advertising; banner advertising; advertising of business web sites; advertising in periodicals, brochures and newspapers; advertising in the popular and professional press; advertising via mobile telephone networks; online advertising on a computer network; advertising and promotion services and information services relating thereto; on-line advertising; advertising by mail order; television advertising; media buying services; mail order retail services for clothing and clothing accessories; retail services provided by means of mail order catalogs for cosmetics, hygienic and medicinal products; classified advertising; the bringing together, for the benefit of others, of a variety of goods, excluding the transport thereof, enabling customers to conveniently view and purchase those goods; event marketing; business advice relating to franchising; advisory services relating to marketing; cooperative advertising and marketing; compilation of directories for publishing on the Internet; arranging of contracts, for others, for the provision of services; compilation of

mailing lists; copywriting; compilation of advertisements for use as web pages on the Internet; promoting the goods and services of others; telemarketing services; brand testing; business advice relating to marketing; business administration in the field of transport and delivery services; commercial administration of the licensing of the goods and services of others; administrative processing of purchase orders; computerized inventory control; public relations; promotional marketing; information services relating to advertising; advisory and consultancy services relating to the procurement of goods for others; advisory services relating to business risk management; business marketing consultancy; consultation services for administration and management of cosmetological and health centers; advisory services relating to the operation of franchises; consultancy services relating to the management of telephone call centers; modelling for advertising or sales promotion; marketing agency services; business administration services for the processing of sales made on the Internet; initiating telephone calls for others; market research services regarding Internet usage habits and customer loyalty; web site traffic optimisation; brand evaluation services; advertising planning services; brand positioning services; search engine optimisation; provision of information and advisory services relating to e-commerce; computerized business information services; provision of advertising space; brand strategy services; press advertising services; on-line advertising and marketing services; publicity and sales promotion services; advertising research; retail or wholesale services for cosmetics; business assistance, management and information services; branding services; compilation of direct mailing lists; price comparison services; promotional services; business strategy development; business management services relating to franchising; mail order retail services for cosmetics; advertising and promotion services; pay per click advertising; advertising and publicity services provided via television, radio or mail; advertising services provided via the Internet; retail or wholesale services for cosmetics, toiletries, dentifrices, soaps and detergents; services of retail Internet shops of cosmetics, perfumes and cosmetics, hygienic and medicinal and cosmetic goods; on-line retail store services featuring cosmetic and beauty products, clothing and accessories; procurement services for others [purchasing goods and

services for other businesses]; business advisory services relating to the establishment and operation of franchises; export agency services.

39 – Bottling services; temporary storage of personal belongings; temporary storage of deliveries; delivery of newspapers; parcel delivery; delivery of gift baskets with selected items regarding a particular occasion or theme; delivery of messages by courier; delivery of goods; delivery of goods by mail order; delivery of goods and messages accompanied by balloons or novelty presentations; delivery of goods by courier; delivery of packages by courier; delivery of cosmetics, hygienic and medicinal and cosmetic goods; booking of transport; transportation information; storage information; advisory services relating to the delivery of goods; consultancy relating to the transportation, packaging, and storage of goods; vehicle routing by computer on data networks; global transportation of freight for others by all available means; monitoring and tracking of package shipments [transport information]; national transportation; providing information relating to the delivery of documents, letters and packages; providing information relating to the transportation and storage of goods; provision of information regarding the order of delivery of "customized" or standard goods via the Internet; providing information about temporary storage services; providing on-line information in the field of transport, packaging and storage of goods; express delivery of freight; express delivery of letters; organization of transport service; arranging of transport; arranging for the shipping of cargo; arranging for the transportation and storage of goods; arranging for the transportation of goods by sea; arranging of transport services; arranging for the storage of goods; dispatch of goods; tracking and tracing of shipments [transport information]; tracking and tracing services for letters and packages [transport information]; armored-car transport; shipping of goods; truck hauling; hauling; carting; transport and storage of trash; transporting furniture; transportation, packaging and storage of goods; car transport; boat transport; railway transport; river transport; portage; pick-up and delivery of packages and goods; packaging of goods; bottling in jars and bottles of cosmetic, hygienic and medicinal and cosmetic products; collection, transportation and delivery of goods, shipping documents, parcels and advertising and marketing correspondence by va-

rious means of transport; supply chain logistics and reverse logistics services consisting of the storage, transportation and delivery of freight; goods warehousing; parcel shipping services; messenger services; express delivery of goods by truck; express delivery of goods by air; transport and storage of goods; transport and storage of goods in refrigerated conditions; transportation of cosmetic products and its components; transportation of goods and parcels; transportation of goods by road; transportation, storage and delivery of cosmetic products; packing articles for transportation; packaging articles to the order and specification of others; packaging and parcelling of goods for transport; packaging and storage of goods; packaging and storage of goods and packages; packaging articles for transportation; wrapping of goods; packing of goods in containers; packing of merchandise; merchandise packaging for others; packaging of goods in transit; packing of goods using sustainable or biodegradable packaging and shipping materials; chauffeur services; delivery services; same day delivery services; courier services [messages or merchandise]; cargo delivery services; logistics services including transportation, packaging, storage and delivery of goods; delivery logistical support services; transportation services provided to individuals; packaging services; gift wrapping; warehouse storage; transport; packing, crating and warehousing services; refrigerated storage of goods; storage of cargo; physical storage of electronically stored data or documents; storage and handling of goods; storage of goods; storage; storage of goods in transit; freight forwarding; express delivery of goods.

42 – Analysis in the field of molecular biology; water analysis; analysis and evaluation of product design; analysis and evaluation of product development; analysis of the compatibility of components of cosmetic and medicinal and cosmetic products selected for the preparation of the final "customized" product according to user orders; chemical analysis; biological and chemical research; biochemical research; web site design; retail design services; design of Internet pages; design and updating of homepages and web pages; industrial design; design, creation and programming of web pages; product design; graphic arts design; technical measuring and testing laboratory services; clinical trials; material testing; product research and development; biotechnological research; cos-

metic research; research in the fields of chemistry and biology; research in the field of gene therapy; research and development of new products for others; research and development services in the field of biochemistry; research and development services in the field of biotechnology; research and development services in the field of diagnostic preparations; scientific research; research services for the development of new products; consulting in the field of cosmetology research; consultancy relating to research and development in the field of therapeutics; consultancy relating to laboratory testing; design consultancy; technical consultancy relating to research services in the field of foods and dietary supplements; consultancy and information services relating to the design, programming and maintenance of computer software; consultancy and research services in the fields of science, engineering and information technology; advisory services relating to gene therapy research; quality control; quality control testing; quality control of goods; quality control of goods and services; laboratory research in the field of bacteriology; laboratory research in the field of cosmetics; laboratory research in the field of chemistry; scientific and industrial research; scientific research for medical purposes; scientific research and analysis; scientific research and development; scientific research in the field of hair care preparations; providing information relating to technological research; providing information and data relating to scientific and technological research and development; providing information and data related to research and development in the field of medicine and hygienic-cosmetic care; providing information in the field of product design; providing information in the field of product development; providing online information on industrial analysis and research services; industrial research, development and testing; conducting clinical trials for pharmaceuticals; design and development of technologies in the field of cosmetology; industrial and graphic art design; product development; testing, analysis and evaluation of the goods and services of others for the purpose of certification; testing, analysis and evaluation of the goods of others for the purpose of certification; quality control testing of products; quality control testing of products for certification purposes; quality testing of products for certification purposes; product testing; conducting of quality control tests; conduc-

ting of quality control tests on goods and services; analytical laboratory services; chemical research and analysis; biological laboratory services; biomedical research; chemistry services; technological research services; laboratory testing; scientific and technological services and research and design relating thereto; scientific and technological services and research and development relating thereto; scientific laboratory services; computer-aided scientific research, testing and analysis services; research and design services; research and development services in the field of bacteriology; research and development services in the field of gene expression systems; research and development services in the field of immunology; research and development services in the field of chemistry; research and development services in the field of cytology; research, testing and analysis services; scientific research, testing and analysis services; laboratory research and analysis; design services relating to printed matter; industrial analysis; industrial analysis and research services in the field of chemistry; industrial analysis and industrial research services; industrial research, testing and analysis services; drug discovery services; cosmetic and medicinal product development services; styling [industrial design]; testing services for the certification of quality or standards; technical testing and quality control services; quality control services for certification purposes; technical measuring services; technical design; technical testing services; technological services and research and design relating thereto; chemical and biological laboratory services; hosting web portals; hosting an on-line web site for creating and hosting micro web sites for businesses; hosting the web sites of others; hosting and rental of memory space for web sites; hosting computer databases; hosting computer software applications for others; hosting multimedia entertainment and educational content for others; hosting memory space on the Internet; hosting e-commerce platforms on the Internet; hosting customized web pages; hosting platforms on the Internet; hosting electronic memory space on the Internet for advertising goods and services; electronic data storage; inspection of goods for quality control; maintenance and consultancy services relating to software used in the field of e-commerce.

44 – Analysis of human body composition for medical purposes; public bath services for hygiene purposes; Turkish bath services; depilatory wa-

xing; hair restoration; hygienic and beauty care for human beings; dermatological services for treating skin conditions; dietary advice; health and beauty care; hair weaving; information relating to massage; consultancy in the field of cosmetics; consultations in the field of face, body and hair cosmetic care, conducted through the Internet; medical consultancy; advice relating to allergies; pharmacy advice; nutritional and dietetic consultancy; lifestyle counselling; beauty consultancy; consulting and information services, including via the Internet, related to biopharmaceutical products; consulting and information services, including via the Internet, related to medicinal products; consulting and information services, including via the Internet, related to pharmaceutical products; consultation services in the field of make-up; consultancy in the field of body and beauty care; consultation services relating to beauty care; beauty consultation services; advisory services relating to weight control; advisory services relating to medical apparatus and instruments; advisory services relating to health; advisory services relating to weight loss; advisory services relating to nutrition; advisory services relating to hair care; consultation services relating to skin care; advisory services relating to pharmaceutical products; medical consultations; medical and pharmaceutical consultation; medical assistance consultancy provided by doctors and other specialized medical personnel; beauty therapy services; cosmetic surgery; cosmetic body care services; hair treatment; aromatherapy services; manicuring; massage; medical care; medical care and analysis services relating to patient treatment; medical analysis for the diagnosis and treatment of persons; medical analysis services relating to the treatment of persons; medical analysis services relating to the treatment of patients; medical diagnostic services [testing and analysis]; medical and surgical diagnostic services; medical and surgical services; medical counselling; medical counselling relating to stress; lifestyle counselling and consultancy for medical purposes; medical, medicinal and pharmaceutical consultancy; medical treatment services provided by clinics and hospitals; medical treatment services provided by a health spa; physical examination; geriatric nursing services; medical testing for diagnostic or treatment purposes; hair styling; providing information in the field of medicine; medical testing services for fitness evaluation; medical testing; hair colo-

ring services; on-line make-up consultation services; teeth whitening services; hairdressing; barbers' services; hairdressing and beauty salon services; pedicure services; hair replacement; weight reduction diet planning and supervision; preparation of prescriptions in pharmacies; medical assistance; provision of health information; providing information about beauty; providing information in the field of hair styling; providing information relating to massage; providing information relating to physical examinations; providing information relating to hairdressing and beauty salon services; providing information relating to medical services; providing information relating to moxibustion; providing information relating to dietary and nutritional supplements; providing information relating to traditional Japanese massage; providing information to patients in the field of administering medication; providing health care information by telephone and the Internet; providing information relating to the preparation and dispensing of medications; provision of medical information; provision of medical information from a web site; nutrition counselling; provision of sauna, beauty salon, hairdressing and massage services; pharmaceutical advice; provision of pharmaceutical information; dispensing of pharmaceuticals; dietary and nutritional guidance; beauty salon services; health spa services for health and wellness of the body and spirit; medical information services provided via the Internet; health counselling; tanning salon and solarium services; hair cutting; tattooing; bodywork therapy; traditional Japanese massage; hair removal by electrolysis; health spa services; visagists' services; hygienic and beauty care for human beings or animals; artificial suntanning services; permanent hair removal and reduction services; hot tub services; services rendered by a dietician; health spa services for health and wellness of the body and spirit incorporating massage, facial and body treatment services, and cosmetic body care services; health and beauty treatment services; individual medical counselling services provided to patients; personal hair removal services; beauty and hair care services; medical and health care clinic services; advisory services relating to health care; cosmetic body care services provided by health spas; cosmetic treatment services for the body, face and hair; cosmetic analysis services for determining the most appropriate cosmetics to be used with a person's face shape and skin tone;

cosmetic and plastic surgery; cosmetician services; laser hair removal services; manicure and pedicure services; nail salon services; health and beauty care services provided by saunas, beauty salons, sanatoriums, hairdressing salons and massage parlors; medical services; medical evaluation services; alternative medicine services; body piercing services; pharmacy dispensary services; make-up consultation and application services; make-up consultation services provided on-line or in-person; beauty treatment services; nail treatment services; facial treatment services; medical, hygienic and beauty care; providing weight loss program services; hair styling services; home health care services; beauty care services; skin care salon services; solarium services; beauty care services provided by a health spa; health spa services for health and wellness of the body and spirit offered at a health resort; hair care services; pharmacists' services to make up prescriptions; electrolysis and depilatory services; cosmetic electrolysis.

(260) AM 2020 107738 A
(800) 1522597
(151) 2019 12 19
(891) 2019 12 19
(731) "Intelligent Systems of Business Control" Ltd
Zavodskaja, 1b, str. 1, fl. 1, room 7,
Zelenograd, RU-124365 Moscow, Russian
Federation
(540)

JEWE

(591) Black, white
(531) 27.05.01; 27.05.17
(511)
9 – Radio frequency identification devices (RFID systems); apparatus and components of radio frequency identification devices (RFID systems), including module RFID readers and recorders, RFID tags, readers, recording devices for transmitting information and communication with RFID tags, programming devices for programming RFID tags, where RFID tags are in form of cards, tags or key rings; contact smart chips; chips (integrated circuits), namely RFID cards; computer network data routers used in security and access control; computer software for issuing and managing RFID tags; magnetic data media; optical data media;

computer hardware for processing and protecting information.

(260) AM 2020 107740 A
(800) 1522643
(151) 2020 02 18
(891) 2020 02 18
(731) Kerten Unlimited Company
13-18 City Quay, Dublin 2, Ireland
(540)

CHARCOOD

(591) Black, white
(511)
43 – Services in providing food and drink; restaurant services; diner, café and snack bar services; takeaway food and drink services; food and drink preparation services; catering services for providing food and drink; fast food restaurant services; provision of prepared meals; reservations and bookings for restaurants; personal chef services; consultancy and advisory services relating to the aforesaid.

(260) AM 2020 107741 A
(800) 1522678
(151) 2019 12 27
(891) 2019 12 27
(731) Ferronordic AB
Nybrogatan 6, SE-114 34 Stockholm, Sweden
(540)



FERRONORDIC

(591) Black, brown
(531) 07.11.25; 27.05.01; 29.01.12
(511)
7 – Construction machines; road making machines; agricultural machines; motors and engines (except for land vehicles); machine coupling and transmission components (except for land vehicles); agricultural implements, other than hand-operated; excavators and loader buckets; cranes [lifting and hoisting apparatus]; road rollers and road rollers; loading ramps; handling apparatus for loading and unloading; controls (hydraulic -) for machines, motors and engines; hydraulic engines and motors; hydraulic devices for opening and

closing doors; pumps [machines]; filters [parts of machines or engines]; spare parts and components for all the aforesaid goods.

12 – Cars; vehicles; apparatus for locomotion by land, air or water; forklift trucks and forklift trucks; lorries and tipping bodies for lorries; motors for land vehicles; tires for vehicle wheels; spare parts and components for all the aforesaid goods.

37 – Building construction; demolition of buildings; repair and maintenance of construction machines, road-making machines and agricultural machines, motors and engines (except for land vehicles), machine coupling and transmission components (except for vehicles), agricultural implements, other than hand-operated, excavators and loader buckets, cranes (lifting and hoisting apparatus), road rollers and road rollers, loading ramps, handling apparatus for loading and unloading, hydraulic controls for machines, motors and engines and engines, hydraulic engines and motors, hydraulic door openers and closers; repair and maintenance of pumps [machines], filters [parts of machines or engines], cars, vehicles, apparatus for locomotion by land, air or water, forklift trucks, lorries and tipping bodies for lorries, engines for vehicles, tyres for vehicle wheels, spare parts and components for all the aforesaid goods; installation services relating to equipment for construction machines, road-making machines and agricultural machines, motors and engines (except for land vehicles), machine coupling and transmission components (except for vehicles), agricultural implements, other than hand-operated, excavators and loader buckets, cranes (lifting and hoisting apparatus), road rollers and road rollers, loading ramps, handling apparatus for loading and unloading, hydraulic controls for machines, motors and engines and engines, hydraulic engines and motors, hydraulic door openers and closers; installation services relating to equipment for pumps (machines), filters [parts of machines or engines], cars, vehicles, apparatus for locomotion by land, air or water, forklift trucks, lorries and tipping bodies for lorries, engines for vehicles, tyres for vehicle wheels, spare parts and components for all the aforesaid goods; rental of excavators, earth-moving machines and construction equipment; asphaltting; tyre repair.

(260) AM 2020 107742 A

(800) 475751

(151) 1983 04 07

(891) 2020 02 10

(731) Doxa Uhren AG (Montres Doxa SA) (Doxa Watches Ltd)
Zürichstrasse 23, CH-2504 Biel/Bienne,
Switzerland

(540)

DOXA

(591) Black, white

(531) 27.05.01; 27.05.17

(511)

14 – Timepieces and their parts.

(260) AM 2020 107744 A

(800) 1126518

(151) 2012 06 19

(891) 2020 03 10

(731) MARTIDERM SL.

Garnatxa, 20-22, Parque Empresarial
de Cervello, E-08758 Cervelló, Spain

(540)

MARTIDERM

(591) Black, white

(511)

3 – Cosmetics; perfumery; essential oils; hair care lotions; dentifrices.

სამართაშორისო სასაქონლო ნიშნები,
რომლებსაც მიენიჭათ ღაცვა საქართველოში

(260) AM 2020 103937 A (800) 1148450 (151) 2012 12 21 (181) 2022 12 21 (891) 2019 05 29 (511) 28	(260) AM 2020 104719 A (800) 1485177 (151) 2019 02 27 (181) 2029 02 27 (891) 2019 02 27 (511) 06, 07, 19, 35, 37
(260) AM 2020 104051 A (800) 1130990 (151) 2012 06 05 (181) 2022 06 05 (891) 2019 04 05 (511) 09	(260) AM 2020 104735 A (800) 1283380 (151) 2015 07 07 (181) 2025 07 07 (891) 2019 08 13 (511) 09, 16, 28, 35, 41, 42
(260) AM 2020 104167 A (800) 936294 (151) 2007 07 26 (181) 2027 07 26 (891) 2019 05 27 (511) 09, 11, 35	(260) AM 2020 104836 A (800) 1486192 (151) 2019 04 25 (181) 2029 04 25 (891) 2019 04 25 (511) 09, 12, 15, 20, 21, 25, 28, 36, 37, 39, 41, 42
(260) AM 2020 104168 A (800) 1218187 (151) 2014 01 31 (181) 2024 01 31 (891) 2019 05 27 (511) 07, 08, 09, 11, 16, 21, 28, 35	(260) AM 2020 104840 A (800) 1486254 (151) 2019 01 28 (181) 2029 01 28 (891) 2019 01 28 (511) 03, 09, 14, 16, 24, 26, 35
(260) AM 2020 104225 A (800) 1478305 (151) 2019 05 16 (181) 2029 05 16 (891) 2019 05 16 (511) 32	(260) AM 2020 104871 A (800) 1487010 (151) 2019 04 05 (181) 2029 04 05 (891) 2019 04 05 (511) 03, 35
(260) AM 2020 104696 A (800) 1484716 (151) 2019 03 28 (181) 2029 03 28 (891) 2019 03 28 (511) 35, 44	(260) AM 2020 104945 A (800) 1487163 (151) 2019 04 17 (181) 2029 04 17 (891) 2019 04 17 (511) 06, 09, 11

(260) AM 2020 104984 A
 (800) 1488093
 (151) 2019 06 12
 (181) 2029 06 12
 (891) 2019 06 12
 (511) 35

(181) 2029 07 29
 (891) 2019 07 29
 (511) 03, 04

(260) AM 2020 104987 A
 (800) 1488158
 (151) 2019 07 10
 (181) 2029 07 10
 (891) 2019 07 10
 (511) 12

(260) AM 2020 105084 A
 (800) 1489074
 (151) 2019 07 29
 (181) 2029 07 29
 (891) 2019 07 29
 (511) 03, 04

(260) AM 2020 105046 A
 (800) 1488239
 (151) 2019 05 14
 (181) 2029 05 14
 (891) 2019 05 14
 (511) 35, 36, 38

(260) AM 2020 105093 A
 (800) 1489302
 (151) 2019 07 02
 (181) 2029 07 02
 (891) 2019 07 02
 (511) 03, 35

(260) AM 2020 105066 A
 (800) 1488604
 (151) 2019 05 10
 (181) 2029 05 10
 (891) 2019 05 10
 (511) 09, 28, 41

(260) AM 2020 105099 A
 (800) 1489415
 (151) 2019 03 29
 (181) 2029 03 29
 (891) 2019 03 29
 (511) 11, 35, 37

(260) AM 2020 105069 A
 (800) 1488684
 (151) 2019 06 04
 (181) 2029 06 04
 (891) 2019 06 04
 (511) 01, 03, 07, 08, 11, 17, 18, 21, 22, 24,
 25, 32

(260) AM 2020 105168 A
 (800) 1489819
 (151) 2019 04 11
 (181) 2029 04 11
 (891) 2019 04 11
 (511) 06, 07, 11, 37

(260) AM 2020 105077 A
 (800) 1488933
 (151) 2019 06 17
 (181) 2029 06 17
 (891) 2019 06 17
 (511) 06, 11

(260) AM 2020 105169 A
 (800) 1489823
 (151) 2019 07 23
 (181) 2029 07 23
 (891) 2019 07 23
 (511) 09

(260) AM 2020 105078 A
 (800) 1488952
 (151) 2019 07 29

(260) AM 2020 105170 A
 (800) 1489844
 (151) 2019 07 23
 (181) 2029 07 23
 (891) 2019 07 23
 (511) 09

(260) AM 2020 105171 A
(800) 1489850
(151) 2019 07 23
(181) 2029 07 23
(891) 2019 07 23
(511) 09

(260) AM 2020 105172 A
(800) 1489883
(151) 2019 06 24
(181) 2029 06 24
(891) 2019 06 24
(511) 07, 12

(260) AM 2020 105174 A
(800) 1490020
(151) 2019 08 15
(181) 2029 08 15
(891) 2019 08 15
(511) 10

(260) AM 2020 105175 A
(800) 1490026
(151) 2019 07 09
(181) 2029 07 09
(891) 2019 07 09
(511) 05, 35

(260) AM 2020 105177 A
(800) 1490064
(151) 2019 08 01
(181) 2029 08 01
(891) 2019 08 01
(511) 03

(260) AM 2020 105180 A
(800) 1490099
(151) 2019 08 21
(181) 2029 08 21
(891) 2019 08 21
(511) 09

(260) AM 2020 105181 A
(800) 1490130
(151) 2019 07 18
(181) 2029 07 18

(891) 2019 07 18
(511) 04, 35

(260) AM 2020 105186 A
(800) 1490278
(151) 2019 05 13
(181) 2029 05 13
(891) 2019 05 13
(511) 36

(260) AM 2020 105189 A
(800) 1490326
(151) 2018 12 14
(181) 2028 12 14
(891) 2018 12 14
(511) 03

(260) AM 2020 105190 A
(800) 1490328
(151) 2019 08 15
(181) 2029 08 15
(891) 2019 08 15
(511) 01, 05

(260) AM 2020 105194 A
(800) 1490488
(151) 2019 07 04
(181) 2029 07 04
(891) 2019 07 04
(511) 09

(260) AM 2020 105203 A
(800) 1248737
(151) 2015 04 09
(181) 2025 04 09
(891) 2019 08 12
(511) 05

(260) AM 2020 105204 A
(800) 1391348
(151) 2017 06 27
(181) 2027 06 27
(891) 2019 08 21
(511) 28

(260) AM 2020 105206 A
 (800) 1418048
 (151) 2018 02 16
 (181) 2028 02 16
 (891) 2019 08 05
 (511) 03

(891) 2019 08 02
 (511) 25

(260) AM 2020 105261 A
 (800) 1490721
 (151) 2019 07 12
 (181) 2029 07 12
 (891) 2019 07 12
 (511) 09, 12, 36, 37, 38, 39

(260) AM 2020 105278 A
 (800) 1491025
 (151) 2019 05 15
 (181) 2029 05 15
 (891) 2019 05 15
 (511) 21, 29, 30, 32, 35, 43

(260) AM 2020 105262 A
 (800) 1490746
 (151) 2019 05 13
 (181) 2029 05 13
 (891) 2019 05 13
 (511) 36

(260) AM 2020 105279 A
 (800) 1491069
 (151) 2019 04 02
 (181) 2029 04 02
 (891) 2019 04 02
 (511) 09, 38, 42, 45

(260) AM 2020 105263 A
 (800) 1490763
 (151) 2019 05 13
 (181) 2029 05 13
 (891) 2019 05 13
 (511) 36

(260) AM 2020 105280 A
 (800) 1491078
 (151) 2019 09 04
 (181) 2029 09 04
 (891) 2019 09 04
 (511) 32

(260) AM 2020 105265 A
 (800) 1490780
 (151) 2019 07 16
 (181) 2029 07 16
 (891) 2019 07 16
 (511) 43

(260) AM 2020 105282 A
 (800) 1491293
 (151) 2019 08 27
 (181) 2029 08 27
 (891) 2019 08 27
 (511) 43

(260) AM 2020 105275 A
 (800) 1490959
 (151) 2019 08 02
 (181) 2029 08 02
 (891) 2019 08 02
 (511) 09

(260) AM 2020 105292 A
 (800) 1491608
 (151) 2019 08 20
 (181) 2029 08 20
 (891) 2019 08 20
 (511) 09, 16, 28, 35, 38, 41, 42

(260) AM 2020 105277 A
 (800) 1490985
 (151) 2019 08 02
 (181) 2029 08 02

(260) AM 2020 105293 A
 (800) 1491627
 (151) 2019 07 23
 (181) 2029 07 23
 (891) 2019 07 23
 (511) 01

(260) AM 2020 105294 A
(800) 1491629
(151) 2019 07 24
(181) 2029 07 24
(891) 2019 07 24
(511) 25

(260) AM 2020 105305 A
(800) 1491782
(151) 2019 07 01
(181) 2029 07 01
(891) 2019 07 01
(511) 09, 16

(260) AM 2020 105307 A
(800) 1491822
(151) 2019 08 13
(181) 2029 08 13
(891) 2019 08 13
(511) 09

(260) AM 2020 105308 A
(800) 1491824
(151) 2019 08 19
(181) 2029 08 19
(891) 2019 08 19
(511) 09

(260) AM 2020 105310 A
(800) 1491924
(151) 2019 08 06
(181) 2029 08 06
(891) 2019 08 06
(511) 09

(260) AM 2020 105311 A
(800) 1491927
(151) 2019 08 19
(181) 2029 08 19
(891) 2019 08 19
(511) 09

(260) AM 2020 105313 A
(800) 1491936
(151) 2019 06 03
(181) 2029 06 03

(891) 2019 06 03
(511) 05, 29, 30, 32

(260) AM 2020 105314 A
(800) 1491970
(151) 2019 08 12
(181) 2029 08 12
(891) 2019 08 12
(511) 09, 28

(260) AM 2020 105315 A
(800) 1491976
(151) 2019 08 22
(181) 2029 08 22
(891) 2019 08 22
(511) 36, 38, 39

(260) AM 2020 105316 A
(800) 1491980
(151) 2019 09 10
(181) 2029 09 10
(891) 2019 09 10
(511) 21

(260) AM 2020 105317 A
(800) 1492078
(151) 2019 07 18
(181) 2029 07 18
(891) 2019 07 18
(511) 05

(260) AM 2020 105318 A
(800) 1492082
(151) 2019 07 16
(181) 2029 07 16
(891) 2019 07 16
(511) 18, 25

(260) AM 2020 105319 A
(800) 1492099
(151) 2019 07 31
(181) 2029 07 31
(891) 2019 07 31
(511) 07, 08, 16, 21, 35

(260) AM 2020 105320 A
 (800) 747921
 (151) 2000 12 07
 (181) 2020 12 07
 (891) 2019 09 05
 (511) 05

(891) 2019 04 18
 (511) 09, 35, 36, 38, 39, 41, 42, 43, 45

(260) AM 2020 105321 A
 (800) 903151
 (151) 2006 08 14
 (181) 2026 08 14
 (891) 2019 08 30
 (511) 01, 04

(260) AM 2020 105493 A
 (800) 1494130
 (151) 2019 05 10
 (181) 2029 05 10
 (891) 2019 05 10
 (511) 09, 28, 41

(260) AM 2020 105332 A
 (800) 1484295
 (151) 2019 04 16
 (181) 2029 04 16
 (891) 2019 08 27
 (511) 35

(260) AM 2020 105494 A
 (800) 1494139
 (151) 2019 09 10
 (181) 2029 09 10
 (891) 2019 09 10
 (511) 34

(260) AM 2020 105486 A
 (800) 1494009
 (151) 2019 08 26
 (181) 2029 08 26
 (891) 2019 08 26
 (511) 09

(260) AM 2020 105495 A
 (800) 1494145
 (151) 2019 04 30
 (181) 2029 04 30
 (891) 2019 04 30
 (511) 07, 09, 11, 12, 37

(260) AM 2020 105490 A
 (800) 1494056
 (151) 2019 08 13
 (181) 2029 08 13
 (891) 2019 08 13
 (511) 07

(260) AM 2020 105496 A
 (800) 1494160
 (151) 2019 09 10
 (181) 2029 09 10
 (891) 2019 09 10
 (511) 09

(260) AM 2020 105491 A
 (800) 1494087
 (151) 2019 09 06
 (181) 2029 09 06
 (891) 2019 09 06
 (511) 05

(260) AM 2020 105497 A
 (800) 1494165
 (151) 2019 08 09
 (181) 2029 08 09
 (891) 2019 08 09
 (511) 09

(260) AM 2020 105492 A
 (800) 1494127
 (151) 2019 04 18
 (181) 2029 04 18

(260) AM 2020 105498 A
 (800) 1494199
 (151) 2019 06 03
 (181) 2029 06 03
 (891) 2019 06 03
 (511) 05, 29, 30, 32

(260) AM 2020 105499 A
(800) 1494241
(151) 2019 07 31
(181) 2029 07 31
(891) 2019 07 31
(511) 03, 05, 09, 10, 41, 44

(260) AM 2020 105681 A
(800) 1496005
(151) 2019 07 19
(181) 2029 07 19
(891) 2019 07 19
(511) 09

(260) AM 2020 105688 A
(800) 1496146
(151) 2019 08 29
(181) 2029 08 29
(891) 2019 08 29
(511) 09, 36, 42

(260) AM 2020 105689 A
(800) 1496177
(151) 2019 06 25
(181) 2029 06 25
(891) 2019 06 25
(511) 09

(260) AM 2020 105848 A
(800) 1499380
(151) 2019 07 19
(181) 2029 07 19
(891) 2019 07 19
(511) 05

(260) AM 2020 105959 A
(800) 1293373
(151) 2016 01 28
(181) 2026 01 28
(891) 2019 10 22
(511) 32

(260) AM 2020 105995 A
(800) 1501104
(151) 2019 08 14
(181) 2029 08 14

(891) 2019 08 14
(511) 09, 28, 41

(260) AM 2020 105996 A
(800) 1501182
(151) 2019 10 16
(181) 2029 10 16
(891) 2019 10 16
(511) 09

(260) AM 2020 105997 A
(800) 1501192
(151) 2019 08 26
(181) 2029 08 26
(891) 2019 08 26
(511) 28

(260) AM 2020 106000 A
(800) 1501227
(151) 2019 09 05
(181) 2029 09 05
(891) 2019 09 05
(511) 30

(260) AM 2020 106016 A
(800) 1501634
(151) 2019 08 27
(181) 2029 08 27
(891) 2019 08 27
(511) 32, 33, 35

(260) AM 2020 106020 A
(800) 1501778
(151) 2019 10 10
(181) 2029 10 10
(891) 2019 10 10
(511) 01

(260) AM 2020 106021 A
(800) 1501780
(151) 2019 10 24
(181) 2029 10 24
(891) 2019 10 24
(511) 03

(260) AM 2020 106287 A
(800) 1497313
(151) 2019 07 26
(181) 2029 07 26
(891) 2019 07 26
(511) 34, 35, 43

(260) AM 2020 106359 A
(800) 1505771
(151) 2019 10 17
(181) 2029 10 17
(891) 2019 10 17
(511) 42

(260) AM 2020 106429 A
(800) 788486
(151) 2002 09 06
(181) 2022 09 06
(891) 2019 05 10
(511) 42

საქონლის ადგილწარმოშობის დასახელება

ადგილწარმოშობის დასახელების ღვინის „მალრანის ქისი“ წარმოების სპეციფიკაცია

სსიპ საქართველოს ინტელექტუალური საკუთრების ეროვნული ცენტრი – საქპატენტი „საქონლის ადგილწარმოშობის დასახელებისა და გეოგრაფიული აღნიშვნის შესახებ“ საქართველოს კანონის მე-8 მუხლის მე-4 პუნქტის შესაბამისად, აქვეყნებს ა(ა)იპ – „მალრანის ღვინის“ მიერ საქპატენტში წარმოდგენილი განაცხადის მასალებს.

თუ განაცხადის მასალების გამოქვეყნებიდან 3 თვის ვადაში ამ მასალებთან დაკავშირებით საქპატენტში არ შემოვა დამატებითი ინფორმაცია, ადგილწარმოშობის დასახელების რეგისტრაციის შესახებ ცნობები შეტანილი იქნება ადგილწარმოშობის დასახელებისა და გეოგრაფიული აღნიშვნის სახელმწიფო რეესტრში და გამოქვეყნდება საქართველოს სამრეწველო საკუთრების ოფიციალურ ბიულეტენში.

თუ განაცხადის მასალების გამოქვეყნებიდან სამი თვის ვადაში ამ მასალებთან დაკავშირებით საქპატენტში შემოვა დამატებითი ინფორმაცია, ის შესასწავლად გადაეგზავნება საქართველოს გარემოს დაცვისა და სოფლის მეურნეობის სამინისტროს.

მალრანის ქისი

ბანაცხადის № 3496/6

ბანაცხადის უბტანის თარიღი: 2020 27 01

ადგილწარმოშობის დასახელება: მალრანის ქისი

საქონლის დასახელება, რომლისთვისაც მოითხოვება ადგილწარმოშობის დასახელების რეგისტრაცია: ღვინო

ბანაცხადებლის სახელი და მისამართი: ა(ა)იპ – „მალრანის ღვინო“, სოფელი მალრანი, ახმეტის რაიონი, საქართველო (GE)

1. ადგილწარმოშობის დასახელება: მალრანის ქისი

2. პროდუქტის აღწერა

2.1. პროდუქტის კატეგორია

ღვინო „მალრანის ქისი“ შეიძლება იყოს მხოლოდ:

- თეთრი მშრალი;
- ქარვისფერი მშრალი.

2.2. პროდუქტის ორგანოლექტიკური მახასიათებლები

ღვინო „მალრანის ქისი“ თეთრი მშრალი უნდა აკმაყოფილებდეს შემდეგ მოთხოვნებს:

- ფერი – ღია ჩალისფრიდან ღია ოქროსფრამდე;
- არომატი და გემო – უზადო, გემოზე ნაზი, რბილი, ხალისიანი, ჰარმონიული, დახვეწილი, ამ გეოგრაფიული ადგილისთვის დამახასიათებელი ჯიშური არომატით, მინდვრის ყვავილების, ხილის (უმეტესად ვაშლის, მსხლის და ატმის) და ციტრუსის ტონებით;
- დავარგებისას ღვინოს უვითარდება გამშრალი ბალახების და ჩირების არომატები.

ღვინო „მალრანის ქისი“ ქარვისფერი მშრალი უნდა აკმაყოფილებდეს შემდეგ მოთხოვნებს:

- ფერი – ოქროსფრიდან მუქ ქარვისფრამდე;
- არომატი და გემო – უზადო, რბილი, დახვეწილი, ჰარმონიული, სხეულიანი, ხავერდოვანი, კარგად გამოხატული ჯიშური არომატით, ზომიერი და რბილი სიმწკლარტით. ახალგაზრდა ღვინოში ხილის არომატები დომინირებს, უმეტესად ვაშლის, მსხლის და ატმის;
- დავარგებისას ღვინოს უვითარდება ბუკეტი მოხალული ნუშის და გარგარის ჩირის ტონებით.

2.3. პროდუქტის ფიზიკური და ქიმიური მახასიათებლები

ღვინო „მალრაანის ქისი“ თეთრი მშრალი უნდა აკმაყოფილებდეს შემდეგ მოთხოვნებს:

- ფაქტობრივი მოცულობითი სპირტმემცველობა – არანაკლებ 11%;
- საერთო მოცულობითი სპირტმემცველობა – არაუმეტეს 15%;
- შაქრიანობა – არაუმეტეს 4 გ/ლ;
- ტიტრული მჟავიანობა ღვინომჟავაზე გადაანგარიშებით – არანაკლებ 5 გ/ლ;
- აქროლადი მჟავიანობა ძმარმჟავაზე გადაანგარიშებით – არაუმეტეს 1.0 გ/ლ;
- გოგირდის დიოქსიდის საერთო მასური კონცენტრაცია – არაუმეტეს 200 მგ/ლ;
- უმაქრო ექსტრაქტის მასის კონცენტრაცია არ უნდა იყოს 16 გ/ლ-ზე ნაკლები.

ღვინო „მალრაანის ქისი“ ქარვისფერი მშრალი უნდა აკმაყოფილებდეს შემდეგ მოთხოვნებს:

- ფაქტობრივი მოცულობითი სპირტმემცველობა – არანაკლებ 12%;
- საერთო მოცულობითი სპირტმემცველობა – არაუმეტეს 15%;
- შაქრიანობა – არაუმეტეს 4 გ/ლ;
- ტიტრული მჟავიანობა ღვინომჟავაზე გადაანგარიშებით – არანაკლებ 4 გ/ლ;
- აქროლადი მჟავიანობა ძმარმჟავაზე გადაანგარიშებით – არაუმეტეს 1.2 გ/ლ;
- გოგირდის დიოქსიდის საერთო მასური კონცენტრაცია – არაუმეტეს 150 მგ/ლ;
- უმაქრო ექსტრაქტის მასის კონცენტრაცია არ უნდა იყოს 22 გ/ლ-ზე ნაკლები.

3. წარმოების გეოგრაფიული ავბილის საზღვრები – მიკროზონა

მალრაანის მიკროზონა მდებარეობს შიდა კახეთში, ახმეტის მუნიციპალიტეტის ადმინისტრაციულ საზღვრებში. ჩრდილოეთიდან მას ესაზღვრება კავკასიონის ქედის სამხრეთ-დასავლეთის კალთები, დასავლეთიდან – ს. ფიჩხოვანისა და ს. ზემო ალვანის წყალგამყოფი ქედი, აღმოსავლეთიდან – ბაბანეურის სახელმწიფო ნაკრძალი, ხოლო სამხრეთიდან – მდინარე ბაბანეურის ფშა.

მალრაანის მიკროზონა მოიცავს სოფლებს: მალრაანი, ფიჩხოვანი, არგოხი და ბაბანეური.

ღვინო „მალრაანის ქისის“ წარმოებისათვის განკუთვნილი ყურძენი მოწეული უნდა იყოს მხოლოდ მალრაანის მიკროზონაში გაშენებული ვენახებიდან.

ყურძნის გადამუშავება და ღვინის დამზადება ხდება მალრაანის მიკროზონის ტერიტორიაზე. ყურძნის გადამუშავება და ღვინის დამზადება, ასევე, დასაშვებია მალრაანის მიკროზონის გარეთ, მხოლოდ კახეთის მევენახეობის ზონის ფარგლებში.

4. ვაზის ჯიშები

„მალრაანის ქისი“ შეიძლება დამზადდეს მხოლოდ ქისის ჯიშის ყურძნიდან (სინონიმი – „მალრაანული ქისი“). დაუშვებელია სხვა ჯიშების გამოყენება.

5. ვენახის გაშენება, სხვლა-ფორმირება და მოვლა

- მალრაანის მიკროზონაში ღვინო „მალრაანის ქისის“ დასამზადებლად განკუთვნილი სამეწარმეო ვენახები გაშენებული უნდა იყოს 400–800 მეტრის სიმაღლეზე ზღვის დონიდან;
- ვენახის რიგთაშორის მანძილი უნდა იყოს 1.0-დან 2.5 მეტრამდე;
- ვაზთაშორის მანძილი რიგში – 0.8–1.5 მეტრი;
- შტამბის სიმაღლე – 70–90 სმ;
- სხვლის ფორმა – ცალმხრივი ან ორმხრივი ქართული, ცალმხრივი ან ორმხრივი კორდონი, თავისუფალი.

6. ყურძნის სიმწიფე, რთველი, ტრანსპორტირება

ღვინო „მალრაანის ქისი“ მზადდება მწიფე ყურძნისაგან, რომლის შექრიანობა აკმაყოფილებს შემდეგ მოთხოვნებს:

- „მალრაანის ქისი“ თეთრი მშრალი – არანაკლებ 19%;
- „მალრაანის ქისი“ ქარვისფერი მშრალი – არანაკლებ 20%.

ღვინო „მალრაანის ქისი“ ქარვისფრის დასამზადებლად ყურძნის კლერტი უნდა იყოს მომწიფებული.

ყურძნის ტრანსპორტირება დასაშვებია მხოლოდ ხის ან პლასტმასის ყუთებით, აგრეთვე, უჟანგავი ფოლადის ძარებით. დაუშვებელია ყურძნის ტრანსპორტირებისას პოლიეთილენის პარკების და/ან ტომრების გამოყენება.

7. ყურძნის მოსავალი და ღვინის გამოსავალი

ყურძნის მოსავალი 1 ჰექტარ ვენახზე არ უნდა აღემატებოდეს 8 ტონას.

ღვინის გამოსავალი არ უნდა აღემატებოდეს 650 ლიტრს ერთი ტონა ყურძნიდან.

8. ყურძნის გადაგვარება, ღვინის დამზადება და ჩამოსხმა

- ღვინო „მალრაანის ქისი“ თეთრი მშრალი

ღვინო „მალრაანის ქისი“ თეთრი მზადდება მხოლოდ თვითნადენი ტკბილისგან. ყურძენს დაწურავენ, თვითნადენ ტკბილს დაწდომის შემდეგ ადუღებენ არაუმეტეს 20°C ტემპერატურაზე.

დასაშვებია დურდოს მაცერაცია დუღილამდე ან/და დუღილის დასაწყისში.

ღვინო შეიძლება დავარგდეს ან ჩამოსხას დავარგების გარეშე. დავარგების შემთხვევაში სავალდებულოა ღვინის დავარგება მუხის კასრებში არანაკლებ 6 თვის განმავლობაში.

- „მალრაანის ქისი“ ქარვისფერი მშრალი

„მალრაანის ქისი“ ქარვისფრის დამზადებისას ალკოჰოლური დუღილი მიმდინარეობს მხოლოდ ქვევრებში სრულ დურდოზე. დუღილი მიმდინარეობს არაუმეტეს 28°C ტემპერატურაზე ინტენსიური დარევის (დღეში 4-5-ჯერ) პირობებში. ალკოჰოლური დუღილის

დამთავრების შემდეგ ქვევრს გადაავსებენ ანალოგიური ღვინით და დააყოვნებენ დურდოზე არანაკლებ რთვლის მომდევნო წლის 1 თებერვლამდე. ამის შემდეგ ღვინოს მოხსნიან ჭაჭიდან და ლექიდან და გადააქვთ სხვა ჭურჭელში.

ღვინო შეიძლება დავარგდეს ან ჩამოსხას დავარგების გარეშე. დავარგების შემთხვევაში სავალდებულოა ღვინის დავარგება მუხის კასრებში არანაკლებ 6 თვის განმავლობაში.

ღვინო „მალრანის ქისის“ სამომხმარებლო ბაზარზე განთავსება დასაშვებია მხოლოდ არაუმეტეს 5 ლიტრი მოცულობის ბოთლებში დაფასოებული სახით.

9. კავშირი ღვინის განსაკუთრებულ ხარისხს, რეპუტაციასა და გეოგრაფიულ ადგილს შორის

9.1. ბუნებრივი ფაქტორები:

კლიმატი

მალრანის მიკროზონაში მიკროკლიმატს განაპირობებს ადგილობრივი რელიეფის თავისებურებები.

მალრანის მიკროზონის ვენახები გაშენებულია კავკასიონის სამხრეთ და სამხრეთ-დასავლეთ კალთებზე მდინარე მაჭარეულის, ბაბანეულისწყლის და მალრანისწყლის ხეობებში.

კლიმატი მიკროზონაში ზომიერი კონტინენტურია, შედარებით ნოტიო, ცხელი ზაფხულით და ხანგრძლივი ცივი ზამთრით.

მიკროზონა გამოირჩევა მზის რადიაციის მაღალი მაჩვენებლით, რადგან მიკროზონაში არსებული სავარგულები მიქცეულია სამხრეთით. მზის ნათების წლიური ხანგრძლივობა საკმაოდ მაღალია და 2050 საათს აღემატება. წლის საშუალო ტემპერატურა 12,2-12,4°C. წლის ყველაზე ცხელი თვე ივლისია. ზოგიერთ წელს ტემპერატურა + 40°C-ს აღწევს. ყველაზე ცივი თვე იანვარია. ზოგიერთ წელს ტემპერატურა -16°C-მდე ეცემა.

მიკროზონაში ნალექების წლიური რაოდენობა საშუალოდ 750–850 მმ-ის ფარგლებშია. ნალექების რაოდენობა და ნალექიან დღეთა წლიური განაწილება ხელსაყრელია მიკროზონაში მევენახეობის განვითარებისთვის.

მიკროზონა დასავლეთიდან, ჩრდილოეთიდან და ჩრდილო-აღმოსავლეთიდან გარშემორტყმულია კავკასიონის კალთების განშტოებებით, რაც განსაკუთრებულ ზეგავლენას ახდენს მიკროზონაზე. კავკასიონის ქედი ხელს უშლის ჩრდილოეთიდან ცივი ჰაერის მასების გავრცელებას. მთის კალთები იცავს ვენახებს ძლიერი ქარებისაგან. მიკროზონა ნაკლებად ქარიანია. გარშემო მთებზე შეფენილი ტყეებიდან კი (მათ შორის, ბაბანეურის ნაკრძალი) ცხელი ზაფხულის განმავლობაში მომავალი გრილი ჰაერი დაბლა სწევს ტემპერატურას, რაც დადებითად მოქმედებს ყურძნის თანაბარ და კარგ დამწიფებაზე.

ნიადაგები

მიკროზონაში გვხვდება შემდეგი ტიპის ნიადაგები:

- შავმიწა ნიადაგები – მცირე ხირხატიანი, საკმაოდ მაღალი ნაყოფიერებით გამოირჩევა. ახასიათებს ტუტე რეაქცია. (pH – 7,5-8,2). ჰუმუსის შემცველობა ამ ნიადაგის სახნავ ფენაში მაღალია და 3,88–7,0% ფარგლებში ცვალებადობს;

- ალუვიური ნიადაგები – ხასიათდება საშუალო ხირხატეობით, წარმოდგენილია რელიეფის დახრილ და მცირედ დახრილ ფერდობებზე, აგრეთვე, მდინარე მაჭარეულის ორივე ნაპირზე. აღნიშნული ნიადაგის თვისებები და გეოგრაფიული მდებარეობა საუკეთესო ნიადაგს წარმოადგენს ქისის ჯიშის ყურძნისათვის;
- ყავისფერი ნიადაგები – საშუალოდ თიხნარი, საკმაოდ ხირხატეანი ნიადაგები – ხასიათდება მაღალი ბუნებრივი ნაყოფიერებით. ამ ნიადაგებზე გაშენებულია ხარისხიანი ღვინოების მომცემი ვენახები, რომლებიც მაღალი პროდუქტიულობით გამოირჩევა.

9.2. ადამიანური ფაქტორი

მევენახეობა-მელვინეობა მიკროზონის ტერიტორიაზე არსებულ სოფლებში უხსოვარი დროიდან იღებს სათავეს. ადგილობრივი მოსახლეობის ძირითად სამეურნეო საქმიანობას ჯერ კიდევ ენეოლითის პერიოდში მევენახეობა-მელვინეობა წარმოადგენდა, რასაც ადასტურებს სოფელ მალრაანში, მდინარე მაჭარეულის ხეობაში, დღემდე შემონახული ძველი მარნები, საწნახელები, ქვევრები და მალრაანის ციხის მიმდებარე კალთებზე არსებული საუკუნოვანი ვაზები ე. წ. „ნავენახარები“.

სოფელ მალრაანს შუაზე ყოფს მდინარე მაჭარეული ანუ „მაჭარ-რეული“, ადგილობრივ მოსახლეობაში გავრცელებული თქმულების მიხედვით, მდინარის სახელწოდება უკავშირდება შემთხვევას, როდესაც საწნახელიდან დაღვრილი მაჭარი მდინარეს შეერია.

XX საუკუნის დასაწყისში ჯიში „მალრანული ქისი“ დაკარგულად ითვლებოდა. გადმოცემის თანახმად, ჯიშის გადარჩენა უკავშირდება მალრაანელ გლეხს, რომელმაც ადიდებული მდინარის მიერ გამორიყული ხე ნახა, რომელზეც ვაზი იყო ასული და ცნობისმოყვარეობის გამო რამდენიმე ლერწი მოჭრა და დარგო, სწორედ ამ რამდენიმე ნერგიდან მოხდა ამ ჯიშის გავრცელება ადგილობრივ მევენახეთა შორის.

1954 წლის დ. ტაბიძის აღწერის თანახმად, „მალრანულის“ ანუ „მალრანული ქისის“ გავრცელების არეალს ოთხი სოფელი წარმოადგენდა: მალრაანი, არგოხი, ფიჩხოვანი და, ასევე, მცირედ გავრცელებული იყო სოფელ ბაბანეურში.

ჯიშის შენარჩუნებაში დიდი წვლილი მიუძღვის ადგილობრივ მოსახლეობას, ვინაიდან კომუნისტური წყობის პერიოდში მაღალმოსავლიან ვაზის ჯიშებს მეტი ყურადღება ექცეოდა და შედარებით ნაკლებ მოსავლიანობის გამო მის გავრცელებას ერიდებოდნენ.

დღეს არსებული მდგომარეობით აღნიშნული ჯიში ადგილწარმოშობის არეალს გასცდა, თუმცა, საუკეთესო თვისებებს სწორედ ისტორიული წარმოშობის ადგილზე ავლენს.

ამჟამად მიკროზონის ტერიტორიაზე ჯიშს საკმაოდ დიდი ფართობი უჭირავს, მხოლოდ ახალშენი ვენახების ფართობმა 100 ჰექტარს გადააჭარბა, ყოველ წელს ხდება ახალი ვენახების გაშენება. მევენახეობა-მელვინეობა ადგილობრივი მოსახლეობის ძირითად სამეურნეო საქმიანობას წარმოადგენს.

მალრაანის მიკროზონის გეოგრაფიული მდებარეობა, ბუნებრივი საზღვრებით განპირობებული განსაკუთრებული მიკროკლიმატი, მიკროზონაში გავრცელებული სავენახე ნიადაგები, ვაზის ადგილობრივი ჯიშის – მალრანულის (მალრანული ქისის) მიერ ამ მიკროზონაში გამოვლენილი გამორჩეული თვისებები და ადგილობრივი მევენახე-მელვინეების მიერ ამ

ჯიშისაგან ღვინოების დამზადების ტრადიციები განსაზღვრავენ ღვინო „მალრაანის ქისის“ გამორჩეულ, განსაკუთრებულ ხარისხს.

ვაზის ჯიში ქისი – „საქართველოს ამპელოგრაფიის“¹ და დ. ტაბიძის „კახეთის ვაზის ჯიშების“² მიხედვით, ქისი სხვა ჯიშებთან შედარებით ახალგაზრდა, მაგრამ ერთ-ერთი ტრადიციული კახური ჯიშია. ქისი ყოველთვის იყო ბუნებრივად შერეული რქაწითლის და მწვანეს ვენახებში. ეს ჯიში ხიხვთან, ასევე, ჩიტისთვალასთან და გრძელმტევანასთან ერთად მონაწილეობდა კახეთის ცნობილი ღვინოების შემადგენლობაში და „ბევრ შემთხვევაში ზოგიერთ სახელმოხვეჭილი ადგილების ღვინის მაღალი ხარისხი ქისის მონაწილეობითაც აიხსნება“.

ასევე, დ. ტაბიძის მიხედვით, ალაზნის მარცხენა ნაპირის ვენახებში, სადაც ჯიში მწვანე ნაკლებად იყო გავრცელებული, სწორედ ჯიში – ქისი გამოიყენებოდა რქაწითლის ღვინის გასაუმჯობესებლად.

XIX საუკუნეში, ვაზის დაავადებების გავრცელების ფონზე, ქისის ნარგაობები სხვა ჯიშებთან შედარებით მეტად შემცირდა. ქისი ნახსენები არ არის 1896 წლის საფილოქსერო კომიტეტის აღწერაში³. 1930-იან წლებში ის მცირედ გავრცელებულ ჯიშად ითვლებოდა და სწორედ ამის გამო ვაზის სტანდარტულ ჯიშთა ასორტიმენტში შევიდა როგორც ხარისხოვანი, მაგრამ მაინც „ვაზის პერსპექტიული ჯიში“.

კახეთის მევენახე-მეღვინეებს შორის განსაკუთრებულ ყურადღებას იპყრობდა ალაზნის მარცხენა ნაპირზე გავრცელებული ქისი. 1940-იან წლებში საქართველოს მევენახეობა-მეღვინეობის სამეცნიერო-კვლევითმა ინსტიტუტმა აღწერა სოფ. მალრაანში გაშენებული ქისი და დაასკვნა, რომ ქისის ეს ფორმა განსხვავდებოდა ალაზნის მარჯვენა ნაპირზე გავრცელებული ქისის ფორმებისაგან. როგორც დ. ტაბიძე აღნიშნავს, სწორედ მათ უწოდეს ქისის ამ ნაირსახეობას „მალრაანული ქისი“. ამავე ავტორის აღწერით ეს ფორმა, ძირითადად, სოფლებში მალრაანი, არგოხი, ფიჩხოვანი და, ასევე, მცირედ გავრცელებული იყო სოფელ ბაზანეურში⁴.

მაღალი ხარისხიდან გამომდინარე, ქისის ყურძენზე მოთხოვნა წლიდან-წლამდე იზრდებოდა და ქისი მთელ კახეთში გავრცელდა. ახალ ვენახებში გვხვდება ამ ჯიშის ორივე ნაირსახეობა – როგორც გაღმა მხარის, ასევე, გამოღმა მხარის ქისი. თუმცა, მეტად ფასობს გაღმა მხარის ანუ ე. წ. „მალრაანული ქისი“, განსაკუთრებით კი თვითონ მალრაანის მიკროზონაში მოწეული ყურძენი და ეს სწორედ მისი გამორჩეული, მაღალი ხარისხიდან გამომდინარე.

მალრაანის მიკროზონის გეოგრაფიული მდებარეობა, ბუნებრივი საზღვრებით განპირობებული განსაკუთრებული მიკროკლიმატი, მიკროზონაში გავრცელებული სავენახე ნიადაგები, ვაზის ჯიშის – ქისი ადგილობრივი ნაირსახეობის მიერ ამ მიკროზონაში გამოვლენილი გამორჩეული თვისებები და ადგილობრივი მევენახე-მეღვინეების მიერ ამ ჯიშისაგან ღვინოების დამზადების ტრადიციები განსაზღვრავენ ღვინო „მალრაანის ქისის“ გამორჩეულ, განსაკუთრებულ ხარისხს.

¹ კეცხოველი ნ., რამიშვილი მ., ტაბიძე დ. (1960). საქართველოს ამპელოგრაფია

² ტაბიძე დ. (1954). კახეთის ვაზის ჯიშები

³ Пиралов А. и Шавердов С. Очерк виноградарства и виноделия в Кавхетии. Сб. свед. по виноград. и винод. на Кавказе, вып. VIII (1896). Тифлис

⁴ ტაბიძე დ. (1954). კახეთის ვაზის ჯიშები

10. ეტიკეტირების და შიგნითის განსაკუთრებული წესები

დასახელება „მადრაანის ქისი“ და აღნიშვნა „დაცული ადგილწარმოშობის დასახელების ღვინო“ ეტიკეტზე, შეფუთვაზე, ასევე, ღვინის თანმხლებ დოკუმენტებში და სარეკლამო მასალებში უცხო ენებზე დაიტანება შემდეგნაირად:

ლათინური შრიფტით – **KISI MAGRAANI**
Protected Designation Of Origin ან/და PDO

რუსული შრიფტით – **КИСИ МАГРААНИ**
Защищённое наименование места происхождения

11. გარდამავალი დებულებები

12. აღრიცხვა და შემოწმება

„მადრაანის ქისის“ წარმოების და შენახვის ტექნოლოგიური პროცესების აღრიცხვა და შეტყობინება ხორციელდება საქართველოს კანონმდებლობით დადგენილი წესის შესაბამისად.

13. ძირითადი საკონტროლო წერტილები

დაცული ადგილწარმოშობის დასახელების ღვინის – „მადრაანის ქისის“ წარმოების პროცესის გაკონტროლების დროს მწარმოებელმა სსიპ ღვინის ეროვნულ სააგენტოს უნდა დაუდასტუროს შემდეგი პარამეტრების შესაბამისობა:

ძირითადი საკონტროლო პუნქტები	შეფასების მეთოდები
ვენახის ადგილმდებარეობა	საკადასტრო რუკა, შემოწმება ადგილზე
ფართობი	ვენახის აღრიცხვის ჟურნალი, კადასტრი, შემოწმება ადგილზე
ვაზის ჯიშები	ვენახის აღრიცხვის ჟურნალი, შემოწმება ადგილზე
კულტივირების მეთოდები	აგროტექნიკურ ღონისძიებათა რეგისტრაციის ჟურნალი, წამლობის ჟურნალი. შემოწმება ადგილზე
მოსავლის აღება და ტრანსპორტირება	რთველის ჟურნალი
ყურძნის საჰექტრო მოსავალი	რთველის ჟურნალი
ყურძნის მთლიანი მოსავალი	რთველის ჟურნალი
ყურძნის გადამუშავება და ღვინის დამზადება	ყურძნის მიღების ჟურნალი, ყურძნის გადამუშავების ჟურნალი, პროდუქციის ბრუნვის აღრიცხვის ჟურნალი, ლაბორატორიული ანალიზების ჟურნალები, შეტყობინებები, შემოწმება ადგილზე
ღვინის ჩამოსხმის, შეფუთვის და შენახვის ადგილი და პირობები	ჩამოსხმის ჟურნალი, მზა ნაწარმის საწყობში პროდუქციის მოძრაობის ჟურნალი, ლაბორატორიული ანალიზების ჟურნალები
ღვინის ფიზიკო-ქიმიური მახასიათებლები ღვინის წარმოების პროცესში, ჩამოსხმამდე და ჩამოსხმის შემდეგ	ლაბორატორიული ანალიზების ჟურნალები
ღვინის ორგანოლექტიკური მახასიათებლები	სადეგუსტაციო კომისიის ოქმები
მიკვლევადობა	ტექნოლოგიური და ლაბორატორიული ჩანაწერები

4. წარმოების მაკონტროლებელი ორბანო

წარმოების სპეციფიკაციის დაცვასა და ადგილწარმოშობის დასახელების მართებულად გამოყენებაზე სახელმწიფო კონტროლს ახორციელებს სსიპ ღვინის ეროვნული სააგენტო საქართველოს კანონმდებლობით დადგენილი წესის შესაბამისად.

15. მიკროზონის რუკა

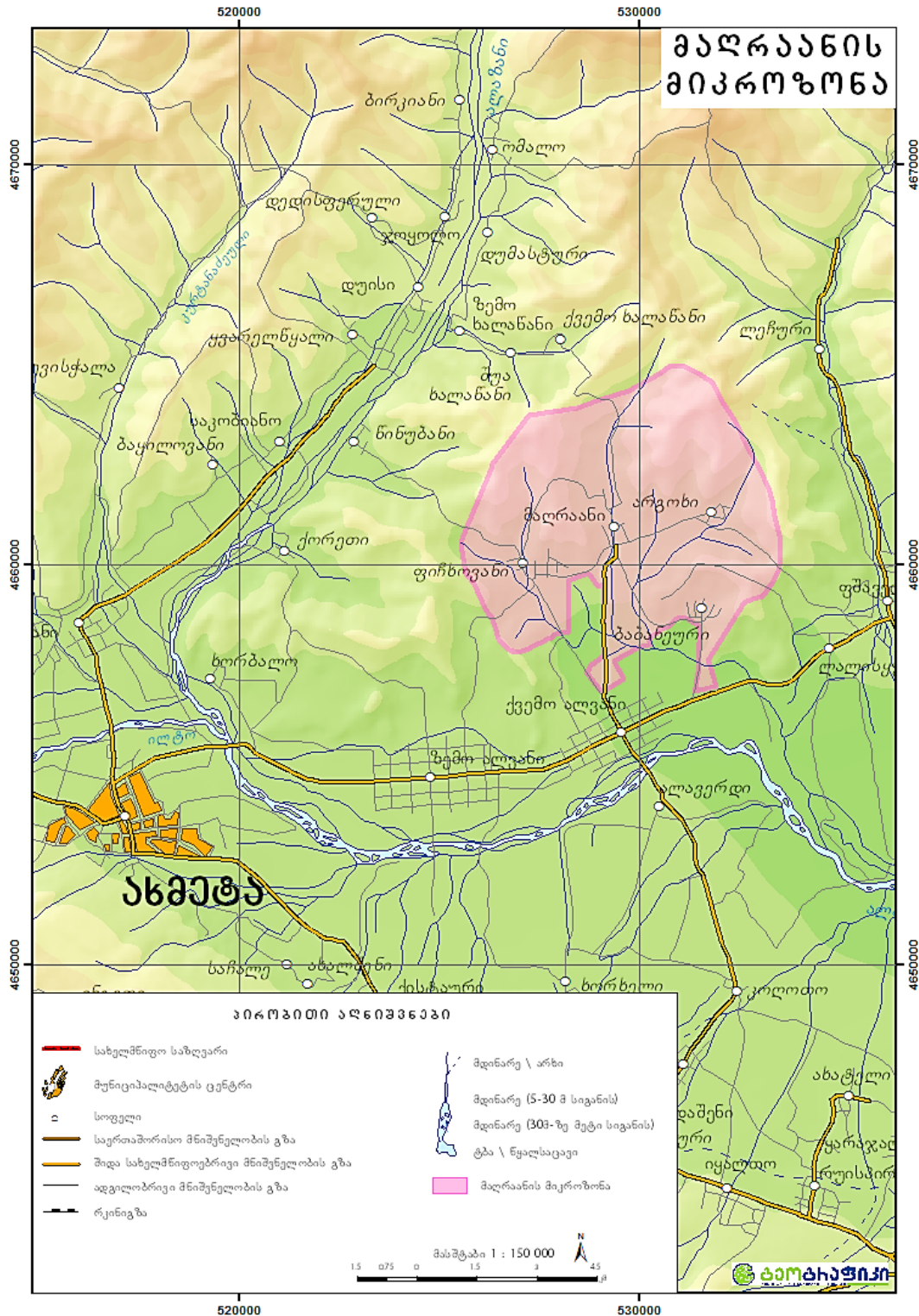

ოზიციალური შეტყობინებები გამობონებები

პატენტების მოქმედების აღდგენა

(21) AP 2009 12474

(11) P 2013 5893 B

(73) პეტერ სელეში;
იენე ჩანი

(54) სიბარმტის ფილტრი

პატენტის გაუქმების თარიღი: 2020 04 30

პატენტის მოქმედების აღდგენის თარიღი: 2020 11 10

(21) AP 2011 12890

(11) P 2014 6203 B

(73) პრისტეკ აგ

(54) სითხის, კმრძოლ, ნავთობპროდუქტების დამუშავების ხერხი

პატენტის გაუქმების თარიღი: 2020 04 14

პატენტის მოქმედების აღდგენის თარიღი: 2020 11 10

(21) AP 2014 13592

(11) P 2016 6516 B

(73) შეზღუდული პასუხისმგებლობის საზოგადოება "ქართული ნატურალური პროდუქტი"

(54) ინტერმენტი კომპოზიცია ბიოაქტიური დანამატისათვის "Grail"

პატენტის გაუქმების თარიღი: 2020 10 06

პატენტის მოქმედების აღდგენის თარიღი: 2020 11 10

(21) AP 2014 13602

(11) P 2015 6404 B

(73) მერაბ ლეკვეი შვილი

(54) ჰანგვით სტრესთან დაკავშირებული მდგომარეობების სამკურნალო საშუალება

პატენტის გაუქმების თარიღი: 2020 10 20

პატენტის მოქმედების აღდგენის თარიღი: 2020 11 10

(21) AP 2018 14895

(11) P 2020 7120 B

(73) გონა ქურდაძე

(54) სილიკონბანუმის მიღების ხერხი

პატენტის გაუქმების თარიღი: 2020 10 05

პატენტის მოქმედების აღდგენის თარიღი: 2020 11 10

(21) AP 2003 8770

(11) P 2007 4059 B

(73) კო2 პაკ ლიმიტედ

(54) კონტეინერის კონსტრუქცია ვაკუუმის მოსაცილებლად

პატენტის გაუქმების თარიღი: 2020 09 30

პატენტის მოქმედების აღდგენის თარიღი: 2020 11 10

პატენტების გაუქმება ალგენის უფლებით

(21) AP 2011 12424

(11) P 2013 5740 B

(73) ელაიდ გლობალ ტობაკო ლიმიტიდ

(54) უფილტრო სიბარეტი

პატენტის გაუქმების თარიღი: 2020 10 24

პატენტის მოქმედების აღდგენის ზღვრული თარიღი: 2021 10 24

(21) AP 2010 12649

(11) P 2016 6504 B

(73) მილენიუმ ფარმასიუტიკალს ინკ.;

ემჯენ ბრიტიშ კოლამბია

(54) ანტი-GCC ანტისხეშულის მოლეკულები, მათი შემცველი კომპოზიციები და მათი გამოყენება

პატენტის გაუქმების თარიღი: 2020 10 22

პატენტის მოქმედების აღდგენის ზღვრული თარიღი: 2021 10 22

(21) AP 2010 12707

(11) P 2017 6604 B

(73) ინსტიტუ ნასიონალ დე ლა სანტე ე დე ლა რეშერშ მედიკალ (ინსერმ);

სენტრ ნასიონალ დე ლა რეშერშ სიენტიფიკ;

ლე ლაბორატუარ სერვიე

(54) პრობასტრინის მონოკლონული ანტისხეშულები და მათი გამოყენება

პატენტის გაუქმების თარიღი: 2020 10 15

პატენტის მოქმედების აღდგენის ზღვრული თარიღი: 2021 10 15

(21) AP 2013 13265

(11) P 2015 6371 B

(73) შპს „ანტრე 2008“

(54) კვების ობიექტების სერვისის ოპტიმიზაციის სატელეკომუნიკაციო სისტემა და ხერხი

პატენტის გაუქმების თარიღი: 2020 10 18

პატენტის მოქმედების აღდგენის ზღვრული თარიღი: 2021 10 18

(21) AP 2014 13602

(11) P 2015 6404 B

(73) მერაბ ლეკვიშვილი

(54) ქანგვიო სტრესთან დაკავშირებული მღვრომარეობების სამკურნალო საშუალება

პატენტის გაუქმების თარიღი: 2020 10 20

პატენტის მოქმედების აღდგენის ზღვრული თარიღი: 2022 10 20

(21) AP 2010 13723

(11) P 2019 6956 B

(73) მილენიუმ ფარმასიუტიკალს ინკ.;

ემჯენ ბრიტიშ კოლამბია

(54) ანტი-GCC ანტისხეშულის მოლეკულები, მათი შემცველი კომპოზიციები და გამოყენება

პატენტის გაუქმების თარიღი: 2020 10 22

პატენტის მოქმედების აღდგენის ზღვრული თარიღი: 2021 10 22

(21) AP 2015 13972
(11) P 2018 6831 B
(73) სსიპ შოთა რუსთაველის ეროვნული სამეცნიერო ფონდი;
სსიპ ივ. ჯავახიშვილის სახ. თბილისის სახელმწიფო უნივერსიტეტი;
გურამ ხიტორი;
იოსებ ჩიკვაძე
(54) ნავთობსაფენის დანალექის უნარჩენო უტილიზაციის ხერხი
პატენტის გაუქმების თარიღი: 2020 10 23
პატენტის მოქმედების აღდგენის ზღვრული თარიღი: 2021 10 23

(21) AP 2016 14795
(11) P 2020 7085 B
(73) კარატ ზის ს. ა. ინდასტრიალ & ოტელიე ენტერპრაიზეს
(54) რაშელ-მანქანა, ბაღი და რაშელ-მანქანის გამოყენება ბაღის დასამზადებლად
პატენტის გაუქმების თარიღი: 2020 10 13
პატენტის მოქმედების აღდგენის ზღვრული თარიღი: 2021 10 13

(21) AP 2003 7158
(11) P 2004 3374 B
(73) შპს „კამელინი“
(54) თაფლის საფუძველზე დამზადებული სამკურნალო საშუალებები, მათი გამოყენება
და მიღების ხერხი
პატენტის გაუქმების თარიღი: 2020 10 17
პატენტის მოქმედების აღდგენის ზღვრული თარიღი: 2021 10 17

პატენტების მოქმედების აღდგენის ვადის ამოწურვა

(21) AP 2004 11890
(11) P 2014 6050 B
(73) ამჯენ ინკ.;
ი. არ. სქუიბ & სანს ლლკ
(54) ალამიანის ანტი-NGF ბამანიტრალეპელი ანტისხეულები, როგორც NGF ზის შერჩევითი
ინჰიბიტორები
პატენტის გაუქმების თარიღი: 2019 07 15
პატენტის მოქმედების აღდგენის ვადის ამოწურვის თარიღი: 2020 07 15

(21) AP 2011 12411
(11) P 2014 6005 B
(73) ვახტანგ კანკავა;
გია ნაცვლიშვილი;
ზურაბ ჩინჩალაძე;
დავით ჩინჩალაძე;
ალექსანდრე კანკავა
(54) მრავალკომპონენტური ცემენტი
პატენტის გაუქმების თარიღი: 2019 10 11
პატენტის მოქმედების აღდგენის ვადის ამოწურვის თარიღი: 2020 10 11

(21) AP 2013 13258
(11) P 2015 6320 B
(73) ლე ლაბორატუარ სერვიე

(54) 3-(2-ბრომო-4,5-დიმეთილფენილ) პროპანოილის სინთეზის ახალი ხერხი, და მისი იზაბრაღინის და მისი ფარმაცევტულად მისაღები მჟავა-ალიტიური მარილების სინთეზში გამოყენება

პატენტის გაუქმების თარიღი: 2019 10 10

პატენტის მოქმედების აღდგენის ვადის ამოწურვის თარიღი: 2020 10 10

(21) AP 2014 13594

(11) P 2016 6498 B

(73) როლანდ ჟორჟოლიანი

(54) საკმდევი ბლოკი

პატენტის გაუქმების თარიღი: 2019 10 09

პატენტის მოქმედების აღდგენის ვადის ამოწურვის თარიღი: 2020 10 09

(21) AP 2014 14148

(11) P 2018 6846 B

(73) ნორსენ ტექნოლოჯიზ ინტერნეიშენალ კორპორეიშენ

(54) შესანახი ავზების ძირის ბარე მხარის კოროზიისგან დამცავი სისტემა

პატენტის გაუქმების თარიღი: 2019 10 16

პატენტის მოქმედების აღდგენის ვადის ამოწურვის თარიღი: 2020 10 16

(21) AP 2003 8704

(11) P 2010 4939 B

(73) ჯეოქს ს. პ. ა.

(54) ფხვნილის წყალბაშმტარი და ჰაერბაშმტარი ლანჩა და მისი დამზადების ხერხი

პატენტის გაუქმების თარიღი: 2019 10 13

პატენტის მოქმედების აღდგენის ვადის ამოწურვის თარიღი: 2020 10 13

(21) AP 2006 9654

(11) P 2009 4653 B

(73) ლე ლაბორატუარ სერვიერ

(54) იზაბრაღინის ჰიდროქლორიდის დელტა-პრისტალური ფორმა, მისი მიღების ხერხი და მისი შემცველი ფარმაცევტული კომპოზიციები

პატენტის გაუქმების თარიღი: 2019 10 10

პატენტის მოქმედების აღდგენის ვადის ამოწურვის თარიღი: 2020 10 10

(21) AP 2006 9655

(11) P 2009 4654 B

(73) ლე ლაბორატუარ სერვიერ

(54) იზაბრაღინის ჰიდროქლორიდის დელტა d-პრისტალური ფორმა, მისი მიღების ხერხი და მისი შემცველი ფარმაცევტული კომპოზიციები

პატენტის გაუქმების თარიღი: 2019 10 10

პატენტის მოქმედების აღდგენის ვადის ამოწურვის თარიღი: 2020 10 10

სასარბებლო მოდელები

პატენტების მოქმედების აღდგენა

(21) AU 2015 13988

(11) U 2018 1977 Y

(73) თემურ ჩახუნაშვილი;

თემურაზ როყვა;

ჟიული ქებაძე;

მერაბ დადუნაშვილი;

ზინაიდა ვაწაძე

(54) ანოდი ელექტროლიზური მანბანუმის დიოქსიდის მისაღებად

პატენტის გაუქმების თარიღი: 2019 11 09

პატენტის მოქმედების აღდგენის თარიღი: 2020 11 10

(21) AU 2015 13989

(11) U 2018 1978 Y

(73) თემურ ჩახუნაშვილი;

თემურაზ როყვა;

ჟიული ქებაძე;

ზინაიდა ვაწაძე;

მერაბ დადუნაშვილი

(54) კათოდი ელექტროლიზური მანბანუმის დიოქსიდის მისაღებად

პატენტის გაუქმების თარიღი: 2019 11 09

პატენტის მოქმედების აღდგენის თარიღი: 2020 11 10

(21) AU 2016 14127

(11) U 2017 1930 Y

(73) თემურ ჩახუნაშვილი;

თემურაზ როყვა;

ჟიული ქებაძე;

ზინაიდა ვაწაძე

(54) სარმაქციო აპარატი მაღალი აბრეშქვობის მქონე ხსნარებში ჭიმბური პროცესების ჩასატარებლად

პატენტის გაუქმების თარიღი: 2020 04 27

პატენტის მოქმედების აღდგენის თარიღი: 2020 11 10

(21) AU 2016 14309

(11) U 2018 1963 Y

(73) თემურ ჩახუნაშვილი;

თემურაზ როყვა;

ჟიული ქებაძე;

ზინაიდა ვაწაძე

(54) ელექტროლიზური აბაზანა მანბანუმის დიოქსიდის მისაღებად

პატენტის გაუქმების თარიღი: 2019 10 27

პატენტის მოქმედების აღდგენის თარიღი: 2020 11 10

(21) AU 2018 14892

(11) U 2019 2014 Y

(73) სოფიო კახრაძე;

მარინე ნიკოლაიშვილი

(54) ეპილეფსიის სამკურნალო საშუალება
პატენტის გაუქმების თარიღი: 2020 10 03
პატენტის მოქმედების აღდგენის თარიღი: 2020 11 10

პატენტების გაუქმება აღდგენის უფლებით

(21) AU 2015 13963
(11) U 2017 1919 Y
(73) სსიპ თსსუ იოველ ქუთათელაძის ფარმაკოქიმიის ინსტიტუტი;
სსიპ თბილისის სახელმწიფო სამედიცინო უნივერსიტეტი
(54) ბელი ელექტროთერაპიისთვის
პატენტის გაუქმების თარიღი: 2020 10 16
პატენტის მოქმედების აღდგენის ზღვრული თარიღი: 2021 10 16

(21) AU 2017 14607
(11) U 2019 2002 Y
(73) ნანა ნებუღიშვილი
(54) ოფლიანობისა და ოფლის სუნის საწინააღმდეგო საშუალება
პატენტის გაუქმების თარიღი: 2020 10 13
პატენტის მოქმედების აღდგენის ზღვრული თარიღი: 2021 10 13

(21) AU 2017 14614
(11) U 2018 1997 Y
(73) მამუკა აბრალავა
(54) ჰიპერის დისტანციურად გაღებისა და დაკვივის მოწყობილობა
პატენტის გაუქმების თარიღი: 2020 10 25
პატენტის მოქმედების აღდგენის ზღვრული თარიღი: 2021 10 25

(21) AU 2018 14904
(11) U 2019 2024 Y
(73) დავით გოგოლი
(54) ელექტროლიტი შინაღნობის თუთია-ბისმუტ-მანგანუმის დანაფარის
ელექტრობამოქმედებისთვის
პატენტის გაუქმების თარიღი: 2020 10 15
პატენტის მოქმედების აღდგენის ზღვრული თარიღი: 2021 10 15

პატენტის მოქმედების აღდგენის ვადის ამოწურვა

(21) AU 2016 14299
(11) U 2019 2006 Y
(73) თეიმურაზ ქათამაძე
(54) მთის მდინარიდან წყალასაღები ნაბეობის მოწყობის ხერხი
პატენტის გაუქმების თარიღი: 2019 10 12
პატენტის მოქმედების აღდგენის ვადის ამოწურვის თარიღი: 2020 10 12

დიზაინები

დიზაინის რეგისტრაციის მოქმედების ვადის გაგრძელება

- (11) D 2016 661 S
 - (73) გიორგი ზაუტაშვილი (GE)
მ. ქანთარიას ქ. 10, ბ. 2, თბილისი, 0186, საქართველო (GE)
 - (54) ბოთლის ეტიკეტი
 - (28) 4
 - (24) 2015 12 30
 - (18) 2025 12 30
 - (58) 2020 10 22
-

სალიცენზიო ხელშეკრულების გაუქმება

- (11) GE D 2006 284 S
- სალიცენზიო ხელშეკრულების რეგისტრაციის ნომერი: 2016005
- მფლობელი (ლიცენზიარი): ობჟექტო ს ოგრანიჩენო ოტვეტსტვენოსტიუ „მასლოექსტრაცი-
ონიი ზაფოდ იუგ რუსი“
პლ. ტოლსტოგო, 8, 344037, ქ. დონის როსტოვი, რუსეთის ფედერაცია
- ლიცენზიატი: ობჟექტო ს ოგრანიჩენო ოტვეტსტვენოსტიუ „ზოლოტაია სემეკა“
პლ. ტოლსტოგო, 8, 344037 ქ. დონის როსტოვი, რუსეთის ფედერაცია

საერთაშორისო დიზაინების რეგისტრაციის მოქმედების
პაღის ბაბრქმლქბა

(11) DM/66800
(73) SWATCH AG (SWATCH SA) (SWATCH LTD.)
Rue Jakob Stämpfli, CH-2502 BIENNE (CH)
(15) 2005 07 01
(24) 2005 07 01
(18) 2025 07 01
(28) 4
(28') 2
(54) Wristwatches

(11) DM/67188
(73) SARA LEE HOUSEHOLD AND BODY CARE NEDERLAND B.V.
Traverse 2, NL-3905 NL Veenendaal (NL)
(15) 2005 10 17
(24) 2005 10 17
(18) 2025 10 17
(28) 2
(28') 2
(54) Air deodorising apparatus, Refill for air deodorising apparatus

(11) DM/73971
(73) GUERLAIN SOCIETE ANONYME (SOCIÉTÉ ANONYME)
68, Avenue des Champs-Élysées, F-75008 PARIS (FR)
(15) 2010 07 05
(24) 2010 07 05
(18) 2025 07 05
(28) 1
(28') 1
(54) Bottle for perfumery products

(11) DM/74247
(73) DE GRISOGONO SA
176bis route de Saint Julien, CH-1228 Plan-les-Ouates (CH)
(15) 2010 09 14
(24) 2010 09 14
(18) 2025 09 14
(28) 1
(28') 1
(54) Ring

(11) DM/74450
(73) RADARLUX RADAR SYSTEMS GMBH
Röttgerweg 10, 51371 Leverkusen (DE)
(15) 2010 09 22
(24) 2010 09 22
(18) 2025 09 22
(28) 2
(28') 2
(54) Speedometers

(11) DM/85935
(73) MAKEL ELEKTRIK MALZEMELERI SANAYI VE TICARET ANONIM SIRKETI
ISTIKLAL MAH.MARESAL FEVZI CAKMAK CAD. NO: 38 KIRAC, ESENYURT, ISTANBUL (TR)
(15) 2015 03 18
(24) 2015 03 18
(18) 2025 03 18
(28) 6
(28') 6
(54) Grounded socket, Grounded socket with switch, Switch with screw, Switch with screw and light,
Switch with socket, Switch with socket and light

(11) DM/86602
(73) COLUMBUS MCKINNON INDUSTRIAL PRODUCTS GMBH
Yale-Allee 30, 42329 Wuppertal (DE)
(15) 2015 06 02
(24) 2015 06 02
(18) 2025 06 02
(28) 3
(28') 3
(54) Ratchet lever hoists

(11) DM/86836
(73) VALENTINO S.P.A.
Via Turati, 16/18, I-20121 MILANO (EM)
(15) 2015 06 26
(24) 2015 06 26
(18) 2025 06 26
(28) 1
(28') 1
(54) Bag

(11) DM/87766
(73) FONTINI S.A.
Pol. Ind. Can Bernades-Subira, C/Anoia 15, E-08130 Santa Perpetua de Mogoda (Barcelona) (ES)
(15) 2015 09 22
(24) 2015 09 22
(18) 2025 09 22
(28) 1
(28') 1
(54) Switch

(11) DM/88120
(73) LABORATOIRES LA PRAIRIE SA
Industriestrasse 8, CH-8604 Volketswil (CH)
(15) 2015 09 16
(24) 2015 09 16
(18) 2025 09 16
(28) 1
(28') 1
(54) Container for cosmetic products

(11) DM/88533
(73) FICOSOTA LTD.
Madara Blvd. 48, BG-9700 Shumen (BG)
(15) 2015 10 21
(24) 2015 10 21
(18) 2025 10 21
(28) 1
(28') 1
(54) Capsule containing washing products

(11) DM/88738
(73) VALENTINO S.P.A.
Via Turati, 16/18, I-20121 MILANO (EM)
(15) 2015 12 14
(24) 2015 12 14
(18) 2025 12 14
(28) 6
(28') 6
(54) Bags

(11) DM/88828
(73) VALENTINO S.P.A.
Via Turati, 16/18, I-20121 MILANO (EM)
(15) 2015 12 14
(24) 2015 12 14
(18) 2025 12 14
(28) 1
(28') 1
(54) Bag

(11) DM/88829
(73) VALENTINO S.P.A.
Via Turati, 16/18, I-20121 MILANO (EM)
(15) 2015 12 14
(24) 2015 12 14
(18) 2025 12 14
(28) 1
(28') 1
(54) Shoe

(11) DM/89018
(73) COMPAGNIE GERVAIS DANONE
17 boulevard Haussmann, F-75009 PARIS (FR)
(15) 2015 12 08
(24) 2015 12 08
(18) 2025 12 08
(28) 1
(28') 1
(54) Pot (packaging)

(11) DM/89019
(73) COMPAGNIE GERVAIS DANONE
17 boulevard Haussmann, F-75009 PARIS (FR)
(15) 2015 12 08
(24) 2015 12 08
(18) 2025 12 08
(28) 1
(28') 1
(54) Pot [packaging]

(11) DM/89049
(73) JAQUISH INDUSTRIAL RESEARCH LLC
14093 Sierra Woodlands, Nevada City, California 95959 (US)
(15) 2015 07 17
(24) 2015 07 17
(18) 2025 07 17
(28) 1
(28') 1
(54) Exercising apparatus

სასაქონლო ნიშნები

რეგისტრაციის მოქმედების ვადის გაგრძელება

(111) M 2000 13554 R2
 (156) 2000 10 30
 (186) 2030 10 30
 (732) მერიალ
 29 ავენიუ ტონი გარნიე, 69007 ლიონი,
 საფრანგეთი

(111) M 2010 20798 R1
 (156) 2010 10 06
 (186) 2030 10 06
 (732) შპს „კახეთი-კო“
 კუდიგორის ქ. 4, 4800, ყვარელი,
 საქართველო

(111) M 2000 13588 R2
 (156) 2000 11 13
 (186) 2030 11 13
 (732) ზე პროექტერ & გემბლ კომპანი
 უან პროექტერ & გემბლ პლაზა,
 ცინცინატი, ოჰაიო, აშშ

(111) M 2010 20499 R1
 (156) 2010 05 27
 (186) 2030 05 27
 (732) რეგორლდ მედია მეგეზინზ
 8, რუ ფრანსუა ორი, 92543 მონრუჟ
 სედექს, საფრანგეთი

(111) M 2000 13560 R2
 (156) 2000 10 30
 (186) 2030 10 30
 (732) ფირათ პლასტიკ კაუჩუკ სან. ვე თიჯ. ა.შ.
 თიურქობა ქოიუ ფ.ქ. 1234907
 ბიუიუქქემეჯე სტამბოლი, თურქეთი

(111) M 2010 20472 R1
 (156) 2010 05 13
 (186) 2030 05 13
 (732) ინდივიდუალური მეწარმე მოროზოვ
 ვიქტორ ალექსანდროვიჩი
 ულ. კოსმონავტოვ, დ.5, კორპ. რ, კვ.40,
 344092 როსტოვ-ნა-დონუ, რუსეთის
 ფედერაცია

(111) M 2001 13711 R2
 (156) 2001 01 30
 (186) 2031 01 30
 (732) იუნაიტედ სტეიტს პოლო ესოსიეიშენ
 1400 ცენტრპარკ ბულვარი, სუიტ 200,
 უესტ პალმ ბიჩი, ფლორიდა 33401, აშშ

(111) M 2010 20821 R1
 (156) 2010 10 15
 (186) 2030 10 15
 (732) მეიბორნ (იუ ქეი) ლიმიტიდ
 მეიბორნ ჰაუსი, ბელიოლ ბიზნეს
 პარკი, ნიუკასლ-აპონ-ტაინი, NE12 8EW,
 გაერთიანებული სამეფო

(111) M 2001 13712 R2
 (156) 2001 01 30
 (186) 2031 01 30
 (732) იუნაიტედ სტეიტს პოლო ესოსიეიშენ
 1400 ცენტრპარკ ბულვარი, სუიტ 200,
 უესტ პალმ ბიჩი, ფლორიდა 33401, აშშ

(111) M 2010 20955 R1
 (156) 2010 11 30
 (186) 2030 11 30
 (732) სს „გეფა“
 აკაკი ბელიაშვილის ქ. 142, 0159,
 თბილისი, საქართველო

(111) M 2001 13713 R2
 (156) 2001 01 30
 (186) 2031 01 30
 (732) იუნაიტედ სტეიტს პოლო ესოსიეიშენ
 1400 ცენტრპარკ ბულვარი, სუიტ 200,
 უესტ პალმ ბიჩი, ფლორიდა 33401, აშშ

(111) M 2010 20956 R1
 (156) 2010 11 30
 (186) 2030 11 30

(732) სს „გეფა“
აკაკი ბელიაშვილის ქ. 142, 0159,
თბილისი, საქართველო

(111) M 2010 20830 R1
(156) 2010 10 15
(186) 2030 10 15
(732) კარიუმ ლტდ
ფალკონ ჰაუზი, 115-123 სტეინზ როუდი,
ჰაუნზსლოუ, TW3 3LL, გაერთიანებული
სამეფო

(111) M 2010 20943 R1
(156) 2010 11 25
(186) 2030 11 25
(732) ჯენერალ მტორს ლლკ
300 რენესენს სენტერი, სიტი-ოფ-
დეტროიტი, მიჩიგანის შტატი
48265-3000, აშშ

(111) M 2011 21305 R1
(156) 2011 03 24
(186) 2031 03 24
(732) შპს „ევროპული სკოლა“
აღ. ყაზბეგის გამზ. 34ა, 0160, თბილისი,
საქართველო

(111) M 2010 20961 R1
(156) 2010 11 30
(186) 2030 11 30
(732) ფოქს მედია ლლკ
10201 უესტ პიკო ბულვარი, ლოს-
ანჯელესი, კალიფორნია 90035, აშშ

(111) M 2011 21285 R1
(156) 2011 03 15
(186) 2031 03 15
(732) შპს „ევროპული სკოლა“
აღ. ყაზბეგის გამზ. 34ა, 0160, თბილისი,
საქართველო

უფლებების სრული ბალანსი

(111) M 1997 5422 R
 (732) სტადა არზნიმიტტელ აგ
 სტადაშტრასე 2 -18, 61118 ზად ვილბელ,
 გერმანია
 (770) გლაქსოსმიტვლან კონსიუმერ ჰელსქეა
 (უკ) აი პი ლიმიტიდ
 980 გრეიტ უესტ როუდი, ბრენტფორდი,
 მიდლსექსი TW8 9GS, გაერთიანებული
 სამეფო
 (580) 2020 09 28

(111) M 1997 5924 R
 (732) სტადა არზნიმიტტელ აგ
 სტადაშტრასე 2 -18, 61118 ზად ვილბელ,
 გერმანია
 (770) გლაქსოსმიტვლან კონსიუმერ ჰელსქეა
 (უკ) აი პი ლიმიტიდ
 980 გრეიტ უესტ როუდი, ბრენტფორდი,
 მიდლსექსი TW8 9GS, გაერთიანებული
 სამეფო
 (580) 2020 09 28

(111) M 1995 1033 R
 (732) სტადა არზნიმიტტელ აგ
 სტადაშტრასე 2 -18, 61118 ზად ვილბელ,
 გერმანია
 (770) გლაქსოსმიტვლან კონსიუმერ ჰელსქეა
 (უკ) აი პი ლიმიტიდ
 980 გრეიტ უესტ როუდი, ბრენტფორდი,
 მიდლსექსი TW8 9GS, გაერთიანებული
 სამეფო
 (580) 2020 09 28

(111) M 1998 10217 R
 (732) აკციონერნოე ობჰესტვო „ნიჟეგოროდსკი
 ხიმიკო-ფარმაცევტიჩესკი ზავოდ“
 სალგანსკაია სტ., 7, ნიჟნი-ნოვგოროდი,
 RU-603950, რუსეთის ფედერაცია
 (770) ტაკედა აუსტრია გმბჰ
 სტ. პეტერ-შტრასე 25, 4020 ლინცი,
 ავსტრია
 (580) 2020 10 27

(111) M 1999 12950 R
 (732) სარტი ჰოლდინგს (იტალი) ს.რ.ლ.
 ვია ალესანდრო მანკონი 30, I-201121
 მილანი, იტალია

(770) კორნელიანი ს.პ.ა.
 ვია პანიცა 5, 46100 მანტოვა, იტალია
 (580) 2020 09 04

(111) M 2003 15255 R
 (732) სტადა არზნიმიტტელ აგ
 სტადაშტრასე 2 -18, 61118 ზად ვილბელ,
 გერმანია
 (770) გლაქსოსმიტვლან კონსიუმერ ჰელსქეა
 (უკ) აი პი ლიმიტიდ
 980 გრეიტ უესტ როუდი, ბრენტფორდი,
 მიდლსექსი TW8 9GS, გაერთიანებული
 სამეფო
 (580) 2020 09 28

(111) M 2007 17365 R
 (732) აპჯონ უეს 1 ელელსი
 235 ისტ 42-ე სტრიტ, ნიუ-იორკი, N.Y.
 10017, აშშ
 (770) პფაიზერ ინკ.
 235 ისტ 42 სტრიტი, ნიუ-იორკი
 10017-5755, აშშ
 (580) 2020 10 13

(111) M 2007 18089 R
 (732) სტადა არზნიმიტტელ აგ
 სტადაშტრასე 2 -18, 61118 ზად ვილბელ,
 გერმანია
 (770) ჯსკ კონსუმერ ჰელსქეა ს.ა.
 რუტ დე ლ'ეტრა, 1197 პრანჟინი, შვეიცარია
 (580) 2020 09 28

(111) M 2010 20499 R
 (732) მონდადორი მეგეზინზ ფრანსე
 48 რიუ გინემერი, 92865 ისი-ლე-
 მულინო, საფრანგეთი
 (770) ექსელსიორ პუბლიკასიონ
 48 რიუ გინემერი, 92865 ისი-ლე-
 მულინო, საფრანგეთი
 (580) 2020 10 09

(111) M 2011 22001 R
 (732) აკციონერნოე ობჰესტვო „ნიჟეგოროდსკი
 ხიმიკო-ფარმაცევტიჩესკი ზავოდ“
 სალგანსკაია სტ., 7, ნიჟნი-ნოვგოროდი,
 RU-603950, რუსეთის ფედერაცია

(770) ტაკედა ფარმასიუტიკალზ ინტერნე-
იშნლ აგ
ტურგაუერშტრასე 130, 8152 გლადპარკი-
ოპფიკონი (ციურხი), შვეიცარია
(580) 2020 10 27

(111) M 2011 22003 R
(732) აკციონერნოე ობჩესტვო „ნიჟეგოროდსკი
ხიმიკო-ფარმაცევტიჩესკი ზავოდ“
სალგანსკაია სტ., 7, ნიჟნი-ნოვგოროდი,
RU-603950, რუსეთის ფედერაცია
(770) ტაკედა ფარმასიუტიკალზ ინტერნეიშნლ
აგ
ტურგაუერშტრასე 130, 8152 გლადპარკი-
ოპფიკონი (ციურხი), შვეიცარია
(580) 2020 10 27

(111) M 2013 23278 R
(732) აკციონერნოე ობჩესტვო „ნიჟეგოროდსკი
ხიმიკო-ფარმაცევტიჩესკი ზავოდ“
სალგანსკაია სტ., 7, ნიჟნი-ნოვგოროდი,
RU-603950, რუსეთის ფედერაცია
(770) ტაკედა ფარმასეუტიკალ კომპანი
ლიმიტიდ
1-1, დოშომაჩი 4-ჩომე, ჩუო-კუ, ოსაკა,
იაპონია
(580) 2020 10 27

(111) M 2013 23279 R
(732) აკციონერნოე ობჩესტვო „ნიჟეგოროდსკი
ხიმიკო-ფარმაცევტიჩესკი ზავოდ“
სალგანსკაია სტ., 7, ნიჟნი-ნოვგოროდი,
RU-603950, რუსეთის ფედერაცია
(770) ტაკედა ფარმასეუტიკალ კომპანი
ლიმიტიდ
1-1, დოშომაჩი 4-ჩომე, ჩუო-კუ, ოსაკა,
იაპონია
(580) 2020 10 27

(111) M 2013 23280 R
(732) აკციონერნოე ობჩესტვო „ნიჟეგოროდსკი
ხიმიკო-ფარმაცევტიჩესკი ზავოდ“
სალგანსკაია სტ., 7, ნიჟნი-ნოვგოროდი,
RU-603950, რუსეთის ფედერაცია
(770) ტაკედა ფარმასეუტიკალ კომპანი
ლიმიტიდ
1-1, დოშომაჩი 4-ჩომე, ჩუო-კუ, ოსაკა,
იაპონია

(580) 2020 10 27

(111) M 2013 23281 R
(732) აკციონერნოე ობჩესტვო „ნიჟეგოროდსკი
ხიმიკო-ფარმაცევტიჩესკი ზავოდ“
სალგანსკაია სტ., 7, ნიჟნი-ნოვგოროდი,
RU-603950, რუსეთის ფედერაცია
(770) ტაკედა ფარმასეუტიკალ კომპანი
ლიმიტიდ
1-1, დოშომაჩი 4-ჩომე, ჩუო-კუ, ოსაკა,
იაპონია
(580) 2020 10 27

(111) M 2013 23282 R
(732) აკციონერნოე ობჩესტვო „ნიჟეგოროდსკი
ხიმიკო-ფარმაცევტიჩესკი ზავოდ“
სალგანსკაია სტ., 7, ნიჟნი-ნოვგოროდი,
RU-603950, რუსეთის ფედერაცია
(770) ტაკედა ფარმასეუტიკალ კომპანი
ლიმიტიდ
1-1, დოშომაჩი 4-ჩომე, ჩუო-კუ, ოსაკა,
იაპონია
(580) 2020 10 27

(111) M 2013 23283 R
(732) აკციონერნოე ობჩესტვო „ნიჟეგოროდსკი
ხიმიკო-ფარმაცევტიჩესკი ზავოდ“
სალგანსკაია სტ., 7, ნიჟნი-ნოვგოროდი,
RU-603950, რუსეთის ფედერაცია
(770) ტაკედა ფარმასეუტიკალ კომპანი
ლიმიტიდ
1-1, დოშომაჩი 4-ჩომე, ჩუო-კუ,
იაპონია
(580) 2020 10 27

(111) M 2013 23787 R
(732) აკციონერნოე ობჩესტვო „ნიჟეგოროდსკი
ხიმიკო-ფარმაცევტიჩესკი ზავოდ“
სალგანსკაია სტ., 7, ნიჟნი-ნოვგოროდი,
RU-603950, რუსეთის ფედერაცია
(770) ტაკედა ფარმასიუტიკალ კომპანი
ლიმიტიდ
1-1, დოშომაჩი 4-ჩომე, ჩუო-კუ, ოსაკა,
იაპონია
(580) 2020 10 27

(111) M 2013 24020 R
 (732) აკციონერნოე ობჩესტვო „ნიჟეგოროდსკი ხიმიკო-ფარმაცევტიჩესკი ზავოდ“ სალგანსკაია სტ., 7, ნიჟნი-ნოვგოროდი, RU-603950, რუსეთის ფედერაცია
 (770) ტაკედა ფარმასეუტიკალ კომპანი ლიმიტიდ
 1-1, დომომაჩი 4-ჩომე, ჩუო-კუ, ოსაკა, იაპონია
 (580) 2020 10 27

(111) M 2014 24741 R
 (732) სვიშროვა ვიქტორია ალექსანდროვნა ვულ. შევჩენკა, 108, კვ. 7, ლვოვი, 79039, უკრაინა
 (770) ობშჩესტვო ს ოგრანიჩენნი ოტვეტსტვენოსტიუ „ლვოვსკაია ტაბაჩნაია ფაბრიკა“ ულ. პრომიშლენნაია, 50/52, კ. 716, ქ. ლვოვი, 79024, უკრაინა
 (580) 2020 10 26

(111) M 2016 27272 R
 (732) სვიშროვა ვიქტორია ალექსანდროვნა ვულ. შევჩენკა, 108, კვ. 7, ლვოვი, 79039, უკრაინა
 (770) ობშჩესტვო ს ოგრანიჩენნი ოტვეტსტვენოსტიუ „ლვოვსკაია ტაბაჩნაია ფაბრიკა“ ულ. ზელენაია, 149, კ. 184, ქ. ლვოვი, 79035, უკრაინა
 (580) 2020 10 26

(111) M 1997 5660 R
 (732) მერკური ფარმა გრუპ ლიმიტიდ კაპიტალ ჰაუზი, 85 კინგ უილიამ სტ. ლონდონი, EC4N 7BL, გაერთიანებული სამეფო
 (770) ამდიფარმ მერკური ინტერნეიშნლ ლიმიტიდ აზტეკ გრუპ ჰაუზი, 11-15 სიტონ პლეისი, სტ. ჰეილირი, ჯერსი, JE4 0QH, ნორმანდიის კუნძულები, გაერთიანებული სამეფო
 (580) 2020 10 12

(111) M 2016 26873 R
 (732) შპს „ALLEGRO“ ლერმონტოვის ქ. 57, ბ. 17, ბათუმი, საქართველო
 (770) შპს „გარდენი“ არდაგანის ტბაში მდებარე კუნძული, ბათუმი 6600, საქართველო
 (580) 2020 10 06

(111) M 2018 29468 R
 (732) აკციონერნოე ობჩესტვო „ნიჟეგოროდსკი ხიმიკო-ფარმაცევტიჩესკი ზავოდ“ სალგანსკაია სტ., 7, ნიჟნი-ნოვგოროდი, RU-603950, რუსეთის ფედერაცია
 (770) ტაკედა ფარმა ა/ს დიბენდალ ალე 10, 2630 ტაასტრუპი, დანია
 (580) 2020 10 27

(111) M 2017 28871 R
 (732) აკციონერნოე ობჩესტვო „ნიჟეგოროდსკი ხიმიკო-ფარმაცევტიჩესკი ზავოდ“ სალგანსკაია სტ., 7, ნიჟნი-ნოვგოროდი, RU-603950, რუსეთის ფედერაცია
 (770) ტაკედა ფარმასეუტიკალ კომპანი ლიმიტიდ
 1-1, დომომაჩი 4-ჩომე, ჩუო-კუ, ოსაკა 540-8645, იაპონია
 (580) 2020 10 27

(111) M 2017 28872 R
 (732) აკციონერნოე ობჩესტვო „ნიჟეგოროდსკი ხიმიკო-ფარმაცევტიჩესკი ზავოდ“ სალგანსკაია სტ., 7, ნიჟნი-ნოვგოროდი, RU-603950, რუსეთის ფედერაცია
 (770) ტაკედა ფარმასეუტიკალ კომპანი ლიმიტიდ
 1-1, დომომაჩი 4-ჩომე, ჩუო-კუ, ოსაკა 540-8645, იაპონია
 (580) 2020 10 27

(111) M 2018 30583 R
 (732) სუმიტომო რაბბერ ინდასტრიზ, ლტდ. 6-9, 3-ჩომე, ვაკინოჰამა-ჩო, ჩუო-კუ, კობე, 651-0072, იაპონია
 (770) დუნლოპ ინტერნეიშნლ ლიმიტიდ

თორნკროფტ მენორ, თორნკროფტ
დრაივ, დორჰინგ როუდ, ლეთერჰედი,
სურეი, KT22 8JB, გაერთიანებული
სამეფო
(580) 2020 10 23

(111) M 2018 30584 R
(732) სუმიტომო რაბბერ ინდასტრიზ, ლტდ.
6-9, 3-ჩომე, ვაკინოჰამა-ჩო, ჩუო-კუ,
კობე, 651-0072, იაპონია
(770) დუნლოპ ინტერნეშნლ ლიმიტედ
თორნკროფტ მენორ, თორნკროფტ
დრაივ, დორჰინგ როუდ, ლეთერჰედი,
სურეი, KT22 8JB, გაერთიანებული
სამეფო
(580) 2020 10 22

მფლობელის სახელის და/ან მისამართის ცვლილება

(111) M 1999 12950 R
 (732) კორნელიანი ს.რ.ლ.
 ვია პანიცა 5, I-46100 მანტუა, იტალია
 (770) სარტი ჰოლდინგს (იტალი) ს.რ.ლ.
 ვია ალესანდრო მანკონი 30, I-201121
 მილანი, იტალია
 (580) 2020 09 04

(111) M 1999 12950 R
 (732) კორნელიანი ს.რ.ლ.
 ვია დურიანი 24, I- 20122 მილანი,
 იტალია
 (770) კორნელიანი ს.რ.ლ.
 ვია პანიცა 5, I-46100 მანტუა,
 იტალია
 (580) 2020 09 04

(111) M 2010 20499 R
 (732) მონდადორი მეგეზინზ ფრანსე
 8, რუ ფრანსუა ორი, 92543 მონრუჟ
 სედექს, საფრანგეთი
 (770) მონდადორი მეგეზინზ ფრანსე
 48 რიუ გინემერი, 92865 ისი-ლე-
 მულინო, საფრანგეთი
 (580) 2020 10 09

(111) M 2010 20499 R
 (732) რევიორლდ მედია მეგეზინზ
 8, რუ ფრანსუა ორი, 92543 მონრუჟ
 სედექს, საფრანგეთი
 (770) მონდადორი მეგეზინზ ფრანსე
 8, რუ ფრანსუა ორი, 92543 მონრუჟ
 სედექს, საფრანგეთი
 (580) 2020 10 09

(111) M 2010 20821 R
 (732) მეიბორნ (იუ ქეი) ლიმიტიდ
 მეიბორნ ჰაუსი, ბელიოლ ბიზნეს
 პარკი, ნიუკასლ-აპონ-ტაინი, NE12 8EW,
 გაერთიანებული სამეფო
 (770) ჯაკველ ინტერნემენელ ლიმიტიდ
 დუდლეი ლეინი, კრამლინგტონ
 NE23 7RH, გაერთიანებული სამეფო
 (580) 2020 09 20

(111) M 2010 20955 R
 (732) სს „გეფა“
 აკაკი ბელიაშვილის ქ. 142, 0159,
 თბილისი, საქართველო
 (770) შპს „ჯი პი სი - აფთიაქი“
 მ. წინამძღვრიშვილის ქ. 106, 0164,
 თბილისი, საქართველო;
 სს „ჯი პი სი“
 მარჯანიშვილის ქ. 26, 0102, თბილისი,
 საქართველო
 (580) 2020 10 20

(111) M 2010 20956 R
 (732) სს „გეფა“
 აკაკი ბელიაშვილის ქ. 142, 0159,
 თბილისი, საქართველო
 (770) შპს „ჯი პი სი - აფთიაქი“
 მ. წინამძღვრიშვილის ქ. 106, 0164,
 თბილისი, საქართველო;
 სს „ჯი პი სი“
 მარჯანიშვილის ქ. 26, 0102, თბილისი,
 საქართველო
 (770) შპს „ჯი პი სი - აფთიაქი“
 მ. წინამძღვრიშვილის ქ. 106, 0164,
 თბილისი, საქართველო;
 სს „ჯი პი სი“
 მარჯანიშვილის ქ. 26, 0102, თბილისი,
 საქართველო
 (580) 2020 10 20

(111) M 2010 20830 R
 (732) კარიუმ ლტდ
 ფალკონ ჰაუზი, 115-123 სტეინზ როუდი,
 ჰაუნზსლოუ, TW3 3LL, გაერთიანებული
 სამეფო
 (770) გოდრეი კონსიუმერ პროდაკტს (უკ)
 ლიმიტიდ
 ფალკონ ჰაუზი, 115-123 სტეინზ როუდი,
 ჰაუნზსლოუ, TW3 3LL, გაერთიანებული
 სამეფო
 (580) 2020 10 15

სასაქონლო ნიშნების რეგისტრაციის შედეგები

(111) M 2000 13244 R
(151) 2000 04 14
(732) გლაქსოსმიტვილი კონსიუმერ ჰელსქეა
(უკ) აი პი ლიმიტიდ
980 გრეიტ უესტ როუდი, ბრენტფორდი,
მიდლსექსი TW8 9GS, გაერთიანებული
სამეფო
(141) 2020 10 29

(111) M 2010 20368 R
(151) 2010 04 15
(732) დლა პაიპერ უკ ლლპ
3 ნობელ სტრიტი, ლონდონი EC2V 7EE,
გაერთიანებული სამეფო
(141) 2020 10 30

(111) M 2010 20392 R
(151) 2010 04 16
(732) ზაზა ბარბაქაძე
ხუდადოვის ქ. 7, ბ. 30, 0101, თბილისი,
საქართველო
(141) 2020 11 02

(111) M 2010 20366 R
(151) 2010 04 07
(732) გიორგი ანდრიაძე
იყალთოს ქ. 16, 0171, თბილისი,
საქართველო
(141) 2020 10 22

(111) M 2010 20370 R
(151) 2010 04 15
(732) ვმ. ვრიგლი ჯრ. კომპანი
1132 ვესტ ბლექჰოუკ სტრიტი,
ჩიკაგო, ილინოისი 60642, აშშ
(141) 2020 10 30

(111) M 2010 20371 R
(151) 2010 04 15
(732) ვმ. ვრიგლი ჯრ. კომპანი
410 ნორთ მიჩიგან ავენიუ, ჩიკაგო,
ილინოისი 60611, აშშ
(141) 2020 10 30

(111) M 2010 20372 R
(151) 2010 04 15
(732) ვმ. ვრიგლი ჯრ. კომპანი
410 ნორთ მიჩიგან ავენიუ, ჩიკაგო,
ილინოისი 60611, აშშ
(141) 2020 10 30

(111) M 2010 20373 R
(151) 2010 04 15
(732) ვმ. ვრიგლი ჯრ. კომპანი
410 ნორთ მიჩიგან ავენიუ, ჩიკაგო,
ილინოისი 60611, აშშ
(141) 2020 10 30

(111) M 2010 20376 R
(151) 2010 04 15
(732) ასტელას ფარმა ინკ.
3-11, ნიჰონბაში-ჰონჩო, 2-ჩომე, ჩუო-კუ,
ტოკიო, იაპონია
(141) 2020 10 30

(111) M 2010 20377 R
(151) 2010 04 15
(732) მოლინარი იტალია ს.პ.ა.
ვია კარლო ლინეო 8, 00197 რომი,
იტალია
(141) 2020 10 30

(111) M 2010 20396 R
(151) 2010 04 16
(732) შპს „ტონუსი“
ხვამლის ქ. 14, 0112, თბილისი,
საქართველო
(141) 2020 11 02

(111) M 2010 20393 R
(151) 2010 04 16
(732) შპს „ტონუსი“
ხვამლის ქ. 14, 0112, თბილისი,
საქართველო
(141) 2020 11 02

(111) M 2010 20380 R
 (151) 2010 04 15
 (732) პეილეს შუსორს უოლდუაიდ, ინკ.
 ჯეიჰოკ ტაუერსი, 700 SW ჯეკსონი,
 სტი. 202, ტოპიკა, KS 66603, აშშ
 (141) 2020 10 30

ლუბლიანას ქ. 15, 0159, თბილისი,
 საქართველო
 (141) 2020 10 21

(111) M 2010 20381 R
 (151) 2010 04 15
 (732) კოლეჯიტ-პალმოლივ კომპანი
 300 პარკ ავენიუ, ნიუ-იორკი,
 N.Y. 10022, აშშ
 (141) 2020 10 30

(111) M 2010 20386 R
 (151) 2010 04 15
 (732) ფილიპ მორის ბრენდს სარლ
 კე ჟანრენო 3, 2000 ნევმატელი,
 შვეიცარია
 (141) 2020 10 30

(111) M 2010 20383 R
 (151) 2010 04 15
 (732) გლაქსოსმიტოკლან ტრეიდინგ სერვისიზ
 ლიმიტიდ
 კარაზინი, კარიგალინი, კაუნტი-კორკი,
 ირლანდია
 (141) 2020 10 30

(111) M 2010 20388 R
 (151) 2010 04 15
 (732) შპს „ლარმაქსი“
 თავისუფლების მოედანი 12, 0600,
 ახალგორი, საქართველო
 (141) 2020 10 30

(111) M 2010 20384 R
 (151) 2010 04 15
 (732) გლაქსოსმიტოკლან ტრეიდინგ სერვისიზ
 ლიმიტიდ
 კარაზინი, კარიგალინი, კაუნტი-კორკი,
 ირლანდია
 (141) 2020 10 30

(111) M 2010 20394 R
 (151) 2010 04 16
 (732) შპს „ალიანს კორ“
 კანდელაკის ქ. 37, 0160, თბილისი,
 საქართველო
 (141) 2020 11 02

(111) M 2010 20385 R
 (151) 2010 04 15
 (732) გლაქსოსმიტოკლან ტრეიდინგ სერვისიზ
 ლიმიტიდ
 კარაზინი, კარიგალინი, კაუნტი-კორკი,
 ირლანდია
 (141) 2020 10 30

(111) M 2010 20395 R
 (151) 2010 04 16
 (732) თეიმურაზ დოლიძე
 თამარაშვილის 11, ბ. 141, 0162,
 თბილისი, საქართველო
 (141) 2020 11 02

(111) M 2010 20364 R
 (151) 2010 04 06
 (732) შპს „ზარაფხანა“
 ლუბლიანას ქ. 15, 0159, თბილისი,
 (141) 2020 10 21

(111) M 2010 20365 R
 (151) 2010 04 06
 (732) შპს „ზარაფხანა“

სალიცენზიო ხელშეკრულების რეგისტრაცია

(111) M 2020 32888 R

(732) შპს „ორვიბო“

ტიციან ტაბიძის ქ. 43, ბ. 37, ვაკის რაიონი, საქართველო

(791) შპს „სმარტ გრუპი“

ვაჟა-ფშაველას გამზ. II კვ. კორპ. 4, ბ. 36ბ, ვაკის რაიონი, თბილისი, საქართველო

(793) №1613

მოქმედების ვადა: 14-10-2020-დან ნიშნის მოქმედების ვადით

ლიცენზიის სახე: განსაკუთრებული

9 – დისტანციური ანთების ელექტროაპარატები; ბატარეები (ანთების სისტემის); ხმის გამამლიერებლები; გამამლიერებელი ელექტრონული მილაკები; დაბრკოლებამდეგი მოწყობილობები (ელექტრობა); გამანაწილებელი კოლოფები (ელექტრობა); სიგნალიზატორი (ხანძრის); ზარები (სასიგნალო), ელექტრული; ბარომეტრები; სამუხტავი მოწყობილობები ელექტროაკუმულატორისათვის; ზარის დილაკები; განმამტოებელი კოლოფები (ელექტრობა); თბორეგულირების მოწყობილობები; მოციმციმე შუქსასიგნალო აპარატები; ზარები (სასიგნალო); კოლექტორები, ელექტრული; გადართვის კოლოფები (ელექტრობა); კომუტატორები; მრიცხველები; მრიცხველები; კონდენსატორები; გამტარები, ელექტრული; ელექტროხაზები (მაგისტრალური); ელექტროწრედის ჩამრთველები; ხაზური შემაერთებელი კოლოფები (ელექტრობა); შემაერთებელი კოლოფები (ელექტრობა); საკომუტაციო დაფები; კონტაქტები, ელექტრული; მარეგულირებელი ხელსაწყოები, ელექტრული; კონვერტერები, გარდამქმნელები, ელექტრული; ელექტრული ხელსაწყოები კომუნიკაციისთვის; გადამრთველები, ელექტრული; შემზღუდველები (ელექტრობა); როზეტები, შტეფსელის ჩანგლები, (ელექტრული შეერთებები); დენის გამმართველები; რედუქტორები (ელექტრობა); სონარები; დეტექტორები; ხმამაღლამოლაპარაკები; მცველები; გამანაწილებელი დაფები (ელექტრობა); გამანაწილებელი პულტები (ელექტრობა); საზომები; გამზომი ხელსაწყოები; ტელეფონის ყურმილები; ფლუორესცენციური ეკრანები; დენის კარგვის ელექტრული ინდიკატორები; გამზომი ხელსაწყოები, ელექტრული; კაბელები, ელექტრული; გაყვანილობა (ელექტრობა); მართვის პულტები, ელექტრუ

ლი; გალვანური ელემენტები; შეერთებები ელექტროხაზებისათვის; შეერთებები, ელექტრული; შეერთებები, ელექტრული; რელეები, ელექტრული; ელექტროლიზის აბაზანები; გადამცემები (ელექტრონული სიგნალის); დისტანციური რადიოგადამცემები (კავშირგაბმულობა); თერმოსტატები; სადენები, ელექტრული; მაგნიტური სადენები; აკუმულატორის დამტენები; დნობადი მცველები; გალენიტის დეტექტორები; აუდიო და ვიდეო მიმღებები; მაჩვენებლები (რაოდენობის); ინდუქტორები (ელექტრობა); მონაცემთა დასამუშავებელი მოწყობილობები; სალაპარაკოაპარატები; ინვერტორები (ელექტრობა); იონიზაციის ხელსაწყოები, ჰაერის და წყლის დამუშავების აპარატების გარდა; კარის ოპტიკური საჭვრეტელები; მეგაფონები; დროის რელეები, ავტომატური; ოპტიკური ამრეკლავები; ბატარეები, ელექტრული; აკუმულატორები, ელექტრული; კომპიუტერული პროგრამები, ჩაწერილი; სიგნალები, მნათი ან მექანიკური; კლემები (ელექტრული); საკეტები, ელექტრული; სასიგნალო სასტვენები; დისტანციური მართვის ელექტროდინამიკური აპარატურა (სიგნალების); ტელემოკარნახე; სატელეფონო გადამცემები; ტემპერატურის ინდიკატორები; ბრუნთა რიცხვის მთვლელები; გაქურდვსაგან დამცავი ელექტრული მოწყობილობები; ბაკენები, ბუიები (სასიგნალო); საიდენტიფიკაციო მაგნიტური ბარათები; ჩიპები (ინტეგრალური სქემები); მზის ბატარეები; სპილენძის სადენი, იზოლირებული; ელექტროზარები კარისათვის; კომპიუტერის პროგრამული უზრუნველყოფა, ჩაწერილი; კომუტაციის მოწყობილობები (მონაცემების დასამუშავებელი მოწყობილობები); დეკომპრესიის კამერები; განათების რეგულატორები, ელექტრული; ინფორმაციის მაგნიტური მატარებლები; კოდირების მოწყობილობები (მაგნიტური); მიკროპროცესორები; დეტექტორები (კვამლის); საანგარიშოები; ელექტრული წიგნაკები; სატელეფონო ავტომოპასუხეები; ვიდეოკამერები, კამკორდერები; მეხსიერების ბარათები მიკროპროცესორით (სმარტ-ბარათები); განცხადებების ელექტრონული დაფები; ვიდეოეკრანები; ვიდეოტელეფონები; კომპიუტერული პროგრამები (ჩასატვირთი პროგრამული უზრუნველყოფა); პერსონალური სტერეომიმღებები; კაბელები (კოაქსიალური); კაბელები (ოპტიკურ-ბოჭკოვანი); დამცავი

სახურავეები შტეფსელის როზეტებისათვის; ქარის მიმართულების მაჩვენებლები; მაჩვენებლები (სინათლის გამოსხივების ელექტრონული); სცენის განათების რეგულატორები; პორტატული მედია პლეიერები; კომპიუტერული სისტემის პროგრამული უზრუნველყოფის აპლიკაცია, ჩასატვირთი; მონიტორები ჩვილის კონტროლისათვის; ვიდეო მონიტორები ჩვილის კონტროლისათვის; პლანშეტური კომპიუტერები; მაგნიტურკოდიანი ბარათი-გასაღებები; ელექტრული სამარჯვები; კომპიუტერის აპარატული უზრუნველყოფა; ციფრული აბრები, ფირნიშები; სმარტ-საათები.

საერთაშორისო სალიცენზიო ხელშეკრულებები

- (800) 871587
(732) Limited liability company "Chernyansky zavod rastitelnykh masel"
12, Magistralnaya str., Chernyanka settlement, Chernyansky district, RU-309560 Belgorod Region, რუსეთის ფედერაცია
(791) ობშესტვო ს ოგრანიჩენოი ოტვეტსტვე-ნოსტიუ „მასლოექსტრაქციონნი ზავოდ იუგ რუსი“
როსტოვსკაია ობლასტ, გ. როსტოვ-ნა-დონუ, პლ. ტოლსტოგო, 8, 344037, რუსეთის ფედერაცია
(793) №1610
ლიცენზიის სახე: მარტივი მოქმედების ვადა: 22-10-2020-დან ნიშნის მოქმედების ვადით
29 – Meat, fish, poultry and game; meat extracts; preserved, dried and cooked fruits and vegetables; jellies; jams, compotes; eggs, milk and milk products; edible oils and fats.
30 – Coffee, tea, cocoa, sugar, rice, tapioca, sago, artificial coffee; flour and preparations made from cereals, bread, pastry and confectionery, ices; honey, treacle; yeast, baking-powder; salt, mustard; vinegar, sauces (condiments); spices; ice.
32 – Beers; mineral and aerated waters and other non-alcoholic drinks; fruit drinks and fruit juices; syrups and other preparations for making beverages.
33 – Alcoholic beverages (except beers).
35 – Advertising; business management; business administration; office functions.
43 – Services for providing food and drink.

- (800) 886597
(732) Limited liability company "Chernyansky zavod rastitelnykh masel"
12, Magistralnaya str., Chernyanka settlement, Chernyansky district, RU-309560 Belgorod Region, რუსეთის ფედერაცია
(791) ობშესტვო ს ოგრანიჩენოი ოტვეტსტვე-ნოსტიუ "მასლოექსტრაქციონნი ზავოდ იუგ რუსი"

- როსტოვსკაია ობლასტ, გ. როსტოვ-ნა-დონუ, პლ. ტოლსტოგო, 8, 344037, რუსეთის ფედერაცია
(793) №1611
ლიცენზიის სახე: მარტივი მოქმედების ვადა: 22-10-2020-დან ნიშნის მოქმედების ვადით
29 – Meat, fish, poultry and game; meat extracts; preserved, dried and cooked fruits and vegetables; jellies, jams, compotes; eggs, milk and dairy products; edible oils and fats.

- (800) 907113
(732) Limited Liability Company "Sistema"
8, Tolstogo sq., RU-344037 Rostov-on-Don, რუსეთის ფედერაცია
(791) ობშესტვო ს ოგრანიჩენოი ოტვეტსტვე-ნოსტიუ "მასლოექსტრაქციონნი ზავოდ იუგ რუსი"
როსტოვსკაია ობლასტ, გ. როსტოვ-ნა-დონუ, პლ. ტოლსტოგო, 8, 344037, რუსეთის ფედერაცია
(793) №1612
ლიცენზიის სახე: მარტივი მოქმედების ვადა: 22-10-2020-დან ნიშნის მოქმედების ვადით
29 – Colza oil for food; rape oil for food; edible oils; corn oil, maize oil, palm kernel oil for food; sesame oil, palm oil for food, olive oil for food, sunflower oil for food; coconut oil.

- 30 – Cookies; pancakes, bread rolls, waffles, vermicelli (noodles), confectionery for decorating Christmas trees, cakes, pastries, peanut confectionery, almond confectionery; farinaceous food pastes; pasta; macaroni, pasty, pate (pastries), capers; groats for human food, husked barley, crushed barley, sago, semolina, farinaceous foods, noodles, ribbon vermicelli, fruit jellies (confectionery), marzipan; custard, lozenges (confectionery), pastilles (confectionery), molasses for food; golden syrup, pepper, biscuits; malt biscuits, macaroons (pastry), petit-beurre biscuits; pies; pizzas; popcorn; weeds (condiment), condiments; ketchup (sauce); sauces (condiments), chow-chow (condiment), relish (condiment), tomato sauce, mayonnaise, soya sauce, chutneys (condiments), dressings for salad; meat gravies, cereal preparations, flour-milling products, gingerbread, cinnamon (spice); curry (spice); cloves

(spice), spices, allspice, ginger (spice), cake paste, pastry, confectionery, sugar confectionery, salt for preserving foodstuffs; spaghetti, rusks, bread-crumbs, tarts, edible decorations for cakes; halvah; bread; unleavened bread, corn flakes, maize flakes, oat flakes, chips (cereal products).

სალიცენზიო ხელშეკრულების გაუქმება

(800) 871587
(793) №1056
მოქმედების შეწყვეტის თარიღი: 29 10 2020

(800) 886597
(793) №1057
მოქმედების შეწყვეტის თარიღი: 29 10 2020

(800) 907113
(793) №1237
მოქმედების შეწყვეტის თარიღი: 29 10 2020

სისტემური საკომპლემენტი გამოგონებები

საერთაშორისო კლასიფიკაციის ინდექსის და ბანაცხალის
გამოქვეყნების ნომრის შესაბამისობის ცხრილი

საერთაშორისო კლასიფიკაციის ინდექსი (51)	ბანაცხალის გამოქვეყნების ნომერი (10)
A 61 K 31/4168; A 61 P 3/04; A 61 P 9/00; A 61 P 3/10; C 07 D 233/91	AP 2020 15132 A
A 61 K 31/7076; A 61 P 31/18	AP 2020 15046 A
A 61 P 35/00; C 07 K 16/00	AP 2020 14875 A
B 65 D 71/00	AP 2020 15295 A
C 22 C 38/50	AP 2020 14510 A

ბანაცხალის გამოქვეყნების ნომრის და საერთაშორისო
კლასიფიკაციის ინდექსის შესაბამისობის ცხრილი

ბანაცხალის გამოქვეყნების ნომერი (10)	საერთაშორისო კლასიფიკაციის ინდექსი (51)
AP 2020 14510 A	C 22 C 38/50
AP 2020 14875 A	A 61 P 35/00; C 07 K 16/00
AP 2020 15046 A	A 61 K 31/7076; A 61 P 31/18
AP 2020 15132 A	A 61 K 31/4168; A 61 P 3/04; A 61 P 9/00; A 61 P 3/10; C 07 D 233/91
AP 2020 15295 A	B 65 D 71/00

საერთაშორისო კლასიფიკაციის ინდექსის, პატენტის ნომრისა
და გამოქვეყნების ნომრის შესაბამისობის ცხრილი

საერთაშორისო კლასიფიკაციის ინდექსი (51)	პატენტის ნომერი (11)	ბანაცხალის გამოქვეყნების ნომერი (10)
A 61 K 9/08; A 61 K 9/14	P 2020 7176 B	AP 2020 14833 A
A 61 K 31/00; A 61 K 9/14; A 61 K 47/26; A 61 K 9/00; A 61 K 47/12	P 2020 7178 B	AP 2020 14782 A
A 61 K 31/44; A 61 P 29/00; C 07 D 401/12; C 07 D 213/75	P 2020 7177 B	AP 2020 14909 A
A 61 K 39 395; C 07 K 16 18; C 07 K 16 28	P 2020 7174 B	AP 2020 14811 A
61 K 47/24; A 61 K 47/14; A 61 K 31/355; A 61 P 31/10; A 61 P 31/04	P 2020 7179 B	AP 2020 15201 A
E 02 D 31/00; E 01 C 3/00; E 01 C 3/04; E 01 B 2/00	P 2020 7173 B	AP 2020 14264 A
H 01 L 31/00	P 2020 7175 B	AP 2020 15077 A

პატენტის ნომრის, ბანაცხაღის გამომქვეყნების ნომრისა და საქართველოს კლასიფიკაციის ინდექსის შესაბამისობის ცხრილი

პატენტის ნომერი (11)	ბანაცხაღის გამომქვეყნების ნომერი (10)	საქართველოს კლასიფიკაციის ინდექსი (51)
P 2020 7173 B	AP 2020 14264 A	E 02 D 31/00; E 01 C 3/00; E 01 C 3/04; E 01 B 2/00
P 2020 7174 B	AP 2020 14811 A	A 61 K 39 395; C 07 K 16 18; C 07 K 16 28
P 2020 7175 B	AP 2020 15077 A	H 01 L 31/00
P 2020 7176 B	AP 2020 14833 A	A 61 K 9/08; A 61 K 9/14
P 2020 7177 B	AP 2020 14909 A	A 61 K 31/44; A 61 P 29/00; C 07 D 401/12; C 07 D 213/75
P 2020 7178 B	AP 2020 14782 A	A 61 K 31/00; A 61 K 9/14; A 61 K 47/26; A 61 K 9/00; A 61 K 47/12
P 2020 7179 B	AP 2020 15201 A	61 K 47/24; A 61 K 47/14; A 61 K 31/355; A 61 P 31/10; A 61 P 31/04

ბანაცხაღის ნომრის, ბანაცხაღის გამომქვეყნების ნომრისა და პატენტის ნომრის შესაბამისობის ცხრილი

ბანაცხაღის ნომერი (21)	ბანაცხაღის გამომქვეყნების ნომერი (10)	პატენტის ნომერი (11)
AP 2015 14264	AP 2020 14264 A	P 2020 7173 B
AP 2016 14782	AP 2020 14782 A	P 2020 7178 B
AP 2016 14811	AP 2020 14811 A	P 2020 7174 B
AP 2016 14833	AP 2020 14833 A	P 2020 7176 B
AP 2014 14909	AP 2020 14909 A	P 2020 7177 B
AP 2019 15077	AP 2020 15077 A	P 2020 7175 B
AP 2018 15201	AP 2020 15201 A	P 2020 7179 B

სასარბებლო მოდელები

საქართველოს კლასიფიკაციის ინდექსის და ბანაცხაღის გამომქვეყნების ნომრის შესაბამისობის ცხრილი

საქართველოს კლასიფიკაციის ინდექსი (51)	ბანაცხაღის გამომქვეყნების ნომერი (10)
C 10 L 1/19; C 11 C 39/10	AU 2020 14497 U

ბანაცხაღის გამომქვეყნების ნომრის და საქართველოს კლასიფიკაციის ინდექსის შესაბამისობის ცხრილი

ბანაცხაღის გამომქვეყნების ნომერი (10)	საქართველოს კლასიფიკაციის ინდექსი (51)
AU 2020 14497 U	C 10 L 1/19; C 11 C 39/10

საერთაშორისო კლასიფიკაციის ინდექსის, პატენტის ნომრისა
და გამომქვეყნების ნომრის შესაბამისობის ცხრილი

საერთაშორისო კლასიფიკაციის ინდექსი (51)	პატენტის ნომერი (11)	ბანაცხადის გამომქვეყნების ნომერი (10)
A 01 G 9/14	U 2020 2057 Y	AU 2020 15204 U
B 65 D 81/03	U 2020 2056 Y	AU 2020 15238 U

პატენტის ნომრის, ბანაცხადის გამომქვეყნების ნომრისა
და საერთაშორისო კლასიფიკაციის ინდექსის შესაბამისობის ცხრილი

პატენტის ნომერი (11)	ბანაცხადის გამომქვეყნების ნომერი (10)	საერთაშორისო კლასიფიკაციის ინდექსი (51)
U 2020 2056 Y	AU 2020 15238 U	B 65 D 81/03
U 2020 2057 Y	AU 2020 15204 U	A 01 G 9/14

ბანაცხადის ნომრის, ბანაცხადის გამომქვეყნების ნომრისა
და პატენტის ნომრის შესაბამისობის ცხრილი

ბანაცხადის ნომერი (21)	ბანაცხადის გამომქვეყნების ნომერი (10)	პატენტის ნომერი (11)
AU 2019 15204	AU 2020 15204 U	U 2020 2057 Y
AU 2018 15238	AU 2020 15238 U	U 2020 2056 Y

დიზაინები

საერთაშორისო კლასიფიკაციის ინდექსის და განაცხადის
გამოქვეყნების ნომრის შესაბამისობის ცხრილი

საერთაშორისო კლასიფიკაციის ინდექსი (51)	განაცხადის გამოქვეყნების ნომერი (10)
09-03	AD 2020 1156 S
09-05	AD 2020 1155 S
19-08	AD 2020 1153 S
19-08	AD 2020 1154 S

განაცხადის გამოქვეყნების ნომრის და საერთაშორისო
კლასიფიკაციის ინდექსის შესაბამისობის ცხრილი

განაცხადის გამოქვეყნების ნომერი (10)	საერთაშორისო კლასიფიკაციის ინდექსი (51)
AD 2020 1153 S	19-08
AD 2020 1154 S	19-08
AD 2020 1155 S	09-05
AD 2020 1156 S	09-03

დაჩქარებული პროცედურით რეგისტრირებული დიზაინები

საერთაშორისო კლასიფიკაციის ინდექსის და პატენტის ნომრის
შესაბამისობის ცხრილი

საერთაშორისო კლასიფიკაციის ინდექსი (51)	პატენტის ნომერი (11)
D 2020 871 S	12-07
D 2020 870 S	32-00

პატენტის ნომრის და საერთაშორისო კლასიფიკაციის ინდექსის
შესაბამისობის ცხრილი

პატენტის ნომერი (11)	საერთაშორისო კლასიფიკაციის ინდექსი (51)
D 2020 870 S	32-00
D 2020 871 S	12-07

განაცხადის ნომრის და პატენტის ნომრის შესაბამისობის ცხრილი

განაცხადის ნომერი (21)	პატენტის ნომერი (11)
AD 2020 1184	D 2020 871 S
AD 2020 1187	D 2020 870 S

სასაქონლო ნიშნები

რეგისტრაციის ნომრის, განაცხადის ნომრის,
განაცხადის გამოქვეყნების ნომრისა და ბიულეტენის ნომრის
შესაბამისობის ცხრილი

რეგისტრაციის ნომერი (111)	განაცხადის Nომერი (210)	განაცხადის გამოქვეყნების ნომერი (260)	ბიულეტენის Nომერი
1	2	3	4
M 2020 33250 R	AM 110046	-	21(553)2020
M 2020 33251 R	AM 110136	-	21(553)2020
M 2020 33252 R	AM 110140	-	21(553)2020
M 2020 33253 R	AM 110141	-	21(553)2020
M 2020 33254 R	AM 110022	-	21(553)2020
M 2020 33255 R	AM 102028	AM 2019 102028 A	20(528)2019
M 2020 33256 R	AM 104091	AM 2020 104091 A	7(539)2020
M 2020 33257 R	AM 104549	AM 2020 104549 A	7(539)2020
M 2020 33258 R	AM 104551	AM 2020 104551 A	7(539)2020
M 2020 33259 R	AM 104767	AM 2020 104767 A	7(539)2020
M 2020 33260 R	AM 104768	AM 2020 104768 A	7(539)2020
M 2020 33261 R	AM 104897	AM 2020 104897 A	12(544)2020
M 2020 33262 R	AM 104940	AM 2020 104940 A	12(544)2020
M 2020 33263 R	AM 105013	AM 2020 105013 A	7(539)2020
M 2020 33264 R	AM 105026	AM 2020 105026 A	13(545)2020
M 2020 33265 R	AM 105033	AM 2020 105033 A	8(540)2020
M 2020 33266 R	AM 105246	AM 2020 105246 A	9(541)2020
M 2020 33267 R	AM 105247	AM 2020 105247 A	9(541)2020
M 2020 33268 R	AM 105248	AM 2020 105248 A	9(541)2020
M 2020 33269 R	AM 105254	AM 2020 105254 A	11(543)2020
M 2020 33270 R	AM 105257	AM 2020 105257 A	8(540)2020
M 2020 33271 R	AM 105644	AM 2020 105644 A	12(544)2020
M 2020 33272 R	AM 105665	AM 2020 105665 A	12(544)2020
M 2020 33273 R	AM 105740	AM 2020 105740 A	13(545)2020
M 2020 33274 R	AM 105742	AM 2020 105742 A	13(545)2020
M 2020 33275 R	AM 105749	AM 2020 105749 A	12(544)2020
M 2020 33276 R	AM 105768	AM 2020 105768 A	12(544)2020
M 2020 33277 R	AM 105795	AM 2020 105795 A	12(544)2020
M 2020 33278 R	AM 105807	AM 2020 105807 A	12(544)2020
M 2020 33279 R	AM 105811	AM 2020 105811 A	11(543)2020
M 2020 33280 R	AM 105819	AM 2020 105819 A	13(545)2020
M 2020 33281 R	AM 105877	AM 2020 105877 A	12(544)2020
M 2020 33282 R	AM 105885	AM 2020 105885 A	13(545)2020
M 2020 33283 R	AM 105967	AM 2020 105967 A	13(545)2020
M 2020 33284 R	AM 105974	AM 2020 105974 A	13(545)2020
M 2020 33285 R	AM 105991	AM 2020 105991 A	13(545)2020
M 2020 33286 R	AM 106043	AM 2020 106043 A	12(544)2020
M 2020 33287 R	AM 106044	AM 2020 106044 A	12(544)2020
M 2020 33288 R	AM 106167	AM 2020 106167 A	13(545)2020
M 2020 33289 R	AM 106183	AM 2020 106183 A	13(545)2020

1	2	3	4
M 2020 33290 R	AM 106184	AM 2020 106184 A	13(545)2020
M 2020 33291 R	AM 106320	AM 2020 106320 A	13(545)2020
M 2020 33292 R	AM 109656	-	21(553)2020
M 2020 33293 R	AM 110291	-	21(553)2020
M 2020 33294 R	AM 110202	-	21(553)2020
M 2020 33295 R	AM 110195	-	21(553)2020

ბანაცხადის გამოქვეყნების ნომრისა და ბანაცხადის ნომრის
შესაბამისობის ცხრილი

ბანაცხადის გამოქვეყნების ნომერი (260)	ბანაცხადის ნომერი (210)	1	2
		1	2
AM 2020 100030 A*	AM 100030	AM 2020 107821 A	AM 107821
AM 2020 105671 A	AM 105671	AM 2020 107822 A	AM 107822
AM 2020 105672 A	AM 105672	AM 2020 107832 A	AM 107832
AM 2020 106777 A	AM 106777	AM 2020 107833 A	AM 107833
AM 2020 107148 A	AM 107148	AM 2020 107887 A	AM 107887
AM 2020 107151 A	AM 107151	AM 2020 107892 A	AM 107892
AM 2020 107263 A	AM 107263	AM 2020 107893 A	AM 107893
AM 2020 107478 A	AM 107478	AM 2020 107894 A	AM 107894
AM 2020 107645 A	AM 107645	AM 2020 107895 A	AM 107895
AM 2020 107646 A	AM 107646	AM 2020 107896 A	AM 107896
AM 2020 107649 A	AM 107649	AM 2020 107897 A	AM 107897
AM 2020 107650 A	AM 107650	AM 2020 107898 A	AM 107898
AM 2020 107652 A	AM 107652	AM 2020 107899 A	AM 107899
AM 2020 107656 A	AM 107656	AM 2020 107900 A	AM 107900
AM 2020 107659 A	AM 107659	AM 2020 107901 A	AM 107901
AM 2020 107660 A	AM 107660	AM 2020 107902 A**	AM 107902
AM 2020 107661 A	AM 107661	AM 2020 107903 A	AM 107903
AM 2020 107667 A	AM 107667	AM 2020 107904 A	AM 107904
AM 2020 107668 A	AM 107668	AM 2020 107905 A	AM 107905
AM 2020 107678 A	AM 107678	AM 2020 107906 A	AM 107906
AM 2020 107679 A	AM 107679	AM 2020 107907 A	AM 107907
AM 2020 107680 A	AM 107680	AM 2020 107908 A	AM 107908
AM 2020 107681 A	AM 107681	AM 2020 107909 A	AM 107909
AM 2020 107682 A	AM 107682	AM 2020 107910 A	AM 107910
AM 2020 107683 A	AM 107683	AM 2020 107911 A	AM 107911
AM 2020 107684 A	AM 107684	AM 2020 107913 A	AM 107913
AM 2020 107807 A	AM 107807	AM 2020 107914 A	AM 107914
AM 2020 107815 A	AM 107815	AM 2020 107916 A	AM 107916
AM 2020 107818 A	AM 107818	AM 2020 107917 A	AM 107917
AM 2020 107819 A	AM 107819	AM 2020 107918 A	AM 107918
AM 2020 107820 A	AM 107820	AM 2020 107919 A	AM 107919
		AM 2020 107920 A	AM 107920
		AM 2020 107921 A	AM 107921
		AM 2020 107922 A	AM 107922
		AM 2020 107930 A	AM 107930
		AM 2020 108059 A	AM 108059

ბანაცხადის ბამოქვეყნების ნომრის საკიბელო საქონლისა
და/ან მომსახურების კლასის მიხედვით

საქონლისა და/ან მომსახურების კლასი (511)	განაცხადის გამოქვეყნების ნომერი (260)
1	2
1	AM 2020 107656 A
1	AM 2020 107913 A
1	AM 2020 107914 A
3	AM 2020 105672 A
3	AM 2020 106777 A
3	AM 2020 107652 A
3	AM 2020 107659 A
5	AM 2020 105672 A
5	AM 2020 107649 A
5	AM 2020 107650 A
5	AM 2020 107660 A
5	AM 2020 107667 A
5	AM 2020 107668 A
5	AM 2020 107818 A
5	AM 2020 107819 A
5	AM 2020 107820 A
5	AM 2020 107821 A
5	AM 2020 107822 A
5	AM 2020 107832 A
5	AM 2020 107833 A
5	AM 2020 107892 A
5	AM 2020 107893 A
5	AM 2020 107894 A
5	AM 2020 107895 A
5	AM 2020 107896 A
5	AM 2020 107897 A
5	AM 2020 107898 A
5	AM 2020 107899 A
5	AM 2020 107900 A
5	AM 2020 107901 A
5	AM 2020 107902 A**
5	AM 2020 107903 A
5	AM 2020 107904 A
5	AM 2020 107905 A
5	AM 2020 107906 A
5	AM 2020 107907 A

1	2
5	AM 2020 107908 A
5	AM 2020 107909 A
5	AM 2020 107910 A
5	AM 2020 107911 A
5	AM 2020 107918 A
5	AM 2020 107919 A
5	AM 2020 107920 A
5	AM 2020 107921 A
5	AM 2020 107922 A
5	AM 2020 107930 A
5	AM 2020 108059 A
9	AM 2020 100030 A*
9	AM 2020 107815 A
12	AM 2020 107887 A
12	AM 2020 107917 A
21	AM 2020 105671 A
21	AM 2020 105672 A
25	AM 2020 107645 A
31	AM 2020 107656 A
33	AM 2020 106777 A
33	AM 2020 107646 A
33	AM 2020 107652 A
33	AM 2020 107661 A
33	AM 2020 107916 A
34	AM 2020 107678 A
34	AM 2020 107679 A
34	AM 2020 107680 A
34	AM 2020 107681 A
34	AM 2020 107682 A
34	AM 2020 107683 A
34	AM 2020 107807 A
35	AM 2020 107478 A
35	AM 2020 107815 A
39	AM 2020 107815 A
41	AM 2020 107263 A
42	AM 2020 107815 A
43	AM 2020 107148 A
43	AM 2020 107151 A
43	AM 2020 107263 A
43	AM 2020 107684 A

დაქარაღებული პროცედურით რეგისტრირებული სასაქონლო ნიშნის ნომრის
საძიებელი საქონლისა და/ან მომსახურების კლასის მიხედვით

საქონლისა და/ან მომსახურების კლასი (511)	დაქარაღებული პროცედურით რეგისტრირებული სასაქონლო ნიშნის ნომერი (111)
7	M 2020 33294 R
8	M 2020 33294 R
9	M 2020 33294 R
11	M 2020 33294 R
12	M 2020 33293 R
29	M 2020 33295 R
33	M 2020 33251 R
33	M 2020 33253 R
33	M 2020 33254 R
33	M 2020 33292 R
35	M 2020 33250 R
43	M 2020 33251 R
43	M 2020 33252 R

სამრეწველო საკუთრების
ოფიციალური ბიულეტენი

21(553)

გამოგონებები

სასარბებლო მოდელები

ღიზინები

სასაქონლო ნიშნები

საქონლის აღბილწარმოშობის დასახელება

მთავარი რედაქტორი: ნ. ბებრიშვილი

კორექტორი: ლ. ჭანტურია

დამკაზადონებლები: მ. ორდენიძე

ქ. სვანიძე

პოლიგრაფიული ჯგუფი: მ. მეჩტიშვილი

ი. გოგოლაშვილი

ლ. დოლიძე

ხელმოწერილია გამოსაცემად 2020 11 09

ტირაჟი 10
შეკვეთა №21

ბიულეტენის ელექტრონული ვერსიის გაცნობა შესაძლებელია საქპატენტის ვებგვერდზე