



**NATIONAL INTELLECTUAL PROPERTY CENTER OF GEORGIA
SAKPATENTI**

**OFFICIAL BULLETIN
OF THE INDUSTRIAL PROPERTY**

2(486)

**2018
TBILISI**

INID CODES FOR IDENTIFICATION OF BIBLIOGRAPHIC DATA

INVENTIONS, UTILITY MODELS

- (10) Number of publication for application, which has been examined
- (11) Number of patent and kind of document
- (21) Serial number of application
- (22) Date of filing of the application
- (23) Date of exhibition or the date of the earlier filing and the number of application, if any
- (24) Date from which patent may have effect
- (31) Number of priority application
- (32) Date of filing of priority application
- (33) Code of the country or regional organization allotting priority application number
- (44) Date of publication of application not granted, but examined and number of bulletin
- (45) Date of publication of registered document
- (51) International Patent Classification Index
- (54) Title of the invention
- (57) Abstract
- (60) Number of examined patent document granted by foreign patent office, date from which patent has effect and country code
- (62) Number of the earlier application and in case of divided application, date of filing an application
- (71) Name, surname and address of applicant (country code)
- (72) Name, surname of inventor (country code)
- (73) Name, surname and address of patent owner (country code)
- (74) Name, surname of representative or patent attorney
- (85) Date of commencement of the national phase of International Application
- (86) Number and date of filing of international application
- (87) Number and date of publication of international application

DESIGNS

- (10) Number of publication for application
- (11) Number of patent and kind of document or number of registration
- (15) Date of registration/Date of patent renewal
- (18) Expected expiration date of patent or registration
- (21) Serial number of application
- (22) Date of filing of the application
- (23) Date of exhibition or the date of the earlier filing and the number of application, if any
- (24) Date from which patent may have effect
- (28) Number of designs included in the application
- (30) Data relating to priority (number of application, date of filing of application, two-letter code identifying the authority with whom the priority application was made)
- (31) Number of priority application
- (32) Date of filing of priority application
- (33) Code of the country or regional organization allotting priority application number
- (34) Two-letter code according to WIPO St.3 identifying the authority with which the priority application was made
- (44) Date of publication of design and number of bulletin (the first publication)
- (45) Date of publication of design registered by WIPO and number of bulletin
- (51) International Classification for designs (class and subclass of the Locarno Classification)
- (54) Title of the invention
- (55) Reproduction of the design
- (57) Description of characteristic features of the design including indication of colors
- (58) Date of recording of any kind of amendment in the Register
- (62) Number of the earlier application, registration and document number and if available the date of filing an application in case of divided application
- (71) Name, surname and address of applicant (country code)
- (72) Name, surname of creator (country code)
- (73) Name, surname and address of patent owner (country code)
- (74) Name, surname of representative or patent attorney
- (81) Contracting states concerned
 - II designated contracting states according to the 1960 Act
 - III designated contracting states according to the 1999 Act
- (85) Owner's permanent address
- (86) Owner's nationality
- (87) Owner's residence
- (88) State in which the owner has a real and effective industrial or commercial establishment

TRADEMARKS

- (111) – Number of registration
- (151) – Date of registration
- (156) – Date of the renewal
- (181) – Expected expiration date of registration
- (186) – Renewal expiration date of registration
- (141) – Date of cancel of duration of the mark
- (210) – Serial number of application
- (220) – Date of filing of the application
- (230) – Data concerning exhibition
- (260) – Number of application, for which favorable decision of examination about registration has been taken (publication number)
- (310) – Number of the first application
- (320) – Date of filing of the first application
- (330) – Code, identifying national or regional Office where the first application was made
- (511) – International Classification of Goods and Services for the purposes of registration of trade marks and/or list of goods and/or services classified according thereto
- (531) – Description of figurative elements of Trade Marks according to the International Classification of the Figurative Elements of Marks
- (540) – Reproduction of Trade Mark
- (550) – Nature and kind of Trade Mark
- (580) – Date of recording of any kind changes in respect of applications or registrations
- (591) – Information concerning colors claimed
- (731) – Name and address of the applicant
- (732) – Name and address of the holder of the registration
- (740) – Name and address of the representative
- (750) – Address for correspondence
- (770) – Name and address of the previous applicant or holder in case of change in ownership
- (771) – Previous name and address of the applicant or holder in case of change in ownership
- (791) – Name and address of the licensee
- (793) – Indication of conditions and/or restrictions under the license (Type of license, number of license agreement, data of license, data of validity of license)
- (800) – Certain data relating to the international registration of Trade Marks under the Protocol Relating to Madrid Agreement (International registration number)

CODES FOR PUBLICATION IN BULLETIN

- (21) AP 0000 000000 – serial number of application for invention
- (10) AP 0000 0000 A – number of published application for invention (first publication)
- (11) P 0000 0000 B – number of patent for invention (second publication)
- (21) API 0000 000000 – number of application for imported patent
- (11) PI 0000 0000 A – number of imported patent (first publication)
- (21) AU 0000 000000 – serial number of application for utility model
- (10) AU 0000 000 U – number of published application for utility model (first publication)
- (11) U 0000 000 Y – number of patent for utility model (second publication)
- (21) AD 0000 000000 – serial number of application for design
- (10) AD 0000 000 S – number of published application for design (first publication)
- (11) D 0000 000 S – number of patent for design (second publication)

INTERNATIONAL PATENT CLASSIFICATION FOR INVENTIONS AND UTILITY MODELS

- SECTION A – HUMAN NECESSITIES
- SECTION B – PERFORMING OPERATIONS; TRANSPORTING
- SECTION C – CHEMISTRY; METALLURGY
- SECTION D – TEXTILES; PAPER
- SECTION E – FIXED CONSTRUCTIONS
- SECTION F – MECHANICAL ENGINEERING; LIGHTING; HEATING; WEAPONS; BLASTING
- SECTION G – PHYSICS
- SECTION H – ELECTRICITY

-
- M – Trade Mark
 - (210) AM 0000 000000 – Serial number of application;
 - (260) AAM 0000 00000 A – Publication number of application;
 - (111) M 0000 00000 R – Number of registration;
 - (111) MMM0000 00000 Rn – Number of renewals, in which n=1,2,3;
 - (111) M 0000 00000 R(P) – Number of registration under partial assignment of rights
-

LIST OF CODES, IN ALPHABETIC SEQUENCE, AND THE CORRESPONDING (SHORT) NAMES OF STATES, OTHER ENTITIES AND INTERGOVERNMENTAL ORGANIZATIONS
(WIPO STANDARD ST.3)

AD	Andorra				
AE	United Arab Emirates				
AF	Afghanistan				
AG	Antigua and Barbuda				
AI	Anguilla				
AL	Albania				
AM	Armenia				
AN	Netherlands Antilles				
AO	Angola				
AP	African Regional Intellectual Property Organization (ARIPO)				
AR	Argentina				
AT	Austria				
AU	Australia				
AW	Aruba				
AZ	Azerbaijan				
BA	Bosnia and Herzegovina				
BB	Barbados				
BD	Bangladesh				
BE	Belgium				
BF	Burkina Faso				
BG	Bulgaria				
BH	Bahrain				
BI	Burundi				
BJ	Benin				
BM	Bermuda				
BN	Brunei Darussalam				
BO	Bolivia				
BR	Brazil				
BS	Bahamas				
BT	Bhutan				
BV	Bouvet Island				
BW	Botswana				
BX	Benelux Office for Intellectual Property (BOIP)				
BY	Belarus				
BZ	Belize				
CA	Canada				
CD	Democratic Republic of the Congo				
CF	Central African Republic				
CG	Congo				
CH	Switzerland				
CI	Cote d'Ivoire				
CK	Cook Islands				
CL	Chile				
CM	Cameroon				
CN	China				
CO	Colombia				
CR	Costa Rica				
CU	Cuba				
CV	Cape Verde				
CY	Cyprus				
CZ	Czech Republic				
DE	Germany				
DJ	Djibouti				
DM	Dominica				
DO	Dominican Republic				
DZ	Algeria				
EA	Eurasian Patent Organization (EAPO)				
EC	Ecuador				
EE	Estonia				
EG	Egypt				
EH	Western Sahara				
EM	Office for Harmonization in the Internal Market (Trademarks and Designs)(OHIM)				
EP	European Patent Office (EPO)				
ER	Eritrea				
ES	Spain				
ET	Ethiopia				
FI	Finland				
FJ	Fiji				
FK	Falkland Islands (Malvinas)				
FO	Faroe Islands				
FR	France				
GA	Gabon				
GB	United Kingdom				
GC	Patent Office of the Cooperation Council for the Arab States of the Gulf (GCC)				
GD	Grenada				
GG	Guernsey				
GH	Ghana				
GI	Gibraltar				
GT	Guatemala				
GW	Guinea- Bissau				
GY	Guyana				
HK	The Hong Kong Special Administrative Region of the People's Republic of China				
HN	Honduras				
HR	Croatia				
HT	Haiti				
HU	Hungary				
IB	International Bureau of the World Intellectual Property Organization (WIPO)				
ID	Indonesia				
IE	Ireland				
IL	Israel				
IM	Isle of Man				
IN	India				
IQ	Iraq				
ID	Indonesia				
IE	Ireland				
IL	Israel				
IM	Isle of Man				
IN	India				
IQ	Iraq				
IR	Iran (Islamic Republic of)				
IS	Iceland				
IT	Italy				
JE	Jersey				
JM	Jamaica				
JO	Jordan				
JP	Japan				
KE	Kenya				
KG	Kyrgyzstan				
KH	Cambodia				
KI	Kiribati				
KM	Saint Kitts and Nevis				
KP	Democratic People's Republic of Korea				
KR	Republic of Korea				
KW	Kuwait				
KY	Cayman Islands				
KZ	Kazakhstan				
LA	Lao People's Democratic Republic				
LB	Lebanon				
LC	Saint Lucia				
LI	Liechtenstein				
LK	Sri Lanka				
LR	Liberia				
LS	Lesotho				
LT	Lithuania				
LU	Luxembourg				
LV	Latvia				
LY	Libyan Arab Jamahiriya				
MA	Morocco				
MC	Monaco				
MD	Republic of Moldova				
ME	Montenegro				
MG	Madagascar				
MK	The former Yugoslav Republic of Macedonia				
ML	Mali				
MM	Myanmar				
MN	Mongolia				
MO	Macao				
MP	Northern Mariana Islands				
MR	Mauritania				
MS	Montserrat				
MT	Malta				
MU	Mauritius				
MV	Maldives				
MW	Malawi				
MX	Mexico				
MY	Malaysia				
MZ	Mozambique				
NA	Namibia				
NE	Niger				
NG	Nigeria				
NI	Nicaragua				
NL	Netherlands				
NO	Norway				
NP	Nepal				
NR	Nauru				
NZ	New Zealand				
OA	African Intellectual Property Organization (OAPI)				
OM	Oman				
PA	Panama				
PE	Peru				
PG	Papua New Guinea				
PH	Philippines				
PK	Pakistan				
PL	Poland				
PT	Portugal				
PW	Palau				
PY	Paraguay				
QA	Qatar				
QZ	Community Plant Variety Office (European Community) (CPVO)				
RO	Romania				
RS	Serbia				
RU	Russian Federation				
RW	Rwanda				
SA	Saudi Arabia				
SB	Solomon Islands				
SC	Seychelles				
SD	Sudan				
SG	Singapore				
SH	Saint Helena				
SI	Slovenia				
SK	Slovakia				
SL	Sierra Leone				
SM	San Marino				
SN	Senegal				
SO	Somalia				
SR	Suriname				
ST	Sao Tome and Principe				
SV	El Salvador				
SY	Syrian Arab Republic				
SZ	Swaziland				
TC	Turks and Caicos Islands				
TD	Chad				
TG	Togo				
TH	Thailand				
TJ	Tajikistan				
TL	Timor-Leste				
TM	Turkmenistan				
TN	Tunisia				
TO	Tonga				
TR	Turkey				
SE	Sweden				
TT	Trinidad and Tobago				
TV	Tuvalu				
TW	Taiwan, Province of China				
TZ	United Republic of Tanzania				
UA	Ukraine				
UG	Uganda				
US	United States of America				
UY	Uruguay				
UZ	Uzbekistan				
VA	Holy See				
VC	Saint Vincent and the Grenadines				
VE	Venezuela				
VG	Virgin Islands (British)				
VN	Viet Nam				
VU	Vanuatu				
WO	World Intellectual Property Organization (WIPO)				
WS	Samoa				
XN	Nordic Patent Institute (NPI)				
YE	Yemen				
ZA	South Africa				
ZM	Zambia				
ZW	Zimbabwe				

**NATIONAL INTELLECTUAL PROPERTY CENTER OF GEORGIA
SAKPATENTI**

**OFFICIAL BULLETIN
OF THE INDUSTRIAL PROPERTY**

2(486)

INVENTIONS

UTILITY MODELS

DESIGNS

TRADEMARKS

APPELLATIONS OF ORIGIN OF GOODS

DATE OF PUBLICATION

2018 01 25

CONTENTS

PUBLISHED TITLES OF PROTECTION	3
INVENTIONS	
▪ APPLICATIONS APPROVED FOR GRANTING PATENTS	4
▪ PATENTED INVENTIONS	8
UTILITY MODELS	
▪ PATENTED UTILITY MODELS	10
DESIGNS	
▪ APPLICATIONS APPROVED FOR REGISTRATION	11
▪ REGISTERED DESIGN	16
▪ DESIGNS REGISTERED ACCORDING TO THE ACCELERATED PROCEDURE	17
TRADEMARKS	
▪ APPLICATIONS FILED UNDER THE NATIONAL PROCEDURE APPROVED FOR REGISTRATION	19
▪ REGISTERED TRADEMARKS	27
▪ TRADEMARKS REGISTERED ACCORDING TO THE ACCELERATED PROCEDURE	30
▪ INTERNATIONAL TRADEMARKS FOR WHICH A DECISION ON GANTING PROTECTION IS TAKEN	32
▪ INTERNATIONAL TRADEMARKS PROTECTED IN GEORGIA	66
APPELLATIONS OF ORIGIN OF GOODS	
▪ THE RIGHT TO USE OF REGISTERED APPELLATIONS OF ORIGIN OF GOODS	79
OFFICIAL NOTIFICATIONS	
TRADEMARKS	
▪ RENEWAL OF REGISTRATIONS	80
▪ COMPLETE TRANSFER OF RIGHT	82
▪ CHANGES IN NAMES AND/OR ADDRESSES OF OWNERS	83
▪ INVALIDATION OF TRADEMARKS REGISTRATION	84
CLASSIFICATION INDEXES	
INVENTIONS	88
UTILITY MODELS	90
DESIGNS	90
TRADEMARKS	93

PUBLISHED TITLES OF PROTECTION

INVENTIONS

- **APPLICATIONS APPROVED FOR GRANTING PATENT:**
14131; 14152; 14032; 14191; 13666; 13870; 13957; 13525; 14213; 14238
- **PATENTED INVENTIONS:**
6809-6815

UTILITY MODELS

- **PATENTED INVENTIONS:**
1958-1960

DESIGNS

- **APPLICATIONS APPROVED FOR REGISTRATION:**
975; 977; 987, 988
- **REGISTERED DESIGN:**
744
- **DESIGN REGISTERED ACCORDING TO THE ACCELERATED PROCEDURE:**
742, 743

TRADEMARKS

- **APPLICATIONS FILED UNDER THE NATIONAL PROCEDURE APPROVED FOR REGISTRATION:**
91749; 91864; 91926; 91938; 91942; 91963; 92068- 92071; 92094; 92124-92126; 92180, 92182; 92218; 92220; 92223; 92308; 92312; 92315, 92316; 92332, 92333; 92346; 92353; 92355-92357; 92465, 92466; 92499; 92508; 92544, 92545; 92606; 92635; 92724; 92729; 92771-92774; 92776, 92777; 92849; 92870, 92871; 92883; 92908; 92928; 92986; 92995
- **REGISTERED TRADEMARKS:**
29275; 29280-29305
- **TRADEMARKS REGISTERED ACCORDING TO THE ACCELERATED PROCEDURE:**
29273, 29274; 29276-29279
- **INTERNATIONAL TRADEMARKS FOR WHICH A DECISION ON GRANTING PROTECTIONS IS TAKEN:**
74551 A**; 88837 A*; 90549; 90712; 90821, 90822; 90824, 90826-90831; 91011; 91013-91016; 91019; 91022; 91028; 91148; 91214; 91216-91219; 91222-91224; 91244, 91245; 91247; 91249; 91251-91253; 91275; 91326, 91327; 91334; 91336-91338; 91363; 91365-91368; 91423; 91429, 91430; 91432-91434; 91436; 91439; 91442, 91443; 91446, 91447; 91452-91455; 91487; 91492; 91496; 91549-91551; 91553; 91557; 91559-91564; 91601, 91602; 91758; 91825, 91826; 91828, 91829; 91892; 92006; 92008, 92009; 92090-92092; 92095
- **INTERNATIONAL TRADEMARKS PROTECTED IN GEORGIA:**
85805; 86197; 86949; 87203; 87602; 87604, 87605, 87764; 87837; 88142; 88148; 88151; 88265; 88281; 88444; 88594; 88666; 88832; 88871; 88878; 88920, 88921; 89029; 89052; 89055, 89056; 89061; 89063-89066; 89071, 89072; 89074, 89075; 89080-89084, 89106, 89107; 89248; 89267; 89353; 89355; 89357, 89358; 89365; 89369; 89373; 89378; 89382; 89390; 89392; 89394-89399; 89401, 89402; 89408-89410; 89412, 89413; 89415, 89416; 89418-89420; 89433, 89434; 89436; 89438-89440; 89442; 89446-89452; 89459-89463; 89465-89471; 89473-89476; 89478; 89481-89488; 89490-89498; 89500-89506; 89508, 89509; 89550; 89553; 89565, 89566; 89571; 89573, 89574; 89577; 89590; 89594; 89613; 89619; 89621, 89622; 89625; 89627, 89628; 89636; 89650; 89656, 89657; 89662-89666; 89668; 89672; 89719-89723; 89725; 89727; 89729; 89731-89733; 89761; 89803-89805; 89850; 90272, 90273; 90275; 90278; 90281; 90283; 90285- 90289; 90293-90295; 90298, 90299; 90659; 90663; 90681

APPELLATIONS OF ORIGIN OF GOODS

- **THE RIGHT TO USE OF REGISTERED APPELLATIONS OF ORIGIN OF GOODS:**
824/1-18, 844/1-18

INVENTIONS

APPLICATIONS APPROVED FOR GRANTING PATENTS

The decision can be appealed at the Chamber of Appeal of Sakpatenti within 3 months from the publication or at the Mtskheta District Court Administrative Cases Board (Address: №17, Samkhedro str., Mtskheta), within 1 month following the publication.

PART A

A 47

(10) AP 2018 14131 A (51) Int. Cl. (2006)
A 47 J 44/02
B 01 F 13/04

(21) AP 2014 014131 (22) 2014 10 06
(31) 14/507,180; 14/047,954
(32) 2014 10 06; 2013 10 07
(33) US; US

(71) CAPBRAN HOLDINGS LLC (US)
Suite 2300 11601 Wilshire Blvd.,
Los Angeles, CA 90025 (US)

(72) SAPIRE, Colin (US)

(74) Tamar Kochlamazashvili

(85) 2016 05 03

(86) PCT/US2014/059345, 2014 10 06

(54) BLENDER

(57) Food-processing device for blending and mixing food comprises mixing vessel, blade holder, and motor base. The motor is high power motor. The device has various safety features designed for high power motor. The blade holder comprises a safety mechanism that prevents motor base from operating without mixing vessel covering the blade. Mixing vessel also contains emitters that interact with detectors on the motor base that can allow a user to select alternate blend speed according to mixing vessel that is attached.

Claims: 1 independent
12 dependent

Fig.: 34

(10) AP 2017 14152 A (51) Int. Cl. (2006)
A 47 L 9/06

(21) AP 2014 014152 (22) 2014 11 12

(71) CRYSTAL LAGOONS (CURACAO)
B.V. (NL)
Kaya W.F.G. (Jombi) Mensing,
14 Curacao (NL)

(72) FISCHMANN TORRES, Fernando Benjamin (CL);
PRIETO DOMINGUEZ, Jorge Eduardo (CL)

(74) Shalva Gvaramadze

(85) 2016 05 20

(86) PCT/IB2014/065981, 2014 11 12

(54) SUCTIONING DEVICE FOR LARGE ARTIFICIAL WATER BODIES

(57) Suctioning device for suctioning flocs from the bottom of large artificial water bodies with surfaces larger than 10,000 m² includes flexible supporting frame made of sheet material, series of head, intermediate and side brushes, comprising first brushes fastened onto said frame for bottom water flocs redirection into suction device, providing minimization of settled flocs dispersion and re-suspension. Suctioning device is designed in order to concentrate the suction power in a series of suction points, series of guard wheels providing auxiliary support, series of collectors for collecting suspending flocs of bottom water and their concentration inside of one or more outer suctioning lines configured for passing suction flocs of bottom water from series of suction points to series of collectors, and connecting means for connecting inner suctioning lines and collectors.

Claims: 2 independent
32 dependent

Fig.: 9

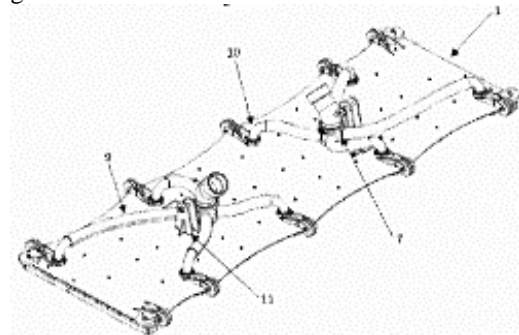

Fig. 1

A 61

(10) AP 2018 14032 A (51) Int. Cl. (2006)
A 61 K 9/00

A 61 K 47/12

A 61 K 47/26

A 61 K 31/167

A 61 K 31/40

A 61 K 31/573

(21) AP 2014 014032 (22) 2014 07 10

(31) 13194763.2; 13176114.0

- (32) 2013 11 28; 2013 07 11
 (33) EP; EP
 (71) CHIESI FARMACEUTICI S.P.A. (IT)
 Via Palermo, 26/A I-43100 Parma (IT)
 (72) MUSA, Rossella (IT);
 PASQUALI, Irene (IT);
 ASKEY-SARVAR, Azita (IT);
 SCHIARETTI, Francesca (IT)
 (74) Shalva Gvaramadze
 (85) 2016 01 06
 (86) PCT/EP2014/064824, 2014 07 10
 (54) **DRY POWDER FORMULATION
 COMPRISING ANTICHOLINERGIC,
 CORTICOSTEROID AND BETA-ADRE-
 NERGIC FOR ADMINISTRATION
 BY INHALATION**
 (57) Compound comprises micronized particles of
 glycopyrronium bromide, dipropionate and
 beclomethasone formoterol fumarate dihydrate,
 fine- and coarse particles fractions. Fine particles
 fraction consists of excipients particles and
 magnesium stearate; at that, particles volume
 median diameter of said fraction is 3-7 μm . Coarse
 particles fraction consists of excipients particles,
 which volume median diameter is more than 175
 μm .
 Claims: 3 independent
 8 dependent

(10) AP 2018 14191 A (51) Int. Cl. (2006)
A 61 K 9/00
A 61 M 15/00
A 61 K 31/167
A 61 K 31/40
B 65 D 83/54
A 61 K 31/573
A 61 K 31/54

- (21) AP 2014 014191 (22) 2014 12 23
 (31) 13199784.3
 (32) 2013 12 30
 (33) EP
 (71) Chiesi Farmaceutici S.P.A. (IT)
 Via Palermo, 26/A, I-43100 Parma PR (IT)
 (72) BONELLI, Sauro (IT);
 COPELLI, Diego (IT);
 MASSIMILIANO DAGLI, Alberi (IT);
 USBERTI, Francesca (IT);
 ZAMBELLI, Enrico (IT)
 (74) Shalva Gvaramadze
 (85) 2016 06 28
 (86) PCT/EP2014/079259, 2014 12 23
 (54) **STABLE PRESSURISED AEROSOL
 SOLUTION COMPOSITION OF
 GLYCOPYRRONIUM BROMIDE AND
 FORMOTEROL COMBINATION**
 (57) An inhalator includes a balloon covered from
 inner side with the resin containing fluorinated
 ethylene-propylene polymer. Aerosol composition,

containing glycopyrronium bromide, formoterol,
 HFA propellant, cosolvent and mineral acid, is
 placed in the balloon.
 Claims: 3 independent
 12 dependent

(10) AP 2018 13666 A (51) Int. Cl. (2006)
A 61 K 31/55
A 61 K 47/06
A 61 K 47/32
A 61 K 47/38
A 61 K 31/5517
A 61 K 9/14

- (21) AP 2013 013666 (22) 2013 05 22
 (31) 12168968.1
 (32) 2012 05 22
 (33) EP
 (71) PAION UK LIMITED (GB)
 Chivers Way, Histon, Cambridge,
 Cambridgeshire CB24 9ZR (GB)
 (72) GRAHAM, John Aitken (GB);
 BAILLIE, Alan James (GB);
 WARD, Kevin Richard (GB);
 PEACOCK, Thomas (GB)
 (74) Shalva Gvaramadze
 (85) 2014 12 18
 (86) PCT/EP2013/060543, 2013 05 22
 (54) **COMPOSITIONS COMPRISING
 SHORT-ACTING BENZODIAZEPINES**

(57) Present invention relates to lyophilized or
 dried by atomization the composition containing
 benzodiazepine of formula (I),

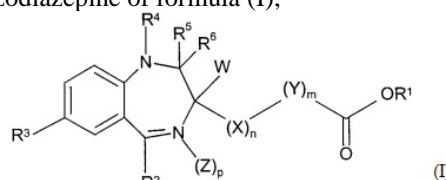

and at least one hydroscopic excipient, particularly
 disaccharides and/or dextran. Furthermore, the
 invention relates to preparation method of the
 composition.

Claims: 5 independent
 11 dependent
 Fig.: 53

(10) AP 2018 13870 A (51) Int. Cl. (2006)
A 61 K 31/495
A 61 P 25/18

- (21) AP 2013 013870 (22) 2013 11 28
 (31) P1200691
 (32) 2012 11 29
 (33) HU
 (71) RICHTER GEDEON NYRT (HU)
 Dion Roy Ut. 19 - 21, H-1103 Budapest (HU)
 (72) PITTER, János György (HU);
 SZATMÁRI, Balázs (HU);

DEBELLE, Marc (FR);
NÉMETH, György József (HU);
LASZLOVSZKY, István (HU)

(74) Liliana Darakhvelidze

(85) 2015 06 29

(86) PCT/IB2013/060465, 2013 11 28

(54) **Trans-4-{2-[4-(2,3-Dichlorophenyl)-Piperazin-1-Yl]-Ethyl}-N,N-Dimethyl-carbamoyl-Cyclohexylamine for Treating Negative Symptoms of Schizophrenia**

(57) Present invention relates to cariprazine and pharmaceutically acceptable salts, hydrates, solvates and polymorphs therefor use in the treatment of primary negative symptoms of schizophrenia and/or predominantly negative symptoms of schizophrenia.

Claims: 2 independent
2 dependent

Fig.: 5

(10) **AP 2017 13957 A** (51) **Int. Cl. (2006)**
A 61 K 38/14
A 61 K 31/545
C 07 D 501/00
C 07 K 9/00

(21) AP 2014 013957 (22) 2014 03 06

(31) 61/779,065

(32) 2013 03 13

(33) US

(71) THERAVANCE BIOPHARMA
ANTIBIOTICS IP LLC (US)
901 Gateway Boulevard South San Francisco,
California 94080 (US)

(72) ZHANG, Weijiang (US);
CHEUNG, Ronnie (US);
FILIPOV, Dimitar (US);
GREEN, Jack (US);
LEE, Junning (US)

(74) Tamaz Shilakadze

(85) 2015 10 12

(86) PCT/US2014/021064, 2014 03 06

(54) **HYDROCHLORIDE SALTS OF AN ANTIBIOTIC COMPOUND**

(57) Present invention relates to compound of formula (I),

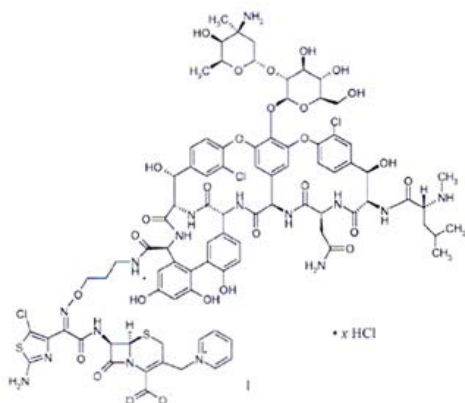

wherein x is equal to 1 or 2. Furthermore, the invention relates to pharmaceutical composition containing these compounds, and their usage at bacterial infections treatment.

Claims: 11 independent

9 dependent

Fig.: 5

PART C

C 01

(10) **AP 2018 13525 A** (51) **Int. Cl. (2006)**
C 01 B 3/24
C 01 B 31/18
C 01 J 3/00

(21) AP 2012 013525 (22) 2012 12 20

(31) 10 2011 122 562.9; 10 2012 008 933.3;
10 2012 015 314.7

(32) 2011 12 20; 2012 04 05; 2012 08 02

(33) DE; DE; DE

(71) CCP TECHNOLOGY GMBH (DE)

Weissenburger Str. 7 81667 München (DE)

(72) KÜHL, Olaf (DE)

(74) Tamaz Shilakadze

(85) 2014 07 17

(86) PCT/EP2012/005309, 2012 12 20

(54) **PROCESS AND SYSTEM FOR CONVERSION OF CARBON DIOXIDE TO CARBON MONOXIDE**

(57) Present invention discloses a process and a device for converting carbon dioxide (CO₂) to carbon monoxide (CO) using hydrocarbons are described. In further details, processe and device are described for generating synthesis gases.

Claims: 5 independent

26 dependent

Fig.: 8

(10) **AP 2018 14213 A** (51) **Int. Cl. (2006)**
C 01 G 15/00
C 01 G 19/00
C 01 G 49/08
C 09 K 9/00
C 09 K 11/62
C 09 K 11/77
G 01 N 33/02
G 01 N 33/15

(21) AP 2014 014213 (22) 2014 12 18

(31) PCT/EP2013/077823; 61/919,037

(32) 2013 12 20; 2013 12 20

(33) EP; US

(71) SICPA HOLDING SA (CH)

Avenue de Florissant 41 CH-1008 Prilly (CH)

(72) MILOS-SCHOUWINK, Mia (CH);
 RAEMY, Xavier Cédric (CH);
 DORIER, Jean-Luc (CH)

(74) Larisa Amirkhanyan

(85) 2016 07 20

(86) PCT/EP2014/078388, 2014 12 18

(54) **THERMOLUMINESCENT COMPOSITE PARTICLE AND MARKING COMPRISING SAME**

(57) There is disclosed composite particle for use in marking that is suitable for identification/authentication purposes. The particle comprises, at least, one superparamagnetic portion and, at least, one thermoluminescent portion, and optionally also thermoconductive portion between superparamagnetic and thermoluminescent portions.

Claims: 11 independent

25 dependent

Fig.: 2

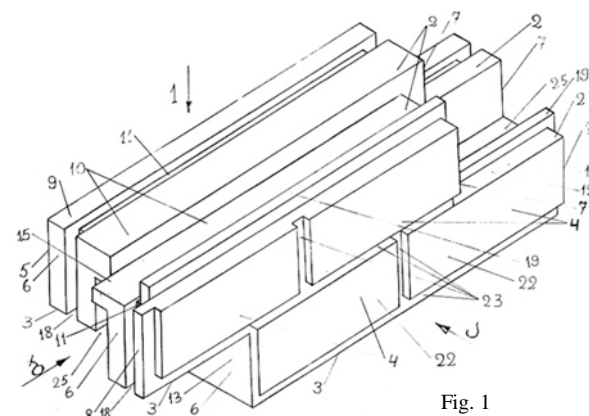

Fig. 1

PART E

E 04

(10) AP 2017 14238 A (51) Int. Cl. (2006)

E 04 C1/40

E 04 C1/41

(21) AP 2016 014238 (22) 2016 08 09

(71) Maia Gorgodze (GE)

Bakhtrionis q. 29, b. 76, Tbilisi (GE)

(72) Tamaz Mushkudiani (GE);

Levan Mushkudiani (GE);

Lasha Mushkudiani (GE)

(54) **WALL HEAT-INSULATING BLOCK**

(57) A block is executed, at least, with couple of adjacent on width the parts having identical shape; at that, one part is shifted relatively to another, in both: horizontal and vertical planes so, that between the parts on one end surface and upper bed the block has outer steps, and opposite thereof it has inner steps on lower bed and another end surface. Said steps are envelope the block from whole longitudinal perimeter. Heat-insulating layers are disposed between inner, intermediate and outer layers in each part of block.

Claims: 2 independent

27 dependent

Fig.: 27

PATENTED INVENTIONS

PART A

A 61

- (11) P 2018 6809 B** **(51) Int. Cl. (2006)**
A 61 K 9/00
A 61 K 31/00
A 61 K 31/164
A 61 K 31/4174
A 61 K 31/505
A 61 K 31/728
A 61 P 11/02
- (10) AP 2017 13662 A (44) 19(479)/2017
(21) AP 2013 013662
(22) 2013 04 16
(24) 2013 04 16
(31) 10 2012 009 495.7; 10 2012 011 447.8
(32) 2012 05 14; 2012 05 15
(33) DE; DE
(86) PCT/EP2013/001117, 2013 04 16
(73) MARIA CLEMENTINE MARTIN
KLOSTERFRAU
VERTRIEBSGESELLSCHAFT MBH (DE)
Gereonsmühlengasse 1-11 50670 Köln (DE)
(72) GREVE, Harald (DE)
(74) Tamar Kochlamazashvili
(54) **COMBINATION THERAPY AGENT
FOR TREATING RHINITIS**

- (11) P 2018 6810 B** **(51) Int. Cl. (2006)**
A 61 K 9/20
A 61 K 9/28
A 61 K 9/50
A 61 K 31/4196
A 61 P 39/04
- (10) AP 2017 13929 A (44) 19(479)/2017
(21) AP 2014 013929
(22) 2014 03 06
(24) 2014 03 06
(31) 61/824,435; 61/774,893
(32) 2013 05 17; 2013 03 08
(33) US; US
(86) PCT/IB 2014/059494, 2014 03 06
(73) NOVARTIS AG (CH)
Lichtstrasse 35 CH-4056 Basel (CH)
(72) GHOSH, Indrajit (IN);
ZHANG, Jia-Ai (UA)
(74) Aleksandre Kartvelishvili
(54) **ORAL FORMULATIONS OF
DEFERASIROX**

PART C

C 07

- (11) P 2018 6811 B** **(51) Int. Cl. (2006)**
C 07 D 401/14
C 07 D 405/14
C 07 D 401/12
A 61 K 31/513
A 61 K 31/501
A 61 K 31/497
A 61 P 25/00
- (10) AP 2017 14022 A (44) 19(479)/2017
(21) AP 2014 014022
(22) 2014 06 13
(24) 2014 06 13
(31) 61/840,144
(32) 2013 06 27
(33) US
(86) PCT/IB2014/062217, 2014 06 13
(73) PFIZER INC. (US)
235 East 42nd St., New-York, NY 10017 (US)
(72) BRODNEY, Michael, Aaron (US);
DAVOREN, Jennifer, Elizabeth (US);
DOUNAY, Amy Beth (US);
EFREMOV, Ivan Viktorovich (US);
GRAY, David Lawrence Firman (US);
GREEN, Michael Eric (US);
HENDERSON, Jaclyn Louise (GB);
LEE, Chewah (US);
MENTE, Scot Richard (US);
O'NEIL, Steven Victor (US);
ROGERS, Bruce Nelsen (US);
ZHANG, Lei (US)
(74) Shalva Gvaramadze
(54) **HETEROAROMATIC COMPOUNDS
AND THEIR USE AS DOPAMINE
D1 LIGANDS**

- (11) P 2018 6812 B** **(51) Int. Cl. (2006)**
C 07 D 403/04
A 61 K 31/4178
A 61 K 31/4184
A 61 P 3/10
- (10) AP 2017 14070 A (44) 19(479)/2017
(21) AP 2014 014070
(22) 2014 07 31
(24) 2014 07 31
(31) 2296/DEL/2013
(32) 2013 07 31
(33) IN

- (86) PCT/IN2014/000507, 2014 07 31
 (73) COUNCIL OF SCIENTIFIC & INDUSTRIAL RESEARCH (IN)
 Anusandhan Bhawan Rafi Marg New Delhi 110 001 (IN);
 SHANTANI PROTEOME ANALYTICS PVT. LTD (IN)
 100 Ncl Innovation Park Dr. Homi Bhabha Road Pune, Maharashtra 411008 (IN)
 (72) REDDY, Dumbala, Srinivasa (IN);
 SAXENA, Chaitanya (IN);
 KOMIRISHETTY, Kashinath (IN)
 (74) Shalva Gvaramadze
 (54) **NOVEL INDAZOLE COMPOUNDS AND A PROCESS FOR THE PREPARATION THEREOF**

C 12

- (11) P 2018 6815 B** (51) **Int. Cl. (2006)**
C 12 G 3/00
C 12 H 1/22
 (10) AP 2017 14336 A (44) 19(479)/2017
 (21) AP 2016 014336
 (22) 2016 12 02
 (24) 2016 12 02
 (73) Jimsher Chkhaidze (GE)
 Paliashvilis q. 92/10, 0162, Tbilisi (GE)
 (72) Jimsher Chkhaidze (GE)
 (54) **METHOD FOR WHISKY PREPARATION**

PART F

F 03

- (11) P 2018 6813 B** (51) **Int. Cl. (2006)**
F 03 B 17/06
F 03 B 13/10
H 02 K 7/18
 (10) AP 2017 14138 A (44) 16(476)/2017
 (21) AP 2014 014138
 (22) 2014 09 29
 (24) 2014 09 29
 (31) 2004/MUM/2012; 1630/MUM/2014
 (32) 2013 10 10; 2014 05 13
 (33) IN; IN
 (86) PCT/IN2014/000626, 2014 09 29
 (73) KIRLOSKAR ENERGEN PRIVATE LIMITED (IN)
 13A, Karve Road Kothrud 411038 Pune (IN)
 (72) BHENDE, Uday Yeshwant (IN);
 JOSHI, Sanjay Prakash (IN);
 ADKAR, Prashant Ramakant (IN);

- MARATHE, Pranav Sham (IN);
 JOSHI, Ashwin Sharad (IN);
 GANU, Shirish Madhav (IN)
 (74) Giorgi Ghvinjilia
 (54) **IN-PIPE TURBINE AND HYDRO-ELECTRIC POWER GENERATION SYSTEM**

PART G

G 01

- (11) P 2018 6814 B** (51) **Int. Cl. (2006)**
G 01 W 1/02
G 01 W 1/06
G 01 W 1/10
 (10) AP 2017 14155 A (44) 19(479)/2017
 (21) AP 2016 014155
 (22) 2016 05 24
 (24) 2016 05 24
 (73) TECHNICAL UNIVERSITY OF GEORGIA (GE)
 M. Kostavas q. 77, 0175, Tbilisi (GE)
 (72) Giorgi Adamov (GE);
 Uri Baghaturia (GE);
 Levan Imnaishvili (GE);
 Dato Lomidze (GE);
 Irakli Lomidze (GE);
 Archil Prangishvili (GE);
 Iver Prangishvili (GE);
 Zviad Tsamalaidze (GE);
 Arsen Khvedelidze (GE)
 (54) **CRITICAL METEOROLOGICAL SITUATION MONITORING, DETECTION AND NOTIFICATION SYSTEM**

UTILITY MODELS

PATENTED UTILITY MODELS

PART A

A 23

- (11) U 2018 1959 Y (51) Int. Cl. (2006)
A 23 L 2/00
(10) AU 2017 14354 U (44) 19(479)/2017
(21) AU 2016 014354
(22) 2016 12 20
(24) 2016 12 20
(73) Revaz Melkadze (GE)
A. Tseretlis gamz. 101, b. 14, 0119,
Tbilisi (GE);
Davit Kiladze (GE)
Sanapiros q. 6, 0108, Tbilisi (GE);
Aleksandre Kiladze (GE)
Chonkadzis q. 12, 0105, Tbilisi (GE)
(72) Revaz Melkadze (GE);
Davit Kiladze (GE);
Aleksandre Kiladze (GE)
(54) **NON-ALCOHOLIC NON
CARBONATED BEVERAGE GEO
VITAMIN**
-

A 61

- (11) U 2018 1960 Y (51) Int. Cl. (2006)
A 61 K 9/08
A 61 K 31/475
(10) AU 2017 13995 U (44) 19(479)/2017
(21) AU 2015 013995
(22) 2015 11 18
(24) 2015 11 18
(73) ECOPHARM PATENT
MANAGEMENT AG (CH)
Haldenstrasse 5, Baar, CH-6342 (CH)
(74) Khatuna Imnadze
(54) **DRUG FOR PARENTERAL USAGE**
-

PART E

E 04

- (11) U 2018 1958 Y (51) Int. Cl. (2006)
E 04 B 1/00
(10) AU 2017 14200 U (44) 19(479)/2017
(21) AU 2016 014200
(22) 2016 07 05
(24) 2016 07 05
(73) Roland Zhorzholiani (GE)
Bogdan Khmel'nitskis q. 17v, b. 40, 0121,
Tbilisi (GE)
(72) Roland Zhorzholiani (GE)
(54) **WALL BLOCK**
-

DESIGNS

APPLICATIONS APPROVED FOR REGISTRATION

The decision can be appealed at the Chamber of Appeal of Sakpatenti within 3 months from the publication or at the Mtskheta District Court Administrative Cases Board (Address: №17, Samkhedro str., Mtskheta), within 1 month following the publication.

- (10) AD 2018 975 S (51) 09-01
(21) AD 2017 975 (22) 2017 08 03
(28) 1
(71) Giorgi Gomelauri (GE)
G. Chanturias q. 14, 0900, Akhmeta, Georgia (GE)
(72) Giorgi Gomelauri (GE)
(54) **GLASS POT FOR HONEY**
(55)



1.1



1.2



1.3



1.4

(10) AD 2018 977 S

(51) 09-01

(21) AD 2017 977

(22) 2017 08 08

(28) 2

(31) 2017500691; 2017500691

(32) 2017 02 14; 2017 02 14

(33) RU; RU

(71) LTD "PARLIAMENT DISTRIBUTION" (RU)

Ul. Popovka, dom 5, Balashikha, Saltikovka m/r, 143916, Moscow, Russia (RU)

(72) Rustam Vasilyevich Tariko (RU)

(74) Aleksandre Gegechkori (GE)

(54) 1.-2. BOTTLE

(55)



1.1



1.2



1.3



1.4



1.5



1.6



2.1

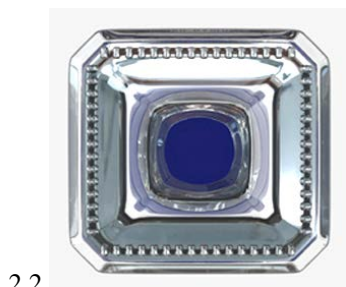

2.2



2.3



2.4



2.5



2.6

(10) AD 2018 987 S

(51) 26-03

(21) AD 2017 987

(22) 2017 09 08

(28) 1

(71) SOLAR ECO SYSTEMS (AE)

Sharjah Saif Zone Authority, Sharjah, united Arab Emirates (AE)

(72) Peter Jagger (AE)

(74) Shalva Gvaramadze (GE)

(54) **SUNSHINE DEVICE FOR CIRCLE LIGHTENING**

(55)

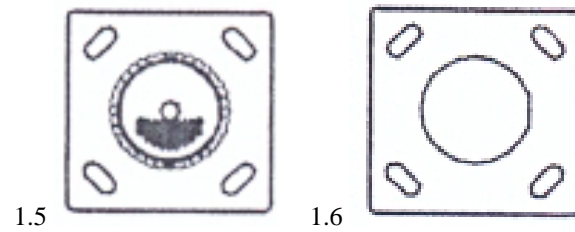
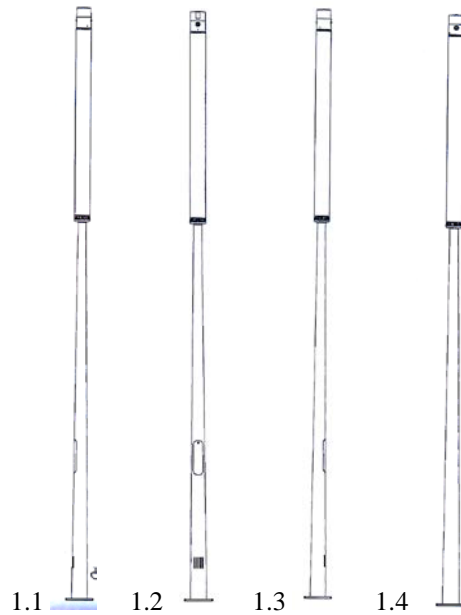

(10) AD 2018 988 S

(51) 26-03

(21) AD 2017 988

(22) 2017 09 08

(28) 1

(71) SOLAR ECO SYSTEMS (AE)

Sharjah Saif Zone Authority, Sharjah, united Arab Emirates (AE)

(72) Peter Jagger (AE)

(74) Shalva Gvaramadze (GE)

(54) **SUNSHINE DEVICE FOR LINEAR LIGHTENING**

(55)

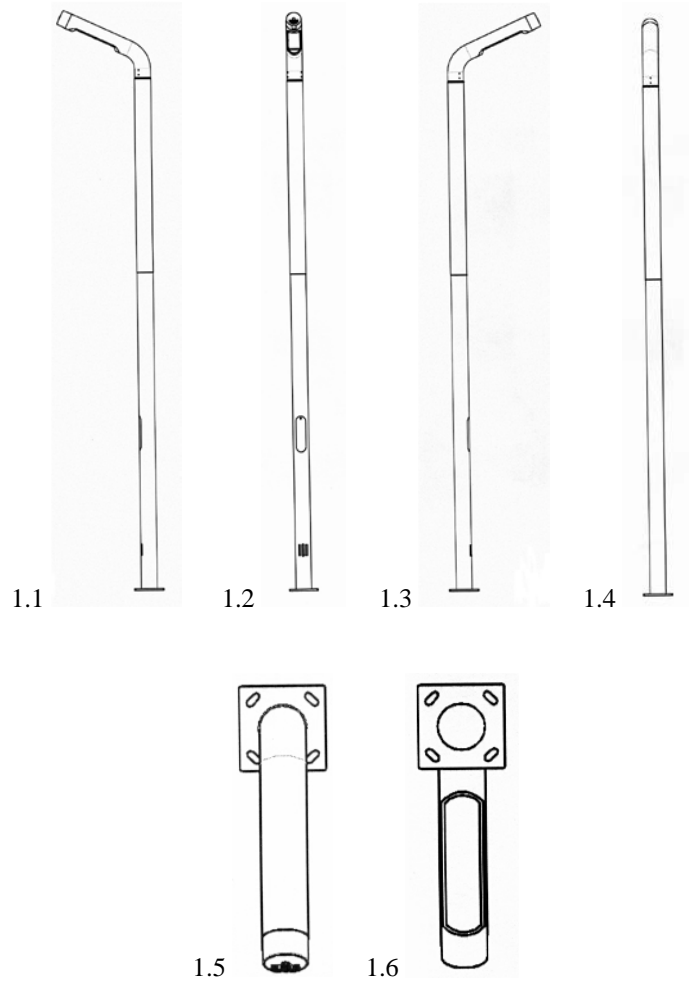

REGISTERED DESIGN

(11) D 2018 744 S **(51) 09-03**
(10) AD 2017 958 S (44) 19(479)/2017
(21) AD 2017 958
(22) 2017 05 15
(24) 2017 05 15
(28) 1
(18) 2022 05 15
(73) Giorgi Gordeziani (GE)
 Kavsadzis q. 4, 0179, Tbilisi, Georgia (GE)
(72) Giorgi Gordeziani (GE)
(54) **PACKAGE BOX**

DESIGNS REGISTERED ACCORDING TO THE ACCELERATED PROCEDURE

The decision can be appealed at the Chamber of Appeal of Sakpatenti within 3 months from the publication.

- (11) **D 2018 742 S** (51) **03-01**
(21) AD 2017 1013 (22) 2017 12 13
(24) 2017 12 13
(28) 1
(18) 2022 12 13
(73) Rusudan Shetsiruli (GE)
S. Tsintsadzis q. 56, b. 41, 0160, Tbilisi, Georgia (GE)
(72) Rusudan Shetsiruli (GE)
(54) **HANDMADE KNITTED HANDBAG**
(55)



1.1



1.2



1.3

(11) D 2018 743 S

(21) AD 2017 1011

(24) 2017 12 07

(28) 3

(18) 2022 12 07

(73) LTD "VAZIANI COMPANY" (GE)

Mshvidobis q. 42, 2200, Telavi, Georgia (GE)

(72) Lali Tsomaia (GE)

(74) Aleksandre Kvernadze (GE)

(54) 1.-3. LABEL

(55)

(51) 19-08

(22) 2017 12 07

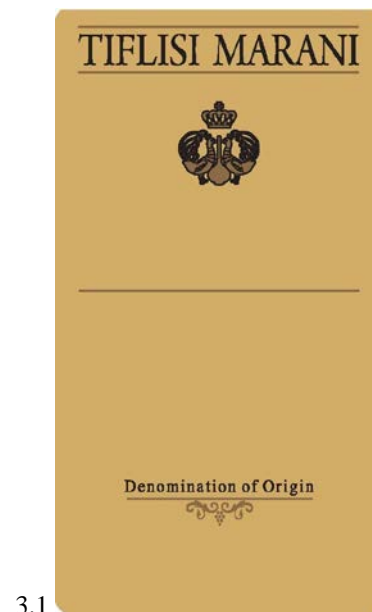
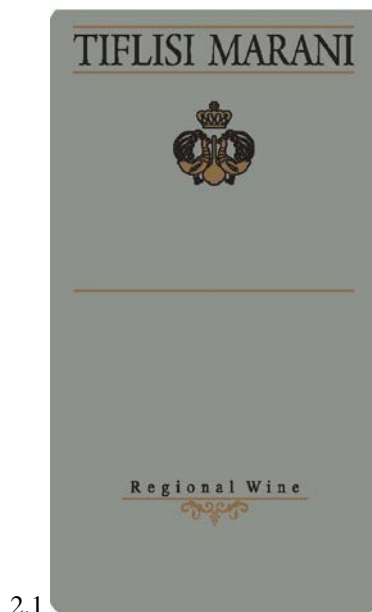

TRADEMARKS

APPLICATIONS FILED UNDER THE NATIONAL PROCEDURE APPROVED FOR REGISTRATION

The decision can be appealed at the Chamber of Appeal of Sakpatenti within 3 months from the publication or at the Mtskheta District Court Administrative Cases Board (Address: №17, Samkhedro St., Mtskheta), within 1 month following the publication.

(260) AM 2018 91749 A
(210) AM 91749
(220) 2017 04 19
(731) LTD "G-M-P"
Sop. Ponitchala 65, 0165, Tbilisi, Georgia
(740) Nugzar Ksovreli
(540)

აღერტეკი
АЛЕРТЕК
ALERTEC

(511) 5

(260) AM 2018 91864A
(210) AM 91864
(220) 2017 04 27
(731) Merk Sharp&Dome corp.
One Merk Drive, Whitehouse-Station,
New Jersey, 08889, United States of America
(740) Tamaz Shilakadze
(540)

ZERBAXA

(591) Black, white
(511) 5

(260) AM 2018 91926 A
(210) AM 91926
(220) 2017 05 02
(731) CJSC "KANONPHARMA PRODUCTION"
Ul. Zarechnaya 105, 141100, Shelkovo, M.O.
Moskow, Russian
(740) Davit Chkopoia
(540)

ვინპოტროპილი GEO
VINPOTROPIL GEO
ВИНПОТРОПИЛ GEO

(511) 5

(260) AM 2018 91938 A
(210) AM 91938
(220) 2017 05 02

(731) CJSC "KANONPHARMA PRODUCTION"
Ul. Zarechnaya 105, 141100, Shelkovo, M.O.
Moskow, Russian
(740) Davit Chkopoia
(540)

ანგიკანდი GEO
Angiacand GEO
Ангиаканд GEO

(511) 5

(260) AM 2018 91942 A
(210) AM 91942
(220) 2017 05 03
(731) British American Tobacco (Brands) Limited
Globe House, 4 Temple Place, London WC2R
2PG, London, United Kingdom
(740) Tamar Kochlamazashvili
(540)

SILK

(591) Black, white
(511) 34

(260) AM 2018 91963 A
(210) AM 91963
(220) 2017 05 04
(731) Natalia Kapanadze
Guramishvilis gamz. 12-a, korp. 4, b. 29,
0192, Tbilisi, Georgia
(740) Giorgi Taktakishvili
(540)

DICLO-PAR
ДИКЛО-ПАР
დიკლო-პარი

(591) Black, white
(511) 5, 35

(260) AM 2018 92068 A
(210) AM 92068
(220) 2017 05 10

(731) LTD "NEOGAS"
Gazapkhulis q. 18, 0177, Tbilisi,
Georgia

(740) Tinatin Pilia
(540)

Neogas Eco Station

(591) Black, white
(511) 4, 35, 37

(260) AM 2018 92069 A

(210) AM 92069

(220) 2017 05 10

(731) LTD "NEOGAS"
Gazapkhulis q. 18, 0177, Tbilisi,
Georgia

(740) Tinatin Pilia
(540)

ნეოგაზი-მწვანე ჩვენი არჩევანია

(591) Black, white
(511) 4, 35, 37

(260) AM 2018 92070 A

(210) AM 92070

(220) 2017 05 10

(731) LTD "NEOGAS"
Gazapkhulis q. 18, 0177, Tbilisi,
Georgia

(740) Tinatin Pilia
(540)

Neogas-Goes Green

(591) Black, white
(511) 4, 35, 37

(260) AM 2018 92071 A

(210) AM 92071

(220) 2017 05 10

(731) LTD "NEOGAS"
Gazapkhulis q. 18, 0177, Tbilisi,
Georgia

(740) Tinatin Pilia
(540)

ნეოგაზის ეკო სადგური

(591) Black, white
(511) 4, 35, 37

(260) AM 2018 92094 A

(210) AM 92094

(220) 2017 05 11

(731) LTD "SOPLIDAN"
Demetre Tavdadebulis q. 10a, Didi Dighomi,
0159, Tbilisi, Georgia

(540)



(591) Grey and green

(531) 06.19.11; 07.15.22; 29.01.12

(511) 29, 30, 31, 35

(260) AM 2018 92124 A

(210) AM 92124

(220) 2017 05 15

(731) AstraZeneca AB
SE-151 85 Södertälje, Sweden

(740) Tamaz Shilakadze
(540)

BEVESPI

(591) Black, white
(511) 5

(260) AM 2018 92125 A

(210) AM 92125

(220) 2017 05 15

(731) Nippon Soda CO LTd
2-1 Ohtemachi, 2-chrom, Chiyoda-ku, Tokio,
Japan

(740) Irakli Gvilia
(540)

TOPSIN

(511) 5

(260) AM 2018 92126 A

(210) AM 92126

(220) 2017 05 15

(731) JSC "M2 REAL ESTATE"
I. Chavchavadzis gamz. 29, Sar. 3, Tbilisi,
Georgia

(740) Nikoloz Jalaghania
(540)

იკბოვრე უკეთესად

(511) 36, 37

(260) AM 2018 92180 A

(210) AM 92180

(220) 2017 05 17

(731) LTD "REALTY AVLABAR"
R. Chkhikvadzis q. 1, Commercial Space 4/2,
4th fl., Blok II, Vake-Saburtalos r-ni,
0101, Tbilisi, Georgia

(540)

ხედი

(511) 43

(260) AM 2018 92182 A

(210) AM 92182

(220) 2017 05 17

(731) JSC "M2 REAL ESTATE"

I. Chavchavadzis gamz. 29, 3th fl., Tbilisi,
Georgia

(740) Nikoloz Jalaghania

(540)

Better Living

(511) 36, 37

(260) AM 2018 92218 A

(210) AM 92218

(220) 2017 05 18

(731) Harrington Development Inc.

Elvira Mendez street, Vallarino Bldg,
3rd floor, Republic of Panama, Panama

(740) Givi Akopashvili

(540)

ბომონდი

(511) 34

(260) AM 2018 92220 A

(210) AM 92220

(220) 2017 05 18

(731) Harrington Development Inc.

Elvira Mendez street, Vallarino Bldg,
3rd floor, Republic of Panama, Panama

(740) Givi Akopashvili

(540)

ცენტი

(511) 34

(260) AM 2018 92223 A

(210) AM 92223

(220) 2017 05 18

(731) Allied Global Tobacco Limited

Wey Court West, Union Road, Farnham,
Surrey, GU9 7PT, United Kingdom

(740) Givi Akopashvili

(540)

ბენდი

(511) 34

(260) AM 2018 92308 A

(210) AM 92308

(220) 2017 05 22

(731) LTD "LENDUP"

V. Dolidze st. 46/Balanchivadzebis q. 41,
0171, Tbilisi, Georgia

(540)

**LENDUP**შიკრულსაფინანსო
ორგანიზაცია

(591) Orange, grey

(531) 26.04.03; 28.19; 29.01.12

(511) 35, 36

(260) AM 2018 92312 A

(210) AM 92312

(220) 2017 05 23

(731) LTD "NEW PHARM GROUP"

D. Aghmasheneblis kheiv. XII km., korp. 2,
b. 43, Vake-Saburtalos r-ni, 0131, Tbilisi,
Georgia

(540)

ლოზატენზი**Lozatenz****Лозатенз**

(511) 5

(260) AM 2018 92315 A

(210) AM 92315

(220) 2017 05 23

(731) LTD "NEW PHARM GROUP"

D. Aghmasheneblis kheiv. XII km., korp. 2,
b. 43, Vake-Saburtalos r-ni, 0131, Tbilisi,
Georgia

(540)

დოქსიტუსი**Doxitus****Докситус**

(511) 5

(260) AM 2018 92316 A
 (210) AM 92316
 (220) 2017 05 23
 (731) LTD "NEW PHARM GROUP"
 D. Aghmasheneblis kheiv. XII km., korp. 2,
 b. 43, Vake-Saburtalos r-ni, 0131, Tbilisi,
 Georgia
 (540)

მოქსიკოლი
Moxiqol
Моксикол

(511) 5

(260) AM 2018 92332 A
 (210) AM 92332
 (220) 2017 05 23
 (731) LTD "NEW PHARM GROUP"
 D. Aghmasheneblis kheiv. XII km., korp. 2,
 b. 43, Vake-Saburtalos r-ni, 0131, Tbilisi,
 Georgia
 (540)



ენო ფარმა
ბ რ ე ვ ი

(591) Pink, white, black
 (531) 26.01.01; 26.01.05; 26.01.06; 26.01.11;
 26.04.01; 26.04.09; 28.19; 29.01.13
 (511) 5, 35

(260) AM 2018 92333 A
 (210) AM 92333
 (220) 2017 05 23
 (731) LTD "NEW PHARM GROUP"
 D. Aghmasheneblis kheiv. XII km., korp. 2,
 b. 43, Vake-Saburtalos r-ni, 0131, Tbilisi,
 Georgia
 (540)



NEW PHARM
G R O U P

(591) Pink, white, black
 (531) 26.01.01; 26.01.05; 26.01.06; 26.01.11;
 26.04.01; 26.04.09; 27.05.05; 29.01.13
 (511) 5, 35

(260) AM 2018 92346 A
 (210) AM 92346
 (220) 2017 05 24

(731) McDonald's International Property
 Company LTD
 251 Little Falls Drive, Wilmington, Delaware
 19808, United States of America
 (740) Shalva Gvaramadze
 (540)

McDelivery

(591) Black, white
 (511) 39

(260) AM 2018 92353 A
 (210) AM 92353
 (220) 2017 05 24
 (731) LTD "G-M-P"
 Sop. Ponitchala 65, 0165, Tbilisi, Georgia
 (740) Nugzar Ksovreli
 (540)

ეროგრა
ЭРОГРА
EROGRA

(511) 5

(260) AM 2018 92355 A
 (210) AM 92355
 (220) 2017 05 24
 (731) LTD "G-M-P"
 Sop. Ponitchala 65, 0165, Tbilisi, Georgia
 (740) Nugzar Ksovreli
 (540)

სინტე
СИНТЕ
SINTE

(511) 5

(260) AM 2018 92356 A
 (210) AM 92356
 (220) 2017 05 24
 (731) LTD "G-M-P"
 Sop. Ponitchala 65, 0165, Tbilisi, Georgia
 (740) Nugzar Ksovreli
 (540)

ომესამო
OMECAM
OMESAM

(511) 5

(260) AM 2018 92357 A
 (210) AM 92357
 (220) 2017 05 25
 (731) Harrington Development Inc.
 Elvira Mendez street, Vallarino Bldg,
 3rd floor, Republic of Panama, Panama
 (740) Givi Akopashvili
 (540)

კომეტი

(511) 34

(260) AM 2018 92465 A
 (210) AM 92465
 (220) 2017 05 30
 (731) Harrington Development Inc.
 Elvira Mendez street, Vallarino Bldg,
 3rd floor, Republic of Panama, Panama
 (740) Givi Akopashvili
 (540)

მერლიბონი

(511) 34

(260) AM 2018 92466 A
 (210) AM 92466
 (220) 2017 05 30
 (731) Harrington Development Inc.
 Elvira Mendez street, Vallarino Bldg,
 3rd floor, Republic of Panama, Panama
 (740) Givi Akopashvili
 (540)

ეფესი

(511) 34

(260) AM 2018 92499 A
 (210) AM 92499
 (220) 2017 06 01
 (731) LTD "GLOBALPHARMI"
 Almasianis q. 13a/Berbutis q. 8, 0171, Tbilisi,
 Georgia
 (740) Giorgi Taktakishvili
 (540)

www.monographbilisi.com

(591) Black, white
 (526) The trademark is protected as a whole. "bilisi"
 shall not be subject to independent legal protection.
 (511) 35, 43

(260) AM 2018 92508 A
 (210) AM 92508
 (220) 2017 06 02

(731) LTD "BAKLACHOPP"
 Vardaniantsis q., korp. 8, territory 1/4,
 Yerevan, Armenia
 (740) Sopio Khuchua
 (540)



(591) Black, white
 (531) 25.01.09; 25.01.10; 25.01.25; 27.05.01;
 27.05.11; 28.05; 28.19
 (511) 43

(260) AM 2018 92544 A
 (210) AM 92544
 (220) 2017 06 05
 (731) Harrington Development Inc.
 Elvira Mendez street, Vallarino Bldg,
 3rd floor, Republic of Panama,
 Panama
 (740) Givi Akopashvili
 (540)

პრაიმ მაქსი

(511) 34

(260) AM 2018 92545 A
 (210) AM 92545
 (220) 2017 06 05
 (731) Harrington Development Inc.
 Elvira Mendez street, Vallarino Bldg,
 3rd floor, Republic of Panama, Panama
 (740) Givi Akopashvili
 (540)

ასენტო

(511) 34

(260) AM 2018 92606 A
 (210) AM 92606
 (220) 2017 06 07
 (731) Nika Goletiani
 Bakhtrionis q. 60, 2200, Telavi,
 Georgia

(540)

Solo
სოლო
СоЛО

(511) 33

(260) AM 2018 92635 A

(210) AM 92635

(220) 2017 06 08

(731) LTD "ALENIKA"

Orbeliani/Melikishvilis q. 5/104, Batumi,
Georgia

(740) Giorgi Taktakishvili

(540)



(591) White, yellow, blue, grey, black

(531) 03.03.01; 25.01.09; 26.03.19; 26.11.08;
27.05.01; 27.05.02; 27.05.03; 29.01.15

(511) 1

(260) AM 2018 92724 A

(210) AM 92724

(220) 2017 06 09

(731) JSC "PHARMFIRMA "SOTEKS"

Pos. Belikovo, d. 11, Selskoe Poselenie
Bereznikovskoe, 141345, Moskovskaya
Oblast, Sergievo-Posadskiy Municipalniy
raion, Russian Federation

(740) Khatuna Imnadze

(540)

AnviMax

(591) Black, white

(511) 5, 35, 39, 42

(260) AM 2018 92729 A

(210) AM 92729

(220) 2017 06 09

(731) JSC "PHARMFIRMA "SOTEKS"

Pos. Belikovo, d. 11, Selskoe Poselenie
Bereznikovskoe, 141345, Moskovskaya

Oblast, Sergievo-Posadskiy Municipalniy
raion, Russian Federation

(740) Khatuna Imnadze

(540)

АнвиМакс

(591) Black, white

(511) 5, 35, 39, 42

(260) AM 2018 92771 A

(210) AM 92771

(220) 2017 06 13

(731) LTD "SUPERBET 2014"

Oniashvilis q. 1, 0190, Tbilisi, Georgia

(740) Gela Peradze

(540)

LEADER-BET

(591) Black, white

(531) 27.05.01; 27.05.17

(511) 41

(260) AM 2018 92772 A

(210) AM 92772

(220) 2017 06 13

(731) Mapaex Consumer Healthcare Private
Limited

E-7, HIG-500, Arera Colony, Bhopal, Madhya
Pradesh – 462016, India

(740) Giorgi Taktakishvili

(540)

IBUZEST

(591) Black, white

(511) 5

(260) AM 2018 92773 A

(210) AM 92773

(220) 2017 06 13

(731) Mapaex Consumer Healthcare Private
Limited

E-7, HIG-500, Arera Colony, Bhopal, Madhya
Pradesh – 462016, India

(740) Giorgi Taktakishvili

(540)

ZESTOFEN

(591) Black, white

(511) 5

(260) AM 2018 92774 A

(210) AM 92774

(220) 2017 06 13

(731) LTD "SUPERBET 2014"

Oniashvilis q. 1, 0190, Tbilisi, Georgia

(740) Gela Peradze
(540)

LEADERBET

(591) Black, white
(531) 27.05.01; 27.05.17
(511) 41

(260) AM 2018 92776 A
(210) AM 92776
(220) 2017 06 13
(731) LTD "SUPERBET 2014"
Oniashvilis q. 1, 0190, Tbilisi, Georgia
(740) Gela Peradze
(540)

LIDERBET

(591) Black, white
(531) 27.05.01; 27.05.17
(511) 41

(260) AM 2018 92777 A
(210) AM 92777
(220) 2017 06 13
(731) LTD "SUPERBET 2014"
Oniashvilis q. 1, 0190, Tbilisi, Georgia
(740) Gela Peradze
(540)

ლიდერბეთი

(591) Black, white
(531) 28.19
(511) 41

(260) AM 2018 92849 A
(210) AM 92849
(220) 2017 06 20
(731) Greek Cooperative Cigarette
Manufacturing Company - SEKAP S.A.
6t Km Quanti-kavala Neshnel Rd. 67100
Quanti, Greece
(740) Giorgi Taktakishvili
(540)

JET-SET

(591) Black, white
(511) 34

(260) AM 2018 92870 A
(210) AM 92870
(220) 2017 06 21
(731) Abdi Ýbrahim Ýlaç Sanayi ve Ticaret

Anonim Þirketi
Reþitpaþa Mahallesi Eski Büyükdere Caddesi
No:4 34467 Maslak Sarýyer Ýstanbul

(740) Tamaz Shilakadze
(540)

Desnova

(591) Black, white
(511) 5

(260) AM 2018 92871 A
(210) AM 92871
(220) 2017 06 21
(731) Abdi Ýbrahim Ýlaç Sanayi ve Ticaret
Anonim Þirketi
Reþitpaþa Mahallesi Eski Büyükdere Caddesi
No:4 34467 Maslak Sarýyer Ýstanbul
(740) Tamaz Shilakadze
(540)

დესნოვა

(591) Black, white
(511) 5

(260) AM 2018 92883 A
(210) AM 92883
(220) 2017 06 21
(731) Amgen Inc.
One Amgen Center Drive, Thousand Oaks,
California 91320-1799, United States of
America
(740) Shalva Gvaramadze
(540)

AIMOVIG

(591) Black, white
(511) 5

(260) AM 2018 92908 A
(210) AM 92908
(220) 2017 06 22
(731) LTD "SPERLUOS GENERAL TRADING CO"
Vazha-Pshavelas gamz. 45, kvart. I, korp. 23,
Living area 61, 0177, Tbilisi, Georgia
(740) Serajedin Mehrani
(540)

Sperluos

(591) Black, golden
(531) 24.09.12; 27.05.01; 29.01.12
(511) 5, 6, 29, 31, 32, 33

(260) AM 2018 92928 A
(210) AM 92928
(220) 2017 06 23
(731) JSC "NOVA TECHNOLOGY"
Uznadzis q. 37, 0102, Tbilisi, Georgia
(740) Mariam Kheviashvili
(540)

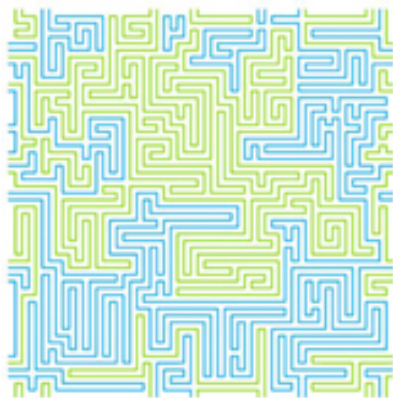

(591) Green, blue
(531) 21.01.14; 26.13.25; 29.01.13
(511) 9, 35, 36, 42

(260) AM 2018 92986 A
(210) AM 92986
(220) 2017 06 26
(731) Nabros Pharma Pvt. LTD
Nabros House, 3rd floor, Behind British
Library, Opp. Art Galary, Law Garden,
Ellisbridge, Ahmedabad – 380006, Gujarat,
India
(740) Giorgi Taktakishvili
(540)



(591) White, red, green, black
(531) 02.01.01; 25.01.18; 26.04.09; 26.04.15; 28.05;
29.01.13
(511) 5

(260) AM 2018 92995 A
(210) AM 92995
(220) 2017 06 26
(731) LTD "G-M-P"
Sop. Ponitchala 65, 0165, Tbilisi, Georgia
(740) Nugzar Ksovreli
(540)

სტიბერილი
СТИБЕРИЛ
STIBERIL

(511) 5

REGISTERED TRADEMARKS

(111) M 2018 29275 R
 (151) 2018 01 10
 (181) 2028 01 10
 (260) AM 2017 91229 A
 (220) 2017 03 13
 (732) TBC BANK

Marjanishvilis q. 7, 0102, Tbilisi, Georgia

(111) M 2018 29280 R
 (151) 2018 01 18
 (181) 2028 01 18
 (260) AM 2016 87632 A
 (220) 2016 06 20

(732) LTD "KATEVE KHOBI"
 S. Tsintsadzis q. 12, Non-dwelling area
 3-6, 3th fl., 0160, Tbilisi, Georgia

(111) M 2018 29281 R
 (151) 2018 01 18
 (181) 2028 01 18
 (260) AM 2016 88127 A
 (220) 2016 08 02

(732) PENG HAN
 Qingdao, Apt. 302, St. Yanji160/7, China

(111) M 2018 29282 R
 (151) 2018 01 18
 (181) 2028 01 18
 (260) AM 2016 88130 A
 (220) 2016 08 02

(732) PENG HAN
 Qingdao, Apt. 302, St. Yanji160/7, China

(111) M 2018 29283 R
 (151) 2018 01 18
 (181) 2028 01 18
 (260) AM 2016 88131 A
 (220) 2016 08 02

(732) PENG HAN
 Qingdao, Apt. 302, St. Yanji160/7, China

(111) M 2018 29284 R
 (151) 2018 01 18
 (181) 2028 01 18
 (260) AM 2016 88132 A
 (220) 2016 08 02

(732) PENG HAN
 Qingdao, Apt. 302, St. Yanji160/7, China

(111) M 2018 29285 R
 (151) 2018 01 22
 (181) 2028 01 22
 (260) AM 2016 88167 A
 (220) 2016 08 04

(732) HANGZHOU HIKVISION DIGITAL
 TECHNOLOGY CO., LTD
 No.555, Qianmo Road, Binjiang District,
 Hangzhou, China

(111) M 2018 29286 R
 (151) 2018 01 22
 (181) 2028 01 22
 (260) AM 2016 88386 A
 (220) 2016 08 24

(732) LTD "Wine and Alcoholic Beverage
 Company SHAKRIANI"
 Tbilisis gzatk. 1, 2200, Telavi, Gerogia

(111) M 2018 29287 R
 (151) 2018 01 22
 (181) 2028 01 22
 (260) AM 2016 88840 A
 (220) 2016 10 05

(732) LTD "BIO UNIVERSAL GEORGIA"
 Pekinis gamz. 31g, 0160, Tbilisi, Gerogia;
 LTD "MANNA"
 I. Abashidzis q. 44, b. 32, 0179, Tbilisi, Gerogia

(111) M 2018 29288 R
 (151) 2018 01 22
 (181) 2028 01 22
 (260) AM 2016 89305 A
 (220) 2016 11 04

(732) OBO Bettermann GmbH & Co.KG
 Hüingser Ring 52, 58710 Menden, Germany

(111) M 2018 29289 R
 (151) 2018 01 22
 (181) 2028 01 22
 (260) AM 2016 89853 A
 (220) 2016 12 07

(732) COLGATE-PALMOLIVE COMPANY
 a Delaware corporation
 300 Park Avenue, New York, New York
 10022, USA

(111) M 2018 29290 R
 (151) 2018 01 22
 (181) 2028 01 22

(260) AM 2016 89901 A
(220) 2016 12 12
(732) LTD "ENVOY HOSTEL AND TOURS"
Betlemis q. 45, 0105, Tbilisi, Georgia

(111) M 2018 29291 R
(151) 2018 01 22
(181) 2028 01 22
(260) AM 2016 90003 A
(220) 2016 12 16
(732) LTD "DOTS"
Ir. Abashidzis q. 73, b. 8, Tbilisi, Georgia

(111) M 2018 29292 R
(151) 2018 01 22
(181) 2028 01 22
(260) AM 2016 90006 A
(220) 2016 12 16
(732) LTD "MODEL HOUSE MATERIA"
Leselidzis q. 22, Tbilisi, Georgia

(111) M 2018 29293 R
(151) 2018 01 22
(181) 2028 01 22
(260) AM 2017 90389 A
(220) 2017 01 11
(732) JSC "GEPHA"
Sanapiros q. 6, Tbilisi, Georgia

(111) M 2018 29294 R
(151) 2018 01 22
(181) 2028 01 22
(260) AM 2017 90412 A
(220) 2017 01 12
(732) Private JSC "Kyiv Cardboard and Paper Mill "
Ul. Kievskaya 130, Obukhovo, Kievskaya
Oblast, 08700, Ukraina

(111) M 2018 29295 R
(151) 2018 01 22
(181) 2028 01 22
(260) AM 2017 90479 A
(220) 2017 01 18
(732) GRUMA, S.A.B. DE C.V.
Rio de la Plata №407 Ote., Colonia de Valle,
San Pedro Garcia Garza, C.P. 66220, N.L.,
Mexico

(111) M 2018 29296 R
(151) 2018 01 22
(181) 2028 01 22
(260) AM 2017 90494 A
(220) 2017 01 18

(732) PHILIP MORRIS PRODUCTS S.A.
Quai Jeanrenaud 3, 2000 Neuchâtel,
Switzerland

(111) M 2018 29297 R
(151) 2018 01 22
(181) 2028 01 22
(260) AM 2017 90553 A
(220) 2017 01 20
(732) JSC "GEPHA"
Sanapiros q. 6, Dzveli Tbilisis r-ni, Tbilisi,
Georgia

(111) M 2018 29298 R
(151) 2018 01 22
(181) 2028 01 22
(260) AM 2017 90588 A
(220) 2017 01 25
(732) THE COCA-COLA COMPANY
One Coca-Cola Plaza, Atlanta, Georgia
30313, USA

(111) M 2018 29299 R
(151) 2018 01 22
(181) 2028 01 22
(260) AM 2017 90633 A
(220) 2017 01 30
(732) Maia Tchumbadze
Mtskhedis q. 8, 0179, Tbilisi, Georgia

(111) M 2018 29300 R
(151) 2018 01 22
(181) 2028 01 22
(260) AM 2017 90645 A
(220) 2017 01 31
(732) FUENTE MARKETING LTD.
Salt Mills Plaza, Unit 48c, Grace Bay Road,
Providenciales, Turks and Caicos Islands

(111) M 2018 29301 R
(151) 2018 01 22
(181) 2028 01 22
(260) AM 2017 90646 A
(220) 2017 01 31
(732) FUENTE MARKETING LTD.
Salt Mills Plaza, Unit 48c, Grace Bay Road,
Providenciales, Turks and Caicos Islands

(111) M 2018 29302 R
(151) 2018 01 22
(181) 2028 01 22
(260) AM 2017 90647 A

(220) 2017 01 31
(732) FUENTE MARKETING LTD.
Salt Mills Plaza, Unit 48c, Grace Bay Road,
Providenciales, Turks and Caicos Islands

(111) M 2018 29303 R
(151) 2018 01 22
(181) 2028 01 22
(260) AM 2017 90664 A
(220) 2017 02 01
(732) ALTERA CORPORATION
101 Innovation drive, San Jose, California
95134, USA

(111) M 2018 29304 R
(151) 2018 01 22
(181) 2028 01 22
(260) AM 2017 90675 A
(220) 2017 02 02
(732) LTD "GR Transit"
Tamar Mepis ganz. 15, 0112, Tbilisi, Georgia

(111) M 2018 29305 R
(151) 2018 01 22
(181) 2028 01 22
(260) AM 2017 90677 A
(220) 2017 02 02
(732) UNILEVER N.V.
Weena 455, 3013 AL Rotterdam, Netherlands

TRADEMARKS REGISTERED ACCORDING TO THE ACCELERATED PROCEDURE

The decision can be appealed at the Chamber of Appeal of Sakpatenti within 3 months from the publication.

(111) M 2018 29273 R
 (151) 2018 01 10
 (181) 2028 01 10
 (210) AM 95534
 (220) 2017 12 18
 (732) LTD "PASHA GLOBAL INVESTMENTS"
 Baratashvilis q. 17, Batumi, Georgia
 (740) Irakli Gvilia
 (540)



(591) Red, yellow, orange, blue, green and pink
 (531) 01.15.23; 29.01.15
 (511) 41, 43

(111) M 2018 29274 R
 (151) 2018 01 10
 (181) 2028 01 10
 (210) AM 95141
 (220) 2017 11 21
 (732) LTD "GLDANI COMFORT"
 Muskhelishvilis chikhi 3, 0105, Tbilisi,
 Georgia
 (740) Nutsa Mamulashvili
 (540)



(591) Lime, orange, dark green, grey, white
 (531) 07.03.02; 07.03.15; 28.19; 29.01.13
 (526) The trademark is protected as a whole.
 "გლდანი" shall not be subject to independent legal
 protection.
 (511) 36, 37

(111) M 2018 29276 R
 (151) 2018 01 10
 (181) 2028 01 10
 (210) AM 95367
 (220) 2017 12 06
 (732) LTD "Gas Georgia"
 Javakhetis III shes., korp. 5, 0182, Tbilisi, Georgia
 (540)



(591) White, sky-blue, black
 (531) 25.03.03; 27.05.02; 27.05.10; 27.05.24;
 29.01.13
 (511) 35

(111) M 2018 29277 R
 (151) 2018 01 17
 (181) 2028 01 17
 (210) AM 95774
 (220) 2018 01 05
 (732) Piter Saad Abdelmalek Abdallah
 Kipshidzis q. 7B, b. 73, 0162, Tbilisi, Georgia
 (740)



— ALTO LIVELLO —

(591) White, black, golden
 (531) 24.01.10; 24.01.15; 24.01.18; 24.09.09;
 27.05.22; 29.01.13
 (511) 20, 43

(111) M 2018 29278 R
(151) 2018 01 17
(181) 2028 01 17
(210) AM 95881
(220) 2018 01 09
(732) Iooiang Pharmaceutical Co., LTD
33, Yongso 2-gil, Gwanghyewon - myeon,
Jincheon gun, Chungcheongbuk - do,
Republic of Korea
(740) Giorgi Taktakishvili
(540)

Cnoxane Inj.

(591) Black, white
(511) 5

(111) M 2018 29279 R
(151) 2018 01 17
(181) 2028 01 17
(210) AM 95757
(220) 2018 01 04
(732) JSC "TBC BANK"
Marjanishvilis q. 7, 0102, Tbilisi, Georgian
(740) Archil Gabatashvili
(540)



(591) Black, scarlet
(531) 26.04.24; 27.05.21; 27.05.24; 27.07.01;
27.07.24; 29.01.12
(511) 36

INTERNATIONAL TRADEMARKS FOR WHICH A DECISION ON GRANTING PROTECTIONS IS TAKEN

The decision can be appealed at the Chamber of Appeal of Sakpatenti within 3 months from the publication or at the Mtskheta District Court Administrative Cases Board (Address: №17, Samkhedro str., Mtskheta), within 1 month following the publication.

(260) AM 2018 74551 A**

(800) 1178830

(731) KIKO S.P.A.

Via Giorgio e Guido Paglia, 1/D, I-24122
BERGAMO (BG), Italy

(540)

KIKO

(591) Black, white

(511)

35 – Retail services, rendered also on-line, featuring soaps, perfumery, deodorants for personal use, essential oils, cosmetics, preparations for the care and the treatment of the hair, dentifrices, creams, lotions, gel, balms for cosmetic use, bath salts, scissors, nail files, tweezers, manicure and pedicure sets, manicure implements, pedicure implements, eyelash curlers, eyelash separators, nail nippers, nail polishers, nail clippers, electric or non-electric, razors, cosmetic brushes, shaving brushes, face sponges for applying make-up, toilet sponges, powder compacts, applicator sticks for applying makeup, nail brushes, eyebrow brushes, eyelash combs, toilet brushes, combs, perfume sprayers, powder compacts, soap dishes, soap dispensers, containers for cosmetic articles, containers for cosmetics, storage canisters, foam toe separators for use in pedicures, spectacles, sunglasses, frames for spectacles, cases and chains for spectacles, eyeglass lenses, jewellery, costume jewellery and watches, excluding services related to goods for infants and children up to 11 years old.

(260) AM 2018 88837 A*

(800) 1310969

(891) 2016 04 06

(731) KALCEKS, akciju sabiedrība

Krustpils iela 53, LV-1057 Rīga, Latvia

(540)



(591) Blue, turquoise, green and white

(531) 26.03.23; 26.13.25; 27.05.10; 27.05.24;
29.01.14

(511)

1 – Chemicals used in industry and science; chemical substances for preserving foodstuffs; chemical products and preparations and the chemicals of natural origin for industry and science purposes.

(260) AM 2018 90549 A

(800) 1327963

(891) 2016 05 13

(731) XYLEM IP MANAGEMENT S.Á.R.L.

11, Breedewues L-1259 Senningerberg,
Luxembourg

(540)

DIRIGO

(511)

7 – Pumps including wastewater pumps; mixers including wastewater mixers; aerators including aerators for treating wastewater; motors for pumps, including electric motors for wastewater pumps; motors for mixers, including electric motors for wastewater mixers; motors for aerators, including electric motors for wastewater aerators.

(260) AM 2018 90712 A

(800) 1329421

(891) 2016 08 11

(731) TAYFUN LEDIN

Neuhartshöfe 16, 85080 Gaimersheim,
Germany

(540)

B BEREKETDÖNER

(591) Red and green

(531) 27.05.17; 27.05.22; 29.01.12

(511)

29 – Preserved, frozen, dried and cooked fruits and vegetables; jams; compotes; eggs; milk; dairy products; edible oils; edible fats.

43 – Services for providing food and drink; temporary accommodation.

(260) AM 2018 90821 A

(800) 1330560

(891) 2016 10 14

(731) Open-Type Joint Stock Company
"ROT FRONT"
2-oy Novokuznetskiy pereulok, d. 13/15
RU-113184 Moscow, Russian Federation

(540)

ЛЕСНАЯ БЫЛЬ

(591) Black, white

(531) 28.05

(511)

30 – Coffee; tea; cocoa; sugar; rice; tapioca; sago; artificial coffee; flour and preparations made from cereals; bread, pastries and confectionery; ice cream; honey; yeast, baking-powder; salt; mustard; vinegar, sauces [condiments]; spices; edible ices.

(260) AM 2018 90822 A

(800) 1330238

(891) 2016 10 12

(731) ILKO ILAC SANAYİ VE TİCARET
ANONİM ŞİRKETİ
Veysel Karani Mah, Colakoglu Sok. No:10,
Kat: 7-8-9 Sancaktepe, Istanbul, Turkey

(540)

Contipass

(591) Black and white

(531) 27.05.17

(511)

5 – Pharmaceutical and veterinary preparations for medical purposes; chemical preparations for medical and veterinary purposes, chemical reagents for pharmaceutical and veterinary purposes; dietary supplements for pharmaceutical and veterinary purposes; dietary supplements; nutritional supplements; medical preparations for slimming purposes; food for babies; herbs and herbal beverages adapted for medicinal purposes; dental preparations and articles; teeth filling material, dental impression material, dental adhesives and material for repairing teeth; sanitary preparations for medical use; hygienic pads; hygienic tampons; plasters; materials for dressings; diapers, including those made of paper and textiles; preparations for destroying vermin; fungicides, herbicides; deodorants, other than for human beings or for animals; air deodorising preparations; disinfectants; antiseptics; detergents for medical purposes.

10 – Surgical, medical, dental and veterinary apparatus and instruments; furniture especially made for medical purposes; artificial limbs and prostheses; medical orthopaedic articles; corsets for medical purposes, orthopedic shoes, elastic and support bandages; adult sexual aids; condoms; babies' bottles; babies' pacifiers; teats; teethingers for babies.

(260) AM 2018 90824 A

(800) 1330239

(891) 2016 10 28

(731) TOVARYSTVO Z OBMEZHENOIU
VIDPOVIDALNISTIU "NATSIONALNA
HORILCHANA KOMPANIYA"
Smilianske shose, 8-i kilometr, bud. 2, s. Ste-
panky, Cherkaskyi raion, Cherkaska oblast
19632, Ukraine

(540)

Jarovska

(591) Black and white

(531) 27.05.17

(511)

33 – Alcoholic beverages, except beer; alcoholic beverages containing fruit; digesters (liqueurs and spirits); aperitifs; arak, arrack; baijiu (Chinese distilled alcoholic beverage); brandy; wine; whisky; anisette (liqueur); anise (liqueur); vodka; kirsch; per-ry; gin; cocktails; curacao; liqueurs; hydromel (mead); peppermint liqueurs; pre-mixed alcoholic beverages, other than beer-based; bitters; nira (sugarcane-based alcoholic beverage); distilled beverages; piquette; rice alcohol; rum; sake; cider; spirits (beverages); alcoholic extracts; alcoholic essences; fruit extracts, alcoholic.

(260) AM 2018 90826 A

(800) 1330652

(891) 2016 10 13

(731) BIOFARMA
50 rue Carnot, F-92284 Suresnes cedex,
France

(540)



(591) Blue Pantone 287 C and metallic gray (hot foil stamping)

(531) 19.03.03; 29.01.13

(554) Three-dimensional

(511)

5 – Pharmaceutical and veterinary products; dermatological preparations for medical use; sanitary products for medical purposes; medicated baths; dietetic food and substances for medical or veterinary use, food for babies; herbal teas; food supplements for humans and animals; plasters, materials for dressings; material for dental fillings and dental impressions; disinfectants; products for destroying vermin; fungicides, herbicides.

(260) AM 2018 90827 A
 (800) 1330259
 (891) 2016 10 13
 (731) Limited Liability Company
 "DOSUG PROBA"
 Shchelkovskoe shosse, 98/57, RU-105523
 Moscow, Russian Federation

(540)
SATOYA

(591) Black and white
 (531) 27.05.17
 (511)
 12 – Casings for pneumatic tires [tyres]; valves for vehicle tires [tyres]; vehicle wheels; brake pads for automobiles; brake shoes for vehicles; repair outfits for inner tubes; adhesive rubber patches for repairing inner tubes; air pumps [vehicle accessories]; rims for vehicle wheels; vehicle wheel rims; non-skid devices for vehicle tires [tyres]; non-skid devices for vehicle tyres; balance weights for vehicle wheels; vehicle wheel spokes; hubs for vehicle wheels; vehicle wheel hubs; brakes for vehicles; anti-skid chains; automobile tires [tyres]; pneumatic tires [tyres]; pneumatic tyres; spikes for tires [tyres]; studs for tires [tyres]; mudguards.

(260) AM 2018 90828 A
 (800) 1330653
 (891) 2016 10 14
 (731) BIOFARMA
 50 rue Carnot, F-92284 Suresnes cedex,
 France



(591) Blue, gray, white
 (531) 19.03.03; 29.01.13
 (554) Three-dimensional
 (511)
 5 – Pharmaceutical and veterinary products; dermatological preparations for medical use; sanitary products for medical purposes; medicated baths; dietetic food and substances for medical or veterinary use, food for babies; herbal teas; food supplements for humans and animals; plasters, materials for dressings; material for dental fillings and dental impressions; disinfectants; products for destroying vermin; fungicides, herbicides.

(260) AM 2018 90829 A
 (800) 1330658
 (891) 2016 11 04
 (731) PHILIP MORRIS PRODUCTS S.A.
 Quai Jeanrenaud 3, CH-2000 Neuchâtel,
 Switzerland

(540)
 PMI **impact**

(591) Black, gray
 (531) 27.05.01; 27.05.19
 (511)
 36 – Funding of projects dedicated to fighting illegal trade and related crimes.

(260) AM 2018 90830 A
 (800) 1330268
 (891) 2016 03 03
 (731) "INTERMEDIAGROUP" Limited Liability
 Company
 Shabolovka Street, 31, building B, RU-115162
 Moscow, Russian Federation



(591) Light-blue, crimson and white
 (531) 26.01.17; 26.01.20; 27.07.01; 28.05; 29.01.13
 (511)
 16 – Printed matter; printed publications; posters; pamphlets; booklets; newsletters; newspapers; magazines; books; paper announcements; writing materials; advertising prospectuses; office requisites, except furniture; handbooks [manuals].

35 – Publication of advertising matter; import-export agencies; rental of advertising space; preparation of publicity materials; efficiency experts; transcription; opinion polling; marketing studies; commercial information agencies; business investigations; professional business consultancy; personnel management consultancy; word processing; arranging newspaper subscriptions for others; organization of exhibitions for commercial or advertising purposes; organization of trade fairs for commercial or advertising purposes; commercial or industrial management assistance; publicity material rental; publication of publicity texts; radio advertising; bill-posting; dissemination of advertising matter; advertising by mail order;

television advertising; business management of hotels; sales promotion for others.

38 – News agencies; message sending; radio broadcasting; television broadcasting.

41 – Videotaping; publication of books; recreation information; entertainment information; club services [education]; educational services; organization of exhibitions for cultural or educational purposes; organization of competitions [education or entertainment]; operating lotteries; entertainment; radio and television entertainment; rental of sound recordings, audio equipment, camcorders, cassette recorders, videotapes; organization of entertainment events; organization of shows [impresario services]; party planning [entertainment]; publication of texts [other than publicity texts]; news reporters services; translation; scriptwriting services; production of radio and television programmes; photography; photographic reporting.

43 – Snack-bars; cafes; restaurants; self-service restaurants; bar services.

(260) AM 2018 90831 A

(800) 657904

(891) 2017 01 18

(731) MESSE MÜNCHEN GMBH
Am Messesee 2,81829 München,
Germany

(540)



(591) Red, yellow, blue, black, white, dark green, light green

(531) 07.05.25; 26.13.25; 26.15.25; 29.01.15

(511)

16 – Printed matter.

35 – Organisation of exhibitions and fairs for business and advertising purposes.

41 – Arranging of exhibitions and fairs for cultural and teaching purposes; organisation and arranging of congresses and meetings; publication and issuing of printed matter.

(260) AM 2018 91011 A

(800) 1331718

(891) 2016 12 20

(731) BPC PHARMA HOLDING LIMITED
11 Boumpoulinas Street, 1st Floor, CY-1060
Nicosia, Cyprus

(540)

Superia

(511)

5 – Pharmaceutical preparations; drugs for medical purposes; medicines for human purposes; veterinary preparations; chemical preparations for pharmaceutical purposes; chemico-pharmaceutical preparations; food for babies; vitamin preparations; dietetic substances adapted for medical use; dietetic beverages adapted for medical purposes; dietetic foods adapted for medical purposes; disinfectants for hygiene purposes; dressings, medical; tissues impregnated with pharmaceutical lotions; sticking plasters for medical purposes; herbicides; pesticides.

29 – Albumen for culinary purposes; seaweed extracts for food; nuts, prepared; gelatine for food; yolk of eggs; soya milk [milk substitute]; edible fats; edible oils; fish-based foodstuffs; pollen prepared as foodstuff; milk products; vegetables, preserved; vegetables, cooked; vegetables, dried; fruit chips; fruit, preserved; crystallized fruits; meat; fish, not live.

(260) AM 2018 91013 A

(800) 1331725

(891) 2016 09 20

(731) JMV SA
Rue du Fossé 40, L-4123 Esch-sur-Alzette,
Luxembourg

(540)



(591) Black and white

(531) 27.05.17; 27.05.21

(511)

16 – Fountain pens; posters; forms, printed; note books; pads [stationery]; loose-leaf binders; wristbands for the retention of writing instruments; pamphlets; booklets; newsletters; document holders [stationery]; printed publications; calendars; pencils; pencil lead holders; books; envelopes [stationery]; bags [envelopes, pouches] of paper or plastics, for packaging; folders for papers; printed matter; prospectuses.

35 – Business information; business management and organization consultancy; professional business consultancy; news clipping services; organization of exhibitions for commercial or advertising purposes;

compilation of information into computer databases; systemization of information into computer databases.

41 – Providing on-line electronic publications, not downloadable; organization of exhibitions for cultural or educational purposes; arranging and conducting of colloquiums; arranging and conducting of congresses; arranging and conducting of conferences; arranging and conducting of seminars; arranging and conducting of symposiums; organization of competitions [education or entertainment], including trademark competitions; electronic desktop publishing; on-line publication of electronic books and journals; publication of texts, other than publicity texts; translation.

45 – Legal services, including notary public services; legal auditing; legal research; intellectual property consultancy; control of intellectual property rights; licensing of intellectual property; licensing of computer software [legal services]; monitoring intellectual property rights; intellectual property appraisals, including patents, trademarks, utility models, industrial designs, know-how, literary works and works of art; legal searching; litigation services and representation of interests before administrative authorities; registration of domain names [legal services]; patent attorney services in the field of intellectual property, including patents, trademarks, appellations of origin of goods, utility models, industrial designs, selection inventions, topologies of integrating circuits, technology transfer, copyrights, domain names, know-how; copyright management; advocate services; alternative dispute resolution services; mediation; monitoring industrial property rights for legal advisory purposes.

(260) AM 2018 91014 A

(800) 1331727

(891) 2016 06 08

(731) HISENSE CO., LTD.

No.17, Donghaixi Road, 266071 Qingdao,
China

(540)

Hisense

(591) Black and white

(531) 27.05.17

(511)

7 – Agricultural machines; aerating pumps for aquaria; incubators for chicken eggs; disintegrators; hair cutting machines for animals; salt harvester; wood-working machines; papermaking machines; paper diaper manufacturing equipment; printing presses; machines for the textile industry; dyeing machines; tea processing machinery; electromechanical food preparation machines; mixing machines; brewing machines; tobacco processing machines; leather-

working machines; ironing machines; sewing machines; bicycle assembling machines; machinery for ceramic industry (including construction ceramics); engraving machines; battery machinery; processing equipment for local specialty products; machinery for producing enamelware; light bulb production machinery; wrapping machines; honeycomb-shaped briquet compressor; dishwashers; electric fruit presses, for household purposes; household soy milk processors [electric]; electric kitchen machines; washing machines (laundry); pharmaceutical industrial processing machinery; embossing machines; glass-working machines; machines for chemical fertilizer manufacture; electromechanical machines for chemical industry; rinsing machines; rolling mills; petrochemical processing machines; bulldozers; elevators (lifts); metalworking machines; foundry machines; steam engines; carburettor feeders; wind-powered installations for generating electricity [wind power plants]; paper clip bending machines; machines for making buttons for clothes; machine tools; machinery for making electric wires and cables; hand-held tools, other than hand-operated; food processors, electric; eye glasses processing equipment; gas separation plants; paint-spraying equipment; dynamos; filters for cleaning cooling air, for engines; pumps (machines); compressed air machines; compressors for refrigerators; hydraulic oil filter; valves (parts of machines); shaft couplings (machines); bearings (parts of machines); conveyor belts for machines; electric welding machines; electric machines and apparatus for cleaning; vacuum cleaners; sifting installations; scroll gate openers, electric; automatic distribution machines; 3D printers; electroplating machines.

9 – Laptop computers; tablet computers; data processing apparatus; computer hardware; computers; recorded computer software; monitors (computer hardware); smart cards (integrated circuit cards); USB flash drives; downloadable electronic publications; electronic pocket translators; electronic pens (visual display units); computer peripheral devices; invoicing machines; cash registers; fingerprint identifier; electronic agendas; false coin detectors; apparatus to check stamping mail; pedometers; ticket dispensers; dictating machines; electronic tags for goods; Electronic Random Number Indicator Equipment [ERNIE]; electronic registration apparatus for recording attendances; weighing machines; measures; electronic notice boards; light-emitting electronic pointers; navigational instruments; telephone apparatus; modems; smartphones; Global Positioning System (GPS) apparatus; mobile telephones; optical communication equipment; telephone sheath; network communication apparatus; cabinets for loudspeakers; electric monitoring apparatus; audio and video receivers; television apparatus; portable media players; digital photo frames; electronic book readers; baby monitors; cameras (photography); surve-

ying apparatus and instruments; audiovisual teaching apparatus; optical apparatus and instruments; materials for electricity mains (wires, cables); semi-conductors; chips (integrated circuits); electrical adapters; video screens; household remote controls; light conducting filaments (optical fibers (fibres)); electric apparatus for commutation; lightning conductors; electrolyzers; fire extinguishing apparatus; radiological apparatus for industrial purposes; protection devices for personal use against accidents; alarms; eyeglasses; 3D spectacles; battery chargers; mobile power supply (rechargeable batteries); slides (photography); portable remote control apparatus for stopping cars; electrically heated clothes.

11 – Lighting apparatus and installations; flashlights (torches); germicidal lamps for purifying air; curling lamps; electric cooking utensils; gas burners; roasting apparatus; kitchen ranges (ovens); electric pressure cookers (autoclaves); electric coffee machines; electric kettles; microwave ovens (cooking apparatus); bread baking machines; electric food steamers; lava rocks for use in barbecue grills; freezers; cooling appliances and installations; refrigerators; refrigerating display cabinets; freezer automatic defroster; air conditioning installations; air purifying apparatus and machines; extractor hoods for kitchens; air humidifier; electric hair dryer; fabric steamers; air sterilizers; drying apparatus; fans (airconditioning); electric heating apparatus; fuel economisers; fog machines for theater; faucets for pipes; automatic watering installations; bath lamps for heating; gas or electric water heaters for washing; solar energy water heater; sanitary apparatus and installations; bath installations; water purifying apparatus and machines; kitchenware sterilizer; drinking fountain; disposable sterilization pouches; electric radiators; lighters; polymerisation installations.

(260) AM 2018 91015 A

(800) 1332743

(891) 2016 11 18

(731) APPLE INC.

1 Infinite Loop, Cupertino CA 95014, USA

(540)



(591) White, purple, pink, blue, and green. The mark consists of three, three-dimensional squares with rounded edges, stacked at an

angle with the bottom square in dark blue, the middle square in purple, and the top square featuring a multi-color design; the top square contains white, purple, pink, blue, and green overlapping waveform images set on a dark purple and dark blue background; the color gray appears in the outline of the image and represents outlining and is not claimed as a feature of the mark

(554) Three-dimensional

(531) 01.15.09; 26.04.03; 26.04.04; 26.04.09; 29.01.15

(511)

9 – Computer software used in developing other software applications; application development software.

42 – Design and development of computer software; computer software consulting services; support and consultation services for developing computer systems, databases and applications; providing computer software information online.

(260) AM 2018 91016 A

(800) 1331738

(891) 2016 06 16

(731) ACEM AZIENDA COSTRUZIONI

ELETTRO-MEDICALI S.p.A.

Viale Filopanti, 4, I-40126 BOLOGNA, Italy

(540)



(591) Blue

(531) 01.05.02; 27.05.17; 29.01.14

(511)

10 – Surgical, medical, dental and veterinary apparatus and instruments, artificial limbs, eyes and teeth; orthopedic articles; suture materials; lamps for medical purposes; ultraviolet ray lamps for medical purposes.

11 – Apparatus for lighting, heating, steam generating, cooking, refrigerating, drying, ventilating, water supply and sanitary purposes; ceiling lights; flashlights; germicidal lamps for purifying air; laboratory lamps; lamp glasses; lamp reflectors; lamps; electric lamps; lampshade holders; lighting apparatus and installations; projector lamps; standard lamps; ultraviolet ray lamps, not for medical purposes.

(260) AM 2018 91019 A

(800) 1331904

(891) 2015 11 05

(731) MC TEKSTİL TURİZM İNŞAAT SANAYİ
VE TİCARET LİMİTED ŞİRKETİ
Demirciler Sitesi Galaksi 2, İşmerkezi No:81,
K:5/76-77-92, Zeytinburnu İstanbul, Turkey

(540)



(591) Black and white

(531) 24.15.02; 27.05.10; 27.05.24

(511)

25 – Clothing, including underwear and outerclot-
hing, other than special purpose protective clothing;
socks, mufflers [clothing], shawls, bandanas, scar-
ves, belts [clothing]; footwear, shoes, slippers,
sandals; headgear, hats, caps with visors, berets,
caps (headwear), skull caps.

35 – Advertising, marketing and public relations; or-
ganization of exhibitions and trade fairs for commer-
cial or advertising purposes; office functions; sec-
retarial services; arranging newspaper subscriptions
for others; compilation of statistics; rental of office
machines; systemization of information into compu-
ter databases; telephone answering for unavailable
subscribers; business management, business admin-
istration and business consultancy; accounting;
commercial consultancy services; personnel recruit-
ment, personnel placement, employment agencies,
import-export agencies; temporary personnel place-
ment services; auctioneering; the bringing together,
for the benefit of others, of a variety of goods, na-
mely, clothing, including underwear and outerclot-
hing, other than special purpose protective clothing,
socks, mufflers [clothing], shawls, bandanas, scar-
ves, belts [clothing], footwear, shoes, slippers, san-
dals, headgear, hats, caps with visors, berets, caps
[headwear], skull caps, enabling customers to conve-
niently view and purchase those goods, such services
may be provided by retail stores, wholesale outlets,
by means of electronic media or through mail order
catalogues.

(260) AM 2018 91022 A

(800) 1331916

(891) 2016 10 28

(731) MONUS d.o.o.

Aleksandra Dubčeka 14, 11080 BEOGRAD-
ZEMUN, Serbia

(540)

NERO

(591) Black and white

(531) 27.05.17

(511)

34 – Tobacco; smokers' articles; matches; cigarettes.

(260) AM 2018 91028 A

(800) 1331979

(891) 2016 09 27

(731) CHINA TOBACCO SICHUAN
INDUSTRIAL CO., LTD.

No.2 Longquan Section, Chenglong Avenue,
National Chengdu Economy and, Technology
Development Area, Longquanyi District,
Chengdu City, Sichuan Province, China

(540)



(591) Black and white

(531) 05.13.08; 07.05.02; 26.11.11; 27.05.11; 28.03

(511)

34 – Cigars; cigarettes; cigarillos; tobacco pipes; ci-
gar cases; cigarette cases; tobacco jars; ashtrays for
smokers; humidors.

(260) AM 2018 91148 A

(800) 1275584

(891) 2016 11 16

(731) SUNECHO LIMITED

Julia House, 3 Themistokli Dervi Street, P.C.,
CY-1066 Nicosia, Cyprus

(540)



(591) Black, white

(531) 26.04.24; 27.05.24

(526) ®

(511)

29 – Meat, fish, poultry and game; meat extracts;
preserved, frozen, dried and cooked fruits and vege-
tables; jellies, jams, compotes; eggs; milk and milk
products; edible oils and fats; ajvar [preserved pep-
pers]; aloe vera prepared for human consumption;
alginates for culinary purposes; anchovy; peanuts,
prepared; albumen for culinary purposes; white of

eggs; beans, preserved; soya beans, preserved, for food; bouillon, including instant bouillon; ginger jam; ham; fatty substances for the manufacture of edible fats; toasted laver; edible birds' nests; peas, preserved; mushrooms, preserved; gelatine; meat jellies; jellies for food; fruit jellies; yolk of eggs; coconut fat; bone oil, edible; lard; suet for food; curd; fruit-based snack food; charcuterie; raisins; caviar; fish roe, prepared; yogurt; sauerkraut; kephir [milk beverage]; kimchi [fermented vegetable dish]; isinglass for food; clams, not live; milk shakes; black pudding [blood sausage]; meat, tinned; vegetables, tinned; fish, tinned; fruits, tinned; bouillon concentrates; gherkins; shrimps, not live; prawns, not live; buttercream; croquettes; silkworm chrysalis, for human consumption; kumys [kumyss] [milk beverage]; spiny lobsters, not live; lecithin for culinary purposes; salmon, not live; onions, preserved; margarine; piccalilli; marmalade; peanut butter; cocoa butter; colza oil for food; coconut butter; corn oil; sesame oil; linseed oil for culinary purposes; olive oil for food; palm oil for food; palm kernel oil for food; sunflower oil for food; coconut oil; butter; shellfish, not live; almonds, ground; animal marrow for food; mussels, not live; condensed milk; protein milk; soya milk [milk substitute]; fish meal for human consumption; vegetable mousses; fish mousses; fruit pulp; meat, preserved; milk beverages, milk predominating; potato fritters; olives, preserved; lobsters, not live; coconut, desiccated; nuts, prepared; tomato paste; liver pastes; pectin for culinary purposes; liver; pickles; powdered eggs; foods made from fish; prostokvasha [sour milk]; poultry, not live; pollen prepared as foodstuff; cranberry sauce [compote]; tomato purée; apple purée; crayfish, not live; crustaceans, not live; fish, preserved; fish, not live; salted fish; ryazhenka [fermented baked milk]; vegetable salads; fruit salads; bacon; sardines, not live; pork; herrings, not live; seeds, prepared; sunflower seeds, prepared; cream [dairy products]; whipped cream; fat-containing mixtures for bread slices; smetana [sour cream]; tomato juice for cooking; vegetable juices for cooking; salted meats; sausages; sausages in batter; preparations for making bouillon including preparations for making instant bouillon; preparations for making soup including preparations for making instant soup; soups, including instant soups; tripe; vegetable soup preparations including instant vegetable soup; whey; cheese; tahini [sesame seed paste]; tofu; sea-cucumbers, not live; truffles, preserved; tuna, not live; oysters, not live; milk ferments for culinary purposes; rennet; fish fillets; dates; crystallized fruits; potato flakes; mashed potatoes; hummus [chickpea paste]; fruit peel; preserved garlic; lentils, preserved; potato chips; low-fat potato chips; fruit chips; non-alcoholic eggnog; seaweed extracts for food; snail eggs for consumption.

30 – Coffee, tea, cocoa and artificial coffee; rice; tapioca and sago; flour and preparations made from cereals; bread, pastry and confectionery; edible ices; sugar, honey, treacle; yeast, baking-powder; salt; mustard; vinegar, sauces (condiments); spices; ice for refreshment; aromatic preparations for food; flavorings [flavourings], other than essential oils, for cakes; flavorings [flavourings], other than essential oils, for beverages; coffee flavorings [flavourings]; star aniseed; cereal bars; high-protein cereal bars; pancakes; noodle-based prepared meals; buns; bread rolls; vanillin [vanilla substitute]; vanilla [flavoring]; waffles; vermicelli [noodles], including instant noodles; natural sweeteners; sausage binding materials; binding agents for ice cream [edible ices]; sea water for cooking; seaweed [condiment]; malt biscuits; cloves [spice]; cake frosting [icing]; glucose for culinary purposes; gluten additives for culinary purposes; thickening agents for cooking foodstuffs; leaven; rice-based snack food; cereal-based snack food; vegetal preparations for use as coffee substitutes; dressings for salad; fruit jellies [confectionery]; confectionery for decorating Christmas trees; cakes; pastries; peanut confectionery; almond confectionery; pasta including instant pasta; ginger [spice]; frozen yogurt [confectionery ices]; capers; caramels [candy]; curry [spice]; ketchup [sauce]; quiches; gluten prepared as foodstuff; sweetmeats [candy]; liquorice [confectionery]; peppermint sweets; cinnamon [spice]; unroasted coffee; starch for food; crackers; custard; hominy grits; semolina; oatmeal; crushed barley; groats for human food; corn, milled; corn, roasted; meat pies; turmeric; couscous [semolina]; farinaceous foods; noodles including instant noodles; ice, natural or artificial; candy; rice cakes; mayonnaise; macaroons [pastry]; macaroni including instant macaroni; maltose; hominy; marinades; marzipan; royal jelly; bean meal; tapioca flour; potato flour; corn flour; wheat flour; soya flour; barley meal; dessert mousses [confectionery]; chocolate mousses; muesli; mint for confectionery; cocoa beverages with milk; coffee beverages with milk; coffee-based beverages; tea-based beverages; chocolate beverages with milk; chocolate-based beverages; cocoa-based beverages; infusions, not medicinal; crushed oats; husked oats; nutmegs; stick liquorice [confectionery]; soya bean paste [condiment]; pastilles [confectionery]; molasses for food; pâtés en croûte; pepper; allspice; peppers [seasonings]; pesto [sauce]; biscuits; petit-beurre biscuits; pies; pizzas; meat gravies; fondants [confectionery]; popcorn; powders for ice cream; mustard meal; pralines; meat tenderizers, for household purposes; cereal preparations; oat-based food; propolis; gingerbread; petits fours [cakes]; puddings; cake powder; fruit coulis [sauces]; ravioli; chewing gum; relish [condiment]; wheat germ for human consumption; spring rolls; palm sugar; aniseed; linseed for human consumption; golden syrup; cake dough; baking soda [bicarbonate of

soda for cooking purposes]; malt for human consumption; salt for preserving foodstuffs; cooking salt; celery salt; sorbets [ices]; ham glaze; soya sauce; tomato sauce; pasta sauce; spaghetti including instant spaghetti; seasonings; preparations for stiffening whipped cream; rusks; breadcrumbs; sushi; sandwiches; tabbouleh; tacos; cream of tartar for culinary purposes; tarts; dough; pastry dough; almond paste; tortillas; garden herbs, preserved [seasonings]; beer vinegar; ferments for pastes; halvah; unleavened bread; chips [cereal products]; corn flakes; oat flakes; chicory [coffee substitute]; iced tea; chutneys [condiments]; cheeseburgers [sandwiches]; chowchow [condiment]; saffron [seasoning]; chocolate; malt extract for food; essences for foodstuffs, except etheric essences and essential oils; husked barley.

(260) AM 2018 91214 A
 (800) 1333645
 (891) 2016 12 07
 (731) PHAT BROTHERS PTE LTD
 205 Henderson Road, N02-02B Henderson
 Industrial Park, Singapore 159549, Singapore
 (540)



(591) Black and white
 (531) 26.13.25; 27.05.01
 (511)
 14 – Watches; wrist watches; chronographs [watches]; mechanical watches; automatic watches; dress watches; sports watches.

(260) AM 2018 91216 A
 (800) 1333652
 (891) 2016 08 05
 (731) BAYER INTELLECTUAL PROPERTY GMBH
 Alfred-Nobel-Straße 10, 40789 Monheim
 am Rhein, Germany
 (540)



(591) Black and white
 (531) 26.11.02; 26.11.06; 26.11.12; 27.05.21

(511)
 41 – Education and training in the field of medicine, lifestyle and health care.

44 – Medical services and information for assisting patients in the context of treatment of pulmonary hypertension.

(260) AM 2018 91217 A
 (800) 799629
 (891) 2016 12 29
 (731) UAB "SCT Lubricants"
 Silutes pl. 119, LT-95112 Klaipeda, Lithuania
 (540)

FANFARO

(511)
 4 – Contact sprays; lubricants; industrial oils and greases, including motor, gear, compressor, hydraulic and industrial oils; contact oils and contact greases; oil additives as well as additives for fuel, especially for car fuel; non-chemical additives for industrial greases, industrial oils, motor oils, gear oils, compressor oils and hydraulic oil.

(260) AM 2018 91218 A
 (800) 1072257
 (891) 2017 02 14
 (731) PACOTRADE AG
 Bundesstrasse 7, CH-6300 Zug, Switzerland
 (540)

PACOJET

(511)
 7 – Electric kitchen machines, electric kitchen appliances for mincing, grinding, pressing, sifting and foaming; electric emulsifiers for household purposes, mixing machines.

21 – Non-electric emulsifiers for household purposes; hand-operated kitchen utensils for mincing, grinding, pressing, straining and foaming; ice-cream makers.

(260) AM 2018 91219 A
 (800) 1085535
 (891) 2017 02 14
 (731) PACOTRADE AG
 Bundesstrasse 7, CH-6300 Zug, Switzerland
 (540)



(591) Grey, black, white

(531) 27.05.01

(511)

7 – Kitchen machines, electric; blenders, electric, for household purposes; mixers; food processors, electric.kers).

21 – Blenders, non-electric, for household purposes; mixers, manual (sha).

(260) AM 2018 91222 A

(800) 1114836

(891) 2016 12 14

(731) ECDL FOUNDATION

The Grange, Stillorgan Road, Blackrock, Co.
Dublin Dublin 4, Ireland

(540)



(591) Black, white

(531) 24.15.01; 26.01.06

(511)

9 – Instructional and teaching apparatus and instruments; computer software; compact discs; video and audio cassette tapes and discs; computer software and publications in electronic form supplied on line from databases or from facilities provided on the Internet; printed matter and publications in electronic form (downloadable) provided on-line from a database or facilities provided on the Internet (including websites) or other computer networks; pre-recorded compact discs or optical discs; pre-recorded tapes including video tapes and cassettes and audio cassettes.

41 – Education and training; arranging and conducting competitions, seminars, conferences and workshops; publication of books and texts; instruction services; certification and examination services; electronic publications in the field of education and training; instruction and training provided on-line from a computer database or from facilities provided on the Internet and other similar information networks; organisation, production and presentation of on-line training and education provided on-line from a computer database or from facilities provided on the Internet and other similar information networks; advisory, consultancy and information services relating to the aforesaid.

(260) AM 2018 91223 A

(800) 1221939

(891) 2016 12 21

(731) MONTRES CHOURIET S.A.

7, place de la Fusterie CH-1204 Genève,
Switzerland

(540)



(591) Black, white

(531) 03.07.17

(511)

14 – Watches, small clocks, individual parts thereof; jewelry products.

(260) AM 2018 91224 A

(800) 1333685

(891) 2016 06 03

(731) ERICH KRAUSE FINLAND OY

Henry Fordin katu 5 N FI-00150 Helsinki,
Finland

(540)



(591) Red, dark red, light red, white, grey, light grey, brown, light brown, beige, light beige, beige-grey, beige-yellow

(531) 20.01.01; 20.01.05; 20.01.15; 27.05.02;
29.01.15

(511)

2 – Gouache paints; finger paints.

8 – Hand tools and implements, hand-operated; cutlery; side arms, other than firearms; razors; wick trimmers [scissors]; cattle shearers; border shears; pruning shears; shears; shearers [hand instruments]; scissors; spatulas [hand tools]; palette knives.

16 – Paper, cardboard and goods made from these materials, not included in other classes; printed matter; bookbinding material; photographs; stationery; adhesives for stationery or household purposes; artists' materials; paint brushes; typewriters and office requisites (except furniture); instructional and teaching material (except apparatus); plastic materials for packaging (not included in other classes); printers' type; printing blocks; fountain pens; aquarelles; albums; note books; pads [stationery]; drawing pads; loose-leaf binders; pamphlets; booklets; paper sheets [stationery]; carbon paper; copying paper [stationery]; luminous paper; modelling wax, not for dental purposes; modelling clay; polymer modelling clay; terrestrial globes; drawing sets; engravings; slate

pencils; pencil leads; document holders [stationery]; pencil holders; chalk holders; holders for stamps [seals]; engraving plates; writing slates; blackboards; galley racks [printing]; drawing boards; punches [office requisites]; magazines [periodicals]; pen clips; bookmarkers; periodicals; printed publications; drawing instruments; calendars; gums [adhesives] for stationery or household purposes; pencils; color pencils; felt-tip pens; pencil lead holders; charcoal pencils; pictures; painting sets with felt-tip pens, soft modelling clay and chinks for children; transfers [decalcomanias]; paintings [pictures], framed or unframed; wood pulp board [stationery]; paintbrushes, brushes for decoration; painters' brushes; writing brushes; glue for stationery or household purposes; drawing pins; envelopes [stationery]; boxes of cardboard or paper; paint boxes [articles for use in school]; correcting fluids [office requisites]; stencils [stationery]; french curves; paper ribbons; gummed tape [stationery]; adhesive bands for stationery or household purposes; correcting tapes [office requisites]; inking ribbons; self-adhesive tapes for stationery or household purposes; drawing rulers; square rulers; paint trays; architects' models; plastics for modelling; plastic modelling materials; toy modelling dough; teaching materials [except apparatus]; sealing compounds for stationery purposes; adhesives [glues] for stationery or household purposes; pencil sharpening machines, electric or non-electric; writing and drawing chalk, also made of wax, plastics and gel; painters' easels; stickers [stationery]; paper knives [cutters] [office requisites]; covers [stationery]; embroidery designs [patterns]; palettes for painters; folders for papers; folders for artistic works; papier mâché; pastels [crayons]; oil pastels; modelling paste; pen cases; seals [stamps]; clipboards; desk mats; bookends; stamp stands; stands for pens and pencils; photograph stands; modelling pads; inking pads; stamp pads; writing cases [sets]; writing materials; inkstands; writing instruments; drawing materials; school supplies [stationery]; printed timetables; rubber erasers; drawing t-squares; penholders; marking pens [stationery]; paper clasps; paper-clips; staples for offices; erasing products; writing board erasers; arithmetical tables; writing or drawing books; pencil sharpeners, electric or non-electric; stencil plates; cardboard tubes; indian inks; drawing squares; manuals [handbooks]; figurines [statuettes] of papier mâché; molds for modelling clays [artists' materials]; canvas for painting; compasses for drawing; watercolor [watercolour] saucers for artists; ink; inkwells; stencils; erasing shields.

18 – Leather and imitations of leather; animal skins; trunks and travelling bags; umbrellas, parasols and walking sticks; whips, harness and saddlery; bags for climbers; bags; sling bags for carrying infants; garment bags for travel; briefcases; valises; handbags; beach bags; bags for sports; bags for campers; shopping bags; wheeled shopping bags; school satchels;

travelling trunks; trunks [luggage]; suitcases; attaché cases; leather tool bags, empty.

25 – Clothing, footwear, headgear; aprons [clothing].

28 – Games and playthings; gymnastic and sporting articles; decorations for Christmas trees; jigsaw puzzles; dolls' houses; toys; stuffed toys; plush toys; mobiles [toys]; practical jokes [novelties]; parlor games; board games; modeling and painting playsets; playsets for painting by colors, felt-tip pens and wax chinks; building games; toy buildings for painting; dolls' rooms; building blocks [toys]; dolls; scale model kits [toys]; scale model vehicles; dolls' clothes.

(260) AM 2018 91244 A

(800) 1333732

(891) 2016 08 03

(731) AL-NAMURA, SPOL. S R.O.

Lysolajské údolí 107/25, CZ-165 00 Praha 6,
Czech Republic

(540)



(591) Red, dark red and black

(531) 01.15.07; 24.17.04; 27.05.17; 29.01.13

(511)

5 – Beverages for medicinal purposes, namely containing lecithin, vitamins and other reinforcing substances; isotonic and energy drinks for medicinal purposes; foodstuffs and dietetic products for medicinal purposes.

32 – Isotonic and energy drinks non-alcoholic, mineral water (natural or artificial), fizzy drinks and other soft drinks, fruit and vegetable drinks non-alcoholic, refreshing beverages non-alcoholic, syrups and other preparations for making beverages, beer.

(260) AM 2018 91245 A

(800) 1333749

(891) 2016 08 29

(731) QIAODAN SPORTS CO., LTD.

Xibian Industrial District, Chendai, Jinjiang
Fujian, China

(540)

乔丹

(591) Black and white
 (531) 28.03
 (511)
 25 – Clothing; layettes; swimsuits; raincoat; theatrical costumes; football shoes; shoes; hats; hosiery; gloves; neckties; trouser straps. wedding clothes.

(260) AM 2018 91247 A
 (800) 1333804
 (891) 2016 11 10
 (731) VALENTYN ZAPOROSHCHUK
 7 Vyshneva, Ichnia city, Chernihivska obl.
 16700, Ukraine
 (540)



(591) Red and white
 (531) 26.01.02; 26.01.20; 26.01.24; 29.01.12
 (511)
 29 – Milk and milk products; whipped cream; cream [dairy products]; condensed milk; yogurt; kefir [milk beverage]; curd; milk shakes; koumiss [kumiss] [milk beverage]; margarine; butter; buttercream; milk beverages, milk predominating; ryazhenka [fermented baked milk]; cheese; smetana [sour cream]; powdered milk; milk ferments for culinary purposes.

(260) AM 2018 91249 A
 (800) 1333834
 (891) 2016 11 17
 (731) Otkrytoe aktsionernoe obshchestvo
 "ASTON PRODUKTY PITANIA I
 PISHCHEVYE INGREDIENTY"
 ul. 1-ya Lugovaya, 3b RU-344002 Rostov-na-
 Donu, Russian Federation
 (540)



(591) orange, dark orange, white, grey-yellow,
 grey-green, light grey, green, light green, dark
 green
 (531) 01.15.15; 05.03.16; 05.05.04; 28.05; 29.01.15
 (511)
 29 – Fatty substances for the manufacture of edible
 fats; coconut fat; bone oil, edible; lard; suet for food;
 edible fats; edible oils; peanut butter; cocoa butter

for food; coconut oil; coconut butter; corn oil; sesa-
 me oil; linseed oil for culinary purposes; olive oil for
 food; palm oil for food; palm kernel oil for food;
 sunflower oil for food; colza oil for food; butter; fat-
 containing mixtures for bread slices.

(260) AM 2018 91251 A
 (800) 1333839
 (891) 2016 12 09
 (731) "R-PHARM" Joint Stock Company
 Berzarina street, 19, bld. 1, RU-123154
 Moscow, Russian Federation
 (540)

ГЛАТИРАТ

(591) Black and white
 (531) 28.05
 (511)
 5 – Pharmaceutical and veterinary preparations; sa-
 nitary preparations for medical purposes; dietetic
 substances adapted for medical use, food for babies;
 plasters, materials for dressings; material for stop-
 ping teeth, dental wax; disinfectants; preparations
 for destroying vermin; fungicides, herbicides.
 35 – Sales promotion for third parties; retail and
 wholesale services for goods of class 5.

(260) AM 2018 91252 A
 (800) 1334127
 (891) 2016 10 27
 (731) STADA Arzneimittel AG
 Stadastraße 2-18, 61118 Bad Vilbel, Germany
 (540)



(591) Red, blue and white.
 (531) 26.11.12; 27.05.05; 29.01.12
 (511)
 3 – Bleaching preparations and other substances for
 laundry use; cleaning, polishing, scouring and abra-
 sive preparations; soaps; perfumery, essential oils,
 cosmetics, hair lotions; dentifrices.
 5 – Pharmaceutical and veterinary preparations; sa-
 nitary preparations for medical purposes; medicine;
 foodstuffs and dietetic substances for medical or
 veterinary purposes; infant formula; dietary supple-
 ments for humans and animals; diagnostic prepara-
 tions for medical purposes; plasters, materials for
 dressings; material for stopping teeth, dental wax;

disinfectants; preparations for destroying vermin; fungicides; herbicides.

10 – Surgical, medical, dental and veterinary apparatus and instruments, diagnostic apparatus for medical purposes, artificial limbs, eyes and teeth; orthopedic articles; suture materials.

35 – Advertising; business management; business administration; office functions; wholesaling and retailing relating to bleaching preparations and other substances for laundry use, cleaning, polishing, scouring and abrasive preparations, soaps, perfumery, essential oils, cosmetics, hair lotions, dentifrices; wholesaling and retailing relating to pharmaceuticals and veterinary preparations, sanitary preparations for medical purposes, medicines, dietetic food and substances adapted for medical or veterinary use, food for babies, dietary supplements for humans and animals, diagnostic preparations for medical purposes; wholesaling and retailing relating to plasters, materials for dressings, material for stopping teeth, dental wax, disinfectants, preparations for destroying vermin, fungicides, herbicides; wholesaling and retailing relating to surgical, medical, dental and veterinary apparatus and instruments, diagnostic apparatus for medical purposes, artificial limbs, eyes and teeth, orthopaedic articles, suture materials, printed matter, instructional and teaching material (except apparatus).

(260) AM 2018 91253 A

(800) 1333883

(891) 2016 10 03

(731) HELSINN HEALTHCARE SA

Via Pian Scairolo 9, CH-6912 Lugano,
Switzerland

(540)



(591) Blue and gray

(531) 24.13.01; 27.01.03; 27.05.10; 29.01.12

(511)

1 – Chemical substances, chemical materials and chemical products.

5 – Pharmaceutical products, veterinary products; sanitary products for medical purposes; dietetic substances for medical use.

35 – The bringing together, for the benefit of others, of a variety of goods, namely chemical substances, chemical materials and chemical products, pharmaceutical and veterinary products, sanitary products for medical purposes, dietetic substances for medical use, (excluding the transport thereof) enabling consumers and wholesalers to conveniently view and purchase those goods.

40 – Treatment and processing of chemical, biochemical and pharmaceutical products for third parties; consulting services relating to the treatment of chemical, biochemical and pharmaceutical products; information and advisory services in the field of chemical, biochemical and pharmaceutical product treatment and processing.

42 – Scientific research and design services; technical and scientific consultancy in the field of chemical, biochemical and pharmaceutical products; scientific and industrial research and consultations in the field of chemical, biochemical and pharmaceutical technology; engineering including engineering expertise in the field of chemical, biochemical and pharmaceutical technology; provision of technological professional knowledge, particularly in the field of chemical, biochemical and pharmaceutical products (franchising).

45 – Licensing in the field of chemical, biochemical and pharmaceutical products; legal representation and advice, particularly before and during national procedures for the regulation of chemical, biochemical and pharmaceutical products.

(260) AM 2018 91275 A

(800) 1334353

(891) 2016 08 16

(731) MSC MEDITERRANEAN SHIPPING
COMPANY HOLDING SA

Chemin Rieu 12-14, CH-1208 Genève,
Switzerland

(540)

MEDLOG

(511)

39 – Transport; packaging and storage of goods; travel organization; transportation logistics services; logistics services consisting of the labeling, packaging, storing, transport and delivery of goods; transport and storage services relating to storage logistics, distribution logistics and returns logistics; transport reservations; national and international transport services; transport of goods by river, railway, ferryboat, car, truck and ship; tanker transport; collection, storage, transport, distribution and delivery of packages, parcels, freight, goods, luggage and personal effects by courier, road, rail, air or water; freight (transport of goods); operation of merchant ships; organization of transport services; arranging transport services; organization of the storage of goods; cargo shipping preparation; chartering of aircraft, vehicles, boats and marine vessels; airport area, station platform and ship loading quay services, namely the fixing and fastening of freight, cargo, shipping containers, refrigerated shipping containers, storage containers and storage tanks in or on aircraft, motor vehicles, cars, trucks, trains, ferry boats or ships; information services relating to moorings; packing of

cargo, packing of freight, packing of goods in containers; packaging of goods; packing of transit products; packing of products to order, to the specifications of others; warehousing, storage; bulk storage; storage of containers and cargo; storage of cargo prior to transport; storage of cargo after transport; storage of bonded goods; storage of goods in transit; storage and handling of goods; storage and handling of shipping containers, refrigerated shipping containers, storage containers and storage tanks; refrigerated storage of goods; refrigerated transport of goods; refrigerated warehousing; warehousing of freight; goods warehousing; inspection of merchandise prior to transport; inspection of shipping containers, refrigerated shipping containers, storage containers and storage tanks prior to transport; inspection of vehicles prior to transport; lighterage services; loading, packing, storage, transportation and unloading of cargo and freight; loading of freight containers onto ships; loading of freight containers onto trucks; loading of freight containers onto rail vehicles; unloading of freight, unloading of ships; loading and unloading of airplanes; harbor crane unloading; freight forwarding services; shipping of cargo, freight forwarding; hauling; truck hauling; portage; distribution (delivery) of goods, express delivery of goods; delivery of cargo, delivery of goods by road or rail, express delivery of freight; tracking, locating and monitoring of shipping containers, refrigerated shipping containers, storage containers and storage tanks; tracking, locating and monitoring of vehicles, ships and aircraft; monitoring and tracking of packages; rental of transport and storage containers; rental of containers for the transport and storage of goods; rental of containers for warehousing and storage; rental of loading containers; rental of containers for the marine transport industry; labeling services; removal services and provision of information relating thereto; removal services and transport of freight and cargo; industrial removal services [transport]; overseas removal services; moving van transport services; advice services relating to moving; providing travel information from an online database; vehicle routing by computer on data networks; providing information relating to transport services; providing information relating to marine transport services; provision of information relating to railway transport; providing information relating to fares, timetables and methods of transport; providing online information in the field of transport, packaging and storage of goods; provision of information relating to cargo unloading services; provision of information relating to warehousing services; freight brokerage; transport brokerage; shipbrokerage; advisory services relating to transportation; advisory services relating to the storage and transportation of goods, freight or cargo; services provided by consultants relating to travel, transport and storage services; consultancy in the field of transport and storage services

provided via telephone call centers and hotlines; rental of fixed and portable storage containers.

(260) AM 2018 91326 A

(800) 1335033

(891) 2016 11 23

(731) NETFLIX, INC.

100 Winchester Circle, Los Gatos CA 95032, USA



(591) Red

(531) 27.05.21; 29.01.01

(511)

41 – Entertainment and educational services, namely, providing non-downloadable movies and television shows via a video-on-demand service, as well as information, reviews, and recommendations regarding movies and television shows; providing a website featuring non-downloadable television shows, movies, and multimedia entertainment content, as well as information, reviews, and recommendations regarding television shows, movies, and multimedia entertainment content.

(260) AM 2018 91327 A

(800) 1334780

(891) 2016 09 14

(731) EURO GAMES TECHNOLOGY LTD

"Maritsa" Str. 4, "Vranya-Lozen-Triugulnika", BG-1151 Sofia, Bulgaria

(540)

FORTUNE SPELLS

(591) Yellow and brown

(531) 27.05.02; 29.01.12

(511)

9 – Apparatus for recording, transmission or reproduction of sound or images; data processing equipment and computers.

28 – Games; amusement machines, automatic and coin-operated; gaming machines adapted for use with an external screen or monitor.

(260) AM 2018 91334 A
 (800) 1335084
 (891) 2016 11 15
 (731) GUERLAIN SOCIETE ANONYME
 68 avenue des Champs Elysées, F-75008
 PARIS, France

(540)



(591) Green, gold
 (531) 26.04.22; 27.05.10; 29.01.13
 (511)
 3 – Perfumes; eau de toilette; eau de parfum; eau de Cologne.

(260) AM 2018 91336 A
 (800) 476778
 (891) 2017 01 20
 (731) CHAMPAGNE GOSSET
 69, rue Jules Blondeau, F-51160
 AY-CHAMPAGNE, France

(540)

GOSSET

(511)
 33 – Wines, spirits and liqueurs.

(260) AM 2018 91337 A
 (800) 1334804
 (891) 2016 07 29
 (731) Obschestvo s ogranichennoy
 otvetstvennostyu
 "UPRAVLYAYUSHCHAYA KOMPANIYA
 "BUKET"
 1-y Graivoronovskiy pr-d, d. 3, RU-109518
 Moscow, Russian Federation

(540)

СолПро

SolPro

(591) Black and white
 (531) 27.05.17; 28.05
 (511)
 29 – Alginates for culinary purposes; anchovy; peanuts, prepared; bouillon; ginger jam; fatty substances for the manufacture of edible fats; edible birds' nests; peas, preserved; mushrooms, preserved; game,

not live; gelatine; jellies for food; fruit jellies; yolk of eggs; coconut fat; edible fats; raisins; caviar; sauerkraut; vegetables, tinned [canned (Am.)]; fruits, tinned [canned (Am.)]; bouillon concentrates; gherkins; shrimps, not live; buttercream; croquettes; silkworm chrysalis, for human consumption; spiny lobsters, not live; onions, preserved; margarine; piccalilli; marmalade; vegetable oils for food; peanut butter; cocoa butter for food; butter; shellfish, not live; almonds, ground; mussels, not live; milk; fruit pulp; vegetables, preserved; vegetables, dried; vegetables, cooked; potato fritters; olives, preserved; lobsters, not live; coconut, desiccated; nuts, prepared; tomato purée; liver pâté; pectin for culinary purposes; liver; pickles; jams; powdered eggs; milk products; pollen prepared as foodstuff; cranberry sauce [compote]; apple purée; crustaceans, not live; vegetable salads; fruit salads; whipped cream; fat-containing mixtures for bread slices; tomato juice for cooking; vegetable juices for cooking; preparations for making bouillon; preparations for making soup; soups; vegetable soup preparations; whey; cheese; tofu; sea-cucumbers, not live; truffles, preserved; oysters, not live; rennet; dates; crystallized fruits; frozen fruits; fruit, preserved; fruit preserved in alcohol; fruit, stewed; potato flakes; fruit peel; lentils, preserved; potato chips; fruit chips; seaweed extracts for food; snail eggs for consumption; eggs.

30 – Aromatic preparations for food; food flavorings, other than essential oils; star aniseed; sponge cakes; pancakes; buns; bread rolls; vanillin [vanilla substitute]; waffles; vermicelli [noodles]; natural sweeteners; sausage binding materials; seaweed [condiment]; cloves [spice]; glucose for culinary purposes; mustard; thickening agents for cooking foodstuffs; artificial coffee; confectionery for decorating Christmas trees; cakes; pastries; peanut confectionery; almond confectionery; pasta; frozen yogurt [confectionery ices]; cocoa; capers; caramels [candy]; gruel, with a milk base, for food; gluten prepared as foodstuff; sweetmeats [candy]; coffee; unroasted coffee; starch for food; crackers; groats for human food; corn, milled; corn, roasted; meat pies; noodles; ice for refreshment; edible ices; candy; rice cakes; maltose; marzipan; honey; ice cream; corn flour; muesli; mint for confectionery; cocoa beverages with milk; coffee-based beverages; coffee beverages with milk; cocoa-based beverages; tea-based beverages; chocolate-based beverages; chocolate beverages with milk; infusions, not medicinal; crushed oats; husked oats; nutmegs; pastilles [confectionery]; molasses for food; pepper; cookies; pies; pizzas; fondants [confectionery]; popcorn; powders for making ice cream; pralines; condiments; meat tenderizers, for household purposes; cereal preparations; oat-based food; propolis; gingerbread; spices; petits fours [cakes]; puddings; cake powder; ravioli; chewing gum; rice; sugar; confectionery; malt for human consumption; salt for preserving foodstuffs; co-

oking salt; spaghetti; preparations for stiffening whipped cream; seasonings; rusks; breadcrumbs; sushi; sandwiches; almond paste; fruit cakes; vinegar; ferments for pastes; halvah; bread; unleavened bread; chips [cereal products]; chicory [coffee substitute]; tea; iced tea; chocolate; malt extract for food; essences for foodstuffs, except etheric essences and essential oils.

(260) AM 2018 91338 A

(800) 1334809

(891) 2016 09 06

(731) TIRSAN TREYLER SANAYİ VE TİCARET ANONİM ŞİRKETİ
Adliye Köyü, 1520 Nolu Sokak, No:3, Arifiye,
TR-54010 SAKARYA, Turkey

(540)

 The logo for TIRSAN features a stylized red and blue 'T' symbol to the left of the word 'TIRSAN' in a bold, blue, sans-serif font.

(591) Blue and red

(531) 26.03.04; 27.05.17; 29.01.12

(511)

12 – Bicycles and their bodies; handlebars and mudguards for bicycles; vehicle bodies; tipping bodies for trucks; trailers (vehicles); vehicle parts, namely, transfer cases; mobile storage tanks; cargo trailer; semi-tractor trailers; bulk hauling trailers; trailers for tractors; frigorific bodies for land vehicles; trailer hitches for vehicles; vehicle seats; head-rests for vehicle seats; safety seats for children, for vehicles; seat covers for vehicles; vehicle covers (shaped); sunblinds adapted for vehicles; direction signals and arms for direction signals for vehicles; windscreen wipers and wiper arms for vehicles; inner and outer tires for vehicle wheels; tubeless tires; tire-fixing sets comprised of tire patches and tire valves for vehicles; windows for vehicles, safely windows for vehicles, rearview mirrors and wing mirrors for vehicles; anti-skid chains for vehicles; luggage carriers for vehicles; bicycle and ski carriers for cars; saddles for bicycles or motorcycles; air pumps for vehicles, for inflating tires; anti-theft alarms for vehicles, horns for vehicles; safety belts for vehicle seats, air bags (safety devices for automobiles); baby carriages, wheelchairs, pushchairs; wheelbarrows; shopping carts; single or multi-wheeled wheelbarrows; shopping trolleys; grocery carts; handling carts; rail vehicles; locomotives; trains; trams; waggons; cable cars; chairlifts; vehicles for locomotion by water and their parts, other than their motors and engines; vehicles for locomotion by air and their parts, other than their motors and engines.

(260) AM 2018 91363 A

(800) 1335148

(891) 2016 12 26

(731) "BELUGA MARKET" LLC

Proletarskaya street, 40A, Zvenigorog,
RU-143180 Moscow region, Russian
Federation

(540)

SMALL COPPER HORSE

(511)

33 – Aperitifs; arrack; brandy; wine; piquette; whiskey; vodka; anisette [liqueur]; kirsch; gin; digesters [liqueurs and spirits]; cocktails; anise [liqueur]; liqueurs; pre-mixed alcoholic beverages, other than beer-based; alcoholic beverages, except beer; alcoholic beverages containing fruit; spirits [beverages]; distilled beverages; mead (hydromel); peppermint liqueurs; bitters; nira (sugarcane-based alcoholic beverage); rum; sake; perry; cider; rice alcohol; alcoholic extracts; alcoholic fruit extracts; alcoholic essences.

(260) AM 2018 91365 A

(800) 1335217

(891) 2016 08 26

(731) CREDIT AGRICOLE SA

12 Place des Etats-Unis, F-92127
MONTROUGE CEDEX, France

(540)

 The logo for CREDIT AGRICOLE features a stylized green and red 'CA' symbol above the text 'A whole bank just for you' in a blue, sans-serif font.

(591) Green, red, blue

(531) 26.11.08; 26.11.12; 27.05.15; 27.05.22;
29.01.13

(511)

9 – Debit cards, and/or credit cards, and/or payment cards with magnetic strips and/or microprocessors with or without contactless payment function; loyalty cards, discount cards, electronic cash cards; machines for counting and sorting money, automatic cash dispensers (ATM); electronic banking terminals for consulting accounts, banking and financial information and enabling the deposit of money and/or checks; electronic banking terminals for carrying out monetary exchanges; counterfeit [false] coin detectors; readers for memory or chip cards, magnetic cards, payment cards, credit cards, debit cards, loyalty cards, discount cards; downloadable computer software applications for personal and hand-held computers, mobile telephones, digital tablets for online access to a site proposing information in the fields of banking, insurance, finance and real estate; software in the fields of banking, insurance, finance and real

estate; secure payment software for Internet-type computer communication networks; equipment for processing secure payments on Internet-type computer communication networks.

16 – Paper, cardboard; printing products; bookbinding material; photographs; newspapers, magazines, leaflets, newsletters, prospectuses, books, printed booklets, printed fact sheets, envelopes, labels, instructional or teaching material (except apparatus); plastic materials for packaging, namely bags, sachets, films and sheets; printing blocks.

35 – Advertising; commercial business management; commercial administration; business consultancy, inquiry and information services, business organization and management consultancy; business management assistance; commercial or industrial company management assistance; commercial business appraisal; professional business consultancy; commercial information and advice for consumers (consumer advice shop); updating of advertising material; dissemination of advertising matter (leaflets, pamphlets, printed matter, samples); accounting; account verification; organization of exhibitions for commercial or advertising purposes; economic forecasting; tax preparation; compilation of statistics; office functions; public relations; collection and systematization of data in a central file; computerized file management; information searches in computer files for others; all these services may be provided via the Internet.

36 – Insurance services, reinsurance services; insurance information; insurance brokerage; insurance consultancy; financial affairs, monetary affairs, banking affairs, real estate affairs; credit agencies; home banking; provision of credits; lease-purchase financing; financial sponsorship; debt collection agencies; capital investment, information relating to finance; information relating to finance, stock exchange listing, stock exchange brokerage, issuing of travelers' checks and letters of credit, issuing of payment securities, issuing of debit and credit cards; pension funds, financial analysis, financial estimates (banking, insurance, real estate); fiscal valuations; financing services, loans (financing), financial transactions, mutual funds, management and investment of funds; management of securities; savings services; mutual funds; undertakings for collective investment in transferable securities; exchange operations; financial operations; monetary operations; payment by installments; fund payment; loans (financing); collateral loans; actuarial, factoring, real estate expertise, real estate management, credit card and debit card services, safe deposit boxes; deposits of valuables; check verification; electronic funds transfer; financial and banking management; financial market research and prospecting; financial indices and financial indexing; all these services may be provided via the Internet.

38 – Telecommunications, communication services, namely, communications via computer, via telephone, via Internet-type network; transmission of information using Internet access codes, via Internet-type networks, via telematic means or computer terminals, electronic transmission of data, images and documents via computer terminals or transmission systems such as waves, satellites, Internet network; on-line messaging services, electronic data exchange services; transmission of information via video communication; telecommunication and electronic messaging services via online services; rental of access time to a database server center; dissemination of banking, financial, insurance and/or real estate information by any method such as data processing, telematics, terrestrial networks, audiovisual technique; transmission of financial statistics and indices and all encrypted data or texts related to banking, financial instruments and securities; secure transmission of messages related to banking and financial transactions and consulting relating thereto; banking and/or financial data transmission via a secure global electronic communication network; provision of access to a secure and global electronic communication network; electronic transfer of information related to payment, capital, securities, commercial paper and cash flow transactions.

41 – Education; training; entertainment; sponsorship of sporting and cultural activities; information relating to entertainment or education; leisure services; publication of books, newspapers, magazines, pamphlets, newsletters, prospectuses, printed booklets, printed fact sheets; organization of competitions (education or entertainment); organization and conducting of training courses, colloquiums, conferences or congresses; organization of exhibitions for cultural or educational purposes; booking of seats for shows; game services provided online from a computer network; gambling services; electronic publication of books, newspapers, magazines, leaflets, newsletters, prospectuses, printed booklets, printed fact sheets; electronic desktop publishing services.

42 – Design and development of software, websites and downloadable computer software applications; programming for computers; maintenance and updating of software, websites and downloadable computer software applications; research and development of new products for others; technical project studies; evaluations, assessments and research in the fields of science and technology provided by engineers; consulting relating to software, websites and downloadable computer software applications; conversion of computer programs and data, other than physical conversion; conversion of data or documents from physical to electronic media; authentication of works of art.

(260) AM 2018 91366 A
 (800) 1335237
 (891) 2016 06 01
 (731) ITALIA INDEPENDENT S.P.A.
 Corso XI Febbraio,19, I-10152 TORINO, Italy



(591) Black, white
 (531) 26.01.01; 26.01.24; 26.04.02; 26.04.24;
 26.07.05

(511)
 14 – Watches; watch bands; table clocks; wall clocks; alarm clocks; chronographs [watches]; chrono cases for clocks and watches and for other chronometric instruments; jewelry and imitation of jewelry; jewelry cases; earrings; bangles; necklaces [jewellery]; rings [jewellery]; charms [jewellery]; pins [jewellery]; jewelry chains; medals; locket [jewellery]; cuff links; tie clips; decorative boxes of precious metal; precious metals and their alloys; ornaments [jewellery]; precious stones; semi-precious stones; jewellery [costume jewelry]; pearls [jewellery]; closures for jewellery; pendants; amulets [jewellery]; ornamental pins.

(260) AM 2018 91367 A
 (800) 1018307
 (891) 2017 01 25
 (731) DORCO CO., LTD.
 (Golim-Dong), 350 Kyungahnchun-Ro,
 Cheoin-Gu, Yongin-Si Kyunggi-Do, Korea
 (Republic of)

(540)

(591) Black, white
 (531) 27.05.01
 (511)
 8 – Non-electric razors; razor blades; kitchen knives; fruit knives; scissors for kitchen use; sickles; sharpening stones; knives; blades [hand tools]; electric razors.

(260) AM 2018 91368 A
 (800) 1079830
 (891) 2017 01 20
 (731) Marburger Tapetenfabrik, J.B. Schaefer
 GmbH & Co. KG
 Bertram-Schaefer-Str. 11, 35274 Kirchhain,
 Germany

(540)

(591) Black, white
 (531) 26.04.02; 26.04.24; 26.11.02; 27.05.11
 (511)
 27 – Carpets, rugs, mats and matting, linoleum and other materials for covering existing floors; wall paper and wall hangings (non-textile); wall hangings and wall cladding with anti-bugging and electro-magnetic compatibility; braids for wall hangings and sample cards for wall hangings (non-textile).

(260) AM 2018 91423 A
 (800) 1335864
 (891) 2017 01 24
 (731) ARC HOLDINGS
 104 avenue du Général de Gaulle, F-62510
 ARQUES, France

(540)

(591) Black, white, red
 (531) 27.05.01; 29.01.12
 (511)
 8 – Hand-operated hand tools and implements; cutlery; table forks; spoons; side arms, other than firearms; apparatus and instruments for slaughtering butchers' animals; hand-operated hand tools.

21 – Kitchen utensils; containers for household use; kitchen containers; glass, unworked or semi-worked, except building glass; porcelain ware; earthenware; bottles; glasses (receptacles); tableware.

(260) AM 2018 91429 A
 (800) 1335524
 (891) 2016 11 04
 (731) TOTO LTD.
 1-1, Nakashima 2-chome, Kokurakita-Ku,
 Kitakyushu-Shi, Fukuoka-Ken 802-8601,
 Japan

(540)

(591) Black, white
 (531) 27.05.17
 (511)
 11 – Toilets [water-closets]; toilet stool units; toilet stool units with warm water washing squirter; toilet seats; toilet seats with warm water squirter for washing; bidets; urinals [sanitary fixtures]; tap water faucets; pipe line cocks [spigots]; showers; wash-hand basins [parts of sanitary installations]; wash-hand bowls [parts of sanitary installations]; bath plumbing fixtures; bath tubs; bath fittings.

(260) AM 2018 91430 A
 (800) 1335535
 (891) 2016 12 16

(731) Aktsionernoe obshchestvo "SLAVYANKA-LUX"
ul. 1-y Konnoy Armii, 65, Belgorodskaya obl.,
RU-309506 Stariy Oskol, Russian Federation

(540)

ЖАКЛИН

(591) Black, white

(531) 28.05

(511)

30 – Confectionery, including chocolate-coated nuts, dessert mousses [confectionery], fruit jellies [confectionery], macaroons [pastry], pastries, stick liquorice [confectionery], tarts; confectionery for decorating Christmas trees; peanut confectionery; almond confectionery; cakes; waffles; caramels [candy]; sweetmeats [candy]; liquorice [confectionery]; peppermint sweets; crackers; candy; marzipan; pastilles [confectionery]; cookies; biscuits; petits fours [cakes]; cake powder; fondants [confectionery]; pralines; gingerbread; confectionery; sugar confectionery; halvah; chocolate.

(260) AM 2018 91432 A

(800) 1335547

(891) 2017 01 05

(731) LACO UHRENMANUFAKTUR GMBH

Rastatter Straße 8, 75179 Pforzheim, Germany

(540)



(591) Black, white

(531) 27.05.01

(511)

14 – Watches.

(260) AM 2018 91433 A

(800) 1335550

(891) 2016 08 01

(731) ROGOLS SERGEJS

vul. Popudrenko, 18a, kv.33, Kyiv 02097,
Ukraine

(540)



(591) Black, white

(531) 26.01.19; 26.01.24

(511)

35 – Arranging subscriptions to telecommunication services for others; import-export agency services; commercial information agency services; advertising agency services; rental of advertising space; employment agency services; computerized file management; outsourced administrative management for companies; demonstration of goods; transcription of communications [office functions]; opinion polling; market studies; business information; commercial information and advice for consumers [consumer advice shop]; business investigations; business research; marketing research; personnel recruitment; business management and organization consultancy; business organization consultancy; business management consultancy; personnel management consultancy; professional business consultancy; layout services for advertising purposes; marketing; news clipping services; updating and maintenance of data in computer databases; updating of advertising material; organization of exhibitions for commercial or advertising purposes; arranging newspaper subscriptions for others; organization of trade fairs for commercial or advertising purposes; shop window dressing; design of advertising materials; business appraisals; data search in computer files for others; sponsorship search; business management assistance; commercial or industrial management assistance; commercial intermediation services; providing business information via a web site; provision of commercial and business contact information; provision of an on-line marketplace for buyers and sellers of goods and services; web indexing for commercial or advertising purposes; presentation of goods on communication media, for retail purposes; retail or wholesale services for pharmaceutical, veterinary and sanitary preparations and medical supplies; sales promotion for others; office machines and equipment rental; rental of advertising time on communication media; publicity material rental; rental of billboards [advertising boards]; rental of vending machines; rental of sales stands; bill-posting; distribution of samples; dissemination of advertising matter; direct mail advertising; writing of publicity texts; advertising; on-line advertising on a computer network; advertising by mail order; television advertising; compilation of information into computer databases; systemization of information into computer databases; advisory services for business management; negotiation and conclusion of commercial transactions for third parties; telemarketing services; business management for freelance service providers; commercial administration of the licensing of the goods and services of others; administration of consumer loyalty programs; administrative processing of purchase orders; modelling for advertising or sales promotion; search engine optimization for sales promotion; procurement services for others [purchasing goods and services for other businesses]; outsourcing services

[business assistance]; business efficiency expert services.

41 – Academies [education]; education information; layout services, other than for advertising purposes; providing on-line electronic publications, not downloadable; correspondence courses; practical training [demonstration]; organization of exhibitions for cultural or educational purposes; arranging and conducting of colloquiums; arranging and conducting of workshops [training]; arranging and conducting of in-person educational forums; arranging and conducting of seminars; arranging and conducting of symposiums; arranging of beauty contests; vocational guidance [education or training advice]; vocational retraining; providing on-line videos, not downloadable; educational examination; on-line publication of electronic books and journals; teaching; coaching [training]; services of schools [education]; photography; photographic reporting.

(260) AM 2018 91434 A

(800) 1335934

(891) 2016 10 05

(731) Obshchestvo s ogranichennoy
otvetstvennostyu "KONDITERSKAYA
FABRIKA IM. N.K. KRUPSKOY"
Ropshinskoje shosse, 9, derevnia Razbegaevo,
Lomonosovsky rayon, RU-188513
Leningradskaya oblast, Russian Federation

(540)



(591) Brown, yellow, white and burgundy

(531) 25.07.06; 26.04.07; 28.05; 29.01.14

(511)

30 – Aromatic preparations for food; high-protein cereal bars; pancakes; noodle-based prepared meals; buns; bread rolls; waffles; vermicelli [noodles]; natural sweeteners; binding agents for ice cream [edible ices]; binding agents for ice cream; binding agents for edible ices; malt biscuits; cake frosting [icing]; glucose for culinary purposes; gluten additives for culinary purposes; thickening agents for cooking foodstuffs; leaven; rice-based snack food; cereal-based snack food; artificial coffee; dressings for salad; fruit jellies [confectionery]; confectionery for decorating Christmas trees; cakes; pastries; peanut confectionery; almond confectionery; pasta; frozen yogurt [confectionery ices]; cocoa; gluten prepared as foodstuff; sweetmeats [candy]; caramels [candy];

candy; liquorice [confectionery]; peppermint sweets; coffee; unroasted coffee; crackers; custard; hominy grits; groats for human food; corn, roasted; maize, roasted; meat pies; noodles; ice for refreshment; ice, natural or artificial; edible ices; rice cakes; macarons [pastry]; mayonnaise; marzipan; hominy; honey; ice cream; flour; meal; dessert mousses [confectionery]; chocolate mousses; muesli; mint for confectionery; coffee beverages with milk; coffee-based beverages; tea-based beverages; chocolate beverages with milk; chocolate-based beverages; cocoa-based beverages; cocoa beverages with milk; infusions, not medicinal; crushed oats; husked oats; stick liquorice [confectionery]; fondants [confectionery]; cookies; biscuits; petit-beurre biscuits; pies; pizzas; popcorn; powders for ice cream; pralines; condiments; cereal preparations; propolis; gingerbread; spices; petits fours [cakes]; puddings; cake powder; fruit coulis [sauces]; ravioli; chewing gum; wheat germ for human consumption; sugar; golden syrup; cake dough; cake batter; confectionery; sugar confectionery; sherbets [ices]; sorbets [ices]; sauces [condiments]; spaghetti; seasonings; preparations for stiffening whipped cream; rusks; breadcrumbs; sushi; sandwiches; tarts; almond paste; tortillas; garden herbs, preserved [seasonings]; halvah; bread; unleavened bread; chips [cereal products]; corn flakes; oat flakes; chicory [coffee substitute]; tea; iced tea; cheeseburgers [sandwiches]; chocolate.

(260) AM 2018 91436 A

(800) 1335643

(891) 2016 12 12

(731) FRIESLANDCAMPINA NEDERLAND B.V.
Stationsplein 4, NL-3818 LE Amersfoort,
Netherlands

(540)



(591) Blue, gold and white

(531) 26.04.22; 26.04.24; 27.05.02; 27.05.17;
27.05.24; 29.01.13

(511)

5 – Food for babies.

29 – Milk and milk products.

30 – Chocolate and chocolate flavoured drinks; cereals and preparations made from cereals.

(260) AM 2018 91439 A

(800) 1336184

(891) 2016 12 22

(731) Sennheiser electronic GmbH & Co. KG
Am Labor 1, 30900 Wedemark, Germany

(540)

SDW

(511)

9 – Apparatus for recording, transmission or reproduction of sound, images or data, namely headphones, headsets, microphones and loudspeakers; telecommunications apparatus and installations.

(260) AM 2018 91442 A

(800) 1336189

(891) 2016 12 16

(731) Aktsionernoe obshchestvo "SLAVYANKA-LUX"

ul. 1-y Konnoy Armii, 65, Stariy Oskol,
RU-309506 Belgorodskaya obl., Russian
Federation

(540)

Romantica

(591) Black, white

(531) 27.05.17

(511)

30 – Confectionery, including chocolate-coated nuts, dessert mousses [confectionery], macaroons [pastry], petits fours [cakes]; cocoa; artificial coffee; flour; cereal preparations; bread rolls; bread; buns; waffles; cake frosting [icing]; fruit jellies [confectionery]; confectionery for decorating Christmas trees; cakes; pastries; peanut confectionery; almond confectionery; pasta; pies; caramels [candy]; sweetmeats [candy]; liquorice [confectionery]; peppermint sweets; crackers; candy; marzipan; muesli; stick liquorice [confectionery]; pastilles [confectionery]; lozenges [confectionery]; cookies; biscuits; petit-beurre biscuits; fondants [confectionery]; pralines; gingerbread; spring rolls; sugar; cake dough; cake batter; confectionery; sugar confectionery; halvah; chips [cereal products]; corn flakes; maize flakes; oat flakes; chocolate.

(260) AM 2018 91443 A

(800) 1335707

(891) 2016 11 22

(731) MİNİK O PAZARLAMA DIŞ TİCARET VE TURİZM ANONİM ŞİRKETİ

Bayar Caddesi Şehit İlknur, Keleş Sokak
No.5 Kat.9, Kozyatağı Kadıköy, İstanbul,
Turkey

(540)

miniKoiOi

(591) Gray, white, green

(531) 27.05.01; 27.05.17; 29.01.12

(511)

10 – Surgical, medical, dental and veterinary apparatus and instruments; artificial limbs, eyes and teeth; orthopedic articles; suture materials.

(260) AM 2018 91446 A

(800) 1335741

(891) 2017 01 12

(731) MUSTAFA NEVZAT İLAÇ SANAYİİ

ANONİM ŞİRKETİ

Prof. Dr. Bülent Tarcan Sok., Pak İş Merkezi

No:5/1, Gayrettepe Beşiktaş TR-34349

İSTANBUL, Turkey

(540)

PENSİLİNA

(591) Black and white

(511)

5 – Pharmaceuticals.

(260) AM 2018 91447 A

(800) 1336194

(891) 2016 12 21

(731) "RN-Lubricants" LLC

District Yuzhniy Promuzel, 8, RU-390011

Ryazan, Russian Federation

(540)



(591) Brown, light brown, dark brown, gray, light gray, dark gray, black, white, green and light blue

(531) 01.15.17; 26.03.23; 29.01.12

(511)

4 – Anthracite; benzine; benzene; benzol; biomass fuel; petroleum jelly for industrial purposes; industrial wax; belting wax; oil-gas; fuel gas; gasoline; producer gas; solidified gases [fuel]; fuel; lubricating graphite; additives, non-chemical, to motor fuel; cutting fluids; lanolin; illuminating grease; grease for leather; grease for footwear; tallow; industrial grease; kerosene; mazut; fuel oil; oils for paints; oils for releasing form work [building]; oil for the preservation of masonry; oil for the preservation of leather; textile oil; lubricating oil; industrial oil; moistening oil; coal tar oil; coal naphtha; castor oil for industrial

purposes; bone oil for industrial purposes; motor oil; sunflower oil for industrial purposes; rape oil for industrial purposes; lubricants; petroleum, raw or refined; soya bean oil preparations for non-stick treatment of cooking utensils; non-slipping preparations for belts; grease for arms [weapons]; lubricating grease; grease for belts; vaporized fuel mixtures; dust absorbing compositions; dust laying compositions; preservatives for leather [oils and greases]; diesel oil; lighting fuel; mineral fuel; carburants; fuel with an alcoholic base; petrol.

(260) AM 2018 91452 A

(800) 1335744

(891) 2016 12 14

(731) OSES GRUP GIDA SAN.VE TİC.LTD.ŞTİ.

Karayolları Mah.568 Sok.No:14/1,

Gaziosmanpaşa, İSTANBUL, Turkey

(540)



(591) Red and green

(531) 26.04.22; 27.05.01; 29.01.02

(511)

43 – Services for providing food and drink; temporary accommodation; day-nurseries (crèches); boarding for animals.

(260) AM 2018 91453 A

(800) 1336196

(891) 2016 12 05

(731) Obschestvo s ogranichennoy

otvetstvennostyu "DYURAN MEDIA"

Vakhitova Street, 4B, RU-603001 Nizhny

Novgorod, Russian Federation

(540)

ROVERS

(591) Black, white

(531) 27.05.17

(511)

1 – Anti-boil preparations for engine coolants; anti-freeze; brake fluid; chemical additives to motor fuel; fluids for hydraulic circuits.

4 – Additives, non-chemical, to motor fuel; cutting fluids; industrial oil; lubricants; lubricating oil; motor oil.

(260) AM 2018 91454 A

(800) 1336027

(891) 2016 11 02

(731) HUQQABAZ GIDA İŞLETMELERİ

SANAYİ VE TİCARET ANONİM ŞİRKETİ

Yenibosna Merkez Mahallesi Sedir Sokak

No:7/1,Bahçelievler İstanbul, Turkey

(540)

huqqabaz

(591) Black, white

(531) 27.05.17

(511)

43 – Arranging and providing temporary accommodation; arranging hotel accommodation; arranging temporary housing accommodations; bar and bistro services; bar and restaurant services; café and cafeteria services; café and restaurant services; canteens; catering services for the provision of food and drink; coffee and juice bar services; coffee and tea bar services; coffee-house and snack-bar services; coffee shop services; day-care services; day-nurseries [crèches]; fast-food restaurant services; hotel and restaurant services; preparation and provision of food and drink for consumption in retail establishments; providing food and drink; providing food and drink in restaurants; providing restaurant services; reservation of restaurants; services for providing food and drink, and temporary accommodation; serving food and drink in restaurants and bars; teahouse services.

(260) AM 2018 91455 A

(800) 1335755

(891) 2016 04 26

(731) TROMMSDORFF GMBH & CO. KG

Trommsdorffstrasse 2-6, 52477 Alsdorf,

Germany

(540)



Trommsdorff

(591) Blue, white

(531) 03.11.03; 26.01.15; 26.01.18; 27.05.05;

27.05.21; 29.01.12

(511)

3 – Soaps; perfumery; essential oils; cosmetics; dentifrices; medicated soap.

5 – Pharmaceutical and veterinary preparations as well as preparations for health care; chemical-me-

dical products for medical therapeutic purposes; sanitary preparations for medical purposes; drugs; medical plaster; dressings; tooth fillings and dental impression materials for dental purposes; disinfectants; preparations for destroying vermin; fungicides; herbicides; dietetic foods for medical purposes; dietetic products for medical purposes; dietetic substances for medical purposes; food supplements; food supplements for dietetic use; mineral food supplements; vitamins; baby food; chemical and pharmaceutical products for the supplemental balanced diet; dietetic food for medical purposes; dietetic beverages for medical purposes.

10 – Surgical, medical, dental and veterinary apparatus, devices and instruments; medical analytical apparatus for medical purpose, medical diagnostic apparatus for medical purposes, diagnostic apparatus for medical purposes; protective clothing for medical purposes; artificial limbs; artificial eyes; artificial teeth; orthopedic articles; thermometers for medical use.

16 – Printed matter, in particular pamphlets, flyers, leaflets, brochures, newspapers and magazines; books; instructional and teaching material, except apparatuses; photographs; packaging materials; boxes and containers made of paper and / or cardboard; paper, cardboard; stationery; packaging materials made of plastic, to the extent included in this class.

25 – Clothing; footwear; headgear.

29 – Dietetic foods for non-medical purposes on the basis of proteins, fats with added fatty acids, vitamins, minerals, trace elements, either individually or in combination, to the extent included in this class.

30 – Dietetic foods for non-medical purposes on the basis of carbohydrates, roughage, with added vitamins, minerals, trace elements, either individually or in combination, to the extent included in this class.

35 – Business management; business administration; office functions; marketing; market research; market analysis; advertising and distribution of goods for advertising purposes; planning and organizing advertising campaigns and events; retail and wholesale services in relation to soaps, perfumery, essential oils, cosmetics, dentifrices, medicated soap, pharmaceutical and veterinary preparations, and preparations for health care, chemical-medical products for medical therapeutic purposes, sanitary preparations for medical purposes, drugs, plaster, dressings, tooth fillings and dental impression materials for dental purposes, disinfectants, preparations for destroying vermin, fungicides, herbicides, dietetic foods for medical purposes, dietetic products for medical purposes, dietetic substances for medical purposes, food supplements, food supplements for dietetic use, mineral food supplements, vitamins, baby food, chemical and pharmaceutical products for the supple-

mental balanced diet, dietetic food for medical purposes, dietetic beverages for medical purposes, surgical, medical, dental and veterinary apparatus, devices and instruments, medical appliances, medical clothing, artificial limbs, artificial eyes, artificial teeth, orthopedic articles, thermometers, printed matter, in particular pamphlets, flyers, leaflets, brochures, newspapers and magazines, books, instructional and teaching material, except apparatuses, photographs, packaging materials, boxes and containers made of paper and / or cardboard, paper, cardboard, stationery, packaging materials made of plastic, clothing, footwear, headgear, dietetic foods for non-medical purposes on the basis of proteins, fats with added fatty acids, vitamins, minerals, trace elements, either individually or in combination, dietetic foods for non-medical purposes on the basis of carbohydrates, roughage, with added vitamins, minerals, trace elements, either individually or in combination; retail and wholesale services over the Internet by means of an online store and by means of teleshopping in relation to soaps, perfumery, essential oils, cosmetics, dentifrices, medicated soap, pharmaceutical and veterinary preparations, and preparations for health care, chemical-medical products for medical therapeutic purposes, sanitary preparations for medical purposes, drugs, plaster, dressings, tooth fillings and dental impression materials for dental purposes, disinfectants, preparations for destroying vermin, fungicides, herbicides, dietetic foods for medical purposes, dietetic products for medical purposes, dietetic substances for medical purposes, food supplements, food supplements for dietetic use, mineral food supplements, vitamins, baby food, chemical and pharmaceutical products for the supplemental balanced diet, dietetic food for medical purposes, dietetic beverages for medical purposes, surgical, medical, dental and veterinary apparatus, devices and instruments, medical appliances, medical clothing, artificial limbs, artificial eyes, artificial teeth, orthopedic articles, thermometers, printed matter, in particular pamphlets, flyers, leaflets, brochures, newspapers and magazines, books, instructional and teaching material, except apparatuses, photographs, packaging materials, boxes and containers made of paper and / or cardboard, paper, cardboard, stationery, packaging materials made of plastic, clothing, footwear, headgear, dietetic foods for non-medical purposes on the basis of proteins, fats with added fatty acids, vitamins, minerals, trace elements, either individually or in combination, dietetic foods for non-medical purposes on the basis of carbohydrates, roughage, with added vitamins, minerals, trace elements, either individually or in combination.

41 – Organizing and conducting congresses, conferences and seminars and publication and issuing of printed matter and audiovisual media on the content and results of the congresses, conferences and seminars.

42 – Research in the field of pharmacy, medicine, hygiene, biotechnology and chemistry; development in the field of pharmacy, medical technology, biotechnology and chemistry; consultancy in the field of biotechnology and chemistry.

44 – Consultancy in the field of pharmacy; medical services; health care for humans; beauty care for humans; medical, dietary and cosmetic consultancy; consultancy regarding nutrition and diets; consultancy in the field of pharmacy, medicine and hygiene.

(260) AM 2018 91487 A

(800) 1336075

(891) 2016 10 27

(731) Aktsionerno Droujestvo "SOPHARMA"
Oulitsa "Iliensko shaussee" 16 BG-1220
Sofia, Bulgaria

(540)

VIDESTIN ВИДЕСТИН

(591) Black, white

(531) 27.05.17

(511)

5 – Pharmaceutical, medical and veterinary preparations; sanitary preparations for medical purposes; dietetic food and substances adapted for medical or veterinary use, food for babies; dietary supplements for humans and animals.

(260) AM 2018 91492 A

(800) 1336109

(891) 2016 12 21

(731) "RN-Lubricants" LLC
District Yuzhniy Promuzel, 8 RU-390011
Ryazan, Russian Federation

(540)



(591) Blue, light blue, dark blue, golden, dark yellow, light brown, black, white and light gray

(531) 18.01.09; 25.07.20; 26.03.23; 27.05.24;
29.01.15

(511)

4 – Anthracite; benzine; benzene; benzol; biomass fuel; petroleum jelly for industrial purposes; industrial wax; belting wax; oil-gas; fuel gas; gasoline; producer gas; solidified gases [fuel]; fuel; lubricating

graphite; additives, non-chemical, to motor fuel; cutting fluids; lanolin; illuminating grease; grease for leather; grease for footwear; tallow; industrial grease; kerosene; mazut; fuel oil; oils for paints; oils for releasing form work [building]; oil for the preservation of masonry; oil for the preservation of leather; textile oil; lubricating oil; industrial oil; moistening oil; coal tar oil; coal naphtha; castor oil for industrial purposes; bone oil for industrial purposes; motor oil; sunflower oil for industrial purposes; rape oil for industrial purposes; lubricants; petroleum, raw or refined; soya bean oil preparations for non-stick treatment of cooking utensils; non-slipping preparations for belts; grease for arms [weapons]; lubricating grease; grease for belts; vaporized fuel mixtures; dust absorbing compositions; dust laying compositions; preservatives for leather [oils and greases]; diesel oil; lighting fuel; mineral fuel; carburants; fuel with an alcoholic base; petrol.

(260) AM 2018 91496 A

(800) 1336117

(891) 2016 12 28

(731) BAYER INTELLECTUAL PROPERTY
GMBH

Alfred-Nobel-Straße 10, 40789 Monheim am
Rhein, Germany

(540)



(591) Blue and light blue

(531) 26.03.04; 26.11.11; 26.13.25; 29.01.04

(511)

5 – Pharmaceutical preparations for the treatment of cancer.

(260) AM 2018 91549 A

(800) 1336230

(891) 2016 11 21

(731) TANGSHAN IMEX INDUSTRIAL CO.,
LTD.

Financial Building, Xinhua West Road,
South District, Tangshan City, Hebei
Province, China

(540)



(591) Black and white
 (531) 27.05.01
 (511)
 11 – Taps for pipes; toilet bowls; bath tubs; wash-hand basins [parts of sanitary installations]; showers; hot air bath fittings; toilet seats; urinals [sanitary fixtures]; sinks; level controlling valves in tanks.

(260) AM 2018 91550 A
 (800) 1336240
 (891) 2016 11 24
 (731) HUAWEI TECHNOLOGIES CO., LTD.
 Administration Building, Huawei Technologies Co., Ltd, Bantian, Longgang District, Shenzhen, China

(540)

vmall

(591) Black and white
 (531) 27.05.05
 (511)
 35 – Demonstration of goods; advertising; business management assistance; commercial information and advice for consumers (consumer advice shop); price comparison services; sales promotion for others; procurement services for others (purchasing goods and services for other businesses); data search in computer files for others; systemization of information into computer databases; administrative processing of purchase orders; accounting; presentation of goods on communication media, for retail purposes; auctioneering; on-line advertising on data communication network; organization of trade fairs for commercial or advertising purposes.

(260) AM 2018 91551 A
 (800) 1336261
 (891) 2016 11 21
 (731) HUAWEI TECHNOLOGIES CO., LTD.
 Administration Building Huawei Technologies Co., Ltd., Bantian, Longgang District, Shenzhen, China

(540)

HUAWEI M-Pen

(591) Black and white
 (531) 27.05.05
 (511)
 9 – Tablet computers; mobile phones; computer hardware; data processing apparatus; cell phone straps; laptop computers; sleeves for laptops; smartphones; modems; computer keyboards; computer programs (downloadable software); touch screen pens for use with smartphones; touch screen pens for use with tablet computers; touch screen pens for use with portable computers; couplers (data processing equipment); interfaces for computers; computer peripheral

devices; smartglasses; smartwatches; protective films adapted for computer screens; wearable activity trackers; covers for smartphones; cases for smartphones; protective films adapted for screens for mobile phones; selfie sticks (hand-held monopods).

(260) AM 2018 91553 A
 (800) 1336283
 (891) 2016 12 19
 (731) BAYER INTELLECTUAL PROPERTY GMBH
 Alfred-Nobel-Str. 10, 40789 Monheim am Rhein, Germany

(540)

ΚΟΠΕΑΚΑ

(591) Black and white
 (531) 28.05
 (511)
 5 – Pharmaceutical preparations.

(260) AM 2018 91557 A
 (800) 1336292
 (891) 2016 12 27
 (731) MOLINARI ITALIA S.P.A.
 Via Carlo Linneo, 8, I-00197 Roma, Italy

(540)



(591) Red and grey
 (531) 26.11.03; 26.11.07; 26.11.12; 27.05.01; 27.05.19; 29.01.12
 (511)
 33 – Alcoholic beverages (except beer); alcoholic essences; alcoholic extracts.

(260) AM 2018 91559 A
 (800) 1336343
 (891) 2016 10 12
 (731) TAPMARK
 Rue Beyaert 54, B-7500 TOURNAI, Belgium

(540)



(591) Pantone black C

(531) 26.01.01; 26.01.04; 26.03.01; 26.03.05;
26.03.23; 27.05.10; 27.05.17; 29.01.12

(511)

25 – Clothing and underwear for children and babies; ski jackets; anoraks [parkas]; after-ski boots; children's headgear; footwear and headgear for babies and infants; wind-resistant clothing; articles of clothing for theatrical use; ballet flats [flat shoes]; bandanas [neckerchiefs]; headbands [clothing]; stockings and tights; romper suits; baby bottoms; children's and infants' cloth bibs; plastic baby bibs; Bermuda shorts; blazers; overalls; blue jeans; bodysuits for babies; teddies [undergarments]; knotted caps for babies; bathing caps; shower caps; ski hats; snowboard boots; boots and shoes; half-boots; suspenders; caps; caps with visors; leather belts [clothing]; belts made from imitation leather; belts of textile [clothing]; rain hats; hats for infants, babies, toddlers and children; socks; baby booties; dance slippers; beach footwear; footwear for sports; shoes and boots for young children; short-sleeve shirts; blouses; woolen tights; ski suits; pram suits; pajamas, dressing gowns; dresses, skirts, trousers, jackets, coats, sweaters; fleece pullovers; ponchos; jumper suits.

35 – Advertising; commercial business management; commercial administration; office functions; retail [or wholesale] store services and services of a retail store on any means of communication online [the Internet], mobile, wireless or remote communication [mail order, tele-shopping] for bleaching preparations and other substances for laundry use, preparations for cleaning, polishing, grease removing and abrading, soaps, perfumery products, essential oils, cosmetics, hair lotions, dentifrices, cotton sticks and cotton wool for cosmetic use, tissues impregnated with cosmetic lotions, cosmetic kits, portable personal stereos and multimedia personal stereos, pre-recorded DVDs, DVDs, DVD players, holders and cases for compact disks and DVDs, compact disks featuring music, prerecorded musical compact disks, interactive compact disks and CD-ROMs, spectacles, cases for spectacles and sunglasses, swimming goggles, diving goggles, ski goggles, goggles for sports, spectacles for children, spectacle frames, snow goggles, precious metals and their alloys other than for dental use, jewelry, jewelry products, precious stones, timepieces, chronometric instruments, diving watches, sports watches, jewelry watches, watches, watches with a game function, watches for outdoor activities, fashion jewelry, jewelry cases [caskets], crosses [jewelry], pendants [jewelry], ornamental jewelry for the head, paper, cardboard, cardboard articles, printing products, characters [numbers and letters], printers' type, apparatus and machines for bookbinding [office equipment], bookbindings, bookbinding material, photographs [printed], printing blocks, stationery, adhesive materials for stationery, instructional or teaching material [ex-

cept apparatus], printed matter, albums, books, newspapers, comic books, magazines [periodicals], manuals, almanacs, brochures, writing or drawing books, notebooks, catalogs, calendars, lithographs, graphic representations, engravings, pictures, posters, decals, modeling paste, prospectuses, signboards of paper or cardboard, stickers [stationery articles], pencils, pens, bibs, paper towels and handkerchiefs, bibs and napkins of paper for babies, table linen of paper, color pencils, felt pens, felt marking pens, paper or plastic bags and sachets [envelopes, pouches] for packaging, backpacks, handbags, travel bags, traveling sets [leather goods], wheeled bags, suitcases, sling bags for carrying infants, wallets, purses, not of precious metal, satchels, umbrellas, bum-bags, handbags, book bags, shoulder bags, souvenir bags, school bags, bags for campers, gym bags, beach bags, sports bags, duffel bags, barrel bags, clutch bags [handbags], small purses, leather bags and wallets, rucksacks on casters, small backpacks, daypacks, hiking backpacks, fabrics, upholstery fabrics, bath linen [except clothing], namely, bath towels and toiletry gloves, bed linen, namely, sheets, pillow cases, fitted bed sheets, covers for comforters, mattress protectors, pillow and cushion protectors, bed blankets, bed covers, eiderdowns [down coverlets], curtains of textile or plastic, table linen, namely, tablecloths, table mats and napkins of fabric, oilcloth [for use as tablecloths], curtain holders of textile material, washing mitts, face towels of textile, beach towels, sleeping bags [sheeting], lap robes, traveling rugs, handkerchiefs of textile, fabric labels, banners, calicoes, flags of textile, curtains and blinds of textiles or plastic, crib canopies, quilts of textile, receiving blankets, children's towels, towels of textile featuring the logos of American football teams, vinyl place mats, individual place mats made of textile, clothing and underwear for children and babies, ski jackets, anoraks [parkas], after-ski boots, children's headgear, footwear and headgear for babies and infants, wind-resistant clothing, articles of clothing for theatrical use, ballet flats [flat shoes], bandanas [neckerchiefs], headbands [clothing], stockings and tights, romper suits, baby bottoms, children's and infants' cloth bibs, plastic baby bibs, Bermuda shorts, blazers, overalls, blue jeans, bodysuits for babies, teddies [undergarments], knot caps, bathing caps, shower caps, ski hats, snowboard boots, boots and shoes, half-boots, suspenders, caps, caps with visors, leather belts [clothing], belts made from imitation leather, belts of textile [clothing], rain hats, hats for infants, babies, toddlers and children, socks, baby booties, dance slippers, footwear for the beach, footwear for sports, shoes and boots for young children, short-sleeve shirts, blouses, woolen tights, ski suits, pram suits, pajamas, dressing gowns, dresses, skirts, trousers, jackets, coats, pullovers, fleece pullovers, ponchos, jumper suits, hair bands, barrettes [hair slides], hair ornaments, hair pins, hair nets, plaited

hair, false hair, headbands, fastenings for suspenders, sewing boxes, buckles [clothing accessories], embroidery for clothing, hair scrunchies, lace and embroidery, ribbons and braids, child restraining devices in the form of fabric harnesses for chairs, artificial Christmas garlands incorporating lights, spangles for clothing, clown wigs, games, toys, mobiles [toys], teddy bears, soft toys [toys], dolls and dolls' clothing accessories [clothing], puppets, play balls and balloons, articles for gymnastics and sports, apparatus for games, portable games with liquid crystal displays, playing cards, building games, parlor games, toy animals, apparatus for video games adapted for use with an external display or screen, pocket apparatus for electronic games designed to be used with an independent display screen or monitor, toy weapons, party favors in the form of small toys, aircraft and table football [toys], seesaws, watches as toys, puzzles [games], skipping ropes, paper party favors, Christmas tree ornaments and decorations, flying disks [toys], jokes and conjuring tricks, baby rattles, baby rattles incorporating teething rings, bendable, pop-up, ride-on, push-and-pull toys, baby toys, enabling consumers to conveniently view and purchase them; presentation on any means of communication for retail sale of household linen, table linen, bed linen, clothing, footwear, headgear, games and toys, books, magazines and periodicals, notebooks and pens; marketing activity; publication of advertising texts; dissemination of advertising material (leaflets, prospectuses, printed matter, samples); outdoor advertising; demonstration of goods; sales promotion for others; commercial information and advice for consumers (consumer advice shop); administrative processing of purchase orders; sales promotion services for others using customer loyalty schemes, loyalty scheme services involving or not involving the use of a card; organization of exhibitions and tests of sports goods for commercial or advertising purposes; classified advertising, recruitment of personnel.

(260) AM 2018 91560 A
 (800) 1336354
 (891) 2016 12 16
 (731) DR. THEISS NATURWAREN GMBH
 Michelinstr. 10, 66424 Homburg, Germany
 (540)

pharmatheiss
 cosmetics

Thermal plus

(591) Grey and blue
 (531) 26.11.02; 26.11.13; 27.05.10; 27.05.11;
 29.01.12

(511)
 3 – Bleaching preparations and other substances for laundry use; cleaning, polishing, scouring and abrasive preparations; soaps; perfumery, essential oils, cosmetics, including non-medical skin cleaning and care preparations, and hair care preparations; hair lotion; dentifrices.

5 – Pharmaceutical and veterinary preparations; medicines for human or veterinary purposes; sanitary preparations for medical purposes; dietetic foodstuffs and substances adapted for medical use; nutritional supplements; vitamin preparations, including beauty capsules.

(260) AM 2018 91561 A
 (800) 1336359
 (891) 2016 08 18
 (731) GRUPO MASSIMO DUTTI, S.A.
 Avenida de la Diputación, edificio Inditex,
 E-15142 ARTEIXO (A Coruña), Spain



(591) Black and white
 (531) 02.01.16; 02.01.23
 (511)

18 – Leather and imitation leather; animal skins; trunks and suitcases; umbrellas and parasols; walking sticks; whips, harness and saddlery; bags; travel bags; handbags; multipurpose bags; Boston bags; tote bags; envelopes [leatherware]; bags for climbers, campers and the beach; handbag frames; frames for umbrellas or parasols; alpenstocks; bags for sports; net bags for shopping; bags [envelopes, pouches] of leather, for packaging; travel cases and key cases [leatherware]; attaché cases; coin purses, not of precious metal; hat boxes of leather; sling bags for carrying infants; wheeled shopping bags; boxes of leather or leatherboard; boxes of vulcanized fiber; card cases (notecases); wallets; satchels [handbags]; school satchels; vanity cases; collars for animals; dog leashes; leather laces; umbrella covers; covers for horse-saddles; haversacks; backpacks; reins for horses; leather thread; suitcase handles; handles for walking sticks and umbrellas; whips; horse blankets; furniture coverings of leather; clothing for

animals; umbrella rings; blinkers [harness]; harness for animals; tackle for animals; harness fittings; walking-stick seats; bandoliers of leather; empty tool bags of leather; muzzles; bridles [harness]; halters; leather board; bands of leather; traveling trunks; shopping bags; straps for soldiers' equipment; harness straps; straps of leather [saddlery]; straps for skates; trimmings of leather for furniture; leather straps; leather butt hides; curried skins; fur coverings and covers for animals; stirrups; parts of rubber for stirrups; bits for animals (harness); reins; attaché cases; moleskin (imitation leather); furs; animal skins; chamois leather other than for cleaning purposes; nosebags; casings, of leather, for springs; knee-pads for horses; horse riding saddles; fastenings for saddles; straps (harnesses); valves of leather.

25 – Clothing, footwear, headgear; clothing for motorists and cyclists; bibs not of paper; headbands [clothing]; bath robes; bathing suits; bathing caps and sandals; boas [mufflers]; sports shoes and beach shoes; hoods [clothing]; shawls; belts [clothing]; money belts [clothing]; wet suits for waterskiing; neckties; corsets; girdles [corsets]; fur stoles; scarves; caps [headwear]; caps; gloves [clothing]; raincoats; girdles [underwear]; body linen [garments]; mantillas; stockings; socks; neckerchiefs; furs [clothing]; pajamas; soles for footwear; heels; veils [clothing]; suspenders; layettes [clothing]; capes; sports jerseys; mittens; ear muffs [clothing]; inner soles; cuffs; dress shields; beach wear; dressing gowns, housecoats [overall]; pockets for clothing; sock suspenders; stocking suspenders; petticoats; tights; leotards; aprons [clothing]; costumes; uniforms; visors [headwear]; wooden shoes; caps; coats; esparto shoes or sandals; non-slip devices for footwear; bath gowns (bathrobes); bath slippers; caps (headwear); blouses; teddies [undergarments]; berets; footmuffs, not electrically heated; lace boots; boots; boot uppers; studs for football boots; half-boots; fittings of metal for footwear; toe caps for footwear; heelpieces for footwear; shirts; shirt yokes; shirt fronts; T-shirts; short-sleeved tee-shirts; bodices [lingerie]; vests; jackets; fishing vests; stuff jackets; slips [undergarments]; ready-made clothing; detachable collars and collars; clothing of leather; clothing of imitation leather; shower caps; slippers; skirts; trousers; ready-made linings [parts of clothing]; top coats; gabardines [clothing]; gymnastic shoes; jerseys [clothing]; pullovers; sweaters; liveries; muffs [clothing]; footwear uppers; pocket squares [clothing]; parkas; pelerines; pelisses; leggings and tights; knitwear [clothing]; clothing for gymnastics; underwear; sandals; saris; underpants; hats; wimples [clothing]; togas; trouser straps; suits; turbans; dresses; slippers; shoes.

(260) AM 2018 91562 A

(800) 1336386

(891) 2016 12 27

(731) MOLINARI ITALIA S.P.A.

Via Carlo Linneo, 8, I-00197 Roma, Italy

(540)



(591) Red, grey, green and black

(531) 25.01.19; 26.11.08; 26.11.11; 27.05.02;

27.05.10; 29.01.14

(511)

33 – Alcoholic beverages (except beer); alcoholic essences; alcoholic extracts.

(260) AM 2018 91563 A

(800) 1336401

(891) 2016 11 21

(731) HUAWEI TECHNOLOGIES CO., LTD.

Administration Building Huawei Technologies Co., Ltd., Bantian, Longgang District, Shenzhen, China

(540)

HUAWEI Vision

(591) Black and white

(531) 27.05.17

(511)

9 – Mobile phones; wireless modems; video telephones; modems; computers; set-top boxes; household network communication terminal devices and equipments for accessing Internet, making phone calls, viewing videos and playing games; digital readers; ADSL broadband accessing terminal devices and equipments; routers; ebook devices; communication modules; Personal Digital Assistants (PDA); telephones for remote telephone conferencing; digital photo frames; intelligent control apparatus for video conference; electric batteries; battery chargers; mouse; headphones; earphones; software in communication field; microphones; tablet computers; USB modems; connectors used to connect Wide Area Network (WAN) and Local Area Network (LAN) (network communication equipment); computer hardware used to enable the subscribers to proceed with video conference in different places simultaneously; computer software used to enable the subscribers to proceed with video conference in different places simultaneously; network communication apparatus used to enable the subscribers to proceed with video conference in different places simultaneously.

(260) AM 2018 91564 A
 (800) 1336448
 (891) 2017 01 24
 (731) AUGUST STORCK KG
 Waldstraße 27, 13403 Berlin, Germany
 (540)



(591) Yellow, red, orange, green, white
 (531) 02.09.04; 04.05.02; 05.03.15; 05.07.11;
 05.07.18; 05.07.22; 08.01.24; 29.01.15
 (511)
 30 – Confectionery; chocolate; chocolate products;
 pastries; ice-cream; preparations for making the afo-
 rementioned products, included in class 30.

(260) AM 2018 91601 A
 (800) 1336671
 (891) 2016 12 22
 (731) MUSTAFA NEVZAT İLAÇ SANAYİİ
 ANONİM ŞİRKETİ
 Pak İş Merkezi, Prof.Dr.Bülent Tarcan Sokak
 No:5/L, Gayrettepe TR-34349 İSTANBUL,
 Turkey
 (540)

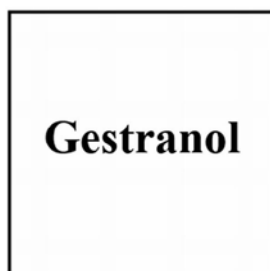

(591) Black, white
 (531) 26.04.01; 26.04.22; 27.05.17
 (511)
 5 – Pharmaceuticals.

(260) AM 2018 91602 A
 (800) 1336677
 (891) 2016 12 22
 (731) MUSTAFA NEVZAT İLAÇ SANAYİİ
 ANONİM ŞİRKETİ
 Pak İş Merkezi, Prof.Dr.Bülent Tarcan Sokak
 No:5/L, Gayrettepe TR-34349 İSTANBUL,
 Turkey

(540)
Claribact

(511)
 5 – Pharmaceuticals.

(260) AM 2018 91758 A
 (800) 1338919
 (891) 2016 11 23
 (731) HUAWEI TECHNOLOGIES CO., LTD
 Administration Building, Huawei Technolo-
 gies Co., Ltd, Bantian, Longgang District,
 Shenzhen, China
 (540)



(591) grey, Black and white
 (531) 03.07.04; 05.03.16; 05.05.20; 10.03.07;
 27.05.17

(511)
 35 – Provision of an on-line marketplace for buyers
 and sellers of goods and services; updating and ma-
 intenance of data in computer databases; rental of
 billboards (advertising boards); outsourced adminis-
 trative management for companies.

36 – Credit sales of communication equipment (fi-
 nancial leasing); providing financial information via
 a web site; electronic funds transfer; online banking;
 financing services; insurance brokerage; insurance
 information.

38 – Providing online forums; streaming of data;
 transmission of digital files; transmission of greeting
 cards online; wire service; news agency services; te-
 leconferencing services; electronic mail service;
 rental of telephones.

39 – Transport; transportation information; transpo-
 rtation logistics; transport services for sightseeing
 tours; car rental; car parking; physical storage of
 electronically stored data or documents; escorting of
 travelers; arranging of travel tours; booking of seats
 for travel; travel reservation; providing driving di-
 rections for travel purposes.

41 – Correspondence courses; educational services;
 training services; teaching; instruction services; edu-
 cation information; educational examination; practi-
 cal training (demonstration); coaching (training); ar-
 ranging and conducting of colloquiums; arranging
 and conducting of conferences; arranging and con-
 ducting of workshops (training); publication of texts,

other than publicity texts; publication of books; providing on-line electronic publications, not downloadable; on-line publication of electronic books and journals; cinema presentations; arranging and conducting of concerts; organization of shows (impresario services); providing on-line music, not downloadable; entertainer services; providing on-line videos, not downloadable; television entertainment; game services provided on-line from a computer network; entertainment services; entertainment information; organization of lotteries.

42 – Technological consultancy; telecommunications technology consultancy; computer technology consultancy; outsource service providers in the field of information technology; software as a service (SaaS); information technology (IT) consultancy; off-site data backup; electronic data storage; cloud computing; digitization of documents (scanning); consultancy in the design and development of computer hardware.

43 – Cafe service; canteen services; hotel reservations; holiday camp services (lodging); providing campground facilities; accommodation bureau services (hotels, boarding houses); bar services; boarding house services; rental of temporary accommodation; tea house; tourist home services; catering services; cafeteria services; rental of meeting rooms; retirement home services.

(260) AM 2018 91825 A

(800) 1339634

(891) 2016 10 28

(731) Closed joint-stock Company "DOMINANTASERVIS"

Komsomolskaya str., 1, Podolsk RU-142100

Moscow Region, Russian Federation

(540)

КРЯ КРЯ

(511)

3 – Laundry preparations; laundry bleach; cleaning, polishing, degreasing and abrasive preparations; cream soaps; soaps in gel form; shower gels; perfumery; essential oils; cosmetics; body oils for cosmetic purposes; body milk for cosmetic purposes; gels for cleaning hands; liquid talcum powder for toilet use; bath foam; tissues impregnated with cosmetic lotions; detergents other than for use in manufacturing operations and for medical purposes; lotions and gels for cosmetic purposes; hair sprays; hair gels; hair lotions; dentifrices; toilet water; deodorants for human beings; cosmetic pencils; cosmetic kits; hair dyes; cosmetic creams; nail polish; lotions for cosmetic purposes; almond oil; rose oil; almond soap; antibacterial soap; lipsticks; shaving preparations; toiletries; mouth washes, not for medical purposes; bleaching preparations [decolorants]

for cosmetic purposes; fabric softeners for laundry use; mascara for eyelashes; shampoos; shampoos for pets; medicated toothpaste.

5 – Pharmaceutical preparations and veterinary preparations; sanitary preparations for medical purposes; dietetic substances adapted for medical use, food for babies; plasters, materials for dressings; material for dental fillings and dental impressions; disinfectants; preparations for destroying noxious animals; fungicides; herbicides; amino acids for veterinary purposes; nutritional supplements for medical purposes, including, nutritional supplements based on protein or fat with vitamins and fatty acids and also nutritional supplements based on carbohydrates or vitamins; candy, medicated; lotions for veterinary, pharmaceutical purposes; medicinal oils; biologically active preparations for medical purposes; vitamin preparations in the form of granules, powders, emulsions, pills, candy, drops, juices or capsules; pharmaceutical preparations for skin care; repellent creams.

(260) AM 2018 91826 A

(800) 1339635

(891) 2016 10 28

(731) Closed joint-stock Company "DOMINANTASERVIS"

Komsomolskaya str., 1, Podolsk, RU-142100

Moscow Region, Russian Federation

(540)

КАРО

(591) Black, white

(531) 28.05

(511)

3 – Laundry preparations; laundry bleach; cleaning, polishing, degreasing and abrasive preparations; cream soaps; soaps in gel form; shower gels; perfumery; essential oils; cosmetics; body oils for cosmetic purposes; body milk for cosmetic purposes; gels for cleaning hands; liquid talcum powder for toilet use; bath foam; tissues impregnated with cosmetic lotions; detergents other than for use in manufacturing operations and for medical purposes; lotions and gels for cosmetic purposes; hair sprays; hair gels; hair lotions; dentifrices; toilet water; deodorants for human beings; cosmetic pencils; cosmetic kits; hair dyes; cosmetic creams; nail polish; lotions for cosmetic purposes; almond oil; rose oil; almond soap; antibacterial soap; lipsticks; shaving preparations; toiletries; mouth washes, not for medical purposes; bleaching preparations [decolorants] for cosmetic purposes; fabric softeners for laundry use; mascara for eyelashes; shampoos; shampoos for pets; medicated toothpaste.

5 – Pharmaceutical preparations and veterinary preparations; sanitary preparations for medical purposes; dietetic substances adapted for medical use, food for babies; plasters, materials for dressings; material for dental fillings and dental impressions; disinfectants; preparations for destroying noxious animals; fungicides; herbicides; amino acids for veterinary purposes; nutritional supplements for medical purposes, including, nutritional supplements based on protein or fat with vitamins and fatty acids and also nutritional supplements based on carbohydrates or vitamins; candy, medicated; lotions for veterinary, pharmaceutical purposes; medicinal oils; biologically active preparations for medical purposes; vitamin preparations in the form of granules, powders, emulsions, pills, candy, drops, juices or capsules; pharmaceutical preparations for skin care; repellent creams.

(260) AM 2018 91828 A

(800) 1339679

(891) 2016 11 23

(731) HUAWEI TECHNOLOGIES CO., LTD.

Administration Building, Huawei Technologies Co., Ltd., Bantian, Longgang District, Shenzhen, China

(540)

HUAWEI B9

(591) Black, white

(531) 27.05.05; 27.07.01

(511)

9 – Mobile phones, smartphones, cellular phones, smartglasses, smartwatches; wearable activity trackers; tablet computers; selfie sticks (hand-held monopods); holograms; connected bracelets (measuring instruments); protective films adapted for computer screens; protective films adapted for screens for mobile phones; covers for smartphones; cases for smartphones; smart cards (integrated circuit cards); integrated circuit cards (smart cards); laptop computers; network communication equipment; computer memories; audio and video receivers; portable media players; computers; notebook computers; computer hardware; modems; measuring instruments; video recorders; camcorders; cameras (photography); mobile power source (rechargeable batteries); electric batteries; loudspeakers; cabinets for loudspeakers; switchboards, electric switching apparatus; headphones; earphones; magnetic encoded identification bracelets; personal stereos.

(260) AM 2018 91829 A

(800) 1339682

(891) 2016 12 02

(731) VALIO LTD

Meijeritie 6, FI-00370 Helsinki, Finland

(540)



(591) Yellow and brown

(531) 07.01.08; 25.01.01; 26.02.09; 26.04.06; 26.07.11; 27.05.03; 29.01.12

(511)

5 – Dietetic food preparations adapted for medical use; nutritional supplements; dietary supplements; dietary fiber; lactic acid bacteria and lactobacillus; food for babies; substitutes for mother's milk.

29 – Meat, fish, poultry and game; meat extracts; preserved, frozen, dried and cooked fruits and vegetables; jellies, jams, compotes; eggs; milk and milk products; cheese; cheese spreads; smetana [sour cream]; prostokvasha [soured milk]; whey; milk powders, dried whey products and whey powders, yogurt; yogurt drinks; drinks made from dairy products; drinking yogurts; whiteners [dairy] for beverages; double cream; milk ferments for culinary purposes; peanut milk for culinary purposes; beverages made from or containing milk; butter; dairy substitutes; oils and fats; lactic acid bacteria drinks; fruit purees, vegetable purees; soups; prepared meals and snacks containing any of the aforesaid goods.

30 – Coffee, tea, cocoa and artificial coffee; rice; tapioca and sago; flour and preparations made from cereals; bread, pastry and confectionery; ices; sugar, honey, treacle; yeast, baking-powder; salt; mustard; vinegar, sauces (condiments); spices; ice; cheese sauce; snacks made from cereals, honey, cocoa, chocolate or coffee; protein cereal bars and protein chocolate bars; hamburgers, pizzas, bread, porridge, gruel, drinks made from cocoa, coffee beverages with milk, frozen yoghurt.

32 – Mineral and aerated waters and other non-alcoholic drinks; preparations for making beverages; fruit drinks and fruit juices; syrups and other preparations for making beverages; smoothies; non-alcoholic beverages.

(260) AM 2018 91892 A

(800) 1339796

(891) 2016 11 23

(731) HUAWEI TECHNOLOGIES CO., LTD.

Administration Building Huawei Technologies Co., Ltd., Bantian, Longgang District Shenzhen, China

(540)

HUAWEI C7

(591) Black and white

(531) 27.05.01

(511)

9 – Mobile phones, smartphones, cellular phones, smartglasses, smartwatches; wearable activity trackers; tablet computers; selfie sticks (hand-held monopods); holograms; connected-bracelets (measuring instruments); protective films adapted for computer screens; protective films adapted for screens for mobile phones; covers for smartphones; cases for smartphones; smart cards (integrated circuit cards); integrated circuit cards (smart cards); laptop computers; network communication equipment; computer memories; audio and video receivers; portable media players; computers; notebook computers; computer hardware; modems; measuring instruments; video recorders; camcorders; cameras (photography); mobile power source (rechargeable batteries); electric batteries; loudspeakers; cabinets for loudspeakers; switchboards, electric switching apparatus; headphones; earphones; magnetic encoded identification bracelets; personal stereos.

(260) AM 2018 92006 A

(800) 1341528

(891) 2017 01 03

(731) CHANGZHOU TRINA SOLAR ENERGY CO., LTD

No.2 Trina Road, Trina PV Park, Xinbei District, Changzhou 213031 Jiangsu, China

(540)

The logo for Trinapeak features the word "Trinapeak" in a bold, sans-serif font. The letter "i" in "Trina" has a small black dot above it, and the letter "a" in "peak" has a small black triangle above it, resembling a mountain peak.

(591) Black, white

(531) 27.05.07; 27.05.08; 27.05.10

(511)

9 – Batteries, electric; single crystal silicon wafers; polysilicon wafers; solar batteries; junction boxes [electricity]; accumulators, electric; chargers for electric batteries; converters, electric; inverters [electricity]; wafers for integrated circuits; semi-conductors; battery jars/accumulator jars; photovoltaic cells; battery boxes/accumulator boxes; distribution boxes [electricity]; solar panels for the production of electricity.

(260) AM 2018 92008 A

(800) 1341531

(891) 2016 11 23

(731) HUAWEI TECHNOLOGIES CO., LTD.

Administration Building Huawei Technologies Co., Ltd., Bantian, Longgang District Shenzhen, China

(540)

The logo for HUAWEI GOWO features the words "HUAWEI GOWO" in a bold, sans-serif font.

(591) Black, white

(531) 27.05.01

(511)

9 – Mobile phones; smartphones; smartglasses; smart watches; wearable activity trackers; tablet computers; selfie sticks (hand-held monopods); holograms; connected bracelets (measuring instruments); protective films adapted for computer screens; covers for smartphones; cases for smartphones; network communication equipment; computer memories; audio and video receivers; portable media players; computers; notebook computers; computer hardware; modems; measuring instruments; video recorders; camcorders; protective films adapted for screens for mobile phones; mobile power source (rechargeable batteries); electric batteries; loudspeakers; cabinets for loudspeakers; switchboards, electric switching apparatus; headphones; earphones; magnetic encoded identification bracelets; personal stereos

(260) AM 2018 92009 A

(800) 1341532

(891) 2016 11 23

(731) HUAWEI TECHNOLOGIES CO., LTD.

Administration Building Huawei Technologies Co., Ltd., Bantian, Longgang District Shenzhen, China

(540)

The logo for HUAWEI C8 features the words "HUAWEI C8" in a bold, sans-serif font.

(591) Black, white

(531) 27.05.01; 27.07.01

(511)

9 – Mobile phones; smartphones; cellular phones; smartglasses; smartwatches; wearable activity trackers; tablet computers; selfie sticks (hand-held monopods); holograms; connected bracelets (measuring instruments); protective films adapted for computer screens; protective films adapted for screens for mobile phones; covers for smartphones; cases for smartphones; smart cards (integrated circuit cards); integrated circuit cards (smart cards); laptop computers; network communication equipment; computer memories; audio and video receivers; portable media players; computers; notebook computers; computer hardware; modems; measuring instruments; video recorders; camcorders; cameras (photography); mobile power source (rechargeable batteries); electric batteries; loudspeakers; cabinets for loudspeakers; switchboards, electric switching apparatus; headphones; earphones; magnetic encoded identification bracelets; personal stereos.

(260) AM 2018 92090 A

(800) 1209032

(891) 2017 01 11

(731) SICHUAN TYRE & RUBBER CO., LTD.
Yangma Town, Jianyang City, Sichuan, China

(540)

(591) Black, white
(531) 26.02.01; 26.02.07; 26.11.12; 27.05.17
(511)

12 – Tires for vehicle wheels; vehicle wheel tires (tyres); automobile tires (tyres); tyres for bicycles, cycles; casings for pneumatic tires (tyres); pneumatic tires (tyres); inner tubes for pneumatic tires (tyres); bicycle tires (tyres); airplane tyres; repair outfits for inner tubes.

(260) AM 2018 92091 A

(800) 1296609
(891) 2017 01 12

(731) ZHEJIANG YANXUE COSMETIC CO., LTD.
No.1329, Yinhai Road, Yidong Industrial Park, Yiwu City 322000 Zhejiang Province, China

(540)

(591) Black, white
(531) 27.05.17
(511)

3 – Cleansing milk; hair lotions; dry-cleaning preparations; abrasive pastes; eyebrow pencils; skin whitening creams; perfumes; cosmetics; cosmetics for animals; air fragrancing preparations.

(260) AM 2018 92092 A

(800) 1325740
(891) 2017 02 20

(731) PHILIP MORRIS PRODUCTS S.A.
Quai Jeanrenaud 3, CH-2000 Neuchâtel, Switzerland

(540)

(591) Black, white
(511)

34 – Tobacco, raw or manufactured; tobacco products; cigars, cigarettes, cigarillos, tobacco for roll-your-own cigarettes, pipe tobacco, chewing tobacco, snuff tobacco, kretek; snus; tobacco substitutes (not for medical purposes); electronic cigarettes; tobacco products for the purpose of being heated; electronic devices and their parts for the purpose of heating cigarettes or tobacco in order to release nicotine-

containing aerosol for inhalation; liquid nicotine solutions for use in electronic cigarettes; smokers' articles, cigarette paper, cigarette tubes, cigarette filters, tobacco tins, cigarette cases, ashtrays, pipes, pocket apparatus for rolling cigarettes, lighters, matches.

41 – Education; training; entertainment; sporting and cultural activities.

(260) AM 2018 92095 A

(800) 1341684
(891) 2016 11 15

(731) NIO CO., LTD.
Suite 115, 569 Anchi Road, Anting Town, Jiading District 201805 Shanghai, China

(540)



(591) Black, white
(531) 26.02.03; 26.02.07; 26.02.09; 26.03.23
(511)

7 – Metalworking machines; guards [parts of machines]; starters for motors and engines; taps [parts of machines, engines or motors].

9 – Computer programs [downloadable software]; vehicle breakdown warning triangles; navigation apparatus for vehicles [on-board computers]; anti-dazzle shades; theft prevention installations, electric; batteries, electric, for vehicles.

12 – Engines for land vehicles; sports cars; cars; tires for vehicle wheels; steering wheels for vehicles; driverless cars [autonomous cars]; motorcycles.

14 – Medals; tie clips; statues of precious metal; cuff links; tie pins; key rings [trinkets or fobs]; wrist-watches; watch chains; badges of precious metal.

25 – Trousers; outerclothing; motorists' clothing; waterproof clothing; shoes; headgear for wear; hosiery; gloves [clothing]; girdles; neckties.

35 – On-line advertising on a computer network; presentation of goods on communication media, for retail purposes; production of advertising films; providing business information via a web site; organization of trade fairs for commercial or advertising purposes, import export agencies, sales promotion for others; business management of sports people.

36 – Insurance consultancy; insurance brokerage; loans [financing]; financing services; land vehicle credit sale (financing lease); capital investment.

37 – Motor vehicle maintenance and repair; anti-rust treatment for vehicles; vehicle service stations [refuelling and maintenance]; vehicle breakdown assistance [repair]; vehicle battery charging; vehicle wash.

42 – Technical project studies; vehicle roadworthiness testing; cartography services.

INTERNATIONAL TRADEMARKS PROTECTED IN GEORGIA

(260) AM 2018 85805 A
(800) 1283487
(151) 2015 10 16
(181) 2025 10 16
(891) 2015 10 16
(511) 30

(260) AM 2018 86197 A
(800) 1287503
(151) 2015 12 03
(181) 2025 12 03
(891) 2015 12 03
(511) 24

(260) AM 2018 86949A
(800) 1294837
(151) 2015 12 01
(181) 2025 12 01
(891) 2015 12 01
(511) 09, 14, 18, 25, 35

(260) AM 2018 87203 A
(800) 839198
(151) 2004 07 19
(181) 2014 07 19
(891) 2016 02 10
(511) 41

(260) AM 2018 87602 A
(800) 1128094
(151) 2012 07 03
(181) 2022 07 03
(891) 2016 01 15
(511) 09

(260) AM 2018 87604 A
(800) 1287677
(151) 2015 11 13
(181) 2025 11 13
(891) 2016 02 09
(511) 35

(260) AM 2018 87605 A
(800) 1298925
(151) 2015 12 11
(181) 2025 12 11

(891) 2015 12 11
(511) 19

(260) AM 2018 87764 A
(800) 1113007
(151) 2012 03 05
(181) 2022 03 05
(891) 2016 03 03
(511) 03

(260) AM 2018 87837 A
(800) 1300461
(151) 2016 02 05
(181) 2026 02 05
(891) 2016 02 05
(511) 09

(260) AM 2018 88142 A
(800) 1222552
(151) 2014 10 13
(181) 2024 10 13
(891) 2016 04 13
(511) 18

(260) AM 2018 88148A
(800) 1303762
(151) 2016 03 14
(181) 2026 03 14
(891) 2016 03 14
(511) 03

(260) AM 2018 88151 A
(800) 1303865
(151) 2016 05 02
(181) 2026 05 02
(891) 2016 05 02
(511) 03

(260) AM 2018 88265 A
(800) 1305151
(151) 2016 06 01
(181) 2026 06 01
(891) 2016 06 01
(511) 36

(260) AM 2018 88281 A
(800) 1304887
(151) 2016 03 25
(181) 2026 03 25
(891) 2016 03 25
(511) 03, 35

(260) AM 2018 88444 A
(800) 1306672
(151) 2016 04 12
(181) 2026 04 12
(891) 2016 04 12
(511) 36, 39

(260) AM 2018 88594 A
(800) 1307962
(151) 2016 05 31
(181) 2026 05 31
(891) 2016 05 31
(511) 03

(260) AM 2018 88666 A
(800) 1309193
(151) 2016 03 01
(181) 2026 03 01
(891) 2016 03 01
(511) 11

(260) AM 2018 88832 A
(800) 1310930
(151) 2016 02 25
(181) 2026 02 25
(891) 2016 02 25
(511) 16, 28

(260) AM 2018 88871 A
(800) 1311343
(151) 2016 05 18
(181) 2026 05 18
(891) 2016 05 18
(511) 05

(260) AM 2018 88878 A
(800) 1311509
(151) 2016 04 15
(181) 2026 04 15
(891) 2016 04 15
(511) 03

(260) AM 2018 88920 A
(800) 1312942
(151) 2016 07 26
(181) 2026 07 26

(891) 2016 07 26
(511) 01, 05

(260) AM 2018 88921 A
(800) 1313031
(151) 2016 05 16
(181) 2026 05 16
(891) 2016 05 16
(511) 29, 30

(260) AM 2018 89029 A
(800) 1314113
(151) 2016 03 02
(181) 2026 03 02
(891) 2016 03 02
(511) 08, 11, 20, 21, 35, 44

(260) AM 2018 89052 A
(800) 1313219
(151) 2016 04 20
(181) 2026 04 20
(891) 2016 04 20
(511) 33

(260) AM 2018 89055 A
(800) 1313249
(151) 2016 06 14
(181) 2026 06 14
(891) 2016 06 14
(511) 33

(260) AM 2018 89056 A
(800) 1313362
(151) 2016 07 28
(181) 2026 07 28
(891) 2016 07 28
(511) 05

(260) AM 2018 89061 A
(800) 1313442
(151) 2016 06 08
(181) 2026 06 08
(891) 2016 06 08
(511) 07

(260) AM 2018 89063 A
(800) 1313550
(151) 2016 02 23
(181) 2026 02 23
(891) 2016 02 23
(511) 29

(260) AM 2018 89064 A
(800) 1313580
(151) 2016 04 29
(181) 2026 04 29
(891) 2016 04 29
(511) 09, 16, 25, 28, 35, 38, 41, 42

(260) AM 2018 89065 A
(800) 1313651
(151) 2016 05 25
(181) 2026 05 25
(891) 2016 05 25
(511) 32, 33

(260) AM 2018 89066 A
(800) 1313700
(151) 2016 07 21
(181) 2026 07 21
(891) 2016 07 21
(511) 06

(260) AM 2018 89071 A
(800) 1313729
(151) 2016 07 14
(181) 2026 07 14
(891) 2016 07 14
(511) 07

(260) AM 2018 89072 A
(800) 1313736
(151) 2016 08 11
(181) 2026 08 11
(891) 2016 08 11
(511) 09

(260) AM 2018 89074 A
(800) 1313757
(151) 2016 08 22
(181) 2026 08 22
(891) 2016 08 22
(511) 09

(260) AM 2018 89075 A
(800) 1313824
(151) 2016 06 08
(181) 2026 06 08
(891) 2016 06 08
(511) 03

(260) AM 2018 89080 A
(800) 1313860
(151) 2016 03 16
(181) 2026 03 16

(891) 2016 03 16
(511) 03

(260) AM 2018 89081 A
(800) 1313878
(151) 2016 04 14
(181) 2026 04 14
(891) 2016 04 14
(511) 25, 35

(260) AM 2018 89082 A
(800) 1313885
(151) 2016 04 20
(181) 2026 04 20
(891) 2016 04 20
(511) 35

(260) AM 2018 89083 A
(800) 1313902
(151) 2016 04 13
(181) 2026 04 13
(891) 2016 04 13
(511) 03

(260) AM 2018 89084 A
(800) 1313920
(151) 2016 07 05
(181) 2026 07 05
(891) 2016 07 05
(511) 09

(260) AM 2018 89106 A
(800) 1315043
(151) 2016 06 10
(181) 2026 06 10
(891) 2016 06 10
(511) 03

(260) AM 2018 89107 A
(800) 1315074
(151) 2016 04 27
(181) 2026 04 27
(891) 2016 04 27
(511) 01, 05, 44

(260) AM 2018 89248 A
(800) 211614
(151) 1958 07 25
(181) 1968 07 25
(891) 2016 08 01
(511) 01, 04

(260) AM 2018 89267 A
(800) 1315435
(151) 2016 07 06
(181) 2026 07 06
(891) 2016 07 06
(511) 02

(260) AM 2018 89353 A
(800) 1317459
(151) 2016 07 12
(181) 2026 07 12
(891) 2016 07 12
(511) 03

(260) AM 2018 89355 A
(800) 1317507
(151) 2016 08 04
(181) 2026 08 04
(891) 2016 08 04
(511) 41

(260) AM 2018 89357 A
(800) 1316650
(151) 2016 02 02
(181) 2026 02 02
(891) 2016 02 02
(511) 19

(260) AM 2018 89358 A
(800) 1316663
(151) 2016 03 23
(181) 2026 03 23
(891) 2016 03 23
(511) 03

(260) AM 2018 89365 A
(800) 1316695
(151) 2016 05 07
(181) 2026 05 07
(891) 2016 05 07
(511) 07, 12, 35

(260) AM 2018 89369 A
(800) 1316756
(151) 2016 08 23
(181) 2026 08 23
(891) 2016 08 23
(511) 03

(260) AM 2018 89373 A
(800) 1316771
(151) 2016 09 11
(181) 2026 09 11

(891) 2016 09 11
(511) 09

(260) AM 2018 89378 A
(800) 1316802
(151) 2015 12 31
(181) 2025 12 31
(891) 2015 12 31
(511) 07

(260) AM 2018 89382 A
(800) 1317531
(151) 2016 08 01
(181) 2026 08 01
(891) 2016 08 01
(511) 33

(260) AM 2018 89390 A
(800) 1316810
(151) 2015 06 22
(181) 2025 06 22
(891) 2015 06 22
(511) 01, 06, 07, 12, 19, 40, 42

(260) AM 2018 89392 A
(800) 1316811
(151) 2016 05 05
(181) 2026 05 05
(891) 2016 05 05
(511) 05

(260) AM 2018 89394 A
(800) 1316836
(151) 2015 12 14
(181) 2025 12 14
(891) 2015 12 14
(511) 35, 36, 42, 45

(260) AM 2018 89395 A
(800) 1317576
(151) 2016 09 08
(181) 2026 09 08
(891) 2016 09 08
(511) 05

(260) AM 2018 89396 A
(800) 1316875
(151) 2016 04 29
(181) 2026 04 29
(891) 2016 04 29
(511) 02

(260) AM 2018 89397 A
(800) 1084535
(151) 2011 07 14
(181) 2021 07 14
(891) 2016 09 08
(511) 07, 08, 11, 21, 35

(260) AM 2018 89398 A
(800) 1272017
(151) 2015 05 15
(181) 2025 05 15
(891) 2016 09 29
(511) 07, 09

(260) AM 2018 89399 A
(800) 1316897
(151) 2016 04 10
(181) 2026 04 10
(891) 2016 04 10
(511) 12

(260) AM 2018 89401 A
(800) 1316912
(151) 2016 06 20
(181) 2026 06 20
(891) 2016 06 20
(511) 25

(260) AM 2018 89402 A
(800) 1316940
(151) 2016 07 14
(181) 2026 07 14
(891) 2016 07 14
(511) 41

(260) AM 2018 89408 A
(800) 1316975
(151) 2016 07 19
(181) 2026 07 19
(891) 2016 07 19
(511) 05

(260) AM 2018 89409 A
(800) 1316976
(151) 2016 07 19
(181) 2026 07 19
(891) 2016 07 19
(511) 05

(260) AM 2018 89410 A
(800) 1316987
(151) 2016 08 12
(181) 2026 08 12

(891) 2016 08 12
(511) 07, 11, 30

(260) AM 2018 89412 A
(800) 1317005
(151) 2015 12 31
(181) 2025 12 31
(891) 2015 12 31
(511) 05

(260) AM 2018 89413 A
(800) 1317009
(151) 2016 04 10
(181) 2026 04 10
(891) 2016 04 10
(511) 12

(260) AM 2018 89415 A
(800) 1317087
(151) 2016 05 09
(181) 2026 05 09
(891) 2016 05 09
(511) 09

(260) AM 2018 89416 A
(800) 1317091
(151) 2016 04 29
(181) 2026 04 29
(891) 2016 04 29
(511) 05

(260) AM 2018 89418 A
(800) 1317122
(151) 2016 06 24
(181) 2026 06 24
(891) 2016 06 24
(511) 31

(260) AM 2018 89419 A
(800) 1317144
(151) 2016 02 03
(181) 2026 02 03
(891) 2016 02 03
(511) 05

(260) AM 2018 89420 A
(800) 1317145
(151) 2016 02 03
(181) 2026 02 03
(891) 2016 02 03
(511) 05

(260) AM 2018 89433 A
(800) 1318494
(151) 2016 06 14
(181) 2026 06 14
(891) 2016 06 14
(511) 30

(260) AM 2018 89434 A
(800) 1318128
(151) 2016 07 13
(181) 2026 07 13
(891) 2016 07 13
(511) 05, 10

(260) AM 2018 89436 A
(800) 1318160
(151) 2015 12 07
(181) 2025 12 07
(891) 2015 12 07
(511) 06, 16, 20, 21

(260) AM 2018 89438 A
(800) 1318220
(151) 2016 03 29
(181) 2026 03 29
(891) 2016 03 29
(511) 09, 16, 25, 35, 38, 41

(260) AM 2018 89439 A
(800) 1318246
(151) 2016 04 18
(181) 2026 04 18
(891) 2016 04 18
(511) 38, 41

(260) AM 2018 89440 A
(800) 1318267
(151) 2016 05 10
(181) 2026 05 10
(891) 2016 05 10
(511) 25

(260) AM 2018 89442 A
(800) 1318285
(151) 2016 06 16
(181) 2026 06 16
(891) 2016 06 16
(511) 05

(260) AM 2018 89446 A
(800) 1318531
(151) 2016 08 01
(181) 2026 08 01

(891) 2016 08 01
(511) 30, 35

(260) AM 2018 89447 A
(800) 1318533
(151) 2016 07 27
(181) 2026 07 27
(891) 2016 07 27
(511) 05

(260) AM 2018 89448 A
(800) 1318558
(151) 2016 08 23
(181) 2026 08 23
(891) 2016 08 23
(511) 12

(260) AM 2018 89449 A
(800) 260978
(151) 1962 10 17
(181) 1972 10 17
(891) 2016 07 27
(511) 29, 30

(260) AM 2018 89450 A
(800) 419256
(151) 1975 11 04
(181) 1985 11 04
(891) 2016 01 29
(511) 29

(260) AM 2018 89451 A
(800) 498622
(151) 1985 11 23
(181) 1995 11 23
(891) 2016 10 26
(511) 05

(260) AM 2018 89452 A
(800) 582886
(151) 1991 07 22
(181) 2001 07 22
(891) 2016 02 23
(511) 03

(260) AM 2018 89459 A
(800) 827439
(151) 2004 05 07
(181) 2014 05 07
(891) 2016 10 24
(511) 05

(260) AM 2018 89460 A
(800) 964123
(151) 2008 04 29
(181) 2018 04 29
(891) 2016 10 26
(511) 05

(260) AM 2018 89461 A
(800) 984101
(151) 2008 07 22
(181) 2018 07 22
(891) 2016 04 24
(511) 41, 43

(260) AM 2018 89462 A
(800) 1001999
(151) 2009 04 27
(181) 2019 04 27
(891) 2016 08 26
(511) 05

(260) AM 2018 89463 A
(800) 1317601
(151) 2016 01 28
(181) 2026 01 28
(891) 2016 01 28
(511) 35, 36

(260) AM 2018 89465 A
(800) 1317632
(151) 2016 03 11
(181) 2026 03 11
(891) 2016 03 11
(511) 01, 11, 19, 20, 35

(260) AM 2018 89466 A
(800) 1318361
(151) 2015 11 27
(181) 2025 11 27
(891) 2015 11 27
(511) 41

(260) AM 2018 89467 A
(800) 1317634
(151) 2016 04 21
(181) 2026 04 21
(891) 2016 04 21
(511) 32

(260) AM 2018 89468 A
(800) 1318365
(151) 2015 11 09
(181) 2025 11 09

(891) 2015 11 09
(511) 29

(260) AM 2018 89469 A
(800) 1317666
(151) 2016 05 16
(181) 2026 05 16
(891) 2016 05 16
(511) 07, 09, 11

(260) AM 2018 89470 A
(800) 1317689
(151) 2016 05 23
(181) 2026 05 23
(891) 2016 05 23
(511) 30, 35

(260) AM 2018 89471 A
(800) 1318381
(151) 2016 02 09
(181) 2026 02 09
(891) 2016 02 09
(511) 08, 11

(260) AM 2018 89473 A
(800) 1317732
(151) 2016 08 19
(181) 2026 08 19
(891) 2016 08 19
(511) 07, 09, 12

(260) AM 2018 89474 A
(800) 1317753
(151) 2016 08 18
(181) 2026 08 18
(891) 2016 08 18
(511) 05

(260) AM 2018 89475 A
(800) 1318399
(151) 2016 03 10
(181) 2026 03 10
(891) 2016 03 10
(511) 09, 28

(260) AM 2018 89476 A
(800) 1317759
(151) 2016 08 29
(181) 2026 08 29
(891) 2016 08 29
(511) 05

(260) AM 2018 89478 A
(800) 1318410
(151) 2016 05 03
(181) 2026 05 03
(891) 2016 05 03
(511) 05

(260) AM 2018 89481 A
(800) 1318411
(151) 2016 05 03
(181) 2026 05 03
(891) 2016 05 03
(511) 05

(260) AM 2018 89482 A
(800) 1317782
(151) 2016 09 09
(181) 2026 09 09
(891) 2016 09 09
(511) 05

(260) AM 2018 89483 A
(800) 1318412
(151) 2016 05 03
(181) 2026 05 03
(891) 2016 05 03
(511) 05

(260) AM 2018 89484 A
(800) 1317854
(151) 2016 04 28
(181) 2026 04 28
(891) 2016 04 28
(511) 35, 44

(260) AM 2018 89485 A
(800) 1318438
(151) 2016 05 19
(181) 2026 05 19
(891) 2016 05 19
(511) 34

(260) AM 2018 89486 A
(800) 1318463
(151) 2016 06 17
(181) 2026 06 17
(891) 2016 06 17
(511) 36

(260) AM 2018 89487 A
(800) 1318473
(151) 2016 05 07
(181) 2026 05 07

(891) 2016 05 07
(511) 12

(260) AM 2018 89488 A
(800) 1318474
(151) 2016 05 07
(181) 2026 05 07
(891) 2016 05 07
(511) 12, 37

(260) AM 2018 89490 A
(800) 1318478
(151) 2016 05 24
(181) 2026 05 24
(891) 2016 05 24
(511) 39

(260) AM 2018 89491 A
(800) 1009149
(151) 2009 05 29
(181) 2019 05 29
(891) 2016 10 26
(511) 05

(260) AM 2018 89492 A
(800) 1059714
(151) 2010 11 23
(181) 2020 11 23
(891) 2016 10 25
(511) 01, 19

(260) AM 2018 89493 A
(800) 1205643
(151) 2014 04 23
(181) 2024 04 23
(891) 2016 10 26
(511) 05

(260) AM 2018 89494 A
(800) 1223490
(151) 2014 08 26
(181) 2024 08 26
(891) 2016 06 29
(511) 11

(260) AM 2018 89495 A
(800) 1225340
(151) 2014 08 26
(181) 2024 08 26
(891) 2016 06 29
(511) 11

(260) AM 2018 89496 A
(800) 1240945
(151) 2015 02 25
(181) 2025 02 25
(891) 2016 10 25
(511) 17, 19

(260) AM 2018 89497 A
(800) 1246028
(151) 2015 01 23
(181) 2025 01 23
(891) 2016 06 01
(511) 05, 10

(260) AM 2018 89498 A
(800) 1252556
(151) 2015 04 24
(181) 2025 04 24
(891) 2016 10 27
(511) 05

(260) AM 2018 89500 A
(800) 1317875
(151) 2016 04 10
(181) 2026 04 10
(891) 2016 04 10
(511) 02

(260) AM 2018 89501 A
(800) 1317903
(151) 2016 06 14
(181) 2026 06 14
(891) 2016 06 14
(511) 05, 10

(260) AM 2018 89502 A
(800) 1317912
(151) 2016 07 27
(181) 2026 07 27
(891) 2016 07 27
(511) 05

(260) AM 2018 89503 A
(800) 1317919
(151) 2016 07 08
(181) 2026 07 08
(891) 2016 07 08
(511) 03

(260) AM 2018 89504 A
(800) 1317951
(151) 2016 08 30
(181) 2026 08 30

(891) 2016 08 30
(511) 03, 05

(260) AM 2018 89505 A
(800) 1317995
(151) 2016 09 06
(181) 2026 09 06
(891) 2016 09 06
(511) 08, 21

(260) AM 2018 89506 A
(800) 1317996
(151) 2016 09 02
(181) 2026 09 02
(891) 2016 09 02
(511) 03

(260) AM 2018 89508 A
(800) 1318005
(151) 2016 09 21
(181) 2026 09 21
(891) 2016 09 21
(511) 20, 24

(260) AM 2018 89509 A
(800) 1318069
(151) 2016 04 21
(181) 2026 04 21
(891) 2016 04 21
(511) 11, 17, 19, 40

(260) AM 2018 89550 A
(800) 1318602
(151) 2016 03 20
(181) 2026 03 20
(891) 2016 03 20
(511) 14

(260) AM 2018 89553 A
(800) 1319255
(151) 2016 08 18
(181) 2026 08 18
(891) 2016 08 18
(511) 05

(260) AM 2018 89565 A
(800) 1319393
(151) 2016 03 29
(181) 2026 03 29
(891) 2016 03 29
(511) 05

(260) AM 2018 89566 A
(800) 1319407
(151) 2016 03 29
(181) 2026 03 29
(891) 2016 03 29
(511) 05

(260) AM 2018 89571 A
(800) 1318681
(151) 2016 02 29
(181) 2026 02 29
(891) 2016 02 29
(511) 09, 16, 38, 41, 42

(260) AM 2018 89573 A
(800) 1318723
(151) 2016 04 07
(181) 2026 04 07
(891) 2016 04 07
(511) 21, 32, 43

(260) AM 2018 89574 A
(800) 1318724
(151) 2016 05 02
(181) 2026 05 02
(891) 2016 05 02
(511) 05, 10

(260) AM 2018 89577 A
(800) 1319431
(151) 2016 04 27
(181) 2026 04 27
(891) 2016 04 27
(511) 05

(260) AM 2018 89590 A
(800) 1318733
(151) 2016 03 14
(181) 2026 03 14
(891) 2016 03 14
(511) 03

(260) AM 2018 89594 A
(800) 1318741
(151) 2016 04 21
(181) 2026 04 21
(891) 2016 04 21
(511) 03

(260) AM 2018 89613A
(800) 1319476
(151) 2016 05 16
(181) 2026 05 16

(891) 2016 05 16
(511) 05

(260) AM 2018 89619 A
(800) 1319493
(151) 2016 06 29
(181) 2026 06 29
(891) 2016 06 29
(511) 17, 19

(260) AM 2018 89621 A
(800) 1319533
(151) 2016 04 20
(181) 2026 04 20
(891) 2016 04 20
(511) 06

(260) AM 2018 89622 A
(800) 1319628
(151) 2016 09 14
(181) 2026 09 14
(891) 2016 09 14
(511) 09, 35, 36

(260) AM 2018 89625 A
(800) 1319713
(151) 2016 10 19
(181) 2026 10 19
(891) 2016 10 19
(511) 20

(260) AM 2018 89627 A
(800) 593987
(151) 1992 06 17
(181) 2002 06 17
(891) 2016 02 23
(511) 03

(260) AM 2018 89628 A
(800) 599216
(151) 1993 03 03
(181) 2003 03 03
(891) 2016 10 31
(511) 09

(260) AM 2018 89636 A
(800) 1304875
(151) 2016 03 21
(181) 2026 03 21
(891) 2016 08 30
(511) 32

(260) AM 2018 89650 A
(800) 1318900
(151) 2016 07 19
(891) 2016 07 19
(511) 25

(260) AM 2018 89656 A
(800) 1319065
(151) 2016 07 13
(181) 2026 07 13
(891) 2016 07 13
(511) 01, 25

(260) AM 2018 89657 A
(800) 1319075
(151) 2016 07 28
(181) 2026 07 28
(891) 2016 07 28
(511) 07, 12

(260) AM 2018 89662 A
(800) 1319164
(151) 2016 03 17
(181) 2026 03 17
(891) 2016 03 17
(511) 03, 05, 10, 35

(260) AM 2018 89663 A
(800) 1319172
(151) 2016 05 27
(181) 2026 05 27
(891) 2016 05 27
(511) 03

(260) AM 2018 89664 A
(800) 1319180
(151) 2016 05 31
(181) 2026 05 31
(891) 2016 05 31
(511) 34

(260) AM 2018 89665 A
(800) 1319184
(151) 2016 06 15
(181) 2026 06 15
(891) 2016 06 15
(511) 05, 10, 42

(260) AM 2018 89666 A
(800) 1319191
(151) 2016 06 29
(181) 2026 06 29

(891) 2016 06 29
(511) 05

(260) AM 2018 89668 A
(800) 1319205
(151) 2016 06 28
(181) 2026 06 28
(891) 2016 06 28
(511) 37

(260) AM 2018 89672 A
(800) 1320418
(151) 2015 10 23
(181) 2025 10 23
(891) 2015 10 23
(511) 06

(260) AM 2018 89719 A
(800) 1320574
(151) 2016 04 22
(181) 2026 04 22
(891) 2016 04 22
(511) 29

(260) AM 2018 89720 A
(800) 1320601
(151) 2016 05 18
(181) 2026 05 18
(891) 2016 05 18
(511) 03, 09, 14, 18, 25

(260) AM 2018 89721 A
(800) 1320605
(151) 2016 05 13
(181) 2026 05 13
(891) 2016 05 13
(511) 29, 30, 31, 32

(260) AM 2018 89722 A
(800) 1320623
(151) 2016 07 15
(181) 2026 07 15
(891) 2016 07 15
(511) 04

(260) AM 2018 89723 A
(800) 1320638
(151) 2016 06 03
(181) 2026 06 03
(891) 2016 06 03
(511) 05

(260) AM 2018 89725 A
(800) 1320641
(151) 2016 07 20
(181) 2026 07 20
(891) 2016 07 20
(511) 04

(260) AM 2018 89727 A
(800) 1320642
(151) 2016 07 20
(181) 2026 07 20
(891) 2016 07 20
(511) 04

(260) AM 2018 89729 A
(800) 1320648
(151) 2016 07 15
(181) 2026 07 15
(891) 2016 07 15
(511) 05

(260) AM 2018 89731 A
(800) 1320690
(151) 2016 08 23
(181) 2026 08 23
(891) 2016 08 23
(511) 05

(260) AM 2018 89732 A
(800) 1320691
(151) 2016 08 23
(181) 2026 08 23
(891) 2016 08 23
(511) 05

(260) AM 2018 89733 A
(800) 1320692
(151) 2016 08 23
(181) 2026 08 23
(891) 2016 08 23
(511) 05

(260) AM 2018 89761 A
(800) 1319925
(151) 2016 02 01
(181) 2026 02 01
(891) 2016 02 01
(511) 42

(260) AM 2018 89803 A
(800) 1321087
(151) 2016 06 12
(181) 2026 06 12

(891) 2016 06 12
(511) 18, 24, 25, 35

(260) AM 2018 89804 A
(800) 1321728
(151) 2015 12 10
(181) 2025 12 10
(891) 2015 12 10
(511) 12, 37

(260) AM 2018 89805 A
(800) 1321102
(151) 2016 07 07
(181) 2026 07 07
(891) 2016 07 07
(511) 25

(260) AM 2018 89850 A
(800) 761260
(151) 2001 06 07
(181) 2011 06 07
(891) 2016 11 16
(511) 05, 29, 30

(260) AM 2018 90272 A
(800) 1325708
(151) 2016 08 30
(181) 2026 08 30
(891) 2016 08 30
(511) 17

(260) AM 2018 90273 A
(800) 1325717
(151) 2016 10 09
(181) 2026 10 09
(891) 2016 10 09
(511) 29

(260) AM 2018 90275 A
(800) 1325722
(151) 2016 09 23
(181) 2026 09 23
(891) 2016 09 23
(511) 33

(260) AM 2018 90278 A
(800) 1325811
(151) 2016 05 02
(181) 2026 05 02
(891) 2016 05 02
(511) 05

(260) AM 2018 90281A
(800) 1325827
(151) 2016 07 18
(181) 2026 07 18
(891) 2016 07 18
(511) 05, 10

(260) AM 2018 90283 A
(800) 1325877
(151) 2016 09 05
(181) 2026 09 05
(891) 2016 09 05
(511) 34

(260) AM 2018 90285 A
(800) 1325881
(151) 2016 09 02
(181) 2026 09 02
(891) 2016 09 02
(511) 43

(260) AM 2018 90286 A
(800) 1138267
(151) 2012 10 09
(181) 2022 10 09
(891) 2016 10 01
(511) 34

(260) AM 2018 90287 A
(800) 1325895
(151) 2016 11 06
(181) 2026 11 06
(891) 2016 11 06
(511) 25

(260) AM 2018 90288 A
(800) 1141623
(151) 2012 09 18
(181) 2022 09 18
(891) 2016 09 01
(511) 06, 20, 40

(260) AM 2018 90289 A
(800) 1325911
(151) 2016 02 05
(181) 2026 02 05
(891) 2016 02 05
(511) 16

(260) AM 2018 90293 A
(800) 1225495
(151) 2014 06 30
(181) 2024 06 30

(891) 2016 11 14
(511) 30, 32

(260) AM 2018 90294 A
(800) 1226012
(151) 2014 10 15
(181) 2024 10 15
(891) 2016 12 01
(511) 09

(260) AM 2018 90295 A
(800) 1325938
(151) 2016 10 03
(181) 2026 10 03
(891) 2016 10 03
(511) 03

(260) AM 2018 90298 A
(800) 1325943
(151) 2016 09 27
(181) 2026 09 27
(891) 2016 09 27
(511) 05

(260) AM 2018 90299 A
(800) 1325944
(151) 2016 09 27
(181) 2026 09 27
(891) 2016 09 27
(511) 05

(260) AM 2018 90659 A
(800) 1328739
(151) 2016 02 10
(181) 2026 02 10
(891) 2016 02 10
(511) 06, 07, 12, 20, 35

(260) AM 2018 90663 A
(800) 1328916
(151) 2016 04 25
(181) 2026 04 25
(891) 2016 04 25
(511) 18

(260) AM 2018 90681 A
(800) 1328980
(151) 2016 05 05
(181) 2026 05 05
(891) 2016 05 05
(511) 01, 02, 04, 16, 17, 19, 20, 24, 35, 36, 37, 39,
41, 42

APPELLATIONS OF ORIGIN OF GOODS

THE RIGHT TO USE OF REGISTERED APPELLATION OF ORIGIN OF GOOD

Registered appellations of origin of goods: **BORJOMI**

The right tu use: LTD "IDS BORJOMI BEVERAGES CO.N.V."

Toris q. 39, 1200, Borjomi, Georgia

Number of registration: 824/1-18

Valid: 2019 01 09

Registered appellations of origin of goods: **MITARBI**

The right tu use: The right tu use: LTD "IDS BORJOMI BEVERAGES CO.N.V."

Toris q. 39, 1200, Borjomi, Georgia

Number of registration: 844/1-18

Valid: 2019 01 09

OFFICIAL NOTIFICATIONS

TRADEMARKS

RENEWAL OF REGISTRATIONS

(111) M 2007 17588 R1

(156) 2017 09 06

(186) 2027 06 28

(732) LTD "FIRMA DISNA"

Ul. Mazepa 34-B, Kyev, 01015, Ukraine;

LTD "TIFLISSKI VINNI POGREB"

Iumashevis q. 27, 0198, Tbilisi, Georgia

(111) M 2007 18038 R1

(156) 2017 12 11

(186) 2027 11 13

(732) JOHN GALLIANO

40, rue François 1, 75008 Paris, France

(111) M 2007 18071 R1

(156) 2017 12 21

(186) 2027 11 30

(732) CARGILL, INCORPORATED

15407 McGinty Road West, Wayzata,

Minnesota 55391-5624, USA

(111) M 2008 18713 R1

(156) 2018 09 17

(186) 2028 09 17

(732) KANGARO INDUSTRIES (REGD.)

B-XXX-6754, Focal Point, Ludhiana - 141

010 (Punjab), India

(111) M 1997 6090 R2

(156) 2017 07 24

(186) 2027 07 24

(732) E.T. BROWNE DRUG COMPANY, INK.

440 Sylvan Avenue, Englewood Cliffs,

New Jersey 07632, USA

(111) M 1997 7715 R2

(156) 2017 11 25

(186) 2027 11 25

(732) FEDERAL EXPRESS CORPORATION

3620 Hacks Cross Road, Building B, 3rd

Floor, Memphis, Tennessee, USA

(111) M 1997 7902 R2

(156) 2017 12 18

(186) 2027 12 18

(732) TITAN COMPANY LIMITED

No.132/133, Divyasree Technopolis, Off

HAL Airport road, Yamalur post,

Yamaluru, Bangalore 560037, India

(111) M 1997 7922 R2

(156) 2017 12 22

(186) 2027 12 22

(732) SPRINT COMMUNICATIONS

COMPANY L.P.

6450 Sprint Parkway, City of Overland Park,

State of Kansas 66251, USA

(111) M 1998 8035 R2

(156) 2018 01 08

(186) 2028 01 08

(732) FLOWIL INTERNATIONAL LIGHTING

(HOLDING) B.V.

Prins Bernhardplein 200 1097 JB

Amsterdam, Netherlands

(111) M 1998 8038 R2

(156) 2018 01 08

(186) 2028 01 08

(732) FLOWIL INTERNATIONAL LIGHTING

(HOLDING) B.V.

Prins Bernhardplein 200 1097 JB

Amsterdam, Netherlands

(111) M 1998 8395 R2

(156) 2018 02 20

(186) 2028 02 20

(732) L' OREAL

14 Rue Royale, 75008 Paris, France

(111) M 1998 8401 R2

(156) 2018 02 23

(186) 2028 02 23

(732) L' OREAL

14 Rue Royale, 75008 Paris, France

(111) M 1998 8402 R2

(156) 2018 02 23

(186) 2028 02 23

(732) L' OREAL 14 Rue Royale, 75008 Paris, France	A company incorporated under the Laws of France 20, rue de la Societe Vinicole, 16100 Cognac, France
(111) M 1998 8403 R2 (156) 2018 02 23 (186) 2028 02 23 (732) L' OREAL 14 Rue Royale, 75008 Paris, France	(111) M 1998 9202 R2 (156) 2018 05 04 (186) 2028 05 04 (732) JAKOB ROHNER LTD. BALGACH Jakob Schmidheiny-Srassse 23, 9436 Balgach, Switzerland
(111) M 1998 8405 R2 (156) 2018 02 23 (186) 2028 02 23 (732) L' OREAL 14 Rue Royale, 75008 Paris, France	(111) M 1998 9446 R2 (156) 2018 05 28 (186) 2028 05 28 (732) F. HOFFMANN-LA ROCHE AG 124 Grenzacherstrasse, CH-4002 Basle, Switzerland
(111) M 1998 8406 R2 (156) 2018 02 23 (186) 2028 02 23 (732) L' OREAL 14 Rue Royale, 75008 Paris, France	(111) M 1998 9579 R2 (156) 2018 06 04 (186) 2028 06 04 (732) TULIP FOOD COMPANY GMBH Kokkolastrasse 2, 40882, Ratingen, Denmark
(111) M 1998 8452 R2 (156) 2018 02 26 (186) 2028 02 26 (732) E. REMY MARTIN & C° A company incorporated under the Laws of France 20, rue de la Societe Vinicole, 16100 Cognac, France	(111) M 1998 9691 R2 (156) 2018 06 11 (186) 2028 06 11 (732) TRULY OPTO-ELECTRONICS LIMITED 13 Floor, Chung Shun Knitting Centre, 1-3 Wing Yip Street Kwai Chung, New Territories, The Hong Kong Special Administrative Region of the people's republic of China
(111) M 1998 8453 R2 (156) 2018 02 26 (186) 2028 02 26 (732) E. REMY MARTIN & C° A company incorporated under the Laws of France 20, rue de la Societe Vinicole, 16100 Cognac, France	(111) M 1997 7938 R2 (156) 1997 12 24 (186) 2027 12 24 (732) CERAMICAS GALA S.A. Caretera Madrid-Irun, Km 244, 09080 Burgos, Spain
(111) M 1998 8454 R2 (156) 2018 02 26 (186) 2028 02 26 (732) E. REMY MARTIN & C° A company incorporated under the Laws of France 20, rue de la Societe Vinicole, 16100 Cognac, France	(111) M 1998 8208 R2 (156) 1998 01 30 (186) 2028 01 30 (732) BIOFARMA 50, rue Carnot, 92284 Suresnes cedex, France
(111) M 1998 8455 R2 (156) 2018 02 26 (186) 2028 02 26 (732) E. REMY MARTIN & Co.	

COMPLETE TRANSFER OF RIGHT

(111) M 1997 5832 R1

(732) GENERAL WIRELESS IP HOLDINGS LLC

300 RadioShack Circle, Fort Worth, TX

76102-1964, USA

(770) TRS QUALITY, INC.

2751, Centerville Rd., Suite 335,

Wilmington, Delaware 19808, USA

(580) 2018 01 11

CHANGES IN NAMES AND/OR ADDRESSES OF OWNERS

(111) M 2007 17588 R1
(732) LTD "TIFLISSKI VINNI POGREB"
Umashevis q, 27, 0198, Tbilisi, Georgia
(770) LTD "TIFLISSKI VINNI POGREB"
Gamsakhurdias gamz., 44, 0160, Tbilisi,
Georgia
(580) 2018 01 17

(770) TITAN COMPANY LIMITED
Golden Enclave, Tower A, Airport Road,
Bangalore 560017, India
(580) 2018 01 10

(111) M 2007 18038 R1
(732) JOHN GALLIANO
40, rue François 1, 75008 Paris, France
(770) JOHN GALLIANO S.A.- a French joint-
stock company
60, rue d'Avron, 75020 Paris, France
(580) 2018 01 10

(111) M 1997 5832 R1
(732) GENERAL WIRELESS IP HOLDINGS LLC
26 patriot Place, Suite 301, Foxboro, MA
02035, USA
(770) GENERAL WIRELESS IP HOLDINGS LLC
300 RadioShack Circle, Fort Worth, TX
76102-1964, USA
(580) 2018 01 11

(111) M 1997 7715 R2
(732) FEDERAL EXPRESS CORPORATION
3620 Hacks Cross Road, Building B, 3rd
Floor, Memphis, Tennessee, USA
(770) FEDERAL EXPRESS CORPORATION
2005, Corporate Avenue, Memphis,
Tennessee 38132-1842, USA
(580) 2018 01 10

(111) M 1997 7902 R2
(732) TITAN COMPANY LIMITED
Golden Enclave, Tower A, Airport Road,
Bangalore 560017, India
(770) TITAN INDUSTRIES LIMITED
Golden Enclave, Tower A, Airport Road,
Bangalore 560017, India
(580) 2018 01 10

(111) M 1997 007902 R2
(732) TITAN COMPANY LIMITED
No.132/133, Divyasree Technopolis, Off
HAL Airport road, Yamalur post, Yamalur,
Bangalore 560037, India

INVALIDATION OF TRADEMARKS REGISTRATION

(111) M 1997 5448 R1

(141) 2007 09 04, The payment for the prolongation of registration on following 10 years is not payed

(732) EUGENE PERMA FRANCE
6, rue d'Athenes, 75009 Paris, FR

(111) M 1997 5451 R1

(141) 2007 09 05, The payment for the prolongation of registration on following 10 years is not payed

(732) ABBOTT PRODUCTS OPERATIONS AG
Hegenheimermattweg 127, 4123 Allschwil

(111) M 1997 5468 R1

(141) 2007 09 06, The payment for the prolongation of registration on following 10 years is not payed

(732) CARTIER INTERNATIONAL AG
(CATRIER INTERNATIONAL LTD),
(CATRTIER INTERNATIONAL SA)
Hinterbergstrasse 22, Postfach 61, 6312
Steinhausen, CH

(111) M 1997 5469 R1

(141) 2007 09 06, The payment for the prolongation of registration on following 10 years is not payed

(732) CARTIER INTERNATIONAL AG
(CATRIER INTERNATIONAL LTD),
(CATRTIER INTERNATIONAL SA)
Hinterbergstrasse 22, Postfach 61, 6312
Steinhausen, CH

(111) M 1997 5471 R1

(141) 2007 09 06, The payment for the prolongation of registration on following 10 years is not payed

(732) NOVARTIS AG
4002 Basel, CH

(111) M 1997 5475 R1

(141) 2007 09 06, The payment for the prolongation of registration on following 10 years is not payed

(732) NOVARTIS AG
4002 Basel, CH

(111) M 1997 5479 R1

(141) 2007 09 06, The payment for the prolongation of registration on following 10 years is not payed

(732) NOVARTIS AG
4002 Basel, CH

(111) M 1997 5481 R1

(141) 2007 09 06, The payment for the prolongation of registration on following 10 years is not payed

(732) GLAXO GROUP LIMITED
980 Great West Road, Brentford, Middlesex
TW8 9GS, GB

(111) M 1997 5487 R1

(141) 2007 09 06, The payment for the prolongation of registration on following 10 years is not payed

(732) NOVARTIS AG
4002 Basel, CH

(111) M 1997 5495 R1

(141) 2007 09 11, The payment for the prolongation of registration on following 10 years is not payed

(732) NOVARTIS AG
4002 Basel, CH

(111) M 1997 5503 R1

(141) 2007 09 11, The payment for the prolongation of registration on following 10 years is not payed

(732) SYNGENTA PARTICIPATIONS AG
Schwarzwaldallee 215, 4058 Basel, CH

(111) M 1997 5505 R1

(141) 2007 09 11, The payment for the prolongation of registration on following 10 years is not payed

(732) SYNGENTA PARTICIPATIONS AG
Schwarzwaldallee 215, 4058 Basel, CH

(111) M 1997 5520 R1

(141) 2007 09 11, The payment for the prolongation of registration on following 10 years is not payed

(732) NOVARTIS AG
4002 Basel, CH

(111) M 1997 5545 R1

(141) 2007 09 11, The payment for the prolongation of registration on following 10 years is not payed

(732) DALLAS CIGARETTE COMPANY
LIMITED
Zaehlerweg 4, 6300 Zug, CH

(111) M 1997 5549 R1
(141) 2007 09 11, The payment for the prolongation of registration on following 10 years is not payed
(732) LEGO Juris A/S
DK-7190 Billund, DK

(111) M 1997 5574 R1
(141) 2007 09 11, The payment for the prolongation of registration on following 10 years is not payed
(732) ROTHMANS OF PALL MALL LIMITED
Zählerweg 4, Zug CH 6300, CH

(111) M 1997 5575 R1
(141) 2007 09 11, The payment for the prolongation of registration on following 10 years is not payed
(732) DIAGEO NORTH AMERICA, INC.
801 Main Avenue, Norwalk CT 06851-1127,
US

(111) M 1997 5577 R1
(141) 2007 09 11, The payment for the prolongation of registration on following 10 years is not payed
(732) RISO KAGAKU CORPORATION
5-34-7, Shiba, Minato-ku, Tokyo 108-8385,
JP

(111) M 1997 5586 R1
(141) 2007 09 11, The payment for the prolongation of registration on following 10 years is not payed
(732) NOVARTIS AG
4002 Basel, CH

(111) M 1997 5588 R1
(141) 2007 09 11, The payment for the prolongation of registration on following 10 years is not payed
(732) NOVARTIS AG
4002 Basel, CH

(111) M 1997 5589 R1
(141) 2007 09 11, The payment for the prolongation of registration on following 10 years is not payed

(732) NOVARTIS AG
4002 Basel, CH

(111) M 1997 5590 R1
(141) 2007 09 11, The payment for the prolongation of registration on following 10 years is not payed
(732) NOVARTIS AG
4002 Basel, CH

(111) M 1997 5591 R1
(141) 2007 09 11, The payment for the prolongation of registration on following 10 years is not payed
(732) NOVARTIS AG
4002 Basel, CH

(111) M 1997 5603 R1
(141) 2007 09 12, The payment for the prolongation of registration on following 10 years is not payed
(732) NOVARTIS AG
4002 Basel, CH

(111) M 1997 5604 R1
(141) 2007 09 12, The payment for the prolongation of registration on following 10 years is not payed
(732) NOVARTIS AG
4002 Basel, CH

(111) M 1997 5605 R1
(141) 2007 09 12, The payment for the prolongation of registration on following 10 years is not payed
(732) NOVARTIS AG
4002 Basel, CH

(111) M 1997 5606 R1
(141) 2007 09 12, The payment for the prolongation of registration on following 10 years is not payed
(732) NOVARTIS AG
4002 Basel, CH

(111) M 1997 5609 R1
(141) 2007 09 12, The payment for the prolongation of registration on following 10 years is not payed
(732) SYNGENTA PARTICIPATIONS AG
Schwarzwaldallee 215, 4058 Basel, CH

(111) M 1997 5613 R1
(141) 2007 09 12, The payment for the prolongation of registration on following 10 years is not payed

(732) SYNGENTA PARTICIPATIONS AG
Schwarzwaldallee 215, 4058 Basel, CH

(111) M 1997 5614 R1
(141) 2007 09 12, The payment for the prolongation of registration on following 10 years is not payed

(732) NOVARTIS AG
4002 Basel, CH

(111) M 1997 5617 R1
(141) 2007 09 12, The payment for the prolongation of registration on following 10 years is not payed

(732) SYNGENTA PARTICIPATIONS AG
Schwarzwaldallee 215, 4058 Basel, CH

(111) M 1997 5618 R1
(141) 2007 09 12, The payment for the prolongation of registration on following 10 years is not payed

(732) NOVARTIS AG
4002 Basel, CH

(111) M 1997 5620 R1
(141) 2007 09 12, The payment for the prolongation of registration on following 10 years is not payed

(732) SYNGENTA PARTICIPATIONS AG
Schwarzwaldallee 215, 4058 Basel, CH

(111) M 1997 5625 R1
(141) 2007 09 13, The payment for the prolongation of registration on following 10 years is not payed

(732) F. HOFFMANN-LA ROCHE AG
124 Grenzacherstrasse, CH-4002 Basle, CH

(111) M 1997 5635 R1
(141) 2007 09 13, The payment for the prolongation of registration on following 10 years is not payed

(732) NOVARTIS AG
4002 Basel, CH

(111) M 1997 5638 R1
(141) 2007 03 13, The payment for the prolongation of registration on following 10 years is not payed

(732) SYNGENTA PARTICIPATIONS AG
Schwarzwaldallee 215, 4058 Basel, CH

(111) M 1997 5651 R1
(141) 2007 09 18, The payment for the prolongation of registration on following 10 years is not payed

(732) NOVARTIS AG
4002 Basel, CH

(111) M 1997 5655 R1
(141) 2007 09 18, The payment for the prolongation of registration on following 10 years is not payed

(732) THE LONDON TOBACCO COMPANY LIMITED
Globe House, 4 Temple Place, London, WC2R 2PG, GB

(111) M 1997 5661 R1
(141) 2007 09 18, The payment for the prolongation of registration on following 10 years is not payed

(732) ATLANTIC INDUSTRIES
P.O. Box 309 GT, Uglan House, South Church Street, George Town, Grand Cayman, BWI, KY

(111) M 1997 5671 R1
(141) 2007 03 19, The payment for the prolongation of registration on following 10 years is not payed

(732) BRITISH AMERICAN TOBACCO (BRANDS) LIMITED
Globe House, 4 Temple Place, London, WC2R 2PG, GB

(111) M 1997 5683 R1
(141) 2007 09 25, The payment for the prolongation of registration on following 10 years is not payed

(732) PROCTER & GAMBLE HOLDING GmbH
Sulzbacher Strasse 40, 65824 Schwalbach am Taunus, DE

(111) M 1997 5710 R1
(141) 2007 03 26, The payment for the prolongation of registration on following 10 years is not payed

(732) BASF Coating GmbH
1, Glasuritstrasse, D-48165 Munster, DE

(111) M 1997 5712 R1
(141) 2007 09 25, The payment for the prolongation of registration on following 10 years is not payed
(732) LABORATOIRES BIOLOGIQUES ARVAL S.A.
Rout de Peupliers 2, CH-1964 Chateouneuf-Conthey, CH

(111) M 1997 5716 R1
(141) 2007 09 25, The payment for the prolongation of registration on following 10 years is not payed
(732) OLYMPIA INTERNATIONAL HOLDINGS LIMITED
Shelton Building, Main Street Road Town, VG

(111) M 1997 5718 R1
(141) 2007 09 25, The payment for the prolongation of registration on following 10 years is not payed
(732) OLYMPIA INTERNATIONAL HOLDINGS LIMITED
Shelton Building, Main Street Road Town, VG

(111) M 1997 5719 R1
(141) 2007 09 25, The payment for the prolongation of registration on following 10 years is not payed
(732) OLYMPIA INTERNATIONAL HOLDINGS LIMITED
Shelton Building, Main Street Road Town, VG

(111) M 1997 5720 R1
(141) 2007 09 25, The payment for the prolongation of registration on following 10 years is not payed
(732) OLYMPIA INTERNATIONAL HOLDINGS LIMITED
Shelton Building, Main Street Road Town, VG

(111) M 1997 5721 R1
(141) 2007 09 25, The payment for the prolongation of registration on following 10 years is not payed
(732) OLYMPIA INTERNATIONAL HOLDINGS LIMITED
Shelton Building, Main Street Road Town, VG

CLASSIFICATION INDEXES

INVENTIONS

CONCORDANCE TABLE OF INTERNATIONAL CLASSIFICATION INDEX AND PUBLICATION NUMBERS

INTERNATIONAL CLASSIFICATION INDEXES (51)	NUMBER OF PUBLISHED APPLICATION (10)
A 47 J 44/02; B 01 F 13/04	AP 2018 14131 A
A 47 L 9/06	AP 2018 14152 A
A 61 K 9/00; A 61 K 47/12; A 61 K 47/26; A 61 K 31/167; A 61 K 31/40; A 61 K 31/573	AP 2018 14032 A
A 61 K 9/00; A 61 M 15/00; A 61 K 31/167; A 61 K 31/40; B 65 D 83/54; A 61 K 31/573; A 61 K 31/54	AP 2018 14191 A
A 61 K 31/55; A 61 K 47/06; A 61 K 47/32; A 61 K 47/38; A 61 K 31/5517; A 61 K 9/14	AP 2018 13666 A
A 61 K 31/495; A 61 P 25/18	AP 2018 13870 A
A 61 K 38/14; A 61 K 31/545; C 07 D 501/00; C 07 K 9/00 C 01 B 3/24; C 01 B 31/18; C 01 J 3/00	AP 2018 13957 A
C 01 G 15/00; C 01 G 19/00; C 01 G 49/08; C 09 K 9/00; C 09 K 11/62; C 09 K 11/77; G 01 N 33/02; G 01 N 33/15	AP 2018 13525 A
E 04 C 1/40; E 04 C 1/41	AP 2018 14213 A
	AP 2018 14238 A

CONCORDANCE TABLE OF PUBLICATION NUMBERS AND INTERNATIONAL CLASSIFICATION INDEX

NUMBER OF PUBLISHED APPLICATION (10)	INTERNATIONAL CLASSIFICATION INDEXES (51)
AP 2018 13525 A	C 01 B 3/24; C 01 B 31/18; C 01 J 3/00
AP 2018 13666 A	A 61 K 31/55; A 61 K 47/06; A 61 K 47/32; A 61 K 47/38; A 61 K 31/5517; A 61 K 9/14
AP 2018 13870 A	A 61 K 31/495; A 61 P 25/18
AP 2018 13957 A	A 61 K 38/14; A 61 K 31/545; C 07 D 501/00; C 07 K 9/00
AP 2018 14032 A	A 61 K 9/00; A 61 K 47/12; A 61 K 47/26; A 61 K 31/167; A 61 K 31/40; A 61 K 31/573
AP 2018 14131 A	A 47 J 44/02; B 01 F 13/04
AP 2018 14152 A	A 47 L 9/06
AP 2018 14191 A	A 61 K 9/00; A 61 M 15/00; A 61 K 31/167; A 61 K 31/40; B 65 D 83/54; A 61 K 31/573; A 61 K 31/54
AP 2018 14213 A	C 01 G 15/00; C 01 G 19/00; C 01 G 49/08; C 09 K 9/00; C 09 K 11/62; C 09 K 11/77; G 01 N 33/02; G 01 N 33/15
AP 2018 14238 A	E 04 C 1/40; E 04 C 1/41

**CONCORDANCE TABLE OF INTERNATIONAL CLASSIFICATION INDEX,
PATENT NUMBERS AND PUBLICATION NUMBERS**

INTERNATIONAL CLASSIFICATION INDEX (51)	NUMBER OF PATENT (11)	NUMBER OF PUBLISHED APPLICATION (10)
A 61 K 9/00; A 61 K 31/00; A 61 K 31/164; A 61 K 31/4174; A 61 K 31/505; A 61 K 31/728; A 61 P 11/02	P 2018 6809 B	AP 2017 13662 A
A 61 K 9/20; A 61 K 9/28; A 61 K 9/50; A 61 K 31/4196; A 61 P 39/04	P 2018 6810 B	AP 2017 13929 A
C 07 D 401/14; C 07 D 405/14; C 07 D 401/12; A 61 K 31/513; A 61 K 31/501; A 61 K 31/497; A 61 P 25/00	P 2018 6811 B	AP 2017 14022 A
C 07 D 403/04; A 61 K 31/4178; A 61 K 31/4184; A 61 P 3/10	P 2018 6812 B	AP 2017 14070 A
C 12 G 3/00; C 12 H 1/22	P 2018 6815 B	AP 2017 14336 A
F 03 B 17/06; F 03 B 13/10; H 02 K 7/18	P 2018 6813 B	AP 2017 14138 A
G 01 W 1/02; G 01 W 1/06; G 01 W 1/10	P 2018 6814 B	AP 2017 14155 A

**CONCORDANCE TABLE OF PATENT NUMBERS,
PUBLICATION NUMBERS AND INTERNATIONAL CLASSIFICATION INDEX**

NUMBER OF PATENT (11)	NUMBER OF PUBLISHED APPLICATION (10)	INTERNATIONAL CLASSIFICATION INDEX (51)
P 2018 6809 B	AP 2017 13662 A	A 61 K 9/00; A 61 K 31/00; A 61 K 31/164; A 61 K 31/4174; A 61 K 31/505; A 61 K 31/728; A 61 P 11/02
P 2018 6810 B	AP 2017 13929 A	A 61 K 9/20; A 61 K 9/28; A 61 K 9/50; A 61 K 31/4196; A 61 P 39/04
P 2018 6811 B	AP 2017 14022 A	C 07 D 401/14; C 07 D 405/14; C 07 D 401/12; A 61 K 31/513; A 61 K 31/501; A 61 K 31/497; A 61 P 25/00
P 2018 6812 B	AP 2017 14070 A	C 07 D 403/04; A 61 K 31/4178; A 61 K 31/4184; A 61 P 3/10
P 2018 6813 B	AP 2017 14138 A	F 03 B 17/06; F 03 B 13/10; H 02 K 7/18
P 2018 6814 B	AP 2017 14155 A	G 01 W 1/02; G 01 W 1/06; G 01 W 1/10
P 2018 6815 B	AP 2017 14336 A	C 12 G 3/00; C 12 H 1/22

**CONCORDANCE TABLE OF APPLICATION NUMBERS, PUBLICATION NUMBERS
AND PATENTS**

NUMBER OF APPLICATION (21)	NUMBER OF PUBLISHED APPLICATION (10)	NUMBER OF PATENT (11)
AP 2013 013662	AP 2017 13662 A	P 2018 6809 B
AP 2014 013929	AP 2017 13929 A	P 2018 6810 B
AP 2014 014022	AP 2017 14022 A	P 2018 6811 B
AP 2014 014070	AP 2017 14070 A	P 2018 6812 B
AP 2014 014138	AP 2017 14138 A	P 2018 6813 B
AP 2016 014155	AP 2017 14155 A	P 2018 6814 B
AP 2016 014336	AP 2017 14336 A	P 2018 6815 B

UTILITY MODELS

CONCORDANCE TABLE OF INTERNATIONAL CLASSIFICATION INDEX, PATENT NUMBERS AND PUBLICATION NUMBERS

INTERNATIONAL CLASSIFICATION INDEX (51)	NUMBER OF PATENT (11)	NUMBER OF PUBLISHED APPLICATION (10)
A 23 L 2/00	U 2018 1959 Y	AU 2017 14354 U
A 61 K 9/08; A 61 K 31/475	U 2018 1960 Y	AU 2017 13995 U
E 04 B 1/00	U 2018 1958 Y	AU 2017 14200 U

CONCORDANCE TABLE OF PATENT NUMBERS, PUBLICATION NUMBERS AND INTERNATIONAL CLASSIFICATION INDEX

NUMBER OF PATENT (11)	NUMBER OF PUBLISHED APPLICATION (10)	INTERNATIONAL CLASSIFICATION INDEX (51)
U 2018 1958 Y	AU 2017 14200 U	E 04 B 1/00
U 2018 1959 Y	AU 2017 14354 U	A 23 L 2/00
U 2018 1960 Y	AU 2017 13995 U	A 61 K 9/08; A 61 K 31/475

CONCORDANCE TABLE OF APPLICATION NUMBERS, PUBLICATION NUMBER AND NUMBER OF PATENTS

NUMBER OF APPLICATION (21)	NUMBER OF PUBLISHED APPLICATION (10)	NUMBER OF PATENT (11)
AU 2015 013995	AU 2017 13995 U	U 2018 1960 Y
AU 2016 014200	AU 2017 14200 U	U 2018 1958 Y
AU 2016 014354	AU 2017 14354 U	U 2018 1959 Y

DESIGNS

CONCORDANCE TABLE OF INTERNATIONAL CLASSIFICATION INDEX AND PUBLICATION NUMBERS

INTERNATIONAL CLASSIFICATION INDEXES (51)	NUMBER OF PUBLISHED APPLICATION (10)
09-01	AD 2018 975 S
09-01	AD 2018 977 S
26-03	AD 2018 987 S
26-03	AD 2018 988 S

**CONCORDANCE TABLE OF PUBLICATION NUMBERS
AND INTERNATIONAL CLASSIFICATION INDEX**

NUMBER OF PUBLISHED APPLICATION (10)	INTERNATIONAL CLASSIFICATION INDEXES (51)
AD 2018 975 S	09-01
AD 2018 977 S	09-01
AD 2018 987 S	26-03
AD 2018 988 S	26-03

**CONCORDANCE TABLE OF INTERNATIONAL CLASSIFICATION INDEX,
PATENT NUMBERS AND PUBLICATION NUMBERS**

INTERNATIONAL CLASSIFICATION INDEX (51)	NUMBER OF PATENT (11)	NUMBER OF PUBLISHED APPLICATION (10)
09-03	D 2018 744 S	AD 2017 958 S

**CONCORDANCE TABLE OF PATENT NUMBERS,
PUBLICATION NUMBERS AND INTERNATIONAL CLASSIFICATION INDEX**

NUMBER OF PATENT (11)	NUMBER OF PUBLISHED APPLICATION (10)	INTERNATIONAL CLASSIFICATION INDEX (51)
D 2018 744 S	AD 2017 958 S	09-03

**CONCORDANCE TABLE OF APPLICATION NUMBERS, PUBLICATION NUMBERS
AND PATENTS**

NUMBER OF APPLICATION (21)	NUMBER OF PUBLISHED APPLICATION (10)	NUMBER OF PATENT (11)
AD 2017 958	AD 2017 958 S	D 2018 744 S

**DESIGN REGISTERED ACCORDING TO THE ACCELERATED
PROCEDURE**

**CONCORDANCE TABLE OF INTERNATIONAL CLASSIFICATION INDEX
AND PUBLICATION NUMBERS**

INTERNATIONAL CLASSIFICATION INDEXES (51)	NUMBER OF PUBLISHED APPLICATION (11)
03-01	D 2018 742 S
19-08	D 2018 743 S

CONCORDANCE TABLE OF PUBLICATION NUMBERS
AND INTERNATIONAL CLASSIFICATION INDEX

NUMBER OF PUBLISHED APPLICATION (11)	INTERNATIONAL CLASSIFICATION INDEXES (51)
D 2018 742 S	03-01
D 2018 743 S	19-08

CONCORDANCE TABLE OF APPLICATION NUMBERS,
PUBLICATION NUMBERS AND PATENTS

NUMBER OF APPLICATION (21)	NUMBER OF PATENT (11)
AD 2017 1013	D 2018 742 S
AD 2017 1011	D 2018 743 S

TRADEMARKS

CONCORDANCE TABLE OF REGISTRATION NUMBERS, APPLICATION NUMBERS, PUBLICATION NUMBERS AND BULLETIN NUMBERS

NUMBER OF REGISTRATION (111)	NUMBER OF APPLICATIONS (210)	NUMBER OF PUBLISHED APPLICATIONS (260)	NUMBER OF BULLETIN
M 2018 29273 R	AM 95534	-	2(486)2018
M 2018 29274 R	AM 95141	-	2(486)2018
M 2018 29275 R	AM 91229	AM 2017 91229 A	18(478)2017
M 2018 29276 R	AM 95367	-	2(486)2018
M 2018 29277 R	AM 95774	-	2(486)2018
M 2018 29278 R	AM 95881	-	2(486)2018
M 2018 29279 R	AM 95757	-	2(486)2018
M 2018 29280 R	AM 87632	AM 2016 87632 A	17(477)2017
M 2018 29281 R	AM 88127	AM 2016 88127 A	14(474)2017
M 2018 29282 R	AM 88130	AM 2016 88130 A	14(474)2017
M 2018 29283 R	AM 88131	AM 2016 88131 A	13(473)2017
M 2018 29284 R	AM 88132	AM 2016 88132 A	13(473)2017
M 2018 29285 R	AM 88167	AM 2016 88167 A	11(471)2017
M 2018 29286 R	AM 88386	AM 2016 88386 A	14(474)2017
M 2018 29287 R	AM 88840	AM 2016 88840 A	14(474)2017
M 2018 29288 R	AM 89305	AM 2016 89305 A	14(474)2017
M 2018 29289 R	AM 89853	AM 2016 89853 A	13(473)2017
M 2018 29290 R	AM 89901	AM 2016 89901 A	17(477)2017
M 2018 29291 R	AM 90003	AM 2016 90003 A	13(473)2017
M 2018 29292 R	AM 90006	AM 2016 90006 A	15(475)2017
M 2018 29293 R	AM 90389	AM 2017 90389 A	17(477)2017
M 2018 29294 R	AM 90412	AM 2017 90412 A	17(477)2017
M 2018 29295 R	AM 90479	AM 2017 90479 A	17(477)2017
M 2018 29296 R	AM 90494	AM 2017 90494 A	17(477)2017
M 2018 29297 R	AM 90553	AM 2017 90553 A	17(477)2017
M 2018 29298 R	AM 90588	AM 2017 90588 A	16(476)2017
M 2018 29299 R	AM 90633	AM 2017 90633 A	16(476)2017
M 2018 29300 R	AM 90645	AM 2017 90645 A	17(477)2017
M 2018 29301 R	AM 90646	AM 2017 90646 A	17(477)2017
M 2018 29302 R	AM 90647	AM 2017 90647 A	17(477)2017
M 2018 29303 R	AM 90664	AM 2017 90664 A	17(477)2017
M 2018 29304 R	AM 90675	AM 2017 90675 A	17(477)2017
M 2018 29305 R	AM 90677	AM 2017 90677 A	17(477)2017

**CONCORDANCE TABLE OF PUBLICATION NUMBERS
AND APPLICATION NUMBERS**

NUMBER OF PUBLISHED APPLICATION (260)	NUMBER OF APPLICATION (210)	1	2
1	2		
AM 2018 91749 A	AM 91749	AM 2018 92346 A	AM 92346
AM 2018 91864 A	AM 91864	AM 2018 92353 A	AM 92353
AM 2018 91926 A	AM 91926	AM 2018 92355 A	AM 92355
AM 2018 91938 A	AM 91938	AM 2018 92356 A	AM 92356
AM 2018 91942 A	AM 91942	AM 2018 92357 A	AM 92357
AM 2018 91963 A	AM 91963	AM 2018 92465 A	AM 92465
AM 2018 92068 A	AM 92068	AM 2018 92466 A	AM 92466
AM 2018 92069 A	AM 92069	AM 2018 92499 A	AM 92499
AM 2018 92070 A	AM 92070	AM 2018 92508 A	AM 92508
AM 2018 92071 A	AM 92071	AM 2018 92544 A	AM 92544
AM 2018 92094 A	AM 92094	AM 2018 92545 A	AM 92545
AM 2018 92124 A	AM 92124	AM 2018 92606 A	AM 92606
AM 2018 92125 A	AM 92125	AM 2018 92635 A	AM 92635
AM 2018 92126 A	AM 92126	AM 2018 92724 A	AM 92724
AM 2018 92180 A	AM 92180	AM 2018 92729 A	AM 92729
AM 2018 92182 A	AM 92182	AM 2018 92771 A	AM 92771
AM 2018 92218 A	AM 92218	AM 2018 92772 A	AM 92772
AM 2018 92220 A	AM 92220	AM 2018 92773 A	AM 92773
AM 2018 92223 A	AM 92223	AM 2018 92774 A	AM 92774
AM 2018 92308 A	AM 92308	AM 2018 92776 A	AM 92776
AM 2018 92312 A	AM 92312	AM 2018 92777 A	AM 92777
AM 2018 92315 A	AM 92315	AM 2018 92849 A	AM 92849
AM 2018 92316 A	AM 92316	AM 2018 92870 A	AM 92870
AM 2018 92332 A	AM 92332	AM 2018 92871 A	AM 92871
AM 2018 92333 A	AM 92333	AM 2018 92883 A	AM 92883
		AM 2018 92908 A	AM 92908
		AM 2018 92928 A	AM 92928
		AM 2018 92986 A	AM 92986
		AM 2018 92995 A	AM 92995

**CONCORDANCE TABLE OF INDEX OF GOODS AND/OR SERVICES
AND APPLICATION NUMBERS**

INDEX OF GOODS AND/OR SERVICES (511)	NUMBER OF PUBLISHED APPLICATIONS (26)	1	2
1	2		
1	AM 2018 92635 A	5	AM 2018 92125 A
4	AM 2018 92068 A	5	AM 2018 92312 A
4	AM 2018 92069 A	5	AM 2018 92315 A
4	AM 2018 92070 A	5	AM 2018 92316 A
4	AM 2018 92071 A	5	AM 2018 92332 A
5	AM 2018 91749 A	5	AM 2018 92333 A
5	AM 2018 91864 A	5	AM 2018 92353 A
5	AM 2018 91926 A	5	AM 2018 92355 A
5	AM 2018 91938 A	5	AM 2018 92356 A
5	AM 2018 91963 A	5	AM 2018 92357 A
5	AM 2018 92124 A	5	AM 2018 92465 A
		5	AM 2018 92466 A
		5	AM 2018 92499 A
		5	AM 2018 92508 A
		5	AM 2018 92544 A
		5	AM 2018 92545 A
		5	AM 2018 92606 A
		5	AM 2018 92635 A
		5	AM 2018 92724 A
		5	AM 2018 92729 A
		5	AM 2018 92771 A
		5	AM 2018 92772 A
		5	AM 2018 92773 A
		5	AM 2018 92774 A
		5	AM 2018 92776 A
		5	AM 2018 92777 A
		5	AM 2018 92849 A
		5	AM 2018 92870 A
		5	AM 2018 92871 A
		5	AM 2018 92883 A

1	2	1	2
5	AM 2018 92908 A	35	AM 2018 92332 A
5	AM 2018 92986 A	35	AM 2018 92333 A
5	AM 2018 92995 A	35	AM 2018 92499 A
6	AM 2018 92908 A	35	AM 2018 92724 A
9	AM 2018 92928 A	35	AM 2018 92729 A
29	AM 2018 92094 A	35	AM 2018 92928 A
29	AM 2018 92908 A	36	AM 2018 92126 A
30	AM 2018 92094 A	36	AM 2018 92182 A
31	AM 2018 92094 A	36	AM 2018 92308 A
31	AM 2018 92908 A	36	AM 2018 92928 A
32	AM 2018 92908 A	37	AM 2018 92068 A
33	AM 2018 92606 A	37	AM 2018 92069 A
33	AM 2018 92908 A	37	AM 2018 92070 A
34	AM 2018 91942 A	37	AM 2018 92071 A
34	AM 2018 92218 A	37	AM 2018 92126 A
34	AM 2018 92220 A	37	AM 2018 92182 A
34	AM 2018 92223 A	39	AM 2018 92346 A
34	AM 2018 92357 A	39	AM 2018 92724 A
34	AM 2018 92465 A	39	AM 2018 92729 A
34	AM 2018 92466 A	41	AM 2018 92771 A
34	AM 2018 92544 A	41	AM 2018 92774 A
34	AM 2018 92545 A	41	AM 2018 92776 A
34	AM 2018 92849 A	41	AM 2018 92777 A
35	AM 2018 91963 A	42	AM 2018 92724 A
35	AM 2018 92068 A	42	AM 2018 92729 A
35	AM 2018 92069 A	42	AM 2018 92928 A
35	AM 2018 92070 A	43	AM 2018 92180 A
35	AM 2018 92071 A	43	AM 2018 92499 A
35	AM 2018 92094 A	43	AM 2018 92508 A
35	AM 2018 92308 A		

CONCORDANCE TABLE OF INDEX OF GOODS AND/OR SERVICES
AND NUMBERS OF TRADEMARKS REGISTERED ACCORDING
TO THE ACCELERATED PROCEDURE

INDEX OF GOODS AND/OR SERVICES (511)	NUMBERS OF REGISTERED ACCORDING TO THE ACCELERATED PROCEDURE (111)
5	M 2018 29278 R
20	M 2018 29277 R
35	M 2018 29276 R
36	M 2018 29274 R
36	M 2018 29279 R
37	M 2018 29274 R
41	M 2018 29273 R
43	M 2018 29273 R
43	M 2018 29277 R

OFFICIAL BULLETIN OF THE INDUSTRIAL PROPERTY

2(486)

EDITOR-IN-CHIEF: N. Bebrishvili

EDITORS-TRANSLATORS: E. Gabunia

PROOFREADER: A. Shikhashvili

COMPUTER LAYOUT: M. Ordenidze
K. Svanidze

www.sakpatenti.gov.ge

E-mail: info@sakpatenti.org.ge