



საქართველოს ინტელექტუალური საკუთრების ეროვნული ცენტრი  
NATIONAL INTELLECTUAL PROPERTY CENTER OF GEORGIA

საქპატენტი  
SAKPATENTI

**OFFICIAL BULLETIN  
OF THE INDUSTRIAL PROPERTY**

**2(534)**

2020  
TBILISI

# INID CODES FOR IDENTIFICATION OF BIBLIOGRAPHIC DATA

## INVENTIONS, UTILITY MODELS

- (10) Number of publication for application, which has been examined
- (11) Number of patent and kind of document
- (21) Serial number of application
- (22) Date of filing of the application
- (23) Date of exhibition or the date of the earlier filing and the number of application, if any
- (24) Date from which patent may have effect
- (31) Number of priority application
- (32) Date of filing of priority application
- (33) Code of the country or regional organization allotting priority application number
- (44) Date of publication of application not granted, but examined and number of bulletin
- (45) Date of publication of registered document
- (51) International Patent Classification Index

- (54) Title of the invention
- (57) Abstract
- (60) Number of examined patent document granted by foreign patent office, date from which patent has effect and country code
- (62) Number of the earlier application and in case of divided application, date of filing an application
- (71) Name, surname and address of applicant (country code)
- (72) Name, surname of inventor (country code)
- (73) Name, surname and address of patent owner (country code)
- (74) Name, surname of representative or patent attorney
- (85) Date of commencement of the national phase of International Application
- (86) Number and date of filing of international application
- (87) Number and date of publication of international application
- (94) Calculated date of expiry of the SPC or the duration of the SPC

## DESIGNS

- (10) Number of publication for application
- (11) Number of patent and kind of document or number of registration
- (15) Date of registration/Date of patent renewal
- (18) Expected expiration date of patent or registration
- (21) Serial number of application
- (22) Date of filing of the application
- (23) Date of exhibition or the date of the earlier filing and the number of application, if any
- (24) Date from which patent may have effect
- (28) Number of designs included in the application
- (30) Data relating to priority (number of application, date of filing of application, two-letter code identifying the authority with whom the priority application was made)
- (31) Number of priority application
- (32) Date of filing of priority application
- (33) Code of the country or regional organization allotting priority application number
- (34) Two-letter code according to WIPO St.3 identifying the authority with which the priority application was made
- (44) Date of publication of design and number of bulletin (the first publication)
- (45) Date of publication of design registered by WIPO and number of bulletin

- (51) International Classification for designs (class and subclass of the Locarno Classification)
- (54) Title of the invention
- (55) Reproduction of the design
- (57) Description of characteristic features of the design including indication of colors
- (58) Date of recording of any kind of amendment in the Register
- (62) Number of the earlier application, registration and document number and if available the date of filing an application in case of divided application
- (71) Name, surname and address of applicant (country code)
- (72) Name, surname of creator (country code)
- (73) Name, surname and address of patent owner (country code)
- (74) Name, surname of representative or patent attorney
- (81) Contracting states concerned
  - II designated contracting states according to the 1960 Act
  - III designated contracting states according to the 1999 Act
- (85) Owner's permanent address
- (86) Owner's nationality
- (87) Owner's residence
- (88) State in which the owner has a real and effective industrial or commercial establishment

## TRADEMARKS

- (111) - Number of registration
- (151) - Date of registration
- (156) - Date of the renewal
- (181) - Expected expiration date of registration
- (186) - Renewal expiration date of registration
- (141) - Date of cancel of duration of the mark
- (210) - Serial number of application
- (220) - Date of filing of the application
- (230) - Data concerning exhibition
- (260) - Number of application, for which favorable decision of examination about registration has been taken (publication number)
- (310) - Number of the first application
- (320) - Date of filing of the first application
- (330) - Code, identifying national or regional Office where the first application was made
- (511) - International Classification of Goods and Services for the purposes of registration of trade marks and/or list of goods and/or services classified according thereto
- (526) - Disclaimer
- (531) - Description of figurative elements of Trade Marks according to the International Classification of the Figurative Elements of Marks

- (540) - Reproduction of Trade Mark
- (550) - Nature and kind of Trade Mark
- (551) - Indication to the effect that the mark is a collective mark, a certification mark or a guarantee mark
- (554) - Three-dimensional mark
- (580) - Date of recording of any kind changes in respect of applications or registrations
- (591) - Information concerning colors claimed
- (731) - Name and address of the applicant
- (732) - Name and address of the holder of the registration
- (740) - Name and address of the representative
- (750) - Addreses for correspondence
- (770) - Name and address of the previous applicant or holder in case of change in ownership
- (771) - Previous name and address of the applicant or holder in case of change in ownership
- (791) - Name and address of the licensee
- (793) - Indication of conditions and/or restrictions under the license (Type of license, number of license agreement, data of license, data of validity of license)
- (800) - Certain data relating to the international registration of Trade Marks under the Protocol Relating to Madrid Agreement (International registration number
- (852) - Partial cancellation of the list of goods and services
- (891) - Date of subsequent designation

## CODES FOR PUBLICATION IN BULLETIN

- (21) AP 0000 000000 - serial number of application for invention
- (10) AP 0000 0000 A - number of published application for invention (first publication)
- (11) P 0000 0000 B - number of patent for invention (second publication)
- (21) API 0000 000000 - number of application for imported patent
- (11) PI 0000 0000 A - number of imported patent (first publication)
- (21) AU 0000 000000 - serial number of application for utility model
- (10) AU 0000 000 U - number of published application for utility model (first publication)
- (11) U 0000 000 Y - number of patent for utility model (second publication)
- (21) AD 0000 000000 - serial number of application for design
- (10) AD 0000 000 S - number of published application for design (first publication)
- (11) D 0000 000 S - registered design

## INTERNATIONAL PATENT CLASSIFICATION FOR INVENTIONS AND UTILITY MODELS

- SECTION A - HUMAN NECESSITIES
- SECTION B - PERFORMING OPERATIONS; TRANSPORTING
- SECTION C - CHEMISTRY; METALLURGY
- SECTION D - TEXTILES; PAPER
- SECTION E - FIXED CONSTRUCTIONS
- SECTION F - MECHANICAL ENGINEERING; LIGHTING; HEATING; WEAPONS; BLASTING
- SECTION G - PHYSICS
- SECTION H - ELECTRICITY

- 
- M - Trade Mark
  - (210) AM 0000 000000 - Serial number of application;
  - (260) AAM 0000 00000 A - Publication number of application;
  - (111) M 0000 00000 R - Number of registration;
  - (111) MMM0000 00000 Rn - Number of renewals, in which n=1,2,3;
  - (111) M 0000 00000 R(P) - Number of registration under partial assignment of rights
-

**LIST OF CODES, IN ALPHABETIC SEQUENCE, AND THE CORRESPONDING (SHORT) NAMES OF STATES, OTHER ENTITIES AND INTERGOVERNMENTAL ORGANIZATIONS  
(WIPO STANDARD ST.3)**

AD	Andorra				
AE	United Arab Emirates	GD	Grenada	NE	Niger
AF	Afghanistan	GG	Guernsey	NG	Nigeria
AG	Antigua and Barbuda	GH	Ghana	NI	Nicaragua
AI	Anguilla	GI	Gibraltar	NL	Netherlands
AL	Albania	GT	Guatemala	NO	Norway
AM	Armenia	GW	Guinea- Bissau	NP	Nepal
AN	Netherlands Antilles	GY	Guyana	NR	Nauru
AO	Angola	HK	The Hong Kong Special Administrative Region of the People's Republic of China	NZ	New Zealand
AP	African Regional Intellectual Property Organization (ARIPO)	HN	Honduras	OA	African Intellectual Property Organization (OAPI)
AR	Argentina	HR	Croatia	OM	Oman
AT	Austria	HT	Haiti	PA	Panama
AU	Australia	HU	Hungary	PE	Peru
AW	Aruba	IB	International Bureau of the World Intellectual Property Organization (WIPO)	PG	Papua New Guinea
AZ	Azerbaijan	ID	Indonesia	PH	Philippines
BA	Bosnia and Herzegovina	IE	Ireland	PK	Pakistan
BB	Barbados	IL	Israel	PL	Poland
BD	Bangladesh	IM	Isle of Man	PT	Portugal
BE	Belgium	IN	India	PW	Palau
BF	Burkina Faso	IQ	Iraq	PY	Paraguay
BG	Bulgaria	IR	Iran (Islamic Republic of)	QA	Qatar
BH	Bahrain	IS	Iceland	QZ	Community Plant Variety Office (European Community) (CPVO)
BI	Burundi	IT	Italy	RO	Romania
BJ	Benin	JE	Jersey	RS	Serbia
BM	Bermuda	JM	Jamaica	RU	Russian Federation
BN	Brunei Darussalam	JO	Jordan	RW	Rwanda
BO	Bolivia	JP	Japan	SA	Saudi Arabia
BR	Brazil	KE	Kenya	SB	Solomon Islands
BS	Bahamas	KG	Kyrgyzstan	SC	Seychelles
BT	Bhutan	KH	Cambodia	SD	Sudan
BV	Bouvet Island	KI	Kiribati	SG	Singapore
BW	Botswana	KM	Saint Kitts and Nevis	SH	Saint Helena
BX	Benelux Office for Intellectual Property (BOIP)	KP	Democratic People's Republic of Korea	SI	Slovenia
BY	Belarus	KR	Republic of Korea	SK	Slovakia
BZ	Belize	KW	Kuwait	SL	Sierra Leone
CA	Canada	KY	Cayman Islands	SM	San Marino
CD	Democratic Republic of the Congo	KZ	Kazakhstan	SN	Senegal
CF	Central African Republic	LA	Lao People's Democratic Republic	SO	Somalia
CG	Congo	LB	Lebanon	SR	Suriname
CH	Switzerland	LC	Saint Lucia	ST	Sao Tome and Principe
CI	Cote d'Ivoire	LI	Liechtenstein	SV	El Salvador
CK	Cook Islands	LK	Sri Lanka	SY	Syrian Arab Republic
CL	Chile	LR	Liberia	SZ	Swaziland
CM	Cameroon	LS	Lesotho	TC	Turks and Caicos Islands
CN	China	LT	Lithuania	TD	Chad
CO	Colombia	LU	Luxembourg	TG	Togo
CR	Costa Rica	LV	Latvia	TH	Thailand
CU	Cuba	LY	Libyan Arab Jamahiriya	TJ	Tajikistan
CV	Cape Verde	MA	Morocco	TL	Timor-Leste
CY	Cyprus	MC	Monaco	TM	Turkmenistan
CZ	Czech Republic	MD	Republic of Moldova	TN	Tunisia
DE	Germany	ME	Montenegro	TO	Tonga
DJ	Djibouti	MG	Madagascar	TR	Turkey
DM	Dominica	MK	The former Yugoslav Republic of Macedonia	SE	Sweden
DO	Dominican Republic	ML	Mali	TT	Trinidad and Tobago
DZ	Algeria	MM	Myanmar	TV	Tuvalu
EA	Eurasian Patent Organization (EAPO)	MN	Mongolia	TW	Taiwan, Province of China
EC	Ecuador	MO	Macao	TZ	United Republic of Tanzania
EE	Estonia	MP	Northern Mariana Islands	UA	Ukraine
EG	Egypt	MR	Mauritania	UG	Uganda
EH	Western Sahara	MS	Montserrat	US	United States of America
EM	Office for Harmonization in the Internal Market (Trademarks and Designs)(OHIM)	MT	Malta	UY	Uruguay
EP	European Patent Office (EPO)	MU	Mauritius	UZ	Uzbekistan
ER	Eritrea	MV	Maldives	VA	Holy See
ES	Spain	MW	Malawi	VC	Saint Vincent and the Grenadines
ET	Ethiopia	MX	Mexico	VE	Venezuela
FI	Finland	MY	Malaysia	VG	Virgin Islands (British)
FJ	Fiji	MZ	Mozambique	VN	Viet Nam
FK	Falkland Islands (Malvinas)	NA	Namibia	VU	Vanuatu
FO	Faroe Islands			WO	World Intellectual Property Organization (WIPO)
FR	France			WS	Samoa
GA	Gabon			XN	Nordic Patent Institute (NPI)
GB	United Kingdom			YE	Yemen
GC	Patent Office of the Cooperation Council for the Arab States of the Gulf (GCC)			ZA	South Africa
				ZM	Zambia
				ZW	Zimbabwe

# **OFFICIAL BULLETIN OF THE INDUSTRIAL PROPERTY**

## **2(534)**

**INVENTIONS  
UTILITY MODELS  
DESIGNS  
TRADEMARKS  
APPELLATIONS OF ORIGIN OF GOODS**

DATE OF PUBLICATION: 2020 01 27

# CONTENTS

<b>PUBLISHED TITLES OF PROTECTION</b> .....	3
<b>INVENTIONS</b>	
▪ APPLICATIONS APPROVED FOR GRANTING PATENTS .....	4
▪ PATENTED INVENTIONS .....	8
<b>UTILITY MODEL</b>	
▪ APPLICATIONS APPROVED FOR GRANTING PATENTS .....	10
▪ PATENTED UTILITY MODELS .....	12
<b>DESIGNS</b>	
▪ APPLICATIONS APPROVED FOR REGISTRATION .....	13
▪ REGISTERED DESIGNS .....	16
▪ DESIGN REGISTERED ACCORDING TO THE ACCELERATED PROCEDURE .....	17
<b>TRADEMARKS</b>	
▪ APPLICATIONS FILED UNDER THE NATIONAL PROCEDURE APPROVED FOR REGISTRATION .....	18
▪ REGISTERED TRADEMARKS .....	26
▪ TRADEMARKS REGISTERED ACCORDING TO THE ACCELERATED PROCEDURE .....	32
▪ INTERNATIONAL TRADEMARKS FOR WHICH A DECISION ON GRANTING PROTECTION IS TAKEN .....	34
▪ INTERNATIONAL TRADEMARKS PROTECTED IN GEORGIA .....	79
<b>APPELLATIONS OF ORIGIN OF GOODS</b>	
▪ WINES AKHMETA, TSARAPI SPECIFICATION .....	89
<b>OFFICIAL NOTIFICATIONS</b>	
<b>INVENTIONS</b>	
▪ EXPIRATION OF PATENTS RESTORATION .....	99
▪ ABOLITION OF PATENTS WITH THE RIGHT TO RESTORE .....	101
<b>UTILITY MODELS</b>	
▪ EXPIRATION OF PATENTS RESTORATION .....	105
▪ ABOLITION OF PATENTS WITH THE RIGHT TO RESTORE .....	105
▪ EXPIRATION OF TERM OF RESTORATION OF PATENT .....	108
<b>DESIGNS</b>	
▪ EXTENSION OF REGISTRATION VALIDITY OF DESIGNS.....	108
▪ TRANSFER OF RIGHT .....	108
▪ EXTENSION OF REGISTRATION OF INTERNATIONAL DESIGNS .....	109
▪ CANCELLATION OF INTERNATIONAL DESIGNS REGISTRATION .....	110
<b>TRADEMARKS</b>	
▪ RENEWAL OF REGISTRATIONS .....	111
▪ COMPLET TRANSFER OF RIGHTS .....	115
▪ CHANGES OF NAMES AND/OR ADDRESSES OF OWNERS .....	116
▪ TERMINATION OF TRADEMARKS REGISTRATION .....	120
<b>CLASSIFICATION INDEXES</b>	
INVENTIONS .....	125
UTILITY MODELS .....	127
DESIGNS .....	128
TRADEMARKS .....	130

## **PUBLISHED TITLES OF PROTECTION**

### **INVENTIONS**

- **APPLICATIONS APPROVED FOR GRANTING PATENT:**  
14717; 14494; 14824; 14609; 14748; 14438; 14693; 14060; 12594
- **PATENTED INVENTIONS:**  
7057-7062

### **UTILITY MODEL**

- **APPLICATION APPROVED FOR GRANTING PATENT:**  
15039; 15142; 14985
- **PATENTED UTILITY MODELS:**  
2030, 2031

### **DESIGNS**

- **APPLICATIONS APPROVED FOR GRANTING PATENT:**  
1096; 1101
- **REGISTERED DESIGNS:**  
832-834
- **DESIGN REGISTERED ACCORDING TO THE ACCELERATED PROCEDURE:**  
835

### **TRADEMARKS**

- **APPLICATIONS FILED UNDER THE NATIONAL PROCEDURE APPROVED FOR REGISTRATION:**  
102918; 103015; 103217; 103438-103442; 103449-103451; 103461, 103462; 103468; 103471, 103472; 103481, 103482; 103560; 103562, 103563; 103567, 103568; 103576; 103584; 103588; 103590, 103591; 103663, 103664; 103670; 103678; 103680; 103690; 103700; 103773; 103775, 103776; 103779; 103786-103788; 103844, 103845; 103858; 103861; 103962, 103963
- **REGISTERED TRADEMARKS:**  
8942; 32209-32269
- **TRADEMARKS REGISTERED ACCORDING TO THE ACCELERATED PROCEDURE:**  
32204-32208; 32270; 32272
- **INTERNATIONAL TRADEMARKS FOR WHICH A DECISION ON GRANTING PROTECTIONS IS TAKEN:**  
100569\*; 101749; 102282; 102285; 102297; 102412, 102413; 102427; 102486; 102570-102579; 102581; 102593-102603; 102639-102647; 102649-102661; 102665, 102666; 102766; 102768, 102769; 102771; 102907; 102911; 102937-102941; 103035-103038; 103130-103133; 103229-103234; 103382; 103404; 103406, 103407; 103489-103491; 103494, 103495; 103536; 103538
- **INTERNATIONAL TRADEMARKS PROTECTED IN GEORGIA:**  
96959; 97488; 97519; 98129; 98336; 99534; 100468; 100623; 100757; 100844, 100845; 100852, 100853; 100856; 100945; 100985; 100998; 101000-101006; 101008-101011; 101013-101016; 101039; 101041; 101064; 101078; 101086-101089; 101104; 101108; 101128-101131; 101190; 101192-101194; 101323; 101325-101328; 101351; 101358; 101435; 101460, 101461; 101483; 101485-101491; 101533; 101537, 101538; 101580; 101593-101595; 101597, 101598; 101746- 101748; 101757, 101758; 101774-101776, 101778-101788; 101791; 101793, 101794; 101804-101811; 101833-101835; 101884-101889; 101891; 101893, 101894; 101898; 101934; 101936; 101946; 101948; 101950; 101994, 101995; 102007-102013

### **APPELLATIONS OF ORIGIN OF GOODS**

- **WINES SPECIFICATION:**  
AKHMETA, TSARAPI

# INVENTIONS

## APPLICATIONS APPROVED FOR GRANTING PATENTS

The decision can be appealed at the Chamber of Appeal of Sakpatenti within 3 months from the publication or at the Mtskheta District Court Administrative Cases Board (Address: №17, Samkhedro str., Mtskheta), within 1 month following the publication.

### PART A

#### A 61

(10) AP 2020 14717 A (51) Int. Cl. (2006)  
A 61 K 31/16  
A 61 P 25/32  
C 07 C 235/06

(21) AP 2016 14717 (22) 2016 08 03  
(31) 102015000041820  
(32) 2015 08 04  
(33) IT  
(71) Laboratorio Farmaceutico C.T.S.R.L. (IT)  
Via Dante Alighieri 71, 18038 Sanremo (IT)  
(72) CACCIAGLIA, Roberto (IT);  
LOCHE, Antonella (IT)  
(74) Shalva Gvaramadze  
(85) 2018 03 01  
(86) PCT/EP2016/068517, 2016 08 03  
(54) **SELECTED AMIDE OF  $\gamma$ -HYDROXYBUTYRIC ACID AND USES THEREOF IN THE TREATMENT OF ALCOHOL MISUSE**

(57) Present invention relates to selected amide of  $\gamma$ -hydroxybutyric acid, a process of manufacture and uses thereof. The invention also includes pharmaceutical composition comprising an effective amount of selected compound of invention for use in preventing or treating drug addiction, especially alcohol misuse or dependency.

Claims: 7 independent  
5 dependent

Fig.: 8

(10) AP 2020 14494 A (51) Int. Cl. (2006)  
A 61 K 31/47  
A 61 P 35/00  
C 07 D 401/04

(21) AP 2015 14494 (22) 2015 10 26  
(31) 62/073,325  
(32) 2014 10 31  
(33) US  
(71) GENOSCIENCE PHARMA (FR)  
10, rue d'Iena 13006 Marseille (FR)  
(72) NICOLAS, Gregory (FR);  
HALFON, Philippe (FR);  
BASSISSI, Firas (FR);

DUBRAY, Clarisse (FR);  
BRUN, Sonia (FR);  
COURCAMBECK, Jérôme (FR);  
BERET, Antoine (FR)

(74) Tamaz Shilakadze  
(85) 2017 05 17  
(86) PCT/IB2015/002438, 2015 10 26  
(54) **SUBSTITUTED 2,4 DIAMINO-QUINOLINE AS NEW ANTICANCER AGENTS**

(57) Present invention relates to 2-primary amino-4-secondary amino-quinoline derivatives of formula I,

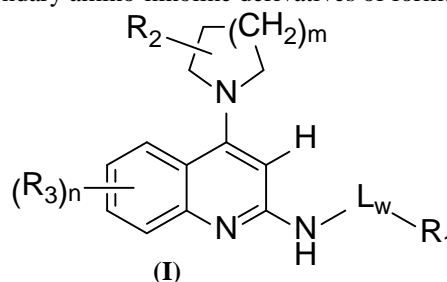

preparation method thereof, pharmaceutical compositions containing them, and their usage for proliferate neoplastic and nonneoplastic diseases treatment.

Claims: 11 independent  
8 dependent

Fig.: 6

(10) AP 2020 14824 A (51) Int. Cl. (2006)  
A 61 K 31/437  
A 61 P 11/00  
C 07 D 471/04

(21) AP 2016 14824 (22) 2016 12 07  
(31) 15199270.8; 16196836.7  
(32) 2015 12 10; 2016 11 02  
(33) EP; EP  
(71) Bayer Pharma Aktiengesellschaft (DE)  
Müllerstr. 178, 13353 Berlin (DE)  
(72) ALBUS, Udo (DE);  
GEHRING, Doris (DE);  
ROSENSTEIN, Björn (DE);  
DELBECK, Martina (DE);  
MOSIG, Johanna (DE);  
HAHN, Michael (DE);  
MÜLLER, Thomas (DE);  
MEIER, Heinrich (DE);

LUSTIG, Klemens (DE);  
TOSCHI, Luisella (DE)

(74) Giorgi Kartvelishvili

(85) 2018 07 06

(86) PCT/EP2016/079973, 2016 12 07

(54) **2-PHENYL-3-(PIPERAZINOMETHYL)IMIDAZO[1,2-A]PYRIDINE DERIVATIVES AS BLOCKERS OF TASK-1 AND TASK-2 CHANNELS, FOR THE TREATMENT OF SLEEP-RELATED BREATHING DISORDERS**

(57) The invention relates to new 2-phenyl-3-(piperazinomethyl)imidazo[1,2-a]pyridine derivative, preparation method thereof, and their usage for the treatment and/or prevention of breathing disorders including sleep-related breathing disorders such as obstructive and central sleep apnea and snoring.

Claims: 11 independent

2 dependent

(10) AP 2020 14609 A (51) Int. Cl. (2006)

A 61 K 31/551

A 61 K 31/5415

A 61 P 31/04

C 07 D 281/02

C 07 D 279/08

(21) AP 2016 14609

(22) 2016 03 23

(31) 15160267.9

(32) 2015 03 23

(33) EP

(71) ECOLE POLYTECHNIQUE FEDERALE DE LAUSANNE (EPFL) (CH)

EPFL Innovation Park J 1015 Lausanne (CH)

(72) STEWART, Cole (CH);

MAKAROV, Vadim, Albertovich (RU)

(74) Tamar Kochlamazashvili

(85) 2017 10 20

(86) PCT/EP2016/056371, 2016 03 23

(54) **2-HOMOPIPERAZINE-1-YL-4H-1,3-BENZOTHIAZINE-4-ONE DERIVATIVES AND PROCESS FOR THE PREPARATION OF 2- (HOMO)PIPERAZINE 1,3-BENZOTHIAZINE-4-ONE HYDROCHLORIDES**

(57) Preparation method for 2-homopiperazine-1-yl-4H-1, 3-benzothiazine-4-one and 2-(homo) piperazine 1, 3-benzothiazine-4-one hydrochlorides.

Claims: 2 independent

7 dependent

Table: 1

(10) AP 2020 14748 A (51) Int. Cl. (2006)

A 61 K 38/03

A 61 K 31/465

A 61 K 38/08

A 61 P 35/00

C 07 D 213/61

C 07 K 7/02

G 01 N 33/68

(21) AP 2016 14748

(22) 2016 09 19

(31) 15002800.9; 16164090.9; 16182764.7

(32) 2015 09 30; 2016 04 06; 2016 08 04

(33) EP; EP; EP

(71) RUPRECHT-KARLS-UNIVERSITÄT HEIDELBERG (DE)

Grabengasse 1, 69117 Heidelberg (DE);  
DEUTSCHES KREBSFORSCHUNGSZENTRUM (DE)

Im Neuenheimer Feld 280 69120

Heidelberg (DE)

(72) HABERKORN, Uwe (DE);

GIESEL, Frederik (DE);

EDER, Matthias (DE);

CARDINALE, Jens (AT);

BENESOVA, Martina (DE);

SCHÄFER, Martin (DE);

KOPKA, Klaus (DE);

BAUDER-WUEST, Ulrike (DE);

EISENHUT, Michael (DE)

(74) Shalva Gvaramadze

(85) 2018 04 12

(86) PCT/EP2016/001573, 2016 09 19

(54) **18F-TAGGED INHIBITORS OF PROSTATE SPECIFIC MEMBRANE ANTIGEN (PSMA) AND THEIR USE AS IMAGING AGENTS FOR PROSTATE CANCER**

(57) Present invention relates to the field of radiopharmaceuticals and their usage as prostate cancer visualization agents.

Claims: 9 independent

2 dependent

Fig.: 20



**PART C****C 04**

(10) AP 2020 14438 A (51) Int. Cl. (2006)  
**C 04 B 28/04**  
**C 04 B 38/08**  
**C 04 B 111/60**

(21) AP 2017 14438 (22) 2017 02 28  
 (71) LEPL LEVAN SAMKHARAULI  
 NATIONAL FORENSICS BUREAU (GE)  
 Il. Chavchavadze Ave. 84, 0162, Tbilisi (GE)  
 (72) Bela Keshelava (GE);  
 Razhden Skhvitaridze (GE);  
 Giorgi Tsintskladze (GE);  
 Malkhaz Turdzeladze (GE);  
 Merab Abazadze (GE)

(74) Liana Chumburidze

(54) **STRUCTURAL LIGHT-WEIGHT  
 CONCRETE**

(57) Structural light-weight concrete includes: Portland cement, light-weight filler – pumice stone, a filler activated with milling, a plasticizer and water; at that, shaly clay activated with nano-modification after thermal treatment at 550-650°C with mechanical greeding and whole passing through a riddle of size 014 is used as filler activated with milling; in the certaion correlation of componetry, in mass %.

Claims: 1 independent

Table: 1

**C 05**

(10) AP 2020 14693 A (51) Int. Cl. (2006)  
**C 05 C 9/00**  
**C 05 C 3/00**  
**C 05 G 3/00**

(21) AP 2016 14693 (22) 2016 07 06  
 (31) 15175476.9  
 (32) 2015 07 06  
 (33) NL  
 (71) STAMICARBON B.V. (NL)  
 Mercator 3, NL-6135 KW Sittard (NL)  
 (72) SOONS, Petrus Catharina Gerlach (NL);  
 SCHAAF SMA, Stefan Hendrikus (NL)  
 (74) Liliana Darakhvelidze  
 (85) 2018 02 06

(86) PCT/NL2016/050486, 2016 07 06

(54) **GRANULATION OF UREA PRODUCTS**

(57) Disclosed is a method of making a granulate of a urea product comprising urea and a salt, such as urea ammonium sulfate, having a high content of the salt. The high content is such as to provide an amount of the salt above the limit of solubility of the salt in urea. The granulate of the invention is characterized by having a smooth surface, which,

e.g. in the event of urea ammonium sulfate, is not normally the case for granulate having the aforementioned high ammonium sulfate content. According to the invention this is realized by dividing the feed liquids to granulation. This division is based on non-final granulation liquids of a sufficiently high content of the salt, and a final granulation liquid (determining the surface) having a salt content of below the solubility limit of the salt, or no salt at all. E.g. in the event of urea ammonium sulfate, the non-final granulation liquids possibly are a slurry of urea and more than 20 wt.% of ammonium sulfate. The final granulation liquid then has 0-20 wt.% of ammonium sulfate, i.e. below the solubility limit.

Claims: 3 independent

7 dependent

Fig.: 2

**C 07**

(10) AP 2020 14060 A (51) Int. Cl. (2006)  
**C 07 C 311/46**  
**A 61 K 31/18**

(21) AP 2014 14060 (22) 2014 07 18

(31) 61/856,146

(32) 2013 07 19

(33) US

(71) Vertex Pharmaceuticals Incorporated (US)  
 50 Northern Avenue Boston, MA 02210 (US)

(72) HADIDA-RUAH, Sara Sabina (US);

ANDERSON, Corey (US);

TERMIN, Andreas P. (US);

BEAR, Brian Richard (US);

ARUMUGAM, Vijayalaksmi (US);

KRENITSKY, Paul (US);

JOHNSON, James Philip (US)

(74) Shalva Gvaramadze

(85) 2016 02 15

(86) PCT/US2014/047265, 2014 07 18

(54) **SULFONAMIDES AS MODULA-  
 TORS OF SODIUM CHANNELS**

(57) An invention relates to compounds of formula I,

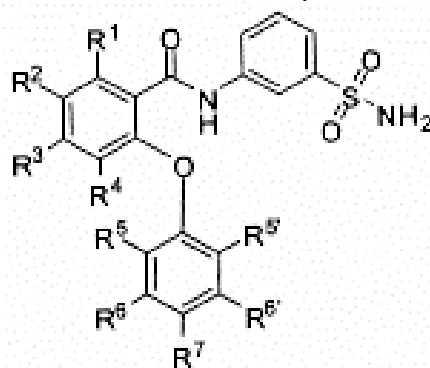

(I)

pharmaceutically acceptable salts thereof, pharmaceutical compositions containing them, and their

usage for the treatment of various disorders, e.g. pain.

Claims: 10 independent  
48 dependent

preparation method thereof, intermediate compounds used in the method, and preparation methods thereof.

Claims: 10 independent  
11 dependent

(10) AP 2020 12594 A (51) Int. Cl. (2006)

C 07 C 315/00

C 07 D 209/52

C 07 C 237/02

C 07 K 5/06

(21) AP 2010 12594 (22) 2010 07 27

(31) 61/229,613; 61/229,648; 61/229,636;  
61/229,652; 61/229,618

(32) 2009 07 29; 2009 07 29; 2009 07 29;  
2009 07 29; 2009 07 29

(33) US; US; US; US; US

(71) MERCK SHARP & DOHME CORP. (US)  
126 East Lincoln Ave., Rahway,  
07065 NJ (US)

(72) TRAVERSE, John (US);  
LEONG, William, W. (US);  
MILLER, Steven, P. (US);  
ALBANEZE-WALKER, Jennifer (US);  
HUNTER, Thomas, J. (US);  
WANG, Lijun (CN);  
LIAO, Hongbiao (CN);  
ARASAPPAN, Ashok (US);  
TRZASKA, Scott, T. (US);  
SMITH, Randi, M. (US);  
LEKHAL, Azzeddine (DZ);  
BOGEN, Stephane, L. (FR);  
KONG, Jianshe (US);  
BENNETT, Frank (GB);  
NJOROGE, F., George (US);  
POIRIER, Marc (CA);  
KUO, Shen-Chun (CN);  
CHEN, Yonggang (CN);  
MATTHEWS, Kenneth (US);  
DEMONCHAUX, Patrice (FR);  
FERREIRA, Amadeo (FR)

(74) Shalva Gvaramadze

(85) 2012 02 23

(86) PCT/US2010/043356, 2010 07 27

(54) **ENANTIO- AND STEREO-SPECIFIC  
SYNTHESIS OF  $\beta$ -AMINO- $\alpha$ -HYDROXY  
AMIDES**

(57) An invention relates to compound of formula I

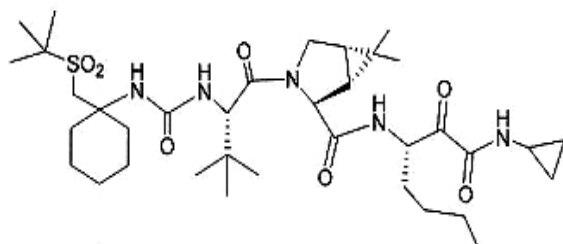

(I)

# PATENTED INVENTIONS

## PART A

### A 61

- (11) **P 2020 7057 B** (51) **Int. Cl. (2006)**  
**A 61 K 31/437**  
**A 61 K 31/519**  
**C 07 D 487/04**
- (10) AP 2019 14901 A (44) 18/(526) 2019  
 (21) AP 2017 14901  
 (22) 2017 04 07  
 (24) 2017 04 07  
 (31) AP201600221  
 (32) 2016 04 12  
 (33) DK  
 (86) PCT/EP2017/058332, 2017 04 07  
 (73) H. LUNDBECK A/S (DK)  
 Ottiliavej 9 2500 Valby (DK)  
 (72) RASMUSSEN, Lars, Kyhn (DK);  
 KEHLER, Jan (DK);  
 MARIGO, Mauro (DK);  
 VITAL, Paulo, Jorge, Vieira (DK);  
 LANGGÅRD, Morten (DK);  
 JESSING, Mikkel (DK);  
 JUHL, Karsten (DK)  
 (74) Tamaz Shilakadze  
 (54) **1,5-DIHYDRO-4H-PYRAZOLO[3,4-D]  
 PYRIMIDIN-4-ONES AND 1,5-DIHYDRO-  
 4H-PYRAZOLO[4,3-C]PYRIDIN-4-ONES  
 AS PDE1 INHIBITORS**

- (11) **P 2020 7058 B** (51) **Int. Cl. (2006)**  
**A 61 K 31/4985**  
**A 61 P 25/00**  
**C 07 D 487/04**
- (10) AP 2019 14615 A (44) 18/(526) 2019  
 (21) AP 2016 14615  
 (22) 2016 04 29  
 (24) 2016 04 29  
 (31) PA201500261; PA201600202; PA201500666  
 (32) 2015 04 30; 2016 04 04; 2015 10 29  
 (33) DK; DK; DK  
 (86) PCT/EP2016/059583, 2016 04 29  
 (73) H. LUNDBECK A/S (DK)  
 Ottiliavej 9 2500 Valby (DK)  
 (72) VITAL, Paulo, Jorge, Vieira (DK);  
 KEHLER, Jan (DK);  
 RASMUSSEN, Lars, Kyhn (DK);  
 LANGGÅRD, Morten (DK);  
 JESSING, Mikkel (DK);  
 JUHL, Karsten (DK)  
 (74) Tamaz Shilakadze

- (54) **IMIDAZOPYRAZINONES AS PDE1  
 INHIBITORS**

## PART B

### B 22

- (11) **P 2020 7061 B** (51) **Int. Cl. (2006)**  
**B 22 D 11/06**
- (10) AP 2019 14718 A (44) 18/(526) 2019  
 (21) AP 2018 14718  
 (22) 2018 03 01  
 (24) 2018 03 01  
 (73) Tamaz Jaliashvili (GE)  
 Mshenebeli St. 4, ap. 3, 3700, Rustavi (GE);  
 Omar Mikadze (GE)  
 Paliashvili St.. 55, ap. 26, 0179, Tbilisi (GE);  
 Vasil Kopaleishvili (GE)  
 Abashidze St. 68, ap. 47, 0162, Tbilisi (GE);  
 Otar Barbakadze (GE)  
 Moscow Ave. V kv., korp. 7, ap. 26,  
 0145, Tbilisi (GE)  
 (72) Tamaz Jaliashvili (GE);  
 Omar Mikadze (GE);  
 Vasil Kopaleishvili (GE);  
 Otar Barbakadze (GE)  
 (54) **METALLIC PLATE CONTINUES  
 CASTING DEVICE**

### B 41

- (11) **P 2020 7059 B** (51) **Int. Cl. (2006)**  
**B 41 J 5/10**  
**G 06 F 3/02**
- (10) AP 2019 14785 A (44) 18/(526) 2019  
 (21) AP 2016 14785  
 (22) 2016 11 18  
 (24) 2016 11 18  
 (31) 15472003.1  
 (32) 2015 11 19  
 (33) EP  
 (86) PCT/EP2016/078194, 2016 11 18  
 (73) CPD LTD. (BG)  
 15-17, Tintyava str. 1113 Sofia (BG)  
 (72) TOROMANOV, Slavcho Hristov (BG)  
 (74) Shalva Gvaramadze  
 (54) **BUTTON FOR KEYBOARD AND  
 KEYBOARD**

**B 67**

- (11) P 2020 7060 B (51) Int. Cl. (2006)  
**B 67 D 1/04**  
**B 67 D 1/06**  
**F 16 K 11/18**
- (10) AP 2019 14931 A (44) 18/(526) 2019  
(21) AP 2016 14931  
(22) 2016 07 27  
(24) 2016 07 27  
(86) PCT/RU2016/000486, 2016 07 27  
(73) BUCHIK, Sergei Aleksandrovich (RU)  
Romanov St. 39, ap. 143, 630091,  
Novosibirsk (RU)  
(72) BUCHIK, Sergei Aleksandrovich (RU)  
(74) Shalva Gvaramadze  
(85) 2018 11 22  
(86) PCT/RU2016/000486, 2016 07 27  
(54) **FLOW SWITCH FOR A DEVICE FOR  
MANUALLY POURING FOAMED AND  
CARBONATED BEVERAGES**

(54) **TUNNEL CONSTRUCTION METHOD  
USING PRE-SUPPORT AND POST-  
SUPPORT AND APPARATUS SUITABLE  
FOR SAME**

**PART E****E 21**

- (11) P 2020 7062 B (51) Int. Cl. (2006)  
**E 21 D 9/00**  
**E 21 D 11/00**  
**E 21 D 11/10**  
**E 21 D 20/02**  
**E 21 D 13/00**
- (10) AP 2019 14719 A (44) 18/(526) 2019  
(21) AP 2016 14719  
(22) 2016 11 23  
(24) 2016 11 23  
(31) 10-2015-0165207  
(32) 2015 11 25  
(33) KR  
(86) PCT/KR2016/013542, 2016 11 23  
(73) SEO, Dong-hyun (KR)  
606 Ho, Kolon Digital Tower Aston, 212  
Gasam Digital 1-ro, Geumcheon-gu, Seoul  
153-803 (KR);  
SEO, Min-kyu (KR)  
606 Ho, Kolon Digital Tower Aston, 212  
Gasam Digital 1-ro, Geumcheon-gu, Seoul  
153-803 (KR);  
HYUN ENGINEERING AND  
CONSTRUCTION CO., LTD. (KR)  
925 Ho, 358-39 Hosu-ro, Ilsandong-gu  
Goyang-city, Gyeonggi-do 410-360 (KR)  
(72) SEO, Min-kyu (KR);  
SEO, Dong-hyun (KR)  
(74) Aleksandre Gegechkori

# UTILITY MODELS

## APPLICATIONS APPROVED FOR GRANTING PATENT

The decision can be appealed at the Chamber of Appeal of Sakpatenti within 3 months from the publication or at the Mtskheta District Court Administrative Cases Board (Address: №17, Samkhedro str., Mtskheta), within 1 month following the publication.

### PART A

#### A 01

(10) AU 2020 15039 U (51) Int. Cl. (2006)  
A 01 D 46/04

- (21) AU 2019 15039 (22) 2019 04 01  
(71) Bakhva Dolidze (GE);  
Iakob Shemokmedi St. 32, Ozurgeti (GE);  
Zurab Andghuladze (GE)  
Chavchavadze St. 10, Ozurgeti (GE);  
Temur Revishvili (GE)  
University St. 9, app. 13, Ozurgeti (GE);  
Liana Shavishvili (GE)  
Metsniereba St. 13, app. 2, Ozurgeti (GE)  
(72) Bakhva Dolidze (GE);  
Zurab Andghuladze (GE);  
Temur Revishvili (GE);  
Liana Shavishvili (GE)

#### (54) AGGREGATE FOR CUTTING TEA-PLANT

(57) An aggregate includes connected to vehicle – motor cultivator by means hinge system, equipped with a drive the apparatus 2 for cutting of tea-plant. Hinge system is side hinge system and executed as a frame consisting of cross bar girt 3 and vertical posts 4. The frame is mounted onto the motor cultivator, from one side, and disposed from another side the frame vertical post is equipped with supporting wheel 5. The aggregate has a node for tea-plant compaction, that is a plate 15 installed onto the motor cultivator, from the side.

Claims: 1 independent  
2 dependent

Fig.: 2

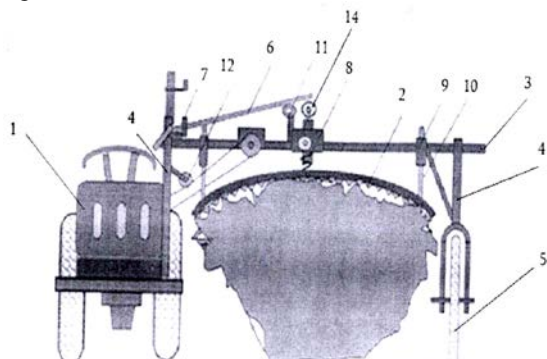

Fig. 1

(10) AU 2020 15142 U (51) Int. Cl. (2006)  
C 25 C 7/00  
C 25 C 7/08

- (21) AU 2019 15142 (22) 2019 07 19  
(71) Tsisana Gagnidze (GE)  
Vazha-Pshavela Ave. 15a, ap. 35, 0160,  
Tbilisi (GE);  
Zhiuli Keadze (GE)  
Nutsubidze III mcr., II kv., korp. 2, ap. 69,  
0186, Tbilisi (GE);  
Rusudan Chagelishvili (GE)  
Zakariadze St. 3, ap. 16, 0177, Tbilisi (GE);  
Vazha Chagelishvili (GE)  
Dariali Turn 6, 0162, Tbilisi (GE)  
(72) Tsisana Gagnidze (GE);  
Zhiuli Keadze (GE);  
Rusudan Chagelishvili (GE);  
Vazha Chagelishvili (GE)

#### (54) ELECTROCHEMICAL REACTOR FOR PIT-RUN AND INDUSTRIAL WASTE WATERS TREATMENT

(57) A reactor includes cylindrical case 1 with conic bottom 3 disposed in the center of volumetric porous flowing carbonaceous cathode pack 4 having mechanical mixer 7; at that, cathode pack consists of perforated carbonaceous material – "Ural TM-4-22".

Claims: 1 independent  
Fig.: 1

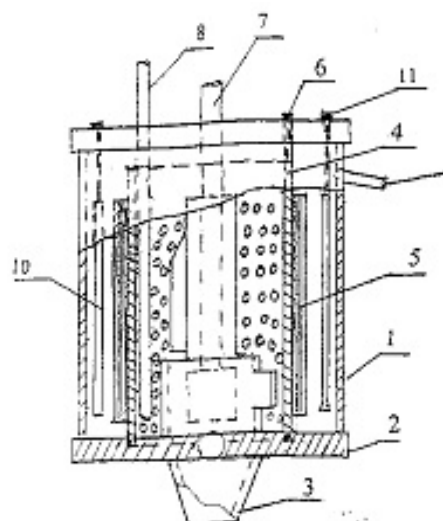

Fig. 1

## PART G

### G 07

(10) AU 2020 14985 U (51) Int. Cl. (2006)  
G 07 F 19/00

(21) AU 2019 14985 (22) 2019 01 13

(71) Levan Sharangia (GE)

Svanidze St. 7, Sokhumi, Georgia (GE)

(72) Levan Sharangia (GE);

Giorgi Gvenetadze (GE)

(54) **CURRENCY EXCHANGE TERMINAL**

(57) There is represented currency exchange terminal including currency exchange reception for bank notes and/or coins of various nominal cost; a device treating bank notes and/or coins placed in currency exchange reception; currency distributing device configured with delivery of bank notes and/or coins corresponding of exchange currency whole cost; at least one keeping currency container with corresponding bank notes and/or coins is functionally connected with currency distributing device.

Claims: 1 independent

5 dependent

Fig.: 1

---

---

**PATENTED UTILITY MODELS****PART A****A 61**

Akaki Peikrishvili (GE);  
Bagrat Godibadze (GE)  
(54) **METHOD FOR SUPERCONDUCTING  
COMPOSITE MGB<sub>2</sub> PREPARATION**

---

- (11) U 2020 2030 Y (51) **Int. Cl. (2006)**  
**A 61 P 5/48**
- (10) AU 2019 14928 U (44) 16/(524)2019  
(21) AU 2018 14928  
(22) 2018 11 20  
(24) 2018 11 20  
(73) Marine Nikolaishvili (GE)  
Shevardenidzis q. 9, b. 13, 0160, Tbilisi,  
Georgia (GE);  
Tea Museliani (GE)  
Kostavas q. 1, Lentekhis r-ni, Georgia (GE);  
Elene Giorgadze (GE)  
D. Aghmasheneblis gamz. 181, b. 17,  
Tbilisi, Georgia (GE);  
Natia Chkheidze (GE)  
Chikovanis q. 85b, Tbilisi, Georgia (GE)  
(72) Marine Nikolaishvili (GE)  
(54) **THERAPEUTIC AGENT FOR TYPE II  
DIABETES**
- 

**PART C****C 22**

- (11) U 2020 2031 Y (51) **Int. Cl. (2006)**  
**C 22 C 12/00**
- (10) AU 2019 14800 U (44) 14/(522)2019  
(21) AU 2018 14800  
(22) 2018 05 29  
(24) 2018 05 29  
(73) Tatiana Gegechkori (GE)  
Vazha-Pshavelas gamz., VI kvart.,  
korp. 38, sad. I, b. 3, 0186, Tbilisi (GE);  
Grigor Mamniashvili (GE)  
Vazha-Pshavelas gamz., VI kvart.,  
korp. 38, sad. I, b. 3, 0186, Tbilisi (GE);  
Vakhtang Peikrishvili (GE)  
Mtskhetis q. 33, 0162, Tbilisi (GE),  
Akaki Peikrishvili (GE)  
Shartavas q. 16, b. 32, 0175, Tbilisi (GE);  
Bagrat Godibadze (GE)  
Nutsbidzis Plato IV mkr., korp. 10v.,  
b. 60, 0183, Tbilisi (GE)  
(72) Tatiana Gegechkori (GE);  
Grigor Mamniashvili (GE);  
Vakhtang Peikrishvili (GE);
-

---

# DESIGNS

## APPLICATIONS APPROVED FOR REGISTRATION

The decision can be appealed at the Chamber of Appeal of Sakpatenti within 3 months from the publication or at the Mtskheta District Court Administrative Cases Board (Address: №17, Samkhedro str., Mtskheta), within 1 month following the publication.

- (10) AD 2020 1096 S      (51) 01-99  
(21) AD 2019 1096      (22) 2019 07 15  
(28) 5  
(71) Archil Gavashelishvili (GE)  
     Nutsubidze Plateau, IV mcr., bld. 29, app. 43, 0183, Tbilisi (GE)  
(72) Archil Gavashelishvili (GE)  
(54) 1.-5. DRIED "TATARA" (SWEET OF WINE JUICE)  
(55)



1.1



1.2



1.3



2.1



2.2



2.3



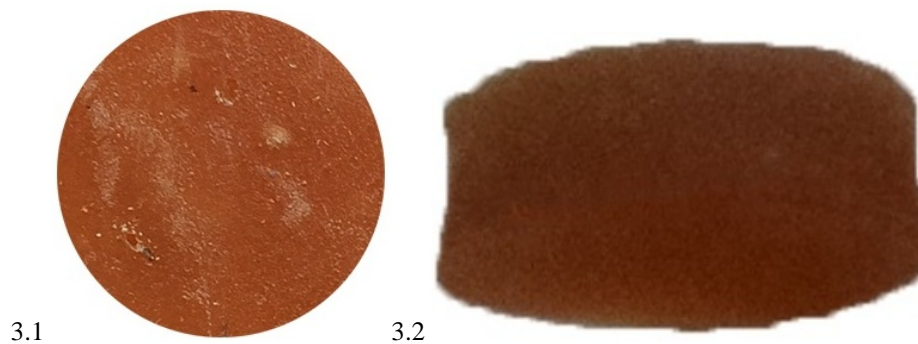

(10) AD 2020 1101 S (51) 03-01  
(21) AD 2019 1101 (22) 2019 08 30  
(28) 5  
(71) Ekaterine Tchapodze (GE)  
D. Aghmashenebeli St. 15, 3500, Ozurgeti (GE)  
(72) Ekaterine Tchapodze (GE)  
(54) 1.-5. BAGS  
(55)



1.1



2.1



2.2



2.3



3.1



4.1



5.1

## REGISTERED DESIGNS

**(11) D 2020 834 S**      **(51) 02-04**  
(10) AD 2019 1087 S      (44) 2019 10 10 №19  
(21) AD 2019 1087  
(22) 2019 04 30  
(24) 2019 04 30  
(28) 2  
(18) 2024 04 30  
(73) Dato Beridze (GE)  
    D. Aghmashenebeli St. 20, ap. 31, 6000,  
    Batumi (GE)  
(72) Dato Beridze (GE)  
(74) Shalva Gvaramadze (GE)  
(54) **1. RUBBER BOOTS, 2. RUBBER SHOES**

---

**(11) D 2020 832 S**      **(51) 03-01**  
(10) AD 2019 1091 S      (44) 2019 09 25 №18  
(21) AD 2019 1091  
(22) 2019 05 28  
(24) 2019 05 28  
(28) 11  
(18) 2024 05 28  
(73) Nino Giorgadze (GE)  
    I. Abashidze St. 69, ap. 13, 0162, Tbilisi (GE)  
(72) Nino Giorgadze (GE)  
(54) **1.-11. HANDBAGS**

---

**(11) D 2020 833 S**      **(51) 06-01**  
(10) AD 2019 1080 S      (44) 2019 09 25 №18  
(21) AD 2019 1080  
(22) 2019 03 25  
(24) 2019 03 25  
(28) 1  
(18) 2024 03 25  
(73) LTD "DAISI+" (GE)  
    Saknavti Settlement, Plot 07/006, 0198,  
    Tbilisi (GE)  
(72) Lali Tsitlanadze (GE)  
(54) **CHAIR**

---

---

## DESIGN REGISTERED ACCORDING TO THE ACCELERATED PROCEDURE

The decision can be appealed at the Chamber of Appeal of Sakpatenti within 3 months from the publication.

- (11) D 2020 835 S (51) 09-01  
(21) AD 2019 1110 (22) 2019 10 10  
(24) 2019 10 10  
(28) 1  
(18) 2024 10 10  
(73) Gocha Pipia (GE)  
Budapest St. 11, app. 55, 0160, Tbilisi (GE)  
(72) Gocha Pipia (GE)  
(74) Ramaz Kritchinishvili (GE)  
(54) **TWISTED BOTTLE**  
(55)



1.1



1.2



1.3



1.4



1.5



1.6

# TRADEMARKS

## APPLICATIONS FILED UNDER THE NATIONAL PROCEDURE APPROVED FOR REGISTRATION

The decision can be appealed at the Chamber of Appeal of Sakpatenti within 3 months from the publication or at the Mtskheta District Court Administrative Cases Board (Address: №17, Samkhedro St., Mtskheta), within 1 month following the publication.

(260) AM 2020 102918 A  
(210) AM 102918  
(220) 2019 04 30  
(731) LTD "GEOPERT"  
I. Chavchavadze Av. 39a, Tbilisi,  
Georgia  
(540)

გეო ჰუმატი

Geo Humate

Гео Гумат

(591) Black, white  
(511) 1

(591) Black, white  
(526) Georgia ჯორჯია  
(511) 4

(260) AM 2020 103438 A  
(210) AM 103438  
(220) 2019 06 03  
(731) Hasan Rezay Agdam  
Varketili, III mas., kvart. 10, korp. Iv,  
0182, Tbilisi, Georgia  
(540)

Nobel  
Нобел  
ნობელ

(591) Black, white  
(511) 4

(260) AM 2020 103015 A  
(210) AM 103015  
(220) 2019 05 07  
(731) LTD "ADVENTURE GREEN GEORGIA"  
Uznadze St. 111, ap. 11, build. 2,  
Didube District, Tbilisi, Georgia  
(540)



(591) White, green  
(531) 03.11.10; 26.01.01; 26.01.15; 27.05.02;  
27.05.09; 29.01.03; 29.01.12  
(526) georgia  
(511) 39

(260) AM 2020 103439 A  
(210) AM 103439  
(220) 2019 06 03  
(731) Hasan Rezay Agdam  
Varketili, III mas., kvart. 10, korp. Iv,  
0182, Tbilisi, Georgia  
(540)

Liberty  
Либерти  
ლიბერტი

(591) Black, white  
(511) 4

(260) AM 2020 103217 A  
(210) AM 103217  
(220) 2019 05 23  
(731) LTD "PORTAL"  
Gamrekeli St. 19, office 44, Vake-Saburtalo  
District, Tbilisi, Georgia  
(540)

Portal Petroleum Georgia LLC  
LTD პორტალ პეტროლეუმ ჯორჯია

(260) AM 2020 103440 A  
(210) AM 103440  
(220) 2019 06 03  
(731) Hasan Rezay Agdam  
Varketili, III mas., kvart. 10, korp. Iv,  
0182, Tbilisi, Georgia  
(540)

Topex  
Топекс  
ტოპექს

(591) Black, white  
(511) 4

26.04.02; 26.04.11; 26.04.24; 27.05.01;  
27.05.09; 27.05.10; 27.05.24; 29.01.14

(511) 34

(260) AM 2020 103441 A  
(210) AM 103441  
(220) 2019 06 03  
(731) Hasan Rezay Agdam  
Varketili, III mas., kvart. 10, korp. Iv,  
0182, Tbilisi, Georgia

(260) AM 2020 103450 A  
(210) AM 103450  
(220) 2019 06 03  
(731) PHILIP MORRIS BRANDS SÀRL  
Quai Jeanrenaud 3, Neuchâtel 2000,  
Switzerland

(540)

**Oland**  
**Оланд**  
**ოლანდ**

(740) Shalva Gvaramadze

(540)

(591) Black, white  
(511) 4



(260) AM 2020 103442 A  
(210) AM 103442  
(220) 2019 06 03  
(731) Hasan Rezay Agdam  
Varketili, III mas., kvart. 10, korp. Iv,  
0182, Tbilisi, Georgia

(591) Orange, different tones blue, sky-blue,  
black, gray, white

(531) 02.01.05; 09.07.01; 09.07.25; 10.03.01;  
26.04.02; 26.04.05; 26.04.14; 26.04.17;  
26.04.22; 27.05.09; 27.05.10; 27.05.24;  
29.01.15

(540)

**Kobenz**  
**Кобенз**  
**კობენზ**

(511) 34

(591) Black, white  
(511) 4

(260) AM 2020 103451 A

(210) AM 103451

(220) 2019 06 03

(731) PHILIP MORRIS BRANDS SÀRL  
Quai Jeanrenaud 3, Neuchâtel 2000,  
Switzerland

(260) AM 2020 103449 A  
(210) AM 103449  
(220) 2019 06 03  
(731) PHILIP MORRIS BRANDS SÀRL  
Quai Jeanrenaud 3, Neuchâtel 2000,  
Switzerland

(740) Shalva Gvaramadze

(540)

(740) Shalva Gvaramadze

(540)



(591) Different tones of gray, black, white, gold

(531) 24.07.01; 25.01.01; 26.03.01; 26.03.18;  
26.03.19; 26.03.22; 26.03.23; 26.03.24;

(591) Different tones of red, gray, black, white,  
orange

(531) 02.01.01; 02.01.05; 09.07.01; 09.07.25;  
10.03.01; 26.04.02; 26.04.05; 26.04.12;  
26.04.14; 26.04.22; 26.11.09; 27.05.01;  
27.05.09; 27.05.10; 27.05.24; 29.01.15

(511) 34



(260) AM 2020 103461 A  
 (210) AM 103461  
 (220) 2019 06 04  
 (731) "INMUSIC BRANDS" INC.  
 200 Scenic View Drive Cumberland,  
 RI 02864, USA  
 (740) Giorgi Batlidze  
 (540)



(591) Black, white  
 (531) 26.05.12; 26.05.18; 27.05.01; 27.05.09;  
 27.05.21  
 (511) 9

(260) AM 2020 103462 A  
 (210) AM 103462  
 (220) 2019 06 04  
 (731) "INMUSIC BRANDS" INC.  
 200 Scenic View Drive Cumberland,  
 RI 02864, USA  
 (740) Giorgi Batlidze  
 (540)

**M-GAME**

(591) Black, white  
 (531) 27.05.01  
 (511) 9

(260) AM 2020 103468 A  
 (210) AM 103468  
 (220) 2019 06 05  
 (731) LTD "GOBI"  
 V. Dolidze St., korp. 9, ap. 20, Tbilisi,  
 Georgia  
 (540)

**ორი ლუკმა**

(591) Black, white  
 (511) 30

(260) AM 2020 103471 A  
 (210) AM 103471  
 (220) 2019 06 05  
 (731) LTD "DERCIKI"  
 I. Evdoshvili str. 13, Kutaisi, Georgia

(540)



(591) Black, white, golden  
 (531) 09.01.01; 09.01.03; 09.01.06; 27.05.01;  
 29.01.12  
 (511) 14, 25, 35

(260) AM 2020 103472 A  
 (210) AM 103472  
 (220) 2019 06 05  
 (731) APPLE INC.  
 One Apple Park Way, California, Cupertino,  
 95014, USA  
 (740) Tamar Kochlamazashvili  
 (540)

**IPHONE**

(591) Black, white  
 (511) 36

(260) AM 2020 103481 A  
 (210) AM 103481  
 (220) 2019 06 06  
 (731) JSC "GEPHA"  
 Akaki Beliashvili St. 142, 0159, Tbilisi,  
 Georgia  
 (740) Salome Jeladze  
 (540)

**HEALSTATION**

(591) Black, white  
 (511) 35, 44

(260) AM 2020 103482 A  
 (210) AM 103482  
 (220) 2019 06 06  
 (731) LTD "MANDARINI"  
 Z. Gorgiladze St. 43, ap. 4, Batumi, Georgia  
 (740) Shalva Gvaramadze  
 (540)



**Mandarini**

(591) Green, white, orange, brown  
 (531) 05.03.13; 05.03.15; 05.07.11; 05.07.22;  
 27.05.01; 29.01.14  
 (511) 30, 35

(260) AM 2020 103560 A  
 (210) AM 103560  
 (220) 2019 06 10  
 (731) JSC "INSURANCE COMPANY ALDAGI"  
 B. Kvernadze Str. 10, Tbilisi, Georgia  
 (540)



(591) Green  
 (531) 26.04.05; 26.04.06; 26.04.07; 29.01.03;  
 29.01.12  
 (511) 16, 35, 36

(260) AM 2020 103562 A  
 (210) AM 103562  
 (220) 2019 06 10  
 (731) JSC "INSURANCE COMPANY ALDAGI"  
 B. Kvernadze Str. 10, Tbilisi, Georgia  
 (540)



(591) Green, grey  
 (531) 26.04.05; 26.04.06; 26.04.07; 27.05.01;  
 29.01.13  
 (511) 16, 35, 36

(260) AM 2020 103563 A  
 (210) AM 103563  
 (220) 2019 06 10  
 (731) JSC "INSURANCE COMPANY ALDAGI"  
 B. Kvernadze Str. 10, Tbilisi, Georgia  
 (540)



(591) Green, grey  
 (531) 26.04.05; 26.04.06; 26.04.07; 28.19; 29.01.13  
 (511) 16, 35, 36

(260) AM 2020 103567 A  
 (210) AM 103567  
 (220) 2019 06 10  
 (731) LTD "AGROHOB"  
 Marshal Gelovani Av. 22, 0159, Tbilisi,  
 Georgia  
 (740) Nugzar Ksovreli

(540)

აგროჰობი  
**Agrohob**

(591) Black, white  
 (511) 35, 43

(260) AM 2020 103568 A  
 (210) AM 103568  
 (220) 2019 06 10  
 (731) LTD "GARAGE"  
 5 St. 21, Vill. Kveda Sameba, Khelvachauri  
 District, 6000, Georgia  
 (540)



(591) White, black, red  
 (531) 18.01.09; 26.11.03; 26.11.06; 27.05.09;  
 27.05.17; 27.05.24; 29.01.13  
 (511) 39, 43

(260) AM 2020 103576 A  
 (210) AM 103576  
 (220) 2019 06 12  
 (731) LTD "TMASI"  
 Zhoneti St. 13, Isani District, Tbilisi,  
 Georgia  
 (540)



(591) Gold, light brown, dark brown  
 (531) 05.03.13; 05.03.15; 05.05.01; 05.05.20;  
 11.03.09; 28.19; 29.01.13  
 (511) 5, 35

(260) AM 2020 103584 A  
 (210) AM 103584  
 (220) 2019 06 12  
 (731) Aleksi Morchiladze  
 Tschkondideli St. 22, 0180, Tbilisi,  
 Georgia



(540)

**august**

(591) Black, white

(511) 32, 33

(260) AM 2020 103588 A

(210) AM 103588

(220) 2019 06 13

(731) TOYOTA JIDOSHA KABUSHIKI KAISHA

(also trading as Toyota Motor Corporation)

1, Toyota-cho, Toyota-shi, Aichi-ken, Japan

(740) Tamar Kochlamazashvili

(540)

**LAND CRUISER EXECUTIVE LOUNGE**

(591) Black, white

(511) 12

(260) AM 2020 103590 A

(210) AM 103590

(220) 2019 06 14

(731) LTD "Khaled Alrajhi Holding Company"

I. Abashidze St. 21a, Office 16, 0179,

Tbilisi, Georgia

(740) Giorgi Taktakishvili

(540)

**Khaled Alrajhi Holding Company**

ხალეფ ალრაჯჰი ჰოლდინგ კომპანი

(591) Golden, white, green

(531) 24.09.01; 27.05.01; 28.05; 29.01.12

(511) 36

(260) AM 2020 103591 A

(210) AM 103591

(220) 2019 06 14

(310) № 069632019

(320) 20 05 2019

(330) CH

(731) THE PROCTER &amp; GAMBLE COMPANYY

One Procter &amp; Gamble Plaza, Cincinnati,

Ohio 45202, USA

(740) Merab Kvimsadze

(540)

**SOS SHOT**

(591) Black, white

(531) 27.05.01

(511) 3

(260) AM 2020 103663 A

(210) AM 103663

(220) 2019 06 17

(731) SCREEN X CO., LTD.

24-31, Dureungyuri-ro, Ochang-eup,

Cheongwon-gu, Cheongju-si, Chung-

cheongbuk-do, Republic of Korea

(740) Tamaz Shilakadze

(540)

**ScreenX**

(591) Black, white

(531) 27.05.01

(511) 35

(260) AM 2020 103664 A

(210) AM 103664

(220) 2019 06 17

(731) SCREEN X CO., LTD

24-31, Dureungyuri-ro, Ochang-eup,

Cheongwon-gu, Cheongju-si, Chung-

cheongbuk-do, Republic of Korea

(740) Tamaz Shilakadze

(540)

**ScreenX**

(591) Black, white

(531) 27.05.01

(511) 41

(260) AM 2020 103670 A

(210) AM 103670

(220) 2019 06 19

(310) № 069592019

(320) 20 05 2019

(330) CH

(731) THE PROCTER &amp; GAMBLE COMPANYY

One Procter &amp; Gamble Plaza, Cincinnati,

Ohio 45202, USA

(740) Merab Kvimsadze

(540)

**RESCUE SHOT**

(591) Black, white

(531) 27.05.01

(511) 3

(260) AM 2020 103678 A

(210) AM 103678

(220) 2019 06 19

(731) LTD "MY HOME"

Digomi Training Trial Farm Area, fl. 2,

Saburtalo district, Tbilisi, Georgia

(540)



(591) White, yellow, black  
 (531) 27.05.21; 28.19; 29.01.12  
 (511) 11, 20, 21, 24, 35

(260) AM 2020 103680 A

(210) AM 103680

(220) 2019 06 19

(731) LTD "MY HOME"

Digomi Training Trial Farm Area, fl. 2,  
 Saburtalo district, Tbilisi, Georgia

(540)



(591) White, yellow, black  
 (531) 27.05.01; 29.01.12  
 (511) 11, 20, 21, 24, 35

(260) AM 2020 103690 A

(210) AM 103690

(220) 2019 06 21

(731) JSC "M<sup>2</sup> REAL ESTATE"

I. Chavchavadze Av. 29, 3rd floor, Tbilisi,  
 Georgia

(740) Nikoloz Jalaghania

(540)

დეველოპმენტის ახალი  
 განზომილება

(591) Black, white  
 (511) 36, 37

(260) AM 2020 103700 A

(210) AM 103700

(220) 2019 06 21

(731) LTD "GORELLI"

Shindisi Highway 2nd km., 1400, Gori,  
 Georgia

(540)

გორელი

GORELLI

ГОРЕЛЛИ

(591) Black, white  
 (511) 33

(260) AM 2020 103773 A

(210) AM 103773

(220) 2019 06 25

(731) JSC "Georgia Beer Company"

Vill. Saguramo, 3311, Mtskheta, Georgia

(540)

რამზეს

Ramesses

(591) Black, white

(511) 32

(260) AM 2020 103775 A

(210) AM 103775

(220) 2019 06 25

(731) SIX CONTINENTS LIMITED

Broudvota Parki, Denemi, Bakingemshiri,  
 UB9 5HR, United Kingdom

(740) Shalva Gvaramadze

(540)

VOCO

(591) Black, white

(511) 35, 43

(260) AM 2020 103776 A

(210) AM 103776

(220) 2019 06 25

(731) SIX CONTINENTS LIMITED

Broudvota Parki, Denemi, Bakingemshiri,  
 UB9 5HR, United Kingdom

(740) Shalva Gvaramadze

(540)

VOCO

AN IHG HOTEL

(591) Black, white

(531) 27.05.09; 27.05.10

(511) 35, 43

(260) AM 2020 103779 A

(210) AM 103779

(220) 2019 06 26

(731) LTD "GLOBALFARMI"

Almasyan St. 13a / Berbuti St. 8, 0171,  
 Tbilisi, Georgia

(740) Giorgi Taktakishvili

(540)



(591) Black, white  
 (531) 27.05.01; 27.05.22; 27.05.23  
 (511) 43

(260) AM 2020 103786 A  
 (210) AM 103786  
 (220) 2019 06 27  
 (731) BALLY GAMING, INC.  
 6601 Bermuda Road, Las Vegas, Nevada  
 89119, USA  
 (740) Giorgi Taktakishvili  
 (540)

**ULTIMATE TEXAS  
 HOLD 'EM**

(591) Black, white  
 (511) 28, 41

(260) AM 2020 103787 A  
 (210) AM 103787  
 (220) 2019 06 27  
 (731) BALLY GAMING, INC.  
 6601 Bermuda Road, Las Vegas, Nevada  
 89119, USA  
 (740) Giorgi Taktakishvili  
 (540)



(591) Black, white  
 (531) 01.01.02; 01.01.10; 21.01.01; 21.01.02;  
 21.01.03; 25.01.01; 26.13.25; 27.05.02;  
 27.05.09; 27.05.10  
 (511) 28, 41

(260) AM 2020 103788 A  
 (210) AM 103788  
 (220) 2019 06 27  
 (731) BALLY GAMING, INC.  
 6601 Bermuda Road, Las Vegas,  
 Nevada 89119, USA  
 (740) Giorgi Taktakishvili

(540)



(591) Black, white  
 (531) 01.01.02; 21.01.01; 21.01.02; 21.01.03;  
 27.05.02; 27.05.10  
 (511) 28, 41

(260) AM 2020 103844 A  
 (210) AM 103844  
 (220) 2019 06 28  
 (310) 88/325,082  
 (320) 04 03 2019  
 (330) US  
 (731) Reign Beverage Company LLC  
 1547 N. Knowles Ave., Los Angeles,  
 Kalifornia, 90063, USA  
 (740) Natela Otaridze  
 (540)



(591) Black, white  
 (531) 04.05.21; 24.09.09  
 (511) 32

(260) AM 2020 103845 A  
 (210) AM 103845  
 (220) 2019 06 28  
 (310) 8825,087  
 (320) 04 03 2019  
 (330) US  
 (731) Reign Beverage Company LLC  
 1547 N. Knowles Ave., Los Angeles,  
 Kalifornia, 90063, USA  
 (740) Natela Otaridze  
 (540)



(591) Black, white, yellow, blue  
 (531) 04.05.21; 24.09.09  
 (511) 32

(260) AM 2020 103858 A  
 (210) AM 103858  
 (220) 2019 07 02  
 (731) LTD "VILLA ERALDO"  
 Al. Kazbegi Av. 1/12, Tbilisi, Georgia  
 (540)

**ვაზლოვანი**  
**VAZLOVANI**

(591) Black, white  
 (511) 33, 43

(260) AM 2020 103861 A  
 (210) AM 103861  
 (220) 2019 07 02  
 (731) NINTENDO CO., LTD  
 11-1, Hokotate-cho, Kamitoba, Minami-ku,  
 Kioto-shi, Kyoto, Japan  
 (740) Merab Kvimsadze  
 (540)

**Pokémon**

(591) Black, white  
 (531) 27.05.01  
 (511) 9, 14, 16, 18, 20, 21, 24, 25, 28, 30, 41

(260) AM 2020 103962 A  
 (210) AM 103962  
 (220) 2019 07 09  
 (731) SUNDARAM-CLAYTON LIMITED  
 'Jayalakshmi Estates' No.29 (old N8),  
 Haddows Road, Chennai, 600 006 , India  
 (740) Tamaz Shilakadze  
 (540)



(591) Black, white  
 (531) 27.05.01; 27.05.02; 27.05.09; 27.05.10  
 (511) 12

(260) AM 2020 103963 A  
 (210) AM 103963  
 (220) 2019 07 09  
 (731) SUNDARAM-CLAYTON LIMITED

'Jayalakshmi Estates' No.29 (old N8),  
 Haddows Road, Chennai, 600 006, India  
 (740) Tamaz Shilakadze  
 (540)



(591) Black, white, red  
 (531) 27.05.01; 27.05.02; 27.05.09; 27.05.10;  
 29.01.13  
 (511) 12

## REGISTERED TRADEMARKS

(111) M 1998 8942P R

(151) 1998 04 21

(181) 2028 04 21

(260) AM 2019 105969 A

(220) 2019 12 02

(732) SUMITOMO HEAVY INDUSTRIES, LTD

1-1 Osaki 2-chome, Shinagawa-ku, Tokyo

141-6025, Japan

(511) 6, 7

(111) M 2020 32209 R

(151) 2020 01 13

(181) 2030 01 13

(260) AM 2018 100433 A

(220) 2018 11 20

(732) INPHA LLP Representative Office in Georgia

Besiki St. 4 Nearby, (plot 46/10), 0108,

Tbilisi Georgia

(111) M 2020 32210 R

(151) 2020 01 13

(181) 2030 01 13

(260) AM 2018 100613 A

(220) 2018 11 29

(732) JSC "LEKKHIM"

Shota Rustaveli St. 23, 01033, Kyiv, Ukraine

(111) M 2020 32211 R

(151) 2020 01 13

(181) 2030 01 13

(260) AM 2018 100614 A

(220) 2018 11 29

(732) JSC "LEKKHIM"

Shota Rustaveli St. 23, 01033, Kyiv, Ukraine

(111) M 2020 32212 R

(151) 2020 01 13

(181) 2030 01 13

(260) AM 2018 100665 A

(220) 2018 11 30

(732) HangZhou JNBY Finery Co., LTD

Room 18A01, Building 1, No.39 Yile Road,

Xihu District, Hangzhou, Zhejiang Province,

China

(111) M 2020 32213 R

(151) 2020 01 13

(181) 2030 01 13

(260) AM 2018 100689 A

(220) 2018 12 05

(732) LTD "პროვაიდერ.ჯი PROVIDER.GE"

I. Ninoshvili St. 60, ap. 27, 6000, Batumi,

Georgia

(111) M 2020 32214 R

(151) 2020 01 14

(181) 2030 01 14

(260) AM 2018 100693 A

(220) 2018 12 05

(732) Kia Motors Korporeishen

12, Heolleung-ro, Seocho-gu, Seoul, Republic

of Korea

(111) M 2020 32215 R

(151) 2020 01 14

(181) 2030 01 14

(260) AM 2018 100772 A

(220) 2018 12 10

(732) Kia Motors Korporeishen

12, Heolleung-ro, Seocho-gu, Seoul, Republic

of Korea

(111) M 2020 32216 R

(151) 2020 01 14

(181) 2030 01 14

(260) AM 2018 100789 A

(220) 2018 12 14

(732) Merab Abazadze

Tsinamdzhvishvili St. 60, Tbilisi, Georgia

(111) M 2020 32217 R

(151) 2020 01 14

(181) 2030 01 14

(260) AM 2018 100794 A

(220) 2018 12 14

(732) RAKUTEN INC.

1-14-1 Tamagawa, Setagaya-ku, Tokyo,

158-0094, Japan

(111) M 2020 32218 R

(151) 2020 01 14

(181) 2030 01 14

(260) AM 2018 100795 A

(220) 2018 12 14

(732) RAKUTEN INC.

1-14-1 Tamagawa, Setagaya-ku, Tokyo,

158-0094, Japan

---

(111) M 2020 32219 R (151) 2020 01 14 (181) 2030 01 14 (260) AM 2018 100796 A (220) 2018 12 14 (732) RAKUTEN INC. 1-14-1 Tamagawa, Setagaya-ku, Tokyo, 158-0094, Japan	(732) EXTREME NETWORKS LIMITED 22 Friars Street, Sudburi, Suffolk, CO10 2AA, United Kingdom
(111) M 2020 32220 R (151) 2020 01 14 (181) 2030 01 14 (260) AM 2018 100809 A (220) 2018 12 18 (732) KARACA ZUCCACIYE TICARET VE SANAYI ANONIM SIRKETI YAKUPLU MERKEZ MAH. BIRLIK CAD. NO:24 BUYUKCEKMECE, ISTANBUL, Turkey	(111) M 2020 32225 R (151) 2020 01 14 (181) 2030 01 14 (260) AM 2019 100921 A (220) 2019 01 07 (732) EXTREME NETWORKS LIMITED 22 Friars Street, Sudburi, Suffolk, CO10 2AA, United Kingdom
(111) M 2020 32221 R (151) 2020 01 14 (181) 2030 01 14 (260) AM 2018 100881 A (220) 2018 12 26 (732) LTD "Caucasus Travel" Metekhi St.19/Feriscvalebi St.20,22, Tbilisi, Georgia	(111) M 2020 32226 R (151) 2020 01 14 (181) 2030 01 14 (260) AM 2019 100922 A (220) 2019 01 07 (732) EXTREME NETWORKS LIMITED 22 Friars Street, Sudburi, Suffolk, CO10 2AA, United Kingdom
(111) M 2020 32222 R (151) 2020 01 14 (181) 2030 01 14 (260) AM 2018 100897 A (220) 2018 12 28 (732) ALIBABA GROUP HOLDING LIMITED Fourth Floor, One Capital Place, P. O. Box 847, George Town, Grand Cayman, Cayman Islands	(111) M 2020 32227 R (151) 2020 01 14 (181) 2030 01 14 (260) AM 2019 100923 A (220) 2019 01 07 (732) EXTREME NETWORKS LIMITED 22 Friars Street, Sudburi, Suffolk, CO10 2AA, United Kingdom
(111) M 2020 32223 R (151) 2020 01 14 (181) 2030 01 14 (260) AM 2018 100899 A (220) 2018 12 28 (732) ALIBABA GROUP HOLDING LIMITED Fourth Floor, One Capital Place, P. O. Box 847, George Town, Grand Cayman, Cayman Islands	(111) M 2020 32228 R (151) 2020 01 14 (181) 2030 01 14 (260) AM 2019 101236 A (220) 2019 01 16 (732) PHARMACIA & UPJOHN COMPANY LLC 7000 Portage Road, Kalamazoo, Michigan 49001, USA
(111) M 2020 32224 R (151) 2020 01 14 (181) 2030 01 14 (260) AM 2019 100918 A (220) 2019 01 04	(111) M 2020 32229 R (151) 2020 01 14 (181) 2030 01 14 (260) AM 2019 101382 A (220) 2019 01 28 (732) LTD "KIMILI" Sh. Mikatadze St. 20, 0101, Tbilisi, Georgia
(111) M 2020 32224 R (151) 2020 01 14 (181) 2030 01 14 (260) AM 2019 100918 A (220) 2019 01 04	(111) M 2020 32230 R (151) 2020 01 14 (181) 2030 01 14 (260) AM 2019 101399 A (220) 2019 01 29

---

(732) COLGATE-PALMOLIVE COMPANY  
a Delaware corporation  
300 Park Avenue, New York, New York  
10022, USA

---

(111) M 2020 32231 R  
(151) 2020 01 14  
(181) 2030 01 14  
(260) AM 2019 101400 A  
(220) 2019 01 29  
(732) COLGATE-PALMOLIVE COMPANY  
a Delaware corporation  
300 Park Avenue, New York, New York  
10022, USA

---

(111) M 2020 32232 R  
(151) 2020 01 14  
(181) 2030 01 14  
(260) AM 2019 101416 A  
(220) 2019 01 31  
(732) Vivo Mobile Communication CO., LTD  
283, BBK Road, Wusha, Chang'An,  
Dongguan, Guangdong, China

---

(111) M 2020 32233 R  
(151) 2020 01 14  
(181) 2030 01 14  
(260) AM 2019 101422 A  
(220) 2019 01 31  
(732) LTD "KIMILI"  
Sh. Mikatadze St. 20, 0101, Tbilisi, Georgia

---

(111) M 2020 32234 R  
(151) 2020 01 14  
(181) 2030 01 14  
(260) AM 2019 101495 A  
(220) 2019 02 01  
(732) AO (JSC) "Vertex"  
197350, Sankt-Peterburg, Doroga v Kamenku  
No.62, Litera A, Russian Federation

---

(111) M 2020 32235 R  
(151) 2020 01 14  
(181) 2030 01 14  
(260) AM 2019 101514 A  
(220) 2019 02 05  
(732) LTD "GEORGIAN HYDRO POWER"  
Vazha-Pshavela Av. 41, Fl. 3,  
(Room 4, 5, 6), 0177, Tbilisi, Georgia

---

(111) M 2020 32236 R  
(151) 2020 01 14  
(181) 2030 01 14

(260) AM 2019 101519 A  
(220) 2019 02 06  
(732) LTD "Georgian Alliance"  
Giorgi Nadareishvili St. 9, 0120, Tbilisi,  
Georgia

---

(111) M 2020 32237 R  
(151) 2020 01 14  
(181) 2030 01 14  
(260) AM 2019 101520 A  
(220) 2019 02 06  
(732) LTD "Georgian Alliance"  
Giorgi Nadareishvili St. 9, 0120, Tbilisi,  
Georgia

---

(111) M 2020 32238 R  
(151) 2020 01 14  
(181) 2030 01 14  
(260) AM 2019 101612 A  
(220) 2019 02 11  
(732) JSC "Georgian Beer Company"  
Village Saguramo, 3311, Mtskheta, Georgia

---

(111) M 2020 32239 R  
(151) 2020 01 14  
(181) 2030 01 14  
(260) AM 2019 101639 A  
(220) 2019 02 12  
(732) MARSА YAĞ SANAYİ VE TİCARET  
ANONİM ŞİRKETİ  
RAMAZANOĞLU MAH. MAHMUT  
BAYRAM CAD. - NO: 9 ŞEYHLİ 34758  
Pendik İstanbul, Turkey

---

(111) M 2020 32240 R  
(151) 2020 01 14  
(181) 2030 01 14  
(260) AM 2019 101646 A  
(220) 2019 02 13  
(732) Lado Kiziria  
Michurin Av., Olympic Village, Bl. 16, ap. 131,  
119602, Moscow, Russian Federation

---

(111) M 2020 32241 R  
(151) 2020 01 14  
(181) 2030 01 14  
(260) AM 2019 101677 A  
(220) 2019 02 19  
(732) LTD "MARANI"  
Village Napareuli, 2211, Telavi, Georgia

---

(111) M 2020 32242 R  
(151) 2020 01 14  
(181) 2030 01 14

(260) AM 2019 101687 A  
 (220) 2019 02 20  
 (732) BRITISH AMERICAN TOBACCO  
 (BRANDS) INC. (a Delaware corporation)  
 251 Little Falls Drive, Suite 100, Delaware,  
 Wilmington, 19808-1674, USA

(111) M 2020 32248 R  
 (151) 2020 01 14  
 (181) 2030 01 14  
 (260) AM 2019 101931 A  
 (220) 2019 02 28  
 (732) LTD "IPKLI"  
 Evgeni Kharadze St. 2a, 0153, Tbilisi, Georgia

(111) M 2020 32243 R  
 (151) 2020 01 14  
 (181) 2030 01 14  
 (260) AM 2019 101688 A  
 (220) 2019 02 20  
 (732) BRITISH AMERICAN TOBACCO  
 (BRANDS) INC. (a Delaware corporation)  
 251 Little Falls Drive, Suite 100, Delaware,  
 Wilmington, 19808-1674, USA

(111) M 2020 32249 R  
 (151) 2020 01 14  
 (181) 2030 01 14  
 (260) AM 2019 101932 A  
 (220) 2019 02 28  
 (732) LTD "IPKLI"  
 Evgeni Kharadze St. 2a, 0153, Tbilisi, Georgia

(111) M 2020 32244 R  
 (151) 2020 01 14  
 (181) 2030 01 14  
 (260) AM 2019 101694 A  
 (220) 2019 02 21  
 (732) LTD "IPKLI"  
 Evgeni Kharadze St. 2a, 0153, Tbilisi, Georgia

(111) M 2020 32250 R  
 (151) 2020 01 14  
 (181) 2030 01 14  
 (260) AM 2019 102022 A  
 (220) 2019 03 01  
 (732) LTD "IPKLI"  
 Evgeni Kharadze St. 2a, 0153, Tbilisi, Georgia

(111) M 2020 32245 R  
 (151) 2020 01 14  
 (181) 2030 01 14  
 (260) AM 2019 101906 A  
 (220) 2019 02 25  
 (732) LTD "ARTPHARMA"  
 Gamrekeli str. 19, Office 30, 0160, Tbilisi,  
 Georgia

(111) M 2020 32251 R  
 (151) 2020 01 14  
 (181) 2030 01 14  
 (260) AM 2019 102023 A  
 (220) 2019 03 01  
 (732) LTD "IPKLI"  
 Evgeni Kharadze St. 2a, 0153, Tbilisi, Georgia

(111) M 2020 32246 R  
 (151) 2020 01 14  
 (181) 2030 01 14  
 (260) AM 2019 101907 A  
 (220) 2019 02 25  
 (732) LTD "ARTPHARMA"  
 Gamrekeli str. 19, Office 30, 0160, Tbilisi,  
 Georgia

(111) M 2020 32252 R  
 (151) 2020 01 14  
 (181) 2030 01 14  
 (260) AM 2019 102043 A  
 (220) 2019 03 04  
 (732) JSC "Georgian Beer Company"  
 Vil. Saguramo, 3311, Mtskheta, Georgia

(111) M 2020 32247 R  
 (151) 2020 01 14  
 (181) 2030 01 14  
 (260) AM 2019 101929 A  
 (220) 2019 02 28  
 (732) LTD "Miss & Mister GOLDEN BRAND"  
 Dighmis mas., V kvart., Bl. 24, ap. 60,  
 Tbilisi, Georgia

(111) M 2020 32253 R  
 (151) 2020 01 14  
 (181) 2030 01 14  
 (260) AM 2019 102044 A  
 (220) 2019 03 04  
 (732) JSC "Georgian Beer Company"  
 Vil. Saguramo, 3311, Mtskheta, Georgia

(111) M 2020 32254 R  
 (151) 2020 01 14  
 (181) 2030 01 14  
 (260) AM 2019 102047 A  
 (220) 2019 03 05



(732) LTD "DIGITAL SYSTEMS"  
Marjanishvili St. 6, 0102, Tbilisi, Georgia

---

(111) M 2020 32255 R  
(151) 2020 01 14  
(181) 2030 01 14  
(260) AM 2019 102048 A  
(220) 2019 03 05

(732) LTD "DIGITAL SYSTEMS"  
Marjanishvili St. 6, 0102, Tbilisi, Georgia

---

(111) M 2020 32256 R  
(151) 2020 01 14  
(181) 2030 01 14  
(260) AM 2019 102049 A  
(220) 2019 03 05

(732) LTD "DIGITAL SYSTEMS"  
Marjanishvili St. 6, 0102, Tbilisi, Georgia

---

(111) M 2020 32257 R  
(151) 2020 01 14  
(181) 2030 01 14  
(260) AM 2019 102143 A  
(220) 2019 03 11

(732) JSC "Georgian Beer Company"  
Vil. Saguramo, 3311, Mtskheta, Georgia

---

(111) M 2020 32258 R  
(151) 2020 01 14  
(181) 2030 01 14  
(260) AM 2019 102154 A  
(220) 2019 03 12

(732) JSC "Georgian Beer Company"  
Vil. Saguramo, 3311, Mtskheta, Georgia

---

(111) M 2020 32259 R  
(151) 2020 01 14  
(181) 2030 01 14  
(260) AM 2019 102161 A  
(220) 2019 03 13

(732) HANGZHOU EZVIZ NETWORK CO. LTD  
No.555 Qianmo Road, Binjiang Distriqt,  
Hangzhou, China

---

(111) M 2020 32260 R  
(151) 2020 01 14  
(181) 2030 01 14  
(260) AM 2018 100078 A  
(220) 2018 11 06

(732) LTD "DAISI+"  
Saknavti Settlement, plot 07/006, 0198, Tbilisi,  
Georgia

---

(111) M 2020 32261 R  
(151) 2020 01 14  
(181) 2030 01 14  
(260) AM 2018 100803 A

(220) 2018 12 18  
(732) Getz Pharma International FZ LLC  
Office No. 1307, 13th Floor, Al-Thuraya  
Tower 1, Dubai Media City, Dubai, United  
Arab Emirates

---

(111) M 2020 32262 R  
(151) 2020 01 14  
(181) 2030 01 14  
(260) AM 2019 101515 A  
(220) 2019 02 05

(732) Soci t  des Produits Nestl  S.A.  
1800 Veve, Switzerland

---

(111) M 2020 32263 R  
(151) 2020 01 14  
(181) 2030 01 14  
(260) AM 2019 101622 A  
(220) 2019 02 12

(732) LTD "ORNADO MEDICINE - ორნადო  
მედიცინა"  
Vil. Irganchai, 1707, Dmanisi District,  
Georgia

---

(111) M 2020 32264 R  
(151) 2020 01 14  
(181) 2030 01 14  
(260) AM 2019 101623 A  
(220) 2019 02 12

(732) LTD "ORNADO MEDICINE - ორნადო  
მედიცინა"  
Vil. Irganchai, 1707, Dmanisi District,  
Georgia

---

(111) M 2020 32265 R  
(151) 2020 01 14  
(181) 2030 01 14  
(260) AM 2019 101624 A  
(220) 2019 02 12

(732) LTD "ORNADO MEDICINE - ორნადო  
მედიცინა"  
Vil. Irganchai, 1707, Dmanisi District,  
Georgia

---

(111) M 2020 32266 R  
(151) 2020 01 14  
(181) 2030 01 14  
(260) AM 2019 101625 A  
(220) 2019 02 12

(732) LTD "ORNADO MEDICINE - ორნადო  
მედიცინა"  
Vil. Irganchai, 1707, Dmanisi District, Georgia

---

(111) M 2020 32267 R  
(151) 2020 01 14  
(181) 2030 01 14  
(260) AM 2019 101626 A  
(220) 2019 02 12  
(732) LTD "ORNADO MEDICINE - ორნადო  
მედიცინა"  
Vil. Irganchai, 1707, Dmanisi District, Georgia

---

(111) M 2020 32268 R  
(151) 2020 01 14  
(181) 2030 01 14  
(260) AM 2019 101627 A  
(220) 2019 02 12  
(732) LTD "ORNADO MEDICINE - ორნადო  
მედიცინა"  
Vil. Irganchai, 1707, Dmanisi District, Georgia

---

(111) M 2020 32269 R  
(151) 2020 01 14  
(181) 2030 01 14  
(260) AM 2019 101638 A  
(220) 2019 02 12  
(732) LTD "NOVATOR PHARMA"  
Vil. Irganchai, 1707, Dmanisi District, Georgia

---

## TRADEMARKS REGISTERED ACCORDING TO THE ACCELERATED PROCEDURE

The decision can be appealed at the Chamber of Appeal of Sakpatenti within 3 months from the publication.

(111) M 2020 32204 R

(151) 2020 01 09

(181) 2030 01 09

(210) AM 106278

(220) 2019 12 21

(732) LTD "ALFA"

Rasulzade St. 5, Marneuli, Georgia

(740) Givi Akopashvili

(540)



(591) Dark green, dark yellow, dark red, blue, white, dark brown to dark green, dark yellow, dark red, blue, white, dark brown

(531) 05.07.19; 19.09.01; 25.01.05; 25.01.13; 25.01.18; 25.01.19; 25.01.25; 27.05.01; 27.05.10; 27.05.24; 29.01.15

(511) 29

(111) M 2020 32205 R

(151) 2020 01 09

(181) 2030 01 09

(210) AM 105804

(220) 2019 11 19

(732) JSC "GEORGIAN BEER COMPANY"

Village Saguramo, 3311, Mtskheta, Georgia

(541)

**SOS**

**Aia**

**Ana**

(591) Black, white

(511) 32, 35, 43

(111) M 2020 32206 R

(151) 2020 01 10

(181) 2030 01 10

(210) AM 106273

(220) 2019 12 20

(732) JSC "TELIANI VALLEY"

Tbilisi Road 3, 2200, Telavi, Georgia

(540)



(591) Black, white

(531) 01.03.01; 02.07.23; 02.07.25; 06.01.01; 06.01.02; 06.01.04; 27.01.06

(511) 33

(111) M 2020 32207 R

(151) 2020 01 10

(181) 2030 01 10

(210) AM 106413

(220) 2019 12 28

(732) LTD "One Gallery"

Vazha-Pshavela Av. 34, I where, living rebel area 12a, Saburtalo District, 0109, Tbilisi, Georgia

(540)



(591) White, red  
 (531) 26.04.01; 26.04.16; 26.04.22; 26.04.24;  
 26.13.25; 27.05.24; 28.19; 29.01.12  
 (511) 35

(111) M 2020 32208 R

(151) 2020 01 13

(181) 2030 01 13

(210) AM 106510

(220) 2020 01 06

(732) LTD "Georgia Real Estate"

For the unity of Georgia Fighters St. 55,  
 ap. 48, Samgori District, Tbilisi,  
 Georgia

(540)



(591) Red, white  
 (531) 26.04.04; 26.04.22; 26.04.24; 27.05.01;  
 27.05.24  
 (511) 9, 35, 36

(111) M 2020 32270 R

(151) 2020 01 17

(181) 2030 01 17

(210) AM 106421

(220) 2019 12 30

(732) DAVID GOGIDZE

Shatberashvili St. 4, ap. 99, 0179, Tbilisi,  
 Georgia

(740) Shalva Gvaramadze

(540)

Healcier

ჰელსიერი

(591) White, green, blue  
 (531) 01.15.05; 27.05.08; 28.19; 29.01.12  
 (511) 34

(111) M 2020 32271 R

(151) 2020 01 20

(181) 2030 01 20

(210) AM 106070

(220) 2019 12 10

(732) JSC "Georgia Beer Company"

Village Saguramo, 3311, Mtskheta, Georgia

(540)



(591) Light white, light blue, grey, red, sky-blue,  
 dark blue

(531) 02.01.08; 06.01.01; 06.01.02; 06.01.04; 28.05;  
 29.01.13

(526) გუდაური

(511) 32

(111) M 2020 32272 R

(151) 2020 01 21

(181) 2030 01 21

(210) AM 106604

(220) 2020 01 15

(732) JAPAN TOBACCO INC

2-2-1 Toranomom, Minato-ku, Tokyo, Japan

(740) Shalva Gvaramadze

(540)

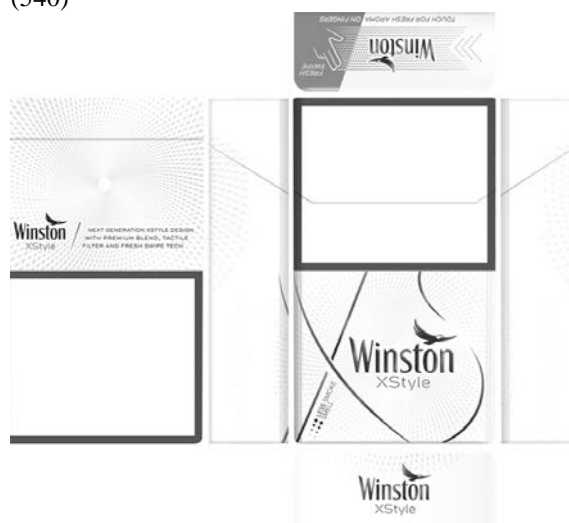

(591) Black, white

(531) 01.03.15; 01.15.09; 02.09.15; 03.07.01;  
 03.07.16; 19.03.24; 26.11.12; 27.05.01;  
 27.05.10

(511) 34

## INTERNATIONAL TRADEMARKS FOR WHICH A DECISION ON GRANTING PROTECTIONS IS TAKEN

The decision can be appealed at the Chamber of Appeal of Sakpatenti within 3 months from the publication or at the Mtskheta District Court Administrative Cases Board (Address: №17, Samkhedro str., Mtskheta), within 1 month following the publication.

(260) AM 2020 100569 A\*

(800) 1435983

(151) 2018 05 29

(891) 2018 05 29

(731) NOKIA CORPORATION

Karakaari 7, FI-02610 Espoo, Finland

(540)



(591) Blue Pantone 293

(531) 27.05.01; 27.05.17; 29.01.04

(511)

37 – Building construction; clock and watch repair; electric appliance installation and repair; machinery installation, maintenance and repair; photographic apparatus repair; repair information; repair of power lines; construction, maintenance, installation and repair of computers, tablet computers, computer hardware, phones, smartphones, electronic organizers, computer peripherals, smart glasses, smart watches, cameras, audio and visual equipment; construction, maintenance, installation and repair of scales, of wearable and portable computing devices, of vehicles, of office machines and equipment, of machines for industrial and agricultural use; construction, maintenance, installation and repair of household appliances, of energy management systems, of home automation systems, of lighting devices and equipment, of sanitary installations, of security systems, of home entertainment and audio/video equipment, of fitness and health equipment, of medical apparatus and instruments, of machine to machine (M2M) communications equipment, of electric and electronic consumer goods, of hand tools, of optical goods and of navigation devices; installation, maintenance and repair of telecommunications and networking devices, equipment and systems, communications networks (other than software), satellite communications and radio and television communications equipment, instruments and machines; upgrading of computer hardware; installation, maintenance and upgrading of computer hardware; information, advisory and consultancy services relating to all the aforesaid services.

(260) AM 2020 101749 A

(800) 1449910

(151) 2018 09 17

(891) 2018 09 17

(731) Samsung C&T Corporation

123, Olympic-ro 35-gil, Songpa-gu, Seoul,

Republic of Korea

(540)

### SAMSUNG

(591) Black, white

(511)

5 – Pharmaceutical products for the treatment of colorectal cancer; biopharmaceuticals for the treatment of cancer; antibodies for medical purposes; pharmaceutical preparations for the treatment of autoimmune diseases; pharmaceutical preparations for the treatment of arthritis; pharmaceutical preparations for the treatment of diseases of the metabolic system; pharmaceutical preparations for the treatment of cancer; pharmaceutical preparations for the treatment of inflammatory diseases; biopharmaceuticals; pharmaceuticals, biosimilars and biological preparations for medical purposes; pharmaceutical preparations for the treatment of leukemia; vaccines against pneumococcal infections; pharmaceutical preparations for ocular use; pharmaceutical drug for the treatment of anemia; biochemical preparations for medical purposes; nutraceutical preparations for therapeutic or medical purposes; nutraceuticals for use as dietary supplements.

10 – Respiration monitors; apparatus for monitoring patients and analysing arrhythmias; equipment for respiratory technology, namely, respiratory masks for medical purposes; apparatus for the treatment of deafness for hearing-impaired children; medical hearing and speaking equipment for the hearing-impaired children; medical equipment for the hard of hearing, for diagnosis and therapy purposes; equipment for the localization of tumours; apparatus for dosage planning and the documentation of tumour radiotherapy; linear accelerators for tumour radiotherapy; medical apparatus and equipment for recording, processing, storing and reproducing medical images; point-of-care diagnostic apparatus, equipment and instruments for medical purposes; protective devices and protective screens for protecting against exposure to x-rays, for medical purposes; apparatus for ECG long-term storage and computerized ECG evaluation electroencephalography; electro-medical apparatus and equipment for x-ray diagnostics and x-ray therapy; medical equipment for digital image recording, for contrast medium analysis with real time image reproduction; urine analysis apparatus;

measuring apparatus for cardiac catheterization; medical CT scanners; peripheral devices of medical CT scanners; dental CT scanners; parts and fittings of dental CT scanners; magnetic resonance imaging [MRI] apparatus; gloves for medical purposes; patient monitoring sensors and alarms; biometric medical scanners for health check and diagnosis; biometric identification medical apparatus for health check and diagnosis.

11 – Sterilizing device for hospitals.

12 – Connected vehicles; driverless cars [autonomous cars]; parts and fittings for autonomous vehicles; electric reversing alarms for vehicle incorporating parking assistance apparatus with foreview and rear-view sensors; anti-theft warning apparatus for motor cars with software and hardware for internet of things.

44 – Medical information services provided via the internet; medical and pharmaceutical consultation; hygienic and beauty care for humans and animals; cosmetic and medical services for the care of the skin; dentistry; conducting physical examination for medical purposes; hospitals; medical clinics; telemedicine services; providing health information; medical equipment rental; conducting physical examination for medical purposes via the internet.

(260) AM 2019 102282 A

(800) 1456382

(151) 2019 01 09

(891) 2019 01 09

(731) JAPAN TOBACCO INC.

2-2-1 Toranomon, Minato-ku, Tokyo,  
Japan

(540)



(591) Black, white

(531) 03.07.01; 25.07.08; 26.04.05; 26.04.15;  
26.04.18; 26.04.24; 26.11.12; 26.15.01;  
27.05.24

(511)

34 – Tobacco, raw or manufactured; smoking tobacco, pipe tobacco, rolling tobacco, chewing tobacco, snus; cigarettes, electronic cigarettes, cigars, cigarillos; snuff; smokers' articles included in class 34; cigarette paper, cigarette tubes and matches.

(260) AM 2020 102285 A

(800) 1456490

(151) 2018 09 05

(891) 2018 09 05

(731) ELTA LIZENZ GMBH

Edisonstraße 1, 59199 Bönen, Germany

(540)



(591) Black, white

(531) 26.11.12; 27.05.01

(511)

8 – Attachments for nail varnish dryers, for sanding, filing and polishing fingernails and toenails; implements (hand-operated) for hairdressing and the cosmetics industry, namely electric hair clippers for humans and pets, electric nose hair trimmers, flat irons, electric steam irons; electric razors, combined electric nose hair trimmers and electric razors, electric nail care kits; electric heated eyelash curlers; glazing irons, pedicure kits, epilators, curling tongs.

9 – Antennas; combined car stereo devices; image processing apparatus and sound reproduction equipment; image processing apparatus and sound reproduction equipment; compact disc players; computer accessories; DVD players; input pens (styluses); radio and television receivers; cases for cellular telephones; mini stereo systems; coin-operated electronic jukeboxes; television; Hi-Fi equipment (terms considered too vague by the International Bureau – rule 13 (2) (b) of the Common Regulations); headphones; loudspeakers and loudspeaker systems consisting thereof, and combinations thereof; mice (data processing equipment); mouse mats; video devices; MP3-player; radios; combined stereo systems; SD card readers; mobile telephone holders; indoor aerials.

10 – Medical and dental apparatus and beauty care apparatus, namely body fat analysis apparatus for medical purposes; arterial blood pressure measuring apparatus; clinical thermometers, including in the form of ear and temple thermometers; massage apparatus for massaging face; hearing aids; inhalers; infrared massagers; pulse measuring devices; massage mats for the car or home (terms considered too vague by the International Bureau – rule 13 (2) (b) of the Common Regulations).

11 – Baking ovens; apparatus for lighting, heating, steam generating, cooking, water supply and sanitary purposes; automatic cappuccino-making machines; automatic electric bread-baking machines; electric coolboxes and thermal boxes (terms considered too vague by the International Bureau – rule 13 (2) (b) of the Common Regulations); electric grills, in parti-

cular electric table grills, electric kettle grills, electric raclette grills, electric contact grills; electric toasters; electric deep fryers; electric coffee-cup warmers; espresso machines; hot air, infrared and convection ovens and grills; automatic coffee machines; small refrigerators; electric coffee percolators; coffee-making machines with thermos flasks; combination automatic espresso, coffee and cappuccino-making machines; cooking rings, combination baking ovens and cooking rings; hot plates and automatic coffee-making machines; including the aforesaid goods for equipping kitchen units; waffle irons, electric; electrical water boilers; electric chocolate-melting apparatus; electric hotdog fryers; electric egg cookers; electric cooking pans; electric rice cookers; electric woks; electric fondue sets; electric hair dryers for domestic use; electric foot spas (terms considered too vague by the International Bureau – rule 13 (2) (b) of the Common Regulations); electric infrared saunas; electric halogen heating apparatus; wireless battery-operated lamps for lighting; electric nail-varnish dryers; facial sauna apparatus; popcorn makers; ice cream freezers; hot sandwich toasters; hot air ovens, electric fires, microwaves, travel hair dryers, electric blankets, footwarmers, teppanyaki grills, ventilating fans, milk foamers (terms considered too vague by the International Bureau – rule 13 (2) (b) of the Common Regulations), extractors, yogurt makers, electric cake makers, electric doughnut makers, electric cake pop makers, humidifiers, pocket torches, electric; USB fans.

14 – Timepieces, in particular wall clocks, alarm clocks, watches.

21 – Brushes (except paint brushes), namely electric toothbrushes; non-electric ice crushers; household or kitchen utensils and containers (not of precious metal or coated therewith); coolers [non-electric containers].

27 – Massage mats for cars.

(260) AM 2019 102297 A

(800) 1456663

(151) 2019 01 15

(891) 2019 01 15

(731) IEFYM SHABSHAI

19 Nissim Alon street, Tel Aviv, Israel

(540)

## High Studio

(591) Black, white

(511)

41 – Academies [education]; aikido instruction; amusement parks services; animal training; arranging and conducting of colloquiums; arranging and conducting of concerts; arranging and conducting of conferences; arranging and conducting of congresses; arranging and conducting of in-person education

forums; arranging and conducting of seminars; arranging and conducting of symposiums; arranging and conducting of workshops [training]; arranging of beauty contests; boarding school education; booking of seats for shows; calligraphy services; cinema presentations; club services [entertainment or education]; coaching [training]; conducting fitness classes; conducting guided tours; correspondence courses; disc jockey services; discotheque services; dubbing, educational examination; educational services provided by schools; education information; electronic desktop publishing; entertainer services; entertainment information; entertainment services; film production, other than advertising films; gambling services; games equipment rental; game services provided on-line from a computer network; gymnastic instruction; health club services [health and fitness training]; holiday camp services [entertainment]; karaoke services; language interpreter services; layout services, other than for advertising purposes; lending library services; microfilming; mobile library services; modelling for artists; movie studio services; music composition services; news reporters services; nightclub services [entertainment]; nursery schools; on-line publication of electronic books and journals; orchestra services; organization of balls; organization of competitions [education or entertainment]; organization of exhibitions for cultural or educational purposes; organization of fashion shows for entertainment purposes; organization of lotteries; organization of shows [impresario services]; organization of sports competitions; party planning [entertainment]; personal trainer services [fitness training]; photographic reporting; photography; physical education; practical training [demonstration]; presentation of circus performances; presentation of live performances; presentation of variety shows; production of music; production of radio and television programmes; production of shows; providing amusement arcade services; providing casino facilities [gambling]; providing films, not downloadable, via video-on-demand transmission services; providing golf facilities; providing museum facilities [presentation, exhibitions]; providing on-line electronic publications, not downloadable; providing on-line music, not downloadable; providing on-line videos, not downloadable; providing recreation facilities; providing sports facilities; providing television programs, not downloadable, via video-on-demand transmission services; providing films, not downloadable, via video-on-demand services; publication of books; publication of texts, other than publicity texts; radio entertainment; recording studio services; recreation information; religious education; rental of artwork; rental of audio equipment; rental of cinematographic apparatus; rental of indoor aquaria; rental of lighting apparatus for theatrical sets or television studios; rental of motion pictures; rental of radio and television sets; rental of show scenery; rental of skin di-

ving equipment; rental of sound recordings; rental of sports equipment, except vehicles; rental of sports grounds; rental of stadium facilities; rental of stage scenery; rental of tennis courts; rental of video cameras; rental of video cassette recorders; rental of videotapes; sado instruction [tea ceremony instruction]; screenplay writing; scriptwriting, other than for advertising purposes; sign language interpretation; songwriting; sport camp services; subtitling; teaching; television entertainment; theatre productions; ticket agency services [entertainment]; timing of sports events; toy rental; training services provided via simulators; translation; tutoring; videotape editing; videotaping; vocational guidance [education or training advice]; vocational retraining; writing of texts; zoological garden services.

44 – Aerial and surface spreading of fertilizers and other agricultural chemicals; alternative medicine services; animal breeding; aquaculture services; artificial insemination services; blood bank services; convalescent home services; dentistry services; farming equipment rental; flower arranging; gardening; horticulture; hospice services; hospital services; human tissue bank services; in vitro fertilization services; landscape design; landscape gardening; lawn care; medical advice for individuals with disabilities; medical assistance; medical clinic services; medical equipment rental; midwife services; nursing home services; nursing, medical; opticians' services; orthodontic services; palliative care; pest control services for agriculture, aquaculture, horticulture and forestry; pet grooming; pharmacy advice; physiotherapy; plant nursery services; plastic surgery; preparation of prescriptions by pharmacists; reforestation services; rehabilitation for substance abuse patients; rental of sanitation facilities; services of a psychologist; speech therapy; telemedicine services; tree planting for carbon offsetting purposes; tree surgery; vermin exterminating for agriculture, aquaculture, horticulture and forestry; veterinary assistance; visagists' services; weed killing; wreath making.

(260) AM 2019 102412 A

(800) 1457718

(151) 2019 01 23

(891) 2019 01 23

(731) OneGroup Company, Limited Liability Company

proezd Nauchny, d. 10, Floor 1, office 462,  
RU-117246 Moscow, Russian Federation

(540)

**ONE  
PRICE  
COFFEE**

(591) Black, white

(531) 27.05.10; 27.05.17

(511)

30 – Artificial coffee; chicory [coffee substitute]; chocolate beverages with milk; coffee flavorings; coffee; coffee-based beverages; unroasted coffee; vegetal preparations for use as coffee substitutes.

35 – Administration of consumer loyalty programs; administrative processing of purchase orders; advertising by mail order; advertising; advisory services for business management; auctioneering; business efficiency expert services; business information; business investigations; business management and organization consultancy; business management assistance; business management consultancy; business management of reimbursement programs for others; business organization consultancy; business research; commercial administration of the licensing of the goods and services of others; commercial information and advice for consumers in the choice of products and services; commercial intermediation services; compiling indexes of information for commercial or advertising purposes; demonstration of goods; direct mail advertising; dissemination of advertising matter; distribution of samples; economic forecasting; marketing research; marketing; negotiation and conclusion of commercial transactions for third parties; negotiation of business contracts for others; on-line advertising on a computer network; organization of exhibitions for commercial or advertising purposes; organization of trade fairs for commercial or advertising purposes; outsourced administrative management for companies; outsourcing services [business assistance]; pay per click advertising; personnel management consultancy; presentation of goods on communication media, for retail purposes; procurement services for others [purchasing goods and services for other businesses]; professional business consultancy; providing business information via a web site; provision of an on-line marketplace for buyers and sellers of goods and services; public relations; publicity material rental; rental of advertising time on communication media; rental of billboards [advertising boards]; rental of sales stands; rental of vending machines; retail and wholesale services; sales promotion for others; search engine optimization for sales promotion; systemization of information into computer databases.

43 – Bar services; café services; cafeteria services; canteen services; food and drink catering; rental of chairs, tables, table linen, glassware; rental of drinking water dispensers; rental of lighting apparatus; rental of tents; rental of transportable buildings; restaurant services; self-service restaurant services; snack-bar services; washoku restaurant services.



(260) AM 2019 102413 A

(800) 1457739

(151) 2018 09 25

(891) 2018 09 25

(731) D ET VE ET ÜRÜNLERİ GIDA  
PAZARLAMA TİCARET ANONİM  
ŞİRKETİDikilitaş Mahallesi, Üzengi Sokak, No:8,  
Beşiktaş, İstanbul, Turkey

(540)

**SALTBAE**

(591) Black, white

(511)

43 – Services for providing of food and drink; restaurant services; self-service restaurant services; cafeterias; cafés, canteen services, cocktail lounges, snack bars, catering, pubs; rental of food service equipment used in services providing food and drink; arranging temporary housing accommodations, namely hotels, motels, holiday camps, boarding houses, rental of tents, youth hostel services, room reservation services; reservation of temporary accommodation, rental of banquet and social function facilities for special occasions, namely, wedding receptions, conferences and meetings; providing day care centers for children, the disabled or the elderly; pet day care services, pet and animal boarding services.

(260) AM 2019 102427 A

(800) 1457992

(151) 2018 12 05

(891) 2018 12 05

(731) Bausch & Lomb Incorporated  
Law Department, 1400 N. Goodman Street,  
Rochester NY 14609, USA

(540)

**BAUSCH** Health

(591) The color(s) gray and blue is/are claimed as a feature of the mark

(531) 24.13.01; 27.05.05; 29.01.12

(526) HEALTH

(511)

3 – Non-medicated skin care preparations; non-medicated skin care preparations, namely, cleansers, exfoliants, moisturizers, sunblocks, skin care cream, skin lotion; non-medicated cosmetic creams and lotions, namely, skin lightening preparations; non-medicated anti-aging preparations, namely, anti-aging cream, anti-wrinkle creams and anti-aging lotion; silicone treated polishing tissues to be used in the polishing of glass and other vitreous surfaces; impregnated cleaning, dusting or polishing cloths, namely, cloths impregnated with a detergent for cleaning; cosmetics; oil absorbing polymer sold as a component of non-medicated skin treatment preparations; body powder; hair shampoo; non-medicated dand-

ruff hair shampoo; body wash; nail care preparations; nail varnishes and polishes; cuticle conditioners; cleaning products, namely, cleaning solution in a spray bottle for use on electronic equipment containing a monitor or display screen; impregnated cleaning cloths, namely, cloths pre-moistened with a cleaning agent, for use on electronic equipment containing a monitor or display screen.

5 – Antifungal preparations; topical anti-itch preparations, namely, lotions, creams, ointments, gels; contact lens solutions; contact lens disinfectants; contact lens wetting solutions; ophthalmic solutions and preparations for the eye; disinfecting and saline solution for medical purposes for contact lenses; chemical preparation sold as a component of contact lens solutions; rewetting drops for use with contact lenses; eye drops; ophthalmic preparations, namely, impregnated strips for applying preparations to the eye; pharmaceutical preparation for injection into the eye; pharmaceuticals, namely, eye drops, solutions, gels and ointments used for the treatment of eye conditions such as dry eyes, allergies, inflammation and redness; pharmaceutical preparations and substances for the treatment of ophthalmological and ocular diseases and disorders; pharmaceutical preparations for use with contact lenses and kits containing said preparations; pharmaceutical preparations for ocular or intraocular surgery; ophthalmic pharmaceutical preparations and substances; ophthalmic preparations and pharmaceutical substances for the treatment of ophthalmic disorders; viscoelastic eye lubricant; pharmaceutical preparations and substances for the treatment of eye diseases, disorders and conditions; ophthalmic pharmaceuticals, namely, solutions and ointments for the treatment of dry eye symptoms; hypertonic ophthalmic solution drug product; ophthalmic pharmaceutical preparation, namely, silicone oil used in ophthalmic surgical procedures; intra-vitreal implants containing a pharmaceutical preparation for the treatment of eye and vision conditions; pharmaceuticals, namely, ophthalmic solutions for the treatment of glaucoma and ocular hypertension; sterile sodium hyaluronate solution in the nature of a pharmaceutical preparation for use in the eyes; pharmaceutical preparations and substances for use in dermatology and skin disorders, skin conditions, acne, fungal infections and skin care; acne medications and acne treatment preparations; pharmaceutical preparations and substances for the prevention and treatment of skin care disorders, conditions, injuries, illnesses and ailments; pharmaceutical preparations and substances for the prevention and treatment of dermatological disorders and diseases and dermatitis; dermatological and skin care pharmaceutical preparations and substances; pharmaceutical preparations and substances for the treatment of ophthalmological, ocular and eye diseases and disorders; medicinal preparation containing sodium propyl-methyl-carbinyl allyl barbiturate and useful as hypnotics;

vitamin and mineral supplements; antibiotics; medicated facial wash, skin care creams and lotions; medicated skin care preparations; food supplements, vitamin and mineral supplements and herbal supplements in tablet, capsule, liquid or powder form; pharmaceutical preparations for the treatment, prevention and/or alleviation of disorders of the gastrointestinal tract; pharmaceutical preparations for the treatment of chorea; pharmaceutical preparations for the treatment of hyperkinetic movement disorders; pharmaceutical preparations for the treatment of neurological disorders and movement disorders; pharmaceutical preparations, namely, pharmaceutical preparations and substances for the treatment of skin disorders, diseases, conditions and ailments; pharmaceutical preparations and substances for the treatment of eye disorders, diseases, conditions and ailments; pharmaceutical preparations and products for ophthalmological use; pharmaceutical preparations and substances for the prevention, treatment and alleviation of pain; anti-depressants; pharmaceutical preparations and substances for the prevention, treatment and alleviation of anxiety, depression, depressive disorders and mental illness; tranquilizers and sedatives; pharmaceutical preparations and substances for the prevention, treatment and alleviation of disorders, diseases, conditions and ailments of the cardiovascular system; pharmaceutical preparations and substances for the treatment of viral, metabolic, endocrine, musculoskeletal, cardiovascular, cardiopulmonary, hepatological, ophthalmic, respiratory, neurological, gastrointestinal, hormonal, dermatological, psychiatric and immune system related diseases and disorders; pharmaceutical preparations for treating allergic rhinitis and asthma; pharmaceutical preparations, namely, immunomodulators; anticholinesterase preparation for the prevention, treatment and alleviation of neurological disorders; vaginally administered metronidazole gel for use in the treatment of vaginal disorders; intravenous preparations for the treatment of hyperammonemia of all origins; skin patch for delivering nitroglycerin to a medical patient; anticonvulsants; pharmaceutical preparations for treating inflammatory disorders such as psoriasis; pharmaceutical preparations and substances for the prevention, treatment and alleviation of stress; pharmaceutical preparations and substances for the prevention, treatment and alleviation of diabetes; pharmaceutical preparations and substances for controlling insulin levels; pharmaceutical preparations and substances for the prevention, treatment and alleviation of hypertension; pharmaceutical preparations and substances for the prevention, treatment and alleviation of angina; pharmaceutical preparations and substances for the cessation of smoking; pharmaceutical preparations and substances for the prevention and treatment of sexually transmitted diseases; pharmaceutical preparations and substances for the prevention and treatment of herpes; pharmaceutical pre-

parations and substances for the prevention, treatment and alleviation of sleep disorders; pharmaceutical preparations and substances for the prevention, treatment and alleviation of acute myocardial infarctions; pharmaceutical preparations and substances for the prevention, treatment and alleviation of symptomatic congestive heart failure; pharmaceutical preparations and substances for the prevention, treatment and alleviation of asymptomatic left ventricular dysfunction; pharmaceutical preparations and substances, namely, fibrinolytic or thrombolytic agents; pharmaceutical preparations and substances for the prevention, treatment and alleviation of pain and inflammation, namely, anti-inflammatories and pain relief medication; pharmaceutical preparations and substances for the prevention, treatment and alleviation of migraines; pharmaceutical preparations and substances for the treatment of fungal infections, onychomycosis, tinea infections, and similar diseases of the skin and nails; pharmaceutical preparations and substances for use in dermatological conditions; topical anti-itch preparations for use on humans for the treatment of skin disorders and skin rashes; medicated skin care products, namely, medicated skin lotion; medicated body lotion; nutritionally fortified soft chews for use as nutritional supplements, probiotic compositions for use as nutritional supplements, multivitamin preparations, food supplements, nutritional supplements, vitamins, natural herbal supplements, mineral supplements, protein supplements, all of the foregoing goods being medicated and containing natural ingredients; pharmaceutical preparations and substances for the treatment of epilepsy, seizures and neurological and psychological diseases and disorders; pharmaceutical products, namely, viscoelastic solutions for intraocular use; medicines and medicinal preparations for human purposes, namely, to support treatment of hemorrhoids, chronic venous insufficiency and lymphedema; sanitary preparations for medical purposes; pharmaceutical preparations to support treatment of hemorrhoids, chronic venous insufficiency and lymphedema; homeopathic pharmaceuticals for use in support treatment of hemorrhoids, chronic venous insufficiency and lymphedema and vitamin preparations, all in the form of tablets or powder or soft gelatin capsules or hard gelatin capsules; homeopathic preparations, namely, homeopathic preparations containing herbs for medical purposes; therapeutic medicinal teas; dietetic food preparations adapted for medical purposes; food supplements for medical purposes, namely, food supplements for enhancing the immune system's resistance and improving bodily health; pharmaceutical preparations, namely, a topical cream for the treatment of pre-cancerous skin lesions; pharmaceutical preparations and substances for the prevention and treatment of disorders, diseases, conditions and ailments of the cardio-vascular system; pharmaceutical preparations and substances

for the prevention and treatment of hypertension; pharmaceutical preparations for the treatment of nausea, emesis; acetaminophen sold as an analgesic for the relief of pain; medicated skin care preparations for use in treating scars and damaged skin; topical gel for medical and therapeutic use in the treatment of scars and damaged skin; antiviral pharmaceutical compounds; antiobesity agent in the nature of a pharmaceutical preparation; dermotherapeutic preparation for use in the treatment of obesity; pharmaceutical products, namely, lipid and triglyceride reducing agents for use in the treatment of cardiovascular and heart disease; diuretic preparations; blend of ingredients sold as an integral component of medicated topical anti-itch preparations; pharmaceutical preparations for the treatment of oral mucositis and xerostomia; pharmaceutical preparations and substances for the treatment of eye disorders, diseases, conditions and ailments; pharmaceutical preparations and products for ophthalmological use; pharmaceutical preparations and substances for the prevention, treatment and alleviation of pain; anti-depressants; pharmaceutical preparations and substances for the prevention, treatment and alleviation of disorders, diseases, conditions and ailments of the cardiovascular system; pharmaceutical preparations and substances for the prevention, treatment and alleviation of parkinson's disease; pharmaceutical preparations and substances for the prevention, treatment and alleviation of huntington's disease; pharmaceutical preparations and substances for the prevention, treatment and alleviation of amyotrophic lateral sclerosis; pharmaceutical preparations and substances for the prevention, treatment and alleviation of alzheimer's disease; pharmaceutical preparations and substances for the prevention, treatment and alleviation of tourette syndrome; pharmaceutical preparations and substances for the prevention, treatment and alleviation of epilepsy; pharmaceutical preparations and substances for the prevention, treatment and alleviation of multiple sclerosis; pharmaceutical preparations and substances for the prevention, treatment and alleviation of cardio-pulmonary disorders, diseases, conditions, and ailments; pharmaceutical preparations and substances for the prevention, treatment and alleviation of disorders, diseases, conditions, and ailments of the circulatory system; pharmaceutical preparations and substances for the prevention, treatment and alleviation of hypertension, high blood pressure, heart failure and ventricular dysfunction; pharmaceutical preparations and substances for the prevention, treatment and alleviation of viral and infectious diseases; pharmaceutical preparations and substances for the prevention, treatment and alleviation of central nervous system disorders, diseases, conditions and ailments, namely, central nervous system movement disorders, ocular motility disorders, spinal cord diseases, encephalitis, cerebral palsy, insomnia, mood disorders,

bipolar disorder, seizure disorders; pharmaceutical preparations and substances, namely, fibrinolytic or thrombolytic agents; pharmaceutical preparations and substances for the prevention, treatment and alleviation of disorders, diseases, conditions and ailments of the respiratory system; pharmaceutical preparations and substances for the prevention, treatment and alleviation of disorders, diseases, conditions and ailments of the endocrine system; pharmaceutical preparations for the treatment of immunologic diseases, namely, auto immune motility diseases, immunologic deficiency syndromes, auto immune diseases, Acquired Immune Deficiency Syndrome (AIDS), hypersensitivity, allergies, tumors of the immunological organs; pharmaceutical preparations and substances for the prevention, treatment and alleviation of disorders, diseases, conditions and ailments of the musculoskeletal system, namely, bone diseases and bone degenerative conditions; pharmaceutical preparations and substances for the prevention, treatment and alleviation of migraines; pharmaceutical preparations and substances for use in oncology; pharmaceutical preparations and substances for the treatment of polycystic ovary syndrome; pharmaceutical preparations and substances for the treatment of infertility; pharmaceutical preparations and substances for the treatment of diabetes; pharmaceutical preparations and substances for the treatment of heart disease; pharmaceutical preparations and substances for the treatment of pain; pharmaceutical preparations and substances for the treatment of cardiovascular disease; pharmaceutical preparations and substances for the treatment of depression and social anxiety; pharmaceutical preparations and substances for the treatment of insomnia; pharmaceutical preparations and substances for the treatment of sleep disorders; pharmaceutical preparations and substances for the treatment of migraine and neurological disorders; veterinary products, namely, veterinary preparations for dogs, cats and horses for use during ophthalmic surgery and recovery therefrom; eye drops for veterinary use; pharmaceutical preparations for the treatment of cancer, neurological and dermatological disorders; pharmaceutical preparations for the treatment of myasthenia gravis, depression, mood/anxiety conditions, solar keratoses and cancer; antidepressants; tranquilizers; nasal spray preparations; pharmaceutical preparations for the treatment of neuromuscular conditions; pharmaceutical preparations, namely, retinoids, for the treatment of skin related diseases, cancer and precancerous conditions, and disorders related to the modulation of apoptosis; vitamin supplement distributed by prescription only; pharmaceutical preparations, namely, an oral glucose gel for the treatment of low blood sugar; pharmaceutical preparation for the treatment of headaches; pharmaceutical preparations, namely, diazepam rectal gel; methyltestosterone for use in the treatment of hormone deficiencies;

medicated skin lotion for the relief of itch caused by insect bites, eczema, sunburn and poison ivy; dressings for wounds; preparations and substances for the relief of anorectal discomfort, inflammation, and irritation; hemorrhoidal suppositories; pharmaceutical preparations for the treatment of irritable bowel syndrome; drugs to treat opioid-induced constipation; psychotropic preparations; cough medicine in the nature of a saline solution, namely, a spray for nasal dryness due to allergies, cold and flu; medicated eye wash; eye drops containing antihistamines and decongestants; pharmaceutical preparations, namely, an ophthalmic preparation for use in eye examinations; pharmaceuticals preparation that operates physiologically to control skin pigmentation; pharmaceutical preparations for wounds; pharmaceutical steroid preparations for topical use; pharmaceutical preparations, namely, antiemetics; preparations for use in cleaning contact lenses and kits containing said preparations.

9 – Contact lenses; software for use in ophthalmic medical and surgical procedures in the field of swept source optical coherence tomography; software used in ophthalmological and optometric instruments, namely, corneal topographer, aberrometer and lasers, all sold as a unit and used for the diagnosis of eye conditions and vision correction; carrying cases and containers for contact lenses; eyeglass chains; eyeglass cords; contact lens cases; plastic blanks, namely, optical lens blanks made of plastic for contact lenses; computer network consisting of a network server and network operating software allowing for the calculation, transfer and storage of data between components of ophthalmic, eye and vision correction systems and the customer support service provider; algorithm software for measuring and tuning the amount of radio frequency energy delivered to a patient treatment area for cosmetic skin procedures.

10 – Cosmetic apparatus, namely, light-based devices providing mainly pulsed light for performing non-ablative aesthetic skin treatment procedures; surgical and medical apparatus and instruments for use in ophthalmic medical and surgical procedures, namely, curved patient interface and suction clip; surgical, medical, and veterinary apparatus and instruments, namely, medical device intended to be used as intraocular lens in order to replace the natural crystalline lens of the eye during cataract surgery; artificial limbs, and teeth; surgical instruments, namely, endoscopes; disposable surgical instruments, other than for the dental sector; veterinary implants consisting primarily of artificial materials; artificial corneal lenses for veterinary use; veterinary lens extractors; veterinary instruments, namely, slit lamps, ophthalmoscopes, tonometers, veterinary ultrasound apparatus, micro-surgical instruments, tension ring injectors, and surgical sewing material, namely, needles and sutures; surgical instruments, namely, an

ultrasonic surgical system consisting of an ultrasonic surgical instrument to separate, fragment, and coagulate tissue, surgical irrigators and aspirators for medical use and related equipment, namely, a precision fluid delivery system comprised of a pump, controller and surgical tubing, fluid canisters, ultrasonic medical handpieces, probes and cannulas sold, leased or licensed separately or as a unit; medical devices, namely, finger-attached ultrasonic probes for diagnostic medical imaging; kit containing one or more surgical instruments, namely, cannulae or ultrasonic probes, and a sterilization tray that holds the instruments; respiratory apparatus for medical use; drug delivery device sold empty; intraocular lenses; phacoemulsification apparatus and instruments for use in ophthalmic surgical procedures; ophthalmic medical and surgical apparatus, equipment and instruments, namely, intraocular lenses, haptics for mounting intraocular lenses, and parts, components and fittings for the aforementioned goods; ophthalmic medical and surgical apparatus, equipment and instruments, namely, intraocular lenses, folding intraocular lenses, and parts, components and fittings for the aforementioned goods; lasers for medical use; lasers for ophthalmic medical and surgical procedures; ophthalmic surgical device used to inject intraocular lenses, and intraocular lenses; single-use ocular syringe preloaded with a capsular tension ring for use in cataract surgery; surgical instrument, namely, a vitreous cutter; ophthalmic surgical instruments and devices used in performing ophthalmic surgical procedures, and component parts thereof; ophthalmic medical devices, namely, intraocular lenses; medical device, namely, prosthetic intraocular implant; line of surgical blades for use in ophthalmic surgery; lasers for the medical and cosmetic treatment of the face and skin; medical devices for non-surgical cosmetic skin treatments; medical devices for contracting skin, body sculpting, and soft tissue reconstruction in a non-invasive manner; medical devices, namely, medical instruments for the non-invasive removal of human body fat utilizing an external energy source; surgical fat-collection canister kit consisting of a canister and a canister base assembly, a canister lid assembly, one or more ports, and one or more syringe caps; surgical instruments for fragmentation, cutting, coagulation, aspiration and irrigation; medical aesthetic devices that administer a combination of pneumatic energy and broadband light or pneumatic energy or broadband light alone for skin treatment and hair removal; medical devices, namely, lasers, radio frequency, ultrasound and thermal devices for use in connection with non-surgical cosmetic skin treatment systems; medical devices, namely, phototherapeutic apparatus for medical purposes, namely, devices for use in the treatment of dermatological conditions including acne; microsurgical instruments used in ophthalmic procedures to remove cataracts;

medical and surgical instruments and apparatus, namely, a vacuum and fluid control system consisting of pumps, tubing, sensors, valves, needles, sleeves, fluid collection containers, and recipient connections; secure tubing connection device used with and in ophthalmic, ocular, cataract and eye-related surgical procedures; surgical instruments, namely, surgical needles for ophthalmic surgery; medical devices, namely, impregnated cellulosic fiber strips for use in ophthalmic diagnosis; surgical, medical apparatus and instruments used in performing ophthalmic, ocular and eye-related surgery, namely, knives and cutters, all of the proceeding to exclude non-ophthalmic goods; medical devices, namely, single-use injector and capsular tension ring; keratome blades, namely, knives, namely, medical and surgical knives for cutting human or animal tissue and organs; ophthalmic and optometric instruments for making both measurements of surfaces of the eye and for performing diagnosis of the eye.

44 – Cosmetic treatment services, namely, the non-invasive removal of human body fat utilizing an external energy source; cosmetic treatment services, namely, skin care, body care and face care services; providing medical information in the field of pharmaceutical preparations and substances for the treatment of skin disorders, diseases, and conditions and ailments, and providing medical information related to chronic pain due to irritable bowel syndrome with diarrhea, opioid-induced constipation, and ulcerative colitis via a website; medical and surgical services, namely, ophthalmic, ocular and eye care medical and surgical services; providing information and advice in the field of health issues via a website; providing information in the field of medical services relating to procedures in the nature of body contouring via a website; providing medical information and medical services in the field of eye care, health of the eye and ophthalmics; providing information for healthcare professionals in the field of ophthalmology via an internet website portal; dermatology services; skin massage therapy; medical spa services, namely, non-invasive cosmetic medical services; liposuction and surgical body shaping services; medical services for the treatment of skin disorders; skin health restoration medical procedures; medical spa services, namely, cosmetic therapies; cosmetic body care services in the nature of non-surgical body contouring; medical services, namely, skin subcutaneous tissue treatment services; aesthetic and therapeutic skin and body treatment services; providing dermatological treatment services using lasers and radio frequency devices; providing health information; medical services, namely, orthokeratology procedures; cosmetic and plastic surgery and dermatological treatment services; medical services in the nature of performing ultrasonic surgical procedures; medical procedures, namely, ultrasonic body shaping treatments; pharmacists' services to

make up prescriptions; preparation and dispensing of medications.

(260) AM 2020 102486 A

(800) 1345215

(151) 2016 05 03

(891) 2019 01 31

(731) ITERCHIMICA S.r.l.

Via Guglielmo Marconi, 21, I-24040 Suisio  
(BG), Italy

(540)



(591) Black, white

(531) 26.15.01

(511)

1 – Chemical for use in industry; unprocessed artificial resins; unprocessed plastics; chemical substances for use as additives to asphalt; chemical substances for use as additives to bitumen; polymers for industrial use; chemical additives for use in industry; chemical compositions for use in construction; rubber compounds for industrial use; deicers; chemical preparations for melting snow and ice; additives for frost protection; soil stabilizers for use in road construction.

(260) AM 2020 102570 A

(800) 1459003

(151) 2018 09 13

(891) 2018 09 13

(731) EURO GAMES TECHNOLOGY LTD.

"Maritsa" Str. 4, "Vranya-Lozen-Triugulnika",  
BG-1151 Sofia, Bulgaria

(540)



(591) Red, gray, black, white and raspberry-red

(531) 27.05.03; 27.05.09; 27.05.10; 29.01.14

(511)

9 – Software; computer gaming software; computer software packages; computer operating system software; computer software, recorded; software drivers; virtual reality software; games software; entertainment software for computer games; computer programs for network management; operating computer software for mainframe computers; monitors (computer hardware); computer hardware; apparatus for recording images; monitors (computer programs); computer game programs; computer programs for recorded games; apparatus for recording, transmission or reproduction of sound or images; communications servers [computer hardware]; electronic components for gambling machines; computer applica-



tion software featuring games and, gaming; computer software for the administration of on-line games and gaming; computer hardware for games and gaming; electronic components and computer software for gambling, gambling machines, gambling games on the Internet and via telecommunication network.

28 – Gaming machines for gambling; chips for gambling; mah-jong; arcade games; gambling machines operating with coins, notes and cards; games; electronic games; parlor games; gaming chips; gaming tables; slot machines [gaming machines]; LCD game machines; slot machines and gaming devices; coin-operated amusement machines; roulette chips; poker chips; chips and dice [gaming equipment]; equipment for casinos; roulette tables; gaming roulette wheels; casino games; gambling machines and amusement machines, automatic and coin-operated; coin-operated amusement machines and/or electronic coin-operated amusement machines with or without the possibility of gain; boxes for coin-operated machines, slot machines and gaming machines; electronic or electrotechnical amusement machines and apparatus, gaming machines, coin-operated entertainment machines; housings for coin-operated machines, gaming equipment, gaming machines, machines for gambling; electropneumatic and electrical slot machines (gaming machines for gambling).

41 – Gambling; services related to gambling; gaming services for entertainment purposes; casino, gaming and gambling services; training in the development of software systems; provision of equipment for gambling halls; providing casino equipment [gambling]; gaming machine entertainment services; providing casino facilities [gambling]; gaming hall services; amusement arcade services; games equipment rental; rental of gaming machines; providing amusement arcade services; rental of gaming machines with images of fruits; editing or recording of sounds and images; sound recording and video entertainment services; hire of sound reproducing apparatus; provision of gaming equipment for casinos; providing of casino facilities; online gambling services; casino, gaming and gambling services; provision of gaming establishments, gaming halls, Internet casinos, online gaming services.

(260) AM 2020 102571 A  
(800) 1459008  
(151) 2019 02 22  
(891) 2019 02 22  
(731) SHIJIAZHANG INDUSTRIAL PUMP  
FACTORY CO., LTD.  
NO.5 JINGYANG ROAD, JINGXING MINE  
DISTRICT, SHIJIAZHANG CITY, HEBEI  
PROVINCE, China

(540)

**SGB**

(591) Black, white  
(531) 27.05.23  
(511)  
7 – Centrifugal pumps; pumps [parts of machines, engines or motors]; pumps [machines].

(260) AM 2020 102572 A  
(800) 1459027  
(151) 2019 01 04  
(891) 2019 01 04  
(731) SINOTRANS & CSC Holdings Co., Ltd.  
Sinotrans Plaza A, A43 Xizhimen Beidajie,  
100044 Beijing, China

(540)

**SINOTRANS**

(591) Black, white  
(531) 27.05.01  
(511)  
39 – Delivery of goods; parcel delivery; lighterage services; barge transport; rental of warehouses; ship-brokerage; freight [shipping of goods]; boat rental; refloating of ships; boat transport; piloting; ferry-boat transport; transport and storage of trash; salvaging; freight forwarding; rental of storage containers; courier services [messages or merchandise]; travel reservation; arranging of transportation for travel tours; stevedoring; packaging of goods; wrapping of goods; car parking; hauling; transportation logistics; unloading cargo; delivery of goods by mail order; pleasure boat transport; transport; transport brokerage; transportation information; transport reservation; vehicle rental; storage; storage information; freighting; transport of travellers; freight brokerage [forwarding (Am.)]; river transport; marine transport; car transport; railway transport; air transport; storage of goods.

(260) AM 2020 102573 A  
(800) 1459058  
(151) 2018 10 26  
(891) 2018 10 26  
(731) Open-Type Joint Stock Company  
"ROT FRONT"  
2-oy Novokuznetskiy pereulok, d. 13/15,  
RU-115184 Moscow, Russian Federation

(540)



(591) Green, mint, turquoise, red, yellow, gold, white, brown, gray

(531) 05.03.11; 05.03.15; 07.03.20; 08.01.22; 25.01.15; 26.01.01; 26.01.02; 26.03.01; 26.03.03; 26.03.07; 26.03.18; 27.05.09; 28.05; 29.01.15

(511)  
30 – Aromatic preparations for food; flavorings, other than essential oils, for cakes; flavorings, other than essential oils, for beverages; coffee flavorings; food flavorings, other than essential oils; star aniseed; high-protein cereal bars; pancakes; noodle-based prepared meals; buns; bread rolls; vanillin [vanilla substitute]; waffles; vermicelli [noodles]; natural sweeteners; sausage binding materials; binding agents for ice cream; sea water for cooking; seaweed [condiment]; malt biscuits; cloves [spice]; cake frosting [icing]; mustard; gluten additives for culinary purposes; yeast; thickening agents for cooking foodstuffs; rice-based snack food; cereal-based snack food; artificial coffee; vegetal preparations for use as coffee substitutes; dressings for salad; fruit jellies [confectionery]; confectionery for decorating Christmas trees; cakes; pastries; peanut confectionery; almond confectionery; pasta; ginger [spice]; frozen yogurt [confectionery ices]; cocoa; capers; caramels [candy]; curry [spice]; ketchup [sauce]; quiches; gluten prepared as foodstuff; sweetmeats [candy]; liquorice [confectionery]; peppermint sweets; cinnamon [spice]; coffee; unroasted coffee; starch for food; crackers; custard; groats for human food; hominy grits; semolina; oatmeal; crushed barley; corn, milled; corn, roasted; meat pies; turmeric; couscous [semolina]; noodles; ice for refreshment; ice, natural or artificial; edible ices; rice cakes; mayonnaise; macarons [pastry]; macaroni; maltose; hominy; marinades; marzipan; honey; royal jelly; ice cream; flour; bean meal; tapioca flour; potato flour; corn flour; wheat flour; soya flour; barley meal; dessert mousses [confectionery]; chocolate mousses; muesli; mint for confectionery; cocoa beverages with milk; coffee beverages with milk; coffee-based beverages; tea-based beverages; chocolate beverages with milk; chocolate-based beverages; cocoa-based beverages; infusions, not medicinal; crushed oats; husked oats; nutmegs; stick liquorice [confectionery]; soya bean paste (condiment); pastilles [confectionery]; molasses for food; pepper; allspice; peppers [seasonings]; pesto [sauce]; cookies; petit-beurre biscuits; pies; pizzas; meat gravies; fondants [confectionery]; popcorn; powders for making ice cream; baking powder; mustard meal; pralines; condiments; meat tenderizers for household purposes; cereal preparations; oat-based food; propolis; gingerbread; spices; petits fours [cakes]; puddings; cake powder; fruit coulis [sauces]; ravioli; chewing gum; relish [condiment]; rice; wheat germ for human consumption; spring rolls; sago; sugar; aniseed; golden syrup; confectionery; baking soda [bicarbonate of soda for cooking

purposes]; malt for human consumption; salt for preserving foodstuffs; cooking salt; celery salt; sherbets [ices]; ham glaze; soya sauce; tomato sauce; sauces [condiments]; spaghetti; seasonings; preparations for stiffening whipped cream; rusks; bread-crumbs; sushi; sandwiches; tabbouleh; tacos; tapioca; cream of tartar for culinary purposes; tarts; almond paste; tortillas; garden herbs, preserved [seasonings]; beer vinegar; vinegar; ferments for pastes; halvah; bread; unleavened bread; corn flakes; oat flakes; chicory [coffee substitute]; tea; iced tea; chutneys [condiments]; cheeseburgers [sandwiches]; chow-chow [condiment]; saffron [seasoning]; malt extract for food; essences for foodstuffs, except etheric essences and essential oils; husked barley.

(260) AM 2020 102574 A

(800) 1459059

(151) 2018 11 26

(891) 2018 11 26

(731) PLIATS IGOR VOLODYMYROVYCH  
prov. Shevchenka, 4, kv. 54, m. Dnipro 49044,  
Ukraine

(540)



Rena Rosh

(591) Black, white

(531) 27.05.01; 27.05.22

(511)

3 – Bleaching preparations and other substances for laundry use; cleaning, polishing, scouring and abrasive preparations; soap; perfumery, essential oils, cosmetics, hair lotions; dentifrices; aromatics (essential oils); essential oils; balms, other than for medical purposes; lip balms, non-medicated; hair balms; hair dyes; cosmetic dyes; joss sticks; lip glosses; nail glitter; cotton wool for cosmetic purposes; cotton sticks for cosmetic purposes; skin whitening creams; depilatory wax; scented water; toilet water; bath gel; beauty gels; shower gel; douching preparations for personal sanitary or deodorant purposes (toiletries); make-up; lipsticks; deodorant soap; deodorants for human beings or for animals; depilatory preparations; baby oils (toiletries); baby bubble bath; ethereal essences; hair grooming preparations; moisturizing milk; skin moisturizers; hair conditioners; eyebrow cosmetics; mascara; cosmetics for animals; sun-tanning preparations (cosmetics); cosmetic creams; beauty masks; beauty milk; cosmetic kits; cosmetic pencils; oils for cosmetic purposes; styling mousse; pomades for cosmetic purposes; cosmetic preparations; cosmetic preparations for baths; cosmetic pre-

parations for slimming purposes; cosmetic preparations for body care; cosmetic preparations for skin care; skin cleansers; cosmetic face powder; cosmetic hand creams; shaving creams; hair spray; nail polish; non-medicated soap; lotions for cosmetic purposes; after-shave lotions; massage gels, other than for medical purposes; facial beauty masks; cosmetic hair lotions; cleaning agents and preparations; cleaning and washing preparations and substances; soap for foot perspiration; antiperspirant soap; liquid soap; granulated soap; cleansing milk for toilet purposes; nail art stickers; fumigation preparations (perfumes); eau de Cologne; eyebrow pencils; oils for cleaning purposes; perfumery; air fragrancing preparations; shaving preparations; theatrical make-up; make-up preparations; nail care preparations; aloe vera preparations for cosmetic purposes; toiletry preparations; sachets for perfuming linen; tissues impregnated with cosmetic lotions; tissues impregnated with make-up removing preparations; non-medicated skin care preparations; bath salts, not for medical purposes; cosmetic sun-protecting preparations; sunscreen preparations; cosmetic skin fresheners; potpourris (fragrances); dry shampoos; toners for cosmetic use; cosmetic facial toners; shampoos.

5 – Pharmaceutical preparations; sanitary preparations for medical purposes; dietetic substances adapted for medical use; mineral nutritional supplements; anti-oxidants for use as dietary supplements; medical preparations for slimming purposes; antiseptics; germicides; balms for medical purposes; medicated hair lotions; medicated lip salves; balsamic preparations for medical purposes; medicated lip balms; medicinal mud; vitamin preparations; sanitary panties; topical gels for medical and therapeutic purposes; pomades for medical purposes; sanitary towels; sanitary tampons; homeopathic supplements; mud for baths; disinfectants for hygiene purposes; deodorants for clothing and textiles; deodorants, other than for human beings or for animals; disposable training pants for infants; babies' diapers (napkins); dietary supplements for humans; medicinal roots; medicinal drinks; medicinal oils; medicated toiletry preparations; therapeutic drugs and agents; medicinal infusions; medicinal herbs; medicinal tea; medicinal hair growth preparations; medicated hair care preparations; medicated skin care preparations; lotions for pharmaceutical purposes; sanitary pads; mineral food supplements; air purifying preparations; diapers for incontinents; medicated lotions and creams for the body, skin, face, and hands; air deodorising preparations; ootherapy preparations; tissues impregnated with pharmaceutical lotions; bath salts for medical purposes; therapeutic preparations for the bath; pharmaceutical preparations for treating dandruff; pharmaceutical preparations for skin care; medicated shampoos.

(260) AM 2020 102575 A

(800) 1459063

(151) 2018 09 13

(891) 2018 09 13

(731) EURO GAMES TECHNOLOGY LTD.

"Maritsa" Str. 4, "Vranya-Lozen-Triugulnika",  
BG-1151 Sofia, Bulgaria

(540)



(591) Orange, gray, black, white and red

(531) 27.05.03; 27.05.09; 27.05.10; 29.01.15

(511)

9 – Computer gaming software for gambling; virtual reality software for gambling; apparatus for recording, transmission or reproduction of sound or images in the field of gambling; electronic components for gambling machines; computer application software featuring games and gaming in the field of gambling; computer hardware for games and gaming in the field of gambling; electronic components and computer software for gambling, gambling machines, gambling games on the Internet and via telecommunication network.

28 – Gaming machines for gambling; chips for gambling; mah-jong; arcade games; gambling machines operating with coins, notes and cards; games; electronic games; parlor games; gaming chips; gaming tables; slot machines [gaming machines]; LCD game machines; slot machines, bingo machines and arcade game machines; coin-operated amusement machines; roulette chips; poker chips; chips and dice [gaming equipment]; equipment for casinos; roulette tables; gaming roulette wheels; casino games; gambling machines and amusement machines, automatic and coin-operated; coin-operated amusement machines and/or electronic coin-operated amusement machines with or without the possibility of gain; boxes for coin-operated machines, slot machines and gaming machines; electronic or electrotechnical amusement machines and apparatus, gaming machines, coin-operated entertainment machines; housings for coin-operated machines, gaming equipment, gaming machines, machines for gambling; electropneumatic and electrical gambling machines (slot machines).

41 – Gambling; services related to gambling; gaming services for entertainment purposes; casino, gaming and gambling services; training in the development of software systems; provision of equipment for gambling halls; providing casino equipment [gambling]; gaming machine entertainment services; providing casino facilities [gambling]; gaming hall services; amusement arcade services; games equipment rental; rental of gaming machines; providing amusement arcade services; rental of gaming machines with images of fruits; editing or recording of sounds and images; sound recording and video en-



tertainment services; hire of sound reproducing apparatus; provision of gaming equipment for casinos; providing of casino facilities; online gambling services; casino, gaming and gambling services; provision of gaming establishments, gaming halls, Internet casinos, online gaming services.

(260) AM 2020 102576 A

(800) 1459090

(151) 2018 12 14

(891) 2018 12 14

(731) Joint-Stock Company "VORONEZHSKAYA  
CONDITERSKAYA FABRIKA"  
ul. Koltsovskaya, d. 40, RU-394030  
Voronezh, Russian Federation

(540)



(591) Dark yellow, yellow, orange, white, brown and light brown

(531) 01.15.11; 27.05.02; 29.01.13

(526) Toffee, premio

(511)

30 – Sweetmeats [candy].

(260) AM 2020 102577 A

(800) 1459102

(151) 2018 09 13

(891) 2018 09 13

(731) EURO GAMES TECHNOLOGY LTD.  
"Maritsa" Str. 4, "Vranya-Lozen-Triugulnika",  
BG-1151 Sofia, Bulgaria

(540)



(591) Red, gray, black, white and burgundy

(531) 27.05.03; 27.05.09; 27.05.10; 27.05.24;  
29.01.15

(511)

9 – Software; computer gaming software; computer software packages; computer operating system software; computer software, recorded; software drivers; virtual reality software; games software; entertainment software for computer games; computer programs for network management; operating computer software for mainframe computers; monitors (com-

puter hardware); computer hardware; apparatus for recording images; monitors (computer programs); computer game programs; computer programs for recorded games; apparatus for recording, transmission or reproduction of sound or images; communications servers [computer hardware]; electronic components for gambling machines; computer application software featuring games and gaming; computer software for the administration of on-line games and gaming; computer hardware for games and gaming; electronic components and computer software for gambling, gambling machines, gambling games on the Internet and via telecommunication network.

28 – Gaming machines for gambling; chips for gambling; mah-jong; arcade games; gambling machines operating with coins, notes and cards; games; electronic games; parlor games; gaming chips; gaming tables; slot machines [gaming machines]; LCD game machines; slot machines, bingo machines and arcade game machines; coin-operated amusement machines; roulette chips; poker chips; chips and dice [gaming equipment]; equipment for casinos; roulette tables; gaming roulette wheels; casino games; gambling machines and amusement machines, automatic and coin-operated; coin-operated amusement machines and/or electronic coin-operated amusement machines with or without the possibility of gain; boxes for coin-operated machines, slot machines and gaming machines; electronic or electrotechnical amusement machines and apparatus, gaming machines, coin-operated entertainment machines; housings for coin-operated machines, gaming equipment, gaming machines, machines for gambling; electropneumatic and electrical gambling machines (slot machines).

41 – Gambling; services related to gambling; gaming services for entertainment purposes; casino, gaming and gambling services; training in the development of software systems; provision of equipment for gambling halls; providing casino equipment [gambling]; gaming machine entertainment services; providing casino facilities [gambling]; gaming hall services; amusement arcade services; games equipment rental; rental of gaming machines; providing amusement arcade services; rental of gaming machines with images of fruits; editing or recording of sounds and images; sound recording and video entertainment services; hire of sound reproducing apparatus; provision of gaming equipment for casinos; providing of casino facilities; online gambling services; casino, gaming and gambling services; provision of gaming establishments, gaming halls, Internet casinos, online gaming services.

(260) AM 2020 102578 A

(800) 1459107

(151) 2018 12 20

(891) 2018 12 20

(731) BAYER AKTIENGESELLSCHAFT  
Kaiser-Wilhelm-Allee, 51373 Leverkusen,  
Germany

(540)



(591) Gray (Pantone 9 CP), pink-red (Pantone 199 CP) and purple (Pantone 2357 CP)

(531) 26.11.02; 26.11.06; 26.11.12; 29.01.12

(511)

5 – Pharmaceutical preparations.

(260) AM 2020 102579 A

(800) 1459122

(151) 2019 03 01

(891) 2019 03 01

(731) IPSEN BIOPHARM LIMITED

Ash Road, Wrexham Industrial Estate,  
Wrexham LL13 9UF, United Kingdom

(540)

**ОНИВАЙД**

(591) Black, white

(531) 28.05

(511)

5 – Pharmaceuticals, medical and veterinary preparations; sanitary preparations for medical purposes; dietetic food and substances adapted for medical or veterinary use; food for babies; dietary supplements for humans and animals; plasters, materials for dressings; material for stopping teeth, dental wax; disinfectants; preparations for destroying vermin; fungicides, herbicides.

(260) AM 2020 102581 A

(800) 1459175

(151) 2019 01 31

(891) 2019 01 31

(731) Obschestvo s ogranichennoy otvetstvennostyu  
Selskohozyajstvennoe proizvodstvennoe  
predpriyatie "YUG"

Zheleznodorozhnaya street, building 63/1,  
Armavir city, RU-352902 Krasnodarskiy  
kraj, Russian Federation

(540)

**КУБАНСКОЕ ЛЮБИМОЕ**

(591) Black, white

(531) 28.05

(511)

29 – Margarine; oils for food; peanut butter; coconut butter; corn oil for food; sesame oil for food; olive oil for food; palm oil for food; palm kernel oil for food; sunflower oil for food; butter; cocoa butter for food; coconut oil for food; linseed oil for food; colza oil for food.

(260) AM 2020 102593 A

(800) 1459417

(151) 2019 01 17

(891) 2019 01 17

(731) Zino Davidoff SA

Rue Faucigny 5, CH-1700 Fribourg,  
Switzerland

(540)

**Cool Water**

(591) Black, white

(531) 27.05.01

(511)

3 – Bleaching preparations and other substances for laundry use; cleaning, polishing, scouring and abrasive preparations; soaps; perfumery, essential oils, cosmetics, hair lotions; dentifrices; scented water; liquid perfume, namely eau fraîche; eau de Cologne; eaux de toilette; eau de parfum; perfumes; toiletries; shampoos; shower gels; bath gels; bath liquids for cosmetic use; shower liquids for cosmetic use; bath foaming gel; shower foaming gel; bath foaming liquids; bath salts; skin lotions for cosmetic use; sanitary preparations being toiletries for body care; tanning products based on suntan creams; suntan creams; non-medicated stimulating lotions for body care; body lotions for cosmetic use; body moisturizing concentrates; pre-shave creams; shaving soap; shaving creams; shaving gels; after-shave products, in particular after-shave balms, after-shave cologne, after-shave oils, after-shave creams, after-shave gel, after-shave powder, after-shave lotions; deodorant soaps; deodorant sprays for personal use; deodorant sticks for personal use; antiperspirants.

(260) AM 2020 102594 A

(800) 1459439

(151) 2019 03 06

(891) 2019 03 06

(731) Victoria's Secret Stores Brand Management,  
Inc.

4 Limited Parkway, Reynoldsburg OH  
43068, USA

(540)

**VICTORIA'S SECRET  
TEASE**

(591) Black, white  
(511)  
3 – Eau de parfum; non-medicated skin care preparation, namely body mist; body sprays; body lotion.

(260) AM 2020 102595 A  
(800) 1459533  
(151) 2019 01 21  
(891) 2019 01 21  
(731) GD Sigelai Electronic Tech Co., Ltd  
B7 Building, No.1 District, Xicheng  
Science and Technology Park, Hengli  
Town, Dongguan, China

(540)



(591) Black, white  
(531) 26.13.25; 27.05.01; 28.03  
(511)  
34 – Tobacco; cigarillos; liquid solutions for use in electronic cigarettes; oral vaporizers for smokers; matches; lighters for smokers; cigarette filters; flavorings, other than essential oils, for tobacco; flavorings, other than essential oils, for use in electronic cigarettes; electronic cigarettes.

(260) AM 2020 102596 A  
(800) 1459539  
(151) 2018 12 21  
(891) 2018 12 21  
(731) KAO KABUSHIKI KAISHA  
(also trading as Kao Corporation)  
14-10, Nihonbashi Kayabacho 1-chome,  
Chuo-ku, Tokyo 103-8210, Japan

(540)

**Attack**

(591) Black, white  
(511)  
3 – Soaps and detergents; perfume and flavour materials, and incense; cosmetics; dentifrices; false nails; false eyelashes; fabric softeners for laundry use; laundry bleach; adhesives for affixing false hair; adhesives for affixing false eyelashes; laundry starch; seaweed gelatine for laundry use [Funori].

(260) AM 2020 102597 A  
(800) 1459618  
(151) 2019 02 22  
(891) 2019 02 22  
(731) Wells Fargo & Company  
1700 Wells Fargo Center, MAC N9305-176,  
Sixth & Marquette, Minneapolis MN 55479,  
USA

(540)



(591) The colors red and white are claimed as a feature of the mark

(531) 26.04.18; 26.04.24; 27.05.24; 29.01.12

(511)

35 – Arranging and conducting incentive reward programs to promote the sale of banking services; business information services, namely, providing customized company and industry performance analysis in the field of banking, finance, investments and insurance; providing business information in the field of company and industry performance; accounts receivable management services; accounts receivable billing services; administration and reconciliation of accounts on behalf of others; administration of business payroll for others; preparation of financial reports for others, namely, provision of consolidated reports and document images of banking and financial activity.

36 – Banking services; business banking services; payment processing services, namely, credit card and debit card transaction processing services; credit card, debit card and electronic check transaction processing services; issuing stored value cards; investment consultation, investment brokerage and investment management services; financial investment services in the fields of securities, mutual funds, certificates of deposit, and portfolio management; insurance agencies, insurance consultation and insurance administration services in the fields of accident, flood, fire, automobile, life, health, home, renters, long-term care, in-home business, watercraft, umbrella, liability, property, identity theft and employer insurance; financial evaluation for insurance purposes; administration of employee benefits plans concerning insurance and finance; accounts payable debiting services; mortgage banking services, mortgage lending services, mortgage brokerage services; commercial lending services; consumer lending services; issuing letters of credit; foreign exchange services, namely, foreign exchange transactions, foreign exchange information services and providing for the exchange of foreign currency; credit and financial consultation; treasury financial management services; trust management accounts services; cash management services; online banking services; online business banking services; bill payment services; electronic payment, namely, electronic processing and subsequent transmission of ACH payment data, electronic check payment data, electronic payments,

and invoice, bill, tax, and distribution payment data; tax payment processing services; providing information in the field of banking, credit card and debit card services, credit card, debit card and electronic check transaction processing services, financial management, investment brokerage, investment management, financial portfolio management, insurance, accounts payable debiting services, mortgage banking, mortgage lending, mortgage brokerage, commercial lending, consumer lending, issuing letters of credit, foreign exchange services, financial treasury management services, trust management accounts services, cash management services, online banking, bill payment services, and tax payment processing services; financing loans for inventory, machinery, vehicles and equipment; providing lease financing for inventory, machinery, vehicles and equipment.

(260) AM 2020 102598 A

(800) 1459627

(151) 2018 11 12

(891) 2018 11 12

(731) NAHAL EGHBALI AZAR (MS)

4th Floor, No.39 Eghbal Melli Ave, Reshadat St, Sarv Sharghi St, Sa'Adat Abad, Tehran, Islamic Republic of Iran

(540)

**Zaman**

**زمان**

(591) Black, white

(531) 28.01

(511)

34 – Tobacco; smoking tobacco; tobacco pipes.

35 – Import-export agency services for the goods including tobacco, smoking tobacco, tobacco pipes.

39 – Packaging of the goods; delivery of the goods including tobacco, tobacco smoking, tobacco pipes.

(260) AM 2020 102599 A

(800) 1459633

(151) 2019 01 09

(891) 2019 01 09

(731) LIMITED LIABILITY COMPANY

"AGROPROMISLOVA COMPANY

"FAVORIT"

vul. Poliova, 1 V, s. Pidhaitsi, Kirovohradskyy r-n, Kirovohradska obl. 27613, Ukraine

(540)



(591) Black, yellow and white

(531) 03.03.01; 03.03.15; 03.03.24; 05.07.02;

05.07.05; 27.05.01; 29.01.13

(511)

7 – Shock absorber plungers (parts of machines); flour mill machines; bulldozers; centrifugal mills; winnowers; lawnmowers [machines]; turf removing ploughs; milking machines; drainage machines; excavators, excavator with one-piece; escalators; reapers; reapers (machines); reapers and binders; millstones; raking machines; grain separators; reapers and threshers; grain husking machines; ditchers [ploughs]; conveyors (machines); diggers [machines]; housings [parts of machines]; cultivators (machines); butter machines; earth moving machines; peeling machines, grinding machines; hair cutting machines for animals; mechanized livestock feeders; mixers [machines]; mills (machines); threshing machines, motorized cultivators; sprayers (machines); ploughs; ploughshares; weeding machines; sifting installations; sifting machines; sowers [machines]; agricultural implements, other than hand-operated; agricultural elevators; agricultural machines; tedding machines; sheaf-binding machines; straw [chaff] cutters; beating machines; beaters, electric.

35 – Administrative processing of orders for the purchase of a range of goods, namely, agricultural machines, agricultural implements; auctioneering of a range of goods, namely, agricultural machines, agricultural implements; demonstration of the range of goods, namely, agricultural machines, agricultural implements; supply services for others of a range of goods, namely, agricultural machines, agricultural implements (purchasing goods for other enterprises); services in retail or wholesale sales of goods, namely, agricultural machines, agricultural implements; presentation of a range of goods namely, agricultural machines, agricultural implements, on means of informing for the purpose of retail sale; promotion of sales for others of a range of goods, namely, agricultural machines, agricultural implements; the bringing together, for the benefit of others, of a variety of goods, namely, agricultural machinery, agricultural implements, excluding the transport thereof, enabling customers to conveniently view and purchase those goods, including via the Internet online.

(260) AM 2020 102600 A

(800) 1459651

(151) 2018 07 30

(891) 2018 07 30

(731) Gaming Laboratories International LLC

600 Airport Road, Lakewood NJ 08701, USA

(540)

**GLI**

(591) Black, white

(511)

9 – Computer hardware and computer software; computer software for use in checking and confirming the compliance of electronic game apparatus, electronic games, lottery games, games of chance and slot machines (including video slot machines); computer software related to remote testing services; unified communications software; computer information security software and related systems, in particular for use in the field of healthcare IT that conforms to specific government standards; hardware, firmware and software, in particular for use in voting machines and voting systems that conforms to specific government standards; internet protocol (IP) cameras; internet protocol (IP) surveillance cameras; computer hardware and software solutions designed to deliver instructional content; training, learning and educational software; training guides and manuals in electronic format; data carriers, memory sticks and other digital recording media; data carriers, memory sticks and other digital recording media, containing software for use in checking and confirming the compliance of electronic game apparatus, electronic games, lottery games, games of chance and slot machines (including video slot machines); parts, fittings and accessories relating to all of the aforesaid.

35 – Business auditing in the nature of electronic gaming and lottery devices, gaming, lottery and paramutual systems and consulting services related thereto; retail (including online retail) and wholesale services related to computer hardware and computer software; outsourcing services in relation to the management of software (terms considered too vague by the International Bureau – rule 13 (2) (b) of the Common Regulations); business auditing; business consultancy services relating to business continuity, disaster planning and recovery; information, advisory, support and consultancy services relating to all of the aforesaid.

41 – Providing of training and education; providing online learning and training services; providing training, learning and education services through integrated learning systems; providing of training and education in relation to computer hardware, computer software, IT systems, IT services and cyber security; arranging and conducting seminars, classes, workshops and training sessions in relation to computer hardware, computer software, IT systems, IT services and cyber security; information, advisory, support and consultancy services relating to all of the aforesaid.

42 – Scientific and technological services and research and design relating thereto; industrial analysis and research services; design and development of computer hardware and software; services of control, tests, checking legality and approval of electronic game apparatus, of programs for electronic

games, of lottery games and games of chance on behalf of national or governmental gaming regulatory authorities (terms considered too vague by the International Bureau – rule 13 (2) (b) of the Common Regulations); testing and inspecting the functionality of electronic gaming and lottery devices, gaming lottery and paramutual systems and associated equipment and consulting services related thereto; testing, analysis and evaluation of gaming equipment and gaming software of others for the purpose of certification obtained over a wireless communication device; providing remote testing, checking and certifying services in relation to gaming machines, electronic game apparatus, electronic games, lottery games, games of chance and slot machines (including video slot machines); cyber security protection, consulting and monitoring; cyber security incident response and investigation services; services of control, tests, checking legality and approval of voting machines and health information technology on behalf of national or governmental regulatory authorities (terms considered too vague by the International Bureau – rule 13 (2) (b) of the Common Regulations); testing voting equipment and IT systems in the health delivery field to determine conformity with certification standards; quality assurance and IT consulting services, including such services provided in the voting equipment and health delivery fields; information technology (IT) services (terms considered too vague by the International Bureau – rule 13 (2) (b) of the Common Regulations); hosting outsourcing services (terms considered too vague by the International Bureau – rule 13 (2) (b) of the Common Regulations); network security services; IT security services, namely, assessing and ascertaining the (unauthorised) accessibility of sensitive information or data; IT help desk services; IT support and maintenance services (terms considered too vague by the International Bureau – rule 13 (2) (b) of the Common Regulations); learning systems services (terms considered too vague by the International Bureau – rule 13 (2) (b) of the Common Regulations); outsourcing services in relation to the management of software; IT process improvement, consulting and design services; IT compliance management; quality auditing; auditing of IT systems for others; IT system implementation services; IT network implementation services (terms considered too vague by the International Bureau – rule 13 (2) (b) of the Common Regulations); disaster recovery services for computer systems and data communications systems; computer disaster recovery planning; computer services and software as a service (SaaS) services featuring software integrated with IP surveillance cameras (terms considered too vague by the International Bureau – rule 13 (2) (b) of the Common Regulations); cyber and computer surveillance services; cyber security services, namely, IT penetration testing services; conducting security reviews and audits of



computer source code; data security services; IT certification services; certification services related to computer hardware, computer software, IT systems, IT services, data and cyber security; testing, auditing, analysis and evaluation services for the purpose of certification of computer hardware, computer software, IT systems, IT services, data and cyber security; unified communications technology services (terms considered too vague by the International Bureau – rule 13 (2) (b) of the Common Regulations); information, advisory, support and consultancy services relating to all of the aforesaid.

45 – Security incident response and investigation services (terms considered too vague by the International Bureau – rule 13 (2) (b) of the Common Regulations); security or surveillance services provided via video footage from IP cameras; reviewing standards and practices to assure compliance with laws and regulations; interviewing of staff for security purposes; conducting staff interviews to assess and ascertain the (unauthorised) accessibility of sensitive information or data; security services, namely, reviewing training material and records to assess and ascertain the (unauthorised) accessibility of sensitive information or data; information, advisory, support and consultancy services relating to all of the aforesaid.

(260) AM 2020 102601 A

(800) 1459709

(151) 2018 10 19

(891) 2018 10 19

(731) NOLAN OTOMOTİV YEDEK PARÇA  
İNŞAAT YAPI MALZEMELERİ TEKSTİL  
SANAYİ VE TİCARET LİMİTED ŞİRKETİ  
BARBAROS H.PAŞA MAH., N.HİKMET  
HİKMET BLV., A BLOK NO:84 A/73,  
ESENYURT, İSTANBUL, Turkey

(540)



(591) Black, white

(531) 26.03.23; 26.11.03; 26.11.11; 27.05.01;  
27.05.11

(511)

12 – Motor land vehicles, motorcycles, mopeds; engines and motors for land vehicles; clutches for land vehicles; transmissions, transmission belts and transmission chains for land vehicles; gearing for land vehicles, brakes, brake discs and brake linings for land vehicles; vehicle chassis, automobile bonnets, vehicle suspension springs, shock absorbers for automobiles, gearboxes for land vehicles, steering wheels for vehicles, rims for vehicle wheels; bicycles and their bodies, handlebars and mudguards for bicycles; vehicle bodies; tipping bodies for trucks;

trailers for tractors; frigorific bodies for land vehicles; trailer hitches for vehicles; vehicle seats; head-rests for vehicle seats; safety seats for children, for vehicles; seat covers for vehicles; vehicle covers (shaped); sun-blinds adapted for vehicles; direction signals and arms for direction signals for vehicles; windscreen wipers and wiper arms for vehicles; inner and outer tires for vehicle wheels; tubeless tires; tire-fixing sets comprised of tire patches and tire valves for vehicles, windows for vehicles, safety windows for vehicles, rearview mirrors and wing mirrors for vehicles; anti-skid chains for vehicles; luggage carriers for vehicles; bicycle and ski carriers for cars; saddles for bicycles or motorcycles; air pumps for vehicles, for inflating tires; anti-theft alarms for vehicles, horns for vehicles; safety belts for vehicle seats, air bags (safety devices for automobiles); baby carriages, wheelchairs, pushchairs; wheelbarrows; shopping carts; single or multi-wheeled wheelbarrows; shopping trolleys; grocery carts; handling carts; rail vehicles; locomotives; trains; trams; waggons; cable cars; chairlifts; vehicles for locomotion by water and their parts, other than their motors and engines; vehicles for locomotion by air and their parts, other than their motors and engines.

35 – Advertising, marketing and public relations; organization of exhibitions and trade fairs for commercial or advertising purposes; design of advertising materials; provision of an online marketplace for buyers and sellers of goods and services; office functions; secretarial services; arranging newspaper subscriptions for others; compilation of statistics; rental of office machines; systemization of information into computer databases; telephone answering for unavailable subscribers; business management, business administration and business consultancy; accounting; commercial consultancy services; personnel recruitment, personnel placement, employment agencies, import-export agencies; temporary personnel placement services; auctioneering; the bringing together, for the benefit of others, of a variety of goods, namely, motor land vehicles, motorcycles, mopeds, engines and motors for land vehicles, clutches for land vehicles, motorcycles, mopeds, engines and motors for land vehicles, clutches for land vehicles, transmissions, transmission belts and transmission chains for land vehicles, gearing for land vehicles, brakes, brake discs and brake linings for land vehicles, vehicle chassis, automobile bonnets, vehicle suspension springs, shock absorbers for automobiles, gearboxes for land vehicles, steering wheels for vehicles, rims for vehicle wheels, bicycles and their bodies, handlebars and mudguards for bicycles, vehicle bodies, tipping bodies for trucks, trailers for tractors, frigorific bodies for land vehicles, trailer hitches for vehicles, vehicle seats, head-rests for vehicle seats, safety seats for children, for vehicles, seat covers for vehicles, vehicle covers (shaped), sun-blinds adapted for vehicles, direction signals and

arms for direction signals for vehicles, windscreen wipers and wiper arms for vehicles, inner and outer tires for vehicle wheels, tubeless tires, tire-fixing sets comprised of tire patches and tire valves for vehicles, windows for vehicles, safety windows for vehicles, rearview mirrors and wing mirrors for vehicles, anti-skid chains for vehicles, luggage carriers for vehicles, bicycle and ski carriers for cars, saddles for bicycles or motorcycles, air pumps for vehicles, for inflating tires, anti-theft alarms for vehicles, horns for vehicles, safety belts for vehicle seats, air bags (safety devices for automobiles), baby carriages, wheelchairs, pushchairs, wheelbarrows, shopping carts, single or multi-wheeled wheelbarrows, shopping trolleys, grocery carts, handling carts, rail vehicles, locomotives, trains, trams, wagons, cable cars, chairlifts, vehicles for locomotion by water and their parts, other than their motors and engines, vehicles for locomotion by air and their parts, other than their motors and engines, enabling customers to conveniently view and purchase those goods, such services may be provided by retail stores, wholesale outlets, by means of electronic media or through mail order catalogues.

(260) AM 2020 102602 A

(800) 1459710

(151) 2018 09 28

(891) 2018 09 28

(731) WMF Group GmbH

Eberhardstraße 35, 73312 Geislingen,  
Germany

(540)

**WMF**

(591) Black, white

(511)

7 – Food and beverage processing and preparation machines and apparatus, all the aforesaid goods included in class 7; electric food processors for domestic use; electric kitchen machines for food preparation [other than cooking]; electric baby food processors; electric kitchen appliances for chopping, mixing, pressing; electric kitchen mixers; food processors, electric; electric grinders for food preparation; electric peeling machines for use in the preparation of food; vegetable spiralizers, electric; electric vegetable peelers; electric salad makers (machine) for household purposes; electric apparatus for cutting vegetables for household purposes; electric salad drainers for household purposes; electric hand blender for household purposes; electric food blenders (for household purposes); beaters being electric appliances; electric food blenders; whisks, electric, for household purposes; electrical squeezers for fruit and vegetable; fruit presses, electric, for household purposes; electric fruit peelers; electric fruit squeezers; electric fruit grinders; apparatus for aerating beverages for household purposes; electric egg bea-

ters for household purposes; electric dough kneading machines; electric pasta makers for domestic use; kneaders (electric kitchen machines); pasta cutters (machines) for household purposes; noodle and pasta making machines for household purposes; electric Kitchen knives; electric kitchen tools; machines for slicing food (electric, kitchen) for household purposes; electric ice crushing machines for household purposes; bread cutting machines for household purposes; electric pizza cutters; grating machines for household use; peelers (electric machines) for household purposes; mincers (electric) for household use; electric coffee frothers for household purposes; power-operated coffee grinders for household purposes; electrical appliances used in kitchen for milling; electric mixers for household purposes; electric milk frothers; kitchen grinders, electric; power-operated coffee grinders; electric pepper mills; electric salt mills; electric graters; beverage making machines for household purposes; mills for household purposes, other than hand-operated; electric machine for making smoothies (pre-mixed beverages of fruits, vegetables and/or milk products).

8 – Hand-operated implements with knives or blades for cutting and chopping purposes for household and kitchen as well as for catering facilities, as far as included in this class; hand-operated vegetable cutters; apple corers; vegetable corers; hand-operated cutting devices for dough, in particular for noodles and pasta; cutlery; knives, forks and spoons; cutlery, knives, forks, spoons made of precious metal; butter curlers.

11 – Food and beverage cooking, heating, cooling and treatment equipment; raclette apparatus; fondues (cooking apparatus); electric domestic deep fryers; popcorn makers; sandwich makers (toasters); sandwich toasters; electric toasters; cotton candy making machines; table top ovens; waffle irons, electric; microwave ovens for domestic use; air fryers; induction cookers; portable induction cookers, electric; electric cooking ovens for household use; electric bread cookers; home bread makers; domestic bread toasters (electric); electric egg cookers for household purposes; electric bottle heaters; electric outdoor grills; electric indoor grills; adapted stands and supports for electric grills; electric panini makers; electric griddles (cooking appliances); electric toaster ovens; electric tea warmers; machines for making ice cream; electric espresso machines; electric coffee filters; electric chocolate makers; electric beverage heaters; electric wireless coffeepots; electrical coffee pots incorporating percolators; electric coffee makers for household use; electric coffee roasters for household purposes; electric tea makers; kettles, electric; water heaters, electric; heaters, electric, for feeding bottles; baby food warmers, electric; sterilizers for babies' feeding bottles; electric appliances for making yogurt; electric house apparatus for coo-

king; autoclaves, electric, for cooking; electric steaming apparatus for cooking; electric food steamer; autoclaves, electric, for cooking; electric skillets; electric broiling pans; hot pots (electrically heated); electric casseroles; electric kitchen machines for cooking for household purposes; electric stew-pots; electric food dehydrators for household purposes; electric griddles (cooking appliances); electric rice cookers; electric woks; electromagnetic induction cookers (for household purposes); domestic cooking ovens; domestic stoves for household purposes; domestic plate warmers; hot plates; heated display cabinets; refrigerated food counters; heating and cooling apparatus for dispensing hot and cold beverages; electric wine coolers for household purposes; electric hot plates; electric refrigerators (for household purposes); electric heated urns; support for lanterns of metal and glass.

21 – Flower pots; flower pot holders; plant pots and saucers; planters of glass and precious metal/ stainless steel; pots for herbs; pots for indoor herbs and herb gardens, in particular with integrated lighting sets and/or irrigation; spice sets; spice racks; spice jars; non-electric spice grinders; cruet sets for oil and vinegar; shakers for spices; fitted covers for buckets or pails; flower bowls of stainless steel; tableware, cookware and containers for household purposes; glasses, drinking vessels and barware; mixing bowls; oven-to-table tableware; cups and mugs; serving platters; serving ladles; plates; knife rests for the table; chopstick rests; ramekins; oven to table racks; baking utensils; bakeware; baking dishes; bread boards; butter-dish covers; steamer baskets; wire baskets [cooking utensils]; egg cups; finger bowls; plates for hors d'oeuvre; coffee mugs; coffee pots; coffee services of precious metal; casseroles [dishes]; saucepan lids; cake tins; cake molds [moulds]; knife rests for the table; cream jugs; salad bowls; gravy boats; chocolate molds; dish covers; dishes; trivets [table utensils]; serving bowls; butlers' trays; serving pots; soufflé dishes; soup bowls; tableware, other than knives, forks and spoons; teapots; tea services [tableware]; tea cups; drip mats for tea; pie pans; cake domes; portable cooking kits for outdoor use; coasters (tableware); saucers; cocktail glasses; household containers of stainless steel; buckets for household use; litter baskets of metal; storage jars of metal; storage jars; beverage ware; candy boxes; bowls for candy; bread bins; bread baskets for household purposes; butter dishes; stainless steel boxes for household use; containers for ice; ice cube molds [moulds]; cruet stands of precious metal; oil cruets of precious metal; bottles; bottle stands; cookie jars; vegetable racks; stands for dishes; drinks containers for household use; non-electric coffee servers of precious metal; jars; kitchen containers; fruit cups; pepper pots; lunch boxes; salt cellars; bowls [basins] for kitchen and household use; syrup jugs; dispensers for cling film [other than fixed]; straw dispensers;

dispensers for serviettes; mug racks; teapot stands; tea caddies; toast racks; cake stands; pedal bins; food storage containers; water bottles; toothpick holders, in particular of stainless steel; sugar bowls, in particular of stainless steel; sugar bowls; stands of precious metal and glass for serving marmalade; support for table numbers; racking [structures] of metal for supporting buffet tableware; butter coolers; double heat insulated containers for food; bottle coolers [receptacles]; beverage coolers [containers]; vacuum flasks for holding food; non-electric vacuum jugs; caviar coolers; heaters for feeding bottles, non-electric; coolers [non-electric containers]; portable beverage coolers; coolers for wine; stainless steel stands for coolers for wine; lemon squeezers [non-electric]; crushers for kitchen use, non-electric; beaters, non-electric; whisks, non-electric, for household purposes; non-electric garlic peelers; non-electric grinders; non-electric coffee grinders; non-electric coffee brewers; coffeepots, non-electric; fruit presses, non-electric, for household purposes; rolling pins, domestic, in particular for dough for noodles and pasta, hand-operated; non-electric pasta makers for domestic use; non-electric milk frothers; mugs for making yogurt for household purposes; mills for household purposes, hand-operated; blenders for food [non-electric]; kitchen grinders, non-electric; non-electric ice crushers; vegetable mashers; hand-operated garlic presses; hand-operated food grinders; coffee grinders, hand-operated; pepper mills, hand-operated; potato ricers; rotary cheese graters; cherry pitters; graters for kitchen use; mixers for food (household containers); mortars for kitchen use; food mashers; non-electric meat grinders; graters; roasting dishes; non-electric skillets; frying pan lids; cooking skewers of metal; roasting dishes; double boilers; hot pots, not electrically heated; steamers [cookware]; closures for pot lids; deep fryer baskets; non-electric griddles; grills [cooking utensils]; cookery molds [moulds]; cauldrons; saucepan lids; cooking utensils for use with domestic barbecues; non-electric canners [pressure cookers]; deep fryers, non-electric; cooking utensils for use with domestic barbecues; pressure cookers, non-electric; non-electric rice cooking pots; non-electric slow cookers; non-electric autoclaves for household use; earthenware saucepans; pot lids; woks; autoclaves, non-electric, for cooking; food steamers, non-electric; molds [moulds] for muesli bar making for household purposes; containers for household or kitchen use; bento boxes; lunch boxes; strainers for household purposes; cruets; ice cube molds for refrigerators; hand-operated salad drainers; thermal insulated containers for food or beverage; insulated cups with lids; thermally insulated flasks for household use; freezer containers for household purposes; cooking pots and pans [non-electric]; blenders (non-electric); mills for household purposes, hand-operated; pepper mills, hand-operated, and salt mills, non-electric; rice cookers, non-el-



electric; sandwich boxes; trays [household]; household or kitchen utensils; colanders for household use; draining trays; dish drying racks; fitted dispensers for wiping, drying, polishing and cleaning paper; cookie [biscuit] cutters; bread tongs; cocktail sticks; cocktail sticks; egg separators, non-electric, for household purposes; ice cream scoops; fish scoops; bottle stands; meat tenderisers for household purposes; tenderizers [kitchen utensils]; vegetable tongs; basting spoons [cooking utensils]; barbecue forks; barbecue tongs; hand-operated implements for cracking lobsters; hand-operated sushi makers; noodle machines, hand-operated; meal trays; honey servers; coffee scoops; candelabra [candlesticks]; candlesticks with wind protection; candle extinguishers; basting brushes; scrapers (kitchen implements); cooking funnels; corn cob holders; flour sifters; knife blocks; mixing spoons [kitchen utensils]; non-electric egg crackers for household use; tortilla presses, non-electric [kitchen utensils]; waffle irons, non-electric; nutcrackers; spatulas; non-electric beaters for kitchen use; mixing spoons [kitchen utensils]; salad tongs; scoops for household purposes; slotted spoons; basting spoons [cooking utensils]; serving forks; serving spoons; serving tongs; napkin holders and rings; spaghetti tongs; asparagus tongs; non-electric ice cream makers; skewers (cooking utensil); tea balls; tealight holders; tea strainers; pastry cutters; dumpling moulds for household use; place card holders; tablecloth holders; pan scrapers; pot stands; pie servers; tortilla presses; carving forks; funnels; dish drying racks; wine drip collars specially adapted for use around the top of wine bottles to stop drips; spatulas for kitchen use; lemon squeezers; sugar scoops; sugar tongs; cocktail shakers; chopsticks; coffee pots; coffee filters, not of paper, being part of non-electric coffee makers; non-electric coffee frothers; coffeepots, non-electric; coffee-filtering machines, non-electric; non-electric plunger style coffee makers; coffee percolators, non-electric; coffee makers, non-electric; kettles, non-electric; non-electric milk frothers; whistling kettles; tea infusers.

(260) AM 2020 102603 A

(800) 1459721

(151) 2019 02 05

(891) 2019 02 05

(731) RENAT AGZAMOV LIMAROVICH

Glavmosstroy str., d. 18, flat 50, RU-119618

Moscow, Russian Federation

(540)

**AGZAMOV**

**АГЗАМОВ**

(591) Black, white

(531) 27.05.01; 28.05

(511)

30 – Meat gravies; pasta; tortillas; macaroons [pastry]; flavorings, other than essential oils, for beverages; potato flour; ramen [Japanese noodle-based dish]; sushi; ferments for pastes; groats for human food; seaweed [condiment]; starch for food; edible paper; palm sugar; cloves [spice]; leaven; liquorice [confectionery]; capers; flavorings, other than essential oils, for cakes; tapioca flour; chewing gum; candy; batter mixes for okonomiyaki [Japanese savory pancakes]; soya flour; gluten prepared as foodstuff; ginger [spice]; cereal bars; vinegar; sago; petits fours [cakes]; tapioca; chocolate beverages with milk; mayonnaise; chips [cereal products]; corn, milled; binding agents for ice cream; pelmeni [dumplings stuffed with meat]; pasta sauce; almond paste; noodles; honey; halvah; tea-based beverages; edible rice paper; maltose; crushed barley; breadcrumbs; preparations for stiffening whipped cream; cookies; spices; chocolate-coated nuts; popcorn; vanilla flavorings for culinary purposes; flowers or leaves for use as tea substitutes; burritos; seasonings; minced garlic [condiment]; almond confectionery; chutneys [condiments]; cheeseburgers [sandwiches]; macaroni; corn flour; rice pulp for culinary purposes; meat pies; tabbouleh; sandwiches; malt extract for food; spring rolls; oat flakes; ice, natural or artificial; pies; noodle-based prepared meals; cake frosting [icing]; peppermint sweets; tea; marzipan; sweetmeats [candy]; thickening agents for cooking foodstuffs; propolis; chocolate-based beverages; rice-based snack food; celery salt; cake powder; pastry dough; flour; couscous [semolina]; buns; allspice; semolina; nut flours; rice cakes; okonomiyaki [Japanese savory pancakes]; chocolate; spaghetti; sherbets [ices]; gingerbread; crackers; cooking salt; oatmeal; malt biscuits; pastilles [confectionery]; infusions, not medicinal; salt for preserving foodstuffs; barley meal; rice pudding; baozi [stuffed buns]; baking powder; cocoa-based beverages; husked barley; peppers [seasonings]; saffron [seasoning]; confectionery for decorating Christmas trees; hominy; ketchup [sauce]; custard; pancakes; corn flakes; sauces [condiments]; ravioli; ice for refreshment; cakes; chicory [coffee substitute]; quiches; petit-beurre biscuits; yeast; rusks; pizzas; fondants [confectionery]; tacos; curry [spice]; tarts; dressings for salad; cereal preparations; glucose for culinary purposes; puddings; beer vinegar; bread; bean meal; artificial coffee; mint for confectionery; vanillin [vanilla substitute]; nutmegs; star aniseed; bread rolls; unroasted coffee; pesto [sauce]; iced tea; chow-chow [condiment]; unleavened bread; pralines; sea water for cooking; garden herbs, preserved [seasonings]; aniseed; oat-based food; hominy grits; essences for foodstuffs, except etheric essences and essential oils; candy decorations for cakes; vegetal preparations for use as coffee substitutes; soya sauce; coffee; sugar; cocoa beverages

with milk; gimbap [Korean rice dish]; cake dough; tomato sauce; wheat flour; ice cream; caramels [candy]; baking soda [bicarbonate of soda for cooking purposes]; food flavorings, other than essential oils; chocolate mousses; fruit coulis [sauces]; dough; coffee-based beverages; frozen yogurt [confectionery ices]; jiaozi [stuffed dumplings]; peanut confectionery; gluten additives for culinary purposes; corn, roasted; soya bean paste [condiment]; coffee beverages with milk; turmeric; pastries; golden syrup; rice; pepper; cereal-based snack food; relish [condiment]; sausage binding materials; mustard meal; chocolate decorations for cakes; vermicelli [noodles]; stick liquorice [confectionery]; natural sweeteners; fruit jellies [confectionery]; pâtés en croûte; cream of tartar for culinary purposes; condiments; wheat germ for human consumption; husked oats; powders for making ice cream; aromatic preparations for food; ham glaze; edible ices; marinades; waffles; muesli; crushed oats; cocoa; mustard; vareniks [stuffed dumplings]; high-protein cereal bars; royal jelly; cinnamon [spice]; dessert mousses [confectionery]; molasses for food; confectionery; meat tenderizers for household purposes; malt for human consumption; coffee flavorings.

35 – Arranging subscriptions to telecommunication services for others; import-export agency services; commercial information agency services; advertising agency services; cost price analysis; rental of advertising space; business auditing; financial auditing; business intermediary services relating to the matching of potential private investors with entrepreneurs needing funding; employment agency services; computerized file management; book-keeping; invoicing; demonstration of goods; transcription of communications [office functions]; opinion polling; market studies; business information; commercial information and advice for consumers in the choice of products and services; business investigations; business research; marketing research; personnel recruitment; business management and organization consultancy; business organization consultancy; business management consultancy; personnel management consultancy; professional business consultancy; consultancy regarding advertising communication strategies; consultancy regarding public relations communication strategies; layout services for advertising purposes; marketing; marketing in the framework of software publishing; targeted marketing; business management of performing artists; business management of sports people; writing of résumés for others; scriptwriting for advertising purposes; news clipping services; updating and maintenance of information in registries; updating and maintenance of data in computer databases; updating of advertising material; word processing; online retail services for downloadable and pre-recorded music and movies; online retail services for downloadable ring tones; online retail services for downloadable

digital music; organization of exhibitions for commercial or advertising purposes; arranging newspaper subscriptions for others; organization of fashion shows for promotional purposes; organization of trade fairs for commercial or advertising purposes; shop window dressing; design of advertising materials; business appraisals; payroll preparation; data search in computer files for others; sponsorship search; administrative assistance in responding to calls for tenders; business management assistance; commercial or industrial management assistance; commercial intermediation services; providing business information via a web site; provision of commercial and business contact information; provision of an on-line marketplace for buyers and sellers of goods and services; web indexing for commercial or advertising purposes; presentation of goods on communication media, for retail purposes; economic forecasting; auctioneering; retail services for works of art provided by art galleries; sales promotion for others; promotion of goods and services through sponsorship of sports events; production of teleshopping programmes; production of advertising films; office machines and equipment rental; rental of advertising time on communication media; publicity material rental; rental of billboards [advertising boards]; rental of vending machines; rental of sales stands; rental of photocopying machines; publication of publicity texts; radio advertising; bill-posting; distribution of samples; dissemination of advertising matter; direct mail advertising; registration of written communications and data; writing of publicity texts; advertising; online advertising on a computer network; advertising by mail order; television advertising; document reproduction; compilation of statistics; compilation of information into computer databases; business inquiries; systemization of information into computer databases; advisory services for business management; negotiation of business contracts for others; negotiation and conclusion of commercial transactions for third parties; compiling indexes of information for commercial or advertising purposes; tax preparation; drawing up of statements of accounts; telemarketing services; psychological testing for the selection of personnel; wholesale services for pharmaceutical, veterinary and sanitary preparations and medical supplies; retail services for pharmaceutical, veterinary and sanitary preparations and medical supplies; interim business management; outsourced administrative management for companies; business management of hotels; business management for freelance service providers; business project management services for construction projects; commercial administration of the licensing of the goods and services of others; business management of reimbursement programs for others; administration of consumer loyalty programs; administration of frequent flyer programs; administrative processing of purchase orders; public relations;

competitive intelligence services; modelling for advertising or sales promotion; typing; market intelligence services; appointment reminder services [office functions]; web site traffic optimization; relocation services for businesses; tax filing services; search engine optimization for sales promotion; appointment scheduling services [office functions]; gift registry services; price comparison services; pay per click advertising; secretarial services; procurement services for others [purchasing goods and services for other businesses]; shorthand; outsourcing services [business assistance]; telephone answering for unavailable subscribers; photocopying services; business efficiency expert services.

43 – Temporary accommodation reservations; holiday camp services [lodging]; rental of lighting apparatus; hotel services; snack-bar services; rental of meeting rooms; boarding house bookings; cafeteria services; boarding for animals; motel services; accommodation bureau services [hotels, boarding houses]; rental of transportable buildings; rental of cooking apparatus; café services; day-nursery [crèche] services; tourist home services; rental of temporary accommodation; food and drink catering; rental of drinking water dispensers; rental of chairs, tables, table linen, glassware; self-service restaurant services; canteen services; hotel reservations; rental of tents; restaurant services; providing campground facilities; retirement home services; boarding house services; bar services; food sculpting.

(260) AM 2020 102639 A

(800) 1460103

(151) 2018 12 26

(891) 2018 12 26

(731) CANSINO BIOLOGICS INC.

401-420,4/F, BIOMEDICAL PARK OF  
WEST ZONE, 185 SOUTH AVENUE, TEDA  
WEST DISTRICT, BINHAI NEW AREA,  
TIANJIN, China

(540)

# Menhycia

(591) Black, white

(531) 27.05.17

(511)

5 – Vaccines; drugs for medical purposes; diagnostic preparations for medical purposes; cultures of microorganisms for medical or veterinary use; dietetic substances adapted for medical use; depuratives; veterinary preparations; preparations for destroying noxious animals; dressings, medical; teeth filling material.

(260) AM 2020 102640 A

(800) 1460116

(151) 2019 01 18

(891) 2019 01 18

(731) RICHTER GEDEON NYRT.

Gyömrői út 19-21, H-1103 Budapest, Hungary

(540)

# ДРОВЕЛИС

(591) Black, white

(531) 28.05

(511)

5 – Pharmaceutical preparations.

(260) AM 2020 102641 A

(800) 1460117

(151) 2018 12 09

(891) 2018 12 09

(731) RICHTER GEDEON NYRT.

Gyömrői út 19-21, H-1103 Budapest, Hungary

(540)

# СИТАДИАБ

(591) Black, white

(531) 28.05

(511)

5 – Pharmaceutical preparations.

(260) AM 2020 102642 A

(800) 1460118

(151) 2018 12 19

(891) 2018 12 19

(731) RICHTER GEDEON NYRT.

Gyömrői út 19-21, H-1103 Budapest, Hungary

(540)

# XYWERON

(591) Black, white

(511)

5 – Pharmaceutical preparations.

(260) AM 2020 102643 A

(800) 1460143

(151) 2019 01 18

(891) 2019 01 18

(731) RICHTER GEDEON NYRT.

Gyömrői út 19-21, H-1103 Budapest, Hungary

(540)

# DROVELIS

(591) Black, white

(511)

5 – Pharmaceutical preparations.

(260) AM 2020 102644 A

(800) 1460225

(151) 2018 11 13

(891) 2018 11 13

(731) Yazykova Larysa Volodymyrivna

vul. Cheliuskintsiv, 125, kv. 76, m. Donetsk  
83001, Ukraine

(540)

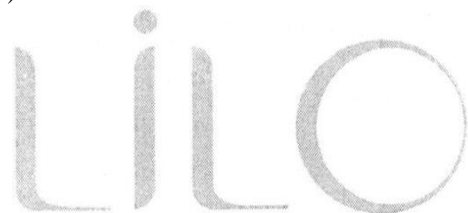

(591) Black, white

(531) 27.05.01

(511)

3 – Abrasives; abrasive cloth; glass cloth [abrasive cloth]; abrasive paper; breath freshening sprays; diamantine [abrasive]; alum stones [astringents]; amber [perfume]; ammonia [volatile alkali] [detergent]; antiperspirants [toiletries]; antistatic preparations for household purposes; flavorings for beverages [essential oils]; cake flavorings [essential oils]; food flavorings [essential oils]; joss sticks; aromatics [essential oils]; potpourris [fragrances]; balms, other than for medical purposes; bergamot oil; whitening; lip glosses; badian essence; vaginal washes for personal sanitary or deodorant purposes; petroleum jelly for cosmetic purposes; cotton wool for cosmetic purposes; cotton sticks for cosmetic purposes; bleaching soda; laundry bleach; bleaching preparations [decolorants] for cosmetic purposes; bleaching salts; decorative transfers for cosmetic purposes; shoe wax; mustache wax; depilatory wax; wax for parquet floors; floor wax; volcanic ash for cleaning; astringents for cosmetic purposes; cloths impregnated with a detergent for cleaning; gaultheria oil; dental bleaching gels; heliotropine; geraniol; make-up; lipsticks; deodorants for pets; deodorants for human beings or for animals; deodorant soap; detergents, other than for use in manufacturing operations and for medical purposes; scented water; scented wood; extracts of flowers [perfumes]; herbal extracts for cosmetic purposes; ethereal essences; essential oils; essential oils of cedarwood; essential oils of lemon; essential oils of citron; Javelle water; jasmine oil; greases for cosmetic purposes; colorants for toilet purposes; preservatives for leather [polishes]; color-removing preparations; degreasers, other than for use in manufacturing processes; dentifrices; ionone [perfumery]; shaving stones. [astringents]; silicon carbide [abrasive]; carbides of metal [abrasives]; adhesives for affixing false eyelashes; adhesives for affixing false hair; adhesives for cosmetic purposes; collagen preparations for cosmetic purposes; hair conditioners; quillaia bark for washing; corundum [abrasive]; cosmetics; eyebrow cosmetics; cosmetics for animals;

beauty masks; cosmetic preparations for baths; hair straightening preparations; cosmetic preparations for eyelashes; cosmetic preparations for skin care; cosmetic preparations for slimming purposes; tailors' wax; shoe cream; skin whitening creams; creams for leather; polishing creams; cosmetic creams; starch glaze for laundry purposes; laundry starch; cakes of toilet soap; lavender water; lavender oil; incense; hair spray; nail polish; hair lotions; lotions for cosmetic purposes; after-shave lotions; massage gels, other than for medical purposes; almond oil; almond soap; almond milk for cosmetic purposes; washing soda, for cleaning; shaving soap; soap for brightening textile; antiperspirant soap; soap for foot perspiration; soap; musk [perfumery]; mint for perfumery; mint essence [essential oil]; cosmetic kits; emery; emery cloth; emery paper; nail art stickers; neutralizers for permanent waving; fumigation preparations [perfumes]; eau de Cologne; eyebrow pencils; cosmetic pencils; oils for toilet purposes; oils for perfumes and scents; oils for cosmetic purposes; oils for cleaning purposes; oil of turpentine for degreasing; mouthwashes, not for medical purposes; bases for flower perfumes; drying agents for dishwashing machines; cleansing milk for toilet purposes; cleansers for intimate personal hygiene purposes, non medicated; refurbishing preparations; scouring solutions; perfumery; toiletry preparations; perfumes; pastes for razor strops; pumice stone; hydrogen peroxide for cosmetic purposes; polishing wax; polishing paper; polishing rouge; polishing stones; polishing preparations; shoe polish; polish for furniture and flooring; pomades for cosmetic purposes; fabric softeners for laundry use; laundry blueing; laundry preparations; air fragrancng preparations; bath preparations, not for medical purposes; leather bleaching preparations; floor wax removers [scouring preparations]; rust removing preparations; varnish-removing preparations; paint stripping preparations; descaling preparations for household purposes; stain removers; lacquer-removing preparations; shaving preparations; depilatory preparations; nail care preparations; hair waving preparations; laundry soaking preparations; sun-tanning preparations [cosmetics]; make-up removing preparations; make-up preparations; shining preparations [polish]; laundry glaze; preparations to make the leaves of plants shiny; denture polishes; preparations for unblocking drain pipes; smoothing preparations [starching]; dry-cleaning preparations; preparations for cleaning dentures; wallpaper cleaning preparations; aloe vera preparations for cosmetic purposes; non-slipping wax for floors; non-slipping liquids for floors; make-up powder; nail varnish removers; windshield cleaning liquids; eye-washes, not for medical purposes; saffrol; sachets for perfuming linen; tissues impregnated with cosmetic lotions; tissues impregnated with make-up removing preparations; turpentine for degreasing; teeth whitening strips; breath freshening strips; soda lye; bath

salts, not for medical purposes; sunscreen preparations; douching preparations for personal sanitary or deodorant purposes [toiletries]; canned pressurized air for cleaning and dusting purposes; dry shampoos; talcum powder, for toilet use; terpenes [essential oils]; tripoli stone for polishing; rose oil; toilet water; mascara; beard dyes; hair dyes; cosmetic dyes; phytocosmetic preparations; lipstick cases; color-brightening chemicals for household purposes [laundry]; henna [cosmetic dye]; cleaning chalk; cleaning preparations; shampoos for pets [non-medicated grooming preparations]; shampoos for animals [non-medicated grooming preparations]; shampoos; cobblers' wax; shoemakers' wax; sandpaper; smoothing stones; grinding preparations; false eyelashes; false nails.

(260) AM 2020 102645 A  
 (800) 1460258  
 (151) 2018 12 31  
 (891) 2018 12 31  
 (731) Selena Marketing International Sp. z o.o.  
 Strzegomska 2-4, PL-53-611 Wrocław,  
 Poland  
 (540)



(591) Dark blue, red and white  
 (531) 25.05.02; 26.04.04; 26.04.18; 27.05.10;  
 27.05.24; 29.01.13  
 (526) PROFESSIONAL  
 (511)  
 1 – Acrylic resins, unprocessed; adhesives for industrial purposes; adhesives for wall tiles; adhesives for wallpaper; adhesives other than for stationery or household purposes; anti-incrustants; artificial resins, unprocessed; brickwork preservatives, except paints and oils; cement preservatives, except paints and oils; chemical preparations to prevent mildew; chemical products for use as fixing agents, namely self-hardening artificial resin and mortar compounds for anchoring fastening elements and contained in cartridges; concrete preservatives, except paints and oils; construction adhesives; damp proofing preparations, except paints, for masonry; epoxy resins, unprocessed; industrial chemicals; masonry preservatives, except paints and oils; preservatives for tiles, except paints and oils; sizing preparations; synthetic resins, unprocessed.  
 2 – Wood dyestuffs, mordants, wood mordants, enamels for painting, paints, primers for wood, fireproof paints, primers, lacquers, oils for the preservation of wood, coatings, wood coatings, coatings for roofing,

wood preservatives, anti-rust preparations for preservation.

17 – Adhesive tapes other than stationery and not for medical or household purposes; caulking materials; draught excluder strips; insulating materials; insulating paints; insulating plaster; insulating tape and band; polyurethane aerosol foams; sealant compounds for joints; seals; silicone and acrylic sealants; substances for insulating buildings against moisture; synthetic resins; washers of rubber; waterproof packings; weatherstripping compositions.

19 – Bitumen; bituminous coatings for roofing; bituminous products for building; building materials, not of metal; building paper; coverings, not of metal, for building; framework, not of metal, for building; mortar for building; plaster; road coating materials; roof coverings, not of metal; roof flashing, not of metal; roofing shingles; tarred strips, for building.

(260) AM 2020 102646 A  
 (800) 1460281  
 (151) 2018 12 20  
 (891) 2018 12 20  
 (731) SEGURIDAD INDUSTRIAL, S.A.  
 Elizguibel, s/n, E-31638 EUGUI  
 (NAVARRA), Spain  
 (540)



(591) White, red and blue  
 (531) 26.01.18; 26.01.24; 27.05.10; 27.05.22;  
 29.01.12  
 (511)  
 9 – Sensors; sensors for establishing velocity; wear sensors for brake pads; pressure sensors; temperature sensors.  
 12 – Vehicle parts and accessories; brake components for vehicles; braking systems for vehicles and parts therefor; drum brakes for land vehicles; transmissions for land vehicles; transmission parts for land vehicles (belts); transmission parts for land vehicles (other than belts); steering mechanisms for land vehicles; steering columns for vehicles; shock absorbers, part of vehicle suspension; shock absorbing springs for automobiles.

(260) AM 2020 102647 A  
 (800) 1460286  
 (151) 2019 01 01  
 (891) 2019 01 01  
 (731) VASU HEALTHCARE PVT. LTD.  
 967/4, G.I.D.C., Makarpura, Vadodara  
 390010, Gujarat State, India

(540)

**DAZZLE**

(591) Black, white

(531) 27.05.17

(511)

5 – Ayurvedic medicinal preparations included in class 5.

(260) AM 2020 102649 A

(800) 1460326

(151) 2019 02 01

(891) 2019 02 01

(731) BRITISH AMERICAN TOBACCO  
(BRANDS) LIMITED

Globe House, 4 Temple Place, London

WC2R 2PG, United Kingdom

(540)



(591) Red, light blue, white, black

(531) 10.01.25; 26.01.03; 26.11.02; 26.11.06;  
26.13.25; 27.05.01; 29.01.13

(511)

34 – Cigarettes; tobacco, raw or manufactured; snuff with tobacco; snus with tobacco; snuff without tobacco; snus without tobacco; roll your own tobacco; pipe tobacco; tobacco products; tobacco substitutes (not for medical purposes); cigars; cigarillos; cigarette lighters; matches; smokers' articles; cigarette paper, cigarette tubes, cigarette filters; pocket apparatus for rolling cigarettes; hand held machines for injecting tobacco into paper tubes; electronic cigarettes; liquids for electronic cigarettes; tobacco products for the purpose of being heated.

(260) AM 2020 102650 A

(800) 1460369

(151) 2019 02 13

(891) 2019 02 13

(731) DEERE &amp; COMPANY

One John Deere Place, Moline IL 61265-8098,  
USA

(540)

**TORQ-GARD**

(591) Black, white

(511)

4 – Industrial oils and greases; lubricants.

(260) AM 2020 102651 A

(800) 1460370

(151) 2019 02 14

(891) 2019 02 14

(731) BIOFARMA

50 rue Carnot, F-92284 Suresnes Cedex,  
France

(540)

**ATOPREL**

(591) Black, white

(511)

5 – Pharmaceutical products; medical preparations; veterinary preparations; sanitary products for medical purposes; dietetic substances and foodstuffs for medical or veterinary use, food for babies; food supplements for humans and animals; plasters, materials for dressings; material for dental fillings and dental impressions; disinfectants; products for destroying vermin; fungicides, herbicides.

(260) AM 2020 102652 A

(800) 1460394

(151) 2019 01 28

(891) 2019 01 28

(731) NAKHLA TOBACCO CO S.A.E.

3 Soliman Al Halabi Street, Azbakia, Cairo,  
Egypt

(540)

النخلة  
**NAKHLA**

(591) Black, white

(531) 27.05.01; 28.01

(511)

34 – Tobacco, raw or manufactured; smoking tobacco, pipe tobacco, rolling tobacco, chewing tobacco, snus; cigarettes, electronic cigarettes, cigars, cigarillos; snuff; smokers' articles included in this class; cigarette paper, cigarette tubes and matches.

(260) AM 2020 102653 A

(800) 1460432

(151) 2018 11 23

(891) 2018 11 23

(731) CHEN CHENG SHENG

Group 9, Jianchou Village, Yiting Town,  
Yiwu City, Jinhua, Zhejiang Province,  
China

(540)

通邦  
**TONG BANG**

(591) Black, white  
 (531) 28.03  
 (511)  
 7 – Oil presses [machines]; beverage preparation machines, electromechanical; sewing machines; wrapping machines; fruit presses, electric, for household purposes; soybean milk machines for household purposes; washing machines [laundry]; electric welding apparatus; dust exhausting installations for cleaning purposes; mixing machines.

(260) AM 2020 102654 A  
 (800) 1460443  
 (151) 2019 03 07  
 (891) 2019 03 07  
 (731) NAKED WOLFE FOOTWEAR PTY. LTD.  
 C/ – Abound Business Solutions Pty Ltd,  
 Level 1, 426 Mt Alexander Road, Ascot  
 Vale VIC 3032, Australia

(540)



(591) Black, white  
 (531) 27.05.24  
 (511)  
 18 – Handbags; messenger bags; overnight bags; articles made from animal hides; articles made from animal skins; articles made from fur; articles made from imitation leather; articles made from leather; articles made from the skin of amphibians; articles made from the skin of birds; articles made from the skin of mammals; leather wallets; articles made from the skin of reptiles; purses; rucksacks; umbrellas; briefcases and suitcases; harness and saddlery; bags for climbers and campers in the nature of all-purpose carrying bags; pocket wallets; pouches (bags); travel goods (luggage); work bags; backpacks; casual bags; clutch bags.

25 – Clothing; sandals; swimming costumes; underwear; scarves; belts; ties; corsets; gloves; stockings; socks; headwear; gym and sportswear; footwear; footwear for children; footwear for men; footwear for women; shoes; boots; slippers.

(260) AM 2020 102655 A  
 (800) 1460448  
 (151) 2019 02 21  
 (891) 2019 02 21  
 (731) YIWU WANSHENG STATIONERY FIRM  
 NO.22411, DISTRICT 3, CHINA COMMODITIES, CITY INTERNATIONAL TRADE MART, YIWU, JINHUA; ZHEJIANG, China

(540)



(591) Black, white  
 (531) 27.01.05; 27.05.01  
 (511)  
 16 – Drawing instruments; stationery; fountain pens; steel pens; writing materials; writing instruments; writing brushes; pencils; paintbrushes; adhesive bands for stationery or household purposes.

(260) AM 2020 102656 A  
 (800) 1460491  
 (151) 2019 02 08  
 (891) 2019 02 08  
 (731) Obshchestvo s ogranichennoy  
 otvetstvennostyu "BIOTEHNOS"  
 pr-kt Andropova, d. 18, korp. 6, pom. XI,  
 kom. 7, RU-115432 Moscow, Russian  
 Federation

(540)

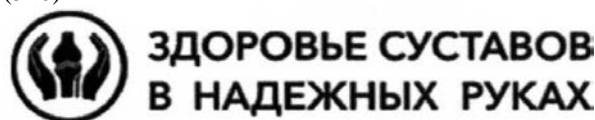

(591) Black, white  
 (531) 02.09.14; 02.09.22; 26.01.03; 26.01.14; 28.05  
 (511)  
 5 – Pharmaceuticals, medical and veterinary preparations.

35 – Advertising; business management; business administration; office functions.

(260) AM 2020 102657 A  
 (800) 1460547  
 (151) 2019 01 10  
 (891) 2019 01 10  
 (731) Tovarichtchestvo s ogranichennoy  
 otvetstvennostyu "ALHADAYA"  
 ulitsa Satpayeva, zdaniye 29D, rayon  
 Bostandykskiy, 050000 Almaty, Kazakhstan

(540)



(591) Black  
 (531) 25.01.25; 27.05.04

(511)

5 – Acaricides; aconitine; alkaloids for medical purposes; alginates for pharmaceutical purposes, algicides, aldehydes for pharmaceutical purposes; dental amalgams of gold; dental amalgams; amino acids for veterinary purposes; amino acids for medical purposes; analgesics; anaesthetics; antibiotics; antiseptics; medicine cases, portable, filled; first-aid boxes, filled; aluminium acetate for pharmaceutical purposes; acetates for pharmaceutical purposes; balms for medical purposes; bandages for dressings; diagnostic biomarker reagents for medical purposes, biocides, bromine for pharmaceutical purposes; paper for mustard plasters; fly catching paper; reagent paper for veterinary purposes; reagent paper for medical purposes; mothproofing paper; petroleum jelly for medical purposes, vaccines, oxygen baths; antiseptic cotton; aseptic cotton; absorbent cotton; wadding for medical purposes; cotton for medical purposes, dietetic substances adapted for medical use; radiological contrast substances for medical purposes; nutritive substances for microorganisms; radioactive substances for medical purposes; bismuth subnitrate for pharmaceutical purposes; melissa water for pharmaceutical purposes; sea water for medicinal bathing; mineral waters for medical purposes, thermal water, dietary fiber; molding wax for dentists; gases for medical purposes; guaiacol for pharmaceutical purposes, sexual stimulant gels; hematogen; hemoglobin; hydrastine; hydrastinine; glycerine for medical purposes; glycerophosphates, glucose for medical purposes; gentian for pharmaceutical purposes; hormones for medical purposes, mustard for pharmaceutical purposes; mustard plasters; mud for baths; medicinal mud; gamboge for medical purposes; gurgun balsam for medical purposes; disinfectants; air deodorising preparations; deodorants, other than for human beings or for animals; deodorants for clothing and textiles; diastase for medical purposes; digitalin; mineral food supplements; nutritional supplements; albumin dietary supplements; dietary supplements for animals; yeast dietary supplements; alginate dietary supplements; glucose dietary supplements; casein dietary supplements; lecithin dietary supplements, linseed oil dietary supplements; propolis dietary supplements; protein dietary supplements; protein supplements for animals; royal jelly dietary supplements; pollen dietary supplements; wheat germ dietary supplements; linseed dietary supplements; enzyme dietary supplements; yeast for pharmaceutical purposes; gelatine for medical purposes; cod liver oil; isotopes for medical purposes; immunostimulants; insecticides; iodine for pharmaceutical purposes; iodides for pharmaceutical purposes; alkaline iodides for pharmaceutical purposes; iodoform; calomel [fungicide]; cream of tartar for pharmaceutical purposes; tartar for pharmaceutical purposes; camphor for medical purposes; capsules for medicines, cachets for pharmaceutical purposes; hemostatic

pencils; wart pencils; caustic pencils; carbolinum [parasiticide]; caustics for pharmaceutical purposes; cachou for pharmaceutical purposes; quassia for medical purposes; quebracho for medical purposes; oxygen for medical purposes; gallic acid for pharmaceutical purposes; acids for pharmaceutical purposes; adhesives for dentures; surgical glues; stem cells for veterinary purposes; stem cells for medical purposes, cocaine; collagen for medical purposes; collodion for pharmaceutical purposes; corn rings for the feet; candy, medicated; angostura bark for medical purposes; barks for pharmaceutical purposes; cedar wood for use as an insect repellent; condurango bark for medical purposes; croton bark; mangrove bark for pharmaceutical purposes; myrobalan bark for pharmaceutical purposes; quinquina for medical purposes; medicated animal feed; medicinal roots; rhubarb roots for pharmaceutical purposes; lint for medical purposes; starch for dietetic or pharmaceutical purposes; creosote for pharmaceutical purposes; blood for medical purposes; cultures of microorganisms for medical or veterinary use; curare; dental lacquer; liquorice for pharmaceutical purposes; lactose for pharmaceutical purposes; candy for medical purposes; adhesive plasters; medicines for alleviating constipation; adhesive tapes for medical purposes; lecithin for medical purposes; lotions for veterinary purposes; medicated hair lotions; lotions for pharmaceutical purposes, medicated after-shave lotions; personal sexual lubricants; lupulin for pharmaceutical purposes; magnesium for pharmaceutical purposes; liniments; ointments for pharmaceutical purposes; sunburn ointments; mercurial ointments; frostbite salve for pharmaceutical purposes; gauze for dressings; medicinal oils; mustard oil for medical purposes; camphor oil for medical purposes; castor oil for medical purposes; oil of turpentine for pharmaceutical purposes; dill oil for medical purposes; dental mastics; dental abrasives; dental impression materials; teeth filling material; dressings, medical; surgical dressings; drugs for medical purposes; medicines for veterinary purposes; serotherapeutic medicines; medicines for human purposes; medicines for dental purposes; menthol; medicinal drinks; moleskin for medical purposes; almond milk for pharmaceutical purposes; powdered milk for babies; royal jelly for pharmaceutical purposes, milk ferments for pharmaceutical purposes; Irish moss for medical purposes; flour for pharmaceutical purposes, linseed meal for pharmaceutical purposes; fish meal for pharmaceutical purposes; fly glue; antibacterial soap; disinfectant soap; medicated soap; freeze-dried meat adapted for medical purposes; mint for pharmaceutical purposes; dietetic beverages adapted for medical purposes; malted milk beverages for medical purposes; narcotics; medicinal infusions; tincture of iodine; eucalyptol for pharmaceutical purposes; tinctures for medical purposes; opium; opodeldoc, decoctions for pharmaceutical purposes; antiparasitic



collars for animals; cotton sticks for medical purposes; stick liquorice for pharmaceutical purposes; sulfur sticks [disinfectants]; pastilles for pharmaceutical purposes; medicated dentifrices; pectin for pharmaceutical purposes; pepsins for pharmaceutical purposes; peptones for pharmaceutical purposes; hydrogen peroxide for medical purposes; pesticides; food for babies; leeches for medical purposes, blood plasma, eyepatches for medical purposes; poultices; compresses; scapulars for surgical purposes; babies' diapers; diapers for pets; diapers for incontinence; bunion pads; breast-nursing pads; pomades for medical purposes, powder of cantharides; pyrethrum powder; belts for sanitary pads for women; anti-uric preparations; bacterial preparations for medical and veterinary use; bacteriological preparations for medical and veterinary use; balsamic preparations for medical purposes; albuminous preparations for medical purposes; biological preparations for veterinary purposes, biological preparations for medical purposes; veterinary preparations; bismuth preparations for pharmaceutical purposes; vitamin preparations; diagnostic preparations for veterinary purposes; diagnostic preparations for medical purposes; bath preparations for medical purposes; therapeutic preparations for the bath; hemorrhoid preparations, preparations for callouses; lice treatment preparations [pediculicides]; acne treatment preparations; preparations to facilitate teething; preparations for the treatment of burns; fumigation preparations for medical purposes; ootherapy preparations; air purifying preparations; bronchodilating preparations; preparations for reducing sexual activity; sterilising preparations; soil-sterilising preparations; corn remedies; pharmaceutical preparations for treating dandruff; preparations for destroying noxious animals; herbicides; preparations for destroying dry rot fungus; larvae exterminating preparations; fly destroying preparations; preparations for destroying mice; slug exterminating preparations; vermin destroying preparations; pharmaceutical preparations for skin care; contact lens cleaning preparations; preparations of microorganisms for medical or veterinary use; lime-based pharmaceutical preparations; styptic pencils; medicated eye-washes; medicinal hair growth preparations; nutraceutical preparations for therapeutic or medical purposes; opiates; anticryptogamic preparations; aloe vera preparations for pharmaceutical purposes; preparations of trace elements for human and animal use; sulfonamides [medicines]; pharmaceutical preparations; pharmaceutical preparations for treating sunburn; enzyme preparations for veterinary purposes; enzyme preparations for medical purposes; phytotherapy preparations for medical purposes; chemico-pharmaceutical preparations; chemical preparations for veterinary purposes; chemical preparations for the diagnosis of pregnancy; chemical preparations for medical purposes; chemical preparations for treating wheat blight; chemical preparations

for treating diseases affecting vine plants; chemical preparations for treating mildew; chemical preparations for treating phylloxera; chemical preparations for pharmaceutical purposes; chilblain preparations; mothproofing preparations; collyrium; lead water; chemical conductors for electrocardiograph electrodes; albuminous foodstuffs for medical purposes; dietetic foods adapted for medical purposes; by-products of the processing of cereals for dietetic or medical purposes; homogenized food adapted for medical purposes; freeze-dried food adapted for medical purposes; pharmaceuticals; sanitary towels; sanitary panties; panty liners [sanitary]; propolis for pharmaceutical purposes; pearl powder for medical purposes; radium for medical purposes; hydrated chloral for pharmaceutical purposes; solvents for removing adhesive plasters; vaginal washes for medical purposes; solutions for contact lenses; chemical reagents for medical or veterinary purposes; gum for medical purposes; rubber for dental purposes; chewing gum for medical purposes; insect repellents; insect repellent incense; repellents for dogs; tissues impregnated with pharmaceutical lotions; sarsaparilla for medical purposes; sugar for medical purposes; asthmatic tea; fumigating sticks; suppositories; linseed for pharmaceutical purposes; tobacco-free cigarettes for medical purposes; siccatives [drying agents] for medical purposes; syrups for pharmaceutical purposes; turpentine for pharmaceutical purposes; milking grease; greases for veterinary purposes; greases for medical purposes; lacteal flour for babies; infant formula; soporifics; bicarbonate of soda for pharmaceutical purposes; bath salts for medical purposes; salts for mineral water baths; salts for medical purposes; potassium salts for medical purposes; sodium salts for medical purposes; smelling salts; mineral water salts; malt for pharmaceutical purposes; semen for artificial insemination; alcohol for pharmaceutical purposes; medicinal alcohol; alloys of precious metals for dental purposes; ergot for pharmaceutical purposes; cooling sprays for medical purposes; antibacterial handwashes; adjuvants for medical purposes; astringents for medical purposes; vermifuges; disinfectants for hygiene purposes; disinfectants for chemical toilets; douching preparations for medical purposes; appetite suppressants for medical purposes; medical preparations for slimming purposes; parasiticides; mouthwashes for medical purposes; febrifuges; depuratives; animal washes [insecticides]; detergents for medical purposes; cattle washes [insecticides]; dog washes [insecticides]; insecticidal veterinary washes; vesicants; purgatives; remedies for perspiration; remedies for foot perspiration; chemical contraceptives; antiparasitic preparations; sedatives; laxatives; tonics [medicines]; medicated toiletry preparations; digestives for pharmaceutical purposes; nervines; media for bacteriological cultures; steroids; strychnine; serums; tanning pills; appetite suppressant pills; slimming pills; jujube, medicated;

antioxidant pills; sanitary tampons; vulnerary sponges; thymol for pharmaceutical purposes; biological tissue cultures for veterinary purposes; biological tissue cultures for medical purposes; smoking herbs for medical purposes; medicinal herbs; transplants [living tissues]; surgical implants comprised of living tissues; pants, absorbent, for incontinence; sanitary panties; babies' diaper-pants; charcoal for pharmaceutical purposes; fennel for medical purposes; porcelain for dental prostheses; phenol for pharmaceutical purposes; enzymes for veterinary purposes; enzymes for medical purposes; ferments for pharmaceutical purposes; formic aldehyde for pharmaceutical purposes; phosphates for pharmaceutical purposes; fungicides; quinine for medical purposes; chinoline for medical purposes; diabetic bread adapted for medical use; chloroform; flowers of sulfur for pharmaceutical purposes; cement for animal hooves; bone cement for surgical and orthopaedic purposes; dental cements; medicinal tea; herbal teas for medicinal purposes; insecticidal animal shampoos; medicated shampoos; medicated shampoos for pets; pediculicidal shampoos; medicated dry shampoos; pre-filled syringes for medical purposes; eucalyptus for pharmaceutical purposes; herbal extracts for medical purposes; plant extracts for pharmaceutical purposes; tobacco extracts [insecticides]; extracts of hops for pharmaceutical purposes; elixirs [pharmaceutical preparations]; ethers for pharmaceutical purposes; esters for pharmaceutical purposes; cellulose esters for pharmaceutical purposes; rat poison; poisons; bacterial poisons; jalap.

30 – Vanilla flavorings for culinary purposes; flavorings, other than essential oils, for cakes; flavorings, other than essential oils, for beverages; coffee flavorings; food flavorings, other than essential oils; star aniseed; baozi [stuffed buns]; cereal bars; high-protein cereal bars; pancakes; noodle-based prepared meals; freeze-dried dishes with the main ingredient being pasta; freeze-dried dishes with the main ingredient being rice; buns; bread rolls; edible rice paper; edible paper; burritos; vanillin [vanilla substitute]; vareniki [stuffed dumplings]; waffles; vermicelli [noodles]; natural sweeteners; sausage binding materials; binding agents for ice cream; sea water for cooking; seaweed [condiment]; malt biscuits; cloves [spice]; mirror icing [mirror glaze]; cake frosting [icing]; glucose for culinary purposes; mustard; gluten additives for culinary purposes; yeast; thickening agents for cooking foodstuffs; leaven; rice-based snack food; cereal-based snack food; artificial coffee; vegetal preparations for use as coffee substitutes; dressings for salad; fruit jellies [confectionery]; candy decorations for cakes; confectionery for decorating Christmas trees; cakes; pastries; peanut confectionery; almond confectionery; pasta; ginger [spice]; frozen yogurt [confectionery ices]; cocoa; cream of tartar for culinary purposes; capers; caramels [ca-

ndy]; curry [spice]; ketchup [sauce]; gimbap [Korean rice dish]; quiches; gluten prepared as foodstuff; flour-based dumplings; sweetmeats [candy]; liquorice [confectionery]; peppermint sweets; dulce de leche; cinnamon [spice]; coffee; unroasted coffee; starch for food; crackers; custard; hominy grits; semolina; oatmeal; crushed barley; groats for human food; ice cubes; corn, milled; corn, roasted; meat pies; turmeric; couscous [semolina]; noodles; ice for refreshment; ice, natural or artificial; edible ices; candy; rice cakes; mayonnaise; macaroons [pastry]; macaroni; maltose; hominy; piccalilli; marinades; marzipan; honey; soya bean paste [condiment]; royal jelly; ice cream; bean meal; tapioca flour; potato flour; corn flour; nut flours; flour; wheat flour; soya flour; barley meal; dessert mousses [confectionery]; chocolate mousses; muesli; mint for confectionery; cocoa beverages with milk; coffee beverages with milk; coffee-based beverages; cocoa-based beverages; chamomile-based beverages; tea-based beverages; chocolate beverages with milk; chocolate-based beverages; infusions, not medicinal; crushed oats; husked oats; okonomiyaki [Japanese savory pancakes]; onigiri [rice balls]; nutmegs; chocolate-coated nuts; stick liquorice [confectionery]; pastilles [confectionery]; molasses for food; pâtés en croûte; pelmeni [dumplings stuffed with meat]; pepper; allspice; peppers [seasonings]; pesto [sauce]; cookies; petit-beurre biscuits; bibimbap [rice mixed with vegetables and beef]; pies; pizzas; meat gravies; fondants [confectionery]; popcorn; powders for making ice cream; baking powder; mustard meal; pralines; aromatic food preparations; condiments; meat tenderizers for household purposes; cereal preparations; oat-based food; propolis; gingerbread; spices; petits fours [cakes]; rice pudding; puddings; cake powder; fruit coulis [sauces]; ravioli; ramen [Japanese noodle-based dish]; chewing gum; relish [condiment]; rice; instant rice; wheat germ for human consumption; spring rolls; sago; palm sugar; sugar; sesame seeds [seasonings]; linseed for culinary purposes [seasoning]; processed seeds for use as a seasoning; aniseed; agave syrup [natural sweetener]; golden syrup; confectionery; batter mixes for okonomiyaki [Japanese savory pancakes]; baking soda [bicarbonate of soda for cooking purposes]; malt for human consumption; salt for preserving foodstuffs; cooking salt; celery salt; sherbets [ices]; ham glaze; soya sauce; tomato sauce; sauces [condiments]; pasta sauce; spaghetti; seasonings; chocolate-based spreads; chocolate spreads containing nuts; preparations for stiffening whipped cream; rusks; breadcrumbs; sushi; sandwiches; tabbouleh; tacos; tapioca; tarts; dough; pastry dough; almond paste; rice pulp for culinary purposes; cake dough; tortillas; garden herbs, preserved [seasonings]; chocolate decorations for cakes; vinegar; beer vinegar; ferments for pastes; halvah; bread; unleavened bread; chips [cereal products]; corn flakes; oat flakes; hot dog sandwiches;

flowers or leaves for use as tea substitutes; jiaozi [stuffed dumplings]; chicory [coffee substitute]; tea; iced tea; chutneys [condiments]; minced garlic [condiment]; cheeseburgers [sandwiches]; chow-chow [condiment]; saffron [seasoning]; chocolate; malt extract for food; essences for foodstuffs, except etheric essences and essential oils; husked barley.

31 – Algarovilla for animal consumption; anchovy, live; oranges, fresh; peanuts, fresh; artichokes, fresh; draff; beans, fresh; locust beans, raw; wreaths of natural flowers; grapes, fresh; algae, unprocessed, for human or animal consumption; fruit residue [marc]; dog biscuits; sea-cucumbers, live; peas, fresh; mushroom spawn for propagation; mushrooms, fresh; trees; palm trees; turf, natural; unsawn timber; undressed timber; yeast for animal consumption; Christmas trees; edible chews for animals; live animals; menagerie animals; peanut cake for animals; oil cake; maize cake for cattle; rape cake for cattle; bagasses of cane [raw material]; cereal seeds, unprocessed; grains [cereals]; grains for animal consumption; lime for animal forage; fish spawn; vegetable marrows, fresh; cocoa beans, raw; potatoes, fresh; chestnuts, fresh; arrangements of fresh fruit; copra; raw barks; rough cork; animal foodstuffs; pet food; stall food for animals; bird food; strengthening animal forage; chicory roots; roots for animal consumption; nettles; groats for poultry; maize; edible sesame, unprocessed; shrubs; rose bushes; spiny lobsters, live; lemons, fresh; vine plants; salmon, live; onions, fresh; flower bulbs; leeks, fresh; olives, fresh; bran mash for animal consumption; shellfish, live; almonds [fruits]; mussels, live; peanut meal for animals; linseed meal for animal consumption; meal for animals; flax meal [fodder]; rice meal for forage; fish meal for animal consumption; straw mulch; beverages for pets; edible insects, live; oats; vegetables, fresh; cucumbers, fresh; lobsters, live; nuts [fruits]; coconuts; kola nuts; bran; distillery waste for animal consumption; residue in a still after distillation; palms [leaves of the palm tree]; cuttle bone for birds; peppers [plants]; aromatic sand [litter] for pets; citrus fruit, fresh; litter for animals; mash for fattening livestock; unprocessed sweet corn ears [husked or unhusked]; animal fattening preparations; preparations for egg laying poultry; fishing bait, live; by-products of the processing of cereals, for animal consumption; seed germ for botanical purposes; poultry, live; wheat; pollen [raw material]; crayfish, live; crustaceans, live; seedlings; plants; aloe vera plants; plants, dried, for decoration; rhubarb, fresh; rice, unprocessed; rye; wheat germ for animal consumption; fish, live; lettuce, fresh; sardines, live; beet, fresh; herrings, live; seeds for planting; linseed for animal consumption; edible linseed, unprocessed; hay; coconut shell; bred stock; sanded paper [litter] for pets; malt for brewing and distilling; straw [forage]; straw litter; salt for cattle; trunks of trees; wood chips for the manufacture of wood pulp; litter

peat; garden herbs, fresh; sugarcane; truffles, fresh; tuna, live; squashes, fresh; oysters, live; fruit, fresh; hazelnuts, fresh; fodder; hops; flowers, natural; flowers, dried, for decoration; chicory, fresh; silkworms; garlic, fresh; lentils, fresh; pine cones; hop cones; spinach, fresh; juniper berries; berries, fresh; eggs for hatching, fertilized; silkworm eggs; barley.

(260) AM 2020 102658 A

(800) 1460555

(151) 2019 02 20

(891) 2019 02 20

(731) THORNTON & ROSS LIMITED  
Linthwaite, Huddersfield, Yorkshire  
HD7 5QH, United Kingdom

(540)



(591) Blue and white

(531) 24.13.01; 24.17.05; 25.03.03; 27.05.01;  
27.05.24; 29.01.13

(511)

3 – Cosmetics; toilet preparations; make-up; perfumery; skin care and hair care preparations; dentifrices; essential oils; soaps; cleaning preparations; bleaching preparations and other substances for laundry use; polishing, scouring and abrasive preparations.

5 – Pharmaceutical preparations and substances; veterinary preparations; sanitary preparations for medical purposes; reagents for use in diagnostic tests for medical purposes; dietetic substances adapted for medical use; food for babies; plasters; materials for dressings; material for stopping teeth; dental wax; disinfectants; preparations for destroying vermin; fungicides; herbicides.

(260) AM 2020 102659 A

(800) 1460573

(151) 2018 12 14

(891) 2018 12 14

(731) GALERIE GMURZYNSKA AG  
Vorstadt 14, CH-6300 Zug, Switzerland

(540)

**GMURZYNSKA**

(591) Black, white

(511)

16 – Watercolors, pencils for painting, watercolors [paintings], paintings (pictures) framed or unframed, reproduction of paintings, blackboards; flip charts of paper; magnetic boards; works of art, included in this class; etchings; printed matter, namely, books,

manuals, printed publications, periodicals, magazines, newspapers, albums, almanacs, atlases, instructional or teaching materials (excluding apparatus); books, printed publications, periodicals, magazines, instructional or teaching material relating to Swiss law; bookmarkers.

35 – Retail sale of works of art provided by art galleries; business management for the benefit of performing artists or entertainers; event marketing services.

36 – Art appraisal; provision of information relating to art appraisal; financial sponsorship of visual arts events; Financial advice and tax advice.

41 – Organization of shows (impresario services); cultural, educational and entertainment services provided by art galleries; rental of works of art; conducting of educational events, conferences, congresses, colloquiums, courses, seminars, training courses, symposiums, teaching and conferences, conferences, seminars, initial and further training courses, exhibitions for educational purposes and on-line correspondence courses; arranging and conducting of galas and other social events, namely, cultural and/or sporting events or entertainment events and competitions (including awarding of prizes).

42 – Authentication of works of art; design of works of art.

(260) AM 2020 102660 A

(800) 1460691

(151) 2018 12 21

(891) 2018 12 21

(731) GRINDEKS, AS

Krustpils iela 53, LV-1057 Rīga, Latvia

(540)

**APIMUN АПИМУН**

(591) Black, white

(531) 27.05.01; 28.05

(511)

3 – Cosmetics; cosmetic preparations for skin care; cosmetics on basis of royal jelly; cosmetics containing royal jelly.

5 – Pharmaceutical preparations; veterinary preparations; vitamin preparations; biological preparations for medical purposes; dietary supplements; food supplements; nutraceutical supplements; topical gels for medical and therapeutic use; antibacterial gels; pharmaceuticals and natural remedies; pharmaceutical preparations for the stimulation of tissue regeneration; pharmaceutical preparations and nutritional supplements for lactation; medicinal substances for medical or veterinary purposes; food for babies and infant formula; nutraceutical preparations for therapeutic or medical purposes; pharmaceutical preparations comprising royal jelly; nutraceutical supple-

ments comprising royal jelly; pharmaceutical and medical gels, ointments and creams.

(260) AM 2020 102661 A

(800) 1460692

(151) 2018 11 01

(891) 2018 11 01

(731) ÇEPAŞ GALVANİZ DEMİR ÇELİK  
MADENCİLİK İNŞAAT NAKLİYE  
TİCARET VE SANAYİ ANONİM ŞİRKETİ  
İstanbul Yolu 25.km Saray mh. 175., Sokak  
(cadde) no:2,2-A, Kahramankazan,  
ANKARA, Turkey

(540)



(591) Black, white, blue

(531) 01.15.23; 25.07.07; 26.01.06; 27.05.09;  
27.05.10; 29.01.13

(511)

6 – Metal poles; metal pillars; scaffolding of metal; metal stakes, steel masts; lighting poles, high mast lighting poles, flag poles, camera poles, commercial sign poles, polygonal lighting poles, gsm towers, energy transmission line towers.

19 – Building materials (as finished products) made of concrete, gypsum, clay, potters' clay, stone, marble, wood, plastics and synthetic materials for building, construction, road construction purposes, included in this class; non-metallic buildings, non-metallic building materials, poles not of metal for power lines, barriers not of metal; natural and synthetic coatings in the form of panels and sheets, being building materials; bitumen cardboard coatings for roofing; bitumen coating for roofing; doors and windows of wood and synthetic materials.

40 – Treatment of common metals.

(260) AM 2020 102665 A

(800) 1460772

(151) 2018 12 18

(891) 2018 12 18

(731) KABUSHIKIKAISHA SOFT 99 CORPORATION (SOFT 99 CORPORATION)

6-5, Tanimachi 2-chome, Chuo-ku,  
Osaka-shi, Osaka 540-0012, Japan

(540)



(591) Red and black  
 (531) 24.07.01; 26.11.02; 26.11.06; 26.11.25;  
 27.05.01; 27.05.19; 27.07.01; 29.01.12

(511)  
 1 – Chemical agents for automobiles; coating agents [chemicals] for automobile bodies; coating agents [chemicals] for automobile windshields; water repellents; chemical additives for engine cooling systems; radiator flushing chemicals; paste fillers for automobile body repair; preparations for preventing the tarnishing of glass.

2 – Paints; anti-rust preparations; anti-rust greases.

3 – Polishing preparations; shining preparations [polish]; soaps and detergents; car waxes; car shampoos; cleaning preparations for automobile and household purposes; grinding preparations; air fragrancing preparations; windshield cleaning liquids; scouring preparations.

(260) AM 2020 102666 A  
 (800) 1460834  
 (151) 2019 02 12  
 (891) 2019 02 12  
 (731) Dr. Theiss Naturwaren GmbH  
 Michelinstr. 10, 66424 Homburg, Germany  
 (540)



(591) Yellow, gold and grey.  
 (531) 26.01.03; 26.01.12; 26.01.18; 26.11.02;  
 26.11.08; 26.11.10; 26.15.01; 27.05.09;  
 27.05.11; 29.01.13

(511)  
 3 – Bleaching preparations and laundry preparations; cleaning, polishing, scouring and abrasive preparations; perfumery, essential oils, non-medicated cosmetics, including non-medicated skin cleaning and skin care preparations, and hair care preparations; non-medicated dentifrices.

5 – Pharmaceutical and veterinary preparations; medicines for human purposes; medicines for veterinary purposes; sanitary preparations for medical purposes; dietetic foodstuffs and substances adapted for medical use; nutritional supplements for humans and animals; vitamin preparations.

(260) AM 2020 102766 A  
 (800) 1461687  
 (151) 2018 11 12

(891) 2018 11 12  
 (731) Limited Liability Company "WIMM-BILL-DANN FOODS"  
 d. 108, Dmitrovskoe shosse, RU-127591  
 Moscow, Russian Federation

(540)



(591) Light green, green, white, grey, red, yellow, pink, crimson  
 (531) 05.07.08; 08.03.01; 19.07.01; 29.01.15  
 (554) მოცულობითი  
 (511)

5 – Powdered milk for babies; dietetic beverages adapted for medical purposes; food for babies; lacteal flour for babies; infant formula.

29 – Fruit-based snack food; yogurt; kefir [milk beverage]; milk shakes; kumys [milk beverage]; milk; albumin milk; powdered milk; milk beverages, milk predominating; milk products; curd; prostokvasha [soured milk]; ryazhenka [fermented baked milk]; whipped cream; cream [dairy products]; smetana [sour cream]; whey; milk ferments for culinary purposes.

(260) AM 2020 102768 A  
 (800) 1461830  
 (151) 2018 11 20  
 (891) 2018 11 20  
 (731) LIMITED LIABILITY COMPANY "BRAND CONSULTING GROUP"  
 vul. Dehtiarna, 9, kv. 31, m. Kyiv 04071,  
 Ukraine

(540)



(591) Black, white

(531) 27.05.02; 27.05.23

(511)

32 – Beers; mineral and aerated waters and other non-alcoholic beverages; fruit beverages and fruit juices; syrups and other preparations for making beverages; aperitifs, non-alcoholic; non-alcoholic beverages; non-alcoholic beverages flavored with coffee; non-alcoholic beverages flavored with tea; non-alcoholic honey-based beverages; non-alcoholic fruit extracts; non-alcoholic fruit juice beverages; grape must, unfermented; waters [beverages]; aerated water; extracts of hops for making beer; essences for making beverages; seltzer water; isotonic beverages; ginger beer; kvass [non-alcoholic beverage]; cocktails, non-alcoholic; beer-based cocktails; lemonades; lithia water; mineral water [beverages]; aloe vera drinks, non-alcoholic; whey beverages; rice-based beverages, other than milk substitutes; soya-based beverages, other than milk substitutes; vegetable juices [beverages]; orgeat; beer wort; beer; powders for effervescing beverages; sarsaparilla [non-alcoholic beverage]; syrups for beverages; syrups for lemonade; preparations for making aerated water; preparations for making liqueurs; essences for making flavoured mineral water, not in the nature of essential oils; preparations for making beverages; smoothies; soda water; fruit juice; malt beer; malt wort; protein-enriched sports beverages; table waters; must; pastilles for effervescing beverages; tomato juice [beverage]; fruit nectars, non-alcoholic; sherbets [beverages]; cider, non-alcoholic.

33 – Alcoholic beverages, except beer; alcoholic beverages containing fruit; digesters [liqueurs and spirits]; aperitifs; arak [arrack]; baijiu [Chinese distilled alcoholic beverage]; brandy; wine; whisky; anisette [liqueur]; anise [liqueur]; vodka; kirsch; perry; gin; cocktails; curacao; liqueurs; hydromel [mead]; peppermint liqueurs; pre-mixed alcoholic beverages, other than beer-based; bitters; nira [sugarcane-based alcoholic beverage]; distilled beverages; piquette; rice alcohol; rum; sake; cider; spirits [beverages]; alcoholic extracts; alcoholic essences; fruit extracts, alcoholic.

(260) AM 2020 102769 A

(800) 1461868

(151) 2019 02 27

(891) 2019 02 27

(731) AVON PRODUCTS, INC.

1 Avon Place, Suffern NY 10901, USA

(540)

AVON  
STAMINA

(591) Black, white

(531) 27.05.01; 27.05.09; 27.05.10; 27.05.14

(511)

3 – Non-medicated toilet preparations; toiletries; skin care preparations; skin moisturizers; body and beauty care preparations; powders, cleansers, creams and lotions, all for the face, hands and body; cosmetic suntan preparations; soaps; shower and bath preparations; beauty masks; talcum powder; nail polish; nail polish remover; false nails; adhesives for cosmetic purposes; cosmetics; eye cream; eye gels; eye lotions; eye make-up remover; eye shadow; eye liner; mascara; lipstick; lip liner; lip-gloss; make-up foundation; blusher; tissues impregnated with cosmetic lotions; cotton sticks for cosmetic purposes; cotton wool for cosmetic purposes; preparations for cleaning, moisturising, colouring and styling the hair; preparations for cleaning the teeth; shaving and aftershave preparations; perfumes; fragrances; toilet waters; cologne; deodorants for human beings; anti-perspirants for personal use (toiletries); essential oils (cosmetic).

(260) AM 2020 102771 A

(800) 1461889

(151) 2019 02 27

(891) 2019 02 27

(731) AVON PRODUCTS, INC.

1 Avon Place, Suffern NY 10901, USA

(540)

AVON  
distillery

(591) Black, white

(531) 01.15.15; 27.03.15; 27.05.09; 27.05.10

(511)

3 – Non-medicated toilet preparations; toiletries; skin care preparations; skin moisturizers; body and beauty care preparations; powders, cleansers, creams and lotions, all for the face, hands and body; cosmetic suntan preparations; soaps; shower and bath preparations; beauty masks; talcum powder; nail polish; nail polish remover; false nails; adhesives for cosmetic purposes; cosmetics; eye cream; eye gels; eye lotions; eye make-up remover; eye shadow; eye liner; mascara; lipstick; lip liner; lip-gloss; make-up foundation; blusher; tissues impregnated with cosmetic lotions; cotton sticks for cosmetic purposes; cotton wool for cosmetic purposes; preparations for cleaning, moisturising, colouring and styling the hair; preparations for cleaning the teeth; shaving and aftershave preparations; perfumes; fragrances; toilet waters; cologne; deodorants for human beings; anti-perspirants for personal use (toiletries); essential oils (cosmetic).



(260) AM 2020 102907 A

(800) 1179643

(151) 2013 09 18

(891) 2019 02 12

(731) THE BODY SHOP INTERNATIONAL LIMITED

Watersmead, Littlehampton, West Sussex  
BN17 6LS, United Kingdom

(540)

## DROPS OF YOUTH

(591) Black, white

(511)

3 – Bath preparations, not medicated; bath salts, not for medical purposes; non-medicated bath salts; cosmetics in the form of milks; cosmetics in the form of lotions; cosmetics in the form of creams; after-sun gels; body creams; oils for the body; moisturisers; cosmetics in the form of oils; cosmetics in the form of gels; sun barriers; non-medicated cosmetics; after-sun oils; essential oils.

(260) AM 2020 102911 A

(800) 1365562

(151) 2017 06 05

(891) 2018 11 19

(731) NOS MODA KUMAŞ TEKSTİL TİCARET VE SANAYİ ANONİM ŞİRKETİ

Osb Kahverengi Cadde, No:1, Nilüfer – Bursa, Turkey

(540)



(591) Black, blue and yellow

(531) 26.04.02; 26.04.05; 26.04.12; 26.04.18;  
26.04.24; 26.11.03; 26.11.13; 26.11.22;  
27.05.24; 29.01.13

(511)

23 – Yarns and threads for textile use; threads and yarns for sewing, embroidery and knitting; thread; elastic yarns and threads for textile use.

(260) AM 2020 102937 A

(800) 1463766

(151) 2018 12 20

(891) 2018 12 20

(731) VIENNA INSURANCE GROUP AG Wiener Versicherung Gruppe

Schottenring 30, A-1010 Wien, Austria

(540)



(591) Red, green and white

(531) 26.03.05; 26.03.23; 29.01.13

(511)

36 – Insurance, financial affairs, monetary affairs, real estate affairs.

(260) AM 2020 102938 A

(800) 1463767

(151) 2018 11 09

(891) 2018 11 09

(731) DZHAVAKHIRI SIAMAK

vul. Marshala Hovorova, 18, kv. 218 A, Odesa 65009, Ukraine

(540)

## OMAR KHAYYAM

(591) Black, white

(511)

33 – Wine; vodka; grape vodka.

(260) AM 2020 102939 A

(800) 1463768

(151) 2019 02 18

(891) 2019 02 18

(731) SICHUAN YIBIN WULIANGYE, GROUP CO., LTD

#150, Minjiang West Road, Yibin, Sichuan, China

(540)



(591) Black, white

(531) 28.03

(511)

33 – Alcoholic beverages, except beer.

(260) AM 2020 102940 A

(800) 1463788

(151) 2019 02 18

(891) 2019 02 18

(731) SICHUAN YIBIN WULIANGYE GROUP  
CO., LTD  
#150, Minjiang West Road, Yibin, Sichuan,  
China

(540)

(591) Black, white

(531) 28.03

(511)

33 – Fruit extracts, alcoholic; distilled beverages; cider; cocktails; wine; alcoholic beverages, except beer; alcoholic beverages containing fruit; Baijiu [Chinese distilled alcoholic beverage].

(260) AM 2020 102941 A

(800) 1463817

(151) 2019 03 01

(891) 2019 03 01

(731) BIOFARMA

50 rue Carnot, F-92284 SURESNES CEDEX,  
France

(540)

**АТОПРЕЛ**

(591) Black, white

(531) 28.05

(511)

5 – Pharmaceutical products; medical preparations; veterinary preparations; sanitary products for medical purposes; dietetic substances and foodstuffs for medical or veterinary use, food for babies; food supplements for humans and animals; plasters, materials for dressings; material for dental fillings and dental impressions; disinfectants; products for destroying vermin; fungicides, herbicides.

(260) AM 2020 103035 A

(800) 1464992

(151) 2018 12 17

(891) 2018 12 17

(731) Limited Liability Company "VMPAUTO"

ulitsa Promyshlennaya, 40, lit.A, RU-198095  
Saint-Petersburg, Russian Federation

(540)

**BREMZ**

(591) Black, white

(511)

1 – Detergent additives to petrol; chemical additives for diesel fuels; chemical additives for oils; chemical additives for motor oil; additives, chemical, to motor

fuel; chemical additives for lubricants; chemical additives for transmission fluids; chemical additives for lubricating oils; chemical additives for engine cooling systems; chemical additives for fuel injection system cleaners; chemical additives for fuel in the nature of octane boosters; chemical additives for internal combustion engine fuels; transmission oil; hydraulic oils; detergent additives for motor oil.

4 – Non-chemical additives for motor oil; additives, non-chemical, to motor fuel; automotive greases; lubricating grease; general purpose greases; lubricating grease for vehicles; industrial oils and greases; lubricating oil; motor oil; industrial oil for batteries; lubricating oil for motor vehicle engines; non-chemical additives for gasoline; non-chemical additives for oils and fuels; non-chemical additives for fuels; non-chemical additives for fuels, lubricants and greases.

(260) AM 2020 103036 A

(800) 1465003

(151) 2018 11 02

(891) 2018 11 02

(731) Joint Stock Company "BRPI"

1st Dobryninsky alley, 15/7, floor 1, premises  
2, room 3, RU-119049 Moscow city, Russian  
Federation

(540)

**Natacha**

(591) Black, white

(511)

30 – Edible ice; ice-cream; ice-cream cakes; ice cream bars [confectionery]; frozen yogurt [confectionery ices]; sherbets [ices]; fruit ice cream.

(260) AM 2020 103037 A

(800) 1465131

(151) 2018 07 25

(891) 2018 07 25

(731) LEPILOV Natalia

str. 1 Mai nr. 53, ap. 1, MD-3500 Orhei,  
Republic of Moldova

(540)



(591) Black, white

(531) 01.03.02; 01.03.07; 02.01.01; 04.05.05;  
11.03.06; 27.05.08; 27.05.17



(511)

30 – Tea and tea-based products; tea extracts; carbonated and non-carbonated beverages based on tea; iced tea; powders mixtures for tea and iced tea; tea and infusions of non-medicinal herbs; ice cream on a stick; ice cream; sorbets; frozen confectionery.

32 – Beers; mineral and aerated waters and other non-alcoholic beverages; fruit beverages and fruit juices; iced fruit drinks; slush (ice crushed drinks); syrups and other preparations for making beverages.

(260) AM 2020 103038 A

(800) 1465146

(151) 2019 02 26

(891) 2019 02 26

(731) HUAWEI TECHNOLOGIES CO., LTD.  
HUAWEI ADMINISTRATION BUILDING,  
BANTIAN, LONGGANG DISTRICT,  
SHENZHEN, 518129 GUANGDONG,  
China

(540)

**HUAWEI FreeLace**

(591) Black, white

(511)

9 – Earphones; cabinets for loudspeakers; headphones; sound transmitting apparatus; sound recording apparatus; microphones; video recorders; camcorders; electrical and electronic video monitoring apparatus; video monitors; portable media players; ultra high definition televisions; liquid crystal display (LCD) televisions; computer software, recorded; computer programs, downloadable; facial recognition apparatus; downloadable image files; smartphone software applications, downloadable; downloadable ring tones for mobile phones; computer software applications, downloadable; downloadable music files; head-mounted video displays; security tokens [encryption devices]; computer programs, recorded; tablet computers; data processing apparatus; smartphones; smartwatches; transmitters of electronic signals; notebook computers; network communication equipment; computer game software, downloadable; electronic publications, downloadable; cameras [photography]; chips [integrated circuits].

(260) AM 2020 103130 A

(800) 1466252

(151) 2018 12 18

(891) 2018 12 18

(731) Obshchestvo s ogranichennoy  
otvetstvennostiyu "GEXA – NETKANYE  
MATERIALY"  
Tsentralnaya ul., d. 3, litera A, A1, A2, a,  
pomeshchenie 304, derevnya Golievo,  
Krasnogorsky raion, RU-143405  
Moskovskaya oblast, Russian Federation

(540)

**АГРОТЕКС**

(591) Green Pantone 349C

(531) 28.05; 29.01.03

(511)

17 – Shock-absorbing buffers of rubber; insulating paper; mineral wool [insulator]; carbon fibers, other than for textile use; lute; insulators; insulators for cables; valves of india-rubber or vulcanized fiber; clack valves of rubber; water-tight rings; insulating paints; insulating varnish; insulating tapes; duct tapes; adhesive bands, other than stationery and not for medical or household purposes; self-adhesive tapes, other than stationery and not for medical or household purposes; viscose sheets, other than for wrapping; reinforcing materials, not of metal, for pipes; weatherstripping compositions; compositions to prevent the radiation of heat; insulating materials; insulating refractory materials; padding materials of rubber or plastics; non-conducting materials for retaining heat; packing [cushioning, stuffing] materials of rubber or plastics; sealant compounds for joints; filtering materials [semi-processed foams or films of plastic]; bags [envelopes, pouches] of rubber, for packaging; pipe muffers, not of metal; clutch linings; threads of rubber, other than for textile use; threads of plastic materials, other than for textile use; elastic threads, other than for textile use; stops of rubber; insulating gloves; insulating plaster; plastic sheeting for agricultural purposes; plastic film, other than for wrapping; rubber stoppers; joint packings; washers of rubber or vulcanized fiber; joint packings for pipes; draught excluder strips; junctions, not of metal, for pipes; substances for insulating buildings against moisture; glass wool for insulation; glass fibers, for insulation; insulating fabrics; fiberglass fabrics for insulation; hoses of textile material; flexible hoses, not of metal; waterproof packings; fittings, not of metal, for flexible pipes; fittings, not of metal, for rigid pipes; metal foil for insulation; slag wool [insulator]; watering hose; canvas hose pipes.

19 – Plastic landscape edgings; geotextiles; street gutters, not of metal; fences, not of metal; greenhouse frames, not of metal; framework, not of metal, for building; cornices, not of metal; water-pipe valves, not of metal or plastic; drain traps [valves], not of metal or plastic; pillars, not of metal, for building; brackets, not of metal, for building; buildings, not of metal; buildings, transportable, not of metal; reinforcing materials, not of metal, for building; pitch; road coating materials; materials for making and coating roads; building materials, not of metal; refractory construction materials, not of metal; porches [structures], not of metal; roof flashing, not of metal; duckboards, not of metal; laths, not of metal; wall linings, not of metal, for building; palisading, not of metal; latticework, not of metal; props, not of metal;

building panels, not of metal; partitions, not of metal; tiles, not of metal, for building; roof coverings, not of metal; roofing, not of metal, incorporating photovoltaic cells; floors, not of metal; ceilings, not of metal; linings, not of metal, for building; paving blocks, not of metal; posts, not of metal; greenhouses, transportable, not of metal; water-pipes, not of metal; gutter pipes, not of metal; drain pipes, not of metal; rigid pipes, not of metal, for building; angle irons, not of metal.

20 – Reels, not of metal, non-mechanical, for flexible hoses; pegs [pins], not of metal; packaging containers of plastic; clips, not of metal, for cables and pipes; clips of plastic for sealing bags; latches, not of metal; latches, not of metal, including clips for fixing the greenhouse cover fabric on arcs; wickerwork; valves, not of metal, other than parts of machines; tent pegs, not of metal; containers, not of metal [storage, transport]; furniture; stakes, not of metal, for plants or trees; bedding, except linen; winding spools, not of metal, non-mechanical, for flexible hoses; furniture fittings, not of metal; poles, not of metal; labels of plastic; boxes of wood or plastic.

21 – Flower pots; containers for household or kitchen use; brush goods; flower-pot covers, not of paper; watering cans; pouring spouts; nozzles for watering hose; fiberglass thread, other than for textile use; sprinklers; sprinklers for watering flowers and plants; gardening gloves; gloves for household purposes; polishing gloves; barbecue mitts; kitchen mitts; dripping pans; clothes-pins; sifters [household utensils]; glass wool, other than for insulation; vitreous silica fibers, other than for textile use; fiberglass, other than for insulation or textile use; sprinkling devices; brushes; aerosol dispensers, not for medical purposes; window-boxes.

22 – Wadding for filtering; ropes; coconut fiber; plastic fibers for textile use; textile fibers; ropes, not of metal; strips for tying-up vines; wrapping or binding bands, not of metal; packing [cushioning, stuffing] materials, not of rubber, plastics, paper or cardboard; bags [envelopes, pouches] of textile, for packaging; binding thread, not of metal, for agricultural purposes; thread, not of metal, for wrapping or binding; sisal; vitreous silica fibers for textile use; glass fibers for textile use; raw fibrous textile; awnings of textile; network; awnings of synthetic materials.

24 – Banners of textile or plastic; bunting of textile or plastic; fabrics for textile use; filtering materials of textile; non-woven textile fabrics; plastic material [substitute for fabrics]; furniture coverings of plastic; cloth; hemp cloth; mosquito nets; fabric; fiberglass fabrics, for textile use; adhesive fabric for application by heat; hemp fabric; elastic woven material; flags of textile or plastic; labels of textile.

25 – Footwear; clothing; gloves [clothing]; headgear for wear; aprons [clothing]; dressing gowns.

(260) AM 2020 103131 A

(800) 1466266

(151) 2018 12 19

(891) 2018 12 19

(731) KSB SE & Co. KgaA

Johann-Klein-Str. 9, 67227 Frankenthal,

Germany

(540)

**KSB SupremeServ**

(591) Blue (Pantone 2945) and grey (Pantone 40% black)

(531) 27.05.01; 27.05.10; 29.01.12

(511)

37 – Installation, assembly, repair, servicing, maintenance, fault clearance and reconditioning of machines, pumps, turbines, compressors, generators, armatures, motors, technical installations, electronic installations and apparatus and parts for the aforesaid goods; rental of pumps, armatures and motors; installation, maintenance and repair of computer network and information technology equipment.

38 – Providing access to e-commerce platforms on the internet; telecommunications; transmission of digital information; information transmission services via digital networks; transmission of sound, picture and data signals; computer communications for the transmission of information; transmission of information via wireless or cable networks; electronic transmission and retransmission of sounds, images, documents, messages and data; access to content, websites and portals; data transmission; web site forwarding services; electronic data interchange services; communication by radio; rental of communication apparatus and instruments for the electronic exchange of information and digital data.

41 – Provision of training courses; conduct of educational events, namely, educational instruction and lectures; providing of training and further training for external personnel; conducting of educational courses in engineering; arranging and conducting of workshops (training); publication of books and other printed materials with scientific and technical content; providing on-line electronic publications, not downloadable.

42 – Engineering services; inspection of machines, pumps, turbines, compressors, generators, armatures, motors, electric and electronic apparatus, and installations composed of the aforesaid goods; technical planning, technical calculation and technological consultancy; material testing and functionality testing; technical research and development, for others, in particular conducting scientific experiments and ana-

lyses; rental of electric or electronic apparatus for controlling and regulating machines, pumps, fittings, motors and engines; conducting scientific surveys, analyses and studies; preparation of technical manuals; measurement evaluation services, technical inspection services; technical support services for the downloading of digital data; technical advice in connection with energy-saving measures; conducting technical project studies, technical data analysis services; data warehousing; engineering services for the analysis of machinery; providing temporary use of web-based applications; providing virtual computer systems through cloud computing.

(260) AM 2020 103132 A

(800) 1466282

(151) 2019 03 28

(891) 2019 03 28

(731) APPLE INC.

One Apple Park Way, MS 169-3IPL,  
Cupertino CA 95014, USA

(540)

**APPLE LIGHTNING**

(591) Black, white

(511)

9 – Electrical and electronic connectors, cables, chargers, and adapters for use with computers, digital format audio players, digital audio recorders, digital video recorders and players, global positioning system (GPS) devices, telephones, computer peripheral devices, and handheld mobile digital electronic devices capable of providing access to the Internet and for the sending, receiving, and storing of telephone calls, faxes, electronic mail, and other digital data; computer peripheral devices.

(260) AM 2020 103133 A

(800) 1466329

(151) 2019 02 06

(891) 2019 02 06

(731) A.V.K. CONFECTIONERY HOLDINGS  
LIMITED

1, Lampousas Street, CY-1095 Nicosia, Cyprus

(540)

**КреАмо**

**CreAmo**

(591) Black, white

(531) 28.05

(511)

30 – Sweetmeats (candy); candy; fruit jellies (confectionery); lozenges (confectionery); pastilles (confectionery); fondants (confectionery); confectionery; sugar confectionery; waffles; cookies; pasta; maca-

roni; crackers; caramels (candy); ice cream; sherbets (ices); sorbets (ices); pralines; flour; meal; oatmeal; biscuits; malt biscuits; macaroons (pastry); petit-beurre biscuits; cereal preparations; gingerbread; rusks; chocolate.

(260) AM 2020 103229 A

(800) 1467401

(151) 2018 12 21

(891) 2018 12 21

(731) WORLD MEDICINE İLAÇ SANAYİ VE  
TİCARET ANONİM ŞİRKETİ

15 Temmuz Mah., Camiyolu Cad. No.50  
K.2, Güneşli, Bağcılar, İstanbul, Turkey

(540)

**FLUMILAST**  
**ФЛЮМИЛАСТ**

(591) Black, white

(531) 28.05

(511)

5 – Medicines for human purposes, medicines for veterinary purposes, vitamin preparations, chemical preparations for medical purposes, dietetic substances adapted for medical use, dietetic foods adapted for medical purposes, baby foods, medicinal herbs, herbal beverages adapted for medical purposes, nutritional supplements, pollen dietary supplements, mineral food supplements, protein dietary supplements, dietary supplements for animals, fodder supplements for veterinary purposes, medicines for dental purposes, hygienic products for medical purposes including sanitary pads, breast-nursing pads and bunion pads, waddings for medical purposes, plasters for medical purposes, dressings for medical purposes, babies' napkins, preparations for destroying noxious plants, preparations for destroying noxious animals, fungicides, deodorants other than for human beings or for animals, air deodorising preparations, disinfectants for hygiene purposes, antiseptics, detergents for medical purposes.

(260) AM 2020 103230 A

(800) 1467402

(151) 2018 12 20

(891) 2018 12 20

(731) ELLIS ENTERPRISES B.V.

Wieldrechtseweg 39, NL-3316 BG Dordrecht,  
Netherlands

(540)



(591) Black, white  
 (531) 24.01.15; 24.01.25; 27.05.21  
 (511)  
 2 – Anti-rust preparations; anti-corrosion preparations.  
 3 – Rust-removing preparations.  
 4 – Lubricants.  
 17 – Insulating coatings; insulation paints; sound absorbing materials.  
 40 – Treatment of metal to prevent rust and corrosion; treatment of metal (sound dampening).

(260) AM 2020 103231 A  
 (800) 1467435  
 (151) 2019 03 11  
 (891) 2019 03 11  
 (731) NOVARTIS AG  
 CH-4002 Basel, Switzerland  
 (540)



(591) Black, white  
 (531) 01.15.23; 26.11.12; 26.13.25  
 (511)  
 5 – Pharmaceutical preparations for human use; food supplements; dietetic substances and foods for medical use; dietary supplements for humans; nutraceutical preparations for therapeutic or medical use.

(260) AM 2020 103232 A  
 (800) 1467476  
 (151) 2019 03 11  
 (891) 2019 03 11  
 (731) NOVARTIS AG  
 CH-4002 Basel, Switzerland  
 (540)



(591) Orange, blue and white  
 (531) 01.15.23; 26.11.12; 26.13.25; 29.01.13  
 (511)  
 5 – Pharmaceutical preparations for human use; food supplements; dietetic substances and foods for medical use; dietary supplements for humans; nutraceutical preparations for therapeutic or medical use.

(260) AM 2020 103233 A  
 (800) 1467491  
 (151) 2019 02 27  
 (891) 2019 02 27  
 (731) TEKA PURO ÜRETİM VE TİC.A.Ş.  
 Tepeören İtösb Mahallesi 14.Cadde, No:8  
 Tuzla Tuzla İstanbul, Turkey  
 (540)

# Chimera

(591) Black, white  
 (531) 27.05.01  
 (511)  
 34 – Tobacco and tobacco substitutes; cigarettes and cigars; electronic cigarettes and oral vaporizers for smokers; smokers' articles; matches.

(260) AM 2020 103234 A  
 (800) 1467497  
 (151) 2019 04 22  
 (891) 2019 04 22  
 (731) JHJM Nevada I, LLC  
 65 Cascade Ln., Las Vegas NV 89113, USA  
 (540)

# GOFLAT

(591) Black, white  
 (511)  
 9 – Sports helmets.

(260) AM 2020 103382 A  
 (800) 1468963  
 (151) 2019 03 26  
 (891) 2019 03 26  
 (731) BAYER AKTIENGESELLSCHAFT  
 Kaiser-Wilhelm-Allee, 51373 Leverkusen,  
 Germany  
 (540)

# MUSREDO

(591) Black, white  
 (511)  
 5 – Pharmaceutical preparations; pharmaceutical preparations in the field of cardiovascular diseases, oncology diseases and renal diseases.

(260) AM 2020 103404 A  
 (800) 1469307  
 (151) 2019 03 27  
 (891) 2019 03 27  
 (731) JIANGSU LANDISI WOOD CO., LTD.  
 Guanhu Town Industrial Zone, Pizhou City,  
 Xuzhou City, Jiangsu Province, China  
 (540)

# FEIYAWOOD

(591) Black, white  
 (531) 27.05.01  
 (511)  
 19 – Lumber; building timber; sawn timber; wood paving; wood, semi-worked; manufactured timber; veneers; wooden floor boards; wooden floor; plywood.

(260) AM 2020 103406 A  
 (800) 1469376  
 (151) 2019 02 19  
 (891) 2019 02 19  
 (731) SEVİNÇLER SAĞLIK ÜRÜNLERİ SANAYİ VE TİCARET ANONİM ŞİRKETİ  
 3.Organize Sanayi Bölgesi, Kamil Şerbetçi Bulv. No.6, Başpınar Şehitkamil, Gaziantep, Turkey  
 (540)



(591) Violet, white  
 (531) 27.05.01; 27.05.02; 27.05.03; 27.05.24; 29.01.13  
 (511)  
 5 – Pharmaceutical and veterinary preparations for medical purposes; chemical preparations for medical purposes; dietary supplements, including those adapted for medical purposes; nutritional supplements; dietary supplements for slimming purposes; food for babies; herbs and herbal beverages adapted for medicinal purposes; dental preparations and articles; sanitary preparations for medical use; hygienic pads; hygienic tampons; plasters; materials for dressings; diapers, including those made of paper and textiles; preparations for destroying vermin; fungicides, herbicides; deodorants, other than for human beings or for animals; air deodorising preparations; disinfectants; antiseptics; detergents for medical purposes.

(260) AM 2020 103407 A  
 (800) 1469414  
 (151) 2019 03 12  
 (891) 2019 03 12  
 (731) KERING  
 40 rue de Sèvres, F-75007 PARIS, France  
 (540)



(591) Black, white  
 (531) 27.05.09

(511)  
 41 – Arranging and conducting of events, conferences, exhibitions, competitions and awards relating to cultural activities, namely fashion, painting, sculpture, literature, music, photography, cinema; entertainment services relating to cultural activities, namely fashion, painting, sculpture, literature, music, photography, cinema; education services relating to cultural activities, namely fashion, painting, sculpture, literature, music, photography, cinema; motion picture production; movie studios; cinematographic film projection; adaptation and editing of motion pictures; all these services provided in the field of recognition, development and promotion of women's place in cultural activities.

(260) AM 2020 103489 A  
 (800) 1469768  
 (151) 2019 01 16  
 (891) 2019 01 16  
 (731) Zuffa, LLC  
 6650 South Torrey Pines Drive, Las Vegas NV 89118, USA

(540)  

(591) Black, white  
 (531) 27.05.10; 27.05.11  
 (511)  
 25 – Apparel and performance apparel, namely, tops as clothing, bottoms as clothing, headwear, footwear, swimwear, undergarments, jackets, warm up suits, gloves, socks, sweatbands, rash guards and Gi robes; loungewear; sleepwear.

28 – Exercise machines; manually-operated exercise equipment; exercise weights; exercise bars; exercise benches; exercise and fitness equipment and accessories, namely, exercise gloves; boxing and mixed martial arts equipment, namely, bag gloves, mixed martial arts gloves, boxing gloves, focus mitts, punching mitts, shin guards, punching bags, heavy bags, free standing bags; pads for use in boxing and mixed martial arts, namely, kick pads, target pads, Thai pads and shin pads; chest protectors, and body shields for use in mixed martial arts and boxing; playground balls; sport balls; pumps for inflating sports equipment, namely, playground balls and sport balls.

41 – Health club services, namely, providing fitness, personal training and exercise facilities; providing instruction in the fields of fitness, personal training, exercise and mixed martial arts; providing instructional programs and classes in fields of fitness, personal training, exercise and mixed martial arts; providing information in the fields of fitness, personal training, exercise and mixed martial arts via a global



computer network; providing instruction in the fields of nutrition, health and wellness.

(260) AM 2020 103490 A

(800) 1469773

(151) 2018 12 27

(891) 2018 12 27

(731) H. Lundbeck A/S

Ottiliavej 9, DK-2500 Valby, Denmark

(540)



(591) Red and black.

(531) 01.01.02; 03.09.17; 29.01.12

(511)

9 – Magnetic, electronic and optical data carriers containing information relating to medicine; software; software for medical purposes; computer software; computer software and hardware for medical purposes; computer application software for medical purposes for mobile phones and tablets; application software; application software for mobile devices (for medical purposes); mobile Apps; mobile Apps (for medical purposes); smart watches (data processing); smart rings (data processing); wearable computers; downloadable images for use on mobile phones; electronic information management systems in the medical sector; recorded computer software, including software for medical and pharmaceutical information, education and sales activities; software for websites, intranet and internet; data processing equipment and computers; application software for mobile devices and apps for information and interaction; application software for social networking services via internet; downloadable software in the nature of a mobile application for providing information on health and medicine; downloadable software in the nature of a mobile application for facilitating communication, namely, allowing patients and healthcare professionals to access and share information in the medical, pharmaceutical, and health fields.

(260) AM 2020 103491 A

(800) 1469802

(151) 2019 04 03

(891) 2019 04 03

(731) LEO GROUP CO., LTD.

NO.1 LEO ROAD, BINHAI, WENLING,  
317503 ZHEJIANG, China

(540)



(591) Black, white

(531) 26.11.02; 26.11.12; 27.05.01

(511)

7 – Pumps [machines]; lawnmowers [machines]; agricultural implements other than hand-operated; scissors, electric; agricultural machines; chaff cutters.

(260) AM 2020 103494 A

(800) 1469832

(151) 2019 03 19

(891) 2019 03 19

(731) HUGEL INC.

61-20, SINBUK-RO, SINBUK-EUP,  
CHUNCHEON-SI, GANGWON-DO,  
Republic of Korea

(540)

## THE CHAEUM

(591) Black, white

(511)

5 – Prefilled injectors with artificial materials for subcutaneous infusion; injectors, including, but not limited to, pre-filled syringes, in the form of a gel, sold alone or in a kit, for use in treating wrinkles, folds, scars and lips, for face and body contouring and for rejuvenating the skin; hypodermic syringes containing pharmaceuticals for the treatment and improvement of skin defect; skin fillers; filler for plastic surgery; filler for urology; filler for dermatology; body filler for plastic surgery; filler for enlarging penis; biomaterials for tissue restoration; pre-filled syringes for use in treating wrinkles, folds, scars and lips, for face and body contouring and for rejuvenating the skin; pre-filled syringes in the form of a gel sold alone or in a kit, for use in treating wrinkles, folds, scars and lips, for face and body contouring and for rejuvenating the skin; pre-filled syringe comprised of hyaluronic acid; filler for dermatology comprised of a pre-filled syringe containing a hyaluronic acid; pre-filled syringes containing pharmaceutical preparations for the treatment and management of skin and soft tissue and prostheses, namely, hyaluronic acid or modified hyaluronic acid or one of its derivatives or salts or other skin or tissue filling materials; pre-filled syringes for medical purposes; pharmaceutical preparations mainly based on hyaluronic acid; pharmaceutical preparations for skin care; hyaluronic acid in ampoule form for medical purposes; ointments for pharmaceutical purposes;

ses; medicated lotions; modified hyaluronic acid preparations for medical purposes; hyaluronic acid preparations for medical purposes; pharmaceutical preparations for the treatment of wrinkles; pharmaceutical preparations for use in dermatology; pharmaceutical preparations; pharmaceutical preparations used in cosmetic surgery; pharmaceutical agents for epidermis; drugs for medical purposes; medical gels for activation of tissues; medicines for human purposes; injectable dermal filler; pharmaceutical preparations for treating skin disorders; topical gels for medical and therapeutic purposes.

10 – Medical injection syringe; medical apparatus for introducing pharmaceutical preparations into the human body; injection device for pharmaceuticals; injectors for medical purposes; syringes for medical purposes; surgical apparatus and instruments; automatic injectors for medical purposes; skin infusion apparatus including surgical implants; surgical prostheses; medical apparatus for facilitating the inhalation of pharmaceutical preparations; dermatoplastic instruments; syringes for injections for the skin; medical apparatus used for treatment with carbon gases for cosmetic surgery; surgical instruments for use in cosmetic surgery, dermatology and treatment of wound; medical apparatus and instruments for the treatment of skin; cases fitted for medical instruments; spittoons for medical purposes; electric esthetic massage apparatus; implants for skin regeneration; urological apparatus and instruments; penis prostheses; medical filling apparatus; injection syringes for fillers; filler injection apparatus for medical purposes; implants consisting of artificial materials; medical filling apparatus for hyaluronate acid or modified hyaluronate acid; endoprotheses; artificial breast implants; supporters for medical purposes; surgical implant comprised of artificial materials; artificial skin for surgical purposes; medical drapes; compression bandages; medical apparatus and instruments; medical apparatus and instruments other than for dental purposes; suture for medical purpose; lifting thread for medical purpose; suture; body insertion thread; surgical thread; dental apparatus and instruments; thread for medical purpose; needle for medical purpose; body rehabilitation apparatus for medical purposes; injection needles for medical use; artificial jaws; disposable syringes; syringes for injections; hypodermic syringes; artificial orthopedic implants; medical, surgical and orthopaedic implants made of artificial materials; orthopaedic articles; medical apparatus; medical apparatus and instruments for plastic surgery; implants for use in treating wrinkles, folds, scars and lips, for face and body contouring and for rejuvenating the skin; medical device for use of filling out skin or tissue of body or face, including, but not limited to, wrinkles, folds, scars and lips.

(260) AM 2020 103495 A  
(800) 1469852  
(151) 2019 01 14  
(891) 2019 01 14  
(731) EGIS GYÓGYSZERGYÁR ZRT.  
Keresztúri út 30-38., H-1106 Budapest,  
Hungary

(540)

## SUPRASTIDEN

(591) Black, white  
(511)  
5 – Pharmaceutical preparations for human use.

(260) AM 2020 103536 A  
(800) 1470955  
(151) 2018 11 21  
(891) 2018 11 21  
(731) MOROZOV VICTOR ALEKSANDROVICH  
Kosmonavtov street, 5, building G,  
apartment 40, RU-344092 Rostov-on-Don,  
Russian Federation

(540)



(591) Beige, brown, white  
(531) 03.01.02; 04.03.09; 24.01.15; 24.01.19;  
26.04.04; 26.04.05; 26.04.16; 29.01.12  
(511)

30 – Vanilla flavorings for culinary purposes; flavorings, other than essential oils, for cakes; flavorings, other than essential oils, for beverages; coffee flavorings; food flavorings, other than essential oils; star aniseed; baozi [stuffed buns]; cereal bars; high-protein cereal bars; pancakes; noodle-based prepared meals; freeze-dried dishes with the main ingredient being pasta; freeze-dried dishes with the main ingredient being rice; buns; bulgur; bread rolls; edible rice paper; edible paper; burritos; vanillin [vanilla substitute]; vareniki [stuffed dumplings]; waffles; vermicelli [noodles]; natural sweeteners; sausage binding materials; binding agents for ice cream; sea water for cooking; seaweed [condiment]; malt biscuits; cloves [spice]; mirror icing [mirror glaze]; cake frosting [icing]; glucose for culinary purposes; mustard; croûtons; buckwheat, processed; gluten additives for culinary purposes; yeast; thickening agents for cooking foodstuffs; leaven; rice-based snack food; cereal-based snack food; artificial coffee; vegetal preparations for use as coffee substitutes; dressings for salad; zephyr [confectionery]; fruit jellies [confectionery]; candy decorations for cakes; confectionery for deco-

rating Christmas trees; cakes; pastries; peanut confectionery; almond confectionery; pasta; ginger [spice]; frozen yogurt [confectionery ices]; cocoa; cream of tartar for culinary purposes; capers; caramels [candy]; curry [spice]; ketchup [sauce]; gimbap [Korean rice dish]; kimchiyeon [fermented vegetable pancakes]; quinoa, processed; quiches; gluten prepared as foodstuff; flour-based dumplings; sweetmeats [candy]; liquorice [confectionery]; peppermint sweets; mints for breath freshening; dulce de leche; cinnamon [spice]; coffee; unroasted coffee; starch for food; crackers; custard; hominy grits; semolina; oatmeal; crushed barley; groats for human food; ice cubes; corn, milled; corn, roasted; meat pies; turmeric; couscous [semolina]; noodles; soba noodles; udon noodles; ice for refreshment; ice, natural or artificial; edible ices; candy; rice cakes; lomper [potato-based flatbread]; mayonnaise; macaroons [pastry]; macaroni; maltose; hominy; piccalilli; marinades; marzipan; honey; royal jelly; ice cream; bean meal; buckwheat flour; tapioca flour; potato flour; corn flour; nut flours; flour; wheat flour; soya flour; barley meal; dessert mousses [confectionery]; chocolate mousses; muesli; mint for confectionery; cocoa beverages with milk; coffee beverages with milk; coffee-based beverages; cocoa-based beverages; chamomile-based beverages; tea-based beverages; chocolate beverages with milk; chocolate-based beverages; infusions, not medicinal; crushed oats; husked oats; okonomiyaki [Japanese savory pancakes]; onigiri [rice balls]; nutmegs; chocolate-coated nuts; stick liquorice [confectionery]; soya bean paste [condiment]; pastila [confectionery]; pastilles [confectionery]; molasses for food; pâtés en croûte; pelmeni [dumplings stuffed with meat]; pepper; allspice; peppers [seasonings]; pesto [sauce]; cookies; petit-beurre biscuits; bibimbap [rice mixed with vegetables and beef]; pies; pizzas; meat gravies; fondants [confectionery]; popcorn; powders for making ice cream; baking powder; mustard meal; pralines; condiments; meat tenderizers for household purposes; cereal preparations; oat-based food; propolis; gingerbread; spices; petits fours [cakes]; rice pudding; puddings; cake powder; fruit coulis [sauces]; ravioli; ramen [Japanese noodle-based dish]; chewing gum; chewing gum for breath freshening; relish [condiment]; rice; instant rice; wheat germ for human consumption; spring rolls; sago; sugar; palm sugar; sesame seeds [seasonings]; linseed for culinary purposes [seasoning]; processed seeds for use as a seasoning; aniseed; agave syrup [natural sweetener]; golden syrup; confectionery; batter mixes for okonomiyaki [Japanese savory pancakes]; baking soda [bicarbonate of soda for cooking purposes]; malt for human consumption; salt for preserving foodstuffs; cooking salt; celery salt; sherbets [ices]; cranberry sauce [condiment]; soya sauce; tomato sauce; apple sauce [condiment]; sauces [condiments]; pasta sauce; spaghetti; seasonings; chocolate-based spreads;

chocolate spreads containing nuts; preparations for stiffening whipped cream; shaved ice with sweetened red beans; rusks; breadcrumbs; sushi; senbei [rice crackers]; sandwiches; tabbouleh; tacos; tapioca; tarts; dough; pastry dough; almond paste; rice pulp for culinary purposes; cake dough; tortillas; garden herbs, preserved [seasonings]; chocolate decorations for cakes; vinegar; beer vinegar; ferments for pastes; halvah; bread; unleavened bread; chips [cereal products]; corn flakes; oat flakes; hot dog sandwiches; flowers or leaves for use as tea substitutes; jiaozi [stuffed dumplings]; chicory [coffee substitute]; tea; iced tea; chutneys [condiments]; minced garlic [condiment]; cheeseburgers [sandwiches]; chow-chow [condiment]; saffron [seasoning]; chocolate; malt extract for food; essences for foodstuffs, except etheric essences and essential oils; husked barley.

35 – Arranging subscriptions to telecommunication services for others; import-export agency services; commercial information agency services; advertising agency services; cost price analysis; rental of advertising space; business auditing; financial auditing; business intermediary services relating to the matching of potential private investors with entrepreneurs needing funding; employment agency services; computerized file management; book-keeping; invoicing; demonstration of goods; transcription of communications [office functions]; opinion polling; market studies; business information; commercial information and advice for consumers in the choice of products and services; business investigations; business research; marketing research; personnel recruitment; business management and organization consultancy; business organization consultancy; business management consultancy; personnel management consultancy; professional business consultancy; consultancy regarding advertising communication strategies; consultancy regarding public relations communication strategies; layout services for advertising purposes; marketing; marketing in the framework of software publishing; targeted marketing; business management of performing artists; business management of sports people; writing of résumés for others; scriptwriting for advertising purposes; news clipping services; updating and maintenance of information in registries; updating and maintenance of data in computer databases; updating of advertising material; word processing; online retail services for downloadable and pre-recorded music and movies; online retail services for downloadable ring tones; online retail services for downloadable digital music; organization of exhibitions for commercial or advertising purposes; arranging newspaper subscriptions for others; organization of fashion shows for promotional purposes; organization of trade fairs for commercial or advertising purposes; shop window dressing; design of advertising materials; business appraisals; payroll preparation; data search in computer files for



others; sponsorship search; administrative assistance in responding to calls for tenders; business management assistance; commercial or industrial management assistance; commercial intermediation services; providing business information via a web site; provision of commercial and business contact information; provision of an on-line marketplace for buyers and sellers of goods and services; web indexing for commercial or advertising purposes; presentation of goods on communication media, for retail purposes; economic forecasting; auctioneering; retail services for works of art provided by art galleries; sales promotion for others; promotion of goods and services through sponsorship of sports events; production of teleshopping programmes; production of advertising films; office machines and equipment rental; rental of advertising time on communication media; publicity material rental; rental of signs for advertising purposes; rental of vending machines; rental of sales stands; rental of photocopying machines; publication of publicity texts; radio advertising; billposting; distribution of samples; dissemination of advertising matter; direct mail advertising; registration of written communications and data; writing of publicity texts; advertising; on-line advertising on a computer network; advertising by mail order; television advertising; document reproduction; compilation of statistics; compilation of information into computer databases; business inquiries; systemization of information into computer databases; advisory services for business management; negotiation of business contracts for others; negotiation and conclusion of commercial transactions for third parties; compiling indexes of information for commercial or advertising purposes; tax preparation; drawing up of statements of accounts; telemarketing services; psychological testing for the selection of personnel; wholesale services for pharmaceutical, veterinary and sanitary preparations and medical supplies; retail services for pharmaceutical, veterinary and sanitary preparations and medical supplies; interim business management; outsourced administrative management for companies; business management of hotels; business management for freelance service providers; business project management services for construction projects; commercial administration of the licensing of the goods and services of others; business management of reimbursement programs for others; administration of consumer loyalty programs; administration of frequent flyer programs; administrative processing of purchase orders; public relations; competitive intelligence services; modelling for advertising or sales promotion; typing; market intelligence services; appointment reminder services [office functions]; web site traffic optimization; relocation services for businesses; tax filing services; search engine optimization for sales promotion; appointment scheduling services [office functions]; gift registry services; price comparison services; pay per

click advertising; secretarial services; procurement services for others [purchasing goods and services for other businesses]; shorthand; outsourcing services [business assistance]; telephone answering for unavailable subscribers; photocopying services; business efficiency expert services; promoting the goods and services of others; retail and wholesale services for coffee, rice, tapioca and sago, flour and preparations made from cereals, bread, pastries and confectionery, edible ices, sugar, honey, treacle, yeast, baking-powder, salt, mustard, vinegar, sauces [condiments], spices, ice [frozen water].

---

(260) AM 2020 103538 A

(800) 1470990

(151) 2019 04 04

(891) 2019 04 04

(731) Obshchestvo s ogranichennoy  
otvetstvennostyu "Dzhapan Tekhnolodzhi  
Grupp Ko., LTD"  
Urbanskogo street, 1, office 6, town Artem,  
RU-692770 Primorskiy kray, Russian  
Federation

(540)



(591) White, light blue, blue, pink, lilac, orange,  
yellow

(531) 02.09.01; 03.13.18; 27.05.02; 28.03; 29.01.15  
(511)

5 – Textile diapers; babies' diaper-pants; paper liners for diapers; babies' diapers of paper; babies' diapers; babies' diapers of textile; diapers for incontinence; disposable diapers of paper for babies; disposable diapers of cellulose for babies; disposable babies' diapers; disposable training pants for infants; babies' diapers of paper and cellulose, disposable; disposable diapers of paper for incontinence; disposable diapers of cellulose for incontinence; disposable diapers for incontinence; disposable training pants of paper or cellulose; inserts made of cloth specially adapted for reusable babies' diapers; babies' napkin-pants [diaper-pants] of paper and cellulose, disposable.

---

**INTERNATIONAL TRADEMARKS PROTECTED  
IN GEORGIA**

(260) AM 2020 96959 A  
(800) 1393495  
(151) 2017 12 14  
(181) 2027 12 14  
(891) 2017 12 14  
(511) 35

---

(260) AM 2020 97488 A  
(800) 1397636  
(151) 2017 10 05  
(181) 2027 10 05  
(891) 2017 10 05  
(511) 06, 09, 16, 35, 39, 40

---

(260) AM 2020 97519 A  
(800) 1398222  
(151) 2017 10 05  
(181) 2027 10 05  
(891) 2017 10 05  
(511) 09, 16, 35, 39, 40

---

(260) AM 2020 98129 A  
(800) 1407465  
(151) 2017 12 26  
(181) 2027 12 26  
(891) 2017 12 26  
(511) 39

---

(260) AM 2020 98336 A  
(800) 1409730  
(151) 2017 10 05  
(181) 2027 10 05  
(891) 2017 10 05  
(511) 06, 09, 16, 35, 39, 40

---

(260) AM 2020 99534 A  
(800) 1423387  
(151) 2018 07 10  
(181) 2028 07 10  
(891) 2018 07 10  
(511) 05

---

(260) AM 2020 100468 A  
(800) 1433706  
(151) 2018 09 24  
(181) 2028 09 24

---

(891) 2018 09 24  
(511) 03, 05, 09, 11, 14, 16, 20, 21, 24, 28, 29, 30,  
31, 32, 35, 41, 44, 45

---

(260) AM 2020 100623 A  
(800) 1436672  
(151) 2018 05 30  
(181) 2028 05 30  
(891) 2018 05 30  
(511) 07, 08, 11

---

(260) AM 2020 100757 A  
(800) 1394672  
(151) 2017 10 05  
(181) 2027 10 05  
(891) 2018 11 14  
(511) 01, 05, 35

---

(260) AM 2020 100844 A  
(800) 1440116  
(151) 2018 05 25  
(181) 2028 05 25  
(891) 2018 05 25  
(511) 09, 11, 12, 20, 21, 24, 28

---

(260) AM 2020 100845 A  
(800) 1440117  
(151) 2018 06 21  
(181) 2028 06 21  
(891) 2018 06 21  
(511) 09, 28

---

(260) AM 2020 100852 A  
(800) 1298127  
(151) 2015 12 09  
(181) 2025 12 09  
(891) 2018 12 04  
(511) 03

---

(260) AM 2020 100853 A  
(800) 1306982  
(151) 2016 01 06  
(181) 2026 01 06  
(891) 2018 09 10  
(511) 43

---

(260) AM 2020 100856 A  
(800) 1365896  
(151) 2017 06 13  
(181) 2027 06 13  
(891) 2018 07 12  
(511) 11

---

(260) AM 2020 100945 A  
(800) 1438584  
(151) 2018 05 23  
(181) 2028 05 23  
(891) 2018 05 23  
(511) 33

---

(260) AM 2020 100985 A  
(800) 1440314  
(151) 2018 10 02  
(181) 2028 10 02  
(891) 2018 10 02  
(511) 11

---

(260) AM 2020 100998 A  
(800) 1440607  
(151) 2018 07 17  
(181) 2028 07 17  
(891) 2018 07 17  
(511) 34

---

(260) AM 2020 101000 A  
(800) 1440641  
(151) 2018 10 03  
(181) 2028 10 03  
(891) 2018 10 03  
(511) 43

---

(260) AM 2020 101001 A  
(800) 1440643  
(151) 2018 10 26  
(181) 2028 10 26  
(891) 2018 10 26  
(511) 30

---

(260) AM 2020 101002 A  
(800) 1440655  
(151) 2018 09 24  
(181) 2028 09 24  
(891) 2018 09 24  
(511) 03

---

(260) AM 2020 101003 A  
(800) 1440664  
(151) 2018 10 26  
(181) 2028 10 26

(891) 2018 10 26  
(511) 30

---

(260) AM 2020 101004 A  
(800) 1440668  
(151) 2018 11 09  
(181) 2028 11 09  
(891) 2018 11 09  
(511) 32, 33

---

(260) AM 2020 101005 A  
(800) 1440687  
(151) 2018 06 20  
(181) 2028 06 20  
(891) 2018 06 20  
(511) 01, 05

---

(260) AM 2020 101006 A  
(800) 1440704  
(151) 2018 09 24  
(181) 2028 09 24  
(891) 2018 09 24  
(511) 03

---

(260) AM 2020 101008 A  
(800) 1440716  
(151) 2018 09 17  
(181) 2028 09 17  
(891) 2018 09 17  
(511) 32

---

(260) AM 2020 101009 A  
(800) 1440729  
(151) 2018 08 13  
(181) 2028 08 13  
(891) 2018 08 13  
(511) 34

---

(260) AM 2020 101010 A  
(800) 1440734  
(151) 2018 10 25  
(181) 2028 10 25  
(891) 2018 10 25  
(511) 02, 16

---

(260) AM 2020 101011 A  
(800) 1440782  
(151) 2018 08 10  
(181) 2028 08 10  
(891) 2018 08 10  
(511) 09, 35, 36, 38, 41, 42, 44, 45

---

(260) AM 2020 101013 A  
(800) 1440798  
(151) 2018 09 12  
(181) 2028 09 12  
(891) 2018 09 12  
(511) 01

---

(260) AM 2020 101014 A  
(800) 1440828  
(151) 2018 05 07  
(181) 2028 05 07  
(891) 2018 05 07  
(511) 03, 09, 14, 18, 21, 25, 35

---

(260) AM 2020 101015 A  
(800) 1440868  
(151) 2018 08 06  
(181) 2028 08 06  
(891) 2018 08 06  
(511) 35, 41

---

(260) AM 2020 101016 A  
(800) 1440920  
(151) 2018 10 08  
(181) 2028 10 08  
(891) 2018 10 08  
(511) 27

---

(260) AM 2020 101039 A  
(800) 1441306  
(151) 2018 10 22  
(181) 2028 10 22  
(891) 2018 10 22  
(511) 03

---

(260) AM 2020 101041 A  
(800) 1441337  
(151) 2018 10 03  
(181) 2028 10 03  
(891) 2018 10 03  
(511) 09

---

(260) AM 2020 101064 A  
(800) 1441686  
(151) 2018 10 05  
(181) 2028 10 05  
(891) 2018 10 05  
(511) 29, 30

---

(260) AM 2020 101078 A  
(800) 1442172  
(151) 2018 11 29  
(181) 2028 11 29

(891) 2018 11 29  
(511) 12

---

(260) AM 2020 101086 A  
(800) 1442428  
(151) 2018 11 07  
(181) 2028 11 07  
(891) 2018 11 07  
(511) 30

---

(260) AM 2020 101087 A  
(800) 1442446  
(151) 2018 11 23  
(181) 2028 11 23  
(891) 2018 11 23  
(511) 05

---

(260) AM 2020 101088 A  
(800) 1442453  
(151) 2018 10 25  
(181) 2028 10 25  
(891) 2018 10 25  
(511) 11

---

(260) AM 2020 101089 A  
(800) 1442461  
(151) 2018 05 16  
(181) 2028 05 16  
(891) 2018 05 16  
(511) 41, 42

---

(260) AM 2020 101104 A  
(800) 1442763  
(151) 2018 11 05  
(181) 2028 11 05  
(891) 2018 11 05  
(511) 35, 38, 41, 42

---

(260) AM 2020 101108 A  
(800) 1442783  
(151) 2018 11 05  
(181) 2028 11 05  
(891) 2018 11 05  
(511) 35, 38, 41, 42

---

(260) AM 2020 101128 A  
(800) 1293894  
(151) 2015 11 24  
(181) 2025 11 24  
(891) 2018 10 23  
(511) 03

---

(260) AM 2020 101129 A  
(800) 1333584  
(151) 2016 05 20  
(181) 2026 05 20  
(891) 2018 12 07  
(511) 09, 16, 25, 28, 41, 42

---

(260) AM 2020 101130 A  
(800) 1358675  
(151) 2017 02 27  
(181) 2027 02 27  
(891) 2018 12 18  
(511) 18, 25, 35

---

(260) AM 2020 101131 A  
(800) 1373752  
(151) 2017 07 14  
(181) 2027 07 14  
(891) 2018 12 05  
(511) 37

---

(260) AM 2020 101190 A  
(800) 1444332  
(151) 2018 10 22  
(181) 2028 10 22  
(891) 2018 10 22  
(511) 09, 16, 35, 38, 42

---

(260) AM 2020 101192 A  
(800) 1444349  
(151) 2018 07 02  
(181) 2028 07 02  
(891) 2018 07 02  
(511) 07

---

(260) AM 2020 101193 A  
(800) 1444357  
(151) 2018 05 30  
(181) 2028 05 30  
(891) 2018 05 30  
(511) 01, 06, 07, 08, 09, 21

---

(260) AM 2020 101194 A  
(800) 1444358  
(151) 2018 06 26  
(181) 2028 06 26  
(891) 2018 06 26  
(511) 21, 32, 33, 34

---

(260) AM 2020 101323 A  
(800) 1445426  
(151) 2018 07 30  
(181) 2028 07 30

(891) 2018 07 30  
(511) 09, 28

---

(260) AM 2020 101325 A  
(800) 1445442  
(151) 2017 08 30  
(181) 2027 08 30  
(891) 2017 08 30  
(511) 03, 05, 06, 08, 11, 16, 20, 21, 24, 27, 35

---

(260) AM 2020 101326 A  
(800) 1445443  
(151) 2018 04 30  
(181) 2028 04 30  
(891) 2018 04 30  
(511) 09

---

(260) AM 2020 101327 A  
(800) 1445540  
(151) 2018 10 09  
(181) 2028 10 09  
(891) 2018 10 09  
(511) 34

---

(260) AM 2020 101328 A  
(800) 1445542  
(151) 2018 09 14  
(181) 2028 09 14  
(891) 2018 09 14  
(511) 29, 35

---

(260) AM 2020 101351 A  
(800) 1445959  
(151) 2018 11 23  
(181) 2028 11 23  
(891) 2018 11 23  
(511) 18, 25

---

(260) AM 2020 101358 A  
(800) 1446176  
(151) 2018 11 12  
(181) 2028 11 12  
(891) 2018 11 12  
(511) 03, 35

---

(260) AM 2020 101435 A  
(800) 1446669  
(151) 2018 11 16  
(181) 2028 11 16  
(891) 2018 11 16  
(511) 18, 25

---

(260) AM 2020 101460 A  
(800) 1447248  
(151) 2018 07 17  
(181) 2028 07 17  
(891) 2018 07 17  
(511) 09, 28, 41

---

(260) AM 2020 101461 A  
(800) 1447326  
(151) 2018 10 31  
(181) 2028 10 31  
(891) 2018 10 31  
(511) 35

---

(260) AM 2020 101483 A  
(800) 1048098  
(151) 2010 08 03  
(181) 2020 08 03  
(891) 2018 12 17  
(511) 05

---

(260) AM 2020 101485 A  
(800) 1168933  
(151) 2013 06 04  
(181) 2023 06 04  
(891) 2018 12 18  
(511) 25

---

(260) AM 2020 101486 A  
(800) 1189522  
(151) 2013 10 17  
(181) 2023 10 17  
(891) 2019 01 14  
(511) 11

---

(260) AM 2020 101487 A  
(800) 1239754  
(151) 2014 08 11  
(181) 2024 08 11  
(891) 2019 01 09  
(511) 10

---

(260) AM 2020 101488 A  
(800) 1358995  
(151) 2017 03 21  
(181) 2027 03 21  
(891) 2019 01 09  
(511) 03, 05, 10

---

(260) AM 2020 101489 A  
(800) 1359703  
(151) 2017 03 23  
(181) 2027 03 23

(891) 2019 01 14  
(511) 03, 05

---

(260) AM 2020 101490 A  
(800) 1421603  
(151) 2018 05 10  
(181) 2028 05 10  
(891) 2018 12 28  
(511) 20

---

(260) AM 2020 101491 A  
(800) 1430864A  
(151) 2018 08 15  
(181) 2028 08 15  
(891) 2018 12 06  
(511) 32

---

(260) AM 2020 101533 A  
(800) 1447768  
(151) 2018 10 29  
(181) 2028 10 29  
(891) 2018 10 29  
(511) 07

---

(260) AM 2020 101537 A  
(800) 1447845  
(151) 2018 12 13  
(181) 2028 12 13  
(891) 2018 12 13  
(511) 05

---

(260) AM 2020 101538 A  
(800) 1447917  
(151) 2018 12 13  
(181) 2028 12 13  
(891) 2018 12 13  
(511) 05

---

(260) AM 2020 101580 A  
(800) 1448905  
(151) 2018 12 12  
(181) 2028 12 12  
(891) 2018 12 12  
(511) 03, 05

---

(260) AM 2020 101593 A  
(800) 1050149  
(151) 2010 07 28  
(181) 2020 07 28  
(891) 2018 12 03  
(511) 05

---

(260) AM 2020 101594 A  
(800) 1360860  
(151) 2017 05 29  
(181) 2027 05 29  
(891) 2018 12 03  
(511) 03, 05

---

(260) AM 2020 101595 A  
(800) 1414961  
(151) 2018 04 17  
(181) 2028 04 17  
(891) 2019 01 08  
(511) 19, 35

---

(260) AM 2020 101597 A  
(800) 1433560  
(151) 2018 08 30  
(181) 2028 08 30  
(891) 2019 01 23  
(511) 30

---

(260) AM 2020 101598 A  
(800) 1435204  
(151) 2018 09 04  
(181) 2028 09 04  
(891) 2019 01 22  
(511) 32

---

(260) AM 2020 101746 A  
(800) 1449814  
(151) 2018 09 21  
(181) 2028 09 21  
(891) 2018 09 21  
(511) 03, 21

---

(260) AM 2020 101747 A  
(800) 1449820  
(151) 2018 04 19  
(181) 2028 04 19  
(891) 2018 04 19  
(511) 09, 42

---

(260) AM 2020 101748 A  
(800) 1449844  
(151) 2018 11 21  
(181) 2028 11 21  
(891) 2018 11 21  
(511) 09

---

(260) AM 2020 101757 A  
(800) 1450075  
(151) 2018 12 18  
(181) 2028 12 18

(891) 2018 12 18  
(511) 12

---

(260) AM 2020 101758 A  
(800) 1450087  
(151) 2018 11 23  
(181) 2028 11 23  
(891) 2018 11 23  
(511) 11

---

(260) AM 2020 101774 A  
(800) 1450278  
(151) 2018 07 24  
(181) 2028 07 24  
(891) 2018 07 24  
(511) 35, 42

---

(260) AM 2020 101775 A  
(800) 1450340  
(151) 2018 09 10  
(181) 2028 09 10  
(891) 2018 09 10  
(511) 30, 43

---

(260) AM 2020 101776 A  
(800) 706417  
(151) 1998 09 19  
(181) 2028 09 19  
(891) 2018 11 14  
(511) 09, 12, 37, 42

---

(260) AM 2020 101778 A  
(800) 862471  
(151) 2005 06 17  
(181) 2025 06 17  
(891) 2019 01 29  
(511) 05

---

(260) AM 2020 101779 A  
(800) 988477  
(151) 2008 11 11  
(181) 2028 11 11  
(891) 2019 01 11  
(511) 09, 16, 37

---

(260) AM 2020 101780 A  
(800) 1098350  
(151) 2011 05 12  
(181) 2021 05 12  
(891) 2019 01 10  
(511) 11

---

(260) AM 2020 101781 A  
(800) 1148486  
(151) 2012 11 22  
(181) 2022 11 22  
(891) 2018 12 11  
(511) 09, 18

---

(260) AM 2020 101782 A  
(800) 1192396  
(151) 2013 09 19  
(181) 2023 09 19  
(891) 2019 01 24  
(511) 05, 42

---

(260) AM 2020 101783 A  
(800) 1206474  
(151) 2014 03 25  
(181) 2024 03 25  
(891) 2019 01 30  
(511) 05

---

(260) AM 2020 101784 A  
(800) 1218341  
(151) 2014 07 18  
(181) 2024 07 18  
(891) 2018 12 19  
(511) 33

---

(260) AM 2020 101785 A  
(800) 1248218  
(151) 2015 03 24  
(181) 2025 03 24  
(891) 2019 01 11  
(511) 05

---

(260) AM 2020 101786 A  
(800) 1283353  
(151) 2014 10 13  
(181) 2024 10 13  
(891) 2019 01 17  
(511) 18, 20, 22, 24, 27

---

(260) AM 2020 101787 A  
(800) 1294067  
(151) 2016 02 23  
(181) 2026 02 23  
(891) 2019 01 29  
(511) 10

---

(260) AM 2020 101788 A  
(800) 1294336  
(151) 2015 12 09  
(181) 2025 12 09

(891) 2019 01 10  
(511) 18, 25, 35

---

(260) AM 2020 101791 A  
(800) 1332999  
(151) 2016 11 25  
(181) 2026 11 25  
(891) 2019 01 29  
(511) 05

---

(260) AM 2020 101793 A  
(800) 1360862  
(151) 2017 05 29  
(181) 2027 05 29  
(891) 2018 12 03  
(511) 03, 05

---

(260) AM 2020 101794 A  
(800) 1379504  
(151) 2017 10 18  
(181) 2027 10 18  
(891) 2018 12 20  
(511) 43

---

(260) AM 2020 101804 A  
(800) 1450682  
(151) 2018 12 21  
(181) 2028 12 21  
(891) 2018 12 21  
(511) 30, 35

---

(260) AM 2020 101805 A  
(800) 1450704  
(151) 2018 10 05  
(181) 2028 10 05  
(891) 2018 10 05  
(511) 09, 35, 38

---

(260) AM 2020 101806 A  
(800) 1450707  
(151) 2018 11 23  
(181) 2028 11 23  
(891) 2018 11 23  
(511) 33

---

(260) AM 2020 101807 A  
(800) 1450712  
(151) 2018 07 20  
(181) 2028 07 20  
(891) 2018 07 20  
(511) 38, 41, 42

---



(260) AM 2020 101808 A  
(800) 1450763  
(151) 2017 10 18  
(181) 2027 10 18  
(891) 2017 10 18  
(511) 03, 09, 14, 16, 18, 25, 28, 35, 41, 42

---

(260) AM 2020 101809 A  
(800) 1450770  
(151) 2018 05 01  
(181) 2028 05 01  
(891) 2018 05 01  
(511) 06, 07, 12

---

(260) AM 2020 101810 A  
(800) 1450779  
(151) 2018 10 12  
(181) 2028 10 12  
(891) 2018 10 12  
(511) 09, 35, 41, 42

---

(260) AM 2020 101811 A  
(800) 1450800  
(151) 2018 11 19  
(181) 2028 11 19  
(891) 2018 11 19  
(511) 05

---

(260) AM 2020 101833 A  
(800) 1451075  
(151) 2018 12 03  
(181) 2028 12 03  
(891) 2018 12 03  
(511) 05

---

(260) AM 2020 101834 A  
(800) 1451080  
(151) 2018 12 03  
(181) 2028 12 03  
(891) 2018 12 03  
(511) 05

---

(260) AM 2020 101835 A  
(800) 1451081  
(151) 2018 12 03  
(181) 2028 12 03  
(891) 2018 12 03  
(511) 05

---

(260) AM 2020 101884 A  
(800) 1452007  
(151) 2018 12 18  
(181) 2028 12 18

(891) 2018 12 18  
(511) 04

---

(260) AM 2020 101885 A  
(800) 1452014  
(151) 2018 12 21  
(181) 2028 12 21  
(891) 2018 12 21  
(511) 03, 10, 25, 44

---

(260) AM 2020 101886 A  
(800) 1452019  
(151) 2018 12 27  
(181) 2028 12 27  
(891) 2018 12 27  
(511) 12

---

(260) AM 2020 101887 A  
(800) 229061  
(151) 1960 02 27  
(181) 2020 02 27  
(891) 2019 01 18  
(511) 32, 33

---

(260) AM 2020 101888 A  
(800) 690807  
(151) 1998 02 20  
(181) 2028 02 20  
(891) 2019 01 31  
(511) 10

---

(260) AM 2020 101889 A  
(800) 706292  
(151) 1998 08 28  
(181) 2028 08 28  
(891) 2018 11 14  
(511) 06, 07, 09, 11, 12, 19, 37, 39, 40, 42

---

(260) AM 2020 101891 A  
(800) 977849  
(151) 2008 07 15  
(181) 2028 07 15  
(891) 2019 02 04  
(511) 12

---

(260) AM 2020 101893 A  
(800) 1175570  
(151) 2013 07 02  
(181) 2023 07 02  
(891) 2019 02 05  
(511) 02, 03, 04

---

(260) AM 2020 101894 A  
(800) 1190643  
(151) 2013 12 19  
(181) 2023 12 19  
(891) 2018 12 14  
(511) 05

---

(260) AM 2020 101898 A  
(800) 1402808  
(151) 2018 01 25  
(181) 2028 01 25  
(891) 2019 02 06  
(511) 05

---

(260) AM 2020 101934 A  
(800) 1414455  
(151) 2018 04 04  
(181) 2028 04 04  
(891) 2018 04 04  
(511) 29, 30

---

(260) AM 2020 101936 A  
(800) 1452054  
(151) 2018 08 08  
(181) 2028 08 08  
(891) 2018 08 08  
(511) 29, 30

---

(260) AM 2020 101946 A  
(800) 1452258  
(151) 2018 12 12  
(181) 2028 12 12  
(891) 2018 12 12  
(511) 34

---

(260) AM 2020 101948 A  
(800) 1452307  
(151) 2018 12 03  
(181) 2028 12 03  
(891) 2018 12 03  
(511) 05

---

(260) AM 2020 101950 A  
(800) 1452313  
(151) 2018 12 03  
(181) 2028 12 03  
(891) 2018 12 03  
(511) 05

---

(260) AM 2020 101994 A  
(800) 1453264  
(151) 2019 01 11  
(181) 2029 01 11

(891) 2019 01 11  
(511) 03

---

(260) AM 2020 101995 A  
(800) 1453278  
(151) 2018 10 26  
(181) 2028 10 26  
(891) 2018 10 26  
(511) 35, 42

---

(260) AM 2020 102007 A  
(800) 1453467  
(151) 2018 05 01  
(181) 2028 05 01  
(891) 2018 05 01  
(511) 06, 07, 12

---

(260) AM 2020 102008 A  
(800) 1453469  
(151) 2018 12 14  
(181) 2028 12 14  
(891) 2018 12 14  
(511) 05, 30

---

(260) AM 2020 102009 A  
(800) 1453477  
(151) 2018 10 18  
(181) 2028 10 18  
(891) 2018 10 18  
(511) 09, 37, 38, 39, 42

---

(260) AM 2020 102010 A  
(800) 1453496  
(151) 2018 09 07  
(181) 2028 09 07  
(891) 2018 09 07  
(511) 35, 36, 41

---

(260) AM 2020 102011 A  
(800) 1453503  
(151) 2018 11 23  
(181) 2028 11 23  
(891) 2018 11 23  
(511) 01

---

(260) AM 2020 102012 A  
(800) 1453510  
(151) 2019 01 03  
(181) 2029 01 03  
(891) 2019 01 03  
(511) 42, 44

---

(260) AM 2020 102013 A  
(800) 1453527  
(151) 2018 07 12  
(181) 2028 07 12  
(891) 2018 07 12  
(511) 02, 03, 05, 09, 10, 14, 16, 18, 21, 25, 26, 28,  
35

---

---

# APPELLATIONS OF ORIGIN OF GOODS

## Appellation of Origin (AO) Wines "AKHMETA" and "TSARAPI" Production Specification

In accordance with Article 8(4) of the Law of Georgia "On Appellations of Origin and Geographical Indications of Goods", the LEPL National Intellectual Property Center of Georgia – Sakpatenti shall publish the application materials submitted by the LEPL “National Wine agency” and the N(N)LE "Kardenakhi Wine".

If within 3 months from the publication of the application materials, additional information concerning these materials is submitted to SAKPATENTI, this information shall be sent for examination to the Ministry of Environment Protection and Agriculture of Georgia.

If additional information is submitted to Sakpatenti within 3 months from the publication of the application materials, it shall be sent for examination to the Ministry of Environment Protection and Agriculture of Georgia.

### AKHMETA

**APPLICATION №** 3493/06

**DATE OF APPLICATION:** 2019 30 10

**AO:** AKHMETA

**NAME OF GOOD FOR WHICH REGISTRATION IS REQUIRED:** Wine

**NAME AND ADDRESS OF APPLICANT:** LEPL National Wine Agency, Marshal Gelovani Ave. №6, 0159, Tbilisi (GE)

**1. NAME:** "AKHMETA"

**2. ADDITIONAL SIGNS:** "Akhmetis Mtsvane" (Akhmeta Green)

**3. TYPE, COLOR AND MAIN REQUIREMENTS**

"AKHMETA" is white or amber wine.

a) "AKHMETA"

"Akhmeta" white accordingly sugar content can be sec (dry), naturally demi-sec (semi-dry) and naturally demi-doux (semi-sweet).

Its organoleptic and physicochemical characteristics shall satisfy the following requirements:

- Sec (dry) – light straw, perfect, delicate, soft, harmonic, cheerful, having aroma of meadow flowers characterizing the location, and bouquet of fruit tones is developed with aging;
- Naturally demi-sec (semi-dry) and naturally demi-doux (semi-sweet) – light greenish golden, perfect, delicate, soft, harmonic, cheerful, having aroma characterizing the location. Demi-sec (semi-dry) and demi-doux (semi-sweet) wines – no less than 10.5 %;
- Volumetric spirit content for sec (dry) wine – no less than 11 %, and for naturally- demi-sec (semi-dry) and demi-doux (semi-sweet) wines – no less than 10.5 %;
- Concentration of finished extract mass – no less than 16 g/l;
- Sugar content in sec (dry) wine – no more than 4 g/l, and for demi-sec (semi-dry) wine – 4-18 g/l, and for demi-doux (semi-sweet) wine – 18-45 g/l;
- Titrated/ Volatile acidity – no less than 5 g/l;
- Other characteristics shall meet requirements provided by the legislation of Georgia.

b) "AKHMETA" amber organoleptic and physicochemical characteristics shall satisfy the following requirements:

- Color – from dark amber to tea-color;
- Aroma and Taste – has a body, energetic, extracted and velvet, having aroma characterizing the location, moderately and softly sharp, making it typical. The bouquet of fruit tones is developed with aging. It is characterized with tanner taste, as a result of maceration on "Chacha" (must);
- Volumetric spirit content – no less than 12 %;
- Concentration of finished extract mass – no less than 22 g/l;
- Titrated/ Volatile acidity – no less than 5 g/l;
- Other characteristics shall meet requirements provided by the legislation of Georgia.

#### **4. SPECIFIC ZONE AVAILABLE AREAS**

The micro-zone Akhmeta is located in Middle Kakheti, on upper part of the River Alazani, in the administrative borders of Akhmeta Municipality, Tsiv-Gombori Range borders it from the South-West and South, Kakheti Range – from the West, Caucasus Mountains – from the North and North-East, and the administrative borders of Telavi Municipality – from the East and South-East.

The micro-zone Akhmeta, except the City Akhmeta, includes the following villages: Sakobiano, Matani, Kistauri, Arashenda, Akhshani, Akhshnisvelebi, Ingeti, Kogori, Osiauri, Sachale, Ozhio, Alaverdi, Koghoti, Chabinaani, Khorkheli, Zemo Khodasheni, Atskuri, Akhaldaba, Charekauli, Zemo Alvani, Khorbalo, Kvemo Alvani, Babaneuli, Maghraani, Pichkhovani, and Argokhi.

#### **5. VINE VARIETIES**

Wine "Akhmeta" white shall be prepared exclusively from the grapes of Kakhuri Mtsvane, vintage takes place in the micro-zone Akhmeta. Usage of other grape varieties is not permitted.

Wine "Akhmeta" amber shall be prepared from the grapes of Kakhuri Mtsvane, and adding of Kisi and/or Khikhvi, 15 % together, from the same region, is permitted.

#### **6. VINEYARD CULTIVATION, SHAPE OF PRUNING AND CARE**

- The micro-zone Akhmeta vineyards are situated on 400-800 m above sea level.
- Distance between the rows in the vineyards – 1-2.5 m;
- Distance between the vines in the row – 0.8-1.5 m;
- Height of stem – 60-90 cm;
- Shape of pruning – one-sided or Georgian two-sided or free.

Wine cultivation, shape and pruning, pests and diseases control, and soil treatment, fertilization, and other operations shall be provided according to agro-technical activities selected by wine-makers..

#### **7. GRAPE MATURITY, VINTAGE, TRANSPORTATION**

- "Akhmeta" shall be produced only with ripe grapes. Sugar content shall be no less than 20% for sec (dry) and demi-sec (semi-dry) wines, and no less than 22%, for demi-doux (semi-sweet) wine, at the vintage;
- Grapes transportation is permitted only with wooden or plastic boxes, with bodyworks made of stainless steel or painted with special colour;
- Usage of polyethylene packages and/or bags is not allowed;
- The grapes shall be protected from dirtying at the transportation.

#### **8. VINTAGE AND WINE PRODUCTION**

Vintage on 1 ha vineyard shall be no more than 8 tons.

- 65.0 daLs – from 1 ton grapes;
- 520.0 daLs – from 1 ha vineyard.

## 9. GRAPE PROCESSING, WINEMAKING AND BOTTLING

Grapes for producing wine "Akhmeta" amber shall be only from the vineyards of the micro-zone Akhmeta.

Grapes processing and winemaking shall be provided exclusively within the borders of Kakheti Zone, bottling – outside of the zone, as well, only in the territory of Georgia.

At that, grapes withdrawal for the treatment from the micro-zone Akhmeta, and wine withdrawal for bottling from the Kakheti viticulture zone is permitted under strong accounting and control.

Wine "Akhmeta" white is made by complete or incomplete alcoholic fermentation of sweet gravity flow.

Must (with whole amount of "chacha" and cluster) alcoholic fermentation at "Akhmeta" amber winemaking is executed exclusively in the "qvevri". After fermentation the "qvevri" is filled with analogical wine and stayed on the must no less than 1 February after vintage.

In the production of wine "Akhmeta" it is permissible to use only the operations, materials and substances permitted by the legislation of Georgia.

Wine "Akhmeta" shall be represented on consumer market only packed in the consumer vessels.

## 10. LINK BETWEEN EXCLUSIVE QUALITY, REPUTATION AND GEOGRAPHICAL AREA

**SOIL.** Soil varieties and sub-varieties distinguished in the micro-zone Akhmeta are the following: 1) brown alkali resistant; 2) brown; 3) meadow brown; 4) alluvial carbonated; 5) humus carbonated.

**Brown typical soils** moderately and very thick, heavy and moderate clay, developed on loess-like clay surfaces, conglomerates and sand-stone drain products. Profile width is 100-140 cm, humus width is moderately 20-30 cm. Its surface accumulative horizon is characterized with well figured grain-nut structure and free from carbonates. The next low horizon has nut structure and mostly is free from carbonates. Deeply, the soils are unstructured and represented with "lime eyes" and "veins".

**Brown alkali resistant soils** calcites are washed comparably deeply, on 80-100 cm depth. Notable, that other sub-varieties of brown soils are less thick than alluvial carbonated.

**Meadow brown soils** upper 20 cm layer is characterized with grain-nut structure and powdery. Said soil depth is represented with nut-pea and pea-belt structure, deeply, from 120 cm, it is unstructured and dense. "Physical clay" fraction (<0,01mm) content in profile varies within 64-87% in granulomere, and "physical clay" fraction high (67 %) content increases soil bond and adhesion capability, and density; that, in its turn, makes worse soil physicochemical features. "Physical clay" and micron fraction excess cause blindness and gleization of said soils.

**Humus carbonated soils** moderately thick, heavy clay and with clay, somewhere slightly developed and washed; developed on the limestones and conglomerates.

**Alluvial carbonated soils** represented as carbonated sub-type characterized with genetic horizons of slight differentiation, bad structure, layered and leptosol. Said soils are represented on slope and flat forms of relief, that together with exposition, light and climate conditions give opportunity to produce high quality AO wines.

**Human Factors** Viticulture and winemaking in the Akhmeta Region, as in the rest of Kakheti, originated from the time immemorial and always occupied one of the distinguished places in the household activities of the local population.

Vakhushti Bagrationi in his remarkable work "Geography of Georgia" notes specially the wines of Manavi, Akhmeta and Kondoli.

Wine "Akhmeta" was created by leading specialists of "Samtresti" and has been produced in the demi-doux (semi-sweet) form since 1958. It has been awarded a number of medals at various international exhibitions and competitions.

Geographical location of the micro-zone Akhema, climate factors of the region, transitional from dry- to moderately humid subtropical; dark brown carbonated soils, specific features of Kakhuri Mtsvane grape variety revealed in this micro-zone, determine the special value of wine "Akhmeta".

### 11. SPECIAL LABELING RULES

The name "Akhmeta" and the sign – PDO (Protected Designation of Origin) on the label, package, in the documents accompanying the wine, and advertising materials, used in foreign languages, shall appear as follows:

With Latin font – **AKHMETA**  
Protected Designation of Origin and/or PDO

Cyrillic font – **АХМЕТА**  
Защищённое наименование места происхождения

### 12. ACCOUNTING AND NOTIFICATION

Accounting and notification of production and storage technological processes of wine "AKHMETA" is carried out in accordance with the rules established by the legislation of Georgia.

### 13. MAIN CONTROLLABLE POINTS

During control of the PDO wine "AKHMETA" production process the producer shall satisfy the requirements established by LEPL National Wine Agency, and shall comply with the following parameters:

<b>Main Controllable Points</b>	<b>Evaluation Methods</b>
Vineyard location	Cadaster map, control on the place
Area	Vineyard accounting magazine, cadaster
Vine variety	Vineyard accounting journal, control on the place
Cultivation methods	Journal of registration of Agrotechnical Measures, treating journal, control on the place
Vintage and transportation	Vintage journal
Grape harvest per ha	Vintage journal
Grape harvest in total	Vintage journal
Grape processing and winemaking	Grape receiving journal, grape processing journal, product turnover calculation journal, laboratory analysis journals, notifications, control on the place
Wine bottling, packaging and storage place and conditions	Bottling journal, journal for motion of ready product in the storehouse, laboratory analysis journals
Physico-chemical characteristics of the wine at winemaking, before and after bottling	Laboratory analysis journals
Organoleptic characteristics of the wine	Tasting commission protocols
Traceability	Technological and laboratory records

**14. CONTROL BODY OF PRODUCTION**

State control for observance of production specification and lawful usage of the appellation of origin PDO shall be carried out by LEPL National Wine Agency, according to the rules established by the legislation of Georgia.





## TSARAPI

**APPLICATION №** 3493/06

**DATE OF APPLICATION:** 2019 30 10

**AO:** TSARAPI

**NAME OF GOOD FOR WHICH REGISTRATION IS REQUIRED:** Wine

**NAME AND ADDRESS OF APPLICANT:** N(N)LE KARDENAKHI WINE; 10, 15<sup>th</sup> turn, Village Kardenakhi, Gurjaani Region (GE)

**1. NAME:** "TSARAPI"

**2. ADDITIONAL SIGNS:**

**3. TYPE, COLOR AND MAIN REQUIREMENTS**

"TSARAPI" is amber sec (dry) wine. Its organoleptic and physicochemical characteristics shall satisfy the following requirements:

- Color – from dark amber to tea-color;
- Aroma and Taste – has a body, energetic, extracted and velvet, having intensive aroma, moderately and softly sharp, making it typical. The bouquet of fruit tones is developed with aging;
- Volumetric spirit content – no less than 12 %;
- Concentration of finished extract mass – no less than 24 g/l;
- Titrated/ Volatile acidity – no less than 5 g/l;
- Other characteristics shall meet requirements provided by the legislation of Georgia.

**4. SPECIFIC ZONE AVAILABLE AREAS**

The micro-zone Tsarapi is located in the administrative territory of village Kardenakhi of Gurjaani Region, on low place of 3-4° inclination exposition of Tsiv-Gombori Range North-East slope, on the right bank of the River Alazani, on the coordinates of 41°48' of the North longitude and 45°44' of the East latitude, on 350-550 m-s from sea level.

The micro-zone Tsarapi is located within the micro-zone Kardenakhi. Mghvrie Khevi (gorge) borders it from North-West to railway, wherefrom to irrigation channel – administrative border of Bakurtsikhe, from the North-East – irrigation channel, from the South-East – administrative border of Anagi, from the South-West Mghvrie Khevi to Bakurtsikhe-Tsnori highway, and after Mghvrie Khevi to the railway.

**5. VINE VARIETIES**

Wine "TSARAPI" shall be produced exclusively from the grapes of Rkatsiteli, vintage takes place in the micro-zone Tsarapi. It can be produced with adding of grapes of Kakhuri Mtsvane and/or Khikhvi, 15 % together, usage of other grape varieties is prohibited.

**6. VINEYARD CULTIVATION, SHAPE OF PRUNING AND CARE**

- The micro-zone Tsarapi vineyards are situated on 350-550 m above sea level.
- Distance between the rows in the vineyards – 1-2.5 m;
- Distance between the vines in the row – 0.8-1.5 m;
- Height of stem – 60-90 cm;
- Shape of pruning – one-sided or Georgian two-sided or free.

Wine cultivation, shape and pruning, pests and diseases control, and soil treatment, fertilization, and other operations shall be provided according to agro-technical activities selected by wine-makers..

## 7. GRAPE MATURITY, VINTAGE, TRANSPORTATION

- "TSARAPI" shall be produced only with ripe grapes. Sugar content shall be no less than 21% at the vintage;
- Grapes transportation is permitted only with wooden or plastic boxes, with bodyworks made of stainless steel or painted with special colour;
- Usage of polyethylene packages and/or bags is not allowed;
- The grapes shall be protected from dirtying at the transportation.

## 8. VINTAGE AND WINE PRODUCTION

Vintage on 1 ha vineyard shall be no more than:

Wine production shall be no more than:

- Rkatsiteli – 10 tons;
- Kakhuri Mtsvane – 8 tons;
- Khikhvi – 6 tons.

Wine production shall be no more than:

- 650 l – from 1 ton grapes;
- 6 500 l – from 1 h vineyard for Rkatsiteli;
- 5 200 l – from 1 h vineyard for Kakhuri Mtsvane;
- 3 900 l – from 1 h vineyard for Khikhvi.

## 9. GRAPE PROCESSING, WINEMAKING AND BOTTLING

Grapes for producing wine "TSARAPI" shall be only from the vineyards of the micro-zone Tsarapi.

Grapes processing and winemaking shall be provided exclusively within the borders of Kakheti Zone, bottling – outside of the zone, as well, only in the territory of Georgia.

At that, grapes withdrawal for the treatment from the micro-zone Tsarapi, and wine withdrawal for bottling from the Kakheti viticulture zone is permitted under strong accounting and control.

Wine "TSARAPI" winemaking is executed exclusively in the "qvevri" by must (with whole amount of "chacha" and cluster) alcoholic fermentation. After fermentation the "qvevri" is filled with analogical wine and stayed on the must no less than 1 February after vintage.

In the production of wine "TSARAPI" it is permissible to use only the operations, materials and substances permitted by the legislation of Georgia.

Wine "TSARAPI" shall be represented on consumer market only packed in the consumer vessels.

## 10. LINK BETWEEN EXCLUSIVE QUALITY, REPUTATION AND GEOGRAPHICAL AREA

**Soil.** Soilmaking rocks consist of deluvial-proluvial originated carbonated clay, soil with clay and leptosol layers.

Mostly the soils are clay and light clay, with mechanical content (physical fraction is clay of <0.01 mm) varying within wide range – 20.0-69.4%.

Humus content in plantage layers is within 2.04-4.91%. General nitrogen, mostly, is characterized with low content – 0.067-0.128%, hydrolyzed nitrogen content varies within 5.00-13.89 mg, soluble phosphorus content is high – 3.0-29.0 mg, in 100 g soil, in arable layers.

Changeable potassium is characterized with high content – 28.0-90.4 mg, in 100 g soil, in arable layers. Calcite content in soil profiles varies within wide range and increases from up to down naturally, and is 2.0-44.0%. Soil area reaction is slightly and moderately alkaline – pH=7.2-8.2.

**Climate.** The micro-zone Tsarapi is characterized with moderately humid climate, hot summer and mild winter, sunshine annual duration is 2154 h-s, and 1589 h-s in vegetation period.

Air moderate annual temperature is 12.5°C, it is 1.0°C in the coldest month (January), and 23.6°C in the warmest months (July, August).

Duration of the period when the temperature is up to 10°C is 211 days, and sum of annual active temperatures is moderately 3920.

Annual sum of precipitations is 770 mm, and accordingly, 585 mm in vegetation period. Precipitations distribution accordance with the seasons are the following: more amounts (32-32%) thereof come in the spring and summer, approximately less – in the autumn (23%) and winter (13%).

Air annual humidity rises to 72%, and 70% – at vine vegetation period.

Moderate annual soil (which is humus carbonated) surface temperature is 15°C. It is the highest and reaches 30°C in July-August.

**Human Factor.** Winemaking by the Kakhetian technology in qvevri (wine jar) began in Georgia 8 thousand years ago and this tradition is still continuous. During eight thousand years the Georgians have elaborated and improved winemaking methods. Thus, the main creators of winemaking according to the Kakhetian technology are the Georgian people who not only have created this unique rule, but, figuratively speaking, carried it in their bosom and saved it from the vicissitudes of life that befell this little country in the course of time.

In 2013, the UNESCO granted the status of intangible cultural heritage to the Georgian traditional method of winemaking in "qvevri", which indicates the uniqueness of this method and is a message to the whole world that wine is a part of the ancient Georgian culture. It was the crown of recognition of the traditional Georgian winemaking method in "qvevri", which gave a new stimulus to implement this method of making wine in Georgia and laid the foundation for its introducing into various European countries.

In the words of famous Italian winemaker and scientist J. Dalmaso, "The winemaking method, which is called the Kakhetian method and is essentially different from the European technology, has once more convinced us that this country had been known for its high quality wines from in the past too and will remain as the creator of this progressive direction in the future as well".

The geographical location of the micro-zone Tsarapi, its characteristic regional climate: mild winter and hot summer, moderate amount of precipitations, a quite high index of the sum of active temperatures, forest brown, humus carbonated soils, the special features of the vine varieties revealed in this micro-zone and local centuries-old tradition of viticulture and winemaking define the special organoleptic features and the high reputation of wine "TSARAPI".

## 11. SPECIAL LABELING RULES

The name "TSARAPI" and the sign – PDO (Protected Designation of Origin) on the label, package, in the documents accompanying the wine, and advertising materials, used in foreign languages, shall appear as follows:

With Latin font – **TSARAPI**  
Protected Designation of Origin and/or PDO

Cyrillic font – **ЦАРАПИ**  
Защищённое наименование места происхождения

**12. ACCOUNTING AND NOTIFICATION**

Accounting and notification of production and storage technological processes of wine "TSARAPI" is carried out in accordance with the rules established by the legislation of Georgia.

**13. MAIN CONTROLLABLE POINTS**

During control of the PDO wine "TSARAPI" production process the producer shall satisfy the requirements established by LEPL National Wine Agency, and shall comply with the following parameters:

<b>Main Controllable Points</b>	<b>Evaluation Methods</b>
Vineyard location	Cadaster map, control on the place
Area	Vineyard accounting magazine, cadaster
Vine variety	Vineyard accounting journal, control on the place
Cultivation methods	Journal of registration of Agrotechnical Measures, treating journal, control on the place
Vintage and transportation	Vintage journal
Grape harvest per ha	Vintage journal
Grape harvest in total	Vintage journal
Grape processing and winemaking	Grape receiving journal, grape processing journal, product turnover calculation journal, laboratory analysis journals, notifications, control on the place
Wine bottling, packaging and storage place and conditions	Bottling journal, journal for motion of ready product in the storehouse, laboratory analysis journals
Physico-chemical characteristics of the wine at winemaking, before and after bottling	Laboratory analysis journals
Organoleptic characteristics of the wine	Tasting commission protocols
Traceability	Technological and laboratory records

**14. CONTROL BODY OF PRODUCTION**

State control for observance of production specification and lawful usage of the appellation of origin PDO shall be carried out by LEPL National Wine Agency, according to the rules established by the legislation of Georgia.

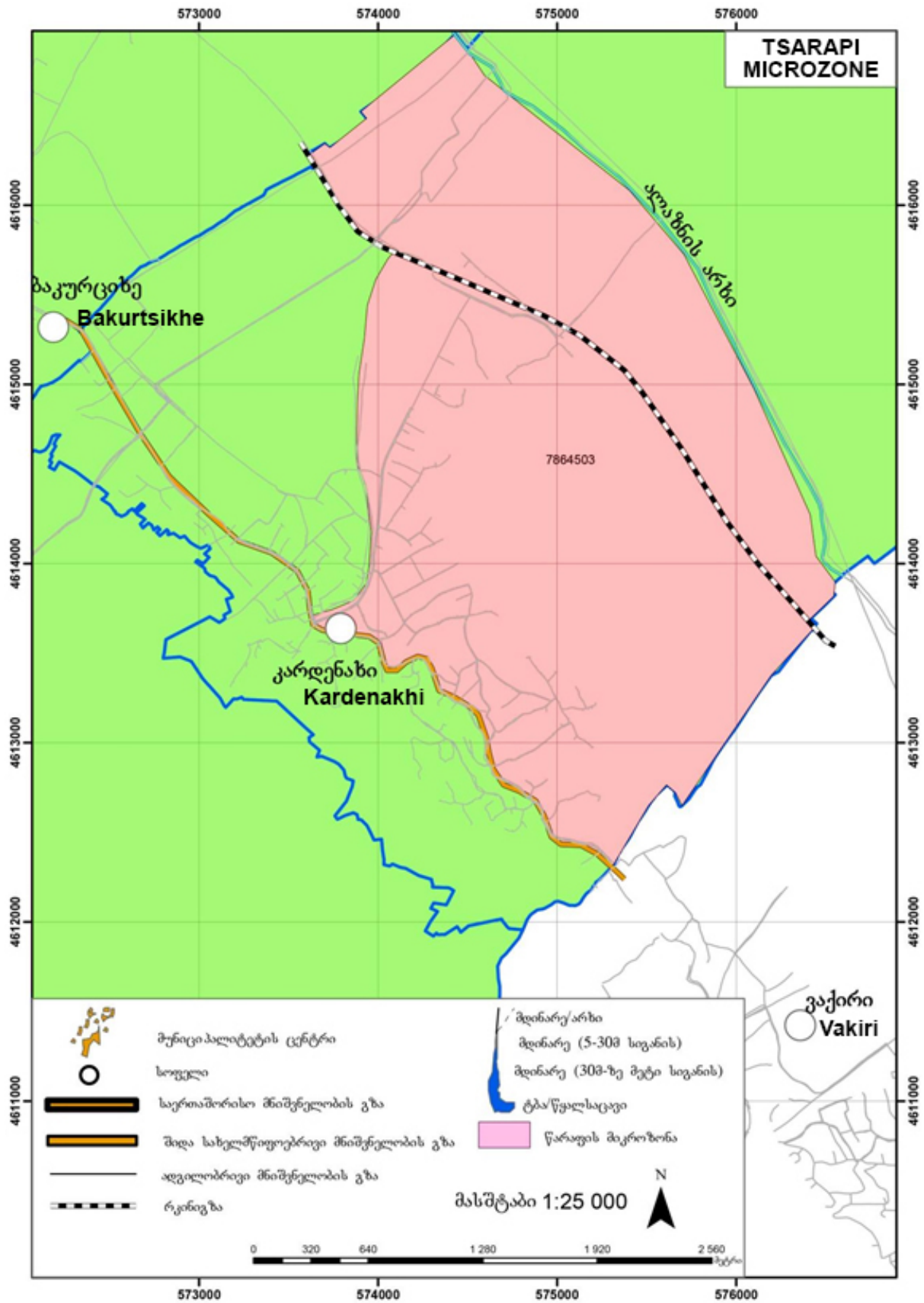

---

# OFFICIAL NOTIFICATIONS

## INVENTION

### EXPIRATION OF PATENTS RESTORATION

(21) AP 2006 10166

**(11) P 2009 4784 B**

(73) Gilead Sciences Inc.

(54) **SUSTAINED RELEASE PHARMACEUTICAL FORMULATIONS**

DATE OF CANCELLATION OF PATENT: 2020 01 05

PATENT RESTRICTION DATE: 2021 01 05

---

(21) AP 2009 11610

**(11) P 2012 5491 B**

(73) LES LABORATOIRES SERVIER

(54) **NEW PROCESS FOR THE SYNTHESIS OF IVABRADINE AND ADDITION SALTS THEREOF WITH A PHARMACEUTICALLY ACCEPTABLE ACID**

DATE OF CANCELLATION OF PATENT: 2019 12 18

PATENT RESTRICTION DATE: 2020 12 18

---

(21) AP 2012 12929

**(11) P 2015 6245 B**

(73) LES LABORATOIRES SERVIER

(54) **NEW PROCESS FOR SYNTHESIS OF IVABRADINE AND ADDITION SALTS THEREOF WITH PHARMACEUTICALLY ACCEPTABLE ACID**

DATE OF CANCELLATION OF PATENT: 2019 12 18

PATENT RESTRICTION DATE: 2020 12 18

---

(21) AP 2012 12943

**(11) P 2015 6270 B**

(73) Badur Tchunashvili;

Aleksandre Petrosyan

(54) **METHOD FOR REACTIVE POWER COMPENSATOR CONTROL**

DATE OF CANCELLATION OF PATENT: 2019 12 26

PATENT RESTRICTION DATE: 2020 12 26

---

(21) AP 2013 13554

**(11) P 2016 6579 B**

(73) MARIA CLEMENTINE MARTIN KLOSTERFRAU VERTRIEBSGESELLSCHAFT MBH

(54) **SYSTEMIC ADMINISTRATION FORMS WITH CONTROLLED RELEASE AND IMPROVED STABILITY**

DATE OF CANCELLATION OF PATENT: 2020 01 04

PATENT RESTRICTION DATE: 2021 01 04

---

(21) AP 2014 13683

**(11) P 2015 6384 B**

(73) Davit Sakhvadze;

Gigo Jandieri;

Teimuraz Tsirekidze;

Ivan Gorbenko

**(54) DEVICE FOR PRODUCING METALLIC POWDER FROM MELT**

DATE OF CANCELLATION OF PATENT: 2019 12 26

PATENT RESTRICTION DATE: 2020 12 26

---

(21) AP 2013 13844

**(11) P 2018 6857 B**

(73) UNIVERSITE DE DROIT ET DE LA SANTE DE LILLE 2

**(54) SATURATED NITROGEN AND N-ACYLATED HETEROCYCLES POTENTIATING THE  
ACTIVITY OF AN ACTIVE ANTIBIOTIC AGAINST MYCOBACTERIA**

DATE OF CANCELLATION OF PATENT: 2019 12 20

PATENT RESTRICTION DATE: 2020 12 20

---

(21) AP 2013 13892

**(11) P 2017 6757 B**

(73) ALIOS BIOPHARMA INC.

**(54) SUBSTITUTED NUCLEOSIDES, NUCLEOTIDES AND ANALOGS THEREOF**

DATE OF CANCELLATION OF PATENT: 2019 12 19

PATENT RESTRICTION DATE: 2020 12 19

---

(21) AP 2015 14011

**(11) P 2017 6654 B**

(73) LEPL "RAPHEL DVALI INSTITUTE OF MASHINE MECHANICS"

**(54) RADIAL-PRESSING MACHINE FOR AXISYMMETRIC ARTICLES PRODUCTION**

DATE OF CANCELLATION OF PATENT: 2019 12 07

PATENT RESTRICTION DATE: 2020 12 07

---

(21) AP 2014 14194

**(11) P 2018 6930 B**

(73) SANTEN PHARMACEUTICAL CO., LTD

**(54) INJECTABLE AGENT AND DEPOT FORMATION METHOD**

DATE OF CANCELLATION OF PATENT: 2019 12 25

PATENT RESTRICTION DATE: 2020 12 25

---

(21) AP 2016 14364

**(11) P 2018 6862 B**

(73) LEPL "RAPHEL DVALI INSTITUTE OF MASHINE MECHANICS"

**(54) RADIAL-SQUEEZING MACHINE**

DATE OF CANCELLATION OF PATENT: 2019 12 27

PATENT RESTRICTION DATE: 2020 12 27

---

(21) AP 2015 14558

**(11) P 2019 7013 B**

(73) MEGA INDUSTRI KONTROL SISTEMLERI TIC. LTD STI

**(54) AN ELECTRONIC SYSTEM FOR PRODUCT IDENTIFICATION AND FILLING MANAGEMENT**

DATE OF CANCELLATION OF PATENT: 2019 12 31

PATENT RESTRICTION DATE: 2020 12 31

---

(21) AP 2003 8910

**(11) P 2008 4486 B**

(73) MOUNTAIN VIEW PHARMACEUTICALS INC.



**(54) POLYMER CONJUGATES OF INTERFERON-BETA WITH ENHANCED BIOLOGICAL POTENCY**

DATE OF CANCELLATION OF PATENT: 2019 12 23

PATENT RESTRICTION DATE: 2020 12 23

---

(21) AP 2004 9458

**(11) P 2008 4505 B**

(73) INCYTE CORPORATION

**(54) 3-CYCLOALKYLAMINOPYRROLIDINE DERIVATIVES AS MODULATORS OF CHEMOKINE RECEPTORS**

DATE OF CANCELLATION OF PATENT: 2019 12 16

PATENT RESTRICTION DATE: 2020 12 16

---

## ABOLITION OF PATENTS WITH THE RIGHT TO RESTORE

(21) AP 2005 10167

**(11) P 2009 4623 B**

(73) Pfizer Products Inc.

**(54) HETEROAROMATIC QUINOLINE COMPOUNDS AND THEIR USE AS PDE10 INHIBITORS**

DATE OF CANCELLATION OF PATENT: 2018 12 22

DATE OF RESTORATION OF PATENT: 2019 12 22

---

(21) AP 2008 10468

**(11) P 2011 5158 B**

(73) LES LABORATOIRES SERVIER

**(54) USE OF IVABRADINE FOR OBTAINING MEDICAMENTS INTENDED FOR THE TREATMENT OF ENDOTHELIAL DYSFUNCTION**

DATE OF CANCELLATION OF PATENT: 2019 01 04

DATE OF RESTORATION OF PATENT: 2020 01 04

---

(21) AP 2006 10811

**(11) P 2012 5413 B**

(73) BRISTOL-MYERS SQUIBB COMPANY

**(54) CRYSTALLINE FORMS OF 1-BENZOYL-4-[2-[4-METHOXY-7-(3-METHYL-1H-1, 2, 4-TRIAZOL-1-YL)-1-[(PHOSPHONOXY) METHYL]-1H-PYRROLO[2,3-C]PYRIDIN-3-YL]-1,2-DIOXOETHYL]-PIPERAZINE**

DATE OF CANCELLATION OF PATENT: 2018 12 13

DATE OF RESTORATION OF PATENT: 2019 12 13

---

(21) AP 2008 11006

**(11) P 2010 5094 B**

(73) Vladimer Tarasashvili

**(54) POLARIZATION-HOLOGRAPHIC METHOD OF AMPLIFICATION AND CORRECTION OF OPTICAL SIGNAL**

DATE OF CANCELLATION OF PATENT: 2018 12 10

DATE OF RESTORATION OF PATENT: 2019 12 10

---

(21) AP 2009 11600  
**(11) P 2011 5273 B**  
(73) Tengiz Gelashvili  
(54) **CLINKER-FREE CEMENT**  
DATE OF CANCELLATION OF PATENT: 2018 12 14  
DATE OF RESTORATION OF PATENT: 2019 12 14

---

(21) AP 2009 11601  
**(11) P 2011 5274 B**  
(73) Tengiz Gelashvili  
(54) **LOW-CLINKER CEMENT**  
DATE OF CANCELLATION OF PATENT: 2018 12 14  
DATE OF RESTORATION OF PATENT: 2019 12 14

---

(21) AP 2008 11899  
**(11) P 2012 5547 B**  
(73) Aziende Chimiche Riunite Angelini Francesco A.C.R.A.F. S.p.A.  
(54) **(AZA) INDOLE DERIVATIVE SUBSTITUTED IN POSITION 5, PHARMACEUTICAL COMPOSITION COMPRISING IT, INTERMEDIATE COMPOUNDS AND PREPARATION PROCESS THEREFOR**  
DATE OF CANCELLATION OF PATENT: 2018 12 16  
DATE OF RESTORATION OF PATENT: 2019 12 16

---

(21) AP 2010 12025  
**(11) P 2013 5749 B**  
(73) "Basalt Fibers" LLC  
(54) **COMPOSITION FOR SHOTCRETE PREPARATION**  
DATE OF CANCELLATION OF PATENT: 2018 12 06  
DATE OF RESTORATION OF PATENT: 2019 12 06

---

(21) AP 2010 12046  
**(11) P 2013 5778 B**  
(73) Roman Verulashvili;  
Isolda Kamushadze;  
David Verulashvili;  
Ketevan Vakhtangishvili;  
Merab Gvenetadze;  
Zurab Machavariani  
(54) **GLASS FIBER COMPOSITION**  
DATE OF CANCELLATION OF PATENT: 2018 12 30  
DATE OF RESTORATION OF PATENT: 2019 12 30

---

(21) AP 2009 12242  
**(11) P 2013 5929 B**  
(73) Seema Ajay RANKA  
(54) **COMPOSITIONS CONTAINING ASPHALT**  
DATE OF CANCELLATION OF PATENT: 2018 12 09  
DATE OF RESTORATION OF PATENT: 2019 12 09

---

(21) AP 2009 12308  
**(11) P 2013 5932 B**  
(73) PATENTES TALGO S.L.

---

(54) **DEVICES FOR MOVING COACHES BUFFERS OF RAILWAY VEHICLES WITH BOGIES  
IN CURVES AND RAILWAY VEHICLE COACH WITH BOGIES**

DATE OF CANCELLATION OF PATENT: 2018 12 15

DATE OF RESTORATION OF PATENT: 2019 12 15

---

(21) AP 2011 12513

**(11) P 2013 5993 B**

(73) Temur Ghvinianidze;

Murtaz Svanidze;

Davit Gvinianidze;

Teona Gvinianidze

(54) **DESSERT LIQUEUR RED BIO-WINE "NIKALA"**

DATE OF CANCELLATION OF PATENT: 2018 12 26

DATE OF RESTORATION OF PATENT: 2019 12 26

---

(21) AP 2010 12784

**(11) P 2014 6201 B**

(73) H. Lundbeck A/S

(54) **HETEROAROMATIC ARYL TRIAZOLE DERIVATIVES AS PDE10A ENZYME  
INHIBITORS**

DATE OF CANCELLATION OF PATENT: 2018 12 15

DATE OF RESTORATION OF PATENT: 2019 12 15

---

(21) AP 2010 12787

**(11) P 2015 6242 B**

(73) H. Lundbeck A/S

(54) **2-ARYLIMIDAZOLE DERIVATIVES AS PDE10A ENZYME INHIBITORS**

DATE OF CANCELLATION OF PATENT: 2018 12 15

DATE OF RESTORATION OF PATENT: 2019 12 15

---

(21) AP 2012 12911

**(11) P 2014 6118 B**

(73) Lia Zhghenti;

Tamta Kikvadze

(54) **DEVICE PICKING-UP HAZELNUTS FROM SOIL SURFACE**

DATE OF CANCELLATION OF PATENT: 2018 12 06

DATE OF RESTORATION OF PATENT: 2019 12 06

---

(21) AP 2012 12931

**(11) P 2016 6453 B**

(73) Akaki Peikrishvili;

Elguja Chagelishvili;

Irakli Bairamashvili;

Merab Tsiklauri;

Bagrat Godibadze;

Avtandil Dgebuadze

(54) **CONTAINER FOR TRANSPORTING AND KEEPING RADIOACTIVE MATERIALS AND  
METHOD OF MAKING THEREOF**

DATE OF CANCELLATION OF PATENT: 2018 12 20

DATE OF RESTORATION OF PATENT: 2019 12 20

---

(21) AP 2011 13166

**(11) P 2015 6219 B**

(73) H. Lundbeck A/S

(54) **BICYCLO [3.2.1] OCTYL AMIDE DERIVATIVES AND USAGE THEREOF**

DATE OF CANCELLATION OF PATENT: 2018 12 22

DATE OF RESTORATION OF PATENT: 2019 12 22

---

(21) AP 2012 13520

**(11) P 2017 6651 B**

(73) EVERON BIOSCIENCES INC.

(54) **RAPAMYCIN COMPOSITION**

DATE OF CANCELLATION OF PATENT: 2018 12 13

DATE OF RESTORATION OF PATENT: 2019 12 13

---

(21) AP 2012 13526

**(11) P 2017 6657 B**

(73) H. Lundbeck A/S

(54) **QUINOLINE DERIVATIVES AS PDE10A ENZYME INHIBITORS**

DATE OF CANCELLATION OF PATENT: 2018 12 21

DATE OF RESTORATION OF PATENT: 2019 12 21

---

(21) AP 2013 13901

**(11) P 2017 6691 B**

(73) CADILA HEALTHCARE LIMITED

(54) **SUBSTITUTED PHTHALAZIN-1 (2H)-ONE DERIVATIVES AS SELECTIVE INHIBITORS OF POLY (ADP-RIBOSE) POLYMERASE-1**

DATE OF CANCELLATION OF PATENT: 2018 12 23

DATE OF RESTORATION OF PATENT: 2019 12 23

---

(21) AP 2014 14180

**(11) P 2017 6764 B**

(73) H. Lundbeck A/S

(54) **QUINAZOLIN-THF-AMINES AS PDE1 INHIBITORS**

DATE OF CANCELLATION OF PATENT: 2018 12 18

DATE OF RESTORATION OF PATENT: 2019 12 18

---

(21) AP 2016 14359

**(11) P 2018 6856 B**

(73) Zaur Chitidze;

Zaur Balantsarashvili;

David Mosulishvili;

Tamazi Mchedlishvili;

Luarsab Mezvrishvili;

Dato Nachkebia;

Ramaz Tkemaladze;

Maya Gogotishvili;

Vakhtang Abaishvili

(54) **AUTOMATED SELF-LOADING SKIDDING AGGREGATE WITH MECHANISM FIXING LOAD IN BODY**

DATE OF CANCELLATION OF PATENT: 2018 12 22

DATE OF RESTORATION OF PATENT: 2019 12 22

---

(21) AP 2016 14373

**(11) P 2018 6924 B**

(73) Paata Gogoladze

(54) **METHOD OF PRODUCTION OF BASALT TEXTILE FIBER FOR MAKING BRAKE PAD MATERIAL**

DATE OF CANCELLATION OF PATENT: 2018 12 30

DATE OF RESTORATION OF PATENT: 2019 12 30

---

(21) AP 2004 9501

**(11) P 2008 4370 B**

(73) LES LABORATOIRES SERVIER

(54) **SYNTHESIS OF PERINDOPRIL AND THE PHARMACEUTICALLY-ACCEPTABLE SALTS THEREOF**

DATE OF CANCELLATION OF PATENT: 2018 12 09

DATE OF RESTORATION OF PATENT: 2019 12 09

---

## UTILITY MODELS

### EXPIRATION OF PATENTS RESTORATION

(21) AU 2016 14187

**(11) U 2017 1936 Y**

(73) Vakhtang Ghlonti;

Nino Ghlonti

(54) **BEEHIVE**

DATE OF CANCELLATION OF PATENT: 2019 06 23

DATE OF RESTORATION OF PATENT: 2020 01 27

---

(21) AU 2016 14354

**(11) U 2018 1959 Y**

(73) Revaz Mikeladze;

Davit Kiladze;

Aleksandre Kiladze

(54) **NON-ALCOHOLIC NON CARBONATED BEVERAGE "GEO VITAMIN"**

DATE OF CANCELLATION OF PATENT: 2018 12 20

DATE OF RESTORATION OF PATENT: 2020 01 27

---

### ABOLITION OF PATENTS WITH THE RIGHT TO RESTORE

(21) AU 2011 12492

**(11) U 2013 1761 Y**

(73) LTD "AVRSI-RATIONAL"

(54) **ADRENO- AND DOPAMINOMIMETIC DRUG SHAPED AS STERILE CONCENTRATE**

DATE OF CANCELLATION OF PATENT: 2019 12 06

PATENT RESTRICTION DATE: 2020 12 06

---

(21) AU 2011 12493  
**(11) U 2013 1762 Y**  
(73) LTD "AVRSI-RATIONAL"  
(54) **COMBINED HEPATOPROTECTIVE VEGETABLE PREPARATION SHAPED AS CAPSULE**  
DATE OF CANCELLATION OF PATENT: 2019 12 06  
PATENT RESTRICTION DATE: 2020 12 06

---

(21) AU 2012 12914  
**(11) U 2014 1801 Y**  
(73) LTD "AVRSI-RATIONAL"  
(54) **COMBINED PLANT PARATHERAPEUTIC AGENT FOR MEMORY STIMULATION IN AS SYRUP**  
DATE OF CANCELLATION OF PATENT: 2019 12 07  
PATENT RESTRICTION DATE: 2020 12 07

---

(21) AU 2012 12915  
**(11) U 2014 1802 Y**  
(73) LTD "AVRSI-RATIONAL"  
(54) **COMBINED PLANT PARATHERAPEUTIC AGENT FOR MEMORY STIMULATION AS CAPSULE**  
DATE OF CANCELLATION OF PATENT: 2019 12 07  
PATENT RESTRICTION DATE: 2020 12 07

---

(21) AU 2012 12916  
**(11) U 2013 1795 Y**  
(73) LTD "AVRSI-RATIONAL"  
(54) **ANTIHYPERTENSIVE THERAPEUTIC AGENT – NONBLON H**  
DATE OF CANCELLATION OF PATENT: 2019 12 07  
PATENT RESTRICTION DATE: 2020 12 07

---

(21) AU 2012 12918  
**(11) U 2013 1779 Y**  
(73) LTD "AVRSI-RATIONAL"  
(54) **COMBINED VEGETABLE PREPARATION OF HEPATOPROTECTIVE ACTIVITY AS SYRUP**  
DATE OF CANCELLATION OF PATENT: 2019 12 07  
PATENT RESTRICTION DATE: 2020 12 07

---

(21) AU 2012 12936  
**(11) U 2013 1790 Y**  
(73) LTD "AVRSI-RATIONAL"  
(54) **ANTISEPTIC SUCKING TABLET WITH RASPBERRY, HONEY, LEMON AND ORANGE FLAVOUR**  
DATE OF CANCELLATION OF PATENT: 2019 12 21  
PATENT RESTRICTION DATE: 2020 12 21

---

(21) AU 2015 14018  
**(11) U 2016 1913 Y**  
(73) Giorgi Chechelashvili;  
Ivane Chkhaidze

---

(54) **WINDOW**

DATE OF CANCELLATION OF PATENT: 2019 12 17

PATENT RESTRICTION DATE: 2020 12 17

---

(21) AU 2015 14021

**(11) U 2016 1914 Y**

(73) Shekspir Iusupov;

Daniel Iosebashvili;

Mukhran Bedianidze

(54) **METHOD FOR BAKING BREAD**

DATE OF CANCELLATION OF PATENT: 2019 12 21

PATENT RESTRICTION DATE: 2020 12 21

---

(21) AU 2016 14345

**(11) U 2017 1949 Y**

(73) Ketevan Tsanova;

Revaz Baghaturia;

Alexander Baghaturia;

Helen Shengelia

(54) **TREATMENT AND PREVENTIVE BEVERAGE AGAINST HYPERURICEMY**

DATE OF CANCELLATION OF PATENT: 2019 12 09

PATENT RESTRICTION DATE: 2020 12 09

---

(21) AU 2016 14355

**(11) U 2018 1968 Y**

(73) Sergo Taliuridze

(54) **BOTTLE LID**

DATE OF CANCELLATION OF PATENT: 2019 12 21

PATENT RESTRICTION DATE: 2020 12 21

---

(21) AU 2016 14357

**(11) U 2017 1950 Y**

(73) Nugzar Meladze

(54) **ANALGESIC AND ANTI-INFLAMMATORY OINTMENT "GRAVARTOL"**

DATE OF CANCELLATION OF PATENT: 2019 12 22

PATENT RESTRICTION DATE: 2020 12 22

---

(21) AU 2016 14358

**(11) U 2018 1966 Y**

(73) Nugzar Meladze

(54) **BIOACTIVE FOOD ADDITIVE "REZIGRAV"**

DATE OF CANCELLATION OF PATENT: 2019 12 22

PATENT RESTRICTION DATE: 2020 12 22

---

(21) AU 2016 14360

**(11) U 2018 1967 Y**

(73) Amiran Gardapkhadze

(54) **NONALCOHOLIC TONIC BEVERAGE**

DATE OF CANCELLATION OF PATENT: 2019 12 22

PATENT RESTRICTION DATE: 2020 12 22

---

## EXPIRATION OF TERM OF RESTORATION OF PATENT

(21) AU 2016 14352

**(11) U 2017 1946 Y**

(73) LEPL "Georgian Technical University";

Tarkhan Tevzadze;

Giorgi Omsarashvili

**(54) UNDERFLOW WATER INTAKE FACILITY**

DATE OF CANCELLATION OF PATENT: 2018 12 16

THE TERM OF RESTORATION OF PATENT VALIDITY HAS EXPIRED: 2019 12 16

---

## DESIGNS

### EXTENSION OF REGISTRATIONS VALIDITY OF DESIGNS

**(11) D 2010 433 S**

(73) Kakhaber Koberidze (GE)

Konstitution St. 48, Rustavi, 3700, Georgia (GE)

**(54) MILITARY TACTICAL SHOES**

(28) 1

(24) 2009 12 10

(18) 2024 12 10

(58) 2020 01 16

---

**(11) D 2015 614 S**

(73) Nino Natsvlishvili (GE)

Digomi Massive, V kvart., korp. 7, ap. 13, 0159, Tbilisi, Georgia (GE)

**(54) ALCOHOL DISTILLATION APPARATUS**

(28) 1

(24) 2015 01 09

(18) 2025 01 09

(58) 2020 01 15

---

## TRANSFER OF RIGHT

**(11) D 2015 614 S**

**(54) ALCOHOL DISTILLATION APPARATUS**

NEW OWNER: Nino Natsvlishvili (GE)

Digomi Massive, V kvart., korp. 7, ap. 13, 0159, Tbilisi, Georgia (GE)

FORMER OWNER: Aleksandre Kvernadze (GE)

PoBox 77, 0108, Tbilisi, Georgia (GE)

(58) 2020 01 09

---



## EXTENSION OF REGISTRATION OF INTERNATIONAL DESIGNS

**(11) DM/71412**

(73) BLANCPAIN SA

Rocher 12, CH-1348 LE BRASSUS (CH)

(15) 2009 02 23

(24) 2009 02 23

(18) 2024 02 23

(28) 1

(28') 1

(54) Wristwatch

**(11) DM/71417**

(73) OMEGA SA (OMEGA AG) (OMEGA LTD.)

Jakob-Stämpfli-Strasse 96, CH-2502 Biel/Bienne (CH)

(15) 2009 03 02

(24) 2009 03 02

(18) 2024 03 02

(28) 2

(28') 2

(54) Wristwatches

**(11) DM/85335**

(73) LVMH FRAGRANCE BRANDS

77 rue Anatole France, F-92300 LEVALLOIS-PERRET (FR)

(15) 2015 01 16

(24) 2015 01 16

(18) 2025 01 16

(28) 1

(28') 1

(54) Small bottle for perfumery products

**(11) DM/85345**

(73) BHS TABLETOP AG

Ludwigsmuehle 1, 95100 Selb (DE)

(15) 2015 01 12

(24) 2015 01 12

(18) 2025 01 12

(28) 6

(28') 6

(54) Cup, Flat oval plate, Plate, Plate [dishes], Salad bowl, Saucer

## CANCELLATION OF REGISTRATION OF INTERNATIONAL DESIGNS

**(11) DM/83655**

(73) THE SWATCH GROUP MANAGEMENT SERVICES AG (THE SWATCH GROUP MANAGEMENT SERVICES SA)

(THE SWATCH GROUP MANAGEMENT SERVICES LTD.)

Seevorstadt 6, CH-2502 BIEL/BIENNE (CH)

DATE OF CANCELLATION OF REGISTRATION: 2019 05 22

(58) 2020 01 14

---

**(11) DM/83707**

(73) V.I.P. PICTURES WORLD GMBH

Marktstrasse 14, 03046 Cottbus (DE)

DATE OF CANCELLATION OF REGISTRATION: 2019 05 23

(58) 2020 01 14

---

**(11) DM/83763**

(73) GARNIER

5 bis chemin de Longo Mai, F-06600 ANTIBES (FR)

DATE OF CANCELLATION OF REGISTRATION: 2019 06 11

(58) 2020 01 14

---

**(11) DM/84007**

(73) DARIO IACONO

Via Tommaso Cannizzaro, 249, I-98123 MESSINA (IT)

DATE OF CANCELLATION OF REGISTRATION: 2019 05 30

(58) 2020 01 14

---

---

# TRADEMARKS

## RENEWAL OF REGISTRATIONS

(111) M 2000 13101 R2  
(156) 2000 01 31  
(186) 2030 01 31  
(732) KIMBERLY-CLARK WORLDWIDE, INC.  
NEENAH, WI 54956, USA

---

(111) M 1999 13061 R2  
(156) 1999 12 15  
(186) 2029 12 15  
(732) DELPHI TECHNOLOGIES, INC.  
5725 Delphi Drive, City of Troy, State of  
Michigan 48098, USA

---

(111) M 2000 13112 R2  
(156) 2000 01 31  
(186) 2030 01 31  
(732) WAHL GMBH  
Roggenbachweg 9, D-78089 Unterkirnach,  
Germany

---

(111) M 2000 13113 R2  
(156) 2000 01 31  
(186) 2030 01 31  
(732) WAHL GMBH  
Roggenbachweg 9, D-78089 Unterkirnach,  
Germany

---

(111) M 2000 13209 R2  
(156) 2000 03 29  
(186) 2030 03 29  
(732) CORPORACION HABANOS S.A.  
Carretera Vieja de Guanabacoa y Linea  
del Ferrocarril Final, Guanabacoa, La Habana,  
Cuba

---

(111) M 2000 13073 R2  
(156) 2000 01 04  
(186) 2030 01 04  
(732) STADA ARZNEIMITTEL AG  
Stadastrasse 2-18, D-61118 Bad Vilbel,  
Germany

---

(111) M 2000 13254 R2  
(156) 2000 04 26  
(186) 2030 04 26  
(732) STADA ARZNEIMITTEL AG  
Stadastrasse 2-18, D-61118 Bad Vilbel,  
Germany

---

(111) M 2000 13255 R2  
(156) 2000 04 26  
(186) 2030 04 26  
(732) STADA ARZNEIMITTEL AG  
Stadastrasse 2-18, D-61118 Bad Vilbel,  
Germany

---

(111) M 2000 13286 R2  
(156) 2000 05 30  
(186) 2030 05 30  
(732) STADA ARZNEIMITTEL AG  
Stadastrasse 2-18, D-61118 Bad Vilbel,  
Germany

---

(111) M 2000 13287 R2  
(156) 2000 05 30  
(186) 2030 05 30  
(732) STADA ARZNEIMITTEL AG  
Stadastrasse 2-18, D-61118 Bad Vilbel,  
Germany

---

(111) M 2000 13288 R2  
(156) 2000 05 30  
(186) 2030 05 30  
(732) STADA ARZNEIMITTEL AG  
Stadastrasse 2-18, D-61118 Bad Vilbel,  
Germany

---

(111) M 2000 13289 R2  
(156) 2000 05 30  
(186) 2030 05 30  
(732) STADA ARZNEIMITTEL AG  
Stadastrasse 2-18, D-61118 Bad Vilbel,  
Germany

---

(111) M 2000 13290 R2  
(156) 2000 05 30  
(186) 2030 05 30  
(732) STADA ARZNEIMITTEL AG  
Stadastrasse 2-18, D-61118 Bad Vilbel,  
Germany

---

(111) M 2000 13291 R2  
(156) 2000 05 30  
(186) 2030 05 30  
(732) STADA ARZNEIMITTEL AG  
Stadastrasse 2-18, D-61118 Bad Vilbel,  
Germany

---

(111) M 2000 13293 R2  
(156) 2000 05 30  
(186) 2030 05 30  
(732) STADA ARZNEIMITTEL AG  
Stadastrasse 2-18, D-61118 Bad Vilbel,  
Germany

---

(111) M 2000 13292 R2  
(156) 2000 05 30  
(186) 2030 05 30  
(732) STADA ARZNEIMITTEL AG  
Stadastrasse 2-18, D-61118 Bad Vilbel,  
Germany

---

(111) M 2000 13294 R2  
(156) 2000 05 30  
(186) 2030 05 30  
(732) STADA ARZNEIMITTEL AG  
Stadastrasse 2-18, D-61118 Bad Vilbel,  
Germany

---

(111) M 2000 13295 R2  
(156) 2000 05 30  
(186) 2030 05 30  
(732) STADA ARZNEIMITTEL AG  
Stadastrasse 2-18, D-61118 Bad Vilbel,  
Germany

---

(111) M 2000 13296 R2  
(156) 2000 05 30  
(186) 2030 05 30  
(732) STADA ARZNEIMITTEL AG  
Stadastrasse 2-18, D-61118 Bad Vilbel,  
Germany

---

(111) M 2000 13341 R2  
(156) 2000 06 09  
(186) 2030 06 09  
(732) MARRIOTT WORLDWIDE  
CORPORATION  
10400 Fernwood Road, Bethesda, Maryland  
20817, USA

---

(111) M 2000 13342 R2  
(156) 2000 06 09  
(186) 2030 06 09  
(732) MARRIOTT WORLDWIDE  
CORPORATION  
10400 Fernwood Road, Bethesda, Maryland  
20817, USA

---

(111) M 2000 13344 R2  
(156) 2000 06 09  
(186) 2030 06 09  
(732) MARRIOTT WORLDWIDE  
CORPORATION  
10400 Fernwood Road, Bethesda, Maryland  
20817, USA

---

(111) M 2000 13362 R2  
(156) 2000 06 09  
(186) 2030 06 09  
(732) STADA ARZNEIMITTEL AG  
Stadastrasse 2-18, D-61118 Bad Vilbel,  
Germany

---

(111) M 2000 13363 R2  
(156) 2000 06 09  
(186) 2030 06 09  
(732) STADA ARZNEIMITTEL AG  
Stadastrasse 2-18, D-61118 Bad Vilbel,  
Germany

---

(111) M 2000 13364 R2  
(156) 2000 06 09  
(186) 2030 06 09  
(732) STADA ARZNEIMITTEL AG  
Stadastrasse 2-18, D-61118 Bad Vilbel,  
Germany

---

(111) M 2000 13365 R2  
(156) 2000 06 09  
(186) 2030 06 09  
(732) STADA ARZNEIMITTEL AG  
Stadastrasse 2-18, D-61118 Bad Vilbel,  
Germany

---

(111) M 2000 13366 R2  
(156) 2000 06 09  
(186) 2030 06 09  
(732) STADA ARZNEIMITTEL AG  
Stadastrasse 2-18, D-61118 Bad Vilbel,  
Germany

---

(111) M 2000 13526 R2  
(156) 2000 10 11  
(186) 2030 10 11  
(732) GALLAHER LIMITED  
Members Hill, Brooklands Road, Weybridge,  
Surrey KT13 0QU, United Kingdom

---

(111) M 2000 13575 R2  
(156) 2000 10 30  
(186) 2030 10 30

(732) GALLAHER LIMITED Members Hill, Brooklands Road, Weybridge, Surrey KT13 0QU, United Kingdom	2-2-1, Toranomom, Minato-ku, Tokyo, Japan
(111) M 2008 18940 R1 (156) 2008 11 28 (186) 2028 11 28 (732) JSC "TBILISI TOBACCO" G. Nadareishvili St. 5, 0137, Tbilisi, Georgia	(111) M 2010 20257 R1 (156) 2010 02 15 (186) 2030 02 15 (732) JAPAN TOBACCO INC. 2-2-1, Toranomom, Minato-ku, Tokyo, Japan
(111) M 2009 19407 R1 (156) 2009 06 16 (186) 2029 06 16 (732) LTD "KVARELI WINE COMPANY" Lermontov St. 3, 4800, Kvareli, Georgia	(111) M 2010 20259 R1 (156) 2010 02 15 (186) 2030 02 15 (732) JAPAN TOBACCO INC. 2-2-1, Toranomom, Minato-ku, Tokyo, Japan
(111) M 2009 19863 R1 (156) 2009 10 16 (186) 2029 10 16 (732) LTD "ARSI" T. Abuladzes St. 21, 0162, Tbilisi, Georgia	(111) M 2010 20260 R1 (156) 2010 02 15 (186) 2030 02 15 (732) JAPAN TOBACCO INC. 2-2-1, Toranomom, Minato-ku, Tokyo, Japan
(111) M 2009 19864 R1 (156) 2009 10 16 (186) 2029 10 16 (732) LTD "ARSI" T. Abuladze St. 21, 0162, Tbilisi, Georgia	(111) M 2010 20406 R1 (156) 2010 04 27 (186) 2030 04 27 (732) KUMHO TIRE CO., INC. Kumho Asiana Bldg., 57, Shinmunro 1 (il)-ga, Jongro-gu, seoul 110-061, Republic of Korea
(111) M 2009 19865 R1 (156) 2009 10 16 (186) 2029 10 16 (732) LTD "ARSI" T. Abuladze St. 21, 0162, Tbilisi, Georgia	(111) M 2010 20302 R1 (156) 2010 02 26 (186) 2030 02 26 (732) BLOCK DRUG COMPANY, INC. Corporation Service Company, Princeton South Corporate Center, Suite 160, 100 Charles Ewing Blvd., Ewing, New Jersey, 08628, USA
(111) M 2010 20152 R1 (156) 2010 01 21 (186) 2030 01 21 (732) Intersun Holding FZCO P.O. box: 61051, Jebel Ali Free Zone, Dubai, United Arab Emirates	(111) M 2010 20309 R1 (156) 2010 03 15 (186) 2030 03 15 (732) GLAXO GROUP LIMITED 980 Great West Road, Brentford, Middlesex TW8 9GS, United Kingdom
(111) M 2010 20145 R1 (156) 2010 01 11 (186) 2030 01 11 (732) LTD "BORAN CONSTRUCTION" Kandelaki St. 8, ap. 56, Tbilisi, Georgia	(111) M 2010 20422 R1 (156) 2010 04 27 (186) 2030 04 27 (732) ASICS CORPORATION 1-1 Minatojima-Nakamachi 7-chome, Chuo-Ku, Kobe City, Hyogo Prefecture, Japan
(111) M 2010 20208 R1 (156) 2010 01 26 (186) 2030 01 26 (732) JAPAN TOBACCO INC.	

(111) M 2010 20423 R1  
(156) 2010 04 27  
(186) 2030 04 27  
(732) ASICS CORPORATION  
1-1 Minatojima-Nakamachi 7-chome,  
Chuo-Ku, Kobe City, Hyogo Prefecture,  
Japan

---

(111) M 2010 20457 R1  
(156) 2010 05 13  
(186) 2030 05 13  
(732) GALLAHER LIMITED  
Members Hill, Brooklands Road, Weybridge,  
Surrey KT13 0QU, United Kingdom

---

(111) M 2010 20464 R1  
(156) 2010 05 13  
(186) 2030 05 13  
(732) JAPAN TOBACCO INC.  
2-2-1, Toranomom, Minato-ku, Tokyo, Japan

---

(111) M 2010 20427 R1  
(156) 2010 04 27  
(186) 2030 04 27  
(732) CELGENE CORPORATION  
86 Morris Avenue, Summit, New Jersey  
07901, USA

---

(111) M 2010 20593 R1  
(156) 2010 07 16  
(186) 2030 07 16  
(732) Pulse Network LLC  
a Daleware limited liability company  
1301 McKinney, Suite 2500, Houston,  
Texas 77010, USA

---

(111) M 2010 20516 R1  
(156) 2010 05 27  
(186) 2030 05 27  
(732) Diageo North America, Inc.  
(a Connecticut corporation)  
801 Main Avenue, Norwalk CT 06851-1127,  
USA

---

(111) M 2010 20751 R1  
(156) 2010 09 15  
(186) 2030 09 15  
(732) GALLAHER LIMITED  
Members Hill, Brooklands Road,  
Weybridge, Surrey, KT13 0QU, United  
Kingdom

---

(111) M 2010 21001 R1  
(156) 2010 12 13  
(186) 2030 12 13  
(732) JAPAN TOBACCO INC.  
2-2-1, Toranomom, Minato-ku, Tokyo, Japan

---

(111) M 2010 20737 R1  
(156) 2010 09 13  
(186) 2030 09 13  
(732) JAPAN TOBACCO INC.  
2-2-1, Toranomom, Minato-ku, Tokyo, Japan

---

(111) M 2010 21011 R1  
(156) 2010 12 15  
(186) 2030 12 15  
(732) JAPAN TOBACCO INC.  
2-2-1, Toranomom, Minato-ku, Tokyo, Japan

---

## COMPLETE TRANSFER OF RIGHT

(111) M 2017 28317 R

(732) Sanovel İlaç Sanayi Ve Ticaret Anonim  
Sirketi

Istinye mah. Balabandere Cad. No:14  
Sarıyer-Istanbul, Turkey

(770) ARVEN İLAC SANAYİ VE TİCARET  
ANONİM SİRKETİ

Istinye Mahallesi, Balabandere Caddesi No:14  
TR-34460 SARIYER/İSTANBUL, Turkey

(580) 30 12 2019

---

## CHANGES OF NAMES AND/OR ADDRESS OF OWNERS

(111) M 1994 156 R (732) Total Holdings SAS 2, place Jean Millier, La Defense 6, F-92400 Courbevoie, France	F-92400 Courbevoie, France (580) 30 12 2019
(770) ELF AQUITAINE, Societe Anonyme 2, place Jean Millier, La Defense 6, F-92400 Courbevoie, France (580) 30 12 2019	(111) M 2001 13797 R (732) GENZYME CORPORATION 50 Binney Street, Cambridge, Massachusetts 02142, USA (770) GENZYME CORPORATION 500 Kendall Street, Cambridge, Massachusetts 02142, USA (580) 21 11 2019
(111) M 1995 494 R (732) Total Holdings SAS 2, place Jean Millier, La Defense 6, F-92400 Courbevoie, France (770) ELF AQUITAINE, Societe Anonyme 2, place Jean Millier, La Defense 6, F-92400 Courbevoie, France (580) 30 12 2019	(111) M 2002 14554 R (732) GENZYME CORPORATION 50 Binney Street, Cambridge, Massachusetts 02142, USA (770) GENZYME CORPORATION 500 Kendall St., Cambridge, MA 02142, USA (580) 21 11 2019
(111) M 1995 493 R (732) Total Holdings SAS 2, place Jean Millier, La Defense 6, F-92400 Courbevoie, France (770) ELF AQUITAINE, Societe Anonyme 2, place Jean Millier, La Defense 6, F-92400 Courbevoie, France (580) 30 12 2019	(111) M 2002 14555 R (732) GENZYME CORPORATION 50 Binney Street, Cambridge, Massachusetts 02142, USA (770) GENZYME CORPORATION 500 Kendall St., Cambridge, MA 02142, USA (580) 21 11 2019
(111) M 1995 456 R (732) Total Holdings SAS 2, place Jean Millier, La Defense 6, F-92400 Courbevoie, France (770) ELF AQUITAINE, Societe Anonyme 2, place Jean Millier, La Defense 6, F-92400 Courbevoie, France (580) 30 12 2019	(111) M 2002 14781 R (732) GENZYME CORPORATION 50 Binney Street, Cambridge, Massachusetts 02142, USA (770) GENZYME CORPORATION 500 Kendall Street, Cambridge, Massachusetts 02142, USA (580) 21 11 2019
(111) M 1994 314 R (732) Total Holdings SAS 2, place Jean Millier, La Defense 6, F-92400 Courbevoie, France (770) ELF AQUITAINE, Societe Anonyme 2, place Jean Millier, La Defense 6, F-92400 Courbevoie, France (580) 30 12 2019	(111) M 1997 5631 R (732) LEADIANT BIOSCIENCES LIMITED 21 Holborn Viaduct - EC1A 2DY LONDON-, United Kingdom (770) SIGMA-TAU RARE DISEASE LTD. 21 Holborn Viaduct - EC1A 2DY LONDON-, United Kingdom (580) 30 12 2019
(111) M 1999 12459 R (732) Total Holdings SAS 2, place Jean Millier, La Defense 6, F-92400 Courbevoie, France (770) ELF AQUITAINE, Societe Anonyme 2, place Jean Millier, La Defense 6,	(111) M 1996 2500 R (732) Total Holdings SAS 2, place Jean Millier, La Defense 6, F-92400 Courbevoie, France



(770) ELF AQUITAINE, Societe Anonyme  
2, place Jean Millier, La Defense 6,  
F-92400 Courbevoie, France  
(580) 30 12 2019

---

(111) M 2006 16459 R  
(732) GENZYME CORPORATION  
50 Binney Street, Cambridge, Massachusetts  
02142, USA  
(770) GENZYME CORPORATION  
500 Kendall Street, Cambridge,  
Massachusetts, 02142, USA  
(580) 21 11 2019

---

(111) M 2007 17487 R  
(732) GENZYME CORPORATION  
50 Binney Street, Cambridge, Massachusetts  
02142, USA  
(770) GENZYME CORPORATION  
500 Kendall Street, Cambridge, Massachusetts,  
02142, USA  
(580) 20 12 2019

---

(111) M 2007 17488 R  
(732) GENZYME CORPORATION  
50 Binney Street, Cambridge, Massachusetts  
02142, USA  
(770) GENZYME CORPORATION  
500 Kendall Street, Cambridge, Massachusetts,  
02142, USA  
(580) 20 12 2019

---

(111) M 2009 19714 R  
(732) GENZYME CORPORATION  
(a Massachusetts Corporation)  
50 Binney Street, Cambridge, Massachusetts  
02142, USA  
(770) GENZYME CORPORATION  
(a Massachusetts Corporation)  
500 Kendall Street, Cambridge, Massachusetts  
02142, USA  
(580) 20 12 2019

---

(111) M 2010 20918 R  
(732) GENZYME CORPORATION  
(a Massachusetts Corporation)  
50 Binney Street, Cambridge, Massachusetts  
02142, USA  
(770) GENZYME CORPORATION  
(a Massachusetts Corporation)  
500 Kendall Street, Cambridge, Massachusetts  
02142, USA  
(580) 20 12 2019

---

(111) M 2010 21026 R  
(732) GENZYME CORPORATION  
(a Massachusetts Corporation)  
50 Binney Street, Cambridge, Massachusetts  
02142, USA

(770) GENZYME CORPORATION  
(a Massachusetts Corporation)  
500 Kendall Street, Cambridge, Massachusetts  
02142, USA  
(580) 20 12 2019

---

(111) M 2011 21885 R  
(732) GENZYME CORPORATION  
(a Massachusetts Corporation)  
50 Binney Street, Cambridge, Massachusetts  
02142, USA  
(770) GENZYME CORPORATION  
(a Massachusetts Corporation)  
500 Kendall Street, Cambridge, Massachusetts  
02142, USA  
(580) 20 12 2019

---

(111) M 2012 22758 R  
(732) GENZYME CORPORATION  
(a Massachusetts Corporation)  
50 Binney Street, Cambridge, Massachusetts  
02142, USA  
(770) GENZYME CORPORATION  
(a Massachusetts Corporation)  
500 Kendall Street, Cambridge, Massachusetts  
02142, USA  
(580) 20 12 2019

---

(111) M 2011 21886 R  
(732) GENZYME CORPORATION  
(a Massachusetts Corporation)  
50 Binney Street, Cambridge, Massachusetts  
02142, USA  
(770) GENZYME CORPORATION  
(a Massachusetts Corporation)  
500 Kendall Street, Cambridge, Massachusetts  
02142, USA  
(580) 20 12 2019

---

(111) M 2011 21887 R  
(732) GENZYME CORPORATION  
(a Massachusetts Corporation)  
50 Binney Street, Cambridge, Massachusetts  
02142, USA  
(770) GENZYME CORPORATION  
(a Massachusetts Corporation)  
500 Kendall Street, Cambridge, Massachusetts  
02142, USA  
(580) 20 12 2019

---

(111) M 2011 21888 R  
(732) GENZYME CORPORATION  
(a Massachusetts Corporation)  
50 Binney Street, Cambridge, Massachusetts  
02142, USA  
(770) GENZYME CORPORATION  
(a Massachusetts Corporation)  
500 Kendall Street, Cambridge, Massachusetts  
02142, USA  
(580) 20 12 2019

---

(111) M 2011 21889 R  
(732) GENZYME CORPORATION  
(a Massachusetts Corporation)  
50 Binney Street, Cambridge, Massachusetts  
02142, USA  
(770) GENZYME CORPORATION  
(a Massachusetts Corporation)  
500 Kendall Street, Cambridge, Massachusetts  
02142, USA  
(580) 20 12 2019

---

(111) M 2011 21890 R  
(732) GENZYME CORPORATION  
(a Massachusetts Corporation)  
50 Binney Street, Cambridge, Massachusetts  
02142, USA  
(770) GENZYME CORPORATION  
(a Massachusetts Corporation)  
500 Kendall Street, Cambridge, Massachusetts  
02142, USA  
(580) 20 12 2019

---

(111) M 2011 21891 R  
(732) GENZYME CORPORATION  
(a Massachusetts Corporation)  
50 Binney Street, Cambridge, Massachusetts  
02142, USA  
(770) GENZYME CORPORATION  
(a Massachusetts Corporation)  
500 Kendall Street, Cambridge, Massachusetts  
02142, USA  
(580) 20 12 2019

---

(111) M 2011 21892 R  
(732) GENZYME CORPORATION  
(a Massachusetts Corporation)  
50 Binney Street, Cambridge, Massachusetts  
02142, USA  
(770) GENZYME CORPORATION  
(a Massachusetts Corporation)  
500 Kendall Street, Cambridge, Massachusetts  
02142, USA  
(580) 20 12 2019

---

(111) M 2011 21893 R  
(732) GENZYME CORPORATION  
(a Massachusetts Corporation)  
50 Binney Street, Cambridge, Massachusetts  
02142, USA  
(770) GENZYME CORPORATION  
(a Massachusetts Corporation)  
500 Kendall Street, Cambridge, Massachusetts  
02142, USA  
(580) 20 12 2019

---

(111) M 2012 22409 R  
(732) Jenzaim Korporeishen (massachusettsis  
Korporacia)  
50 Binney Street, Cambridge, Massachusetts  
02142, USA  
(770) Jenzaim Korporeishen (massachusettsis  
Korporacia)  
500 Kendall Street, Cambridge, Massachusetts  
02142, USA  
(580) 20 12 2019

---

(111) M 2012 22410 R  
(732) GENZYME CORPORATION  
(a Massachusetts Corporation)  
50 Binney Street, Cambridge, Massachusetts  
02142, USA  
(770) GENZYME CORPORATION  
(a Massachusetts Corporation)  
500 Kendall Street, Cambridge, Massachusetts  
02142, USA  
(580) 20 12 2019

---

(111) M 2012 22411 R  
(732) GENZYME CORPORATION  
(a Massachusetts Corporation)  
50 Binney Street, Cambridge, Massachusetts  
02142, USA  
(770) GENZYME CORPORATION  
(a Massachusetts Corporation)  
500 Kendall Street, Cambridge, Massachusetts  
02142, USA  
(580) 20 12 2019

---

(111) M 2014 24881 R  
(732) GENZYME CORPORATION  
(a Massachusetts Corporation)  
50 Binney Street, Cambridge, Massachusetts  
02142, USA  
(770) GENZYME CORPORATION  
(a Massachusetts Corporation)  
500 Kendall Street, Cambridge, Massachusetts  
02142, USA  
(580) 20 12 2019

---

(111) M 2017 28480 R  
(732) TP-LINK INTERNATIONAL LIMITED  
Room 901, 9/F, New East Ocean Center,  
9 Science Museum Road, Tsim Sha Tsui,  
Kowloon, Hong Kong  
(770) TP-LINK INTERNATIONAL LIMITED  
Room 901-902, 9/F, New East Ocean Center,  
9 Science Museum Road, Tsim Sha Tsui,  
Kowloon, Hong Kong  
(580) 26 12 2019

---

(111) M 2017 28481 R  
(732) TP-LINK INTERNATIONAL LIMITED  
Room 901, 9/F, New East Ocean Center,  
9 Science Museum Road, Tsim Sha Tsui,  
Kowloon, Hong Kong  
(770) TP-LINK INTERNATIONAL LIMITED  
Room 901-902, 9/F, New East Ocean Center,  
9 Science Museum Road, Tsim Sha Tsui,  
Kowloon, Hong Kong  
(580) 26 12 2019

---

(111) M 2017 28587 R  
(732) GENZYME CORPORATION  
50 Binney Street, Cambridge, Massachusetts  
02142, USA  
(770) GENZYME CORPORATION  
500 Kendall Street, Cambridge, Massachusetts  
02142, USA  
(580) 20 12 2019

---

(111) M 2018 30123 R  
(732) MILLENNIUM & COPTHORNE  
INTERNATIONAL LIMITED  
9 Raffles Place, #12-01 Republic Plaza,  
048619, Singapore  
(770) MILLENNIUM & COPTHORNE  
INTERNATIONAL LIMITED  
36 Robinson Road #04-01 Siti Haus,  
068877, Singapore  
(580) 13 01 2020

---

## TERMINATION OF TRADEMARKS REGISTRATIONS

(111) M 1999 12410 R (151) 1999 07 02 (732) BRITISH AMERICAN TOBACCO (BRANDS) LIMITED Globe House, 4 Temple Place, London WC 2R 2PG, United Kingdom (141) 2020 01 10	Macrolotto, 59100 Prato, Italy (141) 2020 01 10
(111) M 1999 12417 R (151) 1999 07 02 (732) BRITISH AMERICAN TOBACCO (BRANDS) LIMITED Globe House, 4 Temple Place, London, WC2R 2PG, United Kingdom (141) 2020 01 10	(111) M 1999 12434 R (151) 1999 07 02 (732) UPSA SAS 3, rue Joseph Monier, 92500 Rueil Melmaison, France (141) 2020 01 10
(111) M 1999 12422 R (151) 1999 07 02 (732) GlaxoSmithKline Consumer Healthcare (UK) IP Limited 980 Great West Road, Brentford, Middlesex TW8 9GS, United Kingdom (141) 2020 01 10	(111) M 1999 12435 R (151) 1999 07 02 (732) UPSA SAS 3, rue Joseph Monier, 92500 Rueil Melmaison, France (141) 2020 01 10
(111) M 1999 12423 R (151) 1999 07 02 (732) GlaxoSmithKline Consumer Healthcare (UK) IP Limited 980 Great West Road, Brentford, Middlesex TW8 9GS, United Kingdom (141) 2020 01 10	(111) M 1999 12436 R (151) 1999 07 02 (732) HEWLETT PACKARD ENTERPRISE DEVELOPMENT LP 11445 Compaq Center Drive West, Houston, Texas 77070, USA (141) 2020 01 10
(111) M 1999 12425 R (151) 1999 07 02 (732) WYETH Five Giralda Farms, Madison, New Jersey 07940, USA (141) 2020 01 10	(111) M 1999 12439 R (151) 1999 07 02 (732) COTY B.V. Oudeweg 147, 2031 CC Haarlen, Netherlands (141) 2020 01 10
(111) M 1999 12430 R (151) 1999 07 02 (732) American-Cigarette Company (Overseas) Limited Zählerweg 4, CH-6300 Zug, Switzerland (141) 2020 01 10	(111) M 1999 12440 R (151) 1999 07 02 (732) COTY B.V. Oudeweg 147, 2031 CC Haarlen, Netherlands (141) 2020 01 10
(111) M 1999 12431 R (151) 1999 07 02 (732) SASCH S.P.A. Via Toscana, N15, Zona Industriale	(111) M 1999 12441 R (151) 1999 07 02 (732) COTY B.V. Oudeweg 147, 2031 CC Haarlen, Postbus 2340, 2002 CH Haarlen, Netherlands (141) 2020 01 10
(111) M 1999 12431 R (151) 1999 07 02 (732) SASCH S.P.A. Via Toscana, N15, Zona Industriale	(111) M 1999 12448 R (151) 1999 07 02 (732) GlaxoSmithKline Consumer Healthcare (UK) IP Limited

980 Great West Road, Brentford, Middlesex  
TW8 9GS, United Kingdom  
(141) 2020 01 10

---

(111) M 1999 12449 R  
(151) 1999 07 02  
(732) GlaxoSmithKline Consumer Healthcare (UK)  
IP Limited  
980 Great West Road, Brentford, Middlesex  
TW8 9GS, United Kingdom  
(141) 2020 01 10

---

(111) M 1999 12450 R  
(151) 1999 07 02  
(732) SMITHKLINE BEECHAM CORPORATION  
One Franklin Plaza, Philadelphia,  
Pennsylvania 19101, USA  
(141) 2020 01 10

---

(111) M 1999 12451 R  
(151) 1999 07 02  
(732) SMITHKLINE BEECHAM CORPORATION  
One Franklin Plaza, Philadelphia,  
Pennsylvania 19101, USA  
(141) 2020 01 10

---

(111) M 1999 12452 R  
(151) 1999 07 02  
(732) GlaxoSmithKline Consumer Healthcare (UK)  
IP Limited  
980 Great West Road, Brentford, Middlesex  
TW8 9GS, United Kingdom  
(141) 2020 01 10

---

(111) M 1999 12453 R  
(151) 1999 07 02  
(732) GlaxoSmithKline Consumer Healthcare (UK)  
IP Limited  
980 Great West Road, Brentford, Middlesex  
TW8 9GS, United Kingdom  
(141) 2020 01 10

---

(111) M 1999 12479 R  
(151) 1999 07 09  
(732) PESQUERA SAN JOSE S.A.  
Avenida El Bosque Norte 0440, Oficina  
902, Santiago, Chile  
(141) 2020 01 17

---

(111) M 1999 12468 R  
(151) 1999 07 09  
(732) MEDA Pharma GmbH & Co. KG

Benzstrasse 1, D-61352 Bad Homburg,  
Germany  
(141) 2020 01 17

---

(111) M 1999 12481 R  
(151) 1999 07 09  
(732) HOUSE OF DONUTS INTERNATIONAL  
P.O. Box 1111, George Town, Grand Cayman,  
Cayman Islands  
(141) 2020 01 17

---

(111) M 1999 12469 R  
(151) 1999 07 09  
(732) BAYER INTELLECTUAL PROPERTY  
GMBH  
Alfred-Nobel-Strasse 10, 40789 Monheim am  
Rhein, Germany  
(141) 2020 01 17

---

(111) M 1999 12470 R  
(151) 1999 07 09  
(732) BAYER INTELLECTUAL PROPERTY  
GMBH  
Alfred-Nobel-Strasse 10, 40789 Monheim am  
Rhein, Germany  
(141) 2020 01 17

---

(111) M 1999 12471 R  
(151) 1999 07 09  
(732) BAYER INTELLECTUAL PROPERTY  
GMBH  
Alfred-Nobel-Strasse 10, 40789 Monheim am  
Rhein, Germany  
(141) 2020 01 17

---

(111) M 1999 12472 R  
(151) 1999 07 09  
(732) BAYER INTELLECTUAL PROPERTY  
GMBH  
Alfred-Nobel-Strasse 10, 40789 Monheim am  
Rhein, Germany  
(141) 2020 01 17

---

(111) M 1999 12473 R  
(151) 1999 07 09  
(732) BAYER INTELLECTUAL PROPERTY  
GMBH  
Alfred-Nobel-Strasse 10, 40789 Monheim am  
Rhein, Germany  
(141) 2020 01 17

---

(111) M 1999 12464 R (151) 1999 07 09 (732) MALLINCKRODT LLC 675 McDonnel Boulevard, P.O. Box 5840, ST. Louis, Missouri 63134, USA (141) 2020 01 17	Vazha-Pshavela Av. 46, ap. 14, 0177, Tbilisi, Georgia (141) 2020 01 08
(111) M 2009 19443 R (151) 2009 06 29 (732) CJSC Commercial Bank "PRIVATBANK" NaberezhnayaPobedi St. 50, Dnepropetrovsk, 49094, Ukraine (141) 2020 01 08	(111) M 2009 19452 R (151) 2009 06 29 (732) LTD "SAGI 2008" Vazha-Pshavela Av. 46, ap. 14, 0177, Tbilisi, Georgia (141) 2020 01 08
(111) M 2009 19445 R (151) 2009 06 29 (732) LTD "STOMER GEORGIA" Vill. Aghaiani, 2601, Kaspi District, Georgia (141) 2020 01 08	(111) M 2009 19453 R (151) 2009 06 29 (732) LTD "KARVASLA" T. Abuladze St. 21, 0162, Tbilisi, Georgia (141) 2020 01 08
(111) M 2009 19446 R (151) 2009 06 29 (732) CJSC Commercial Bank "PRIVATBANK" NaberezhnayaPobedi St. 50, Dnepropetrovsk, 49094, Ukraine (141) 2020 01 06	(111) M 2009 19461 R (151) 2009 06 29 (732) Zaur Kokrashvili Sergo Zakariadze St. 9, ap. 2, 0177, Tbilisi, Georgia (141) 2020 01 08
(111) M 2009 19447 R (151) 2009 06 29 (732) PJSC Commercial Bank "PRIVATBANK" NaberezhnayaPobedi St. 50, Dnepropetrovsk, 49094, Ukraine (141) 2020 01 08	(111) M 2009 19462 R (151) 2009 06 29 (732) Nemiroff Intellectual Property Establishment Haus Rechsteiner, P.O. Box 634/Stadtle 31, LI-9490 Vaduz, Liechtenstein (141) 2020 01 08
(111) M 2009 19449 R (151) 2009 06 29 (732) LTD "SAGI 2008" Vazha-Pshavela Av. 46, ap. 14, 0177, Tbilisi, Georgia (141) 2020 01 08	(111) M 2009 19463 R (151) 2009 06 29 (732) Nemiroff Intellectual Property Establishment Haus Rechsteiner, P.O. Box 634/Stadtle 31, LI-9490 Vaduz, Liechtenstein (141) 2020 01 08
(111) M 2009 19450 R (151) 2009 06 29 (732) LTD "SAGI 2008" Vazha-Pshavela Av. 46, ap. 14, 0177, Tbilisi, Georgia (141) 2020 01 08	(111) M 2009 19464 R (151) 2009 06 29 (732) Nemiroff Intellectual Property Establishment Haus Rechsteiner, P.O. Box 634/Stadtle 31, LI-9490 Vaduz, Liechtenstein (141) 2020 01 08
(111) M 2009 19451 R (151) 2009 06 29 (732) LTD "SAGI 2008"	(111) M 2009 19465 R (151) 2009 06 29 (732) Nemiroff Intellectual Property Establishment Haus Rechsteiner, P.O. Box 634/Stadtle 31, LI-9490 Vaduz, Liechtenstein (141) 2020 01 08

---

(111) M 1999 12465 R (151) 1999 07 09 (732) RHODIA CHIMIE, Societe par Actions Simplifíee 26 quai Alphonse Le Gallo - 92512 BOULOGNE-BILLANCOURT CEDEX, France (141) 2020 01 17	(111) M 2009 19487 R (151) 2009 06 29 (732) CORSINA EUROPE GMBH Verinherstrasse 45, 81541 München, Germany (141) 2020 01 08
(111) M 2009 19467 R (151) 2009 06 29 (732) Raffles International limited 250 Nort Bridge Road, #10-00 Raffles City Tower, 179101, Singapore (141) 2020 01 08	(111) M 2009 19503 R (151) 2009 06 29 (732) NINE WEST DEVELOPMENT LLC 1411 Broadway, New York, NY 10018, USA (141) 2020 01 08
(111) M 2009 19472 R (151) 2009 06 29 (732) JSC "TELIANI VALLEY" Tbilisi Av. 3, Telavi, 2200, Georgia (141) 2020 01 08	(111) M 2009 19488 R (151) 2009 06 29 (732) Anton Obolashvili Tamar Mepe Av. 7, ap. 13, 0102, Tbilisi, Georgia (141) 2020 01 08
(111) M 2009 19478 R (151) 2009 06 29 (732) LLC "VIVARO" Abovyana St. 37, Yerevan, Armenia (141) 2020 01 08	(111) M 2009 19490 R (151) 2009 06 29 (732) BIOGEN MA INC. a Massachusetts Corporation 250 Binney Street, Cambridge, Massachusetts 02142, USA (141) 2020 01 08
(111) M 2009 19482 R (151) 2009 06 29 (732) LTD "VOIADJ.GE" I. Abashidze St. 68, 0162, Tbilisi, Georgia (141) 2020 01 08	(111) M 2009 19491 R (151) 2009 06 29 (732) Biogen MA Inc. a Massachusetts Corporation 250 Binney Street, Cambridge, Massachusetts 02142, USA (141) 2020 01 08
(111) M 2009 19483 R (151) 2009 06 29 (732) NOVARTIS AG 4002 Basel, Switzerland (141) 2020 01 08	(111) M 2009 19441 R (151) 2009 06 18 (732) LTD "Ramaz Laghidze" M. Tamarashvili St., korp. 8, ap. 38, 0162, Tbilisi, Georgia (141) 2020 01 08
(111) M 2009 19484 R (151) 2009 06 29 (732) NOVARTIS AG 4002 Basel, Switzerland (141) 2020 01 08	(111) M 2009 19492 R (732) Duduna Turmanidze Kekelidze St. 6, ap. 1, 0179, Tbilisi, Georgia (141) 2020 01 08
(111) M 2009 19485 R (151) 2009 06 29 (732) NOVARTIS AG 4002 Basel, Switzerland (141) 2020 01 08	(111) M 2009 19493 R (151) 2009 06 29 (732) KIMBERLY-CLARK WORLDWIDE, INC. NEENAH, WI 54956, USA (141) 2020 01 08

---

(111) M 2009 19494 R  
(151) 2009 06 29  
(732) Korneli Korchilava  
Mikaberidze St. 37, 4400, Poti, Georgia  
(141) 2020 01 08

---

(111) M 2009 19495 R  
(151) 2009 06 29  
(732) Union "DOSTAKARI"  
Iv. Gomarteli St. 17, 4000, Sachkhere,  
Georgia  
(141) 2020 01 08

---

(111) M 2009 19496 R  
(151) 2009 06 29  
(732) LTD "EXPRESSDIAGNOSTIC"  
Nutsbidze 3 mkr, I kvart., korp. 7,  
ap. 22, 0183, Tbilisi, Georgia  
(141) 2020 01 08

---

(111) M 2009 19497 R  
(151) 2009 06 29  
(732) JAPAN TOBACCO INC.  
2-2-1, Toranomon, Minato-ku, Tokyo, Japan  
(141) 2020 01 08

---

(111) M 2009 19499 R  
(151) 2009 06 29  
(732) MIROGLIO FASHION S.R.L.  
Via Santa Margherita 23, 12051 Alba,  
Cuneo, Italy  
(141) 2020 01 08

---

(111) M 2009 19500 R  
(151) 2009 06 29  
(732) LTD "ORION TECHNOLOGY"  
Cabadze St. 5, 0112, Tbilisi, Georgia  
(141) 2020 01 08

---

(111) M 2009 19442 R  
(151) 2009 06 18  
(732) LTD "AZARTOTEKHI"  
I. Petritsi St. 8, ap. 2, 0131, Tbilisi, Georgia  
(141) 2020 01 08

---

(111) M 2009 19502 R  
(151) 2009 06 29  
(732) JAPAN TOBACCO INC.  
2-2-1, Toranomon, Minato-ku, Tokyo, Japan  
(141) 2020 01 08

---



---

# CLASSIFICATION INDEXES

## INVENTIONS

### CONCORDANCE TABLE OF INTERNATIONAL CLASSIFICATION INDEX AND PUBLICATION NUMBERS

INTERNATIONAL CLASSIFICATION INDEXES (51)	NUMBER OF PUBLISHED APPLICATION (10)
A 61 K 31/16; A 61 P 25/32; C 07 C 235/06	AP 2020 14717 A
A 61 K 31/47; A 61 P 35/00; C 07 D 401/04	AP 2020 14494 A
A 61 K 31/437; A 61 P 11/00; C 07 D 471/04	AP 2020 14824 A
A 61 K 31/551; A 61 K 31/5415; A 61 P 31/04; C 07 D 281/02; C 07 D 279/08	AP 2020 14609 A
A 61 K 38/03; A 61 K 31/465; A 61 K 38/08; A 61 P 35/00; C 07 D 213/61; C 07 K 7/02; G 01 N 33/68	AP 2020 14748 A
C 04 B 28/04; C 04 B 38/08; C 04 B 111/60	AP 2020 14438 A
C 05 C 9/00; C 05 C 3/00; C 05 G 3/00	AP 2020 14693 A
C 07 C 311/46; A 61 K 31/18	AP 2020 14060 A
C 07 C 315/00; C 07 D 209/52; C 07 C 237/02; C 07 K 5/06	AP 2020 12594 A

### CONCORDANCE TABLE OF PUBLICATION NUMBERS AND INTERNATIONAL CLASSIFICATION INDEX

NUMBER OF PUBLISHED APPLICATION (10)	INTERNATIONAL CLASSIFICATION INDEXES (51)
AP 2020 12594 A	C 07 C 315/00; C 07 D 209/52; C 07 C 237/02; C 07 K 5/06
AP 2020 14060 A	C 07 C 311/46; A 61 K 31/18
AP 2020 14438 A	C 04 B 28/04; C 04 B 38/08; C 04 B 111/60
AP 2020 14494 A	A 61 K 31/47; A 61 P 35/00; C 07 D 401/04
AP 2020 14609 A	A 61 K 31/551; A 61 K 31/5415; A 61 P 31/04; C 07 D 281/02; C 07 D 279/08
AP 2020 14693 A	C 05 C 9/00; C 05 C 3/00; C 05 G 3/00
AP 2020 14717 A	A 61 K 31/16; A 61 P 25/32; C 07 C 235/06
AP 2020 14748 A	A 61 K 38/03; A 61 K 31/465; A 61 K 38/08; A 61 P 35/00; C 07 D 213/61; C 07 K 7/02; G 01 N 33/68
AP 2020 14824 A	A 61 K 31/437; A 61 P 11/00; C 07 D 471/04

### CONCORDANCE TABLE OF INTERNATIONAL CLASSIFICATION INDEX, PATENT NUMBERS AND PUBLICATION NUMBERS

INTERNATIONAL CLASSIFICATION INDEX (51)	NUMBER OF PATENT (11)	NUMBER OF PUBLISHED APPLICATION (10)
A 61 K 31/437; A 61 K 31/519; C 07 D 487/04	P 2020 7057 B	AP 2019 14901 A
A 61 K 31/4985; A 61 P 25/00; C 07 D 487/04	P 2020 7058 B	AP 2019 14615 A
B 22 D 11/06	P 2020 7061 B	AP 2019 14718 A
B 41 J 5/10; G 06 F 3/02	P 2020 7059 B	AP 2019 14785 A
B 67 D 1/04; B 67 D 1/06; F 16 K 11/18	P 2020 7060 B	AP 2019 14931 A
E 21 D 9/00; E 21 D 11/00; E 21 D 11/10; E 21 D 20/02; E 21 D 13/00	P 2020 7062 B	AP 2019 14719 A

**CONCORDANCE TABLE OF PATENT NUMBERS,  
PUBLICATION NUMBERS AND INTERNATIONAL CLASSIFICATION INDEX**

NUMBER OF PATENT (11)	NUMBER OF PUBLISHED APPLICATION (10)	INTERNATIONAL CLASSIFICATION INDEX (51)
P 2020 7057 B	AP 2019 14901 A	A 61 K 31/437; A 61 K 31/519; C 07 D 487/04
P 2020 7058 B	AP 2019 14615 A	A 61 K 31/4985; A 61 P 25/00; C 07 D 487/04
P 2020 7059 B	AP 2019 14785 A	B 41 J 5/10; G 06 F 3/02
P 2020 7060 B	AP 2019 14931 A	B 67 D 1/04; B 67 D 1/06; F 16 K 11/18
P 2020 7061 B	AP 2019 14718 A	B 22 D 11/06
P 2020 7062 B	AP 2019 14719 A	E 21 D 9/00; E 21 D 11/00; E 21 D 11/10; E 21 D 20/02; E 21 D 13/00

**CONCORDANCE TABLE OF APPLICATION NUMBERS, PUBLICATION NUMBERS  
AND PATENTS**

NUMBER OF APPLICATION (21)	NUMBER OF PUBLISHED APPLICATION (10)	NUMBER OF PATENT (11)
AP 2016 14615	AP 2019 14615 A	P 2020 7058 B
AP 2016 14719	AP 2019 14719 A	P 2020 7062 B
AP 2018 14718	AP 2019 14718 A	P 2020 7061 B
AP 2016 14785	AP 2019 14785 A	P 2020 7059 B
AP 2017 14901	AP 2019 14901 A	P 2020 7057 B
AP 2016 14931	AP 2019 14931 A	P 2020 7060 B

## UTILITY MODELS

### CONCORDANCE TABLE OF INTERNATIONAL CLASSIFICATION INDEX AND PUBLICATION NUMBERS

INTERNATIONAL CLASSIFICATION INDEXES (51)	NUMBER OF PUBLISHED APPLICATION (10)
A 01 D 46/04	AU 2020 15039 U
C 25 C 7/00; C 25 C 7/08	AU 2020 15142 U
G 07 F 19/00	AU 2020 14985 U

### CONCORDANCE TABLE OF PUBLICATION NUMBERS AND INTERNATIONAL CLASSIFICATION INDEX

NUMBER OF PUBLISHED APPLICATION (10)	INTERNATIONAL CLASSIFICATION INDEXES (51)
AU 2020 14985 U	G 07 F 19/00
AU 2020 15039 U	A 01 D 46/04
AU 2020 15142 U	C 25 C 7/00; C 25 C 7/08

### CONCORDANCE TABLE OF INTERNATIONAL CLASSIFICATION INDEX, PATENT NUMBERS AND PUBLICATION NUMBERS

INTERNATIONAL CLASSIFICATION INDEX (51)	NUMBER OF PATENT (11)	NUMBER OF PUBLISHED APPLICATION (10)
A 61 P 5/48	U 2020 2030 Y	AU 2019 14928 U
C 22 C 12/00	U 2020 2031 Y	AU 2019 14800 U

### CONCORDANCE TABLE OF PATENT NUMBERS, PUBLICATION NUMBERS AND INTERNATIONAL CLASSIFICATION INDEX

NUMBER OF PATENT (11)	NUMBER OF PUBLISHED APPLICATION (10)	INTERNATIONAL CLASSIFICATION INDEX (51)
U 2020 2030 Y	AU 2019 14928 U	A 61 P 5/48
U 2020 2031 Y	AU 2019 14800 U	C 22 C 12/00

### CONCORDANCE TABLE OF APPLICATION NUMBERS, PUBLICATION NUMBERS AND PATENTS

NUMBER OF APPLICATION (21)	NUMBER OF PUBLISHED APPLICATION (10)	NUMBER OF PATENT (11)
AU 2018 14800	AU 2019 14800 U	U 2020 2031 Y
AU 2018 14928	AU 2019 14928 U	U 2020 2030 Y

**DESIGNS****CONCORDANCE TABLE OF INTERNATIONAL CLASSIFICATION INDEX  
AND PUBLICATION NUMBERS**

INTERNATIONAL CLASSIFICATION INDEXES (51)	NUMBER OF PUBLISHED APPLICATION (10)
01-99	AD 2020 1096 S
03-01	AD 2020 1101 S

**CONCORDANCE TABLE OF PUBLICATION NUMBERS  
AND INTERNATIONAL CLASSIFICATION INDEX**

NUMBER OF PUBLISHED APPLICATION (10)	INTERNATIONAL CLASSIFICATION INDEXES (51)
AD 2020 1096 S	01-99
AD 2020 1101 S	03-01

**CONCORDANCE TABLE OF INTERNATIONAL CLASSIFICATION INDEX,  
PATENT NUMBERS AND PUBLICATION NUMBERS**

INTERNATIONAL CLASSIFICATION INDEX (51)	NUMBER OF PATENT (11)	NUMBER OF PUBLISHED APPLICATION (10)
02-04	D 2020 834 S	AD 2019 1087 S
03-01	D 2020 832 S	AD 2019 1091 S
06-01	D 2020 833 S	AD 2019 1080 S

**CONCORDANCE TABLE OF PATENT NUMBERS,  
PUBLICATION NUMBERS AND INTERNATIONAL CLASSIFICATION INDEX**

NUMBER OF PATENT (11)	NUMBER OF PUBLISHED APPLICATION (10)	INTERNATIONAL CLASSIFICATION INDEX (51)
D 2020 832 S	AD 2019 1091 S	03-01
D 2020 833 S	AD 2019 1080 S	06-01
D 2020 834 S	AD 2019 1087 S	02-04

**CONCORDANCE TABLE OF APPLICATION NUMBERS, PUBLICATION NUMBERS  
AND PATENTS**

NUMBER OF APPLICATION (21)	NUMBER OF PUBLISHED APPLICATION (10)	NUMBER OF PATENT (11)
AD 2019 1080	AD 2019 1080 S	D 2020 833 S
AD 2019 1087	AD 2019 1087 S	D 2020 834 S
AD 2019 1091	AD 2019 1091 S	D 2020 832 S

## DESIGN REGISTERED ACCORDING TO THE ACCELERATED PROCEDURE

### CONCORDANCE TABLE OF INTERNATIONAL CLASSIFICATION INDEX AND PUBLICATION NUMBERS

INTERNATIONAL CLASSIFICATION INDEXES (51)	NUMBER OF PUBLISHED APPLICATION (11)
09-01	D 2020 835 S

### CONCORDANCE TABLE OF PUBLICATION NUMBERS AND INTERNATIONAL CLASSIFICATION INDEX

NUMBER OF PUBLISHED APPLICATION (11)	INTERNATIONAL CLASSIFICATION INDEXES (51)
D 2020 835 S	09-01

### CONCORDANCE TABLE OF APPLICATION NUMBERS, PUBLICATION NUMBERS AND PATENTS

NUMBER OF APPLICATION (21)	NUMBER OF PATENT (11)
AD 2019 1110	D 2020 835 S

## TRADEMARKS

### CONCORDANCE TABLE OF REGISTRATION NUMBERS, APPLICATION NUMBERS, PUBLICATION NUMBERS AND BULLETIN NUMBERS

NUMBER OF REGISTRATION (111)	NUMBER OF APPLICATIONS (210)	NUMBER OF PUBLISHED APPLICATIONS (260)	NUMBER OF BULLETIN
M 1998 8942P R	AM 105969	-	2(534)2020
M 2019 32204 R	AM 106278	-	2(534)2020
M 2019 32205 R	AM 105804	-	2(534)2020
M 2019 32206 R	AM 106273	-	2(534)2020
M 2019 32207 R	AM 106413	-	2(534)2020
M 2019 32208 R	AM 106510	-	2(534)2020
M 2020 32209 R	AM 100433	AM 2019 100433 A	13(521)2019
M 2020 32210 R	AM 100613	AM 2019 100613 A	14(522)2019
M 2020 32211 R	AM 100614	AM 2019 100614 A	14(522)2019
M 2020 32212 R	AM 100665	AM 2019 100665 A	14(522)2019
M 2020 32213 R	AM 100689	AM 2019 100689 A	15(523)2019
M 2020 32214 R	AM 100693	AM 2019 100693 A	14(522)2019
M 2020 32215 R	AM 100772	AM 2019 100772 A	14(522)2019
M 2020 32216 R	AM 100789	AM 2019 100789 A	12(520)2019
M 2020 32217 R	AM 100794	AM 2019 100794 A	15(523)2019
M 2020 32218 R	AM 100795	AM 2019 100795 A	15(523)2019
M 2020 32219 R	AM 100796	AM 2019 100796 A	15(523)2019
M 2020 32220 R	AM 100809	AM 2019 100809 A	13(521)2019
M 2020 32221 R	AM 100881	AM 2019 100881 A	15(523)2019
M 2020 32222 R	AM 100897	AM 2019 100897 A	16(524)2019
M 2020 32223 R	AM 100899	AM 2019 100899 A	16(524)2019
M 2020 32224 R	AM 100918	AM 2019 100918 A	17(525)2019
M 2020 32225 R	AM 100921	AM 2019 100921 A	16(524)2019
M 2020 32226 R	AM 100922	AM 2019 100922 A	16(524)2019
M 2020 32227 R	AM 100923	AM 2019 100923 A	16(524)2019
M 2020 32228 R	AM 101236	AM 2019 101236 A	17(525)2019
M 2020 32229 R	AM 101382	AM 2019 101382 A	16(524)2019
M 2020 32230 R	AM 101399	AM 2019 101399 A	17(525)2019
M 2020 32231 R	AM 101400	AM 2019 101400 A	17(525)2019
M 2020 32232 R	AM 101416	AM 2019 101416 A	17(525)2019
M 2020 32233 R	AM 101422	AM 2019 101422 A	16(524)2019
M 2020 32234 R	AM 101495	AM 2019 101495 A	18(526)2019
M 2020 32235 R	AM 101514	AM 2019 101514 A	17(525)2019
M 2020 32236 R	AM 101519	AM 2019 101519 A	17(525)2019
M 2020 32237 R	AM 101520	AM 2019 101520 A	17(525)2019
M 2020 32238 R	AM 101612	AM 2019 101612 A	17(525)2019
M 2020 32239 R	AM 101639	AM 2019 101639 A	17(525)2019
M 2020 32240 R	AM 101646	AM 2019 101646 A	17(525)2019
M 2020 32241 R	AM 101677	AM 2019 101677 A	17(525)2019
M 2020 32242 R	AM 101687	AM 2019 101687 A	17(525)2019
M 2020 32243 R	AM 101688	AM 2019 101688 A	17(525)2019
M 2020 32244 R	AM 101694	AM 2019 101694 A	18(526)2019
M 2020 32245 R	AM 101906	AM 2019 101906 A	17(525)2019
M 2020 32246 R	AM 101907	AM 2019 101907 A	17(525)2019
M 2020 32247 R	AM 101929	AM 2019 101929 A	17(525)2019
M 2020 32248 R	AM 101931	AM 2019 101931 A	18(526)2019

---

1	2	3	4
M 2020 32249 R	AM 101932	AM 2019 101932 A	18(526)2019
M 2020 32250 R	AM 102022	AM 2019 102022 A	18(526)2019
M 2020 32251 R	AM 102023	AM 2019 102023 A	18(526)2019
M 2020 32252 R	AM 102043	AM 2019 102043 A	18(526)2019
M 2020 32253 R	AM 102044	AM 2019 102044 A	18(526)2019
M 2020 32254 R	AM 102047	AM 2019 102047 A	18(526)2019
M 2020 32255 R	AM 102048	AM 2019 102048 A	18(526)2019
M 2020 32256 R	AM 102049	AM 2019 102049 A	18(526)2019
M 2020 32257 R	AM 102143	AM 2019 102143 A	18(526)2019
M 2020 32258 R	AM 102154	AM 2019 102154 A	18(526)2019
M 2020 32259 R	AM 102161	AM 2019 102161 A	18(526)2019
M 2020 32260 R	AM 100078	AM 2019 100078 A	12(520)2019
M 2020 32261 R	AM 100803	AM 2019 100803 A	13(521)2019
M 2020 32262 R	AM 101515	AM 2019 101515 A	18(526)2019
M 2020 32263 R	AM 101622	AM 2019 101622 A	18(526)2019
M 2020 32264 R	AM 101623	AM 2019 101623 A	18(526)2019
M 2020 32265 R	AM 101624	AM 2019 101624 A	18(526)2019
M 2020 32266 R	AM 101625	AM 2019 101625 A	18(526)2019
M 2020 32267 R	AM 101626	AM 2019 101626 A	18(526)2019
M 2020 32268 R	AM 101627	AM 2019 101627 A	18(526)2019
M 2020 32269 R	AM 101638	AM 2019 101638 A	17(525)2019
M 2020 32270 R	AM 106421	–	2(534)2020
M 2020 32271 R	AM 106070	–	2(534)2020
M 2020 32272 R	AM 106604	–	2(534)2020

CONCORDANCE TABLE OF PUBLICATION NUMBERS  
AND APPLICATION NUMBERS

NUMBER OF PUBLISHED APPLICATION (260)	NUMBER OF APPLICATION (210)	1	2
1	2		
AM 2020 102918 A	AM 102918	AM 2020 103568 A	AM 103568
AM 2020 103015 A	AM 103015	AM 2020 103576 A	AM 103576
AM 2020 103217 A	AM 103217	AM 2020 103584 A	AM 103584
AM 2020 103438 A	AM 103438	AM 2020 103588 A	AM 103588
AM 2020 103439 A	AM 103439	AM 2020 103590 A	AM 103590
AM 2020 103440 A	AM 103440	AM 2020 103591 A	AM 103591
AM 2020 103441 A	AM 103441	AM 2020 103663 A	AM 103663
AM 2020 103442 A	AM 103442	AM 2020 103664 A	AM 103664
AM 2020 103449 A	AM 103449	AM 2020 103670 A	AM 103670
AM 2020 103450 A	AM 103450	AM 2020 103678 A	AM 103678
AM 2020 103451 A	AM 103451	AM 2020 103680 A	AM 103680
AM 2020 103461 A	AM 103461	AM 2020 103690 A	AM 103690
AM 2020 103462 A	AM 103462	AM 2020 103700 A	AM 103700
AM 2020 103468 A	AM 103468	AM 2020 103773 A	AM 103773
AM 2020 103471 A	AM 103471	AM 2020 103775 A	AM 103775
AM 2020 103472 A	AM 103472	AM 2020 103776 A	AM 103776
AM 2020 103481 A	AM 103481	AM 2020 103779 A	AM 103779
AM 2020 103482 A	AM 103482	AM 2020 103786 A	AM 103786
AM 2020 103560 A	AM 103560	AM 2020 103787 A	AM 103787
AM 2020 103562 A	AM 103562	AM 2020 103788 A	AM 103788
AM 2020 103563 A	AM 103563	AM 2020 103844 A	AM 103844
AM 2020 103567 A	AM 103567	AM 2020 103845 A	AM 103845
		AM 2020 103858 A	AM 103858
		AM 2020 103861 A	AM 103861
		AM 2020 103962 A	AM 103962
		AM 2020 103963 A	AM 103963



CONCORDANCE TABLE OF INDEX OF GOODS AND/OR SERVICES  
AND APPLICATION NUMBERS

INDEX OF GOODS AND/OR SERVICES (511)	NUMBER OF PUBLISHED APPLICATIONS (26)	1	2
1	2	30	AM 2020 103482 A
1	AM 2020 102918 A	30	AM 2020 103861 A
3	AM 2020 103591 A	32	AM 2020 103584 A
3	AM 2020 103670 A	32	AM 2020 103773 A
4	AM 2020 103217 A	32	AM 2020 103844 A
4	AM 2020 103438 A	32	AM 2020 103845 A
4	AM 2020 103439 A	33	AM 2020 103584 A
4	AM 2020 103440 A	33	AM 2020 103700 A
4	AM 2020 103441 A	33	AM 2020 103858 A
4	AM 2020 103442 A	34	AM 2020 103449 A
5	AM 2020 103576 A	34	AM 2020 103450 A
9	AM 2020 103461 A	34	AM 2020 103451 A
9	AM 2020 103462 A	35	AM 2020 103471 A
9	AM 2020 103861 A	35	AM 2020 103481 A
11	AM 2020 103678 A	35	AM 2020 103482 A
11	AM 2020 103680 A	35	AM 2020 103560 A
12	AM 2020 103588 A	35	AM 2020 103562 A
12	AM 2020 103962 A	35	AM 2020 103563 A
12	AM 2020 103963 A	35	AM 2020 103567 A
14	AM 2020 103471 A	35	AM 2020 103576 A
14	AM 2020 103861 A	35	AM 2020 103663 A
16	AM 2020 103560 A	35	AM 2020 103678 A
16	AM 2020 103562 A	35	AM 2020 103680 A
16	AM 2020 103563 A	35	AM 2020 103775 A
16	AM 2020 103861 A	35	AM 2020 103776 A
18	AM 2020 103861 A	36	AM 2020 103472 A
20	AM 2020 103678 A	36	AM 2020 103560 A
20	AM 2020 103680 A	36	AM 2020 103562 A
20	AM 2020 103861 A	36	AM 2020 103563 A
21	AM 2020 103678 A	36	AM 2020 103590 A
21	AM 2020 103680 A	36	AM 2020 103690 A
21	AM 2020 103861 A	37	AM 2020 103690 A
21	AM 2020 103861 A	39	AM 2020 103015 A
24	AM 2020 103678 A	39	AM 2020 103568 A
24	AM 2020 103680 A	41	AM 2020 103664 A
24	AM 2020 103861 A	41	AM 2020 103786 A
24	AM 2020 103861 A	41	AM 2020 103787 A
25	AM 2020 103471 A	41	AM 2020 103788 A
25	AM 2020 103861 A	41	AM 2020 103861 A
28	AM 2020 103786 A	43	AM 2020 103567 A
28	AM 2020 103787 A	43	AM 2020 103568 A
28	AM 2020 103788 A	43	AM 2020 103775 A
28	AM 2020 103861 A	43	AM 2020 103776 A
30	AM 2020 103468 A	43	AM 2020 103779 A
		43	AM 2020 103858 A
		44	AM 2020 103481 A

---

CONCORDANCE TABLE OF INDEX OF GOODS AND/OR SERVICES  
AND NUMBERS OF TRADEMARKS REGISTERED ACCORDING  
TO THE ACCELERATED PROCEDURE

INDEX OF GOODS AND/OR SERVICES (511)	NUMBERS OF REGISTERED ACCORDING TO THE ACCELERATED PROCEDURE (111)
9	M 2020 32208 R
29	M 2020 32204 R
32	M 2020 32205 R
32	M 2020 32271 R
33	M 2020 32206 R
34	M 2020 32270 R
34	M 2020 32272 R
35	M 2020 32205 R
35	M 2020 32207 R
35	M 2020 32208 R
36	M 2020 32208 R
43	M 2020 32205 R

# OFFICIAL BULLETIN OF THE INDUSTRIAL PROPERTY

INVENTIONS  
UTILITY MODELS  
DESIGNS  
TRADEMARKS  
APPELLATIONS OF ORIGIN OF GOODS

## 2(534)

EDITOR-IN-CHIEF: N. Bebrishvili

EDITOR-TRANSLATOR: E. Gabunia

PROOFREADER: A. Shikhashvili

COMPUTER LAYOUT: M. Ordenidze  
K. Svanidze

[www.sakpatenti.gov.ge](http://www.sakpatenti.gov.ge)

E-mail: [info@sakpatenti.org.ge](mailto:info@sakpatenti.org.ge)