



**NATIONAL INTELLECTUAL PROPERTY CENTER OF GEORGIA
SAKPATENTI**

**OFFICIAL BULLETIN
OF THE INDUSTRIAL PROPERTY**

22(434)

**2015
TBILISI**

INID CODES FOR IDENTIFICATION OF BIBLIOGRAPHIC DATA

INVENTIONS, UTILITY MODELS

- (10) Number of publication for application, which has been examined
- (11) Number of patent and kind of document
- (21) Serial number of application
- (22) Date of filing of the application
- (23) Date of exhibition or the date of the earlier filing and the number of application, if any
- (24) Date from which patent may have effect
- (31) Number of priority application
- (32) Date of filing of priority application
- (33) Code of the country or regional organization allotting priority application number
- (44) Date of publication of application not granted, but examined and number of bulletin
- (45) Date of publication of registered document
- (51) International Patent Classification Index
- (54) Title of the invention
- (57) Abstract
- (60) Number of examined patent document granted by foreign patent office, date from which patent has effect and country code
- (62) Number of the earlier application and in case of divided application, date of filing an application
- (71) Name, surname and address of applicant (country code)
- (72) Name, surname of inventor (country code)
- (73) Name, surname and address of patent owner (country code)
- (74) Name, surname of representative or patent attorney
- (85) Date of commencement of the national phase of International Application
- (86) Number and date of filing of international application
- (87) Number and date of publication of international application

DESIGNS

- (10) Number of publication for application
- (11) Number of patent and kind of document or number of registration
- (15) Date of registration/Date of patent renewal
- (18) Expected expiration date of patent or registration
- (21) Serial number of application
- (22) Date of filing of the application
- (23) Date of exhibition or the date of the earlier filing and the number of application, if any
- (24) Date from which patent may have effect
- (28) Number of designs included in the application
- (30) Data relating to priority (number of application, date of filing of application, two-letter code identifying the authority with whom the priority application was made)
- (31) Number of priority application
- (32) Date of filing of priority application
- (33) Code of the country or regional organization allotting priority application number
- (34) Two-letter code according to WIPO St.3 identifying the authority with which the priority application was made
- (44) Date of publication of design and number of bulletin (the first publication)
- (45) Date of publication of design registered by WIPO and number of bulletin
- (51) International Classification for designs (class and subclass of the Locarno Classification)
- (54) Title of the invention
- (55) Reproduction of the design
- (57) Description of characteristic features of the design including indication of colors
- (58) Date of recording of any kind of amendment in the Register
- (62) Number of the earlier application, registration and document number and if available the date of filing an application in case of divided application
- (71) Name, surname and address of applicant (country code)
- (72) Name, surname of creator (country code)
- (73) Name, surname and address of patent owner (country code)
- (74) Name, surname of representative or patent attorney
- (81) Contracting states concerned
 - II designated contracting states according to the 1960 Act
 - III designated contracting states according to the 1999 Act
- (85) Owner's permanent address
- (86) Owner's nationality
- (87) Owner's residence
- (88) State in which the owner has a real and effective industrial or commercial establishment

TRADEMARKS

- (111) – Number of registration
- (151) – Date of registration
- (156) – Date of the renewal
- (181) – Expected expiration date of registration
- (186) – Renewal expiration date of registration
- (141) – Date of cancel of duration of the mark
- (210) – Serial number of application
- (220) – Date of filing of the application
- (230) – Date concerning exhibition
- (260) – Number of application, for which favorable decision of examination about registration has been taken (publication number)
- (310) – Number of the first application
- (320) – Date of filing of the first application
- (330) – Code, identifying national or regional Office where the first application was made
- (511) – International Classification of Goods and Services for the purposes of registration of trade marks and/or list of goods and/or services classified according thereto
- (531) – Description of figurative elements of Trade Marks according to the International Classification of the Figurative Elements of Marks
- (540) – Reproduction of Trade Mark
- (550) – Nature and kind of Trade Mark
- (580) – Date of recording of any kind changes in respect of applications or registrations
- (591) – Information concerning colors claimed
- (731) – Name and address of the applicant
- (732) – Name and address of the holder of the registration
- (740) – Name and address of the representative
- (750) – Address for correspondence
- (770) – Name and address of the previous applicant or holder in case of change in ownership
- (771) – Previous name and address of the applicant or holder in case of change in ownership
- (791) – Name and address of the licensee
- (793) – Indication of conditions and/or restrictions under the license (Type of license, number of license agreement, data of license, data of validity of license)
- (800) – Certain data relating to the international registration of Trade Marks under the Protocol Relating to Madrid Agreement (International registration number)

CODES FOR PUBLICATION IN BULLETIN

- (21) AP 0000 000000 – serial number of application for invention
- (10) AP 0000 0000 A – number of published application for invention (first publication)
- (11) P 0000 0000 B – number of patent for invention (second publication)
- (21) API 0000 000000 – number of application for imported patent
- (11) PI 0000 0000 A – number of imported patent (first publication)
- (21) AU 0000 000000 – serial number of application for utility model
- (10) AU 0000 000 U – number of published application for utility model (first publication)
- (11) U 0000 000 Y – number of patent for utility model (second publication)
- (21) AD 0000 000000 – serial number of application for design
- (10) AD 0000 000 S – number of published application for design (first publication)
- (11) D 0000 000 S – number of patent for design (second publication)

INTERNATIONAL PATENT CLASSIFICATION FOR INVENTIONS AND UTILITY MODELS

- SECTION A – HUMAN NECESSITIES
- SECTION B – PERFORMING OPERATIONS; TRANSPORTING
- SECTION C – CHEMISTRY; METALLURGY
- SECTION D – TEXTILES; PAPER
- SECTION E – FIXED CONSTRUCTIONS
- SECTION F – MECHANICAL ENGINEERING; LIGHTING; HEATING; WEAPONS; BLASTING
- SECTION G – PHYSICS
- SECTION H – ELECTRICITY

-
- M – Trade Mark
 - (210) AM 0000 000000 – Serial number of application;
 - (260) AAM 0000 00000 A – Publication number of application;
 - (111) M 0000 00000 R – Number of registration;
 - (111) MMM0000 00000 Rn – Number of renewals, in which n=1,2,3;
 - (111) M 0000 00000 R(P) – Number of registration under partial assignment of rights
-

LIST OF CODES, IN ALPHABETIC SEQUENCE, AND THE CORRESPONDING (SHORT) NAMES OF STATES, OTHER ENTITIES AND INTERGOVERNMENTAL ORGANIZATIONS
(WIPO STANDARD ST.3)

AD	Andorra				
AE	United Arab Emirates				
AF	Afghanistan				
AG	Antigua and Barbuda				
AI	Anguilla				
AL	Albania				
AM	Armenia				
AN	Netherlands Antilles				
AO	Angola				
AP	African Regional Intellectual Property Organization (ARIPO)				
AR	Argentina				
AT	Austria				
AU	Australia				
AW	Aruba				
AZ	Azerbaijan				
BA	Bosnia and Herzegovina				
BB	Barbados				
BD	Bangladesh				
BE	Belgium				
BF	Burkina Faso				
BG	Bulgaria				
BH	Bahrain				
BI	Burundi				
BJ	Benin				
BM	Bermuda				
BN	Brunei Darussalam				
BO	Bolivia				
BR	Brazil				
BS	Bahamas				
BT	Bhutan				
BV	Bouvet Island				
BW	Botswana				
BX	Benelux Office for Intellectual Property (BOIP)				
BY	Belarus				
BZ	Belize				
CA	Canada				
CD	Democratic Republic of the Congo				
CF	Central African Republic				
CG	Congo				
CH	Switzerland				
CI	Cote d'Ivoire				
CK	Cook Islands				
CL	Chile				
CM	Cameroon				
CN	China				
CO	Colombia				
CR	Costa Rica				
CU	Cuba				
CV	Cape Verde				
CY	Cyprus				
CZ	Czech Republic				
DE	Germany				
DJ	Djibouti				
DM	Dominica				
DO	Dominican Republic				
DZ	Algeria				
EA	Eurasian Patent Organization (EAPO)				
EC	Ecuador				
EE	Estonia				
EG	Egypt				
EH	Western Sahara				
EM	Office for Harmonization in the Internal Market (Trademarks and Designs)(OHIM)				
EP	European Patent Office (EPO)				
ER	Eritrea				
ES	Spain				
ET	Ethiopia				
FI	Finland				
FJ	Fiji				
FK	Falkland Islands (Malvinas)				
FO	Faroe Islands				
FR	France				
GA	Gabon				
GB	United Kingdom				
GC	Patent Office of the Cooperation Council for the Arab States of the Gulf (GCC)				
GD	Grenada				
GG	Guernsey				
GH	Ghana				
GI	Gibraltar				
GT	Guatemala				
GW	Guinea- Bissau				
GY	Guyana				
HK	The Hong Kong Special Administrative Region of the People's Republic of China				
HN	Honduras				
HR	Croatia				
HT	Haiti				
HU	Hungary				
IB	International Bureau of the World Intellectual Property Organization (WIPO)				
ID	Indonesia				
IE	Ireland				
IL	Israel				
IM	Isle of Man				
IN	India				
IQ	Iraq				
ID	Indonesia				
IE	Ireland				
IL	Israel				
IM	Isle of Man				
IN	India				
IQ	Iraq				
IR	Iran (Islamic Republic of)				
IS	Iceland				
IT	Italy				
JE	Jersey				
JM	Jamaica				
JO	Jordan				
JP	Japan				
KE	Kenya				
KG	Kyrgyzstan				
KH	Cambodia				
KI	Kiribati				
KM	Saint Kitts and Nevis				
KP	Democratic People's Republic of Korea				
KR	Republic of Korea				
KW	Kuwait				
KY	Cayman Islands				
KZ	Kazakhstan				
LA	Lao People's Democratic Republic				
LB	Lebanon				
LC	Saint Lucia				
LI	Liechtenstein				
LK	Sri Lanka				
LR	Liberia				
LS	Lesotho				
LT	Lithuania				
LU	Luxembourg				
LV	Latvia				
LY	Libyan Arab Jamahiriya				
MA	Morocco				
MC	Monaco				
MD	Republic of Moldova				
ME	Montenegro				
MG	Madagascar				
MK	The former Yugoslav Republic of Macedonia				
ML	Mali				
MM	Myanmar				
MN	Mongolia				
MO	Macao				
MP	Northern Mariana Islands				
MR	Mauritania				
MS	Montserrat				
MT	Malta				
MU	Mauritius				
MV	Maldives				
MW	Malawi				
MX	Mexico				
MY	Malaysia				
MZ	Mozambique				
NA	Namibia				
NE	Niger				
NG	Nigeria				
NI	Nicaragua				
NL	Netherlands				
NO	Norway				
NP	Nepal				
NR	Nauru				
NZ	New Zealand				
OA	African Intellectual Property Organization (OAPI)				
OM	Oman				
PA	Panama				
PE	Peru				
PG	Papua New Guinea				
PH	Philippines				
PK	Pakistan				
PL	Poland				
PT	Portugal				
PW	Palau				
PY	Paraguay				
QA	Qatar				
QZ	Community Plant Variety Office (European Community) (CPVO)				
RO	Romania				
RS	Serbia				
RU	Russian Federation				
RW	Rwanda				
SA	Saudi Arabia				
SB	Solomon Islands				
SC	Seychelles				
SD	Sudan				
SG	Singapore				
SH	Saint Helena				
SI	Slovenia				
SK	Slovakia				
SL	Sierra Leone				
SM	San Marino				
SN	Senegal				
SO	Somalia				
SR	Suriname				
ST	Sao Tome and Principe				
SV	El Salvador				
SY	Syrian Arab Republic				
SZ	Swaziland				
TC	Turks and Caicos Islands				
TD	Chad				
TG	Togo				
TH	Thailand				
TJ	Tajikistan				
TL	Timor-Leste				
TM	Turkmenistan				
TN	Tunisia				
TO	Tonga				
TR	Turkey				
SE	Sweden				
TT	Trinidad and Tobago				
TV	Tuvalu				
TW	Taiwan, Province of China				
TZ	United Republic of Tanzania				
UA	Ukraine				
UG	Uganda				
US	United States of America				
UY	Uruguay				
UZ	Uzbekistan				
VA	Holy See				
VC	Saint Vincent and the Grenadines				
VE	Venezuela				
VG	Virgin Islands (British)				
VN	Viet Nam				
VU	Vanuatu				
WO	World Intellectual Property Organization (WIPO)				
WS	Samoa				
XN	Nordic Patent Institute (NPI)				
YE	Yemen				
ZA	South Africa				
ZM	Zambia				
ZW	Zimbabwe				

**NATIONAL INTELLECTUAL PROPERTY CENTER OF GEORGIA
SAKPATENTI**

**OFFICIAL BULLETIN
OF THE INDUSTRIAL PROPERTY**

22(434)

**INVENTIONS
UTILITY MODELS
DESIGNS
TRADEMARKS**

DATE OF PUBLICATION

2015 11 25

CONTENTS

PUBLISHED TITLES OF PROTECTION	3
INVENTIONS	
▪ APPLICATIONS APPROVED FOR GRANTING PATENTS	4
▪ PATENTED INVENTIONS	8
UTILITY MODELS	
▪ APPLICATION APPROVED FOR GRANTING PATENT	9
▪ PATENTED UTILITY MODELS	10
DESIGNS	
▪ APPLICATIONS APPROVED FOR REGISTRATION	11
▪ REGISTERED DESIGN	12
TRADEMARKS	
▪ APPLICATIONS FILED UNDER THE NATIONAL PROCEDURE APPROVED FOR REGISTRATION	14
▪ REGISTERED TRADEMARKS	18
▪ TRADEMARKS REGISTERED ACCORDING TO THE ACCELERATED PROCEDURE	24
▪ INTERNATIONAL TRADEMARKS FOR WHICH A DECISION ON GANTING PROTECTION IS TAKEN	25
▪ INTERNATIONAL TRADEMARKS PROTECTED IN GEORGIA	72
OFFICIAL NOTIFICATIONS	
INVENTIONS	
▪ RENEWAL OF A PATENT	82
TRADEMARKS	
▪ RENEWAL OF REGISTRATIONS	83
▪ COMPLETE TRANSFER OF RIGHTS	86
▪ CHANGES IN NAMES AND/OR ADDRESSES OF OWNERS	87
CLASSIFICATION INDEXES	
INVENTIONS	88
UTILITY MODELS	89
DESIGNS	90
TRADEMARKS	92

PUBLISHED TITLES OF PROTECTION

INVENTIONS

- **APPLICATIONS APPROVED FOR GRANTING PATENTS:**
12845; 12649; 12866; 12773; 13281; 13059; 12975; 12399; 13389; 13580
- **PATENTED INVENTIONS:**
6402-6405

UTILITY MODELS

- **APPLICATION APPROVED FOR GRANTING PATENT:**
13763
- **PATENTED UTILITY MODELS:**
1879, 1880

DESIGNS

- **APPLICATIONS APPROVED FOR REGISTRATION:**
859, 868
- **REGISTERED DESIGN:**
652

TRADEMARKS

- **APPLICATIONS FILED UNDER THE NATIONAL PROCEDURE APPROVED FOR REGISTRATION:**
77946; 78392, 78393; 78904; 78953; 79048; 79100; 79127; 79292; 79636; 79647; 79670; 79826; 79890; 79984; 79987*; 80299; 80601; 80604; 80622; 80624; 80626; 80711; 80882; 81242, 81243; 81333
- **REGISTERED TRADEMARKS:**
26434-26463; 26465, 26466; 26479-26513
- **TRADEMARKS REGISTERED ACCORDING TO THE ACCELERATED PROCEDURE:**
26476-26478
- **INTERNATIONAL TRADEMARKS FOR WHICH A DECISION ON GRANTING PROTECTIONS IS TAKEN:**
78615; 78938; 79398; 79732; 79737, 79738; 79850; 80062; 80244; 80267; 80337; 80372; 80376; 80386; 80389, 80390; 80392-80395; 80400; 80402; 80406; 80415; 80440-80444; 80447-80463; 80465; 80467-80469; 80472, 80473; 80475-80480; 80484; 80486; 80493; 80496; 80498-80501; 80504-80507; 80511-80515; 80517-80519; 80521, 80522; 80524; 80527-80529; 80533, 80534; 80538, 80539; 80541; 80544; 80549; 80551-80553; 80555; 80557; 80564-80566; 80574; 80612; 80628; 80630; 80640, 80641; 80643; 80647-80649; 80658; 80660; 80668, 80669; 80674, 80675; 80677; 80687-80689; 80691; 80693; 80701; 80703, 80704; 80731, 80732; 80758-80761; 80763; 81063-81068; 81078; 81113; 81115
- **INTERNATIONAL TRADEMARKS PROTECTED IN GEORGIA:**
75332; 75965; 76180; 77197; 77327; 77542; 77550, 77551; 77554-77556; 77559-77561; 77649; 77655, 77656; 77660; 77671; 77678; 77680; 77979; 78094; 78100; 78131; 78146; 78151; 78345; 78348; 78354; 78405; 78421; 78463, 78464; 78467; 78471; 78478; 78482; 78551; 78672; 78724-78727; 78729; 78731; 78758, 78759; 78761-78765; 78767-78772; 78791; 78793-78795; 78798; 78818, 78819; 78822-78824; 78827; 78830-78832; 78837; 78839; 78847; 78860; 78862-78872; 78874-78878; 78881, 78882; 78884, 78885; 78890; 78892; 78894; 78900-78902; 79014, 79143; 79147-79155; 79159-79161; 79166; 79347; 79458, 79459; 79461; 79463, 79464; 79468; 79707; 79712; 79714; 79716-79719; 79721-79723; 79726; 79728, 79729; 79805, 79806

INVENTIONS

APPLICATIONS APPROVED FOR GRANTING PATENTS

The decision can be appealed at the Chamber of Appeal of Sakpatenti within 3 months from the publication or at the Mtskheta District Court Administrative Cases Board (Address: №17, Samkhedro str., Mtskheta), within 1 month following the publication.

PART A

A 61

(10) AP 2015 12845 A (51) Int. Cl. (2006)
A 61 K 31/216
A 61 K 31/282
A 61 K 31/337
A 61 K 31/41
A 61 K 31/4192
A 61 K 31/4196
A 61 K 31/428
A 61 K 31/4545
A 61 K 31/69
A 61 P 25/02

(21) AP 2011 012845 (22) 2011 01 26
(31) 2010-015935
(32) 2010 01 27
(33) JP
(71) TAKEDA PHARMACEUTICAL
COMPANY LIMITED (JP)
1-1, Doshomachi 4-chome, Chuo-ku, Osaka,
541- 0045 (JP)

(72) KITAMOTO, Naomi (JP)

(74) Shalva Gvaramadze

(85) 2012 08 23

(86) PCT/JP2011/052077, 2011 01 26

(54) **COMPOUNDS FOR SUPPRESSING
A PERIPHERAL NERVE DISORDER
INDUCED BY AN ANTI-CANCER
AGENT**

(57) Present invention relates to drag containing compound selected from ethyl(6 R-6-[N-(2-chlorine-4-fluorine phenyl) sulfonyl]-1-cyclohexane-1-carboxylate or salt thereof and (3S)-3-[N-(2-fluorine-4-fluorine phenyl sulfonyl)-3,6-dihydro-2H-pyran-4-carboxylate or salt thereof and which are applied for depression peripheral neurologic disorders, induced by anticancer agent.

Claims: 1 independent
15 dependent

(10) AP 2015 12649 A (51) Int. Cl. (2006)
A 61 K 39/395

(21) AP 2010 012649 (22) 2010 10 22
(31) 61/254,474
(32) 2009 10 23
(33) US

(71) MILLENNIUM PHARMACEUTICALS,
INC. (US)

The Takeda Oncology Company 40
Landsdowne Street Cambridge,
MA 02139 (US);

AMGEN BRITISH COLUMBIA (CA)
7990 Enterprise Street Burnaby,
BC V5A 1V7 (CA)

(72) NAM, Samuel, S. (US);
GREENFIELD, Edward, A. (US);
BABCOOK, John (US);
O'KEEFE, Theresa (US);
QIN, Shixin (US)

(74) Shalva Gvaramadze

(85) 2012 03 28

(86) PCT/US2010/053686, 2010 10 22

(54) **ANTI-GCC ANTIBODY
MOLECULES AND RELATED
COMPOSITIONS AND METHODS**

(57) An invention relates to antibodies and immunoconjugates directed against GCC receptor. Pharmaceutical compositions containing them are applied for cancer treatment.

Claims: 17 independent
37 dependent

Fig.: 4

(10) AP 2015 12866 A (51) Int. Cl. (2006)
A 61 K 39/395

(21) AP 2011 012866 (22) 2011 03 01

(31) 61/310,692; 61/310,695; 61/311,057

(32) 2010 03 04; 2010 03 04; 2010 03 05

(33) US; US; US

(71) MACROGENICS, INC. (US)
9640 Medical Center Drive Rockville,
MD 20850 (US)

(72) LOO, Deryk, T. (US);
HUANG, Ling (US);
CHEN, Francine, Zhifen (US);
MOORE, Paul, A. (US);
JOHNSON, Leslie, S. (US)

(74) Khatuna Imnadze

(85) 2012 10 04

(86) PCT/US2011/026689, 2011 03 01

(54) **ANTIBODIES REACTIVE WITH
B7-H3, IMMUNOLOGICALLY ACTIVE
FRAGMENTS THEREOF AND USES
THEREOF**

(57) An invention relates to antibodies and their fragments, which are immunoreactive relative to mammalian, particularly, human B7-H3 receptor and capable to increase immune system activity against various type cancer cells.

Claims: 6 independent
14 dependent

Fig.: 34

PART B

B 03

(10) AP 2015 12773 A (51) Int. Cl. (2006)
B 03 D 1/02

(21) AP 2010 012773 (22) 2010 12 03

(31) 61/266,770

(32) 2009 12 04

(33) US

(71) BARRICK GOLD CORPORATION (CA)
Bce Place, Canada Trust Tower 161
Bay Street, Suite 3700 Toronto, Ontario,
M5J 2S1 (CA)

(72) GORAIN, Barun (CA)

(74) Shalva Gvaramadze

(85) 2012 07 02

(86) PCT/IB2010/003538, 2010 12 03

(54) SEPARATION OF COPPER
MINERALS FROM PYRITE USING
AIR-METABISULFITE TREATMENT

(57) Present invention relates to sulfide material flotation, which follows aeration with oxidizing gas and contacting with sulfoxide reagent.

Claims: 2 independent
12 dependent

Fig.: 10

Table: 7

PART C

C 07

(10) AP 2015 13281 A (51) Int. Cl. (2006)

C 07 C 233/46

C 07 C 233/56

C 07 C 275/20

A 61 P 9/12

A 61 K 31/17

A 61 K 31/16

(21) AP 2012 013281 (22) 2012 04 04

(31) 61/472,410; 61/608,361

(32) 2011 04 06; 2012 03 08

(33) US; US

(71) THE MEDICAL COLLEGE OF
WISCONSIN (US)
8701 Watertown Plank Road, Ilwauke
WI 53226 (US);
THE BOARD OF REGENTS OF THE
UNIVERSITY OF TEXAS SYSTEM (US)
201. v. 7s St. Austin, TX 78701 (US)

(72) IMIG, John, David (US);
CAMPBELL, William, B. (US);
FALCK, John, Russell (US)

(74) Tamaz Shilakadze

(85) 2013 11 05

(86) PCT/US2012/032090, 2012 04 04

(54) EPOXYEICOSATRIENOIC ACID
ANALOGS AND METHODS OF
MAKING AND USING THE SAME

(57) Compounds and compositions includes analogs of epoxyeicosatrienoic acid (EET), acting as EET agonists and applied for nephrotoxicity treatment and hypertension caused by drugs influence.

Claims: 16 independent
4 dependent

Fig.: 29

(10) AP 2015 13059 A (51) Int. Cl. (2006)

C 07 D 233/90

C 07 D 401/12

C 07 D 401/14

C 07 D 407/12

C 07 D 409/06

C 07 D 409/14

C 07 D 413/06

C 07 D 413/14

C 07 D 417/06

C 07 D 417/12

C 07 D 471/04

C 07 D 487/04

C 07 D 487/08

C 07 D 495/04

(21) AP 2009 013059 (22) 2009 06 17

(62) 2008-161049 2008 06 19 (JP);

- 2009-004882 2009 01 13 (JP)
 (31) 2008-161049; 2009-004882
 (32) 2008 06 19; 2009 01 13
 (33) JP; JP
 (71) TAKEDA PHARMACEUTICAL
 COMPANY LIMITED (JP)
 1-1, Doshomachi 4-chome, Chuo-ku,
 Osaka-shi, Osaka 5410045 (JP)
 (72) KUROITA, Takanobu (JP);
 IMAEDA, Yasuhiro (JP);
 IWANAGA, Kouichi (JP);
 TAYA, Naohiro (JP);
 TOKUHARA, Hidekazu (JP);
 FUKASE, Yoshiyuki (JP)
 (74) Shalva Gvaramadze
 (85) 2013 04 16
 (86) PCT/JP2009/061438, 2009 06 17
 (54) **HETEROCYCLIC COMPOUND AND
 USE THEREOF**
 (57) Compound of formula (I),

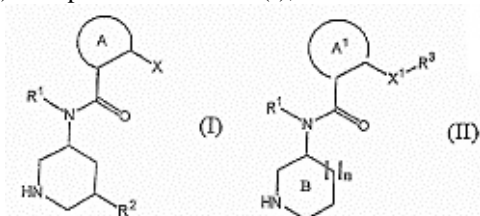

medicine capable to inhibit renin on basis thereof
 and application therefor various organs disorders
 prophylactic and treatment.

Claims: 9 independent
 10 dependent
 Table: 2

C 22

- (10) AP 2015 12975 A (51) Int. Cl. (2006)
 C 22 C 14/00
 C 22 C 29/14
 C 22 C 38/14
 (21) AP 2013 012975 (22) 2013 01 22
 (71) Zurab Aslamazashvili (GE)
 Davit Tavkhelidzis q. 1, b. 58, 0186,
 Tbilisi (GE);
 Giorgi Oniashvili (GE)
 Bazaletis q. 7, b. 6, 0179, Tbilisi (GE);
 Garegin Zakharov (GE)
 Ertsov q. 11, b. 9, 0192, Tbilisi (GE);
 Giorgi Tavadze (GE)
 D. Uznadzis q. 4, b. 77, 0102, Tbilisi (GE);
 Avtandil Khvadagiani (GE)
 Kandelakis q. 6, b. 10, 0160, Tbilisi (GE);
 Otari Okrostsvardze (GE)
 Meunargias q. 73, b. 26, 0101, Tbilisi (GE);
 Alexander Berner (IL)
 32682 Haifa, Mitspe St. Ap. 8, Israel (IL)
 (72) Zurab Aslamazashvili (GE);
 Giorgi Oniashvili (GE);

- Garegin Zakharov (GE);
 Giorgi Tavadze (GE);
 Avtandil Khvadagiani (GE);
 Otari Okrostsvardze (GE);
 Alexander Berner (IL)
 (54) **SOLID ALLOY**
 (57) Solid alloy containing titanium containing
 component, additionally contains transition metals
 of IV period or alloys on basis thereof (Me), and
 titanium-boron (TiB, TiB₂) and titanium-carbon-
 nitrogen (TiCN, Ti₂CN) alloys as titanium
 containing component in fine-dispersed condition
 of size up to 120 nm in the following correlation of
 componentry, mas %:
 Titanium-boron (TiB, TiB₂) alloy - 14-20;
 Titanium-carbon-nitrogen (TiCN, Ti₂CN)
 alloy - 75-82;
 Transition metals of IV period or alloys
 on basis thereof (Me) - 2-10.
 Claims: 1 independent
 Fig.: 3
 Table: 1

PART E

E 04

- (10) AP 2015 12399 A (51) Int. Cl. (2006)
 E 04 D 3/30
 E 04 D 1/30
 (21) AP 2011 012399 (22) 2011 09 30
 (31) 20106017
 (32) 2010 10 01
 (33) FI
 (71) RAUTARUUKKI OYJ (FI)
 Suolakivenkatu 1, FI-00810 Helsinki (FI)
 (72) AUTIO, Mika (FI);
 FLORCZAK, Pawel (PL);
 HUOPANA, Tuomo (FI);
 LEMPINEN, Juhani (FI);
 PERTTULA, Matti (FI);
 SAVOLA, Juho (FI)
 (74) Shalva Gvaramadze
 (54) **PROFILE SHEET AND JOINT
 BETWEEN PROFILE SHEETS**
 (57) Profile sheets 1 includes longitudinal profiling
 4 and the folds 12 passing along lateral edges 2, 3,
 one or more transverse profiling 7 passing in
 direction of upper and lower edges 5,6, which from
 upper view is wavy on roof surface 9. At profile
 sheets connection to each other, to create connec-
 ting plot 15 the longitudinal profile of another late-
 ral edge 3 of profile sheet is ended with substanti-
 ally total fold 12 comprising a lug 18 and couple of
 inclined parts 17 divergent from the lug, and
 substantially truncated fold 13 consisting of lug 19

of partial fold and one inclined part on first lateral edge 2.

Claims: 2 independent
12 dependent

Fig.: 5

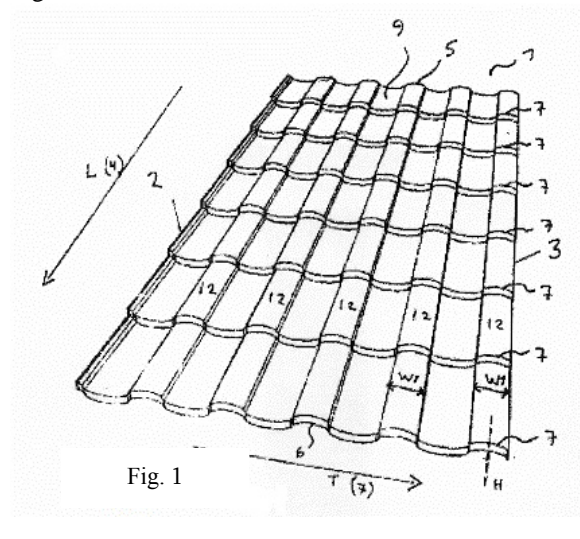

PART F

F 42

(10) AP 2015 13389 A (51) Int. Cl. (2006)
F 42 B 7/10
F 42 B 10/14

(21) AP 2014 013389 (22) 2014 02 14

(71) Vasil Kotorashvili (GE)
Sop. Gldani, 3304, Tbilisi (GE)

(72) Vasil Kotorashvili (GE)

(74) Gela Peradze

(54) CARTRIDGE

(57) A cartridge includes cartridge case with igniter cap and powder charge, a bullet 4, a stabilizer 5, the blades 7 attached to stabilizer case, wherein each blade is executed as multitude threads. The stabilizer 5 has stepped case, which central part diameter is equal to bullet diameter; one of extreme parts is joint with a hollow 6 executed in bullet body, and another is capable be attached to said blades. Furthermore, the stabilizer 5 is executed with polymeric material; the blades in said part of stabilizer are attached in passed perpendicular of axis of bullet in intercrossing holes so that at their folding in one circle direction end of each blade is capable be placed with ceiling by adjacent blade; and at output from gun tube is capable be open inclined relative to bullet axis so that blade ends are not exit beyond bullet diameter.

Claims: 1 independent

Fig.: 4

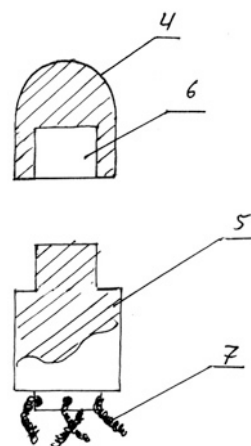

Fig. 4

PART G

G 01

(10) AP 2015 13580 A (51) Int. Cl. (2006)
G 01 F 23/28

(21) AP 2014 013580 (22) 2014 09 24

(71) Shota Amiridze (GE)

Dighmis masivi, V kvart., korp. 16, b. 58,
0159, Tbilisi (GE);

Genadi Elnikov (GE)

Lilos dasakhleba, IV kvart., korp. 2,

b. 15, 0198, Tbilisi (GE);

Giorgi Zunturashvili (GE)

Meore Rekhis q. 26, 0101, Tbilisi (GE);

Marad Kukhaleishvili (GE)

Tsulukidzis q. 27, 2100, Zugdidi (GE)

(72) Shota Amiridze (GE);

Genadi Elnikov (GE);

Giorgi Zunturashvili (GE);

Marad Kukhaleishvili (GE)

(54) MONITORING SYSTEM OF OPEN
IRRIGATING CHANNELS

(57) A system includes water charge measuring equipment comprising water level gauge and data collector; at that, water level gauge is executed as ultrasonic or laser range finder, and the equipment additionally includes modems GSM, which by means of mobile phone network are connected to analog modems GSM connected to data collector computer.

Claims: 1 independent

Fig.: 1

PATENTED INVENTIONS

PART A

A 61

(11) P 2015 6404 B (51) Int. Cl. (2006)
A 61 K 33/26
A 61 K 33/04
A 61 K 36/00

(10) AP 2015 13602 A (44) 15(427)/2015
(21) AP 2014 013602
(22) 2014 10 20
(24) 2014 10 20

(73) Merab Lekveishvili (GE)
Sop. Ianeti, 39112, Samtredia (GE)

(72) Merab Lekveishvili (GE)

(74) Nugzar Ksovreli

(54) **DRUG FOR TREATMENT OF
CONDITIONS RELATED TO
OXIDATIVE STRESS**

(11) P 2015 6405 B (51) Int. Cl. (2006)
A 61 K 33/26
A 61 K 33/04

(10) AP 2015 13672 A (44) 15(427)/2015
(21) AP 2014 013672
(22) 2014 12 24
(24) 2014 12 24

(73) Merab Lekveishvili (GE)
Sop. Ianeti, 39112, Samtredia (GE)

(72) Merab Lekveishvili (GE)

(74) Nugzar Ksovreli

(54) **TREATING-PREVENTING
COMPOSITION FOR TREATMENT OF
CONDITIONS RELATED TO
OXIDATIVE STRESS**

(11) P 2015 6402 B (51) Int. Cl. (2006)
A 61 K 36/00
A 61 K 31/00

(10) AP 2015 13205 A (44) 15(427)/2015
(21) AP 2013 013205
(22) 2013 08 23
(24) 2013 08 23

(73) JSC "PHARMA START" (UA)
8, Ivana Lapse bulv., 03680, Kyiv (UA)

(72) LUKIC, Dragan (RS)

(74) Davit Dzamukashvili

(54) **SOLID DRUG OF SEDATIVE,
SPASMOLYTIC AND HYPNOTIC
ACTION**

PART B

B 60

(11) P 2015 6403 B (51) Int. Cl. (2006)
B 60 P 3/40
B 60 P 3/41

(10) AP 2015 13406 A (44) 15(427)/2015
(21) AP 2014 013406
(22) 2014 03 05
(24) 2014 03 05

(73) Zaur Chitidze (GE)

Tarkhnishvilis q. 16, 0179, Tbilisi (GE);

Zaur Balamtsarashvili (GE)

Sulkhan Tsintsadzis q. 7, 0160, Tbilisi (GE);

Davit Mosulishvili (GE)

Megobrobis Gamz., korp. 41, b. 64, 3700,
Rustavi (GE);

Natia Chelidze-Tkeshelashvili (GE)

Sop. Pirveli Tola, 0418, Ambrolauris
raioni (GE);

Ramaz Tkemaladze (GE)

Sop. Etseri, 5510, Chiaturis R-ni (GE);

Vakhtang Abaishvili (GE)

Shartavas q. 6, b. 53, 0160, Tbilisi (GE);

Maia Gogotishvili (GE)

Galis q. 23, 0179, Tbilisi (GE)

(72) Zaur Chitidze (GE);

Zaur Balamtsarashvili (GE);

Davit Mosulishvili (GE);

Natia Chelidze-Tkeshelashvili (GE);

Ramaz Tkemaladze (GE);

Vakhtang Abaishvili (GE);

Maia Gogotishvili (GE)

(54) **AUTOMATED SKIDDING**

SELF-LOADING AGGREGATE

UTILITY MODELS

APPLICATION APPROVED FOR GRANTING PATENT

The decision can be appealed at the Chamber of Appeal of Sakpatenti within 3 months from the publication or at the Mtskheta District Court Administrative Cases Board (Address: №17, Samkhedro str., Mtskheta), within 1 month following the publication.

PART C

C 04

**(10) AU 2015 13763 U (51) Int. Cl. (2006)
C 04 B 7/00**

(21) AU 2015 013763 (22) 2015 03 13

(71) Elena Shapakidze (GE)

I. Chavchavadzis gamz. 35a, b. 7, 0179,

Tbilisi (GE);

Guram Nadareishvili (GE)

Shio Mghvimelis q. 13, b. 10, Tbilisi (GE);

Ioseb Gejadze (GE)

I. Chavchavadzis gamz. 35a, b. 7, 0179,

Tbilisi (GE);

Murad Tkemaladze (GE)

Ts. Dadianis q. 34, korp. 6, b. 33, 0180,

Tbilisi (GE);

Marine Nadirashvili (GE)

Khetagurovis q. 6, 0102, Tbilisi (GE);

Vera Maisuradze (GE)

Asatianis q. 10a, b. 36, 0177, Tbilisi (GE);

LEPL Ivane Javakhishvili TBILISI

STATE UNIVERSITY (GE)

I. Chavchavadzis gamz. 1, 0179, Tbilisi (GE);

LEPL Shota Rustaveli NATIONAL SCIENCE

FOUNDATION (GE)

M. Aleksidzis q. 1, Tbilisi (GE)

(72) Elena Shapakidze (GE);

Guram Nadareishvili (GE);

Ioseb Gejadze (GE);

Murad Tkemaladze (GE);

Marine Nadirashvili (GE);

Vera Maisuradze (GE)

**(54) POZZOLAN PORTLAND CEMENT
CONTENT**

(57) Pozzolan Portland cement contains clinker, pozzolan additive and plaster; at that, it contains volcanic-type eruption – ignimbrite as pozzolan additive, with the following correlation of componentry (mas %):

Clinker – 60-90

Ignimbrite – 6-35

Plaster – 3-5

Claims: 1 independent

Table: 4

PATENTED UTILITY MODELS

PART G

G 01

- (11) U 2015 1880 Y** **(51) Int. Cl. (2006)**
 G 01 N 27/22
- (10) AU 2015 13762 U (44) 15(427)/2015
(21) AU 2015 013762
(22) 2015 03 12
(24) 2015 03 12
- (73) Zurab Dzhokharidze (GE)
Vazha-Pshavelas III kvart., korp. 24, b. 21,
0186, Tbilisi (GE);
Naira Dzhokharidze (GE)
Shevardenidzis q. 11, b. 16, 0160, Tbilisi (GE);
Sophia Kolomikova (GE)
Khornabujis q. 19, 0110, Tbilisi (GE)
- (72) Zurab Dzhokharidze (GE);
Naira Dzhokharidze (GE);
Sophia Kolomikova (GE)
- (54) **THERMOHYGROMETER**
-

G 06

- (11) U 2015 1879 Y** **(51) Int. Cl. (2006)**
 G 06 Q 90/00
 H 04 M 3/42
- (10) AU 2015 13741 U (44) 15(427)/2015
(21) AU 2015 013741
(22) 2015 02 23
(24) 2015 02 23
- (73) Zurab Katsitadze (GE)
Tornike Eristavis q. 34, 5500,
Chiatura (GE);
Davit Kakulia (GE)
Tornike Eristavis q. 34, 5500,
Chiatura (GE)
- (72) Zurab Katsitadze (GE);
Davit Kakulia (GE)
- (54) **METHOD FOR TELEPHONE
ADVERTISING SUPPORT**
-

DESIGNS

APPLICATIONS APPROVED FOR REGISTRATION

The decision can be appealed at the Chamber of Appeal of Sakpatenti within 3 months from the publication or at the Mtskheta District Court Administrative Cases Board (Address: №17, Samkhedro str., Mtskheta), within 1 month following the publication.

- (10) **AD 2015 859 S** (51) **09-01**
(21) AD 2015 000859 (22) 2015 06 29
(28) 1
(71) LTD "KAKHETIAN TRADITIONAL WINEMAKING" (GE)
 S. Tsintsadzis q. 12, 0160, Tbilisi (GE)
(72) Aleksandrs Znovss (GE)
(74) Ekaterine Gogoladze
(54) **BOTTLE**
(55)



1

- (10) AD 2015 868 S (51) 10-07
(21) AD 2015 000868 (22) 2015 07 21
(28) 6
(73) Guram Gelashvili (GE)
Dighmis Masivi, V kvart., korp. 25b, b. 35, 0159, Tbilisi (GE)
(72) Guram Gelashvili (GE)
(54) **CLOCK**
(55)



1



2



3



4



5



6

REGISTERED DESIGN

- (11) **D 2015 652 S** (51) **05-06**
(10) AD 2015 849 S (44) 15(427)/2015
(21) AD 2015 000849
(22) 2015 04 24
(24) 2015 04 24
(18) 2020 04 24
(73) LTD "DAFNA" (GE)
 Lilos das., Plot 05/004, 0198, Tbilisi (GE)
(72) Zainal Abidin Alkaish (GE)
(74) Vakhtang Torotadze
(54) **ARTIFICIAL OR NATURAL
 LEAF MATERIAL FOR TOILET
 PAPER OR NAPKIN**
-

TRADEMARKS

APPLICATIONS FILED UNDER THE NATIONAL PROCEDURE APPROVED FOR REGISTRATION

The decision can be appealed at the Chamber of Appeal of Sakpatenti within 3 months from the publication or at the Mtskheta District Court Administrative Cases Board (Address: №17, Samkhedro St., Mtskheta), within 1 month following the publication.

(260) AM 2015 77946 A
(210) AM 77946
(220) 2014 07 14
(731) OLD NAVY (ITM) INC.
2 Folsom Street, San Francisco, CA 94105,
USA
(740) Tamar Kochlamazashvili
(540)

OLD NAVY

(511) 4

(260) AM 2015 78392 A
(210) AM 78392
(220) 2014 08 26
(731) MCDONALD'S INTERNATIONAL
PROPERTY COMPANY, LTD.
A corporation organized and existing under
the laws of the State of Delaware.
2711 Centerville Road, Wilmington, Delaware
19808, USA
(740) Shalva Gvaramadze
(540)



(591) Yellow, red, white, black
(531) 29.01.14, 02.01.07
(511) 43

(260) AM 2015 78393 A
(210) AM 78393
(220) 2014 08 26
(731) THE GILLETTE COMPANY
One Gillette Park, Boston Massachusetts
02127, USA

(740) Shalva Gvaramadze
(540)



CHILL

(591) Black, white
(531) 01.15.17, 24.01.07, 27.05.17
(511) 8

(260) AM 2015 78904 A
(210) AM 78904
(220) 2014 09 30
(731) ELEMENTOS TRADE LIMITED
Avlonos, 1 Maria House 1075, Kyprus
(740) Vakhtang Torotadze
(540)



(591) Black, white
(531) 24.17.04, 24.13.09, 27.05.02
(511) 29

(260) AM 2015 78953 A
(210) AM 78953
(220) 2014 10 03
(731) SHENZHEN CHENGRUN
COMMUNICATION EQUIPMENT CO., LTD
402, West Wing, Huamei Building, Zhenxing
Road, Futian District, Shenzhen, China
(740) Shalva Gvaramadze
(540)



(591) Black, white
(531) 26.13.25, 27.05.17, 26.11.12
(511) 9

(260) AM 2015 79048 A
 (210) AM 79048
 (220) 2014 10 10
 (731) Fund of Development of Alaverdi
 "TALAVARI"
 Nutsubidzis q. 221, korp. 1a, b. 21,
 Vake-Saburtalos raioni, Tbilisi, Georgia
 (740) Alexandre Kvernadze
 (540)

მაწვნის სახლი

(511) 43

(260) AM 2015 79100 A
 (210) AM 79100
 (220) 2014 10 16
 (310) 64549
 (320) 2014 04 16
 (330) JM
 (731) APPLE INC
 1, Infinite Loop, Cupertino, California 95014,
 USA
 (740) Tamar Kochlamazashvili
 (540)

PHOTOKIT

(511) 9

(260) AM 2015 79127 A
 (210) AM 79127
 (220) 2014 10 17
 (731) HARRINGTON DEVELOPMENT INC.
 Elvira Mendez street, Vallarino Bldg, 3rd
 Floorr, Panama
 (740) Givi Akopashvili
 (540)

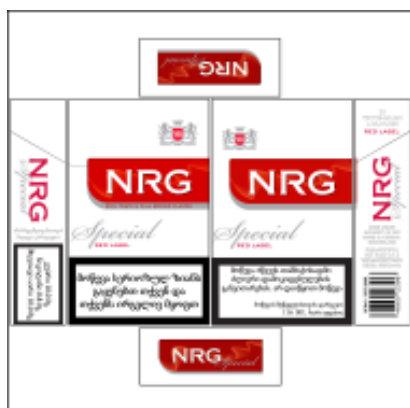

(591) Silver, red, white
 (531) 19.03.24, 24.01.15, 25.01.01, 26.04.04,
 27.05.23, 29.01.13
 (526) The trademark is protected as a whole. "Special RED LABEL" shall not be subject to independent legal protection.
 (511) 34

(260) AM 2015 79292 A
 (210) AM 79292
 (220) 2014 10 31
 (731) JOHNSON & JOHNSON
 A New Jersey Corporation
 One Johnson & Johnson Plaza, New-Brunswick,
 New Jersey, 08933-7001, USA
 (740) Giorgi Taktakishvili
 (540)

СИПТУРО

(511) 5

(260) AM 2015 79636 A
 (210) AM 79636
 (220) 2014 11 25
 (731) LTD "EVROPHARMA GEORGIA"
 Machabelis q. 5, Tbilisi, Georgia
 (740) Nia Masiukovich
 (540)

კალმაცინ ფორტე
Кальмацин Форте
Calmazin Forte

(511) 35

(260) AM 2015 79647 A
 (210) AM 79647
 (220) 2014 11 25
 (731) Natela Tkheldze-Nebulishvili
 Didi Dighomi, me-3 mkr., me-12 korp., b. 49,
 0159, Tbilisi, Georgia
 (740) Natela Tkheldze-Nebulishvili
 (540)

N.T. style

(511) 25, 35

(260) AM 2015 79670 A
 (210) AM 79670
 (220) 2014 11 26
 (731) "EPIK GROUP"
 Mazniasvili q. 4, komertsiuli parti №2, sart. 1,
 Didube-Chugureti raioni, Tbilisi, Georgia
 (740) Vakhtang Torotadze
 (540)



(591) Blue-grey, kraiola, white, black, copper-pink
 (531) 27.05.15, 26.04.01, 26.04.07, 28.19, 29.01.14
 (511) 37, 42

(260) AM 2015 79826 A
 (210) AM 79826
 (220) 2014 12 05
 (731) MAJID AL FUTTAIM HOLDING LLC
 P.O. Box 124441, Dubai, United Arab
 Emirates

(740) Merab Kvimsadze
 (540)

**Great Moments for everyone,
 everyday**

(511) 35

(260) AM 2015 79890 A
 (210) AM 79890
 (220) 2014 12 11
 (731) GILEAD SCIENCES IRELAND UC
 IDA Business and Technology Park,
 Carrigtohill, Co. Cork, Ireland

(740) Shalva Gvaramadze
 (540)

ЭПКЛЮЗА

(511) 5

(260) AM 2015 79984 A
 (210) AM 79984
 (220) 2014 12 23
 (731) QINGDAO NINE-ALLIANCE GROUP CO.,
 LTD
 Shanghai Western Road, Laixi City, Qingdao,
 China

(740) Davit Zurabishvili
 (540)



(591) Black, white
 (531) 26.01.12, 26.01.18, 27.05.22, 28.03
 (511) 29

(260) AM 2015 79987 A*
 (210) AM 79987
 (220) 2014 12 23
 (310) 035399
 (320) 2014 07 04
 (330) MD
 (731) REEMTSMA CIGARETTENFABRIKEN
 GMBH

Max-Born-Shttrasse 4, 22761, Hamburg,
 Germany

(740) Giorgi Gvinjilia
 (540)

FUSION

(591) Black, white
 (531) 27.01.06, 27.05.15
 (511) 34

(260) AM 2015 80299 A
 (210) AM 80299
 (220) 2015 01 16
 (731) SPAR Russia B.V.
 Rokin 101, 1012KM Amsterdam, Netherlands
 (740) Tamaz Shilakadze
 (540)



(591) White, dark and light green, yellow
 (531) 26.04.10, 27.05.21, 29.01.13, 01.15.09,
 26.01.18
 (511) 3, 21, 29, 30, 31, 32, 33, 34, 35

(260) AM 2015 80601 A
 (210) AM 80601
 (220) 2015 02 04
 (731) TWENTIETH CENTURY FOX FILM
 CORPORATION
 10201 West Pico Boulevard, Los Angeles,
 California 90035, USA

(740) Tamaz Shilakadze
 (540)

DUFF

(511) 32

(260) AM 2015 80604 A
 (210) AM 80604
 (220) 2015 02 04
 (731) TWENTIETH CENTURY FOX FILM
 CORPORATION
 10201 West Pico Boulevard, Los Angeles,
 California 90035, USA

(740) Tamaz Shilakadze
 (540)

DUFF BEER

(526) The trademark is protected as a whole.
 "BEER" shall not be subject to independent legal
 protection.
 (511) 32

(260) AM 2015 80622 A
 (210) AM 80622
 (220) 2015 02 06
 (731) KÖNIG LUDWIG INTERNATIONAL
 GmbH & Co KG
 Schloss Strasse 8 Germany
 (740) Giorgi Gvinjilia
 (540)

König Ludwig Weissbier

(526) The trademark is protected as a whole.
 "Weissbier" shall not be subject to independent legal
 protection.
 (511) 32

(260) AM 2015 80624 A
 (210) AM 80624
 (220) 2015 02 06
 (731) KÖNIG LUDWIG INTERNATIONAL
 GmbH & Co KG
 Schloss Strasse 8 Germany
 (740) Giorgi Gvinjilia
 (540)

König Ludwig Dunkel

(526) The trademark is protected as a whole.
 "Dunkel" shall not be subject to independent legal
 protection.
 (511) 32

(260) AM 2015 80626 A
 (210) AM 80626
 (220) 2015 02 06
 (731) KÖNIG LUDWIG INTERNATIONAL
 GmbH & Co KG
 Schloss Strasse 8 Germany
 (740) Giorgi Gvinjilia
 (540)

Kaltenberg

(511) 32

(260) AM 2015 80711 A
 (210) AM 80711
 (220) 2015 02 11
 (731) LITTLE CAESAR ENTERPRISES, INC.
 2211 Woodward Avenue, Detroit, Michigan
 48201-3400, USA
 (740) Shalva Gvaramadze
 (540)

HOT-N-READY

(511) 43

(260) AM 2015 80882 A
 (210) AM 80882
 (220) 2015 02 18

(731) INTERSUN HOLDING FZCO
 P.O. Box 61051 Jebel Ali Free Zone, Dubai,
 United Arab Emirates
 (740) Tamar Kochlamazashvili
 (540)



(591) Red, white, golden
 (531) 25.01.05, 27.05.24, 29.01.13
 (511) 29, 30, 31, 32, 35

(260) AM 2015 81242 A
 (210) AM 81242
 (220) 2015 03 16
 (731) MOULISTA FINANCE & INVESTMENTS
 LTD
 Office 37A, Stadiou Str., Aglantzia, P.C.
 2103, Nicosia, Cyprus
 (740) Davit Dzamukashvili
 (540)

Стумари

(511) 33

(260) AM 2015 81243 A
 (210) AM 81243
 (220) 2015 03 16
 (731) MOULISTA FINANCE & INVESTMENTS
 LTD
 Office 37A, Stadiou Str., Aglantzia, P.C.
 2103, Nicosia, Cyprus
 (740) Davit Dzamukashvili
 (540)

Stumari

(511) 33

(260) AM 2015 81333 A
 (210) AM 81333
 (220) 2015 03 19
 (731) NISSAN JIDOSHA KABUSHIKI KAISHA
 (also trading as Nissan Motor Co., Ltd.)
 No:2, Takara-cho, Kanagawa-ku, Yokohama-shi,
 Kanagawa-ken, Japan
 (740) Shalva Gvaramadze
 (540)

NISSAN

(591) Black, white
 (531) 27.05.17
 (511) 1, 2, 3, 4, 5, 9, 11, 27, 35, 38, 41

REGISTERED TRADEMARKS

(111) M 2015 26434 R

(151) 2015 10 27

(181) 2025 10 27

(260) AM 78315 A

(220) 2014 08 19

(732) PERRY ELLIS INTERNATIONAL GROUP

Holdings Limited

Montague Sterling Center, 5th Floor, East Bay
Street, Nassau, Bahamas

(111) M 2015 26435 R

(151) 2015 10 27

(181) 2025 10 27

(260) AM 78316 A

(220) 2014 08 19

(732) PERRY ELLIS INTERNATIONAL GROUP

Holdings Limited

Montague Sterling Center, 5th Floor, East Bay
Street, Nassau, Bahamas

(111) M 2015 26436 R

(151) 2015 10 27

(181) 2025 10 27

(260) AM 78331 A

(220) 2014 08 20

(732) DD IP Holder LLC

130 Royall Street, Canton, Massachusetts
02021, USA

(111) M 2015 26437 R

(151) 2015 10 27

(181) 2025 10 27

(260) AM 78379 A

(220) 2014 08 25

(732) ASTELLAS DEUTSCHLAND GMBH

Georg-Brauchle-Ring 64-66, Munich 80992,
Germany

(111) M 2015 26438 R

(151) 2015 10 27

(181) 2025 10 27

(260) AM 78411 A

(220) 2014 08 29

(732) LG HAUSYS, Ltd

One IFC Building, 10 Gukjegeumyung-ro,
Yeongdeungpo-gu, Seoul 150-876, Republic
of Korea

(111) M 2015 26439 R

(151) 2015 10 27

(181) 2025 10 27

(220) 2014 09 03

(732) WESTERN DIGITAL TECHNOLOGIES, INC

a Delaware corporation

3355 Michelson Drive, Suite 100 Irvin

California 92612, USA

(111) M 2015 26440 R

(151) 2015 10 27

(181) 2025 10 27

(260) AM 78562 A

(220) 2014 09 08

(732) NOVARTIS AG

4002 Basel, Switzerland

(111) M 2015 26441 R

(151) 2015 10 27

(181) 2025 10 27

(260) AM 78563 A

(220) 2014 09 08

(732) NISSAN JIDOSHA KABUSHIKI KAISHA

(also trading as Nissan Motor Co., Ltd.)

No.2, Takara-cho, Kanagawa-ku, Yokohama-shi,
Kanagawa-ken, Japan

(111) M 2015 26442 R

(151) 2015 10 27

(181) 2025 10 27

(260) AM 78582 A

(220) 2014 09 09

(732) OJSC "TATCHIMPHARMPREPARAT"

420091, Republic of Tatarstan, Kazan,

Ul. Belomorskaya, d. 260, Russian Federation

(111) M 2015 26443 R

(151) 2015 10 27

(181) 2025 10 27

(260) AM 78596 A

(220) 2014 09 10

(732) DENSO CORPORATION

1-1 Showa-cho, Kariya-city, Aichi-pref,
Japan

(111) M 2015 26444 R

(151) 2015 10 27

(181) 2025 10 27

(260) AM 78597 A

(220) 2014 09 10

(732) DENSO CORPORATION

1-1 Showa-cho, Kariya-city, Aichi-pref,
Japan

<p>(111) M 2015 26445 R (151) 2015 10 27 (181) 2025 10 27 (260) AM 78662 A (220) 2014 09 12 (732) LTD "GEORGIAN BREND'S COMPANY" Kakhetis gzat. 110a, Georgia</p>	<p>G. Dzotsenidzis q.5, b.29, 0183 Tbilisi, Georgia</p>
<p>(111) M 2015 26446 R (151) 2015 10 27 (181) 2025 10 27 (260) AM 78717 A (220) 2014 09 18 (732) HOMELAND HOUSEWARES, LLC 11755 Wilshire Blvd, Suite 1200, Los Angeles, California, USA</p>	<p>(111) M 2015 26451 R (151) 2015 10 27 (181) 2025 10 27 (260) AM 78781 A (220) 2014 09 23 (732) Irakli Kiria G. Dzotsenidzis q. 5, b. 29, 0183, Tbilisi, Georgia</p>
<p>(111) M 2015 26447 R (151) 2015 10 27 (181) 2025 10 27 (260) AM 78756 A (220) 2014 09 19 (732) STARBUCKS CORPORATION d/b/a Starbucks Coffee Company (a Washington corporation) 2401 Utah Avenue South, Seattle, Washington 98134, USA</p>	<p>(111) M 2015 26452 R (151) 2015 10 27 (181) 2025 10 27 (260) AM 78782 A (220) 2014 09 23 (732) Irakli Kiria G. Dzotsenidzis q. 5, b. 29, 0183, Tbilisi, Georgia</p>
<p>(111) M 2015 26448 R (151) 2015 10 27 (181) 2025 10 27 (260) AM 78757 A (220) 2014 09 19 (732) STARBUCKS CORPORATION d/b/a Starbucks Coffee Company (a Washington corporation) 2401 Utah Avenue South, Seattle, Washington 98134, USA</p>	<p>(111) M 2015 26453 R (151) 2015 10 27 (181) 2025 10 27 (260) AM 78783 A (220) 2014 09 23 (732) Irakli Kiria G. Dzotsenidzis q. 5, b. 29, 0183, Tbilisi, Georgia</p>
<p>(111) M 2015 26449 R (151) 2015 10 27 (181) 2025 10 27 (260) AM 78773 A (220) 2014 09 22 (732) PAUL International SA rue de Saint-Leger 2, c/o Paul Suisse SA, 1205 GENEVE, Switzerland</p>	<p>(111) M 2015 26454 R (151) 2015 10 27 (181) 2025 10 27 (260) AM 78784 A (220) 2014 09 23 (732) Irakli Kiria G. Dzotsenidzis q. 5, b. 29, 0183, Tbilisi, Georgia</p>
<p>(111) M 2015 26450 R (151) 2015 10 27 (181) 2025 10 27 (260) AM 78780 A (220) 2014 09 23 (732) IRAKLI QIRIA</p>	<p>(111) M 2015 26455 R (151) 2015 10 27 (181) 2025 10 27 (260) AM 78838 A (220) 2014 09 29 (732) KENTUCKY FRIED CHICKEN INTERNATIONAL HOLDINGS, INC. 1441 Gardiner Lane, Louisville, Kentucky 40213, USA</p>
<p>(111) M 2015 26456 R (151) 2015 10 27 (181) 2025 10 27 (260) AM 78844 A</p>	<p>(111) M 2015 26456 R (151) 2015 10 27 (181) 2025 10 27 (260) AM 78844 A</p>

(220) 2014 09 29
(732) KENTUCKY FRIED CHICKEN
INTERNATIONAL HOLDINGS, INC.
1441 Gardiner Lane, Louisville, Kentucky
40213, USA

(111) M 2015 26457 R
(151) 2015 10 27
(181) 2025 10 27
(260) AM 78845 A
(220) 2014 09 29
(732) KENTUCKY FRIED CHICKEN
INTERNATIONAL HOLDINGS, INC.
1441 Gardiner Lane, Louisville, Kentucky
40213, USA

(111) M 2015 26458 R
(151) 2015 10 27
(181) 2025 10 27
(260) AM 78854 A
(220) 2014 09 29
(732) KENTUCKY FRIED CHICKEN
INTERNATIONAL HOLDINGS, INC.
1441 Gardiner Lane, Louisville, Kentucky
40213, USA

(111) M 2015 26459 R
(151) 2015 10 27
(181) 2025 10 27
(260) AM 78911 A
(220) 2014 10 01
(732) EURO PARFUMS FZE
P.O. Box 49138, Sharjah, United Arab
Emirates

(111) M 2015 26460 R
(151) 2015 10 27
(181) 2025 10 27
(260) AM 78912 A
(220) 2014 10 01
(732) LTD "OMEGA-2"
P. Sarajishvilis q. 13-15-17, 0159, Tbilisi,
Georgia

(111) M 2015 26461 R
(151) 2015 10 27
(181) 2025 10 27
(260) AM 79049 A
(220) 2014 10 10
(732) SHULTON, INC.
One Procter & Gamble Plaza, Cincinnati OH
45202, USA

(111) M 2015 26462 R
(151) 2015 10 27
(181) 2025 10 27
(260) AM 79087 A
(220) 2014 10 15
(732) NOVARTIS AG
4002 Basel, Switzerland

(111) M 2015 26463 R
(151) 2015 10 27
(181) 2025 10 27
(260) AM 79090 A
(220) 2014 10 15
(732) NOVARTIS AG
4002 Basel, Switzerland

(111) M 2015 26465 R
(151) 2015 10 28
(181) 2025 10 28
(260) AM 78279 A
(220) 2014 08 14
(732) N(N)LE "ASSOTIATION IDS BORJOMI"
Toris g. 39, 1200, Tbilisi, Georgia

(111) M 2015 26466 R
(151) 2015 10 28
(181) 2025 10 28
(260) AM 78280 A
(220) 2014 08 14
(732) N(N)LE "ASSOTIATION IDS BORJOMI"
Toris g. 39, 1200, Tbilisi, Georgia

(111) M 2015 26479 R
(151) 2015 11 13
(181) 2025 11 13
(260) AM 76401 A
(220) 2014 03 25
(732) LTD "BESINI COMPANY"
Gamrekelis q. 19, Vake-Saburtalos raioni,
0160, Tbilisi, Georgia

(111) M 2015 26480 R
(151) 2015 11 13
(181) 2025 11 13
(260) AM 76495 A
(220) 2014 03 31
(732) LTD "LADIES' HAPPINESS"
Gamsakhurdia St. 7, 0171, Tbilisi,
Georgia

(111) M 2015 26481 R
(151) 2015 11 13
(181) 2025 11 13

(260) AM 76639 A
 (220) 2014 04 10
 (732) ROCKFORD CORPORATION
 600 South Rockford Drive, Tempe, AZ 85281,
 USA

(111) M 2015 26482 R
 (151) 2015 11 13
 (181) 2025 11 13
 (260) AM 77193 A
 (220) 2014 05 20
 (732) AMGEN INC.
 One Amgen Center Drive, Thousand-Ouks,
 CA 91320-1799, USA

(111) M 2015 26483 R
 (151) 2015 11 13
 (181) 2025 11 13
 (260) AM 77573 A
 (220) 2014 06 17
 (732) Mey Alkollu Ickiler Sanayii
 Ve Ticaret Anonim Sirketi
 Abide-i Hüriyet Cad. No:211 Bolkan Center B Blok
 Şişli, İstanbul

(111) M 2015 26484 R
 (151) 2015 11 13
 (181) 2025 11 13
 (260) AM 77675 A
 (220) 2014 06 24
 (732) THE PROCTER & GAMBLE COMPANY
 One Procter & Gamble Plaza, Cincinnati
 Ohio 45202, USA

(111) M 2015 26485 R
 (151) 2015 11 13
 (181) 2025 11 13
 (260) AM 77679 A
 (220) 2014 06 24
 (732) RECKITT & COLMAN (OVERSEAS)
 LIMITED
 Dansom Lane, Hull, HU8 7DS, England,
 United Kingdom

(111) M 2015 26486 R
 (151) 2015 11 13
 (181) 2025 11 13
 (260) AM 77851 A
 (220) 2014 07 07
 (732) LTD "ELIT"
 Salmis q. 10, 2/3 part, 0105, Tbilisi,
 Georgia

(111) M 2015 26487 R
 (151) 2015 11 13
 (181) 2025 11 13
 (260) AM 77853 A
 (220) 2014 07 07
 (732) LTD "ELIT"
 Salmis q. 10, 2/3 part, 0105, Tbilisi, Georgia

(111) M 2015 26488 R
 (151) 2015 11 13
 (181) 2025 11 13
 (260) AM 77889 A
 (220) 2014 07 10
 (732) Societe Nationale d'Exploitation
 Industrielle des Tabacs et Allumettes, SASU
 143 Boulevard Romain Rolland, 75014 Paris
 France

(111) M 2015 26489 R
 (151) 2015 11 13
 (181) 2025 11 13
 (260) AM 77898 A
 (220) 2014 07 11
 (732) Societe Nationale d'Exploitation
 Industrielle des Tabacs et Allumettes, SASU
 143 Boulevard Romain Rolland, 75014 Paris
 France

(111) M 2015 26490 R
 (151) 2015 11 13
 (181) 2025 11 13
 (260) AM 77945 A
 (220) 2014 07 14
 (732) OLD NAVY (ITM) INC.
 2 Folsom Street, San Francisco, CA 94105,
 USA

(111) M 2015 26491 R
 (151) 2015 11 13
 (181) 2025 11 13
 (260) AM 77950 A
 (220) 2014 07 14
 (732) OLD NAVY (ITM) INC.
 2 Folsom Street, San Francisco, CA 94105, USA

(111) M 2015 26492 R
 (151) 2015 11 16
 (181) 2025 11 16
 (260) AM 78160 A
 (220) 2014 07 30
 (732) SOCIETE NATIONALE D'EXPLOITATION
 Industrielle des Tabacs et Allumettes, SASU,
 143 boulevard Romain Rolland, 75014 Paris,
 France

(111) M 2015 26493 R
(151) 2015 11 16
(181) 2025 11 16
(260) AM 78175 A
(220) 2014 07 31
(732) LTD "COMPANY BESINI"
Gamrekelis q. 19, Vake-Saburtalos raioni,
0160, Tbilisi, Georgia

(111) M 2015 26494 R
(151) 2015 11 16
(181) 2025 11 16
(260) AM 78213 A
(220) 2014 08 03
(732) GLOBAL GURAYSH FZCO
P.O. Box 119640, Dubai, United Arab
Emirates

(111) M 2015 26495 R
(151) 2015 11 16
(181) 2025 11 16
(260) AM 78408 A
(220) 2014 08 29
(732) ATTERBURY IP COMPANY
(PROPRIETARY) LIMITED
The Atterbury Building, Lynnwood Bridge,
4 Daventry Street, Lynnwood Manor,
0081, Gauteng, South Africa

(111) M 2015 26496 R
(151) 2015 11 16
(181) 2025 11 16
(260) AM 78808 A
(220) 2014 09 26
(732) SOCIÉTÉ DES PRODUITS NESTLÉ S.A.
CH-1800 Vevey, Switzerland

(111) M 2015 26497 R
(151) 2015 11 16
(181) 2025 11 16
(260) AM 78809 A
(220) 2014 09 26
(732) SOCIÉTÉ DES PRODUITS NESTLÉ S.A.
CH-1800 Vevey, Switzerland

(111) M 2015 26498 R
(151) 2015 11 16
(181) 2025 11 16
(260) AM 78810 A
(220) 2014 09 26
(732) SOCIÉTÉ DES PRODUITS NESTLÉ S.A.
CH-1800 Vevey, Switzerland

(111) M 2015 26499 R
(151) 2015 11 16
(181) 2025 11 16
(260) AM 78898 A
(220) 2014 09 30
(732) T.C. DEBICA S.A.
ul. 1-go Maja 1, 39-200 Debica, Poland

(111) M 2015 26500 R
(151) 2015 11 16
(181) 2025 11 16
(260) AM 78981 A
(220) 2014 10 06
(732) PIERRE BALMAIN S.A
44, rue Francois 1er, 75008 Paris, France

(111) M 2015 26501 R
(151) 2015 11 16
(181) 2025 11 16
(260) AM 79046 A
(220) 2014 10 10
(732) NOVARTIS AG
4002 Basel, Switzerland

(111) M 2015 26502 R
(151) 2015 11 16
(181) 2025 11 16
(260) AM 79091 A
(220) 2014 10 15
(732) NOVARTIS AG
4002 Basel, Switzerland

(111) M 2015 26503 R
(151) 2015 11 16
(181) 2025 11 16
(260) AM 79192 A
(220) 2014 10 22
(732) SWISS PHARMA INTERNATIONAL AG
Waldmannstrasse 8, 8001 Zurich, Switzerland

(111) M 2015 26504 R
(151) 2015 11 16
(181) 2025 11 16
(260) AM 79193 A
(220) 2014 10 22
(732) SWISS PHARMA INTERNATIONAL AG
Waldmannstrasse 8, 8001 Zurich, Switzerland

(111) M 2015 26505 R
(151) 2015 11 16
(181) 2025 11 16
(260) AM 79194 A
(220) 2014 10 23

(732) JSC "IVERIA"
Gudautis q. 7, 0119, Tbilisi, Georgia

(111) M 2015 26506 R
(151) 2015 11 16
(181) 2025 11 16
(260) AM 79198 A
(220) 2014 10 24
(732) NOVARTIS AG
4002 Basel, Switzerland

(111) M 2015 26507 R
(151) 2015 11 16
(181) 2025 11 16
(260) AM 79222 A
(220) 2014 10 27
(732) PHILIP MORRIS BRANDS SÀRL
Quai Jeanrenaud 3, 2000 Neuchâtel, Switzerland

(111) M 2015 26508 R
(151) 2015 11 16
(181) 2025 11 16
(260) AM 79351 A
(220) 2014 11 04
(732) LTD "AvtoMaxx"
B. Khmel'nitsk'is g. 153a, b. 60, Tbilisi,
Georgia

(111) M 2015 26509 R
(151) 2015 11 16
(181) 2025 11 16
(260) AM 79414 A
(220) 2014 11 07
(732) LTD "G-M-P"
Sop. Ponitchala 65, 0165, Tbilisi, Georgia

(111) M 2015 26510 R
(151) 2015 11 16
(181) 2025 11 16
(260) AM 79440 A
(220) 2014 11 11
(732) SHULTON, INC.
One Procter & Gamble Plaza,
Cincinnati OH 45202, USA

(111) M 2015 26511 R
(151) 2015 11 16
(181) 2025 11 16
(260) AM 79545 A
(220) 2014 11 19
(732) BRF S.A.
Rua Jorge Tzachel, 475 Fazenda, City of
Itajaí, State of Santa Catarina, Brazil

(111) M 2015 26512 R
(151) 2015 11 16
(181) 2025 11 16
(260) AM 79653 A
(220) 2014 11 25
(732) DD IP Holder LLC.
130 Royall Street, Canton, Massachusetts
02021, USA

(111) M 2015 26513 R
(151) 2015 11 17
(181) 2025 11 17
(260) AM 75088 A
(220) 2013 12 09
(732) LA PERLA GLOBAL MANAGEMENT
S.r.l.
Via Tortona 35, Milan, Italy

TRADEMARKS REGISTERED ACCORDING TO THE ACCELERATED PROCEDURE

The decision can be appealed at the Chamber of Appeal of Sakpatenti within 3 months from the publication.

(111) M 2015 26476 R
(151) 2015 11 11
(181) 2025 11 11
(210) AM 84380
(220) 2015 10 28
(732) LTD "DIKKE INTERNATIONAL"
G. Lortkipanidzis q. 2 (Lermontovis
q. 16), 0107, Tbilisi, Georgia
(740) Davit Zurabishvili
(540)



(591) Blue, sky-blue, white
(531) 26.11.12, 27.05.10, 29.01.12
(511) 41

(111) M 2015 26477 R
(151) 2015 11 13
(181) 2025 11 13
(210) AM 78030
(220) 2014 07 22
(732) LTD "KAKHETIAN TRADITIONAL
WINEMAKING"
Ksnis q. 12, 0192, Tbilisi, Georgia
(740) Ekaterine Gogoladze
(540)



(591) Black, white
(531) 07.01.01-27.05.04-28.19.00-
(526) The trademark is protected as a whole.
"KAKHETI", "კახეთი" shall not be subject to inde-
pendent legal protection.
(511) 33

(111) M 2015 26478 R
(151) 2015 11 13
(181) 2025 11 13
(210) AM 78037
(220) 2014 07 22
(732) LTD "KAKHETIAN TRADITIONAL
WINEMAKING"
Ksnis q. 12, 0192, Tbilisi, Georgia
(740) Ekaterine Gogoladze
(540)



(591) Black, white
(531) 07.01.01-27.05.04-28.19.00-
(526) The trademark is protected as a whole.
"KAKHETI", "კახეთი" shall not be subject to inde-
pendent legal protection.
(511) 33

INTERNATIONAL TRADEMARKS FOR WHICH A DECISION ON GRANTING PROTECTIONS IS TAKEN

The decision can be appealed at the Chamber of Appeal of Sakpatenti within 3 months from the publication or at the Mtskheta District Court Administrative Cases Board (Address: №17, Samkhedro str., Mtskheta), within 1 month following the publication.

(260) AM 2015 78615 A

(800) 1214416

(891) 2014 06 11

(731) PHILIP MORRIS PRODUCTS S.A.

Quai Jeanrenaud 3, CH-2000 Neuchâtel,
Switzerland

(540)



(591) Black, white, grey

(511)

9 – Batteries for electronic cigarettes; batteries for electronic devices that are used for heating tobacco; battery chargers for electronic devices that are used for heating tobacco; USB chargers for electronic devices that are used for heating tobacco; car chargers for electronic cigarettes; car chargers for devices that are used for heating tobacco.

11 – Electronic vaporizers; apparatus for heating liquids; apparatus for generating vapor, wired vaporizer.

34 – Tobacco, raw or manufactured; tobacco products; including cigars, cigarettes, cigarillos, tobacco for roll-your-own cigarettes, pipe tobacco, chewing tobacco, snuff tobacco, kretek; snus; tobacco substitutes (not for medical purposes); smokers' articles, including cigarette paper and tubes, cigarette filters, tobacco tins, cigarette cases and ashtrays, pipes, pocket apparatus for rolling cigarettes, lighters; matches; tobacco sticks, heated tobacco products, electronic devices that heat cigarettes; electronic smoking apparatus; electronic cigarettes; electronic cigarettes for use as an alternative to traditional cigarettes; electronic nicotine inhalation devices; vaporizing devices for tobacco, tobacco products and tobacco substitutes; smokers' articles for electronic cigarettes; chargers, extinguishers and accessories, parts and fittings for use in connection with electronic cigarettes or apparatus for heating tobacco; electronic rechargeable cigarette cases.

(260) AM 2015 78938 A

(800) 1217015

(891) 2014 07 14

(731) SPORTING CLUBE DE PORTUGAL

Estádio José Alvalade, Rua Prifessor Fernando da Fonseca, P-1600-616 Lisboa, Portugal

(540)



(591) Black, white

(511)

25 – Clothing, footwear, headgear.

28 – Games and playthings; gymnastic and sporting articles not included in other classes; decorations for Christmas trees.

35 – Business management and business administration.

41 – Education; providing of training; entertainment and sporting and cultural activities.

(260) AM 2015 79398 A

(800) 1221160

(891) 2014 07 14

(731) SPORTING CLUBE DE PORTUGAL

Estádio José Alvalade, Rua Prifessor
Fernando da Fonseca, P-1600-616 Lisboa,
Portugal

(540)

SPORTING
CLUBE DE
PORTUGAL

(591) Black, white

(511)

25 – Clothing, footwear, headgear.

28 – Games and playthings; gymnastic and sporting articles not included in other classes; decorations for Christmas trees.

35 – Advertising; business management; business administration; office functions.

(260) AM 2015 79732 A

(800) 840857

(891) 2014 07 28

(731) International Laboratory Accreditation
Cooperation vereniging naar Nederlands recht
Radboudkwartier 223, 3511 CJ Utrecht,
Netherlands

(540)



(591) Black, white

(511)

42 – Development, recordal and maintenance of norms and standards for harmonizing processes and methods for the accreditation of testing and calibration laboratories and inspection institutions and the development and updating of regulations for the mutual and international recognition of calibration certificates and testing and inspection reports; advising accreditation institutions regarding the acquisition of international recognition of their calibration certificates, testing and inspection reports; the organisation of mutual assessment studies regarding the functioning of the national accreditation organisations and conducting research as to the necessity of interpretation of the relevant aspects of conformity assessments for improving harmonisation.

(260) AM 2015 79737 A

(800) 1162505

(891) 2014 11 04

(731) PANDORA A/S

Hovedvejen 2, DK-2600 Glostrup, Denmark

(540)

PANDORA ESSENCE COLLECTION

(511)

14 – Jewellery.

(260) AM 2015 79738 A

(800) 1198102

(891) 2014 01 20

(731) HENKEL AG & CO. KGAA

Henkelstraße 67, 40589 Düsseldorf, Germany

(540)



(591) Red, blue and white

(511)

3 – Soaps not for personal use, washing and bleaching preparations and other substances for laundry use, rinsing agents for laundry and tableware; cleaning, polishing, degreasing and abrasive preparations; preparations for cleaning metal, wood, stone, porcelain, glass, synthetics and textiles; crust preventing and crust resolving agents for pipes and apparatus namely decalcification agents for household purpose.

5 – Disinfectants; deodorant and deodorising agents, except for humans and animals.

(260) AM 2015 79850 A

(800) 1224852

(891) 2014 09 05

(731) DIVAPHARMA GmbH

Motzener Str. 41, 12277 Berlin, Germany

(540)

broncho-angin

(511)

5 – Pharmaceutical and veterinary preparations; sanitary preparations for medical purposes; dietetic food and substances adapted for medical or veterinary use, food for babies; dietary supplements for humans and animals; plasters, materials for dressings; material for stopping teeth, dental wax; disinfectants; preparations for destroying vermin; fungicides, herbicides.

29 – Meat, fish, poultry and game; meat extracts; preserved, frozen, dried and cooked fruits and vegetables; jellies, jams, compotes; eggs, milk and milk products; edible oils and fats.

30 – Coffee, tea, cocoa, sugar, rice, tapioca, sago, artificial coffee; flour and preparations made from cereals, bread, pastry and confectionery, edible ices; honey, treacle; yeast, baking-powder; salt, mustard; vinegar, sauces (condiments); spices; ice.

(260) AM 2015 80062 A

(800) 1089698

(891) 2014 10 23

(731) AEROPOSTALE PROCUREMENT

COMPANY, INC.

112 W. 34th Street, 22nd Floor New York

NY 10120, USA

(540)

PS4U

(511)

3 – Cosmetics and personal care products for children, namely, bath beads, bath fizzies, bath soap, body glitter, body scrub, body wash, bubble bath; cosmetics and make-up, namely, blush, eye shadow, foundation make-up, lipstick, make-up pencils, make-

up powder, make-up remover; nail polish, nail art stickers, facial cleansers, skin cleansers, foot scrubs, hair conditioner, hair shampoo; non-medicated skin care preparations, namely, lotion for the face, lotion for the hands, skin moisturizer; styling gels, lip balm, lip gloss, mouthwash, shower gel, sunscreen preparations, sun block and sun tan lotion all available in retail stores and online retail stores.

18 – Hand bags, all-purpose carrying bags, backpacks, beach bags, book bags, coin purses, clutch bags, cosmetic bags sold empty, messenger bags, purses, tote bags, wallets and umbrellas, all available in retail stores and online retail stores.

25 – Clothing, namely girls' and boys' wearing apparel, namely jeans, shirts, T-shirts, polo shirts, knit shirts, tank tops; outerwear, namely, jackets, coats, raincoats, scarves; pants, sweaters, sweatshirts, hooded sweatshirts, sweatpants, shorts, board shorts, swimsuits, rash guards, loungewear, pajamas, belts, socks, gloves; undergarments, namely, panties, boxer shorts and briefs; footwear, namely shoes, boots, flip flops, sandals, slippers and sneakers; and headgear, namely hats and caps, all available in retail stores and online retail stores.

(260) AM 2015 80244 A

(800) 1192114

(891) 2014 09 08

(731) PharmaS d.o.o. za proizvodnju i promet
lijekova

Radnička 47, HR-10000 Zagreb, Croatia

(540)

Pharmas pro balans

(511)

5 – Pharmaceutical and veterinary preparations; sanitary preparations for medical purposes; dietetic substances adapted for medical use, food for babies; food supplements, plasters, materials for dressing; material for stopping teeth, dental wax; disinfectants; preparations for destroying vermin; fungicides; herbicides.

(260) AM 2015 80267 A

(800) 1228793

(891) 2014 09 10

(731) Limited Liability Company

"TRUSTINVESTSTROI"

Fruit and vegetable base, Warehouse No:30,

Ramensky district, Kuznetsovo village,

RU-140192 Moscow region, Russian

Federation

(540)

Baker House

(591) Black and White

(511)

30 – Aromatic preparations for food; flavorings, other than essential oils, for cakes; star aniseed; cookies; pancakes; buns; bread rolls; vanillin [vanilla substitute]; vanilla [flavoring]; waffles; vermicelli [noodles]; coffee flavorings; natural sweeteners; sausage binding materials; binding agents for ice cream; edible ices; sea water for cooking; glucose for culinary purposes; mustard; yeast; thickening agents for cooking foodstuffs; rice-based snack food; cereal-based snack food; artificial coffee; vegetal preparations for use as coffee substitutes; pastries; confectionery for decorating Christmas trees; fruit jellies [confectionery]; cakes; peanut confectionery; almond confectionery; pasta; pasties; frozen yoghurt [confectionery ices]; cocoa; capers; caramels; gruel, with a milk base, for food; quiches; gluten prepared as foodstuff; sweetmeats; liquorice [confectionery]; peppermint sweets; coffee; unroasted coffee; starch for food; crackers; hominy grits; groats for human food; corn, milled; corn, roasted; meat pies; turmeric for food; couscous [semolina]; farinaceous foods; noodles; ice for refreshment; ice, natural or artificial; candy; rice cakes; maltose; hominy; marzipan; custard; honey; royal jelly; ice cream; sorbets [ices]; bean meal; tapioca flour for food; potato flour for food; corn flour; flour; wheat flour; soya flour; barley meal; muesli; mint for confectionery; cocoa beverages with milk; coffee beverages with milk; coffee-based beverages; tea-based beverages; chocolate beverages with milk; chocolate-based beverages; cocoa-based beverages; infusions, not medicinal; crushed oats; husked oats; nutmegs; pastilles [confectionery]; molasses for food; pepper; petits fours [cakes]; biscuits; malt biscuits; macaroons [pastries]; petit-beurre biscuits; pies; pizzas; fondants [confectionery]; popcorn; powders for ice cream; pralines; condiments; chow-chow [condiment]; relish [condiment]; chutneys; meat tenderizers, for household purposes; cereal preparations; flour-milling products; oat-based food; bee glue; gingerbread; cinnamon [spice]; cloves [spice]; spices; allspice; ginger [spice]; puddings; cake powder; ravioli; chewing gum; rice; spring rolls; sugar; aniseed; cake paste; confectionery; baking soda; tapioca; malt for human consumption; salt for preserving foodstuffs; cooking salt; celery salt; spaghetti; seasonings; saffron [seasoning]; preparations for stiffening whipped cream; rusks; breadcrumbs; sushi; sandwiches; garden herbs, preserved [seasonings]; tacos; soya bean paste [condiment]; almond paste; tortillas; tarts; garden herbs, preserved; vinegar; ferments for pastes; halvah; bread; unleavened bread; chips [cereal products]; chicory [coffee substitute]; tea; iced tea; chocolate; malt extract for food; essences for foodstuffs, except etheric essences and essential oils.

(260) AM 2015 80337 A

(800) 1229771

(891) 2014 09 12

(731) Zuffa, LLC

2960 W. Sahara Avenue, Las Vegas

NV 89102, USA

(540)

ULTIMATE FIGHTING

(511)

41 – Entertainment, namely live stage shows and performances featuring sports and mixed martial arts.

(260) AM 2015 80372 A

(800) 1230203

(891) 2014 08 11

(731) KASTAMONU ENTEGRE AĞAÇ SANAYİ VE TİCARET ANONİM ŞİRKETİ

Mahir İz Cad. No:25, Altunizade Üsküdar,

İstanbul, Turkey

(540)

Goldenclick

(511)

19 – Sand, gravel, crushed stone, asphalt, bitumen, cement, gypsum for use in construction, road construction, repair and covering work, building materials as finished products made of concrete, gypsum, clay, potters' clay, natural or artificial stone, wood, plastics and synthetic materials for building, buildings not of metal construction, road construction purposes, included in this class; non-metallic building materials, non-metallic transportable buildings, poles not of metal, barriers not of metal, doors and windows of wood and synthetic materials, traffic signs not of metal, non-luminous and non-mechanical, for roads, monuments and statuettes of stone, concrete and marble, natural and synthetic surface coatings in the form of panels and sheets, being building materials; heat adhesive synthetic surface coating, being building materials; bitumen cardboard coatings for roofing; bitumen coating for roofing, building glass, prefabricated swimming pools not of metal structures, aquarium sand.

(260) AM 2015 80376 A

(800) 1230256

(891) 2014 09 12

(731) Joint-Stock Company "KRASNYJ OCTYABR"

ul. Malaya Krasnoselskaya, d. 7, str. 24,

RU-107140 Moscow, Russian Federation

(540)

**СЛАВЯНСКИЙ
ПРОСТОР**

(591) Black, white

(511)

30 – Confectionery made of sugar, namely caramels, sweets, chocolate, pralines.

(260) AM 2015 80386 A

(800) 1230352

(891) 2013 12 26

(731) KARTOPU KOLONYA VE PLASTİK SANAYİ İTHALAT İHRACAT VE TİCARET LİMİTED ŞİRKETİ

Kışla Cad. Fabrikalar Sok., İşkent Sanayi

Sitesi A, Blok No:62-63 Rami, İSTANBUL,

Turkey

(540)



(591) Black and White

(511)

3 – Perfumery; essential oils; colognes; lotions for cosmetic purposes; deodorants and anti-perspirants for personal use; after-shave lotions; cosmetics; cosmetic cases, filled; cosmetic creams; shampoos; shower gels; petroleum jelly for cosmetic purposes; hair removing creams; tissues impregnated with cosmetic lotions; cotton wool for cosmetic purposes; nail polish removers containing acetone; dentifrices; tooth paste; tooth whitening pastes; tooth powders; moistened tooth powder; tooth cleaning preparations; tooth cleaning preparations for medical use; cleaning preparations for dental prosthesis; mouthwashes, not for medical purposes; soaps for personal use; soaps for medical use; deodorising soaps; antiperspirant soap; soap for foot perspiration; abrasive preparations; emery cloth; sandpaper; pumice stone; abrasive pastes.

(260) AM 2015 80389 A

(800) 1230364

(891) 2014 04 15

(731) PRIVATE JOINT STOCK COMPANY "INDUSTRIAL ASSOCIATION "KONTI"

Bul. Shevchenko, 6-b, Donetsk 83015, Ukraine

(540)



(591) Black and White

(511)

28 – Games and playthings; gymnastic and sporting articles not included in other classes; decorations for Christmas trees; air pistols (toys); amusement machines, automatic and coin-operated; apparatus for games; appliances for gymnastics; arcade video ga-

me machines; archery implements; artificial fishing bait; artificial snow for Christmas trees; ascenders (mountaineering equipment); backgammon games; bags especially designed for skis and surfboards; ball pitching machines; balls for games; bar-bells; baseball gloves; batting gloves (accessories for games); bells for Christmas trees; billiard balls; billiard cues; billiard cue tips; billiard markers; billiard table cushions; billiard tables; bingo cards; bite indicators (fishing tackle); bite sensors (fishing tackle); bladders of balls for games; board games; bob-sleighs; bodyboards; body-building apparatus; bowling apparatus and machinery; bows for archery; boxing gloves; building blocks (toys); building games; butterfly nets; camouflage screens (sports articles); candle holders for Christmas trees; caps for pistols (toys); carnival masks; chalk for billiard cues; checkerboards; checkers (games); chessboards; chess games; chest expanders (exercisers); chips for gambling; Christmas trees of synthetic material; Christmas tree stands; clay pigeons (targets); clay pigeon traps; climbers' harness; coin-operated billiard tables; confetti; conjuring apparatus; controllers for game consoles; counters (discs) for games; creels (fishing traps); cricket bags; cups for dice; darts; decoys for hunting or fishing; dice; discuses for sports; divot repair tools (golf accessories); dolls; dolls' beds; dolls' clothes; dolls' feeding bottles; dolls' houses; dolls' rooms; dominoes; dumb-bells; edges of skis; elbow guards (sports articles); electronic targets; explosive bonbons (Christmas crackers); fairground ride apparatus; fencing gauntlets; fencing masks; fencing weapons; fish hooks; fishing tackle; flippers for swimming; floats for fishing; flying discs (toys); foosball tables; games; gaming machines for gambling; gloves for games; golf bags, with or without wheels; golf clubs; golf gloves; gut for fishing; gut for rackets; hang gliders; harness for sailboards; harpoon guns (sports articles); hockey sticks; horseshoe games; hunting game calls; ice skates; in-line roller skates; jigsaw puzzles; kaleidoscopes; kite reels; kites; knee guards (sports articles); landing nets for anglers; lines for fishing; machines for physical exercises; mah-jong; marbles for games; masks (plaything); masts for sailboards; men's athletic supporters (sports articles); mobiles (toys); nets for sports; novelties for parties, dances (party favors, favours); ornaments for Christmas trees, except illumination articles and confectionery; pachinkos; paintball guns (sports apparatus); paintballs (ammunition for paintball guns) (sports apparatus); paper party hats; paragliders; parlor games; percussion caps (toys); piñatas; play balloons; playing balls; playing cards; plush toys; poles for pole vaulting; portable games with liquid crystal displays; practical jokes (novelties); protective paddings (parts of sports suits); punching bags; puppets; quoits; rackets; radio-controlled toy vehicles; rattles (playthings); reels for fishing; ring games; rocking horses; rods for fishing; rollers for

stationary exercise bicycles; roller skates; rosin used by athletes; roulette wheels; sailboards; scale model kits (toys); scale model vehicles; scent lures for hunting or fishing; scooters (toys); scrapers for skis; scratch cards for playing lottery games; seal skins (coverings for skis); shin guards (sports articles); shuttlecocks; skateboards; skating boots with skates attached; ski bindings; skis; skittles; skittles (games); sleds (sports articles); slides (playthings); sling shots (sports articles); slot machines (gaming machines); snowboards; snow globes; snowshoes; soap bubbles (toys); sole coverings for skis; spinning tops (toys); spring boards (sports articles); starting blocks for sports; stationary exercise bicycles; strings for rackets; stuffed toys; surfboard leashes; surfboards; surf skis; swimming belts; swimming jackets; swimming kick boards; swimming pools (play articles); swings; tables for table tennis; targets; teddy bears; tennis ball throwing apparatus; tennis nets; theatrical masks; toy figures; toy models; toy pistols; toys; toys for domestic pets; toy vehicles; trampolines; twirling batons; video game machines; waterskis; water wings; wax for skis; weight lifting belts (sports articles).

30 – Coffee, tea, cocoa and artificial coffee; rice; tapioca and sago; flour and preparations made from cereals; bread, pastry and confectionery; ices; sugar, honey, treacle; yeast, baking-powder; salt; mustard; vinegar, sauces (condiments); spices; ice; aniseed; peanut confectionery; high-protein cereal bars; baking soda (bicarbonate of soda for cooking purposes); soya bean paste (condiment); bean meal; star aniseed; tapioca flour for food; flour; flour-milling products; bread rolls; buns; sandwiches; vanillin (vanilla substitute); vanilla (flavoring); waffles; vermicelli (noodles); cream of tartar for culinary purposes; farinaceous foods; oatmeal; oat flakes; oat-based food; sea water for cooking; seaweed (condiment); binding agents for ice cream (edible ices); biscuits; cloves (spice); mustard meal; cake frosting (icing); glucose for culinary purposes; relish (condiment); gluten additives for culinary purposes; essences for foodstuffs, except etheric essences and essential oils; fruit jellies (confectionery); chewing gum; custard; leaven; rice-based snack food; cereal-based snack food; frozen yogurt (confectionery ices); frozen kefir (confectionery ices); flavorings, other than essential oils, for beverages; flavorings, other than essential oils, for cakes; flavorings, other than essential oils; wheat germ for human consumption; preparations for stiffening whipped cream; thickening agents for cooking foodstuffs; chips (cereal products); ginger (spice); unroasted coffee; coffee flavorings; coffee-based beverages; coffee beverages with milk; vegetal preparations for use as coffee substitutes; cocoa beverages with milk; cocoa-based beverages; cocoa-based ingredients for confectionery products; cocoa; cocoa mixes; cocoa powder; capers; caramels (candy); lozenges (confec-

tionery); curry (spice); potato flour for food; ketchup (sauce); gluten prepared as foodstuff; sugar confectionery; tortillas; cinnamon (spice); starch for food; hominy grits; groats for human food; corn, milled; corn, roasted; corn flour; popcorn; corn flakes; turmeric for food; couscous (semolina); salt for presser-ving foodstuffs; confectionery for decorating Christmas trees; edible ices; ice for refreshment; ice, natural or artificial; liquorice (confectionery); noodles; candy; flaxseed for human consumption; mayonnaise; macaroni; maltose; hominy; chow-chow (condiment); marinades; marzipan; royal jelly; honey; molasses for food; macarons (pastry); almond paste; almond confectionery; pancakes; spring rolls; gruel, with a milk base, for food; ice-cream; dessert mousses (confectionery); chocolate mousses; nutmegs; muesli; meat gravies; meat tenderizers, for household purposes; mint for confectionery; peppermint sweets; infusions, not medicinal; husked oats; ravioli; pepper; pesto (sauce); beer vinegar; quiches; sweetmeats (candy); pizzas; pies; fondants (confectionery); powder for edible ices; pralines; condiments; dressings for salad; seasonings; unleavened bread; bee glue; gingerbread; puddings; cake powder; fruit coulis (sauces); rice cakes; baking powder; ferments for pastes; sago; garden herbs, preserved (seasonings); celery salt; golden syrup; soya flour; soya sauce; malt for human consumption; malt biscuits; malt extract for food; tomato sauce; spaghetti; noodle-based prepared meals; ham glaze; rusks; breadcrumbs; petit-beurre biscuits; sushi; tabbouleh; tacos; tapioca; petits fours (cakes); crackers; cake dough; tarts; sorbets (ices); halvah; bread; chicory (coffee substitute); iced tea; tea-based beverages; chutneys (condiments); saffron (seasoning); chocolate; chocolate-based beverages; chocolate beverages with milk; barley meal; crushed barley.

(260) AM 2015 80390 A

(800) 1230366

(891) 2014 05 29

(731) BORA CREATIONS S.L.

Calle Rey Sancho, 7, Local 3, E-07180 Santa Ponsa, Mallorca, Spain

(540)

ESSENCE

(511)

3 – Preparations for cleaning, care and beautification of the skin, nails and hair; hair colorants; hair dyes; hair styling products; hair lotions; hair care products; soaps; perfumery; fragrances; perfumes; eau de toilette; eau de parfum; cosmetics; cosmetic products for decorative purposes; eye make-up removers; make-up removing preparations; nail polish remover; make-up; bB cream (blemish balm); cosmetic powder; rouge; tinted facial cream; tinted body cream; cosmetic concealer; cosmetic blemish stick; highlighter for the beautification of the skin; tattoo pencils;

mascara; powder for increasing eyelash volume; eye shadow powder; eye shadow cream; eye shadow foundation; eyebrow powder; eyebrow cream; eyebrow pencils; liquid eye liner, powder eye liner, eye liner pencils, eye liner gel; kayal eye pencils; lip glosses; lip balm; lipstick; lip liner; nail polish; express drying drops for nail polish; artificial nails; nail pencil for French manicure; nail whitening pencils; nail whiteners; nail polish correction pencils; nail care pencils; nail gel; primer for preparation of gel manicure; cleanser; nail polish base coat; nail polish top coat; nail hardener; oils for treatment of nails and cuticles; stickers for beautification, care and protection of finger nails; french manicure tip guides; products for sculpting and making of false fingernails (cosmetics); nail polish with metallic or other effects; nail decoration glitter; cosmetic powders; gems and accessories for decorating nails; nail care products (included in this class); products for sculpting and making of gel nails (cosmetics); hand creams; glitter spray; body tattoos; false eyelashes.

4 – Candles; scented candles (included in this class).

8 – Hand-operated hand tools and instruments for the cosmetic and decorative care of finger and foot nails; nail files; nail polishing files; emery files; nail scissors; nail clippers; rosewood sticks; tongs; tweezers; applicators for false eyelashes.

9 – Sunglasses; spectacles; spectacle cases; covers for mobile telephones and for smartphones; cases for ipads; cases for laptops.

16 – Stationery; paper, cardboard and goods made from these materials not included in other classes.

18 – Empty cosmetic bags; vanity cases; handbags; umbrellas; leather goods and goods of imitations of leather not included in other classes.

21 – Combs; hair brushes, body brushes; nail brushes; cosmetic sponges; cosmetic brushes; applicators for cosmetics; glassware; porcelain goods not included in other classes.

25 – Kerchiefs (clothing); belts; clothing; footwear; headgear; clothing accessories included in this class; underwear; stockings; tights; gaiters (underwear).

26 – Hair ornaments; barrettes [hair-slides]; hair bands; bows for the hair.

35 – Retail store services featuring cosmetic and beauty products.

44 – Beauty care services.

(260) AM 2015 80392 A

(800) 1230380

(891) 2014 07 28

(731) DIVERSE BRAND & MARKETING
SP. Z O.O.

ul. Grzybowska 5A, PL-00-132 Warszawa,
Poland

(540)

DIVERSE

(511)

3 – Body and haircare preparations, perfumery, essential oils, toiletries for washing and shaving.

9 – Spectacles, spectacle cases.

18 – Travelling bags, sports bags, shopping bags, beach bags, rucksacks, bags for campers, suitcases, school haversacks, office attache cases, attache cases, travel cases, cases of leather and imitations of leather, key cases, ladies handbags, wallets, purses.

25 – Clothing, footwear, headgear, furs, coats, jackets, suits, jackets, waistcoats, sweatshirts, suits, trousers, shorts, skirts, shirts, blouses, dresses, jumpers, pullovers, tracksuits, baby ware and adults underwear, socks, tights, stocking, hats, caps, belts, neckerchiefs, shawls, ties, bow ties.

32 – Beers, mineral and aerated waters and other non-alcoholic drinks, fruit drinks and fruit juices, syrups and other preparations for making beverages, energy drinks.

35 – Wholesale and retail shop services with clothing, footwear, caps and other headgear, tights, underwear, cosmetics, toilet agents, spectacles, spectacle cases, travelling bags, bags, sports bags, shopping bags, rucksacks, bags for campers, suitcases, school haversacks, office attache cases, attache cases, cases, suitcases, ladies handbags, wallets, purses, home, office, stores and hotel furniture; management of a retail enterprise for others; commercial business management; wholesale and retail shop services with beers, mineral and aerated waters and other non-alcoholic drinks, fruit drinks and fruit juices, syrups and other preparations for making beverages, energy drinks.

(260) AM 2015 80393 A

(800) 1230381

(891) 2014 07 28

(731) DIVERSE BRAND & MARKETING SP.
Z O.O.

ul. Grzybowska 5A, PL-00-132 Warszawa,
Poland

(540)

DIVERSE EXTREME TEAM

(511)

3 – Body and haircare preparations, perfumery, essential oils, toiletries for washing and shaving.

9 – Spectacles, spectacle cases.

18 – Travelling bags, sports bags, shopping bags, beach bags, rucksacks, bags for campers, suitcases, school haversacks, office attache cases, attache ca-

ses, travel cases, cases of leather and imitations of leather, key cases, ladies handbags, wallets, purses.

25 – Clothing, footwear, headgear, furs, coats, jackets, suits, jackets, waistcoats, sweatshirts, suits, trousers, shorts, skirts, shirts, blouses, dresses, jumpers, pullovers, tracksuits, baby ware and adults underwear, socks, tights, stocking, hats, caps, belts, neckerchiefs, shawls, ties, bow ties.

32 – Beers, mineral and aerated waters and other non-alcoholic drinks, fruit drinks and fruit juices, syrups and other preparations for making beverages, energy drinks.

35 – Wholesale and retail shop services with clothing, footwear, caps and other headgear, tights, underwear, cosmetics, toilet agents, spectacles, spectacle cases, travelling bags, bags, sports bags, shopping bags, rucksacks, bags for campers, suitcases, school haversacks, office attache cases, attache cases, cases, suitcases, ladies handbags, wallets, purses, home, office, stores and hotel furniture; management of a retail enterprise for others; commercial business management; wholesale and retail shop services with beers, mineral and aerated waters and other non-alcoholic drinks, fruit drinks and fruit juices, syrups and other preparations for making beverages, energy drinks.

(260) AM 2015 80394 A

(800) 1230389

(891) 2014 06 28

(731) JSC "IGRISTIE VINA"

Sverdlovskaya naberezhnaya, 34, RU-195027
Saint-Petersburg, Russian Federation

(540)

Наследие мастера Левъ Голицынь

(591) Black and White

(511)

33 – Brandy; wine; alcoholic beverages.

(260) AM 2015 80395 A

(800) 1230420

(891) 2014 10 03

(731) "VUQMA – QIDA" Limited Liability
Company

70, Ajemi Nakhchivani str., Binagadi district,
AZ-1130 Baku, Azerbaijan

(540)

DOLCENUTS

(511)

29 – Preserved, frozen, dried and cooked fruits and vegetables; jellies, jams, compotes; eggs; milk and milk products; edible oils and fats.

30 – Confectionery.

35 – Sale of goods indicated in classes 29 and 30.

39 – Packaging of goods indicated in 29 and 30.

(260) AM 2015 80400 A

(800) 1230530

(891) 2014 05 07

(731) Saimaa Beverages OY LTD

Valtakatu 2 PL 226, FI-53101 Lappeenranta,
Finland

(540)

Saimaa

(591) Black and White

(511)

32 – Beers; mineral and aerated waters and other non-alcoholic beverages; fruit beverages and fruit juices; syrups and other preparations for making beverages.

33 – Alcoholic beverages (except beer).

(260) AM 2015 80402 A

(800) 1230532

(891) 2014 05 13

(731) PRIVATE JOINT STOCK COMPANY

"INDUSTRIAL ASSOCIATION "KONTI"

Bul. Shevchenko, 6-b, Donetsk 83015,
Ukraine

(540)



(591) Black, white, brown, light brown, dark brown, yellow, red, blue, dark blue and light blue.

(511)

28 – Games and playthings; gymnastic and sporting articles not included in other classes; decorations for Christmas trees; air pistols (toys); amusement machines, automatic and coin-operated; apparatus for games; appliances for gymnastics; arcade video game machines; archery implements; artificial fishing bait; artificial snow for Christmas trees; ascenders (mountaineering equipment); backgammon games; bags especially designed for skis and surfboards; ball pitching machines; balls for games; bar-bells; baseball gloves; batting gloves (accessories for games); bells for Christmas trees; billiard balls; billiard cues; billiard cue tips; billiard markers; billiard table cushions; billiard tables; bingo cards; bite indicators (fishing tackle); bite sensors (fishing tackle); blad-

ders of balls for games; board games; bob-sleighs; bodyboards; body-building apparatus; bowling apparatus and machinery; bows for archery; boxing gloves; building blocks (toys); building games; butterfly nets; camouflage screens (sports articles); candle holders for Christmas trees; caps for pistols (toys); carnival masks; chalk for billiard cues; checkerboards; checkers (games); chessboards; chess games; chest expanders (exercisers); chips for gambling; Christmas trees of synthetic material; Christmas tree stands; clay pigeons (targets); clay pigeon traps; climbers' harness; coin-operated billiard tables; confetti; conjuring apparatus; controllers for game consoles; counters (discs) for games; creels (fishing traps); cricket bags; cups for dice; darts; decoys for hunting or fishing; dice; discuses for sports; divot repair tools (golf accessories); dolls; dolls' beds; dolls' clothes; dolls' feeding bottles; dolls' houses; dolls' rooms; dominoes; dumb-bells; edges of skis; elbow guards (sports articles); electronic targets; explosive bonbons (Christmas crackers); fairground ride apparatus; fencing gauntlets; fencing masks; fencing weapons; fish hooks; fishing tackle; flippers for swimming; floats for fishing; flying discs (toys); foosball tables; games; gaming machines for gambling; gloves for games; golf bags, with or without wheels; golf clubs; golf gloves; gut for fishing; gut for rackets; hang gliders; harness for sailboards; harpoon guns (sports articles); hockey sticks; horseshoe games; hunting game calls; ice skates; in-line roller skates; jigsaw puzzles; kaleidoscopes; kite reels; kites; knee guards (sports articles); landing nets for anglers; lines for fishing; machines for physical exercises; mah-jong; marbles for games; masks (plaything); masts for sailboards; men's athletic supporters (sports articles); mobiles (toys); nets for sports; novelties for parties, dances (party favors, favours); ornaments for Christmas trees, except illumination articles and confectionery; pachinkos; paintball guns (sports apparatus); paintballs (ammunition for paintball guns) (sports apparatus); paper party hats; paragliders; parlor games; percussion caps (toys); pinatas; play balloons; playing balls; playing cards; plush toys; poles for pole vaulting; portable games with liquid crystal displays; practical jokes (novelties); protective paddings (parts of sports suits); punching bags; puppets; quoits; rackets; radio-controlled toy vehicles; rattles (playthings); reels for fishing; ring games; rocking horses; rods for fishing; rollers for stationary exercise bicycles; roller skates; rosin used by athletes; roulette wheels; sailboards; scale model kits (toys); scale model vehicles; scent lures for hunting or fishing; scooters (toys); scrapers for skis; scratch cards for playing lottery games; seal skins (coverings for skis); shin guards (sports articles); shuttlecocks; skateboards; skating boots with skates attached; ski bindings; skis; skittles; skittles (games); sleds (sports articles); slides (playthings); sling shots (sports articles); slot machines (gaming

machines); snowboards; snow globes; snowshoes; soap bubbles (toys); sole coverings for skis; spinning tops (toys); spring boards (sports articles); starting blocks for sports; stationary exercise bicycles; strings for rackets; stuffed toys; surfboard leashes; surfboards; surf skis; swimming belts; swimming jackets; swimming kick boards; swimming pools (play articles); swings; tables for table tennis; targets; teddy bears; tennis ball throwing apparatus; tennis nets; theatrical masks; toy figures; toy models; toy pistols; toys; toys for domestic pets; toy vehicles; trampolines; twirling batons; video game machines; waterskis; water wings; wax for skis; weight lifting belts (sports articles).

30 – Coffee, tea, cocoa and artificial coffee; rice; tapioca and sago; flour and preparations made from cereals; bread, pastry and confectionery; ices; sugar, honey, treacle; yeast, baking-powder; salt; mustard; vinegar, sauces (condiments); spices; ice; aniseed; peanut confectionery; high-protein cereal bars; baking soda (bicarbonate of soda for cooking purposes); soya bean paste (condiment); bean meal; star aniseed; tapioca flour for food; flour; flour-milling products; bread rolls; buns; sandwiches; vanillin (vanilla substitute); vanilla (flavoring); waffles; vermicelli (noodles); cream of tartar for culinary purposes; farinaceous foods; oatmeal; oat flakes; oat-based food; sea water for cooking; seaweed (condiment); binding agents for ice cream (edible ices); biscuits; cloves (spice); mustard meal; cake frosting (icing); glucose for culinary purposes; relish (condiment); gluten additives for culinary purposes; essences for foodstuffs, except etheric essences and essential oils; fruit jellies (confectionery); chewing gum; custard; leaven; rice-based snack food; cereal-based snack food; frozen yogurt (confectionery ices); frozen kefir (confectionery ices); flavorings, other than essential oils, for beverages; flavorings, other than essential oils, for cakes; flavorings, other than essential oils; wheat germ for human consumption; preparations for stiffening whipped cream; thickening agents for cooking foodstuffs; chips (cereal products); ginger (spice); unroasted coffee; coffee flavorings; coffee-based beverages; coffee beverages with milk; vegetal preparations for use as coffee substitutes; cocoa beverages with milk; cocoa-based beverages; cocoa-based ingredients for confectionery products; cocoa; cocoa mixes; cocoa powder; capers; caramels (candy); lozenges (confectionery); curry (spice); potato flour for food; ketchup (sauce); gluten prepared as foodstuff; confectionery with sugar; tortillas; cinnamon (spice); starch for food; hominy grits; groats for human food; corn, milled; corn, roasted; corn flour; pop corn; corn flakes; turmeric for food; couscous (semolina); salt for preserving foodstuffs; confectionery for decorating Christmas trees; edible ices; ice for refreshment; ice, natural or artificial; liquorice (confectionery); noodles; candy; flaxseed for human consumption; may-

onnaise; macaroni; maltose; hominy; chow-chow (condiment); marinades; marzipan; royal jelly; honey; molasses for food; macaroons (pastry); almond paste; almond confectionery; pancakes; spring rolls; gruel, with a milk base, for food; ice-cream; dessert mousses (confectionery); chocolate mousses; nutmegs; muesli; meat gravies; meat tenderizers, for household purposes; mint for confectionery; peppermint sweets; infusions, not medicinal; husked oats; ravioli; pepper; pesto (sauce); beer vinegar; quiches; sweetmeats (candy); pizzas; pies; fondants (confectionery); powder for edible ices; pralines; condiments; dressings for salad; seasonings; unleavened bread; bee glue; gingerbread; puddings; cake powder; fruit coulis (sauces); rice cakes; baking powder; ferments for pastes; sago; garden herbs, preserved (seasonings); celery salt; golden syrup; soya flour; soya sauce; malt for human consumption; malt biscuits; malt extract for food; tomato sauce; spaghetti; noodle-based prepared meals; ham glaze; rusks; breadcrumbs; petit-beurre biscuits; sushi; tabbouleh; tacos; tapioca; petits fours (cakes); crackers; cake dough; tarts; sorbets (ices); halvah; bread; chicory (coffee substitute); iced tea; tea-based beverages; chutneys (condiments); saffron (seasoning); chocolate; chocolate-based beverages; chocolate beverages with milk; barley meal; crushed barley.

(260) AM 2015 80406 A

(800) 1230533

(891) 2014 05 13

(731) PRIVATE JOINT STOCK COMPANY
"INDUSTRIAL ASSOCIATION "KONTI"
Bul. Shevchenko, 6-b, Donetsk 83015,
Ukraine

(540)



(591) Black, white, brown, light brown, dark brown, yellow, red, blue, dark blue and light blue

(511)

28 – Games and playthings; gymnastic and sporting articles not included in other classes; decorations for Christmas trees; air pistols (toys); amusement machines, automatic and coin-operated; apparatus for games; appliances for gymnastics; arcade video game machines; archery implements; artificial fishing bait; artificial snow for Christmas trees; ascenders (mountaineering equipment); backgammon games; bags especially designed for skis and surfboards; ball pitching machines; balls for games; barbells; baseball gloves; batting gloves (accessories for

games); bells for Christmas trees; billiard balls; billiard cues; billiard cue tips; billiard markers; billiard table cushions; billiard tables; bingo cards; bite indicators (fishing tackle); bite sensors (fishing tackle); bladders of balls for games; board games; bobsleighs; bodyboards; body-building apparatus; bowling apparatus and machinery; bows for archery; boxing gloves; building blocks (toys); building games; butterfly nets; camouflage screens (sports articles); candle holders for Christmas trees; caps for pistols (toys); carnival masks; chalk for billiard cues; checkerboards; checkers (games); chessboards; chess games; chest expanders (exercisers); chips for gambling; Christmas trees of synthetic material; Christmas tree stands; clay pigeons (targets); clay pigeon traps; climbers' harness; coin-operated billiard tables; confetti; conjuring apparatus; controllers for game consoles; counters (discs) for games; creels (fishing traps); cricket bags; cups for dice; darts; decoys for hunting or fishing; dice; discusses for sports; divot repair tools (golf accessories); dolls; dolls' beds; dolls' clothes; dolls' feeding bottles; dolls' houses; dolls' rooms; dominoes; dumb-bells; edges of skis; elbow guards (sports articles); electronic targets; explosive bonbons (Christmas crackers); fairground ride apparatus; fencing gauntlets; fencing masks; fencing weapons; fish hooks; fishing tackle; flippers for swimming; floats for fishing; flying discs (toys); foosball tables; games; gaming machines for gambling; gloves for games; golf bags, with or without wheels; golf clubs; golf gloves; gut for fishing; gut for rackets; hang gliders; harness for sailboards; harpoon guns (sports articles); hockey sticks; horseshoe games; hunting game calls; ice skates; in-line roller skates; jigsaw puzzles; kaleidoscopes; kite reels; kites; knee guards (sports articles); landing nets for anglers; lines for fishing; machines for physical exercises; mah-jong; marbles for games; masks (plaything); masts for sailboards; men's athletic supporters (sports articles); mobiles (toys); nets for sports; novelties for parties, dances (party favors, favours); ornaments for Christmas trees, except illumination articles and confectionery; pachinkos; paintball guns (sports apparatus); paintballs (ammunition for paintball guns) (sports apparatus); paper party hats; paragliders; parlor games; percussion caps (toys); pinatas; play balloons; playing balls; playing cards; plush toys; poles for pole vaulting; portable games with liquid crystal displays; practical jokes (novelties); protective paddings (parts of sports suits); punching bags; puppets; quoits; rackets; radio-controlled toy vehicles; rattles (playthings); reels for fishing; ring games; rocking horses; rods for fishing; rollers for stationary exercise bicycles; roller skates; rosin used by athletes; roulette wheels; sailboards; scale model kits (toys); scale model vehicles; scent lures for hunting or fishing; scooters (toys); scrapers for skis; scratch cards for playing lottery games; seal skins (coverings for

skis); shin guards (sports articles); shuttlecocks; skateboards; skating boots with skates attached; ski bindings; skis; skittles; skittles (games); sleds (sports articles); slides (playthings); sling shots (sports articles); slot machines (gaming machines); snowboards; snow globes; snowshoes; soap bubbles (toys); sole coverings for skis; spinning tops (toys); spring boards (sports articles); starting blocks for sports; stationary exercise bicycles; strings for rackets; stuffed toys; surfboard leashes; surfboards; surf skis; swimming belts; swimming jackets; swimming kick boards; swimming pools (play articles); swings; tables for table tennis; targets; teddy bears; tennis ball throwing apparatus; tennis nets; theatrical masks; toy figures; toy models; toy pistols; toys; toys for domestic pets; toy vehicles; trampolines; twirling batons; video game machines; waterskis; water wings; wax for skis; weight lifting belts (sports articles).

30 – Coffee, tea, cocoa and artificial coffee; rice; tapioca and sago; flour and preparations made from cereals; bread, pastry and confectionery; ices; sugar, honey, treacle; yeast, baking-powder; salt; mustard; vinegar, sauces (condiments); spices; ice; aniseed; peanut confectionery; high-protein cereal bars; baking soda (bicarbonate of soda for cooking purposes); soya bean paste (condiment); bean meal; star aniseed; tapioca flour for food; flour; flour-milling products; bread rolls; buns; sandwiches; vanillin (vanilla substitute); vanilla (flavoring); waffles; vermicelli (noodles); cream of tartar for culinary purposes; farinaceous foods; oatmeal; oat flakes; oat-based food; sea water for cooking; seaweed (condiment); binding agents for ice cream (edible ices); biscuits; cloves (spice); mustard meal; cake frosting (icing); glucose for culinary purposes; relish (condiment); gluten additives for culinary purposes; essences for foodstuffs, except etheric essences and essential oils; fruit jellies (confectionery); chewing gum; custard; leaven; rice-based snack food; cereal-based snack food; frozen yogurt (confectionery ices); frozen kefir (confectionery ices); flavorings, other than essential oils, for beverages; flavorings, other than essential oils, for cakes; flavorings, other than essential oils; wheat germ for human consumption; preparations for stiffening whipped cream; thickening agents for cooking foodstuffs; chips (cereal products); ginger (spice); unroasted coffee; coffee flavorings; coffee-based beverages; coffee beverages with milk; vegetal preparations for use as coffee substitutes; cocoa beverages with milk; cocoa-based beverages; cocoa-based ingredients for confectionery products; cocoa; cocoa mixes; cocoa powder; capers; caramels (candy); lozenges (confectionery); curry (spice); potato flour for food; ketchup (sauce); gluten prepared as foodstuff; confectionery with sugar; tortillas; cinnamon (spice); starch for food; hominy grits; groats for human food; corn, milled; corn, roasted; corn flour; pop corn; corn

flakes; turmeric for food; couscous (semolina); salt for preserving foodstuffs; confectionery for decorating Christmas trees; edible ices; ice for refreshment; ice, natural or artificial; liquorice (confectionery); noodles; candy; flaxseed for human consumption; mayonnaise; macaroni; maltose; hominy; chow-chow (condiment); marinades; marzipan; royal jelly; honey; molasses for food; macaroons (pastry); almond paste; almond confectionery; pancakes; spring rolls; gruel, with a milk base, for food; ice-cream; dessert mousses (confectionery); chocolate mousses; nutmegs; muesli; meat gravies; meat tenderizers, for household purposes; mint for confectionery; peppermint sweets; infusions, not medicinal; husked oats; ravioli; pepper; pesto (sauce); beer vinegar; quiches; sweetmeats (candy); pizzas; pies; fondants (confectionery); powder for edible ices; pralines; condiments; dressings for salad; seasonings; unleavened bread; bee glue; gingerbread; puddings; cake powder; fruit coulis (sauces); rice cakes; baking powder; ferments for pastes; sago; garden herbs, preserved (seasonings); celery salt; golden syrup; soya flour; soya sauce; malt for human consumption; malt biscuits; malt extract for food; tomato sauce; spaghetti; noodle-based prepared meals; ham glaze; rusks; bread-crumbs; petit-beurre biscuits; sushi; tabbouleh; tacos; tapioca; petits fours (cakes); crackers; cake dough; tarts; sorbets (ices); halvah; bread; chicory (coffee substitute); iced tea; tea-based beverages; chutneys (condiments); saffron (seasoning); chocolate; chocolate-based beverages; chocolate beverages with milk; barley meal; crushed barley.

(260) AM 2015 80415 A
 (800) 1230606
 (891) 2014 09 16
 (731) KEPWARE, INC.
 400 Congress Street, Portland ME 04101,
 USA
 (540)



(591) Black, white
 (511)
 9 – Downloadable software for industrial process control and industrial automation.
 42 – Computer software development in the field of process control and industrial automation.

(260) AM 2015 80440 A
 (800) 1230850
 (891) 2014 08 06

(731) KASTAMONU ENTEGRE AĞAÇ SANAYİ
 VE TİCARET ANONİM ŞİRKETİ
 Mahir iz Cad. No:25, TR-34662 Altunizade
 Üsküdar İstanbul, Turkey
 (540)



(591) Grey, white, brown
 (526) WORKTOPS
 (511)
 20 – Worktops not made of metal.

(260) AM 2015 80441 A
 (800) 1230914
 (891) 2014 10 07
 (731) ECSITE, ASSOCIATION INTERNATIONALE SANS BUT LUCRATIF
 Avenue Louise 89, 7ème étage, B-1050
 Bruxelles, Belgium
 (540)

SPOKES

(511)
 9 – Electronic publications and audio-visual productions, whether or not contained on data carriers, in the field of science and science communication; downloadable electronic publications in the nature of magazines, in the field of science and science communication.

16 – Printed matter, including newspapers, magazines, newsletters, in the field of science and science communication.

41 – Organizing and conducting of events, conferences and workshops for networking, developing ideas and strategic thinking with regard to the science field; organizing and facilitating networking and cooperation between local and regional stakeholders aiming amongst others to address and target challenges of cities or regions; publication of documents in the field of training, science, public law and social affairs; publication of non-publicity books, texts, leaflets and printed matter, if necessary online, in the fields of science, museums, local and regional political stakeholders; training courses relating to science; conducting of educational courses in science; arranging and conducting conferences, workshops and seminars; publication of the editorial content of sites accessible via a global computer network; providing publications from a global computer network or the internet which may be browsed; museum services; organization or support of training opportunities and workshops; production, editing and dissemination of information and resources with regard to the science field; on-line library services, namely, providing electronic library services which feature

newspapers, magazines, photographs and pictures via an on-line computer network; publishing of newsletters, magazines and scientific books; providing newsletters and magazines in the field of science.

(260) AM 2015 80442 A

(800) 1230923

(891) 2014 10 08

(731) QUEST ION LIMITED

Unit F, 26/F, MG Tower, 133 Hoi Bun Road,
Kwun Tong, Kowloon East, Hong Kong,
China

(540)

QN EUROPE

(526) EUROPE

(511)

35 – Advertising; business management; business administration; office functions; accounting; direct marketing; electronic commerce services, namely, providing information about products via telecommunication networks for advertising and sales purposes; administrative processing of purchase orders; advertising by mail order; advisory services for business management; arranging newspaper subscriptions for others; arranging subscriptions to telecommunication services for others; auctioneering; billposting; business appraisals; business auditing; business efficiency expert services; business information; business inquiries; business investigations; business management and organization consultancy; business management assistance; business management consultancy; business management of hotels; business management of performing artists; business management of sports people; business organization consultancy; business research; commercial administration of the licensing of the goods and services of others; commercial information agencies; commercial information and advice for consumers [consumer advice shop]; commercial or industrial management assistance; compilation of information into computer databases; compilation of statistics; computerized file management; cost price analysis; data search in computer files for others; demonstration of goods; direct mail advertising; dissemination of advertising matter; distribution of samples; document reproduction; drawing up of statements of accounts; economic forecasting; employment agencies; import-export agencies; invoicing; layout services for advertising purposes; marketing; marketing research; marketing studies; modelling for advertising or sales promotion; news clipping services; office machines and equipment rental; on-line advertising on a computer network; opinion polling; organization of exhibitions for commercial or advertising purposes; organization of fashion shows for promotional purposes; organization of trade fairs for commercial or advertising purposes; outsourcing

services [business assistance]; payroll preparation; personnel management consultancy; personnel recruitment; photocopying services; presentation of goods on communication media, for retail purposes; price comparison services; procurement services for others [purchasing goods and services for other businesses]; production of advertising films; professional business consultancy; psychological testing for the selection of personnel; public relations; publication of publicity texts; publicity; publicity agencies; publicity columns preparation; publicity material rental; radio advertising; relocation services for businesses; rental of advertising space; rental of advertising time on communication media; rental of photocopying machines; rental of vending machines; retail or wholesale services for pharmaceutical, veterinary and sanitary preparations and medical supplies; sales promotion for others; secretarial services; shop window dressing; shorthand; sponsorship search; systemization of information into computer databases; tax preparation; telemarketing services; telephone answering for unavailable subscribers; television advertising; transcription; typing; updating of advertising material; word processing; writing of publicity texts.

39 – Transport; packaging and storage of goods; travel arrangement; air transport; aircraft rental; ambulance transport; armored-car transport; arranging of cruises; arranging of travel tours; barge transport; boat rental; boat storage; boat transport; booking of seats for travel; bottling services; bus transport; car parking; car rental; car transport; carting; chauffeur services; courier services [messages or merchantdisse]; delivery of goods; delivery of goods by mail order; distribution of energy; electricity distribution; escorting of travellers; ferry-boat transport; flower delivery; franking of mail; freight brokerage; freight forwarding; freight [shipping of goods]; freighting; garage rental; guarded transport of valuables; hauling; horse rental; ice-breaking; launching of satellites for others; lighterage services; marine transport; message delivery; motor coach rental; newspaper delivery; operating canal locks; packaging of goods; parcel delivery; parking place rental; passenger transport; physical storage of electronically-stored data or documents; piloting; pleasure boat transport; portorage; railway coach rental; railway transport; railway truck rental; refloating of ships; refrigerator rental; removal services; rental of aircraft engines; rental of diving bells; rental of diving suits; rental of freezers; rental of motor racing cars; rental of storage containers; rental of vehicle roof racks; rental of warehouses; rental of wheelchairs; rescue operations [transport]; river transport; salvage of ships; salvaging; shipbrokerage; sightseeing [tourism]; stevedoring; storage; storage information; storage of goods; taxi transport; towing; traffic information; tram transport; transport; transport and storage of trash; transport brokerage; transport by pipeline;

transport of travellers; transport reservation; transportation information; transportation logistics; transporting furniture; travel reservation; underwater salvage; unloading cargo; vehicle breakdown assistance [towing]; vehicle rental; water distribution; water supplying; wrapping of goods.

41 – Entertainment; sporting and cultural activities; education; providing of training; academies [education]; amusement parks; amusements; animal training; arranging and conducting of colloquiums; arranging and conducting of concerts; arranging and conducting of conferences; arranging and conducting of congresses; arranging and conducting of seminars; arranging and conducting of symposiums; arranging and conducting of workshops [training]; arranging of beauty contests; boarding schools; booking of seats for shows; bookmobile services; calligraphy services; cinema presentations; circuses; club services [entertainment or education]; coaching [training]; conducting fitness classes; correspondence courses; disc jockey services; discotheque services; dubbing; education information; educational examination; electronic desktop publishing; entertainer services; entertainment information; film production, other than advertising films; gambling; game services provided on-line from a computer network; games equipment rental; gymnastic instruction; health club services [health and fitness training]; holiday camp services [entertainment]; language interpreter services; layout services, other than for advertising purposes; lending libraries; microfilming; modelling for artists; movie studios; music composition services; music-halls; news reporters services; night clubs; nursery schools; operating lotteries; orchestra services; organization of balls; organization of competitions [education or entertainment]; organization of exhibitions for cultural or educational purposes; organization of fashion shows for entertainment purposes; organization of shows [impresario services]; organization of sports competitions; party planning [entertainment]; personal trainer services [fitness training]; photographic reporting; photography; physical education; practical training [demonstration]; presentation of live performances; production of music; production of radio and television programmes; production of shows; providing amusement arcade services; providing casino facilities [gambling]; providing golf facilities; providing karaoke services; providing museum facilities [presentation, exhibitions]; providing on-line electronic publications, not downloadable; providing recreation facilities; providing sports facilities; publication of books; publication of electronic books and journals online; publication of texts, other than publicity texts; radio entertainment; recording studio services; recreation information; religious education; rental of audio equipment; rental of camcorders; rental of cine-films; rental of lighting apparatus for theatrical sets or television studios; rental of movie

projectors and accessories; rental of radio and television sets; rental of show scenery; rental of skin diving equipment; rental of sound recordings; rental of sports equipment, except vehicles; rental of sports grounds; rental of stadium facilities; rental of stage scenery; rental of tennis courts; rental of video cassette recorders; rental of videotapes; scriptwriting services; services of schools [education]; sign language interpretation; sport camp services; subtitling; television entertainment; theatre productions; ticket agency services [entertainment]; timing of sports events; toy rental; translation; tuition; videotape editing; videotape film production; videotaping; vocational guidance [education or training advice]; vocational retraining; writing of texts, other than publicity texts; zoological garden services.

(260) AM 2015 80443 A

(800) 1230986

(891) 2014 09 09

(731) Limited Liability Company

"TRUSTINVESTSTROI"

Fruit and vegetable base, Warehouse No:30,
Ramensky district, Kuznetsovo village,
RU-140192 Moscow region, Russian
Federation

(540)



(591) Blue, red, gold and white

(526) гарантия качества

(511)

29 – Fruit jellies; jams; frosted fruits; candied fruit; raisins; yogurt; dairy products; cream; fruit composites; canned fruits; jams; marmalade; dairy products; fruit pulp; pectin for culinary purposes; boiled fruits; fruit salads; whipped cream; cottage cheese; dates; fruit chips; fruit peel; candied fruits; fruit paste.

30 – Bread rolls; vanillin [vanilla substitute]; vanilla [flavoring]; waffles; wafers; yeast; confectionery for decorating Christmas trees; chewing gum; thickening agents for cooking foodstuffs; preparations made from cereals; frozen yoghurt [confectionery ices]; caramels; confectionery; confectionery made of flour; candy; candy sugar; edible ices; marzipan; ice cream; fruit ice creams; products made of flour; pastilles [confectionery]; cookies; almond cookies; crackers; rusks; cakes; pastries; preparations for stiffening whipped cream; powders for ice cream; powders for cakes and pies; powders for edible ice; cake dough; candy decorations for cakes; aromatic preparations for food; popcorn; pralines; gingerb-

read; puddings; sweet sauces; berry pies; fruit pies; chocolate-based beverages; chocolate.

32 – Preparations for making liqueurs; syrups for lemonade; whey beverages; fruit juices; non-alcoholic fruit nectars; sorbets [beverages].

35 – Intermediary services in the field of product sales; marketing research; wholesale and retail store services of goods included in 29, 30, 32 classes.

(260) AM 2015 80444 A

(800) 1231002

(891) 2014 10 16

(731) SOPHARMA AD

oulitsa "Iliensko chausse" 16, BG-1220
SOFIA, Bulgaria

(540)

ACNERIN
АКНЕРИН

(591) Black, white

(511)

5 – Pharmaceutical, veterinary and sanitary preparations; dietetic substances adapted for medical use, food for babies.

(260) AM 2015 80447 A

(800) 1231012

(891) 2014 09 19

(731) Closed Joint-Stock Company

"PENZA CONFECTIONERY FACTORY"
ul. Kalinina, d. 112a, RU-440034 Penza,
Russian Federation

(540)

Морской бриз

(591) Black, white

(511)

30 – Confectionery; sweetmeats [candy]; caramels [candy]; fondants [confectionery]; pralines; pastilles [confectionery]; biscuits; waffles; pastries.

(260) AM 2015 80448 A

(800) 237918

(891) 2014 10 23

(731) BEZ Transformátory, a.s.

Rybničná 40 SK-835 54 Bratislava, Slovakia

(540)



(591) Black, white

(511)

7 – Small motors, medium motors, generators, turbo-generators and dynamos, exciters, winders, aggregates for welding, rotor starters.

9 – Welding aggregates, transformers, reactors, switchboards, gradual switches, pressure switches, locking switches, multiple switches, shunt regulators, star-delta switches, toggle switches, lever switches, switch-separators, separator switches with circuit breakers, oil switches and switchboards.

11 – Electric ovens.

(260) AM 2015 80449 A

(800) 607805

(891) 2014 09 16

(731) REFRACTORY INTELLECTUAL
PROPERTY GMBH & CO. KG

Wienerbergstrasse 11, A-1100 Wien, Austria

(540)

ANKERTUN

(591) Black, white

(511)

19 – Refractory ceramic masses and molded parts.

(260) AM 2015 80450 A

(800) 618519

(891) 2014 10 03

(731) MOTUL

119, boulevard Félix-Faure, F-93300
AUBERVILLIERS, France

(540)

TECHNOSYNTHESE

(511)

4 – Industrial oils and greases; lubricants; dust-absorbing, wetting and binding compositions; fuels (including motor spirit) and illuminants; candles, wicks.

(260) AM 2015 80451 A

(800) 1017961

(891) 2014 10 21

(731) WEZAG GmbH Werkzeugfabrik

8, Wittigstrasse, 35260 Stadtallendorf, Germany

(540)

WEZAG

(511)

7 – Machines and power-operated hand tools for pressing, crimping, stripping, extraction, clamping, mounting, trimming, cutting, punching and perforating; machines for stripping, twisting, winding and unwinding cables; pneumatic, hydraulic and electric crimping machines; pneumatic, hydraulic and electric hand crimping tools; pneumatic, hydraulic and electric presses; parts, attachments and replacement parts of the aforementioned machines as far as contained in class 07.

8 – Hand-operated pleers; hand-operated pliers for pressing, crimping, stripping, extraction, clamping,

mounting, trimming, cutting, punching and perforating; parts, attachments and replacements parts of the aforementioned pliers, as far as contained in class 08; hand-operated tools for removing electric contacts and electric plugs from housing; tool boxes [including hand-operated pliers and their parts, attachments and replacement parts].

(260) AM 2015 80452 A

(800) 1062056

(891) 2014 10 09

(731) KMA Concepts Limited

Suite 1003, Silvercord Tower 1, 30 Canton Road, TST, Kowloon, Hong Kong), China

(540)

STIKEEZ

(591) Black, white

(511)

28 – Plastic character toys; toy animals; toy figures.

(260) AM 2015 80453 A

(800) 1083376

(891) 2014 10 03

(731) MOTUL

119 boulevard Félix Faure, F-93300 AUBERVILLIERS, France

(540)

ESTER Core

(511)

4 – Industrial oils and greases; lubricants; dust absorbing, wetting and binding compositions; fuels (including motor spirit) and illuminants; candles and wicks for lighting.

(260) AM 2015 80454 A

(800) 1119647

(891) 2014 10 21

(731) BEIERSDORF AG

Unnastrasse 48, 20253 Hamburg, Germany

(540)

NIVEA ACTIVE CLEAN

(511)

3 – Soaps; perfumeries, preparations for body and beauty care.

(260) AM 2015 80455 A

(800) 1147119

(891) 2014 09 30

(731) ASICS CORPORATION

7-1-1, Minatojima-Nakamachi, Chuo-ku, Kobe-shi, Hyogo 650-8555, Japan

(540)

ASICS

(591) Black, white

(511)

18 – Handbag frames; purse frames; horseshoes; industrial packaging containers of leather; bags and the like; pouches and the like; bags for sports; waist bags; shoulder bags; tote bags; handbags; duffel bags; Boston bags; traveling bags; shoe bags; knapsacks; rucksacks; cases; suitcases; trunks; bags with wheels; pouches; business card cases; carrying cases for commutation tickets; coin purses; wallets; key cases; vanity cases (not fitted); umbrellas and their parts; walking sticks; canes; metal parts of canes and walking-sticks; handles for canes and walking-sticks.

24 – Woven fabrics; knitted fabrics; felt and non-woven textile fabrics; personal articles of woven textile (not for wear); towels (of textile); face towels of textile; handkerchiefs; mosquito nets; bedsheets; futon quilts; futon quilt cases (linen); futon ticks (unstuffed futon); pillowcases (pillow slips); blankets; banners and flags (not of paper).

25 – Clothing; tee-shirts; sport shirts; polo shirts; sleeveless shirts; long-sleeved shirts; pants; panties, shorts and briefs; shorts; vests; sweaters; shirts for suits; jackets; long overcoats; half coats; overcoats; topcoats; windproof jackets; waterproof jackets; windproof pants; waterproof pants; sweat shirts; sweat pants; singlets; tank tops; skirts; tights; underwear (underclothing); brassieres; swimwear (bathing suits); bathing drawers; swimming caps (bathing caps); socks and stockings; gloves and mittens (clothing); stockings; scarves (scarfs); mufflers; neck warmers; arm warmers; bandanas (neckerchiefs); ear muffs (clothing); headgear for wear; garters; sock suspenders; suspenders (braces); waistbands; belts for clothing; footwear (other than special footwear for sports); sneakers; sports shoes; athletic shoes; running shoes; jogging shoes; training shoes; fitness shoes; walking shoes; driving shoes; work shoes; winter boots; boots; casual shoes; formal shoes; sandal (shoes); infants' shoes and boots; insoles (for shoes and boots); studs for shoes for sports; cleats for attachments to sport shoes; clothes for sports; athletic uniforms; sports stockings; wristbands; special footwear for sports; marathon shoes; footwear for track and field athletics; golf shoes; soccer shoes; futsal shoes; basketball shoes; volleyball shoes; baseball shoes; rugby shoes; tennis shoes; American football shoes; table tennis shoes; handball shoes; badminton shoes; fencing shoes; wrestling shoes; gymnastic shoes; bowling shoes; taijiquan shoes; tug-of-war shoes; ski boots; cheerleading shoes; boxing shoes; weight lifting shoes; taekwondo shoes; archery shoes; climbing boots (mountaineering boots).

(260) AM 2015 80456 A
 (800) 1147183
 (891) 2014 09 30
 (731) ASICS CORPORATION
 7-1-1, Minatojima-Nakamachi, Chuo-ku,
 Kobe-shi, Hyogo 650-8555, Japan

(540)



(591) Black, white

(511)

18 – Handbag frames; purse frames; horseshoes; industrial packaging containers of leather; bags and the like; pouches and the like; bags for sports; waist bags; shoulder bags; tote bags; handbags; duffel bags; Boston bags; traveling bags; shoe bags for travel; knapsacks; rucksacks; attaché cases of leather; suitcases; trunks; bags with wheels; pouches; business card cases; commutation-ticket holders; coin purses; wallets; key cases; vanity cases (not fitted); umbrellas and their parts; walking sticks; canes; metal parts of canes and walking-sticks; handles for canes and walking-sticks.

(260) AM 2015 80457 A
 (800) 1147188
 (891) 2014 09 30
 (731) ASICS CORPORATION
 7-1-1, Minatojima-Nakamachi, Chuo-ku,
 Kobe-shi, Hyogo 650-8555, Japan

(540)

ONITSUKA TIGER

(591) Black, white

(511)

18 – Handbag frames; purse frames; horseshoes; industrial packaging containers of leather; bags and the like; pouches and the like; bags for sports; waist bags; shoulder bags; tote bags; handbags; duffel bags; Boston bags; traveling bags; shoe bags; knapsacks; rucksacks; cases of leather; suitcases; trunks; bags with wheels; pouches; business card cases; carrying cases for commutation tickets; coin purses; wallets; key cases; vanity cases (not fitted); umbrellas and their parts; walking sticks; canes; metal parts of canes and walking-sticks; handles for canes and walking-sticks.

(260) AM 2015 80458 A
 (800) 1147189
 (891) 2014 09 30
 (731) ASICS CORPORATION
 7-1-1, Minatojima-Nakamachi, Chuo-ku,
 Kobe-shi, Hyogo 650-8555, Japan

(540)



(591) Black, white

(511)

18 – Industrial packaging containers of leather; bags and the like; pouches and the like; bags for sports; waist bags; shoulder bags; tote bags; handbags; duffel bags; Boston bags; traveling bags; shoe bags; knapsacks; rucksacks; cases of leather; suitcases; trunks; bags with wheels; pouches; business card cases; carrying cases for commutation tickets; coin purse; wallets; key cases; vanity cases (not fitted); umbrellas and their parts; walking sticks; canes; metal parts of canes and walking-sticks; handles for canes and walking-sticks; saddlery; leather and fur (unworked or semi-worked).

(260) AM 2015 80459 A
 (800) 1151783
 (891) 2014 09 16
 (731) SILHOUETTE International Schmied AG
 Ellbognerstrasse 24, A-4020 Linz, Austria

(540)



(591) Black, white

(511)

9 – Optical apparatus and instruments, in particular optical apparatus for the eyes; spectacles, in particular optical spectacles, sunglasses, sports glasses, protective glasses, spectacles equipped with decorative elements; spectacle frames, mountings, supports, fixations and temples for spectacles; spectacle frames, spectacle mountings, supports as well as temples for spectacles equipped with decorative elements; optical spectacles and sunglasses, the frames thereof manufactured of metal or of a combination of metal and plastics; spectacle mountings, temples for spectacles, spectacle supports and spectacle frames manufactured of metal or of a combination of metal and plastics; chains for spectacles, in particular chains for spectacles equipped with decorative elements; spectacle glasses; optical lenses, contact lenses; optical goods, optical goods of plastics; optical glass; accessories for spectacles, namely containers and cases for the aforesaid goods.

18 – Leather and imitations of leather, and goods made of these materials as far as not included in other classes; trunks and travelling bags; umbrellas, parasols and walking sticks; bags, in particular handbags, key cases (leatherware), vanity cases.

42 – Services provided by an industrial designer; preparation of technical expertise and documentary reports, research in the field of optics, in particular in the field of lenses and spectacles, as well as in the field of material for the manufacture of optical equipment, apparatus and instruments, in particular ophthalmic instruments as well as of spectacles and spectacle frames.

(260) AM 2015 80460 A

(800) 1152069

(891) 2014 09 30

(731) ASICS CORPORATION

7-1-1, Minatojima-Nakamachi, Chuo-ku,
Kobe-shi, Hyogo 650-8555, Japan

(540)



(591) Black, white

(511)

24 – Woven fabrics; knitted fabrics; felt and non-woven textile fabrics; oilcloth; gummed waterproof cloth; vinyl coated cloth; rubberized cloth; leather cloth; filtering materials of textile; towels; Japanese cotton towels [Tenugui]; handkerchiefs; Japanese ceremonial wrapping cloth [Fukusa]; Japanese general wrapping cloth [Furoshiki]; mosquito nets; bedsheets; futon quilts and quilts; futon and quilts cases (linen); futon ticks (unstuffed futon); pillowcases (pillow slips); blankets; table napkins of textile; dish towels for drying; shower curtains; banners and flags (not of paper); toilet seat covers of textile; seat covers of textile; wall hangings of textile; curtains; table cloths (not of paper); draperies (thick drop curtains); shrouds (sheets for wrapping corpses); shrouds for dressing a corpse for funeral (kyokatabira kimono); Japanese cloth screens with black-and-white stripes (kuroshiro-maku); Japanese cloth screens with red-and-white stripes (kohaku-maku); billiard cloth (baize); labels of cloth.

(260) AM 2015 80461 A

(800) 1231079

(891) 2014 02 28

(731) KABUSHIKI KAISHA MIZKAN
HOLDINGS

2-6, Nakamura-Cho, Handa-Shi, Aichi-Ken
475-8585 Japan

KABUSHIKI KAISHA MITSUKAN
GROUP HONSHA

2-6 Nakamura-cho, Handa-shi, Aichi-ken,
475-8585, Japan

(540)



(591) Black, white

(511)

29 – Edible oils and fats; milk products; meat for human consumption (fresh, chilled or frozen); eggs; fresh, chilled or frozen edible aquatic animals (not live); frozen vegetables; frozen peppers; frozen fruits; processed meat products; processed seafood products; processed foods made from seaweed; processed vegetables; pickles; sweet pickles; piccalilli; pickled vegetables; spreads based on vegetables; spreads based on fruits; spreads based on milk products; chili pepper jelly; processed chili pepper; canned chili pepper; chili pepper puree; processed fruits; fried tofu pieces (abura-age); freeze-dried tofu pieces (kohri-dofu); jelly made from devils' tongue root (konnyaku); soybean milk (soy milk); tofu; fermented soybeans (natto); processed eggs; pre-cooked curry stew, stew and soup mixes; broth; bouillon; soup; powdered soup base; soup base; soup preparations; soup mixes; hot pot soup; broth used for cooking ingredients in a hot pot; ready-made mix consisting primarily of fish and/or vegetables with other added ingredients for making rice dishes; ready-made mix consisting primarily of fish and/or vegetables with other added ingredients seasoned with sugar, salt, vinegar and/or with other seasonings for making rice dishes; soup stock; stew and soup mixes; prepared vegetables for gomoku chirashi sushi; ready-made seasoned mix consisting primarily of fish and/or vegetables with other added ingredients, flavored with sugar, salt, vinegar, and/or other seasonings, for making rice dishes; ready-made mix consisting primarily of meat, seafood or vegetables seasoned with soy sauce and/or with other seasonings for making rice dishes; edible seaweed, namely, dried flakes of laver for sprinkling on rice in hot water (ochazuke-nori); furi-kake (dried flakes of fish, meat, vegetables or seaweed); dried flakes of fish, meat, vegetables or seaweed and/or other ingredients for rice balls; fermented soybean foods as accompaniment (name-mono); preserved pulses; protein for use as a food additive; edible gel containing collagen which is used as a seasoning, or in a sauce, or in a soup base such as for a hot pot; dried flakes of fish, meat, vegetables or seaweed and/or other ingredients for cooked rice with hot water (Ochazuke-no-moto).

30 – Binding agents for ice cream; meat tenderizers for household purposes; preparations for stiffening whipped cream; aromatic preparations for food (not from "essential oils"); tea; coffee and cocoa; ice; confectionery, bread and buns; japanese arrowroot starch noodles (kuzukiri); sandwiches; steamed buns stuffed with minced meat (Chinese-manjuh); hamburgers (sandwiches); pizzas (prepared); hot dogs (sandwiches); meat pies (prepared); seasonings; flavorings, other than essential oils; condiments; sauce as condiments; sauce base as condiments; powdered sauce as condiments; sauce gel as condiments; wine

reduction sauce (wine sauce for cooking); spirit reduction sauce (spirit sauce for cooking); browning sauce for cooking; seasoning mixes; ready-made sauce; powdered sauce base; relish as condiments; flavorings, other than essential oils, for hot pot dishes (nabemono); seasoning for hot pot dishes (nabemono); dipping sauce for noodle; dipping sauce for tempura; basting sauce; dipping sauce; sesame sauce; marinades; vinegar; sushi seasoning; powdered sushi seasoning mixes; seasoned vinegar; citrus seasoned soy sauce (ponzu); ponzu citrus seasoning; dressing for salad; soy sauce; soybean paste; ketchup; tomato sauce; mayonnaise; salad cream; mustard; wine powder (seasonings); chutney; sweet seasoning; fermented seasonings; citrus seasoning; spices; ice cream mixes; sherbet mixes; unroasted coffee (unprocessed); cereal preparations; dried starch noodles (harusame); glass noodles; Chinese stuffed dumplings (gyoza, cooked); Chinese steamed dumplings (shumai, cooked); sushi; fried balls of batter mix with small pieces of octopus (takoyaki); boxed lunches consisting of rice, with added meat, fish or vegetables; ravioli (prepared); yeast powder; fermented malted rice (Koji); yeast; baking powder; instant confectionery mixes; pasta sauce; by-product of rice for food (sake lees); husked rice; husked oats; husked barley; gluten prepared as foodstuff; flour for food; seasoning for cooked rice with hot water (seasoning mixes for Ochazuke).

32 – Beer; carbonated drinks (refreshing beverages); non-alcoholic fruit juice beverages; vegetable juices (beverages); extracts of hops for making beer; whey beverages; vinegar-based soft drinks; vinegar-based fruit juices; vinegar-based vegetable juices; vinegar-based whey beverages.

33 – Japanese liquors (in general); western liquors (in general); alcoholic fruit beverages; japanese shochu-based beverages (chuhai); Chinese liquors (in general); flavored tonic liquors; sweetened cooking rice wine (mirin); cooking rice wine; cooking wine; sake; alcoholic beverages, except beer; spirits as beverages; wine; cooking western liquors.

(260) AM 2015 80462 A

(800) 1231117

(891) 2014 11 03

(731) SANOFI

54 rue La Boétie, F-75008 Paris, France

(540)

SARACTA

(511)

5 – Pharmaceutical products.

(260) AM 2015 80463 A

(800) 1231128

(891) 2014 09 18

(731) AVON PRODUCTS, INC.

777 Third Avenue, New York NY 10017,

USA

(540)

AVON PRIME

(526) PRIME

(511)

3 – Non-medicated toilet preparations; toiletries; skin care preparations; skin moisturizers; body and beauty care preparations; powders, creams and lotions, all for the face, hands and body; cosmetic sun-tan preparations; soaps; shower and bath preparations; beauty masks; talcum powder; nail polish; nail polish remover; enamel for nails; false nails; adhesives for cosmetic purposes; cosmetics; eye makeup remover, eye shadow, eye liner, mascara, lipstick, lip liner, lipgloss; make-up foundation; blusher; tissues impregnated with cosmetic lotions; cotton sticks for cosmetic purposes; cotton wool for cosmetic purposes; preparations for cleaning, moisturising, colouring and styling the hair; preparations for cleaning the teeth; shaving and aftershave preparations; perfumes, fragrances, toilet waters, eau de cologne; deodorants and anti-perspirants for personal use; essential oils (cosmetic).

(260) AM 2015 80465 A

(800) 1231143

(891) 2013 12 30

(731) TESAY BU PROFİL SİSTEMLERİ

SANAYİ VE TİCARET LİMİTED ŞİRKETİ

İkitelli Organize Sanayi Bölgesi, Fatih Sanayi,

8A Blok Başakşehir, İstanbul, Turkey

(540)



(591) Black, white

(511)

6 – Ores of metal, namely, zinc ores, nickel ores, iron ores, lead ores, manganese ores, chrome ores; common metals, unwrought and semi-worked, for further manufacture, namely, irons and steels, nickel, tin and its alloys, zinc based alloys, copper based alloys, iron alloys, lead-tin alloys, aluminum and its alloys; steel plates and sheets, cast iron for use in building; portable metal buildings, construction material of metal, metal floors, metal staircases, portable metal staircases, metal gates and fences, metal railings for fences, metal roofing, metal palings, prefabricated metal platforms, metal telephone booths, vendor booths made primarily of metal, transportable greenhouses of metal for household use, metal swimming pools, metal diving boards, metal silos, crash barriers of metal for roads, metal scaffolding, metal casting forms for concrete, metal posts, construction elements made of metal, namely, shores,

supports; high pressure metal containers, general purpose metal storage containers, containers of metal for chemicals, compressed gases and liquids, metal containers for the storage and transportation of goods, metal barrels, vats of metal, flexible metal foil for use in the manufacture of pouches, bags and lids; metal tool boxes, metal mail boxes, metal shelf brackets; metal window screens, metal sieves being parts of drains; metallic doors, windows, shutters, slatted shutters, metal jalousies; metal accessories of doors and windows, namely, door handles, window handles, metal panels for doors and windows, doors and windows closers and openers, non-electric, window latches of metal; non-electric cables, metal cable wire, metal rods for brazing and welding; metal hardware, namely, screws, nails, bolts, nuts, metal chains, pulley; door hardware, namely keys and key cylinders; metal hinges, rivets, non-electric metal door bells, metal bells, metal nameplates and door nameplates, door chains of metal, door and window handles of metal, fittings of metal for doors and windows, marine anchors, metal handles for tools, badges of metal for vehicles; ducts of metal for ventilating and air conditioning and heating installations, metal vent covers for HVAC ducts, metal drains for use in the construction of basement waterproofing systems and pitch pans, metal chimneys, metal manhole covers for drains, poles of metal for electric power lines; boards of metal, namely, advertising boards, wall boards of metal; metal license plates, non-luminous and non-mechanical metal road signs, loading and unloading pallets of metal, metal name badges, metal name plates; metal pipes for liquid and gas transfer, metal pipe couplings and joints, metal pipe collars, metal junctions for pipes, metal pipe muffs, elbows of metal for pipes, metal valves other than parts of machines, metal taps for casks; (including valves of metal, drilling pipes of metal); metal cash boxes; materials of metal for railway construction, metal rails, metal railway crossovers; metal bollards, metal mooring buoys, metal structural supports therefor, used to support decking; metallic moulds for metal casting; works of art of common metal, sculptures made of non-precious metal, statuettes of non-precious metal, monuments of non-precious metal, busts of non-precious metal; metal poles, metal fence posts; metal ropes, belts of metal for handling loads, loading and unloading pallets of metal.

17 – Raw or semi-worked rubber and gum for use in the manufacture of goods made from these materials and not included in other classes; gutta-percha; asbestos; latex, mica and goods made from these materials; insulating materials; non-conducting materials for retaining heat; insulators for electric mains; insulating fabrics; foils of metal for insulating; insulating paints; insulating paper; asbestos paper; asbestos cloth; asbestos fabrics; adhesive bands other than stationery and not for medical or household purpo-

ses; insulating tape and band; asbestos coverings; asbestos sheets; asbestos felt; rubber stoppers; fillers for expansion joints; chemical compositions for repairing leaks; flexible plumbing pipes of plastic, rubber or natural rubber, canvas hose pipes; flexible compressed air pipe fittings, not of metal, vehicle radiator connecting hoses; synthetic plastic as semi-finished products in form of foils, plates, rods, profiles, hoses except for fire hoses, tubes, blocks, foam rubber, natural rubber, synthetic elastomer resin blended with additives and colorants sold in a pellet form, rubber, cellulose acetate film, plastic film other than for wrapping, semi-processed brake lining material, clutch linings, rubber thread not for textile use, plastic fibers, natural rubber threads, not for textile use, natural rubber and rubber bags for merchandise packaging; goods made of rubber, natural rubber, plastic and similar materials namely rubber and natural rubber pads (shock absorber), expansion joint fillers, rubber stoppers, sealing plugs made primarily from rubber, billets from rubber, rubber sleeves for protecting parts of machinery, foam rubber for protecting parts of machinery, rings of rubber for use as pipe connection seals, gasket sealer for use in plumbing, gasket rings.

19 – Materials for constructing, coating, repairing roads, namely, asphalt, pitch and tar, bitumen asphalt, sand, gravel, slag stone, mixtures of sand and sand stones, non-agricultural lime for use in construction, slag-lime cement, gypsum; blocks of concrete, plaster and colored plaster for building purposes, articles of artificial stone for building purposes; concrete, clay roofing tiles, natural stones, artificial stones, building materials, namely, semi-worked woods, building materials in shaped forms made of wood, prefabricated building materials made of wood, window frames, wood door frames; window shutters, jalousie profiles and systems, wood paneling, vendor booths made of wood, parquet flooring made of wood, wood boards, floor tiles of wood, semi-worked wood, wood posts, wood beams, plastic tiles; flooring or wall claddings of synthetic materials; natural marble, artificial marble, inner and outer facings of natural or artificial stones, place and floor coatings; concrete panels, concrete pipes, concrete beams, concrete blocks, concrete bollards, concrete pipes, concrete walls, concrete fences, concrete roof repair compounds, concrete slabs, concrete roof tiles, barriers of concrete, concrete poles for electric power lines; plaster for building purposes, namely, plaster boards, plaster panels, plaster walls, plasters for prefabricated buildings; bricks, rigid pipes, not of metal, tubes and connection pieces; non-luminous, non-mechanical signs not of metal; monuments of stone, concrete or marble; statues of stone, concrete or marble; natural or synthetic non-metallic surface coatings for building purposes in the form of plates or strips (heat-adhesive); glass blocks for building, glass bricks, glass tiles, glass panes, glass panels for

building construction purposes; prefabricated swimming pools not of metal; aquarium sand.

(260) AM 2015 80467 A

(800) 1231161

(891) 2014 02 20

(731) BORSA İSTANBUL ANONİM ŞİRKETİ
Reşitpaşa Mahallesi, Tuncay Artun Caddesi,
Emirgan, TR-34467 İstanbul, Turkey

(540)



(591) Turquoise

(511)

9 – Devices and computer hardware for processing and/or transmitting data; computer software.

16 – Printed documents; printed publications, newspapers, magazines, books, guide books, calendars, posters, pictures, placards, panel boards, stickers; informative and instructive publication relating to the services rendered by the stock exchange.

35 – Provision of information, prices and statistical information within the scope of the stock exchange services along with any other calculation relating to economic and financial data, recording and saving the same in a database; collection, arrangement and systematization of the foregoing in a database; computer aided processing of information relating to the stock exchange; information and research for trading activities; collection of trading information; services of trade value assessment; information and consultancy services for the foregoing services; price analysis services; economic forecast services.

36 – Providing services for trading capital market instruments, foreign exchange, precious metals and precious stones and other contracts, documents and assets deemed appropriate by the capital markets' regulator; distribution and publication of the established prices; services for matching the buy-sell orders or facilitating such matching; services for operating and/or managing the systems and regulated markets to that end; formation, calculation and publication of the indexes for the traded capital market instruments; compilation, custody, process and submission of all data related to the indexes; banking services; financial management services; financial analysis services; financial sponsorship services; information services for financial matters; financial consultancy services; underwriting business; stock exchange services; electronic stock exchange services; clearing and safe custody services; intermediary

services for the purchase and sale of securities; services for the issue of financial products; services for portfolio management; computer aided analysis of the value of securities and index; formation, calculation and publication of the indexes for the securities traded on the stock exchange, distribution and publication of the price information, statistical data, index data, clearing and safe custody data, data relating to the intermediation activities that are related with the securities; computer aided financial services; organizational consultancy services relating to the services included in this class; provision of financial information through a computer database.

38 – Services for satellite communication; services for communication between computers; services for communication by phone; services for transmission of images and messages by the help of a computer; electronic mail services, services for fax delivery, Internet services, namely services for conveying price information, statistical data, index data, clearing and safe custody data, data relating to the intermediation activities and any other financial and economic data related with the stock exchange.

41 – Services for education; educational services, services for the publication of price information, statistical data, index data, clearing and safe custody data, data relating to the intermediation activities and any other financial and economic data related with the stock exchange, books, periodicals, magazines.

42 – Computer consulting services, computer software and hardware testing services, computer software maintenance services, computer software consultancy, computer virus protection services, computer system design; services for computer programming, services for designing computer software, services for the maintenance of computer software, services for updating computer software, consultancy services in the field of computer hardware, services for formation of computer database, services for recovery of computer data, computer services related to the provision of data, services for computer system analysis, computer consultancy services, services for renting computers, services for renting computer software, services for reproducing computer programming services for formation and installment of computer software.

(260) AM 2015 80468 A

(800) 1231171

(891) 2014 04 09

(731) SOPRO BAUCHEMIE GMBH
Biebricher Strasse 74, 65203 Wiesbaden,
Germany

(540)

X-ZEM

(511)

1 – Chemicals used in industry; impregnating preparations; adhesives used in industry, in particular made of synthetic resins; chemical products for industrial purposes being additives for building materials; chemical products for industrial purposes being additives for screed, concrete and mortar; liquid plastics, unprocessed, included in this class; preservatives for building materials (except for organic substances); tempering agents for concrete, mortar and screed, included in this class, namely for preventing drying out of concrete and mortar used in screed and pre-fabricated concrete components, for rendering concrete screed resistant against impacts, abrasion, freeze and chemical stress, for increasing imperviousness against liquids and gases as well as for controlling the working consistency; unprocessed artificial resin; surface-active agents (tensides); damp proofing preparations for brickwork, except paints; horticulture chemicals; antifreeze; chemical products as aid for washing out joint compounds; solvents for paints, varnishes and lacquers; silicones.

2 – Paints, varnishes, lacquers; preservatives against corrosion, anti-rust agents, wood preservatives; coloring compounds; thinners for paints; mordants; primers; bitumen varnishes; chemical color-intensifying and color-brightening agents for applying to and coating of ceramics, natural stone and concrete.

3 – Cleaning, polishing, scouring and abrasive preparations; cleaning and conditioning substances for mineral undercoat, metal, plastics, wood; washing agents for joint fillers, included in this class; tool cleaning agents; scouring solutions; color removing agents; polishing wax.

6 – Common metals and their alloys; metal building materials; transportable buildings of metal; cables and wires of common metal (non-electric); ironmongery, small items of ironware; pipes of metal; tubes of metal; goods of metal, included in this class; tile floorings of metal; floor tiles of metal; windows of metal.

11 – Heating apparatus, electric heating mats as well as sanitary installations.

17 – Rubber, gutta-percha, gum, asbestos, mica and goods made from these materials, included in this class; goods made of plastics as semi-finished products; artificial and synthetic resins (semi-finished products), resins (semi-finished products) for fabricating adhesives; cast resins (semi-finished products) including silica sand; sealing, packing and insulating materials, sealing tapes, sealing collars; rubber gloves for insulating purposes, not for household purposes; joint fillers (sealant compounds for joints); insulating coating agents paints and insulating lacquers; insulating paints; self-adhesive tapes, other than stationery and not for medical or household purposes; insulating coatings and insulating

materials; filling material as insulating, damping and sealing materials; bituminous coatings for roofing for sealing and insulating purposes.

19 – Building materials (non-metallic), in particular with damping and insulating properties; building materials (non-metallic); building materials (non-metallic), namely hydraulic binding agents such as cement, lime, gypsum and as additives for binding and hardening concrete, mortar and stony building materials; building materials (non-metallic), namely mixtures of hydraulic binding agents with aggregates, pozzolanic materials and/or chemical substances; mortar (building material), plaster (building material), screeds (building material); reinforcing fabrics (non-metallic) for building purposes; contact sludges (non-metallic) for building purposes; building materials, nonmetallic, in the form of filling materials for building purposes for preparing surfaces made of concrete, mortar and other stony building materials; silica sand for building purposes; bitumen; bituminous products for building; pipes, not of metal, for building purposes; concrete, concrete building elements; roof coverings, not of metal; bituminous coatings for roofing (except for sealing and insulating purposes); windows, not of metal; felts for building; gravel; sand for building purposes; prefabricated swimming pools (not of metal); prefabricated chimneys, not of metal; floor tiles, not of metal, tile floorings, not of metal; binding material for road repair, road coating materials.

24 – Woven goods and textile goods, included in this class.

27 – Carpets, rugs, mats and matting, linoleum and other floor coverings; wall hangings (non-textile).

37 – Building construction, consulting regarding matters concerning construction, namely in the fields of application of building materials; renting of construction tools and building materials; repair in the fields of structural and civil engineering and interior fittings.

(260) AM 2015 80469 A

(800) 1231182

(891) 2014 05 26

(731) RETAL INDUSTRIES LIMITED
Chrysanthou Mylona, 10, MAGNUM
HOUSE, 3030, Limassol, Cyprus

(540)



(591) Light-blue, blue, light pale blue and pale blue
(511)

1 – Plastics, unprocessed, including polyethylene terephthalate.

16 – Plastic film for wrapping.

17 – Semi-processed plastics, including preforms (blanks) for manufacturing containers for food and non-food products, including bottles, cans; plastic films, not for packaging.

20 – Goods of plastics, not related to other classes, including handles for carrying bottles, screw tops, not of metal, for containers, including bottles.

21 – Plastic bottles for water, reusable, empty; household containers for food and non-food products, including cans.

40 – Processing of polyethylene terephthalate; processing of polyethylene.

42 – Research and development of new products for others; consultancy in the field of development, design and/or planning relating to equipment for manufacturing plastic packaging, packaging design services.

(260) AM 2015 80472 A
(800) 1231221
(891) 2014 08 19
(731) TAMASU BUTTERFLY EUROPA GMBH
Am Schürmannshütt 30h, 47441 Moers,
Germany

(540)



(591) Pink

(511)

18 – Casual bags, in particular travelling bags, handbags and sports bags.

24 – Towels, not of paper.

25 – Clothing, in particular outerclothing, winter jackets, wind resistant jackets, fleece jackets, underwear, T-shirts, sports and leisure clothing, sports shirts, sports trousers, tracksuits, jogging suits and leotards, sweatbands and headbands; knitwear (clothing), in particular jumpers, sweatshirts; terry-towelling goods, namely bathrobes; footwear, particularly athletic shoes for tennis and table tennis; headgear, in particular hats and caps.

28 – Articles of sporting apparatus; sports and games equipment for table tennis and tennis, and parts therefor; ball pitching machines; tables for table tennis.

(260) AM 2015 80473 A
(800) 1231224
(891) 2014 07 28
(731) ORION Co., Ltd.
217, 1 Gongdan-ro Gumi-si, Gyeongsangbuk-do, Republic of Korea

(540)

ODS

(591) Black, white

(511)

9 – Monitors; video screens; electric batteries; solar batteries; secondary cells; electric audio and visual apparatus and instruments; television monitors; television receivers (TV sets); television apparatus; sound and video recording and playback machines; LCD panels; LED monitors; DID (Digital Information Display); PDP (Plasma Display Panel); video monitors; LCD large-screen displays; touch panels; touch pads; light emitting diodes (LED); organic light emitting diodes (OLED).

(260) AM 2015 80475 A

(800) 1231230

(891) 2014 08 04

(731) WE ARE UNITED, SL

Calle La Sangre, N°7, puerta 18, E-46002
Valencia, Spain

(540)



(591) Black, white

(511)

18 – Leather and imitations of leather and goods made from these materials not included in other classes; animal skins; trunks and suitcases; umbrellas and parasols; walking sticks; whips, harness and saddlery.

25 – Clothing, footwear, headgear.

(260) AM 2015 80476 A

(800) 1231251

(891) 2014 09 25

(731) AVON PRODUCTS, INC.

World Headquarters, 777 Third Avenue,
New York NY 10017, USA

(540)

AVON BE FUN

(511)

3 – Non-medicated toilet preparations; toiletries; skin care preparations; skin moisturizers; body and beauty care preparations; powders, creams and lotions, all for the face, hands and body; cosmetic sun-tan preparations; soaps; shower and bath preparations; beauty masks; talcum powder; nail polish; nail polish remover; enamel for nails; false nails; adhesi-

ves for cosmetic purposes; cosmetics; eye makeup remover, eye shadow, eye liner, mascara, lipstick, lip liner, lip gloss; make-up foundation; blusher; tissues impregnated with cosmetic lotions; cotton sticks for cosmetic purposes; cotton wool for cosmetic purposes; preparations for cleaning, moisturising, colouring and styling the hair; preparations for cleaning the teeth; shaving and aftershave preparations; perfumes, fragrances, toilet waters, eau de cologne; deodorants and anti-perspirants for personal use; essential oils (cosmetic).

(260) AM 2015 80477 A
(800) 1231252
(891) 2014 09 25
(731) AVON PRODUCTS, INC.
World Headquarters, 777 Third Avenue,
New York NY 10017, USA

(540)

AVON BE DARING

(511)

3 – Non-medicated toilet preparations; toiletries; skin care preparations; skin moisturizers; body and beauty care preparations; powders, creams and lotions, all for the face, hands and body; cosmetic sun-tan preparations; soaps; shower and bath preparations; beauty masks; talcum powder; nail polish; nail polish remover; enamel for nails; false nails; adhesives for cosmetic purposes; cosmetics; eye makeup remover, eye shadow, eye liner, mascara, lipstick, lip liner, lip gloss; make-up foundation; blusher; tissues impregnated with cosmetic lotions; cotton sticks for cosmetic purposes; cotton wool for cosmetic purposes; preparations for cleaning, moisturising, colouring and styling the hair; preparations for cleaning the teeth; shaving and aftershave preparations; perfumes, fragrances, toilet waters, eau de cologne; deodorants and anti-perspirants for personal use; essential oils (cosmetic).

(260) AM 2015 80478 A
(800) 1231283
(891) 2014 10 28
(731) GREENLAND SEAFOOD EUROPE GMBH
Otto-Lilienthal-Straße 23, 28199 Bremen,
Germany

(540)

MAREFINO

(511)

29 – Fish, sea foods, molluscs, crayfish, mussels, oysters, sea-cucumbers, crustacea, shellfish, not live; fresh, preserved, dried, salted (cured), frozen, marinated and cooked fish; fish fillets, foods prepared from fish, tinned fish, prepared meals consisting mainly of fish or seafood, fish stock, fish broth, fish crackers, isinglass for food, fish meal for human consumption, fish mousses, processed fish spawn.

35 – Trading and consumer information, namely retailing and wholesaling in relation to fish, seafood, shellfish, crayfish, mussels, oysters, sea cucumbers, crustaceans, shellfish, all of the aforesaid not being live, fresh, preserved, dried, salted (cured), frozen, marinated and cooked fish, fish fillets, foods prepared from fish, tinned fish, prepared meals consisting predominantly of fish or seafood, fish stock, fish broth, fish crackers, isinglass for food, fish meal for human consumption, fish mousses, processed fish spawn.

(260) AM 2015 80479 A
(800) 1231299
(891) 2014 11 06
(731) OPEL SPECIAL VEHICLES GMBH
Mainzer Str. (Adam Opel AG – M55), 65428
Rüsselsheim, Germany

(540)

IntelliLux LED

(511)

9 – Scientific, nautical, surveying, weighing, measuring, signalling, checking (supervision), life-saving and teaching apparatus and instruments; apparatus and instruments for conducting, switching, transforming, accumulating, regulating or controlling electricity; apparatus for recording, transmission or reproduction of sound or images; magnetic data carriers, recording discs; mechanisms for coin-operated apparatus; cash registers, calculating machines and data processing equipment and computers; fire-extinguishing apparatus.

12 – Motor vehicles, parts and replacement parts therefor, included in this class.

(260) AM 2015 80480 A
(800) 1231341
(891) 2014 04 24
(731) MINNIEMUSE, LLC C/O SNR
REGISTERED AGENT SERVICES, INC.
4520 Main Street, Suite 1100, Kansas City
MO 64111, USA

(540)



MinnieMuse

(591) Black, white

(511)

3 – Cosmetics, perfumery and non-medicated toiletries; perfumes; colognes; essential oils; skin care lotions; cosmetic creams; skin moisturizing gels; soaps; hair lotions; dentifrices.

9 – Applications software for mobile phones, namely, software for use in database management and

software for use in electronic storage of data; downloadable electronic publications, namely, books and magazines in the field of clothing; mobile phone accessories, namely, cell phone cases, headphones, screen covers, holders for attaching mobile phones in vehicles, hands-free apparatus for use in vehicles, phone covers, pouches for protection of phones; cases for portable consumer electronic devices, namely, printers, computers, cell phones, and cases for tablet computers; optical apparatus and instruments, namely, eyewear, spectacles, sunglasses, spectacle lenses, spectacle frames, parts and accessories thereof, namely, cases for spectacles and sunglasses, chains for spectacles and sunglasses, cords for spectacles and sunglasses.

14 – Precious metals and their alloys and goods in precious metals or coated therewith, not included in other classes, namely, rings, earrings, necklaces, bangles, and bracelets; jewelry, imitation jewelry, costume jewelry, precious stones and semi-precious stones; horological and chronometric instruments, clocks and watches; and cases and parts therefor.

16 – Printed matter, namely, bumper stickers, calendars, comic books, autograph books, decals, bookmarks; publications in the nature of magazines, periodical publications, programs and guides in the field of fashion, art and beauty; stationery and office supplies, namely, pens, pencils, notebooks, posters, diaries, calendars, ring binders, postcards, greeting cards; printed computer programs in the nature of computer game instruction manuals, paper and plastic shopping bags, checkbook covers and passport cases, desktop business-card holders.

18 – Leather and imitations of leather, and goods made of these materials and not included in other classes, namely, leather pouches, suitcases, bags, shopping bags, beach bags, handbags, satchels, school bags, sports bags, cases, vanity cases in the nature of unfitted vanity cases and vanity cases sold empty, briefcases, attache bags, wallets, purses, luggage, travelling trunks, suitcases, backpacks, rucksacks, sling bags, labels and tags for luggage; animal skins, hides; trunks and travelling bags; handbags, rucksacks, purses, wallets; umbrellas, clothing for animals.

25 – Clothing namely, outer clothing in the nature of anoraks and ponchos, under clothing in the nature of bras, underpants, long johns, and vests, underwear, tights, shirts, dressing gowns, dresses, wedding dresses, gowns, saris, shirts, skirts, trousers, ready made clothes in the nature of shirts, pants, dresses, T shirts, skirts, shorts, jeans, and leggings, knitwear in the nature of cardigans, jumpers, sweaters, pullovers, overcoats, coats, rain coats, waterproof clothing in the nature of waterproof jackets and waterproof trousers, parkas, jackets, suits, layettes, swim-suits, beachwear, bikinis, mittens, gloves, muffs, scarves, and clothing belts; footwear; headgear, na-

mely, headwear, hats, caps, shower caps, headbands, and sun visors; lingerie, hosiery.

35 – Promoting the graphic arts design services of others by means of a website featuring graphic artwork submitted by graphic art designers; advertising services for others; marketing services for others; business administration; retail store services; and online retail store services.

36 – Art brokerage; consultation in art as an investment.

42 – Fashion design consulting services; fashion trend consulting services.

(260) AM 2015 80484 A

(800) 1231400

(891) 2014 08 28

(731) VALENTINO S.p.A.

Via Turati, 16/18, I-20121 Milano, Italy

(540)



VALENTINO

(591) Black, white

(511)

3 – Cosmetics, including night and day creams; face and body care and cleansing products, bath foam; shaving foam, aftershave; foundation cream; nail polish; deodorants for men and women; hand and body soaps; shampoos and hair rinses; hair spray; dentifrices; fragrances, namely, perfumes, eau de cologne and essential oils for personal use for men and women.

(260) AM 2015 80486 A

(800) 1231473

(891) 2014 04 07

(731) NOSTRUM OIL & GAS PLC

4th Floor, 53-54 Grosvenor Street, London
W1K 3HU, United Kingdom

(540)

NOSTRUM OIL & GAS

(511)

1 – Chemicals used in industry, science and photography, as well as in agriculture, horticulture and forestry; unprocessed artificial resins, unprocessed plastics; manures; fire extinguishing compositions; tempering and soldering preparations; chemical substances for preserving foodstuffs; tanning substances; adhesives used in industry.

4 – Industrial oils and greases; lubricants; dust absorbing, wetting and binding compositions; fuels (including motor spirit) and illuminants; candles and wicks for lighting.

6 – Pipes of metal; pipelines of metal; oil pipelines of metal; gas pipes of metal; gas pipelines of metal.

7 – Machines and machine tools, both the aforementioned being for use in the oil and gas extraction, refining and processing industry; motors and engines (except for land vehicles); machine coupling and transmission components (except for land vehicles); pumping machinery; drilling machinery.

35 – Advertising; business management; business administration; office functions; all the aforementioned concerning the oil and gas industry.

37 – Oil extraction; drilling for oil; oil pumping; mining; gas extraction; drilling for gas; gas pumping; maintenance pipelines.

39 – Oil transportation; gas transportation; chemical transportation.

40 – Treatment of materials; oil refining; treatment of petrochemicals; treatment of gas.

42 – Scientific and technological services and research and design relating thereto; industrial analysis and research services; design and development of computer hardware and software; consultancy relating to oil, gas and chemicals; research into oil and gas extraction and refining; geophysical surveying.

(260) AM 2015 80493 A

(800) 1231504

(891) 2014 09 19

(731) VITAL ANSTALT FAPA
Eschnerstrasse 64, FL-9487 Bendern,
Liechtenstein

(540)

Menopearl

(511)

5 – Nutritional supplements for medical purposes; vitamin preparations; nutritional supplements based on minerals, amino acids, trace element preparations; dietetic foods; medicinal herbs; nutritional supplements for medical purposes and for use in foods and dietary supplements for human consumption; nutritional supplements for non-medical use containing proteins, amino acids, fatty acids, with the addition of vitamins, minerals, trace elements, individually or combined; nutritional supplements for non-medical use containing vitamins, minerals, trace elements, individually or combined.

(260) AM 2015 80496 A

(800) 1231526

(891) 2014 09 22

(731) Obshchestvo s ogranichennoy
otvetstvennostyu "SIBIRSKIY DELIKATES"
ul. Mira, d. 59A, Omskiy r-n, Omskaya
oblast', RU-644510 Krasnoyarka, Russian
Federation

(540)



(591) Brown, light brown, red, orange, green,
white, light yellow and black

(511)

30 – Pelmeni [meat stuffed dumplings].

(260) AM 2015 80498 A

(800) 1231535

(891) 2014 10 07

(731) DR. NICOLAI VON FÜNER
Athener Platz 11, 81545 München, Germany

(540)

ARTEAST

(591) Black, white

(511)

9 – Media content, particularly, musical sound recordings, musical video recordings, records [sound recordings], recorded tape cassettes, musical recordings in the form of discs, downloadable music files.

16 – Printed matter.

25 – Clothing, footwear, headgear.

35 – Advertising, marketing and promotional services, particularly, promotion [advertising] of concerts.

41 – Entertainment, cultural activities, particularly, arranging and conducting of concerts.

45 – Intellectual property consultancy.

(260) AM 2015 80499 A

(800) 1231570

(891) 2014 06 30

(731) AVVA DEVELOPMENT LTD
Markou Botsari, 3, 2nd floor, CY-3040
Limassol, Cyprus

(540)

ECOFIXIME

(591) Black, white
 (511)
 5 – Antibiotics; amino acids for veterinary purposes; pharmaceutical and veterinary preparations; sanitary preparations for medical purposes; dietetic foods adapted for medical purposes; dietetic substances adapted for medical use; food for babies; nutritional supplements; mineral food supplements; nutritive substances for microorganisms; chemical reagents for medical or veterinary purposes; chemical preparations for veterinary purposes; suppositories; syrups for pharmaceutical purposes; medicines for veterinary purposes; bacteriological preparations for medical and veterinary use; bacterial preparations for medical and veterinary use; enzyme preparations for veterinary purposes; greases for veterinary purposes; enzymes for veterinary purposes.

(260) AM 2015 80500 A
 (800) 1231605
 (891) 2014 09 22
 (731) SHENZHEN JASIC TECHNOLOGY CO., LTD.
 3, Qinglan 1st Road, Pingshan District, Shenzhen, 518000 Guangdong, China
 (540)



(591) Black, white
 (511)
 7 – Welding machines; soldering irons, gas-operated; electrodes for welding machines; welding apparatus, electric; electric arc cutting apparatus; heat welding torch; soldering lamps; cutting machines; electron industry equipment; robots.

(260) AM 2015 80501 A
 (800) 783369
 (891) 2014 11 14
 (731) SONETT VERMOEGENSVERWALTUNG GMBH
 Ziegeleiweg 5, 88693 Deggenhausertal, Germany
 (540)

SONETT

(511)
 3 – Washing and cleaning agents for household and industrial use, washing detergents, bleaching, softener, woolwash and woolcare products, laundry rinse; spot removers; scouring and fat-dissolving preparations; decalcifier; washing up detergents for household and industrial use, washing up liquid, dishwasher detergent, clear rinse; regenerating salt; soaps;

perfumery; essential oils; cosmetics and body care; dentifrices.

5 – Disinfectants for household and industrial use.

(260) AM 2015 80504 A
 (800) 1145511
 (891) 2014 10 09
 (731) FRESH NUTS GMBH
 Bredowstr. 17, 22113 Hamburg, Germany
 (540)

Meray

(511)
 29 – Dates; ground almonds, almond (processed); hazelnut spreads; sunflower seeds (processed); sunflower seeds for human consumption; prepared cashew nuts; peas, (preserved); processed peas; chickpeas, processed; roasted peanuts; beans, prepared; beans, preserved; fat (preserved); peanuts (processed); peanut butter; raisins; dried sultanas; dried figs; processed nuts; fruits (preserved); canned nuts; dried fruits; (preserved) soybeans for food; fruits (cooked); candied fruit; fruit slices; fruit snacks; jellies (jelly); jams; dried fruits; fruit purees; glazed fruits; candied fruit snacks; candied fruit; prepared fruit, vegetables, nuts; dried legumes; dried soybeans; coconuts (dried); ground nuts; spiced nuts; nuts (processed); edible seeds; seeds (processed).

30 – Almond confections; [almonds], [coated with chocolate]; [roasted] corn; snacks, prepared from corn; fried corn; chips [cereal products]; [milled] corn; shelled and cooked corn (hominy); corn flakes; processed corn; roasted coffee beans; toast; cocoa [roasted, powdered, granulated or/as a beverage]; sweetened beans (amanatto); coffee as whole beans; nut candy; anise [grains]; frozen processed rice; processed grains; fruits with chocolate icing; candied ginger; nuts coated with chocolate; snack bar with nuts [food]; snack bars with nuts [candy]; coated nuts [confectionery]; macadamia nuts with chocolate icing; fruit jelly ices; jelly confectionery; honey; rice snacks.

31 – Fresh dates; unprocessed dates, hazelnuts, sunflower seeds, cashews; peas [fresh]; fresh corn; unprocessed corn; beans, fat [fresh] unprocessed beans; peanuts, unprocessed; peanuts [fruits]; peanuts, fresh; fresh apricots; unprocessed apricots; unprocessed nutmeat; unprocessed grains for human consumption; berries [fresh fruits]; vegetable seeds; almonds [fruit]; edible nuts (unprocessed); fresh nuts; nuts, unprocessed nuts; natural seeds; unprocessed edible seeds; sesame.

(260) AM 2015 80505 A
 (800) 1156377
 (891) 2014 09 16

(731) CASA DEL DOLCE S.r.l.
Strada Conzorziale dei Beni, 1/3, I-24045
FARA GERA D'ADDA (BG), Italy

(540)



(591) Black, white

(511)

30 – Coffee, tea, cocoa, sugar, rice, tapioca, sago, artificial coffee; flour and preparations made from cereals, bread, pastry, confectionery, confectionery products, sweets; chewing gum, not for medical purposes; ice cream; honey, golden syrup, flavoured syrup; yeast, baking-powder; salt, mustard; vinegar, sauces (condiments); spices; ice.

32 – Beers; mineral and aerated waters and other non-alcoholic drinks; fruit drinks and fruit juices; syrups and other preparations for making beverages.

(260) AM 2015 80506 A

(800) 1195627

(891) 2014 12 04

(731) PREFERRED GUEST, INC.

One StarPoint, STAMFORD CT 06902, USA

(540)

SPG

(591) Black, white

(511)

43 – Providing of food and drink.

(260) AM 2015 80507 A

(800) 1231638

(891) 2014 09 18

(731) LEGRAND FRANCE

128 ave du Maréchal de Lattre-de-Tassigny,
F-87000 LIMOGES, France;

LEGRAND SNC

128 avenue du Maréchal de Lattre-de-
Tassigny F-87000 LIMOGES, France

(540)

IN'
MATIC

(591) Black, grey

(511)

9 – Apparatus, instruments and devices for electrical control, remote control, signaling, calling, surveyl-

lance, video surveillance, access control, detection and alarm; apparatus and instruments, including modular, for electric current power, driving, transmission, distribution, sharing, transformation, accumulation, regulation or control of electric current; electrical installation apparatus; mechanisms for electrical installation apparatus and electrical control apparatus; apparatus, devices and installations for electrical control, remote control, radio control, infrared control, especially for lighting, heating, watering, air conditioning, ventilation, alarm apparatus, roller shutters, blinds, projection screens, television, doors, doormen, locks, presence simulation and, in general, all electrically-operated apparatus; wind and/or sun sensor sets for apparatus for controlling roller shutters or blinds; lighting control apparatus; remote controls; radio remote controls; remote control relays; auxiliary remote control apparatus; electric control unit or radio bus control; transmitters and receivers (remote controls), especially infrared; radio transmitters (remote controls); single-function or multi-function electric control units; interfaces for control apparatus; electrical cells and batteries; battery boxes; electrical ballasts and their monitors; power supplies (electricity); transformers; breakers (circuit breakers); compensators (electricity); modular blocks (electricity); repeaters; connectors; circuit breakers; circuit breaker mechanisms; switches; electric current switches; switches with pilots; light switches; power switches; key-operated switches and push-buttons; key, badge or card switches (especially for hotel rooms) and key holders for these; changeover switches; push-buttons (electricity); push-buttons with label holders (electricity); push-buttons (electricity); coded-keypad control apparatus, including switches and push-buttons; two-way switches; double two-way switches; two-way and push-buttons light switches; auxiliary contacts; auxiliary contact interfaces; wire outlets; cable outlets; timers for lighting and/or electrical installations; indicators (electricity); relays; programming units; programming units for electric heating and for electric household apparatus; time switches and time-delay switches; dusk-to-dawn switches and relays; load controllers; voltage regulators; cruise control devices; variators; voltage regulators; power regulators; power units; potentiometers; light regulators; light regulators and remote control regulators; limit regulators/switches; speed regulators (electricity); plugs and sockets (electricity); current plugs and sockets; filler plates (electricity); television plugs and sockets; plugs and sockets for video; telephone plugs and sockets; plugs and sockets for signaling, calling and/or alarm apparatus; plugs and sockets for electric control and lighting apparatus; central vacuum electric sockets; lightning rod sockets; multi-outlet power strips; adapters (electricity); electric conductors, especially cables, wires, cords, rails and buses; installation and/or distribution profi-

les for electric conductors and/or apparatus; signaling units; beacon units; beacon lights; indicator lights (signaling) and diffusers for these; illuminated label holders (signaling); interfaces, connector devices, function cards and auxiliary modules, all for signaling installations and apparatus; central units for the management of signaling and/or alarm apparatus; sound monitoring apparatus, especially for children's rooms; electrical audio signaling, calling and/or alarm apparatus and equipment, especially for doors and gates; bell and/or call buttons; bells and chimes (warning devices), especially for doors and gates; electric doorbells; warning signals for electric networks; warning lights; flasher lamps and flashtubes (signaling and alarms); acoustic [sound] alarms; horns; anti-theft alarms (other than for vehicles); fire alarms; electric warning bells; buzzers; sirens; radio transmitters and receivers; alarm stations; fire safety stations; home automation stations; intrusion alarm apparatus, especially wired or radio; telephone transmitters and relay interfaces for these; management apparatus for controls linked to fire alarms; modular apparatus for technical alarms; detectors; infrared detectors; infrared receivers; interfaces between transmitters and receivers; magnetic opening detectors, in particular for garage doors; presence detectors; movement detectors; intruder detectors; proximity sensors; radio frequency detectors; fire and smoke detectors; stand-alone releasing detectors; gas sensors; flood detectors; temperature increase detectors; glass breakage detectors; pre-signal detectors; interfaces for detectors; photoelectric cells; electric contacts, especially for doors and gates; electric or electronic locking, locks and strikes and controls and remote controls for these, especially with keypads; prehung door units for electric locking of emergency exits; door closing selectors; cases and readers for access control apparatus; coded keypads for buildings; magnetic and/or electronic and/or optical and/or digital keys, cards and badges, especially for access control; programming keys for electronic keys; apparatus and instruments for measuring and/or regulating temperature; thermostats; probes for thermostats; energy management apparatus, especially for electric heating; interphone and telephone exchanges and apparatus; interphone and telephone handsets; parts and components of all the aforementioned products, including mechanisms, boxes, cases, supports, claws, stands, holding frames, overhanging frames, adapters, plates, back plates, finishing plates, decorative plates, shirt fronts, casings, cowlings, shutters, hub caps, label holders, control keys and fingers.

(260) AM 2015 80511 A
 (800) 1231640
 (891) 2014 09 18
 (731) LEGRAND FRANCE

128 avenue du Maréchal, de Lattre-de-Tassigny, F-87000 LIMOGES, France
 LEGRAND SNC
 128 avenue du Maréchal de Lattre-de-Tassigny F-87000 LIMOGES, France

(540)

IN'MATIC

(591) Black, grey

(511)

9 – Apparatus, instruments and devices for electrical control, remote control, signaling, calling, surveillance, video surveillance, access control, detection and alarm; apparatus and instruments, including modular, for electric current power, driving, transmission, distribution, sharing, transformation, accumulation, regulation or control of electric current; electrical installation apparatus; mechanisms for electrical installation apparatus and electrical control apparatus; apparatus, devices and installations for electrical control, for remote control, radio control, infrared control, especially for lighting, heating, watering, air conditioning, ventilation, alarm apparatus, roller shutters, blinds, projection screens, television, doors, doormen, locks, presence simulation and, in general, all electrically-operated apparatus; wind and/or sun sensor sets for apparatus for controlling roller shutters or blinds; lighting control apparatus; remote controls; radio remote controls; remote control relays; auxiliary remote control apparatus; electric control unit or radio bus control; transmitters and receivers (remote controls), especially infrared; radio transmitters (remote controls); single-function or multi-function electric control units; interfaces for control apparatus; electrical cells and batteries; battery boxes; electrical ballasts and their monitors; power supplies (electricity); transformers; breakers (circuit breakers); compensators (electricity); modular blocks (electricity); repeaters; connectors; circuit breakers; circuit breaker mechanisms; switches; electric current switches; switches with pilots; light switches; power switches; key-operated switches and push-buttons; key, badge or card switches (especially for hotel rooms) and key holders for these; changeover switches; push-buttons (electricity); push-buttons with label holders (electricity); push-buttons (electricity); coded-keypad control apparatus, including switches and push-buttons; two-way switches; double two-way switches; two-way and push-buttons light switches; auxiliary contacts; auxiliary contact interfaces; wire outlets; cable outlets; timers for lighting and/or electrical installations; indicators (electricity); relays; programming units; programming units for electric heating and for electric household apparatus; time switches and time-delay switches; dusk-to-dawn switches and relays; load controllers; voltage regulators; cruise control devices; variators; voltage regulators; power regulators; power units; potentiometers; light regulators;

light regulators and remote control regulators; limit regulators/switches; speed regulators (electricity); plugs and sockets (electricity); current plugs and sockets; filler plates (electricity); television plugs and sockets; plugs and sockets for video; telephone plugs and sockets; plugs and sockets for signaling, calling and/or alarm apparatus; plugs and sockets for electric control and lighting apparatus; central vacuum electric sockets; lightning rod sockets; multi-outlet power strips; adapters (electricity); electric conductors, especially cables, wires, cords, rails and buses; installation and/or distribution profiles for electric conductors and/or apparatus; signaling units; beacon units; beacon lights; indicator lights (signaling) and diffusers for these; illuminated label holders (signaling); interfaces, connector devices, function cards and auxiliary modules, all for signaling installations and apparatus; central units for the management of signaling and/or alarm apparatus; sound monitoring apparatus, especially for children's rooms; electrical audio signaling, calling and/or alarm apparatus and equipment, especially for doors and gates; bell and/or call buttons; bells and chimes (warning devices), especially for doors and gates; electric doorbells; warning signals for electric networks; warning lights; flasher lamps and flashtubes (signaling and alarms); acoustic [sound] alarms; horns; anti-theft alarms (other than for vehicles); fire alarms; electric warning bells; buzzers; sirens; radio transmitters and receivers; alarm stations; fire safety stations; home automation stations; intrusion alarm apparatus, especially wired or radio; telephone transmitters and relay interfaces for these; management apparatus for controls linked to fire alarms; modular apparatus for technical alarms; detectors; infrared detectors; infrared receivers; interfaces between transmitters and receivers; magnetic opening detectors, in particular for garage doors; presence detectors; movement detectors; intruder detectors; proximity sensors; radio frequency detectors; fire and smoke detectors; stand-alone releasing detectors; gas sensors; flood detectors; temperature increase detectors; glass breakage detectors; pre-signal detectors; interfaces for detectors; photoelectric cells; electric contacts, especially for doors and gates; electric or electronic locking, locks and strikes and controls and remote controls for these, especially with keypads; prehung door units for electric locking of emergency exits; door closing selectors; cases and readers for access control apparatus; coded keypads for buildings; magnetic and/or electronic and/or optical and/or digital keys, cards and badges, especially for access control; programming keys for electronic keys; apparatus and instruments for measuring and/or regulating temperature; thermostats; probes for thermostats; energy management apparatus, especially for electric heating; interphone and telephone exchanges and apparatus; interphone and telephone handsets; parts and components of all the

mentioned products, including mechanisms, boxes, cases, supports, claws, stands, holding frames, overhanging frames, adapters, plates, back plates, finishing plates, decorative plates, shirt fronts, casings, cowlings, shutters, hub caps, label holders, control keys and fingers.

(260) AM 2015 80512 A

(800) 1231682

(891) 2014 08 20

(731) GÜRTEKS PAZARLAMA A.Ş.

2. Organize Sanayi Bölgesi, Vali Muammer Güler Bulvarı No'Lu Cad. No:9, TR-83228 Şehitkamil-Gaziantep, Turkey

(540)



(591) Black, white, gold

(511)

27 – Carpets, rugs, mats; prayer rugs; linoleum, artificial turf, linoleum for covering floors; gymnasium mats; wallpaper, wall hangings not of textile.

(260) AM 2015 80513 A

(800) 1231693

(891) 2014 08 07

(731) SHIMANO INC.

3-77 Oimatsu-cho, Sakai-ku, Sakai City, Osaka 590-8577, Japan

(540)

SYMPHOMATIC

(511)

12 – Parts and accessories for electrically assisted bicycles, namely, internal gear hubs, electric motors, electric motor units, drive units consisting of electric motor units and reduction gears, front chain wheels, crank sets, cranks, gear shifting apparatus, all for electrically assisted bicycles; electrically assisted bicycles.

(260) AM 2015 80514 A

(800) 1231713

(891) 2014 10 06

(731) YEREVAN BRANDY COMPANY

CJSC Admiral Isakov ave. 2, 0082 Yerevan, Armenia

(540)

ԱՐԱՐԱՏ ԵՐԵՅՈՒՆԻ

(511)

33 – Alcoholic beverages (except beer).

(260) AM 2015 80515 A
 (800) 1231720
 (891) 2014 06 06
 (731) MONSTER ENERGY COMPANY
 1 Monster Way, Corona CA 92879, USA
 (540)

GREENLIGHT

(511)
 5 – Nutritional supplements in liquid form; vitamin fortified beverages for medical use.

32 – Non-alcoholic beverages, namely, energy drinks, energy drinks flavored with juice, fruit-flavored drinks, soft drinks, sports drinks, all enhanced with vitamins, minerals, nutrients, amino acids and/or herbs.

(260) AM 2015 80517 A
 (800) 1231722
 (891) 2014 06 27
 (731) Tovarystvo z obmezheniou vidpovidalnistiu
 Firma "SV"
 vul. Poliova, 11, Ruska Lozova, Derhachivskyi raion, Kharkivska oblast 62332, Ukraine
 (540)

SAMA

(591) Red
 (511)
 3 – Breath freshening sprays; amber [perfume]; ammonia [volatile alkali] [detergent]; antistatic preparations for household purposes; badian essence; laundry blueing; colorants for toilet purposes; colour-brightening chemicals for household purposes [laundry]; bergamot oil; joss sticks; laundry glaze; shining preparations [polish]; beard dyes; pastes for razor strops; shaving stones, antiseptic; shaving soap; shaving preparations; eyebrow cosmetics; eyebrow pencils; petroleum jelly for cosmetic purposes; cosmetic preparations for baths; bath salts, not for medical purposes; cotton wool for cosmetic purposes; cotton sticks for cosmetic purposes; shoe wax; shoe cream; shoe polish; bleaching soda; cream for whitening the skin; laundry bleaching preparations; bleaching salts; dental bleaching gels; bleaching preparations [decolorants] for cosmetic purposes; cosmetic preparations for slimming purposes; decorative transfers for cosmetic purposes; cosmetic preparations for eyelashes; false eyelashes; adhesives for affixing false eyelashes; moustache wax; hair colorants; hair lotions; hair waving preparations; volcanic ash for cleaning; astringents for cosmetic purposes; cloths impregnated with a detergent for cleaning; gaultheria oil; heliotropine; geraniol; potassium hypochloride; make-up; make-up preparations; make-up re-

moving preparations; lipsticks; disinfectant soap; deodorants for personal use; deodorant soap; depilatories; depilatory wax; depilatory preparations; scented water; scented wood; extracts of flowers [perfumes]; ethereal essences; essential oils; javelle water; jasmine oil; greases for cosmetic purposes; laundry soaking preparations; aromatics [essential oils]; flavourings for beverages [essential oils]; colour-removing preparations; degreasers other than for use in manufacturing processes; scale removing preparations for household purposes; jewellers' rouge; dentifrices; denture polishes; preparations for cleaning dentures; ionone [perfumery]; bases for flower perfumes; essential oils of cedarwood; adhesives for affixing false hair; adhesives for cosmetic purposes; quillaia bark for washing; cosmetics; make-up powder; beauty masks; cosmetic kits; whitening; cleaning chalk; cosmetic creams; laundry starch; starch glaze for laundry purposes; cakes of toilet soap; lavender water; lavender oil; lacquer-removing preparations; hair spray; nail varnish; essential oils of lemon; polishing rouge; lotions for cosmetic purposes; tissues impregnated with cosmetic lotions; after-shave lotions; smoothing preparations [starching]; almond oil; almond soap; almond milk for cosmetic purposes; washing soda, for cleaning; detergents other than for use in manufacturing operations and for medical purposes; washing preparations; soap; soap for brightening textile; cakes of soap; soap for foot perspiration; antiperspirant soap; cleansing milk for toilet purposes; musk [perfumery]; fabric softeners for laundry use; mint for perfumery; mint essence [essential oil]; neutralizers for permanent waving; nail polish; nail care preparations; false nails; fumigation preparations [perfumes]; eau de Cologne; cosmetic pencils; oils for perfumes and scents; oils for cosmetic purposes; oils for toilet purposes; oils for cleaning purposes; oil of turpentine for degreasing; perfumery; perfumes; laundry wax; pumice stone; hydrogen peroxide for cosmetic purposes; stain removers; mouth washes, not for medical purposes; pomades for cosmetic purposes; laundry bleach; laundry preparations; dry-cleaning preparations; antiperspirants [toiletries]; safrol; sachets for perfuming linen; turpentine, for degreasing; sun-tanning preparations [cosmetics]; soda lye; sunscreen preparations; potpourris [fragrances]; talcum powder, for toilet use; swabs [toiletries]; terpenes [essential oils]; tripoli stone for polishing; rose oil; toiletries; toilet water; mascara; paint stripping preparations; cosmetic dyes; refurbishing preparations; cleaning preparations; scouring solutions; shampoos; cosmetic preparations for skin care.

(260) AM 2015 80518 A
 (800) 1231776
 (891) 2014 09 03
 (731) FONDO MONTEBELLO S.R.L.

Via Maestri del Lavoro, 9, Localita' Pozza,
I-41053 MARANELLO (MO), Italy

(540)



(591) Black, white

(511)

29 – Meat, fish, poultry and game; meat extracts; preserved, dried and cooked fruits and vegetables; jellies, jams, compotes; eggs, milk and milk products; edible oils and fats.

30 – Coffee, tea, cocoa, sugar, rice, tapioca, sago, artificial coffee; flour and preparations made from cereals, bread, pastry and confectionery, ices; honey, treacle; yeast, baking-powder, salt, mustard, vinegar, sauces (condiments); spices.

(260) AM 2015 80519 A

(800) 1231801

(891) 2014 10 24

(731) Limited Liability Company "BIG"

Kashirskiy proezd, d. 23, RU-115201
Moscow, Russian Federation

(540)

Fiorino d'Oro

(591) Black, white

(511)

33 – Aperitifs; arrack [arak]; brandy; wine; piquette; whisky; vodka; gin; digesters [liqueurs and spirits]; cocktails; liqueurs; alcoholic beverages; alcoholic beverages containing fruit; spirits [beverages]; distilled beverages; mead [hydromel]; peppermint liqueurs; bitters; rum; sake; cider; rice alcohol; alcoholic extracts; fruit extracts, alcoholic; alcoholic essences.

(260) AM 2015 80521 A

(800) 1231819

(891) 2014 11 17

(731) Obschestvo s ogranichennoy otvetstvennostyu

"Laboratoriya sovremennogo zdorovya"
ul. Khimzavodskaya 11/20, Berdsk, RU-633004
Novosibirskaya oblast', Russian Federation

(540)

ELBIFID

(511)

5 – Albumin dietary supplements; albuminous food-stuffs for medical purposes; albuminous preparations for medical purposes; alginate dietary supplements; aloe vera preparations for pharmaceutical purposes; antioxidant pills; appetite suppressant pills; balms for medical purposes; biocides; biological prepara-

tions for medical purposes; by-products of the processing of cereals for dietetic or medical purposes; casein dietary supplements; decoctions for pharmaceutical purposes; diabetic bread adapted for medical use; dietetic beverages adapted for medical purposes; dietary fiber; dietetic foods adapted for medical purposes; dietetic substances adapted for medical use; digestives for pharmaceutical purposes; enzyme dietary supplements; enzyme preparations for medical purposes; flour for pharmaceutical purposes; food for babies; glucose dietary supplements; hematogen; herbal teas for medicinal purposes; lacteal flour for babies; lecithin dietary supplements; liniments; linseed dietary supplements; linseed oil dietary supplements; lotions for pharmaceutical purposes; malted milk beverages for medical purposes; medicinal herbs; medicinal infusions; medicinal oils; medicinal roots; medicinal tea; milk ferments for pharmaceutical purposes; mineral food supplements; nervines; nutritional supplements; pharmaceutical preparations for skin care; pollen dietary supplements; preparations of trace elements for human and animal use; propolis dietary supplements; protein dietary supplements; royal jelly dietary supplements; royal jelly for pharmaceutical purposes; slimming pills; syrups for pharmaceutical purposes; vitamin preparations; wheat germ dietary supplements; yeast for pharmaceutical purposes.

(260) AM 2015 80522 A

(800) 1001396

(891) 2008 11 07

(731) Joint Stock Company

"YUZHURALKONDITER"

d. 12 ul. Darvina, RU-454087 Chelyabinsk,
Russian Federation

(540)

МЕРЕНДИНКИ

(591) Black, white

(511)

30 – Waffles, cakes, pastries, peanut confectionery, almond confectionery, pasty, cocoa, cocoa products, caramels, sweetmeats, liquor ice, peppermint sweets, coffee, crackers, meat pies, farinaceous food, candy for food, fruit jellies, marzipan, custard, ice cream, sherbets, muesli, coffee beverages with milk, coffee-based beverages, tea-based beverages, chocolate beverages with milk, chocolate-based beverages, cocoa-based beverages, lozenges, petit fours, biscuits, pies, fondants, pralines, gingerbread, chewing gum, not for medical purposes, cake paste, confectionery, rusks, sandwiches, tarts, halvah, bread, tea; cocoa beverages with milk.

(260) AM 2015 80524 A

(800) 1066182

(891) 2014 09 05

(731) WESTIN HOTEL MANAGEMENT, L.P.
One StarPoint, Stamford CT 06902, USA
(540)

HEAVENLY

(511)
20 – Throw pillows and bolster pillows.

24 – Bath linen, bed blankets, bed linen, bed sheets, bed spreads, bed blankets, pillow cases, duvet covers, curtains, duvets, household linen, pillow shams, towels, shams, bed skirts and shower curtains.

(260) AM 2015 80527 A
(800) 1149463
(891) 2014 09 22
(731) PRYVATNE PIDPRYIEMSTVO "D.YU.M"
vul. Shevchenka, bud. 323, m. Lviv 79069,
Ukraine
(540)



INTERNATIONAL

(591) Golden, yellow and cherry
(511)
3 – Breath freshening sprays; shaving preparations; shaving soap; eyebrow cosmetics; eyebrow pencils; lipsticks; hair spray; cosmetic preparations for baths; beauty masks; after-shave lotions; soap; hair lotions; cosmetic preparations for eyelashes; nail polish; make-up preparations; nail polish; deodorants for human beings; dentifrices; cosmetic creams; cosmetics; cosmetic kits; make-up removing preparations; eau de cologne; cosmetic pencils; breath freshening sprays; mouth washes, not for medical purposes; bath salts, not for medical purposes; lotions for cosmetic purposes; cleansing milk for toilet purposes; perfumes; perfumery; pomades for cosmetic purposes; bases for flower perfumes; cakes of toilet soap; almond milk for cosmetic purposes; eyebrow pencils; make-up powder; sun-tanning preparations [cosmetics]; sunscreen preparations; toilet water; mascara; shampoos; cosmetic preparations for skin care.

(260) AM 2015 80528 A
(800) 1231876
(891) 2014 06 11
(731) AYTAŞ ALÇI ENERJİ MADEN VE
İNŞAAT SAN.TİC.A.Ş.

Turan Güneş Bulvarı No:12/14 Çankaya
Yıldızevler Çankaya ANKARA, Turkey

(540)



(591) Blue, orange, white
(511)
1 – Chemicals used in industry, science, photography, agriculture, horticulture and forestry; manures and soils; unprocessed artificial resins and unprocessed plastics; fire extinguishing compositions; adhesives not for medical, household and stationery purposes; admixtures for cement and concrete; materials for plaster insulations; adhesives for grout, tiles and marble.

19 – Sand, gravel, crushed stone, asphalt, bitumen, cement, gypsum for use in construction, road construction, repair and covering work; building materials (as finished products) made of concrete, gypsum, clay, potters' clay, natural or artificial stone, wood, plastics and synthetic materials for building, construction, road construction purposes, included in this class; non-metallic building materials, non-metallic transportable buildings, poles not of metal for power lines; barriers not of metal, doors and windows of wood and synthetic materials; traffic signs not of metal, non-luminous and non-mechanical, for roads; monuments and statuettes of stone, concrete and marble; natural and synthetic surface coatings in the form of panels and sheets, being building materials; heat adhesive synthetic surface coating, being building materials; bitumen cardboard coatings for roofing; bitumen coating for roofing; building glass; prefabricated swimming pools not of metal (structures); aquarium sand; lime, cement and plaster for use in construction; panels, boards, platforms, walls, building elements made of plaster; bricks, tiles, floor tiles, briquettes, roofing tiles; ready-mixed concretes, mortars, plasters, colored plasters.

(260) AM 2015 80529 A
(800) 1231887
(891) 2014 09 16
(731) APPLE INC.
1 Infinite Loop, Cupertino CA 95014, USA
(540)



(591) Black, white
(526) WATCH
(511)
14 – Horological and chronometric instruments; watches; timepieces; chronographs for use as timepieces; chronometers; watchstraps; watch bands; cases

for watches, and horological and chronometric instruments; parts for watches, and horological and chronometric instruments.

(260) AM 2015 80533 A

(800) 1231908

(891) 2014 10 23

(731) DR. WILLMAR SCHWABE GMBH & CO. KG
Willmar-Schwabe-Str.4, 76227 Karlsruhe,
Germany

(540)



a caring cure

(591) Black and white

(511)

5 – Pharmaceutical and veterinary preparations; sanitary preparations for medical purposes; plasters, materials for dressings; material for stopping teeth, dental wax; disinfectants; preparations for destroying vermin; fungicides, herbicides; dietetic preparations adapted for medical use.

38 – Telecommunications.

44 – Hygienic care for human beings; medical services.

(260) AM 2015 80534 A

(800) 1231918

(891) 2014 09 12

(731) ZUFFA, LLC
2960 W. Sahara Avenue, Las Vegas NV
89102, USA

(540)

UFC

(511)

41 – Entertainment services, namely production of martial arts competitions, events, information, entertainment shows and interactive programs both live and for distribution via television, cable, satellite, audio and video media, cartridges, video and computer discs, and communication and global computer networks; on-line electronic newsletters delivered by email in the field of current events, news and information featuring sports, mixed martial arts and entertainment; providing on-line newsletters in the field of current events, news and information featuring sports, mixed martial arts and entertainment.

(260) AM 2015 80538 A

(800) 1231947

(891) 2014 06 10

(731) DIGITAL RETAIL, SIA

Maskavas iela 108/110-50, LV-1003 RĪGA,
Latvia

(540)



(591) Blue, yellow and white

(511)

9 – Scientific, nautical, surveying, photographic, cinematographic, optical, weighing, measuring, signaling, checking (supervision), life-saving and teaching apparatus and instruments; apparatus and instruments for conducting, switching, transforming, accumulating, regulating or controlling electricity; apparatus for recording, transmission or reproduction of sound or images; magnetic data carriers, recording discs; compact discs, DVDs and other digital recording media; mechanisms for coin-operated apparatus; cash registers, calculating machines, data processing equipment, computers; computer software; fire-extinguishing apparatus.

36 – Insurance; financial affairs; monetary affairs; real estate affairs.

38 – Telecommunications.

(260) AM 2015 80539 A

(800) 1231949

(891) 2014 07 31

(731) KITBAG LIMITED
2 Gregory Street, Hyde, Cheshire SK14 4TH,
United Kingdom

(540)

KITBAG

(511)

9 – Videos; CDs; DVDs; articles for use in playing sports and games for protective purposes; articles for wear for playing sports and games for protective purposes; sunglasses; covers for mobile phones; covers for mobile tablets and laptops.

16 – Books; magazines; printed matter.

24 – Towels; duvets; duvet covers; bed linen.

25 – Clothing; footwear; headgear; sportswear.

28 – Articles for use in playing sports and games; articles for use in playing sports and games for protective purposes; equipment for use in playing sports and games; gymnastic and sporting articles not included in other classes; but not including any such goods in the form of kitbags.

35 – Retail and wholesale services connected with the sale of sporting equipment, clothing, footwear, headgear and printed matter; none being bags.

(260) AM 2015 80541 A
 (800) 1231968
 (891) 2014 09 16
 (731) APPLE INC.
 1 Infinite Loop, Cupertino CA 95014, USA
 (540)

 The logo for Apple Watch, featuring the Apple logo (a silhouette of an apple with a bite taken out of it) to the left of the word "WATCH" in a bold, sans-serif font.

(591) Black, white
 (511)
 10 – Health, fitness, exercise, and wellness sensors, monitors and displays; medical apparatus and devices.

(260) AM 2015 80544 A
 (800) 1232024
 (891) 2014 08 25
 (731) MERKUR GAMING GMBH
 Borsigstr. 22, 32312 Lübbecke, Germany
 (540)

Fabulanimals

(511)
 9 – Scientific, nautical, surveying, photographic, cinematographic, optical, weighing, measuring, signalling, checking (supervision), life-saving and teaching apparatus and instruments; apparatus and instruments for conducting, switching, transforming, accumulating, regulating or controlling electricity; apparatus for recording, transmission or reproduction of sound or images; magnetic data carriers, recording discs; compact discs, DVDs and other digital recording media; cash registers, calculating machines, data processing equipment, computers; computer software; fire-extinguishing apparatus; musical jukeboxes and parts for the aforesaid automatic machines; automatic cash dispensers, automatic money counting and money changing machines; coin-operated mechanisms; computer and video games software; games software for use on any computer platform, including electronic entertainment and games consoles; computer game programs; computer games; video games (software); computer games provided through a global computer network or supplied by means of multi-media electronic broadcast or through telecommunications or electronic transmission or via the internet; computer games, leisure and recreational software, video games and computer software, all being provided in the form of storage media; programs for operating electric and electronic apparatus for games, amusement and/or entertainment purposes; electronic terminals for generating lottery tickets; computer software for computer games on the internet; online games (software), in particular for online betting games, online prize games, online gambling games, online games of skill and online casino games; computer

software in the form of an app for mobile devices and computers; calculating apparatus in coin-operated machines and parts for the aforesaid goods; apparatus for recording, transmission, processing or reproduction of data, including sound or images, including parts for all the aforesaid goods, except radio sets, television receivers, hi-fi systems, video recorders, telephone apparatus, fax machines and telephone answering machines; computer hardware and software for casino and amusement arcade games, for gaming machines, slot machines or video lottery gaming machines or games of chance via the internet; electric, electronic, optical or automatic apparatus, for identifying data carriers, identity cards and credit cards, bank notes and coins; electric, electronic or optical alarm and monitoring installations, including video cameras and apparatus for image transmission and image processing; data processing apparatus and computers, including data processing apparatus and computers being components for data networks and parts facilitating data network communications; electric wiring harnesses; circuit boards, printed circuit boards (electronic components) and combinations thereof, being assemblies and parts for apparatus, included in this class.

28 – Toys; gymnastic and sporting articles not included in other classes; decorations for christmas trees; gaming apparatus (including coin-operated apparatus); coin-operated arcade games (machines); games for amusement arcades (included this class); coin-operated video gaming apparatus; video games adapted for use with external screens or monitors only; casino fittings, namely roulette tables, roulette wheels; coin-operated automatic gaming machines and gaming machines, in particular for gaming arcades, with or without a prize payout; electronic or electrotechnical gaming apparatus, automatic gaming machines, gaming machines, slot machines operated by coins, tokens, banknotes, tickets or by means of electronic, magnetic or biometric storage media, in particular for commercial use in casinos and amusement arcades, with or without a prize payout; automatic gaming machines and gaming machines, in particular for commercial use in casinos and gaming arcades, with or without a prize payout; coin-operated gaming machines and/or electronic money-based gaming apparatus (machines), with or without prizes; housings adapted for gaming machines, gaming apparatus and automatic gaming machines, operated by means of coins, tokens, tickets or by means of electronic, magnetic or biometric storage media, in particular for commercial use in casinos and gaming arcades, with or without a prize payout; electronic games; electronic game entertainment apparatus and accessories; video output game machines; drawing apparatus for prize games and lotteries, draws or raffles; housings of metal, plastic and/or wood for coin-operated automatic machines; apparatus for games (including video ga-

mes), other than adapted for use with external screens or monitors only; electropneumatic and electric pulling machines (gaming machines); gaming tables, in particular for table football, billiards, sliding games; arrows and flying discs (toys); electric, electronic or electromechanical apparatus for bingo games, lotteries or video lottery games and for betting offices, networked or unnetworked; LCD games consoles; automatic gaming machines; including all the aforesaid automatic machines, machines and apparatus operating in networks; apparatus and devices for accepting and storing money, being fittings for the aforesaid automatic machines, included in this class.

(260) AM 2015 80549 A
(800) 1232043
(891) 2014 06 06
(731) THULE SWEDEN AB
Borggatan 2, SE-330 33 Hillerstorp, Sweden
(540)

THULE

(511)
9 – Bags, sleeves, cases, covers and backpacks for electronic, digital, photographic devices, apparatus and instruments; spectacle cases; bags adapted to contain protective helmets; helmets; parts, fittings and accessories for the aforesaid goods.

12 – Vehicles, conveyances and apparatus for locomotion by land, air or water; vehicles and conveyances; articles for use in securing and supporting goods on vehicles; carriers and cases for vehicles; carriers, bags, panniers and cases for use on vehicles or vehicle roofs; vehicle trunk, glove compartment, console and door, visor, seat organizer bags and cases; vehicle trash-containers; anti-theft devices for vehicles; racks for vehicles and accessories for racks, namely bags, carriers, ski carriers, snowboard carriers, carriers for surf boards, kayak carriers, boat carriers, baggage carriers and bike carriers; rear mounted carriers namely cargo carriers, bike carriers and ski holders; roof boxes for vehicles; spoilers for vehicles; cargo nets for vehicles; security locks for vehicle carriers; covers for vehicles and parts of vehicles; covers for carriers and roof boxes for vehicles; covers and bags for wheels; bags for vehicles; towing apparatus for vehicles; towing brackets; towing hooks; trailers; trailer covers and frameworks for trailer covers; trailer couplings; child seats for vehicles; multifunctional child transport carriers; strollers; child transport trailers; non-skid devices for vehicle tyres; wheels for vehicles; seats for use in vehicles; sleighs for vehicles; accessories, parts and fittings for the aforesaid goods.

18 – Luggage, bags, wallets and other carriers; bags (included in this class), including carrier bags, bags for sports, travel bags; luggage; trunks; baggage;

backpacks; purses; child carriers worn on the body; umbrellas; parasols; accessories, parts and fittings for the aforesaid goods

(260) AM 2015 80551 A
(800) 1232095
(891) 2014 09 23
(731) Publichne aktsionerne tovarystvo
"KARLSBERG UKRAINA"
vul. Sapozhnikova, 6, Zaporizhzhia 69076,
Ukraine
(540)



(591) Green, white, black, red, hot yellow and light yellow
(526) ЛЬВІВСЬКА ПИВОВАРНЯ ЛЬВІВСЬКЕ
УКРАЇНА
(511)
32 – Non-alcoholic beverages; waters [beverages]; aerated water; preparations for making aerated water; essences for making beverages; ginger ale; kvass [non-alcoholic beverage]; preparations for making beverages; beer wort; beer; malt beer; malt wort; must; extracts of hops for making beer.

(260) AM 2015 80552 A
(800) 1232153
(891) 2014 09 26
(731) VIENNA INSURANCE GROUP AG Wiener
Versicherung Gruppe
Schottenring 30, A-1010 Vienna, Austria
(540)



(591) Red, blue, black and white
(511)
36 – Insurance; financial affairs; monetary affairs; real estate affairs.

(260) AM 2015 80553 A
(800) 1232154
(891) 2014 09 26
(731) VIENNA INSURANCE GROUP AG Wiener
Versicherung Gruppe
Schottenring 30, A-1010 Vienna, Austria

(540)

SIGMA **INTERALBANIAN** 
VIENNA INSURANCE GROUP

(591) Red, blue, black and white

(511)

36 – Insurance; financial affairs; monetary affairs;
 real estate affairs.

(260) AM 2015 80555 A

(800) 1232181

(891) 2014 10 13

(731) **PIERRE FABRE DERMOCOSMETIQUE**
 45 place Abel Gance, F-92100 BOULOGNE,
 France

(540)

ASCOFILLINE

(511)

1 – Chemical products for use in industry in the ma-
 nufacture of cosmetic products.

(260) AM 2015 80557 A

(800) 1232206

(891) 2014 11 24

(731) **COMPAGNIE GENERALE DES**
ETABLISSEMENTS MICHELIN
 12 cours Sablon, F-63000 CLERMONT-
 FERRAND, France

(540)

X CORE

(511)

12 – Pneumatic tires and inner tubes for vehicle
 wheels; casings for pneumatic tires; treads for ret-
 reading tires; tracks for track vehicles.

(260) AM 2015 80564 A

(800) 1232278

(891) 2014 10 03

(731) **ALMIRALL, S.A.**
 Ronda General Mitre, 151, E-08022
 Barcelona, Spain

(540)

Brimica
Genuair 

(591) Blue, green and black

(511)

5 – Pharmaceutical products.

10 – Inhalers.

(260) AM 2015 80565 A

(800) 1232285

(891) 2014 03 13

(731) **SÖLEN ÇİKOLATA GIDA SANAYİ VE**
TİCARET A.Ş

4.Organize Sanayi Bölgesi 83412, Nolu
 Cadde No:4, ŞEHİTKAMİL GAZİANTEP,
 Turkey

(540)



(591) Different tones of pink, orange, yellow, red
 and white. The principal parts of the mark is
 red.

(511)

29 – Preserved, frozen, dried and cooked fruits and
 vegetables; jellies, jams, compotes; eggs; milk and
 milk products; edible oils and fats, sesame oil; pota-
 to chips; chocolate nut butter.

30 – Coffee, tea, cocoa and artificial coffee; rice;
 tapioca and sago; flour and preparations made from
 cereals; bread, pastry and confectionery; edible ices;
 sugar, honey, treacle; yeast, baking-powder; salt;
 mustard; vinegar, sauces (condiments); spices; ice;
 halvah; candy; chocolate; chocolate bars; pralines;
 caramels; waffles; biscuits; cakes; Turkish delight;
 ice cream; roasted corn.

(260) AM 2015 80566 A

(800) 1232316

(891) 2014 09 17

(731) **APPLE INC.**

1 Infinite Loop, Cupertino CA 95014, USA

(540)



(591) Black, white

(526) Pay

(511)

36 – Financial services; financial transaction servi-
 ces; bill payment services; providing secure com-
 mercial transactions; debit and credit card services,
 electronic payment services.

(260) AM 2015 80574 A

(800) 1232335

(891) 2014 09 23

(731) **ASH-D ICECEK GIDA OTOMOTIV**
TEMIZLIK SANAYI VE TICARET
ANONIM SİRKETİ

Ahi Evren Cad. Ata Center No:1 Kat:1,
 Maslak Sisli İstanbul, Turkey

(540)



(591) Purple and white

(526) BEVERAGE FOR BREASTFEEDING MOTHERS

(511)

5 – Dietary supplements, including those adapted for medical purposes; nutritional supplements; dietary supplements for slimming purposes; food for babies; herbs and herbal beverages adapted for medicinal purposes.

(260) AM 2015 80612 A

(800) 937991

(891) 2014 11 06

(731) CONTINENTAL REIFEN DEUTSCHLAND GMBH

Vahrenwalder Str. 9, 30165 Hannover, Germany

(540)

CONTACT

(511)

12 – Vehicle tires.

(260) AM 2015 80628 A

(800) 1232514

(891) 2014 10 31

(731) ASH-D ICECEK GIDA OTOMOTIV TEMIZLIK SANAYI VE TICARET ANONIM SIRKETI

Ahi Evren Cad. Ata Center No:1 Kat:1, Maslak Sisli, İstanbul, Turkey

(540)



(591) Pink, yellow, orange and white

(511)

32 – Non-alcoholic beverages.

(260) AM 2015 80630 A

(800) 1232540

(891) 2014 11 05

(731) PHILIP MORRIS BRANDS SÀRL

Quai Jeanrenaud 3, CH-2000 Neuchâtel,

Switzerland

(540)



(591) Black, white

(511)

34 – Tobacco, raw or manufactured; tobacco products, including cigars, cigarettes, cigarillos, tobacco for roll-your-own cigarettes, pipe tobacco, chewing tobacco, snuff tobacco, kretek; snus; tobacco substitutes (not for medical purposes); smokers' articles, including cigarette paper and tubes, cigarette filters, tobacco tins, cigarette cases and ashtrays, pipes, pocket apparatus for rolling cigarettes, lighters; matches.

(260) AM 2015 80640 A

(800) 1232551

(891) 2014 10 09

(731) COMPUTER BETTING COMPANY GmbH

Füchselbachstrasse 7, A-4060 Leonding, Austria

(540)



(591) Blue and grey

(511)

9 – Computer software.

41 – Entertainment.

42 – Design and development of computer hardware and software.

(260) AM 2015 80641 A

(800) 1232552

(891) 2014 10 09

(731) COMPUTER BETTING COMPANY GmbH

Füchselbachstrasse 7, A-4060 Leonding, Austria

(540)



(591) Red

(511)

9 – Computer software.

41 – Entertainment.

42 – Design and development of computer hardware and software.

(260) AM 2015 80643 A

(800) 1232574

(891) 2014 09 30

(731) EGIS GYÓGYSZERGYÁR ZRT.

Keresztúri út 30-38, H-1106 Budapest,
Hungary
(540)

PLATEGRA

(511)
5 – Human pharmaceutical preparations for use in the cardiovascular field, available on prescription.

(260) AM 2015 80647 A
(800) 1232614
(891) 2014 07 09
(731) ARAIK VAZGENOVYCH KHACHATRYAN
Prospekt Sorokarichchia, Zhovtnia, 46/1,
ap. 37, Kyiv 03039, Ukraine
(540)

CO-CO
GRILL

(591) Black, white
(511)
43 – Bar services; hotels; canteens; cafés; cafeterias; providing campground facilities; food and drink catering; restaurants; self-service restaurants; snack-bars.

(260) AM 2015 80648 A
(800) 1232620
(891) 2014 09 25
(731) BECTON, DICKINSON AND COMPANY
1 Becton Drive, MC 090, Franklin Lakes
NJ 07417, USA
(540)

BD

(511)
1 – Chemical, biological and diagnostic reagents and prepared laboratory media for scientific or research purposes.

5 – Chemical, biological and diagnostic reagents and prepared laboratory media for clinical or medical purposes.

9 – Laboratory instruments, namely, assay plates, petri dishes, pipets, tubes, specimen transport containers, anaerobic jars and coagulation timers, flow cytometers and computer software therefor; laboratory apparatus for storing and testing blood cultures; sample preparation and real-time polymerase chain reaction (RT-PCR) analyzer for the detection and identification of infectious diseases for scientific use.

10 – Medical instruments and apparatus, namely, syringes, needles, catheters, sample collection devices namely specimen cups and tubes, centrifuges, lancets, lancet devices, tubes, tubing, stopcocks, adapters, holders, access valves, extension sets, transdu-

cer kits comprised of drip chamber, tubing, stopcocks, infusion sets, containers for medical waste, and replacement parts therefor.

(260) AM 2015 80649 A
(800) 1232629
(891) 2014 09 30
(731) CELGENE CORPORATION
86 Morris Avenue, Summit NJ 07901, USA
(540)

BIOVANCE

(511)
5 – Biological tissue intended for use as a wound covering; wound dressings; burn dressings; surgical dressings; pharmaceutical preparations for wounds.

(260) AM 2015 80658 A
(800) 1232666
(891) 2014 10 07
(731) KEMPINSKI AG
Maximilianstr. 17, 80539 Munich, Germany
(540)

(591) Black, white
(511)
35 – Business management; business consultancy and advisory services.

36 – Real estate brokerage for residential property on a time sharing base, for condominiums and other real estates.

37 – Consultancy services relating to maintenance and repair of hotels, resorts and housing space on a time sharing base and other commercial properties; construction consultation.

42 – Technical consultancy in the field of design of hotels, resorts and housing space on a time sharing base and other commercial properties; architectural consultation; engineering services; consultancy in the field of interior decoration.

43 – Services for providing food and drink; reservation services for hotel rooms and other accommodations; hotel services; resort hotel services (accommodation); restaurant services.

(260) AM 2015 80660 A
(800) 1232679
(891) 2014 10 17
(731) Open Joint Stock Company "GAZ"
prosp. Lenina, 88, RU-603004 Nizhny
Novgorod, Russian Federation

(540)

Labels Next

(591) Black, white

(511)

16 – Note books; pamphlets; booklets; wrapping paper; printed publications; wrapping articles of paper or plastic; cardboard articles; calendars; envelopes [stationery]; boxes of cardboard or paper; paper ribbons; graphic prints; stickers [stationery]; covers [stationery]; plastic cling film, extensible, for palletization; greeting cards; bags of paper; folders for papers; plastic film for wrapping; wrapping materials; prospectuses; flags of paper; blueprints; flyers, emblems, labels, not of textile.

35 – Demonstration of goods; organization of exhibitions for commercial or advertising purposes; organization of trade fairs for commercial or advertising purposes; shop window dressing; presentation of goods on communication media, for retail purposes; wholesale services and retail store services; sales promotion for others; advertising; on-line advertising on a computer network; television advertising; procurement services for others [purchasing goods and services for other businesses].

(260) AM 2015 80668 A

(800) 1232729

(891) 2014 10 22

(731) MARS, INCORPORATED

6885 Elm Street, McLean VA 22101-3883,
USA

(540)



(591) Yellow, black and shades of brown

(511)

31 – Agricultural, horticultural and forestry products not included in other classes; live animals and birds; fresh fruits and vegetables; foodstuffs for animals and birds; strengthening food for animals and birds; lime for animal forage; raw barks; beverages for pets; roots for food; cuttle bone for birds; edible chewing bones and edible chews for animals; litter for animals; products for animal litter; aromatic sand for pets.

(260) AM 2015 80669 A

(800) 1232730

(891) 2014 10 22

(731) MARS, INCORPORATED

6885 Elm Street, McLean VA 22101-3883,
USA

(540)

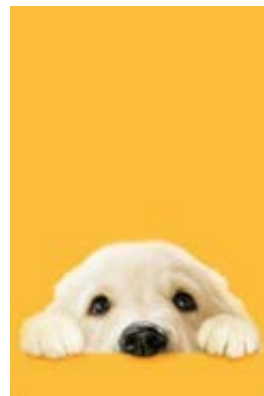

(591) Yellow, black, beige and brown

(511)

31 – Agricultural, horticultural and forestry products not included in other classes; live animals and birds; fresh fruits and vegetables; foodstuffs for animals and birds; strengthening food for animals and birds; lime for animal forage; raw barks; beverages for pets; roots for food; cuttle bone for birds; edible chewing bones and edible chews for animals; litter for animals; products for animal litter; aromatic sand for pets.

(260) AM 2015 80674 A

(800) 1232772

(891) 2014 06 17

(731) LISTANO LIMITED

37 Greenhill Street, Stratford-upon-Avon,
Warwickshire CV37 6LE, United Kingdom

(540)

MARIA DUVAL CENTER

(511)

16 – Paper and cardboard (unprocessed, semi-processed or for stationery or printing); printed matter; bookbinding material; photographs; stationery; adhesives for stationery and household purposes; artists' materials; paintbrushes; typewriters and office requisites (except furniture); instructional and teaching material (except apparatus); printers' type; printing blocks.

35 – Advertising; business management; business administration; office functions; distribution of prospectuses and samples for advertising or commercial purposes; business consultancy and information, document reproduction, computerized file management, organization of exhibitions for commercial or advertising purposes.

45 – Astrology, parapsychology, radiesthesia, cartomancy, fortune telling, futurology.

(260) AM 2015 80675 A

(800) 1232811

(891) 2014 10 07

(731) Dochirnie pidpriemstvo "KONDYTERSKA KORPORATSIIA "ROSHEN"

Elektrykiv vul., 26/9, Kyiv 04176, Ukraine

(540)

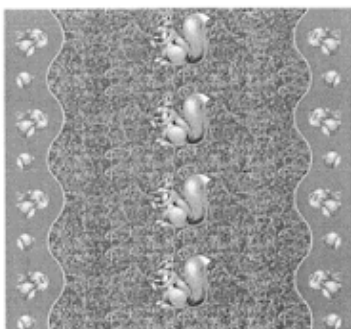

(591) Black, white

(511)

30 – Candies, chocolate candies.

(260) AM 2015 80677 A

(800) 1232818

(891) 2014 10 21

(731) Joint Stock Company

"EURASIAN FOODS CORPORATION"

Bayzakov Str., 69, 050026 Almaty, Kazakstan

(540)



(591) Green, light green, red, orange, yellow, pink, white, blue and beige

(511)

30 – Salt, mustard; vinegar, sauces (condiments) including prepared horseradish [condiment], sauces, mayonnaise, ketchup [sauce]; spices; ice.

(260) AM 2015 80687 A

(800) 1232835

(891) 2014 10 07

(731) Dochirnie pidpriemstvo

"KONDYTERSKA KORPORATSIIA

"ROSHEN"

Elektrykiv vul., 26/9, Kyiv 04176, Ukraine

(540)

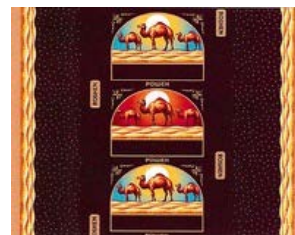

(591) Brown, blue, red, yellow and white

(511)

30 – Sweetmeats [candy]; chocolate candies.

(260) AM 2015 80688 A

(800) 1232838

(891) 2014 11 20

(731) HETTICH MARKETING-UND

VERTRIEBS GMBH & CO. KG

Vahrenkampstraße 12-16, 32278

Kirchlengern, Germany

(540)

cast|werk
automotive
electronics

(591) Black, white and blue

(526) The trademark is protected as a whole. "automotive electronics" shall not be subject to independent legal protection.

(511)

6 – Metal building materials; cables and wires of common metal; ironmongery, small items of metal hardware; hinges for motor vehicles.

7 – Crankcases for machines, motors and engines; motor and engine parts of all kinds (except those for land vehicles).

9 – Housings for electronic equipment; apparatus for the reproduction of sound or images, and parts therefor; frames for electronic components.

12 – Automobile parts, as far as included in this class; dashboard mounts and instrument panels for use in vehicles of all kinds; mounts for central consoles in motor vehicles, housings and mounts for navigation apparatus and displays; drive housings for motor vehicles, in particular tailgates for motor vehicles, parts for electric or mechanical drives for window opening systems in motor vehicles, parts for opening and closing mechanisms for vehicle doors and glove compartments for vehicles, guide rails for central armrests in motor vehicles.

19 – Building materials (non-metallic).

(260) AM 2015 80689 A

(800) 1232852

(891) 2014 11 20

(731) HENKEL AG & CO. KGAA
Henkelstrasse 67, 40589 Düsseldorf, Germany
(540)



(591) Black, white
(511)

1 – Chemical products for industrial purposes; unprocessed artificial resins, unprocessed plastics; adhesives used in industry, silicones.

3 – Cleaning and polishing agents (except for leather); abrasives, dishwashing agents; scouring agents; chemical preparations for degreasing, deoiling, cleaning of machines, metal, wood, stone, porcelain, glass and synthetics.

16 – Adhesives for household, stationery and do-it-yourself purposes.

17 – Packing, stopping and insulating material, sealants; adhesive bands other than for household or medical purposes, sealant compounds for joints, self-adhesive tapes other than for stationery and not for medical or household purposes, synthetic resins, insulating paints, insulating plaster, insulating tape, caulking materials.

(260) AM 2015 80691 A

(800) 1232884

(891) 2014 10 08

(731) QIERTE CO., LTD.

Yangguang Mansion, Yangguang East Road,
Chendai, Jinjiang City, FUJIAN PROVINCE,
China

(540)



(591) Black, white
(511)

25 – Clothing; sports shoes; layettes [clothing]; football shoes; footwear; hats; hosiery; leather belts for clothing; scarves; gloves [clothing].

(260) AM 2015 80693 A

(800) 1232890

(891) 2014 05 07

(731) SEHRIYAR GIDA INSAAT TEKSTIL
TURIZM VE PETROL ÜRÜNLERİ
SANAYİ TICARET LIMITED SİRKETİ
526/4 Sokak No:9 İsmail Bey, Apt. A Blok
Kat:1 D:3, Karabağlar İZMİR, Turkey

(540)

Kahve Durağı



(591) Black, white, dark brown, yellow
(511)

30 – Coffee; ground and whole bean coffee; coffee extracts; instant coffee; artificial coffee; coffee substitutes; coffee concentrates; coffee essences; coffee flavourings; coffee mixtures; caffeine-free coffee; flavoured coffee; coffee based beverages including coffee beverages with milk; cold coffee based drinks including drinks blended with milk and ice; tea; herbal and non herbal tea; tea extracts; tea substitutes; tea-based beverages including iced tea and chai tea; cocoa; cocoa based beverages including cocoa beverages with milk; aerated beverages with coffee, cocoa or chocolate; flavourings for beverages (other than essential oils); chocolate syrup; essences for foodstuffs except etheric essences and essential oils; ice cream; rice; macaroni; ravioli; bakery products; pastries; flour for food; dough products; waffles; puddings; sorbets (ices); sugar; chocolate, candy and confectionery; ices; honey, treacle; yeast, baking-powder; salt, mustard; vinegar, sauces (condiments); cereal based food bars; snack bars containing grains, nuts and/or dried fruit; dessert products including tarts, cheesecakes, trifles, crumbles, puddings, rice pudding and chocolate mousse; flour and preparations made from cereals, breads and pastries; flour based savoury snacks; pizzas; pasta products; prepared meals containing pasta; quiches; baked goods including pies, meat pies, sausage rolls, pasties, biscuits and cookies; bakery products including, muffins, doughnuts, croissants, bagels and scones; cakes including fruit cakes, sponge cakes, iced cakes, bar cakes, cup cakes, lamingtons, brownies and other cakes included this class; sandwiches including open sandwiches and toasted sandwiches; pasta salads; rice salads; salad dressings; flavourings for soups (other than essential oils); spices; condiments.

32 – Beers; malt beers; mineral water (beverages); soda water; waters (beverages); fruit juices; vegetable juices (beverages); syrups for beverages; lemonades; sorbets (beverages); non alcoholic carbonated beverages; concentrates, syrups or powders used in the preparation of soft drinks; soft drinks; cola drinks; isotonic beverages; grape must (unfermented); tomato juice (beverages); traditional Turkish hot drink made from finely ground tubers of orchids, milk and sugar "salep".

35 – The bringing together, for the benefit of others, of coffee, mixtures of coffee, coffee extracts, coffee substitutes, tea, tea extracts and tea-based preparations, cocoa and preparations having a base of cocoa, chocolate, chocolate products, sugar, natural

sweeteners, honey and honey substitutes, treacle syrup, confectionery, pastries, bakery products, cakes, sandwiches, sweets, biscuits, food products based on rice, on flour or on cereals, flour, spices, flavorings and seasonings, non-electric coffee machines, parts and accessories thereof, non-electric coffee grinders, parts and accessories thereof, coffee filters, household or kitchen utensils and containers, articles of glass, porcelain, majolica or earthenware, cups, coffee cups, cappuccino cups, tea cups, chocolate cups, cups for chocolate-based beverages, mugs, tea pots, sugar bowls, plates, glasses, napkin holders, excluding the transport thereof, enabling customers to conveniently view and purchase those goods; advertising; advertising and publicity services provided via television, radio or mail; business management; providing management assistance relating to coffee and tea stores; coffee and tea store franchising services; business consultancy relating to coffee and tea store franchising services; providing professional business services assistance in the management, establishment, design, construction, equipping and operation of coffee and tea stores, restaurants and take-away food stores; business advisory services relating to the setting up of and running of coffee and tea stores, restaurants and take away food stores; promotion and advertising services; business advice and consultancy; business advice relating to franchising; commercial management; arranging and conducting of promotional and marketing events; organization of exhibitions and events for commercial or advertising purposes; assistance and advice regarding business organization and management; consultancy services relating to advertising; publicity and marketing; on-line advertising.

43 – Services for providing food and drink; cafe and restaurant services; coffee-house and snack-bar services; bar services; cafeterias; coffee shops; catering for the provision of food and beverages; mobile take-away fast food services; consultancy, advisory and information services in relation to the provision of food and drink.

(260) AM 2015 80701 A

(800) 1232972

(891) 2014 11 04

(731) SCHWEIZERISCHE EIDGENOSSENSCHAFT V.D. ARMASUISSE EIDG.

Departement für Verteidigung, Bevölkerungsschutz und Sport Kasernenstrasse 19,
CH-3003 Bern, Switzerland

(540)

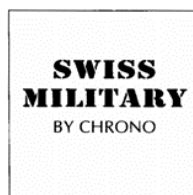

(591) Black, white

(511)

14 – Watches of Swiss origin.

(260) AM 2015 80703 A

(800) 1233086

(891) 2014 09 04

(731) CREF LTD

Bolshoi Afanasievskiy per., 41, RU-119019
Moskva, Russian Federation

(540)

(591) Blue, light green, white

(511)

16 – Paper, cardboard and goods made from these materials, not included in other classes; printed matter; printed publications; books; photographs; stationery; artists' materials; paint brushes; typewriters and office requisites (except furniture); instructional and teaching material (except apparatus); handbooks [manuals]; plastic materials for packaging (not included in other classes).

28 – Games and playthings; gymnastic and sporting articles not included in other classes; decorations for Christmas trees.

41 – Education; providing of training; entertainment; sporting and cultural activities; academies [education]; videotaping; dubbing; publication of books; education information; layout services, other than for advertising purposes; game services provided on-line from a computer network; providing on-line electronic publications, not downloadable; correspondence courses; practical training [demonstration]; organization of exhibitions for cultural or educational purposes; providing recreation facilities; arranging and conducting of workshops [training]; arranging and conducting of seminars; organization of competitions [education or entertainment]; vocational guidance [education or training advice]; vocational retraining; electronic desktop publishing; publication of electronic books and journals on-line; publication of texts, other than publicity texts; writing of texts, other than publicity texts; club services [entertainment or education]; educational services, instruction services, teaching; translation; coaching [training]; recording studio services; language interpreter services; services of schools [education]; nursery schools; photography; production of shows.

(260) AM 2015 80704 A

(800) 1233092

(891) 2014 10 09

(731) CREMERIE COSMETICHE S.R.L.

Via A. Avogadro di Casanova, 26/28, I-36100
Vicenza (VI), Italy

(540)



(591) Black, white

(511)

3 – Cosmetics; body cleaning and beauty care preparations; perfumery and fragrances; oils for cosmetic purposes; essential oils; oils for perfumes and scents; shampoo; hair rinses; creams [non-medicated] for cleaning the skin; body mask cream; day creams; night cream; lip cream; hand creams; non-medicated foot cream; non-medicated scalp treatment cream; non-medicated face creams; sun tan lotion; creams for tanning the skin; anti-aging creams; dermatological creams [other than medicated]; non-medicated cleansing creams; exfoliant creams; moisturising skin creams [cosmetic]; non-medicated creams; skin cleansers [cosmetic]; body milks; hair balm; cosmetics for the use on the hair; hair lotions; hair dyes.

(260) AM 2015 80731 A

(800) 1233226

(891) 2014 10 16

(731) EDMUND FALKENHAHN AG

Postfach 942, Felbaweg 10, FL-9494 Schaan,
Liechtenstein

(540)



(591) Gold

(511)

14 – Precious metals and their alloys and goods in precious metals or coated therewith (not included in other classes).

16 – Seal of approval.

36 – Insurance; financial affairs; monetary affairs.

(260) AM 2015 80732 A

(800) 1233237

(891) 2014 03 19

(731) MASHNIN SIARHEI

ul. Tomina 6a-140, 230000 Grodno, Belarus

(540)



(591) Gold

(511)

9 – Downloadable software; computer software for business and social networking, uploading and search-

ing for information on employment and career opportunities and job listings, information in the fields of sales and rent, for creating electronic notice boards; computer software to enable uploading, downloading, searching, discussing and sharing documents, information, videos, sound content, texts and other means of communication and multimedia; computer software, namely an application programming interface that can be used with other applications; downloadable electronic publications for business and social networks, recruitment, employment, sales and rent; electronic notice boards; computer software for administering websites.

35 – Advertising, including advertising in social networks; business management; business administration; office functions; arranging subscriptions to telecommunication services for others; import-export agencies; commercial information agencies; advertising agencies; cost price analysis; rental of advertising space; rental of advertising space in the Internet; auditing; employment agencies; computerized database management; compilation and systemization of information into computer databases containing information on employment, business, sales and/or exchange of goods and/or services; management of computer databases containing information on employment, business, sales and/or exchange of goods and/or services; accounting; invoicing; business efficiency expert services; demonstration of goods; transcription of communications; opinion polling; market studies; business information; commercial information, and advice for consumers (consumer advice shop); business investigations; business research; marketing research; personnel recruitment; business management and organization consultancy; business organization consultancy; business management consultancy; professional business consultancy; layout services for advertising purposes; marketing; business management of performing artists; business management of sports people; updating of advertising material; collecting and arranging of topic-referred press articles; word processing; organization of exhibitions for commercial or advertising purposes; arranging newspaper subscriptions for others; receiving information, data for others; organization of fashion shows for promotional purposes; organization of trade fairs for commercial or advertising purposes; shop window dressing; business appraisals; payroll preparation; data search in computer files for others; sponsorship search; business management assistance; commercial or industrial management assistance; presentation of goods on communication media, for retail purposes; economic forecasting; auctioneering; sales promotion for others; production of advertising films; office machines and equipment rental; rental of advertising time on communication media; publicity material rental; rental of vending machines; rental of pho-

tocopying machines; publication of publicity texts; radio advertising; bill-posting; outdoor advertising; distribution of samples; dissemination of advertising matter; direct mail advertising; writing of publicity texts; on-line advertising on a computer network; advertising by mail order; television, advertising; document reproduction; compilation of statistics; compilation of information into computer databases; business inquiries; systemization of information into computer databases; advisory services for business management; tax preparation; drawing up of statements of accounts; publicity columns preparation; telemarketing services; psychological testing for the selection, of personnel; business management of hotels; commercial administration of the licensing of the goods and services of others; administrative processing of purchase orders; public relations; modelling for advertising or sales promotion; typing; relocation services for businesses; price comparison services; secretarial services; procurement services for others (purchasing goods and services for other businesses); shorthand; outsourcing services (business assistance); telephone answering for unavailable subscribers; photocopying services; sale services for goods in classes 1-34 including via the Internet; organization operation and supervision of sales for others; provision of the above-mentioned services via computer, communication and social networks; advertisements on the Internet; web-site advertisement; preparation of advertisements including for the purpose of using as a web-site; preparation of catalogues for publication, including on the Internet; rental of advertising space on web sites.

38 – Telecommunications; news agencies; wireless broadcasting; television broadcasting; cable television broadcasting; electronic bulletin board services (telecommunications services); information about telecommunication; providing access to a global computer network; providing access to databases; providing access to Internet discussion forums; providing telecommunications connections to a global computer network; providing telecommunication channels for teleshopping services; transmission of greeting cards online; message sending; transmission of messages, images, audio content, videos, graphics, including computer and/or mobile device aided; transmission of telegrams; transmission of digital files; electronic mail; rental of message sending apparatus; rental of access time to global computer networks; rental of modems; rental of telecommunication equipment; rental of telephones; rental of facsimile apparatus; radio broadcasting; communications by fiber (fibre) optic networks; communications by radiotelephones; communications by computer terminals; satellite transmission; communications by telegrams; communications by telephone; facsimile transmission; paging services (radio, telephone or other means of electronic communication); teleconferencing services; telex services; voice mail services;

telecommunications routing and junction services; telegraph services; telephone services; providing access to websites on the Internet to share texts, images, software, audio content, video files and messages among users via wire and wireless access to the web-site; transmission of messages, multimedia content, videos, audio content, photos, animation, images, texts and other content via a global computer network and other communication networks; providing online communications links which transfer users to other websites; providing Internet chatrooms, online forums, discussion forums and electronic bulletin boards for users to post, search, watch, share, evaluate and comment on the posted information; providing access to computer, electronic and Internet databases in the field of business and social networking; providing uploading, posting, displaying and electronically transmitting data, messages and information; social networks services; dissemination of information via computer networks and the Internet; providing access to online electronic notice boards; providing access to the websites of others by means of the universal login; providing access to communications of others via the Internet; audio, text, video broadcasting via computers and/or mobile devices, including uploading, sending, displaying, reproduction, tagging; audio, text, video broadcasting via communications networks, including uploading, sending, displaying, reproduction, tagging.

41 – Education; providing of training; entertainment; booking of seats for shows; gambling; education information; entertainment information; recreation information; layout services, other than for advertising purposes; game services provided on-line from a computer network; providing on-line electronic publications, not downloadable; practical training (demonstration); providing recreation facilities; arranging and conducting of colloquiums; arranging and conducting of congresses; arranging and conducting of conferences; arranging and conducting of workshops (training); arranging and conducting of seminars; arranging and conducting of symposiums; organization of competitions (education or entertainment); operating lotteries; vocational guidance (education or training advice); television entertainment; providing amusement arcade services; cinema presentations; presentation of live performances; theatre productions; conducting fitness classes; discotheque services; night clubs; organization of exhibitions for cultural or educational purposes; providing casino facilities (gambling); electronic desktop publishing; radio entertainment; entertainer services; writing of texts, other than publicity texts; news reporters services; club services (entertainment or education); teaching and educational services; provision of the above-mentioned services via computer and communication networks; publication of electronic books and journals on-line; providing non downloadable electronic publications, also on-line, including bo-

oks, periodicals, texts, audio content, videos and graphics.

42 – scientific and technological services and research and design relating thereto; industrial analysis and research services; design and development of computer and/or mobile device hardware and software; computer system analysis; recovery of computer data; computer virus protection services; installation of computer software; meteorological information; consultancy in the design and development of computer hardware; computer software consultancy; updating of computer software; monitoring of computer systems by remote access; maintenance of computer software; providing search engines for the Internet; data conversion of computer programs and data (not physical conversion); computer system design; rental of web servers; computer rental; rental of computer software; hosting computer sites (web sites); duplication of computer programs; computer software design; creating and maintaining web sites for others; computer and/or mobile device programming; hosting computer sites (web sites); maintaining computer and/or mobile applications; maintaining interactive websites and non-downloadable software on the Internet for uploading, downloading, posting, showing, displaying, tracking, sharing and transmitting messages, comments, multimedia content, videos, movies, photos, audio content, animation, images, text, information, and other content.

45 – Legal services; security services for the protection of property and individuals; personal and social services rendered by others to meet the needs of individuals; marriage agencies; detective agencies; night guards; adoption agency services; arbitration services; lost property return; genealogical research; legal research; security consultancy; intellectual property consultancy; monitoring intellectual property rights for legal advisory purposes; monitoring of burglar and security alarms; licensing of intellectual property; licensing of computer software (legal services); organization of religious meetings; opening of security locks; guards; planning and arranging of wedding ceremonies; missing person investigations; litigation services; baby sitting; pet sitting; evening dress rental; clothing rental; registration of domain names (legal services); personal background investigations; escorting in society (chaperoning); horoscope casting; copyright management; on-line dating club services; alternative dispute resolution services; house sitting; mediation; Internet-based social introduction and social networking services; dating services, including provided via the Internet; providing information in the field of personal development, charitable, philanthropic, volunteer, public and community services, and humanitarian activities, including via social networks.

(260) AM 2015 80758 A

(800) 783833

(891) 2014 09 25

(731) S. Tous, S.L.

Ctra. de Vic, El Guix, 3 E-08243 MANRESA
(Barcelona), Spain

(540)

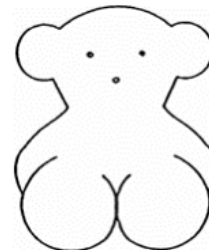

(591) Black, white

(511)

3 – Bleaching preparations and other substances for laundry use; cleaning, polishing, scouring and abrasive preparations; soaps; perfumery, essential oils, cosmetics, hair lotions; dentifrices.

(260) AM 2015 80759 A

(800) 840556

(891) 2015 01 13

(731) TAYAŞ GIDA SANAYİ VE TİCARET
ANONİM ŞİRKETİ

Gebze Organize Sanayi Bölgesi, İhsan Dede
Cad. 800, Sok. N:122, Gebze Kocaeli, Turkey

(540)



(591) Black, white

(511)

30 – Coffee, tea, cocoa, sugar, rice, tapioca, sago, artificial coffee; flour and preparations made from cereals, bread, pastry and confectionery, ices; honey, treacle; yeast, baking-powder; salt, mustard; vinegar, sauces (condiments); spices; ice.

(260) AM 2015 80760 A

(800) 862442

(891) 2015 01 14

(731) Zott SE & Co. KG

Dr.-Steichele-Straße 4, 86690 Mertingen,
Germany

(540)

Bayerntaler

(511)

29 – Cheese and cheese products from Bavaria.

30 – Chocolate from Bavaria.

(260) AM 2015 80761 A
(800) 872290
(891) 2014 10 29
(731) UNIVERSAL ENTERTAINMENT CORPORATION
3-7-26 Ariake, Koto-ku, Tokyo 135-0063,
Japan

(540)

ARUZE GAMING

(511)

9 – Arcade video game machines and replacement parts therefor; slot machines and replacement parts therefor; video gambling and gaming machines for commercial use and replacement parts therefor; games for home use adapted for use with television receivers only; computer program storage media which store programs for games for home use adapted for use with television receivers only; downloadable computer programs for games for home use adapted for use with television receivers only; computer program storage media which store programs for hand-held games with liquid crystal displays; downloadable computer programs for hand-held games with liquid crystal displays; cabinets of arcade video game machines; cabinets of slot machines; cabinets of video gaming machines for commercial use; multi-terminal gaming machines with a video display for commercial use.

28 – Amusement machines and apparatus for use in amusement parks (other than arcade video game machines) and replacement parts therefor; game machines and apparatus; hand-held games with liquid crystal displays and their fittings; multi-terminal gaming machines without a video display for commercial use.

41 – Providing casino facilities, amusement parks, amusement arcades and other amusement facilities; amusement information; providing information relating to game machines, arcade game machines and amusement machines; rental of slot machines, game machines, amusement machines and arcade game machines; game services provided online; organization and conducting of exhibitions for slot machines, game machines, amusement machines and arcade game machines.

(260) AM 2015 80763 A
(800) 948752
(891) 2014 09 25
(731) S. TOUS, S.L.
Ctra. de Vic, El Guix, 3, E-08243 MANRESA
(Barcelona), Spain

(540)

TOUS

(591) Black, white

(511)

16 – Paper, cardboard and goods made from these materials, not included in other classes; printed mat-

ter; bookbinding material; photographs; stationery; adhesives for stationery or household purposes; artists' materials; paint brushes; typewriters and office requisites (except furniture); instructional and teaching material (except apparatus); plastic materials for packaging (not included in other classes); printers' type; printing blocks.

35 – Import and export services; services of advertising, management of commercial business and commercial administration; retailing services in stores and via global communications networks.

(260) AM 2015 81063 A
(800) 1236451
(891) 2014 12 12
(731) JANSSEN PHARMACEUTICA NV
Turnhoutseweg 30, B-2340 Beerse,
Belgium

(540)

VIEMPO

(511)

5 – Human pharmaceutical preparations.

(260) AM 2015 81064 A
(800) 1236452
(891) 2014 12 12
(731) JANSSEN PHARMACEUTICA NV
Turnhoutseweg 30, B-2340 Beerse, Belgium

(540)

ARGIETA

(511)

5 – Human pharmaceutical preparations.

(260) AM 2015 81065 A
(800) 1236453
(891) 2014 12 12
(731) JANSSEN PHARMACEUTICA NV
Turnhoutseweg 30, B-2340 Beerse, Belgium

(540)

QOLISTO

(511)

5 – Human pharmaceutical preparations.

(260) AM 2015 81066 A
(800) 1236454
(891) 2014 12 12
(731) JANSSEN PHARMACEUTICA NV
Turnhoutseweg 30, B-2340 Beerse, Belgium

(540)

RYMEZIO

(511)

5 – Human pharmaceutical preparations.

(260) AM 2015 81067 A
 (800) 1237057
 (891) 2014 09 30
 (731) EGIS GYÓGYSZERGYÁR ZRT.
 Keresztúri út 30-38, H-1106 Budapest,
 Hungary

(540)

IRSAMLÁ

(511)
 5 – Pharmaceutical preparations for human use.

(260) AM 2015 81068 A
 (800) 1236455
 (891) 2014 12 12
 (731) JANSSEN PHARMACEUTICA NV
 Turnhoutseweg 30, B-2340 Beerse, Belgium

(540)

STREFYXA

(511)
 5 – Human pharmaceutical preparations.

(260) AM 2015 81078 A
 (800) 1236461
 (891) 2014 11 21
 (731) AVON PRODUCTS, INC.
 World Headquarters, 777 Third Avenue,
 New York NY 10017, USA

(540)

AVON ATTRACTION

(511)
 3 – Non-medicated toilet preparations; toiletries; skin care preparations; skin moisturizers; body and beauty care preparations; powders, creams and lotions, all for the face, hands and body; cosmetic sun-tan preparations; soaps; shower and bath preparations; beauty masks; talcum powder, nail polish; nail polish remover; enamel for nails; false nails; adhesives for cosmetic purposes; cosmetics; eye makeup remover, eye shadow, eye liner, mascara, lipstick, lip liner, lip gloss; make-up foundation; blusher; tissues impregnated with cosmetic lotions; cotton sticks for cosmetic purposes; cotton wool for cosmetic purposes; preparations for cleaning, moisturising, colouring and styling the hair; preparations for cleaning the teeth; shaving and aftershave preparations; perfumes, fragrances, toilet waters, eau de cologne; deodorants and anti-perspirants for personal use; essential oils (cosmetic).

(260) AM 2015 81113 A
 (800) 667329
 (891) 2014 12 17
 (731) ROYAL CANIN SAS
 650 avenue de la Petite Camargue, F-30470
 AIMARGUES, France

(540)



(591) Black, white

(511)

31 – Agricultural, horticultural and forestry products (neither prepared, nor transformed), grains (seeds), live animals; fresh fruits and vegetables; seeds, natural plants and flowers, animal foodstuffs, malt, litter for animals.

(260) AM 2015 81115 A
 (800) 1151606
 (891) 2014 12 15
 (731) APR Applied Pharma Research SA
 Via Corti, 5, CH-6828 Balerna, Switzerland

(540)

HALYKOO

(511)

3 – Soaps; perfumes, essential oils, hair lotions, shampoos, personal hygiene products, namely foam cleansers for personal use, for the eyes; bath foams; talcum powders [for cosmetic use]; sunscreen preparations, sunscreen creams, sunscreen drops; creams, gels, lotions, ointments and solutions for use against dry and damaged skin or for diseases of the mucous membranes for cosmetic use.

5 – Pharmaceutical products for use in dermatology, for skin care, for treating the eyes, respiratory diseases and gastrointestinal diseases; sanitary products for use in medicine; pharmaceutical products for the treatment of thrush, pharmaceutical products for the treatment of aphthae; dietetic foods for medical use; food for babies; medical plasters; materials for dressings; all-purpose disinfectants; dietetic food supplements, food supplements for medical use; food supplements; health food supplements for persons with special dietetic needs; mineral food supplements; health food supplements which are based on vitamins; topical, dermatological preparations for treating insect bites and stings; medicated plasters for the treatment of insect bites; anti-insect sprays; soporifics; talcum powder for medical use; probiotic, bacterial compositions for medical use; food supplements, namely probiotic compositions; medical creams for use after exposure to the sun; medical creams for damaged skin or for diseases of the mucous membranes.

INTERNATIONAL TRADEMARKS PROTECTED IN GEORGIA

(260) AM 2015 75332 A
(800) 1185689
(151) 2013 06 22
(181) 2023 06 22
(891) 2013 06 22
(511) 03

(260) AM 2015 77551 A
(800) 1180372
(151) 2013 07 30
(181) 2023 07 30
(891) 2014 03 31
(511) 14, 18, 25

(260) AM 2015 75965 A
(800) 1083089
(151) 2011 03 29
(181) 2021 03 29
(891) 2013 11 05
(511) 03, 04, 08, 16, 21, 25, 26, 35

(260) AM 2015 77554 A
(800) 1205196
(151) 2013 11 06
(181) 2023 11 06
(891) 2013 11 06
(511) 05, 35, 41, 42, 44

(260) AM 2015 76180 A
(800) 1193288
(151) 2013 11 27
(181) 2023 11 27
(891) 2013 11 27
(511) 05, 16

(260) AM 2015 77555 A
(800) 1205281
(151) 2014 03 04
(181) 2024 03 04
(891) 2014 03 04
(511) 04

(260) AM 2015 77197 A
(800) 1201637
(151) 2014 03 12
(181) 2024 03 12
(891) 2014 03 12
(511) 12

(260) AM 2015 77556 A
(800) 1205290
(151) 2014 02 18
(181) 2024 02 18
(891) 2014 02 18
(511) 39

(260) AM 2015 77327 A
(800) 1193942
(151) 2013 12 16
(181) 2023 12 16
(891) 2014 04 28
(511) 43

(260) AM 2015 77559 A
(800) 1205336
(151) 2014 01 08
(181) 2024 01 08
(891) 2014 01 08
(511) 03

(260) AM 2015 77542 A
(800) 1205154
(151) 2014 04 02
(181) 2024 04 02
(891) 2014 04 02
(511) 03

(260) AM 2015 77560 A
(800) 1205343
(151) 2013 11 21
(181) 2023 11 21
(891) 2013 11 21
(511) 05

(260) AM 2015 77550 A
(800) 1002149
(151) 2009 03 30
(181) 2019 03 30
(891) 2014 05 13
(511) 03

(260) AM 2015 77561 A
(800) 1205433
(151) 2014 03 04
(181) 2024 03 04
(891) 2014 03 04
(511) 34

(260) AM 2015 77649 A
(800) 1205929
(151) 2014 03 12
(181) 2024 03 12
(891) 2014 03 12
(511) 03

(260) AM 2015 77655 A
(800) 1206025
(151) 2014 04 25
(181) 2024 04 25
(891) 2014 04 25
(511) 10, 28

(260) AM 2015 77656 A
(800) 1206037
(151) 2014 04 29
(181) 2024 04 29
(891) 2014 04 29
(511) 12

(260) AM 2015 77660 A
(800) 1206148
(151) 2014 03 18
(181) 2024 03 18
(891) 2014 03 18
(511) 19

(260) AM 2015 77671 A
(800) 1206323
(151) 2014 04 23
(181) 2024 04 23
(891) 2014 04 23
(511) 07, 08

(260) AM 2015 77678 A
(800) 1206461
(151) 2014 03 11
(181) 2024 03 11
(891) 2014 03 11
(511) 29, 30

(260) AM 2015 77680 A
(800) 1206469
(151) 2014 04 11
(181) 2024 04 11
(891) 2014 04 11
(511) 05, 10

(260) AM 2015 77979 A
(800) 1208503
(151) 2014 01 30

(181) 2024 01 30
(891) 2014 01 30
(511) 29, 30

(260) AM 2015 78094 A
(800) 1209748
(151) 2014 04 15
(181) 2024 04 15
(891) 2014 04 15
(511) 14

(260) AM 2015 78100 A
(800) 1002033
(151) 2009 02 24
(181) 2019 02 24
(891) 2014 05 07
(511) 31

(260) AM 2015 78131 A
(800) 1209942
(151) 2014 03 21
(181) 2024 03 21
(891) 2014 03 21
(511) 05

(260) AM 2015 78146 A
(800) 1210110
(151) 2014 02 28
(181) 2024 02 29
(891) 2014 02 28
(511) 09, 12, 37, 41

(260) AM 2015 78151 A
(800) 1210178
(151) 2014 03 04
(181) 2024 03 04
(891) 2014 03 04
(511) 12

(260) AM 2015 78345 A
(800) 1211155
(151) 2014 04 16
(181) 2024 04 16
(891) 2014 04 16
(511) 32, 33

(260) AM 2015 78348 A
(800) 1211199
(151) 2014 04 11
(181) 2024 04 11
(891) 2014 04 11
(511) 41

(260) AM 2015 78354 A
(800) 1211288
(151) 2014 03 20
(181) 2024 03 20
(891) 2014 03 20
(511) 34

(260) AM 2015 78405 A
(800) 1211762
(151) 2014 06 16
(181) 2024 06 16
(891) 2014 06 16
(511) 05

(260) AM 2015 78421 A
(800) 1211927
(151) 2013 12 02
(181) 2023 12 02
(891) 2013 12 02
(511) 29, 30, 43

(260) AM 2015 78463 A
(800) 1212654
(151) 2014 05 26
(181) 2024 05 26
(891) 2014 05 26
(511) 09, 25

(260) AM 2015 78464 A
(800) 1212658
(151) 2014 07 02
(181) 2024 07 02
(891) 2014 07 02
(511) 05

(260) AM 2015 78467 A
(800) 1212710
(151) 2014 02 14
(181) 2024 02 14
(891) 2014 02 14
(511) 19, 20, 28

(260) AM 2015 78471 A
(800) 1212762
(151) 2014 02 26
(181) 2024 02 26
(891) 2014 02 26
(511) 01, 16

(260) AM 2015 78478 A
(800) 1212840
(151) 2014 04 23

(181) 2024 04 23
(891) 2014 04 23
(511) 30

(260) AM 2015 78482 A
(800) 1212890
(151) 2014 06 27
(181) 2024 06 27
(891) 2014 06 27
(511) 03

(260) AM 2015 78551 A
(800) 1213660
(151) 2014 04 14
(181) 2024 04 14
(891) 2014 04 14
(511) 03

(260) AM 2015 78672 A
(800) 1214873
(151) 2013 12 24
(181) 2023 12 24
(891) 2013 12 24
(511) 19, 37, 40, 42

(260) AM 2015 78724 A
(800) 1215652
(151) 2014 06 16
(181) 2024 06 16
(891) 2014 06 16
(511) 05

(260) AM 2015 78725 A
(800) 1215653
(151) 2014 06 16
(181) 2024 06 16
(891) 2014 06 16
(511) 05

(260) AM 2015 78726 A
(800) 1215683
(151) 2014 04 25
(181) 2024 04 25
(891) 2014 04 25
(511) 03, 14, 18, 25, 35

(260) AM 2015 78727 A
(800) 1215693
(151) 2014 06 02
(181) 2024 06 02
(891) 2014 06 02
(511) 09

(260) AM 2015 78729 A
(800) 1215725
(151) 2014 01 24
(181) 2024 01 24
(891) 2014 01 24
(511) 11, 12

(260) AM 2015 78731 A
(800) 1215731
(151) 2014 03 13
(181) 2024 03 13
(891) 2014 03 13
(511) 09

(260) AM 2015 78758 A
(800) 1215767
(151) 2014 05 07
(181) 2024 05 07
(891) 2014 05 07
(511) 05

(260) AM 2015 78759 A
(800) 1215768
(151) 2014 05 07
(181) 2024 05 07
(891) 2014 05 07
(511) 05

(260) AM 2015 78761 A
(800) 1215784
(151) 2014 07 14
(181) 2024 07 14
(891) 2014 07 14
(511) 32, 33

(260) AM 2015 78762 A
(800) 1215792
(151) 2014 05 15
(181) 2024 05 15
(891) 2014 05 15
(511) 05

(260) AM 2015 78763 A
(800) 1215798
(151) 2014 06 30
(181) 2024 06 30
(891) 2014 06 30
(511) 33

(260) AM 2015 78764 A
(800) 1215805
(151) 2014 05 07

(181) 2024 05 07
(891) 2014 05 07
(511) 05

(260) AM 2015 78765 A
(800) 1215832
(151) 2013 01 30
(181) 2023 01 30
(891) 2013 01 30
(511) 05, 09, 10

(260) AM 2015 78767 A
(800) 1215837
(151) 2013 11 22
(181) 2023 11 22
(891) 2013 11 22
(511) 29, 30, 43

(260) AM 2015 78768 A
(800) 1215879
(151) 2014 05 26
(181) 2024 05 26
(891) 2014 05 26
(511) 33, 35

(260) AM 2015 78769 A
(800) 1215880
(151) 2014 05 26
(181) 2024 05 26
(891) 2014 05 26
(511) 33, 35

(260) AM 2015 78770 A
(800) 880319
(151) 2006 01 12
(181) 2016 01 12
(891) 2014 03 18
(511) 33

(260) AM 2015 78771 A
(800) 1045345
(151) 2010 05 13
(181) 2020 05 13
(891) 2014 06 02
(511) 03

(260) AM 2015 78772 A
(800) 1051055
(151) 2010 07 19
(181) 2020 07 19
(891) 2014 06 02
(511) 03

(260) AM 2015 78791 A
(800) 1215900
(151) 2014 05 28
(181) 2024 05 28
(891) 2014 05 28
(511) 12

(260) AM 2015 78793 A
(800) 1215903
(151) 2014 02 26
(181) 2024 02 26
(891) 2014 02 26
(511) 41

(260) AM 2015 78794 A
(800) 1215916
(151) 2014 04 25
(181) 2024 04 25
(891) 2014 04 25
(511) 06, 35

(260) AM 2015 78795 A
(800) 1215924
(151) 2014 05 28
(181) 2024 05 28
(891) 2014 05 28
(511) 09, 16

(260) AM 2015 78798 A
(800) 1215927
(151) 2014 07 23
(181) 2024 07 23
(891) 2014 07 23
(511) 05, 35

(260) AM 2015 78818 A
(800) 1215964
(151) 2013 12 24
(181) 2023 12 24
(891) 2013 12 24
(511) 11

(260) AM 2015 78819 A
(800) 1215992
(151) 2014 02 07
(181) 2024 02 07
(891) 2014 02 07
(511) 01, 02, 03, 41, 42

(260) AM 2015 78822 A
(800) 1216002
(151) 2014 05 05

(181) 2024 05 05
(891) 2014 05 05
(511) 35, 36, 37, 39, 41, 43, 45

(260) AM 2015 78823 A
(800) 1216119
(151) 2014 03 03
(181) 2024 03 03
(891) 2014 03 03
(511) 09, 28

(260) AM 2015 78824 A
(800) 1216120
(151) 2014 03 18
(181) 2024 03 18
(891) 2014 03 18
(511) 09, 28, 35, 41

(260) AM 2015 78827 A
(800) 1216157
(151) 2014 02 11
(181) 2024 02 11
(891) 2014 02 11
(511) 36, 41

(260) AM 2015 78830 A
(800) 1216181
(151) 2014 03 14
(181) 2024 03 14
(891) 2014 03 14
(511) 07, 11

(260) AM 2015 78831 A
(800) 1216182
(151) 2014 03 14
(181) 2024 03 14
(891) 2014 03 14
(511) 07, 11

(260) AM 2015 78832 A
(800) 1216183
(151) 2014 03 14
(181) 2024 03 14
(891) 2014 03 14
(511) 07, 11

(260) AM 2015 78837 A
(800) 1216205
(151) 2014 05 06
(181) 2024 05 06
(891) 2014 05 06
(511) 07, 11, 35, 36, 37, 39

(260) AM 2015 78839 A
(800) 1216207
(151) 2014 05 09
(181) 2024 05 09
(891) 2014 05 09
(511) 03, 09, 18, 25, 35

(260) AM 2015 78847 A
(800) 1216273
(151) 2014 07 01
(181) 2024 07 01
(891) 2014 07 01
(511) 13, 25, 28

(260) AM 2015 78860 A
(800) 1216296
(151) 2014 01 15
(181) 2024 01 15
(891) 2014 01 15
(511) 03, 05, 16

(260) AM 2015 78862 A
(800) 1216359
(151) 2014 05 09
(181) 2024 05 09
(891) 2014 05 09
(511) 29

(260) AM 2015 78863 A
(800) 1216377
(151) 2014 03 14
(181) 2024 03 14
(891) 2014 03 14
(511) 09

(260) AM 2015 78864 A
(800) 1216396
(151) 2014 04 16
(181) 2024 04 16
(891) 2014 04 16
(511) 28

(260) AM 2015 78865 A
(800) 1216430
(151) 2014 06 17
(181) 2024 06 17
(891) 2014 06 17
(511) 30

(260) AM 2015 78866 A
(800) 1216431
(151) 2014 05 07

(181) 2024 05 07
(891) 2014 05 07
(511) 18, 25

(260) AM 2015 78867 A
(800) 1216464
(151) 2014 06 25
(181) 2024 06 25
(891) 2014 06 25
(511) 29, 30, 31, 32

(260) AM 2015 78868 A
(800) 1216486
(151) 2014 02 21
(181) 2024 02 21
(891) 2014 02 21
(511) 01, 05, 29

(260) AM 2015 78869 A
(800) 1216493
(151) 2014 06 24
(181) 2024 06 24
(891) 2014 06 24
(511) 09, 42

(260) AM 2015 78870 A
(800) 1216550
(151) 2014 03 13
(181) 2024 03 13
(891) 2014 03 13
(511) 03, 05, 10, 21

(260) AM 2015 78871 A
(800) 1216552
(151) 2014 03 24
(181) 2024 03 24
(891) 2014 03 24
(511) 32

(260) AM 2015 78872 A
(800) 1216601
(151) 2014 06 11
(181) 2024 06 11
(891) 2014 06 11
(511) 09, 14

(260) AM 2015 78874 A
(800) 568001
(151) 1991 02 20
(181) 2021 02 20
(891) 2014 02 17
(511) 05

(260) AM 2015 78875 A
(800) 837673
(151) 2004 04 07
(181) 2024 04 07
(891) 2014 05 09
(511) 25

(260) AM 2015 78876 A
(800) 956777
(151) 2008 01 23
(181) 2018 01 23
(891) 2014 04 01
(511) 30

(260) AM 2015 78877 A
(800) 1171193
(151) 2013 06 03
(181) 2023 06 03
(891) 2014 04 29
(511) 03, 09, 14

(260) AM 2015 78878 A
(800) 1171828
(151) 2013 06 04
(181) 2023 06 04
(891) 2014 06 17
(511) 04, 37

(260) AM 2015 78881 A
(800) 1216664
(151) 2014 05 02
(181) 2024 05 02
(891) 2014 05 02
(511) 04, 09, 11, 19

(260) AM 2015 78882 A
(800) 1216666
(151) 2008 10 27
(181) 2018 10 27
(891) 2008 10 27
(511) 03, 05

(260) AM 2015 78884 A
(800) 1216675
(151) 2014 05 26
(181) 2024 05 26
(891) 2014 05 26
(511) 03

(260) AM 2015 78885 A
(800) 1216683
(151) 2014 05 22

(181) 2024 05 22
(891) 2014 05 22
(511) 05

(260) AM 2015 78890 A
(800) 1216702
(151) 2014 07 09
(181) 2024 07 09
(891) 2014 07 09
(511) 05

(260) AM 2015 78892 A
(800) 1216704
(151) 2014 07 07
(181) 2024 07 07
(891) 2014 07 07
(511) 33

(260) AM 2015 78894 A
(800) 1216705
(151) 2014 07 07
(181) 2024 07 07
(891) 2014 07 07
(511) 33

(260) AM 2015 78900 A
(800) 1216709
(151) 2014 03 05
(181) 2024 03 05
(891) 2014 03 05
(511) 09, 35, 36

(260) AM 2015 78901 A
(800) 1216710
(151) 2014 03 05
(181) 2024 03 05
(891) 2014 03 05
(511) 09, 35, 36

(260) AM 2015 78902 A
(800) 1216714
(151) 2013 12 31
(181) 2023 12 31
(891) 2013 12 31
(511) 09, 35, 41, 43

(260) AM 2015 79014 A
(800) 1217717
(151) 2014 06 20
(181) 2024 06 20
(891) 2014 06 20
(511) 29, 30, 31, 33, 35

(260) AM 2015 79143 A
(800) 1218609
(151) 2014 02 11
(181) 2024 02 11
(891) 2014 02 11
(511) 35

(260) AM 2015 79147 A
(800) 1218656
(151) 2014 05 26
(181) 2024 05 26
(891) 2014 05 26
(511) 35

(260) AM 2015 79148 A
(800) 1218657
(151) 2014 05 26
(181) 2024 05 26
(891) 2014 05 26
(511) 05, 09, 25

(260) AM 2015 79149 A
(800) 1218679
(151) 2014 08 04
(181) 2024 08 04
(891) 2014 08 04
(511) 33, 35

(260) AM 2015 79150 A
(800) 1218689
(151) 2014 08 05
(181) 2024 08 05
(891) 2014 08 05
(511) 05

(260) AM 2015 79151 A
(800) 1218700
(151) 2014 07 16
(181) 2024 07 16
(891) 2014 07 16
(511) 39

(260) AM 2015 79152 A
(800) 1218710
(151) 2014 05 26
(181) 2024 05 26
(891) 2014 05 26
(511) 05, 09, 25

(260) AM 2015 79153 A
(800) 1218744
(151) 2014 07 30

(181) 2024 07 30
(891) 2014 07 30
(511) 03

(260) AM 2015 79154 A
(800) 1218745
(151) 2014 07 30
(181) 2024 07 30
(891) 2014 07 30
(511) 03

(260) AM 2015 79155 A
(800) 1218746
(151) 2014 07 30
(181) 2024 07 30
(891) 2014 07 30
(511) 03

(260) AM 2015 79159 A
(800) 1218747
(151) 2014 04 17
(181) 2024 04 17
(891) 2014 04 17
(511) 05, 10

(260) AM 2015 79160 A
(800) 1218752
(151) 2014 06 20
(181) 2024 06 20
(891) 2014 06 20
(511) 32

(260) AM 2015 79161 A
(800) 1218756
(151) 2014 04 17
(181) 2024 04 17
(891) 2014 04 17
(511) 05, 10

(260) AM 2015 79166 A
(800) 1218784
(151) 2014 04 08
(181) 2024 04 08
(891) 2014 04 08
(511) 35

(260) AM 2015 79347 A
(800) 1220490
(151) 2014 05 22
(181) 2024 05 22
(891) 2014 05 22
(511) 33

(260) AM 2015 79458 A
(800) 1221758
(151) 2014 09 25
(181) 2024 09 25
(891) 2014 09 25
(511) 25

(260) AM 2015 79459 A
(800) 683188
(151) 1997 11 19
(181) 2017 11 19
(891) 2014 07 02
(511) 03

(260) AM 2015 79461 A
(800) 730114
(151) 2000 02 15
(181) 2020 02 15
(891) 2014 07 24
(511) 25

(260) AM 2015 79463 A
(800) 865625
(151) 2005 09 26
(181) 2025 09 26
(891) 2014 07 30
(511) 12

(260) AM 2015 79464 A
(800) 907298
(151) 2006 09 15
(181) 2016 09 15
(891) 2014 07 16
(511) 03, 14, 16, 18, 20, 24, 25, 35, 43

(260) AM 2015 79468 A
(800) 1044340
(151) 2010 06 08
(181) 2020 06 08
(891) 2014 08 05
(511) 29

(260) AM 2015 79707 A
(800) 1223403
(151) 2014 06 26
(181) 2024 06 26
(891) 2014 06 26
(511) 4, 9, 12, 14, 16, 25, 28, 32, 35, 36, 38, 39, 41, 43

(260) AM 2015 79712 A
(800) 1223509
(151) 2014 08 13

(181) 2024 08 13
(891) 2014 08 13
(511) 33

(260) AM 2015 79714 A
(800) 1223533
(151) 2013 11 21
(181) 2023 11 21
(891) 2013 11 21
(511) 10

(260) AM 2015 79716 A
(800) 1223566
(151) 2014 03 10
(181) 2024 03 10
(891) 2014 03 10
(511) 35, 41

(260) AM 2015 79717 A
(800) 1223587
(151) 2014 05 20
(181) 2024 05 20
(891) 2014 05 20
(511) 12, 16, 17

(260) AM 2015 79718 A
(800) 1223625
(151) 2014 07 16
(181) 2024 07 16
(891) 2014 07 16
(511) 41

(260) AM 2015 79719 A
(800) 1223641
(151) 2014 07 01
(181) 2024 07 01
(891) 2014 07 01
(511) 06

(260) AM 2015 79721 A
(800) 1223695
(151) 2014 09 02
(181) 2024 09 02
(891) 2014 09 02
(511) 35, 37, 42

(260) AM 2015 79722 A
(800) 1223720
(151) 2014 07 29
(181) 2024 07 29
(891) 2014 07 29
(511) 07, 16, 24

(260) AM 2015 79723 A
(800) 1223732
(151) 2014 09 11
(181) 2024 09 11
(891) 2014 09 11
(511) 29, 30, 43

(260) AM 2015 79726 A
(800) 1223733
(151) 2014 09 11
(181) 2024 09 11
(891) 2014 09 11
(511) 29, 30, 43

(260) AM 2015 79728 A
(800) 370187
(151) 1970 07 28
(181) 2020 07 28
(891) 2014 10 31
(511) 05

(260) AM 2015 79729 A
(800) 591153
(151) 1992 09 23
(181) 2022 09 23
(891) 2014 08 14
(511) 05

(260) AM 2015 79805 A
(800) 1224315
(151) 2014 09 02
(181) 2024 09 02
(891) 2014 09 02
(511) 18, 25, 35, 40

(260) AM 2015 79806 A
(800) 1224323
(151) 2014 08 13
(181) 2024 08 13
(891) 2014 08 13
(511) 32

OFFICIAL NOTIFICATIONS

INVENTIONS

RENEWAL OF A PATENT

(11) **P 2012 5669 B**

(73) KITE GEN RESEARCH S.R.L. (IT)

(54) **WIND SYSTEM CONVERSING ENERGY BY KITES CONVEYANCE ON RAIL BY
DRAGGING MODULES AND, METHOD OF ELECTRIC ENERGY GENERATION BY SUCH
SYSTEM**

DATE OF RENEWAL: 2015 11 25

TRADEMARKS

RENEWAL OF REGISTRATIONS

(111) M 1995 1012 R2
 (156) 2015 09 25
 (186) 2025 09 25
 (732) NOVUS INTERNATIONAL, INC
 20 Research Park Drive, St. Charles, MO
 63304, USA

(111) M 1995 1205 R2
 (156) 2015 11 22
 (186) 2025 11 22
 (732) L'OREAL
 14, rue Royale, F-75008 Paris, France

(111) M 1995 1150 R2
 (156) 2015 11 13
 (186) 2025 11 13
 (732) PRESCRIPTIVES INC.
 767, Fifth Avenue, New York, USA

(111) M 1995 1207 R2
 (156) 2015 11 22
 (186) 2025 11 22
 (732) L'OREAL
 14, rue Royale, F-75008 Paris, France

(111) M 1995 1188 R2
 (156) 2015 11 17
 (186) 2025 11 17
 (732) STEINWAY & SONS
 a New York Corporation
 Stenway Place, Long Island City, New York
 11105, USA

(111) M 1995 1208 R2
 (156) 2015 11 22
 (186) 2025 11 22
 (732) L'OREAL
 14, rue Royale, F-75008 Paris, France

(111) M 1995 1190 R2
 (156) 2015 11 17
 (186) 2025 11 17
 (732) STEINWAY & SONS
 a New York Corporation
 Stenway Place, Long Island City, New York
 11105, USA

(111) M 1995 1209 R2
 (156) 2015 11 22
 (186) 2025 11 22
 (732) L'OREAL
 14, rue Royale, F-75008 Paris, France

(111) M 1995 1193 R2
 (156) 2015 11 20
 (186) 2025 11 20
 (732) STEINWAY & SONS
 a New York Corporation
 Stenway Place, Long Island City, New York
 11105, USA

(111) M 1995 1222 R2
 (156) 2015 11 29
 (186) 2025 11 29
 (732) L'OREAL
 14, rue Royale, F-75008 Paris, France

(111) M 1995 1200 R2
 (156) 2015 11 21
 (186) 2025 11 21
 (732) L'OREAL
 14, rue Royale, F-75008 Paris, France

(111) M 1995 1223 R2
 (156) 2015 11 29
 (186) 2025 11 29
 (732) L'OREAL
 14, rue Royale, F-75008 Paris, France

(111) M 1995 1202 R2
 (156) 2015 11 21
 (186) 2025 11 21
 (732) L'OREAL
 14, rue Royale, F-75008 Paris, France

(111) M 1995 1226 R2
 (156) 2015 11 30
 (186) 2025 11 30
 (732) L'OREAL
 14, rue Royale, F-75008 Paris, France

(111) M 1995 1227 R2
 (156) 2015 11 30
 (186) 2025 11 30
 (732) L'OREAL
 14, rue Royale, F-75008 Paris, France

(111) M 1995 1250 R2
 (156) 2015 12 07
 (186) 2025 12 07
 (732) INTERCONTINENTAL GREAT BRANDS
 LLC
 100 Deforest Ave, East Hanover, NJ, 07936, USA

(111) M 1995 1251 R2
 (156) 2015 12 07
 (186) 2025 12 07
 (732) INTERCONTINENTAL GREAT BRANDS
 LLC
 100 Deforest Ave, East Hanover, NJ, 07936, USA

(111) M 1995 1252 R2
 (156) 2015 12 07
 (186) 2025 12 07
 (732) INTERCONTINENTAL GREAT BRANDS
 LLC
 100 Deforest Ave, East Hanover, NJ, 07936, USA

(111) M 1995 1266 R2
 (156) 2015 12 12
 (186) 2025 12 12
 (732) INTERCONTINENTAL GREAT BRANDS
 LLC
 100 Deforest Ave, East Hanover, NJ, 07936,
 USA

(111) M 1995 1271 R2
 (156) 2015 12 13
 (186) 2025 12 13
 (732) INTERCONTINENTAL GREAT BRANDS
 LLC
 100 Deforest Ave, East Hanover, NJ, 07936,
 USA

(111) M 1995 1273 R2
 (156) 2015 12 13
 (186) 2025 12 13
 (732) INTERCONTINENTAL GREAT BRANDS
 LLC
 100 Deforest Ave, East Hanover, NJ, 07936, USA

(111) M 1995 1278 R2
 (156) 2015 12 19
 (186) 2025 12 19
 (732) INTERCONTINENTAL GREAT BRANDS
 LLC
 100 Deforest Ave, East Hanover, NJ, 07936,
 USA

(111) M 1995 1286 R2
 (156) 2015 12 26
 (186) 2025 12 26
 (732) ABBOTT GMBH & CO.KG
 Max-Planck-Ring 2, 65205 Wiesbaden, Germany

(111) M 1995 1290 R2
 (156) 2015 12 26
 (186) 2025 12 26
 (732) SAFT LIMITED
 River Drive, South Shields, Tyne & Wear
 NE33 2TR, United Kingdom

(111) M 1995 1298 R2
 (156) 2015 12 27
 (186) 2025 12 27
 (732) ABBOTT GMBH & CO.KG
 Max-Planck-Ring 2, 65205 Wiesbaden, Germany

(111) M 1995 1302 R2
 (156) 2015 12 27
 (186) 2025 12 27
 (732) ABBOTT GMBH & CO.KG
 Max-Planck-Ring 2, 65205 Wiesbaden, Germany

(111) M 1996 1409 R2
 (156) 2016 01 31
 (186) 2026 01 31
 (732) YKK Corporation
 1, Kanda Izumi-Cho, Chiyoda-Ku, Tokyo, Japan

(111) M 1996 1412 R2
 (156) 2016 01 31
 (186) 2026 01 31
 (732) YKK Corporation
 1, Kanda Izumi-Cho, Chiyoda-Ku, Tokyo, Japan

(111) M 1996 1413 R2
 (156) 2016 01 31
 (186) 2026 01 31
 (732) YKK Corporation
 1, Kanda Izumi-Cho, Chiyoda-Ku, Tokyo, Japan

(111) M 2005 15950 R1
 (156) 2015 10 29
 (186) 2025 05 18
 (732) LTD "BADAGONI"
 Sof. Zemo Khodasheni, 0910, Akhmetis
 raioni, Georgia

(111) M 2005 15953 R1
(156) 2015 11 03
(186) 2025 05 19
(732) LTD "BADAGONI"
Sof. Zemo Khodasheni, 0910, Akhmetis
raioni, Georgia

(111) M 2005 16290 R1
(156) 2015 10 17
(186) 2025 10 17
(732) LTD "AVERSI-FARMA"
Davit Agmasheneblis gamz., 148/2, 0112,
Tbilisi, Georgia

(111) M 2006 16423 R1
(156) 2016 01 16
(186) 2026 01 16
(732) NISSAN JIDOSHA KABUSHIKI KAISHA
(also trading as Nissan Motor Co., Ltd.)
No.2 Takaracho, Kanagawa-ku, Yokohama-shi,
Kanagawa-ken, Japan

(111) M 1996 2446 R2
(156) 2016 06 21
(186) 2026 06 21
(732) PERFETTI VAN MELLE BENELUX B.V.
Zoete Inval 20, 4815 HK Breda, Netherlands

(111) M 1996 2501 R2
(156) 2016 06 25
(186) 2026 06 25
(732) PERFETTI VAN MELLE BENELUX B.V.
Zoete Inval 20, 4815 HK Breda, Netherlands

(111) M 1996 2511 R2
(156) 2016 06 27
(186) 2026 06 27
(732) MCDONALD'S INTERNATIONAL
PROPERTY COMPANY, LTD.
2711 Centerville Road, Suite 400,
Wilmington, Delaware, USA

(111) M 1996 2624 R2
(156) 2016 07 16
(186) 2026 07 16
(732) ARES TRADING S.A.
Zone Industrielle de l'Ouriettaz, CH-1170
Aubonne, Switzerland

(111) M 1996 3358 R2
(156) 2016 09 26
(186) 2026 09 26

(732) HOWDEN GROUP LIMITED
One London Wall, London EC2Y 5AB,
United Kingdom

(111) M 1996 3359 R2
(156) 2016 09 26
(186) 2026 09 26
(732) HOWDEN GROUP LIMITED
One London Wall, London EC2Y 5AB,
United Kingdom

(111) M 1995 766 R2
(156) 2015 11 06
(186) 2025 07 28
(732) SCHUELKE & MAYR GMBH
Robert-Koch-Strasse 2, 22851 Norderstedt,
Germany

(111) M 1995 808 R2
(156) 2015 08 08
(186) 2025 08 08
(732) THOMSON SCIENTIFIC INC., A
PENNSYLVANIA CORPORATION
3501 Market Street, Philadelphia,
Pennsylvania 19104, USA

(111) M 1995 809 R2
(156) 2015 08 08
(186) 2025 08 08
(732) THOMSON SCIENTIFIC INC., A
PENNSYLVANIA CORPORATION
3501 Market Street, Philadelphia,
Pennsylvania 19104, USA

COMPLETE TRANSFER OF RIGHTS

(111) M 2000 013096 R1
 (732) KABUSHIKI KAISHA SONY COMPUTER ENTERTAINMENT, also trading as SONY COMPUTER ENTERTAINMENT INC.,
 2-6-21, Minami-Aoyama, Minato-ku, Tokyo, Japan
 (770) SNE PLATFORM INC.,
 2-6-21, Minami-Aoyama, Minato-ku, Tokyo, Japan
 (580) 2015 11 12

(111) M 2008 018352 R
 (732) COLOREX COMÉRCIO E DESENVOLVIMENTO DE PRODUTOS LTDA, Deputado Vicente Penido No:06, Vila Guilberme, CER 02064-120, Sao Paulo/SP, Brazil
 (770) SAINT GOBAIN VIDROS S.A.,
 Av. Santa Marina, No: 482, 3rd floor, São-Paulo, Brazil
 (580) 2015 07 31

(111) M 2011 021197 R
 (732) PTC THERAPEUTICS, INC.
 (Delaware Corporation)
 100 Corporate Court, South Plainfield, New jersey 07080, USA
 (770) GENZYME CORPORATION
 (a Massachusetts Corporation)
 500 kendall street, Cambridge, Massachusetts 02142, USA
 (580) 2015 11 03

(111) M 2011 021198 R
 (732) PTC THERAPEUTICS, INC.
 (Delaware Corporation)
 100 Corporate Court, South Plainfield, New jersey 07080, USA
 (770) GENZYME CORPORATION
 (a Massachusetts Corporation)
 500 kendall street, Cambridge, Massachusetts 02142, USA
 (580) 2015 11 03

(111) M 2011 021199 R
 (732) PTC Therapeutics, Inc.
 (Delaware Corporation)
 100 Corporate Court, South Plainfield, New jersey 07080, USA
 (770) GENZYME CORPORATION
 (a Massachusetts Corporation)
 500 kendall street, Cambridge, Massachusetts 02142, USA

(580) 2015 11 03

(111) M 2011 021671 R
 (732) LTD "UNIMED GROUP CORP"
 Ad. Mitskevichis q. 29, b. 61, 0194, Georgia
 (770) LTD "PRIMA-VITA"
 Saq. samkhedro gzisa da Akhmetelis quchis gadakveta, 0159, Tbilisi, Georgia
 (580) 2015 11 06

(111) M 2011 021747 R
 (732)) LTD "UNIMED GROUP CORP"
 Ad. Mitskevichis q. 29, b. 61, 0194, Georgia
 (770) LTD "PRIMA-VITA"
 Saq. samkhedro gzisa da Akhmetelis quchis gadakveta, 0159, Tbilisi, Georgia
 (580) 2015 11 06

(111) M 2012 022809 R
 (732)) LTD "UNIMED GROUP CORP"
 Ad. Mitskevichis q. 29, b. 61, 0194, Georgia
 (770) LTD "PRIMA-VITA"
 Saq. samkhedro gzisa da Akhmetelis quchis gadakveta, 0159, Tbilisi, Georgia
 (580) 2015 11 06

(111) M 2014 024940 R
 (732) DARIA LIKHOVITSKAYA
 Trotskaia q.9, b.34, Moskovi, Russian Federation
 (770) LTD "BIFUZI"
 Dzveli Tbilisis r-ni, Shanidzis q. 16, 0179, Tbilisi, Georgia
 (580) 2015 07 21

(111) M 2014 024941 R
 (732) DARIA LIKHOVITSKAYA
 Trotskaia q.9, b.34, Moskovi, Russian Federation
 (770) LTD "BIFUZI"
 Dzveli Tbilisis r-ni, Shanidzis q. 16, 0179, Tbilisi, Georgia
 (580) 2015 07 22

CHANGES IN NAMES AND/OR ADDRESSES OF OWNERS

(111) M 2000 013096 R1
(732) KABUSHIKI KAISHA SONY COMPUTER ENTERTAINMENT, also trading as SONY COMPUTER ENTERTAINMENT INC.
2-6-21, Minami-Aoyama, Minato-ku, Tokyo, Japan
(770) KABUSHIKI KAISHA SONY COMPUTER ENTERTAINMENT, also trading as SONY COMPUTER ENTERTAINMENT INC.
I-I, AKASAKA 7-CHOME, MINATO-KU, TOKYO, Japan
(580) 2015 11 12

(111) M 2000 013096 R1
(732) SNE Platform Inc.
2-6-21, Minami-Aoyama, Minato-ku, Tokyo, Japan
(770) KABUSHIKI KAISHA SONY COMPUTER ENTERTAINMENT, also trading as SONY COMPUTER ENTERTAINMENT INC.
2-6-21, Minami-Aoyama, Minato-ku, Tokyo, Japan
(580) 2015 11 12

(111) M 2000 013096 R1
(732) KABUSHIKI KAISHA SONY COMPUTER ENTERTAINMENT, also trading as SONY COMPUTER ENTERTAINMENT INC.
1-7-1 Konan, MINATO-KU, TOKYO, Japan
(770) KABUSHIKI KAISHA SONY COMPUTER ENTERTAINMENT, also trading as SONY COMPUTER ENTERTAINMENT INC.
2-6-21, Minami-Aoyama, Minato-ku, Tokyo, Japan
(580) 2015 11 12

(111) M 2005 015953 R
(732) LTD "BADAGONI"
Sof. Zemo Khodasheni, 0910, Akhmetis raioni, Georgia
(770) LTD "MEGVINEOBIS RAINDI"
Sof. Kistauri, 0908, Akhmetis raioni, Georgia
(580) 2015 11 12

(111) M 2006 016751 R
(732) CADBURY FRANCE S.A.S.
6 Av Réaumur, 92140 Clamart, France
(770) CADBURY FRANCE S.A.S.
143 Boulevard Romain Rolland, 75685 Paris Cedex 14, France
(580) 2015 11 12

(111) M 2006 016752 R
(732) CADBURY FRANCE S.A.S.
6 Av Réaumur, 92140 Clamart, France
(770) CADBURY FRANCE S.A.S.
143 Boulevard Romain Rolland, 75685 Paris Cedex 14, France
(580) 2015 11 12

(111) M 2006 016753 R
(732) CADBURY FRANCE S.A.S.
6 Av Réaumur, 92140 Clamart, France
(770) CADBURY FRANCE S.A.S.
143 Boulevard Romain Rolland, 75685 Paris Cedex 14, France
(580) 2015 11 12

(111) M 2006 016754 R
(732) CADBURY FRANCE S.A.S.
6 Av Réaumur, 92140 Clamart, France
(770) CADBURY FRANCE S.A.S.
143 Boulevard Romain Rolland, 75685 Paris Cedex 14, France
(580) 2015 11 12

CLASSIFICATION INDEXES

INVENTIONS

CONCORDANCE TABLE OF INTERNATIONAL CLASSIFICATION INDEX AND PUBLICATION NUMBERS

INTERNATIONAL CLASSIFICATION INDEXES (51)	NUMBER OF PUBLISHED APPLICATION (10)
A 61 K 31/216; A 61 K 31/282; A 61 K 31/337; A 61 K 31/41; A 61 K 31/4192; A 61 K 31/4196; A 61 K 31/428; A 61 K 31/4545; A 61 K 31/69; A 61 P 25/02	AP 2015 12845 A
A 61 K 39/395	AP 2015 12649 A
A 61 K 39/395	AP 2015 12866 A
B 03 D 1/02	AP 2015 12773 A
C 07 C 233/46; C 07 C 233/56; C 07 C 275/20; A 61 P 9/12; A 61 K 31/17; A 61 K 31/16	AP 2015 13281 A
C 07 D 233/90; C 07 D 401/12; C 07 D 401/14; C 07 D 407/12; C 07 D 409/06; C 07 D 409/14; C 07 D 413/06; C 07 D 413/14; C 07 D 417/06; C 07 D 417/12; C 07 D 471/04; C 07 D 487/04; C 07 D 487/08; C 07 D 495/04;	AP 2015 13059 A
C 22 C 14/00; C 22 C 29/14; C 22 C 38/14	AP 2015 12975 A
E 04 D 3/30; E 04 D 1/30	AP 2015 12399 A
F 42 B 7/10; F 42 B 10/14	AP 2015 13389 A
G 01 F 23/28	AP 2015 13580 A

CONCORDANCE TABLE OF PUBLICATION NUMBERS AND INTERNATIONAL CLASSIFICATION INDEX

NUMBER OF PUBLISHED APPLICATION (10)	INTERNATIONAL CLASSIFICATION INDEXES (51)
AP 2015 12399 A	E 04 D 3/30; E 04 D 1/30
AP 2015 12649 A	A 61 K 39/395
AP 2015 12773 A	B 03 D 1/02
AP 2015 12845 A	A 61 K 31/216; A 61 K 31/282; A 61 K 31/337; A 61 K 31/41; A 61 K 31/4192; A 61 K 31/4196; A 61 K 31/428; A 61 K 31/4545; A 61 K 31/69; A 61 P 25/02
AP 2015 12866 A	A 61 K 39/395
AP 2015 12975 A	C 22 C 14/00; C 22 C 29/14; C 22 C 38/14
AP 2015 13059 A	C 07 D 233/90; C 07 D 401/12; C 07 D 401/14; C 07 D 407/12; C 07 D 409/06; C 07 D 409/14; C 07 D 413/06; C 07 D 413/14; C 07 D 417/06; C 07 D 417/12; C 07 D 471/04; C 07 D 487/04; C 07 D 487/08; C 07 D 495/04;
AP 2015 13281 A	C 07 C 233/46; C 07 C 233/56; C 07 C 275/20; A 61 P 9/12; A 61 K 31/17; A 61 K 31/16
AP 2015 13389 A	F 42 B 7/10; F 42 B 10/14
AP 2015 13580 A	G 01 F 23/28

**CONCORDANCE TABLE OF INTERNATIONAL CLASSIFICATION INDEX,
PATENT NUMBERS AND PUBLICATION NUMBERS**

INTERNATIONAL CLASSIFICATION INDEX (51)	NUMBER OF PATENT (11)	NUMBER OF PUBLISHED APPLICATION (10)
A 61 K 33/26, 33/04, 36/00	P 2015 6404 B	AP 2015 13602 A
A 61 K 33/26, 33/04	P 2015 6405 B	AP 2015 13672 A
A 61 K 36/00; A 61 K 31/00	P 2015 6402 B	AP 2015 13205 A
B 60 P 3/40; B 60 P 3/41	P 2015 6403 B	AP 2015 13406 A

**CONCORDANCE TABLE OF PATENT NUMBERS,
PUBLICATION NUMBERS AND INTERNATIONAL CLASSIFICATION INDEX**

NUMBER OF PATENT (11)	NUMBER OF PUBLISHED APPLICATION (10)	INTERNATIONAL CLASSIFICATION INDEX (51)
P 2015 6402 B	AP 2015 13205 A	A 61 K 36/00; A 61 K 31/00
P 2015 6403 B	AP 2015 13406 A	B 60 P 3/40; B 60 P 3/41
P 2015 6404 B	AP 2015 13602 A	A 61 K 33/26, 33/04, 36/00
P 2015 6405 B	AP 2015 13672 A	A 61 K 33/26, 33/04

**CONCORDANCE TABLE OF APPLICATION NUMBERS, PUBLICATION NUMBERS
AND PATENTS**

NUMBER OF APPLICATION (21)	NUMBER OF PUBLISHED APPLICATION (10)	NUMBER OF PATENT (11)
AP 2013 013205	AP 2015 13205 A	P 2015 6402 B
AP 2014 013406	AP 2015 13406 A	P 2015 6403 B
AP 2014 013602	AP 2015 13602 A	P 2015 6404 B
AP 2014 013672	AP 2015 13672 A	P 2015 6405 B

UTILITY MODELS

**CONCORDANCE TABLE OF INTERNATIONAL CLASSIFICATION INDEX
AND PUBLICATION NUMBERS**

INTERNATIONAL CLASSIFICATION INDEXES (51)	NUMBER OF PUBLISHED APPLICATION (10)
C 04 B 7/00	AU 2015 13763 U

**CONCORDANCE TABLE OF PUBLICATION NUMBERS
AND INTERNATIONAL CLASSIFICATION INDEX**

NUMBER OF PUBLISHED APPLICATION (10)	INTERNATIONAL CLASSIFICATION INDEXES (51)
AU 2015 13763 U	C 04 B 7/00

**CONCORDANCE TABLE OF INTERNATIONAL CLASSIFICATION INDEX,
PATENT NUMBERS AND PUBLICATION NUMBERS**

INTERNATIONAL CLASSIFICATION INDEX (51)	NUMBER OF PATENT (11)	NUMBER OF PUBLISHED APPLICATION (10)
G 01 N 27/22	U 2015 1880 Y	AU 2015 13762 U
G 06 Q 90/00; H 04 M 3/42	U 2015 1879 Y	AU 2015 13741 U

**CONCORDANCE TABLE OF PATENT NUMBERS,
PUBLICATION NUMBERS AND INTERNATIONAL CLASSIFICATION INDEX**

NUMBER OF PATENT (11)	NUMBER OF PUBLISHED APPLICATION (10)	INTERNATIONAL CLASSIFICATION INDEX (51)
U 2015 1879 Y	AU 2015 13741 U	G 06 Q 90/00; H 04 M 3/42
U 2015 1880 Y	AU 2015 13762 U	G 01 N 27/22

**CONCORDANCE TABLE OF APPLICATION NUMBERS,
PUBLICATION NUMBERS AND PATENTS**

NUMBER OF APPLICATION (21)	NUMBER OF PUBLISHED APPLICATION (10)	NUMBER OF PATENT (11)
AU 2015 013741	AU 2015 13741 U	U 2015 1879 Y
AU 2015 013762	AU 2015 13762 U	U 2015 1880 Y

DESIGNS

**CONCORDANCE TABLE OF INTERNATIONAL CLASSIFICATION INDEX
AND PUBLICATION NUMBERS**

INTERNATIONAL CLASSIFICATION INDEXES (51)	NUMBER OF PUBLISHED APPLICATION (10)
09-01	AD 2015 859 S
10-07	AD 2015 868 S

**CONCORDANCE TABLE OF PUBLICATION NUMBERS
AND INTERNATIONAL CLASSIFICATION INDEX**

NUMBER OF PUBLISHED APPLICATION (10)	INTERNATIONAL CLASSIFICATION INDEXES (51)
AD 2015 859 S	09-01
AD 2015 868 S	10-07

**CONCORDANCE TABLE OF INTERNATIONAL CLASSIFICATION INDEX,
PATENT NUMBERS AND PUBLICATION NUMBERS**

INTERNATIONAL CLASSIFICATION INDEX (51)	NUMBER OF PATENT (11)	NUMBER OF PUBLISHED APPLICATION (10)
05-06	D 2015 652 S	AD 2015 849 S

**CONCORDANCE TABLE OF PATENT NUMBERS,
PUBLICATION NUMBERS AND INTERNATIONAL CLASSIFICATION INDEX**

NUMBER OF PATENT (11)	NUMBER OF PUBLISHED APPLICATION (10)	INTERNATIONAL CLASSIFICATION INDEX (51)
D 2015 652 S	AD 2015 849 S	05-06

**CONCORDANCE TABLE OF APPLICATION NUMBERS,
PUBLICATION NUMBERS AND PATENTS**

NUMBER OF APPLICATION (21)	NUMBER OF PUBLISHED APPLICATION (10)	NUMBER OF PATENT (11)
AD 2015 000849	AD 2015 849 S	D 2015 652 S

TRADEMARKS

CONCORDANCE TABLE OF REGISTRATION NUMBERS, APPLICATION NUMBERS, PUBLICATION NUMBERS AND BULLETIN NUMBERS

NUMBER OF REGISTRATION (111)	NUMBER OF APPLICATIONS (210)	NUMBER OF PUBLISHED APPLICATIONS (260)	NUMBER OF BULLETIN
M 2015 26434 R	AM 78315	AM 2015 78315 A	8(420) 2015
M 2015 26435 R	AM 78316	AM 2015 78316 A	9(421) 2015
M 2015 26436 R	AM 78331	AM 2015 78331 A	9(421) 2015
M 2015 26437 R	AM 78379	AM 2015 78379 A	10(422) 2015
M 2015 26438 R	AM 78411	AM 2015 78411 A	8(420) 2015
M 2015 26439 R	AM 78475	AM 2015 78475 A	9(421) 2015
M 2015 26440 R	AM 78562	AM 2015 78562 A	11(423) 2015
M 2015 26441 R	AM 78563	AM 2015 78563 A	11(423) 2015
M 2015 26442 R	AM 78582	AM 2015 78582 A	9(421) 2015
M 2015 26443 R	AM 78596	AM 2015 78596 A	10(422) 2015
M 2015 26444 R	AM 78597	AM 2015 78597 A	10(422) 2015
M 2015 26445 R	AM 78662	AM 2015 78662 A	12(424) 2015
M 2015 26446 R	AM 78717	AM 2015 78717 A	9(421) 2015
M 2015 26447 R	AM 78756	AM 2015 78756 A	10(422) 2015
M 2015 26448 R	AM 78757	AM 2015 78757 A	10(422) 2015
M 2015 26449 R	AM 78773	AM 2015 78773 A	11(423) 2015
M 2015 26450 R	AM 78780	AM 2015 78780 A	9(421) 2015
M 2015 26451 R	AM 78781	AM 2015 78781 A	9(421) 2015
M 2015 26452 R	AM 78782	AM 2015 78782 A	9(421) 2015
M 2015 26453 R	AM 78783	AM 2015 78783 A	10(422) 2015
M 2015 26454 R	AM 78784	AM 2015 78784 A	10(422) 2015
M 2015 26455 R	AM 78838	AM 2015 78838 A	12(424) 2015
M 2015 26456 R	AM 78844	AM 2015 78844 A	10(422) 2015
M 2015 26457 R	AM 78845	AM 2015 78845 A	10(422) 2015
M 2015 26458 R	AM 78854	AM 2015 78854 A	10(422) 2015
M 2015 26459 R	AM 78911	AM 2015 78911 A	10(422) 2015
M 2015 26460 R	AM 78912	AM 2015 78912 A	10(422) 2015
M 2015 26461 R	AM 79049	AM 2015 79049 A	11(423) 2015
M 2015 26462 R	AM 79087	AM 2015 79087 A	10(422) 2015
M 2015 26463 R	AM 79090	AM 2015 79090 A	10(422) 2015
M 2015 26465 R	AM 78279	AM 2015 78279 A	12(424) 2015
M 2015 26466 R	AM 78280	AM 2015 78280 A	12(424) 2015
M 2015 26479 R	AM 76401	AM 2015 76401 A	7(419) 2015
M 2015 26480 R	AM 76495	AM 2015 76495 A	10(422) 2015
M 2015 26481 R	AM 76639	AM 2015 76639 A	7(419) 2015
M 2015 26482 R	AM 77193	AM 2015 77193 A	11(423) 2015
M 2015 26483 R	AM 77573	AM 2015 77573 A	7(419) 2015
M 2015 26484 R	AM 77675	AM 2015 77675 A	12(424) 2015
M 2015 26485 R	AM 77679	AM 2015 77679 A	12(424) 2015
M 2015 26486 R	AM 77851	AM 2015 77851 A	13(425) 2015
M 2015 26487 R	AM 77853	AM 2015 77853 A	13(425) 2015
M 2015 26488 R	AM 77889	AM 2015 77889 A	10(422) 2015
M 2015 26489 R	AM 77898	AM 2015 77898 A	8(420) 2015
M 2015 26490 R	AM 77945	AM 2015 77945 A	12(424) 2015
M 2015 26491 R	AM 77950	AM 2015 77950 A	11(423) 2015
M 2015 26492 R	AM 78160	AM 2015 78160 A	10(422) 2015
M 2015 26493 R	AM 78175	AM 2015 78175 A	8(420) 2015
M 2015 26494 R	AM 78213	AM 2015 78213 A	8(420) 2015

1	2	3	4
M 2015 26495 R	AM 78408	AM 2015 78408 A	8(420) 2015
M 2015 26496 R	AM 78808	AM 2015 78808 A	12(424) 2015
M 2015 26497 R	AM 78809	AM 2015 78809 A	12(424) 2015
M 2015 26498 R	AM 78810	AM 2015 78810 A	12(424) 2015
M 2015 26499 R	AM 78898	AM 2015 78898 A	12(424) 2015
M 2015 26500 R	AM 78981	AM 2015 78981 A	11(423) 2015
M 2015 26501 R	AM 79046	AM 2015 79046 A	12(424) 2015
M 2015 26502 R	AM 79091	AM 2015 79091 A	13(425) 2015
M 2015 26503 R	AM 79192	AM 2015 79192 A	12(424) 2015
M 2015 26504 R	AM 79193	AM 2015 79193 A	12(424) 2015
M 2015 26505 R	AM 79194	AM 2015 79194 A	13(425) 2015
M 2015 26506 R	AM 79198	AM 2015 79198 A	12(424) 2015
M 2015 26507 R	AM 79222	AM 2015 79222 A	13(425) 2015
M 2015 26508 R	AM 79351	AM 2015 79351 A	12(424) 2015
M 2015 26509 R	AM 79414	AM 2015 79414 A	13(425) 2015
M 2015 26510 R	AM 79440	AM 2015 79440 A	13(425) 2015
M 2015 26511 R	AM 79545	AM 2015 79545 A	12(424) 2015
M 2015 26512 R	AM 79653	AM 2015 79653 A	13(425) 2015
M 2015 26513 R	AM 75088	AM 2015 75088 A	10(422) 2015
M 2015 26476 R	AM 83935	-	22(434)2015
M 2015 26477 R	AM 83935	-	22(434)2015
M 2015 26478 R	AM 83935	-	22(433)2015

**CONCORDANCE TABLE OF PUBLICATION NUMBERS
AND APPLICATION NUMBERS**

NUMBER OF PUBLISHED APPLICATION (260)	NUMBER OF APPLICATION (210)	1	2
		1	2
AM 2015 77946 A	AM 77946	AM 2015 79670 A	AM 79670
AM 2015 78392 A	AM 78392	AM 2015 79826 A	AM 79826
AM 2015 78393 A	AM 78393	AM 2015 79890 A	AM 79890
AM 2015 78904 A	AM 78904	AM 2015 79984 A	AM 79984
AM 2015 78953 A	AM 78953	AM 2015 79987 A*	AM 79987
AM 2015 79048 A	AM 79048	AM 2015 80299 A	AM 80299
AM 2015 79100 A	AM 79100	AM 2015 80601 A	AM 80601
AM 2015 79127 A	AM 79127	AM 2015 80604 A	AM 80604
AM 2015 79292 A	AM 79292	AM 2015 80622 A	AM 80622
AM 2015 79636 A	AM 79636	AM 2015 80624 A	AM 80624
AM 2015 79647 A	AM 79647	AM 2015 80626 A	AM 80626
		AM 2015 80711 A	AM 80711
		AM 2015 80882 A	AM 80882
		AM 2015 81242 A	AM 81242
		AM 2015 81243 A	AM 81243
		AM 2015 81333 A	AM 81333

**CONCORDANCE TABLE OF INDEX OF GOODS AND/OR SERVICES
AND APPLICATION NUMBERS**

INDEX OF GOODS AND/OR SERVICES (511)	NUMBER OF PUBLISHED APPLICATIONS (260)	1	2
1	2	31	AM 2015 80299 A
1	AM 2015 81333 A	31	AM 2015 80882 A
2	AM 2015 81333 A	32	AM 2015 80299 A
3	AM 2015 80299 A	32	AM 2015 80601 A
3	AM 2015 81333 A	32	AM 2015 80604 A
4	AM 2015 77946 A	32	AM 2015 80622 A
4	AM 2015 81333 A	32	AM 2015 80624 A
5	AM 2015 79292 A	32	AM 2015 80626 A
5	AM 2015 79890 A	32	AM 2015 80882 A
5	AM 2015 81333 A	33	AM 2015 80299 A
8	AM 2015 78393 A	33	AM 2015 81242 A
9	AM 2015 78953 A	33	AM 2015 81243 A
9	AM 2015 79100 A	34	AM 2015 79127 A
9	AM 2015 81333 A	34	AM 2015 79987 A*
11	AM 2015 81333 A	34	AM 2015 80299 A
21	AM 2015 80299 A	35	AM 2015 79636 A
25	AM 2015 79647 A	35	AM 2015 79826 A
27	AM 2015 81333 A	35	AM 2015 80299 A
29	AM 2015 79984 A	35	AM 2015 80882 A
29	AM 2015 80299 A	35	AM 2015 81333 A
29	AM 2015 80882 A	37	AM 2015 79670 A
30	AM 2015 80299 A	38	AM 2015 81333 A
30	AM 2015 80882 A	41	AM 2015 81333 A
		42	AM 2015 79670 A
		43	AM 2015 78392 A
		43	AM 2015 79048 A
		43	AM 2015 80711 A

**CONCORDANCE TABLE OF INDEX OF GOODS AND/OR SERVICES
AND NUMBERS OF TRADEMARKS REGISTERED ACCORDING
TO THE ACCELERATED PROCEDURE**

INDEX OF GOODS AND/OR SERVICES (511)	NUMBERS OF REGISTERED ACCORDING TO THE ACCELERATED PROCEDURE (111)
33	M 2015 26477 R
33	M 2015 26478 R
41	M 2015 26476 R

OFFICIAL BULLETIN OF THE INDUSTRIAL PROPERTY

22(434)

EDITOR-IN-CHIEF: N. Bebrishvili

EDITORS-TRANSLATORS: E. Gabunia

PROOFREADER: A. Shikhashvili

COMPUTER LAYOUT: M. Ordenidze
K. Svanidze

www.sakpatenti.org.ge

E-mail: info@sakpatenti.org.ge